



IBM zSeries 890

IBM eServer zSeries 890 Overview



Greg Hutchison
Advanced Technical Support
Washington Systems Center

© 2004 IBM Corporation

zSeries 890

Trademarks

The following are trademarks of the International Business Machines Corporation in the United States and/or other countries.

CICS*	IBM eServer	RMF
DB2*	IBM logo*	Sysplex Timer*
Enterprise Storage Server	IMS	VM/ESA*
ESCON*	Multiprise*	VSE/ESA
FICON	OS/390*	WebSphere*
FICON Express	Parallel Sysplex*	z/Architecture
HiperSockets	Performance Toolkit for z/VM	z/OS
HiperSpace	PR/SM	z/VM
IBM*	Resource Link	zSeries

The following are trademarks or registered trademarks of other companies.

- Linux is a registered trademark of Linus Torvalds
- Penguin (Tux) compliments of Larry Ewing
- Java and all Java-related trademarks and logos are trademarks of Sun Microsystems, Inc., in the United States and other countries
- UNIX is a registered trademark of The Open Group in the United States and other countries.
- Microsoft, Windows and Windows NT are registered trademarks of Microsoft Corporation.
- SET and Secure Electronic Transaction are trademarks owned by SET Secure Electronic Transaction LLC.

Notes:

Performance is in Internal Throughput Rate (ITR) ratio based on measurements and projections using standard IBM benchmarks in a controlled environment. The actual throughput that any user will experience will vary depending upon considerations such as the amount of multiprogramming in the user's job stream, the I/O configuration, the storage configuration, and the workload processed. Therefore, no assurance can be given that an individual user will achieve throughput improvements equivalent to the performance ratios stated here.

IBM hardware products are manufactured from new parts, or new and serviceable used parts. Regardless, our warranty terms apply.

All customer examples cited or described in this presentation are presented as illustrations of the manner in which some customers have used IBM products and the results they may have achieved. Actual environmental costs and performance characteristics will vary depending on individual customer configurations and conditions.

This publication was produced in the United States. IBM may not offer the products, services or features discussed in this document in other countries, and the information may be subject to change without notice. Consult your local IBM business contact for information on the product or services available in your area.

All statements regarding IBM's future direction and intent are subject to change or withdrawal without notice, and represent goals and objectives only.

Information about non-IBM products is obtained from the manufacturers of those products or their published announcements. IBM has not tested those products and cannot confirm the performance, compatibility, or any other claims related to non-IBM products. Questions on the capabilities of non-IBM products should be addressed to the suppliers of those products.

Prices subject to change without notice. Contact your IBM representative or Business Partner for the most current pricing in your geography.

© 2004 IBM Corporation

Terminology

▪ APAR	- Authorized Program Analysis Report	▪ CIU	- Customer Initiated Upgrade
▪ ATM	- Asynchronous Transfer Mode	▪ CLK	- Clock
▪ CBP	- Coupling Facility Peer Channel (copper)	▪ CMOS	- Complementary metal oxide semiconductor
▪ CBR	- Coupling Facility Receiver Channel (ICB)	▪ CNC	- ESCON Channel
▪ CBS	- Coupling Facility Sender Channel (ICB)	▪ CP	- Central Processor
▪ CBU	- Capacity Backup	▪ CPACF	- CP Assist for Cryptographic Function
▪ CBY	- ESCON Converter Channel (byte mode)	▪ CTC	- Channel to channel
▪ CEC	- Central Electronics Complex	▪ CU	- Control Unit
▪ CF	- Coupling Facility	▪ DB2	- Database 2
▪ CFCC	- Coupling Facility Control Code	▪ BTU	- British Thermal Unit
▪ CFM	- Cubic Feet per Minute	▪ DCA	- Distributed Converter Assembly
▪ CFP	- Coupling Facility Peer Channel (fiber)	▪ ECKD	- Extended Count Key Data
▪ CFR definition)	- Coupling Facility Receiver Channel (ISC-3)	▪ ESA	- Enterprise System Architecture
▪ CFS	- Coupling Facility Sender Channel (ISC-3)	▪ ESCON	- Enterprise Systems CONNecton
▪ CHPID	- Channel Path Identifier	▪ ETR	- External Time Reference (Sysplex Timer)

Terminology

▪ FCP	- Fibre Channel Protocol	▪ ICC	- Integrated Console Controller
▪ FCTC	- Ficon Channel to Channel	▪ ICB	- Integrated Cluster Bus
▪ FDDI	- Fiber Distributed Data Interface	▪ ICF	- Internal Coupling Facility
▪ FENET	- Fast Ethernet (100 bps)	▪ ICP	- Internal Coupling Peer Channel
▪ FICON	- Fibre CONnection	▪ ICSF	- Integrated Cryptographic Service Facility
▪ FIPS	- Federal Information Processing Std (USA)	▪ IBF	- Internal Battery Feature
▪ FQC	- Fiber Quick Connect (ESCON Trunk)	▪ ICKDSF	- Device Support Facility (software)
▪ G4	- IBM 9672 Generation 4 eServer	▪ IFL	- Integrated Facility for Linux
▪ G5	- IBM 9672 Generation 5 eServer (etc)	▪ IGS	- IBM Global Services
▪ GbE	- Gigabit Ethernet	▪ IMPP	- Installation Manual – Physical Planning
▪ GUI	- Graphical User Interface	▪ IOCP	- Input Output Control Program
▪ HCD	- Hardware Configuration Definition	▪ IPL	- Initial Program Load
▪ HCM	- Hardware Configuration Manager	▪ IQD	- HiperSocket channel type definition
▪ HZ	- Hertz (ISO 1000)	▪ ISC	- InterSystem Coupling
▪ IC	- Internal Coupling	▪ JVM	- Java Virtual Machine

Terminology

▪ KBTU	- 1000 BTU	▪ MPCIPA	- Multipath Channel with IP Assist
▪ KVA	- Kilovolt - Amperes	▪ MSU	- Million Service Units
▪ LAN	- Local Area Network	▪ MTU	- Maximum Transmission Unit
▪ LCSS	- Logical Channel SubSystem	▪ N/C	- No Charge
▪ LIC	- Licensed Internal Code	▪ OAT	- OSA Address Table
▪ LICCC Code	- Licensed Internal Code Configuration	▪ OOCoD	- On/ Off Capacity on Demand
▪ LPAR	- Logically Partitioned mode	▪ OSA	- Open Systems Adapter
▪ LSPR	- Large Systems Performance Reference	▪ OSA-ICC Console Controller	- Open Systems Adapter – Integrated
▪ LX	- Long Wave Fiber (single mode fiber)	▪ OSA/SF	- OSA/Support Facility
▪ MBA	- Memory Bus Adapter	▪ OSC	- Oscillator
▪ MCM	- Multiple Chip Module	▪ PCHID	- Physical Channel Identifier
▪ MCP	- Mode Conditioning Patch	▪ PCI	- Peripheral Component Interconnect
▪ MES	- Miscellaneous Equipment Specification	▪ PCICA	- PCI Cryptographic Accelerator
▪ MIF ID	- Multiple Image Facility Identifier	▪ PCIXCC	- PCI X Cryptographic Coprocessor
▪ MIP	- Millions of Instructions per Second	▪ PKDS	- Private/Public Key Data Set
		▪ PR/SM	- Processor Resource / Systems Manager

Terminology

▪ PTF	- Temporary Program Fix	▪ SW	- Software (programs and operating systems)
▪ PU	- Physical Unit	▪ SX	- Short Wave Fiber (multimode fiber)
▪ QDIO	- Queued Direct Input and Output	▪ TCA	- Total Cost of Acquisition
▪ QoS	- Quality of Service	▪ TDES	- Triple Data Encryption Standard
▪ RPQ	- Request for Price Quotation	▪ TKE	- Trusted Key Entry
▪ SAP	- System Assist Processor	▪ TPF	- Operating System
▪ SC	- Storage Control	▪ TR	- Token Ring
▪ SD	- System Data	▪ TRLE	- Transport Resource List Entry
▪ SHA	- Secure Hash Algorithm	▪ VA	- Volt Amperes
▪ SCSI	- Small Computer System Interface	▪ VM/ESA	- Operating System
▪ SDK	- Software Development Kit	▪ VSE/ESA	- Operating System
▪ SOD	- Statement of Direction	▪ WAN	- Wide Area Network
▪ SSL	- Secure Sockets Layer	▪ zAAP	- zSeries Application Assist Processor
▪ STI	- Self Timed Interconnect	▪ z/OS	- Operating System
▪ STSI	- Store System Information	▪ z/VM	- Operating System

Agenda

- Introduction ←
- Book Structure
- Upgrades
- I/O
- Sysplex Considerations
- Statements of Direction
- Operating Systems
- Cryptography
- Hardware Management Console
- Migration Planning
- Physical Planning
- Reference Material



z890 Positioning

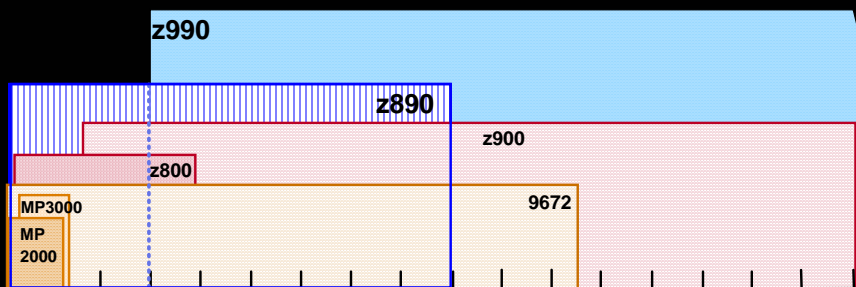

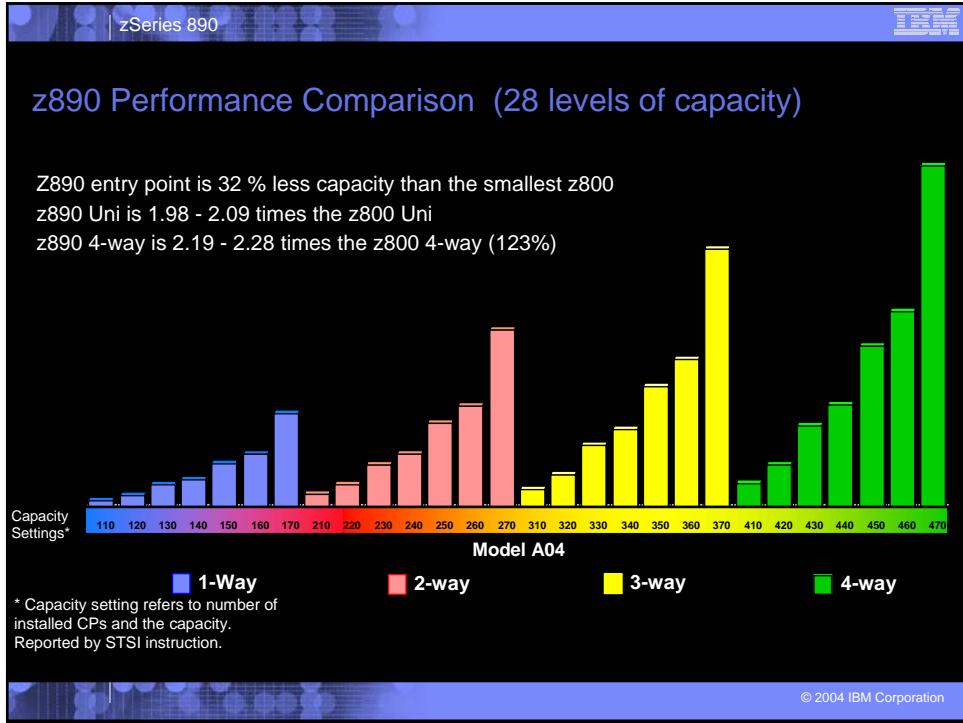

zSeries 890

z890 MSU's

1-Way			2-Way			3-Way			4-Way		
Feature Code	MSU	Capacity Setting	Feature Code	MSU	Capacity Setting	Feature Code	MSU	Capacity Setting	Feature Code	MSU	Capacity Setting
6110	4	110	6210	8	210	6310	11	310	6410	15	410
6120	7	120	6220	13	220	6320	20	320	6420	26	420
6130	13	130	6230	26	230	6330	38	330	6430	49	430
6140	17	140	6240	32	240	6340	47	340	6440	62	440
6150	26	150	6250	50	250	6350	74	350	6450	97	450
6160	32	160	6260	62	260	6360	91	360	6460	119	460
6170	56	170	6270	107	270	6370	158	370	6470	208	470

Note: For MSU values, refer to: ibm.com/servers/eserver/zseries/library/swpriceinfo/
www.ibm.com/support/techdocs/atmastr.nsf/WebIndex/WP100258 (fewer faster engines)

© 2004 IBM Corporation

z890 System Overview



One Frame System

Processor -- 2086 Model A04

- ▶ 1 flexible model
- ▶ 64-bit z/Architecture
- ▶ Up to 5 PUs (in single book)
 - ▶ up to 4 PUs characterizable
- ▶ CMOS9S-SOI Technology
- ▶ SuperScalar
- ▶ Crypto assist for DES and SHA in every PU
- ▶ Capacity Upgrade on Demand
- ▶ On/Off Capacity on Demand
 - For CPs, IFL, ICF, zAAP
- ▶ Capacity Backup (CUB)
- ▶ Customer Initiated Upgrade (CIU)
- ▶ Air cooled
- ▶ Up to 30 LPs active
- ▶ Optional ETR attachment

Memory

- ▶ Maximum system memory 32 GB
 - Minimum system memory 8 GB
- ▶ Card sizes 8, 16, 32 GB

zSeries Application Assist Processor (zAAP or AAP)

- A new zSeries Application Assist Processor for Java (zAAP)
 - ▶ zAAPs are designed exclusively for z/OS and z/OS.e Java code execution
 - ▶ z/OS & z/OS.e JVMs assists with the execution of Java code from CP's to zAAPs

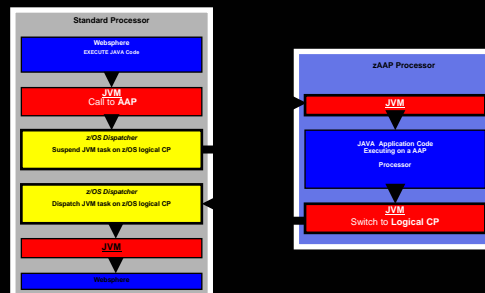

- Provides a true Single Tier integrated application and database server
 - ▶ Potential performance and QoS improvement over typical 2-tier front-end application server TCP/IP connected back-end data server platforms

- The zAAP assists reduce the CP time needed to run WebSphere applications, freeing capacity for additional workloads

zAAP Characteristics

- Orderable by feature code (FC6520), up to one for each CP
- The zAAP assist can run all Java code
- Users can manage the use of CPs such that Java code runs only on a CP, only on a zAAP, or on both, when zAAPs are busy
- Subsystems that will exploit zAAPs include:
 - ▶ WAS 5.1
 - ▶ CICS/TS 2.3
 - ▶ DB2 V8
 - ▶ IMS V8
 - ▶ WebSphere WBI for z/OS
- Required Software
 - ▶ z/OS 1.6 and z/OS.e 1.6
 - ▶ JVM 1.4.1
 - ▶ SDK 1.4.1
 - ▶ IBM, Vendor and Customer Java

CP's + zAAP's

0-way	1-way	2-way	3-way	4-way
-----	-----	-----	-----	-----
0+0	1+0	2+0	3+0	4+0
	1+1	2+1	3+1	
		2+2		

z/OS Dispatcher Options for zAAP - IEAOPTxx

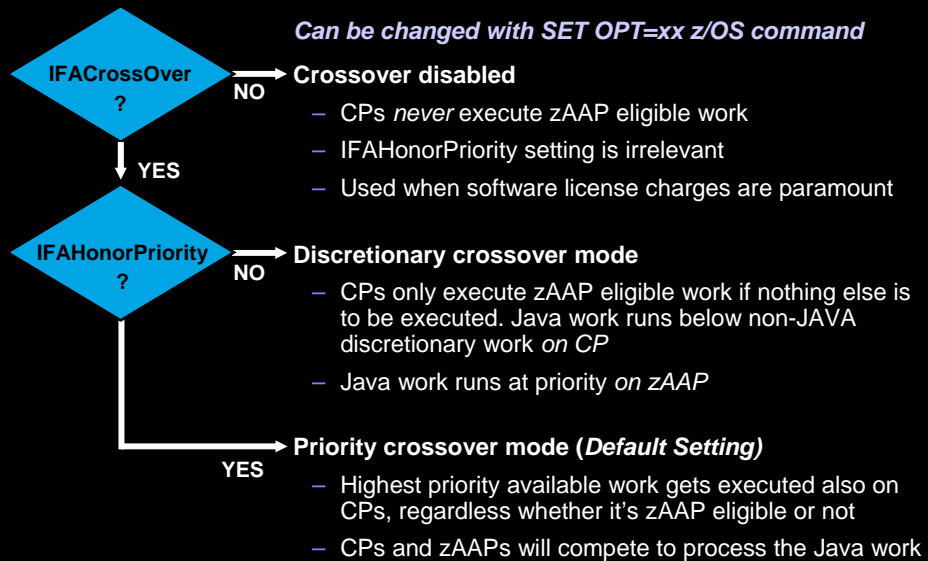

zSeries 890

z890 ESA/390 Partition for z/OS - zAAP support

Logical processor assignment

- Dedicated central processors
- Dedicated central processors and integrated facility for applications
- Not dedicated central processors
- Not dedicated central processors and integrated facility for applications

Not dedicated central processor details

Initial processing weight 1 to 999 Initial capping

Enable WorkLoad Manager

Minimum processing weight

Maximum processing weight

Number of processors - Initial Reserved

Number of integrated facility for application - Initial Reserved

zAAP called "Integrated Facility for Applications" (IFA)

Dedicated

Shared

Weight = CP weight, but share based on ICF + IFL + zAAP

Init and Rsvd zAAPs

© 2004 IBM Corporation

zSeries 890

zAAP Benefits

- **Help improve standard CP and system productivity**
 - zAAPs can reduce CP capacity requirements for JAVA based applications which may free up capacity for other workloads
- **Help simplify and reduce server infrastructures and improve operational efficiencies**
 - Help reduce hardware/network latency as might be seen in distributed web application environments
 - Integrate web applications with mission critical database workloads
- **zAAPs may be able to deliver significant TCA savings**
 - Reduced need for networking infrastructure
 - Low acquisition cost and operating cost (\$125K per zAAP)
 - No effect on software MSU costs
 - No additional IBM software charges

© 2004 IBM Corporation

zAAP Projection Tool

- "zAAP Projection Tool for Java 2 Technology Edition, SDK1.3.1 Users"
- URLs:
 - www6.software.ibm.com/dl/zosjava2/zosjava2-p
 - ibm.com/servers/eserver/zseries/software/java/
- Referred to in:
 - z/OS R6 Introduction and Release Guide
 - R6 Hot Topics
- White Paper:
 - <http://www.ibm.com/support/techdocs/atmsastr.nsf/WebIndex/WP100417>

zAAP Performance White Paper

Title: z/OS Performance: Capacity Planning Considerations for zAAP Processors
<http://www.ibm.com/support/techdocs/atmsastr.nsf/WebIndex/WP100417>

Provide several alternatives to estimate the potential to exploit the zAAP

1. The first portion of the paper will show the results of measurements done inside of IBM with various Java based workloads. These results can be used to estimate the typical ratios of Java to non-Java processor consumption for different workload types.
2. The next section of the paper will explain a technique which can be used for workloads currently in the development phase. These workloads are typically run for short periods of time to allow measurements to be made.
3. The final section of the paper will explain a technique which can be used for workloads currently running in a production environment. These are workloads which run for extended periods of time, often in a 24 by 7 environment.

z890 System Overview

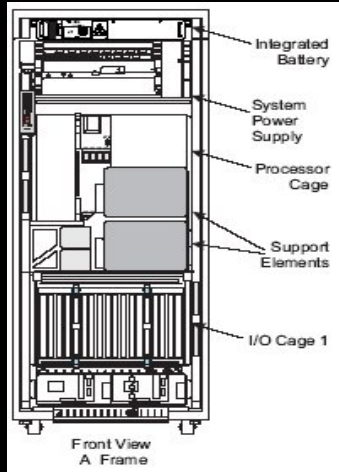

I/O

- ▶ 64-bit Architecture (42/48-bit I/O addressing in hardware)
- ▶ Up to 8 x 2 GB/s Self-Timed Interconnects (STIs)
 - 7 I/O Domains plus 1 STI for ICB-3/ICB-4
- ▶ Up to 2 Logical Channel SubSystems (LCSS)
 - Up to 256 channels per LCSS, 512 total
 - Spanning allowed between LCSS's
 - Dynamic I/O support for 2 LCSS's
- ▶ Up to 40 OSA-Express or OSA-Express2 network connectors
 - 24 on Capacity Setting 110
 - Checksum Offload in hardware
 - Intrusion Detection
 - OSA-Integrated Console Controller (ICC)
- ▶ **Up to 80 FICON™ Express2 Channels**
 - 64 on Capacity Setting 110
- ▶ SCSI over Fibre Channel (FCP for Linux, VM, z/VS)
 - IPL from FCP disk for Linux and VM SA dump
- ▶ Up to 16 HiperSockets
- ▶ Crypto function
 - CPACF in every PU
 - PCICA
 - PCIXCC
 - Crypto Express2
 - TKE 4.2
 - No CHPID numbers required
- ▶ Parallel Sysplex®
 - ICB-4 (2 GB/s), ICB-3, ISC-3, IC, CF Duplexing



z890 Channel Subsystem

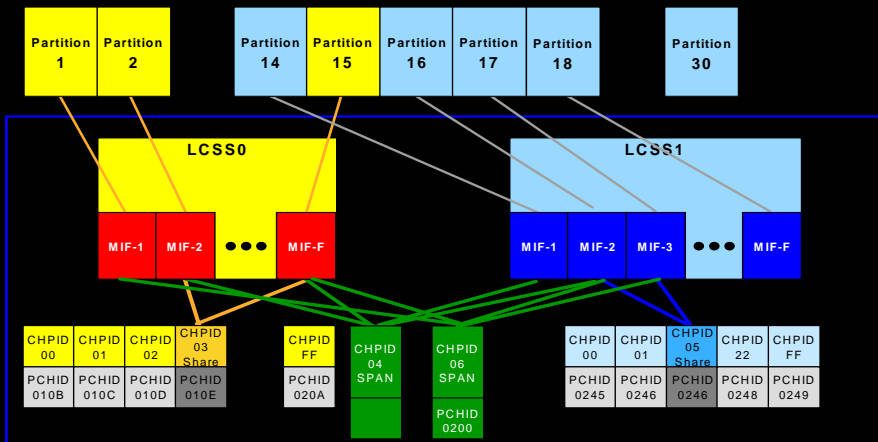

256 channels per logical channel subsystem

Channel Maximums

	Z890 (6110)	Z890	Z800	Z990
LPARs	15	30	15	20
I/O Slots	16	28	16	34
LCSS	2	2	1	4
Channels	256	512	256	1024
ESCON	240	420	240	1024
FICON Express	32	40	32	120
FICON Express2	64	80	0	0
OSA-Express	24 ports	40 ports	24 ports	48 ports
OSA-Express2	24 ports	40 ports	0	48 ports
HiperSockets	16	16	4	16
ISC-3	48	48	24	48
ICB-3	16	16	5 (6 on OCF)	16
ICB-4	8	8	0	16
IC	32	32	32	32
OSA-E ATM	0	0	24	0

↑ Capacity Setting 110

Agenda

- Introduction
- **Book Structure** ←
- Upgrades
- I/O
- Sysplex Considerations
- Statements of Direction
- Operating Systems
- Cryptography
- Hardware Management Console
- Migration Planning
- Physical Planning
- Reference Material



What does z890 look like?

- Always one frame
 - ▶ Slightly shorter than a G5/G6
 - ▶ Slightly taller than z800
 - ▶ Smaller floor space clearance dimensions than a z800
- All new CEC cage
 - ▶ Top of the Frame
 - ▶ One processor book
- I/O Cage
 - ▶ One, same as z990 Cargo cage
 - 28 I/O Slots for zSeries I/O cards
 - ▶ No longer available
 - z900 style "compatibility" cage
 - Older S/390 9672 I/O cards
 - ICB-2, OSA-2 FDDI
 - OSA-Express ATM 155

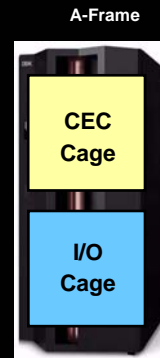

z890 CEC Cage

- Single book
- Multichip module with 5 processor units
- One memory card - 8, 16 or 32 GB each (8, 16, 24, 32 offered)
- Channel buses - 2.0 GB/sec
- 8 Self-Timed Interconnect (STI) ports
- 2 Memory Bus Adapters (MBA)

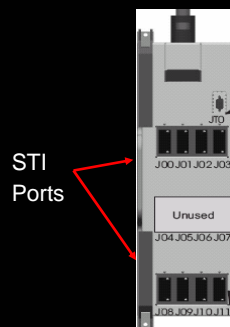
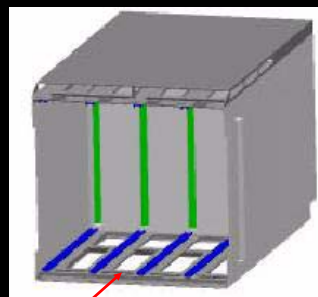

Book (side view)

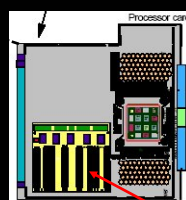

MCM

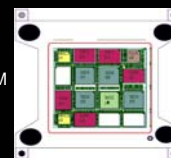

z890 5-way MCM

- Advanced 93mm x 93mm MCM
 - ▶ 100 Glass Ceramic layers
 - ▶ 16 chip sites, 13 in use
 - ▶ 0.4 km of internal wire
 - ▶ 46% smaller than IBM zSeries 900 (z900)
 - ▶ 23% more I/O connections
 - ▶ 133% I/O density improvement
 - ▶ 5,184 LGA connectors vs 1,849 pins for z800

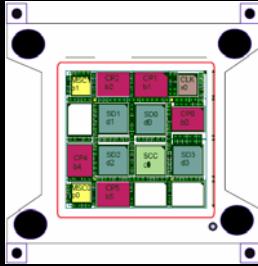

Note: MBA not on MCM

- CMOS 9S-SOI chip Technology
 - ▶ PU, SC, SD and MSC chips
 - ▶ Copper interconnections, 8 copper layers
 - ▶ 5 PU chips/MCM
 - 14.1 mm x 18.9 mm
 - 122 million transistors/PU
 - L1 cache/PU
 - 256 KB I-cache
 - 256 KB D-cache
 - 1.0 ns Cycle Time
 - ▶ 4 System Data (SD) cache chips/MCM
 - 17.5 mm x 17.5mm
 - World's densest chip
 - L2 cache
 - 521 million transistors/chip
 - 32 MB
 - ▶ One Storage Control (SC) chip
 - 17.3mm x 17.3mm
 - 98 million transistors
 - Densest I/Os
 - 3692 Power Signal I/Os
 - L2 access to/from MBAs (off MCM)
 - ▶ Two Storage Control (MSC) chips
 - Memory cards (L3) interface to L2
 - ▶ One Clock (CLK) chip - CMOS 8S
 - Clock and ETR Receiver

Agenda

- Introduction
- Book Structure
- **Upgrades** ←
- I/O
- Sysplex Considerations
- Statements of Direction
- Operating Systems
- Cryptography
- Hardware Management Console
- Migration Planning
- Physical Planning
- Reference Material



z890 Upgrades/Downgrades (any to any)

1-Way		2-Way		3-Way		4-Way	
Feature Code	Capacity Setting	Feature Code	Capacity Setting	Feature Code	Capacity Setting	Feature Code	Capacity Setting
6110	110	6210	210	6310	310	6410	410
6120	120	6220	220	6320	320	6420	420
6130	130	6230	230	6330	330	6430	430
6140	140	6240	240	6340	340	6440	440
6150	150	6250	250	6350	350	6450	450
6160	160	6260	260	6360	360	6460	460
6170	170	6270	270	6370	370	6470	470

- Any horizontal upgrade is concurrent (i.e. 6130 to 6230)
- Others (vertical or diagonal) require an IPL (except z/VM)
- OA07510 (z/OS 1.4 +) permits all upgrades as concurrent
- z/VM 5.1 concurrent upgrades for z/OS 1.4+ and Linux guests
- Capacity setting is reported by the STSI instruction
- 6070 = zero CP's (ICF's or IFL's only)

z890 Upgrades/Downgrades (any to any)

1-Way		2-Way		3-Way		4-Way	
Feature Code	Capacity Setting	Feature Code	Capacity Setting	Feature Code	Capacity Setting	Feature Code	Capacity Setting
6110	110	6210	210	6310	310	6410	410
6120	120	6220	220	6320	320	6420	420
6130	130	6230	230	6330	330	6430	430
6140	140	6240	240	6340	340	6440	440
6150	150	6250	250	6350	350	6450	450
6160	160	6260	260	6360	360	6460	460
6170	170	6270	270	6370	370	6470	470

- Vertical upgrades may require an IPL (except z/VM)
- OA07510 (z/OS 1.4 +) permits all upgrades as concurrent
- z/VM 5.1 concurrent upgrades for z/OS 1.4+ and Linux guests

z890 Upgrades/Downgrades (any to any)

1-Way		2-Way		3-Way		4-Way	
Feature Code	Capacity Setting	Feature Code	Capacity Setting	Feature Code	Capacity Setting	Feature Code	Capacity Setting
6110	110	6210	210	6310	310	6410	410
6120	120	6220	220	6320	320	6420	420
6130	130	6230	230	6330	330	6430	430
6140	140	6240	240	6340	340	6440	440
6150	150	6250	250	6350	350	6450	450
6160	160	6260	260	6360	360	6460	460
6170	170	6270	270	6370	370	6470	470

- ▀ Diagonal upgrades may require an IPL (except z/VM)
- ▀ OA07510 (z/OS 1.4 +) permits all upgrades as concurrent
- ▀ z/VM 5.1 concurrent upgrades for z/OS 1.4+ and Linux guests

z890 Upgrades/Downgrades (any to any)

1-Way		2-Way		3-Way		4-Way	
Feature Code	Capacity Setting	Feature Code	Capacity Setting	Feature Code	Capacity Setting	Feature Code	Capacity Setting
6110	110	6210	210	6310	310	6410	410
6120	120	6220	220	6320	320	6420	420
6130	130	6230	230	6330	330	6430	430
6140	140	6240	240	6340	340	6440	440
6150	150	6250	250	6350	350	6450	450
6160	160	6260	260	6360	360	6460	460
6170	170	6270	270	6370	370	6470	470

- ▀ Any horizontal upgrade is concurrent (i.e. 6140 to 6240)
- ▀ Others (vertical or diagonal) require an IPL (except z/VM)
- ▀ OA07510 (z/OS 1.4 +) permits all upgrades as concurrent
- ▀ z/VM 5.1 concurrent upgrades for z/OS 1.4+ and Linux guests

z890 Upgrades/Downgrades (any to any)

1-Way		2-Way		3-Way		4-Way	
Feature Code	Capacity Setting	Feature Code	Capacity Setting	Feature Code	Capacity Setting	Feature Code	Capacity Setting
6110	110	6210	210	6310	310	6410	410
6120	120	6220	220	6320	320	6420	420
6130	130	6230	230	6330	330	6430	430
6140	140	6240	240	6340	340	6440	440
6150	150	6250	250	6350	350	6450	450
6160	160	6260	260	6360	360	6460	460
6170	170	6270	270	6370	370	6470	470

z890 Configuration Rules

- 5 PU's
 - ▶ Total (CP, SAP, ICF, IFL, zAAP, spares, On/Off CoD or CBU) activated cannot exceed 5
- Mandatory
 - ▶ 1 SAP and one other PU type - CP, ICF, IFL
 - ▶ Can be all CP, ICF or IFL, but not all zAAPs
 - A zAAP requires a "partner CP" (1:1) ratio
 - z890 maximum zAAP = 2
- Unconfigured PU's are spares
- Capacity Setting "xyz" for software pricing
 - ▶ Preceded by a 6 (feature code) - 6xyz
 - ▶ X indicates number of CPs (6270)
 - ▶ Y indicates capacity setting (6270)
 - ▶ Z indicates (6270, 6271, 6272)
 - 0 = CP
 - 1 = On/Off CoD Use Day
 - 2 = Capacity Marker
 - ▶ 6070 for no CPs (ICFs, IFLs only)

1-Way		2-Way		3-Way		4-Way	
Feature Code	Capacity Setting	Feature Code	Capacity Setting	Feature Code	Capacity Setting	Feature Code	Capacity Setting
6110	110	6210	210	6310	310	6410	410
6120	120	6220	220	6320	320	6420	420
6130	130	6230	230	6330	330	6430	430
6140	140	6240	240	6340	340	6440	440
6150	150	6250	250	6350	350	6450	450
6160	160	6260	260	6360	360	6460	460
6170	170	6270	270	6370	370	6470	470

CAPACITY MARKER of “high watermark”

1-Way		2-Way		3-Way		4-Way	
Feature Code	Capacity Setting	Feature Code	Capacity Setting	Feature Code	Capacity Setting	Feature Code	Capacity Setting
6110	110	6210	210	6310	310	6410	410
6120	120	6220	220	6320	320	6420	420
6130	130	6232	230	6330	330	6430	430
6140	140	6240	240	6340	340	6440	440
6150	150	6250	250	6350	350	6450	450
6160	160	6260	260	6360	360	6460	460
6170	170	6270	270	6370	370	6470	470

FC6232 reflects the downgrade history

If upgraded later to a CP =< FC6230 again, only a service charge is required.

Conversions are not supported.

Z800 to z890 Upgrades – Frame roll MES



Models

0X2, 0A2, 002, 003, 004

To ANY
Capacity
Setting



Model A04

E-Config will default to the next closest Capacity setting model, but the user may change to any capacity setting desired.

The z800 serial number is preserved on the z890

z800 to z890 Features that carry forward on upgrade

- OSA-Express
 - ▶ All except ATM 155
- FICON Express
- ESCON
- ICB-3
- FC0218, ISC-3 Daughter card
- RPQ 8P2197 ISC-3 Daughter card (10-20 km)
- PCICA
- TKE 3.x for legacy control only
 - ▶ If Crypto Express2 is ordered, TKE must be updated with TKE 4.2
 - Could be a multi-step upgrade depending on level of 3.x
- TKE 4.0 (for legacy)
 - ▶ If Crypto Express2 is ordered, TKE must be updated with TKE 4.2
- TKE features (Token Ring/Ethernet adapters)
- HMC's
 - ▶ FC0073
 - ▶ FC0074
 - ▶ FC0075
- FC0089 Ethernet Hub for HMC network
- On/Off CoD if applicable

z800 to z890 to z990 Upgrades

- No upgrade from any IBM S/390® 9672, Multiprise or IBM @server zSeries 900 (z900)

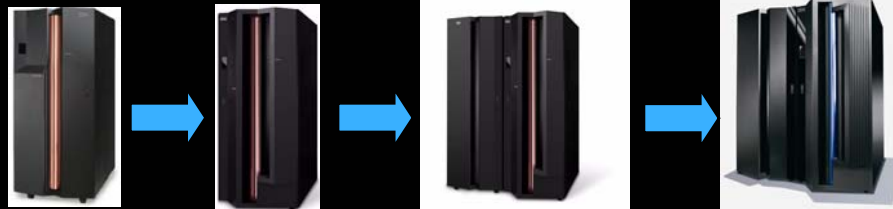

z800

- ▶ Model 0X2
- ▶ Model 0A2
- ▶ Model 002
- ▶ Model 003
- ▶ Model 004

z890

- ▶ starting with capacity setting of...
- 170 (1-way)
- 250 (2-way)
- 330 (3-way)
- 430 (4-way)
- 070 (0-way) to A08 (0-way)

z990

- ▶ Model A08
- ▶ 0 to 8-way

System z9 (z9-109)

z890 Memory Planning

- Memory scrubbing
- Redundant memory throughout to minimize memory outages.
- No spare DIMMs. Memory card replacement requires an outage
- HSA is LARGE (1.0 to 2.0 GB)
 - FIX
 - MCL F35031.029
 - MCL F35031.032
 - 768 MB to 1897 MB

Memory Cards	PU's	Card Feature Code	LICC enabled feature code	Memory Size	Memory Cards
8 GB	1-4	FC2008	FC3102	8 GB	1
16 GB	1-4	FC2016	FC3104	16 GB	1
32 GB	1-4	FC2032	FC3106	24 GB	1
32 GB	1-4	FC2032	FC3108	32 GB	1

z890 Upgrade Options

- On/Off Capacity on Demand - Temporary upgrade (FC9898 & FC9896)
 - Nondisruptive temporary addition of CPs, IFLs, ICFs and zAAPs
 - "Right to use" feature - Orderable as MES or with new build to initiate contract and administrative setup
 - Customer orders and installs upgrade via Resource Link and IBM RSF
 - Nondisruptive removal when capacity is no longer wanted
 - **OCTOBER 29, 2004**
 - On/Off CoD TEST up to 24 hours with NO CHARGE from IBM
 - Order can remain on RETAIN for an extended period (was 30 days)
 - Currently, no maintenance charges are incurred, but plans are in place to add Maintenance charges in the future
- CIU – Customer Initiated Upgrade - Express - Permanent upgrade (FC9898)
 - Customer capability to order and install permanent upgrade
 - Any LICCC enabled engine
 - Memory increment from 24GB to 32GB
 - CIU feature - MES ordered to initiate contract and administrative setup
 - Customer orders and installs upgrade via Resource Link and IBM RSF
- CBU – Capacity Backup - Temporary emergency capacity upgrade**
 - Nondisruptive temporary addition of CPs ONLY in an emergency situation
 - Not applicable to zAAPs, IFLs, ICFs
 - CBU contract required to order CBU features and CBU LIC CC
 - Customer activates upgrade for test or temporary emergency
 - Nondisruptive downgrade after test or recovery completed
 - Five CBU ten day tests

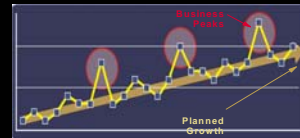

Free 24 hour test



"Right to Use" features for On/OFF CoD + CBU can be loaded simultaneously

* For z890 CPs only for horizontal upgrade. OS may require IPL for vertical or diagonal upgrades (see APAR OA07510)

** For z890 - To FULL size engines only

On/Off Capacity on Demand

From	To
110	120, 210
120	130, 210, 220, 310
130	140, 150, 220, 230, 320, 410, 420
140	150, 160, 230, 240, 320, 420
150	160, 240, 250, 330, 340, 420, 430
160	170, 240, 250, 260, 330, 340, 430, 440
170	260, 270, 350, 360, 440, 450
210	220, 310, 410
220	230, 320, 410, 420
230	240, 250, 330, 340, 420, 430
240	250, 260, 330, 340, 430, 440
250	260, 350, 360, 440, 450
260	270, 350, 360, 440, 450, 460
270	370, 460, 470

From	To
310	320, 410
320	330, 420
330	340, 350, 430, 440
340	350, 360, 430, 440
350	360, 450, 460
360	370, 450, 460
370	470
410	420
420	430
430	440, 450
440	450, 460
450	460
460	470
470	n/a

Capacity Back Up

From	To
110	270, 370, 470
120	270, 370, 470
130	270, 370, 470
140	270, 370, 470
150	270, 370, 470
160	270, 370, 470
170	270, 370, 470
210	370, 470
220	370, 470
230	370, 470
240	370, 470
250	370, 470
260	370, 470
270	370, 470

From	To
310	470
320	470
330	470
340	470
350	470
360	470
370	470
410	n/a
420	n/a
430	n/a
440	n/a
450	n/a
460	n/a
470	n/a

Agenda

- Introduction
- Book Structure
- Upgrades
- I/O 
- Sysplex Considerations
- Statements of Direction
- Operating Systems
- Cryptography
- Hardware Management Console
- Migration Planning
- Physical Planning
- Reference Material

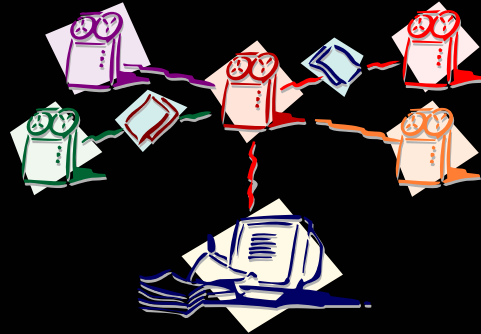

DS6000 Highlights



ESS reliability and host attachment features now available in an incredibly small, modular, affordable package

- **DS6000**
 - 3U package for controllers and disk expansion units
 - Open systems and mainframe support
 - Advanced functions interoperate with DS8000, ESS
 - High storage density footprint
 - 16 drives per 3U package, including controller
 - Up to 13 expansion units
 - Scalable to 224 Disk Drives; 67.2TB
- **Differentiators**
 - zSeries and iSeries native attachment
 - Including Parallel Access Volumes support
 - Same advanced software features as DS8000, ESS 800, ESS 750
 - High availability features not generally found in midrange storage products



www.storage.ibm.com

zSeries 16 port ESCON Feature

- **High density package**
 - Carry forward from z800
 - 16-port feature (FC 2323)
 - Ordering increment, four channels (FC 2324)
 - At least one spare channel port per card
 - Active ports - LIC CC controlled
 - Active channels balanced across all installed features
 - After the first pair, ESCON features are installed in increments of one

- **Small form factor MTRJ connector**
 - 62.5 micron multimode fiber
 - Conversion kit available from IGS for existing ESCON duplex fiber infrastructure

- **Fiber Quick Connect (FQC)**
 - Factory installation of direct-attach fiber harness
 - Supports all installed ESCON features
 - New builds or conversions to z890
 - Enables attachment to fiber trunking

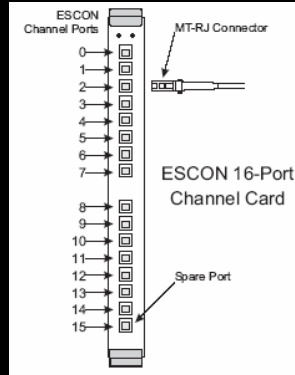

Number of Channels	Cards
4 - 28	2
32 - 44	3
48 - 60	4
...	...
244 - 268	18
...	...
408 - 420	28

Number of Channels	Cards
4 - 28	2
32 - 44	3
48 - 60	4
...	...
228 - 240	16

Note: ESCON Director 9032-005 withdrawn from marketing December 31, 2004

Capacity Setting 110

zSeries FICON Express

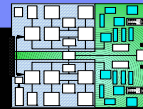

- **FICON Express LX (long wavelength) - FC 2319**
 - Carry forward from z800
 - Supports 9 micron single mode fiber

- **FICON Express SX (short wavelength) - FC 2320**
 - Carry forward from z800
 - Supports 50 or 62.5 micron multimode fiber
 - Not Compatible with FICON Bridge (FICON Bridge is LX only)

- **Port capacity**
 - Maximum of 20 features / 40 ports (32 on Capacity Setting 110)
 - All ports on each feature identically configured (LX or SX)

- **Modes of Operation: applicable to each port**
 - FCV (FICON Bridge Converted); applicable to LX feature only (NOT AVAILABLE ON FICON EXPRESS2)
 - FICON to FICON Bridge on ESCON Director Model 5
 - FC (Fibre Channel)
 - Native FICON
 - FICON Channel-To-Channel
 - FCP (Fibre Channel Protocol)
 - Support of SCSI devices in Linux, VM, z/VSE environments

- **Bandwidth**
 - 1 or 2 Gbps link data rate
 - Auto-negotiated with device

- **Service Enhancement**
 - Support for FCP Concurrent Patch (z890/z990 only)
 - CNFG ON/OFF - Not required for most LIC changes

- **Improved Performance**
 - Z890/z990 only
 - Data with small blocksizes (4K) could see improvement relative to z800/z900 up to 15 percent

FC 2319 (LX), FC2320 (SX)



FICON EXPRESS2 (January 28, 2005)

New

- 4 channels per feature
- Now up to 80 channels in the same amount of physical space (see following slide)
- Two CHPID types
 - FC - native FICON and CTC
 - FCP - communicating with SCSI devices
- Connectivity options for each channel
 - 1 or 2 Gbps, auto-negotiated
 - Can be shared among LPARs
 - Can be defined as a spanned channel
 - Intermix of FC and FCP in the same director
 - Supports cascading - connecting directors in succession
- Supported connectivity devices
 - Refer to: <http://www.ibm.com/servers/eserver/zseries/connectivity/>

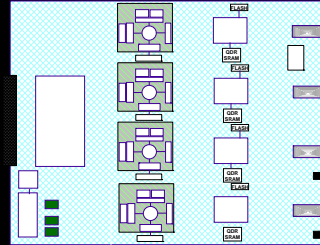

LX = FC3319
SX = FC3320

FICON EXPRESS2 (January 28, 2005)

New

- Connector - LC Duplex
- LX - 9 micron single mode fiber
 - Unrepeated distance - 10 kilometers (6.2 miles)
 - Receiving device must also be LX
- SX - 50 or 62.5 micron multimode fiber
 - Variable distance & speed and fiber type
 - Receiving device must also be SX
- Maximum (all "flavors" of FICON)
 - z990 - 60 features, 240 channels
 - 48 features, Model A08
 - z890 - 20 features, 80 channels
 - 16 features, smallest sub-uni
- 4 channels of LX or SX (no mix)

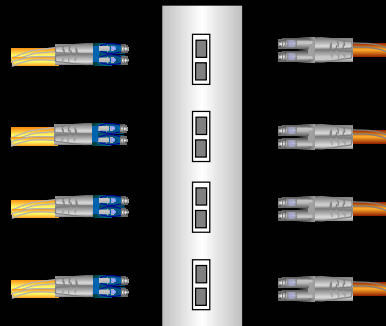

LX

or

SX



FICON EXPRESS2 – Minimum Software

- **FICON EXPRESS2 (CHPID TYPE FC), on z890 and z990 including Channel-To- Channel (CTC)**
 - z/OS and z/OS V1.3, and later (HCD PTF for APAR OA09114)
 - z/VM V3.1, V4.3 and later (may require PTFs), and V5.1
 - VSE/ESA V2.6, and later
 - TPF V4.1 at PUT 16
 - Linux on zSeries
 - The currently available distributions: SUSE SLES 8 and SLES 9, Red Hat RHEL 3, and Conectiva CLEE

- **FICON EXPRESS2 (CHPID TYPE FCP) on z890 and z990 for support of SCSI disks**
 - PTF for APAR VM63610
 - z/VM V5.1 (for z/VM install, IPL, and operation from SCSI disks)
 - z/VM V4.4, and later for
 - Performance Assist for Adapter Interruptions
 - Performance Assist for V=V Guests
 - Guest IPL from SCSI devices
 - z/VM V4.3, and later (for Linux as a guest under z/VM)
 - z/VSE V3.1 (available March 4, 2005)
 - Linux on zSeries
 - The currently available distributions: SUSE SLES 8 and SLES 9, Red Hat RHEL 3, and Conectiva CLEE

- **FCV (CONVERTER) Channels are NOT SUPPORTED on FICON EXPRESS2**
 - If FCV required, use RQP 8P2295 to enable order of FICON Express for transitioning purposes

FICON EXPRESS2 Estimated Performance

I/O per second (k)
4k block size,
100% utilized

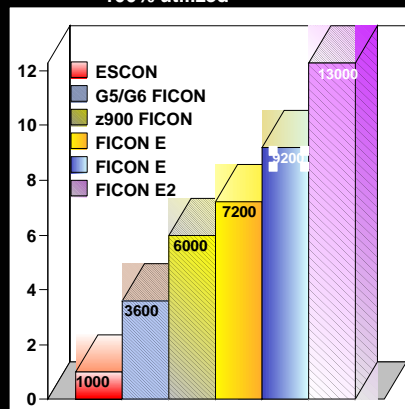

MB/sec throughput (Full Duplex)

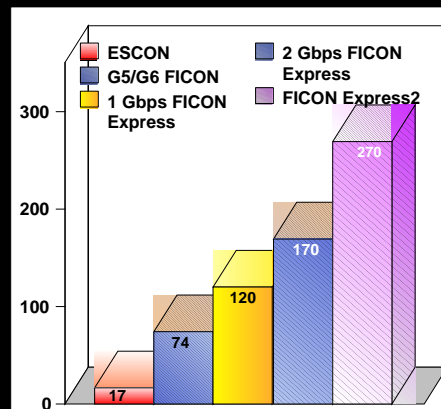

This performance data was measured in a controlled environment on a z990 running an I/O driver program under z/OS 1.6. The actual throughput or performance that any user will experience will vary depending upon considerations such as the amount of multiprogramming in the user's job stream, the I/O configuration, the storage configuration, and the workload processed.

zSeries 890

zSeries SCSI IPL Feature



- **SCSI IPL is available as an optional, no-charge feature FC9904 for all zSeries**
 - FICON Express or FICON Express2 channel is required
- **FCP without SCSI IPL Feature**
 - Allows Linux, VM and z/VSE data to be stored on SCSI or FCP device
 - IPL to SCSI disk results in an error
 - An ECKD device is required
- **FCP with SCSI IPL Feature**
 - Allows Linux, VM and z/VSE data to be stored on SCSI or FCP device
 - Allows Linux, VM and z/VSE to install and load (IPL) on SCSI or FCP disk
 - IPL from both LPAR and/or z/VM guests
 - For z/VM guest IPL, z/VM 4.4 is required.
- **Standalone dump program can be loaded SCSI or FCP disk in order to dump the contents of a logical partition, and the dump data can be written to this same disk (except z/VSE).**
- **Linux LPARs can be started and run completely from SCSI or FCP disk**
 - z/VM continues to require ESCON or FICON attached disk or tape for its own IPL, storing of guest dumps, and other functions
 - Except for z/VM 5.1 (available 09/24/2004)
 - Emulates FBA 9336-20 on SCSI disk

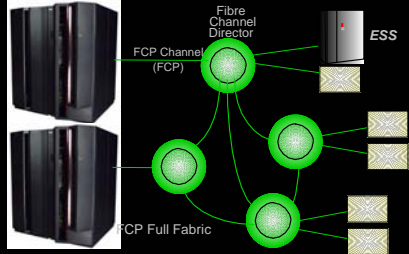

© 2004 IBM Corporation

zSeries 890

FICON Purge Path Extended for native FICON (CHPID type FC)



- **Designed to enhanced FICON problem determination**
- **Error-recovery function is extended**
 - Transfers error-related data and statistics
 - Between the channel and entry switch
 - Control unit and its entry switch
 - To the host z/OS operating system
 - Reported in EREP
- **Exclusive to z990 and z890**
- **Supported by z/OS and z/OS.e V1.4, and later, with PTFs for APAR OA06846 and EREP APAR IR51695**
 - APAR OA06846 requires IPL
- **Requires supporting LIC on control units**
 - For 2105-800 LIC R6G.8B040701
 - For 2105-800 LIC R9Z.8B040805 w/VRMF 2.3.2.118
 - For 2105-F20 LIC R9Z.FB040805 w/VRMF 2.3.2.117
 - DS6000/DS8000 GA

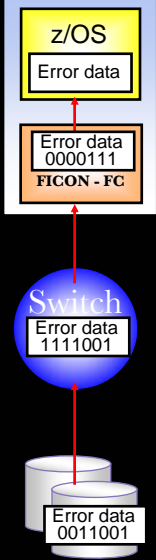

© 2004 IBM Corporation

OSA-Express2



- **Newest member - 10 Gigabit Ethernet LR (long reach)**
 - One port per feature
 - 9 micron single mode fiber, SC Duplex connector
- **New - Gigabit Ethernet features**
 - Gigabit Ethernet LX (Long wavelength)
 - 9 micron single mode fiber, LC Duplex connector
 - Gigabit Ethernet SX (Short wavelength)
 - 50 or 62.5 micron multimode fiber, LC Duplex connector
 - Designed to achieve line speed - 1 Gbps in each direction
- **Support offered by both 10 GbE and GbE:**
 - Queued Direct Input/Output (QDIO) for TCP/IP traffic only
 - Use TN3270 or Enterprise Extender for SNA traffic
 - **Layer 2 support** for flexible and efficient data transfer
 - **640 TCP/IP stacks** for improved virtualization
 - **Large send** for CPU efficiency
 - **Concurrent LIC update** to help minimize network traffic disruption
- **CHPID type for all features and functions listed is OSD**
- **Availability – January 28, 2005**

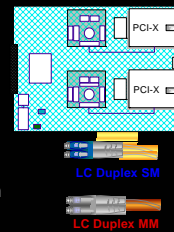
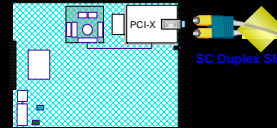

OSA-Express2 Support Requirements

- **OSA-Express2 Gigabit Ethernet requires:**
 - z890 or z990 hardware LIC support for GA2/4 (January 2005)
 - z/OS 1.3 or z/OS.e 1.3 or later
 - z/VM 3.1 or z/VM 4.3 or later with service
 - z/VSE 3.1 (planned March 4, 2004) and VSE/ESA™ 2.6 with service or later
 - TPF 4.1 PUT13 with service for APAR PJ27333
 - Linux on zSeries with Gigabit Ethernet support:
 - SUSE LINUX SLES 8 or 9, Red Hat RHEL 3, Turbolinux TLES 8 or Conectiva CLEE
 - See the 2084DEVICE or 2086DEVICE PSP for any additional service required
- **OSA-Express2 10 Gigabit Ethernet requires:**
 - z890 or z990 hardware LIC support for GA2/4 (January 2005)
 - z/OS 1.3 or z/OS.e 1.3 or later
 - For Checksum Offload, z/OS or z/OS.e 1.5 or later
 - z/VM 3.1 or z/VM 4.3 or later with service (January 2005)
 - z/VSE 3.1 and VSE/ESA 2.6 or later with service
 - TPF 4.1 PUT13 with service for APARs PJ27333 and PJ29930
 - Linux on zSeries with code IBM plans to deliver as Open Source in early 2005
 - See the 2084DEVICE or 2086DEVICE PSP for any additional service required
- **For CHPID Mapping (optional), updated CHPID Mapping Tool from Resource Link**

OSA-Express2 & OSA-Express features

- **Up to 40 network connections - z890**
 - 24 on z890 capacity setting 110
- **Choose from 5 features**
 - OSA-Express2 10 GbE, GbE LX and SX
 - 10/100/1000 mbps
 - Same Cat 5 cable as Fast Ethernet
 - OSA ICC support
 - OSA-Express 1000BASE-T Ethernet
 - 10/100/1000 mbps
 - Same Cat 5 cable as Fast Ethernet
 - OSA ICC support
 - OSA-Express Token-Ring (4/16/100 Mbps)
 - Cat 5 copper cable
- **Modes of Operation for 1000BASE-T Ethernet, Token-Ring**
 - QDIO = TCP/IP traffic only
 - TN3270 or Enterprise Extender for SNA traffic
 - Non-QDIO = TCP/IP and/or SNA/APPN®/HPR
 - OSA-ICC for 1000BASE-T only
- **SOD - z990/z890 are the last zSeries servers to support Token-Ring OSA - new build, upgrade, MES, or carry forward**

10 Gigabit Ethernet Feature 3368 ①

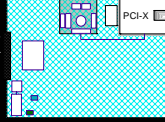

Gigabit Ethernet Features 3364 (LX), 3365 (SX) ② ③

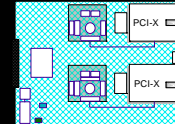

Ethernet (1000BASE-T) Feature 1366

④

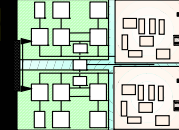

Token Ring Feature 2367

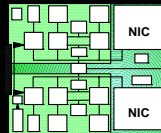

⑤

OSA-Express2 – Third Generation OSA-Express

35% increase >
from the second generation

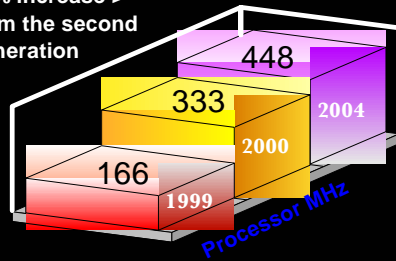

Third
Second
First

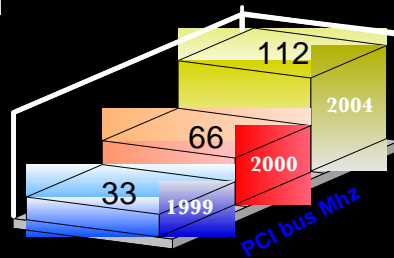

70% increase
from the second generation

- OSA-Express2 is the **3rd generation** of Ethernet technology to deliver the throughput to help satisfy bandwidth-hungry applications
- OSA-Express2 GbE is designed to achieve line speed - 1 Gbps in each direction



OSA-Express2 Large Send Support

- OSA-Express2 (GbE and 10 GbE) (January 28, 2005)
- Segmentation of IP packets done by OSA NIC, not IP stack
 - Offloads the TCP segmentation processing from host TCP/IP stack
 - Host code path length reduced
 - Sends 64 KB blocks to OSA
- Processing performed by OSA NIC
 - TCP/IP checksum processing
 - TCP packet processing
 - Sends out 1.5 KB packets (1492 byte)
- QDIO mode only (CHPID type OSD)
 - For outbound traffic only
 - For IPv4, IPv6
 - For unicast datagrams
- Supported by
 - Linux on zSeries
 - SUSE as part of SLES 9 SP2 (service pack) Available July 7, 2005
 - z/OS Communications Server with z/OS or z/OS.e 1.7 (1.6 with PTF) for IPv4 traffic only
 - z/OS 1.6 APARS PK02490, OA11148

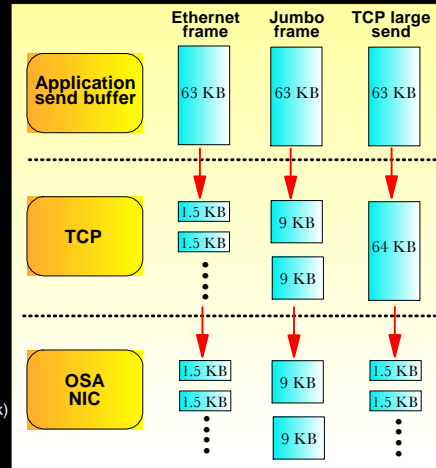

Link layer transport for protocol-independent data transfer

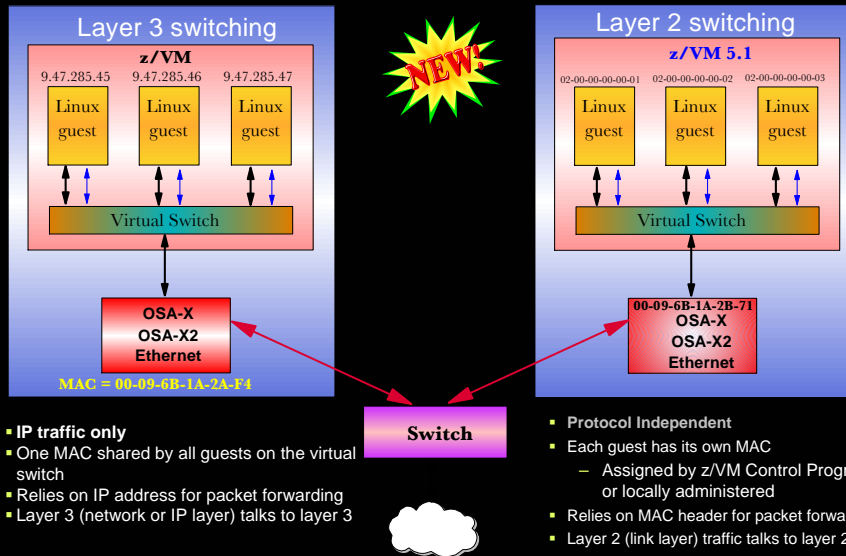

- IP traffic only
- One MAC shared by all guests on the virtual switch
- Relies on IP address for packet forwarding
- Layer 3 (network or IP layer) talks to layer 3

- Protocol Independent
- Each guest has its own MAC
 - Assigned by z/VM Control Program or locally administered
- Relies on MAC header for packet forwarding
- Layer 2 (link layer) traffic talks to layer 2

OSA-Express2 and OSA-Express Layer 2 Support

Function and Potential Benefits

- Provides protocol independence for network traffic
 - IPX, NetBios, SNA, AppleTalk, Decnet, IPv4, IPv6
- May facilitate server consolidation onto z990 and z890
- May reduce CPU utilization for router images/LPAR/guests
- May reduce network configuration complexity



Support and Requirements

- Requires z890/990 hardware LIC support for GA2/4
 - z890/990 OSA-Express Ethernet (October 29, 2004)
 - All Ethernet features EXCEPT Fast Ethernet (FC #2366)
 - All z890/990 OSA-Express2 Ethernet (January 28, 2005)
- Requires z/VM 5.1
 - OSA-Express: APAR VM63538 (December 3, 2004)
 - OSA-Express2: With additional service (January 28, 2005)
- Requires Linux with code IBM plans for Open Source delivery in:
 - October 2004 for kernel 2.4
 - Early 2005 for kernel 2.6
- See 2084DEVICE or 2086DEVICE PSP for any additional service required

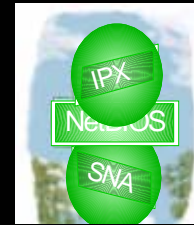

OSA-Express Stack Utilization Improvement

Function and Potential Benefits

- OSA-Express features support 160 TCP/IP stacks. Previously, to use all those stacks, the CHPID had to be shared by multiple logical partitions (LPARs). There was a restriction (only allowing a single control unit definition per CHPID) that limited the number of stacks to 84 per LPAR. That restriction is lifted. Now, a single LPAR can contain all 160 stacks offered by OSA-Express.
- Provides flexibility for OSA-Express configuration, especially with z/VM
- Note: OSA-Express2 supports 640 stacks per LPAR.



Support and Requirements

- Requires z890/990 hardware LIC support for GA 2/4 (October 29, 2004)
- OSA-Express features Gigabit Ethernet (any), 1000Base-T Ethernet, Fast Ethernet, or Token-Ring configured as OSD (TCP/IP only)
- Requires z/OS and z/OS.e 1.6 with service for HCD APAR OA03689
- z/VM 3.1, 4.3 or later with service for APARs VM63524 and PQ91421 (January 28, 2005)
- z/VSE 3.1
- See 2084DEVICE or 2086DEVICE PSP for any additional service required
- Linux on zSeries current distributions:
 - SUSE SLES 8 or 9, Red Hat RHEL 3, or Conectiva CLEE

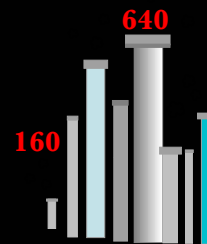

OSA-Integrated Console Controller (OSA-ICC)

- Console Controller for z990 and z890
 - System Console (IPL) and operations support for multiple LPARs
 - 120 Sessions per port (2 ports per feature)
 - **Exclusive to OSA-Express 1000BASE-T Ethernet**
- Minimum software:
 - z/OS V1.3, z/VM V4.4, VSE/ESA™ V2.6, TPF 4.1
- Supports Ethernet-attached TN3270E emulated sessions
- Can coexist in configurations using prior IBM 2074 models and older 3174 controllers

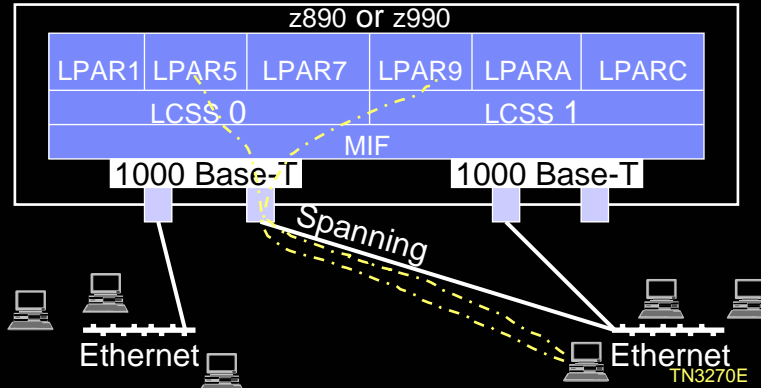

© 2004 IBM Corporation

OSA-ICC Resources

The image shows three screenshots related to OSA-ICC resources:

- LPAR Work Area:** A screenshot of the LPAR Work Area showing various LPARs (e.g., 8A0, 8B0, 8B1, 8A3, 8A1, 8C8, 8C1, 8C2, 8C3, 8C4, 8C5, 8C6, 8C7, 8C8, 8C9, 8CA, 8CB) and their status (Online, Reserved, Shared).
- SPC Recovery:** A screenshot of the SPC Recovery utility showing options like Start as, Stop as, Reset Normal, Reset Clear, and Load.
- OSA Manual Configuration:** A screenshot of the OSA Manual Configuration utility showing configuration file options (Import source file, Export source file, Edit source file, Validate source file, Disassemble configuration file) and a table of configurations.

Node	State	CCSS	SI	Range	Device	Hardware	LSI	Client's	Session	Type	EMUC	RSMP	RETC
8A0	Online	00	1	0001	2000p1			00	00	00	00	00	00
8A1	Online	00	1	0002	2000p1			00	00	00	00	00	00
8A2	Online	00	1	0003	2000p1			00	00	00	00	00	00
8A3	Online	00	1	0004	2000p1			00	00	00	00	00	00
8A4	Online	00	1	0005	2000p1			00	00	00	00	00	00
8A5	Online	00	1	0006	2000p1			00	00	00	00	00	00
8A6	Online	00	1	0007	2000p1			00	00	00	00	00	00
8A7	Online	00	1	0008	2000p1			00	00	00	00	00	00
8A8	Online	00	1	0009	2000p1			00	00	00	00	00	00
8A9	Online	00	1	0010	2000p1			00	00	00	00	00	00
8B0	Online	00	2	2000	2000p1			00	00	00	00	00	00
8B1	Online	00	2	2001	2000p1			00	00	00	00	00	00
8B2	Online	00	2	2002	2000p1			00	00	00	00	00	00
8B3	Online	00	2	2003	2000p1			00	00	00	00	00	00
8B4	Online	00	2	2004	2000p1			00	00	00	00	00	00
8B5	Online	00	2	2005	2000p1			00	00	00	00	00	00
8B6	Online	00	2	2006	2000p1			00	00	00	00	00	00
8B7	Online	00	2	2007	2000p1			00	00	00	00	00	00
8B8	Online	00	2	2008	2000p1			00	00	00	00	00	00
8B9	Online	00	2	2009	2000p1			00	00	00	00	00	00
8C0	Online	00	2	2010	2000p1			00	00	00	00	00	00
8C1	Reserved	00	2	2011	2000p1			00	00	00	00	00	00
8C2	Reserved	00	2	2012	2000p1			00	00	00	00	00	00
8C3	Reserved	00	2	2013	2000p1			00	00	00	00	00	00
8C4	Reserved	00	2	2014	2000p1			00	00	00	00	00	00
8C5	Reserved	00	2	2015	2000p1			00	00	00	00	00	00
8C6	Reserved	00	2	2016	2000p1			00	00	00	00	00	00
8C7	Reserved	00	2	2017	2000p1			00	00	00	00	00	00
8C8	Reserved	00	2	2018	2000p1			00	00	00	00	00	00
8C9	Reserved	00	2	2019	2000p1			00	00	00	00	00	00
8CA	Reserved	00	2	2020	2000p1			00	00	00	00	00	00
8CB	Reserved	00	2	2021	2000p1			00	00	00	00	00	00

- SA22-7990 OSA-ICC User's Guide
- SG24-6364 OSA-ICC Implementation Redbook
- <http://w3-1.ibm.com/support/techdocs/atsmastr.nsf/WebIndex/FLASH10295>

© 2004 IBM Corporation

HiperSockets

- **Four times the connectivity of z800/z900**
 - From 4 to 16 HiperSockets
 - Connect four times more TCP/IP stacks
 - Increased number of communication queues (from 1,024 to 4,096)
 - Support for multiple LCSS
 - Single LP can connect to 16 HiperSockets
- **Support for spanned CHPIDs across multiple LCSS**
 - One HiperSocket can be shared by up to 30 LPARs
- **Support for 64-bit HSA address space**
- **Virtual LAN (IEEE 802.1q) support**
- **Broadcast for IPv4**
- **Support of additional IP assist features for IPv6**

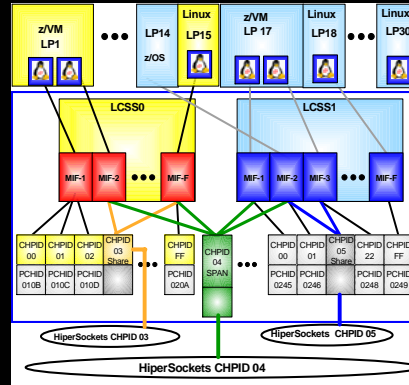

Very High Speed Interconnection between programs running z/OS, z/VM, VSE/ESA or Linux®

Spanned Channel Support

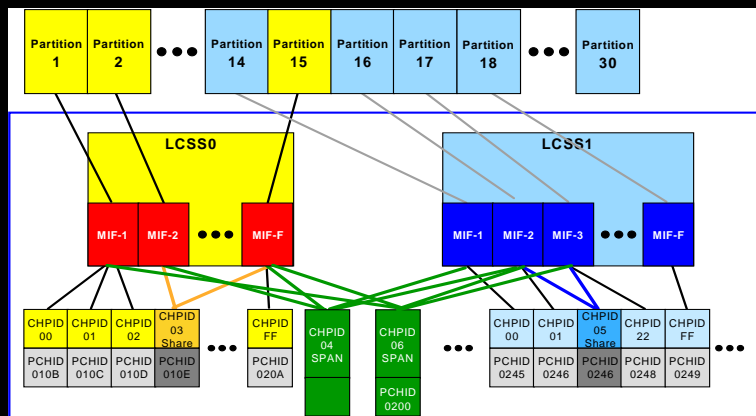

- CHPID 04 shows example of a spanned channel (HiperSockets or Internal Coupling links)
- CHPID 06 shows example of a spanned channel (FC, FCP, OSE, OSD, OSC, CBP, CBS, CFP, CFS)
- Not supported: ESCON, FICON Conversion, Coupling Receiver (CBR, CFR)

CHPID Mapping Tool

- Ease of use tool to simplify mapping of CHPIDs to PCHIDs
- Availability and manual mapping functions
- Tool used with HCD/HCM for assigning PCHIDs to CHPIDs
 - Requires changes to current HCD process
- Supports channel MESSs
 - CHPID to PCHID mapping contained in IOCP
- "Mandatory"
- Customer Responsibility!

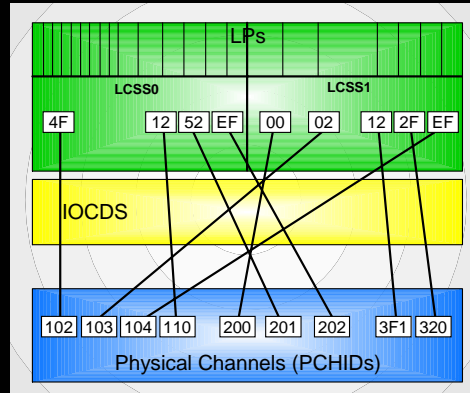

www.ibm.com/servers/resourceink

Default Priorities-Availability Option Chosen

- **Previously-**
 - If no priority defined, order of processing based on CNTLUNIT number only when "Process CU Priority" executed
 - *This has caused some issues and should be used with care*
- **New Algorithm**
 - CNTLUNITs with multiple paths will now be given a default priority by the tool based on number of paths
 - This does not solve the issue of related single path control units
 - e.g. Console controllers used for Master and Alternate consoles

New Sorting Order Algorithm for Availability

- All user assigned priorities
- C/Us with 8 CHPIDs (sorted by C/U number)
- C/Us with 7 CHPIDs (sorted by C/U number)
-
- C/Us with 1 CHPID (sorted by C/U number)
- Pseudo C/Us (CHPIDs without C/Us, sorted by C/U number)
 - This case can occur for CHPIDs which have no control units defined

CHPID Mapping Tool Configuration Inputs (All models)

- **Previously**
 - *Final Mapping*: hwc file based on CCN number
 - Obtained from ResourceLink
 - *Planning*: cfr file from econfig
- **Now**
 - *Final Mapping*: cfr file based on CCN number
 - Obtained from ResourceLink
 - *Planning*: cfr file from econfig

Plus....

Validated IOCP file for the target machine from HCD/HCM or with IOCP

Agenda

- Introduction
- Book Structure
- Upgrades
- I/O
- **Sysplex Considerations** ←
- Statements of Direction
- Operating Systems
- Cryptography
- Hardware Management Console
- Migration Planning
- Physical Planning
- Reference Material



zSeries Coupling Links for Parallel Sysplex

- **InterSystem Channel-3**
 - ISC-3 links ordered in increments of one
 - Activated links balanced across features
 - Maximum of 12 features / 48 links
- **Two modes of operation**
 - Peer Mode (2 Gigabits per second - Gbps)
 - Compatibility Mode (1 Gbps)
- **Feature Codes**
 - ISC-3 FCs 0217(ISC-M) 0218 (ISC-D / ISC link)
 - FC0218 carry forward from z800
 - Activate link - FC 0219
 - Four ports per feature (two ports per ISC-D)
 - Supports 9 micron single mode fiber
- **ISC-3 Peer Mode Supported Distance Increased**
 - 100 km with repeaters
 - Peer Mode ONLY

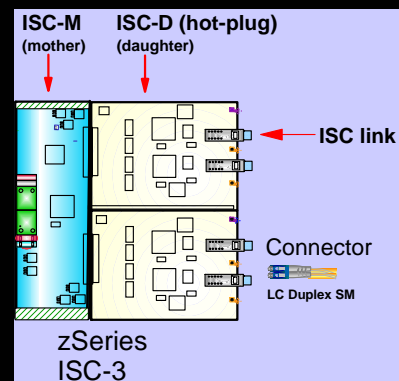

ICB-3 & ICB-4 Support

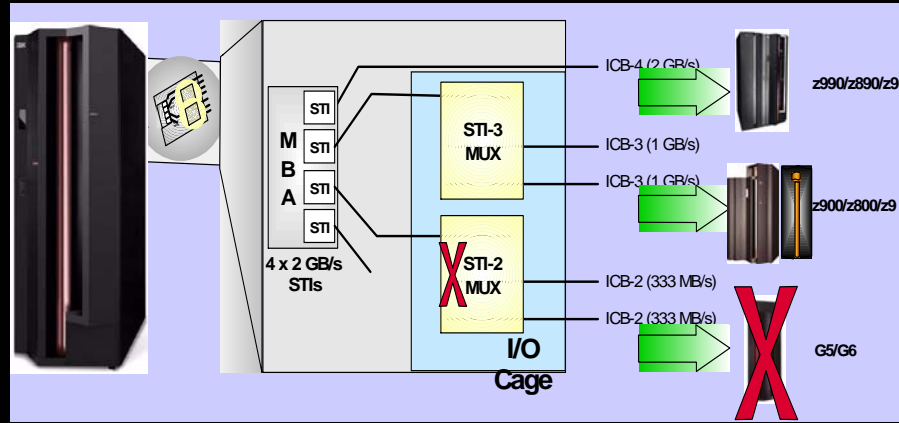

Internal Coupling Links - IC

- **Defined as ICP in HCD/HCM/IOCP**
 - Peer mode only
- **Avoid over defining**
 - Uses real CP resources
 - Maximum: (#CPs + #ICFs) - 1
 - Recommended maximum is two links per sysplex
 - Two links requires four CHPIDs
 - Can use the bi-directional capability

ibm.com/support/techdocs/atsmastr.nsf/WebIndex/FLASH10271

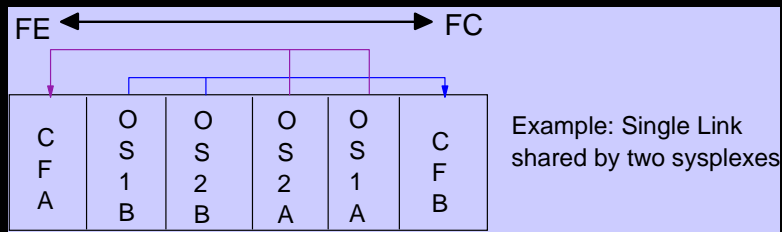

z890 CF Link to G5/G6 and z800/z900

Connectivity Options	z890/z990 ISC-3	z890 ICB-2	z890/z990 ICB-3	z890/z990 ICB-4
G5/G6 ISC	1 Gbit/sec Compat Mode	Not Supported	n/a	n/a
z900/z800 ISC-3	2 Gbit/sec Peer Mode*	Not Supported	n/a	n/a
z890/z990 ISC-3	2 Gbit/sec Peer Mode	Not Supported	n/a	n/a
G5/G6 ICB	n/a	Not Supported	n/a	n/a
z900 ICB-2	n/a	Not Supported	n/a	n/a
z990 ICB-2	n/a	Not Supported	n/a	n/a
z900/z800 ICB-3	n/a	Not Supported	1 GByte/sec Peer Mode	n/a
z990 ICB-3	n/a	Not Supported	Requires IO Slot ICB-4 Preferred	n/a
z890/z990 ICB-4	n/a	Not Supported	n/a	2 GBytes/sec Peer Mode

* RPQ - 20Km for 1Gbit/sec in peer or compatibility mode

zSeries Coupling Link Maximums

Link Type	z890	z890 Capacity Setting 110	z800	z990
IC	32	32	32	32
ISC-3	48*	48*	24	48*
ICB-2	0	0	0	8
ICB-3	16	16	5 (6 for OCF model)	16
ICB-4	8	8	0	16
Maximum Number of <i>All Links</i>	64	64	26	64

* Up to 32 ISC-3's in compatibility mode

ICB-2 is NOT supported on z890

Parallel Sysplex Enhancements – CFCC Level 13

- **Support for up to 48 links**
- **Availability enhancement**
 - CFCC Patch Apply enhancement (DRIVER 55 – z890 & z990 only)
 - Disruptive patches affect one CF LPAR at a time
 - Rolling patch on separate CF LPARs without the need for a System Power On Reset
 - Excellent for testing in test sysplexes without impact to production

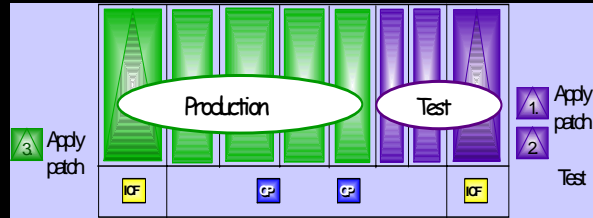

- **Performance enhancements**
 - DB2 data sharing
 - Potentially improved performance for "Cast out process" when using large DB2 buffer pools
 - APAR OA01517 enables exploiters to request placement into a CF with CFCC Level 13, but it's not a requirement

z990 CFCC Level 14 – z890/990 GA2/4

- **Function and Potential Benefit**
 - Contains improvements to the CF dispatcher and internal serialization mechanisms designed to better manage coupled workloads
- **Requirements and Support**
 - Requires z890/990 hardware LIC support for GA2/4 (October 29, 2004)
 - z/OS 1.3 or z/OS.e 1.3 and higher
 - Optional APAR fix OA08556 to improve performance when duplexing structures
 - z/OS 1.4 and higher
 - Optional APAR fix OA08742 to allow sysplex connectors to request structure allocation in a Level 14 Coupling Facility
 - APAR OA08742 requires IPL
 - z/VM 3.1 and z/VM 4.3 and higher for virtual CF support
- **CF Storage Sizing with CFCC level 14**
 - May increase storage requirements
 - Use CFSSIZER tool to determine: www.ibm.com/servers/eserver/zseries/cfsizer/

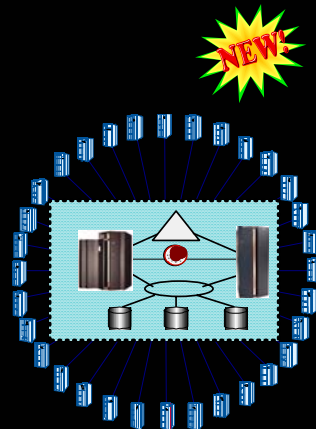

zSeries continues to meet the requirements for advanced clustering

Parallel Sysplex coexistence with 9672 G5 or higher

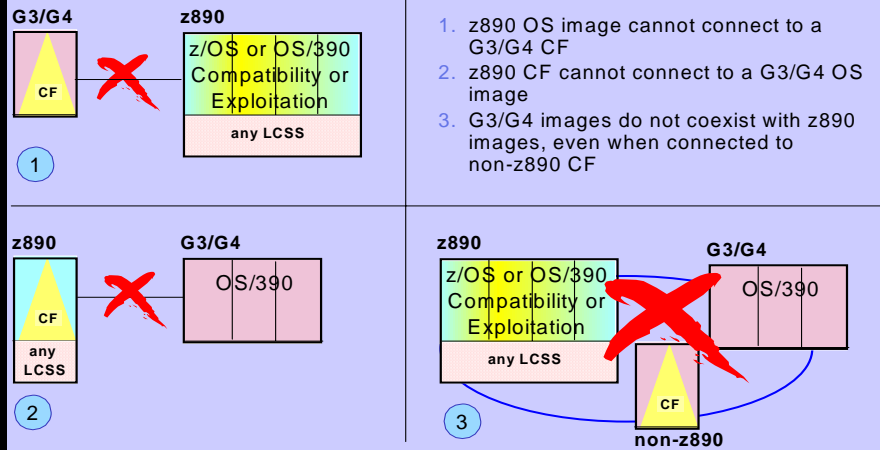

1. z890 OS image cannot connect to a G3/G4 CF
2. z890 CF cannot connect to a G3/G4 OS image
3. G3/G4 images do not coexist with z890 images, even when connected to non-z890 CF

z800 ISC-3 Fiber Configurations

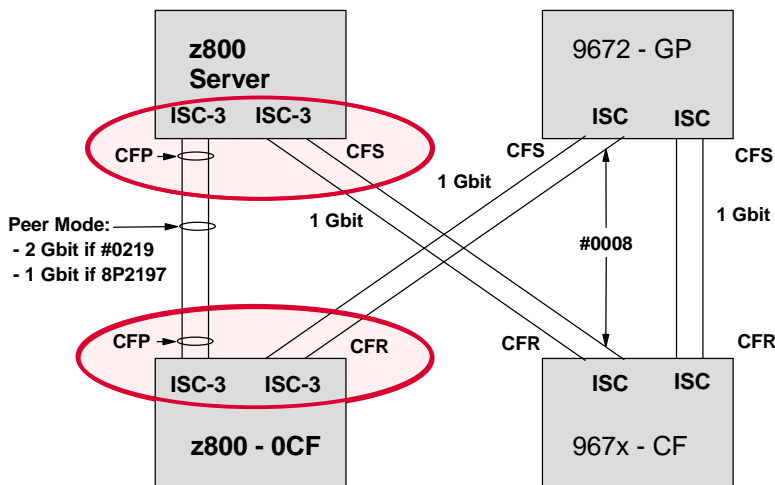

z800 **CANNOT** connect to 9672 500 Mbit links (#0007)

Message Time Ordering - MTO

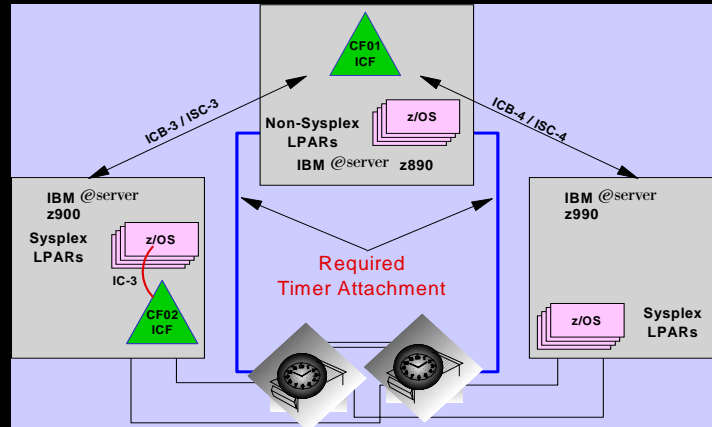

Agenda

- Introduction
- Book Structure
- Upgrades
- I/O
- Sysplex Considerations
- **Statements of Direction** ←
- Operating Systems
- Cryptography
- Hardware Management Console
- Migration Planning
- Physical Planning
- Reference Material



Statements of Direction may be changed by IBM at any time.

Statements of Direction

- **Token Ring on HMC, SE, TKE workstations and IBM 2074 Console Controller to be discontinued:** The z890 and z990 are the last zSeries servers to offer Token Ring on these devices.
- **HMC's are to become "closed" platforms**
 - This has implications for customers using the ESCON Director Console or Sysplex Timer Console installed as an application on HMC's.
 - The ESCON Director and Sysplex Timer will require a separate console that supports Token Ring ==>> BUY A CONSOLE NOW !
 - Support for 9672 G5 and above
 - TCP/IP only
- **OSA-Express**
 - Layer 2 Support (QDIO mode only) – Satisfied October 2004
 - Allowing protocol-independent network connectivity
 - Initially available to z/VM and Linux (z/OS later)
 - Z890 and z990 are the last IBM mainframes to offer OSA Token Ring
- **Future zSeries processors will not use ISC-3 to connect to 9672 G5/6 HiperLinks (ISC-2)**

FCP LUN Access Control



Without LUN Access Control

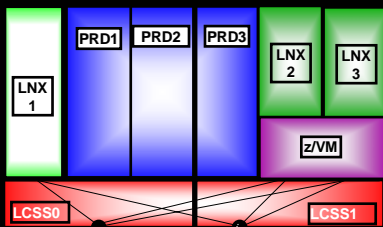

With LUN Access Control

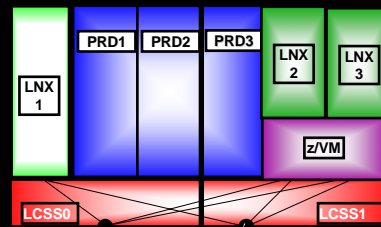

▪ No LUN Access Control

- Image access to shared FCP channel allows read-write access to all LUNs not masked
- No concurrent LUN sharing

▪ With LUN Access Control

- Image defined LUN access on shared FCP channel
- Read-only LUN sharing
- * Planned availability to be announced

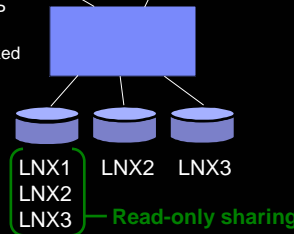
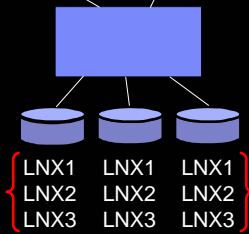

Statement of Direction - z/OS Communications Server

(satisfied in announcement letter 205-030, February 15, 2005)

- August 2004: It is IBM's intent to support VTAM® in z/OS Communications Server for the foreseeable future.** Customers have a substantial investment in 3270 and SNA applications. We continue to support and enhance VTAM's capabilities while integrating it with new technologies. IBM has no plans at this time to discontinue SNA support in z/OS Communications Server. As of June 2004, customers can, for selected SNA workloads, use Communications Server products for Linux, Linux on zSeries, Microsoft® Windows®, and AIX® to replace some of the old SNA infrastructure components, such as the IBM 3745/46 or other channel-attached SNA controllers. z/OS Communications Server can replace some SNA Network Interconnect (SNI) workloads using Enterprise Extender and Extended Border Node functions.

It is IBM's intent to introduce an additional solution in 2005 that uses NCP (Network Control Program) software running within Linux on zSeries. The intent is to provide a migration path for customers who use traditional SNA (including SNA Network Interconnect (SNI)) to communicate with their business partners. This solution can allow them to continue using traditional SNA without a dependency on IBM 3745 and 3746 Communications Controller hardware.

- <http://www.ibm.com/software/network/ccl>

All statements regarding IBM future direction and intent are subject to change or withdrawal without notice, and represent goals and objectives only. Any reliance on this Statement of Direction is at the relying party's sole risk and will not create any liability or obligation for IBM.

SNA support options

- Options for z/OS environments:**
 - Communications Server for z/OS
 - Helps reduce dependency on 3745/46 with Enterprise Extender EBN support for B2B SNA communications
- Options for Linux environments**
 - Communications Server for Linux on zSeries
 - New options for environments with outboard SNA/IP integration points
 - For selected SNA workloads
- Communication Controller for Linux on zSeries**
 - Selected NCP (Network Control Program) Software functions running within Linux on zSeries are planned
 - Can allow customers to continue using traditional SNA without a dependency on IBM 3745 and 3746 Communications Controller hardware.

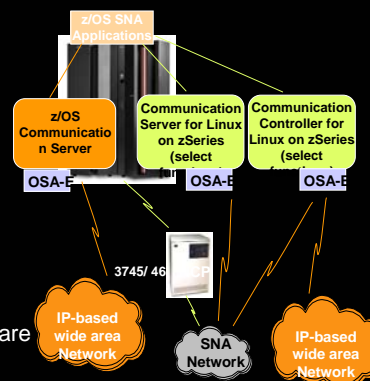

Agenda

- Introduction
- Book Structure
- Upgrades
- I/O
- Sysplex Considerations
- Statements of Direction
- **Operating Systems** ←
- Cryptography
- Hardware Management Console
- Migration Planning
- Physical Planning
- Reference Material

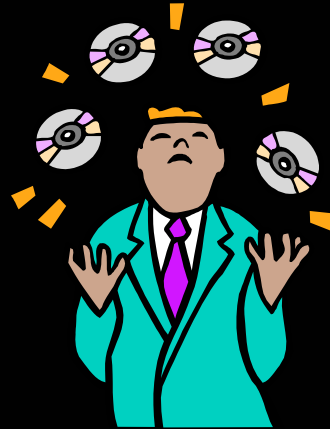

Multiple Logical Channel Subsystems and up to 30 LPARs

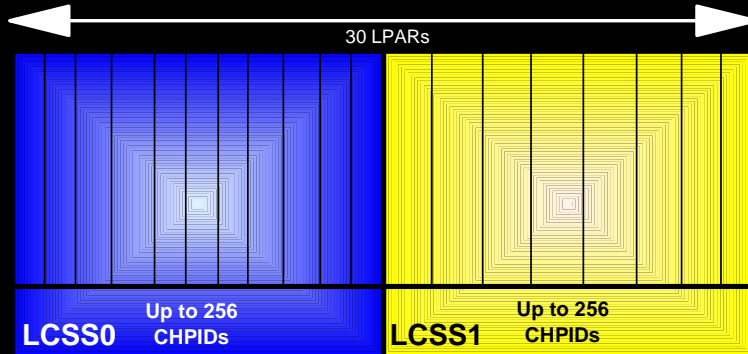

2 Logical Channel SubSystems (LCSS)

30 LPARs across 2 LCSS

or

15 LPARs per LCSS

Maximum of 15 LPARs on Capacity Setting 110 (FC6110)

Compatibility versus Exploitation

Compatibility

- Can use HCD to create an IODF with multiple LCSSs
- Software ACTIVATE can be performed
 - Number of defined LCSSs is irrelevant
- Can only perform a hardware ACTIVATE if:
 - The changed/new resources are restricted to LCSS-0
- POR is required for activating IODF:
 - with additional LCSSs
 - with new LPARs
 - with changed/new resources in LCSS-1
- Sysplex Considerations

Exploitation

- Can perform full hardware ACTIVATE
 - With multiple LCSSs defined
- Run in LCSS-1
- > 15 LPARs
- Dynamic I/O changes in LCSS-1
- Extended Channel Measurement Block (ECMB) support
- 48 ISC Links
- QDIO Multiple Control Units
- CF Level 13

<http://www-1.ibm.com/support/techdocs/atsmastr.nsf/WebIndex/FLASH10236>

Z890: Operating System Support Summary

Operating Systems	ESA/390 (31-bit)	z/Arch (64-bit)	Compatibility	Exploitation
OS/390 2.10 **support ended	Yes	Yes	Yes ³	No
z/OS 1.2 ** support ended	No	Yes	Yes ³	No
z/OS 1.3 & z/OS.e 1.3	No	Yes	Yes ³	No
z/OS 1.4 & z/OS.e 1.4	No	Yes	Yes ³	Yes
z/OS 1.5 & z/OS.e 1.5	No	Yes	Included ³	Included ³
z/OS 1.6/1.7 & z/OS.e 1.6	No	Yes	Included ³	Included ³
Linux for S/390	Yes	No	Yes	Yes
Linux for zSeries	No	Yes	Yes	Yes
z/VM 3.1	Yes	Yes	Yes	No
z/VM 4.3	Yes	Yes	Yes	No
z/VM 4.4	Yes	Yes	Included	Included
z/VM 5.1/5.2	No	Yes	Included	Included
VSE/ESA 2.6, 2.7	Yes	No	Yes	No ²
z/VSE 3.1	Yes	No	Yes	Yes
TPF 4.1	Yes	No	Yes	No ¹
z/TPF 1.1	No	Yes	Yes	No ¹

1 - TPF and zTPF (64-bit) use LCSS-0 only, but more than 15 LPARs are permitted. See APAR PJ29309 (included in z/TPF).

2 - VSE 2.7 exploits Thin Interrupts with 4Q04 SPE

3 - Web Deliverable for Secure Crypto

4 - z/VSE can execute in 31-bit mode only. It does not implement z/Architecture, and specifically does not implement 64-bit mode capabilities.

z/VM V5.2

- **MCL009 in the J13479 (SE-FCS 3X) stream must be installed**
- **For additional information on this required update, refer to Resource Link at:**
- **<http://www.ibm.com/servers/resourcelink/>**
 - "Alerts", then select "zSeries - z890", then select "051205 HIPER MCL for 2084, 2086."

Agenda

- Introduction
- Book Structure
- Upgrades
- I/O
- Sysplex Considerations
- Statements of Direction
- Operating Systems
- **Cryptography** ←
- Hardware Management Console
- Migration Planning
- Physical Planning
- Reference Material



Cryptography

- **CP Crypto Assist for Cryptographic Functions (CP Assist)**
 - High performance clear key DES and SHA-1 engine in every CP
 - Shipped with SHA-1 enabled. DES & TDES require enablement FC3863
 - CHPID no longer required
- **PCI Cryptographic Accelerator (PCICA) – increments = 0, 1 or 2 features (2 engines per card)**
 - High performance Public Key (SSL) Acceleration
 - Carried forward on z800 upgrades
- **PCIXCC Cryptographic Coprocessor – increments = 0, 2, 3 or 4 features**
 - I/O Cage installable PCIXCC feature
 - Adds security rich functions previously found in CCF and PCICC
 - CHPID not required
 - Service offering for User Defined eXtensions (UDX)
 - PCIXCC Receives EAL 5, FIPS 140-2 Level 4 Validation
- **New function**
 - 19 digit Personal Account Numbers
 - TKE 5.0 Code and Workstation
 - TKE 4.2 Code
 - TKE 4.1 Operational Key Entry
 - EMV (Europay Mastercard and Visa) 2000 Standard
 - PKE/PKD Service Enhancements
 - Double Length Derived Unique Key Per Transaction (DUKPT) – PCIXCC
- **Performance Reports**
 - <http://www-1.ibm.com/servers/eserver/zseries/security/cryptography.html>



The total quantity of FICON Express, OSA-Express, PCICA, and PCIXCC cannot exceed 20 features per server

© 2004 IBM Corporation

Crypto Express2 (FC0863)



- **Dual Integrated Cryptographic Coprocessors**
 - Provides PCIXCC and PCICA functionality
- **Improved throughput over the PCIXCC**
- **Scalable (no CP affinity) - 0 to 8 features**
 - The total number of Crypto Express2, PCICA and PCIXCC features cannot exceed 8 features per server
 - Minimum purchase increment is two (Crypto Express2 and/or PCIXCC)
- **Current applications expected to run without change**
- **Connection to STI interface; no external cables**
- **Fully programmable, User Defined Extensions (UDX) support**
- **Designed for FIPS 140-2 Level 4 Certification**
- **Trusted Key Entry (TKE) 4.X support**
 - Secure operational and master key loading
 - Smart Card Reader support (TKE 4.2 only)

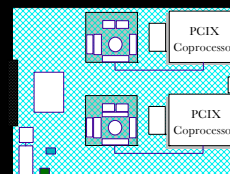

© 2004 IBM Corporation

Crypto Express2 Support Requirements

- **z890 or z990 hardware LIC support for GA2/4 (January 28, 2005)**
- **z/OS 1.2 or z/OS.e 1.3 or later with Web Deliverable:**
 - z990 Cryptographic support OR
 - z990 and z890 Enhancements to Cryptographic Support
- **z/VM 5.1 or later with service (January 28, 2005)**
 - Support for z/OS and Linux on zSeries guests
- **VSE/ESA 2.7 and IBM TCP/IP for VSE/ESA 1.5**
- **Linux on zSeries with code IBM plans to deliver Open Source in:**
 - October 2004 for kernel 2.4
 - Early in 2005 for kernel 2.6
- **NOTE: z/VM, VSE/ESA and Linux support clear key SSL ONLY.**
- **See the 2084DEVICE or 2086DEVICE PSP for any additional service.**
 - Requires ICSF toleration APAR OA099157

19-digit Personal Account Numbers on z890/990



- **Function and Potential benefits**
 - Designed to meet the industry requirement for Card Validation Value (CVV) generate and verification services for 19-digit Personal Account Numbers (PANs).
 - Old: 13-digit & 16-digit PANs
 - New: 19-digit PAN
 - Designed to increase anti-fraud security
- **Requirements and Support**
 - Exclusive to z890 and z990 PCIXCC and Crypto Express2
 - PCIXCC with z890 or z990 hardware LIC support for GA2/4 (October 29, 2004)
 - OR
 - Crypto Express2 with z890 or z990 hardware LIC support for GA2/4 (January 28, 2005)
 - Requires z/OS or z/OS.e 1.6 with the **ICSF 64-bit Virtual Support for z/OS 1.6 and z/OS.e 1.6 Web deliverable planned for December 17, 2004.**
 - See the 2084DEVICE or 2086DEVICE PSP for any additional service required

2048-bit clear and secure key RSA operations



- **Function and Potential Benefits**
 - 2048-bit clear and secure key RSA management capability
 - Support of new Automated Teller Machine (ATM) standards
 - The 2048-bit functional control vector will support four ICSF services: Public Key Decrypt, Symmetric Key Import, Symmetric Key Export, and Symmetric Key Generate
 - Designed to increase anti-fraud security
- **Requirements and Support**
 - PCICC with **Feature #0867 for z800 and z900 (Not applicable to CCF)** OR
 - PCIXCC on z890 or z990 OR
 - Crypto Express2 with z890 or z990 hardware LIC support for GA2/4 (Jan 28, 2005)
 - On z800 or z900 with PCICC; z/OS 1.3 or z/OS.e 1.3 or later
 - On z890 or z990: z/OS 1.3 or z/OS.e 1.3 or later with:
 - For PCIXCC: z990 Cryptographic Support
 - For Crypto Express2 and PCIXCC: z990 and 890 Enhancements to Cryptographic Support
 - On z800 or z900 with PCICC, z/VM 4.3 or later for Linux on zSeries guests.
 - On all hardware, z/VM 5.1 for support of z/OS and Linux on zSeries guests.
 - For Crypto Express2, with service planned January 28, 2005
 - See 2084DEVICE or 2086DEVICE PSP bucket for any required service
 - For Crypto Express2, Linux on zSeries with code IBM plans to deliver Open Source in:
 - October 2004 for kernel 2.4
 - Early in 2005 for kernel 2.6
 - For PCIXCC or PCICC, Linux on zSeries with clear key RSA support:
 - SUSE SLES 8 or 9, Red Hat RHEL 3, Turbolinux TLES 8, or Conectiva CLEE

Less than 512-bit clear key RSA operations on z890/990

- **Function and Potential Benefits**
 - Designed to allow clear key RSA operations using keys less than 512-bits including ICSF Callable services and their corresponding verbs: Digital Signature Verify (CSNDDSV), Public Key Encrypt (CSNDPKE), and Public Key Decrypt (CSNDPKD).
 - May allow the migration of some additional cryptographic applications to z890 and z990 servers without rewriting the applications.
- **Requirements and Support**
 - **Currently Available for PCICC on z800 and z900**
 - New for z890 and z990 PCIXCC and Crypto Express2
 - PCIXCC with z890 or z990 hardware LIC support for GA2/4 (October 29, 2004)
OR
 - Crypto Express2 with z890 or z990 hardware LIC support for GA2/4 (Planned January 28, 2005)
 - z/OS 1.3 or z/OS.e 1.3 or later with Web Deliverable:
 - For PCIXCC: z990 Cryptographic Support
 - For Crypto Express2 and PCIXCC: z990 and 890 Enhancements to Cryptographic Support
 - z/VM 5.1 or later with service (Planned January 28, 2005)
 - Support for z/OS guests
 - See the 2084DEVICE or 2086DEVICE PSP for any additional service required

Trusted Key Entry – TKE Workstation

- **TKE 4.2 Workstation support (FC0853) - New Build after Jan. 2005**
 - FC08599 NEW TKE Workstation – (Ethernet only)
 - FC0846 TKE with DVD-RAM drive and Token-Ring (November 2004)
 - Withdrawn October 2005
 - FC0849 TKE with DVD-RAM drive and Ethernet (November 2004)
 - Withdrawn October 2005
 - Smart Card Reader (FC0887)
 - Additional Cards (FC0888)
- **TKE 4.1 Workstation support (FC0852) - Prior to January 2005**
- **TKE 4.0 Workstation support (FC0851) - Carry forward from z800**
 - MCL update to 4.1 required to control PCIXCC
- **TKE 3.x Workstation support - Carry forward to control legacy systems only**
 - MCL update to TKE 4.1 control PCIXCC
 - Previous TKE upgrades required ordering a new TKE workstation
- **Read the 'Migration and Use' chapters of the ICSF Systems Programmer's Guide (SA22-7540) for tips on PCIXCC**
 - Appendix E



NOTE: TKE customers will now need to enable TKE commands from the SE panel for each PCIXCC before using TKE commands. No impact to non-TKE customer.

System z9 Trusted Key Entry Workstation 5.0

- **Optional TKE Workstation:**
 - **The only TKE feature that supports z9-109**
 - Orderable on z9-109, z990, z890, z900 and z800
 - TKE 5.0 LIC: FC 0855
 - Requires TKE 5.0 hardware
 - TKE 5.0 hardware: FC 0859
 - Requires TKE 5.0 LIC
 - xSeries-based system unit, keyboard, flat panel, mouse
 - PCI-X Crypto Coprocessor
 - **Ethernet connectivity only**
 - Optional Smart Card Reader: FC 0887
 - Optional Additional Smart Cards: FC 0888
- **TKE 5.0 Hardware and LIC support to enter secure cryptographic keys for:**
 - z9-109: Crypto Express2
 - z990 and z890: PCIXCC and Crypto Express2
 - z900 and z800: CCF and PCICC



PCI-X Crypto Coprocessor

Agenda

- Introduction
- Book Structure
- Upgrades
- I/O
- Sysplex Considerations
- Statements of Direction
- Operating Systems
- Cryptography
- **Hardware Management Console**
- Migration Planning
- Physical Planning
- Reference Material

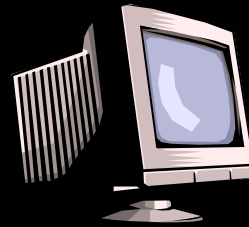
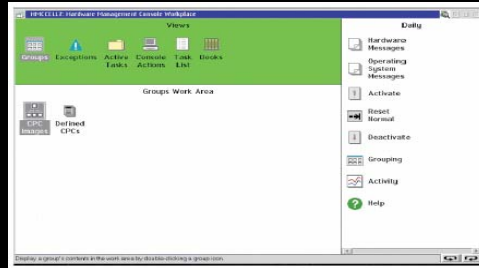

zSeries Hardware Management Console

- **Supported HMCs are 0073, 0074, 0075, 0076, 0077, 0078, 0079, 0080**
 - FC0073 - G1-G6, C02-C05, 2003, 7060, all zSeries (withdrawn)
 - FC0074, FC0075 - G4, G5, G6, C05, 7060, all zSeries (withdrawn)
 - **FC0076** - G5, G6, all zSeries
 - Feature Code to exchange T/R-Ethernet for Dual-Ethernet on FC0075
 - **FC0077** - Dual-Ethernet - G6, all zSeries
 - **FC0078** - Ethernet and Token-Ring - G6, all zSeries
 - **FC0079** - Dual Ethernet - G6, all zSeries (November 2004)
 - **FC0080** - Ethernet and Token Ring - G6, all zSeries (November 2004)
 - **FC6094** - 17 inch Flat Panel (November 2004)
 - **FC6095** - 20 inch Flat Panel (November 2004)
- Can now order up to 10 HMC's, Ethernet Switches, MAU's (November 2004)
- **HMC Version Code 1.8.2 supports...**
 - G6 / Driver 26
 - z900/z800 / Driver 3G
 - z890 / Driver level 55 (GA)
- **Last zSeries to offer Token-Ring connection to HMC/SE or TKE**
 - Migrate to Ethernet in the future
 - ESCON Director and Sysplex Timer Console networks will remain Token-Ring
 - Future server HMC will not permit ESCON Director or Sysplex Timer Console function



- New build - MAU supplied in Frame if Token Ring is ordered
- Ethernet Switch (16 port)
 - FC0089
 - 10/100 mbps
 - Carry forward FC0089 from z800 (8-port)



Hardware Management Console Requirements and limitations (HMC Version 2.9.0)

- The 2094 HMC will **NOT** support the following systems: G1, G2, G3 or G4
- The following legacy systems will be supported, but they must be upgraded to a new AROM level, and support will be provided for the specified driver.
 - **z990 & z890 (Driver 55)**
 - MCL 130 for EC J12560
 - **z900 & z800 (Driver 3G)**
 - MCL 001 for EC J13150 or
 - MCL 009 for EC J11215 or
 - MCL 004 for EC J11911 and MCL 166 for EC J11213
 - **G5 & G6 (Driver 26)**
 - **M3000 (Driver 24)**

Transitioning

- **Existing HMC Feature Codes 0075,0076,0077,0078**
 - Will require additional memory to be added
 - 512MB to 1GB
- **In September 2005, all HMC orders will be shipped with the new driver level**

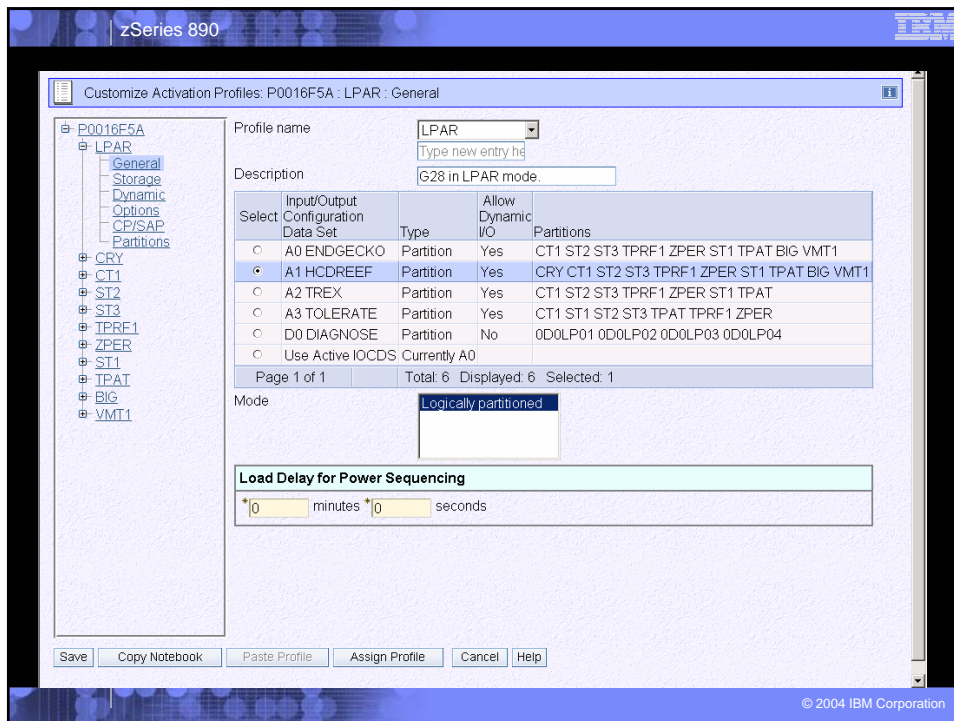
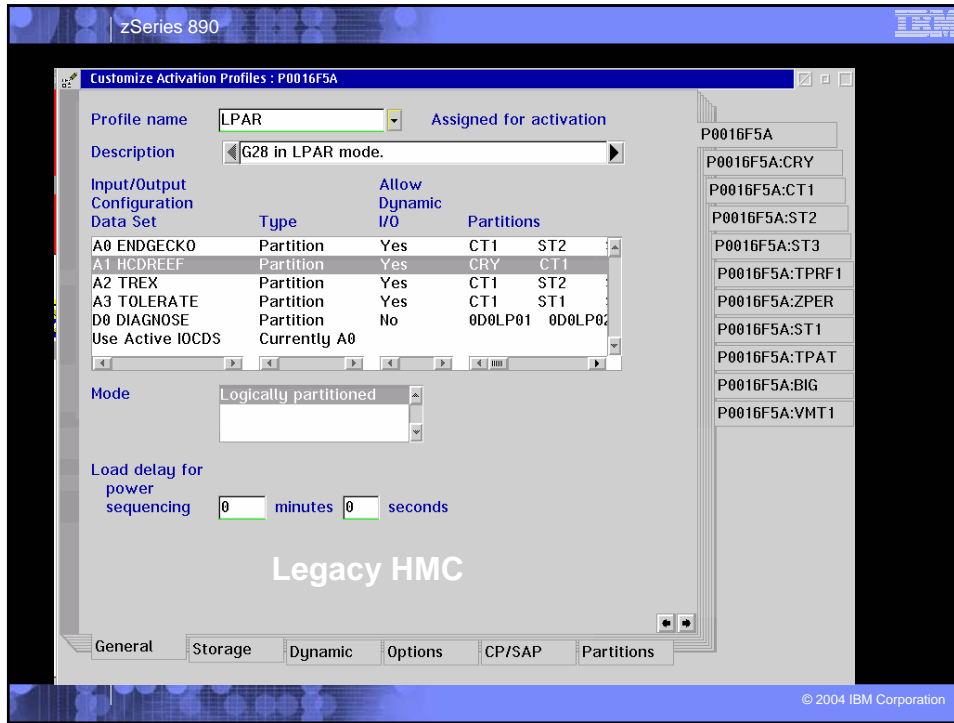

Agenda

- Introduction
- Book Structure
- Upgrades
- I/O
- Sysplex Considerations
- Statements of Direction
- Operating Systems
- Cryptography
- Hardware Management Console
- **Migration Planning** ←
- Physical Planning
- Reference Material



Channels not support on the z890

- **No Internal-Disk**
 - Consider the IBM DS6000 or DS8000
 - Consider the IBM 2105-750
 - Consider IBM Certified used DASD
- **No emulated I/O**
 - Use OSA-ICC or IBM 2074
- **Parallel channels**
 - Same as z800
 - Use Optica ESCON® Converter or IBM 9034
- **OSA-Express Fast Ethernet features**
 - Carried forward on upgrades - not orderable on new builds
 - Use 1000BASE-T Ethernet for new builds
- **PCICC features**
 - No carry forward
 - Replaced by PCIXCC/Crypto Express2 for most commonly used functions



Channels not support on the z890

OSA-2 adapters

- Use equivalent OSA-Express adapter
 - May require a different connector
- No equivalent OSA-Express for FDDI OSA-2
 - Use multiprotocol switch or router with appropriate network interface
- ibm.com/support/techdocs/atmsastr.nsf/WebIndex/WP100340

OSA-Express adapters

- OSA-Express ATM adapters
 - Not available on upgrades or new builds
 - Use multiprotocol switch or router with appropriate network interface (e.g., 1000BASE-T or Gigabit Ethernet)

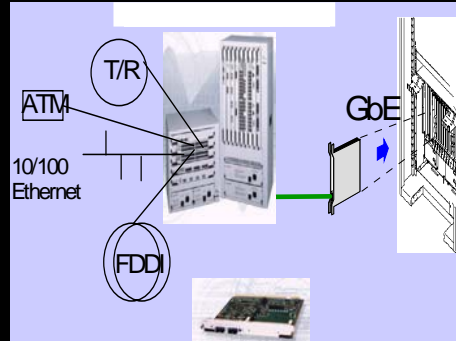

© 2004 IBM Corporation

Server Time Protocol (STP) Overview

- **Designed to provide capability for multiple System z9 and zSeries servers to maintain time synchronization with each other**
 - Does not require the 9037 Sysplex Timer if all servers STP capable
- **Timing information transmitted over ISC-3 links (Peer mode), ICB-3 and ICB-4 links**
- **Supports a multi-site timing network of up to 100 km (62 miles)**
 - Allows a Parallel Sysplex cluster to span up to 100 km
- **May reduce the cross-site connectivity required for a multi-site Parallel Sysplex cluster**
- **Can coexist with an External Time Reference (ETR) network (9037 based)**
 - Mixed Timing Network
- **Designed to allow use of dial-out time services to set the time to international time standard (UTC) as well as adjust to UTC**
- **Planned to be available as a feature on z9-109, z990 and z890**
- **Prerequisites**
 - z9-109 HMC
 - z/OS V1.7

•All statements regarding IBM future direction and intent are subject to change or withdrawal without notice, and represents goals and objectives only.

© 2004 IBM Corporation

Implementation Assistance Program (IAP)

- **Objective**
 - Accelerate the adoption of STP with IBM assistance
- **Assistance planned**
 - Consultation
 - Review of migration plans
 - Technical support
- **Planned Availability dates**
 - October 2005 (z990, z890)
 - 1Q06 (z9)

Agenda

- Introduction
- Book Structure
- Upgrades
- I/O
- Sysplex Considerations
- Statements of Direction
- Operating Systems
- Cryptography
- Hardware Management Console
- Migration Planning
- **Physical Planning** ←
- Reference Material

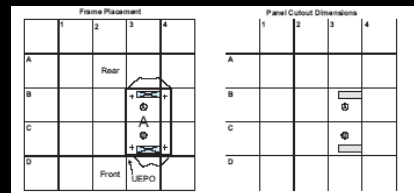
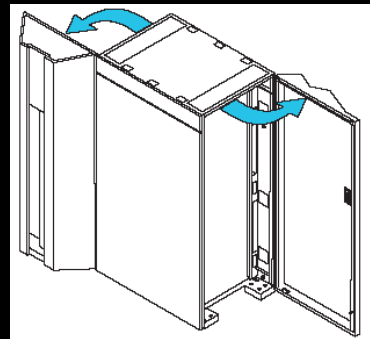

Physical Planning – IMPP (GC28-6828)

- **All systems are air cooled, one frame systems**
 - raised floor (recommended) or non-raised floor

- **Height reduction (FC9975 no charge)**
 - Accommodates door height restrictions
 - IBF batteries will come unplugged if height reduction is ordered

- **Optional Internal Battery Feature-IBF (FC3210 chargeable)**
 - Installed as a pair (top - front and back)
 - No width reductions are required
 - Can be added later via MES

- **Power - Dual power cables (Hubbell) 50/60Hz**
 - 3 Phase, 200V-480V
 - 1 Phase, 200V-415V
 - Cabled in upper CEC cage

A look inside

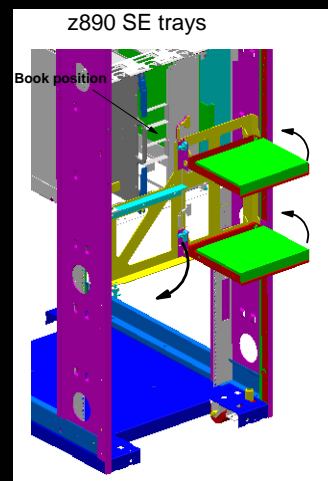
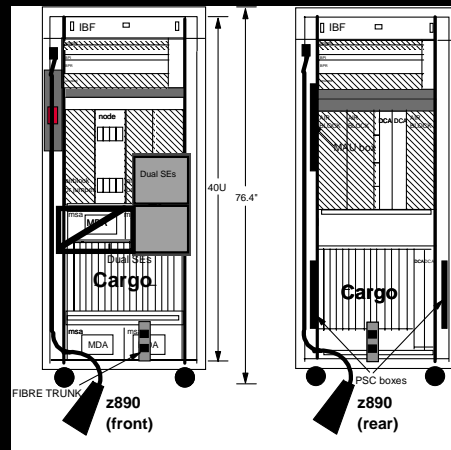

Dimensions

Top section can be removed for shipping, but only if really necessary.

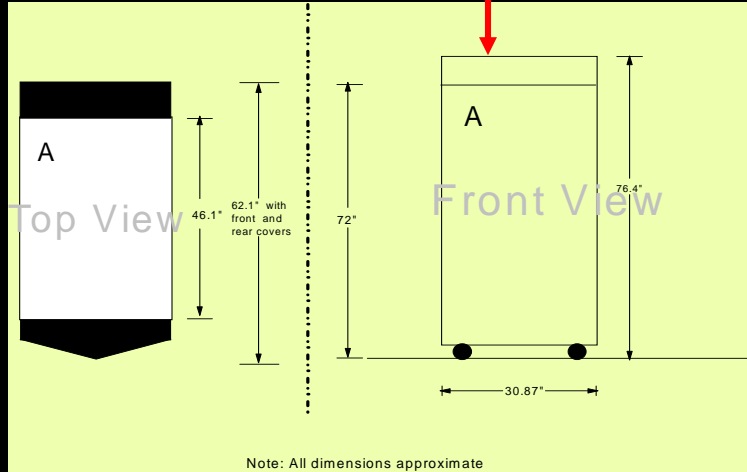

Note: All dimensions approximate

Heat Exchange

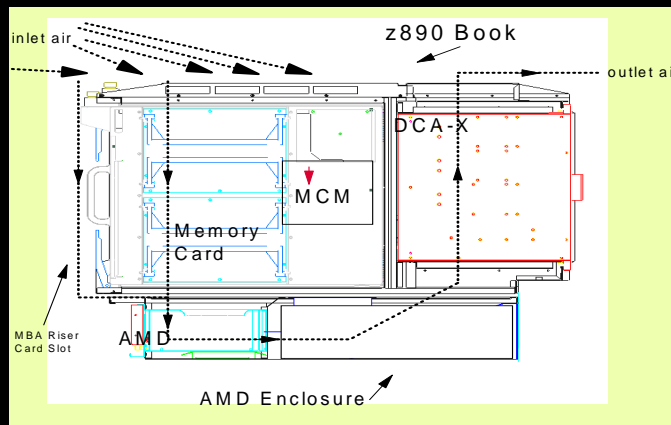

Cold air in from the front.

Heated air out through the back.

G5/G6, MP3000, z800, z890 Physical Characteristics

	G5 / G6 Minimum 1 Frame System	G5 / G6 Maximum 2 Frame System	Multiprise 3000 1 Frame System Maximum	z800 Maximum	z890 Minimum	z890 Maximum
Power 50/60 Hz, kVA	0.6 / 1.0	5.5 / 5.5	1.32	2.95KW	1.5	4.7
Heat Output KBTU/hr	2.0 / 2.5	18.8 / 18.8	4.5	10.0	5.12	16.05
Air Flow CFM Air Flow m ³ /min	290 / 290 7.1 / 7.1	1400 / 1400 38.6 / 38.6		400 11.1	640 17.64	640 17.64
Floor Space - Sq. meters - Sq. feet	1.0 / 1.6 10.4 / 16.4	1.8 / 1.8 19.7 / 19.7		0.83 8.9	1.24 13.33	1.24 13.33
Including service clearance - Sq. meters - Sq. feet	2.5 / 2.5 27.4 / 27.4	4.8 / 4.8 51.9 / 51.9		6.0 64.5	3.03 32.61	3.03 32.61
Approximate weight - kg - lbs	612 / 612 1346 / 1346	938 / 938 2057 / 2057	236 520	545 1201	674 1482	785 1730
Approximate height - cm - inches	199.8 78.7	199.8 78.7	80 31.5	181.1 71.3	194.1 76.4	194.1 76.4

I/O Features: Connectors / Cables

Feature Code	Feature Name	Connector Type	Cable Type
0219	ISC-3 link	LC Duplex	9 micron SM
6154	External Time Reference (ETR)	MTRJ	62.5 micron MM
2324	ESCON channel	MTRJ	62.5 micron MM
2319	FICON Express LX	LC Duplex	9 micron SM
2320	FICON Express SX	LC Duplex	50, 62.5 micron MM
3319	FICON Express2 LX	LC Duplex	9 micron SM
3320	FICON Express2 SX	LC Duplex	50, 62.5 micron MM
2364	OSA-Express GbE LX	SC Duplex	9 micron SM
2365	OSA-Express GbE SX	SC Duplex	50, 62.5 micron MM
2366	OSA-Express Fast Ethernet	RJ-45	Category 5 UTP
2367	OSA-Express Token-Ring	RJ-45	STP or UTP
1364	OSA-Express GbE LX	LC Duplex	9 micron SM
1365	OSA-Express GbE SX	LC Duplex	50, 62.5 micron MM
1366	OSA-Express 1000BASE-T Ethernet	RJ-45	Category 5 UTP
3364	OSA-Express2 GbE LX	LC Duplex	9 micron SM
3365	OSA-Express2 GbE SX	LC Duplex	50, 62.5 micron MM
3368	OSA-Express2 10 GbE LR	SC Duplex	9 micron SM

SM = Single mode fiber, MM = Multimode fiber, LX = Long wavelength transceiver,
 SX = Short wavelength transceiver, UTP = Unshielded Twisted Pair,
 STP = Shielded Twisted Pair, LR = Long Reach transceiver

Agenda

- Introduction
- Book Structure
- Upgrades
- I/O
- Sysplex Considerations
- Statements of Direction
- Operating Systems
- Cryptography
- Hardware Management Console
- Migration Planning
- Physical Planning
- Reference Material ←



z890 Publications via ResourceLink

- | | | | |
|---|-----------|--|-----------|
| ▪ Agreement for Licensed Internal Code | SC28-6822 | ▪ Maintenance Information for Desktop Consoles | GC38-3115 |
| ▪ Application Programming Interfaces | SB10-7030 | ▪ Maintenance Information for Fiber Optic Links | SY27-2597 |
| ▪ Capacity Backup User's Guide | SC28-6823 | ▪ Maintenance Information for Thinkpad Consoles | GC38-3117 |
| ▪ CHPID Mapping Tool User's Guide | SC28-6825 | ▪ Parts Catalog | GC28-6829 |
| ▪ CF Channel I/O Interface Physical Layer | SA23-0395 | ▪ Planning for Fiber Optic Links | GA23-0367 |
| ▪ ESCON and FICON Channel-to-Channel | SB10-7034 | ▪ PR/SM Planning Guide | SB10-7036 |
| ▪ ESCON Physical Layer | SA23-0394 | ▪ Safety Notices | G229-9054 |
| ▪ FICON I/O Interface Physical Layer | SA24-7172 | ▪ Safety Inspection | GC28-6833 |
| ▪ Hardware Management Console Operations Guide (V1.8.2) | SC28-6830 | ▪ Service Guide | GC28-6827 |
| ▪ Installation Manual for Physical Planning | GC28-6828 | ▪ Standalone IOCP User's Guide | SB10-7040 |
| ▪ Installation Manual | GC28-6826 | ▪ SCSI IPL - Machine Loader Messages | SC28-6839 |
| ▪ IOCP User's Guide | SB10-7037 | ▪ Support Element Operations Guide (Version 1.8.2) | SC28-6831 |
| | | ▪ www.redbooks.ibm.com | |
| | | ▪ z890 Technical Introduction | SG24-6310 |
| | | ▪ zAAP Implementation | SG24-6386 |
| | | ▪ z890 SAPR Guide | SA04-002 |

End of Presentation

IBM

@server

zSeries 890

Questions !!?



© 2004 IBM Corporation