



IBM Software Network 2013
Fare partnership con il Software IBM

Roma, 24 - 25 gennaio 2013

**Smart Cloud & Enterprise Mobility:
Rethink IT**

Davide Albo - Mobility Consultant,
Worklight Tiger Team Europe



Il mobile sta cambiando ...

- ... Il modo in cui la gente spende il proprio tempo
- ... come le aziende interagiscono con il mercato
- ... la modalità di lavoro dei dipendenti di un'azienda (accesso a dati ed applicazioni)
- ... le priorità dei Top Executives in qualsiasi compagnia
- ... gli investimenti dei clienti, dei Vendors e dei Business Partners



Il Mobile sta crescendo più di qualsiasi altra tecnologia, migliorando la produttività delle persone e quindi del business

Mobile significa anche “trasformazione”

da

- Spedizione di email, accesso al calendar, social networking
- **Transazioni di base** (acquistare libri, musica, etc.)

a

- Essere capaci di essere sempre in contatto ovunque ed in qualsiasi momento
- Funzionalità di business “in motion” grazie alle **Transazioni Mobile**

Cos'è una transazione mobile ? Lo scambio di qualsiasi informazione che abbia un valore di business

- “Catturare” il comportamento del consumatore
- Programmi di Client loyalty
- Collaboration
- Employee self-service
- Ticketing, booking, check-in
- Pagamenti
- Acquisto di beni o servizi
- Valutazione di un bene ed altre interazioni social
- Firma di documenti legali



Tutte le compagnie siano esse private che pubbliche sono coinvolte in “Transazioni mobile”

Il mobile fornisce opportunità enormi

Business to Enterprise



- **Incrementare:**
 - la produttività aziendale
 - i processi di claim
 - il revenue
 - la velocità nel prendere decisioni
- **Ridurre:**
 - I costi del personale (utilizzando device personali anziché aziendali)
 - Ridurre i costi di carburante, gas, o di manutenzione delle flotte (dove applicabile)
- **Estendere** app esistenti a personale mobile
- **Risolvere** issues IT più velocemente

Business to Consumer



- **Migliorare:**
 - customer satisfaction
 - Relazione con i clienti
 - Customer service
 - Competitività sul mercato
 - Immagine
 - Servizi virtuali affiancati a quelli reali
 - Le vendite attraverso offerte personalizzate
- **Approfondire la conoscenza del cliente** studiandone il suo comportamento sul mercato

Gli obiettivi primari tra applicazioni B2C e B2E sono differenti

Business to Consumer

Conoscere il contesto

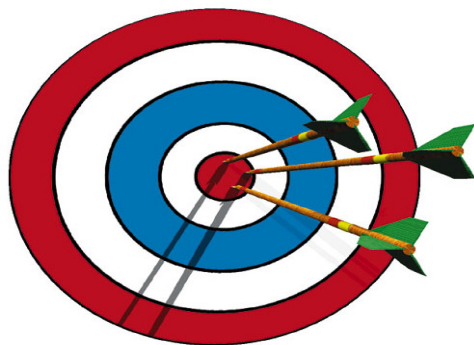

Incrementare la “**CUSTOMER LOYALTY**” puntando sulle giuste esigenze e necessità fornendo **UNICITA’ E TEMPESTIVITA’**

Business to Enterprise

Mobilità legata ai processi business

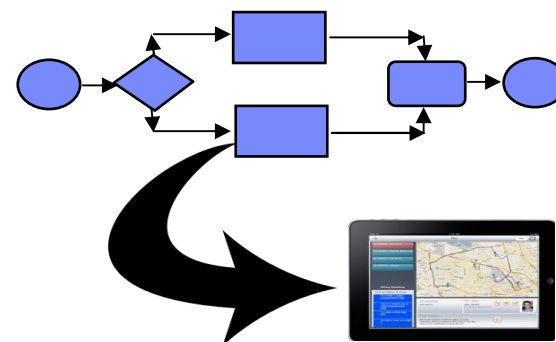

Migliorare ed incrementare l’efficienza dei **processi** recependo ed automatizzando le iterazioni di processo **IN QUALSIASI MOMENTO ED IN QUALSIASI LUOGO**

Un nuovo modo di fare shopping grazie al Mobile

1. Definire una shopping list

- Pre-popolare una lista basata sulla storia del cliente
- Essere a conoscenza delle vacanze o di date particolari
- Fornire suggerimenti basati su scelte ed azioni precedenti (comportamento)

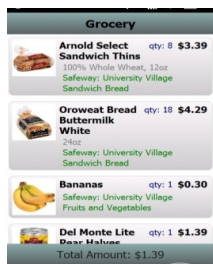

6. Utilizzare il prodotto

- Recepire commenti e feedback



5. Pagare il prodotto

- Self scan barcodes nel negozio utilizzabili tramite smartphone
- Eseguire un pagamento mobile



2. Check sugli store

- Assicurarsi che i prodotti siano presenti

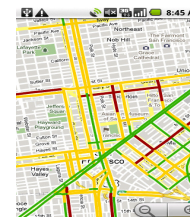

3. Visitare uno store

- Fornire informazioni su come raggiungere un negozio
- Fornire indicazioni all'interno del negozio

4. Selezionare i prodotti

- Identificare caratteristiche specifiche:
 - Allergie
 - Diabete
 - Calorie
- Verificare il prezzo





Chi dominerà il mercato del mobile ?

1995 Palm

500,000 units sold in 6mths.
70% market share



2001 Nokia

40% Market share of all
mobile phones



2008 RIM

Fastest growing stock. 56%
of smartphones, 77% 3yr
CAGR (19.7% share in 10/11)



2011 Apple

Most valuable company in
the world, 27.3% of
US smartphones



2013+ Microsoft ?

2013+ Android

43.7% of the US
smartphone market 10/11





Sviluppare Enterprise mobile: punti d'attenzione



- Mobile è ormai strategico, è necessario quindi avere un approccio
- strutturato sia per lo sviluppo che per il delivery.

Approcci	Punti deboli
100% Sviluppo Nativo – si utilizzano linguaggi nativi delle varie piattaforme (es. Objective C con SDK Apple per iOS)	<ul style="list-style-type: none">• Sviluppo e manutenzioni costosi• Time to market elevato & limiti nella scalabilità dello sviluppo• Risorse costose
Sviluppo app ibride – si adottano linguaggi open source e strumenti come HTML5/JS/CSS3 e PhoneGap	<ul style="list-style-type: none">• Mancanza di funzionalità di livello enterprise• Accesso limitato alle funzionalità dei dispositivi• Nessuna integrazione con il back end o con i service
Piattaforme di prima generazione per creare Applicazioni Enterprise (MEAP) – come ad esempio KONY, Antenna Software, Verivo e Sybase SUPP	<ul style="list-style-type: none">• Strumenti di editing WYSIWYG IDEs limitati• Linguaggi di scripting limitati e scalabilità limitata nello sviluppo• Mancanza di un ROI efficace



Le principali sfide del mobile enterprise

Produrre app multi piattaforma

- Insieme altamente frammentato di piattaforme,, devices, form-factors, linguaggi di sviluppo, APIs, e tools
- Il modello di programmazione nativa non è portabile
- Soluzioni tradizionali da web a mobile non idonee



Accelerare il time to market

- Elevato numero di rilasci ed updates
- Sfide nel fornire updates agli utenti finali
- Forte pressione sui team di sviluppo per poter realizzare in tempo e con qualità



Necessità di creare app di alta qualità

- User experience di alta qualità è un requisito
- Qualità influenzata sia dal modo di progettare che dalle funzionalità
- Impiegati e clienti condividono lo

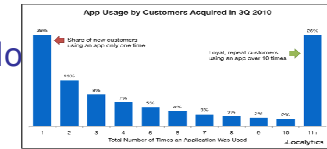

Connettere le apps e i relativi utenti ai servizi e ai sistemi esistenti

- I servizi di back end esistenti e le applicazioni in genere necessitano di essere adattate e/o estese per il mobile Spesso le reti wireless aziendali sono a corto di banda per poter ospitare I device dei dipendenti



E' necessario rendere sicure e sapere gestire le mobile apps

Mobile devices are shared more often

- Smartphone personali e tablets condivisi con la famiglia
- Enterprise tablet condivisi con I colleghi



Mobile devices have multiple personas

- Strumenti di lavoro
- Dispositivo di intrattenimento
- Organizzazione personale
- Profilo di sicurezza ad personam



Mobile devices are diverse

- Immaturità degli OS immaturity per la gestione aziendale
- BYOD impone multi OSs
- Vendor / carrier impongono diverse versioni di OS



Mobile devices are used in more locations

- Un unico luogo in cui offrire connettività privata o pubblica
- Ovunque ed in qualsiasi momento
- Crescente diffusione del WIFI in azienda

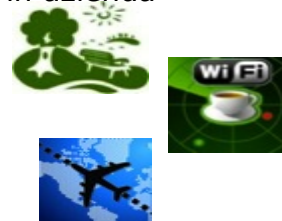

Mobile devices prioritize the user

- Problemi con la user experience non sono tollerate
- L'architettura degli OS agevola l'utente
- Difficoltà nell'imporre policy specifiche



BYOD: Bring Your Own Device

Diverse sfide da affrontare durante il ciclo di vita

Costruire e connettere

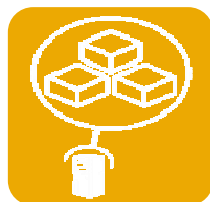

Build mobile applications

Connect & run mobile systems

Gestione e Sicurezza



Manage mobile devices and apps

Secure mobile business

Estendere e trasformare

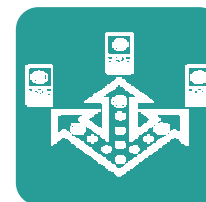

Extend capabilities to mobile devices

Transform the business

Key Capabilities

- Sviluppo applicazioni mobile, ibride e native
- Integrazione di dati aziendali e dei servizi
- Sicurezza applicativa

Key Capabilities

- Gestione del ciclo di vita mobile
- Controllo ed analisi dei dati mobile
- Gestione e sicurezza della comunicazione sulla rete

Key Capabilities

- Soluzioni mobile che includono social, e-commerce e analytics
- Strategia, pianificazione, implementazione
- Mobile come servizio

IBM può soddisfare con successo tutti i criteri di una piattaforma mobile enterprise

- **Aperta:** basata su standard e pronto ad adeguamenti futuri
- **Governata:** sicurezza end-to-end con gestione centralizzata dello sviluppo
- **Integrata:** processi di business pienamente integrati, dai dispositivi Mobile ai sistemi di back-end

Come trasformare le sfide in opportunità

Utilizzo del mobile è in continua crescita

96% year to year increase in mobile cyber Monday sales between 2012 and 2011

Il Mobile permette di eseguire azioni istantanee e continue

90% of mobile users keep their device within arm's reach 100% of the time

Il Mobile modifica la natura delle interazioni tradizionali

90% of users use multiple screens as channels come together to create integrated experiences

Il Mobile + molto più di un semplice telefono cellulare

Global Machine-to-machine connections will increase from 2 billion in 2011 to **18 billion** at the end of 2022

Interazione mobile presenta nuove opportunità

Mobile Commerce is expected to reach **\$119 billion** by 2015



Il Portfolio IBM per il Mobile



Costruire mobile apps
Connettere sistemi per il mobile



Gestire dispositivi mobili ed apps
Sicurezza delle transazioni mobile



Estendere le feature per il mobile
Trasformare i processi

IBM Mobile Foundation



IBM Endpoint Manager for Mobile Devices

IBM Social & Analytics



IBM Connections, SameTime, ECM, Tealeaf

IBM Mobile Services

Mobile Infrastructure Strategy and Planning



IBM Interactive Design

Mobile Enterprise Services for Managed Mobility









Mobile Application Innovation Services



IBM può fornire un offering sul Mobile completa ed integrata

IBM SW offering and Mobile usage scenario

Mapping sulle iniziative Mobile

<p>Worklight</p> <ul style="list-style-type: none"> adopt a comprehensive Mobile platform for development, deployment and management of Mobile applications 	 <p>Build & Connect</p>	 <p>Manage & Secure</p>
<p>Collaboration Solutions</p> <ul style="list-style-type: none"> exploit Multi-channel development and Mobile web delivery promoting the transformation to Social Business 	 <p>Build & Connect</p>	 <p>Extend & Transform</p>
<p>Rational Solutions</p> <ul style="list-style-type: none"> improve Mobile application development supporting all programming models and the full application lifecycle 	 <p>Build & Connect</p>	
<p>Endpoint Manager</p> <ul style="list-style-type: none"> deliver Mobile devices security by providing full visibility, control & automation and implementing BYOD initiatives 	 <p>Manage & Secure</p>	
<p>Security Solutions</p> <ul style="list-style-type: none"> satisfy security requirements for access & connectivity (over the Network & Enterprise) and for Mobile apps 	 <p>Manage & Secure</p>	
<p>ECM, Commerce, EMM, Business Analytics</p> <ul style="list-style-type: none"> extend capabilities to Mobile users and improve workforce, sales, social activities, decisions and interactions analysis 	 <p>Extend & Transform</p>	



IBM Mobile Sviluppo applicativo ed integrazione

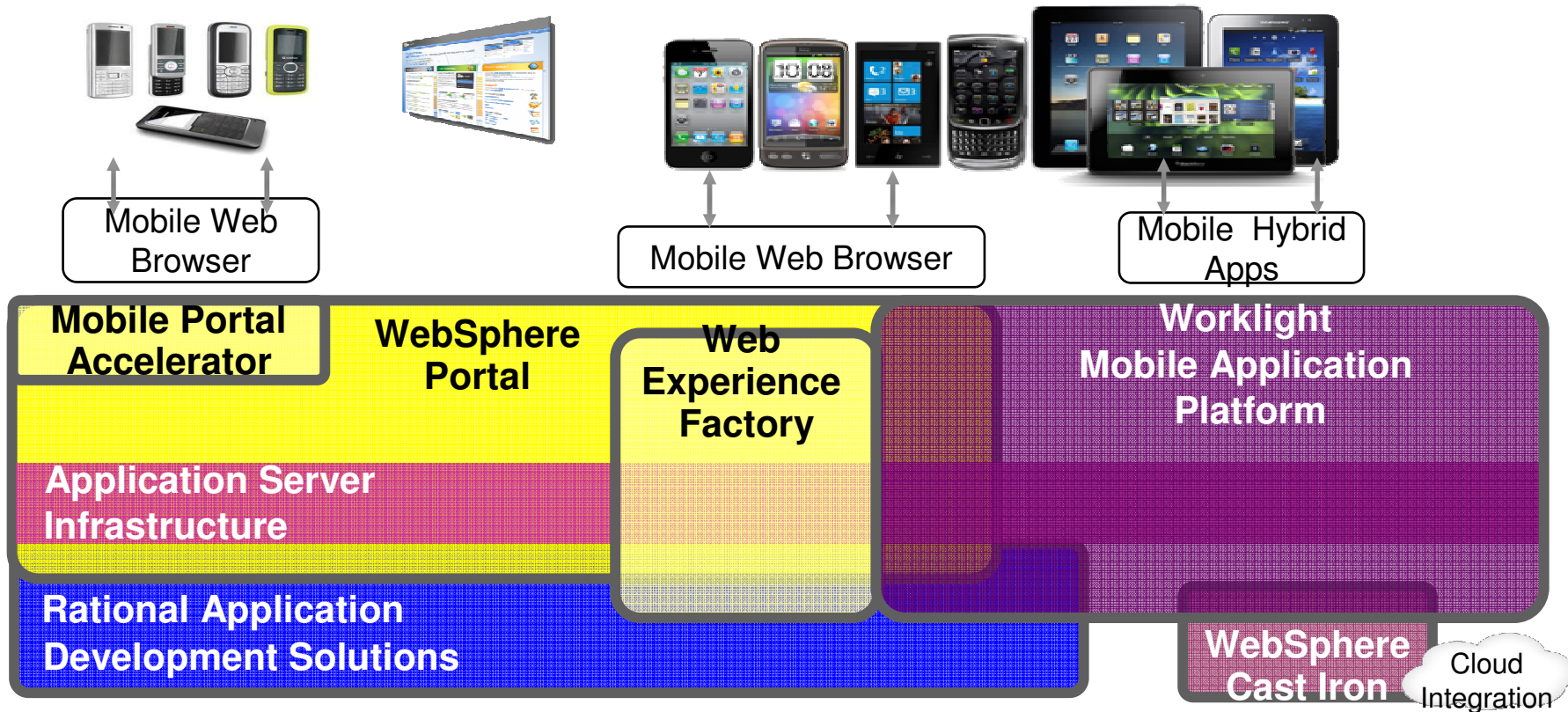

IBM Mobile Foundation: panoramica

New!

IBM Mobile Foundation V5.0.5



Costruire, connettere, gestire e rendere sicure le applicazioni mobile

Include:

- IBM Worklight V5.0.5
- IBM WebSphere Cast Iron
- IBM Endpoint Manager for Mobile Devices 8.2

Worklight: la piattaforma open per creare mobile app



Aperta, avanzata, facile da apprendere, semplice da integrare

- Sviluppo e deploy rapido di Mobile apps, capace di indirizzare anche “Sicurezza e Gestione” applicativa ed inoltre può:
 - Estendere applicazioni esistenti per device mobili
 - Fornire integrazione verso I sistemi di back-end
 - Creare app di qualsiasi natura (web, ibrida, nativa)
 - Installabile ed eseguibile su qualsiasi device mobile
 - Supporta I modelli B2E, B2B, B2C
 - Collezione dati per analisi ti tipo real-time
 - Si integra con soluzioni software IBM:
 - Collaboration Solutions (Portal platform)
 - Rational Application Development solutions
 - Endpoint Management for Mobile Devices
 - Security Solutions (Access Manager, etc.)
 - Cloud integration (WebSphere Cast Iron), ESB (Message Broker), BPM, Appl. Server

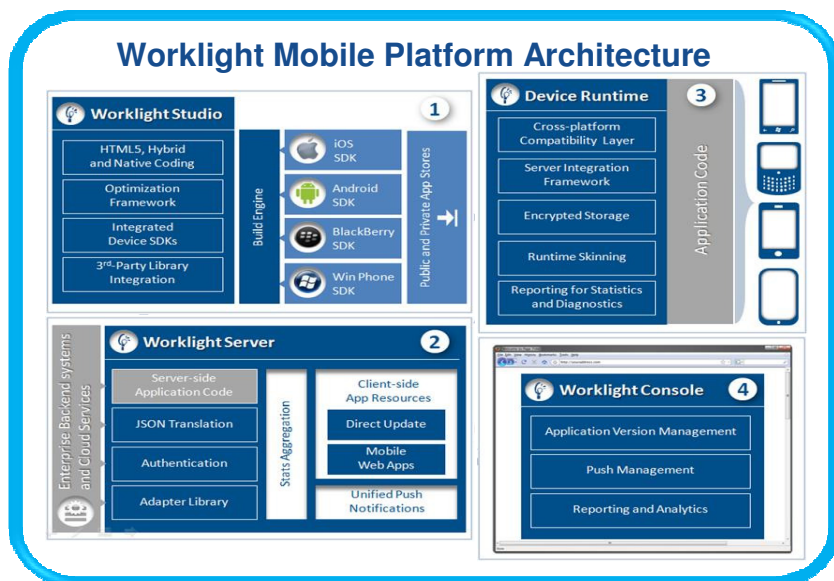

Semplicemente, il modo più rapido di integrare applicazioni in Cloud

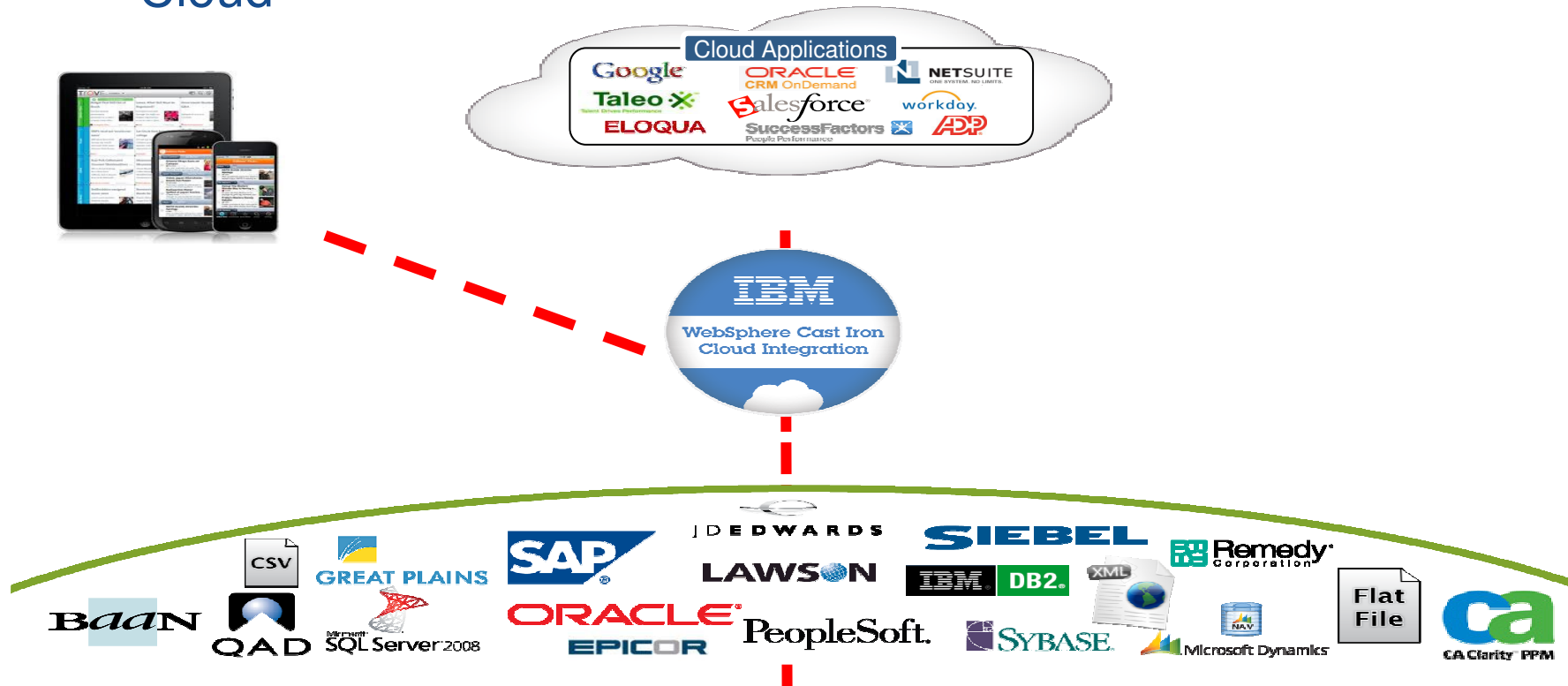



La soluzione IBM per gestire device mobili

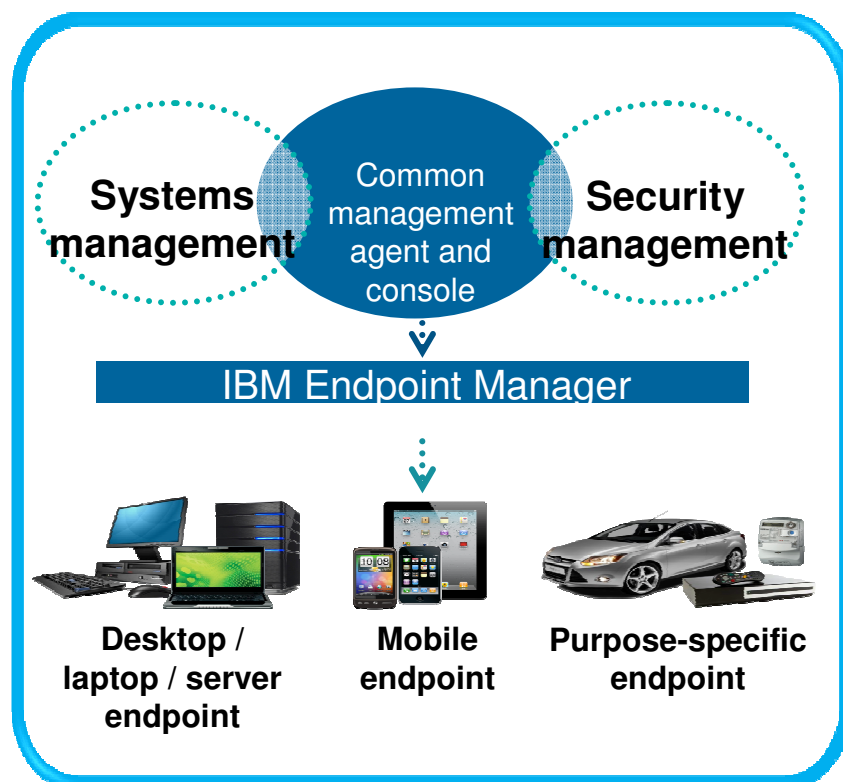

- Indirizzare problematiche legate alla sicurezza del device e garantire alcune policy di sicurezza aziendale:
 - Criptaggio dei dati
 - Rilevare minacce per la sicurezza
 - Tracking dell'uso per poter gestire le spese di connettività
- Creare un asset inventory per le apps, HW, SW O.S.
 - Fornire un application store aziendale
- Integrazione con i sistemi di back-end IT
 - Integrazione con Worklight (per il deploying automatico delle mobile applications)

Soluzioni di collaboration Multi-Canale

**Build &
Connect**

Soluzioni integrate per promuovere rapidamente soluzioni web in modalità mobile fornendo e garantendo una customer experience eccezionale

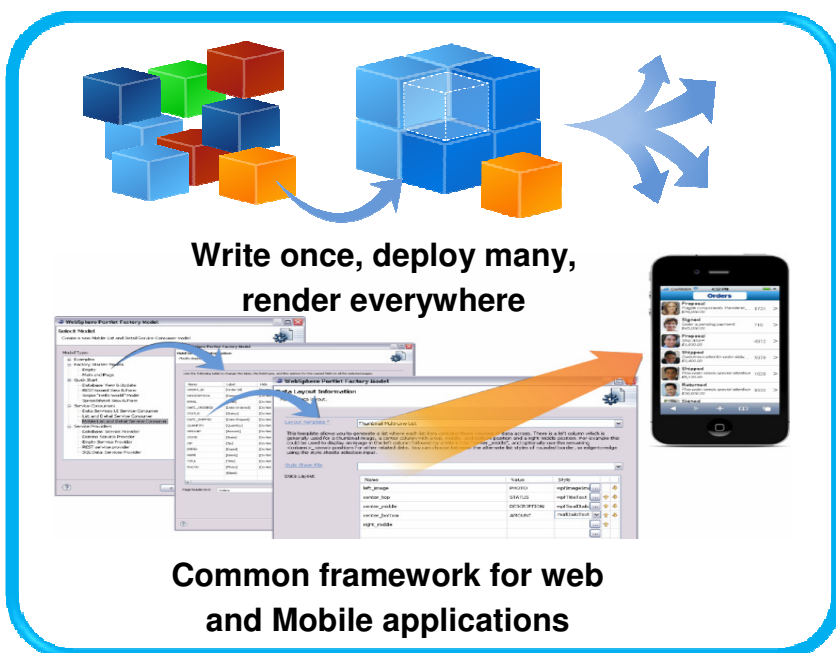

- [Web Experience Factory](#)
- Accelerare lo sviluppo e l'utilizzo di applicazioni multi-canale per desktop e mobile
- Agevolare il riuso degli asset in modo semplice ed automatizzato per valorizzare gli investimenti sostenuti
- [WebSphere Portal](#)
 - Definire una web experiences completa sia per desktop che per dispositivi Mobile, supportando workflows, content management e funzionalità di tipo social
 - Integrazione con Worklight per estendere ulteriormente le capacità verso i device mobili
- [Mobile Portal Accelerator](#)
 - Fornire una presentazione dinamica del portale con tecnologie di rendering che traducono ed ottimizzano i contenuti in base alle specifiche funzionalità del dispositivo

Soluzioni per il controllo del ciclo di vita delle applicazioni mobile



**Piattaforma per lo sviluppo enterprise
che supporta tutti i modelli di
programmazione mobile**

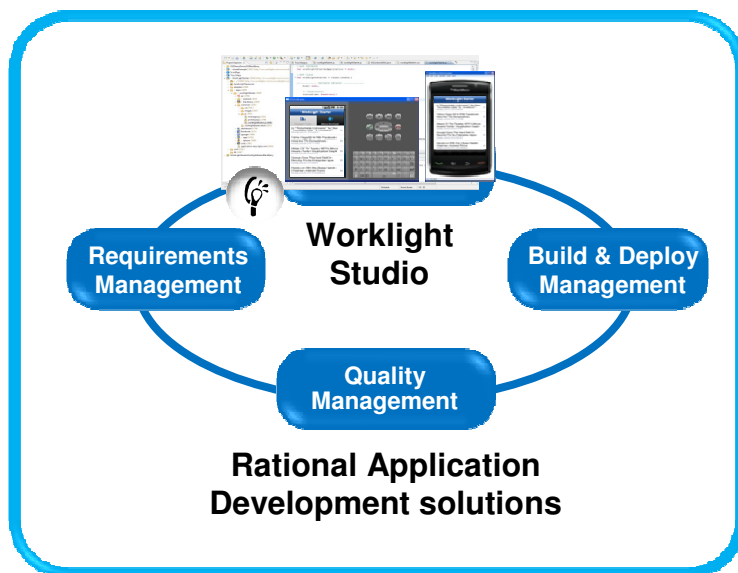

- Mobile Development Lifecycle Solution
 - Basato sulle funzionalità fornite da Rational Collaborative Lifecycle Management + Worklight (package for development)
 - Supporta il ciclo di vita completo per le applicazioni mobile (requisiti, design, sviluppo, test, deploy, gestione)
 - Enable teams to develop and deliver multiplatform Mobile applications
 - Accelera la produttività di teams enterprise con lo sviluppo di best practices e di configurazioni per il test integrato
 - Riduce il costo per lo sviluppo ed i test
 - Integrazione con Worklight (Rational Team Concert and Worklight forniscono un “ambiente di sviluppo” controllato per le applicazioni mobile)
- Altri tools Rational
 - Fornisce ulteriori funzionalità per accelerare lo sviluppo di applicazioni mobile



© Copyright IBM Corporation 2012. All rights reserved. The information contained in these materials is provided for informational purposes only, and is provided AS IS without warranty of any kind, express or implied. IBM shall not be responsible for any damages arising out of the use of, or otherwise related to, these materials. Nothing contained in these materials is intended to, nor shall have the effect of, creating any warranties or representations from IBM or its suppliers or licensors, or altering the terms and conditions of the applicable license agreement governing the use of IBM software. References in these materials to IBM products, programs, or services do not imply that they will be available in all countries in which IBM operates. Product release dates and/or capabilities referenced in these materials may change at any time at IBM's sole discretion based on market opportunities or other factors, and are not intended to be a commitment to future product or feature availability in any way. IBM, the IBM logo, Rational, the Rational logo, Telelogic, the Telelogic logo, and other IBM products and services are trademarks of the International Business Machines Corporation, in the United States, other countries or both. Other company, product, or service names may be trademarks or service marks of others.



IBMSoftwareNetwork2013
Fare partnership con il Software IBM



BACKUP

Panoramica architettura

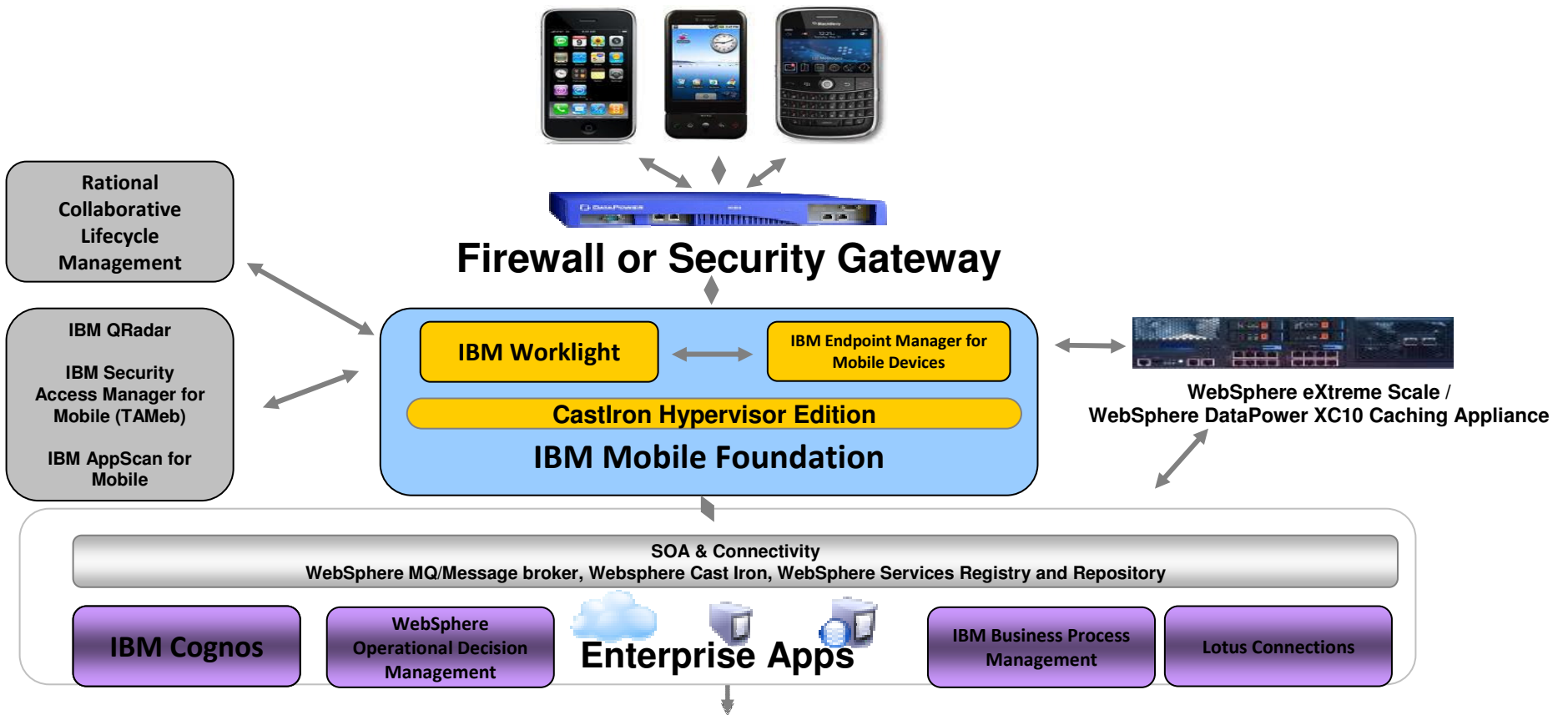



IBMSoftwareNetwork2013
Fare partnership con il Software IBM



Worklight: sviluppo, esecuzione e test delle applicazioni mobile



IBM Worklight



Worklight Studio

La piattaforma di sviluppo completa ed estendibile che permette il riutilizzo totale del codice (riuso) e l'ottimizzazione sulla base del dispositivo target

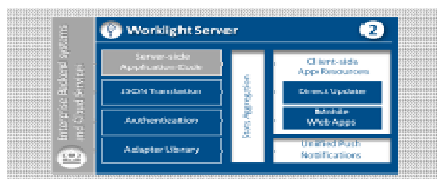

Worklight Server

Il middleware che ospita **notifiche push**, gestione delle versioni, la **sicurezza** e l'**integrazione** tramite adapters

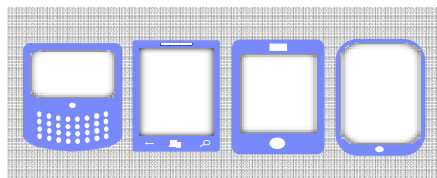

Worklight Runtime Components

Diverse librerie ed APIs che s'interfacciano con funzioni native dei dispositivi e del server Worklight



Worklight Console

Un cruscotto web per visualizzare analisi statistiche real time ed avere il controllo delle apps e dell'infrastruttura

IBM Worklight V5.0.5

- **Mobile OS:**



- Android 2.2, 2.3, 3.0, 4.x
- iOS dalla 4 in su
- BlackBerry dalla 6 in su (no 10)
- Windows Phone 7.5
- JME devices

- Supporto librerie **JavaScript** :

- Dojo Mobile (bundled);
- JQuery Mobile (bundled)



- Sencha Touch (supporto)

- Notifications: push ed SMS
- Sicurezza applicativa
- Cripting dei dati
- OffLine: data synchronization, client/server e viceversa
- Application Center
- Console analisi dati statistici



- Piattaforme che possono ospitare il server Worklight:

- All but z/OS (SOD) - Linux (incl z/Linux), AIX, Windows

- Application server

- Liberty (bundled)
- WAS 7 / 8 / 8.5 Base & ND, Tomcat (opzionale)



- Integrazione via adapter per databases:
 - Derby (bundled) ; DB2, MySQL, Oracle (opzionale)
- Integrazione via adapter per servizi Http:
 - Rest
 - Soap
- Adapter Cast Iron
- Adapter JMS
- Integrazione con DataPower
- Integrazione con tool di BI & Analytics (Cognos, Coremetrics) 1st Phase



Worklight: modelli di sviluppo applicativo

Web

Scritte in HTML5
JavaScript and CSS3.
Sviluppo rapido ed economico, ma meno efficace delle native

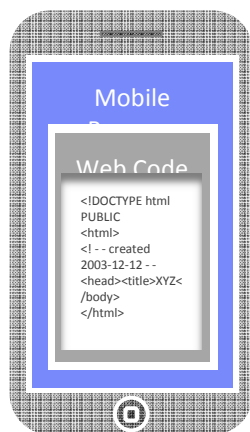

Browser Access

Apps Ibride - Web

Codice HTML5 e librerie runtime di Worklight impaccettate all'interno delle app ed eseguita all'interno di una shell nativa

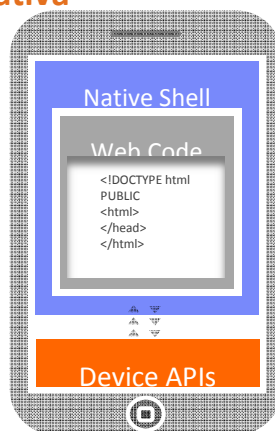

Downloadable

Apps Ibride - Miste

Introdurre nel codice web quello nativo per esigenze specifiche e ricavare il top per la user experience.

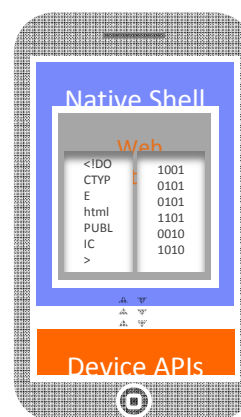

Downloadable

Apps Native

Piattaforma specifica. Richiede esperienza e skill unici. Costi elevati e tempi di sviluppo più lunghi. Top user experience.

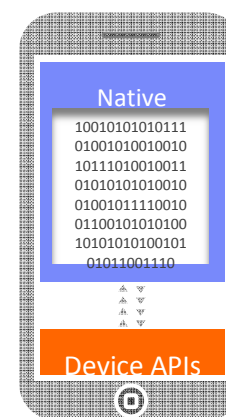

Downloadable

Vantaggi nell'adozione di applicazioni ibride



- Facile da imparare e da utilizzare
- La stessa UI delle app native
- Conveniente in termini di costi
- Time to market rapidissimo
- Utilizzo di tutte le funzionalità del dispositivo mobile
- Unico codice per tutte le piattaforme

Ritorno d'investimento significativo adottando IBM Worklight come piattaforma

Fattori chiave d'efficienza Worklight:

- Competenze per lo sviluppo web facilmente reperibili sul mercato e a basso costo
- Condivisione del codice comune per tutte le piattaforme
- Ottimizzazione elevata ed efficiente delle apps
- Utilizzo di librerie UI pronte all'uso con supporto di editor visuali
- Riutilizzo della connettività enterprise e layer d'integrazione
- Componenti Out-of-the-box di sicurezza ed autenticazione

ROI (ritorno d'investimento):

- Riduce l'effort nello sviluppo su 2 e 3 dispositivi (oltre il 90%)
- I costi si riducono con l'incremento di apps
- Riduce i costi relativi all'integrazione e all'infrastruttura mobile (effort minimale)
- Bassi costi relativi alla manutenzione e all'update delle apps
- Time to market per lo sviluppo di apps rapidissimo (settimane non mesi)

Confronto tra applicazioni mobile Native vs Ibride

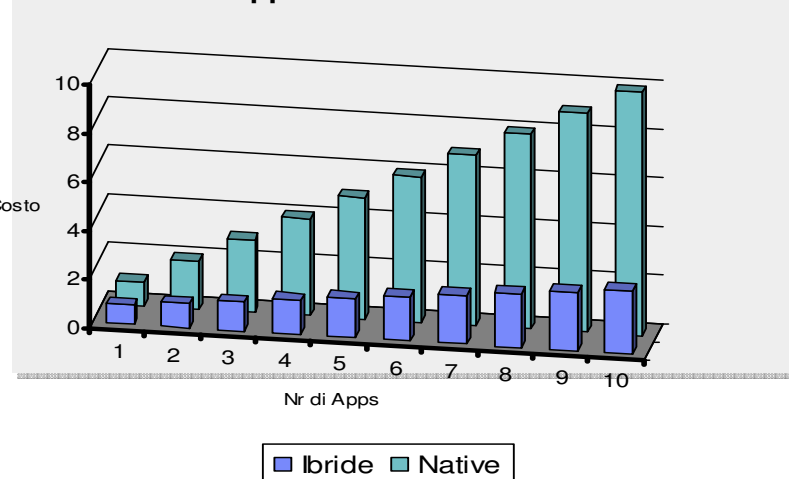



Integrazione con Rational Team Concert (RTC)

New and Enhanced!

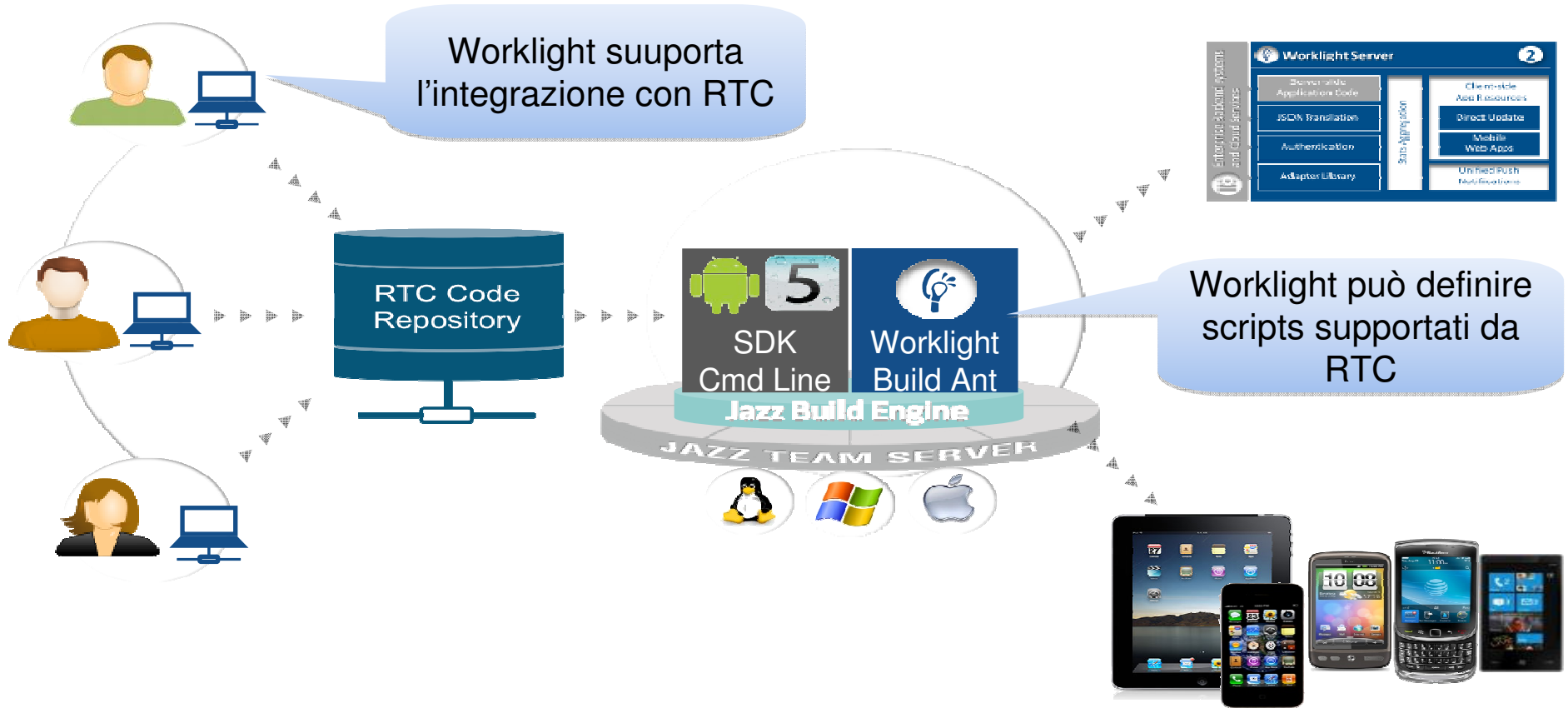



IBMSoftwareNetwork2013
Fare partnership con il Software IBM



Endpoint Manager per mobile: la gestione dei dispositivi mobili



Le domande cui rispondere per essere pronti al BYOD

Sicurezza/Privacy:

- Come metterai in SICUREZZA i Mobile Devices?
- Hai definito e pronte le POLICIES di utilizzo e gestione?
- Hai definito un piano di COMUNICAZIONE e CONSAPEVOLEZZA delle policy?

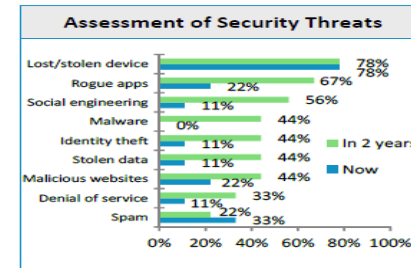

Sviluppo ed Integrazioni delle Applicazioni

- Hai bisogno di APP STORE PRIVATO?

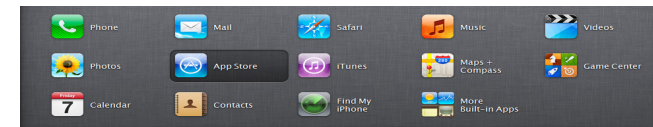



BYOD – Gestire e mettere in sicurezza i mobile devices

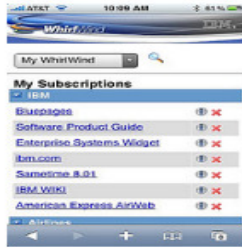

- ✓eMail
- ✓Contacts
- ✓Calendar
- ✓Intranet Access
- ✓Sensitive Personal Information
- ✓Other?

- ✓Security Policy
- ✓Password
- ✓Device Timeout
- ✓Disk Encryption
- ✓Malware Protection
- ✓Other?

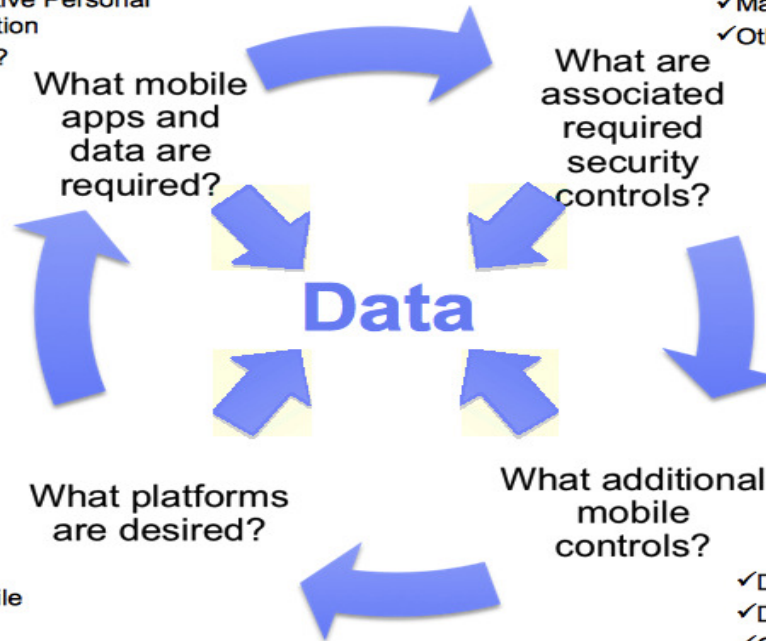
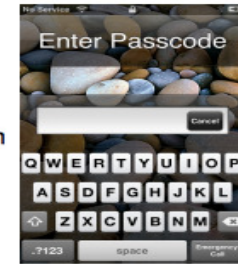

- Blackberry
- Windows Mobile
- Symbian
- iOS
- Android

- ✓Data Wipe
- ✓Device Kill
- ✓Other?





PCs e mobile devices hanno molti aspetti gestionali in comune

Traditional Endpoint Management

- OS provisioning
- Power Mgmt

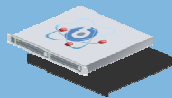

Mobile Device Management

- Device inventory
- Security policy mgmt
- Application mgmt
- Device config (VPN/Email/Wifi)
- Encryption mgmt
- Roaming device support
- Integration with internal systems
- Scalable/Secure solution
- Easy-to-deploy
- Multiple OS support
- Consolidated infrastructure
- Device Wipe
- Location info
- Jailbreak/Root detection
- Enterprise App store
- Self-service portal



Gestire i Mobile Devices – Il Problema

Problematiche di gestione & sicurezza

- potenziale accesso non autorizzato (device perso, rubato)
- encryption dei dati disabilitata
- device non sicuri che accedono la rete
- perdita e/o condivisione dei dati aziendali

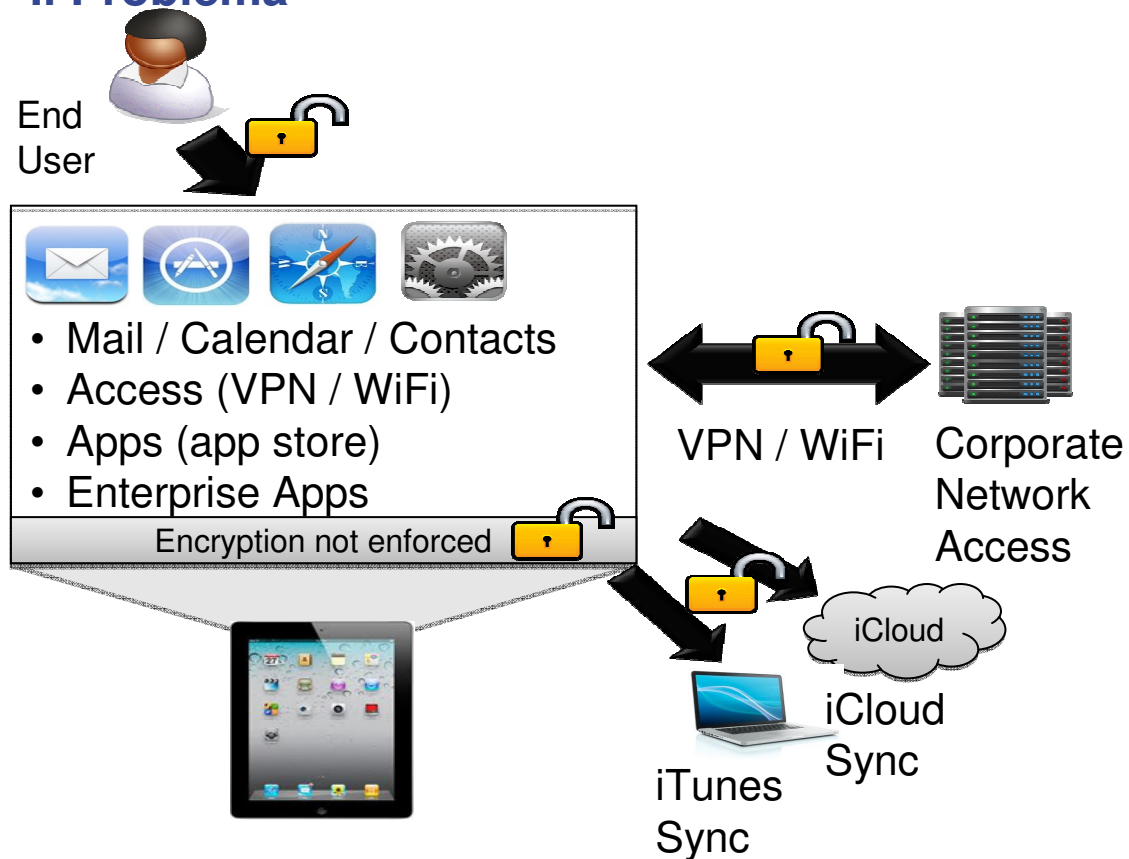



Gestire i Mobile Devices – La Soluzione

Endpoint Manager for Mobile Devices

- Gestione di password policies
- Configurazione device encryption
- Force encrypted backup
- Disable iCloud sync
- Configurazione profili di accesso to corporate email, apps, VPN, WiFi e validazione loro compliance!
- Wipe selettivo dei dati aziendali
- Wipe completo del device

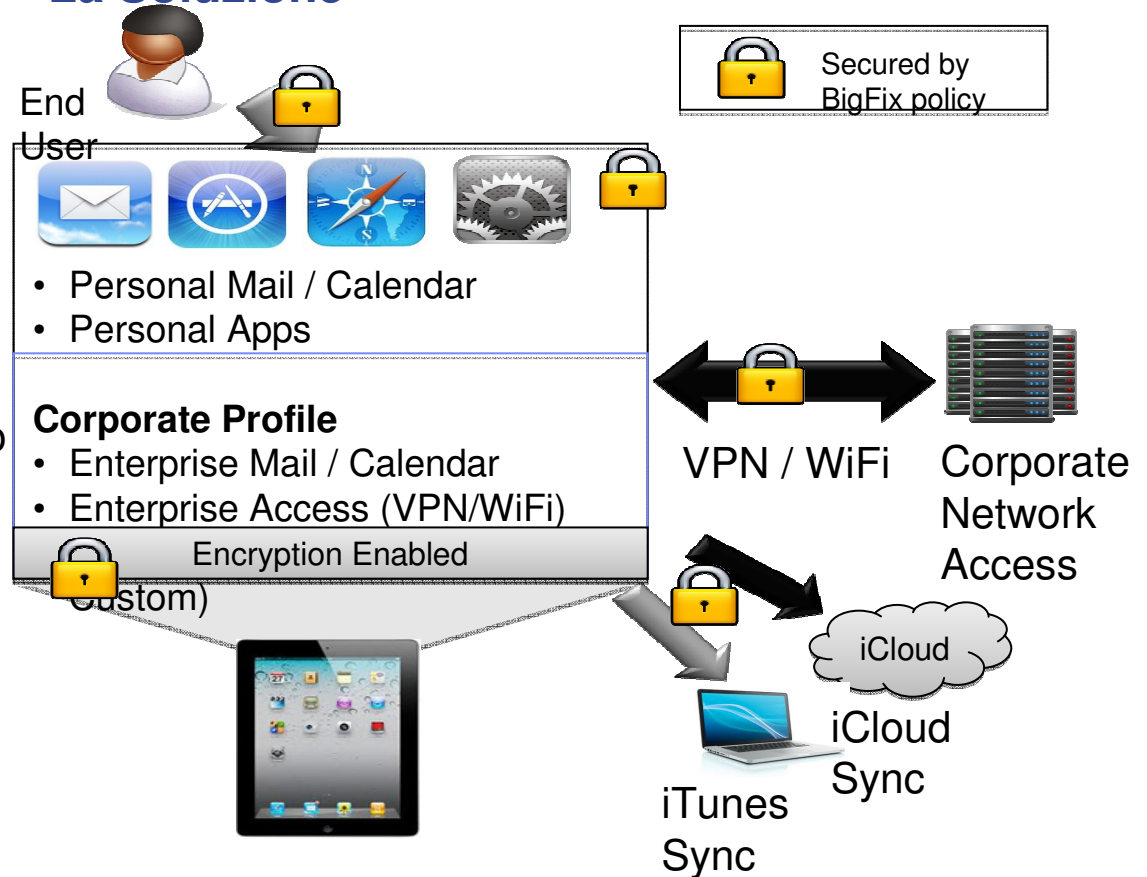



IBMSoftwareNetwork2013
Fare partnership con il Software IBM



IBM WebSphereCast Iron

il middleware di integrazione verso i sistemi di back end



Template Integration Processes (TIPs)

Nessuna codifica

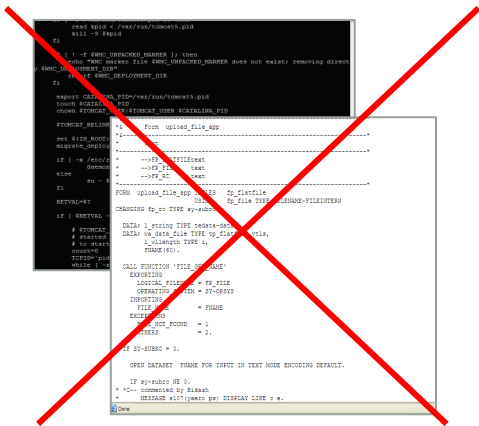

...ma solo configurazione

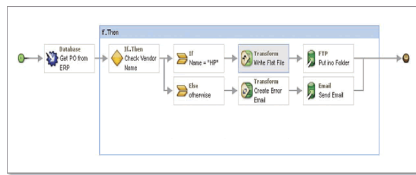
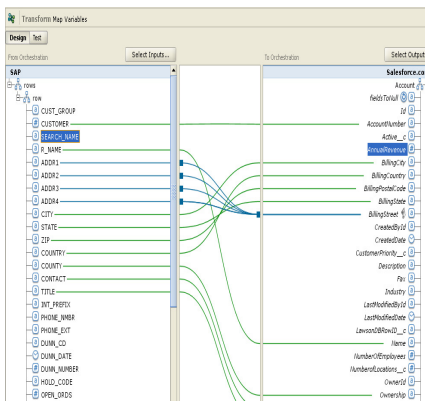

Templates Integration Processes (TIPs) preconfigurati

 **Configuration**

1. Introduction
2. Oracle Table Creation
3. Edit Configuration Properties
4. Verify Oracle connectivity
5. Update the Oracle Table Information
6. Map the Database fields
7. Sample Input Data
8. Verify Integration

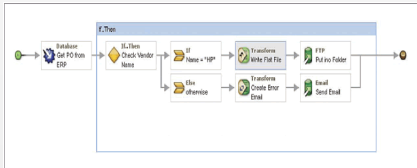

Connettività rapida, semplice e flessibile per le Mobile Apps WebSphere Cast Iron Hypervisor Edition

processi (IIP's) per connettere mobile apps ai sistemi di backend & cloud, riducendo i costi di progetto fino a 80%

- Connettività e business logica bidirezionale la fine di incrementare la qualità del dato ed ottimizzare i processi di business
- Monitoraggio centralizzato per tutti i progetti di connettività
- Semplice e flessibile, user-friendly, wizard-based, l'architettura basata sul concetto "configuration, not coding" consente di poter replicare progetti d'integrazione mobile

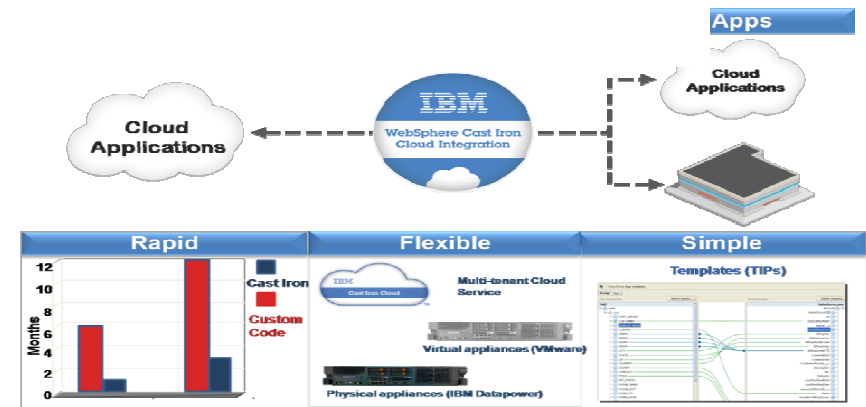

Integrazione semplice e flessibile, permette di integrare rapidamente sistemi di back-end e SaaS con applicazioni di tipo mobile

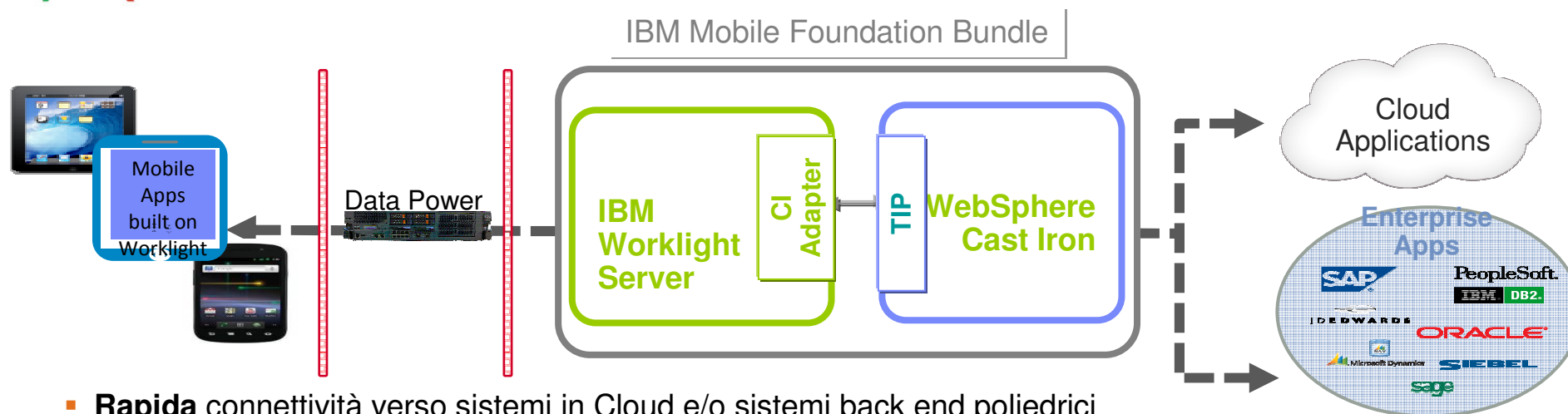

- **Rapida** connettività verso sistemi in Cloud e/o sistemi back end poliedrici
 - Ricezione di dati Real-time da centinaia di applicazioni aziendali per apps Mobile costruite con Worklight
- **Optimizzazione** per scenari di integrazione verso Worklight
 - Worklight Cast Iron adapter per comunicare in maniera trasparente con Cast Iron (JSON/Rest)
 - Modelli (template) Cast Iron (TIPs) per integrare sistemi verso Worklight
- **Sicurezza** in testa alla catena
 - Sicurezza, accelerazione e scalabilità utilizzando gli appliances Data Power



IBM Software Network 2013
Fare partnership con il Software IBM



Modello di licenze



Licenze

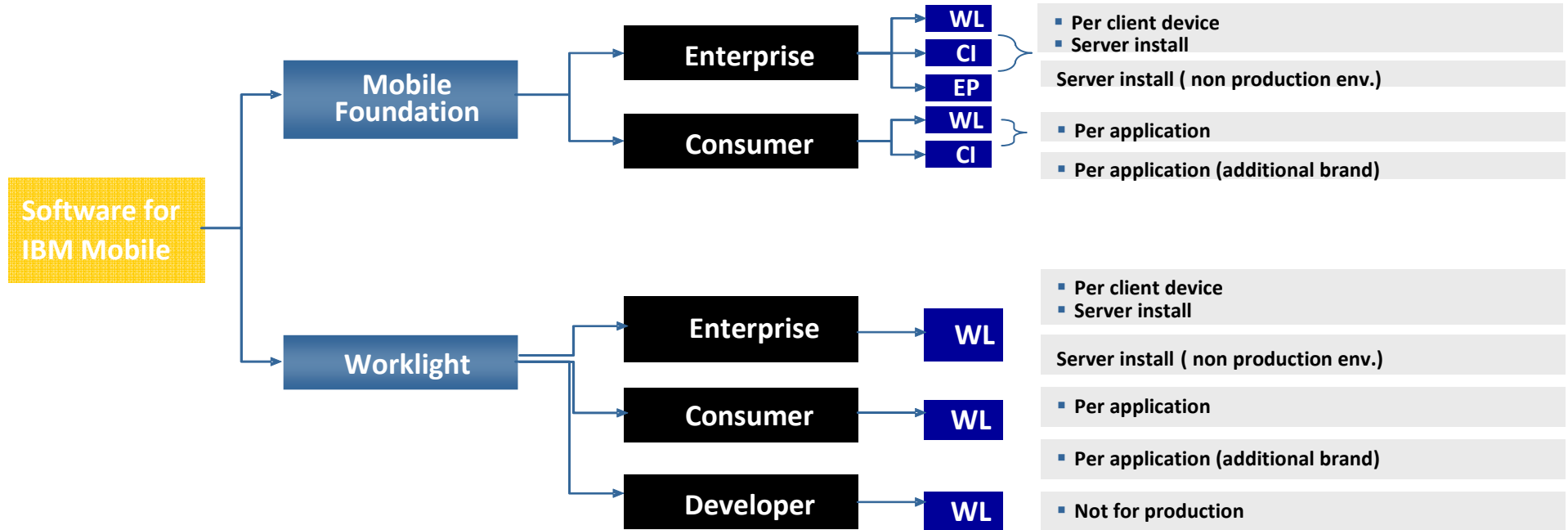

Enterprise

Numero illimitato di app, numero predefinito di mobile devices, numero illimitato di mobile OS

Consumer

Numero illimitato di utenti, numero illimitato di mobile devices

WL	Worklight
CI	Cast Iron
EP	Endpoint Manager



IBM Software Network 2013
Fare partnership con il Software IBM



Referenze

Storie di successo: TBC Corporation

Nation's largest vertically integrated marketer of tires delivers B2C and B2E mobile apps

The Need:

- Marketing and commerce teams began evaluating the mobile channel as a means to **create new revenue and brand differentiation opportunities**.
- Support the growing need of customers to engage in **mobile commerce via a store locator application**
- **Address the BYOD** trend in the market and enable their employees to access relevant backend data on the go

The Solution:

- IBM Worklight helped in-house development team to create 5-6 apps in the initial phase and more going forward.
- Hybrid HTML5 apps delivered to +6000 associates under the TBC brand and millions of end-users

The Benefit:

- Support large scale mobile development (9-12 apps)
- **Maintain complete control of advanced user experience using commonly available web development skills**
- **Rapid integration with enterprise data and infrastructure** with Worklight's middle-tier integration layer
- Strong coverage of **B2E and B2C** mobile requirements

See the video: [TBC & Worklight Video](#)



*“Abbiamo stimato che lavorando con la piattaforma Worklight abbiamo già risparmiato **tra l'80%-90% solo per i tempi di sviluppo relativi ai 3 device target**”*



Storie di successo: TBC Corporation

From outline ...

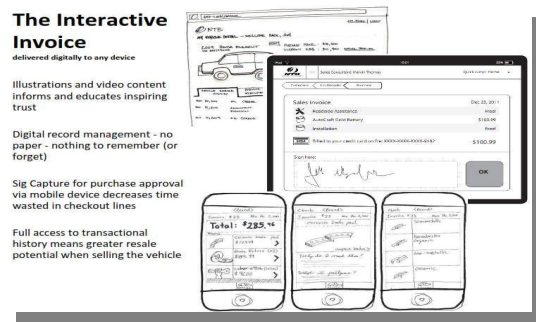
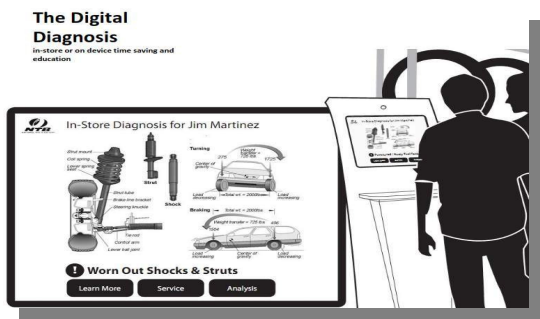

... to app

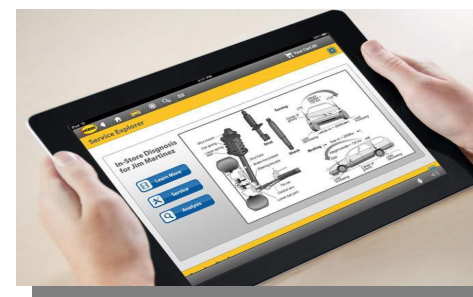

“21 Days from installation to 3 applications in beta”

“No New Resources - full lifecycle process using existing design, development, QA, and infrastructure team”



Customer Story: Lotte Credit Card

Augmenting offerings with a mobile platform

The Need:

- Korean companies are facing a demand for mobile apps from over 7 million smartphone users, up from only 800,000 in 2009, forcing them to vigorously explore options for value-added services.

The Solution:

- To capitalize quickly on this rapidly growing trend, Lotte Credit Card turned to IBM Worklight to develop an advanced application with a rich and engaging user experience using over 100 screens, location-based features and scannable mobile coupons. The application incorporates augmented reality components—a first in the region—helping users find the retail locations of its reward partners on the go.

The Benefit:

- Reduced time to market and associated costs
- Deployment of one of the region's most advanced financial mobile applications
- Enabling better customer and employee user experience across more devices

“We chose IBM Worklight because it was the best technology for Lotte to consolidate application development, enhancement and maintenance, while ensuring cost savings and timely delivery to our customers.”

—Kim, Young Sam, IT Planning Team Leader, Lotte Credit Card

Solution components:

- IBM Worklight
- Finance All Solutions (FAS)

Customer Story: Lotte Credit Card



Hybrid app with +150 screens merging native and web-based coding





IBM Software Network 2013
Fare partnership con il Software IBM



Risorse Mobile Foundation

Risorse IBM Mobile Foundation

- IBM Mobile Enterprise:
<http://www-01.ibm.com/software/solutions/mobile-enterprise/>
- IBM Mobile Foundation: www.ibm.com/software/mobile-solutions
- IBM WebSphere Cast Iron: [WebSphere Cast Iron](http://www.ibm.com/software/cast-iron)
- IBM Endpoint Manager per dispositivi mobili:
<http://www-142.ibm.com/software/products/us/en/ibmendpmanaformobidevi>
- Prova la IBM Worklight Developer Edition, è [Edition 5.0](http://www.ibm.com/worklight)





IBMSoftwareNetwork2013
Fare partnership con il Software IBM



Confronto con la « Competition »

Key Differentiator : Industry Standards

Critical for long term costs and IP ownership

- Worklight utilizza un modello di programmazione basato su standard / la Competition utilizza in generale linguaggi proprietari
- IBM stima un risparmio in termini di effort che si aggira dalle 3 alle 5 volte più basso

IBM Worklight	Competition
<ul style="list-style-type: none"> • IBM Worklight uses Open frameworks – like JQuery mobile, Sencha Touch, Dojo mobile or others • Uses HTML5, JS, CSS for GUI code 	<ul style="list-style-type: none"> • Use Custom widgets and proprietary programming languages • Proprietary Cross-compilers convert above to device specific binary code
<ul style="list-style-type: none"> • Your code is readable by your developers • You can hire developers with skills and partners who can deliver solutions 	<ul style="list-style-type: none"> • Your application is non customizable outside proprietary tools • Pay for special training • Pay for consulting services for changes • Non-portable skills • Poor partner eco-system

Key Differentiator: External libraries

Save development \$ by leveraging third party libraries

- E' possibile sfruttare l'enorme ecosistema di librerie di 3 parti per costruire applicazioni mobile

IBM Worklight	Competition
<ul style="list-style-type: none"> • Worklight provides open standards based integration points • Hence third party libraries can integrate easily • Can be done on client side and server side 	<ul style="list-style-type: none"> • Competition provides a locked model • You generate binary packages from proprietary studio, with limited or no third party extensions
<ul style="list-style-type: none"> • Client side examples – Custom hardware, like scanner, printer, card reader, superior encryption, extended offline caching • Server side libraries – Custom encryption / decryption, caching, 	<ul style="list-style-type: none"> • Pay for any custom extensions • It will be added to studio and then downloaded to clients (delay + cost)

Key Differentiator: Direct Update

2 days versus 4 weeks to issue critical patch / security update

Problema:

- Intervenire rapidamente su un app in produzione per effettuare attività di fix o improvement

Soluzione:

IBM Worklight	Competition
<ul style="list-style-type: none"> • Incorporate the fix, package the app and deploy all iOS / Android etc. versions 	<ul style="list-style-type: none"> • Incorporate the fix for each environment • Submit for review with each AppStores (4-6 weeks)
<ul style="list-style-type: none"> • Customers launch mBanking app • Worklight client automatically finds new version available • Forces user to download updated version or Quit 	<ul style="list-style-type: none"> • Display updated version in the form of notification • User has an option to upgrade or no.
<ul style="list-style-type: none"> • Mandatory fix applied 	<ul style="list-style-type: none"> • Old application versions continue to exist
<ul style="list-style-type: none"> • Done in 1-2 days 	<ul style="list-style-type: none"> • Done in 4-6 weeks