

# IBM Software Network 2013

## Fare partnership con il Software IBM

Roma, 24 - 25 gennaio 2013

**Alessandro Haag**  
La Gestione del Cloud:  
semplificazione e automazione  
tramite le soluzioni IBM



# Increase business agility by building the workload-optimized cloud

**IBM SmartCloud Provisioning** combines infrastructure and platform capabilities to deliver elastic workload aware management, image lifecycle management and resilient, high-scale provisioning across heterogeneous platforms

## Differentiating capabilities of the business-ready cloud:

1. Accelerate application deployment with workload aware management  
*Reduced standardized topology deployment from over 2 months to 18 minutes*
1. Manage virtual environment with rich image management and analytics  
*40% - 80% labor cost reduction by increasing image/admin ratio efficiency*
1. Avoid vendor lock-in with choice of Hypervisor and Hardware  
*KVM is 24% cheaper in up front server & software costs compared to competition*
1. Improve agility with robust, automated, high-scale provisioning  
*Deploy 100s of new VMs in less than 5 minutes*

## IBM SmartCloud Provisioning

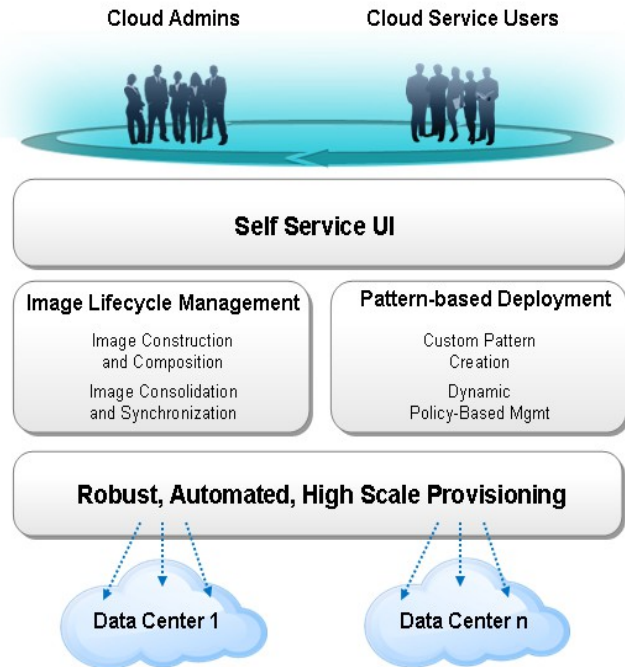

## Components

## Value Proposition

### High Scale Low Touch

Deploy hundreds of virtual machines in an hour; provides automatic recovery and high tolerance to failures in the network. Optimizes admin tasks.

### Virtual Image Library

Provide image management services such as federation, comparison, inventory, search, versioning, replication, portability check and remediation

### Image Construction and Composition Tool

Help build images that are reusable, self-descriptive, customizable, shareable, and manageable. Images can contain the basic operating system plus additional software bundles

### Workload Deployer

Integrated support for virtual systems patterns

### Virtualization Layer

Vendors agnostic: support KVM, Microsoft Hyper-V, PowerVM, VMware, Xen with one single technology

## Lower operational costs by leveraging existing hardware and hypervisors

- **Single management platform** across different infrastructures reduces complexity and operational cost.
- Supports deployment of virtual servers with multiple platforms on **Power and VMWare**
- Design and deploy consistent and repeatable composite applications into a cloud of virtualized hardware running a supported hypervisor : **KVM, Xen, Hyper V, PowerVM**
- Integrates compute, network, storage and application delivery: **enable organizational integration**

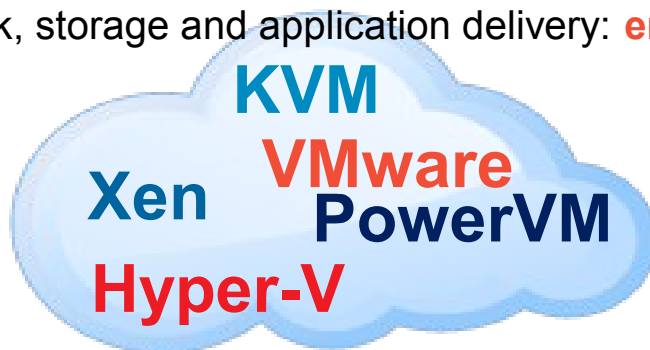

# IaaS and PaaS with SmartCloud Provisioning

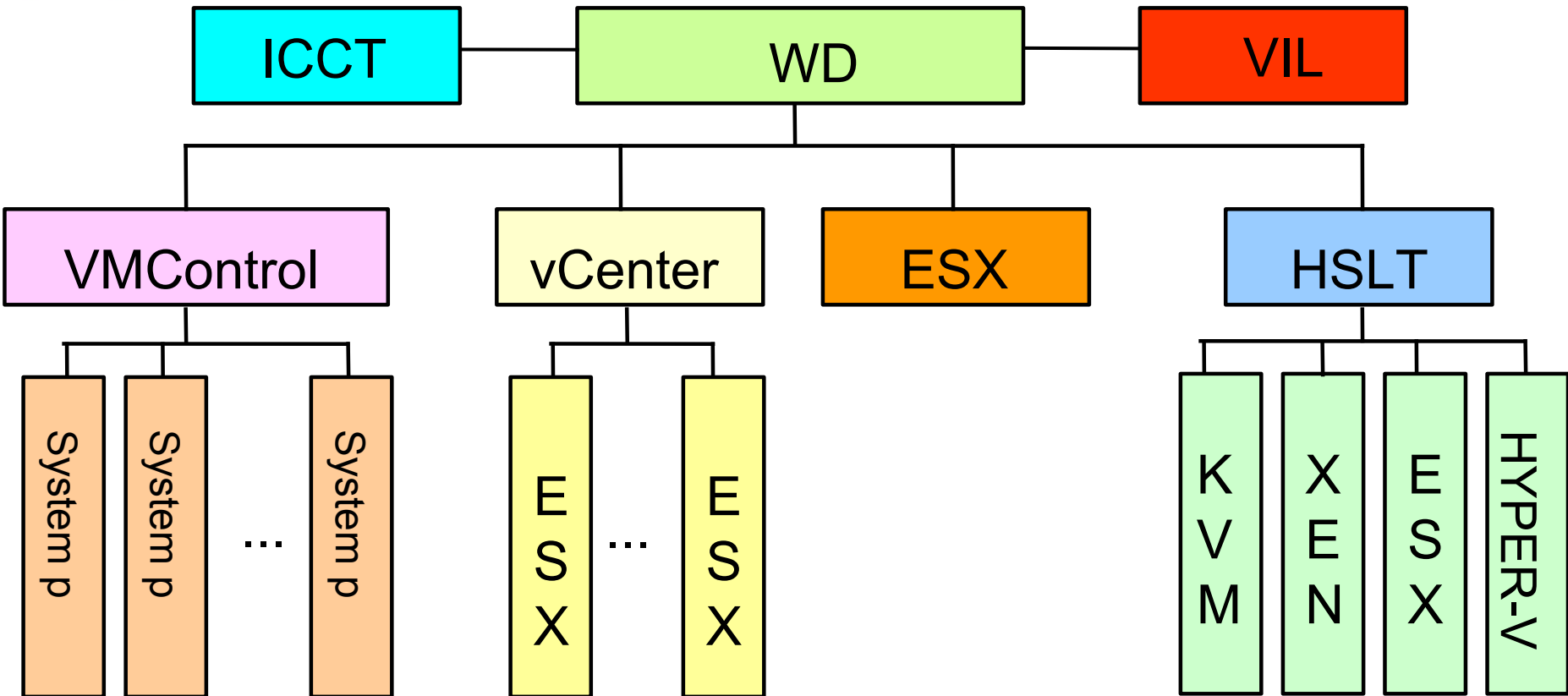

# Respond to business changes quickly with resilient, high-scale provisioning

- **Fast VM provisioning** for near-instant deployment of 100s of virtual machines and scale based on business needs
- **Rich set of web interfaces into the cloud** that can be driven by a user or scripts for complete automation
- **Reliable, non-stop cloud** capable of automatically tolerating and recovering from software and hardware failures
- **Near-zero downtime** due to faults, hypervisor/management software upgrades or addition/removal of hardware



Requested VMs will be up and running under a minute using standard HW

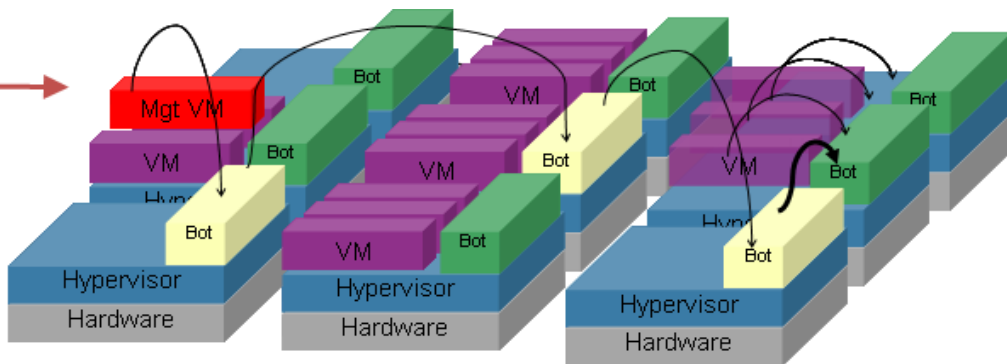

# Innovative cloud architecture: 4 Key Ingredients

## 1. Multiple, load-balanced instances of all services

- Distributed request processing
- Designed to run on lower cost hardware

## 2. Parallel processing against storage

- Serve images and user data (streaming simultaneously from multiple devices like a file sharing network)

End Users

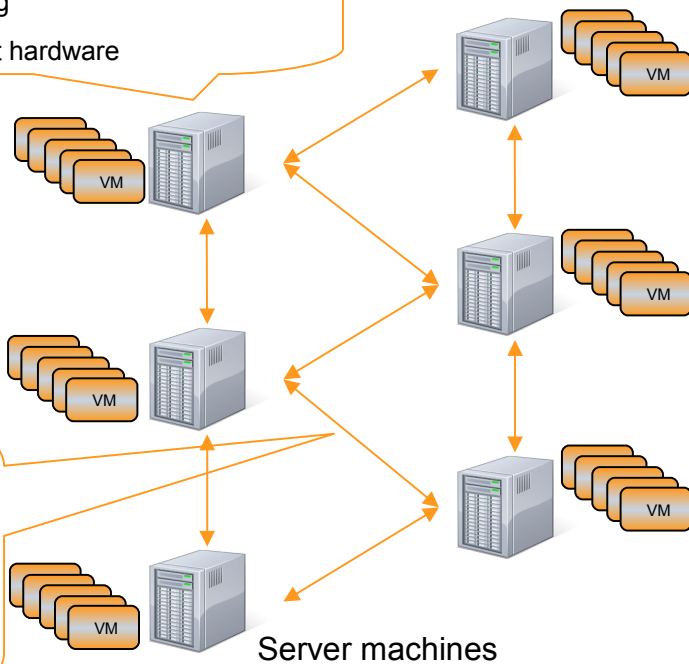

## 3. Self-adapting peer-peer communication and coordination

- All services monitor and restart each other, and dynamically elect the leader

## 4. SW is deployed using network loading and image updating

- Base software is loaded via network boot (PXE)
- Services are images, so update themselves by restarting with new image version

Storage devices (iSCSI)

**No single points of failure, no bottlenecks in data serving/processing, no intervention to repair broken parts!**

# Workload-optimized cloud maximizes business outcomes



• Performance

• Availability

• Isolation

• Security

## Workload placement

*Intuitive load balancing for storage and compute nodes each workload*



## Workload awareness

*Deployment and management in the context of the needs of each workload*



## Workload Optimized

### Characteristics of successful cloud deployments

- ✓ Automatic scalability and on-demand service to respond to business changes quickly
- ✓ Built-in intelligence to track and manage virtual images to increase utilization and efficiency
- ✓ Workload aware management for repeatability and faster deployment



# Workload Deployer Deployment Models

## Custom Images

- Basic execution services for standalone VM images
- Complete control over image contents
- Basic image management/library functions
- IBM provided product images
- Ability to create custom images
- Leverages IBM image management tools

## Virtual Systems

- IBM defined product images and patterns for common topologies
- Ability to create custom patterns
- Traditional configuration and administration model
- Aligned around existing products
- Automated provisioning of images into patterns

## Virtual Patterns

- Application awareness
- Fully integrated software stacks
- IBM defined topologies
- Simplified interaction model
- Highly standardized and automated
- Integrated middleware with cloud capabilities
- Integrated lifecycle management

# Accelerate time to market with repeatable, composite application deployment across private and public clouds

- **Rapid application deployment**: Deploy business applications in minutes
- **Dynamic, policy-based management** of elastic and scalable workloads
- Enables **third-party software deployments** to “build once” and deploy across private and public clouds

## Elastic and Scalable Workloads



## Deploy applications faster



# Virtual System / Patterns

**Pattern creation and deployment:** with a simple drag and drop mechanism it is possible to create patterns representing middleware topologies and deploy them with a few clicks into the cloud

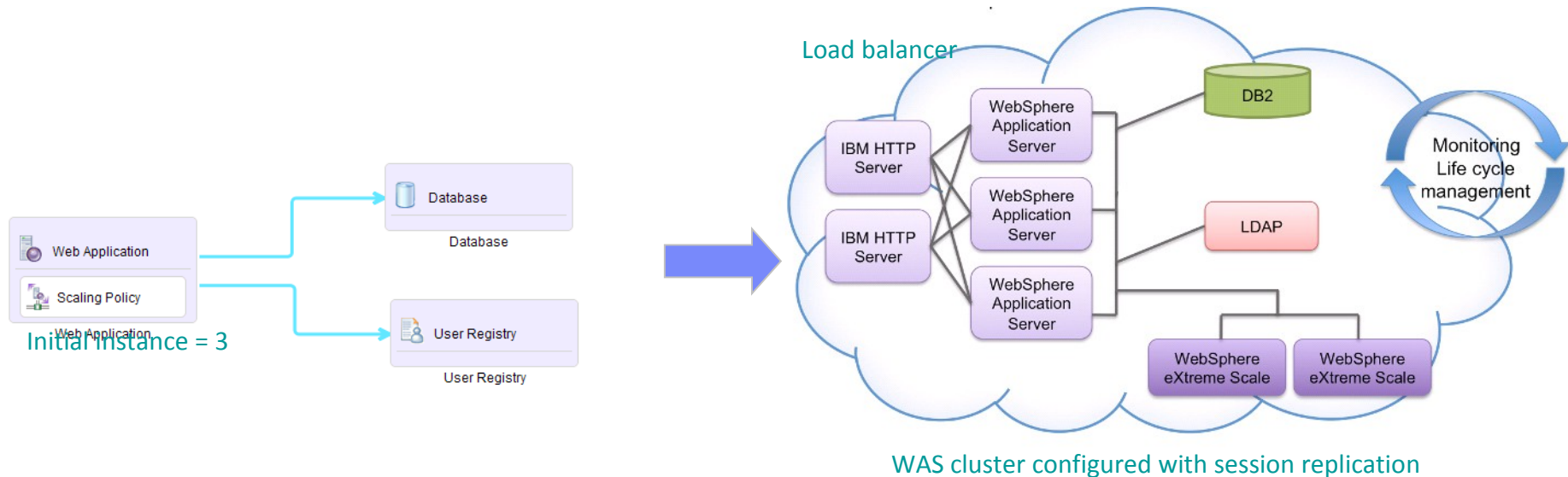

## Manage virtual environments with rich image lifecycle management and analytics

- **Image construction and composition tool** simplifies complex and time consuming process of creating virtual images and deployment through a simple graphical tool
- **Federated image library** allows management of VM image sprawl, drift and image complexity across multiple image repositories and hypervisors
- **Detect vulnerabilities exposures in images** to ensure that no virtual machines are created without the proper level of security patches
- **Images stored in hypervisor-neutral format**, avoiding duplication and allowing conversion to mix/match hypervisor technologies

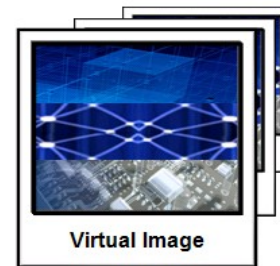

# Construct images with ICCT and SCP as a cloud provider

1. Using ICCT, the Software Specialist creates new Software bundles to extend a base image
2. Using ICCT, the Image Builder selects a base OS image available inside SCP
3. The Image Builder creates a new instance of the selected image in SCP (cloud provider)
4. Using ICCT, the Image Builder installs the selected software bundles
5. The Image Builder captures the new image
6. The new image is now available for deployment via the SCP component

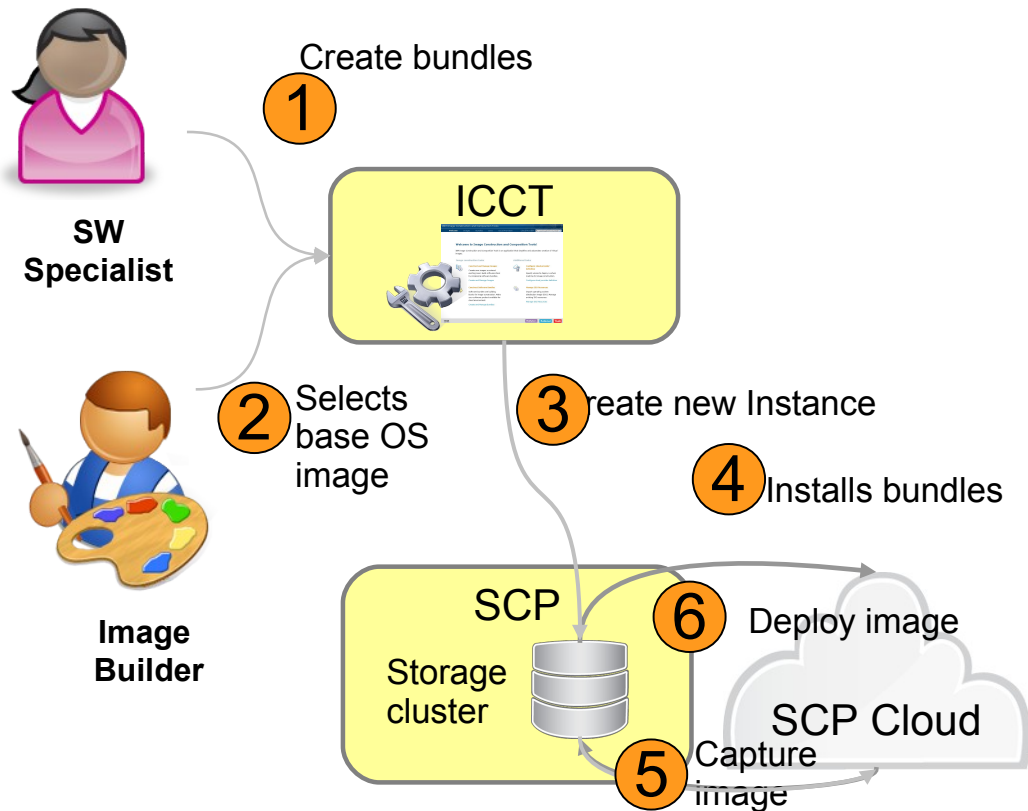

# Image Management

## Virtual Image Library

**Federation of Images**  
coming from different  
hypervisors

**Discovery**  
across the virtual  
infrastructure

**Advanced Automatic  
Indexing / cataloging**  
of images

**Fine grained  
and instance  
level  
authorization**

**Compatibility checks and  
Remediation**  
to help creating  
cross-hypervisor images

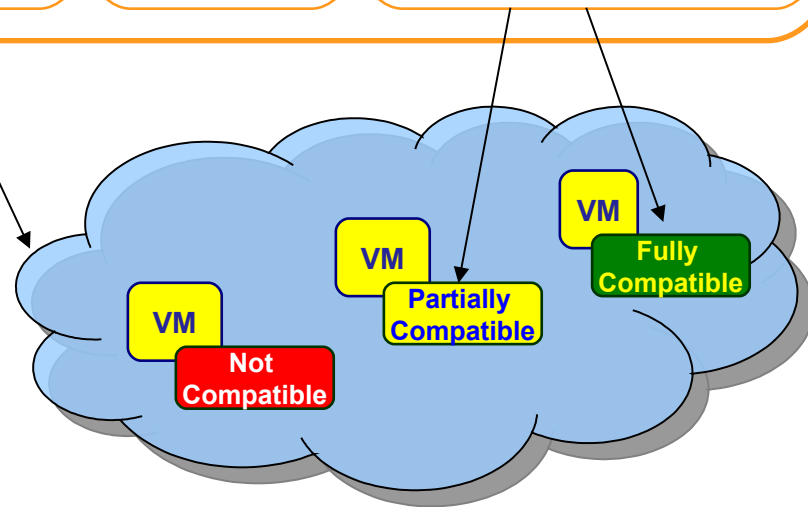
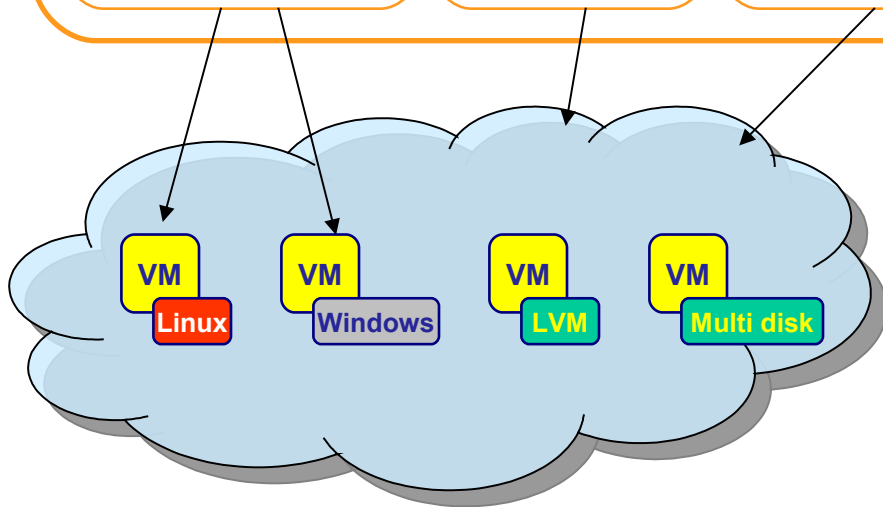

# Extend the workload-optimized cloud for greater levels of security, resilience and optimization

## Assurance

Monitor the health and performance of virtualized and cloud environments

## Endpoint Security

Unify real-time visibility and enforcement to deploy and manage patches to all endpoints

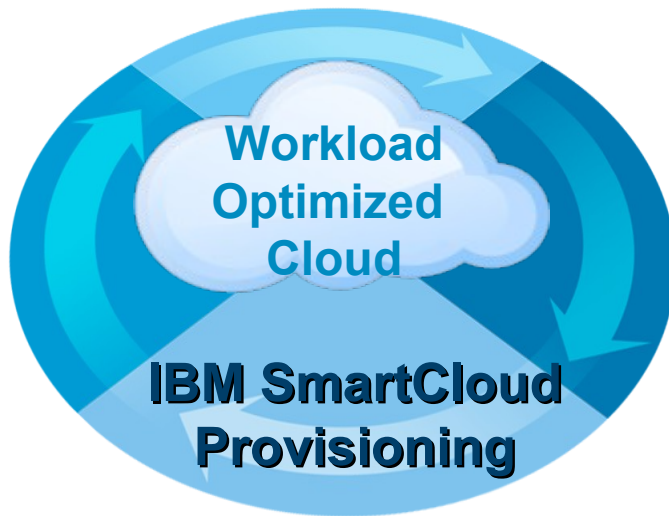

## Resilience

Simplify the protection and management of data

## Cost Management

Usage and accounting integration, rating engine and tiered pricing for cloud

## Continuous Delivery (DevOps)

One-touch automated continuous delivery and integration of software delivery process



# SmartCloud Continuous Delivery (DevOps)

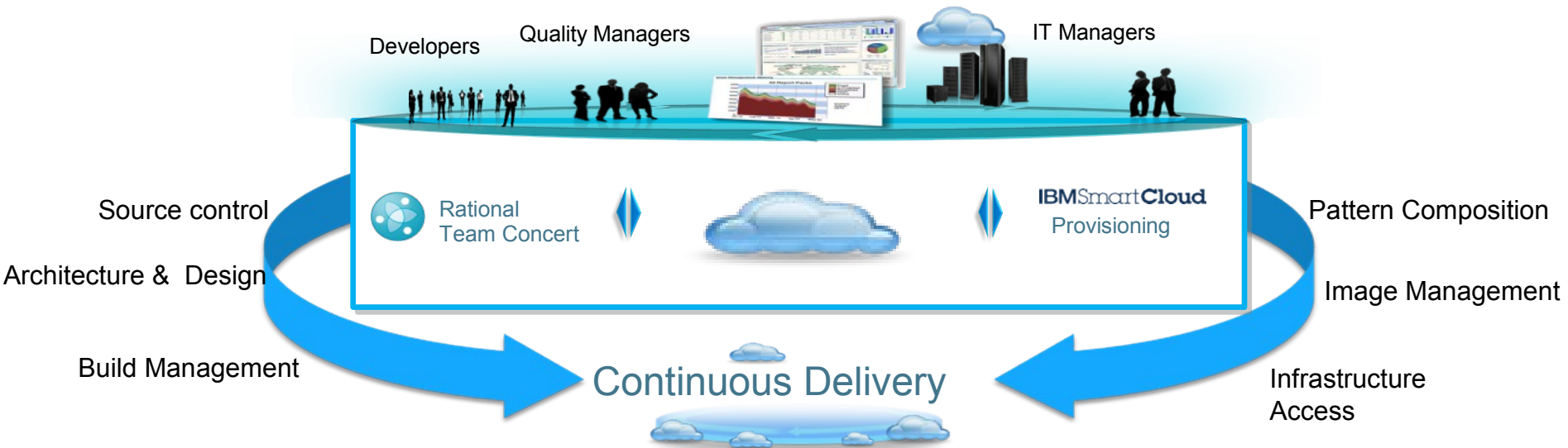

## Business Value

- Improved efficiency, accelerated delivery; automated hand-off between processes
- Reduced risk, improved quality; Managed change from development to deployment
- Optimized resources; Best Practices utilized via workload patterns



# Continuous Delivery (DevOps): Gaps between Customers – Business – Dev&Test - Ops

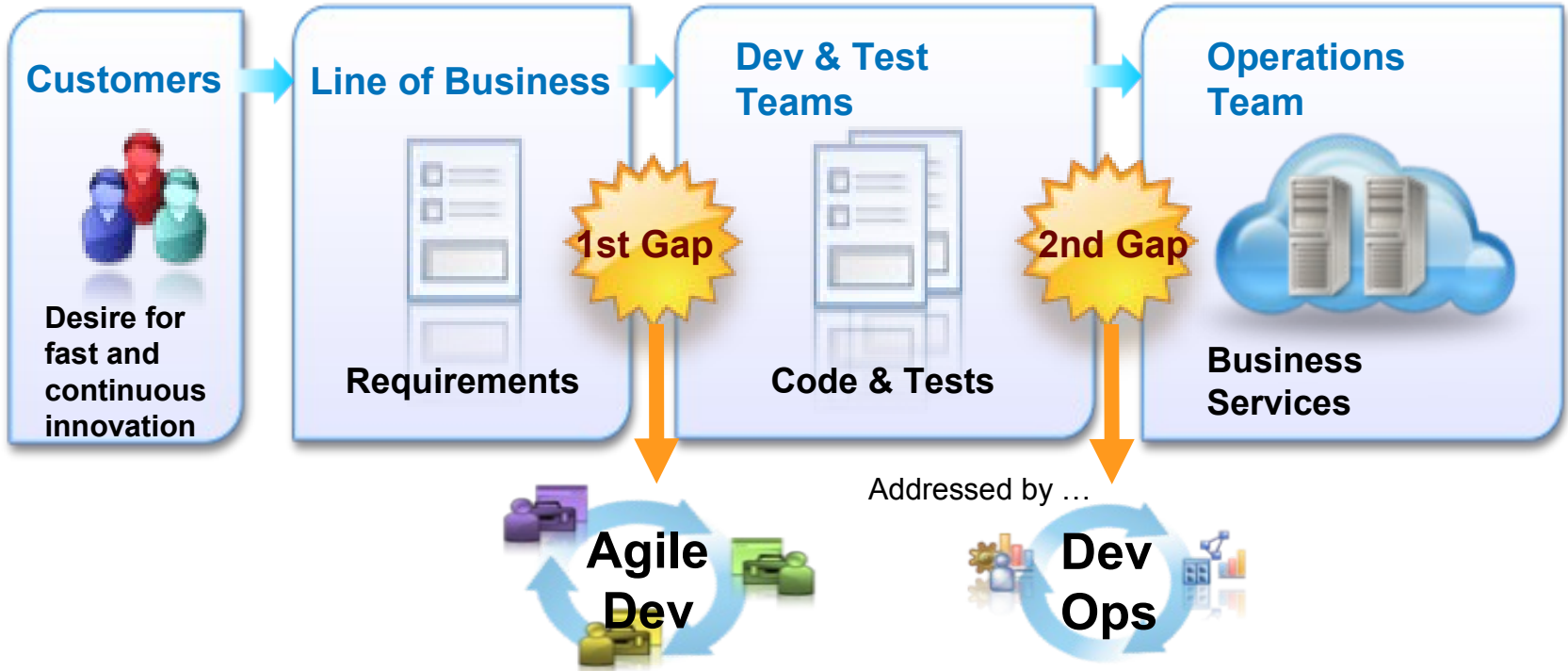

# Continuous Delivery (DevOps): Full lifecycle scenarios

**Scenario 1:** Collaborative creation of production-like environment patterns

**Scenario 2:** Testing application changes continuously by Dev and Test teams

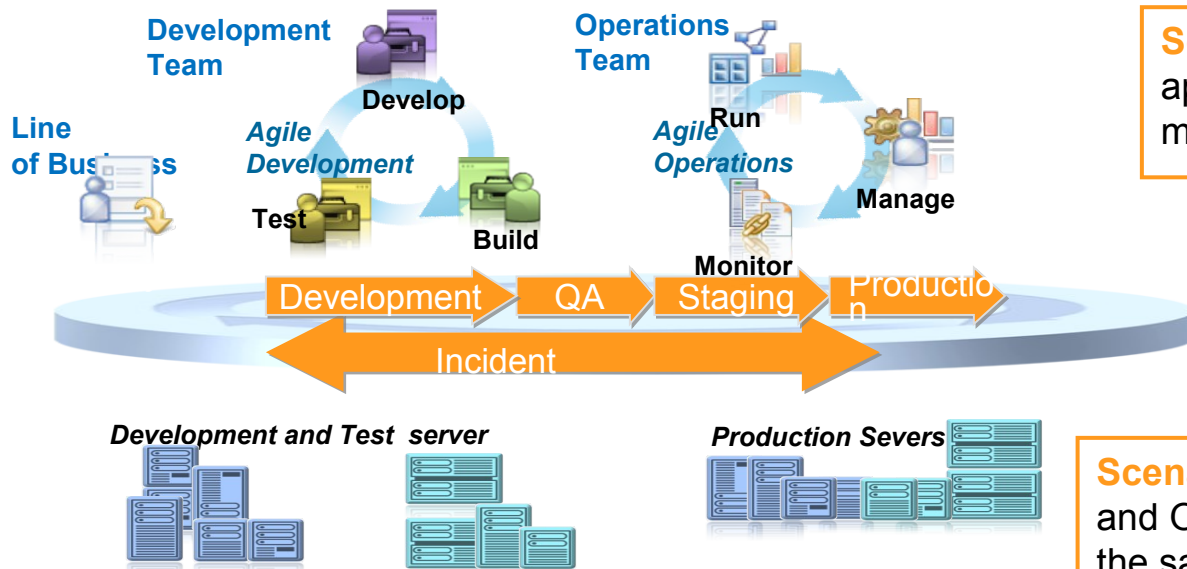

**Scenario 3:** Deliver application changes into multiple environments

**Scenario 4:** Collaborative incident management

**Scenario 5:** Collaborative Dev and Ops troubleshooting using the same analysis and instrumentation

**Scenario 6:** Management of entire delivery pipeline with end-to-end visibility and dashboards