



Information Server for zOS

Enrico Caraffi IT Specialist
IBM Software Group

IBM Information
On Demand 2008
>>> Comes To You

ALLA LUCE DELL'INFORMATION ON DEMAND

Milano, 15 aprile 2008



Agenda



- 1) l'opportunità offerta dall'HW IFL e dall'ambienti VM z/Linux
- 2) VM z/Linux: la piattaforma ideale per la Integrazione dei sistemi IT
- 3) Introduzione all'Information Server
- 4) Alcune componenti strategiche dell'offerta IS

L'evoluzione Tecnologica dei Processori Specializzati su Mainframe

★ negli ultimi 10 anni la tecnologia delle macchine z™

Ha prodotto una varietà di soluzioni basate su processori dedicati che

- Abilitano il supporto a qualsiasi tipo di carico
- E permettono di contenere il TCO

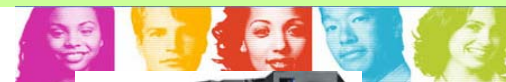

Condivisione dati
attraverso i
mainframes

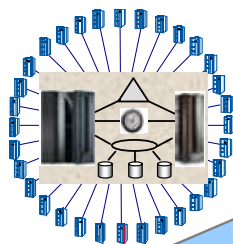

**Internal Coupling
Facility (ICF) 1997**



**Integrated Facility
for Linux (IFL)
2001**

- Processori a Supporto del sistema operativo Linux



**System z9 Application
Assist Processor (zAAP)
2004**

- Processori dedicati alla esecuzione di JAVA in z/OS

**IBM System z9 Integrated
Information Processor
(IBM zIIP) 2006**

- Sono Processori dedicati a specifici carichi di lavoro legati al DB2:
 - Accessi remoti*
 - BI Queries
 - Query Parallele
 - Utility DB2

Architettura Hardware di riferimento

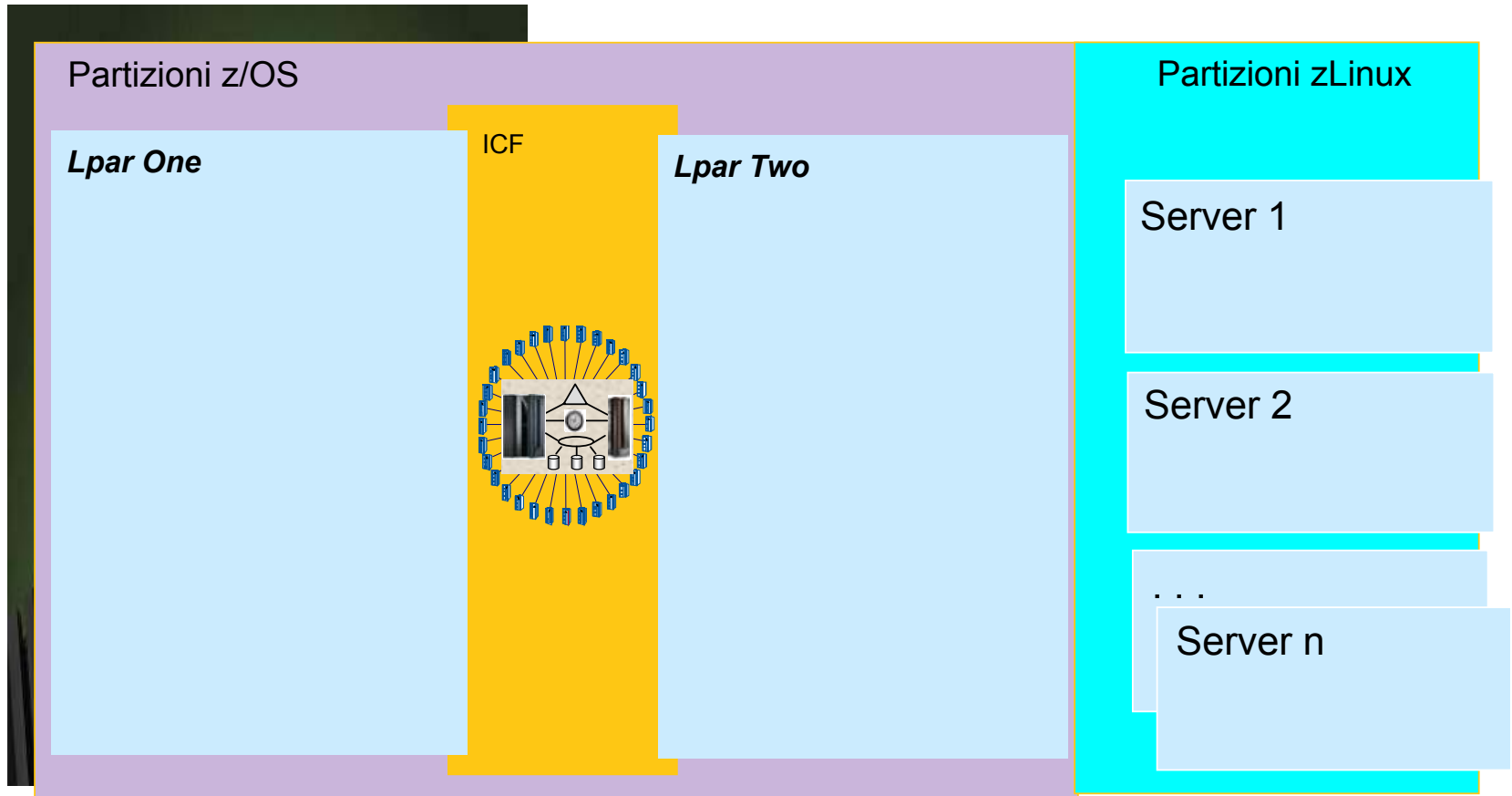

Architettura Hardware di riferimento

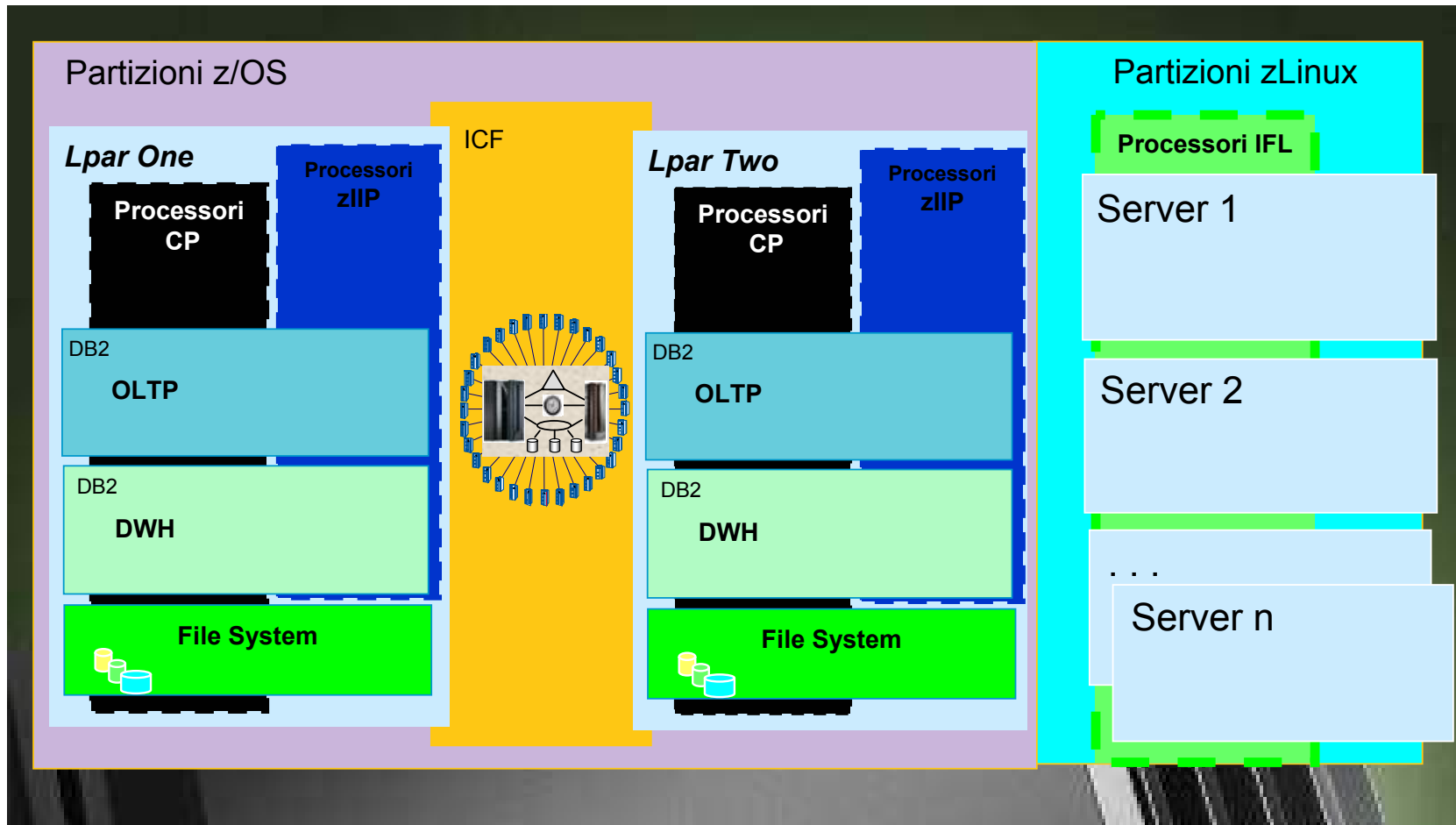

Flessibilità delle Macchine Virtuali z/Linux 1/2

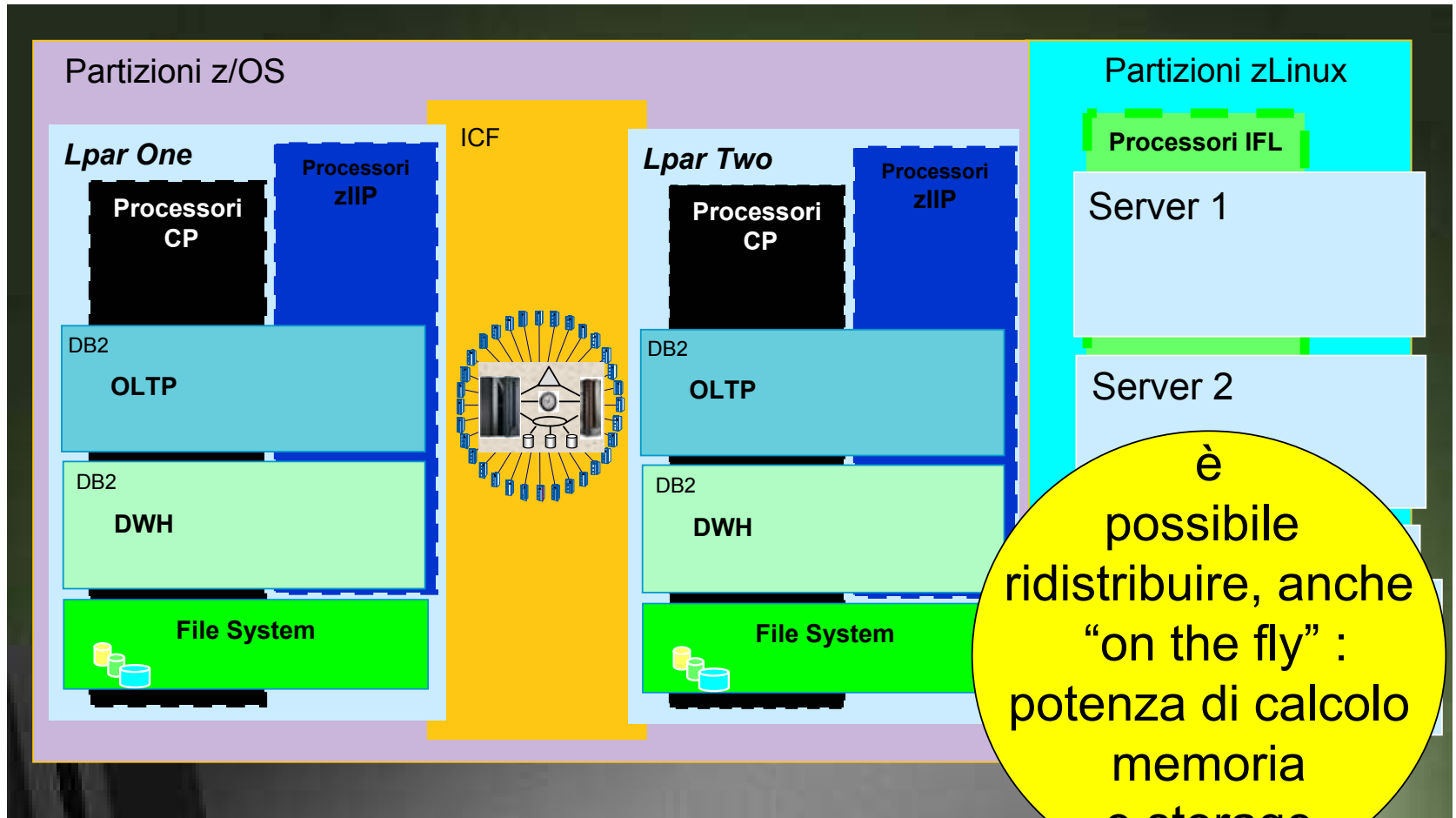

Flessibilità delle Macchine Virtuali z/Linux 2/2

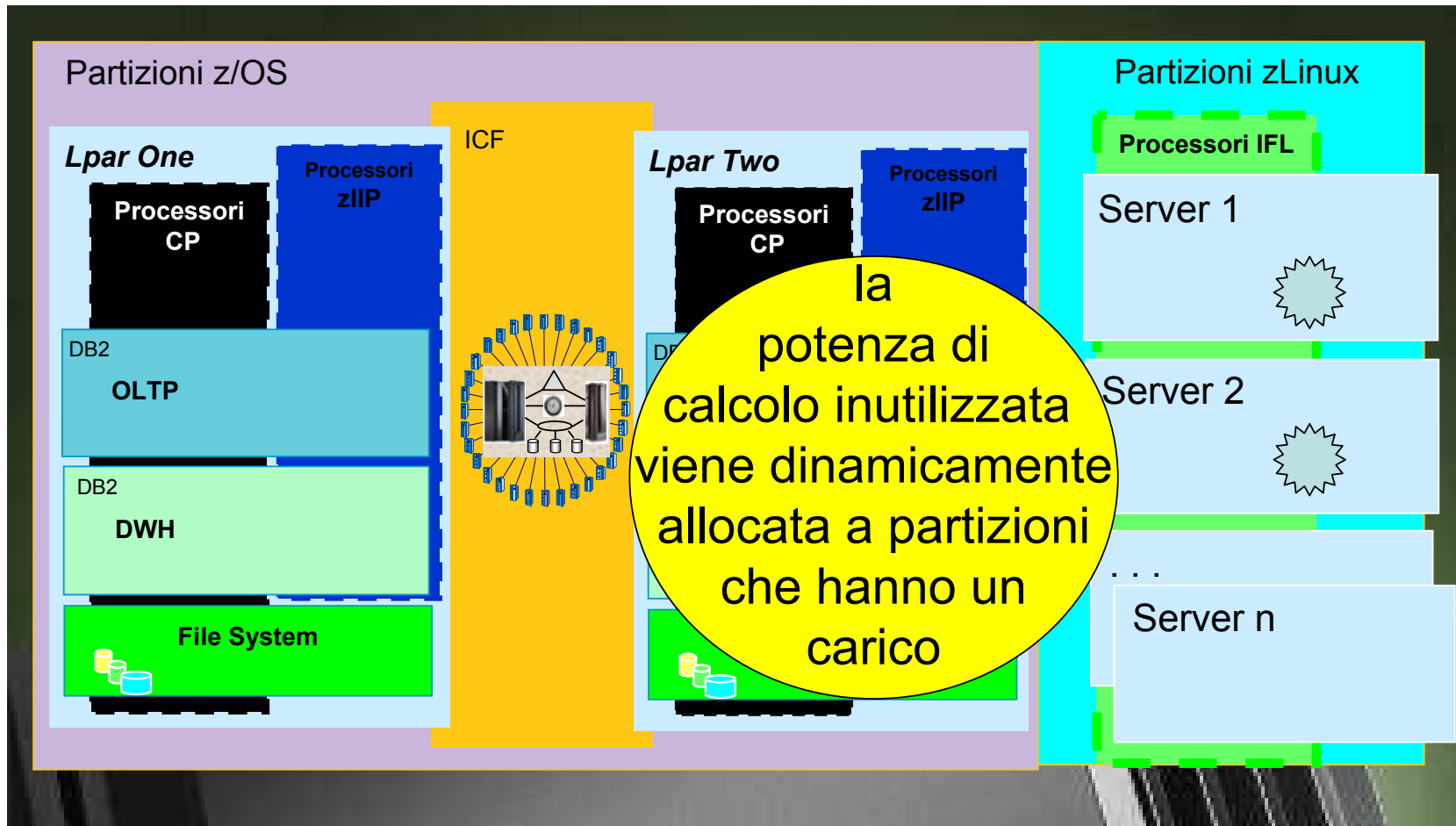

Operabilità interna Tra z/OS e z/Linux

La prossimità fisica tra i sistemi consente:



- Connessioni dirette tra i file systems in R&W

Mainframe z/OS + z/Linux

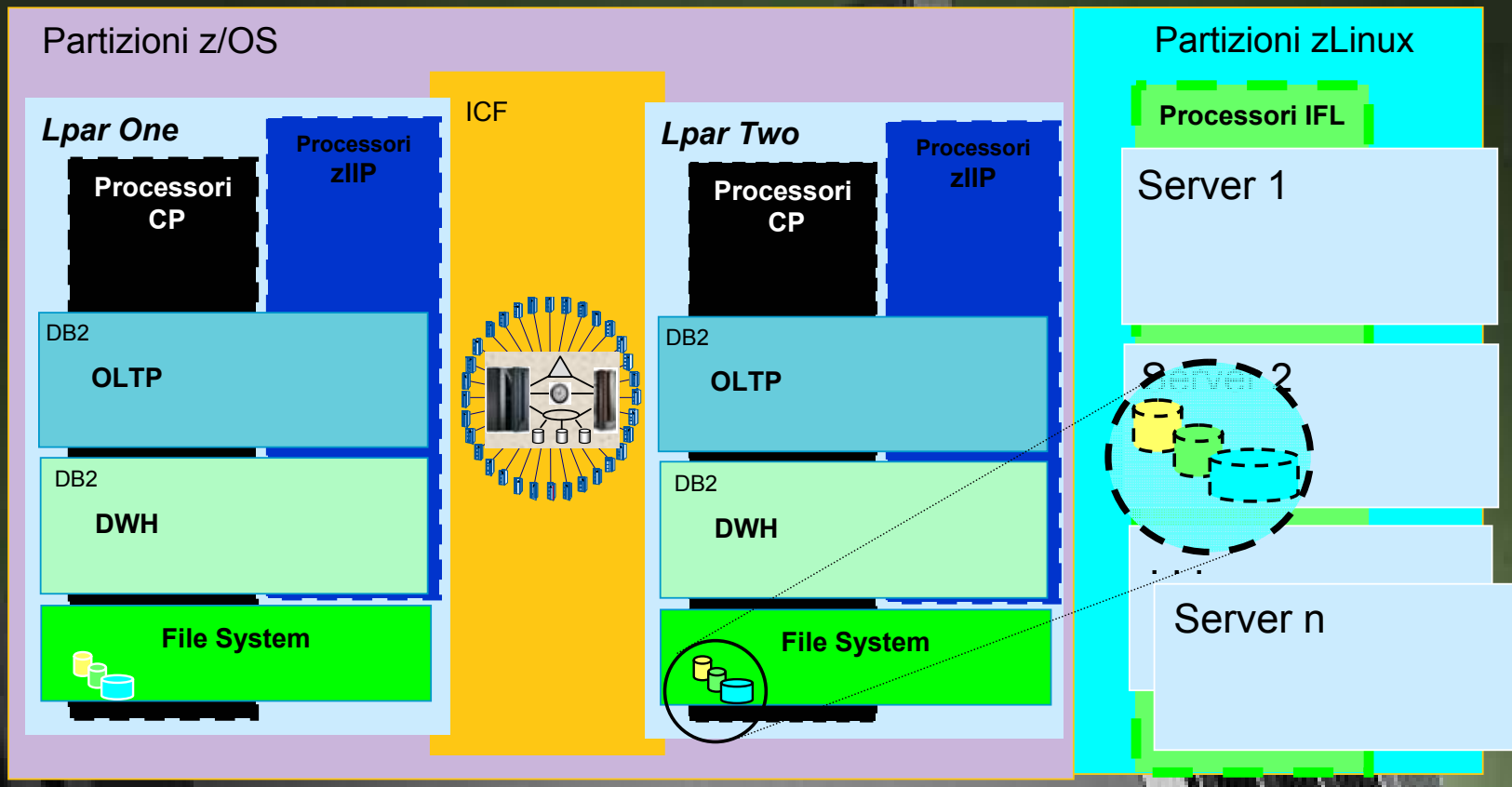

Operabilità interna Tra z/OS e z/Linux

La prossimità fisica tra i sistemi consente:



Efficientamenti nello scambio dati tra processi basati sulla memoria, ad es:

- “Batch Pipes” per supporto alle Load del DB2
-

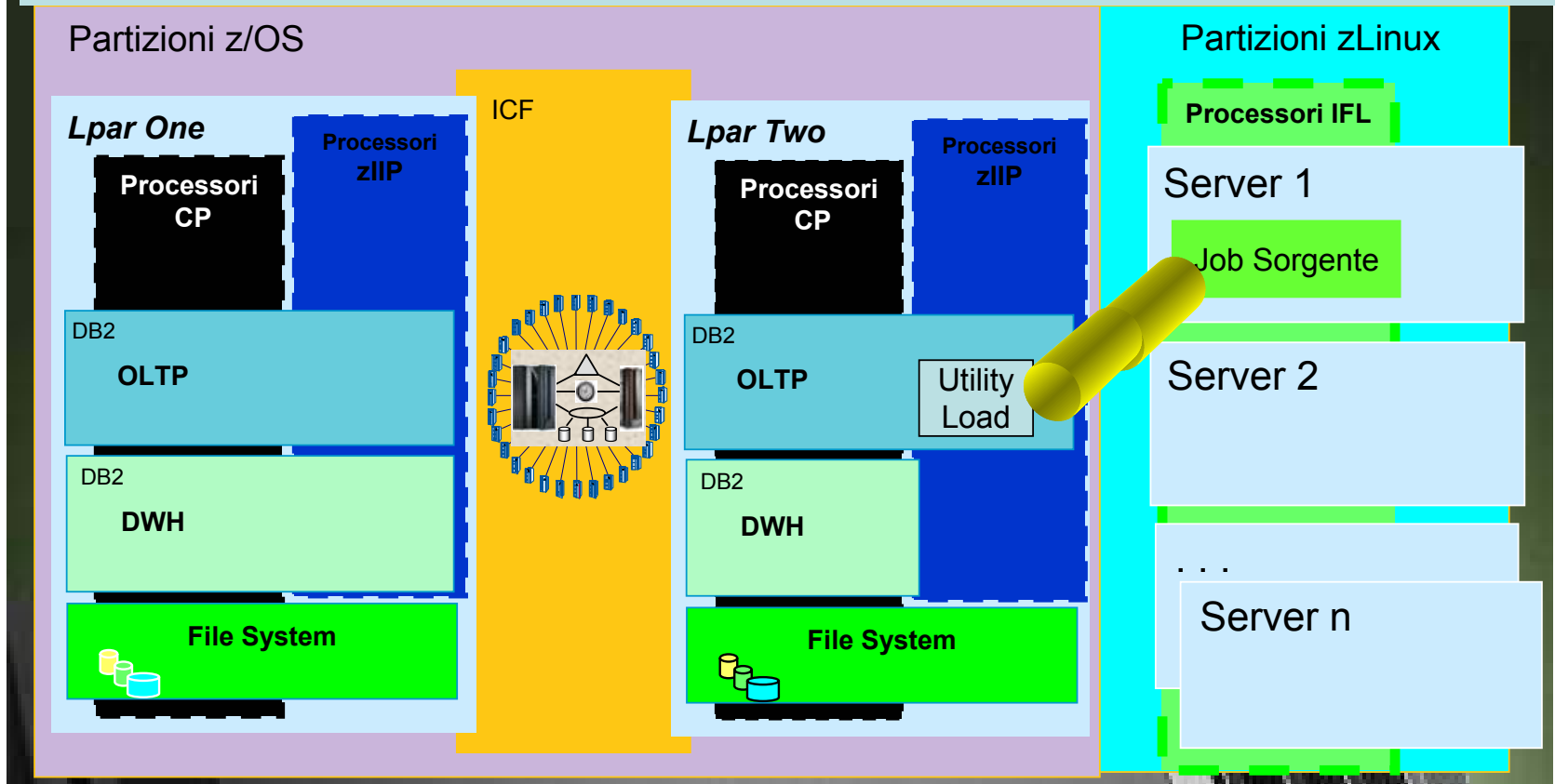

Operabilità interna Tra z/OS e z/Linux

La prossimità fisica tra i sistemi consente:

Efficientamenti nello scambio dati tra processi basati sulla memoria, ad es:

- “Batch Pipes” per supporto alle Load del DB2
- “Hipersockets” di supporto all’accesso DRDA sul DB2

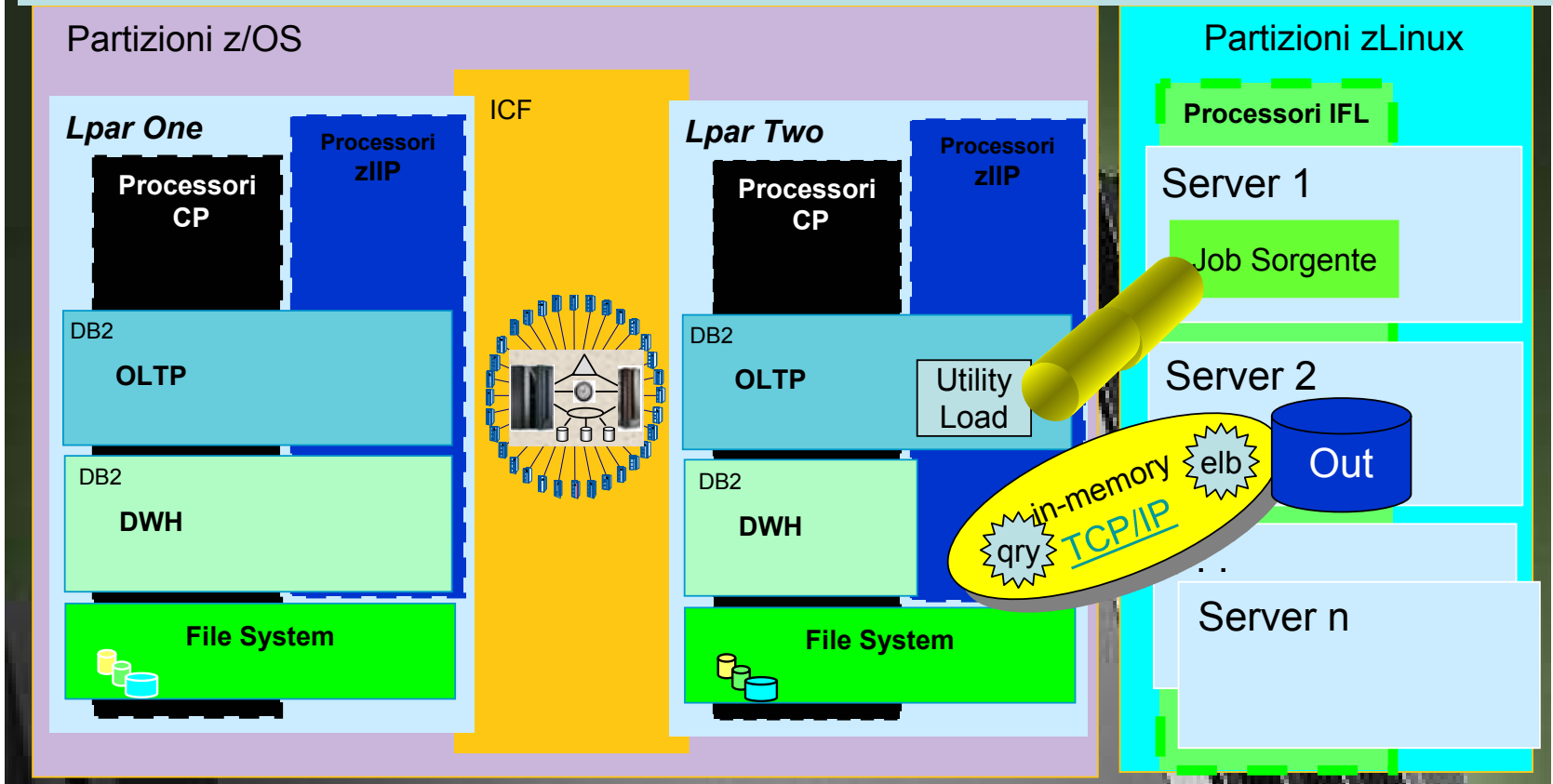

Integrazione con il mondo IT Aziendale



Mainframe z/OS

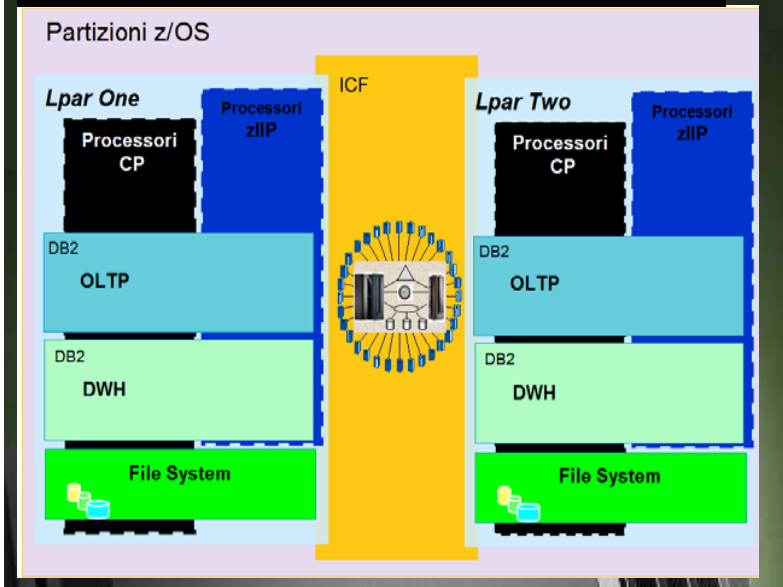

La presenza di sistemi distribuiti non consolidati impone spesso di avere a che fare con dati non omogenei

Questo fatto e altre ragioni storiche hanno prodotto situazioni poco organiche, una forte dispersione di risorse e processi di data Integration che risultano ridondanti, dispersivi e poco standardizzati

Sistemi non consolidati

Windows/Unix/Linux = **LUW**

Contengono molte Sorgenti e Destinazioni eterogenee

DATA BASE

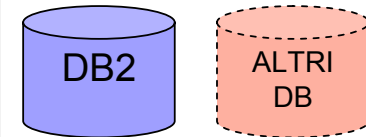

FLAT FILE

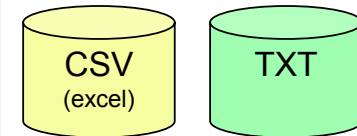

Altri Standard

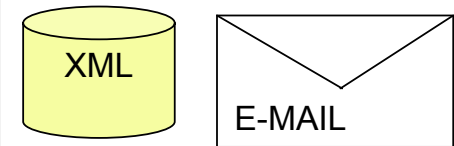

L'incubo dell'Integrazione Dati tra diverse Piattaforme

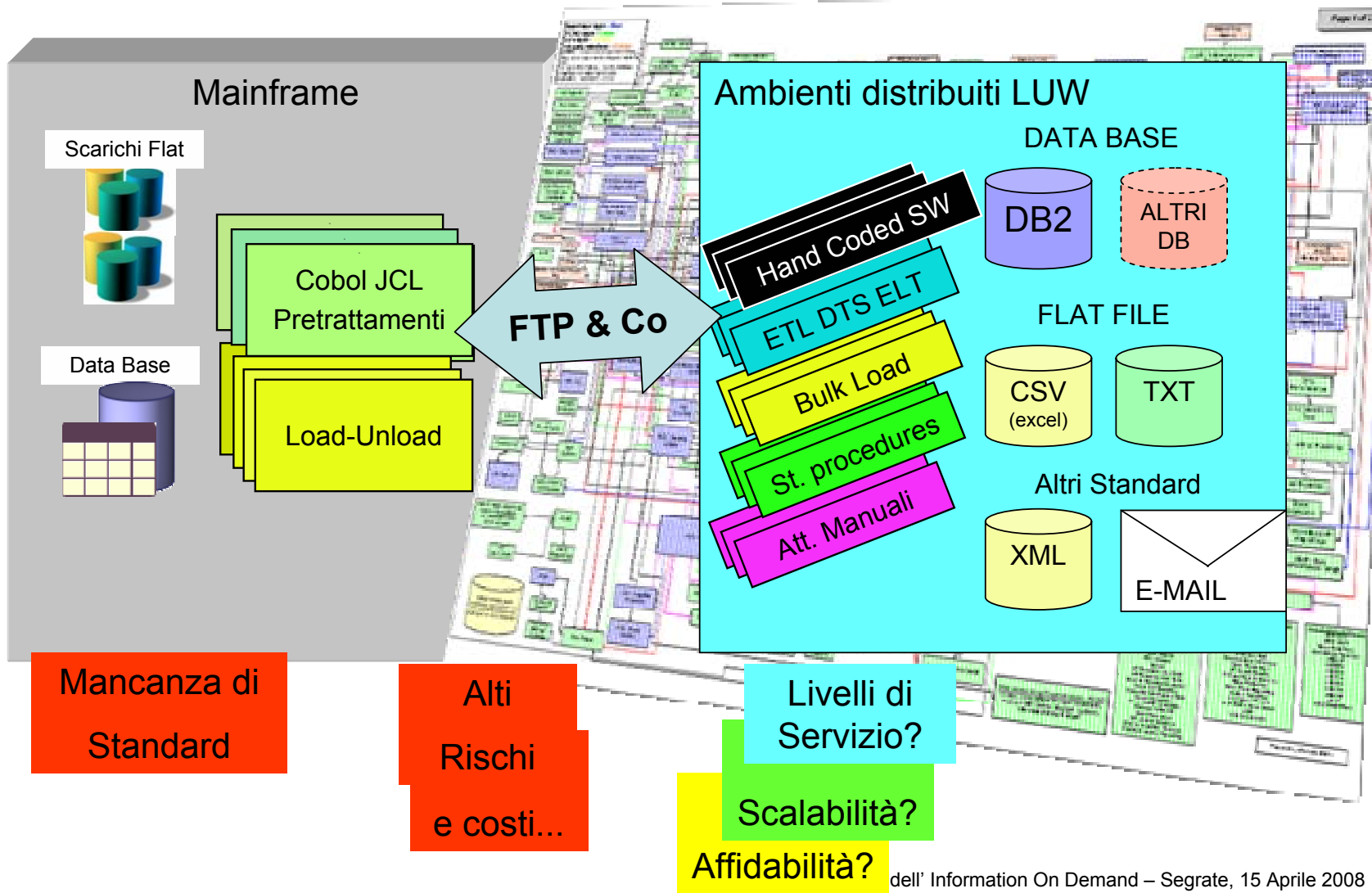

La piattaforma Z-Linux = Hub strategico di Integrazione



Mainframe z/OS + z/Linux

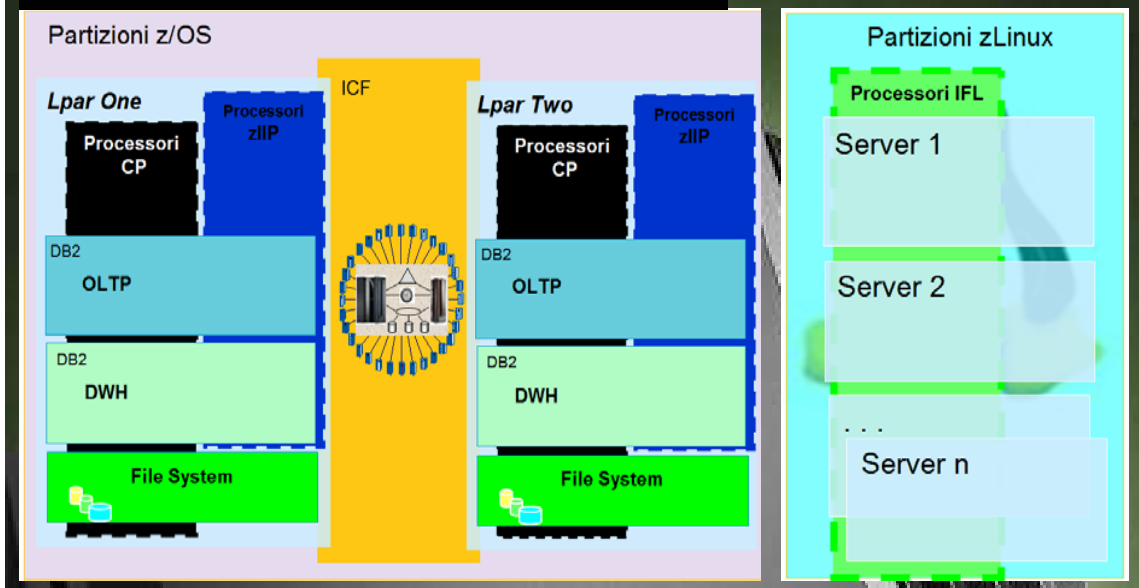

La piattaforma Z-Linux si pone quale ideale centro di tutti i percorsi di data integration:

- Perchè si integra facilmente con il mondo distribuito
- Perchè si integra in modo efficiente con il mondo z/OS
- Perchè sfrutta la scalabilità data dalla virtualizzazione

Sistemi non consolidati

Windows/Unix/Linux = LUW

Contengono molte Sorgenti e Destinazioni eterogenee

DATA BASE

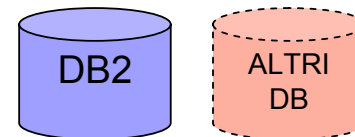

FLAT FILE

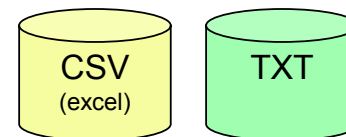

Altri Standard

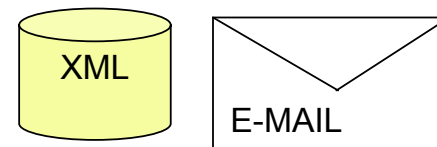

La piattaforma Z-Linux = Hub strategico di Integrazione



Mainframe z/OS + z/Linux

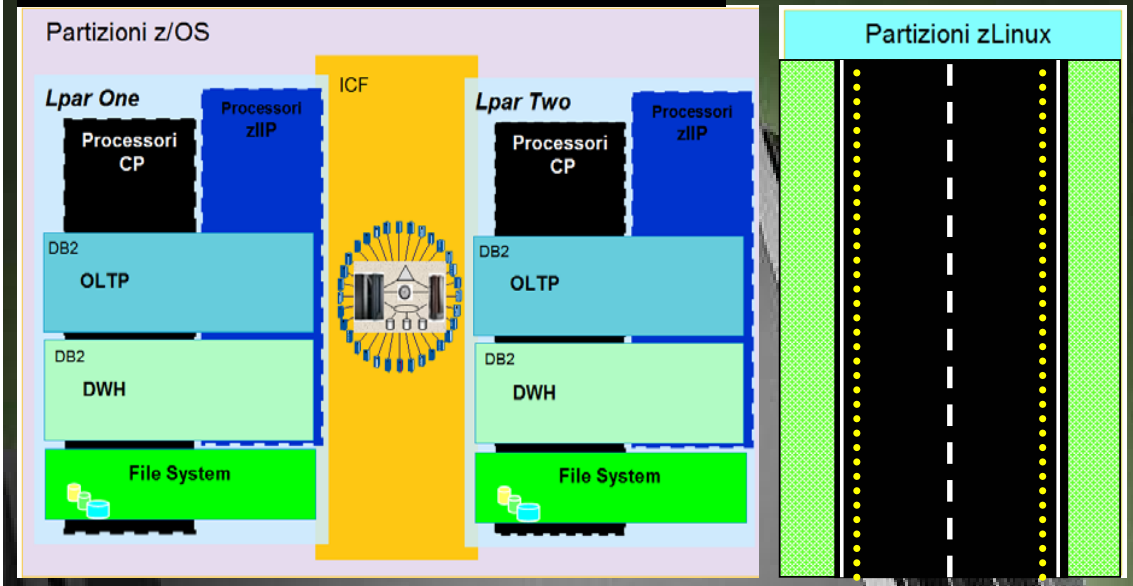

Sistemi non consolidati

Windows/Unix/Linux = LUW

Contengono molte Sorgenti e Destinazioni eterogenee

DATA BASE

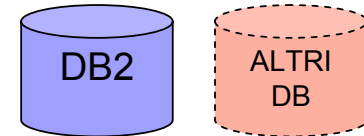

FLAT FILE

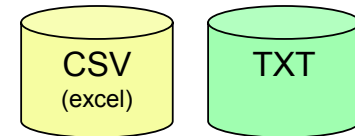

Altri Standard

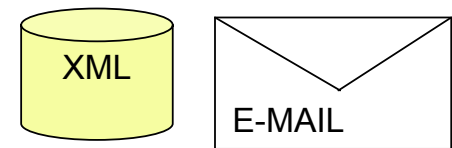

Ma un Hub funziona..

entro di tutti

- F distribuito

- F **Se esite un Vettore..** ondo z/OS

- Perchè sfrutta la scalabilità data dalla virtualizzazione

La piattaforma Z-Linux = Hub strategico di Integrazione



Mainframe z/OS + z/Linux

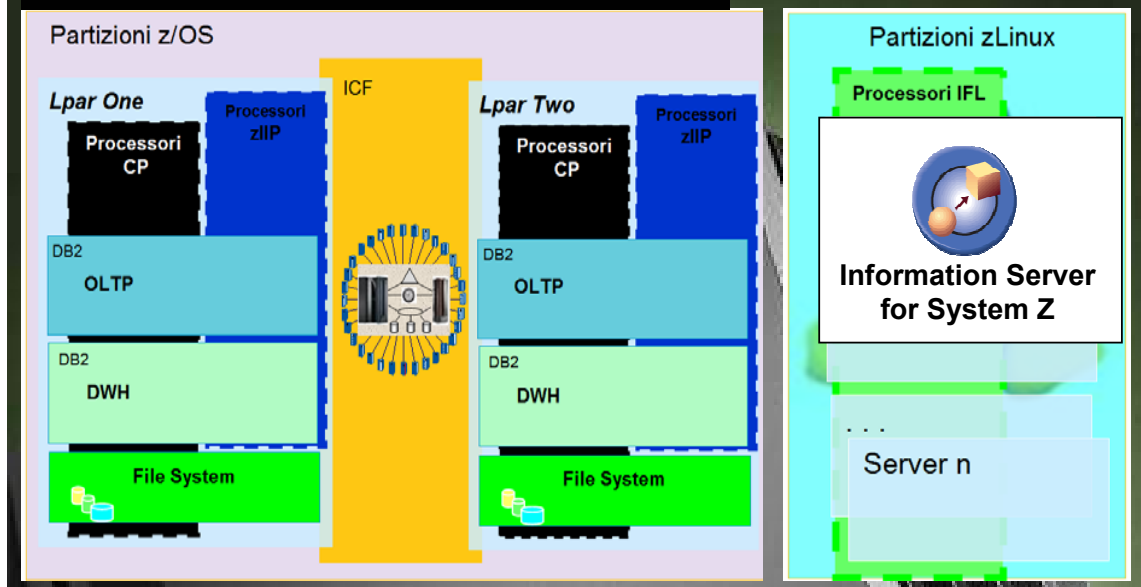

Sistemi non consolidati

Windows/Unix/Linux = **LUW**

Contengono molte Sorgenti e Destinazioni eterogenee

DATA BASE

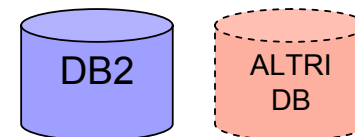

FLAT FILE

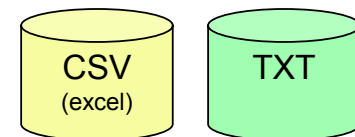

Altri Standard

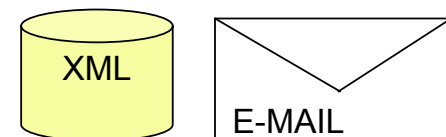

Anche nel nostro caso..
...servirà un vettore:

Information Server = Vettore Dedicato alla Integrazione Dati

Cosa è IBM Information Server ?

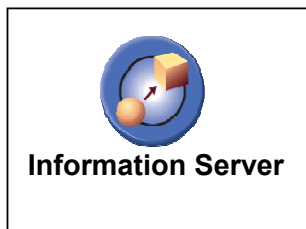

IS nasce a fine 2006

E' la Nuova piattaforma Software di IBM su cui convergono:

- Le Versioni aggiornate dei classici strumenti dedicati alla
 - Integrazione dati*
 - Federazione*
 - Integrazione applicativa**
- E i nuovi strumenti per la gestione organica dei metadati*

E' ad oggi disponibile sulle piattaforme

- Unix*
- Windows*
- Linux*
- z/Linux (GA Nov 2007)*

Quali sono I principi base all'origine di IS?

1) *Indirizzare la progettualità con metodologie di lavoro*

- *Semplici da applicare* - *Guidate dagli strumenti*
- *Efficaci e Profittevoli* - *Funzionano e fanno risparmiare*
- *E a largo spettro* - *Offrono un approccio olistico al tema*

Comprendere



Scoprire, modellare e gestire la struttura ed il contenuto dell'informazione

Bonificare



Standardizzare, riconciliare e correggere le informazioni

Trasformare



Combinare e ristrutturare le informazioni per nuovi utilizzi

Federare



Sincronizzare, spostare e virtualizzare le informazioni on-line

Servizi comuni della piattaforma

Gestione metadati unificata



Servizi di Amministrazione



Quali sono I principi base all'origine di IS?

1) **Indirizzare la progettualità con metodologie di lavoro**

2) **Ottemperare ai requisiti fondamentali di ogni SW**

funzionali = Avere le capacità di fare

non funzionali = Avere Usabilità, Robustezza, Adattabilità, Scalabilità..

Comprendere



Scoprire, modellare e gestire la struttura ed il contenuto dell'informazione

Bonificare



Standardizzare, riconciliare e correggere le informazioni

Trasformare



Combinare e ristrutturare le informazioni per nuovi utilizzi

Federare



Sincronizzare, spostare e virtualizzare le informazioni on-line

Servizi comuni della piattaforma

Motori di Calcolo Parallelo



Connettività su applicazioni, dati e contenuti



Gestione metadati unificata



Servizi di Amministrazione



Publica Web Servizi sui dati



Ciascuna ruolo viene affidato ..

A uno specifico Tool



O a uno specifico componente della piattaforma

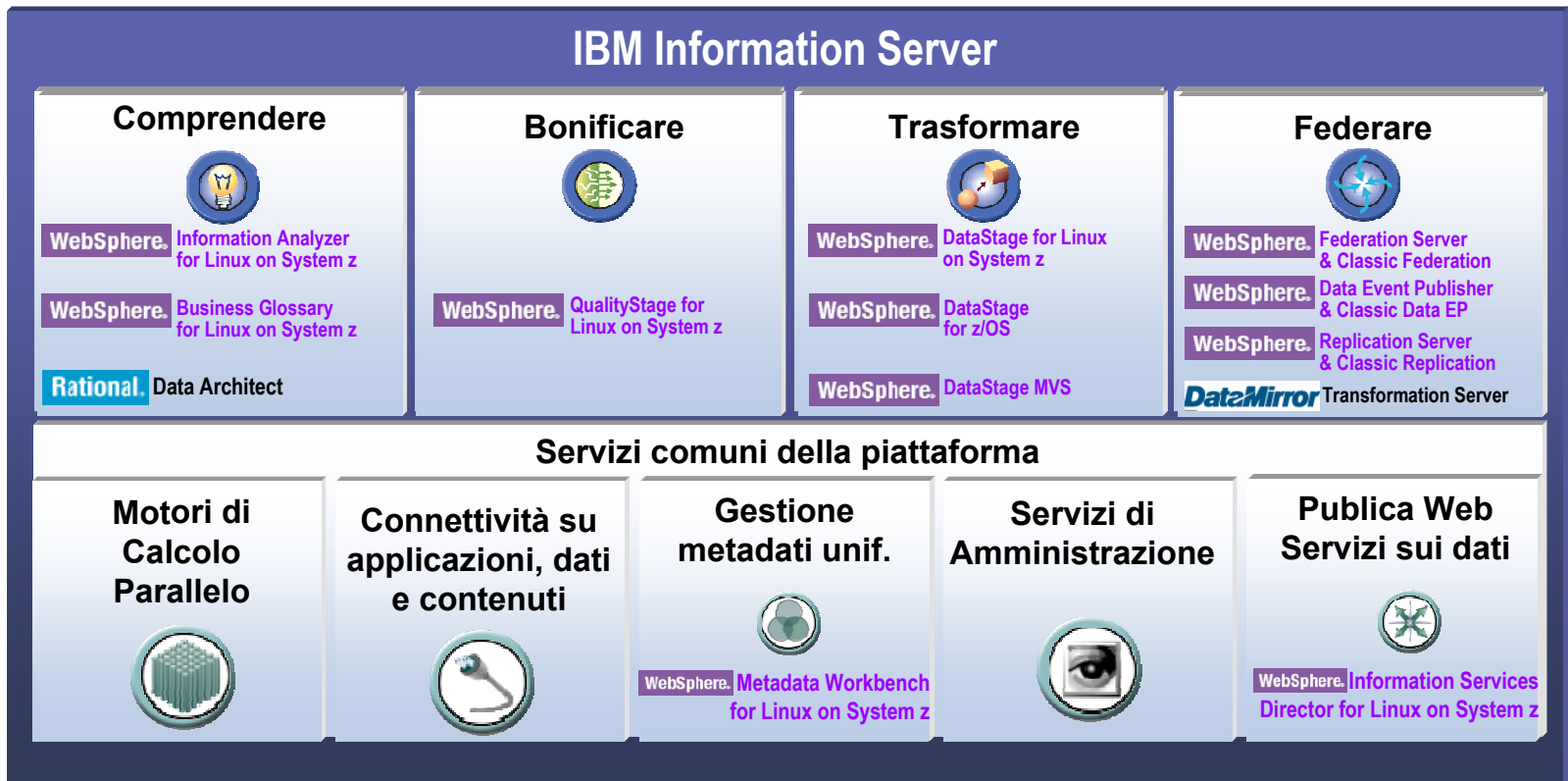

Ciascuna ruolo viene affidato ..

Spesso più strumenti si alternano e/o cooperano nello stesso ambito

- per adeguarsi a specifiche tecniche
- o per adeguarsi alle figure professionali coinvolte

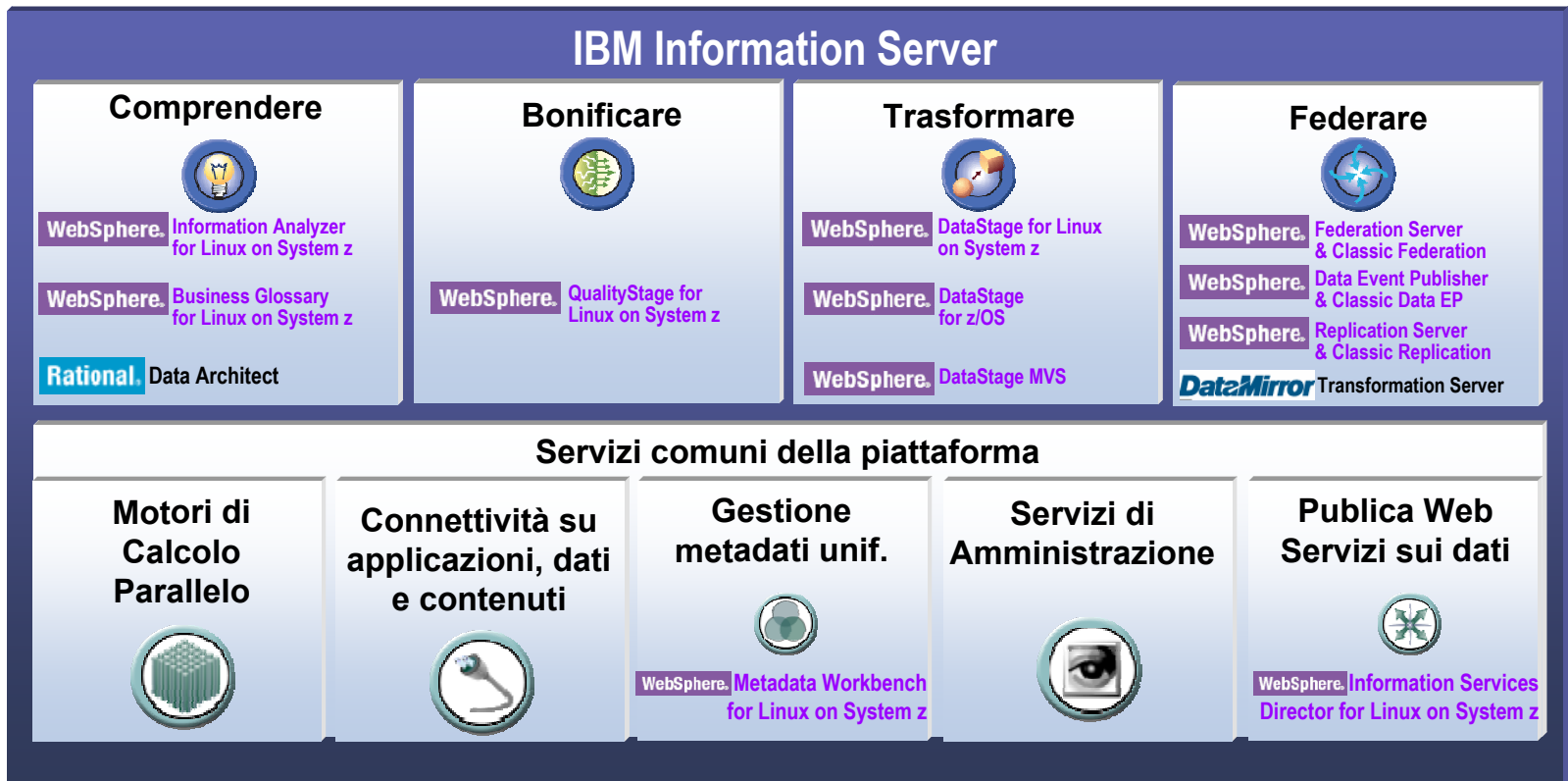

Oggi avremo brevi accenni solo per alcuni componenti



IBM Information Server

Comprendere



WebSphere. Information Analyzer
for Linux on System z

WebSphere. Business Glossary
for Linux on System z

Rational. Data Architect

Bonificare



WebSphere. QualityStage for
Linux on System z

Trasformare



WebSphere. DataStage for Linux
on System z

WebSphere. DataStage
for z/OS

WebSphere. DataStage MVS

Federare



WebSphere. Federation Server
& Classic Federation

WebSphere. Data Event Publisher
& Classic Data EP

WebSphere. Replication Server
& Classic Replication

DataMirror Transformation Server

Servizi comuni della piattaforma

Motori di Calcolo Parallelo



Connettività su applicazioni, dati e contenuti



Gestione metadati unif.



WebSphere. Metadata Workbench
for Linux on System z

Servizi di Amministrazione



Publica Web Servizi sui dati



WebSphere. Information Services
Director for Linux on System z

Quali sono le scelte architettoniche a sostegno di IS?



1) La SOA

è l'infrastruttura scelta per supportare tutto Information Server

- *Permette l'integrazione dei vari strumenti sw*
- *E' aperta ai futuri strumenti*
- *È aperta alle personalizzazioni*

2) il WEB

come canale che da fruibilità al patrimonio informativo interno a IS

- *per far circolare informazioni e conoscenza*
- *Per creare una nuova cultura aziendale*

Vediamo brevemente..



IBM Information Server

Comprendere



WebSphere. Information Analyzer
for Linux on System z

WebSphere. Business Glossary
for Linux on System z

Rational. Data Architect

Bonificare



WebSphere. QualityStage for
Linux on System z

Trasformare



WebSphere. DataStage for Linux
on System z

WebSphere. DataStage
for z/OS

WebSphere. DataStage MVS

Federare



WebSphere. Federation Server
& Classic Federation

WebSphere. Data Event Publisher
& Classic Data EP

WebSphere. Replication Server
& Classic Replication

DataMirror Transformation Server

Servizi comuni della piattaforma

Motori di Calcolo Parallelo



Connettività su applicazioni, dati e contenuti



Gestione metadati unif.



WebSphere. Metadata Workbench
for Linux on System z

Servizi di Amministrazione



Publica Web Servizi sui dati



WebSphere. Information Services
Director for Linux on System z

Cos'è WebSphere Information Analyzer?



- **Fornisce un'analisi dettagliata dei sistemi esistenti**
 - Analisi focalizzata su dati di applicazioni, database e files, per contenuto, qualità e struttura
 - Affidabile e dettagliato profiling di campi e relazioni attraverso strutture e sorgenti multiple
- **Consente la misurazione ed il reporting della qualità dell'informazione**
- **Crea i metadati che descrivono dove l'informazione è gestita attraverso i sistemi coinvolti**
 - Consentendo l'analisi di specifiche fonti si mettono in evidenza i punti che costituiscono potenziali criticità



Subject Matter Experts



Data Analysts

IBM Information Analyzer

Analizza strutture dati e ne controlla l'aderenza alle regole di integrazione e qualità

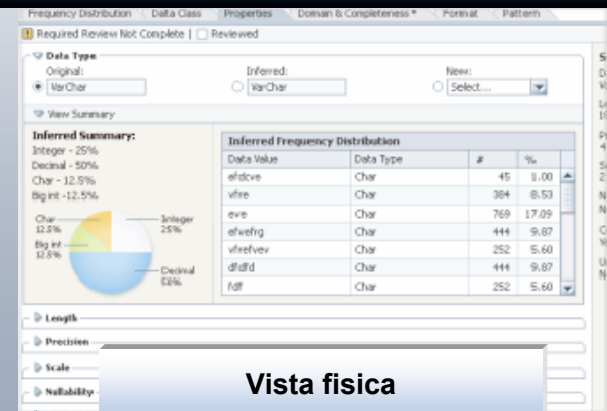

Vista fisica

Metodo di lavoro con Information Analyzer



comprendere



Analisi predisposta in 3 passi:

Analisi delle Colonne



Analisi delle frequenze di distribuzione



Analisi di Classe, Proprietà, Formato, Dominio e Completezza

Analisi della Tabella

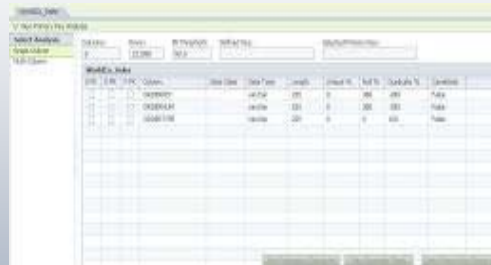

Analisi delle “Primary Keys”

Analisi Tra-Tabelle

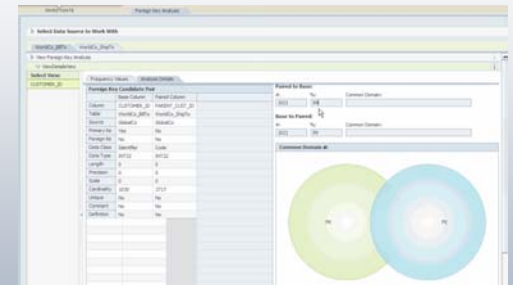

Analisi delle “Foreign Keys” e delle analogie tra colonne

Metodo di lavoro con Information Analyzer



Analisi delle Colonne



Analisi delle frequenze di distrib

Analisi della Tabella

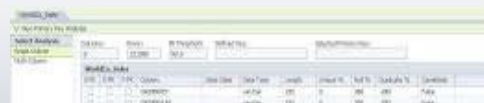

Analisi Tra-Tabelle

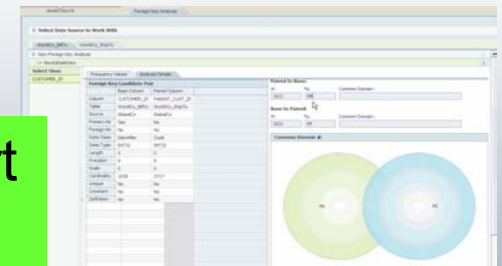

Analisi delle "Foreign Keys"
e delle analogie tra colonne

Fornisce una serie di report

- Di immediata fruibilità
- Adattabili nel formato
- Personalizzabili



Analisi di Classe, Proprietà, Form

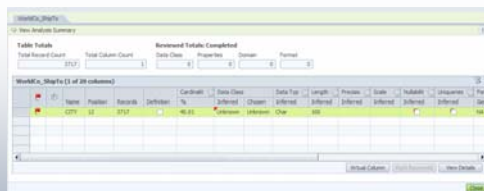

Annotazioni e
evidenziazioni dei campi da controllare

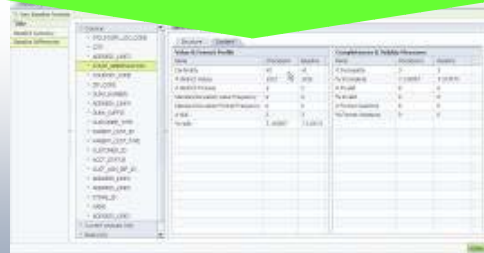

Capacità di confronto rispetto a "baselines"

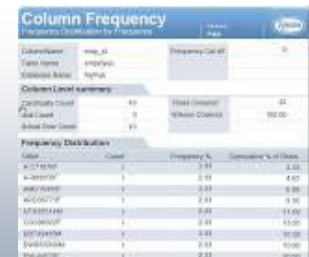

Report dei risultati

Quali ritorni da Information Analyzer?



- **Apporta valore al patrimonio dei metadati:**
 - Consente di certificare le regole già note
 - Consente di scoprire nuove relazioni
 - Misura l'effettivo utilizzo degli spazi allocati per le informazioni
- **Diminuisce i rischi progettuali**
 - Anticipa la rilevazione delle anomalie sull'input
 - Copre integralmente la base dati profilata
- **Riduce tempi e costi progettuali**
 - Consente di creare un processo affidabile
 - Riduce gli errori e le omissioni nell'analisi
 - Riduce i cicli di Test e Re-Work
 - E' propedeutico all'utilizzo di strumenti:
 - Per la Data Quality
 - Motori di ETL
 - Glossario Terminologia di Business

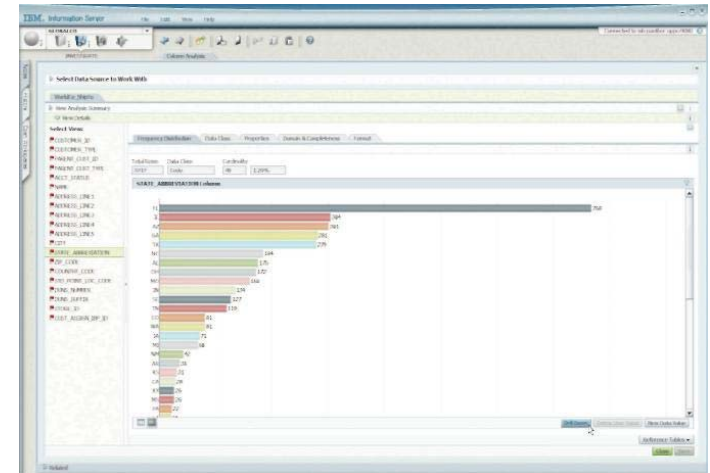
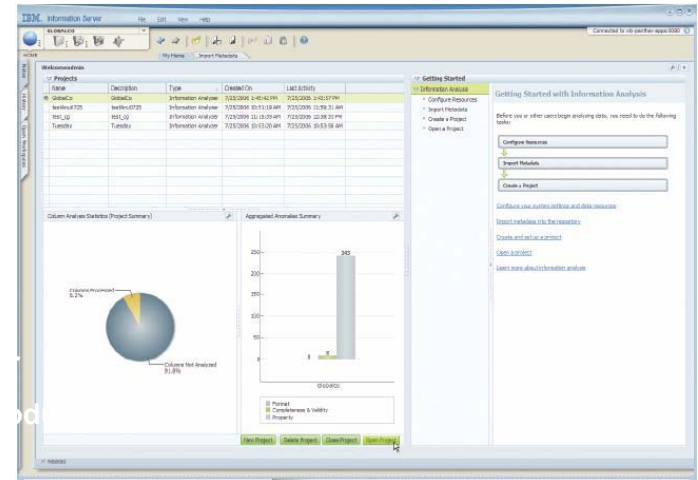

Formati più frequenti



Column Name : **E00FCC**

Column Level Summary

Format Cardinality Count :	9
Value Cardinality Count :	21
Null Count :	0
Total Actual Row Count :	73627

Most Frequent Format Count

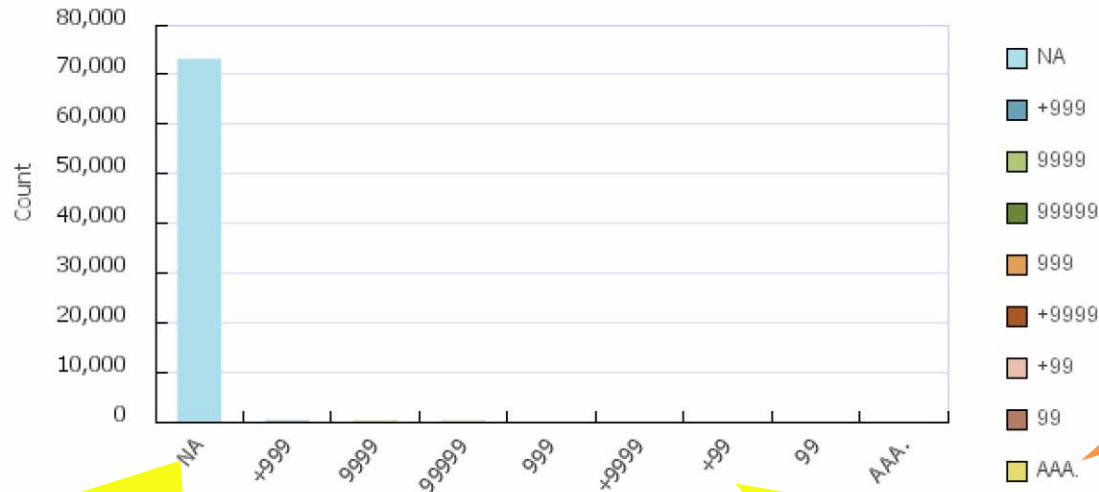

Cosa rappresenta questo formato? Ocorre Zoommare (segue..)

Oltre il 99% dei record non ha il campo valorizzato

Occorrerà standardizzare questo campo! Probabilmente il "+" equivale a "00"

Formati più frequenti



Column Level Details				
Format	Count	Total Rows %	Total Rows Cumulative %	Example Values
NA	73126	99.3195	99.3195	[SPACES]
+999	190	.2581	99.5776	+420 +420 +042
9999	170	.2309	99.8085	0042 0049 0042 0420
99999	106	.1440	99.9525	00420 00421 41572 00349 00042
999	21	.0285	99.9810	420 042 597
+9999	9	.0122	99.9932	+0420
+99	3	.0041	99.9973	+42 +44
99	1	.0014	99.9986	38
AAA.	1	.0014	100.0000	TEL.
Top Y values :	73,627	100.0000		

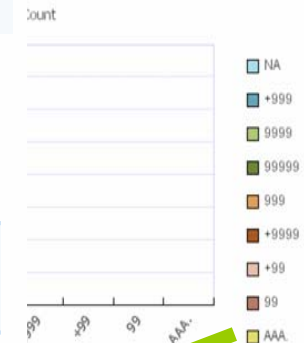

***Abbiamo una singola riga
Con un contenuto non numerico***

Valori più frequenti

Null Count :	0
Actual Row Count :	73627
Total Rows Covered :	57016
%Rows Covered :	77.44

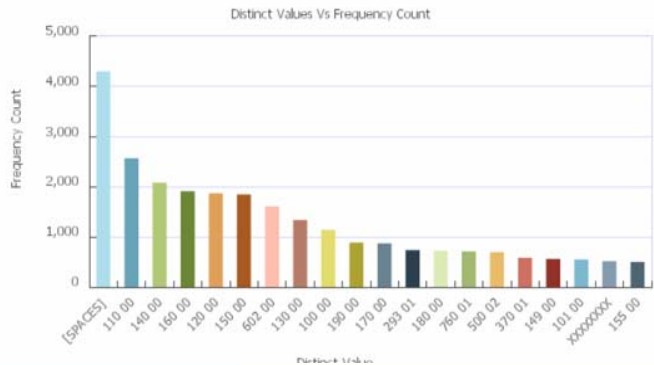

Distinct Value	Frequency Count	Frequency %	Cumulative %
[SPACES]	4300	5.84	.00
110 00	2577	3.50	.00
140 00	2087	2.83	.00
160 00	1916	2.60	.00
120 00	1874	2.55	.00
150 00	1852	2.52	.00
602 00	1615	2.19	.00
130 00	1342	1.82	.00
100 00	1146	1.56	.00
190 00	889	1.21	.00
170 00	873	1.19	.00
293 01	740	1.01	.00
180 00	727	.99	.00
760 01	714	.97	.00
500 02	698	.95	.00
370 01	587	.80	.00
149 00	562	.76	.00
101 00	561	.76	.00
XXXXXXXX	519	.70	.00
155 00	502	.68	.00
360 01	467	.63	.00

Formati più frequenti



Column Name :	E00CIP
Column Level Summary	
Format Cardinality Count :	152
Value Cardinality Count :	7376
Null Count :	0
Total Actual Row Count :	73627

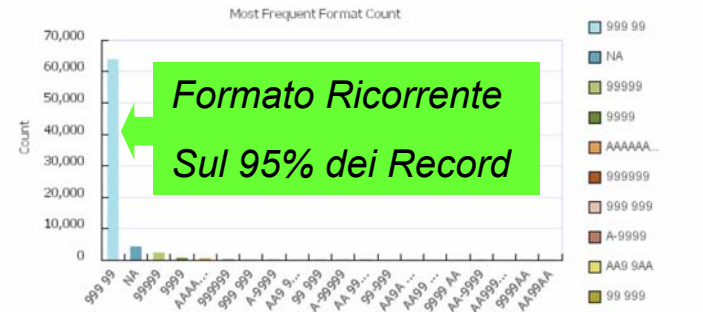

Format	Count	Total Rows %	Total Rows Cumulative %	Example Values
99999	2393	3.2502	95.8616	16000 14000 10000 15000 29301
9999	565	.7674	97.7879	1010 1060 1190 1210 1000
AAAAAAAA	565	.7674	97.5552	XXXXXXXX VVVVVVVV ZZZZZZZZ CCCCCCCC NNNNNNNN
999999	215	.2920	97.8473	125047 127000 127322 117418
999 999	177	.2404	98.0877	400021 190 000

Valori Accettabili?

Dove utilizzare WebSphere Information Analyzer?



- **Progetti di Migrazione e Integrazione:**

- Le Conoscenze sulle basi dati di input non sono sempre complete e/o pienamente aggiornate
- Il contenuto di alcuni campi sottende “patterns” o semantiche non sempre evidenti
- I sistemi da integrare possono essere entrambi poco documentati e da profilare
- Una profilazione (cross-table) può evidenziare (e/o scoprire e/o confermare) correlazioni tra diverse tabelle anche di diversi database

- **Procedure interne in ottica QA**

- Un processo che voglia garantire stabilmente determinati livelli di qualità nei dati prevederà una periodica re-analisi sui dati.
- La profilazione consente di individuare la fenomenologia delle anomalie tipiche di ciascun database indirizzando:
 - I processi di Quality improvement
 - I Processi di Controllo della Qualità

Table Alias :	
Column Name :	E00CEX
Column Level Summary	
Cardinality Count :	521
Null Count :	0
Actual Row Count :	73627
Total Rows Covered :	72471
%Rows Covered :	98.43

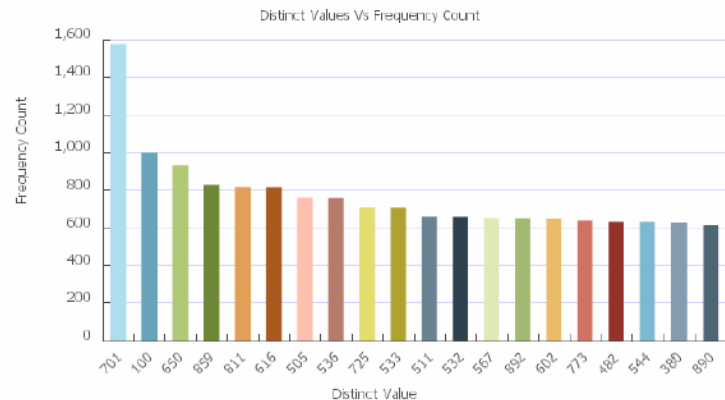

Vediamo brevemente..



IBM Information Server

Comprendere



WebSphere. Information Analyzer
for Linux on System z

WebSphere. Business Glossary
for Linux on System z

Rational. Data Architect

Bonificare



WebSphere. QualityStage for
Linux on System z

Trasformare



WebSphere. DataStage for Linux
on System z

WebSphere. DataStage
for z/OS

WebSphere. DataStage MVS

Federare



WebSphere. Federation Server
& Classic Federation

WebSphere. Data Event Publisher
& Classic Data EP

WebSphere. Replication Server
& Classic Replication

DataMirror Transformation Server

Servizi comuni della piattaforma

Motori di Calcolo Parallelo



Connettività su applicazioni, dati e contenuti



Gestione metadati unif.



WebSphere. Metadata Workbench
for Linux on System z

Servizi di Amministrazione



Publica Web Servizi sui dati



WebSphere. Information Services
Director for Linux on System z

Cosa è WebSphere DataStage?



- Un tool di ETL
 - Estrae I dati dalle sorgenti
 - Li Trasforma
 - Li carica
- E' in grado di:
 - Fare Conversioni, Calcoli, trattamenti sulle stringhe di Dati
 - Leggere e scrivere dati nei formati più disparati
 - Interfacciarsi con DBMS più diffusi sul mercato
 - Relazionarsi con applicativi esistenti:
 - Programmi C
 - Moduli Cobol
 - Stored Procedures
 - Pacchetti applicativi (es.SAP)

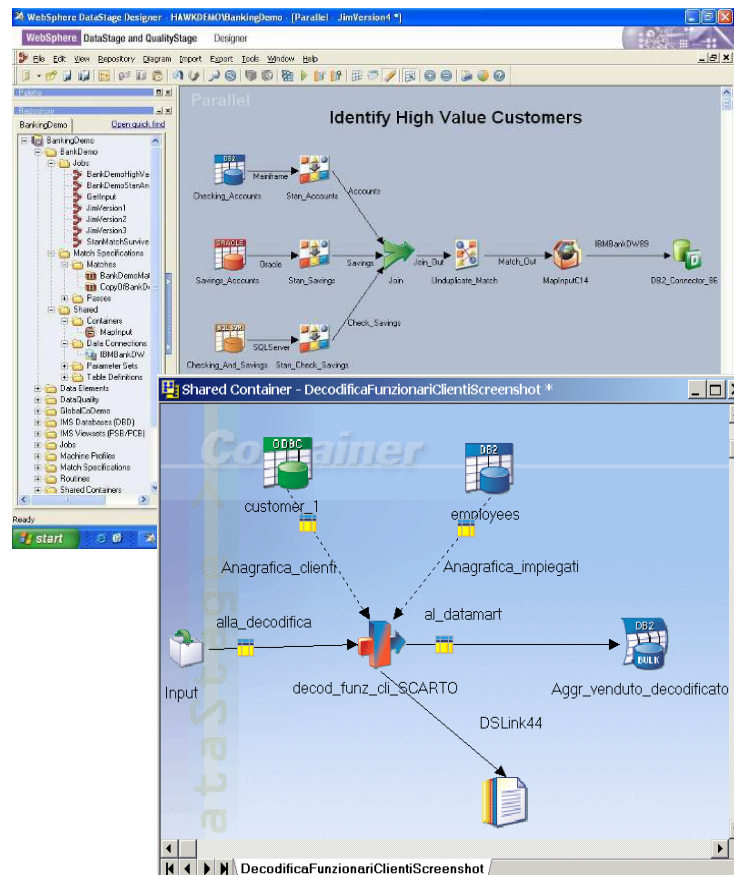

Come lavora WebSphere DataStage?

- Consente la progettazione visuale delle procedure senza bisogno di codice, sfruttando centinaia di funzioni built-in
 - Riutilizzo ottimizzato delle procedure
 - Supporto batch & real-time
 - Produce componenti riusabili tra progetti
- Funzionalità ETL complete con approccio orientato ai metadati
- Supporto alla collaborazione ed al lavoro in team
- Fornisce accesso ad ogni genere di fonte dati



Come lavora WebSphere DataStage?



File Set



Sequential File



Parallel SAS Data Set



SAS



DB2



Oracle

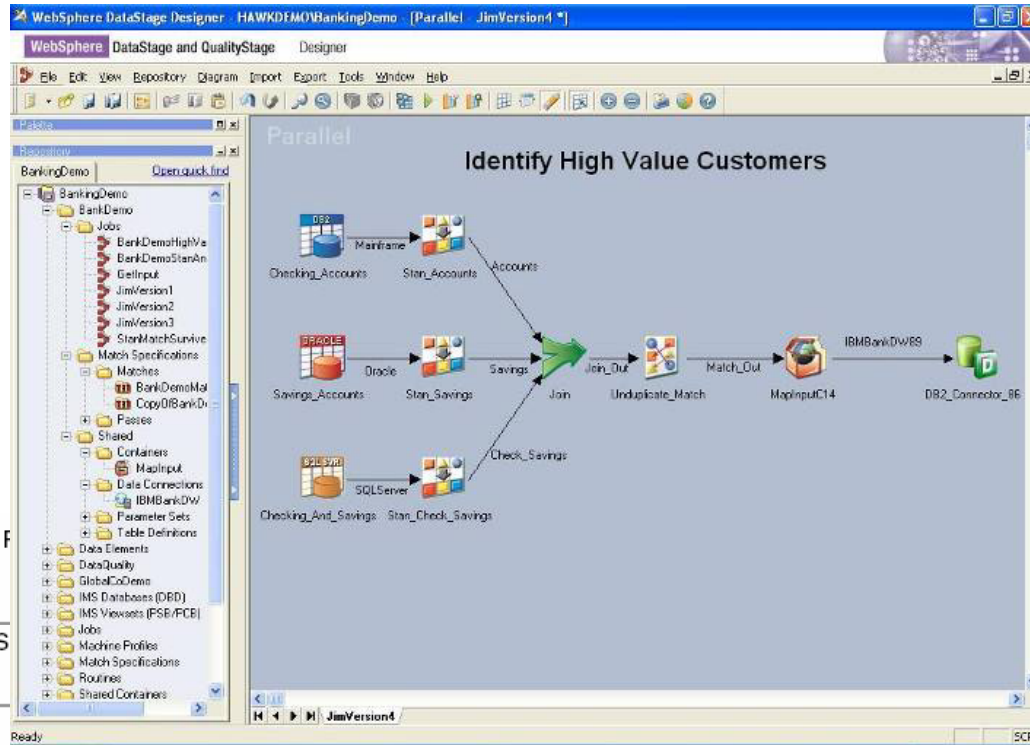

Write Range Map



Encode



Decode



Compress



Expand



Row Generator



Remove Duplicates



Data Set



Modify



Head



Tail

IBM WebSphere DataStage dove opera?



- E' in grado di supportare lo sviluppo di processi destinati ad essere eseguiti tanto su piattaforme distribuite quanto su mainframe:
 - Si basa su un unico ambiente di sviluppo con repository comune dei metadati e permette di sviluppare Job di tipo "mainframe", sulla stessa interfaccia grafica utilizzata in ambito dipartimentale
 - Consente Estrazione nativa di dati in ambiente mainframe S/390 (DB2, IMS, IDMS, VSAM, ISAM, ...)
 - Consente di elaborare piccole e grandi moli di dati in ambiente dipartimentale accedendo ai vari formati 'flat' e ai principali data base

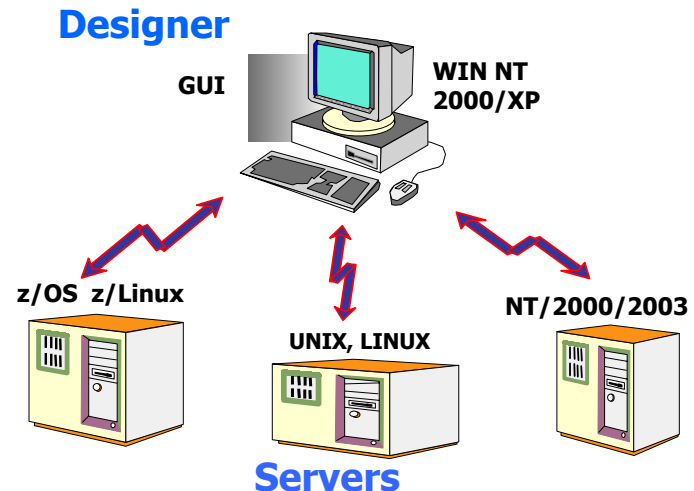

IS e Datastage: su piattaforma z/Linux

Partizioni z/Linux
IS Server Components

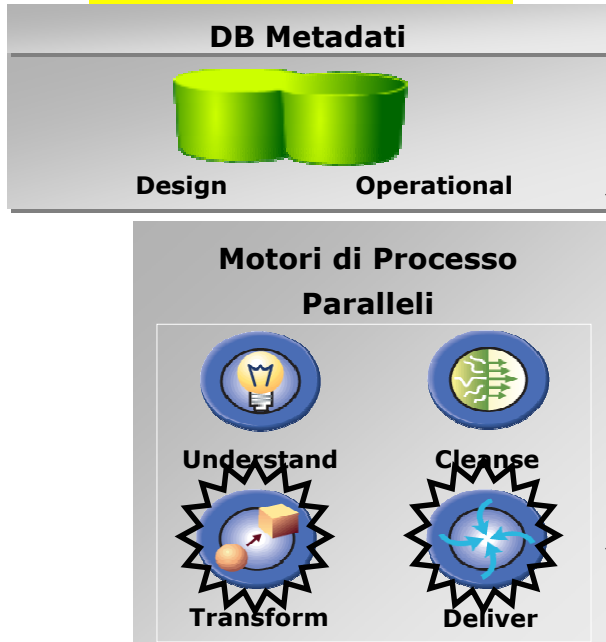

Partizioni z/OS



Dal lato z/OS si hanno:

- Basi Dati DB2
- Altre Sorgenti Federate
- File System Shared (NFS)

CONNETTIVITA' COMUNE



Dati Strutturati e non, Applicativi, Data Mainframe

Client Grafico

Play

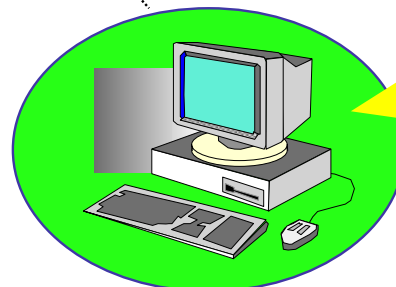

Generazione di codice Cobol e JCL per Integrazione dati su z/OS

Partizioni **z/Linux**
IS Server Components

Dal lato Server si
ha il **repository**
dei metadati

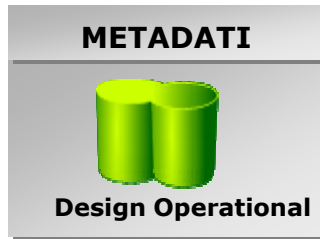

Partizioni **z/OS**

Dal lato z/OS si hanno:

“Sub”

• librerie Cobol
• librerie di JCL
• dati da trattare
• i Moduli da interfacciare

Lato Client

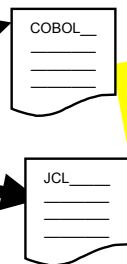
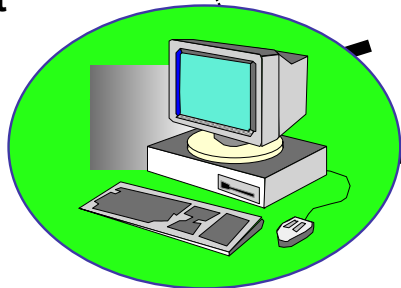

FTP

- Sorgente Cobol
- JCL Esecuzione

Vediamo ora



IBM Information Server

Comprendere



WebSphere. Information Analyzer
for Linux on System z

WebSphere. Business Glossary
for Linux on System z

Rational. Data Architect

Bonificare



WebSphere. QualityStage for
Linux on System z

Trasformare



WebSphere. DataStage for Linux
on System z

WebSphere. DataStage
for z/OS

WebSphere. DataStage MVS

Federare



WebSphere. Federation Server
& Classic Federation

WebSphere. Data Event Publisher
& Classic Data EP

WebSphere. Replication Server
& Classic Replication

DataMirror Transformation Server

Servizi comuni della piattaforma

Motori di Calcolo Parallelo



Connettività su applicazioni, dati e contenuti



Gestione metadati unif.



WebSphere. Metadata Workbench
for Linux on System z

Servizi di Amministrazione



Publica Web Servizi sui dati



WebSphere. Information Services
Director for Linux on System z

IBM Metadata Workbench

- E' uno strumento Web-based nato per l'esplorazione del patrimonio di MetaDati presenti nell'Information Server
 - Tracciati
 - Regole di trasformazione
- Consente una analisi che spazia:
 - Dalla tracciatura fisica del dato (lineage)
 - All'analisi di impatto e delle interdipendenze
 - Al significato di Business
- Consente di esaminare dati provenienti anche da tool esterni a IS come:
 - Strumenti di Business Intelligence
 - Strumenti di modellazione



Resp. Integrazione Dati **Sviluppatore**

IBM Metadata Workbench®

Comprendere  Provides IT professionals with a tool for exploring and understanding the assets generated and used by the Information Server suite.



Report Finder - Data Movement

1. Choose the information to view: View where data comes from
2. Choose a type of information asset to report on: BI Report Attribute
3. Choose a specific information asset to report on: Customer Name Attribute
4. Choose the type of report output: Graph
5. Create Report

Data Movement for: Customer Name Attribute

Job Flow Variable: CUST_NAME → Is Source Of Flow Variable - Created From Data Field - Created From Data Field → Data Field: DWCUSTNAME → Report Attribute → BI Report Attribute: Customer Name Attribute

1) Da dove proviene il dato presente in questo report?



- Importa e Naviga tra i Metadati presi dagli strumenti di BI
- Naviga attraverso gli attributi
- Ricostruisci il percorso dei dati attraverso I diversi tools

Aumenta la comprensione e la credibilità dei dati di business riportati

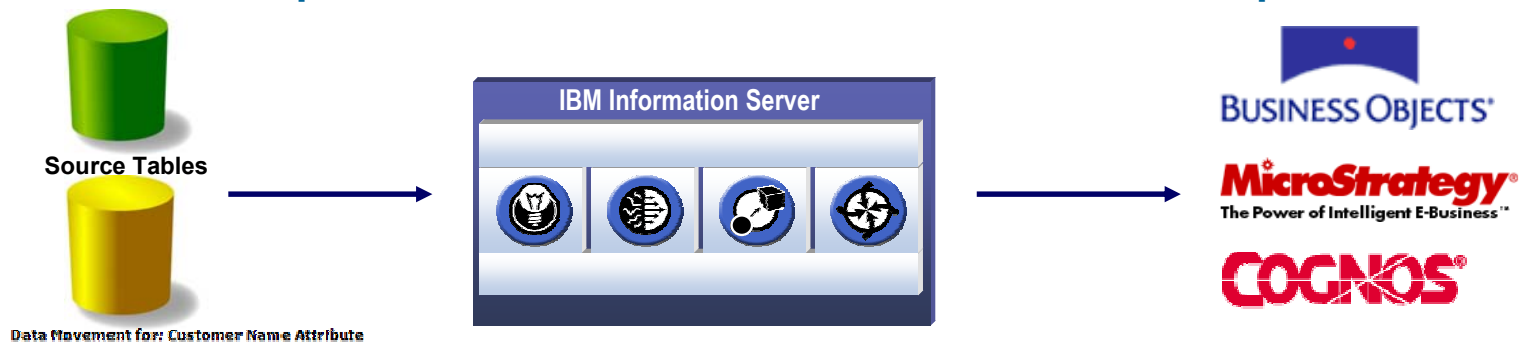

Data Movement for: Customer Name Attribute

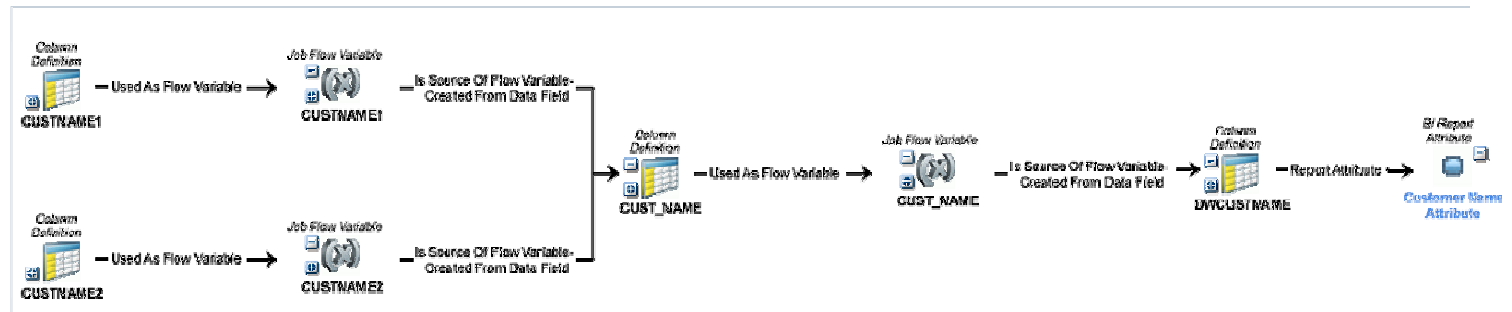

2) Cosa accade se cambiamo questa colonna?



- Mostra gli impatti sia graficamente che sottoforma di lista
- Analizza anche gli impatti sui report di BI
- Consente analizzare partendo da qualsiasi oggetto della catena

Riduce il costo associato alle evoluzioni del sistema IT

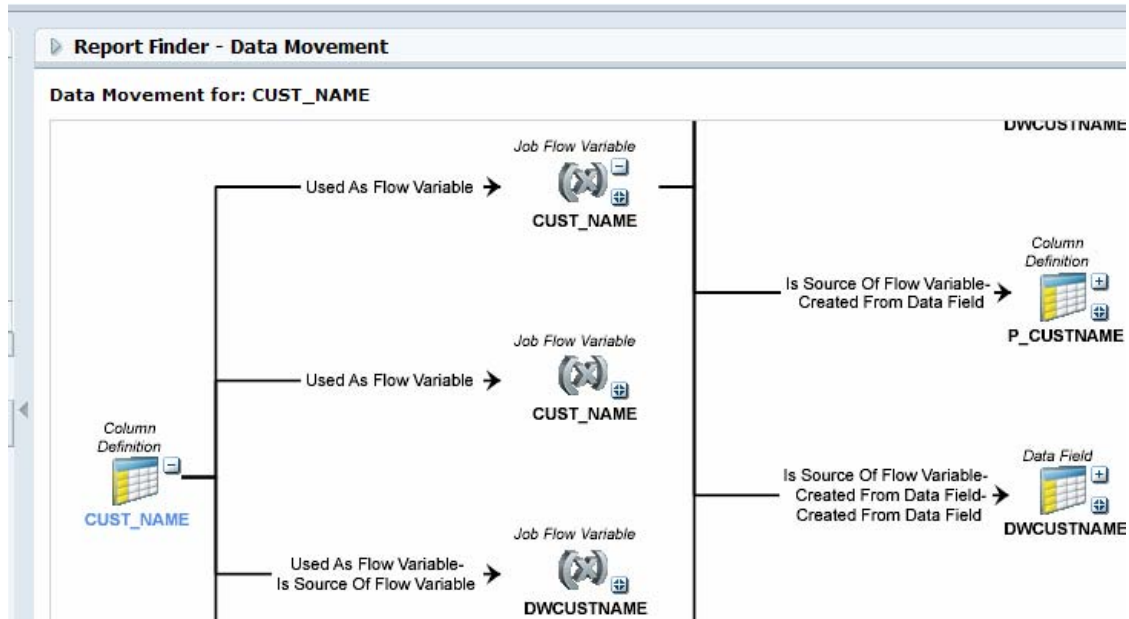

3) Cosa Significa questo campo?



- Mostra le relazioni tra i “business terms”, le “entità” dei modelli dati e i “campi” tecnici (colonne e dati dei reports)
- Consente di capire il significato di un campo
- Consente di comprendere le relazioni semantiche e logiche

Assicura il reporting richiesto dalle nuove norme (SO e Basilea II)

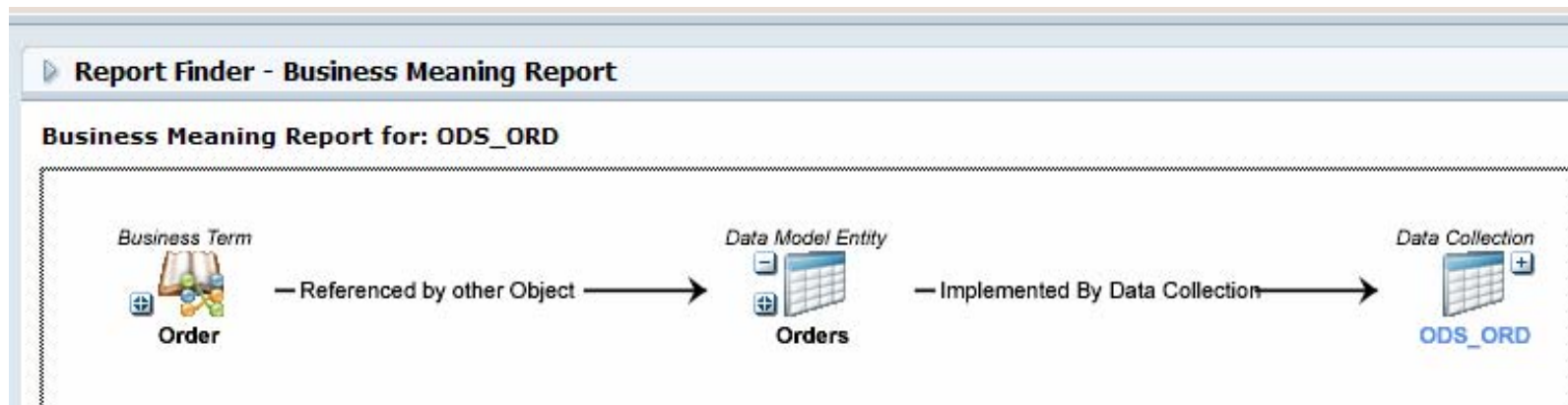



Affinchè I metadati siano disponibili per le funzioni appena descritte occorre che siano contenuti nel “repository” di Information Server.

Questo accade:

- In modo trasparente per tutte le componenti di Information Server
- Attraverso una azione esplicita di “imporazione” per i metadati provenienti da altri sw di mercato.

IBM Information Server Architettura della gestione Metadati

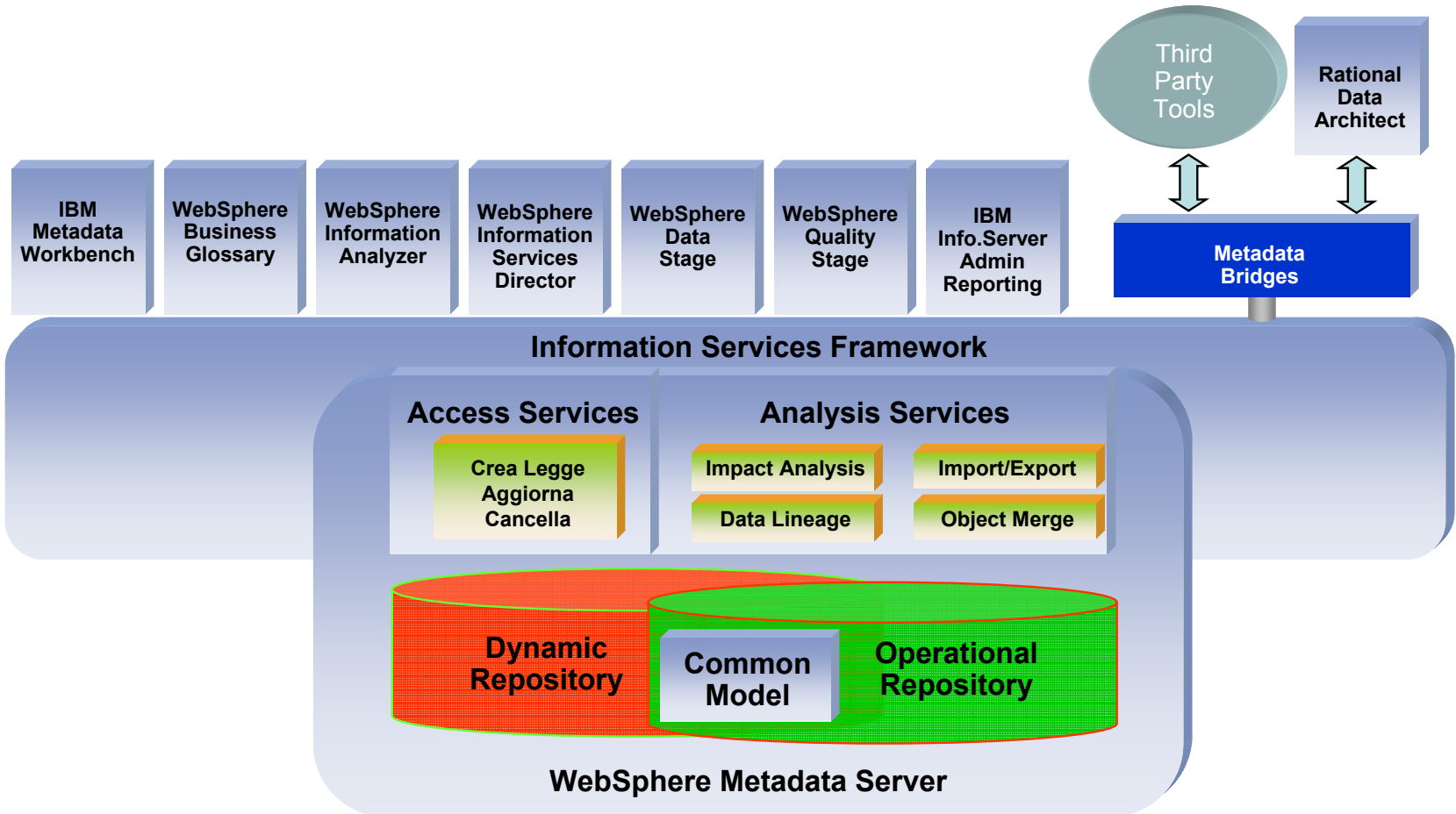

Selecting the correct metadata strategy

Understanding the business metadata requirements and where the customer fits in the metadata maturity lifecycle is critical to knowing which products to position as the solution.



<i>Example Business Requirement</i>	<i>Metadata Solutions</i>
We have an initiative to create a common set of business terms.	Business Glossary Portfolio
We need to be able to assess the impact of system changes.	Metadata Workbench
We need to share integration requirements between the business and IT.	Metadata Server Business Glossary Portfolio
We need to audit data loads by validating computations performed.	DataStage
We need to use data models created in our modeling tool with our ETL process.	Import / Export Manager
We need to provide access to integration reporting to a wider audience.	Information Server Web Console



Ottenere il massimo attraverso:

- Tool integrati e metadati condivisi fanno ottenere:
 - Risparmi di tempo e denaro
 - Migliore qualità nei risultati
 - Agilità del sistema per reagire agli stimoli del mercato (Time to Market)
- Un Vocabolario comune alle diverse funzioni:
 - Abilita la condivisione e la comprensione dei problemi
 - La comunicazione tra diversi skill professionali
 - Fa risparmiare tempo

The key is to make the metadata capture and share processes effortless



Fine

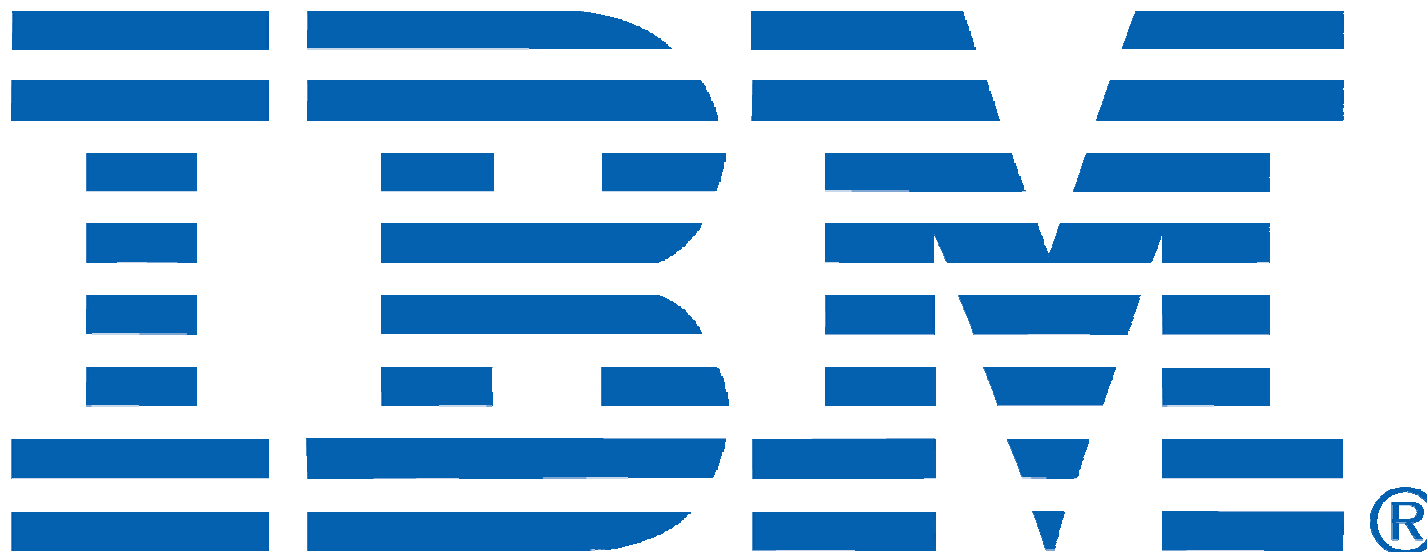

Grazie

Extra slides



....in caso di emergenza



IBM Information Server for System z

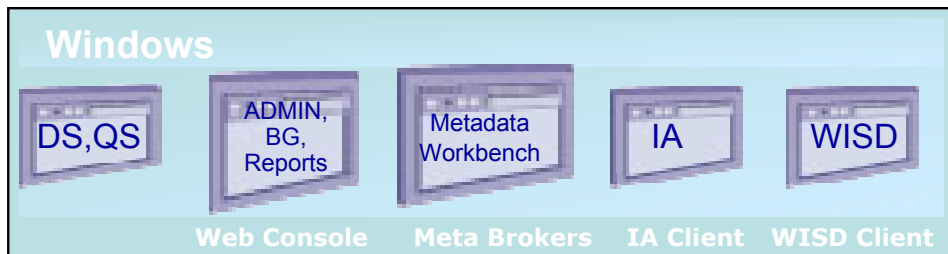

Roles-based GUI Design Tools work the way "you" do

IBM Information Server for System z

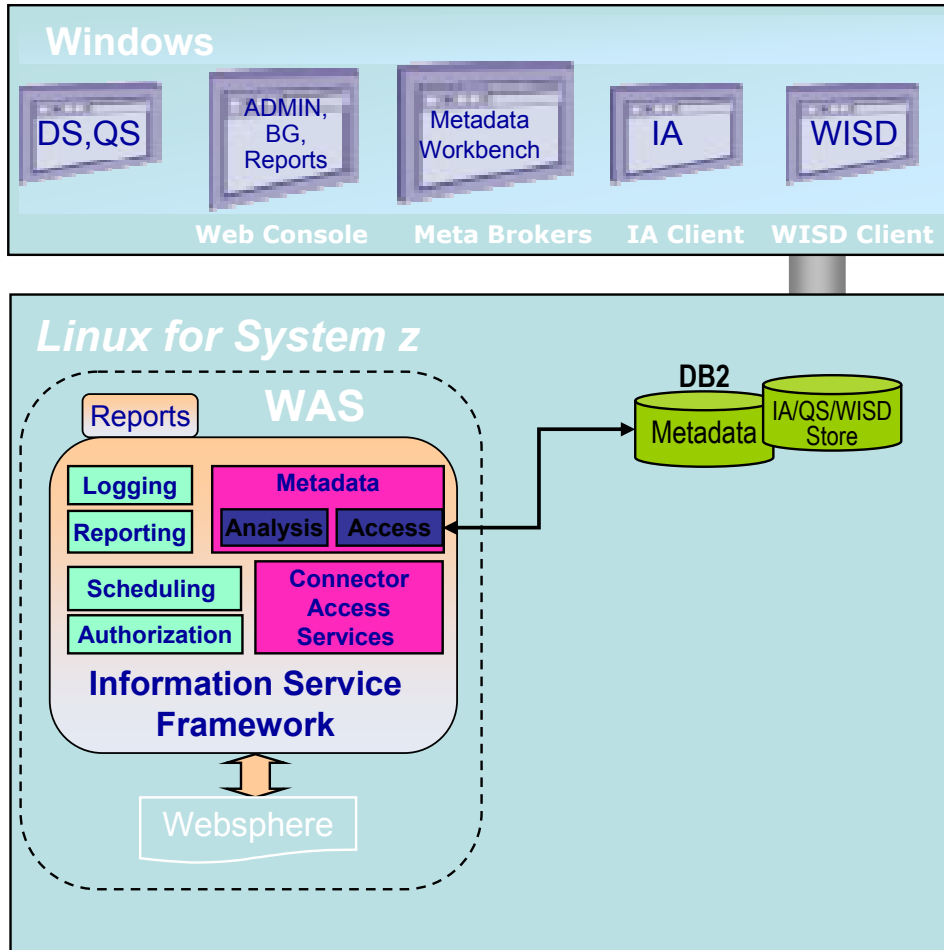

- **Common reusable services** framework leverages the power of a SOA environment
- **Meta data repository** promotes:
 - reuse
 - compliance to standards
 - visual lineage
 - impact analysis

IBM Information Server for System z

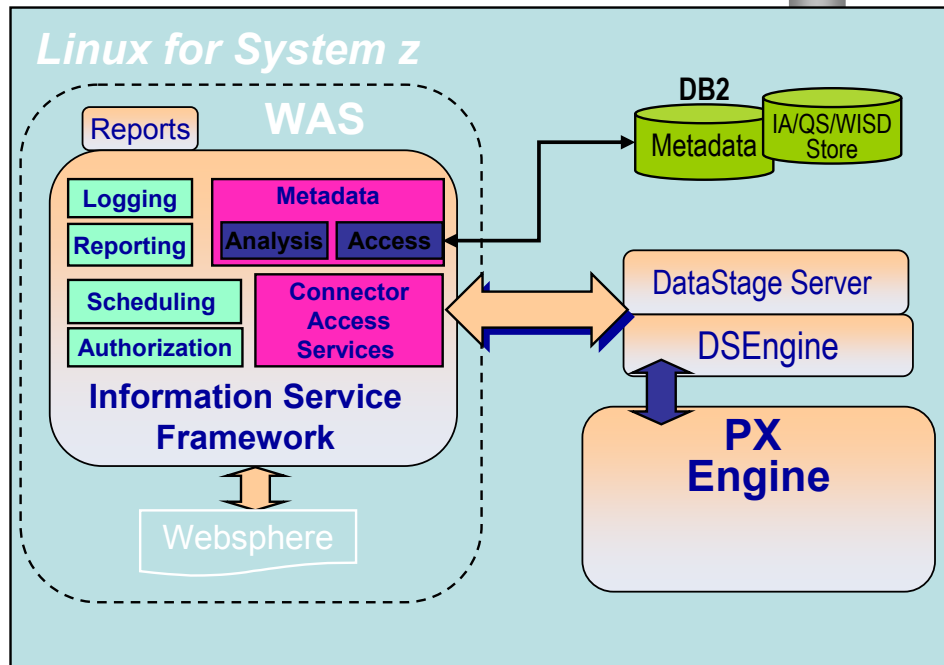
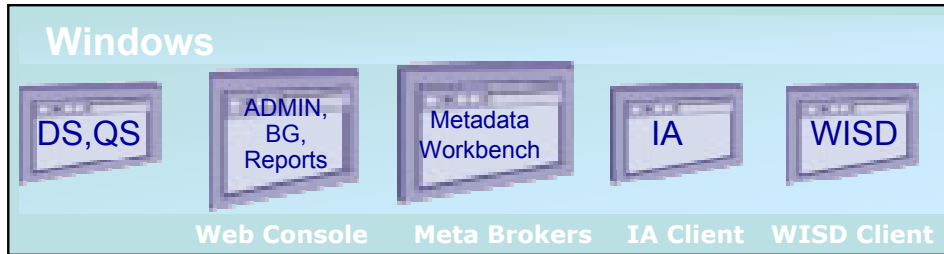

Linux for z Operational Environment

- Full Information Server suite: WebSphere QualityStage, WebSphere Information Analyzer...
- Robust, parallel processing
- Minimal impact on z/OS costs: Leverages IFLs and zIIPs

IBM Information Server for System z

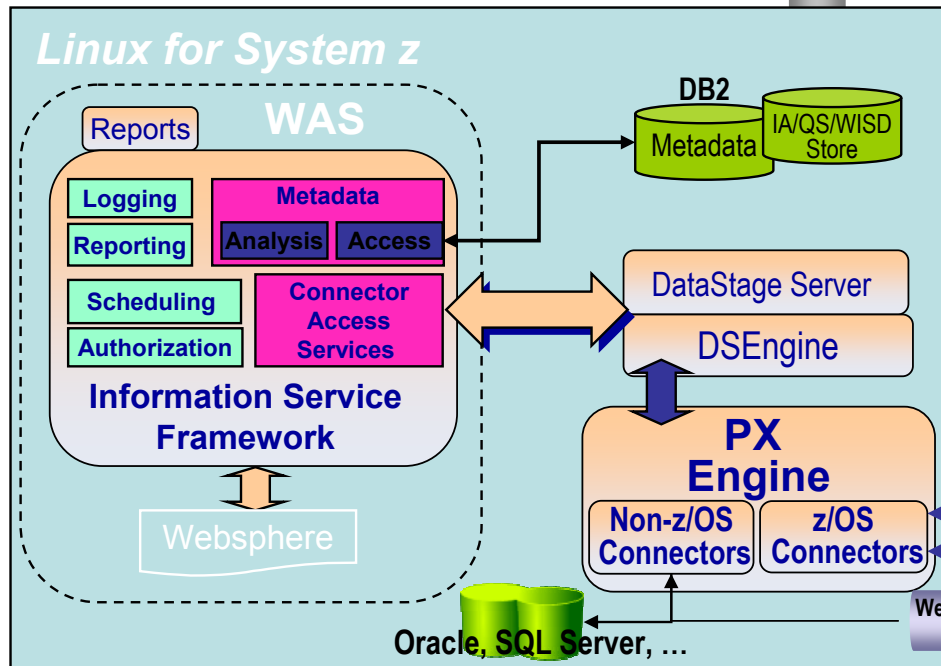
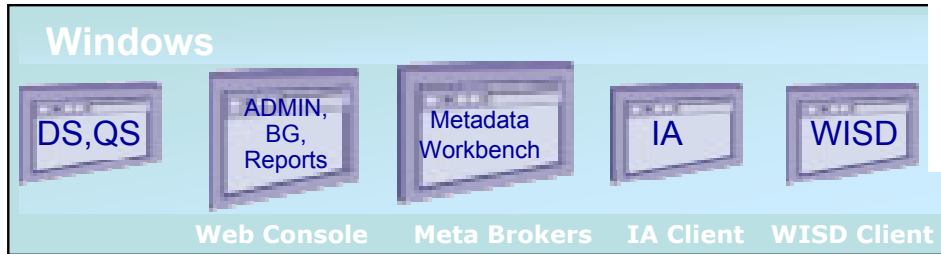

Rich connectivity with:

- Application & distributed data
- Hipersocket connectivity to z data
- WS Classic Federation for non-DB2
- WS Data Event Publishers for CDC

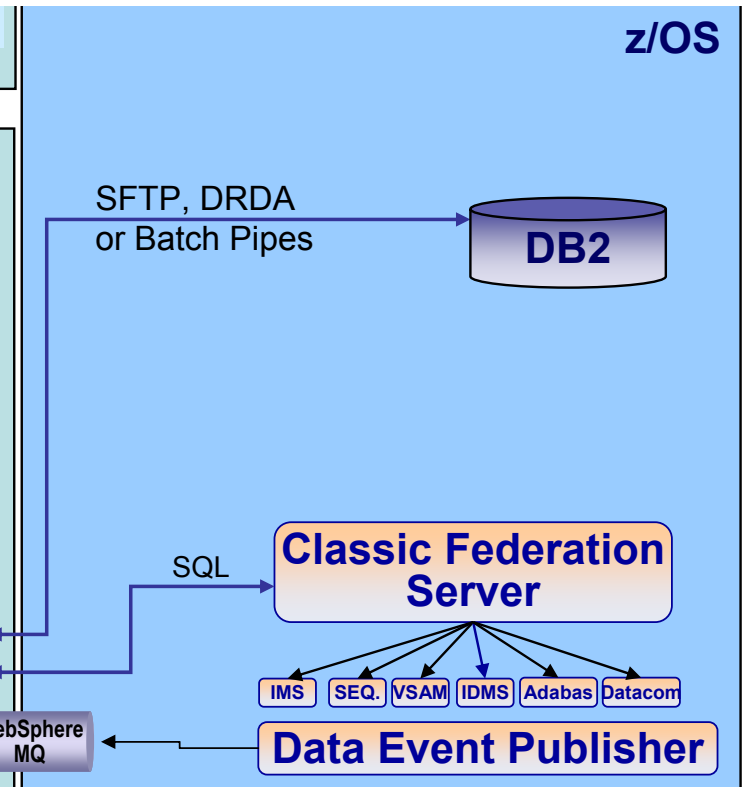

IBM Information Server for System z

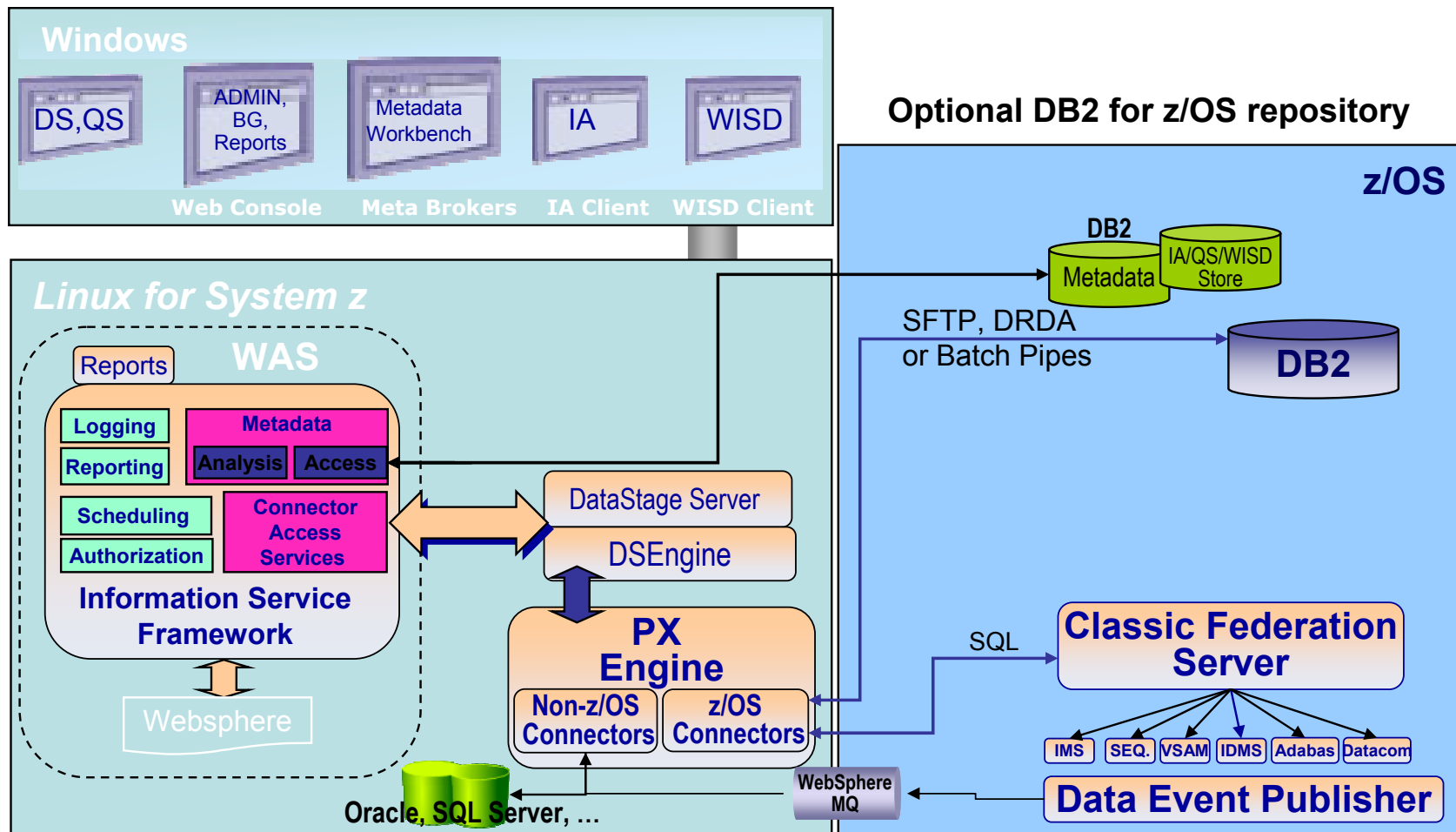

IBM Information Server for System z

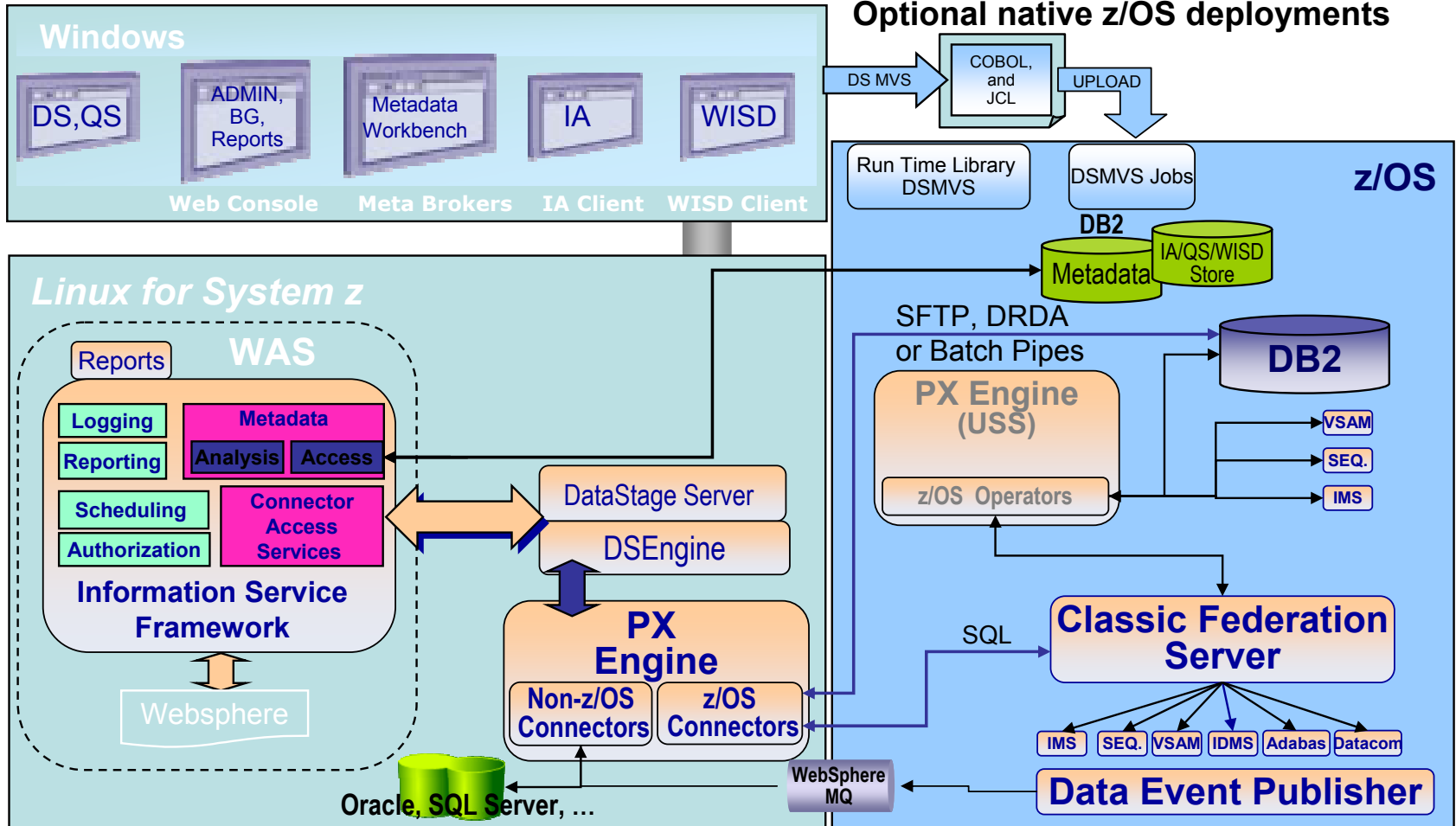

The Areas of Metadata

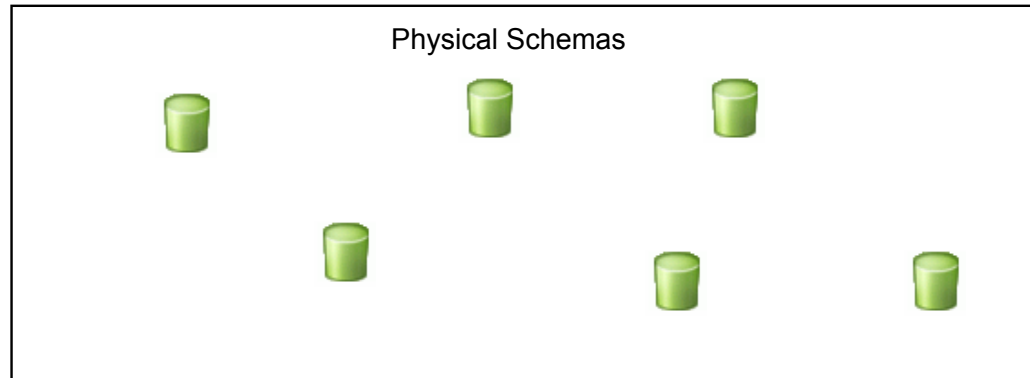
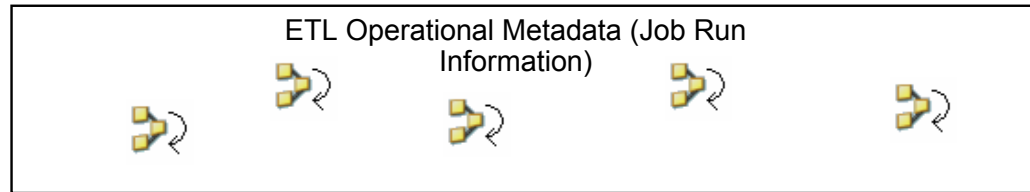
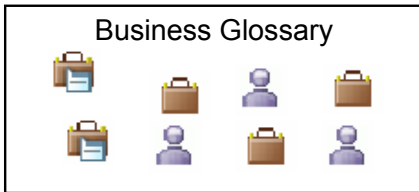

The Areas of Metadata Connected

