



Data High Availability: GDOC (Geographically Dispersed Open Clusters) Solutions for Open Environments

Alessandro Sartirana
IBM Server Services IT Architect



IBM Governance and Risk Management 
Maximize Value, Manage Risk

What if you Compare the World of the IT Solutions and the World of the Aircrafts

- Would you fly with this aircraft?



Many IT Shops Have Availability Objectives in the 2-Nines and 3-Nines Range

- Some IT shops have an objective of 99.7% or less
- What if the airlines operated at 99.7%
 - 120 crashes each day in the US
- Let's put 99.9% (3-nines) in perspective
 - One hour of unsafe drinking water per month
 - Two unsafe landings at O'Hare every day
 - 16,000 pieces of mail lost per hour
 - 20,000 incorrect drug prescriptions each year
 - 500 incorrect surgical operations performed each week
 - 50 newborn babies dropped at birth by doctors each day
 - 22,000 checks deducted from the wrong account each hour
 - No TV or telephone for 10 minutes per week
 - Heart fails to beat 32,000 times per year
- Even 5-nines (99.999%) reliability would result in 460 fatal accidents per year
- Thankfully, the airlines are now operating with > 7-nines reliability (99.999996%) and still improving

If we had 120 crashes every day
in the US,

There would be
no airline industry!

Two unsafe landings at O'Hare
every day!

We would need a much larger
fire department!

And, a lot of people to clean up
afterwards!

Expensive? Absolutely!

The Architecture is Critical for Managing Complexity

- Without architecture what do you obtain?
- Direction conflict?
- Useless complexity?



What if the airlines flew single engine aircrafts?

- Would you fly on this airplane?
- The airlines recognize the value of redundancy
- In IT, we live (or fail) with single points of failure!
- What if we in IT were designing airplanes, we might get something like this

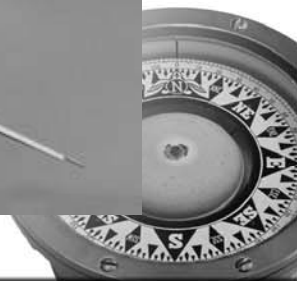

The Availability Chain

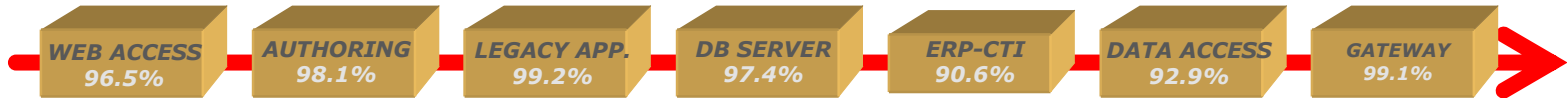

Overall availability = 76,29

%Availability	Downtime/Year
100	0
99.99	52.8 min
99.98	1h 45 min
99.90	8h 45 min
99.80	17h 30 min
99.70	26h 17 min
99.50	43h 43 min
99	87h 36 min



High Availability Definition

High Availability is the ability of minimizing the systems unavailability and ensuring/keeping the highest service levels. It is realized through the redundancy of a single component and through a coordinated block of hardware, software and connectivity at system level



Availability Objectives Must Align with Business Requirements and Give Us Something to Measure Ourselves

- Airlines have safety standards demanded by the traveling public and established by government regulations
 - In the US, the FAA establishes and enforces airline rules and standards
 - The flying public understands the value of safety and would not fly if the airlines did not have high safety standards and results
 - We measure safety based on seat miles flown
- In IT we set availability objectives based on what we think we can deliver
 - IT has few regulatory requirements
 - The value of IT is not understood and the business users are left at the mercy of IT
 - IT measures time (What's a defective minute?), rather than what we deliver – information transactions

Introduction: What is GDOC?

- IBM's solution expertise coupled with the latest technology to achieve the highest level of application and data availability for open systems
 - This Translates to improving your ability to serve your customers
 - GDOC is a combination of technology and IBM expertise. IBM's expertise and experience is used as the foundation to create the right solution for the client. IBM's experience includes implementations of high availability multi-site recovery systems world wide which helps to differentiate the GDOC solution
 - Leveraging software from Symantec Corporation
 - Provides an open, multi-vendor system solution, running on Unix, Windows, Linux
 - Addresses automation, management, and testing of data and application availability and recovery across multiple data centers

Downtime and Lost Data Can Pose a Serious Threat to Your Business

- Lengthy outages mean lost revenue, reputation and possibly customers
- Loss of time-sensitive and private data can threaten ongoing viability
- System outages can compromise the capabilities of first responders
- Extensive outages can lead to your dissatisfaction and lower employee productivity
- Lost data can make it difficult to meet regulatory requirements
 - Basel II from the Bank for International Settlements
 - International accounting standards and international financial reporting standards from the International Accounting Standards Board
 - The Sarbanes-Oxley Act
 - The USA PATRIOT Act
 - The Health Insurance Portability and Accountability Act (HIPAA)

Business-critical systems Require Fully Automated, High-Availability Solutions

- Is application high availability and recovery a current business focus?
- How long can your business afford to be down in case of an outage?
- Do you have mission-critical data at two or more mirrored, geographically distant centers?
- Does your business require automated recovery processes that provide aggressive recovery times?
- Can you test your high availability and application recovery capabilities on a regular basis?
 - Is this testing successful?
- ***How do you know whether you are really prepared?***



The Best of Two Worlds: IBM Services Plus Symantec Management Software

- IBM has proven methods and experience to successfully deliver:
 - Requirements gathering and solution design
 - Network bandwidth analysis
 - Dual data center replication
 - Disaster recovery testing

- Market-leading Storage Foundation Enterprise high-availability and recovery software from Symantec which provides:
 - Automation of application startup and application restart on another server in the event of a server failure
 - Monitoring of data replication and application status
 - Single console for management of all clusters
 - Ongoing Testing

Open Systems - Recovery Automation Product Matrix

Automation \ Platform	Windows	AIX	Linux	HP/UX	Solaris	zOS
Recovery Automation with GDPS						X
Recovery Automation with Symantec Software	X	X	X	X	X	
Tivoli System Automation	X	X	X			
HACMP-XD		X				
MSCS	X					



RPO/RTO Versus Cost

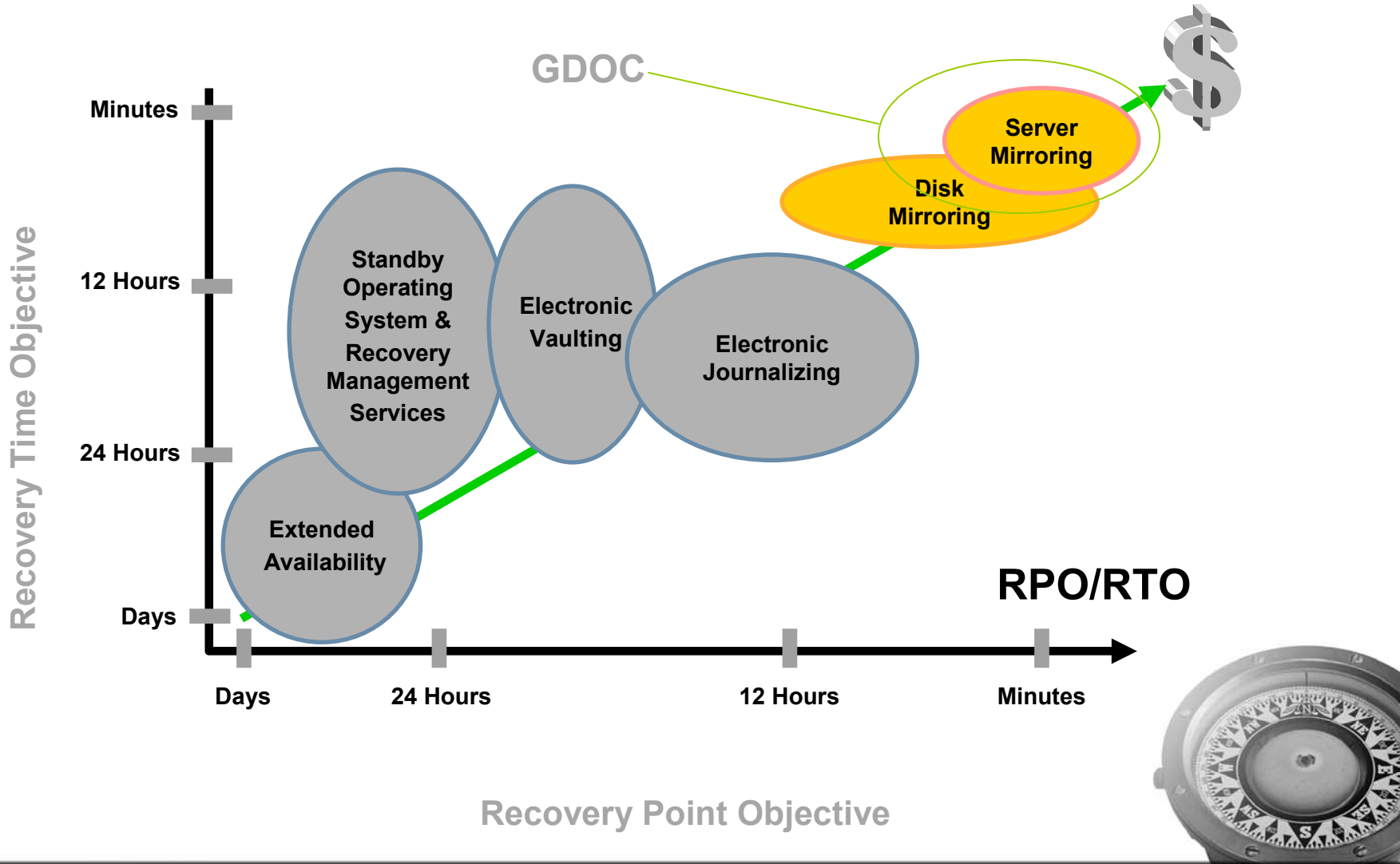

What a Typical GDOC Solution Looks Like

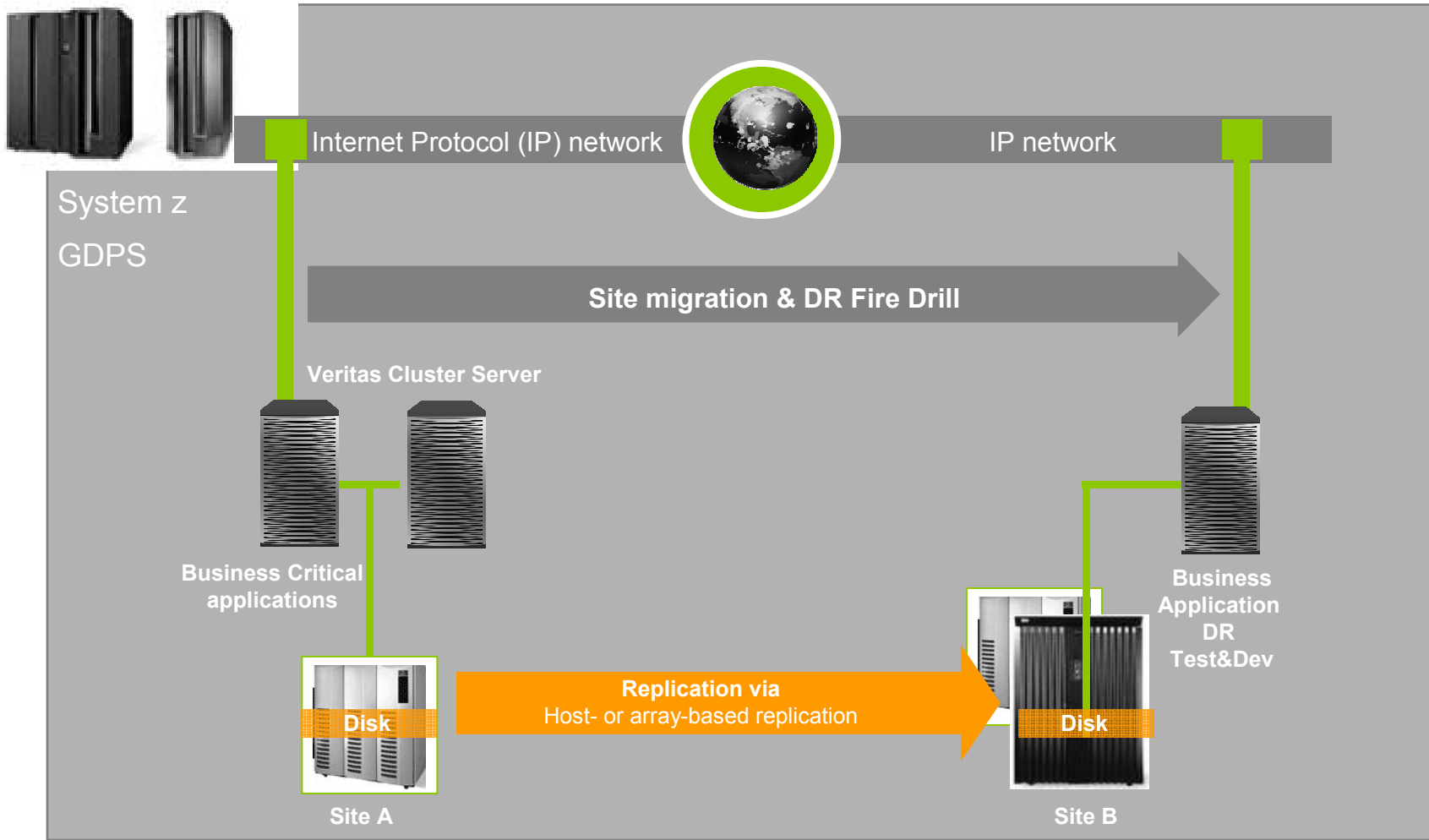

Application Failover Across Sites

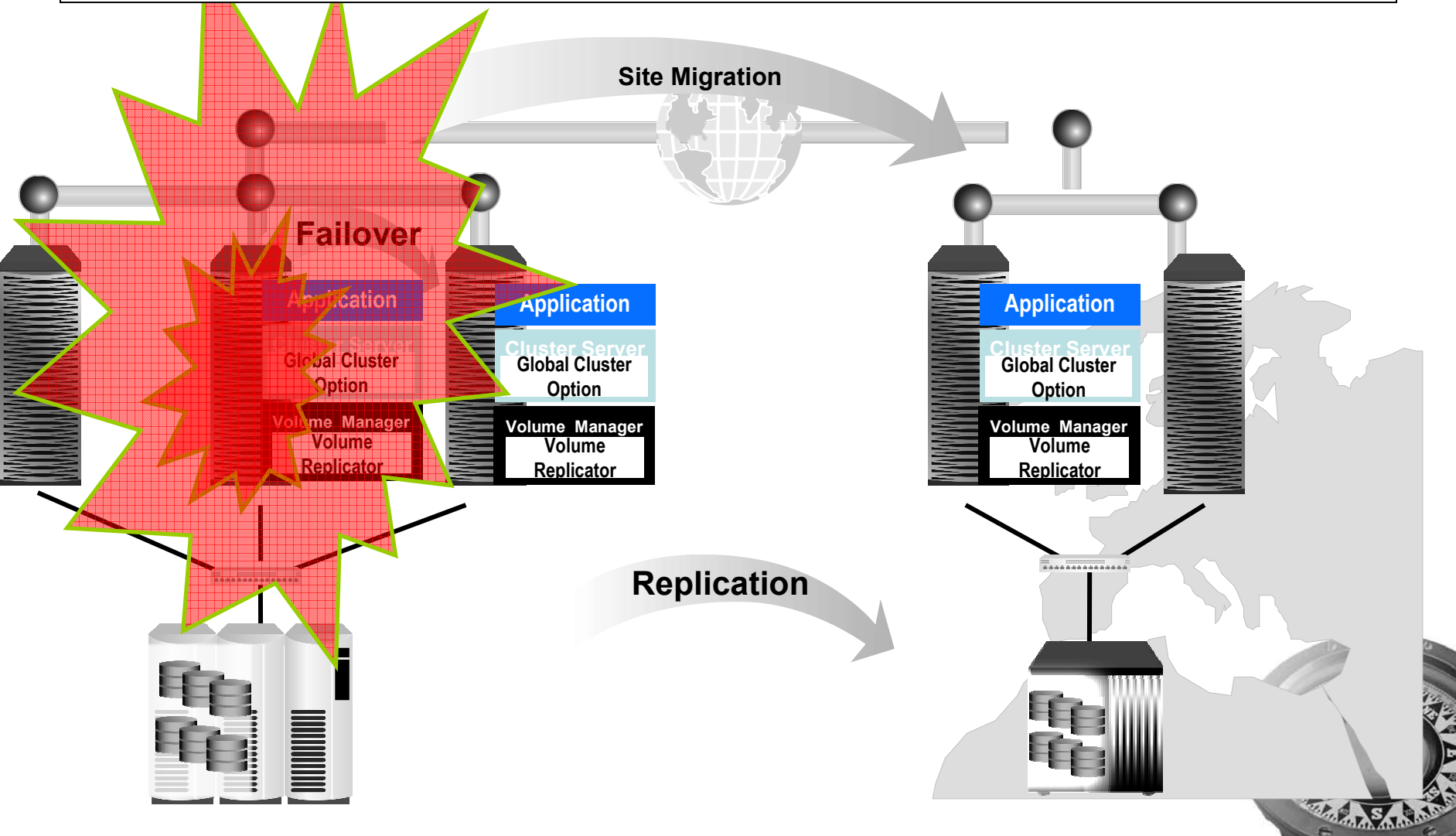

Local BC and Remote WAN DR

Local Clustering (LAN)

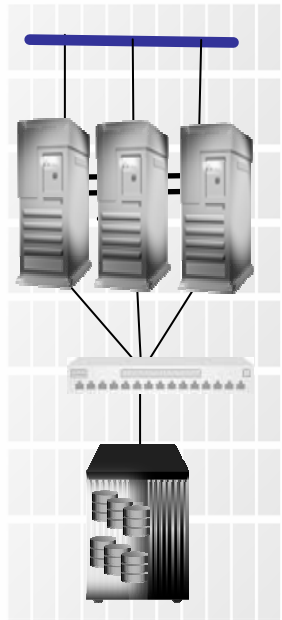

Metropolitan Disaster Recovery (MAN)

Remote Mirroring

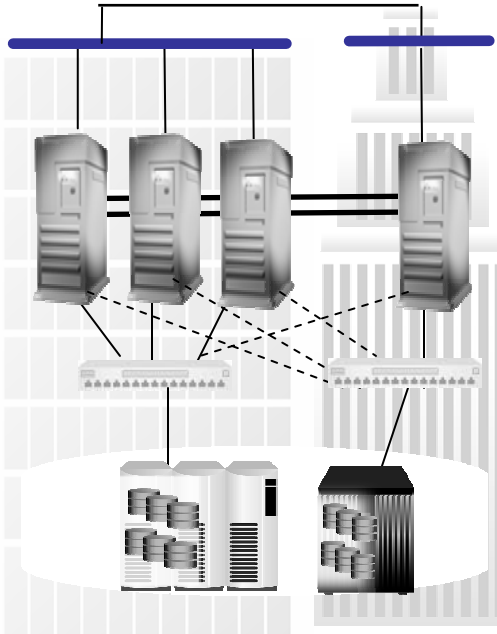

Remote Mirror, SAN Attached, Fibre

Replication

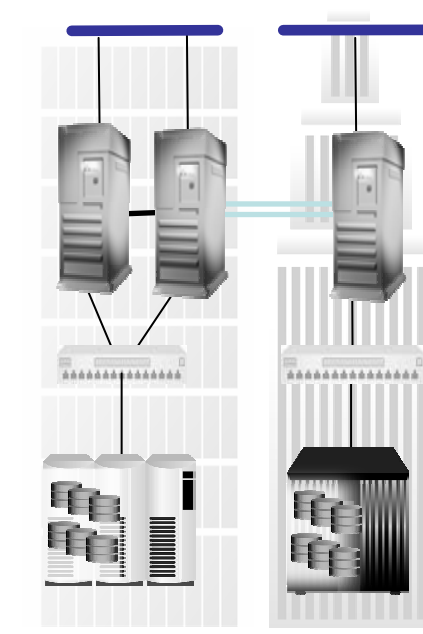

Replication, IP, DWDM, Escon

Wide Area Disaster Recovery (WAN)

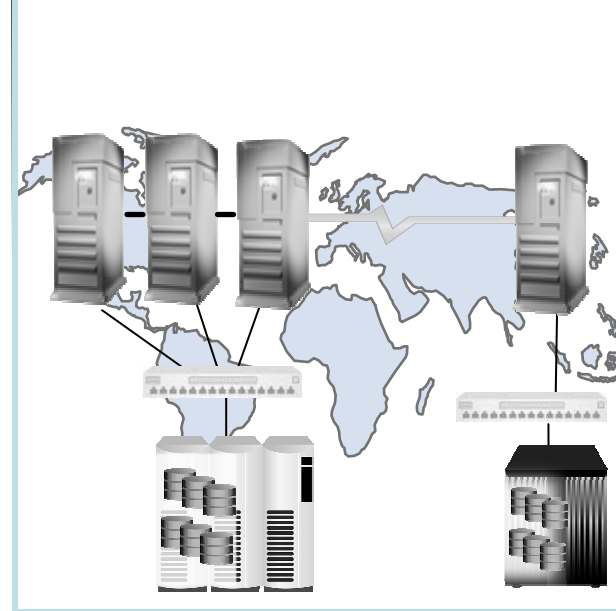

GDOC Elements

- Replication technology: DS8000 with Metro Mirror (formerly synchronous PPRC), IBM DB2 HADR, EMC SRDF/A, Veritas Volume Replicator, Oracle DataGuard, HDS TrueCopy, NetApp SnapMirror, etc.
- Cluster Server for server availability within a site
- Global Cluster Option for availability across sites
- IBM Methodology and Services

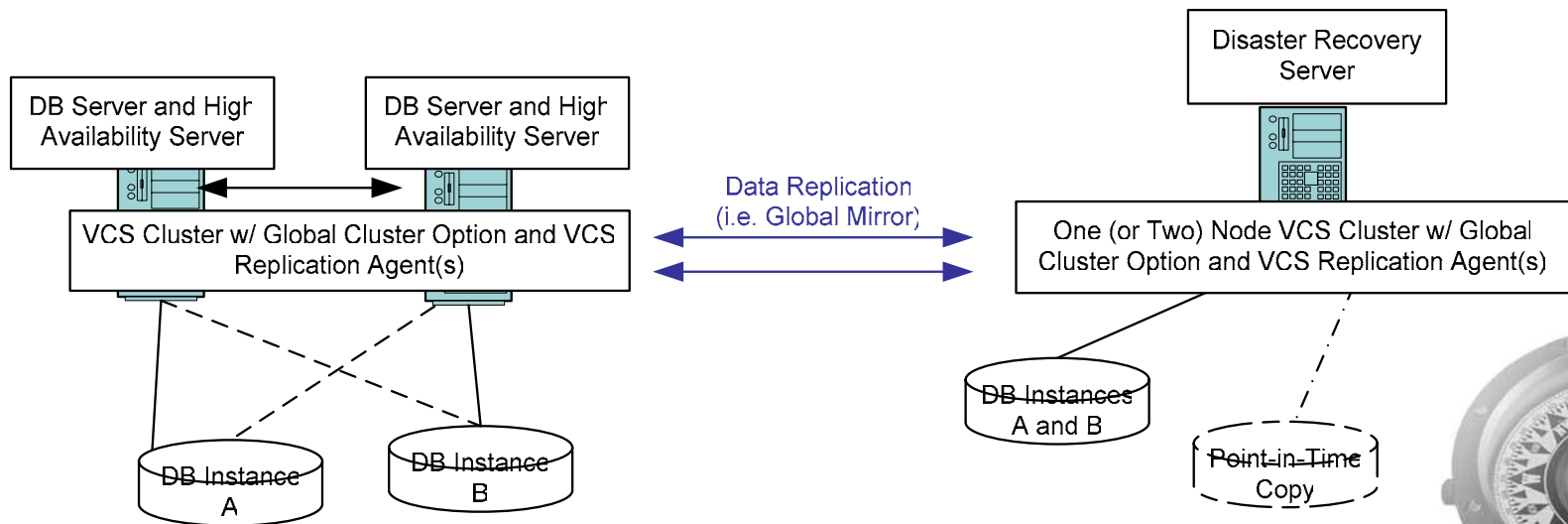

Simplified View - Centralized Consoles

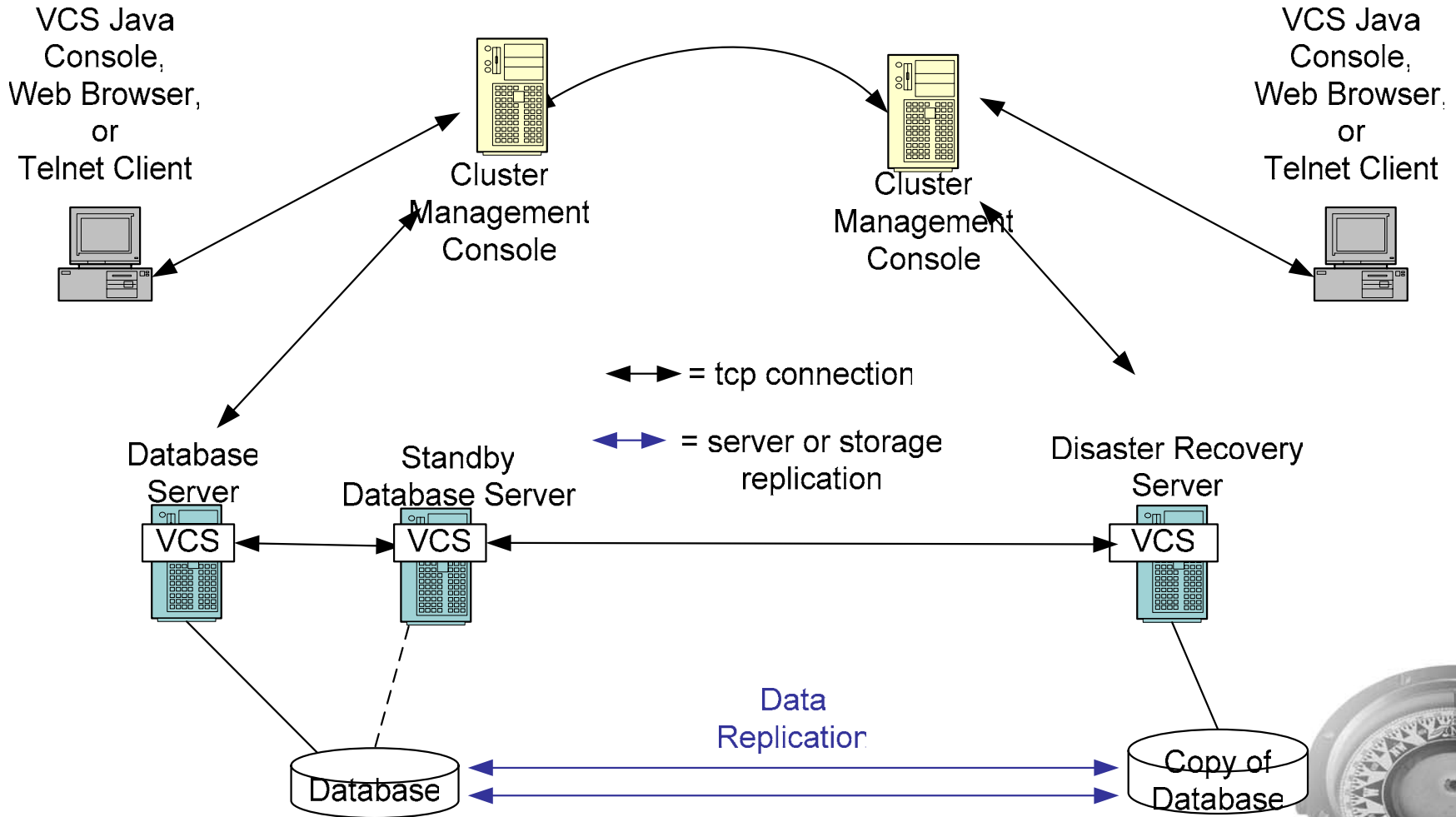

Future Integration with GDPS

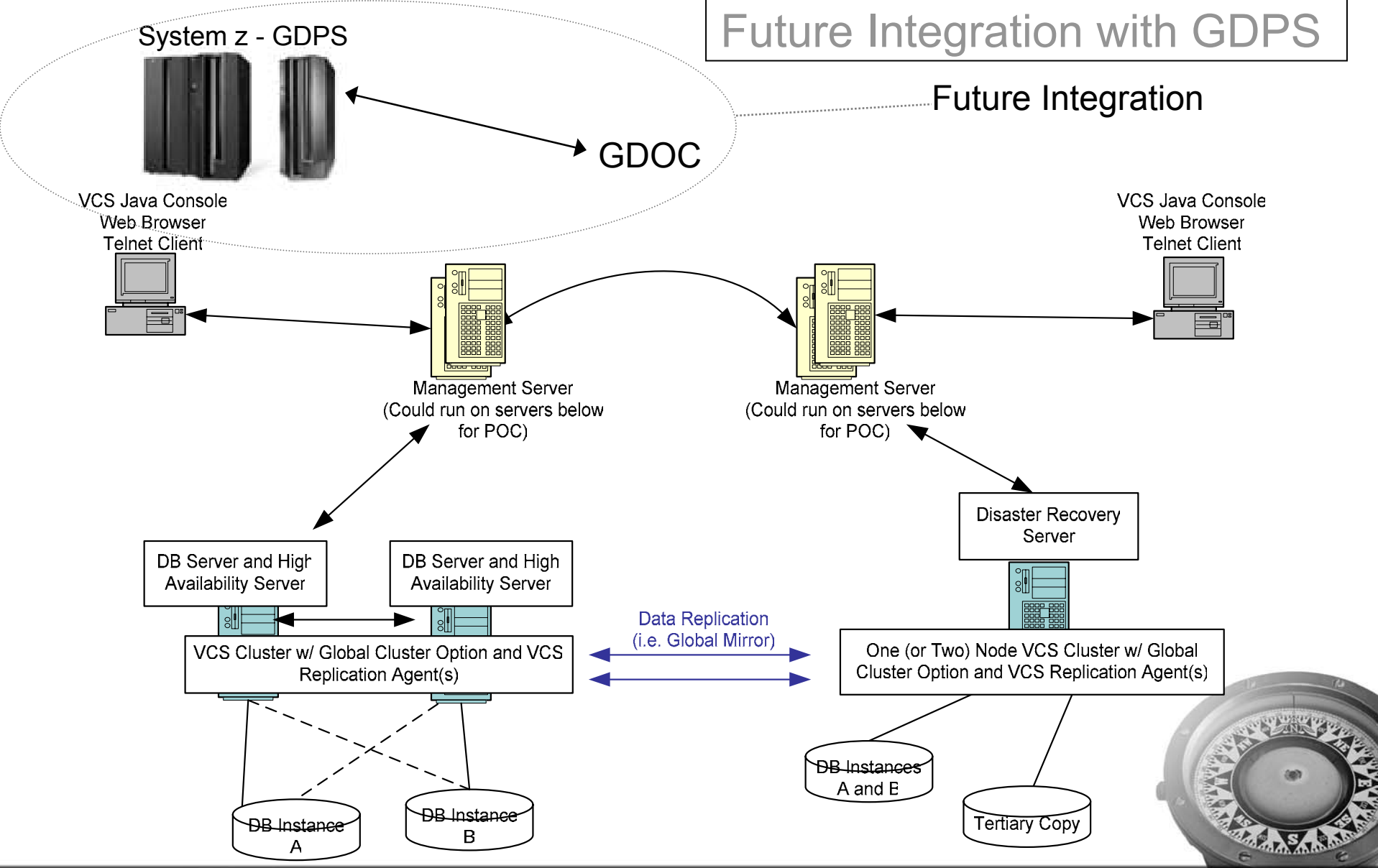

System Architecture - VCS Communications View

- important for customers that firewall ports between sites

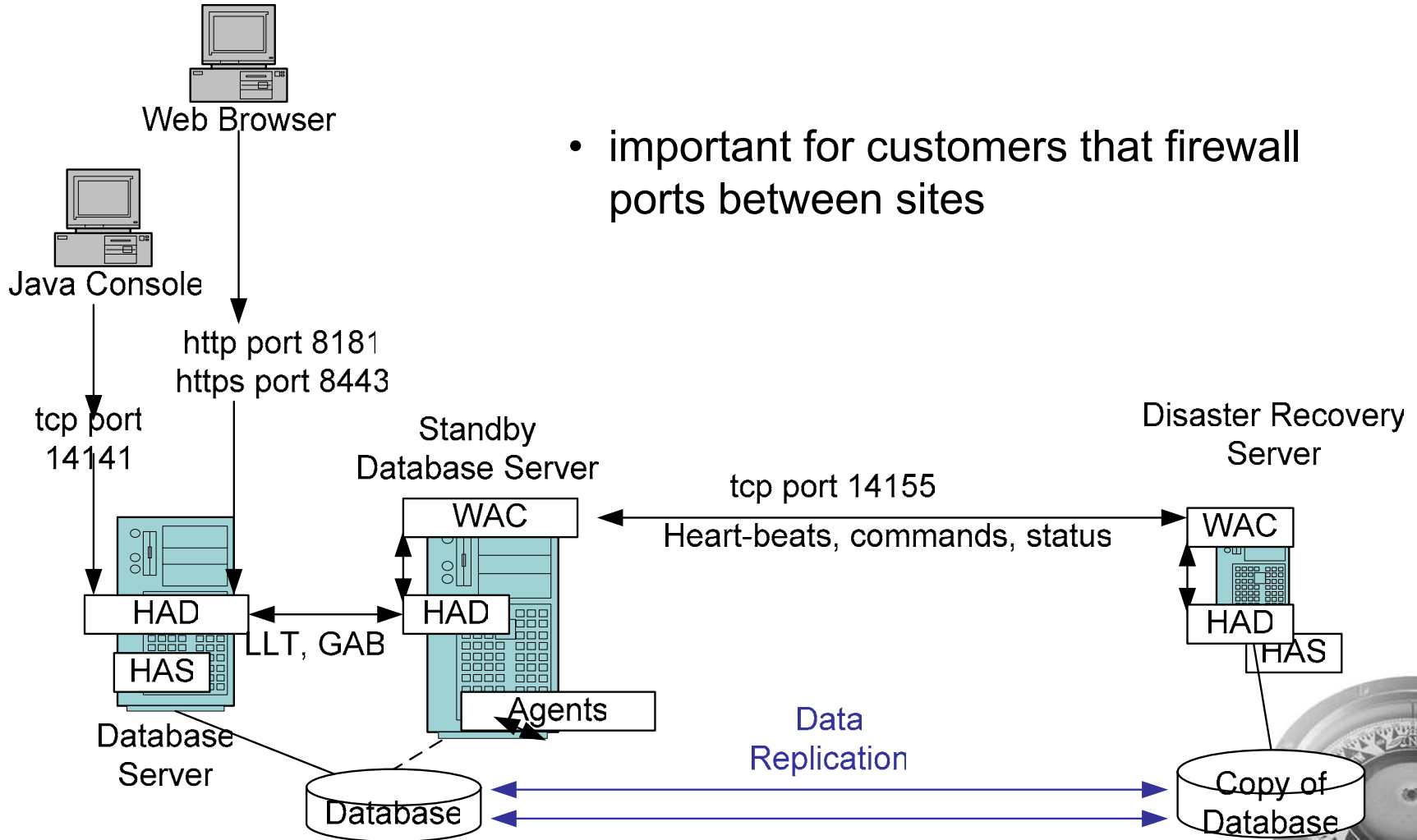

System Architecture - VCS Service Groups View

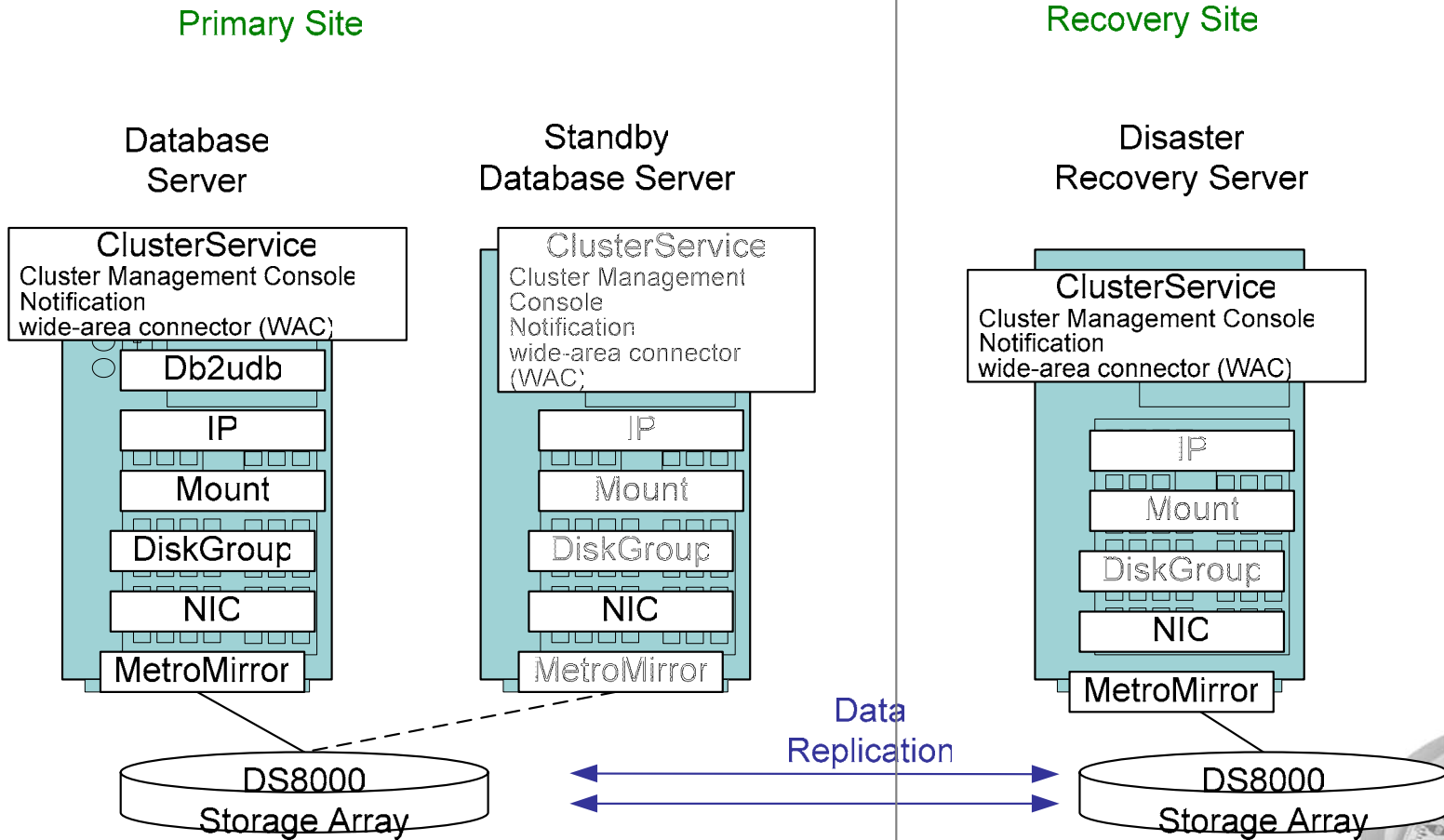

Just as Airline Safety is No Accident, Achieving Availability Improvements Requires Management Focus and a Commitment to a Proactive IT Culture

- In order to support the business transformations underway and meet the ensuing higher availability demands, IT must also transform itself
 - We are suffering under the weight of decades old processes
 - We do not effectively use the skills we have to prevent fires and manage exceptions
 - We do not have the database designs to effectively manage required information
- The transformation of IT requires a strong foundation
 - Strategy
 - Governance model
 - People, process, and information
- Just like safety in the airlines, high availability in IT requires careful management and focus
 - Safety does not just happen by itself without care and attention to details
 - High availability will not happen without a similar focus
- We can and must learn from other industries, such as the airlines

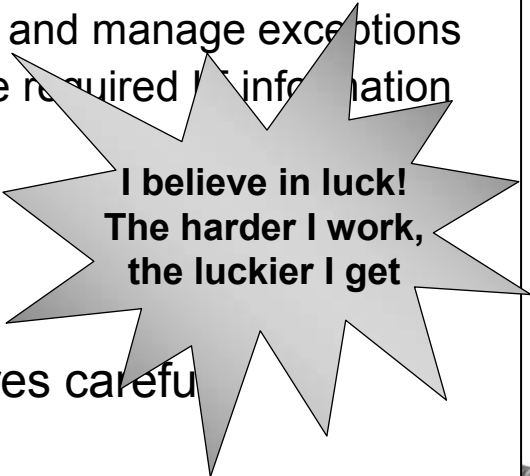

**I believe in luck!
The harder I work,
the luckier I get**

Any Questions?



* What makes you special?

Thank You!



IBM Governance and Risk Management *
Maximize Value, Manage Risk