

WebSphere Message Broker



Message Flows

Version 6 Release 1

WebSphere Message Broker



Message Flows

Version 6 Release 1

Note

Before you use this information and the product that it supports, read the information in the Notices appendix.

This edition applies to version 6, release 1, modification 0, fix pack 2 of IBM WebSphere Message Broker and to all subsequent releases and modifications until otherwise indicated in new editions.

© **Copyright International Business Machines Corporation 2000, 2008. All rights reserved.**

US Government Users Restricted Rights – Use, duplication or disclosure restricted by GSA ADP Schedule Contract with IBM Corp.

Contents

About this topic collection. v

Part 1. Developing message flows 1

Developing message flows 3

Message flows overview	4
Getting started with Quick Start wizards	130
Designing a message flow	139
Managing message flows	214
Defining message flow content	227
Developing message flow applications using WebSphere Adapters	245
Developing ESQL	257
Using XPath	411
Using TCP/IP in message flows	422
Developing Java	449
Developing message mappings	472
Defining a promoted property	554
Configure monitoring events for message flows	562
Collecting message flow accounting and statistics data	564
Developing a user exit	570
Configuring aggregation flows	572
Configuring flows for message collection	593
Configuring timeout flows	603
Configuring flows to handle WebSphere MQ message groups	609

Part 2. Working with Web services 613

Working with Web services 615

WebSphere Message Broker and Web services	615
What is SOAP?.	617
What is WSDL?	629
What is SOAP MTOM?	633
WS-Addressing.	635
WS-Security	645
WebSphere Service Registry and Repository	666
External standards.	681
Message flows for Web services	689

Part 3. Working with files 715

Working with files 717

How the broker processes files	717
How the file nodes and additional instances share access to files	719
Using LocalEnvironment variables with file nodes	721
File name patterns.	724
mqsarchive subdirectory	726
Reading a file	727
Writing a file	735

Part 4. Deploying 743

Deploying 745

Deployment overview	746
Deploying a message flow application	757
Deploying a broker configuration.	767
Deploying a publish/subscribe topology	768
Deploying a publish/subscribe topics hierarchy	770
Checking the results of deployment	772
Canceling a deployment that is in progress	774
Renaming objects that are deployed to execution groups	776
Removing a deployed object from an execution group	776

Part 5. Debugging 779

Testing and debugging message flow applications 781

Flow debugger overview	781
Debugging a message flow	783
Testing message flows using the Test Client	806

Part 6. Reference 815

Message flows 819

Message flow preferences	819
Description properties for a message flow	819
Built-in nodes	822
User-defined nodes	1225
WebSphere Adapters properties	1225
Supported code pages	1329
WebSphere MQ connections	1357
Listing database connections that the broker holds	1358
Quiescing a database	1358
Support for UNICODE and DBCS data in databases	1358
Data integrity within message flows	1359
Validation properties	1359
Parsing on demand	1363
Exception list structure	1364
Configurable message flow properties.	1372
Message flow porting considerations	1374
Monitoring profile	1375
Message flow accounting and statistics data.	1381
Coordinated message flows	1398
Element definitions for message parsers	1399
Message mappings	1410
XML constructs	1433
Data sources on z/OS	1448

ESQL reference 1451

Syntax diagrams: available types	1452
--	------

ESQL data types in message flows	1452
ESQL variables	1465
ESQL field references	1465
ESQL operators	1472
ESQL statements	1478
ESQL functions: reference material, organized by function type	1564
ESQL constants	1662
Broker properties that are accessible from ESQL and Java	1663
Special characters, case sensitivity, and comments in ESQL	1666
ESQL reserved keywords	1668
ESQL non-reserved keywords	1668
Example message	1671
Message mappings	1673
Message Mapping editor	1673
Mapping node	1683

Migrating message mappings from Version 5.0	1691
Restrictions on migrating message mappings	1692

Flow application debugger 1697

Flow debugger shortcuts	1697
Flow debugger icons and symbols	1698
Java Debugger	1700

Part 7. Appendixes 1701

**Appendix. Notices for WebSphere
Message Broker. 1703**

Trademarks in the WebSphere Message Broker information center	1705
--	------

Index 1707

About this topic collection

This PDF has been created from the WebSphere Message Broker Version 6.1 (June 2008) information center topics. Always refer to the WebSphere Message Broker online information center to access the most current information. The information center is periodically updated on the document update site and this PDF and others that you can download from that Web site might not contain the most current information.

The topic content included in the PDF does not include the "Related Links" sections provided in the online topics. Links within the topic content itself are included, but are active only if they link to another topic in the same PDF collection. Links to topics outside this topic collection are also shown, but these attempt to link to a PDF that is called after the topic identifier (for example, ac12340_.pdf) and therefore fail. Use the online information to navigate freely between topics.

Feedback: do not provide feedback on this PDF. Refer to the online information to ensure that you have access to the most current information, and use the Feedback link that appears at the end of each topic to report any errors or suggestions for improvement. Using the Feedback link provides precise information about the location of your comment.

The content of these topics is created for viewing online; you might find that the formatting and presentation of some figures, tables, examples, and so on are not optimized for the printed page. Text highlighting might also have a different appearance.

Part 1. Developing message flows

Developing message flows	3	Exploiting user exits	198
Message flows overview	4	Ensuring that messages are not lost	200
Message flow projects	5	Providing user-defined properties to control behavior	203
Message flow nodes	5	Handling errors in message flows	203
Configurable services	50	Managing message flows	214
Message flow version and keywords	50	Creating a message flow project	215
Message flow connections	52	Deleting a message flow project	216
Threading	53	Creating a broker schema	217
Execution model.	53	Creating a message flow.	218
The message tree	53	Opening an existing message flow	219
Parsers	74	Copying a message flow using copy.	220
Properties	109	Renaming a message flow	221
Message flow transactions	113	Moving a message flow	222
Broker schemas.	114	Deleting a message flow.	223
Generating events for monitoring.	116	Deleting a broker schema	224
Message flow accounting and statistics data	119	Version and keyword information for deployable objects	224
Message flow aggregation	124	Saving a message flow	225
Message collection.	126	Defining message flow content	227
Converting data with message flows	128	Using the node palette	228
User exits	129	Adding a message flow node	231
Getting started with Quick Start wizards	130	Adding a subflow	234
Quick Start wizards overview	131	Renaming a message flow node	234
Creating an application from scratch	131	Configuring a message flow node	235
Creating an application based on WSDL or XSD files	132	Using dynamic terminals	237
Creating an application based on an existing message set	134	Removing a message flow node	238
Creating an application using WebSphere Adapters	135	Connecting message flow nodes	239
Creating an application using the Configure New Web Service Usage wizard	135	Removing a node connection	242
Designing a message flow	139	Adding a bend point	242
Deciding which nodes to use	141	Removing a bend point	243
Using more than one input node	152	Aligning and arranging nodes.	244
Defining input message characteristics	153	Developing message flow applications using WebSphere Adapters	245
Using nodes for decision making.	154	Preparing your system to use WebSphere Adapters nodes	245
Using subflows.	156	Activating IBM Tivoli License Manager for WebSphere Adapters	246
Optimizing message flow response times	158	Adding external software dependencies for SAP Configuring the SAP server to work with the adapter	247
System considerations for message flow development	160	Adding external software dependencies for Siebel	250
Creating destination lists	162	Configuring the Siebel application to work with the adapter	251
Using WebSphere MQ cluster queues for input and output	162	Adding external software dependencies for PeopleSoft	253
Using WebSphere MQ shared queues for input and output (z/OS)	164	Creating a custom event project in PeopleTools Connecting to an EIS using the Adapter Connection wizard	254
Validating messages	164	Developing ESQL	257
Viewing the logical message tree in trace output Accessing databases from message flows	167	ESQL overview.	258
Accessing databases from ESQL	172	Managing ESQL files	268
Configuring globally coordinated message flows Configuring JMSInput and JMSOutput nodes to support global transactions.	173	Writing ESQL	280
Configuring the broker to enable a JMS provider's proprietary API	176	Using XPath	411
Configuring message flows for data conversion Using MQGet nodes	182	XPath overview	411

Multi-language node property fields	412	Automatically generating messages to drive a flow	608
Namespace support	415	Performance considerations for timeout flows	609
XPath Expression Builder	416	Configuring flows to handle WebSphere MQ message groups	609
Creating XPath expressions	419	Receiving messages in a WebSphere MQ message group	610
Selecting the grammar mode	420	Sending messages in a WebSphere MQ message group	611
Using TCP/IP in message flows	422	Sending message segments in a WebSphere MQ message	612
TCP/IP overview	422		
TCP/IP nodes	425		
Connection management	428		
Scenarios for Message Broker and TCP/IP	430		
Working with TCP/IP	434		
Developing Java	449		
Managing Java Files	449		
Writing Java	454		
Developing message mappings	472		
Message mappings overview	473		
Creating message mappings	476		
Message mapping scenarios	515		
Defining a promoted property	554		
Promoting a property	554		
Renaming a promoted property	557		
Removing a promoted property	558		
Converging multiple properties	559		
Configure monitoring events for message flows	562		
Collecting message flow accounting and statistics data	564		
Starting to collect message flow accounting and statistics data	564		
Stopping message flow accounting and statistics data collection	567		
Viewing message flow accounting and statistics data collection parameters	568		
Modifying message flow accounting and statistics data collection parameters	569		
Resetting message flow accounting and statistics archive data	569		
Developing a user exit	570		
Deploying a user exit	571		
Configuring aggregation flows	572		
Creating the aggregation fan-out flow	573		
Creating the aggregation fan-in flow	577		
Associating fan-out and fan-in aggregation flows	581		
Setting timeouts for aggregation	583		
Using multiple AggregateControl nodes	584		
Correlating input request and output response aggregation messages	585		
Using control messages in aggregation flows	585		
Handling exceptions in aggregation flows	588		
Using WebSphere MQ to store state in aggregation nodes	590		
Configuring flows for message collection	593		
Creating a flow for message collection	593		
Configuring the Collector node	595		
Using control messages with the Collector node	602		
Configuring timeout flows	603		
Sending timeout request messages	603		
Sending a message after a timed interval	605		
Sending a message multiple times after a specified start time	606		

Developing message flows

A message flow is a sequence of processing steps that run in the broker when an input message is received. The topics in this section describe how to create and maintain message flows.

Concept topics:

- “Message flows overview” on page 4
- “Message flow projects” on page 5
- “Message flow nodes” on page 5
- “Message flow version and keywords” on page 50
- “Message flow connections” on page 52
- “Threading” on page 53
- “Execution model” on page 53
- “The message tree” on page 53
- “Parsers” on page 74
- “Properties” on page 109
- “Message flow transactions” on page 113
- “Broker schemas” on page 114
- “Generating events for monitoring” on page 116
- “Message flow accounting and statistics data” on page 119
- “Message flow aggregation” on page 124
- “Message collection” on page 126
- “Converting data with message flows” on page 128
- “User exits” on page 129

Task topics:

- “Getting started with Quick Start wizards” on page 130
- “Designing a message flow” on page 139
- “Managing message flows” on page 214
- “Defining message flow content” on page 227
- “Developing message flow applications using WebSphere Adapters” on page 245
- “Developing ESQL” on page 257
- “Using XPath” on page 411
- “Developing Java” on page 449
- “Developing message mappings” on page 472
- “Defining a promoted property” on page 554
- “Configure monitoring events for message flows” on page 562
- “Collecting message flow accounting and statistics data” on page 564
- “Developing a user exit” on page 570
- “Configuring aggregation flows” on page 572
- “Configuring flows for message collection” on page 593
- “Configuring timeout flows” on page 603
- “Configuring flows to handle WebSphere MQ message groups” on page 609

See also a section of topics that contain reference information about message flows.

The workbench provides a set of toolbar icons that invoke wizards that you can use to create any of the resources associated with message flows, for example, message flow projects and ESQL files. Hover your mouse pointer over each icon to see its function.

The workbench lets you open resource files with other editors. Use only the workbench message flow editor to work with message flow files, because this editor correctly validates all changes that you make to these files when you save the message flow.

When you have completed developing your message flow, deploy it to a broker to start its execution.

Tip: You can debug your message flow using the flow debugger.

For a basic introduction to developing message flows, see the IBM Redbooks publication *WebSphere Message Broker Basics*.

Message flows overview

A message flow is a sequence of processing steps that run in the broker when an input message is received.

You define a message flow in the workbench by including a number of message flow nodes, each of which represents a set of actions that define a processing step. The connections in the flow determine which processing steps are carried out, in which order, and under which conditions. A message flow must include an input node that provides the source of the messages that are processed. You must then deploy the message flow to a broker for execution.

When you want to exchange messages between multiple applications, you might find that the applications do not understand or expect messages in exactly the same format. You might need to provide some processing between the sending and receiving applications that ensures that both can continue to work unchanged, but can exchange messages successfully.

You define the processing that is required when you create and configure a message flow. The way that you do this determines what actions are performed on a message when it is received, and the order in which the actions are completed.

You can create a message flow using the built-in nodes, nodes that you or a vendor have created (user-defined nodes), or other message flows (known as subflows). When you want to invoke a message flow to process messages, you deploy it to a broker, where it is executed within an execution group.

The mode in which your broker is working, can affect the number of execution groups and message flows that you can deploy, and the types of node that you can use. See Restrictions that apply in each operation mode.

The following topics describe the concepts that you need to understand to design, create, and configure a message flow and its associated resources:

- Projects
- Nodes
- Version and keywords

- “Message flow connections” on page 52
- “Execution model” on page 53
- “Threading” on page 53
- “Parsers” on page 74
- “Logical tree structure” on page 60
- “Properties” on page 109
- “Generating events for monitoring” on page 116
- Accounting and statistics data
- “Message flow transactions” on page 113
- Aggregation
- “Message collection” on page 126
- “Converting data with message flows” on page 128
- “Message flows, ESQL, and mappings” on page 49
- “Broker schemas” on page 114
- “Message mappings overview” on page 473
- “ESQL overview” on page 258

For a basic introduction to developing message flows, see the IBM® Redbooks® publication WebSphere Message Broker Basics.

Message flow projects

A message flow project is a specialized container in which you create and maintain all the resources associated with one or more message flows.

You can create a message flow project to contain a single message flow and its resources, or you can group together related message flows and resources in a single message flow project to provide an organizational structure to your message flow resources.

Message flow project resources are created as files, and are displayed within the project in the Broker Development view. These resources define the content of the message flow, and additional objects that contain detailed configuration information, in the form of ESQL modules and mappings, for one or more nodes within the message flow.

Import one of the following samples from the Samples Gallery (see related links) to see how the sample’s message flow resources are stored in a Message Flow project. If the sample has a message set, its message set resources are stored in a Message Set project.

- Video Rental sample
- Comma Separated Value (CSV) sample

You can view samples only when you use the information center that is integrated with the Message Broker Toolkit.

Message flow nodes

A message flow node is a processing step in a message flow.

A message flow node receives a message, performs a set of actions against the message, and optionally passes the message on to the next node in the message flow. A message flow node can be a built-in node, a user-defined node, or a subflow node.

A message flow node has a fixed number of input and output points known as terminals. You can make connections between the terminals to define the routes that a message can take through a message flow.

The mode that your broker is working in can affect the types of node that you can use; see Restrictions that apply in each operation mode.

Built-in node

A built-in node is a message flow node that is supplied by WebSphere® Message Broker. The built-in nodes provide input and output, manipulation and transformation, decision making, collating requests, and error handling and reporting functions.

For information about all of the built-in nodes supplied by WebSphere Message Broker, see “Built-in nodes” on page 822.

User-defined node

A user-defined node is an extension to the broker that provides a new message flow node in addition to those supplied with the product. It must be written to the user-defined node API provided by WebSphere Message Broker for both C and Java™ languages. The following sample demonstrates how you can write your own nodes in both C and Java languages.

- User-defined Extension sample

You can view samples only when you use the information center that is integrated with the Message Broker Toolkit.

Subflow

A subflow is a directed graph that is composed of message flow nodes and connectors and is designed to be embedded in a message flow or in another subflow. A subflow must include at least one Input node or one Output node. A subflow can be executed by a broker only as part of the message flow in which it is embedded, and therefore cannot be independently deployed.

A message is received by an Input node and processed according to the definition of the subflow. That might include being stored through a Warehouse node, or delivered to another message target, for example through an MQOutput node. If required, the message can be passed through an Output node back to the main flow for further processing.

The subflow, when it is embedded in a main flow, is represented by a subflow node, which has a unique icon. The icon is displayed with the correct number of terminals to represent the Input and Output nodes that you have included in the subflow definition.

The most common use of a subflow is to provide processing that is required in many places within a message flow, or is to be shared between several message flows. For example, you might code some error processing in a subflow, or create a subflow to provide an audit trail (storing the entire message and writing a trace entry).

The use of subflows is demonstrated in the following samples:

- Error Handler sample
- Coordinated Request Reply sample

The Error Handler sample uses a subflow to trap information about errors and store the information in a database. The Coordinated Request Reply sample uses a subflow to encapsulate the storage of the ReplyToQ and

ReplyToQMgr values in a WebSphere MQ message so that the processing logic can be reused in other message flows and to allow alternative implementations to be substituted. You can view samples only when you use the information center that is integrated with the Message Broker Toolkit.

A node does not always produce an output message for every output terminal: often it produces one output for a single terminal based on the message received or the result of the operation of the node. For example, a Filter node typically sends a message on either the true terminal or the false terminal, but not both.

If more than one terminal is connected, the node sends the output message on each terminal, but sends on the next terminal only when the processing has completed for the current terminal. Updates to a message are never propagated to previously-executed nodes, only to nodes following the node in which the update has been made. The order in which the message is propagated to the different output terminals is determined by the broker; you cannot change this order. The only exception to this rule is the FlowOrder node, in which the terminals indicate the order in which the message is propagated to each.

The message flow can accept a new message for processing only when all paths through the message flow (that is, all connected nodes from all output terminals) have been completed.

The following sample uses Environment variables in the XML_Reservation sample to store information that has been taken from a database table and to pass that information to a node downstream in the message flow.

- Airline Reservations sample

You can view samples only when you use the information center that is integrated with the Message Broker Toolkit.

WebSphere Adapters nodes

A WebSphere Adapters node is a message flow node that is used to communicate with Enterprise Information Systems (EIS).

SAP, Siebel, and PeopleSoft adapters are supported by the following nodes:

- SAPInput node
- SAPRequest node
- SiebelInput node
- SiebelRequest node
- PeopleSoftInput node
- PeopleSoftRequest node

The TwineballInput and TwineballRequest nodes are sample nodes with their own sample EIS. You can use the TwineBall nodes to see how adapters nodes work. You cannot use the TwineBall nodes to connect to the external SAP, Siebel, and PeopleSoft EIS systems.

The mode in which your broker is working, can affect the number of execution groups and message flows that you can deploy, and the types of node that you can use. See Restrictions that apply in each operation mode.

The following terms are associated with WebSphere Adapters:

EIS Enterprise information systems. This term is used to describe the applications that comprise an enterprise's existing system for handling

company-wide information. An enterprise information system offers a well-defined set of services that are exposed as local or remote interfaces or both. Enterprise Resource Planning (ERP) and Customer Relationship Management (CRM) are typical enterprise information systems.

EMD Enterprise Metadata Discovery. A specification that you can use to examine an EIS and get details of business object data structures and APIs. An EMD stores definitions as XML schemas by default, and builds components that can access the EIS. In WebSphere Message Broker you use the Adapter Connection wizard to examine an EIS. EMD can also be known as ESD (Enterprise Service Discovery) or ODA (Object Discovery Agent).

Business object

A set of attributes that represent a business entity (such as Employee), an action on the data (such as a create or update operation), and instructions for processing the data. Components of the business integration system use business objects to exchange information and trigger actions.

The WebSphere Adapters support two modes of communication:

- **Inbound:** An event is generated on the EIS and the adapter responds to the event by sending a message to the message broker. The WebSphere Adapters input nodes support inbound communication. When the EIS sends an event to the adapter, a message is propagated from the WebSphere Adapters input node.
- **Outbound:** The message broker uses the adapter to send a request to the EIS. The WebSphere Adapters request nodes support outbound communication. When a message is propagated to the WebSphere Adapters request node, the adapter sends a request to the EIS.

The WebSphere Adapters nodes need an adapter component to access the EIS. The input nodes need an inbound adapter component, which allows the EIS to invoke the message flow when an event occurs. The request nodes need an outbound adapter component, which is used by the message flow to invoke a service in the EIS.

The WebSphere Adapters nodes also need a message set to ensure that the WebSphere Message Broker messages that are propagated to and from the nodes reflect the logical structure of the data in the EIS.

For more information about support for adapters on different operating systems, see WebSphere Message Broker Requirements.

The following topics provide an overview of the WebSphere Adapters:

- “Overview of WebSphere Adapter for SAP Software”
- “Overview of WebSphere Adapter for Siebel Business Applications” on page 36
- “Overview of WebSphere Adapter for PeopleSoft Enterprise” on page 43

Overview of WebSphere Adapter for SAP Software:

With WebSphere Adapter for SAP Software you can create integrated processes that include the exchange of information with an SAP server, without special coding.

Using the adapter, an application component (the program or piece of code that performs a specific business function) can send requests to the SAP server (for example, to query a customer record in an SAP table or to update an order document) or receive events from the server (for example, to be notified that a

customer record has been updated). The adapter creates a standard interface to the applications and data on the SAP server, so that the application component does not have to understand the lower-level details (the implementation of the application or the data structures) on the SAP server.

WebSphere Adapter for SAP Software complies with the Java Connector Architecture (JCA) 1.5, which standardizes the way in which application components, application servers, and Enterprise Information Systems (EIS), such as an SAP server, interact with each other.

The adapter, which you generate with the Adapter Connection wizard, uses a standard interface and standard data objects. The adapter takes the standard data object sent by the application component and calls the SAP function. The adapter then returns a standard data object to the application component. The application component does not have to deal directly with the SAP function; it is the SAP adapter that calls the function and returns the results.

For example, the application component that needed the list of customers would send a standard business object with the range of customer IDs to the SAP adapter. The application component would receive, in return, the results (the list of customers) in the form of a standard business object. The application component would have no need to know how the function worked or how the data was structured. The adapter would perform all the interactions with the actual SAP function.

Similarly, the client application might want to know about a change to the data on the SAP server (for example, a change to a particular customer). You can generate an adapter component that listens for such events on the SAP server and notifies client applications with the update. In this case, the interaction begins at the SAP server.

For more information, see “Technical overview of Adapter for SAP Software.”

Technical overview of Adapter for SAP Software:

WebSphere Adapter for SAP Software provides multiple ways to interact with applications and data on SAP servers. Outbound processing (from an application to the adapter to the SAP server) and inbound processing (from the SAP server to the adapter to an application) are supported.

WebSphere Adapter for SAP Software connects to SAP systems running on SAP Web application servers. The adapter supports Advanced Event Processing (AEP) and Application Link Enabling (ALE) for inbound processing, and the Business Application Programming Interface (BAPI), AEP, ALE, and Query Interface for SAP Systems (QISS) for outbound processing. You set up the adapter to perform outbound and inbound processing by using the Adapter Connection wizard to generate business objects based on the services it discovers on the SAP server.

For outbound processing, the adapter client invokes the adapter operation to create, update, or delete data on the SAP server or to retrieve data from the SAP server.

For inbound processing, an event that occurs on the SAP server is sent from the SAP server to the adapter. The ALE inbound interface to the adapter starts event listeners that detect the events. Conversely, the Advanced event processing

interface polls the SAP server for events. The adapter then delivers the event to an endpoint, which is an application or other consumer of the event from the SAP server.

You configure the adapter to perform outbound and inbound processing by using the Adapter Connection wizard to create a message set that includes the interface to the SAP application as well as business objects based on the functions or tables that it discovers on the SAP server.

Overview of the outbound processing interfaces

WebSphere Adapter for SAP Software provides multiple interfaces to the SAP server for outbound processing.

- Through its BAPI interfaces, the adapter issues remote function calls (RFCs) to RFC-enabled functions, such as a Business Application Programming Interface (BAPI) function. These remote function calls create, update, or retrieve data on an SAP server and return the results to the calling application.
 - The BAPI interface works with individual BAPIs (simple BAPIs). For example, you might want to check to see whether specific customer information exists in an SAP database.
 - The BAPI work unit interface works with ordered sets of BAPIs. For example, you might want to update an employee record. To do so, you use three BAPIs:
 1. To lock the record (to prevent any other changes to the record)
 2. To update the record
 3. To have the record approved
 - The BAPI result set interface uses two BAPIs to select multiple rows of data from an SAP database.

BAPI calls are useful when you need to perform data retrieval or manipulation and a BAPI or RFC function that performs the task already exists.

- The Query interface for SAP Software retrieves data from specific SAP application tables. It can return the data or check for the existence of the data. You can use this type of interaction with SAP if you need to retrieve data from an SAP table without using an RFC function or a BAPI.
- With the Application Link Enabling (ALE) interface, you exchange data using SAP Intermediate Data structures (IDocs). For outbound processing, you send an IDoc or a packet of IDocs to the SAP server.

The ALE interface, which is particularly useful for batch processing of IDocs, provides asynchronous exchange. You can use the queued transactional (qRFC) protocol to send the IDocs to a queue on the SAP server. The qRFC protocol ensures the order in which the IDocs are received. It is often used for system replications or system-to-system transfers.

- With the ALE pass-through IDoc interface, the adapter sends the IDoc to the SAP server with no conversion of the IDoc. The Message tree contains a BLOB field that represents the IDoc.
- With the Advanced event processing interface, you send data to the SAP server. The data is then processed by an ABAP handler on the SAP server.

Overview of the inbound processing interfaces

WebSphere Adapter for SAP Software provides the following interfaces to the SAP server for inbound processing.

- With the ALE inbound processing interface, the adapter listens for events and receives one or more IDocs from the SAP server. As with ALE outbound processing, ALE inbound processing provides asynchronous exchange. You can use the qRFC interface to receive the IDocs from a queue on the SAP server, which ensures the order in which the IDocs are received.
If you select assured-once delivery, the adapter uses a data source to persist the event data, and event recovery is provided to track and recover events in case a problem occurs when the adapter attempts to deliver the event to the endpoint.
- With the ALE pass-through IDoc interface, the SAP server sends the IDoc through the adapter to the endpoint with no conversion of the IDoc. The Message tree contains a BLOB field that represents the IDoc.
- The Advanced event processing interface polls the SAP server for events. It discovers events waiting to be processed. It then processes the events and sends them to the endpoint.

How the adapter interacts with the SAP server

The adapter uses the SAP Java Connector (SAP JCo) API to communicate with SAP applications. An application sends a request to the adapter, which uses the SAP JCo API to convert the request into a BAPI function call. The SAP system processes the request and sends the results to the adapter. The adapter sends the results in a response message to the calling application.

For more information, see the following topics.

- “The Adapter Connection wizard (SAP)”
- “The BAPI interface”
- “The ALE interfaces” on page 15
- “Query interface for SAP Software” on page 26
- “The Advanced event processing interface” on page 29

The Adapter Connection wizard (SAP):

The Adapter Connection wizard is a tool that you use to create services. The Adapter Connection wizard establishes a connection to the SAP server, discovers services (based on search criteria that you provide), and generates business objects and interfaces based on the services discovered.

Using WebSphere Message Broker, you establish a connection to the SAP server to browse the metadata repository on the SAP server. The SAP metadata repository, which is a database of the SAP data, provides a consistent and reliable means of access to that data.

You specify connection information (such as the user name and password needed to access the server), and you specify the interface that you want to use (for example, BAPI). The service metadata that is associated with that interface is displayed. You can then provide search criteria and select the information (for example, you can list all BAPIs that relate to “CUSTOMER” by using the search filter with “BAPI_CUSTOMER*”, then select one or more BAPIs).

The result of running the Adapter Connection wizard is an adapter connection project and a message set project that contain the interfaces and business objects along with the adapter.

The BAPI interface:

The WebSphere Adapter for SAP Software supports outbound processing for simple BAPIs, BAPI units of work, and BAPI result sets. In outbound processing, client applications call BAPIs and other RFC-enabled functions on the SAP server.

The adapter models SAP BAPI function calls as business objects. These function calls create, delete, update, or retrieve data on an SAP system. You can work with individual BAPI functions (simple BAPIs), BAPI work units (ordered sets of BAPI functions), or BAPI result sets (which return a set of data).

BAPI interface (Simple BAPIs)

A simple BAPI performs a single operation, such as retrieving a list of customers. The adapter supports simple BAPI calls by representing each with a single business object schema.

BAPI work unit interface

A BAPI work unit consists of a set of BAPIs that are processed in sequence to complete a task. For example, to update an employee record in the SAP system, the record needs to be locked before being updated. This task is accomplished by calling three BAPIs, in sequence, in the same work unit. The following three BAPIs illustrate the kind of sequence that forms such a unit of work:

- BAPI_ADDRESSEMP_REQUEST
- BAPI_ADDRESSEMP_CHANGE
- BAPI_ADDRESSEMP_APPROVE

The first BAPI locks the employee record, the second updates the record, and the third approves the update. The advantage of using a BAPI unit of work is that the client application can request the employee record change with a single call, even though the work unit consists of three separate functions. In addition, if SAP requires that the BAPIs be processed in a specific sequence for the business flow to complete correctly, the work unit supports this sequence.

BAPI result set interface

BAPI result sets use the GetList and GetDetail functions to retrieve an array of data from the SAP server. The information that is returned from the GetList function is used as input to the GetDetail function.

For example, if you want to retrieve information on a set of customers, you use BAPI_CUSTOMER_GETLIST, which acts as the query BAPI, and BAPI_CUSTOMER_GETDETAIL, which acts as the result BAPI. The BAPIs perform the following steps:

1. The BAPI_CUSTOMER_GETLIST call returns a list of keys (for example, CustomerNumber).
2. Each key is mapped dynamically to the business object for BAPI_CUSTOMER_GETDETAIL.
3. BAPI_CUSTOMER_GETDETAIL is processed multiple times, so that an array of customer information is returned.

You use the Adapter Connection wizard to discover the BAPI_CUSTOMER_GETLIST and BAPI_CUSTOMER_GETDETAIL functions and build the key relationship between the two BAPIs. The wizard then generates business object definitions for these BAPIs along with other SCA service resources.

At run time, the client sets the values in the BAPI_CUSTOMER_GETLIST business object, and the adapter returns the corresponding set of customer detail records from the SAP server.

For more information, see the following topics.

- “Outbound processing for the BAPI interface”
- “Business objects for the BAPI interface”

Outbound processing for the BAPI interface:

You use the BAPI interface for outbound processing, in which a broker sends a request to the SAP server. The SAP server processes the request and returns the response to the broker. Outbound processing can be used with simple BAPI functions, BAPI work units, or BAPI result sets.

The following list describes the sequence of processing actions that result from an outbound request using the BAPI interface.

The broker that makes the BAPI call uses the interface information that was generated by the Adapter Connection wizard.

1. The adapter receives a request from a broker in the form of a BAPI business object.
2. The adapter converts the BAPI business object to an SAP JCo function call.
3. The adapter uses the Remote Function Call (RFC) interface to process the BAPI or RFC function call in the SAP application.
4. After passing the data to the SAP server, the adapter handles the response from SAP and converts it back into the business object format that is required by the broker.
5. The adapter sends the response back to the broker.

Business objects for the BAPI interface:

A business object is a structure that consists of data, the action to be performed on the data, and additional instructions for processing the data.

The broker uses business objects to send data to SAP or obtain data (through the adapter) from SAP. In other words, the broker sends a business object to the adapter, and the adapter converts the data in the business object to a format that is compatible with an SAP API call. The adapter then runs the SAP API with this data.

The adapter uses the BAPI metadata that is generated by the Adapter Connection wizard to construct a business-object definition. This metadata contains BAPI-related information such as the operation of the business object, import parameters, export parameters, table parameters, transaction information, and dependent or grouped BAPIs.

The BAPI business-object definition that is generated by the Adapter Connection wizard is modeled on the BAPI function interface in SAP. The business-object definition represents a BAPI function, such as a BAPI_CUSTOMER_GETLIST function call.

How business-object definitions are created

You create business-object definitions by using the Adapter Connection wizard. The wizard connects to the application, discovers data structures in the application, and generates business-object definitions to represent them. It also generates other resources that are needed by the adapter, such as the interface information that indicates the input and output parameters.

Business object structure

The structure of a BAPI business object depends on the interface type (simple BAPI, BAPI work unit, or BAPI result set).

For more information, see the following topics.

- “Business object structure for a simple BAPI”
- “Business object structure for a nested BAPI”
- “Business object structure for a BAPI transaction”
- “Business object structure for a BAPI result set” on page 15

Business object structure for a simple BAPI:

A business object for a simple BAPI call reflects a BAPI method or function call in SAP. Each business object property maps to a BAPI parameter. The metadata of each business-object property indicates the corresponding BAPI parameter. The operation metadata determines the correct BAPI to call.

For a simple BAPI that performs Create, Update, Retrieve, and Delete operations, each operation is represented by a business object, with the business objects being grouped together within a wrapper.

The business object wrapper can be associated with multiple operations, but for a simple BAPI, each business object is associated with only one operation. For example, while a wrapper business object can contain BAPIs for Create and Delete operations, BAPI_CUSTOMER_CREATE is associated with the Create operation, not the Delete operation.

The BAPI business objects are children of the business object wrapper, and, depending on the operation to be performed, only one child object in this wrapper needs to be populated at run time in order to process the simple BAPI call. Only one BAPI, the one that is associated with the operation to be performed, is called at a time.

Business object structure for a nested BAPI:

A nested BAPI business object contains structure parameters that can contain one or more other structures as components.

A BAPI business object can contain both simple parameters and structure parameters. A business object that contains structure parameters can in turn contain other structures, such as simple parameters and a business object.

Business object structure for a BAPI transaction:

A business object that represents a BAPI work unit (also known as a BAPI transaction) is actually a wrapper object that contains multiple child BAPI objects. Each child BAPI object within the wrapper object represents a simple BAPI.

The adapter supports a BAPI work unit using a top-level wrapper business object that consists of multiple child BAPIs, each one representing a simple BAPI in the sequence. The BAPI wrapper object represents the complete work unit, while the child BAPI objects contained within the BAPI wrapper object represent the individual operations that make up the unit of work.

Business object structure for a BAPI result set:

The top-level business object for a result set is a wrapper that contains a GetDetail business object. The GetDetail business object contains the results of a query for SAP data. The GetDetail business object also contains, as a child object, the query business object. The query business object represents a GetList BAPI. These two BAPIs work together to retrieve information from the SAP server.

The ALE interfaces:

The SAP Application Link Enabling (ALE) interface and ALE pass-through IDoc interface enable business process integration and asynchronous data communication between two or more SAP systems or between SAP and external systems. The data is exchanged in the form of Intermediate Documents (IDocs).

The adapter supports outbound and inbound processing by enabling the exchange of data in the form of business objects.

- For inbound processing, SAP pushes the data in IDocs to the SAP adapter. The adapter converts the IDocs to business objects and delivers them to the endpoint.
- For outbound processing, the SAP adapter converts the business object to an IDoc and delivers it to SAP.

To use the ALE interface or ALE pass-through IDoc interface for inbound processing, make sure that your SAP server is properly configured (for example, you must set up a partner profile and register a program ID to listen for events).

Application systems are loosely coupled in an ALE integrated system, and the data is exchanged asynchronously.

IDocs

Intermediate Documents (IDocs) are containers for exchanging data in a predefined (structured ASCII) format across system boundaries. The IDoc type indicates the SAP format that is to be used to transfer the data. An IDoc type can transfer several message types (the logical messages that correspond to different business processes). IDocs can be used for outbound and inbound processing.

For example, if an application developer wants to be notified when a sales order is created on the SAP server, the developer runs the Adapter Connection wizard to discover the ORDERS05 IDoc on the SAP server. The wizard then generates the business object definition for ORDERS05. The wizard also generates other resources, such as an EIS export component and SCA interfaces.

IDocs are exchanged for inbound and outbound events, and IDocs can be exchanged either as individual documents or in packets.

The processing of IDoc data depends on whether you are using the ALE interface or the ALE pass-through IDoc interface.

- **ALE interface**

For outbound processing, the adapter uses the IDoc business object to populate the appropriate RFC-enabled function call made to the SAP server.

For inbound processing, IDocs can be sent from the SAP server as parsed or unparsed documents

- For parsed documents, the adapter parses the IDoc and creates a business object that reflects the internal structure of the IDoc.
- For unparsed IDocs, the adapter processes the IDoc but does not convert the data portion of the IDoc.

- **ALE pass-through IDoc interface**

For both outbound and inbound processing, the adapter does no conversion of the IDoc, which is useful when the client wants to perform the IDoc parsing.

Transactional RFC processing

The adapter uses tRFC (transactional RFC) to guarantee delivery and to ensure that each IDoc is exchanged only once with SAP. The tRFC component stores the called RFC function in the database of the SAP system with a unique transaction identifier (TID).

The most common reason for using transaction ID support is to ensure once-only delivery of data. To make sure of this feature, select the transaction RAR file (CWYAP_SAPAdapter_Tx.rar) when you configure the adapter.

The SAP transaction ID property is always generated by the Adapter Connection wizard; however, it is supported only for outbound operations when the CWYAP_SAPAdapter_Tx.rar version of the adapter is used.

The client application must determine how to store the SAP transaction ID and how to relate the SAP transaction ID to the data being sent to the adapter. When the events are successful, the client application should not resubmit the event associated with this TID again to prevent the processing of duplicate events.

- If the client application does not send an SAP transaction ID with the business object, the adapter returns one after running the transaction.
- If the client application has an SAP transaction ID, it must populate the SAP transaction ID property with that value before running the transaction.

The SAP transaction ID can be used for cross-referencing with a global unique ID that is created for an outbound event. You can create the global unique ID for managing integration scenarios.

Queued RFC processing

The adapter uses qRFC (queued transactional RFC) to ensure that IDocs are delivered in sequence to a queue on the SAP server or are received in sequence from the SAP server.

For more information about ALE interfaces, see the following topics:

- “Outbound processing for the ALE interface” on page 17
- “Inbound processing for the ALE interface” on page 17
- “Pass-through support for IDocs, and MQSeries link for R/3 link migration” on page 23

- “ALE business objects” on page 25

Outbound processing for the ALE interface:

The adapter supports outbound processing (from the adapter to the SAP server) for the ALE interface and the ALE pass-through IDoc interface. ALE uses IDocs for data exchange, and the adapter uses business objects to represent the IDocs.

The following list describes the sequence of processing actions that result from an outbound request using the ALE interface and ALE pass-through IDoc interface.

The client application that makes the request uses the interface information that was generated by the Adapter Connection wizard.

1. The adapter receives a request, which includes an IDoc business object, from a client application.

For pass-through IDocs, the Message tree contains a BLOB field that represents the IDoc. No separate IDoc business object exists for pass-through IDocs.

2. The adapter uses the IDoc business object to populate the appropriate RFC-enabled function call used by the ALE interface.
3. The adapter establishes an RFC connection to the ALE interface and passes the IDoc data to the SAP system. If you are using the qRFC protocol, the adapter passes the IDoc data in the order specified in the wrapper business object to the specified queue on the SAP server.
4. After passing the data to SAP, the adapter performs one of the following steps:
 - If the call is not managed by a J2C local transaction, the adapter releases the connection to SAP and does not return any data to the caller. When no exceptions are raised, the outbound transaction is considered successful. You can verify whether the data is incorporated into the SAP application by inspecting the IDocs that have been generated in SAP.
 - If the call is managed by a J2C local transaction, the adapter returns the transaction ID.

The adapter uses the tRFC protocol to support J2C local transactions.

Inbound processing for the ALE interface:

The adapter supports inbound processing (from the SAP server to the adapter) for the ALE interface and the ALE pass-through IDoc interface.

When you are configuring a module for the ALE interface or the ALE pass-through interface, you indicate whether the IDocs are sent as a packet and, for the ALE interface, you can specify whether they are sent parsed or unparsed. You make these selections in the Adapter Connection wizard. When you use the ALE pass-through IDoc interface, the Message tree contains a BLOB field that represents the IDoc. No separate IDoc business object exists for pass-through IDocs.

The following list describes the sequence of processing actions that result from an inbound request using the ALE interface.

1. The adapter starts event listeners to the SAP server.
2. Whenever an event occurs in SAP, the event is sent to the adapter through the event listeners.
3. The adapter converts the event into a business object before sending it to the endpoint.

The adapter uses the event recovery mechanism to track and recover events in case of abrupt termination. The event recovery mechanism uses a data source for persisting the event state.

The following table provides an overview of the differences between the ALE interface and the ALE pass-through IDoc interface for inbound processing.

Interface	When to use	SplitIDoc = true	SplitIDoc = false	Parsed IDoc = true
ALE inbound	This interface converts the raw incoming IDocs to business objects, which are readily consumable by the client at the endpoint.	On receiving the IDoc packet from SAP, the adapter converts the IDocs to business objects, one by one, before sending each one to the endpoint.	On receiving the IDoc packet from SAP, the adapter converts the IDocs in the packet as one business object before sending it to the endpoint.	The incoming IDoc is only partially parsed (the control record of the IDoc is parsed but the data record is not). The client at the endpoint is responsible for parsing the data record.
ALE pass-through IDoc	This interface wraps the raw incoming IDoc in a business object before delivering it to the client at the endpoint. The client is responsible for parsing the raw IDoc.	On receiving the IDoc packet from SAP, the adapter wraps each raw IDoc within a business object before sending the objects, one by one, to the endpoint.	On receiving the IDoc packet from SAP, the adapter wraps the raw IDoc packet in a business object before sending it to the endpoint.	This attribute is not applicable to the ALE pass-through IDoc interface. (Neither the control record nor the data record of the IDoc is parsed.)

For more information, see the following topics.

- “Event error handling”
- “Event recovery” on page 19
- “Event processing for parsed IDoc packets” on page 20
- “Event processing for unparsed IDocs” on page 21
- “IDoc status updates” on page 22

Event error handling:

WebSphere Adapter for SAP Software provides error handling for inbound ALE events by logging the errors and attempting to restart the event listener.

When the adapter detects an error condition, it performs the following actions:

1. The adapter logs the error information in the event log or trace file.
Log and trace files are in the `/profiles/profile_name/logs/server_name` path of the folder in which WebSphere Message Broker is installed.
2. The adapter attempts to restart the existing event listeners.
The adapter uses the activation specification values for `RetryLimit` and `RetryInterval`.
 - If the SAP application is not active, the adapter attempts to restart the listeners for the number of times configured in the `RetryLimit` property.
 - The adapter waits for the time specified in the `RetryInterval` parameter before attempting to restart the event listeners.
3. If the attempt to restart the event listeners fails, the adapter performs the following actions:

- The adapter logs the error condition in the event log or trace file.
- The adapter cleans up the existing ALE event listeners.
- The adapter starts new event listeners.

The adapter uses the values of the `RetryLimit` and `RetryInterval` properties when starting the new event listeners.

4. If all the retry attempts fail, the adapter logs the relevant message and CEI events and stops trying to recover the ALE event listener.

You must restart the adapter or SCA application in this case.

Event recovery:

You can configure the adapter for ALE inbound processing so that it supports event recovery in case of abrupt termination.

When event recovery is specified, the adapter persists the event state in an event recovery table that resides on a data source. Event recovery is not the default behavior; you must specify it by enabling once-only delivery of events during adapter configuration. You must also set up the data source before you can create the event recovery table.

Data source

Event recovery for ALE inbound processing requires that a JDBC data source be configured. You select a JDBC provider, then create a new data source.

Event recovery table

You can create the event recovery table manually, or you can have the adapter create the event table. The value of the `EP_CreateTable` configuration property determines whether the event recovery table is created automatically. The default value of this property is `True` (create the table automatically).

To create the table manually, use the information provided in the following table.

Table 1. Event recovery table fields

Table field name	Type	Description
EVNTID	VARCHAR(255)	Transaction ID for the tRFC (Transactional Remote Function Call) protocol. The tRFC protocol significantly improves the reliability of the data transfer, but it does not ensure that the order of ALE transactions specified in the application is observed. Event ordering is also affected by the number of event listeners. However, at some point all ALE transactions are transferred.
EVNTSTAT	INTEGER	Event processing status. Possible values are: <ul style="list-style-type: none"> • 0 (Created) • 1 (Executed) • 3 (In Progress) • -1 (Rollback)

Table 1. Event recovery table fields (continued)

Table field name	Type	Description
XID	VARCHAR(255)	An XA resource keeps track of transaction IDs (XIDs) in the event recovery table. The adapter queries and updates that XID field. The XA resource is used to enable assured once delivery. Make sure the activation specification property Assured Once Delivery is set to true.
BQTOTAL	INTEGER	Total number of IDocs in the packet.
BQPROC	INTEGER	Sequence number of the IDoc in the packet that the adapter is currently processing.
EVNTDATA	VARCHAR(255)	Not used.

To use event recovery for multiple endpoints, you must configure a separate event recovery table for each endpoint, although you can use the same data source to hold all the event recovery tables.

Event processing for parsed IDoc packets:

An inbound event can contain a single IDoc or multiple IDocs, with each IDoc corresponding to a single business object. The multiple IDocs are sent by the SAP server to the adapter in the form of an IDoc packet. You can specify, during adapter configuration, whether the packet can be split into individual IDocs or whether it must be sent as one object (non-split).

Event processing begins when the SAP server sends a transaction ID to the adapter. The following sequence occurs.

1. The adapter checks the status of the event and takes one of the following actions:
 - If this is a new event, the adapter stores an EVNTID (which corresponds to the transaction ID) along with a status of 0 (Created) in the event recovery table.
 - If the event status is -1 (Rollback), the adapter updates the status to 0 (Created).
 - If the event status is 1 (Executed), the adapter returns an indication of success to the SAP system.
2. The SAP system sends the IDoc to the adapter.
3. The adapter converts the IDoc to a business object and sends it to the endpoint.

For single IDocs and non-split IDoc packets, the adapter can deliver objects to endpoints that support transactions as well as to endpoints that do not support transactions.

 - For endpoints that support transactions, the adapter delivers the object as part of a unique XA transaction. When the endpoint processes the event and the transaction is committed, the status of the event is updated to 1 (Executed).
The endpoint must be configured to support XA transactions.
 - For endpoints that do not support transactions, the adapter delivers the object to the endpoint and updates the status of the event to 1 (Executed). The adapter delivers the business object without the quality of service (QOS) that guarantees once-only delivery.

4. For split packets only, the adapter performs the following tasks:
 - a. The adapter updates the BQTOTAL column (or table field) in the event recovery table to the number of IDocs in the packet. This number is used for audit and recovery purposes.
 - b. The adapter sends the business objects to the message endpoint, one after the other, and updates the BQPROC property to the sequence number of the IDoc it is working on. The adapter delivers the objects to the appropriate endpoint as part of a unique XA transaction (a two-phase commit transaction) controlled by the application server.
 - c. When the endpoint receives the event and the transaction is committed, the adapter increments the number in the BQPROC property.
 The message endpoint must be configured to support XA transactions. If the adapter encounters an error while processing a split IDoc packet, it can behave in one of two ways, depending on the IgnoreIDocPacketErrors configuration property:
 - If the IgnoreIDocPacketErrors property is set to false, the adapter stops processing any additional IDocs in the packet and reports errors to the SAP system.
 - If the IgnoreIDocPacketErrors property is set to true, the adapter logs an error and continues processing the rest of the IDocs in the packet. The status of the transaction is marked 3 (InProgress). In this case, the adapter log shows the IDoc numbers that failed, and you must resubmit those individual IDocs separately. You must also manually maintain these records in the event recovery table.
 This property is not used for single IDocs and for non-split IDoc packets.
 - d. The SAP system sends a COMMIT call to the adapter.
 - e. After the adapter delivers all the business objects in the IDoc packet to the message endpoint, it updates the event status to 1 (Executed).
 - f. In case of abrupt interruptions during IDoc packet processing, the adapter resumes processing the IDocs from the current sequence number. The adapter continues updating the BQPROC property, even if IgnoreIDocPacketErrors is set to true. The adapter continues the processing in case you terminate the adapter manually while the adapter is processing an IDoc packet.
5. If an exception occurs either while the adapter is processing the event or if the endpoint generates an exception, the event status is updated to -1 (Rollback).
6. If no exception occurs, the SAP server sends a CONFIRM call to the adapter.
7. The adapter deletes the records with a 1 (Executed) status and logs a common event infrastructure (CEI) event that can be used for tracking and auditing purposes.

Event processing for unparsed IDocs:

Unparsed IDocs are passed through, with no conversion of the data (that is, the adapter does not parse the data part of the IDoc). The direct exchange of IDocs in the adapter enables high-performance, asynchronous interaction with SAP, because the parsing and serializing of the IDoc occurs outside the adapter. The consumer of the IDoc parses the IDoc.

The adapter processes the data based on whether the packet IDoc is split or non-split and whether the data needs to be parsed.

- The adapter can process packet IDocs as a packet or as individual IDocs. When an IDoc is received by the adapter from SAP as a packet IDoc, it is either split

and processed as individual IDocs, or it is processed as a packet. The value of the SplitIDocPacket metadata at the business-object level determines how the IDoc is processed.

In the case of split IDocs, the wrapper contains only a single, unparsed IDoc object.

- The Type metadata specifies whether the data should be parsed. For unparsed IDocs, this value is UNPARSEDIDOC; for parsed IDocs, the value is IDOC. This value is set by the Adapter Connection wizard.

Unparsed data format

In the fixed-width format of an unparsed IDoc, the segment data of the IDoc is set in the IDocData field of the business object. It is a byte array of fixed-length data.

The entire segment length might not be used. The adapter pads spaces to the fields that have data; the rest of the fields are ignored, and an end of segment is set. The end of segment is denoted by null.

The following figure shows a segment with fields demarcated by the '|' symbol for reference.



Figure 1. Example of a segment before processing

When the adapter processes this segment into unparsed data, it takes into account only those fields that have data in them. It maintains the field width for each segment field. When it finds the last field with data, it appends a null to mark the end of segment.



Figure 2. Example of a segment after processing

The next segment data processed as unparsed data would be appended after the null.

Limitations

The unparsed event feature introduces certain limitations on the enterprise application for a particular IDoc type.

- The enterprise application supports either parsed or unparsed business-object format for a given IDoc type or message type.
- For a given IDoc type, if you select unparsed business-object format for inbound, you cannot have inbound and outbound interfaces in the same EAR file, because outbound is based on parsed business objects.
- The DummyKey feature is not supported for unparsed IDocs.

IDoc status updates:

To monitor IDoc processing, you can configure the adapter to update the IDoc status.

When the adapter configuration property `ALEUpdateStatus` is set to `true` (indicating that an audit trail is required for all message types), the adapter updates the IDoc status of ALE business objects that are retrieved from the SAP server. After the event is sent to the message endpoint, the adapter updates the status of the IDoc in SAP to indicate whether the processing succeeded or failed. Monitoring of IDocs applies only to inbound processing (when the IDoc is sent from the SAP server to the adapter).

The adapter updates a status IDoc (ALEAUD) and sends it to the SAP server.

An IDoc that is not successfully sent to the endpoint is considered a failure, and the IDoc status is updated by the adapter. Similarly, an IDoc that reaches the endpoint is considered successfully processed, and the status of the IDoc is updated.

The status codes and their associated text are configurable properties of the adapter, as specified in the activation specification properties and shown in the following list:

- `ALESuccessCode`
- `ALEFailureCode`
- `ALESuccessText`
- `ALEFailureText`

Perform the following tasks to ensure that the adapter updates the standard SAP status code after it retrieves an IDoc:

- Set the `AleUpdateStatus` configuration property to `true` and set values for the `AleSuccessCode` and `AleFailureCode` configuration properties.
- Configure the inbound parameters of the partner profile of the logical system in SAP to receive the ALEAUD message type. Set the following properties to the specified values:

Table 2. Inbound properties of the logical system partner profile

SAP property	Value
Basic Type	ALEAUD01
Logical Message Type	ALEAUD
Function module	IDOC_INPUT_ALEAUD
Process Code	AUD1

Pass-through support for IDocs, and MQSeries link for R/3 link migration:

Both the inbound and outbound SAP adapters support a pass-through mode for IDocs.

In this mode, the bit stream for the IDoc is provided without any form of parsing. The bit stream can then be used directly in a message flow, and parsed by other parsers, or sent unchanged over transports.

Use the Adapter Connection wizard to select pass-through support: on the Configure settings for adapter pane, select ALE pass-through IDoc as the interface type.

A business object is created that contains one field, which is the bit stream of the IDoc. You can transform this business object in a Compute node to an MQSeries® link for R/3 format message, as shown in the following example.

```
DECLARE ns NAMESPACE
'http://www.ibm.com/xmlns/prod/websphere/j2ca/sap/sapmatmas05';

CREATE COMPUTE MODULE test4_Compute
CREATE FUNCTION Main() RETURNS BOOLEAN
BEGIN
CALL CopyMessageHeaders();
-- CALL CopyEntireMessage();
set OutputRoot.MQSAPH.SystemNumber = '00';
set OutputRoot.BLOB.BLOB =
InputRoot.DataObject.ns:SapMatmas05.IDocStreamData;
RETURN TRUE;
END;

CREATE PROCEDURE CopyMessageHeaders() BEGIN
DECLARE I INTEGER 1;
DECLARE J INTEGER;
SET J = CARDINALITY(InputRoot.*[]);
WHILE I < J DO
SET OutputRoot.*[I] = InputRoot.*[I];
SET I = I + 1;
END WHILE;
END;

CREATE PROCEDURE CopyEntireMessage() BEGIN
SET OutputRoot = InputRoot;
END;
END MODULE;
```

You can also create a request business object from an MQSeries link for R/3 message, as shown in the following example.

```
CREATE COMPUTE MODULE test4_Compute
CREATE FUNCTION Main() RETURNS BOOLEAN
BEGIN
set
OutputRoot.DataObject.ns:SapMatmas05.IDocStreamData =
InputRoot.BLOB.BLOB;
RETURN TRUE;
END;
END MODULE;
```

The name of the SapMatmas05 element depends on selections that you make when you run the Adapter Connection wizard.

ALE pass-through IDoc business object structure:

During ALE processing, the adapter exchanges business objects with the SAP application. The Message tree contains a BLOB field that represents the IDoc.

The Message tree contains a transaction ID, a queue name, stream data, and the IDoc type. The transaction ID (SAPTransactionID) is used to ensure once-only delivery of business objects, and the queue name (qRFCQueueName) specifies the name of the queue on the SAP server to which the IDocs should be delivered. If you are not using transaction IDs or queues, these properties are blank.

ALE business objects:

A business object is a structure that consists of data, the action to be performed on the data, and additional instructions for processing the data. The adapter client uses business objects to send data to SAP or to obtain data (through the adapter) from SAP.

The adapter uses the IDoc metadata that is generated by the Adapter Connection wizard to construct a business-object definition. This metadata contains ALE-related information such as segment information, field names, and an indication of whether the business object handles a single IDoc or an IDoc packet.

The Message tree contains a BLOB field that represents the IDoc.

How business-object definitions are created

You create business-object definitions by using the Adapter Connection wizard. The wizard connects to the application, discovers data structures in the application, and generates business-object definitions to represent them. It also generates other resources that are needed by the adapter, such as the interface information that indicates the input and output parameters.

For more information, see the following topics.

- “ALE business object structure”
- “Transaction ID support” on page 26
- “Dummy keys” on page 26

ALE business object structure:

During ALE processing, the adapter exchanges business objects with the SAP application. The business object represents an individual IDoc or an IDoc packet. This business object is a top-level wrapper object that contains one or more IDoc child objects, each one corresponding to a single IDoc. The same business object format is used for inbound and outbound processing.

The wrapper business object contains a transaction ID, a queue name, and one or more IDoc business objects. The transaction ID (SAPTransactionID) is used to ensure once-only delivery of business objects, and the queue name (qRFCQueueName) specifies the name of the queue on the SAP server to which the IDocs should be delivered. If you are not using transaction IDs or queues, these properties are blank.

For individual IDocs, the wrapper business object contains only one instance of an IDoc business object. For IDoc packets, the wrapper business object contains multiple instances of an IDoc business object.

The IDoc business object contains the following objects:

- The control record business object contains the metadata required by the adapter to process the business object.
- The data record business object contains the actual business object data to be processed by the SAP application and the metadata required for the adapter to convert it to an IDoc structure for the RFC call.

| For an unparsed IDoc, in which the data part of the IDoc is not parsed by the
| adapter, the IDoc business object contains a dummy key, a control record, and the
| IDoc data.

Transaction ID support:

An SAP transaction ID is contained within the ALE wrapper business object. You can use transaction ID support to ensure once-only delivery of ALE objects.

The most common reason for using transaction ID support is to ensure once and only once delivery of data. To make sure of this feature, select the transaction RAR file (CWYAP_SAPAdapter_Tx.rar) when you configure the adapter..

The SAP transaction ID property is always generated by the Adapter Connection wizard; however, it is supported only for outbound operations when the CWYAP_SAPAdapter_Tx.rar version of the adapter is used.

The client application must determine how to store the SAP transaction ID and how to relate the SAP transaction ID to the data being sent to the adapter. When the events are successful, the client application should not resubmit the event associated with this TID again to prevent the processing of duplicate events.

- If the client application does not send an SAP transaction ID with the business object, the adapter returns one after executing the transaction.
- If the client application has an SAP transaction ID, it needs to populate the SAP transaction ID property with that value before executing the transaction.

The SAP transaction ID can be used for cross-referencing with a global unique ID that is created for an outbound event. The global unique ID is something you can create for managing integration scenarios.

Dummy keys:

You use a dummy key to map a key field from an IDoc control or data record business object to the dummyKey property of the top-level business object. The dummyKey property is used for flow control and business process logic. You can use the dummyKey when you need the top-level business object to participate in a relationship.

The adapter supports dummy key mapping in the following manner:

- You must configure the property-level application-specific information of the dummyKey property as the path to the property from which the value should be set. For example: dataRecord/SapOrders05e2edk01005/idocDocumentNumber
- Multiple cardinality objects are not supported. If the path contains a multiple cardinality object, the value is ignored and the default first index is used.
- If the application-specific information is incorrect or if the mapped property value is empty, the adapter causes the event to fail. This is also the case when the application-specific information is configured to set an object type value as the dummyKey.

Note: The dummyKey property can contain only a simple type.

Dummy key processing is not supported for unparsed IDocs.

Query interface for SAP Software:

The Query interface for SAP Software (QISS) provides you with the means to retrieve data from application tables on an SAP server or to query SAP application tables for the existence of data. The adapter can perform hierarchical data retrieval from the SAP application tables.

Query interface for SAP Software supports outbound interactions for read operations (RetrieveAll and Exists) only. You can use this interface in local transactions to look up records before write operations (Create, Update, or Delete). For example, you can use the interface as part of a local transaction to do an existence check on a customer before creating a sales order. You can also use the interface in non-transaction scenarios.

Query interface for SAP Software supports data retrieval from SAP application tables, including hierarchical data retrieval from multiple tables. The interface supports static as well as dynamic specification of where clauses for the queries.

The Adapter Connection wizard finds the application data tables in SAP, interprets the hierarchical relationship between tables, and constructs a representation of the tables and their relationship in the form of a business object. The wizard also builds a default where clause for the query.

You can control the depth of the data retrieval as well as the amount of information using the `maxRow` and `rowsSkip` properties.

For more information, see the following topics.

- “Outbound processing for the query interface for SAP Software”
- “Business objects for the query interface for SAP Software” on page 28

Outbound processing for the query interface for SAP Software:

You use the Query interface for SAP Software for outbound processing only.

The client application that makes the request uses the interface information that was generated by the Adapter Connection wizard.

The following list describes the sequence of processing actions that result from an outbound request using the query interface for SAP Software.

1. The adapter receives a request, which includes a table object, from a client application.
The query business object can be within a container business object, or it can be received as a table business object.
2. The adapter determines, from the table object sent with the query, the name of the table to examine.
3. The adapter determines the columns to retrieve or examine.
4. The adapter determines the rows to retrieve or examine.
5. The adapter responds.
 - In the case of a RetrieveAll operation, the adapter returns a result set in the form of a container of query business objects, which represent the data for each row retrieved from the table. If the query is received as a table business object (not inside a container), the rows are returned one at a time, as they are retrieved.
 - In the case of the Exists operation, the adapter returns an indication of whether the data exists in the SAP table.

- If no data exists, the adapter generates an exception.

Business objects for the query interface for SAP Software:

A business object is a structure that consists of data, the action to be performed on the data, and additional instructions, if any, for processing the data. The input to the Query interface for SAP Software is a table business object. The table business object represents the columns in a table on the SAP server. The adapter uses the table business object to obtain data from tables on the SAP server.

How data is represented in business objects

The adapter uses metadata that is generated by the Adapter Connection wizard to construct a business-object definition.

The data in the business object represents the columns of the associated table in SAP.

How business objects are created

You create business-object definitions by using the Adapter Connection wizard. The wizard connects to the application, discovers data structures in the application, and generates business-object definitions to represent them. It also generates other resources that are needed by the adapter, such as the interface information that indicates the input and output parameters.

Business object structure

The table business object can be part of a container.

The table business object contains columns selected from the specified SAP table.

In addition to column information, the table business object also contains a query business object as the last parameter.

The properties of the query business object are `sapWhereClause`, `sapRowsSkip`, and `sapMaxRows`:

- The `sapWhereClause` property retrieves information from SAP tables. The default value is populated by the Adapter Connection wizard. The space character is used as the delimiter to parse the `sapWhereClause`.
- The `sapMaxRows` property is the maximum number of rows to be returned. The default value is 100.
- The `sapRowsSkip` property is the number of rows to skip before retrieving data. The default value is 0.

The tables can be modeled as hierarchical business objects. You specify the parent-child relationship of the tables in the Adapter Connection wizard.

Tables are linked by a foreign key to form parent-child relationships. The child table business object has a foreign key that references a property in the parent query business object.

In the KNA1 business object, notice the reference to `SapAdrc`, a child business object. The `SapAdrc` table object, shown in the following figure, has a column

named AddressNumber. This column has an associated property (ForeignKey) that contains a reference to the parent business object.

The return from the Query interface for SAP Software call for a RetrieveAll operation is a container of table objects.

The Advanced event processing interface:

The Advanced event processing interface of the WebSphere Adapter for SAP Software is used for both inbound and outbound processing.

For inbound processing, it polls for events in SAP, converts them into business objects, and sends the event data as business objects to WebSphere Message Broker.

For outbound processing, the adapter processes events sent from an application to retrieve data from or update data in the SAP server.

For more information, see the following topics.

- “Outbound processing”
- “Inbound processing for the advanced event processing interface” on page 32
- “Business objects” on page 35

Outbound processing:

During outbound processing, business object data is converted into an ABAP handler function, which is called on the SAP server. When the data is returned by the ABAP handler function, the data is converted to a business object, and the business object is returned as a response.

The following list describes the sequence of processing actions that result from an outbound request using the Advanced event processing interface.

1. The adapter receives the Advanced event processing record, which contains business data along with the metadata.
2. The Advanced event processing interface of the adapter uses the metadata of the business object to obtain the type of IDoc specified and to reformat the business object data into the structure of that IDoc.
3. After it reformats the data, the adapter passes the business object data to an object-specific ABAP handler (based on the operation), which handles the integration with an SAP native API.
4. After the object-specific ABAP handler finishes processing the business object data, it returns the response data in IDoc format to the adapter, which converts it to the business object.
5. The adapter returns the results to the caller.

For more information, see the following topics.

- “ABAP handler overview”
- “ABAP handler creation” on page 31
- “Call Transaction Recorder wizard” on page 32

ABAP handler overview:

An ABAP handler is a function module that gets data into and out of the SAP application database. For each business object definition that you develop, you must support it by developing a custom ABAP handler.

ABAP handlers reside in the SAP application as ABAP function modules. ABAP handlers are responsible for adding business-object data into the SAP application database (for Create, Update, and Delete operations) or for using the business-object data as the keys to retrieving data from the SAP application database (for the Retrieve operation).

You must develop operation-specific ABAP handlers for each hierarchical business object that needs to be supported. If you change the business object definition, you must also change the ABAP handler.

An ABAP handler can use any of the SAP native APIs for handling the data. The following list contains some of the native APIs.

- Call Transaction
Call Transaction is the SAP-provided functionality for entering data into an SAP system. Call Transaction guarantees that the data adheres to the SAP data model by using the same screens an online user sees in a transaction. This process is commonly referred to as *screen scraping*.
- Batch data communication (BDC)
Batch Data Communication (BDC) is an instruction set that SAP can follow to process a transaction without user intervention. The instructions specify the sequence in which the screens in a transaction are processed and which fields are populated with data on which screens. All of the elements of an SAP transaction that are exposed to an online user have identifications that can be used in a BDC.
- ABAP SQL
ABAP SQL is the SAP proprietary version of SQL. It is database- and platform-independent, so that whatever SQL code you write, you can run it on any database and platform combination that SAP supports. ABAP SQL is similar in syntax to other versions of SQL and supports all of the basic database table commands such as update, insert, modify, select, and delete. For a complete description of ABAP SQL, see your SAP documentation.
Using ABAP SQL, an ABAP handler can modify SAP database tables with business object data for create, update, and delete operations. It can also use the business object data in the where clause of an ABAP select statement as the keys.
Use of ABAP SQL to modify SAP tables is not recommended, because it might corrupt the integrity of the database. Use ABAP SQL only to retrieve data.
- ABAP Function Modules and Subroutines
From the ABAP handler, you can call ABAP function modules or subroutines that implement the required function.

The adapter provides the following tools to help in the development process:

- The adapter includes the Call Transaction Recorder wizard to assist you in developing the ABAP handlers that use call transactions or BDC sessions.
- The Adapter Connection wizard generates the required business objects and other resources for Advanced event processing. The business objects are based on IDocs, which can be custom or standard.
- The adapter provides samples that you can refer to for an understanding of the Advanced event processing implementation.

ABAP handler creation:

For each IDoc object definition that you develop, you must support it by developing a custom ABAP handler.

You can use either standard IDocs or custom IDocs for the Advanced event processing interface. After defining the custom IDoc for an integration scenario, create an ABAP handler (function module) for each operation of the business object that needs to be supported.

Each function should have the following interface to ensure that adapter can call it:

```
*" IMPORTING
*" VALUE(OBJECT_KEY_IN) LIKE /CWL/LOG_HEADER-OBJ_KEY OPTIONAL
*" VALUE(INPUT_METHOD) LIKE BDWFAP_PAR-INPUTMETHD_OPTIONAL
*" VALUE(LOG_NUMBER) LIKE /CWL/LOG_HEADER-LOG_NR OPTIONAL
*" EXPORTING
*" VALUE(OBJECT_KEY_OUT) LIKE /CWL/LOG_HEADER-OBJ_KEY
*" VALUE(RETURN_CODE) LIKE /CWL/RFCRC_STRU-RFCRC
*" VALUE(RETURN_TEXT) LIKE /CWL/LOG_HEADER-OBJ_KEY
*" TABLES
*" IDOC_DATA STRUCTURE EDID4
*" LOG_INFO STRUCTURE /CWL/EVENT_INFO
```

The following table provides information about the parameters:

Table 3. Interface parameters

Parameter	Description
OBJECT_KEY_IN	Should be no value.
INPUT_METHOD	Indicates whether the IDoc should be processed in a dialog (that is, through Call Transaction). Possible values are: " " - Background (no dialog) "A" - Show all screens "E" - Start the dialog on the screen where the error occurred "N" Default
LOG_NUMBER	Log Number.
OBJECT_KEY_OUT	Customer ID returned from the calling transaction.
RETURN_CODE	0 - Successful. 1 - Failed to retrieve. 2 - Failed to create, update, or delete.
RETURN_TEXT	Message describing the return code.
IDOC_DATA	Table containing one entry for each IDoc data segment. The following fields are relevant to the inbound function module: Docnum - The IDoc number. Segnam - The segment name. Sdata - The segment data.
LOG_INFO	Table containing details regarding events processed with either a success or error message.

Call Transaction Recorder wizard:

The adapter provides the Call Transaction Recorder wizard to assist you in developing the ABAP handlers that use call transactions or BDC sessions.

The Call Transaction Recorder wizard enables you to generate sample code for call transactions to facilitate development. It generates sample code stubs for each screen that is modified during the recording phase.

To access this wizard, enter the /CWLD/HOME transaction in the SAP GUI.

The following example is sample code that is generated by the wizard. You can adopt this code in the ABAP Handler.

```
* Customer master: request screen chnge/dspl cent.
perform dynpro_new using 'SAPMF02D' '0101' .

* Customer account number
perform dynpro_set using 'RF02D-KUNNR' '1' .

* Function Command
perform dynpro_set using 'BDC_OKCODE' '/00' .

* Function Command
perform dynpro_set using 'BDC_OKCODE' '/00' .

* Customer master: General data, CAM address, communication
perform dynpro_new using 'SAPMF02D' '0111' .

* Title
perform dynpro_set using 'SZA1_D0100-TITLE_MEDI' 'Mr.' .

* Function Command
perform dynpro_set using 'BDC_OKCODE' '=UPDA' .

* Call Transaction
Call Transaction 'XD02' using bdcdata
  mode input_mode
  update 'S'
  messages into bdc_messages.
```

The wizard does not generate the required business object. You use the Adapter Connection wizard to generate the business object.

Inbound processing for the advanced event processing interface:

The adapter uses the Advanced event processing interface to poll for events on the SAP server, to process the events, and to send them to an endpoint.

The following list describes the sequence of processing actions that result from an inbound request using the Advanced event processing interface.

1. A triggered event enters the event table with an initial status of pre-queued.
2. When the adapter polls for events, the status of the event changes from pre-queued to queued if there are no database locks for the combination of the user who created the event and the event key.
3. After the event is retrieved from the event table, the status of the event is updated to InProgress.

If locks exist, the status of the event is set to locked and the event is re-queued into the queue. Every event with a pre-queued or locked status is updated with every poll. You can configure the polling frequency using the Poll Frequency property.

4. After preprocessing all pre-queued events, the adapter selects the events.

The property Poll Quantity determines the maximum number of events returned for a single poll call.

5. For each event, the adapter uses the remote function specified for the Retrieve operation to retrieve the data and send it to the endpoint.

If the AssuredOnceDelivery property is set to true, an XID value is set for each event in the event store. After each event is picked up for processing, the XID value for that event is updated in the event table.

If before the event is delivered to the endpoint, the SAP connection is lost or the application is stopped, and the event is consequently not processed completely, the XID column ensures that the event is reprocessed and sent to the endpoint. After the SAP connection is reestablished or the adapter starts up again, it first checks for events in the event table that have a value in the XID column. It then processes these events first and then polls the other events during the poll cycles.

6. After each event is processed, it is updated or archived in the SAP application.

When the event is processed successfully, it is archived and then deleted from the event table.

The adapter can also filter the events to be processed by business object type. The filter is set in the Event Filter Type property. This property has a comma-delimited list of business object types, and only the types specified in the property are picked for processing. If no value is specified for the property, no filter is applied and all the events are picked up for processing.

For more information, see the following topics.

- “Event detection”
- “Event triggers” on page 35

Event detection:

Event detection refers to the collection of processes that notify the adapter of SAP application object events. Notification includes, but is not limited to, the type of the event (object and operation) and the data key required for the external system to retrieve the associated data.

Event detection is the process of identifying that an event was generated in the SAP application. Typically, adapters use database triggers to detect an event. However, because the SAP application is tightly integrated with the SAP database, SAP allows very limited access for direct modifications to its database. Therefore, the event-detection mechanisms are implemented in the application transaction layer above the database.

Adapter-supported event detection mechanisms

The four event-detection mechanisms that are supported by the adapter are described in the following list:

- Custom Triggers, which are implemented for a business process (normally a single SAP transaction) by inserting event detection code at an appropriate point within the SAP transaction

- Batch programs, which involve developing an ABAP program containing the criteria for detecting an event
- Business workflows, which use the object-oriented event detection capabilities of SAP
- Change pointers, a variation of business workflows, which use the concept of change documents to detect changes for a business process

All these event-detection mechanisms support real-time triggering and retrieval of objects. In addition, custom triggers and batch programs provide the ability to delay the retrieval of events. An event whose retrieval is delayed is called a future event.

Each event detection mechanism has advantages and disadvantages that need to be considered when designing and developing a business object trigger. Keep in mind that these are only a few examples of event detection mechanisms. There are many different ways to detect events.

After you determine the business process to support (for example, sales quotes or sales orders) and determine the preferred event-detection mechanism, implement the mechanism for your business process.

When implementing an event detection mechanism, it is a good idea to support all of the functionality for a business process in one mechanism. This limits the impact in the SAP application and makes event detection easier to manage.

Event table

Events that are detected are stored in an SAP application table. This event table is delivered as part of the ABAP component. The event table structure is as follows.

Table 4. Event table fields

Name	Type	Description
event_id	NUMBER	Unique event ID that is a primary key for the table.
object_name	STRING	Business graph name or business object name.
object_key	STRING	Delimited string that contains the keys for the business object.
object_function	STRING	Operation corresponding to the event (Delete, Create, or Update).
event_priority	NUMBER	Any positive integer to denote the priority of the event.
event_time	DATE	Date and time when the event was generated.
event_status	NUMBER	Event processing status. Possible values are: 0 - Ready for poll 1 - Event delivered 2 - Event prequeued 3 - Event in progress 4 - Event locked -1 - Event failed
Xid	STRING	Unique XID (transaction ID) value for assured-once delivery.
event_user	STRING	User who created the event.

Table 4. Event table fields (continued)

Name	Type	Description
event_comment	STRING	Description of the event.

Event triggers:

After an event is identified by one of the event-detection mechanisms, it is triggered by one of the adapter-delivered event triggers. Event triggers can cause events to be processed immediately or in the future.

The function modules that trigger events are described in the following list.

- /CWLD/ADD_TO_QUEUE
This function module triggers events to the current event table for immediate processing.
- /CWLD/ADD_TO_QUEUE_IN_FUTURE
This function module triggers events to the future event table to be processed at a later time.

Both functions are for real-time triggering.

Current event table

If the event will be triggered in real-time, /CWLD/ADD_TO_QUEUE_AEP commits the event to the current event table (/CWLD/EVT_CUR_AEP). Specifically, it adds a row of data for the object name, verb, and key that represents the event.

Future event table

If an event needs to be processed at a future date, the processing that is described in the following list occurs.

1. A custom ABAP handler calls /CWLD/ADD_TO_QUEUE_IN_FUTURE_AEP with the event.
2. The /CWLD/ADD_TO_QUEUE_IN_FUTURE_AEP module commits the event to the future event table (/CWLD/EVT_FUT_AEP). Specifically, it adds a row of data for the object name, verb, and key that represents the event. In addition, it adds a Date row
3. The adapter-delivered batch program /CWLD/SUBMIT_FUTURE_EVENTS_AEP reads the future event table.
4. If scheduled to do so, the batch program retrieves events from the future event table.
5. After it retrieves an event, the batch program calls /CWLD/ADD_TO_QUEUE_AEP.
6. The /CWLD/ADD_TO_QUEUE_AEP module triggers the event to the current event table.

/CWLD/ADD_TO_QUEUE_IN_FUTURE_AEP uses the system date as the current date when it populates the Date row of the future event table.

Business objects:

A business object is a structure that consists of data, the action to be performed on the data, and additional instructions, if any, for processing the data.

How data is represented in business objects

Advanced event processing business objects are based on custom IDocs, standard IDocs, or extension IDocs available in the SAP system.

How business-object definitions are created

You create business-object definitions by using the Adapter Connection wizard. The wizard connects to the application, discovers data structures in the application, and generates business-object definitions to represent them. It also generates other resources that are needed by the adapter, such as the interface information that indicates the input and output parameters.

For custom interfaces that you want to support, as a first step, you need to define the custom IDoc in the SAP system. You can then use the Adapter Connection wizard to discover this custom IDoc and build the required resources, including the business-object definition.

Overview of WebSphere Adapter for Siebel Business Applications:

With WebSphere Adapter for Siebel Business Applications, you can create integrated processes that exchange information with a Siebel application, without special coding.

WebSphere Adapter for Siebel Business Applications provides a way to create integrated processes that exchange information with a Siebel application. With the adapter, an application can send requests to the Siebel Business Applications server or receive notifications of changes from the server.

The adapter creates a standard interface to the applications and data on the Siebel Business Applications server, so that the application does not have to understand the lower-level details (the implementation of the application or the data structures) on the Siebel Business Applications server. An application, for example, can send a request to the Siebel Business Applications server, to query or update an Account record, represented by a Siebel business component instance. It can also receive events from the server, for example, to be notified that a customer record has been updated. This provides you with improved business workflow and processes to help manage your customer relations.

WebSphere Adapter for Siebel Business Applications complies with the Java Connector Architecture (JCA). JCA standardizes the way application components, application servers, and Siebel applications, such as Siebel Business Applications server, interact with each other.

The adapter configuration, which you generate with the Adapter Connection wizard, uses a standard interface and standard data objects. The adapter takes the standard data object sent by the application component and calls the Siebel Business Applications function. The adapter then returns a standard data object to the application component. The application component does not have to deal directly with the Siebel Business Applications function; it is the Siebel Business Applications adapter that calls the function and returns the results.

For example, the application component that needs the list of customers sends a standard business object with the range of customer IDs to Adapter for Siebel Business Applications. In return, the application component receives the results (the list of customers) in the form of a standard business object. The application component does not need to know how the function worked or how the data was structured. The adapter performs all the interactions with the actual Siebel Business Applications function.

Similarly, the client application might want to know about a change to the data on the Siebel Business Applications server (for example, a change to a particular customer). You can generate an adapter component that polls for such events on the Siebel Business Applications server and notifies client applications of the update. In this case, the interaction begins at the Siebel Business Applications server.

Technical overview of the Adapter for Siebel Business Applications:

WebSphere Adapter for Siebel Business Applications supports the exchange of information between your existing applications and Siebel Business Applications. The adapter supports Siebel entities, including business objects, business components, and business services. This enables you to create business processes that exchange data.

The adapter supports outbound processing (requests for data or services from an application to the Siebel application) and inbound processing (event notification from a Siebel application server to an application).

With Adapter for Siebel Business Applications, you can use existing or newly-created applications that run in a supported runtime environment to send requests for data and services to Siebel Business Applications.

You can also add event-generation triggers to Siebel business objects to have notifications of events, such as the creation, update, and deletion of a record, sent to one or more of your applications.

For more information, see the following topics.

- “Outbound processing”
- “Inbound processing” on page 38
- “Business objects” on page 42
- “Adapter Connection wizard (Siebel)” on page 42

Outbound processing:

WebSphere Adapter for Siebel Business Applications supports synchronous outbound processing. This means that when the component sends a request in the form of a WebSphere business object hierarchy to the adapter, the adapter processes the request and returns a WebSphere business object hierarchy that represents the result of the operation.

When the adapter receives a WebSphere business object hierarchy, the adapter processes it as follows:

1. The adapter extracts metadata from the WebSphere business object hierarchy.
2. It identifies the appropriate Siebel objects to access (for example, Siebel business objects and business components, or Siebel business services,

integrations objects, and integration components) depending on the objects against which the artifacts were generated.

3. The adapter extracts the outbound operation to perform from the WebSphere business object hierarchy.
4. After accessing the required Siebel objects, the adapter retrieves, updates, deletes, or creates a Siebel business component hierarchy or performs the corresponding business service method on the integration component hierarchy.
5. If there are updates (Create, Update, Delete), the adapter populates that Siebel object (business or integration component hierarchy) with data from the hierarchy of WebSphere business objects.

Supported Outbound Operations

WebSphere Adapter for Siebel Business Applications supports the following outbound operations as shown in the table below.

Table 5. Supported outbound operations

Operation	Description
Create	Creates the business component.
Delete	Deletes the business component and its children.
Exists	Checks for the existence of incoming business objects. The output business object, "ExistsResult" will be returned with the boolean value populated.
Retrieve	Specifies the value of the business component.
RetrieveAll	Retrieves multiple instances of the same business component and populates it as the container business graph.
Update	Updates the Siebel application with the incoming business object.

Inbound processing:

WebSphere Adapter for Siebel Business Applications supports asynchronous inbound processing, which means that the adapter polls the Siebel Business Applications at specified intervals for events. When the adapter detects an event, it converts the event data into a business object and sends it to the component.

Before inbound processing can occur, a Siebel event business component must be created in the Siebel application (IBM2 for Siebel version 7.x and IBM_EVENT for Siebel version 8) and its name specified against the corresponding property in the adapter activation specification.

When the adapter detects an event for Siebel event business components or integration components, it processes the event by retrieving the updated data for the Siebel event business component or integration component and converting it into a business object. The adapter then sends the business object to the event business component. For example, if an event business component (an account) is updated, an event trigger adds an event record to the event business component. The adapter polls the event business component, retrieves the event record, and processes it.

When the adapter finds an event for a Siebel event business component, it processes the event in the following way:

1. The adapter retrieves the event information from the Siebel event business component.
2. The adapter retrieves the corresponding event business component instance hierarchy.
3. The adapter populates the associated WebSphere business object or business graph (if it was generated) with the values that it retrieves from the event business component.
4. The adapter sends a notification to each registered application.

If an inbound event in the event table fails or is invalid, the event status is updated to -1, which indicates an error in processing the event, and a resource exception message is issued that explains the reason for the error.

Event store:

The event store is a persistent cache where event records are saved until the polling adapter can process them. To keep track of inbound events as they make their way through the system, the adapter uses an event store.

The creation, update, or deletion of an event record in the Siebel business application is an 'event'. Each time a business object is created, updated, or deleted, the adapter updates the status of the event in an event store.

For example, if you have a customer component and a new customer has just been added to it, this signals an update. If the adapter is configured to receive the events about the new update, there will be triggers attached to the Siebel end and connected to the customer component. The triggers add a record to the event business component. The record contains information about the new customer, such as the customer ID. This information is stored in the object key. The object key is the unique identifier that provides the key name and value of the event business component that was updated (for example, Id=1-20RT). The object name is the WebSphere business object name that represents the customer component (for example, AccountBG or Account). The adapter retrieves this event and the new customer information that relates to it. It then processes the event and delivers it to the export.

During inbound processing, the adapter polls the event business components from the event store at regular intervals. Each time it polls, a number of events are processed by the adapter. Events are processed in ascending order of priority and ascending order of the event time stamp. In each poll cycle, new events are picked up. The adapter retrieves the value set in the object key field for the event and loads the business object that corresponds to it. The business object, or optionally the business graph, is created from the retrieved information and is delivered to the exports.

If you set the activation specification property AssuredOnceDelivery to true, a transaction ID (XID) value is set for each event in the event store. After the event is retrieved for processing, the XID value for it is updated in the event store and displayed in the XID column in the event business component. The event is then delivered to its corresponding export, and the status is updated to show that the event has been successfully delivered. If the application is stopped or the event is not processed completely, the XID column is filled with a value. This ensures that the event is reprocessed and sent to the export. After the connection is reestablished or the adapter starts again, the adapter checks for events in the event

store that have a value in the XID column. The adapter processes these events first and then polls the other events during the poll cycles.

The adapter can either process all events or process events filtered by business object type. You set the filter through the activation specification property, `EventTypeFilter`. This property contains a comma-delimited list of business object types. Only the types specified in the property are processed. If the `EventTypeFilter` property is not set, then all of the events are processed. If the `FilterFutureEvents` property is set to `true`, the adapter filters events based on the time stamp. The adapter compares the system time in each poll cycle to the time stamp on each event. If an event is set to occur in the future, it is not processed until that time.

After an event is successfully posted and delivered to the export, the entry is deleted from the event store. Failed events (posting and delivery to the export is unsuccessful), remain in the event store and are marked -1. This prevents duplicate processing.

Event store structure for Siebel business objects and business components

The IBM2 event business component stores information about the event. The information stored is used by the resource adapter during event subscription to build the corresponding business object and send it to the registered exports. The information that is stored, as well as the structure of the event store used by the adapter, is shown in the following table.

Table 6. Event store structure for IBM2 Siebel event business objects and business components

Field	Description	Example
Description	Any comment associated with the event.	Account Create Event
Event ID	The ID of the event row.	Automatically generated unique ID in Siebel (for example: 1-XYZ)
Event timestamp	The time stamp for the event. The format is in <i>mm/dd/yyyy hh:mm:ss</i>	02/24/2007 11:37:56
Event type	The type of event.	Create, Update, or Delete
Object key	A unique identifier of the business object row for which the event was created. It is a name value pair consisting of the name of the property (key name) and value.	Id=1-20RT
Object name	The name of the business object or business graph for which the event was detected.	IOAccountPRMANIICAccount
Priority	The event priority.	1

Table 6. Event store structure for IBM2 Siebel event business objects and business components (continued)

Field	Description	Example
Status	<p>The event status. This is initially set to the value for a new event and updated by the adapter as it processes the event. The status can have one of the following values:</p> <ul style="list-style-type: none"> • 0: Identifies a new event. • 1: Identifies an event that has been delivered to an export. • -1: An error occurred while processing the event. <p>This column cannot be null.</p>	0
XID	The transaction ID. This is to ensure 'assured once delivery'.	None

Event store structure for Siebel business services

The event is retrieved from the IBM2 event business component and the information is used to retrieve the event business component. This creates a business graph which is published to the registered exports.

Table 7. Event store structure for IBM2 Siebel business services

Field	Description	Example
Description	Any comment associated with the event.	Account PRM ANI Event
Event ID	The ID of the event row.	Automatically generated unique ID in Siebel (for example: 1-XYZ)
Event timestamp	The time stamp for the event. The format is in <i>mm/dd/yyyy hh:mm:ss</i>	02/24/2007 11:37:56
Event type	The type of event.	Create, Update, or Delete
Object key	A unique identifier of the business object row for which the event was created. It is a name value pair consisting of the name of the property (key name) and value.	Name=TestName;Location=BGM, where 'Name' and 'Location' are the keys in the integration component. 'TestName' and 'BGM' are the values specified, and ; is the event key delimiter.
Object name	The name of the business object or business graph for which the event was detected.	IOAccountPRMANIICAccount
Priority	The event priority.	1

Table 7. Event store structure for IBM2 Siebel business services (continued)

Field	Description	Example
Status	<p>The event status. This is initially set to the value for a new event and updated by the adapter as it processes the event. The status can have one of the following values:</p> <ul style="list-style-type: none"> • 0: Identifies a new event. • 1: Identifies an event that has been delivered to an export. • -1: An error occurred while processing the event. <p>This column cannot be null.</p>	0
XID	The transaction ID. This is to ensure 'assured once delivery'.	None

Business objects:

To send data or obtain data from Siebel Business Applications, the adapter uses business objects. A business object is a structure that consists of data, the action to be performed on the data, and additional instructions, if any, for processing the data. The data can represent either a business entity, such as an invoice or an employee record, or unstructured text.

How business objects are created

You create business objects by using the Adapter Connection wizard, which connects to the application, discovers data structures in the application, and generates business objects to represent them. It also generates other resources that are needed by the adapter.

The Siebel business objects are created with long names by default. To generate business objects with shorter names, select **Generate business objects with shorter names** on the Configure Objects screen of the Adapter Connection wizard. For more information, see "Naming conventions for business objects representing Siebel business services" on page 1288.

Business object structure

The adapter supports business objects that are hierarchically structured. The top-level business object must have a one-to-one correspondence with the Siebel business component, and collections that occur within the top-level object are children of it. Information about the processed object is stored in the application-specific information for the object and each of its attributes.

Adapter Connection wizard (Siebel):

The Adapter Connection wizard is a tool that you use to configure your adapter. The wizard establishes a connection to the Siebel server, discovers business objects and services (based on search criteria you provide), and generates business objects based on the services discovered.

Using the Adapter Connection wizard, you establish a connection to the Siebel server to browse the metadata repository on the Siebel server. You also specify connection information, such as the Connection URL, user name, and password needed to access the server.

The result of running the wizard is a message set project that contains the Siebel business objects and services along with the adapter.

Overview of WebSphere Adapter for PeopleSoft Enterprise:

With the adapter for PeopleSoft Enterprise you can create integrated processes that exchange information with PeopleSoft Enterprise through a standard interface. This interface shields the client application from having to understand the lower level details regarding implementation or the application or data structures it uses.

With the adapter, a client application can send a request, for example to a PeopleSoft Enterprise database to query a record in an HR table, or it can receive events from the server, such as notification that an employee record has been updated.

WebSphere Adapter for PeopleSoft Enterprise complies with the Java Connector Architecture (JCA), which standardizes the way application components, application servers, and enterprise information systems, such as a PeopleSoft Enterprise server, interact with each other.

The adapter component, which you generate with the Adapter Connection wizard uses a standard interface and standard data objects. The adapter component takes the standard data object sent by the client application and calls the PeopleSoft function. It then returns a standard data object to the client application. The client application does not have to deal directly with the PeopleSoft function; it is the adapter component that calls the function and returns the results.

For example, the client application that needed the list of employees would send a standard business object with the range of skill codes to the PeopleSoft adapter component. The client application would receive, in return, the results (the list of employees) in the form of a standard business object. The client application would have no need to know how the function worked or how the data was structured. The adapter component would perform all the interactions with the actual PeopleSoft function.

Similarly, the client application might want to know about a change to the data on the PeopleSoft Enterprise server (for example, a change to the skills set of a particular employee). You can generate an adapter component that listens for such events on the PeopleSoft Enterprise server and notifies client applications with the update. In this case, the interaction begins at the PeopleSoft Enterprise server.

For more information, see “Technical overview.”

Technical overview:

The adapter supports the exchange of business data between the PeopleSoft Enterprise server and WebSphere Message Broker. It does so by connecting to two layers of PeopleTools application programming interface classes that reveal the underlying business data for integration.

Adapter for PeopleSoft Enterprise establishes bidirectional connectivity with the PeopleSoft Enterprise server by connecting to two PeopleTools application programming interfaces as follows:

1. The adapter accesses the primary API layer to create a session instance and to connect to the application server through the Jolt port.
2. The adapter then accesses the PeopleSoft Component Interface API, which reveals underlying business objects, logic, and functionality.

In PeopleSoft, a component is a set of pages grouped together for a business purpose (such as an employee profile), and a component interface is an API that provides synchronous access to a component from an external application. After the adapter connects to the component interface, the following entities are exposed to the adapter and available for integration:

- All business objects in the component interface definition
- PeopleCode methods associated with the underlying components
- Records, except searches and menu-specific processing options

For more information, see the following topics.

- “Outbound processing”
- “Inbound processing” on page 45
- “Business objects” on page 46

Outbound processing:

The Adapter for PeopleSoft Enterprise supports synchronous outbound request processing. Synchronous outbound processing means that when the client application sends a request in the form of a business object to the adapter, the adapter processes the request and returns a business object representing the result of the operation to the client application.

When the adapter receives a WebSphere business object hierarchy, adapter processes it as follows:

1. The adapter extracts metadata from the WebSphere business object hierarchy that identifies the appropriate PeopleSoft component interface to access.
2. The adapter extracts the outbound operation to perform from the WebSphere business object hierarchy.
3. Once it accesses the component interface, the adapter sets the keys from values specified in the business objects. If key values are not generated, for example with a create operation, the PeopleSoft application generates key fields.
4. After it retrieves the PeopleSoft objects, the adapter instantiates an existing component interface to delete, retrieve, update, or create a component interface.
5. If there are updates (Create, Update), the adapter populates the component interface with data from the WebSphere business object hierarchy. If there are Deletes, the adapter populates the component interface only with StatusColumnName and value information.

The adapter processes attributes in the order defined in the business object. For example, if there is a complex attribute between two simple attributes, the adapter processes the simple attribute at the first position, then the complex attribute followed by the simple attribute. After the changes are made, the component interface is saved to commit the data to the PeopleSoft database. This pattern of processing is used for Create and Update operations only.

Supported outbound operations

WebSphere Adapter for PeopleSoft Enterprise supports the following outbound operations:

Table 8. Supported outbound operations

Operation	Description
Create	Creates the business object.
Delete	Deletes the business object and its children. Because the adapter supports only logical deletes, objects are marked as deleted but not removed.
Exists	Checks for the existence of incoming business objects.
Retrieve	Retrieves the PeopleSoft component, and maps component data onto the business object hierarchy.
RetrieveAll	Retrieves multiple instances of the PeopleSoft component, and maps component data onto the business object hierarchy.
Update	Updates the corresponding PeopleSoft component with the incoming business object.

Inbound processing:

The WebSphere Adapter for PeopleSoft Enterprise supports inbound event processing.

Inbound event processing means that the adapter polls the PeopleSoft Enterprise server at specified intervals for events. When the adapter detects an event, it converts the event data into a business object and sends it to the client application.

In order to use inbound event processing, you must create a custom event project in PeopleSoft, as described in “Creating a custom event project in PeopleTools” on page 254.

For more information, see “Event store.”

Event store:

The event store is a table that holds events that represent data changes until the polling adapter can process them. The adapter uses the event store to keep track of event entities.

To use inbound processing, you must use PeopleTools Application Designer to create a custom project for event notification. The custom project uses two PeopleCode functions that determine the way future events are processed, and the custom project creates the event store the adapter needs for inbound processing. Each time a business object is created, updated, or deleted, the PeopleCode function used in the project and then added to the component interface inserts a new record in the event store, with the appropriate object name, keys, and status value.

With inbound processing, the adapter polls the event entities from the event store at configured poll intervals. In each poll call, a configured number of events are processed by the adapter. The order of event processing is based on the ascending order of priority and the ascending order of the event time stamp. The events with

the status, Ready for poll (0), are picked up for polling in each poll cycle. The adapter uses the object name and object key to retrieve the corresponding business object.

If you set the activation specification property AssuredOnceDelivery to true, an XID (transaction ID) value is set for each event in the event store, and it is used to ensure that an event is delivered only once to the target application. After an event is obtained for processing, the XID value for that event is updated in the event store. The event is then delivered to its corresponding export, and its status is updated to show that event delivery has been completed. If the application is stopped before the event can be delivered to the export or if delivery has failed, the event might not be processed completely. In this case, the XID value represents in-progress status, and the XID column ensures that the event is reprocessed and sent to the export. Once the database connection is re-established or the adapter starts again, the adapter checks for events in the event table that have a value in the XID column of Ready for Poll (0). The adapter processes these events first, and then polls the other events during the poll cycles.

The adapter uses special processing for events that have status code (99), which indicates that they will occur in the future. During a poll cycle, when the adapter retrieves events with a future status, the adapter compares the system time with the time stamp on each event. If the event time is earlier than or equal to the system time, the adapter processes the event and changes the event status to Ready for Poll (0).

If you want the adapter to process future status events in the present time, use the function IBM_PUBLISH_EVENT instead of IBM_FUTURE_PUBLISH_EVENT. Doing so means that the event is identified as Ready to Poll (0) instead of Future (99).

As events are retrieved and processed from the event store, the status of the event changes to reflect the cycle, as shown in the table below.

Table 9. Event status values

Status short name	Description	Event table value
Error processing event	An error occurred during event processing.	-1
Ready for poll	The event has not yet been picked up by the adapter. The event is ready to be picked up.	0
Success	The event has been delivered to the event manager.	1
Deleted	The event has been processed successfully and should be removed from the event store.	4
Future Events	These events should be processed at a future date.	99

Business objects:

To send data or obtain data from PeopleSoft Enterprise, the adapter uses business objects. A business object is a structure that consists of data, the action to be

performed on the data, and additional instructions, if any, for processing the data. The data can represent either a business entity, such as an invoice or an employee record, or unstructured text.

How business objects are created

You create business objects by using the Adapter Connection wizard. The wizard connects to the application, discovers data structures in the application, and generates business objects to represent them. It also generates other resources that are needed by the adapter.

Business object structure

The adapter supports business objects that are hierarchically structured. The top-level business object must have a one-to-one correspondence with the PeopleSoft component interface, and collections that occur within the top-level object are children of it. Information about the processed object is stored in the application-specific information for the object and each of its attributes.

The following table describes the attributes that comprise a business object.

Attribute property	Description
Name	Indicates the name of the Business Object attribute.
Type	Indicates the type of the Business Object attribute. The adapter uses character mapping between PeopleSoft component property types and the generated business object attribute types. PeopleSoft component property types map to generated attribute types in the following manner: CHAR maps to attribute type String NUMBER maps to attribute type BigDecimal LONG maps to attribute type Long SIGN maps to attribute type BigDecimal DATE maps to attribute type Date TIME maps to attribute type Time DTTM maps to attribute type DateTime
Key	Child business objects have their own keys that have the primary key application-specific information. They also inherit keys from their parent business object.
Cardinality	Single cardinality for simple attributes; multiple cardinality for container attributes.

Message flow node palette

The palette contains all of the built-in nodes, which are organized into categories, or drawers. A drawer is a container for a list of icons, such as the **Favorites** drawer. You can drag the nodes that you use most often into the Favorites drawer for easy access. If you create your own nodes, you can also add them to the palette. You can drag a node from the palette onto the canvas, and create a connection between two nodes.

If you right-click the palette, you can add a selected node to the canvas, or customize the appearance and behavior of the palette. The following example shows the palette in List view, using small icons.

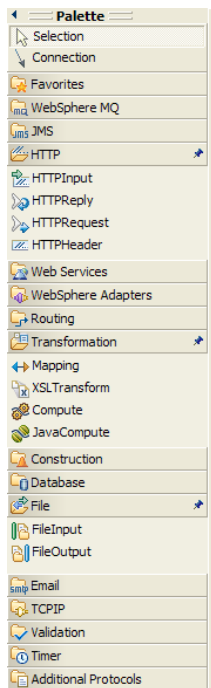

The Customize Palette dialog box allows you to reorder node categories, set the drawer behavior for individual categories, and rename or hide nodes or categories.

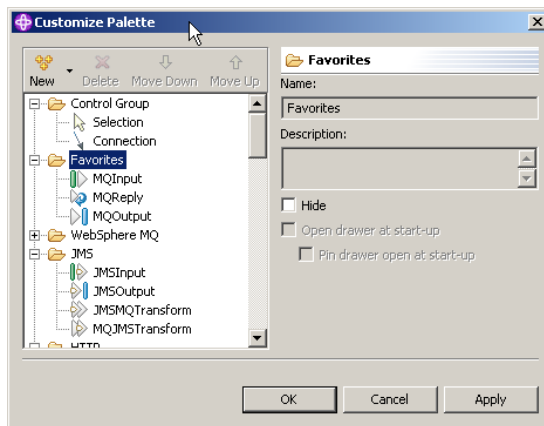

You cannot move any category above the Favorites category. You can hide the Favorites category, but you cannot delete or rename it.

The Palette Settings dialog box allows you to set the palette layout, determine the behavior of palette drawers, and choose a particular font.

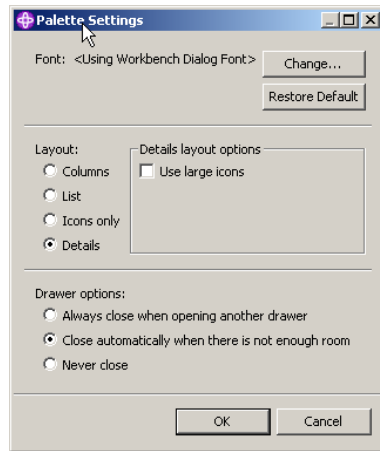

The following topics explain how to change the palette layout and settings:

- “Changing the palette layout” on page 228
- “Changing the palette settings” on page 229
- “Customizing the palette” on page 229

Message flows, ESQL, and mappings

A message flow represents the set of actions performed on a message when it is received and processed by a broker. The content and behavior of a message flow is defined by a set of files that you create when you complete your definition and configuration of the message flow content and structure:

- The message flow definition file `<message_flow_name>.msgflow`. This is a required file and is created automatically for you. It contains details about the message flow characteristics and contents (for example, what nodes it includes, its promoted properties, and so on).
- The ESQL resources file `<message_flow_name>.esql`. This file is required only if your message flow includes one or more of the nodes that must be customized using ESQL modules. You can create this file yourself, or you can cause it to be created for you by requesting specific actions against a node.

You can customize the following built-in nodes by creating free-form ESQL statements that use the built-in ESQL statements and functions, and your own user-defined functions:

- Compute
- Database
- Filter

- The message mappings file `<message_flow_name><_nodename>.msgmap`. This file is required only if your message flow contains one or more of the nodes that must be customized using mappings. You can create this file yourself, or you can cause it to be created for you by requesting specific actions against a node. A different file is required for each node in the message flow that uses the Message Mapping editor.

You can customize the following built-in nodes by specifying how input values map to output values:

Node	Usage
“DataDelete node” on page 866	Use this node to delete one or more rows from a database table without creating an output message.

Node	Usage
“DataInsert node” on page 869	Use this node to insert one or more rows in a database table without creating an output message.
“DataUpdate node” on page 872	Use this node to update one or more rows in a database table without creating an output message.
“Extract node” on page 884	Use this node to create a new output message that contains a subset of the contents of the input message. Use the Extract node only if no database is involved in the map. The Extract node is deprecated in WebSphere Message Broker Version 6.0. Although message flows that contain an Extract node remain valid in WebSphere Message Broker Version 6.0, where possible, redesign your message flows so that any Extract node is replaced by a Mapping node.
“Mapping node” on page 978	Use this node to construct output messages and populate them with information that is new, modified from the input message, or taken from a database. You can also use the Mapping node to update, insert or delete rows in a database table.
“Warehouse node” on page 1213	Use this node to store all or part of a message in a database table without creating an output message.

You can use built-in ESQL functions and statements to define message mappings, and you can use your own ESQL functions.

Configurable services

Configurable services are typically runtime properties. You can use them to define properties that are related to external services on which the broker relies; for example, an SMTP server or a JMS provider.

Instead of defining properties on the node or message flow, you can create configurable services so that nodes and message flows can refer to them to find properties at run time. If you use this method, you can change the values of attributes for a configurable service on the broker, which then affects the behavior of a node or message flow without the need for redeployment.

Unless it is explicitly stated by the function that is using the configurable service, you need to stop and start the execution group for the change of property value to take effect.

Use the following commands to work with configurable services:

- Use the `mqsicreateconfigurable-service` command to create configurable services.
- Use the `mqsdeleteconfigurable-service` command to delete configurable services.
- Use the `mqschange-properties` command to set attributes after you have created the configurable services.
- Use the `mqsireport-properties` command to report attributes.

For a full list of configurable services and their properties, see Configurable services properties.

Message flow version and keywords

When you are developing a message flow, you can define the version of the message flow as well as other key information that you want to be associated with it. After the message flow has been deployed, you can view the properties of the message flow in the workbench. These properties include the deployment and

modification dates and times (the default information that is displayed) as well as any additional version or keyword information that you have set.

You can define information to give details of the message flow that has been deployed; therefore, you can check that it is the message flow that you expect.

Version

You can set the version of the message flow in the Version property.

You can also define a default message flow version in the Default version tag of the message flow preferences. All new message flows that are created after this value has been set have this default applied to the Version property at the message flow level.

Keywords

Keywords are extracted from the compiled message flow (the .cmf file) rather than the message flow source (the .msgflow file). Not all of the source properties are added to the compiled file. Therefore, add message flow keywords in only these places:

- The label property of a Passthrough node
- ESQL comments or string literals
- The Long Description property of the message flow

Any keywords that you define must follow certain rules to ensure that the information can be parsed. The following example shows some values that you might want to define in the Long Description property:

```
$MQSI Author=John Smith MQSI$  
$MQSI Subflow 1 Version=v1.3.2 MQSI$
```

The following table contains the information that the workbench shows.

Message flow name	
Deployment Time	28-Aug-2004 15:04
Modification Time	28-Aug-2004 14:27
Version	v1.0
Author	John Smith
Subflow 1 Version	v1.3.2

In this display, the version information has also been defined using the Version property of the object. If the version information has not been defined using the property, it is omitted from this display.

If message flows contain subflows, you can embed keywords in each subflow.

Restrictions within keywords

Do not use the following characters within keywords because they cause unpredictable behavior:

```
^$. | \<>?+*=&[]
```

You can use these characters in the values that are associated with keywords; for example:

- `$MQSI RCSVER=$id$ MQSI$` is acceptable
- `$MQSI $name=Fred MQSI$` is not acceptable

Message flow connections

A connection is an entity that connects an output terminal of one message flow node to the input terminal of another. It represents the flow of control and data between two message flow nodes.

The connections of the message flow, represented by black lines within the message flow editor view, determine the path that a message takes through the message flow. You can add bend points to the connection to alter the way in which it is displayed.

See “Bend points” for a description of bend points. See “Message flow node terminals” for a description of terminals.

Bend points

A bend point is a point that is introduced in a connection between two message flow nodes at which the line that represents the connection changes direction.

Use bend points to change the visual path of a connection to display node alignment and processing logic more clearly and effectively. Bend points have no effect on the behavior of the message flow; they are visual modifications only.

A connection is initially made as a straight line between the two connected nodes or brokers. Use bend points to move the representation of the connection, without moving its start and end points.

Message flow node terminals

A terminal is the point at which one node in a message flow is connected to another node.

Use terminals to control the route that a message takes, depending whether the operation performed by a node on that message is successful. Terminals are wired to other node terminals using message flow node connections to indicate the flow of control.

Every built-in node has a number of terminals to which you can connect other nodes. Input nodes (for example, `MQInput`) do not have in terminals; all other nodes have at least one in terminal through which to receive messages to be processed. Most built-in nodes have failure terminals that you can use to manage the handling of errors in the message flow. Most nodes have output terminals through which the message can flow to a subsequent node.

If you have any user-defined nodes, these might also have terminals that you can connect to other built-in or user-defined node terminals.

Dynamic terminals are terminals that you can add to certain nodes after you have added them to a message flow in the Message Flow editor. For example, you can add dynamic output terminals to the `Route` and `DatabaseRoute` nodes, or you can add dynamic input terminals to the `Collector` node. You can also delete and

rename dynamic terminals. If a node has five or more terminals, they are displayed in a group. For example, the following example shows a node with more than four

output nodes. 

Threading

A message flow is inherently thread-safe, and message flows can be run concurrently on more than one thread.

An instance of a message flow processing node is shared and used by all the threads that service the message flow in which the node is defined.

The number of threads servicing a flow is configured using the Additional instances property on the node.

Execution model

The execution model is the system used to start message flows through a series of nodes.

When an execution group is initialized, the appropriate loadable implementation library (LIL) files and Plug-in Archive (PAR) files are made available to the runtime environment. The execution group runtime process starts, and creates a dedicated configuration thread. In the message flow execution environment, the message flow is thread-safe. You can run message flows concurrently on many operating system threads, without having to consider serialization issues. Consider the following points:

- An input message sent to a message flow is processed only by the thread that received it.
- The memory requirements of an execution group are not unduly affected by running message flows on more operating system threads.
- The message flow execution environment is conceptually similar to procedural programming. Nodes that you insert into a message flow are similar to subroutines called using a function call interface. However, rather than a call-return interface, in which parameters are passed in the form of input message data, the execution model is referred to as a propagation-and-return model.
- A message flow is inherently thread-safe, and message flows can be run concurrently on more than one thread.

The message tree

A message tree is a structure that is created, either by one or more parsers when an input message bit stream is received by a message flow, or by the action of a message flow node.

A message is used to describe:

- A set of business data that is exchanged by applications
- A set of elements that are arranged in a predefined structure
- A structured sequence of bytes

WebSphere Message Broker routes and manipulates messages after converting them into a logical tree. The process of conversion, called parsing, makes obvious

the content and structure of a message, and simplifies later operations. After the message has been processed, the parser converts it back into a bit stream.

WebSphere Message Broker supplies a range of parsers to handle the many different messaging standards in use. See *Parsers*.

After a message has been parsed, it can be processed in a message flow.

The logical tree has contents that are identical to the message, but the logical tree is easier to manipulate within the message flow. The message flow nodes provide an interface to query, update, or create the content of the tree.

How the message tree is populated

The message tree is initially populated by the input node of the message flow.

When the input node receives the input message, it creates and completes the Properties tree (the first subtree of the message tree). See “Message tree structure” on page 61.

The node then examines the contents of the input message bit stream and creates the remainder of the message tree to reflect those contents. This process depends to some extent on the input node itself, which is governed by the transport across which the message is received:

WebSphere MQ Enterprise Transport and WebSphere MQ Telemetry Transport protocols

If your application communicates with the broker across these protocols, and your message flow includes the corresponding MQInput or SCADAInput node, all messages that are received must start with a Message Queue Message Descriptor (MQMD) header. If a valid MQMD is not present at the start of the message, the message is rejected, and no further processing takes place.

The input node first invokes the MQMD parser and creates the subtree for that header.

A message can have zero or more additional headers following the MQMD. These headers are chained together, with the Format field of one header defining the format of the following header, up to and including the last header, which defines the format of the message body. If an MQRFH and an MQRFH2 header exist in the chain, the name and value data in either of these two headers can also contain information about the format of the following data. If the value that is specified in Format is a recognized parser, this value always takes precedence over the name and value data.

The broker invokes the appropriate parser to interpret each header, following the chain in the message. Each header is parsed independently. The fields within a single header are parsed in an order that is governed by the parser. You cannot predict the order that is chosen, but the order in which fields are parsed does not affect the order in which the fields are displayed within the header.

The broker ensures that the integrity of the headers that precede a message body is maintained. The format of each part of the message is defined, either by the Format field in the immediately preceding header (if the following part is a recognized WebSphere MQ format), or by the values that are set in the MQRFH or MQRFH2 header:

- The format of the first header is known because it must be MQMD.
- The format of any subsequent header in the message is set in the Format field in the preceding header.
- The format of the body corresponds to the message domain and the parser that must be invoked for the message body (for example, XMLNSC). This information is set either in the MQRFH or MQRFH2 header, or in the *Message Domain* property of the input node that receives the message.

This process is repeated as many times as required by the number of headers that precede the message body. You do not need to populate these fields yourself; the broker handles this sequence for you.

The broker completes this process to ensure that Format fields in headers correctly identify each part of the message. If the broker does not complete this process, WebSphere MQ might be unable to deliver the message. The message body parser is not a recognized WebSphere MQ header format, therefore the broker replaces this value in the last header's Format field with the value MQFMT_NONE. The original value in that field is stored in the Domain field within the MQRFH or MQRFH2 header to retain the information about the contents of the message body.

For example, if the MQRFH2 header immediately precedes the message body, and its Format field is set to XMLNSC, which indicates that the message body must be parsed by the XMLNSC parser, the MQRFH2 Domain field is set to XMLNSC, and its Format field is reset to MQFMT_NONE.

These actions might result in information that is stored explicitly by an ESQL or Java expression being replaced by the broker.

When all the headers have been parsed, and the corresponding sub-trees have been created within the message tree, the input node associates the specified parser with the message body. Specify the parser that is to be associated with the message body content, either in a header in the message (for example, the <mcd> folder within the MQRFH2 header), or in the input node properties (if the message does not include headers). The input node makes the association as described in the following list:

- If the message has an MQRFH or MQRFH2 header, the domain that is identified in the header (either in Format or the name and value data) determines the parser that is associated with this message.

The SCADAInput node creates WebSphere MQ format messages with MQRFH2 headers from the input messages that the listener receives on the TCP/IP port.

- If the message does not have an MQRFH or MQRFH2 header, or if the header does not identify the domain, the *Message Domain* property of the input node indicates the domain of the message, and the parser that is to be used. You can specify a user-defined domain and parser.
- If the message domain cannot be identified by header values or by the *Message Domain* property of the input node, the message is handled as a binary object (BLOB). The BLOB parser is associated with the message. A BLOB can be interpreted as a string of hexadecimal characters, and can be modified or examined in the message flow by specifying the location of the subset of the string.

By default, the message body is not parsed straight away, for performance reasons. The message body might not need to be parsed during the message flow. It is parsed only when a reference is made to its contents.

For example, the message body is parsed when you refer to a field in the message body, for example: `Root.XMLNSC.MyDoc.MyField`. Depending on the paths that are taken in the message flow, this parse can take place at different points. This "parse when first needed" approach is also referred to as 'partial parsing' or 'on demand parsing', and in typical processing does not affect the logic of a message flow. However, there are some implications for error handling scenarios; see "Handling errors in message flows" on page 203.

If you want a message flow to accept messages from more than one message domain, include an MQRFH2 header in your message from which the input nodes extract the message domain and related message definition information (message set, message type, and message format).

If you set up the message headers or the input node properties to identify a user-defined domain and parser, the way in which it interprets the message and constructs the logical tree might differ from that described here.

WebSphere MQ Multicast Transport, WebSphere MQ Real-time Transport, WebSphere Broker File Transport, WebSphere Broker Adapters Transport, WebSphere MQ Web Services Transport, and WebSphere Broker JMS Transport protocols

If your application communicates with the broker across these supported protocols, and your message flow includes the corresponding input nodes, messages that are received do not have to include a particular header. If recognized headers are included, the input node invokes the appropriate parsers to interpret the headers and to build the relevant parts of the message tree, as described for the other supported protocols.

If there are no headers, or these headers do not specify the parser for the message body, set the input node properties to define the message body parser. If you do not set the node properties in this way, the message is treated as a BLOB. You can specify a user-defined parser.

The specified parser is associated with the message body by the input node (in the same way as it is for the WebSphere MQ Enterprise Transport and WebSphere MQ Telemetry Transport protocols), and by default the message body is not parsed immediately.

If you set up the message headers or the input node properties to identify a user-defined domain and parser, the way in which it interprets the message and constructs the logical tree might differ from that described here.

All other protocols

If you want your message flow to accept messages from a transport protocol for which WebSphere Message Broker does not provide built-in support, or you want it to provide some specific processing on receipt of a message, use either the Java or the C language programming interface to create a new user-defined input node.

This interface does not automatically generate a Properties subtree for a message (this subtree is discussed in "Message tree structure" on page 61). A message does not need to have a Properties subtree, but you might find it useful to create one to provide a consistent message tree structure,

regardless of input node. If you are using a user-defined input node, you must create a Properties subtree within the message tree yourself.

To process messages that do not conform to any of the defined message domains, use the C language programming interface to create a new user-defined parser.

Refer to the node interface to understand how it uses parsers, and whether you can configure it to modify its behavior. If the node uses a user-defined parser, the tree structure that is created for the message might differ slightly from that created for built-in parsers. A user-defined input node can parse an input message completely, or it can participate in partial parsing in which the message body is parsed only when it is required.

You can also create your own output and message processing nodes in C or Java.

Properties versus MQMD folder behavior for various transports

Differences exist in the way the Properties folder and the MQMD folder are treated with respect to which folder takes precedence for the same fields. This treatment is characterized by the transport type (for example, HTTP or WebSphere MQ) that you use.

When the message flow is sourced by an MQInput node then you have an MQMD to parse. In this case the Properties folder is sourced by the MQMD values and so the MQMD folder takes precedence over the Properties folder in terms of value propagation between the folders. This scenario means that you can perform ESQL, for example, `SET OutputRoot.MQMD.CorrelId` and this command updates the Properties folder value.

When the message flow is sourced from a input node that is not the MQInput node (such as the HTTPInput node or a user-defined input node), then no MQMD is parsed. This scenario means the Properties folder is not sourced from an input MQMD, it is created and populated with transport values that come from other transport specific headers. When you create an MQMD folder in a message flow that was not sourced from the WebSphere MQ transport, the MQMD header does not take precedence over the Properties folder because the WebSphere MQ transport did not populate the Properties folder. Therefore, in this case, the Properties folder overwrites any values in MQMD.

The Properties folder is constructed and represents a message received on the transport. In this scenario two entirely different transports are being used which have different meanings and, therefore, different requirements of the Properties folder. When sourced from an HTTPInput node, the HTTP headers have control over the Properties folder for like fields. When sourced from an MQInput node the MQMD has control over the Properties folder for like fields.

Therefore, it follows that when you add an MQMD folder to a tree that was created by the HTTP Transport then this MQMD folder does not have control over the Properties folder, and the value propagation direction is not MQMD to Properties, it is Properties to MQMD. The correct approach here is for you to set the Properties folders replyIdentifier field and to use this to populate the MQMD:

```
SET OutputRoot.Properties.ReplyIdentifier = X' ..... ';
```

The behavior is not unique to just the CorrelId to ReplyIdentifier fields. It applies for all like fields between the MQMD and Properties folder:

- If the exception is returned to the input node and the catch terminal is connected, the Message and LocalEnvironment trees that were created originally by the input node, and propagated through the out terminal, are restored, and any updates that you made to their content in the nodes that followed the input node are lost. The Environment tree is not restored, and its contents are preserved. If the nodes following the input node include a Compute node that creates a new LocalEnvironment or Message tree, those trees are lost. The ExceptionList tree reflects the one or more exceptions that have been recorded.
- If the exception is caught within the message flow by a TryCatch node, the Message and LocalEnvironment trees that were previously propagated through the try terminal of the TryCatch node are restored and propagated through the catch terminal. Any updates that you made to their content in the nodes that followed the TryCatch node are lost. The Environment tree is not restored, and its contents are preserved. If the nodes following the TryCatch node include a Compute node that creates a new LocalEnvironment or Message tree, those trees are lost. The ExceptionList tree reflects the one or more exceptions that have been recorded.

Exception handling paths in a message flow: Exception handling paths start at a failure terminal (most message processing nodes have these), the catch terminal of an input node, a TryCatch node, or an AggregateReply node, but are no different in principle from a normal message flow path. Such a flow consists of a sequence of nodes connected together by the designer of the message flow. The exception handling paths differ in the kind of processing that they do to record or react to the exception. For example, they might examine the exception list to determine the nature of the error, and take appropriate action or log data from the message or exception.

The LocalEnvironment and message tree that are propagated to the exception handling message flow path are those at the start of the exception path, not those at the point when the exception is thrown. The figure below illustrates this point:

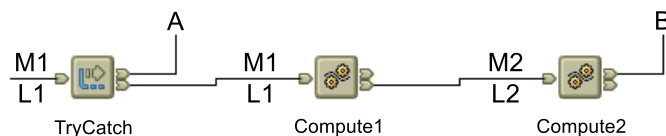

- A message (M1) and LocalEnvironment (L1) are being processed by a message flow. They are passed through the TryCatch node to Compute1.
- Compute1 updates the message and LocalEnvironment and propagates a new message (M2) and LocalEnvironment (L2) to the next node, Compute2.
- An exception is thrown in Compute2. If the failure terminal of Compute2 is not connected (point **B**), the exception is propagated back to the TryCatch node, but the message and LocalEnvironment are not. The exception handling path starting at point **A** has access to the first message and LocalEnvironment, M1 and L1. The Environment tree is also available and retains the content it had when the exception occurred.
- If the failure terminal of Compute2 is connected (point **B**), the message and LocalEnvironment M2 and L2 are propagated to the node connected to that failure terminal. The Environment tree is also available and retains the content it had when the exception occurred.

Logical tree structure

The logical tree structure is the internal (broker) representation of a message. It is also known as the message assembly.

When a message arrives at a broker, it is received by an input node that you have configured in a message flow. Before the message can be processed by the message flow, the message must be interpreted by one or more parsers that create a logical tree representation from the bit stream of the message data.

The tree format contains identical content to the bit stream from which it is created, but it is easier to manipulate within the message flow. Many of the built-in message flow nodes provide an interface for you to query and update message content within the tree, and perform other actions against messages and databases to help you to provide the required function in each node.

Several interfaces are provided:

- ESQL, a programming language that you can code in the Compute, Database, and Filter nodes.
- Java, a programming language that you can code in the JavaCompute node.
- Mappings, a graphical method of achieving transformation from input to output structures, available in the DataDelete, DataInsert, DataUpdate, Extract, Mapping, and Warehouse nodes.
- XSL, a language for transforming XML that you can use in the XSLT node.

The tree structure that is created by the parsers is largely independent of any message format (for example, XML). The exception to this is the subtree that is created as part of the message tree to represent the message body. This subtree is message dependent, and its content is not further described here.

The input node creates this message assembly, which consists of four trees:

- “Message tree structure” on page 61
- “Environment tree structure” on page 63
- “Local environment tree structure” on page 64
- “Exception list tree structure” on page 67

The first of these trees is populated with the contents of the input message bit stream, as described in “How the message tree is populated” on page 54; the remaining three trees are initially empty.

Each of the four trees created has a root element (with a name that is specific to each tree). Each tree is made up of a number of discrete pieces of information called *elements*. The root element has no *parent* and no *siblings* (siblings are elements that share a single parent). The root is parent to a number of *child* elements. Each child must have a parent, can have zero or more siblings, and can have zero or more children.

The four trees are created for both built-in and user-defined input nodes and parsers.

The input node passes the message assembly that it has created to subsequent message processing nodes in the message flow:

- All message processing nodes can read the four trees.

- You can code ESQL in the Database and Filter nodes, or use mappings in the nodes that support that interface to modify the Environment and LocalEnvironment trees only.
- The Compute node differs from other nodes in that it has both an input message assembly and at least one output message assembly. Configure the Compute node to determine which trees are included in the output message assembly; the Environment tree is an exception in that it is always retained from input message assembly to output message assembly.

To determine which of the other trees are included, you must specify a value for the *Compute mode* property of the node (displayed on the Advanced tab). The default action is for only the message to be created. You can specify any combination of message, LocalEnvironment, and ExceptionList trees to be created in the output message assembly.

If you want the output message assembly to contain a complete copy of the input message tree, you can code a single ESQL SET statement to make the copy. If you want the output message to contain a subset of the input message tree, code ESQL to copy those parts that you want. In both cases, your choice of *Compute mode* must include Message.

If you want the output message assembly to contain all or part of the input LocalEnvironment or ExceptionList tree contents, code the appropriate ESQL to copy information you want to retain in that tree. Your choice of *Compute mode* must include LocalEnvironment, or Exception, or both.

You can also code ESQL to populate the output message, Environment, LocalEnvironment, or ExceptionList tree with information that is not copied from the input tree. For example, you can retrieve data from a database, or calculate content from the input message data.

- A similar capability exists in the JavaCompute node. See “Writing Java” on page 454 for more information.

Message tree structure:

The message tree is a part of the logical message tree in which the broker stores its internal representation of the message body.

The root of a message tree is called Root. The message tree is always present, and is passed from node to node within a single instance of a message flow.

The message tree includes all the headers that are present in the message, in addition to the message body. The tree also includes the Properties subtree (described in “Parsers” on page 74), if that is created by the parser. If a supplied parser has created the message tree, the element that represents the Properties subtree is followed by zero or more headers.

If the message has been received across the WebSphere MQ Enterprise Transport, WebSphere MQ Mobile Transport, or WebSphere MQ Telemetry Transport, the first header (the second element) must be the MQMD. Any additional headers that are included in the message appear in the tree in the same order as in the message. The last element beneath the root of the message tree is always the message body.

If a user-defined parser has created the message tree, the Properties tree, if present, is followed by the message body.

The message tree structure is shown below. If the input message is not a WebSphere MQ message, the headers that are shown might not be present. If the parser that created this tree is a user-defined parser, the Properties tree might not

be present.

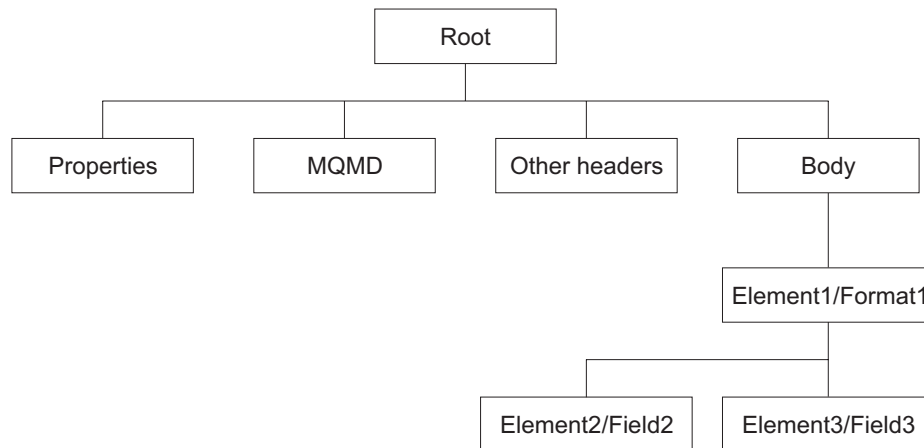

The Body tree is a structure of child elements (described below) that represents the message content (data), and reflects the logical structure of that content. The Body tree is created by a body parser (either a supplied parser or a user-defined parser), as described in “Parsers” on page 74.

Each element within the parsed tree is one of three types:

Name element

A name element has a string associated with it, which is the name of the element. An example of a name element is `XMLElement`, as described in “XML element” on page 1438. A name element also has a second string associated with it, which is the namespace of the element; this string might be empty.

Value element

A value element has a value associated with it. An example of a value element is `XMLContent`, as described in “XML content” on page 1438.

Name-value element

A name-value element is an optimization of the case where a name element contains only a value element and nothing else. The element contains both a name and a value. An example of a name-value element is `XMLAttribute`, as described in “XML attribute” on page 1436.

For information about how the message tree is populated, see “How the message tree is populated” on page 54.

Properties folder: The Properties folder is the first element of the message tree and holds information about the characteristics of the message.

The root of the Properties folder is called Properties. It is the first element under Root. All message trees that are generated by the built-in parsers include a Properties folder for the message. If you create your own user-defined parser, you can choose whether the parser creates a Properties folder. However, for consistency, you should include this action in the user-defined parser.

The Properties folder contains a set of standard properties that you can manipulate in the message flow nodes in the same way as any other property. Some of these fields map to fields in the supported WebSphere MQ headers, if present, and are passed to the appropriate parser when a message is delivered from one node to another.

For example, the MQRFH2 header contains information about the message set, message type, and message format. These values are stored in the Properties folder as MessageSet, MessageType, and MessageFormat. To access these values using ESQL or Java within the message processing nodes, refer to these values in the Properties folder; do not refer directly to the fields in the headers from which they are derived.

The Properties parser ensures that the values in the header fields match the values in the Properties folder on input to, and output from, every node. For any field, if only one header is changed (the Properties header or a specific message header), that value is used. If both the Properties header and the specific message header are changed, the value from the Properties folder is used.

When the message flow processing is complete, the Properties folder is discarded.

Environment tree structure:

The environment tree is a part of the logical message tree in which you can store information while the message passes through the message flow.

The root of the environment tree is called Environment. This tree is always present in the input message; an empty environment tree is created when a message is received and parsed by the input node. You can use this tree as you choose, and create both its content and structure.

WebSphere Message Broker refers to (but never creates) a field in this tree in only one situation. If you have requested data collection for message flow accounting and statistics, and have indicated that accounting origin basic support is required, the broker checks for the existence of the field Environment.Broker.AccountingOrigin. If the field exists, the broker uses its value to set the accounting origin for the current data record. For further information about the use of this field, see “Setting message flow accounting and statistics accounting origin” on page 566. (Contrast this with the “Local environment tree structure” on page 64, which the broker uses in several situations.)

The environment tree differs from the local environment tree in that a single instance of it is maintained throughout the message flow. If you include a Compute node, a Mapping node, or a JavaCompute node in your message flow, you do not have to specify whether you want the environment tree to be included in the output message. The environment tree is included automatically, and the entire contents of the input environment tree are retained in the output environment tree, subject to any modifications that you make in the node. Any changes that you make are available to subsequent nodes in the message flow, and to previous nodes if the message flows back (for example, to a FlowOrder or TryCatch node).

If you want to create your own information, create it in the environment tree within a subtree called Variables.

The following figure shown an example of an environment tree:

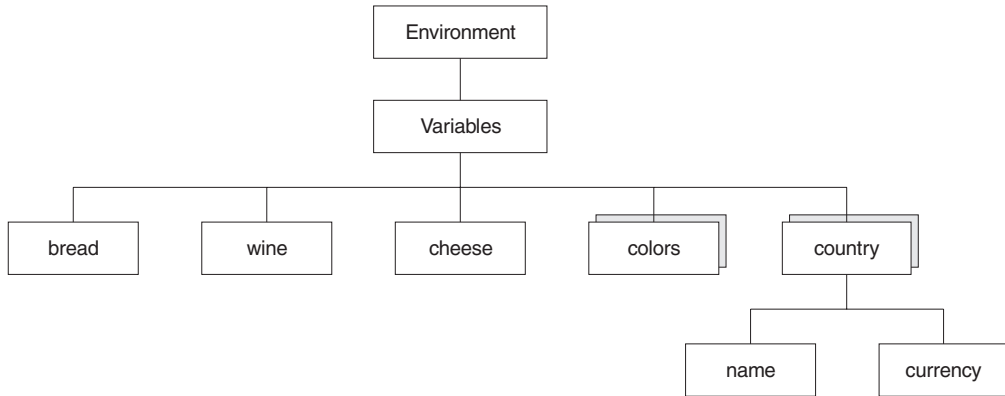

You could use the following ESQL statements to create the content shown above.

```

SET Environment.Variables =
    ROW('granary' AS bread, 'riesling' AS wine, 'stilton' AS cheese);
SET Environment.Variables.Colors[] =
    LIST{'yellow', 'green', 'blue', 'red', 'black'};
SET Environment.Variables.Country[] = LIST{ROW('UK' AS name, 'pound' AS currency),
    ROW('USA' AS name, 'dollar' AS currency)};
  
```

When the message flow processing is complete, the Environment tree is discarded.

Local environment tree structure:

The local environment tree is a part of the logical message tree in which you can store information while the message flow processes the message.

The root of the local environment tree is called LocalEnvironment. This tree is always present in the input message: an empty local environment tree is created when a message is received by the input node.

Use the local environment tree to store variables that can be referred to and updated by message processing nodes that occur later in the message flow. You can also use the local environment tree to define destinations (that are internal and external to the message flow) to which a message is sent. WebSphere Message Broker also stores information in LocalEnvironment in some circumstances, and references it to access values that you might have set for destinations. (Contrast this to the Environment tree structure, which the broker refers to in one situation only, see “Environment tree structure” on page 63.)

The following figure shows an example of the local environment tree structure. The children of Destination are protocol-dependent.

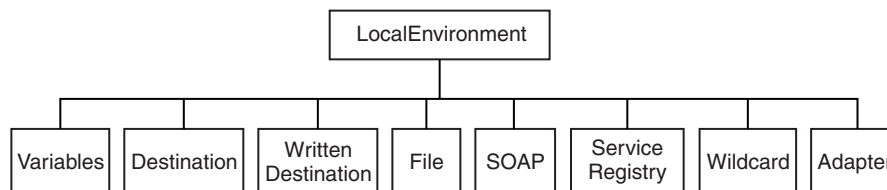

In the tree structure shown, LocalEnvironment has several children:

Variables

This subtree is optional. If you create local environment variables, store

them in a subtree called Variables. It provides a work area that you can use to pass information between nodes. This subtree is never inspected or modified by any supplied node.

Variables in the local environment can be changed by any subsequent message processing node, and persist until the message flow goes out of scope and the node that created it has completed its work and returns control to the previous node

The variables in this subtree are persistent only within a single instance of a message flow. If you have multiple instances of a message passing through the message flow, and need to pass information between them, you must use an external database.

Destination

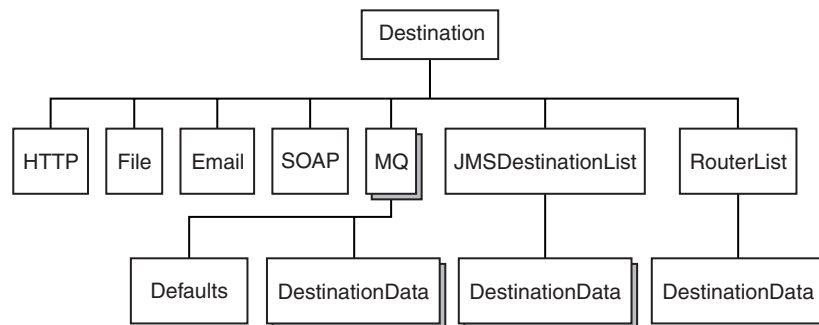

This subtree consists of a number of children that indicate the transport types to which the message is directed (the Transport identifiers), or the target Label nodes that are used by a RouteToLabel node.

- Transport information

Transport information is used by some input and output nodes, including HTTP, MQ, JMS, SOAP, File, and e-mail.

HTTP

If the message flow starts with an HTTPInput node, a single name element HTTP is added to Destination. The element HTTP.RequestIdentifier is created and initialized so that it can be used by an HTTPReply node. You can also create other fields in the HTTP structure for use by the HTTPRequest node; for example, the URL of the service to which the request is sent. The topic for each node contains more information about the contents of Destination for the WebSphere MQ Web Services Transport protocol.

MQ

If the message flow includes an MQOutput node, each element is a name element, MQ (A deprecated alternative exists, called *MQDestinationList*. Use MQ for all new message flows). If more than one element exists, each is processed sequentially by the node. See the example in “Populating Destination in the LocalEnvironment tree” on page 311.

If you have included a user-defined output node in the message flow, the contents of Destination (if supported) are defined by that node.

You can configure output nodes to examine the list of destinations and send the message to those destinations, by setting the property Destination Mode to Destination List. If you do so, you must create this

subtree and its contents to define those destinations, giving it the name Destination. If you do not do so, the output node cannot deliver the messages.

If you prefer, you can configure the output node to send messages to a single fixed destination, by setting the property Destination Mode to Queue Name or Reply To Queue. If you select either of these fixed options, the destination list has no effect on broker operations and you do not have to create this subtree.

You can construct the MQ element to contain a single optional Defaults element. The Defaults element, if created, must be the first child and must contain a set of name-value elements that give default values for the message destination and its PUT options for that parent.

You can also create a number of elements called DestinationData within MQ. Each of these can be set up with a set of name-value elements that defines a message destination and its PUT options.

The set of elements that define a destination is described in “Data types for elements in the DestinationData subtree” on page 1401.

The content of each instance of DestinationData is the same as the content of Defaults for each protocol, and can be used to override the default values in Defaults. You can set up Defaults to contain values that are common to all destinations, and set only the unique values in each DestinationData subtree. If you do not set a value either in DestinationData or Defaults, the value that you have set for the corresponding node property is used. Similarly, if you specify a field name or value with the wrong spelling or case, it is ignored, and the value that you have set for the corresponding node property is used.

The information that you insert into DestinationData depends on the characteristic of the corresponding node property: this information is described in “Accessing the LocalEnvironment tree” on page 308.

- Routing information

The child of Destination is *RouterList*. It has a single child element called *DestinationData*, which has a single entry called *labelName*. If you are using a dynamic routing scenario involving the *RouteToLabel* and *Label* nodes, you must set up the Destination subtree with a *RouterList* that contains the reference labels.

WrittenDestination

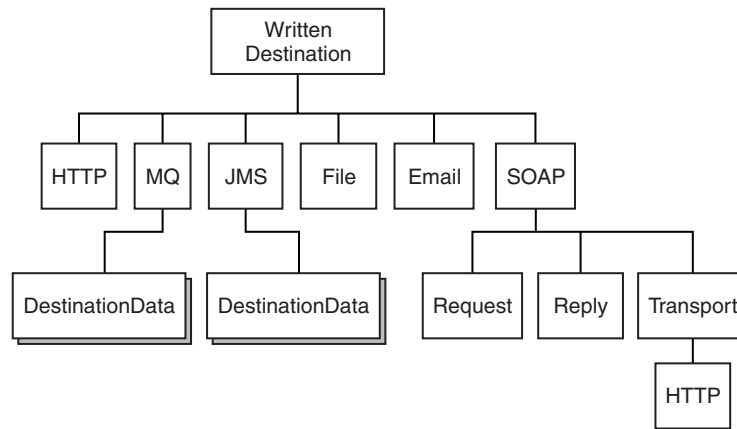

This subtree contains the addresses to which the message has been written. Its name is fixed and it is created by the message flow when a message is propagated through the Out terminal of a request, output, or reply node.

The subtree includes transport-specific information (for example, if the output message has been put to a WebSphere MQ queue, it includes the queue manager and queue names).

You can use one of the following methods to obtain information about the details of a message after it has been sent by the nodes:

- Connect a Compute node to the Out terminal.
- Configure a user exit to process an output message callback event, as described in “Exploiting user exits” on page 198.

The topic for each node that supports WrittenDestination information contains details about the data that it contains.

File This subtree contains information that is stored by the FileInput node.

This information describes the file, and also contains data about the current record.

More details about the information that is stored in this subtree are in “Using LocalEnvironment variables with file nodes” on page 721.

SOAP This subtree contains information that is stored by SOAPInput, SOAPAsyncResponse, or SOAPRequest nodes.

More details about the information that is stored in this subtree are in “WS-Addressing information in the LocalEnvironment” on page 642.

Service Registry

This subtree contains information for queries by the EndpointLookup and RegistryLookup nodes.

More details about the information that is stored in this subtree are in “Dynamically defining the search criteria” on page 677, “EndpointLookup node output” on page 678, and “RegistryLookup node output” on page 680.

Wildcard

This subtree contains information about the wildcard characters that are stored by the FileInput node.

On the FileInput node you can specify a file name pattern that contains wildcard characters.

More details about the information that is stored in this subtree are in “Using LocalEnvironment variables with file nodes” on page 721.

When the message flow processing is complete, the local environment tree is discarded.

The following samples demonstrate how to use LocalEnvironment to dynamically route messages based on the destination list:

- Airline Reservations sample
- Message Routing sample

The following sample uses the local environment tree to store information that is later added to the output message that is created by the message flow:

- User-defined Extension sample

You can view samples only when you use the information center that is integrated with the Message Broker Toolkit.

Exception list tree structure:

The exception list tree is a part of the logical message tree in which the message flow writes information about exceptions that occur when a message is processed.

The root of the exception list tree is called `ExceptionList`, and the tree consists of a set of zero or more exception descriptions. The exception list tree is populated by the message flow if an exception occurs. If no exception conditions occur during message flow processing, the exception list that is associated with that message consists of a root element only. This list is, in effect, an empty list of exceptions.

The exception list tree can be accessed by other nodes within the message flow that receive the message after the exception has occurred. You can modify the contents of the exception list tree only in a node that provides an interface to modify the outbound message tree; for example, the `Compute` node.

If an exception condition occurs, message processing is suspended and an exception is thrown. Control is passed back to a higher level; that is, an enclosing catch block. An exception list is built to describe the failure condition, and the whole message, together with the local environment tree, and the newly-populated exception list, is propagated through an exception-handling message flow path.

The child of `ExceptionList` is always `RecoverableException`. Typically, only one child of the root is created, although more than one might be generated in some circumstances. The child of `ExceptionList` contains a number of children, the last of which provides further information specific to the type of exception. The following list includes some of the exception types that you might see:

- `FatalException`
- `RecoverableException`
- `ConfigurationException`
- `SecurityException`
- `ParserException`
- `ConversionException`
- `DatabaseException`
- `UserException`
- `CastException`
- `MessageException`
- `SQLException`
- `SocketException`
- `SocketTimeoutException`
- `UnknownException`

The following figure shows the structure of the exception list tree for a recoverable exception:

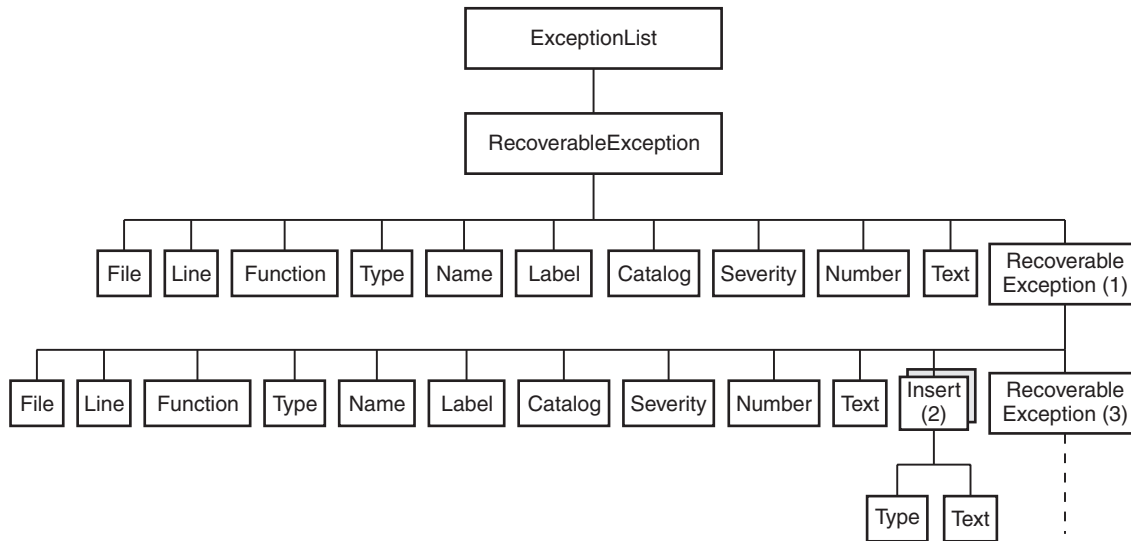

The exception description structure can be both repeated and nested to produce an exception list tree. In this tree:

- The depth (that is, the number of parent-child steps from the root) represents increasingly detailed information for the same exception.
- The width of the tree represents the number of separate exception conditions that occurred before processing was abandoned. This number is usually one, and results in an exception list tree that consists of a number of exception descriptions that are connected as children of each other.
- At the numbered points in the tree:
 1. This child can be one of RecoverableException, ParserException, DatabaseException, UserException, ConversionException, or MessageException. All of these elements have the children shown; if present, the last child is the same element as its parent.
 2. This element might be repeated.
 3. If present, this child contains the same children as its parent.

The children in the tree take the form of a number of name-value elements that give details of the exception, and zero or more name elements whose name is Insert. The NLS (National Language Support) message number identified in a name-value element identifies a WebSphere Message Broker error message. The Insert values are used to replace the variables within this message and provide further detail about the cause of the exception.

The name-value elements within the exception list shown in the figure above are described in the following table.

Name	Type	Description
File ¹	String	C++ source file name
Line ¹	Integer	C++ source file line number
Function ¹	String	C++ source function name
Type ²	String	Source object type
Name ²	String	Source object name
Label ²	String	Source object label

Name		Type	Description
Text ¹		String	Additional text
Catalog ³		String	NLS message catalog name ⁴
Severity ³		Integer	1 = information 2 = warning 3 = error
Number ³		Integer	NLS message number ⁴
Insert ³	Type	Integer	The data type of the value: 0 = Unknown 1 = Boolean 2 = Integer 3 = Float 4 = Decimal 5 = Character 6 = Time 7 = GMT Time 8 = Date 9 = Timestamp 10 = GMT Timestamp 11 = Interval 12 = BLOB 13 = Bit Array 14 = Pointer
	Text	String	The data value

Notes:

1. Do not use the File, Line, Function, and Text elements for exception handling decision making. These elements ensure that information can be written to a log for use by IBM Service personnel, and are subject to change in both content and order.
2. The Type, Name, and Label elements define the object (usually a message flow node) that was processing the message when the exception condition occurred.
3. The Catalog, Severity, and Number elements define an NLS message: the Insert elements that contain the two name-value elements shown define the inserts into that NLS message.
4. NLS message catalog name and NLS message number refer to a translatable message catalog and message number.

When the message flow processing is complete, the exception list tree is discarded.

The following sample uses the exception list in the XML_Reservation message flow to pass error information to the Throw node, which generates an error message that includes the information from ExceptionList:

- Airline Reservations sample

You can view samples only when you use the information center that is integrated with the Message Broker Toolkit.

Correlation names

A correlation name is a field reference that identifies a well-defined starting point in the logical message tree and is used in field references to describe a standard part of the tree format.

When you access data in any of the four trees (message, environment, local environment, or exception list), the correlation names that you can use depend on the node for which you create ESQL or mappings, and whether the node creates an output message. For example, a Trace node does not alter the content of the message as it passes through the node, but a Compute node can construct a new output message.

You can introduce new correlation names with SELECT expressions, quantified predicates, and FOR statements. You can create non-correlation names in a node by using reference variables.

Correlation names in nodes that do not create an output message: Most message flow nodes do not create an output message; all ESQL expressions that you write in ESQL modules or in mappings within these nodes refer to just the input message. Use the following correlation names in the ESQL modules that you write for Database and Filter nodes:

Root The root of the message passing through the node.

Body The last child of the root of the message; that is, the body of the message. This name is an alias for `Root.*[<]`.

For a description of how to use the asterisk (*) in field references, see “Using anonymous field references” on page 290.

Properties

The standard properties of the input message.

Environment

The structure that contains the current global environment variables that are available to the node. Environment can be read and updated from any node for which you can create ESQL code or mappings.

LocalEnvironment

The structure that contains the current local environment variables that are available to the node. LocalEnvironment can be read and updated from any node for which you can create ESQL code or mappings.

DestinationList

The structure that contains the current local environment variables available to the node. Its preferred name is LocalEnvironment, although the DestinationList correlation name can be used for compatibility with earlier versions.

ExceptionList

The structure that contains the current exception list to which the node has access.

You cannot use these correlation names in the expression of any mapping for a Mapping, Extract, Warehouse, DataInsert, DataUpdate, or DataDelete node.

Correlation names in nodes that create an output message: If you are coding ESQL for a Compute node, the correlation names must distinguish between the two message trees involved: the input message and the output message. The correlation names in ESQL within these nodes are:

InputBody

The last child of the root of the input message. This name is an alias for `InputRoot.*[<]`.

For a description of how to use `*`, see “Using anonymous field references” on page 290.

InputRoot

The root of the input message.

InputProperties

The standard properties of the input message.

Environment

The structure that contains the current global environment variables that are available to the node. Environment can be read and updated.

InputLocalEnvironment

The structure that contains the local environment variables for the message passing through the node.

InputDestinationList

The structure that contains the local environment variables for the message passing through the node. Use the correlation name `InputDestinationList` for compatibility with earlier versions; if compatibility is not required, use the preferred name `InputLocalEnvironment`

InputExceptionList

The structure that contains the exception list for the message passing through the node.

OutputRoot

The root of the output message.

In a Compute node, the correlation name `OutputBody` is not valid.

OutputLocalEnvironment

The structure that contains the local environment variables that are sent out from the node.

While this correlation name is always valid, it has meaning only when the Compute Mode property of the Compute node indicates that the Compute node is propagating the LocalEnvironment.

OutputDestinationList

The structure that contains the local environment variables that are sent out from the node. Use the correlation name `OutputDestinationList` for compatibility with earlier versions; if compatibility is not required, use the preferred name `OutputLocalEnvironment`

OutputExceptionList

The structure that contains the exception list that the node is generating.

While this correlation name is always valid, it has meaning only when the Compute Mode property of the Compute node indicates that the Compute node is propagating the ExceptionList.

Predefined and self-defining messages

Both predefined and self-defining messages are supported.

Each message that flows through your broker domain has a specific structure that is meaningful to the applications that send or receive that message.

WebSphere Message Broker refers to the structure as the *message template*. Message template information comprises the *message domain*, *message set*, *message type*, and *physical format* of the message. Together these values identify the structure of the data that the message contains.

The message domain identifies the parser that is used to parse and write instances of the message. Message set, message type, and physical format are optional, and are used by model-driven parsers such as the MRM parser.

You can use:

- Messages that you have modeled using the workbench; these are referred to as *predefined messages*. A model-driven parser requires predefined messages.
- Messages that can be parsed without a model; these are called *self-defining messages*.

Predefined messages: When you create a message using the workbench, you define the fields (*Elements*) in the message, along with any special field types that you might need, and any specific values (Value Constraints) to which the fields might be restricted.

Every message that you model in the workbench must be a member of a message set. You can group related messages together in a message set: for example, request and response messages for a bank account query can be defined in a single message set.

When you deploy a message set to a broker, the definition of that message set is sent by the Configuration Manager to the broker in a form appropriate to the parser that is used to parse and write the message. The broker can manage multiple message dictionaries simultaneously.

For information about the benefits of predefining messages, see [Why model messages?](#)

The Video Rental sample and the Comma Separated Value (CSV) sample demonstrate how to model messages in XML, CWF, and TDS formats. The EDIFACT sample, FIX sample, SWIFT sample, and X12 sample provide message sets for industry-standard message formats, which might be useful if you use any of those formats. You can view samples only when you use the information center that is integrated with the Message Broker Toolkit.

Self-defining messages: You can create and route messages that are self-defining. The best example of a self-defining message is an XML document.

Self-defining messages can also be modeled using the workbench. However, you do not have to deploy these message sets to the brokers that support those message flows. See [Why model messages?](#)

The Large Messaging sample, the Airline Reservations sample, and several other samples in the Samples Gallery use self-defining XML messages for the sake of simplicity; they don't require a message set. The Coordinated Request Reply sample demonstrates how you can transform a message from self-defining XML to a predefined binary format, and the Data Warehouse sample demonstrates how you can extract information from an XML message and transform it into BLOB format to store it in a database. You can view samples only when you use the information center that is integrated with the Message Broker Toolkit.

Parsers

A parser is a program that interprets the bit stream of an incoming message, and creates an internal representation of the message in a tree structure. The parser also regenerates a bit stream for an outgoing message from the internal message tree representation.

A parser is invoked when the bit stream that represents an input message is converted to the internal form that can be handled by the broker; this invocation of the parser is known as *parsing*. The internal form, a logical tree structure, is described in “Logical tree structure” on page 60. The way in which the parser interprets the bit stream is unique to that parser; therefore, the logical message tree that is created from the bit stream varies from parser to parser.

Similarly, a parser is invoked when a logical tree that represents an output message is converted into a bit stream; this invocation of the parser is known as *writing*.

The broker requires access to a parser for every message domain to which your input messages and output messages belong. In addition, the broker requires a parser for every identifiable message header that is included in the input or output message. Parsers are invoked when required by the message flow.

Body parsers

WebSphere Message Broker provides built-in support for messages in the following message domains by providing the message body parsers that are listed below:

- MRM (“MRM parser and domain” on page 98)
- XMLNSC, XMLNS, and XML (“XML parsers and domains” on page 81)
- SOAP (“SOAP parser and domain” on page 78)
- DataObject (“DataObject parser and domain” on page 100)
- JMSMap and JMSStream (“JMS parsers and domains” on page 101)
- MIME (“MIME parser and domain” on page 101)
- BLOB (“BLOB parser and domain” on page 106)
- IDOC (“IDOC parser and domain” on page 107)

See “Which body parser should you use?” on page 76 for a discussion about which message body parser to use under what circumstances.

You specify which message domain to use for your message at the place in the message flow where parsing or writing is initiated.

- To parse a message bit stream, typically you set the *Message Domain* property of the input node that receives the message. But, if you are initiating the parse operation in ESQL, use the DOMAIN clause of the CREATE statement.

The message tree that is created is described in “Message tree structure” on page 61.

The last child element of the Root element of the message tree takes the name of the body parser that created the tree. For example, if the *Message Domain* property was set to MRM, the last child element of Root is called MRM, which indicates that the message tree is owned by the MRM parser.

- To write a message, the broker calls the owning body parser to create the message bit stream from the message tree.

Some body parsers are *model-driven*, which means that they use predefined messages from a message set when parsing and writing. The MRM, SOAP, DataObject, IDOC, and (optionally) XMLNSC parsers are model-driven parsers. To use these parsers, messages must be modeled in a message set and deployed to the broker from the Message Broker Toolkit.

Other body parsers are *programmatic*, which means that the messages that they parse and write are *self-defining* messages, and no message set is required. See “Predefined and self-defining messages” on page 72.

When you use a model-driven parser, you must also specify the *Message Set* and, optionally, the *Message Type* and *Message Format* so that the parser can locate the deployed message definition with which to guide the parsing or writing of the message.

To parse a message bit stream, typically you set the *Message Set*, *Message Type*, and *Message Format* properties of the input node that receives the message. Or, if you are initiating the parse operation in ESQL, you use the SETTYPE, and FORMAT clauses of the CREATE statement. This information is copied into the *Properties* folder of the message tree.

To write a message, the broker calls the owning body parser to create the message bit stream from the message tree. If the parser is a model-driven parser, it uses the *MessageSet*, *MessageType*, and *MessageFormat* fields in the Properties folder.

Whether *Message Type* or *Message Format* are needed depends on the message domain.

Even if the body parser is not model-driven, it is good practice to create and use a message set in the Message Broker Toolkit because it simplifies the development of your message flow applications, even though the message set is not deployed in the broker runtime environment. See Why model messages? for information about the advantages of creating a message set.

Header parsers

WebSphere Message Broker also provides parsers for the following message headers, which your applications can include in input or output messages:

- WMQ MQMD (“The MQMD parser” on page 1405)
- WMQ MQMDE (“The MQMDE parser” on page 1406)
- WMQ MQCFH (“The MQCFH parser” on page 1403)
- WMQ MQCIH (“The MQCIH parser” on page 1403)
- WMQ MQDLH (“The MQDLH parser” on page 1404)
- WMQ MQIIH (“The MQIIH parser” on page 1405)
- WMQ MQRFH (“The MQRFH parser” on page 1407)
- WMQ MQRFH2 and MQRFH2C (“The MQRFH2 and MQRFH2C parsers” on page 1407)
- WMQ MQRMH (“The MQRMH parser” on page 1408)
- WMQ MQSAPH (“The MQSAPH parser” on page 1408)
- WMQ MQWIH (“The MQWIH parser” on page 1409)
- WMQ SMQ_BMH (“The SMQ_BMH parser” on page 1409)
- JMS header (Representation of messages across the JMS Transport)

- HTTP headers (HTTP headers)

All header parsers are programmatic and do not use a message set when parsing or writing.

User-defined parsers

To parse or write message body data or headers that the supplied parsers do not handle, you can create user-defined parsers that use the WebSphere Message Broker user-defined parser programming interface.

Tip: No parser is provided for messages, or parts of messages, in the WMQ format MQFMT_IMS_VAR_STRING. Data in this format is often preceded by an MQIIH header (format MQFMT_IMS). WebSphere Message Broker treats such data as a BLOB message. If you change the CodedCharSetId or the encoding of such a message in a message flow, the MQFMT_IMS_VAR_STRING data is not converted, and the message descriptor or preceding header does not correctly describe that part of the message. If you need the data in these messages to be converted, use the MRM domain and create a message set to model the message content, or provide a user-defined parser.

Which body parser should you use?

The characteristics of the messages that your applications exchange indicate which body parser you must use.

WebSphere Message Broker provides a range of message parsers. Each parser processes either message body data for messages in a particular message domain (for example, XML), or particular message headers (for example, the MQMD).

Review the messages that your applications send to the broker, and determine to which message domain the message body data belongs, using the following criteria as a guide.

If your application data uses SOAP-based Web services, including SOAP with Attachments (MIME) or MTOM

Use the SOAP domain. The SOAP domain has built-in support for WS-Addressing and WS-Security standards.

If your application data is in XML format other than SOAP

The domain that you use depends on the nature of the XML documents and the processing that you want to perform. See “Which XML parser should you use?” on page 77

If your application data comes from a C or COBOL application, or consists of fixed-format binary data

Use the MRM domain with a Custom Wire Format (CWF) physical format.

If your application data consists of formatted text, perhaps with field content that is identified by tags, or separated by specific delimiters, or both

Use the MRM domain with a Tagged/Delimited String (TDS) physical format.

If your application data is created using the JMS API

The domain that you use depends on the type of the JMS message. For a full description of JMS message processing, see JMS message as input.

If your application data is from a WebSphere Adapter such as the adapters for SAP, PeopleSoft, or Siebel

Use the DataObject domain.

If your application data is in SAP text IDoc format, such as those exported using the WebSphere MQ Link for R3

Use the MRM domain with a Tagged/Delimited String (TDS) physical format.

If your application data is in MIME format other than SOAP with Attachments (for example, RosettaNet)

Use the MIME domain. If the message is multipart MIME, you might need to parse specific parts of the message with other parsers. For example, you might use the XMLNSC parser to parse the XML content of a RosettaNet message.

If you do not know, or do not need to know, the content of your application data

Use the BLOB domain.

Which XML parser should you use?:

If your messages are general purpose XML documents, you can use one of the dedicated XML domains (XMLNSC or XMLNS) to parse the message, or you can use the MRM domain to parse the message.

Note: Although SOAP XML can be parsed using any namespace-aware XML parser, use the dedicated SOAP domain to parse SOAP XML because the SOAP domain provides full support for SOAP with Attachments, and standards such as WS-Addressing and WS-Security.

Note: The XML domain is deprecated. Do not use it for developing new message flows. The XML domain still works with existing message flows.

Which XML parser you choose depends on the nature of your XML messages, and the transformation logic that you want to use. The differentiating features of each domain are:

- The XMLNSC parser has a new architecture that gives significant performance improvements over the XMLNS and XML parsers.
- The XMLNSC parser can be used with or without an XML Schema that is generated from a message set. Using a message set with the XMLNSC parser allows the parser to operate in validating mode which provides the following capabilities:
 - XML Schema 1.0 compliant validation when parsing and writing.
 - The XML Schema indicates the real data type of a field in the message instead of always treating the field as a character string.
 - Base64 binary data can be automatically decoded.
- The MRM parser must be used with a message dictionary that is generated from a message set. This message dictionary enables the MRM parser to provide the following capabilities: For example:
 - Validation against the dictionary when parsing and writing. Note that validation is not XML Schema 1.0 compliant.
 - The dictionary indicates the real data type of a field in the message instead of always treating the field as a character string.
 - Base64 binary data can be automatically decoded.
- The XMLNS parser is programmatic and does not use a model when parsing. This means that:
 - All data in an XML message is treated as character strings.
 - Validation is not possible when parsing and writing.

- The MRM parser uses information from the XML physical format of a message set to simplify the task of creating transformation logic:
 - Date and time information can be extracted from a data value using a specified format string.
 - When creating output messages, the MRM parser can automatically generate the XML declaration, and other XML constraints.
- The XMLNSC and XMLNS parsers do not use XML physical format information from a message set. Transformation logic must explicitly create all constructs in an output message.
- The MRM parser discards some parts of an XML message when parsing; for example, white space formatting, XML comments, XML processing instructions, and inline DTDs. If you use this parser, you cannot create these constructs when building an output message.
- The XMLNSC parser, by default, discards white space formatting, XML comments, XML processing instructions, and inline DTDs. However, options are provided to preserve all of these constructs, except inline DTDs. You can create them all, except inline DTDs, when constructing an output message.
- The XMLNS parser preserves all parts of an XML document, including white space formatting. You can create all XML constructs when constructing an output message.
- The XMLNSC and MRM parsers build compact message trees that use fewer syntax elements than the XMLNS parser for attributes and simple elements. This makes these parsers more suitable than the XMLNS parser for parsing very large XML messages.
- The XMLNS parser builds a message tree that conforms more closely than the XMLNSC or MRM parsers to the XML Data Model. You might want to use this parser if you are using certain XPath expressions to access the message tree, and the relative position of parent and child nodes is important, or if you are accessing text nodes directly.

Tip: If performance is critical, use the XMLNSC domain.

Tip: If you need to validate the content and values in XML messages, use the XMLNSC domain.

Tip: If you need to preserve formatting in XML messages on output, use the XMLNSC domain with the option to retain mixed content.

Tip: If you require message tree to conform as closely as possible to the XML data model, perhaps because you are using certain XPath expressions to access the message tree, use the XMLNS domain.

Tip: If you are taking non-XML data that has been parsed by the CWF or TDS formats of the MRM domain, and merely transforming the data to the equivalent XML, use the MRM domain. This can be achieved by adding an XML physical format to the message set with default values, and changing the Message Format in the Properties folder of the message tree.

SOAP parser and domain

You can use the SOAP parser to create a common WSDL-based logical tree format for working with Web services, independent of the physical bitstream format.

Use the SOAP parser in conjunction with the SOAP nodes in your message flow.

Messages in the SOAP domain are processed by the SOAP parser. The SOAP parser creates a common logical tree representation for all SOAP-based Web services and validates the message against a WSDL definition. If a runtime message is not allowed by the WSDL, an exception is thrown, otherwise the portType and operation names from the WSDL are saved in the logical tree.

The SOAP domain offers WS-* processing, together with a canonical tree shape that is independent of the wire format (XML or MIME).

The standards supported are:

- WSDL 1.1
- SOAP 1.1 and 1.2
- MIME 1.0
- Message Transmission Optimization Mechanism (MTOM) 1.0

A WSDL 1.1 definition must be deployed to describe the Web service messages that the SOAP domain needs to parse and write at runtime. The SOAP parser is, therefore, always model-driven. The bitstream format for these runtime messages can be SOAP 1.1 or SOAP 1.2, optionally wrapped by MIME as an SwA (SOAP with Attachments) or MTOM message.

When a message set that supports the SOAP domain is added to a broker archive (bar) file, XML Schemas are created automatically from the message definition files in the message set, and any WSDL files in the message set are added to the bar file. The WSDL and XML Schema are deployed to the broker and used by the SOAP parser.

If you want the SOAP domain to parse your SOAP Web service, you must:

1. Create a new message set, or locate an existing message set.
2. Ensure that either the message set has its *Default message domain* project set to SOAP, or the *SOAP* check box (under *Supported message domains*) is selected, to indicate that the message set supports the SOAP domain.
3. Import your WSDL file to create a message definition file. The WSDL is also added to the message set. Message definition files for the SOAP envelope and the SOAP logical tree are also added to the message set automatically.
4. Add the message set to a broker archive (bar) file, which generates the required XML Schema and WSDL in a file with extension .xsdzip, and deploy the bar file to the broker.
5. If you associate your WSDL with a SOAP node in your message flow, the *Message Set* property is automatically set in the node. The *Message domain* property is always pre-selected as SOAP.

Tip: The SOAP parser invokes the XMLNSC parser to parse and validate the XML content of the SOAP Web service. See “XMLNSC parser” on page 85.

SOAP message details:

A SOAP message consists of an <Envelope>, which is the root element in every SOAP message, and this contains two child elements, an optional <Header> and a mandatory <Body>.

If the SOAP message has attachments, the ‘envelope’ is wrapped by MIME, or is encoded as MTOM.

For further information on the structure of a SOAP message, see “The structure of a SOAP message” on page 617.

SOAP tree overview:

This tree format allows you to access the key parts of the SOAP message in a convenient way.

This is a diagrammatic representation of the SOAP domain tree:

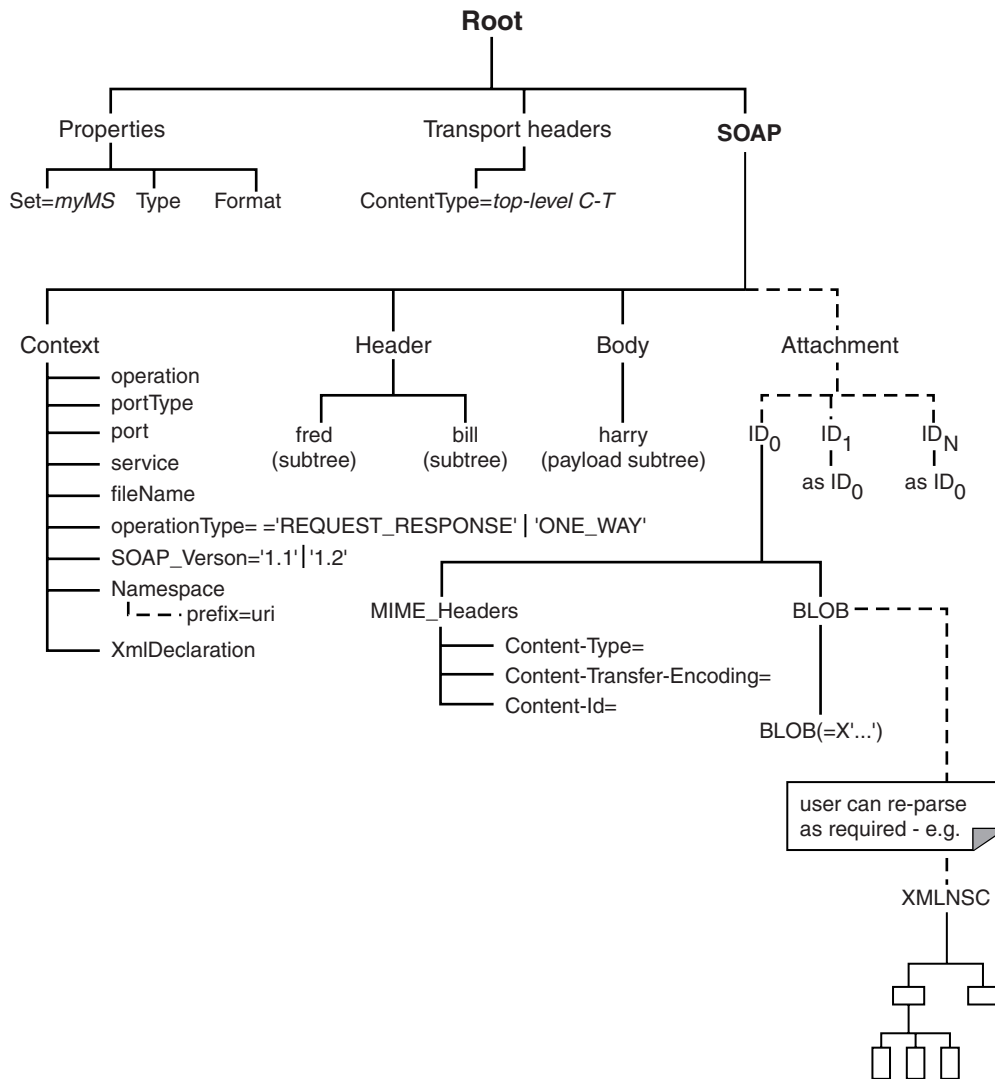

The SOAP tree contains the following elements:

SOAP.Header

Contains the SOAP header blocks (children of Envelope.Header)

SOAP.Body

Contains the SOAP payload (children of Envelope.Body)

The content of the Body subtree depends on the WSDL style.

SOAP.Attachment

Contains attachments for an SwA message in their non encoded format.

Note that attachments for an MTOM message are represented inline as part of the SOAP content in a base 64 representation.

SOAP.Context

Contains the following information, set by the SOAP parser on input:

- * operation - the WSDL operation name
- * portType - the WSDL port type name
- * port - the WSDL port name (if known)
- * service - the WSDL service name (if known)
- * fileName - the original WSDL file name
- * operationType - one of 'REQUEST_RESPONSE', 'ONE_WAY', 'SOLICIT_RESPONSE', 'NOTIFICATION'
- * SOAP_Version - one of '1.1' or '1.2'
- * Namespace - nameValue children of Namespace associate a namespace prefix to a URI
- * XmlDeclaration - represents the standard XML declaration.

Only Namespace, SOAP_Version, and XmlDeclaration influence the bitstream generated for a SOAP tree; the other fields are for information only.

XML parsers and domains

You can use the XML domains that are described in this topic to parse and write messages that conform to the W3C XML standard.

The term *XML domains* refers to a group of three WebSphere Message Broker domains that are used to parse XML documents.

When reading an XML message, the parser that is associated with the domain builds a message tree from the input bit stream. The input bit stream must be a well-formed XML document that conforms to the W3C XML Specification (version 1.0 or 1.1).

When writing a message, the parser creates an XML bit stream from a message tree.

The domains have different characteristics, and guidance about which domain to choose is provided by "Which XML parser should you use?" on page 77.

XMLNSC domain

The XMLNSC domain is the recommended domain for parsing all general purpose XML messages, including those messages that use XML namespaces. See "XMLNSC parser" on page 85.

- The XMLNSC parser has an architecture that results in ultra-high performance when parsing all kinds of XML.
- The XMLNSC parser reduces the amount of memory used by the logical message tree that is created from the parsed message. The default behavior of the parser is to discard non-significant white space and mixed content, comments, processing instructions, and embedded DTDs; however controls are provided to retain mixed content, comments, and processing instructions, if required.
- The XMLNSC parser can operate as a model-driven parser, and can validate XML messages against XML Schemas generated from a message set, to ensure that your XML messages are correct.

XMLNS domain

If the XMLNSC domain does not meet your requirements, use the alternative namespace-aware domain and parser. See “XMLNS parser” on page 94.

XML domain

The XML domain is not namespace-aware. It is deprecated and should not be used to develop new message flows. See “XML parser” on page 98.

The MRM domain also provides XML parsing and writing facilities. For guidance on when you might use MRM XML instead of one of the XML parsers, see “Which XML parser should you use?” on page 77.

By default, the three XML parsers are *programmatic* parsers and do not use a message set at run time when parsing and writing. However, the XMLNSC parser can operate as a model-driven parser and can validate XML messages for correctness against XML Schemas generated from a message set. See “XMLNSC validation” on page 89.

When you use the XMLNS or XML parsers, or the XMLNSC parser without a message set, it is still good practice to create and use a message set in the Message Broker Toolkit; this simplifies the development of your message flow applications, even though the message set is not deployed to the broker run time.

For the advantages of creating a message set, see Why model messages?

The XML parsers are on-demand parsers. For more information, see “Parsing on demand” on page 1363.

The information that is provided with WebSphere Message Broker provides a summary of XML terminology, concepts, and message constructs. These aspects are important when you use XML messages in your message flows.

Tip: For more detailed information about XML see the World Wide Web Consortium (W3C) Web site.

Example XML message parsing: A simple XML message might take the following form:

```
<?xml version="1.0" encoding="UTF-8" standalone="no"?>
<!DOCTYPE Envelope
PUBLIC "http://www.ibm.com/dtds" "example.dtd"
[<!ENTITY Example_ID "ST_TimeoutNodes Timeout Request Input Test Message">]
>
<Envelope version="1.0">
  <Header>
    <Example>&Example_ID;</Example>
    <!-- This is a comment -->
  </Header>
  <Body version="1.0">
    <Element01>Value01</Element01>
    <Element02/>
    <Element03>
      <Repeated>ValueA</Repeated>
      <Repeated>ValueB</Repeated>
    </Element03>
    <Element04><P>This is <B>bold</B> text</P></Element04>
  </Body>
</Envelope>
```

The following sections show the output created by the Trace node when the above message has been parsed in the XMLNS and XMLNSC parsers. They demonstrate the differences in the internal structures that are used to represent the data as it is processed by the broker.

Example XML Message parsed in the XMLNS domain: In the following example, the white space elements within the tree are present because of the space, tab, and line breaks that format the original XML document; for clarity, the actual characters in the trace have been replaced with "WhiteSpace". White space within an XML element does have business meaning, and is represented using the Content syntax element. The XmlDecl, DTD, and comments, are represented in the XML domain using explicit syntax elements with specific field types.

```
(0x01000010):XMLNS      = (
  (0x05000018):XML      = (
    (0x06000011): = '1.0'
    (0x06000012): = 'UTF-8'
    (0x06000014): = 'no'
  )
  (0x06000002):          = 'WhiteSpace'
  (0x05000020):Envelope = (
    (0x06000004): = 'http://www.ibm.com/dtds'
    (0x06000008): = 'example.dtd'
    (0x05000021): = (
      (0x05000011):Example_ID = (
        (0x06000041): = 'ST_TimeoutNodes Timeout Request Input Test Message'
      )
    )
  )
)
(0x06000002):          = 'WhiteSpace'
(0x01000000):Envelope = (
  (0x03000000):version = '1.0'
  (0x02000000):          = 'WhiteSpace'
  (0x01000000):Header  = (
    (0x02000000):          = 'WhiteSpace'
    (0x01000000):Example = (
      (0x06000020): = 'Example_ID'
      (0x02000000): = 'ST_TimeoutNodes Timeout Request Input Test Message'
      (0x06000021): = 'Example_ID'
    )
    (0x02000000):          = 'WhiteSpace'
    (0x06000018):          = ' This is a comment '
    (0x02000000):          = 'WhiteSpace'
  )
  (0x02000000):          = 'WhiteSpace'
  (0x01000000):Body    = (
    (0x03000000):version = '1.0'
    (0x02000000):          = 'WhiteSpace'
    (0x01000000):Element01 = (
      (0x02000000): = 'Value01'
    )
    (0x02000000):          = 'WhiteSpace'
    (0x01000000):Element02 =
    (0x02000000):          = 'WhiteSpace'
    (0x01000000):Element03 = (
      (0x02000000):          = 'WhiteSpace'
      (0x01000000):Repeated = (
        (0x02000000): = 'ValueA'
      )
    )
    (0x02000000):          = 'WhiteSpace'
    (0x01000000):Repeated = (
      (0x02000000): = 'ValueB'
    )
  )
  (0x02000000):          = 'WhiteSpace'
)
(0x02000000):          = 'WhiteSpace'
```

```

(0x01000000):Element04 = (
  (0x01000000):P = (
    (0x02000000): = 'This is '
    (0x01000000):B = (
      (0x02000000): = 'bold'
    )
    (0x02000000): = ' text'
  )
)
(0x02000000):          = 'WhiteSpace'
)
(0x02000000):          = 'WhiteSpace'
)

```

Example XML Message parsed in the XMLNSC domain: The following trace shows the elements that are created to represent the same XML structure within the compact XMLNSC parser in its default mode. In this mode, the compact parser does not retain comments, processing instructions, or mixed text.

The example illustrates the significant saving in the number of syntax elements that are used to represent the same business content of the example XML message when using the compact parser.

By not retaining mixed text, all of the white space elements that have no business data content are no longer taking any runtime footprint in the broker message tree. However, the mixed text in Element04.P is also discarded, and only the value of the child folder, Element04.P.B, is held in the tree; the text *This is* and *text* in P is discarded. This type of XML structure is not typically associated with business data formats; therefore, use of the compact XMLNSC parser is typically desirable. However, if you need this type of processing, either do not use the XMLNSC parser, or use it with *Retain mixed text mode* enabled.

The handling of the XML declaration is also different in the XMLNSC parser. The version, encoding, and standalone attributes are held as children of the `XmlDeclaration`, rather than as elements with a particular field type.

```

(0x01000000):XMLNSC = (
  (0x01000400):XmlDeclaration = (
    (0x03000100):Version = '1.0'
    (0x03000100):Encoding = 'UTF-8'
    (0x03000100):StandAlone = 'no'
  )
  (0x01000000):Envelope = (
    (0x03000100):version = '1.0'
    (0x01000000):Header = (
      (0x03000000):Example = 'ST_TimeoutNodes Timeout Request Input Test Message'
    )
    (0x01000000):Body = (
      (0x03000100):version = '1.0'
      (0x03000000):Element01 = 'Value01'
      (0x01000000):Element02 =
      (0x01000000):Element03 = (
        (0x03000000):Repeated = 'ValueA'
        (0x03000000):Repeated = 'ValueB'
      )
      (0x01000000):Element04 = (
        (0x01000000):P = (
          (0x03000000):B = 'bold'
        )
      )
    )
  )
)

```

The following samples use the XML parser to process messages:

- Coordinated Request Reply sample
- Large Messaging sample
- Message Routing sample

You can view samples only when you use the information center that is integrated with the Message Broker Toolkit.

Some predefined message models are supplied with the Message Broker Toolkit and can be imported using the New Message Definition File wizard and selecting the IBM-supplied message option. See IBM supplied messages that you can import.

XMLNSC parser:

The XMLNSC parser is a flexible, general-purpose XML parser that offers high performance XML parsing and optional XML Schema validation.

The XMLNSC parser has a range of options that make it suitable for most XML processing requirements. Some of these options are only available in the XMLNSC parser.

Although the XMLNSC parser is capable of parsing XML documents without an XML Schema, extra features of the parser become available when it operates in model-driven mode. In model-driven mode, the XMLNSC parser is guided by an XML Schema, which describes the shape of the message tree (the logical model).

XML Schemas are created automatically from the content of a message set when the message set is added to a broker archive (bar) file. The XML Schemas are deployed to the broker and used by the XMLNSC parser to validate your XML messages. Validation is fully compliant with the XML Schema 1.0 specification.

For guidance on when to use the XMLNSC domain and parser, see “Which XML parser should you use?” on page 77.

If you want the XMLNSC domain to parse a message, select *Message Domain* as XMLNSC on the appropriate node in the message flow. Additionally, if you want the XMLNSC parser to validate your messages, perform the additional steps that are described in “XMLNSC validation” on page 89.

Features of the XMLNSC parser

Feature	Present	Description
Namespace support	Yes	Namespace information is used if it is present. No user configuration is required. See “XML parsers namespace support” on page 97.
On-demand parsing	Yes	See “Parsing on demand” on page 1363.
Compact message tree	Yes	Less memory is used when building a message tree from an XML document. See “Manipulating messages in the XMLNSC domain” on page 364.

Feature	Present	Description
Opaque parsing	Yes	One or more elements can be parsed opaquely. See "XMLNSC opaque parsing" on page 88.
Ultra high performance	Yes	The architecture of the XMLNSC parser means that the parser's use of processor resources is significantly less than that of the other XML parsers.
Validation	Yes	See the table that follows this one.
Inline DTD support	Partial	Inline DTDs are processed but discarded. See "XMLNSC DTD support" on page 93.
XML Data Model compliance	Partial	The compact nature of the message tree means that some XPath queries are not supported.

The following features are only available when message validation is enabled. See "XMLNSC validation" on page 89.

Feature	Description
Message validation	Validates compliance with the XML Schema 1.0 specification.
xsi:nil support	Sets the value of an element to NULL if it has xsi:nil="true" and the XML Schema indicates that it is nillable.
Default value support	Sets the value of an empty element, or missing attribute, to its default value, according to XML Schema rules.
Use correct simple types	Allows the use of the simple types that are defined in the XML Schema when building the message tree.
Base64 support	Converts base64 data to BLOB when parsing. Converts BLOB to base64 when writing.

If you specify the SOAP domain as the owner of a SOAP Web Services message, the SOAP parser invokes the XMLNSC parser in model-driven mode to parse the XML content of the SOAP message.

If you specify the DataObject domain as the owner of a WebSphere Adapter message, and the message is written to a destination other than a WebSphere Adapter, the DataObject parser invokes the XMLNSC parser to write the message as XML.

XMLNSC empty elements and null values:

Empty elements and null values occur frequently in XML documents.

A robust message flow must be able to recognise and handle empty elements and null values. Similarly, elements in a message tree might have a NULL value, an empty value, or no value at all. This topic explains the parsing and writing of these values by the XMLNSC domain. For advice on good ESQ or Java coding practices see “Null handling” on page 108.

Parsing

Description	XML input parsed by XMLNSC	Value of 'element' in message tree
Empty element value	<element/>	Empty string
Empty element value	<element></element>	Empty string
Folder with child elements	<element><childElement/></element>	No value
Nil element value	<element xsi:nil="true"/>	Empty string or NULL Note: Which value depends on whether the element definition is 'nillable' in the XML Schema

Note that both forms of an empty element result in the same value in the message tree.

Writing

Description	Value of 'element' in message tree	XML output from XMLNSC parser
Empty element value	Empty string	<element/>
Null element value	NULL	<element/>
Folder with child elements	No value	<element><childElement/></element>

Empty elements

An empty element can take two forms in an XML document:

- <element/>
- <element></element>

The XMLNSC parser treats both forms in the same way. The element is added to the message tree with a value of "" (the empty string).

When a message tree is output by the XMLNSC parser, it always uses the first form for elements that have a value of "" (the empty string).

Elements with an xsi:nil attribute

The following behavior is available only when validation is enabled in the message flow.

If an element in the input document has an xsi:nil attribute with the value 'true', and the 'nillable' property of the element definition in the XML schema is set to 'true', the XMLNSC parser sets the value of the message tree element to NULL.

When a message tree is output by the XMLNSC parser, if the value of the element is NULL and the element has no child elements, the element is written as <element/>; but, if the element has an xsi:nil attribute, it is written exactly like any other attribute.

Note that the XMLNSC parser only outputs xsi:nil attributes that are already in the message tree. It does not automatically output xsi:nil attributes for all message tree elements that have a NULL value and are 'nillable'.

XMLNSC opaque parsing:

Opaque parsing is a performance feature that is offered by the XMLNSC domain.

If you are designing a message flow and you know that certain elements in a message are never referenced by the message flow, specify that these elements should be parsed opaquely. This reduces the costs of parsing and writing the message, and might improve performance in other parts of the message flow.

Use the property *Opaque Elements* on the *Parser options* page of the relevant message flow node to specify the elements that you want to be parsed opaquely. This property specifies a list of element names. If an element in the input XML message is named in this list, the element is parsed as a single string.

An opaque element cannot be queried like an ordinary element; its value is the segment of the XML bit stream that belongs to the element, and it has no child elements in the message tree, even though it can represent a large subtree in the XML document.

When an opaque element is serialized, the value of the element is copied directly into the output bit stream. The string is converted to the correct code page, but no other changes are made. Because this might produce a bit stream that is not valid XML, some care is required.

An element should not be parsed opaquely in any of the following cases:

- The message flow needs to access one of its child elements.
- The message flow changes the namespace prefix in a way that affects the opaque element or one of its child elements **and** the element is to be copied to the output bit stream.
- The element, or any child element, contains a reference to an internal entity that is defined in an inline DTD **and** the element is to be copied to the output bit stream.
- The element contains child attributes that have default values that are defined in an inline DTD **and** the element is to be copied to the output bit stream.

Make sure that you check the above points before you specify an element for opaque parsing.

There are some drawbacks to using opaque parsing. When it is enabled, some parts of the message are never parsed. This might allow XML that is either badly formed or not valid to pass through the message flow without being detected. For this reason, if you enable validation, you cannot use opaque parsing.

The XMLNS domain offers a more limited opaque parsing facility, but this is provided only to support existing applications. New message flows should use the XMLNSC domain for opaque parsing.

Specifying opaque elements for the XMLNSC parser:

Specify an element as an opaque element so that its content is ignored by the XMLNSC parser.

To specify the elements that are to be skipped by the XMLNSC parser:

1. Right-click the selected message flow node and click Properties and select Parser Options.
2. At the bottom of the XMLNSC Parser Options panel, is an area that lists the elements that have already been selected as opaque elements. Click **Add...** to add an element to this list. A new pane **Add Opaque elements Entry** opens.
3. In the **Add Opaque elements Entry** pane, specify the new XML element that you want to be opaquely passed. Each opaque element must be specified as an ESQL element name or an XPath expression of the form `//prefix:name` (or `//name`, if your input document does not contain namespaces).

Note: A prefix is used rather than a full URI to identify the namespace; see “XPath namespace support” on page 461 for further information.

Click **Edit...** or **Delete...** to edit the list of opaque elements.

XMLNSC validation:

The XMLNSC parser offers high-performance, standards-compliant XML Schema validation at any point in a message flow.

Validation of the input XML message or the message tree is performed against the XML Schemas that are deployed.

Validation is not the same as *parsing*. When parsing, the XMLNSC parser always checks that the input document is well-formed XML, according to the XML specification. If validation is enabled, the XMLNSC parser also checks that the XML document obeys the rules in the XML Schema.

Enabling XML Schema validation in a message flow

You must complete the following tasks to construct a message flow that validates an XML document in accordance with an XML Schema:

- Enable validation at the appropriate point in the message flow. This is typically achieved by setting the *Validate* property of the appropriate node to Content or Content and Value. See “Validating messages” on page 164.
- Ensure that all required XML Schema files are deployed. See “Deploying XML Schemas” below.
- Specify the message set in which the XML Schemas are deployed. Typically, you specify the message set by selecting the Message Set property on the node.

Deploying XML Schemas

All XML Schemas that are used by WebSphere Message Broker must be created as message definition files within a message set.

To create and deploy a message set for XML Schema validation:

1. Create a new message set or locate an existing message set.

2. Ensure that the message set has its *Default message domain* set to XMLNSC, or that the XMLNSC check box under *Supported message domains* is selected, to indicate that the message set supports the XMLNSC domain.
3. Create a message definition file in the message set to represent your message. If you have an existing XML Schema or DTD that describes your message, you can import it. You can repeat this step for each message that you want to validate.
4. Add the message set to a broker archive (bar) file, which generates the required XML Schema in a file with extension .xsdzip, and deploy the bar file to the broker.

Standards compliant validation

XMLNSC validation complies fully with XML Schema v1.0 as defined in the specifications that are available at <http://www.w3.org/TR/xmlschema-1/> and <http://www.w3.org/TR/xmlschema-2/>, with the following minor exceptions:

- Any floating point value that is smaller than 10E-43 is treated as zero.
- Any member of a group or complex type, that has both minOccurs > 1024 and maxOccurs > 1024, is validated as if minOccurs = 0 and maxOccurs is unbounded.

Validating XML v1.1 documents

You can validate documents that conform to the XML v1.1 specification, but support is limited by the fact that the XML Schema v1.0 documents must conform to XML v1.0.

As an example, you cannot always declare an XML v1.1 tag name in XML Schema v1.0. This limitation is not imposed by the XMLNSC parser implementation; it is a limitation of XML Schema v1.0.

Interpreting validation errors

A validation error is an error that results when the XML document breaks the rules that are defined in the XML schema. The XML Schema standard specifies exactly what these rules are, and how they should be applied. Validation errors that the XMLNSC parser issues contain information that links the error to the XML Schema rule that has been violated.

All validation errors are reported in BIP5025 or BIP5026 messages. Both messages begin with text in the following form:

```
XML schema validation error '[cvc-error key: error description]'
```

Examples:

```
'cvc-minInclusive-valid: The value "2" is not valid with respect to the minInclusive facet with value "3" for type "po:itemCountType".'  
'cvc-complex-type.2.4.a: Expecting element with local name "numItems" but saw "totalValue".'
```

To find the XML Schema rule that has been violated, open the XML Schema specification and search for the error key.

Example 1: Open <http://www.w3.org/TR/xmlschema-1/> and search for 'cvc-minInclusive-valid'. Follow the link to the XML Schema rules for the minInclusive facet.

Example 2: Open <http://www.w3.org/TR/xmlschema-1/> and search for 'cvc-complex-type'. Follow the link to the XML Schema rules for validating the content of a complex type. In this case, the error key contains extra information. The '2.4.a' refers to the exact sub-rule that was violated. It should not be included when searching for the rule.

If the XML Schema specification does not provide enough information, you can find more information using a search engine. The XML Schema standard is very widely used, and many online tutorials and other resources are available.

XMLNSC message tree options:

The XMLNSC options that are described below affect the parsing of an XML document by the XMLNSC parser. They have no effect on XML output.

Retain Mixed Content

Mixed content is XML text which occurs between elements.

```
<parent>
  <childElement1>Not mixed content</childElement1>
  This text is mixed content
  <childElement2>Not mixed content</childElement2>
</parent>
```

By default, the XMLNSC parser discards all mixed content. Mixed content is retained in the message tree if you select *Retain mixed content* in the Parser options page of the input node. For further information, see 'Handling mixed text' in "Manipulating messages in the XMLNSC domain" on page 364.

Retain Comments

By default, the XMLNSC parser discards all comments in the input XML. Comments are retained in the message tree if you select *Retain comments* in the Parser options page of the input node. For further information, see 'Handling comments' in "Manipulating messages in the XMLNSC domain" on page 364.

Retain Processing Instructions

By default, the XMLNSC parser discards all processing instructions in the input XML. Processing instructions are retained in the message tree if you select *Retain processing instructions* in the Parser options page of the input node. For further information, see 'Handling processing instructions' in "Manipulating messages in the XMLNSC domain" on page 364.

Build tree using XML Schema data types

By default, the XMLNSC parser uses the CHARACTER data type for all element and attribute values that the parser creates in the message tree. However, if you are using the XMLNSC parser to validate the XML document, you can select *Build tree using XML Schema data types* in the Parser options page of the input node. This causes element and attribute values to be cast to the message broker data type that most closely matches their XML Schema simple type. The exact mapping between XML schema types and message broker types can be found in "XMLNSC data types."

XMLNSC data types:

The table shows the mapping between XML Schema simple types and the data types that the XMLNSC parser uses in the message tree.

XML Schema type	Data type in message tree
anyURI	CHARACTER
base64Binary	BLOB
Boolean	BOOLEAN
Byte	INTEGER
Date	DATE
dateTime	TIMESTAMP
Decimal	DECIMAL
Double	FLOAT
duration	INTERVAL
ENTITIES	List of CHARACTER
ENTITY	STRING
Float	FLOAT
gDay	DATE
gMonth	DATE
gMonthDay	DATE
gYear	DATE
gYearMonth	DATE
hexBinary	BLOB
ID	CHARACTER
IDREF	CHARACTER
IDREFS	List of CHARACTER
int	INTEGER
Integer	DECIMAL
language	CHARACTER
Long	INTEGER
Name	CHARACTER
NCName	CHARACTER
negativeInteger	DECIMAL
NMTOKEN	CHARACTER
NMTOKENS	List of CHARACTER
nonNegativeInteger	DECIMAL
nonPositiveInteger	DECIMAL
normalizedString	CHARACTER
NOTATION	CHARACTER
positiveInteger	DECIMAL
Qname	CHARACTER
short	INTEGER
string	CHARACTER
Time	DATETIME

XML Schema type	Data type in message tree
Token	CHARACTER
unsignedByte	INTEGER
unsignedInt	INTEGER
unsignedLong	DECIMAL
unsignedShort	INTEGER

Note: Base64 decoding is automatically performed by the XMLNSC parser.

List types

In the message tree, a list type is represented as a parent node with an anonymous child node for each list item. This allows repeating lists to be handled without any loss of information.

If a list element repeats, the occurrences appear as siblings of one another, and each occurrence has its own set of child nodes representing its own list items.

XMLNSC DTD support:

The input XML message might contain an inline DTD.

Parsing

If the input XML document has an inline DTD, the XMLNSC parser reads and uses information in the DTD while parsing, but does not add the DTD information to the message tree.

Internal entity definitions in the DTD are used to automatically expand entity references that are encountered in the body of the document.

Attributes that are missing from the input document are automatically supplied with the default value specified in the DTD.

The XMLNSC parser never adds the DTD to the message tree because the information that it contains has already been used during the parse. This behavior keeps the message tree compact and reduces CPU usage, and means that the XMLNSC parser does not always produce exactly the same document as it parsed. However, the business meaning of the output document is not altered.

If these restrictions are a problem, the XMLNS domain and parser provide full support for parsing and writing of the DTD. See “XMLNS DTD support” on page 96.

Writing

The XMLNSC parser can output a DTD that contains entity definitions only. This behavior allows the XMLNSC parser to be used for writing out XML documents that use internal entities (the most common reason for using a DTD). See “Manipulating messages in the XMLNSC domain” on page 364 for further details.

External DTDs

No support is offered for external DTDs

XMLNS parser:

The XMLNS parser is a flexible, general-purpose XML parser.

The XMLNS parser is not model-driven and does not use an XML Schema when parsing XML documents.

For guidance on when to use the XMLNS domain and parser, see “Which XML parser should you use?” on page 77.

If you want the XMLNS domain to parse a particular message, you must select *Message Domain* as XMLNS on the appropriate node in the message flow.

Features of the XMLNS parser

Feature	Present	Description
Namespace support	Yes	Namespace information is used if it is present. No user configuration is required. See “Namespace support” on page 415.
On-demand parsing	Yes	See “Parsing on demand” on page 1363.
Compact message tree	No	
Opaque parsing	Partial	Limited support from ESQL only for parsing a single element opaquely. See “XMLNS opaque parsing” on page 95.
Ultra high performance	No	
Validation	No	
Inline DTD support	Yes	Inline DTDs are processed and retained in the message tree. See “XMLNS DTD support” on page 96.
XML Data Model compliance	Yes	The resultant message tree conforms to the XML Data Model.

XMLNS empty elements and null values:

Empty elements and null values occur frequently in XML documents.

A robust message flow must be able to recognise and handle empty elements and null values. Similarly, elements in a message tree might have a NULL value, an empty value, or no value at all. This topic explains the parsing and writing of these values by the XMLNS domain. For advice on good ESQL or Java coding practices see “Null handling” on page 108.

Parsing

Description	XML input parsed by XMLNS	Value of 'element' in message tree
Empty element value	<code><element/></code>	Empty string
Empty element value	<code><element></element></code>	Empty string
Folder with child elements	<code><element><childElement/></element></code>	No value
Nil element value	<code><element xsi:nil="true"/></code>	Empty string

Note that both forms of an empty element result in the same value in the message tree.

Note also that a NULL value is never put into the message tree by the XMLNS parser.

Writing

Description	Value of 'element' in message tree	XML output from XMLNS parser
Empty element value	Empty string	<code><element/></code>
Null element value	NULL	<code><element/></code>
Folder with child elements	No value	<code><element><childElement/></element></code>

Empty elements

An empty element can take two forms in an XML document:

- `<element/>`
- `<element></element>`

The XMLNS parser treats both forms in the same way. The element is added to the message tree with a value of "" (the empty string).

When a message tree is output by the XMLNS parser, it always uses the first form for elements that have a value of "" (the empty string).

Elements with an xsi:nil attribute

The XMLNS parser treats the `xsi:nil` attribute exactly like any other attribute. When `xsi:nil` is encountered while parsing, it does not set the value of the parent element to NULL. If you require this behavior you should use the XMLNSC parser. When writing a message tree, if an `xsi:nil` attribute exists it will be output in the same way as any other attribute.

XMLNS opaque parsing:

Opaque parsing is a performance feature that is offered by the XMLNS domain.

XMLNS opaque parsing has been superseded by the opaque parsing feature of the XMLNSC domain. Do not use the XMLNS parser for opaque parsing unless your message flow requires features that are only offered by the XMLNS parser.

If you are designing a message flow, and you know that a particular element in a message is never referenced by the message flow, you can specify that that element is to be parsed opaquely. This reduces the costs of parsing and writing the message, and might improve performance in other parts of the message flow.

To specify that an XML element is to be parsed opaquely, use an ESQL CREATE statement with a PARSE clause to parse the XML document. Set the FORMAT qualifier of the PARSE clause to the constant, case-sensitive string 'XMLNS_OPAQUE' and set the TYPE qualifier of the PARSE clause to the name of the XML element that is to be parsed in an opaque manner.

The TYPE clause can specify the element name with no namespace (to match any namespace), or with a namespace prefix or full namespace URI (to match a specific namespace).

XMLNS opaque elements cannot be specified via the node properties.

Consider the following example:

```
DECLARE soap NAMESPACE 'http://schemas.xmlsoap.org/soap/envelope/';

DECLARE BitStream BLOB ASBITSTREAM(InputRoot.XMLNS
    ENCODING InputRoot.Properties.Encoding
    CCSID InputRoot.Properties.CodedCharSetId);

--No Namespace
CREATE LASTCHILD OF OutputRoot
  DOMAIN('XMLNS')
  PARSE (BitStream
    ENCODING InputRoot.Properties.Encoding
    CCSID InputRoot.Properties.CodedCharSetId
    FORMAT 'XMLNS_OPAQUE'
    TYPE 'Body');

--Namespace Prefix
CREATE LASTCHILD OF OutputRoot
  DOMAIN('XMLNS')
  PARSE (BitStream
    ENCODING InputRoot.Properties.Encoding
    CCSID InputRoot.Properties.CodedCharSetId
    FORMAT 'XMLNS_OPAQUE'
    TYPE 'soap:Body');

--Namespace URI
CREATE LASTCHILD OF OutputRoot
  DOMAIN('XMLNS')
  PARSE (BitStream
    ENCODING InputRoot.Properties.Encoding
    CCSID InputRoot.Properties.CodedCharSetId
    FORMAT 'XMLNS_OPAQUE'
    TYPE '{http://schemas.xmlsoap.org/soap/envelope/}:Body');
```

XMLNS DTD support:

The input XML might contain an inline DTD.

Parsing

If the input XML document has an inline DTD, the XMLNS parser reads and uses information in the DTD while parsing, and adds the DTD information to the message tree.

Internal entity definitions in the DTD are used to automatically expand entity references that are encountered in the body of the document.

Attributes that are missing from the input document are automatically supplied with the default value specified in the DTD.

Writing

The XMLNS parser can output any inline DTD that has been constructed in the message tree.

External DTDs

No support is offered for external DTDs

XML parsers namespace support:

Namespaces in XML messages are supported by the XMLNSC and XMLNS parsers. Namespaces are not supported by the XML parser.

Parsing

The XMLNS and XMLNSC parsers can parse any well-formed XML document, whether or not the document contains namespaces. If elements or attributes have namespaces, those namespaces are applied to the elements and attributes in the message tree. Namespace prefix mappings are also carried in the message tree, and are used when serializing the message tree back to XML.

- If an element or attribute in the input XML has a namespace, the corresponding node in the message tree also has that namespace.
- If an element contains a namespace declaration (an xmlns attribute), a child element that contains its prefix and namespace URI is created in the message tree.

While the message is passing through a message flow, namespaces and namespace mappings can be modified using ESQL or any of the other transformation technologies that are offered by message broker.

Writing

Namespaces and their prefixes are preserved in the message tree when parsing, and are used when the XMLNS and XMLNSC parsers convert a message tree to an XML bitstream.

- When serializing a message tree, the parser scans for namespace declarations on each XML element. If any are found, it uses them to select the namespace prefixes in the output document.
- If an element in the message tree has a namespace, but there is no in-scope namespace declaration for its namespace URI, a valid namespace prefix is automatically generated and used in the output XML. Auto-generated prefixes have the form NS1, NS2, and so on.

Tip: If an element in the message tree has a child element that is a 'default namespace' declaration, every child of that element (whether an XML element or an XML attribute, at any nesting depth) must have a namespace. If this rule is not enforced message broker cannot generate correct XML output for the message tree.

XML parser:

The XML domain is very similar to the XMLNS domain, but the XML domain has no support for XML namespaces or opaque parsing.

The XML domain is deprecated, but existing message flows that use the XML domain continue to work. Use the XMLNSC domain when developing new message flows.

The XML parser is not model-driven and does not use an XML Schema when parsing XML documents.

If you want the XML domain to parse a particular message, you must select *Message Domain* as XML on the appropriate node in the message flow.

Tip: The XMLNSC and XMLNS parsers both support XML messages that do not use namespaces, with no extra configuration.

Features of the XML parser

Feature	Present	Description
Namespace support	No	
On-demand parsing	Yes	See "Parsing on demand" on page 1363.
Compact message tree	No	
Opaque parsing	No	
Ultra high performance	No	
Validation	No	
Inline DTD support	Yes	Inline DTDs are processed and retained in the message tree.
XML Data Model compliance	Yes	The resultant message tree conforms to the XML Data Model.

MRM parser and domain

You can use the MRM domain to parse and write a wide range of message formats.

The MRM domain can be used to parse and write a wide variety of message formats. It is primarily intended for non-XML message formats, but it can also parse and write XML. For guidance on when to consider using the MRM parser, instead of one of the XML parsers, to parse XML, see "Which XML parser should you use?" on page 77

The key features of the MRM domain are:

- Support for messages from applications that are written in C, COBOL, PL/I and other languages, by using the Custom Wire Format (CWF) physical format. This support includes the ability to create a message model directly from a C header file or COBOL copybook.

- Support for text messages, perhaps with field content that is identified by tags, separated by specific delimiters, or both, by using the Tagged Delimited String (TDS) physical format. This includes industry standards such as CSV, HL7, SWIFT, EDIFACT, and X12.
- Support for XML messages, including those that use XML namespaces, by using the XML physical format.

WebSphere Message Broker uses the MRM parser to read and write messages that belong to the MRM domain. When reading a message, the MRM parser constructs a message tree from a bit stream. When writing a message, the MRM parser creates a bit stream from a message tree. The MRM parser is always model-driven, and it is guided by a message dictionary that describes the shape of the message tree (the logical model) and the physical layout of the bytes or characters in the bit stream (the physical format). A message dictionary is created automatically from the content of a message set when it is added to the broker archive (bar) file. Therefore, when you create a message set for use with the MRM domain, you must define both the logical model and the appropriate physical format information.

The operation of the parser depends on the physical format that you have associated with the input or output message:

- For a binary message, the parser reads a set sequence of bytes according to information in the CWF physical format, and translates them into the fields and values in the message tree.
- For a text message, the parser uses a key piece of TDS physical format information called *Data Element Separation* to decide how to parse each portion of the message bit stream. This informs the parser whether the message uses delimiters, tags, fixed length elements, patterns, and so on. The parser then reads the data according to information in the TDS physical format, and translates it into the fields and values in the message tree.
- For an XML message, the parser reads the XML markup language (element tags and attributes), guided by information in the XML physical format, and translates them into the fields and values in the message tree.

Because the MRM parser is model-driven, it can perform validation of messages against the model that is defined in the deployed dictionary. The level of validation that is performed by the MRM parser is similar to that defined by XML Schema 1.0, but is not fully compliant. If you use XML messages, and you want fully compliant XML Schema 1.0 validation, use the XMLNSC domain.

The MRM parser is an on-demand parser. See “Parsing on demand” on page 1363.

If you want to use the MRM domain to parse a particular message:

1. Create a new message set with an appropriate CWF, TDS, or XML physical format; or locate an existing message set.
2. Ensure that the message set has its *Default message domain* set to MRM, or that the *MRM* check box under *Supported message domains* is selected to indicate that the message set supports the MRM domain.
3. Create a message definition file in the message set to represent your message, ensuring that both logical and physical format information is provided. If you have an existing C, COBOL, XML Schema, or DTD description of your message, you can import the description using a wizard.
4. Add the message set to a broker archive (bar) file which will generate a message dictionary for use by the MRM parser, and deploy the bar file to the broker.

5. Select MRM as *Message Domain* on the appropriate node in your message flow.
6. Additionally set values for *Message Set*, *Message Type*, and *Message Format* on the node. *Message Type* is the name of the message in the message definition file.

The following samples all use the MRM parser to process messages:

- Video Rental sample
- Comma Separated Value (CSV) sample
- EDIFACT sample
- FIX sample
- SWIFT sample
- X12 sample

You can view samples only when you use the information center that is integrated with the Message Broker Toolkit.

Some predefined message models are supplied with the Message Broker Toolkit and can be imported using the New Message Definition File From IBM supplied Message wizard. The CSV, ALE IDoc, and File IDoc models are specifically for use with the MRM domain. See IBM supplied messages that you can import.

IBM supplies predefined message sets for industry standard formats SWIFT, X12, EDIFACT, and FIX. Contact dubadapt@ie.ibm.com for more information.

DataObject parser and domain

Use the DataObject domain to parse and write messages for WebSphere Adapters.

The DataObject domain must be used when you use the WebSphere Adapter nodes in your message flow.

WebSphere Message Broker uses the DataObject parser to read and write message from Enterprise Information Systems (EIS) such as SAP, PeopleSoft, and Siebel. Such messages belong to the DataObject domain.

When it receives a message from an adapter, the DataObject parser constructs a message tree from the business object that it receives from the EIS. When it writes a message, the DataObject parser creates from the message tree the business object that it sends to the EIS. The DataObject parser is always *model-driven*, and it is guided by the XML Schemas that model the EIS business objects. The XML Schemas are created automatically from the content of a message set when the message set is added to the broker archive (bar) file.

If you want to parse a message using the DataObject domain, you must:

1. Create a new message set, or locate an existing message set.
2. Ensure that either the message set has its *Default message domain* project set to DataObject, or the *DataObject* check box (under *Supported message domains*) is selected, to indicate that the message set supports the DataObject domain.
3. Create a message definition file in the message set to represent your EIS business object. Use the *New adapter connection* wizard to connect to the EIS and retrieve the Business object metadata.
4. Add the message set to a broker archive (bar) file, which generates XML Schema for the DataObject parser to use, and deploy the bar file to the broker.
5. If you associate your adapter inbound or outbound message with an adapter node in your message flow, the *Message Set* property is automatically set in the node. The *Message domain* property is always pre-selected as DataObject.

Tip: If a message that belongs to the DataObject domain is written to a destination other than a WebSphere Adapter, the DataObject parser invokes the XMLNSC parser to write the message as XML.

The following adapter samples use the DataObject parser to process messages:

- SAP Connectivity sample
- Twineball Example EIS Adapter sample

You can view samples only when you use the information center that is integrated with the Message Broker Toolkit.

JMS parsers and domains

The JMSMap and JMSStream domains can be used for modeling messages that are produced by the implementations of the Java Messaging Service standard.

Use the JMSMap domain when handling JMS messages of type MapMessage. Use the JMSStream domain when handling JMS messages of type StreamMessage.

These message types appear in the broker in XML format, and are therefore supported in an identical way to XML domain messages.

For a full description of JMS MapMessage and StreamMessage processing, see WebSphere Broker JMS Transport.

MIME parser and domain

Use the MIME domain if your messages use the MIME standard for multipart messages.

The MIME (Multipurpose Internet Mail Extension) parser does not support the full MIME standard, but does support common uses of MIME. You can send the messages to the broker over HTTP or over other transport types, such as WebSphere MQ. Use the MIME domain if your messages use the MIME standard for multipart messages.

The MIME domain does not support Content-Type values with a media type of *message*.

To specify that a message uses the MIME domain, select MIME as the *Message Domain* on the relevant message flow node.

Use the MIME domain and parser to parse and write MIME messages. The MIME parser creates a logical tree, and sets up the broker ContentType property. You can use Compute nodes and JavaCompute nodes to manipulate the logical tree. Set the Content-Type value using the ContentType property in the MIME domain.

Example MIME message

The following example shows a simple multipart MIME message. The message shown is a SOAP with Attachments message with two parts: the root part and one attachment part. The boundary string *MIME_boundary* delimits the parts.

```
MIME-Version: 1.0
Content-Type: Multipart/Related; boundary=MIME_boundary; type=text/xml
Content-Description: Optional description of message.
```

```
Optional preamble text
--MIME_boundary
Content-Type: text/xml; charset=UTF-8
Content-Transfer-Encoding: 8bit
Content-ID: <rootpart@example.com>
```

```
<?xml version='1.0' ?>
<SOAP-ENV:Envelope
  xmlns:SOAP-ENV="http://schemas.xmlsoap.org/soap/envelope/">

  <SOAP-ENV:Header xmlns:ins="http://myInsurers.com">
    <ins:ClaimReference>abc-123</ins:ClaimReference>
  </SOAP-ENV:Header>

  <SOAP-ENV:Body xmlns:ins="http://myInsurers.com">
    <ins:SendClaim>
      <ins:ClaimDetail>myClaimDetails</ins:ClaimDetail>
      <ins:ClaimPhoto>
        <href>cid:claimphoto@example.com</href>
      </ins:ClaimPhoto>
    </ins:SendClaim>
  </SOAP-ENV:Body>

</SOAP-ENV:Envelope>
```

```
--MIME_boundary
Content-Type: application/octet-stream
Content-Transfer-Encoding: binary
Content-ID: <claimphoto@example.com>
```

```
myBinaryData
--MIME_boundary--
Optional epilogue text
```

Example MIME logical tree

The following diagram shows a MIME logical tree. A MIME logical tree does not need to contain all of the children that are shown in the diagram. The value of the Content-Type header of a MIME message is the same as the ContentType field in the Properties subtree. The Transport-headers are headers from the transport that is used, such as an MQMD or HTTP.

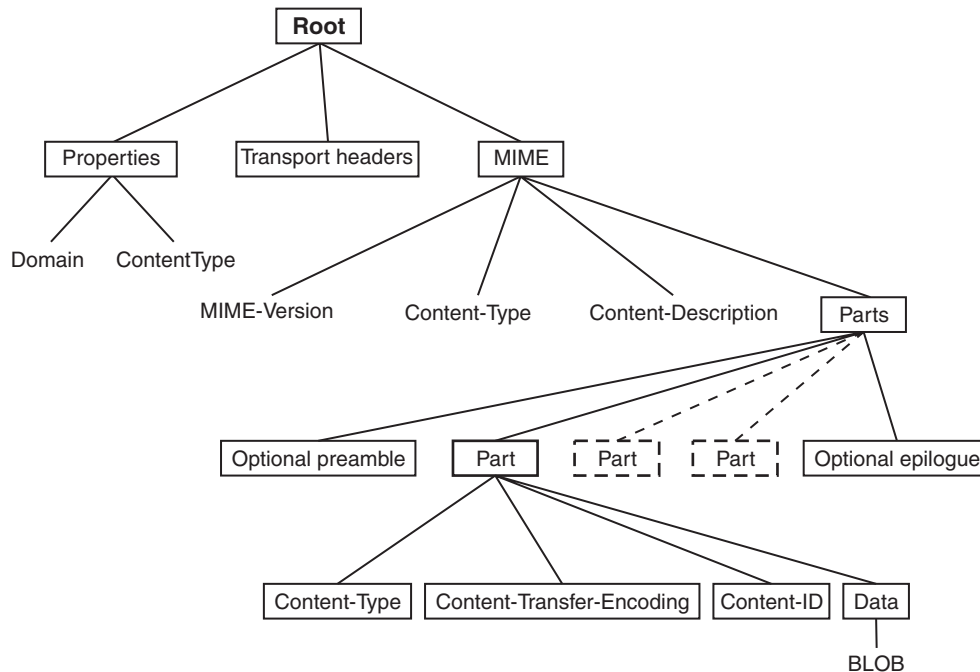

You can further parse the BLOB data in the tree (for example, by using an ESQL CREATE statement) if you know about the format of that MIME part. You might be able to find information about the format from its Content-Type field in the logical tree. Alternatively, you might know the format that your MIME messages take, and be able to parse them appropriately. For example, you might know that the first MIME Part is always an XML message, and that the second MIME Part is a binary security signature.

You must specify how to parse other message formats, such as tagged delimited or binary data, within your message flow, because the MIME parser does not do this. You must also specify how to handle encoded and signed message parts, because the MIME parser does not process these.

Some pre-defined MIME message models are supplied with the workbench and can be imported using the New Message Definition From IBM Supplied Message wizard.

MIME messages: MIME headers

A MIME message consists of both data and metadata. MIME metadata consists of HTTP-style headers and MIME boundary delimiters. Each header is a colon-separated name-value pair on a line. The ASCII sequence <CR><LF> terminates the line. A sequence of these headers, called a header block, is terminated by a blank line: <CR><LF><CR><LF>. Any headers that are in this HTTP style can appear in a MIME document. Some common MIME headers are described in MIME standard header fields.

Content-Type

The only header that must be present is the *Content-Type* header. This header specifies the type of the data in the message. If the Content-Type value starts with

“multipart”, the message is a multipart MIME message. For multipart messages the Content-Type header must also include a boundary attribute that gives the text that is used to delimit the message parts. Each MIME part has its own Content-Type field that specifies the type of the data in the part. This can also be multipart, which allows multipart messages to be nested. MIME parts with any other Content-Type values are handled as BLOB data.

If a MIME document is sent over HTTP, the Content-Type header appears in the HTTP header block rather than in the MIME message body. For this reason, the broker manages the value of the Content-Type header as the ContentType property in the *Properties* folder of the logical tree. This allows the MIME parser to obtain the Content-Type value for a MIME document that is received over HTTP. If you need to either create a new MIME tree or modify the value of the Content-Type, set the Content-Type value using the ContentType property in the MIME domain. If you set the Content-Type value directly in the MIME tree or HTTP tree, this value might be ignored or used inconsistently. The following ESQL is an example of how to set the broker ContentType property:

```
SET OutputRoot.Properties.ContentType = 'text/plain';
```

Parsing

The MIME domain does not enforce the full MIME specification. Therefore, you can work with messages that might not be valid in other applications. For example, the MIME parser does not insist on a **MIME-Version** header. The MIME parser imposes the following constraints:

- The MIME headers must be properly formatted:
 - Each header is a colon-separated name-value pair, on a line of its own, terminated by the ASCII sequence <CR><LF>.
 - The header line must use 7-bit ASCII.
 - Semicolons are used to separate parameters:
Content-Type: Multipart/Related; boundary=MIME_boundary; type=text/xml
 - A header might contain a comment in parentheses, for example:
MIME-Version: 1.0 (Generated by XYZ)
- A line that starts with white space is treated as a continuation of the previous line. Therefore, a long header can be split across more than one line.
- If two or more headers in a header block have the same name, their values are concatenated into a comma-separated list.
- A top-level MIME Content-Type header must be available. The header is not case-sensitive. If the transport is HTTP, any Content-Type value in the HTTP header is used as the top-level Content-Type. If the transport is not HTTP, the Content-Type must appear in the initial header block of the MIME message.
- The Content-Type value is a media type followed by the / character and a subtype. Examples of this are text/xml and multipart/related. The parser does not validate subtypes. The Content-Type value can be followed by one or more parameters that are separated by semicolons.
- If the media type of a message is multipart, a boundary attribute must provide the text that is used to delimit the separate MIME parts.
- Each individual MIME part can have its own Content-Type header. The part header can have a media type of multipart, so that multipart messages can be nested. In this case, a valid boundary attribute must be provided, and its value must be different from any that has been previously defined in the message. MIME parts that have any other Content-Type value are handled as BLOB data.

- MIME multipart boundary delimiters are represented in 7-bit ASCII. The boundary delimiter consists of a line starting with a hyphen pair, followed by a boundary string. This sequence must not occur within the MIME message at any point other than as a boundary. A MIME end-delimiter is a hyphen pair, followed by the MIME boundary string, followed by a further hyphen pair. All delimiter lines must end in the ASCII sequence <CR><LF>. An example of a delimited message is:

```
--MIME_boundary
message_data
--MIME_boundary
message_data
--MIME_boundary--
```

where *MIME_boundary* is the boundary delimiter string, and *message_data* represents message data.

- The MIME media type *message* is not supported and results in an error at run time.
- Any preamble data (text between the initial MIME header block and the first boundary delimiter) or epilogue data (text after the final boundary delimiter) is stored in the logical tree as a value-only element. Preamble data and epilogue data can appear only as the first and last children, respectively, of a Parts node.
- The MIME parser does not support on demand parsing and ignores the *Parse Timing* property. The parser does not validate MIME messages against a message model, and ignores the Message Brokers Toolkit *Validate* property.

Special cases of multipart MIME

The MIME parser is intended primarily for use with multipart MIME messages. However, the parser also handles some special cases:

- Multipart MIME with just one part. The logical tree for the MIME part saves the Content-Type and other information as usual, but the Data element for the attachment is empty.
- Single-part MIME. For single-part MIME, the logical tree has no Parts child. The last child of the MIME tree is the Data element. The Data element is the parent of the BLOB that contains the message data.
- MIME parts with no content.

Secure MIME (S/MIME)

S/MIME is a standard for sending secure e-mail. S/MIME has an outer level Content-Type of *multipart/signed* with parameters **protocol** and **micalg** that define the algorithms that are used to encrypt the message. One or more MIME parts can have encoded content. These parts have Content-Type values such as *application/pkcs7-signature* and a Content-Transfer-Encoding of *base64*. The MIME domain does not attempt to interpret or verify whether the message is actually signed.

MIME tree details:

Logical tree elements

A MIME message is represented in the broker as a logical tree with the following elements:

- The root of the tree is a node called MIME.

- All correctly formatted headers are stored in the logical tree, regardless of whether they conform to the MIME standard. The headers appear in the logical tree as name=value, as shown here:
Content-Type=text/xml
- A multipart MIME message is represented by a subtree with a root node called Parts.
- Any preamble or epilogue data associated with a multipart MIME message is represented by value-only elements appearing as the first and last children of Parts.
- In the special case of single-part MIME, the content is represented by a subtree with the root called Data.
- Each part of a multipart MIME message is represented by an element called Part with a child element for each MIME header, and a last child called Data.
- The Data element represents the content of a MIME part. This makes it easier to test for the presence of body content using ESQL because the Data element is always the last child of its parent.

Writing MIME messages

When writing a message, the MIME parser creates a message bit stream using the logical message tree. The MIME domain does not enforce all of the constraints that the MIME specification requires, therefore it might generate MIME messages that do not conform to the MIME specification. The constraints that the MIME parser imposes are:

- The tree must have a root called MIME, and constituent Parts, Part, and Data elements, as described in “Logical tree elements” on page 105.
- Exactly one Content-Type header must be present at the top level of the tree, or be available via the ContentType property. Media subtypes are not validated.
- If the media type is *multipart* then there must also be a valid boundary parameter.
- Any constituent MIME parts may have exactly one Content-Type header. If the value of this header starts with *multipart* then it must also include a valid boundary parameter. The value of this boundary parameter must not be the same as other boundary parameter values in the definition.
- The MIME Content-Type value “message” is not supported and results in an error at run time.
- All name-value elements in the tree are written as name: value followed by the ASCII sequence <CR><LF>.

If you have other elements in the tree, the parser behaves in the same way as the HTTP header parser:

- A name-only element or a NameValue element with a NULL value results in Name: NULL .
- Any children of a name-value element are ignored.

The message flow must serialize subtrees if they exist. This can be done using the ESQL command ASBITSTREAM.

BLOB parser and domain

The BLOB message domain includes all the messages with content that cannot be interpreted and subdivided into smaller sections of information.

Messages in this domain are processed by the BLOB parser. The BLOB parser is a program that interprets a bit stream or message tree that represents a message that belongs to the BLOB domain, and generates the corresponding tree from the bit stream on input, or a bit stream from the tree on output.

A BLOB message is handled as a single string of bytes, and although you can manipulate it, you cannot identify specific pieces of the byte string using a field reference, in the way that you can with messages in other domains.

You can process messages in the BLOB domain in the following ways:

- You can refer to the message content if you know the location (offset) of particular information within the message. You can specify offset values in ESQL statements within nodes in a message flow to manipulate the information.
- You can store the message in an external database, in whole or in part (where the part is identified by the offset of the data that is to be stored).
- You can use the Mapping node to map to and from a predefined BLOB message, and to map to and from items of BLOB data. The BLOB message cannot be:
 - The message content in a message where Content Validation is defined as Open or Open Defined (for example, the message body of a SOAP envelope)
 - The message represented by a wildcard inside another message

The UnknownParserName field is ignored.

The BLOB message body parser does not create a tree structure in the same way that other message body parsers do. It has a root element BLOB, which has a child element, also called BLOB, which contains the data.

For example, `InputBody.BLOB.BLOB[10]` identifies the tenth byte of the message body; `substring(InputBody.BLOB.BLOB from 10 for 10)` references 10 bytes of the message data starting at offset 10.

If you want to use the BLOB parser to parse a particular message, select BLOB as the Message Domain on the relevant node in your message flow.

The following sample demonstrates how you can extract information from an XML message and transform it into BLOB format to store it in a database.

- Data Warehouse sample

You can view samples only when you use the information center that is integrated with the Message Broker Toolkit.

IDOC parser and domain

The IDOC domain can be used to process messages that are sent to the broker by SAP R3 clients across the WebSphere MQ link for R3. Such messages are known as SAP ALE IDocs.

Note: The IDOC domain is deprecated and is not recommended for developing new message flows. Instead use the MRM domain with a TDS physical format. See “MRM parser and domain” on page 98.

A typical ALE IDoc message that has been sent from SAP to the WebSphere MQ link for R3 consists of an MQMD header, an MQSAPH header, and the ALE IDoc itself. The IDoc is made up of fixed size structures:

- The first structure is the Control Structure (DC). This is a complex element 524 bytes long that contains a fixed set of SAP-defined simple elements.

- One or more Data Structures (DDs). Each DD is a complex element 1063 bytes long that contains a fixed set of SAP-defined simple elements that occupies 63 bytes, followed by 1000 bytes of user-defined segment data.

WebSphere Message Broker uses the IDOC parser to read and write ALE IDocs that belong to the IDOC domain. When reading a message, the IDOC parser constructs a message tree from a bit stream. When writing a message, the IDOC parser creates a bit stream from a message tree.

The IDOC parser processes the SAP-defined elements in the DC, and then, for each DD, the IDOC parser processes the SAP-defined elements and then invokes the MRM parser to process the user-defined segment data, using its CWF physical format. The IDOC parser is therefore a model-driven parser, and requires that you create a message set in which to model the IDoc message, and deploy it to the broker.

If you want the IDOC domain to parse a particular message, you must:

1. Create a new message set with a CWF physical format, or locate an existing message set.
2. Ensure that either the message set has its *Default message domain* project set to IDOC, or the *IDOC* check box (under *Supported message domains*) is selected, to indicate that the message set supports the IDOC domain.
3. Create message definition files in the message set to represent your message. See *Building the message model for the IDOC parser* for the steps involved.
4. Add the message set to a broker archive (bar) file which generates a message dictionary for use by the MRM parser, and deploy the bar file to the broker.
5. Select *Message Domain* as IDOC on the appropriate node in your message flow.
6. Additionally, select *Message Set* and *Message Format* on the node. (You do not need to select *Message Type*).

Null handling

A business message might contain fields that are either empty or have a specific out-of-range value. In these cases, the application that receives the message is expected to treat the field as if it did not have a value. The logical message tree supports this concept by allowing the value of any element to be set to NULL.

Ways to represent a null value: In an XML document, the usual way to represent a null value is to leave the element or attribute empty.

For example: `<price></price>` or `<element price=""/>`

The `xsi:nil` attribute provides a way to make this more explicit: `price=<xsi:nil="true"/>`

Some business messages use a special value to represent null: `<price>-999</price>`

This style of null representation is supported only by the MRM parser.

ESQL support for null values: Using ESQL, you can set the value of a message tree element to `NULL:SET OutputRoot.XMLNSC.myField VALUE = NULL;`

Note that this is quite different from `SET OutputRoot.XMLNSC.myField = NULL;` which would cause `myField` to be deleted from the message tree.

The same effect can be achieved using Java or a Mapping node.

XMLNSC parser support for null values: Typically, the XML parsers (XMLNSC, XMLNS, and XML) do not create null values in the message tree; an empty element or an empty attribute value merely produces an empty string value in the message tree.

If validation is enabled, the XMLNSC parser detects and processes any `xsi:nil` attributes in the input document. If the `xsi:nil` attribute is set to 'true', and the element is nillable, the attribute's parent element in the message tree is given a NULL value.

For more information about XML parser support for empty and null elements, see "XMLNSC empty elements and null values" on page 86 and "XMLNS empty elements and null values" on page 94.

MRM parser support for null values: XML physical format

When parsing, the MRM XML parser can detect and process `xsi:nil` attributes in the input XML document. If the `xsi:nil` attribute is set to 'true', and the element is nillable, the attribute's parent element in the message tree is given a NULL value.

For information about enabling `xsi:nil` support in the MRM parser, see XML Null handling options.

The following topics provide more information about NULL handling in the MRM parser:

All physical formats

The MRM parser can detect a null that is represented by an out-of-range value. The 'null value' must be specified in the physical format of the message set.

While parsing, the MRM parser checks the null value for each element in the message. If the value in the bit stream matches the null value in the message set, the MRM parser sets the value in the message tree to NULL.

The same check is performed when converting a message tree to a bit stream. If the value in the message tree is NULL, the MRM parser outputs the null value from the message set.

- Custom wire format: NULL handling
- MRM XML physical format: NULL handling
- TDS format: NULL handling

Properties

This topic discusses the following types of broker properties:

- "Built-in" or broker-supplied properties, which are sometimes known simply as "broker properties": see "Broker properties."
- Promoted properties: see "Promoted properties" on page 110.
- User-defined properties: see "User-defined properties" on page 111.

Broker properties

For each broker, WebSphere Message Broker maintains a set of properties. You can access some of these properties from your ESQL programs. A subset of the

properties is also accessible from Java code. It can be useful, during the runtime of your code, to have real-time access to details of a specific node, flow, or broker.

Four categories of broker properties exist.

- Properties relating to a specific node
- Properties relating to nodes in general
- Properties relating to a message flow
- Properties relating to the execution group

For a description of the broker, flow, and node properties that are accessible from ESQL and Java, see “Broker properties that are accessible from ESQL and Java” on page 1663.

Broker properties have the following characteristics.

- They are grouped by broker, execution group, flow, and node.
- They are case sensitive. Their names always start with an uppercase letter.
- They return NULL if they do not contain a value.

All nodes that allow user programs to edit ESQL support access to broker properties. These nodes are:

- Compute nodes
- Database nodes
- Filter nodes
- All derivatives of these nodes

User-defined properties can be queried, discovered, and set at run time to dynamically change the behavior of a message flow. You can use the Configuration Manager Proxy (CMP) API to manipulate these properties, which can be used by a systems monitoring tool to perform automated actions in response to situations that it detects in the monitored systems. For more information, see “User-defined properties” on page 111.

A *complex property* is a property to which you can assign multiple values. Complex properties are displayed in a table in the Properties view, where you can add, edit, and delete values, and change the order of the values in the table. You cannot promote complex properties; therefore, they do not appear in the Promote properties dialog box. Nor can you configure complex properties; therefore, they are not supported in the Broker Archive editor. For an example of a complex property, see the Query elements property of the DatabaseRoute node.

For more information about editing a node’s properties, see “Configuring a message flow node” on page 235.

Promoted properties

A promoted property is a message flow node property that has been promoted to the level of the message flow in which it is included.

A message flow contains one or more message flow nodes, each of which is an instance of a message flow type (a built-in node, or a user-defined node). You can promote the properties of a message flow node to apply to the message flow to which it belongs. If you do this, any user of the message flow can set values for the properties of the nodes in this higher message flow by setting them at the message flow level, without being aware of the message flow’s internal structure.

You can promote compatible properties (that is, properties that represent comparable values) from more than one node to the same promoted property; you can then set a single property that affects multiple nodes.

For example, you might want to set the name of a data source as a property of the message flow, rather than a property of each individual node in the message flow that references that data source. You create a message flow that accesses a database called SALESDATA. However, while you are testing the message flow, you want to use a test database called TESTDATA. If you set the data source properties of each individual node within the message flow to refer to SALESDATA, you can promote the data source property for each node in the flow that refers to it, and update the property to have the value TESTDATA which overrides the node data source properties values while you test the message flow (the promoted property always takes precedence over the settings for the properties within any relevant nodes).

A subset of message flow node properties is also configurable (that is, the properties can be updated at deploy time). You can promote configurable properties: if you do so, the promoted property (which can have a different name from the property or properties that it represents) is the one that is available to update at deploy time. Configurable properties are those associated with system resources, for example queues and data sources: they can be set at deploy time by an administrator rather than a message flow developer.

You cannot promote a complex property, so it does not appear in the Promote properties dialog box. For more information about complex properties, see “Broker properties” on page 109.

User-defined properties

A user-defined property (UDP) is a property that is defined when you construct a message flow using the Message Flow editor. This property can be used by the ESQL or Java program inside message flow nodes, such as a Compute node.

The advantage of UDPs is that their values can be changed by operational staff at deployment and run time. You do not need to change your application programs. For example, if you use the UDPs to hold data about your computer center, you can configure a message flow for a particular computer, task, or environment at deployment time, without having to change the code at the message node level.

When you launch the Message flow editor to either create a message flow or modify an existing message flow, as well as deciding which nodes are required in the message flow, you also have the option (provided by the tab) of defining and giving initial values to some user-defined properties. Use the **User Defined Properties** tab at the bottom of the edit window. See Message Flow editor for more information.

As well as being defined using the Message flow editor, a UDP must also be defined using either a DECLARE statement with the EXTERNAL keyword in any ESQL program that uses it, or the getUserDefinedAttribute method in any JavaCompute node that uses it.

See the “DECLARE statement” on page 1525 for details of the DECLARE statement, and see “Accessing user-defined properties from a JavaCompute node” on page 466 for more information about how to use a UDP in a JavaCompute node.

Any value that you give to a UDP when you define it in a message flow overrides the value of that variable in your ESQL program.

The value of a UDP can also be modified at deployment time by using the Broker Archive editor to edit the bar file. This value overrides any value that was given when you defined the message flow.

The value of the UDP is set at the message flow level and is the same for all eligible nodes that are contained in the flow. An *eligible node* is a node that supports UDPs and is within the scope of the declaration that declares the UDP to your application. For example, if you use the Message Flow editor to change the value of a user property called *timezone*, which is declared in a schema called *mySchema*, in a message flow called *myFlow*, the UDP is available at run time to all the nodes in *myFlow* that support UDPs and that fall within *mySchema*.

Similarly, if you use the Message Flow editor to change the value of a user-defined property in a subflow, the newly edited property is available to all the nodes in the subflow that support UDPs and that are within the scope of the declaration. The property is not available, for example, to nodes in the parent flow.

Controlling user-defined properties at run time

User-defined properties can be queried, discovered, and set at run time to dynamically change the behavior of a message flow. You can use the Configuration Manager Proxy (CMP) API to manipulate these properties, which can be used by a systems monitoring tool to perform automated actions in response to situations that it detects in the monitored systems.

For example, a message flow contains a Route node, which is used to differentiate between the classes of customer that are defined in the message. The Route node has a user-defined property called *ProcessClasses*, which is set with an initial value of *All*. When *ProcessClasses* is set to *All*, the node routes messages from any class of customer to its first terminal for immediate processing.

When certain conditions are detected (for example, the monitoring system detects that the request load is causing the service level agreement to fall below its target), the Route node must be set to pass requests from only "Gold" class customers for immediate processing, while other customers' requests are sent to another output terminal, which queues them for later batch processing. Therefore, the monitoring application sets *ProcessClasses* to *Gold* so that the Route node routes the less critical messages to the second terminal.

To make it easier to know what a user-defined property does, and what values it can have, adopt a suitable naming convention. For example, a user-defined property named *property01*, with an initial value of *valueA* is not as useful as a property named *RouteToAorB* with an initial value of *RouteA*.

For more information, see [Setting user-defined properties dynamically at run time](#).

Precedence of UDP value overriding

You can define a user-defined property in four ways:

- In the ESQL code
- In the Message Flow editor
- Through a bar file override
- With the CMP API

You define a UDP in ESQL, in the Message Flow editor, or through a bar file override before bar file deployment. A bar file override takes precedence over changes in the Message Flow editor, and changes in the Message Flow editor take precedence over changes in the ESQL code.

The BrokerProxy.deploy() call can take precedence over the bar file override, or the bar file override can take precedence over the BrokerProxy.deploy() call. In both cases, changes that are made survive when the broker is restarted.

The precedence of the values for user-defined properties is demonstrated in the following sequence:

1. The user-defined property ProcessClasses is set to All in a message flow bar file. After deployment of the bar file, the value of ProcessClasses is All.
2. The same user-defined property (ProcessClasses) is set to Gold by using the CMP API to issue the call setUserDefinedProperty("ProcessClasses", "Gold"). After successful execution of the BrokerProxy.deploy() call, the value of ProcessClasses is Gold.
3. The broker is shut down and restarted. The value of ProcessClasses is still Gold.
4. The original flow bar file is redeployed. After deployment, the value of ProcessClasses is All.

Message flow transactions

A message flow can be one of two styles:

“Coordinated message flows”

These ensure that all updates to resources are committed or rolled back together within a single transaction.

“Uncoordinated message flows” on page 114

These allow updates to resources to occur independently; the updates are not affected by the overall success or failure of the message flow.

Coordinated message flows

You can configure a message flow that includes interaction with an external database or other recoverable resource so that all of its processing is coordinated within a single, global, transaction. This coordination ensures that either all processing is successfully completed, or no processing is completed. The transaction is committed (if all processing is successful), or rolled back (if at least one part of the processing is unsuccessful). Therefore, all affected resources (queues, databases, and so on) are maintained in a consistent state, and data integrity is preserved.

Updates that are made by a coordinated message flow are committed when the flow processes the input message successfully. The updates are backed out if both of the following conditions are met:

- Any node within the flow throws an exception that is not caught by a node other than the input node
- The input node’s Catch terminal is not connected

To configure a message flow as coordinated, set the Coordinated property on the message flow.

For some input nodes, such as MQInput or SCADAInput nodes, set the Transaction Mode property on the nodes in the flow to Automatic. The Automatic option makes messages part of the global transaction, and marks the message flow as transactional if the input message is persistent, or uncoordinated if the input message is not persistent. Subsequent nodes in the flow that set the Transaction Mode property to Automatic are included in the global transaction if the flow is marked transactional by the input node.

Transaction coordination of message flows is provided on distributed systems by WebSphere MQ, and on z/OS[®] systems by RRS. Message flows are always globally coordinated on z/OS, regardless of the setting of the message flow's Coordinated property.

Uncoordinated message flows

Uncoordinated flows are flows for which the Coordinated property is not set. Updates to resources that are used by a uncoordinated flow are managed by the separate resource managers. Some resource managers, such as WebSphere MQ, allow updates to be made non-transactionally, or as part of a resource-specific transaction. Other resource managers, such as database managers, always use a resource-specific transaction. A resource-specific transaction is a transaction with a scope that is limited to the resources that are owned by a single resource manager, such as a database or queue manager.

Resource-specific transactions are typically used when only one type of recoverable resource is used in a flow. An example of such a flow is one that contains an MQInput and an MQOutput node, but which does not access any databases. Do not use resource-specific transactions when more than one resource exists and data integrity must be maintained.

Updates that are made to a resource that is accessed non-transactionally are committed immediately. An MQInput node that is configured to be non-transactional removes messages from the queue immediately; if the flow fails, the messages are lost.

Set the Transaction Mode property to Automatic to make some input nodes (such as MQInput or SCADAInput) part of a transaction, depending on the persistence of the input message. If the input message is persistent, messages are made part of the transaction, and the flow is marked as transactional. If the message is not persistent, the flow is marked as non-transactional.

The following sample demonstrates the use of globally-coordinated transactions and the differences in the message flow when database updates are coordinated (the main flow), and when they are not (the error flow).

- Error Handler sample

You can view samples only when you use the information center that is integrated with the Message Broker Toolkit.

Broker schemas

A broker schema is a symbol space that defines the scope of uniqueness of the names of resources defined within it. The resources are message flows, ESQL files, and mapping files.

The broker schema is defined as the relative path from the project source directory to the flow name. When you first create a message flow project, a default broker schema named (default) is created within the project.

You can create new broker schemas to provide separate symbol spaces within the same message flow project. A broker schema is implemented as a folder, or subdirectory, within the project, and provides organization within that project. You can also use project references to spread the scope of a single broker schema across multiple projects to create an application symbol space that provides a scope for all resources associated with an application suite.

A broker schema name must be a character string that starts with a Unicode character followed by zero or more Unicode characters or digits, and the underscore. You can use the period to provide a structure to the name, for example Stock.Common. A directory is created in the project directory to represent the schema, and if the schema is structured using periods, further subdirectories are defined. For example, the broker schema Stock.Common results in a directory Common within a directory Stock within the message flow project directory.

If you create a resource (for example, a message flow) in the default broker schema within a project, the file or files associated with that resource are created in the directory that represents the project. If you create a resource in another broker schema, the files are created within the schema directory.

For example, if you create a message flow Update in the default schema in the message flow project Project1, its associated files are stored in the Project1 directory. If you create another message flow in the Stock.Common broker schema within the project Project1, its associated files are created in the directory Project1\Stock\Common.

Because each broker schema represents a unique name scope, you can create two message flows that share the same name within two broker schemas. The broker schemas ensure that these two message flows are recognized as separate resources. The two message flows, despite having the same name, are considered unique.

If you move a message flow from one project to another, you can continue to use the message flow within the original project if you preserve the broker schema. If you do this, you must update the list of dependent projects for the original project by adding the target project. If, however, you do not preserve the broker schema, the flow becomes a different flow because the schema name is part of the fully qualified message flow name, and it is no longer recognized by other projects. This action results in broken links that you must manually correct. For further information about correcting errors after moving a message flow, see “Moving a message flow” on page 222.

Do not move resources by moving their associated files in the file system; you must use the workbench to move resources to ensure that all references are corrected to reflect the new organization.

The following scope and reuse conditions apply when you create functions, procedures, and constants in a broker schema:

Functions

- Functions are locally reusable and can be called by module-scope subroutines or mappings within the same schema.

- Functions are globally reusable and can be called by other functions or procedures in ESQL or mapping files within any schema defined in the same or another project.

Procedures

- Procedures are locally reusable and can be called from module-scope subroutines in ESQL files within the same schema.
- Procedures are globally reusable and can be called by other functions or procedures in ESQL files within any schema defined in the same or another project.

Procedures cannot be used in mapping files.

Constants

- Constants are locally reusable and can be used where they are defined in any ESQL or mapping file within the same broker schema.
- Constants are not globally reusable; you cannot use a constant that is declared in another schema.

If you want to reuse functions or procedures globally:

- Specify the path of the function or procedure:
 - If you want to reuse a function or procedure in an ESQL file, either provide a fully-qualified reference, or include a PATH statement that defines the path. If you choose to define the path, code the PATH statement in the same ESQL file as that in which the function is coded, but not within any MODULE.
 - If you want to reuse a function in a mapping file, do one of the following:
 - Qualify the function in the Composition Expression editor.
 - Select **Organize Schema References** in the outline view. This detects dependent PATHs and automatically updates the reference.
 - Select **Modify Schema References** in the outline view. You can then select the schema in which the function is defined.

(You cannot reuse a procedure in a mapping file.)
- Set up references between the projects in which the functions and procedures are defined and used.

Generating events for monitoring

You can configure your message flow to emit event messages that can be used to support transaction monitoring, transaction auditing and business process monitoring.

An event is a message published by a message flow when something interesting happens. The message contains information about the source of the event, the time of the event, and the reason for the event. The message can include the message bitstream, and can also include selected fields from the message body. These fields can be used to correlate messages that belong to the same transaction.

Events can be used to support transaction monitoring, transaction auditing and business process monitoring.

Business process monitoring

The events published by a broker can be monitored by WebSphere Business Monitor. Important fields in the message payload can be added to the events

emitted by your message flows, allowing them to be monitored. You can use the following items to help you use WebSphere Business Monitor to monitor your message flows:

Message Driven bean

The events must be submitted to the CEI repository in order for WebSphere Business Monitor to monitor them. A message driven bean is supplied for this purpose. The message driven bean subscribes to the event topic and writes events that match its subscription to the CEI repository.

WebSphere Business Monitor Model

WebSphere Message Broker includes an example Monitor Model for use with WebSphere Business Monitor. This model allows simple flow entry and flow exit events to be monitored. It can be extended to allow monitoring of events which include one or more fields from the message payload. This model is supplied as an IBM Supplied Message.

The following sample provides a Message Driven Bean and a WebSphere Business Monitor Model to help you use WebSphere Business Monitor to monitor events in your message flows:

- WebSphere Business Monitor sample

You can view samples only when you use the information center that is integrated with the Message Broker Toolkit.

Transaction monitoring and auditing

The events published by WebSphere Message Broker can be written to a transaction repository, creating an audit trail of the transactions that are processed by a broker. A transaction repository can be used for monitoring, auditing and replay of transactions. You can perform the following tasks to set up transaction monitoring and auditing.

Design a monitoring profile for your transactions

By default, every flow entry event issued by WebSphere Message Broker contains the message bitstream and a localTransactionId (for transports which have a suitable id). In most cases this information is not sufficient to allow querying of the logged transactions. Key fields and other correlation data can be extracted from the message payload and placed into the ApplicationData/SimpleContent element of the event. The logging application or message flow can extract these fields and log them with the message bitstream.

Subscribe to the event topic and write events to a repository

You can create a message flow that subscribes to the event topic and writes events to a relational database. The details of the database schema depend on the requirements of your organization, for example the number of key fields and transaction ids.

Apply the monitoring profile to your message flows

For information about applying the monitoring profile to your message flows, see “Configure monitoring events for message flows” on page 562.

Monitoring basics

Message flows can be configured to emit event messages that can be used to support transaction monitoring, transaction auditing and business process monitoring.

Events are emitted by the input node in message flows that have been configured to enable monitoring. The following types of input node can emit events:

- “MQInput node” on page 1007
- “JMSInput node” on page 949
- “SOAPInput node” on page 1104
- “SOAPAsyncResponse node” on page 1092
- “HTTPInput node” on page 920

Event types

A message flow can emit the following types of event:

- Message flow entry (transaction start)
- Message flow exit (transaction end)
- Message flow failure (transaction rollback)

If you have enabled event monitoring for a message flow, the message flow emits a pair of events for every message:

- A message flow entry event is emitted when a message arrives at one of the message flow’s input nodes. A message flow entry event is always emitted if the message flow is configured for monitoring.
- A message flow exit event is emitted if the message is processed successfully by the message flow.
- A message flow failure event is emitted if the message flow failed to process the message successfully and the message was backed out. A message flow failure event is only issued if one of the following conditions are true:
 - Neither the Failure or the Catch terminal of the input node is connected.
 - An unhandled exception has occurred in the path from the Failure or Catch terminal of the input node.

A message flow exit (transaction end) event signals that the message flow has ended its own processing successfully. However, processing of the business transaction might have failed, and the message flow might have handled the failure before ending.

Event output options

Events are published to a topic, where they can be read by multiple subscribers. The topic name is of the form:

```
$SYS/Broker/brokerName/Monitoring/executionGroupName/flowName
```

The hierarchical structure allows subscribers to filter the events which they receive. One subscriber can receive events from all message flows in the broker, while another receives only the events from a single execution group.

Message payload data captured in events

Events are generated at flow entry, flow exit and exception events. These events are generated by the supported list of input nodes. The payload data in all events is the sample data received by the input node, and therefore does not show any transformations that have been made to the message data by the message flow.

Monitoring Profiles

A monitoring profile controls the content of the monitoring events emitted by one or more message flows. The default monitoring profile with name `DefaultMonitoringProfile` exists, and is the profile which is used by all message flows. A new monitoring profile can be created using the `mqsicreateconfigurable-service` command.

Message flow accounting and statistics data

Message flow accounting and statistics data is the information that can be collected by a broker to record performance and operating details of message flow execution.

These reports are not the same as the publish/subscribe statistics reports that you can generate. The publish/subscribe statistics provide information about the performance of brokers and the throughput between the broker and clients that are connected to the broker. Message flow accounting and statistics reports provide information about the performance and operating details of a message flow execution.

Message flow accounting and statistics data records dynamic information about the runtime behavior of a message flow. For example, it indicates how many messages are processed and how large those messages are, as well as CPU usage and elapsed processing times. The broker collects the data and records it in a specified location when one of a number of events occurs (for example, when a snapshot interval expires or when the execution group you are recording information about stops).

The broker takes information about statistics and accounting from the operating system. On some operating systems, such as Windows®, UNIX®, and Linux®, rounding can occur because the system calls that are used to determine the CPU times are not sufficiently granular. This rounding might affect the accuracy of the data.

The following restrictions apply to data collection:

- If the message flow starts with a `SCADAInput` node or a `Real-timeInput` node, no data is collected (and no error is reported).
- Data relating to the size of messages is not collected for WebSphere Adapters nodes (for example, the `SAPIInput` node), the `FileInput` node, the `JMSInput` node, or any user-defined input node that does not create a message tree from a bit stream.

Under some circumstances, message size is recorded for the Web Services nodes (for example, the `SOAPInput` node), but the value might not reflect the real input message size and should be ignored.

Collecting message flow accounting and statistics data is optional; by default it is switched off. To use this facility, request it on a message flow or execution group basis. The settings for accounting and statistics data collection are reset to the defaults when an execution group is redeployed. Previous settings for message flows in an execution group are not passed on to the new message flows deployed to that execution group. Data collection is started and stopped dynamically when you issue the `mqsichangeflowstats` command; you do not need to make any change to the broker or to the message flow, or redeploy the message flow, to request statistics collection.

You can activate data collection on both your production and test systems. If you collect the default level of statistics (message flow), the impact on broker performance is minimal. However, collecting more data than the default message flow statistics can generate high volumes of report data that might cause a small but noticeable performance overhead.

When you plan data collection, consider the following points:

- Collection options
- Accounting origin
- Output formats

You can find more information on how to use accounting and statistics data to improve the performance of a message flow in this developerWorks® article on message flow performance.

The following SupportPac™ provides additional information about using accounting and statistics:

- Using statistics and accounting SupportPac (IS11)

Message flow accounting and statistics collection options

The options that you specify for message flow accounting and statistics collection determine what information is collected. You can request the following types of data collection:

- Snapshot data is collected for an interval of approximately 20 seconds. The exact length of the interval depends on system loading and the level of current broker activity. You cannot modify the length of time for which snapshot data is collected. At the end of this interval, the recorded statistics are written to the output destination and the interval is restarted.
- Archive data is collected for an interval that you have set for the broker on the `mqscreatebroker` or `mqschangebroker` command. You can specify an interval of between 10 and 14400 minutes, the default value is 60 minutes. At the end of this interval, the recorded statistics are written to the output destination and the interval is restarted.

An interval is prematurely expired and restarted when any of the following events occur:

- The message flow is redeployed.
- The set of statistics data to be collected is modified.
- The broker is shut down.

This preserves the integrity of the data already collected when that event occurs.

z/OS On z/OS, you can set the command parameter to 0, which means that the interval is controlled by an external timer mechanism. This support is provided by the Event Notification Facility (ENF), which you can use instead of the broker command parameter if you want to coordinate the expiration of this timer with other system events.

You can request snapshot data collection, archive data collection, or both. You can activate snapshot data collection while archive data collection is active. The data recorded in both reports is the same, but is collected for different intervals. If you activate both snapshot and archive data collection, be careful not to combine information from the two different reports, because you might count information twice.

You can use the statistics generated for the following purposes:

- You can record the load that applications, trading partners, or other users put on the broker. This allows you to record the relative use that different users make of the broker, and perhaps to charge them accordingly. For example, you could levy a nominal charge on every message that is processed by a broker, or by a specific message flow.

Archive data provides the information that you need for a use assessment of this kind.

- You can assess the execution of a message flow to determine why it, or a node within it, is not performing as you expect.

Snapshot data is appropriate for performance assessment.

- You can determine the route that messages are taking through a message flow. For example, you might find that an error path is taken more frequently than you expect and you can use the statistics to understand when the messages are routed to this error path.

Check the information provided by snapshot data for routing information; if this is insufficient for your needs, use archive data.

Message flow accounting and statistics accounting origin

Accounting and statistics data can be accumulated and reported with reference to an identifier associated with a message within a message flow. This identifier is the accounting origin. This provides a method of producing individual accounting and statistics data for multiple accounting origins that generate input to message flows. The accounting origin can be a fixed value, or it can be dynamically set according to your criteria.

For example, if your broker hosts a set of message flows associated with a particular client in a single execution group, you can set a specific value for the accounting origin for all these flows. You can then analyze the output provided to assess the use that the client or department makes of the broker, and charge them accordingly.

If you want to track the behavior of a particular message flow, you can set a unique accounting origin for this message flow, and analyze its activity over a given period.

To make use of the accounting origin, you must perform the following tasks:

- Activate data collection, specifying the correct parameter to request basic support (the default is none, or no support). For details, see `mqsichangeflowstats` command.
- Configure each message flow for which you want a specific origin to include ESQL statements that set the unique value that is to be associated with the data collected. Data for message flows for which a specific value has not been set are identified with the value `Anonymous`.

The ESQL statements can be coded in a Compute, Database, or Filter node.

You can configure the message flow either to set a fixed value, or to determine a dynamic value, and can therefore create a very flexible method of recording sets of data that are specific to particular messages or circumstances. For more information, refer to “Setting message flow accounting and statistics accounting origin” on page 566.

You can complete these tasks in either order; if you configure the message flow before starting data collection, the broker ignores the setting. If you start data collection, specifying accounting origin support, before configuring the message flow, all data is collected with the Accounting Origin set to `Anonymous`. The broker

acknowledges the origin when you redeploy the message flow. You can also modify data collection that has already started to request accounting origin support from the time that you issue the command. In both cases, data that has already been collected is written out and collection is restarted.

When data has been collected, you can review information for one or more specific origins. For example, if you select XML publication messages as your output format, you can start an application that subscribes to the origin in which you are interested.

Output formats for message flow accounting and statistics data

When you collect message flow statistics, you can choose the output destination for the data.

Select one of the following destinations:

- User trace
- XML publication
- SMF

Statistics data is written to the specified output location in the following circumstances:

- When the archive data interval expires.
- When the snapshot interval expires.
- When the broker shuts down. Any data that has been collected by the broker, but has not yet been written to the specified output destination, is written during shutdown. It might therefore represent data for an incomplete interval.
- When any part of the broker configuration is redeployed. Redeployed configuration data might contain an updated configuration that is not consistent with the existing record structure (for example, a message flow might include an additional node, or an execution group might include a new message flow). Therefore the current data, which might represent an incomplete interval, is written to the output destination. Data collection continues for the redeployed configuration until you change data collection parameters or stop data collection.
- When data collection parameters are modified. If you update the parameters that you have set for data collection, all data that is collected for the message flow (or message flows) is written to the output destination to retain data integrity. Statistics collection is restarted according to the new parameters.
- When an error occurs that terminates data collection. You must restart data collection yourself in this case.

User trace

You can specify that the data that is collected is written to the user trace log. The data is written even when trace is switched off. The default output destination for accounting and statistics data is the user trace log. The data is written to one of the following locations:

- **Windows** On Windows systems, if the broker workpath has been set using the `-w` option of the `mqsicreatebroker` command, data is written to `workpath\log`. If the broker workpath has not been specified, data is written to `C:\Documents and Settings\All Users\Application Data\IBM\MQSI\common\log`.
- **Linux** **UNIX** On Linux and UNIX systems, data is written to `/var/mqsi/common/log`.

- **z/OS** On z/OS systems, data is written to `/component_filesystem/log`.

XML publication

You can specify that the data that is collected is published. The publication message is created in XML format and is available to subscribers registered in the broker network that subscribe to the correct topic.

The topic on which the data is published has the following structure:

```
$SYS/Broker/brokerName/StatisticsAccounting/recordType/executionGroupLabel/messageFlowLabel
```

The variables correspond to the following values:

brokerName

The name of the broker for which statistics are collected.

recordType

Set to Snapshot or Archive, depending on the type of data to which you are subscribing. Alternatively, use # to register for both snapshot and archive data if it is being produced.

executionGroupLabel

The name of the execution group for which statistics are collected.

messageFlowLabel

The label on the message flow for which statistics are collected.

Subscribers can include filter expressions to limit the publications that they receive. For example, they can choose to see only snapshot data, or to see data that is collected for a single broker. Subscribers can specify wild cards (+ and #) to receive publications that refer to multiple resources.

The following examples show the topic with which a subscriber should register to receive different sorts of data:

- Register the following topic for the subscriber to receive data for all message flows running on *BrokerA*:
\$SYS/Broker/*BrokerA*/StatisticsAccounting/#
- Register the following topic for the subscriber to receive only archive statistics relating to a message flow *Flow1* running on execution group *Execution* on broker *BrokerA*:
\$SYS/Broker/*BrokerA*/StatisticsAccounting/Archive/*Execution*/*Flow1*
- Register the following topic for the subscriber to receive both snapshot and archive data for message flow *Flow1* running on execution group *Execution* on broker *BrokerA*:
\$SYS/Broker/*BrokerA*/StatisticsAccounting/#/*Execution*/*Flow1*

Message display, test and performance utilities SupportPac (IH03) can help you with registering your subscriber.

SMF

On z/OS, you can specify that the data collected is written to SMF. Accounting and statistics data uses SMF type 117 records. SMF supports the collection of data from multiple subsystems, and you might therefore be able to synchronize the information that is recorded from different sources.

When you want to interpret the information recorded, you can use any utility program that processes SMF records.

Message flow aggregation

Aggregation is the generation and fan-out of related requests that are derived from a single input message, and the fan-in of the corresponding replies to produce a single aggregated reply message.

The initial request that is received by the message flow, representing a collection of related request items, is split into the appropriate number of individual requests to satisfy the subtasks of the initial request. This process is known as fan-out, and it is provided by a message flow that includes aggregation nodes.

Replies from the subtasks are combined and merged into a single reply, which is returned to the original requester (or another target application) to indicate completion of the processing. This process is known as fan-in, and it is also provided by a message flow that includes aggregation nodes.

A message aggregation is initiated by a message flow that contains the `AggregateControl` node followed by an `AggregateRequest` node. The responses are aggregated back together using a flow that contains the `AggregateReply` node. The aggregation nodes work correctly only for transports that use a request/reply model; for example, WebSphere MQ Enterprise Transport.

If you use WebSphere MQ Enterprise Transport, the responses that are received by the fan-in flow must be valid reply messages that contain the reply identifier. You must set the reply identifier to the value of the message in the request message's message descriptor (MQMD), then store the reply identifier in the correlation identifier field (`CorrelId`) of the MQMD. If the `CorrelId` is set to `MQCI_NONE`, the `AggregateReply` node issues an error because the reply message is not valid, and cannot be matched to a request message.

WebSphere Message Broker provides three message flow nodes that support aggregation:

- The `AggregateControl` node
- The `AggregateRequest` node
- The `AggregateReply` node

When you include these nodes in your message flows, the multiple fan-out requests are issued in parallel from within a message flow. The standard operation of the message flow is for each node to perform its processing in sequence.

You can also use these aggregation nodes to issue requests to applications outside the broker environment. Messages can be sent asynchronously to external applications or services; the responses are retrieved from those applications, and the responses are combined to provide a single response to the original request message.

These nodes can help to improve response time because slow requests can be performed in parallel, and they do not need to follow each other sequentially. If the subtasks can be processed independently, and they do not need to be handled as part of a single unit of work, they can be processed by separate message flows.

You can design and configure a message flow that provides a similar function without using the aggregation nodes, by issuing the subtask requests to another

application (for example, using the HTTPRequest node), and recording the results of each request in the LocalEnvironment. After each subtask has completed, merge the results from the LocalEnvironment in a Compute node, and create the combined response message for propagating to the target application. However, all the subtasks are performed sequentially, and they do not provide the performance benefits of parallel operation that you can achieve if you use the aggregation nodes.

Examples of aggregation flows that use the aggregation nodes are provided in the following samples:

- Aggregation sample
- Airline Reservations sample

The Aggregation sample demonstrates a simple four-way aggregation, and the Airline Reservations sample simulates requests that are related to an airline reservation service, and illustrates the techniques that are associated with aggregation flows. You can view samples only when you use the information center that is integrated with the Message Broker Toolkit.

In previous releases of WebSphere Message Broker, the aggregation nodes used a table in the broker database to persist aggregation requests. From WebSphere Business Integration Message Broker Version 5.0 onwards, you can use WebSphere MQ instead. The external functioning of aggregation nodes is unchanged, but you can configure an execution group to use WebSphere MQ queues for storing aggregations, instead of a database table. Using WebSphere MQ in this way improves performance and means that you can run aggregation in a non-persistent mode when persistence of aggregation requests is not required. For details of how to migrate and configure an execution group to use WebSphere MQ, see “Using WebSphere MQ to store state in aggregation nodes” on page 590. If you change from using a database table to using WebSphere MQ to store aggregation state, no migration of existing aggregations is performed. Therefore, you must ensure that no outstanding aggregations exist, because these aggregations are not migrated.

The aggregation nodes store state for aggregations on WebSphere MQ queues. If you do not specify a timeout on the AggregateControl node, or if you leave it set to zero, aggregation requests that WebSphere MQ stores internally are never cleaned up unless all reply messages return. This situation could lead to a gradual build up of messages on the internal queues. Set the timeout to a value greater than zero to ensure that requests are cleaned up and queues do not fill with redundant requests. It is good practice to set the timeout value to a large value, for example, 864000 seconds (24 hours), so that the queues clear old aggregation messages even if timeouts are not required or expected.

The aggregation nodes use WebSphere MQ message expiry to manage timeout of messages. For message expiry to work, the aggregation nodes must browse the message queues. The aggregation nodes browse the queues automatically to ensure that expired messages are processed.

z/OS On z/OS, you can configure WebSphere MQ to run a scavenger process that browses the queues instead of the aggregation nodes. To enable the scavenger, set the broker’s queue manager property EXPRYINT to 5 seconds. If you do not set EXPRYINT, or set it to a value higher than 10 seconds, the aggregation nodes revert to browsing the aggregation queues automatically.

Message collection

Message collection is the generation of a single message that can derive from multiple messages from one or more sources. This single message containing multiple source messages is known as a message collection.

You can use a Collector node to group together messages from one or more sources into a message collection, so that they can be processed together by downstream nodes. You can also manually build a message collection using a JavaCompute node.

Structure of a message collection

A message collection tree contains sub-trees that hold the content of the individual messages received by the Collector node. The message assembly that is propagated from the Collector node to other nodes in your message flow contains the following four components:

- Message (including transport headers)
- Local environment
- Global environment
- Exception list

The following figure is an example of the message tree structure of a message collection. The message collection in this example contains two messages, one received from WebSphere MQ, and one from a file input source.

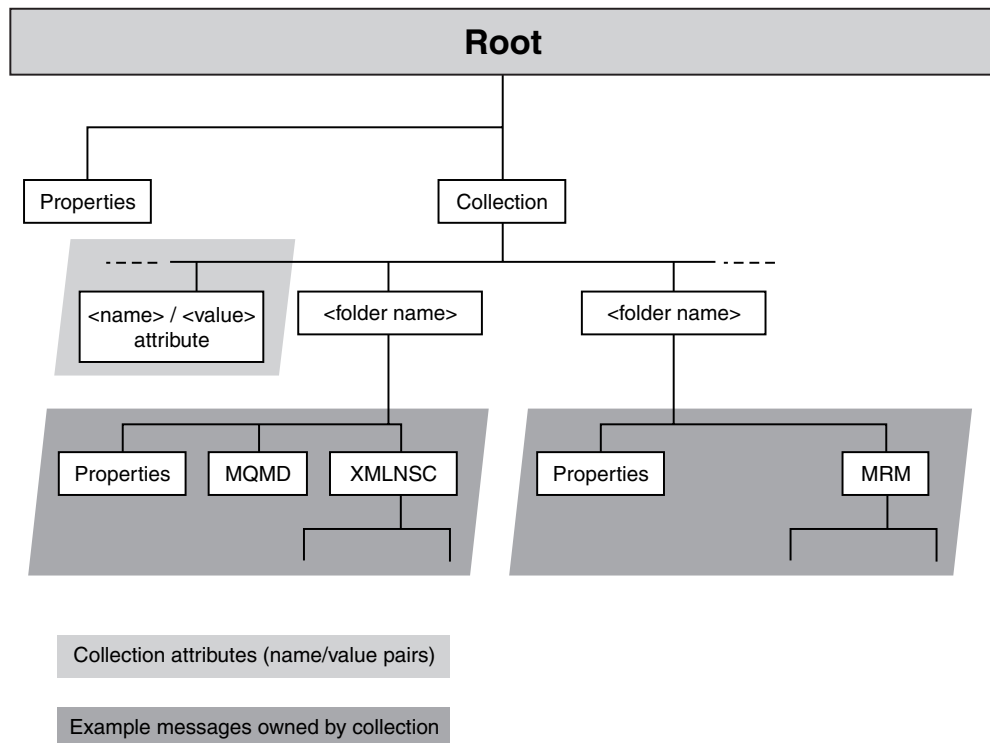

A message collection has a Properties header and a single folder element named Collection. A message collection can also have zero or more attributes that are name/value pairs; the name of an attribute must be unique within a message

collection. These are shown as <name> / <value> in the figure. A standard attribute for the message collection is an attribute called *CollectionName*. If you use a Collector node to generate a message collection, the value for the collection name is generated based on the values you configure in the node. The collection name attribute is not compulsory.

Within the Collection folder in the message collection tree structure are folders, shown as <folder name> in the diagram. These folders contain the message tree of each message added to the message collection. Each of these folders has a name, but this name does not have to be unique within the message collection. The value for the <folder name> is derived from the source of the input message. The LocalEnvironment, Environment and ExceptionList trees are not included in the structure, but are instead carried separately as a part of the message assembly. There is no concept of a LocalEnvironment associated with each message in a message collection.

You can not use a message collection as a source message for another message collection. Nested message collections are not permitted. For example, If you attempt to pass a message collection to an input terminal on a Collector node, an error is generated.

Generating a message collection using a Collector node

You can use the Collector node to make multiple synchronous or asynchronous requests in parallel. The results of these requests can be joined together downstream if required. This is different from the behavior of the aggregation nodes where there is a fixed pattern of request/response and where reply messages are grouped by request id. In contrast, the collector node does not need an initial fan-out stage and can group together unrelated input messages by correlating their content. You can configure dynamic input terminals on a Collector node to receive messages from different sources. You can also configure properties on the Collector node, known as event handlers, to determine how messages are added to a message collection, and when a message collection is complete.

Processing a message collection

A message collection is supported by the following nodes only:

- Compute
- JavaCompute

Errors are generated by other nodes if they receive a message collection.

You can use ESQL or XPATH expressions to access the content of messages in a message collection by referencing the folder names. To access the contents of a message in a message collection using ESQL you can use code similar to the following ESQL:

```
InputRoot.<collection name>.<folder1>.XMLNSC
```

Examples of XPath expressions that you can use to access the message collection are:

- /*: returns a list of all the messages in the message collection.
- /@*: returns a list of all the attributes of the message collection.
- /@Name: returns the value of the attribute Name.

You might not be able to determine the order of the messages within a message collection. If you generate a message collection using the Collector node, the messages are arranged in the same order as the messages arrived at the node.

Converting data with message flows

Convert data that you are transferring between different environments.

Data conversion is the process by which data is transformed from the format recognized by one operating system into that recognized by a second operating system with different characteristics such as numeric order.

If you are using a network of systems that use different methods for storing numeric values, or you need to communicate between users who view data in different code pages, you must consider how to implement data conversion.

Numeric order

For numeric and encoding aspects, consider:

- Big Endian versus Little Endian
- Encoding values in WebSphere MQ (the Encoding field in the MQMD)

Encoding values are system specific. For example, Windows typically has an encoding of 546, hexadecimal value X'00000222'. The three final hexadecimal digits identify:

1. The float number format

This value can be 1 (IEEE format byte order normal), 2 (IEEE format byte order reversed), or 3 (zSeries[®] format byte order normal).

Operations on floating point numbers, whether IEEE or z/Series (S/390[®]) format, are subject to rounding error.

2. The packed decimal number format

This value can be 1 (byte order normal) or 2 (byte order reversed).

3. The hexadecimal number format

This value can be 1 (byte order normal) or 2 (byte order reversed).

The bit order within a byte is never reversed. Byte order normal means that the least significant digit occupies the highest address.

Systems that process numbers in normal byte order are Big Endian (z/Series, iSeries[™], Linux, and UNIX). Systems that process numbers in reversed byte order are Little Endian (mainly PCs).

For further details about numeric order, see "Appendix D Machine encodings" of the *Application Programming Reference* section in the WebSphere MQ Version 6 information center online.

Code page conversions

Code page conversion might be required for any of the following reasons:

- ASCII versus EBCDIC
- National languages
- Operating system specific code pages

For more information about code page support in WebSphere MQ, see the *Application Programming Reference* section in the WebSphere MQ Version 6 information center online.

When you use WebSphere Message Broker, you can use the data conversion facilities of WebSphere MQ, WebSphere Message Broker, or both.

WebSphere MQ facilities

Headers and message body are converted according to the MQMD values, and other header format names. You might have to set up data conversion exits to convert the body of your messages.

When you use WebSphere MQ facilities, the whole message is converted to the specified encoding and CCSID, according to the setting of the format in the WebSphere MQ header.

For more detail about data conversion using WebSphere MQ facilities, see "Appendix F Data conversion" in the *Application Programming Reference* section in the WebSphere MQ Version 6 information center online.

WebSphere Message Broker facilities

You can model your messages in the MRM through the workbench. Predefined elements of the messages are converted according to their type and physical layer characteristics. For further details, see *Configuring physical properties*. You can also use self-defining messages. You can then use the Compute or JavaCompute node to configure encoding and CCSIDs. You do not need WebSphere MQ data conversion exits.

- String data is converted according to the CCSID setting.
- Decimal integer and float extended decimal types are converted according to the CCSID setting.
- Decimal integer and float (other physical data types) are converted according to the Encoding setting.
- Binary and Boolean data is not converted.

WebSphere Message Broker can also convert those WebSphere MQ headers for which parsers are provided.

When you use WebSphere Message Broker facilities, the whole message is not converted to the specified encoding and CCSID: you can specify a different encoding, or CCSID, or both, in each header to perform a different conversion for the following part of the message. The encoding and CCSID in the last header defines the values for the message body.

User exits

A user exit is user-provided custom software, written in C, to track data passing through message flows.

User-provided functions can be invoked at specific points during the life cycle of a message while it passes through the message flow, and can invoke utility functions to query information about the point in the flow, and the contents of the message assembly. The utility function can also modify certain parts of the message assembly. For more information about using user exits, see *Why use a user exit?*

The user exits can be invoked when one or more of the following events occur:

- The end of a unit-of-work (UOW) or transaction (COMMIT or ROLLBACK).
- A message passes between two nodes.
- A message is successfully enqueued or sent to a transport in an output, reply, or request node.
- A message is dequeued or received in an input, response, or TimeoutNotification node.

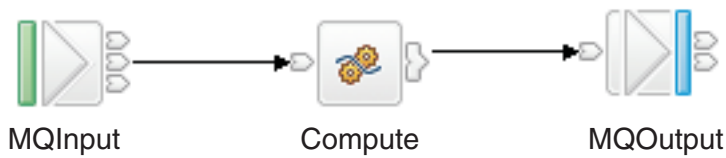

In the basic message flow shown here, you can track messages at three levels:

- Transaction level
- Node level
- Input or output level

At the transaction level, you can track the following events:

- Messages being read into the flow
- Completion of the transaction

At the node level, you can track the following events:

- A message passing from one node to another
- Completion of processing for one node

At the message input or output level, you can track the following events:

- Messages being read into the flow
- Messages being written from the flow

Therefore, you can track five different types of event, which occur in the following sequence:

1. A message is dequeued from the input source (read into the flow).
2. A message is propagated to the node for processing.
3. A request message is sent to the output node's transport, and transport-specific destination information is written to "WrittenDestination" in the LocalEnvironment.
4. Node processing is completed.
5. The transaction ends.

Getting started with Quick Start wizards

A Quick Start wizard sets up the basic resources that are required to develop a Message Broker application. The wizard sets up and gives names to containers for the resources in which you subsequently develop your application.

The topics in this section describe how to use the Quick Start wizards.

Concept topics:

- "Quick Start wizards overview" on page 131

Task topics:

- "Creating an application from scratch" on page 131
- "Creating an application based on WSDL or XSD files" on page 132
- "Creating an application based on an existing message set" on page 134
- "Creating an application using WebSphere Adapters" on page 135

Quick Start wizards overview

This concept topic describes the Quick Start wizards.

You can use a Quick Start wizard to set up the basic resources that are required to develop a Message Broker application. The wizard sets up and gives names to containers for the resources in which you subsequently develop an application. The resources that can be set up are as follows:

Message flow project

A specialized container in which you create and maintain all the resources associated with one or more message flows.

Message set project

A specialized container in which you create and maintain all the resources that are associated with a message set.

Message set

A container for grouping messages and associated message resources (elements, types, groups).

Message flow

A container for a sequence of processing steps that execute in the broker when an input message is received.

Working set

A specialized container in which you can group related application projects, so that you limit the number of resources that are displayed in the Broker Development view.

The Quick Start wizards are:

- **Start from scratch**, described in “Creating an application from scratch”
- **Start from WSDL and/or XSD files**, described in “Creating an application based on WSDL or XSD files” on page 132
- **Start from existing message set**, described in “Creating an application based on an existing message set” on page 134
- **Start from adapter connection**, described in “Creating an application using WebSphere Adapters” on page 135

Creating an application from scratch

This task topic describes how to use the Start from scratch wizard to create the basic resources that are required to develop a Message Broker application. The Start from scratch wizard creates a message flow project, a message set project, sets up the project dependency, creates a message set and, optionally, creates a message flow and working set. To create these resources, perform the actions in this topic.

1. Switch to the Broker Application Development perspective.
2. Open the Start from scratch wizard by doing one of the following:
 - At the top of the Broker Development view, click on the down arrow . A list containing the three Quick Start wizards is displayed.
 - Click **Start from scratch**.
 - Click **File> New> Project** or right-click anywhere in the Broker Development view and then click **New> Project** on the pop-up menu. The New Project window opens.
 - a. Expand **Message Brokers**. A list of wizards is displayed.

- b. Click the **Start from scratch** and click **Next**.

The **New Message Broker Application** panel of the wizard is displayed. In this panel, you can type the names of the basic resources that are required to develop a Message Broker application.

3. Type into the appropriate fields, the names of the message flow project, the message set project, the message set, the message flow, and the name of the working set that contains the two new projects. Default names of the message flow project, the message flow, and the working set are already displayed in the appropriate fields, but you can edit these fields by typing your own names for these resources.

Note: You can change any of the names that are displayed by typing into the appropriate field the name that you want. You can also clear either of the check boxes that relate to the creation of a new message flow or a new working set; if you do this, you cannot enter text into the associated name field, and the associated resource file will not be created.

4. Click **Next**. The **Message set Physical Formats** panel is displayed. The panel lists three physical formats: **XML documents**, **Binary data** (Custom Wire Format), and **Text data** (TDS Format).
5. Select one or more of the check boxes to describe the type of message data that you want to process. If you do not select a check box, **XML documents** is selected by default.
6. Click **Finish** to complete the task. The Start from scratch wizard closes.

The wizard creates a message flow project, message set project, message set, and, optionally, a message flow, with the names that you have specified. It also creates, optionally, a new working set, with the name that you have specified. The working set contains all of the resources you have created, and the Broker Development view shows the new working set as the active working set. If you have chosen not to create a new working set, the projects are created in the active working set currently shown in the Broker Development view.

The XML, CWF or TDS formats are created with default names for the message set.

The message flow, if created, is opened in the message flow editor.

If you have created a message flow, you can now go on to “Defining message flow content” on page 227.

Creating an application based on WSDL or XSD files

This task topic describes how to create a new application that is based on existing WSDL or XSD files.

1. Switch to the Broker Application Development perspective.
2. Open the New Message Broker Application wizard.
 - a. Click **File> New> Project**, or right-click anywhere in the Broker Development view and then click **New> Project**. The New Project window opens.
 - b. Double-click **Message Brokers**. A list of wizards is displayed.
 - c. Select **Start from WSDL and/or XSD files** and then click **Next**.

The first panel of the New Message Broker Application wizard is shown.

3. Set up the basic resources that are required to develop a Message Broker application that uses existing WSDL and XSD files as a starting point.
 - Type the name of your new application in the **Message flow project name** field.

The name that you type is also displayed in the **Message set project name** and **Message set name** fields, but with 'MessageSet' appended.

Similarly, the name that you type is also displayed in the **Message flow name** field (with 'Flow' appended), and in the **Working set name** field.

- Click **Next**.

Note: You can change any of the names that are displayed by typing into the appropriate field the name that you want. You can also clear either of the check boxes that relate to the creation of a new message flow or a new working set; if you do this, you cannot enter text into the associated name field.

4. Select the WSDL or XSD files that you want to use as the initial contents of the message set.
 - If you want to choose WSDL or XSD files that exist in your workspace, click **Use resources from the workspace**.

You are presented with a list of resources from which you can choose. Resources are filtered to only show artifacts in the active working set.

- If you want to choose WSDL or XSD files that exist outside your workspace, click **Use external resources** and type a directory name in the **From directory** field. Click **Browse ...**

You are presented with a list of the items in that directory. Make your choice from this list.

In both cases, a two-pane view is displayed. On the left side, containers (for example, projects, folders, and message sets) are displayed. On the right side, the contents of these containers are shown. Depending on which button was clicked, either a workspace view or a file system view of the resources is displayed.

If the only use of the XSD file is from the WSDL bindings, you do not need to select an XSD file that a selected WSDL file depends on.

The view incorporates an option that allows you to copy the source file into the `importFiles` directory of the message set.

You can use this option as follows:

If you choose only WSDL files, you can select the check box.

If you choose only XSD files, the option is automatically selected and the check box is greyed out. If you subsequently select a WSDL file, the check box is enabled but the selection state is not changed; that is, the check box remains selected.

Regardless of what you select, if the `importFiles` folder exists in the message set project after the import, it is collapsed.

If you import only WSDL files, the wizard sets the default message domain to SOAP.

5. Click **Next**. If you selected one or more WSDL files, the WSDL files that you selected are shown in a check box tree, with the acceptable bindings for each file shown as children.
6. (Optional) Select one or more bindings for each of the WSDL files that you selected. If you do not select at least one binding for each WSDL file, an error message is displayed and the **Next** and **Finish** buttons are disabled.

7. Click **Next**. If you selected one or more XSD files, the XSD files that you selected are displayed in the next pane, with the global elements for each file shown as children.
8. (Optional) Select the global elements from which you want to create message definitions. Click **Next**.
9. (Optional) If any errors or warnings are listed, either click **Finish**, if you want the import to be attempted regardless of the errors or warnings listed, or click **Cancel** to terminate the import. You can then correct any errors and attempt the import again.
10. Click **Finish**.

After a WSDL file has been imported into a message set, you can drag and drop the WSDL file onto the message flow editor.

Creating an application based on an existing message set

Before you start:

You must have completed the following task:

- Creating a message set

This task topic describes how to create a new application that is based on an existing message set.

1. Switch to the Broker Application Development perspective.
2. Open the New Message Broker Application wizard.
 - a. Click **File> New> Project**, or right-click anywhere in the Broker Development view and then click **New> Project**. The New Project window opens.
 - b. Click **Message Brokers**. A list of wizards is displayed.
 - c. Select **Start from existing message set** and then click **Next**.

The first panel of the New Message Broker Application wizard is shown.

3. Set up the basic resources that are required to develop a Message Broker application from an existing message set.
 - a. (Optional) If the message set that you want to use is in a .zip file, click **Import a message set from a ZIP file** and either type the location of the message set in the **Zip file** and **Zipped message set** fields, or click **Browse...** and select and open the .zip file from the list that is displayed, and then select the required message set. If the .zip file that you specify does not contain a message set, you receive a message that tells you this. If you want, you can then type a different location for the message set in the **Zip file** field. Otherwise click **Cancel**.
 - b. (Optional) If the message set that you want to use is not in a .zip file, click **Create a new message set by copying an existing message set** and type into the **Message set to copy** field the name of the message set file that you want to copy. A list is displayed of the message set names that you can choose from. Message sets are filtered to only show artifacts in the active working set.
 - c. Click **Next**.

A panel of the New Message Broker Application wizard is shown. In this panel, you can type the names of the projects, the message flow, the message set, and the working set that contains the two new projects.

4. Type into the appropriate fields, the names of the projects, the message flow, the message set, and the working set that contains the two new projects. Default names of the message flow project, the message flow, and the working set are already displayed in the appropriate fields, but you can edit these fields by typing your own names for these resources. Note, however, that if the message set is copied from a .zip file that is a project interchange file, you cannot edit the names of the message set project and the message set; the names are imported from the .zip file.
5. Click **Finish**. The new message set project, message set, message flow project, and message flow are created. A new working set is also created, if required. The new projects appear in the specified working set. The contents of the message set project and the message flow project are displayed in the Broker Development view. The message flow is opened in the message flow editor.

Creating an application using WebSphere Adapters

Use the **Start from adapter connection** quick start wizard to create an application that uses WebSphere Adapters.

Before you start:

- Read “WebSphere Adapters nodes” on page 7
 - Prepare the environment for WebSphere Adapters nodes
 - Perform the preparatory tasks listed in “Developing message flow applications using WebSphere Adapters” on page 245
1. Switch to the Broker Application Development perspective.
 2. At the top of the Broker Development view, from the list of Quick Start wizards, click **Start from adapter connection**. If the list of wizards is not displayed, click the down arrow . The Adapter Connection wizard opens.
 3. Follow the instructions in the wizard.
 4. Click **Finish**.

When you have completed the steps in the wizard, the specified message set project contains a message set with a message type for each business object, and the specified message flow project references the message set project.

Creating an application using the Configure New Web Service Usage wizard

Use this topic to generate a message flow using the Configure New Web Service usage wizard.

This task topic describes how to create a new application using the Configure New Web Service Usage wizard.

1. Open a message set project containing a WSDL file.
2. Select a WSDL file from either the message set or the ImportFiles folder and drag and drop the WSDL file onto the Message Flow Editor canvas. Validation occurs and if any of the following errors occurs, a message appears in a message box:
 - WSDL file does not come either from a message set or ImportFiles folder of the message set project.

For a multiple-file WSDL the process also checks that either, imports inside the main WSDL have been properly imported into the message set, or imports are available in the ImportFiles folder.

- The message set that contains the WSDL file does not support any one of the SOAP, XMLNSC, XMLNS, or MRM domains.

However, if the message set that contains the WSDL file does not support only the SOAP domain, you are given an option to generate a flow based on the HTTP nodes, and the process continues.

- There are no HTTP bindings in the WSDL file.
- There are no port types in the WSDL file.

Note that the WSDL file being dropped onto the Message Flow Editor canvas should be WS-I compliant for the flow and sub-flows to be created correctly. If there are no errors, the first page of a **Configure New Web Service Usage** wizard appears. See Configure Web Service Usage details for further information on the following fields.

3. In **Web service usage**, select Expose message flow as a web service or Invoke web service from message flow. Selecting Expose message flow as a web service means that you can use WebSphere Message Broker with other applications on the web, whereas selecting Invoke web service from message flow means that you use WebSphere Message Broker to start the web service.
4. Select the **Port type** you are going to use. By default, the initially selected port type is the first one that has at least one http binding associated with it.

You receive an error message in the following circumstances:

- Selected port type does not contain at least one operation.
 - No SOAP bindings (with HTTP transport) in the WSDL document are associated with the port type.
5. Select the **Binding** you are going to use. You receive an error message in the following circumstances:
 - Selected binding has no operations associated with it.
 - Selected binding has no ports associated with it.

The **Service Port** box lists all the WSDL ports that point to a selected binding.

6. Select the **Binding operations** that you require. By default, only those operations implemented by the binding you choose are selected.

If you select one of the operations that is not implemented by the selected binding, you receive a warning message, but you can continue.

7. Click **Next** to go to the second page . See File generation details for further information on the following fields.
8. Select **HTTP nodes** if you have imported the WSDL file from a message set and do not want the default value of **SOAP nodes**. If you select **HTTP nodes** you see a message explaining the advantages of using the SOAP nodes. Using SOAP nodes allows you to use features such as WS_Security and WS_Addresssing. However, if the message set does not support the SOAP domain you receive an error message.

Note, that if you import the WSDL file from the ImportFiles folder, you cannot select **SOAP nodes**.

All the file names that are about to be generated, together with their location are listed on this page.

A **Details** pane appears if there are any warnings about the subflow that is generated.

9. Click **Finish** to complete the wizard, create the subflow, and add appropriate nodes to the main flow. See “Web service provider message flow generated” for details about the subflow and nodes generated by the wizard if you selected Expose message flow as a web service as the initial step.

See “Web service consumer message flow generated” on page 138 for details about the subflow and nodes generated by the wizard if you selected Invoke web service from message flow as the initial step.

Web service provider message flow generated

This provides additional information in relation to the Configure New Web Service Usage wizard about the message flow generated when the flow is a web service provider.

Note that the default name for the generated subflow is prefixed by the name of the WSDL file you selected.

Generated message flow

The message flow generated consists of a:

SoapInput node

This SOAPInput node fills in the LocalEnvironment destination tree with the SOAP operation so that it can be followed either by a:

- SOAPExtract node, or by a
- RouteToLabel node. In this case, appropriate Label nodes need to be in place.

The out terminal of the SOAPInput node is connected to the in terminal of the SOAPExtract node.

Subflow node

The subflow node name reflects the name of the WSDL file.

SOAPReply node

This node sends the response message back to the originating client.

Typically, you connect the output of your node, or nodes, that handle your operation, or operations, to the in terminal of the SOAPReply node.

Generated message subflow

The generated subflow is constructed as follows:

- The input node is connected to the SOAPExtract node, which removes the SOAP envelope.

The SOAPExtract node also allows for routing of the SOAP messages, based on the operation being performed. In particular, the SOAP message is routed to a Label node within the message flow as identified by the SOAP operation within the message.

- The Failure output terminal of the SOAPExtract node is connected to the Output node used when a process fails named, for example, failure.
- A Label node is generated for each SOAP operation and each Label node is connected to the corresponding Output node.
- Each Output node in the subflow corresponds to an output terminal for the SOAPExtract node in the main message flow.

Therefore, there is one failure output terminal, plus one output terminal for each operation.

Typically, you connect the output terminal corresponding to the operation you require to the node, or nodes, that handle this operation, for example, Compute node.

Web service consumer message flow generated

This provides additional information in relation to the Configure New Web Service Usage wizard about the message flow generated when the flow is a web service consumer.

Note that the default name for the generated subflow is prefixed by the name of the WSDL file you selected.

Generated message flow

The low generated consists of a single node that has a number of output terminals:

- Failure
- Error
- Fault
- One more, corresponding to the name of the selected operation.

Typically, your message flow feeds an input message to the in terminal of the generated subflow node, and handles various outcomes of the web service invocation.

The default name of the subflow node is a combination of selected operation and WSDL file name. You can change the name of the corresponding `.msgflow` file on the second page of the wizard; see Configure New Web Service Usage wizard: File generation details.

The generated `.msgflow` file is placed into the `gen` folder of the message set project; see “Generated message subflow” for details of this subflow.

Generated message subflow

The generated subflow is constructed as follows:

- A SOAPRequest node immediately follows an Input node. This is a synchronous request and response node that blocks after sending the request, until the response is received. The SOAPRequest node parses the response message.
- The Failure and Error terminals are connected to the Output nodes for failure and error respectively.
- The Out terminal is connected to the SOAPExtract node.

The SOAPExtract node removes the SOAP envelope so that the body of a SOAP message is extracted.

The SOAPExtract node also allows for routing of the SOAP messages, based on the operation being performed. Note that only the selected operation and fault are handled.

In particular, the SOAP message is routed to a Label node within the message flow as identified by the SOAP operation or a `ws__Fault` label, if fault is returned from the web service.

Each Label node is connected to the corresponding Output node.

The Failure terminal of the SOAPExtract node is connected to the Output node for failure.

- Each Output node in the subflow corresponds to an output terminal for the subflow node.
Therefore, there are three output terminals:
 - Failure
 - Fault
 - One for the selected operation.

Designing a message flow

A message flow can perform a wide range of operations, depending on your business and operational requirements. For best performance and capability, you must design it to include the most appropriate nodes.

Before you start:

Read the following concept topic: “Message flow nodes” on page 5.

When you design a message flow, consider the following questions and options:

- The mode that your broker is working in can affect the types of node that you can use and the number of message flows you can deploy. For more information, see Restrictions that apply in each operation mode.
- Which nodes provide the function that you require. In many cases, you can choose between several nodes that provide a suitable function. You might have to consider other factors listed here to determine which node is best for your overall needs. You can include built-in nodes, user-defined nodes, and subflow nodes. For more information, see “Deciding which nodes to use” on page 141.
- Whether it is appropriate to include more than one input node. For more information, see “Using more than one input node” on page 152.
- How to specify the characteristics of the input message. For more information, see “Defining input message characteristics” on page 153.
- Whether to determine the path that a message follows through the message flow, based on the content or the characteristics of the message. Several nodes provide checks or examination of the message, and have output terminals that can be connected to direct certain messages to different nodes. For more information, see “Using nodes for decision making” on page 154.
- Whether you can use subflows that provide a well-defined subset of processing. You might be able to reuse subflows that were created for another project (for example, an error processing routine), or you might create a subflow in your current project, and reuse it in several places within the same message flow. For more information, see “Using subflows” on page 156.
- What response times your applications expect from the message flow. This factor is influenced by several aspects of how you configure your nodes and the message flow. For more information, see “Optimizing message flow response times” on page 158.
- Whether your message flow processing makes demands on system resources such as stack size. For more information, see “System considerations for message flow development” on page 160.
- Whether you can use the destination list within the LocalEnvironment that is associated with the message to determine the processing within the message flow (for example, using RouteToLabel and Label nodes), or the target for the output messages (for example, by setting the Destination Mode property of the MQOutput node to Destination List). For more information, see “Creating destination lists” on page 162.

- Whether to use WebSphere MQ cluster queues. For more information, see “Using WebSphere MQ cluster queues for input and output” on page 162.
- Whether to use WebSphere MQ shared queues on z/OS . For more information, see “Using WebSphere MQ shared queues for input and output (z/OS)” on page 164.
- Whether to validate input messages that are received by the input node, or output messages that are generated by the Compute node, or both. For more information, see “Validating messages” on page 164.
- Whether to view or record message structure in Trace node output. For more information, see “Viewing the logical message tree in trace output” on page 167.
- Whether your message flows access data in databases. You must configure brokers, databases, and database connections to enable this function, as described in Configuring databases. You must also configure your message flows; see “Accessing databases from message flows” on page 170.

If you include nodes that use ESQL, for information about how to code the appropriate statements, see “Accessing databases from ESQL” on page 172. If you want to access databases from Java nodes using JDBC, see “Interacting with databases using the JavaCompute node” on page 467 or Extending the capability of a Java message processing or output node.

You can also access databases through the Broker Application Development perspective in the workbench; see “Adding database definitions to the Message Broker Toolkit” on page 494.

- Whether your message flows access data in files. Using the FileInput and FileOutput nodes, your message flows can read messages from files and write messages to files in the local file system, or on a network file system that appears local to the broker. For more information, see “Working with files” on page 717.
- Whether your messages must be handled within a transaction. You can set the properties of some built-in nodes to control how transactions are managed, and how messages are processed within a transaction. For more information, see “Configuring globally coordinated message flows” on page 173.
If you want to include JMSInput and JMSOutput nodes in your message flow transactions, you must consider the additional information in “Configuring JMSInput and JMSOutput nodes to support global transactions” on page 176.
- Whether you want your messages to go through data conversion. For information about the available options, see “Configuring message flows for data conversion” on page 183.
- Whether you want to use the MQGet node. For more information about how messages are processed by the MQGet node, and a description of a request-reply scenario using this node, see “Using MQGet nodes” on page 185.
- How your message flows can benefit from user exits. For more information, see “Exploiting user exits” on page 198.
- What steps to take to ensure that messages are not lost. For more information, see “Ensuring that messages are not lost” on page 200.
- How errors are handled within the message flow. You can use the facilities provided by the broker to handle any errors that arise during message flow execution (for example, if the input node fails to retrieve an input message, or if writing to a database results in an error). However, you might prefer to design your message flow to handle errors in a specific way. For more information, see “Handling errors in message flows” on page 203.

- Whether you want a systems monitoring tool to be able to query, discover, and set certain user-defined properties at run time. For more information, see [Setting user-defined properties dynamically at run time](#).

For a basic introduction to developing message flows, see the IBM Redbooks publication [WebSphere Message Broker Basics](#). (This link works only if you are connected to the Internet.)

Deciding which nodes to use

WebSphere Message Broker includes a large number of message processing nodes that you can use within your message flows.

Before you start:

Read the concept topic about message flow nodes.

WebSphere Message Broker also provides an interface that you can use to define your own nodes, known as user-defined nodes.

The mode that your broker is working in can affect the types of node that you can use; see [Restrictions that apply in each operation mode](#).

Your decision about which nodes to use depends on the processing that you want to perform on your messages.

Input and output nodes

Input and output nodes define points in the message flow to which client applications send messages (input nodes, such as MQInput), and from which client applications receive messages (output nodes, such as MQOutput). Client applications interact with these nodes by putting messages to, or getting messages from, the I/O resource that is specified by the node as the source or target of the messages. Although a message flow must include at least one input node, it does not need to include an output node.

- If you are creating a message flow that you want to deploy to a broker, you must include at least one input node to receive messages. The input node that you choose depends on the source of the input messages, and where in the flow you want to receive the messages:

MQInput

Use an MQInput node if the messages arrive at the broker on a WebSphere MQ queue, and the node is to be at the start of a message flow.

The use of message flows that contain MQInput nodes in WebSphere Message Broker Version 6.1 is deprecated. Redesign your message flows to remove the MQe nodes and replace them with MQ nodes that are configured to your own specifications and coordinated with your MQe Gateway configuration. For more details, see [Migrating a message flow that contains WebSphere MQ Everyplace® nodes](#).

MQGet

Use an MQGet node if the messages arrive at the broker on a WebSphere MQ queue and the node is not to be at the start of a message flow.

SCADAInput

Use a SCADAInput node if the messages are sent by a telemetry device.

HTTPInput

Use an HTTPInput node if the messages are sent by a Web services client.

FileInput

Use a FileInput node if the messages are contents of files.

TCPIPClientInput or TCPIPServerInput

Use a TCPIPClientInput node or a TCPIPServerInput node to create a TCP/IP connection when messages are sent through raw TCP/IP sockets.

TCPIPClientReceive or TCPIPServerReceive

Use a TCPIPClientReceive node or a TCPIPServerReceive node to read the messages that arrive in the message flow through a TCP/IP connection.

Real-timeInput or Real-timeOptimizedFlow

Use one of these nodes if the messages are sent by a JMS or multicast application.

The Real-timeInput node is an input node and the Real-timeOptimizedFlow node is a complete message flow that provides a high performance publish/subscribe message flow.

JMSInput

Use a JMSInput node if the messages are sent by a JMS application.

User-defined input node

Use a user-defined input node if the message source is a client or application that uses a different protocol or transport.

Input node

If you are creating a message flow that you want to embed in another message flow (a subflow) that you will not deploy as a standalone message flow, you must include at least one Input node to receive messages into the subflow.

An instance of the Input node represents an In terminal. For example, if you have included one instance of the Input node, the subflow icon shows one In terminal, which you can connect to other nodes in the main flow in the same way that you connect any other node.

To deploy a message flow, it must have at least one input node. If your message flow does not contain an input node, you are prevented from adding it to the broker archive file. The input node can be in the main flow, or in a message flow that is embedded in the main flow.

You can use more than one input node in a message flow. For more information, see "Using more than one input node" on page 152.

- If you want to send the messages that are produced by the message flow to a target application, you can include one or more output nodes. The output node that you choose depends on the transport across which the target application expects to receive those messages:

Publication

Use a Publication node to distribute the messages using the publish/subscribe network for applications that subscribe to the broker across all supported protocols. A Publication node is an output node that uses output destinations that are identified by subscribers whose subscriptions match the characteristics of the current message.

MQOutput

Use an MQOutput node if the target application expects to receive messages on a WebSphere MQ queue, or on the WebSphere MQ reply-to queue that is specified in the input message MQMD.

The use of message flows that contain MQeOutput nodes in WebSphere Message Broker Version 6.1 is deprecated. Redesign your message flows to remove the MQe nodes and replace them with MQ nodes that are configured to your own specifications and coordinated with your MQe Gateway configuration. For more details, see Migrating a message flow that contains WebSphere MQ Everyplace nodes.

MQReply

Use an MQReply node if the target application expects to receive messages on the WebSphere MQ reply-to queue that is specified in the input message MQMD.

SCADAOutput

Use a SCADAOutput node if a telemetry device is the target of the output messages, and the Publication node is not suitable.

HTTPReply

Use an HTTPReply node if the messages are in response to a Web services client request.

HTTPRequest

Use an HTTPRequest node if your message flow interacts with a Web service.

FileOutput

Use a FileOutput node if a file is the target of the output messages.

TCPIPClientOutput or TCPIPServerOutput

Use a TCPIPClientOutput node or a TCPIPServerOutput node if the messages are to be sent to the target application through raw TCP/IP sockets.

Real-timeOptimizedFlow

Use a Real-timeOptimizedFlow node if the target application is a JMS or multicast application.

JMSOutput

Use a JMSOutput node if the messages are for a JMS destination.

JMSReply

The JMSReply node has a similar function to the JMSOutput node, but the JMSReply node sends JMS messages only to the reply destination that is supplied in the JMSReplyTo header field of the JMS message tree. Use the JMSReply node to treat a JMS

message that is produced from a message flow as a reply to a JMS input message, and when you have no other routing requirements.

User-defined output node

Use a user-defined output node if the target is a client or application that uses a different protocol or transport.

EmailOutput node

Use the EmailOutput node to send e-mail messages to one or more recipients.

Output node

If you are creating a message flow that you want to embed in another message flow (a subflow) that you will not deploy as a standalone message flow, you must include at least one Output node to propagate messages to subsequent nodes that you connect to the subflow.

An instance of the Output node represents an Out terminal. For example, if you have included two instances of the Output node, the subflow icon shows two Out terminals, which you can connect to other nodes in the main flow in the same way that you connect any other node.

WebSphere Adapters nodes

Use the WebSphere Adapters nodes to interact with Enterprise Information Systems (EIS) such as SAP, Siebel, and PeopleSoft. The following input and request nodes are available:

- SAPIInput node
- SAPRequest node
- SiebelInput node
- SiebelRequest node
- PeopleSoftInput node
- PeopleSoftRequest node
- TwineballInput node
- TwineballRequest node

The WebSphere Adapters input nodes monitor an EIS for a particular event. When that event occurs, business objects are sent to the input node. The node constructs a tree representation of the business objects and propagates it to the Out terminal so that the data can be used by the rest of the message flow.

The WebSphere Adapters request nodes can send and receive business data. They request information from an EIS and propagate the data to the rest of the message flow.

Nodes for manipulating, enhancing, and transforming messages

Most enterprises have applications that have been developed over many years, on different systems, using different programming languages, and different methods of communication. WebSphere Message Broker removes the need for applications to understand these differences by providing the ability to configure message flows that transform messages from one format to another.

For example, personal names are held in many forms in different applications. Family name first or last, with or without middle initials, upper or lower case: these are just some of the permutations. Because you can configure your message flow to know the requirements of each

application, each message can be transformed to the correct format without modifying the sending or receiving application.

You can work with the content of the message to update it in several ways. Your choices here might depend on whether the message flow must handle predefined (modeled) messages, self-defining messages (for example, XML), or both.

A message flow can completely rebuild a message, convert it from one format to another (whether *format* means order of fields, byte order, language, and so on), remove content from the message, or introduce specific data into it. For example, a node can interact with a database to retrieve additional information, or to store a copy of the message (whole or part) in the database for offline processing.

The following examples show how important message transformation can be:

- An order entry application has a Part ID in the body of the message, but its partner stock application expects it in the message header. The message is directed to a message flow that knows the two different formats, and can therefore reformat the information as it is needed.
- A data-entry application creates messages containing stock trade information. Some applications that receive this message need the information as provided, but others need additional information added to the message about the price to earnings (PE) ratio. The stock trade messages are directed to a message flow that passes the message unchanged to some output nodes, but calculates and adds the extra information for the others. The message flow does this by looking up the current stock price in a database, and uses this value and the trade information in the original message to calculate the PE value before passing on the updated message.

You can also create message flows that use these nodes to interact with each other. Although the default operation of one message flow does not influence the operation of another message flow, you can force this action by configuring your message flows to store and retrieve information in an external source, such as a database.

Compute

Use the Compute node to:

- Manipulate message content
- Transform the message in some way
- Interact with a database to modify the content of the message or the database and pass on one or more new messages

You can use this node to manipulate predefined and self-defining messages.

Use the ESQL editor to create an ESQL module, specific to this node, that contains the statements that define the actions to perform against the message or database. Do not use the ESQL code that you develop for use in a Compute node in any other type of node.

You can control the way in which the database is accessed by this node by specifying user and password information for the data source that you specify in the node property. Use the `mqsisetdbparms` command to initialize and maintain these values.

If your message manipulation requirements are complex, perform these within a single Compute node. Fewer, more complex Compute nodes perform better than a larger number of simpler nodes because the broker parses the message on entry to each Compute node.

JavaCompute

Use the JavaCompute node to:

- Examine an incoming message and, depending on its content, propagate it unchanged to one of the node's two output terminals. The node behaves in a similar way to a Filter node, but uses Java instead of ESQL to decide which output terminal to use.
- Change part of an incoming message and propagate the changed message to one of the output terminals.
- Interact with a database through a JDBC type 4 connection to modify the content of the message or the database and pass on one or more new messages
- Create and build a new output message that is totally independent of the input message.

Mapping

Use the Mapping node to create a new message from the input message by mapping the content of elements of the output message from elements of the input message, or from database content. You can also extract parts of the message, and optionally change their content, to create a new output message that is a partial copy of the message that is received by the node. The Mapping node handles only predefined messages.

You can control the way in which the database is accessed by this node by specifying user and password information for the data source that you specify in the node property. Use the `mqsisetdbparms` command to initialize and maintain these values.

Use the Mapping editor to develop mappings to perform simple manipulations on predefined messages. Do not use the mappings that you develop for use in a Mapping node in any other type of node.

Extract

The Extract node is deprecated in WebSphere Message Broker Version 6.1. Although message flows that contain an Extract node remain valid in WebSphere Message Broker Version 6.1, where possible, redesign your message flows so that any Extract node is replaced by a Mapping node.

With an Extract node you can create a new output message from specified elements of the input message. You can extract parts of the message, and optionally change their content, to create a new output message that is a partial copy of the message received by the node. The Extract node handles only predefined messages.

Use the Mapping editor to develop mappings to perform simple manipulations on predefined messages in the Extract node. Do not use the mappings that you develop for use in an Extract node in any other type of node.

Database

Use the Database node to interact with a database that is identified by the node properties. The Database node handles both predefined and self-defining messages. Use the ESQL editor to code ESQL functions to update database content from the message, insert new information into the database, and delete information from the database, perhaps based on information in the message. Do not use the ESQL code that you develop for use in a Database node in any other type of node.

This node provides a very flexible interface with a wide range of functions. It also has properties that you can use to control the way in which the interaction participates in transactions.

You can control the way in which the database is accessed by this node by specifying user and password information for the data source that you specify in the node properties. Use the `mqsisetdbparms` command to initialize and maintain these values.

You can update only databases from this node; you cannot update message content. If you want to update message content, use the Compute or Mapping node.

DataDelete, DataInsert, DataUpdate

The DataDelete, DataInsert, and DataUpdate nodes are specialized forms of the Database node that provide a single mode of interaction (deletion of one or more rows, insertion of one or more rows, or update of one or more existing rows).

The DataDelete, DataInsert, and DataUpdate nodes handle only predefined messages. Use a mapping editor to develop mappings to perform these functions. Do not use the mappings that you develop for these nodes in any other type of node. You can use these nodes to control the transactional characteristics of the updates that they perform.

You can control the way in which the database is accessed by this node by specifying user and password information for the data source that you specify in the node property. Use the `mqsisetdbparms` command to initialize and maintain these values.

You can update only databases from these nodes; you cannot update message content. If you want to update message content, use the Compute or Mapping node.

Warehouse

The Warehouse node provides a store interface that you can use to store all or part of the message in a database, for example, for audit reasons. The Warehouse node handles only predefined messages. Use the Mapping editor to develop mappings to perform this action. Do not use the mappings that you develop for a Warehouse node in any other type of node.

You can control the way in which the database is accessed by this node by specifying user and password information for the data source that you specify in the node property. Use the `mqsisetdbparms` command to initialize and maintain these values.

You can update only a database from this node; you cannot update message content. If you want to update message content, use the Compute or Mapping node.

DatabaseRoute node

Use the DatabaseRoute node to route a message using information from a database in conjunction with applied XPath routing expressions. The node looks up a collection of named column values from a located database row and synchronously applies one or more XPath expressions to these acquired values. Use the DatabaseRoute node to implement message routing with minimal programming logic. For more advanced routing scenarios, use a Compute node or a JavaCompute node.

DatabaseRetrieve node

Use the DatabaseRetrieve node to ensure that information in a message is up to date. Use the node to modify a message using information from a database. For example, you can add information to a message using a key, such as an account number, that is contained in a message. Use the DatabaseRetrieve node to implement message routing with minimal programming logic. For more advanced routing scenarios, use a Compute node or a JavaCompute node.

XSLTransform

Use the XSLTransform node (formerly known as the XMLTransformation node) to transform an input XML message into another format using XSLT style sheets and to set the message domain, message set, message type, and message format for the generated message. It is imperative that the data can be parsed into a XML message. The style sheet, using the rules that are defined within it, can perform the following actions:

- Sort the data
- Select data elements to include or exclude based on some criteria
- Transform the data into another format

The Xalan-Java transformation engine (Apache Xalan-java XSLT processor) is used as the underlying transformation engine. For more information about XML Transformations, the W3C specification of the syntax, and semantics of the XSL Transformations language for transforming XML documents into other XML documents, see W3C XSL Transformations.

You can deploy style sheets and XML files to broker execution groups, to help with style sheet and XML file maintenance.

JMSMQTransform

Use the JMSMQTransform node to transform a message with a JMS message tree into a message that has a tree structure that is compatible with the format of messages that are produced by the WebSphere MQ JMS provider.

The JMSMQTransform node can be used to send messages to existing message flows and to interoperate with WebSphere MQ JMS and WebSphere MQ Publish/Subscribe.

MQJMSTransform

Use the MQJMSTransform node to receive messages that have a WebSphere MQ JMS provider message tree format, and transform them into a format that is compatible with messages that are to be sent to JMS destinations.

You can use the MQJMSTransform node to send messages to existing message flows and to interoperate with WebSphere MQ JMS and WebSphere MQ Publish/Subscribe.

MQOptimizedFlow

Use the MQOptimizedFlow node to replace a publish/subscribe message flow that consists of an MQInput node connected to a Publication node, and that uses the JMS over WebSphere MQ transport. The MQOptimizedFlow node cannot be used on z/OS systems.

Use the MQOptimizedFlow node to improve performance, particularly where a single publisher produces a persistent publication for a single subscriber.

User-defined

Use a user-defined node to handle specific requirements that are not met by the built-in nodes.

For example, if your node accesses a database, include a user-defined node to interact with the database. You can control the way in which the database is accessed by this node by specifying user and password information for the data source that you specify in the node property. Use the mqsisetdbparms command to initialize and maintain these values.

Nodes for making decisions

You can use nodes that determine the order and flow of control within the message flow in various ways to make decisions about how messages are processed by the flow. You can also use nodes (TimeoutControl and TimeoutNotification) that determine the time, and frequency of occurrence, of events within the message flow. Routing is independent of message transformation, although the route that a message takes might determine exactly what transformation is performed on it.

For example, a money transfer application always sends messages to one other application. You might decide that every message with a transfer value of more than \$10,000 must also be sent to a second application, to enable all high-value transactions to be recorded.

In another example, a national auto club offers a premier service to specific members for orders above a threshold value. Most orders are routed through the typical channels, but, if the membership number and order value meet certain criteria, the order gets special treatment.

You can also establish a more dynamic routing option by building additional routing information into the message when it is processed. Optional sets of rules are set up to receive messages according to values (destinations) set into the message. You can establish these rules such that a message is processed by one or more of the optional sets of rules, in an order determined by the added message content.

Use the following nodes to make decisions about the route that a message follows through the message flow:

Validate

Use the Validate node to check that the message that arrives on its input terminal is as expected. You can check that the message has the expected message template properties (that is, the message domain, message set and message type) and that the content of the

message is correct. You can check the message against one or more of message domain, message set, or message type.

The Validate node replaces the Check node, which is deprecated in WebSphere Message Broker Version 6.1. The Validate node works in the same way as the Check node, but it has additional Validation properties to allow the validation of message content by parsers that support that capability.

Filter Use the Filter node with an ESQL statement to determine the next node to which the message is sent by this node. Do not use the ESQL code that you develop for use in a Filter node in any other type of node.

The node's terminals are True, False, Unknown, and Failure; the message is propagated to the True terminal if the test succeeds, and to the False terminal if it fails. If the statement cannot be resolved (for example, it tests the value of a field that is not in the input message), the message is propagated to the Unknown terminal. If any other error is detected, the message is propagated to the Failure terminal.

The test in the ESQL statement can depend on message content, database content, or a combination of the two.

If you reference a database, you can control the way in which it is accessed by this node by specifying user and password information for each data source defined in the registry on the broker system. Use the `mqsisetdbparms` command to initialize and maintain these values.

Use this node in preference to the Compute node to provide message selection and routing; the Filter node is more efficient for this task.

FlowOrder

Connect the terminals of this node to force the message to be processed by one sequence of nodes, followed by a second sequence of nodes.

Passthrough

Use the Passthrough node to enable version control of a subflow at run time. Use this node to add a label to your subflow. By combining this label with keyword replacement from your version control system, you can identify which version of a subflow is included in a deployed message flow. You can use this label for your own purposes. If you have included the correct version keywords in the label, you can see the value of the label:

- Stored in the broker archive (bar) file, using the `mqsireadbar` command
- As last deployed to a particular broker, on the properties of a deployed message flow in the Message Broker Toolkit
- In the run time, if you enable user trace for that message flow

Route node

Use the Route node to direct messages that meet certain criteria down different paths of a message flow. For example, you can forward a message to different service providers, based on the request details. You can also use the Route node to bypass unnecessary steps. For example, you can check to see if certain

data is in a message, and perform a database lookup operation only if the data is missing. If you set the Distribution Mode property to All, you can trigger multiple events that each require different conditions. For example, you can log requests that relate to a particular account identifier, and send requests that relate to a particular product to be audited.

Use the Route node to implement message routing with minimal programming logic. For more advanced routing scenarios, use a Compute node or a JavaCompute node.

RouteToLabel and Label

Use the RouteToLabel node following a Compute node for complex routing. Define a list of destinations in a Compute node that are acted on by the RouteToLabel node, which interrogates the destinations and passes the message on to the corresponding Label node.

ResetContentDescriptor

Use the ResetContentDescriptor node to set new message properties that are used when the message bit stream is next parsed by a subsequent node in the message flow.

Nodes for controlling time-sensitive operations

You might want a batch job to run every day at a specific time, or you might want information to be processed and published at fixed intervals (for example, currency exchange rates are calculated and sent to banks), or you might want to take a specified recovery action if certain transactions are not completed within a defined time. For all these cases two timeout nodes (TimeoutControl and TimeoutNotification) are provided.

TimeoutControl

Use a TimeoutControl node and a TimeoutNotification node together in a message flow to control events that occur at a specific time or at defined time intervals. The TimeoutControl node receives an input message that contains a timeout request. All or part of this input message is validated and stored to be propagated by an associated TimeoutNotification node in the message flow. The input message is also propagated unchanged to the next node in the message flow.

More than one TimeoutControl node can be associated with each TimeoutNotification node.

TimeoutNotification

Use a standalone TimeoutNotification node to generate messages that are propagated at configured times or time intervals to the next node in the message flow for further processing.

Nodes for collating requests

Use the AggregateControl, AggregateReply, and AggregateRequest nodes to collate related requests and responses. Use these nodes to generate several requests in response to one input message, to control and coordinate the responses that are received in response to those requests, and to combine the information that is provided by the responses to continue processing.

Nodes for handling and reporting errors

Use the following nodes to affect error handling and reporting:

Trace Include a Trace node to generate one or more trace entries to record what is happening in the message flow at this point.

TryCatch

Include a TryCatch node to control the error processing when exceptions are thrown.

Throw

Include a Throw node to force an exception to be thrown, and specify the identity of the exception, to make it easier to diagnose the problem.

Using more than one input node

You can include more than one input node in a single message flow.

Before you start:

Read the following concept topic:

- “Message flow nodes” on page 5

You might find this useful in the following situations:

- The message flow provides common processing for messages that are received from multiple transports. For example, a single message flow might handle:
 - Data in messages received from WebSphere MQ, and therefore through a WebSphere MQ queue and an MQInput node
 - Messages that are received from native IP connections (a Real-timeInput node)
- You need to set standard properties on the MQInput node if input messages:
 - are predefined, and
 - are all received from WebSphere MQ, and
 - do not include an MQRFH2 header.

If the required standard properties are not always the same for every message, you can include more than one input node and configure each to handle a particular set of properties.

This requirement is not necessary for self-defining messages.

- Each input node in a message flow causes the broker to start a separate thread of execution. Including more than one input node might improve the message flow performance. However, if you include multiple input nodes that access the same input source (for example, a WebSphere MQ queue), the order in which the messages are processed cannot be guaranteed. If you want the message flow to process messages in the order in which they are received, this option is not appropriate.

If you are not concerned about message order, consider using additional instances of the same message flow rather than multiple input nodes. If you set the Additional Instances property of the message flow when you deploy it to the broker, multiple copies of the message flow are started in the execution group. This is the most efficient way of handling multiple instances.

Look at the following sample :

- Scribble sample

This sample uses two input nodes: an MQInput node and a Real-timeInput node. You can use these two input nodes to enable the sample's message flow to accept input from both WebSphere MQ transport and native IP connections. You can view samples only when you use the information center that is integrated with the Message Broker Toolkit.

Defining input message characteristics

When a message is received by an input node in a message flow, the node detects how to interpret that message by determining the domain in which the message is defined and starting the appropriate parser.

Before you start:

Read the following concept topic:

- "Parsers" on page 74

You can provide message domain information to the input node in one of two ways:

1. You can configure the built-in input nodes to indicate the message domain, and therefore the parser to be started, for each message that is received.
2. You can set values in the input message itself that specify this information. Include an MQRFH2 header, which contains a folder that defines the message characteristics. This approach is more flexible because it means that the input node can start the appropriate parser based on the content of each message.

If the input message is defined in the MRM domain, and is therefore interpreted by the MRM parser, you must specify the following additional properties:

- The Message set within which the message is defined
- The Message type, which is defined by the message model
- The Message format, which defines the physical characteristics of the message

The way that these properties are set depends upon the type of message, or node, that you want to use:

- If the message is a WebSphere MQ message, these properties can be set either in the input node or in the MQRFH2 header of the incoming message. If the properties are set in both, the properties of the MQRFH2 header take precedence. If the properties are not found in either the node or the MQRFH2 header, the default value is empty and the BLOB parser is used.
- If the message is a JMS message, the property that is set on the node takes precedence. If the Message domain is empty, the Message domain is, by default, derived according to certain criteria following a predetermined order of precedence; see Order of precedence for deriving the message domain.
- If the input message belongs to a Message domain other than those for which a parser is supplied, you must provide a user-defined parser to handle it, and a user-defined input node to accept it for processing in the message flow. Check the documentation provided with the user-defined parser and node for further information.
- If the Message domain is in a TimeoutControl node, an empty Message domain has either of the following results:
 - If the Stored message location property is also empty, the full message is stored. When the message comes back at TimeoutNotification, it is parsed in the same way as the original message.

- If the Stored message location property is not empty, a partial message is stored and no parser is associated, so, by default, it is treated as BLOB.
- If the Message domain is in a ResetContentDescriptor node, an empty Message domain has either of the following results:
 - If Reset message domain is cleared, the domain is not reset.
 - If Reset message domain is selected, the default is BLOB.
- If the input node cannot determine the message characteristics, the default value is empty and the message is considered to be in the BLOB domain, and the BLOB parser is started.

Import either of the following samples, or another sample that uses a Message set, from the Samples Gallery, and look at the values on the **Input Message Parsing** properties tab of the input node in the sample's message flow.

- Video Rental sample
- Comma Separated Value (CSV) sample

You can view samples only when you use the information center that is integrated with the Message Broker Toolkit.

Using nodes for decision making

Before you start:

Read the concept topic about message flow nodes.

You can use several built-in nodes in different ways to control the path that a message takes through the message flow.

These nodes let you decide how messages are processed by specifying the route that each message takes through the message flow based on dynamic values such as message structure and content.

For more information, see the following topics:

- "Testing the message structure (Validate node)"
- "Controlling the order of processing within a message flow" on page 155
- "Testing the message content (Filter node)" on page 155
- "Using the destination list to route messages (RouteToLabel and Label nodes)" on page 156

Testing the message structure (Validate node)

Use the Validate node to test the characteristics of the message structure.

If you set the Validate node properties appropriately, you can request that one or all of the message domain, message set, and message type are compared to a specific value. If the message matches those values for which you have requested the check, it is routed through the match terminal and is processed by the sequence of nodes that you have connected to that terminal.

If the message does not match any one of those values for which you have requested the check, it is routed through the failure terminal and is processed by the sequence of nodes that you have connected to that terminal.

For example, you might design a message flow that provides additional processing for all messages that are in the MRM domain. You can include a Validate node that tests just that characteristic of the message, and passes it to a sequence of nodes

that provide the specialized processing. If the message is not in the MRM domain, the extra nodes are bypassed, and the failure terminal is wired up directly to the node that follows the sequence required for MRM messages only.

Controlling the order of processing within a message flow

Use the FlowOrder node to control the order of processing within a message flow.

When you connect message flow nodes together, the broker determines the way in which the different connections are processed. This includes the order in which they are processed. If you have connected more than one node or sequence of nodes to a single output terminal, you cannot predict whether one sequence is processed before another for any given message.

If the order of processing is important in your message flow, use the FlowOrder node to force a prescribed order of processing of the messages that are propagated by this node.

The FlowOrder node has two output terminals that you can connect to control the order in which subsequent nodes process the message. The output terminals, named *first* and *second*, are always processed in that order.

When you connect a node or sequence of nodes to the terminal named *first*, the input message is passed to the next node, and all processing defined by all subsequent nodes in this sequence is completed before control returns to the FlowOrder node.

The input message is then propagated to the next node in the sequence of nodes connected to the terminal named *second*.

The message passed to both sequences of nodes, from the terminal named *first* and the terminal named *second*, is identical. It is always the message that the FlowOrder node receives as input. The message that the FlowOrder node propagates to the terminal named *second* is in no way affected by the processing of the message that has been performed by the sequence of nodes connected to the terminal named *first*.

The FlowOrder node provides no other processing on the input message; it is used only for imposing order on subsequent processing.

Testing the message content (Filter node)

This topic describes how you can use the Filter node to determine the path taken by a message through the message flow based on its content.

You can customize the Filter node using ESQL statements to determine if the message content meets some condition. The condition tested must yield a Boolean result, that is it must be true or false (or unknown). You can create the test to reference information from a database, if applicable.

You can connect nodes following the Filter node to the corresponding terminals of the Filter node, and process the message according to its content.

Look at the following samples to see how to use the Filter node:

- Airline Reservations sample
- Error Handler sample

You can view samples only when you use the information center that is integrated with the Message Broker Toolkit.

Using the destination list to route messages (RouteToLabel and Label nodes)

You can determine the path that a message takes through the message flow using the RouteToLabel and Label nodes.

These nodes provide a more flexible way to process messages than the Filter node, which depends on the Boolean result of an ESQL expression for its logic.

When you use RouteToLabel and Label nodes, you must include a Compute node that determines, using some combination of message content, database content, and ESQL logic, how messages are to be processed next. Configure the Compute node to create a destination list (within the DestinationList folder in the LocalEnvironment subtree) that contains the destination for each message, specified as the LabelName of a Label node. The Compute node passes the message to the RouteToLabel node, which reads the destination list and propagates the message to either the first or last item on the destination list, according to the value that is specified for the RouteToLabel node's Mode property. Although there is no limit to the number of destinations that the Compute node writes in the destination list, the RouteToLabel node propagates the message only to a single label node. This use of the destination list is in contrast to its use to define the final recipients of the output messages. For more information about the procedure for creating a destination list, see "Creating destination lists" on page 162.

If you intend to derive destination values from the message itself, or from a database, you might also need to cast values from one type to another. For more information about the LocalEnvironment, see "Local environment tree structure" on page 64. For more information about casting, see "Supported casts" on page 1644.

Look at the following sample to see how to use these nodes:

- Airline Reservations sample

The XML_PassengerQuery message flow in the previous sample demonstrates how you can use the destination list in the LocalEnvironment to route messages based on the information in the message itself. You can view samples only when you use the information center that is integrated with the Message Broker Toolkit.

Using subflows

Subflows can be included in your message flows in exactly the same way as you include built-in or user-defined nodes.

You can also connect subflows to other nodes in the same way. You can define a subflow once, and use it in more than one message flow (and even in more than one message flow project), so a subflow can provide the following benefits:

- Reusability and reduced development time.
- Consistency and increased maintainability of your message flows (consider a subflow as analogous to a programming macro, or to inline code that is written once but used in many places).
- Flexibility to tailor a subflow to a specific context (for example, by updating the output queue or data source information).

However, remember that a subflow is not a single node, and its inclusion increases the number of nodes in the message flow, which might affect its performance.

Consider these examples of subflow use:

- You can define a subflow that provides a common sequence of actions that applies to several message flows if an error is encountered; for example, you might have a common error routine that writes the message to a database through the Warehouse node, and puts it to a queue for processing by an error recovery routine. The use of this routine in multiple message flows, or in several places within one message flow, provides an efficient and consistent use of resources and avoids reinventing such routines every time an error is encountered.
- You might want to perform a common calculation on messages that pass through several different message flows; for example, you might access currency exchange rates from a database and apply these to calculate prices in several different currencies. You can include the currency calculator subflow in each of the message flows in which it is appropriate.

Use the Passthrough node to enable version control of a subflow at run time. The Passthrough node allows you to add a label to your message flow or subflow. By combining this label with keyword replacement from your version control system, you can identify which version of a subflow is included in a deployed message flow. You can use this label for your own purposes. If you have included the correct version keywords in the label, you can see the value of the label:

- Stored in the broker archive (bar) file, using the mqsireadbar command
- As last deployed to a particular broker, on the properties of a deployed message flow in the Message Broker Toolkit
- In the run time, if you enable user trace for that message flow

The message that it propagates on its Out terminal is the same message that it received on its In terminal; for example, if you develop an error processing subflow to include in several message flows, you might want to modify that subflow. However, you might want to introduce the modified version initially to just a subset of the message flows in which it is included. Set a value for the instance of the Passthrough node that identifies which version of the subflow you have included.

The use of subflows is demonstrated in the following samples:

- Error Handler sample
- Coordinated Request Reply sample

The Error Handler sample uses a subflow to trap information about errors and store the information in a database. The Coordinated Request Reply sample uses a subflow to encapsulate the storage of the ReplyToQ and ReplyToQMgr values in a WebSphere MQ message so that the processing logic can be easily reused in other message flows and to allow alternative implementations to be substituted.

You can view samples only when you use the information center that is integrated with the Message Broker Toolkit.

Adding keywords to subflows

You can embed keywords in each subflow that you use in a message flow. A different keyword must be used in each instance of a subflow. This is because only the first recorded instance of each keyword within the message flow .cmf file is

available to Configuration Manager Proxy applications and to the toolkit. The order that subflows appear in the .cmf file is not guaranteed.

Optimizing message flow response times

This topic describes how you can improve message flow response times.

Before you start:

Read the following concept topic:

- “Message flow nodes” on page 5

When you design a message flow, the flexibility and richness of the built-in nodes often means that there are several ways to achieve the processing and therefore the end results that you require. However, you can also find that these different solutions deliver different performance and, if this is an important consideration, you must design for performance as well as function.

Your applications can perceive performance in either of these ways:

1. The response time indicates how quickly each message is processed by the message flow. The response time is particularly influenced by how you design your message flows. Response time is discussed in this topic.
2. The throughput indicates how many messages of particular sizes can be processed by a message flow in a given time. The throughput is mainly affected by configuration and system resource factors, and is discussed in the topic on optimizing message flow throughput along with other domain configuration information. See [Optimizing message flow throughput](#).

Several aspects influence message flow response times. However, as you create and modify your message flow design to arrive at the best results that meet your specific business requirements, you must also consider the eventual complexity of the message flow. The most efficient message flows are not necessarily the easiest to understand and maintain; experiment with the solutions available to arrive at the best balance for your needs.

Several factors influence message flow response times:

The number of nodes that you include in the message flow

Every node increases the amount of processing required in the broker, so consider the content of the message flow carefully, including the use of subflows.

Use as few nodes as possible in a message flow; every node that you include in the message flow increases the amount of processing required in the broker. The number of nodes within a single flow has an upper limit. This limit is governed by system resources, particularly the stack size.

For more information about stack sizes, see “System considerations for message flow development” on page 160.

How the message flow routes and processes messages

In some situations, you might find that the built-in nodes, and perhaps other nodes that are available in your system, provide more than one way of providing the same function. Choose the simplest configuration. For example, if you want to define some specific processing based on the value of a field in each message, you might design a message flow that has a sequence of Filter nodes to handle each case. If appropriate, you can group

messages through the Filter node to reduce the number that each message type has to pass through before being processed.

For example, you might have a message flow that handles eight different messages (Invoice, Despatch Note, and so on). You can include a Filter node to identify each type of message and route it according to its type. You can optimize the performance of this technique by testing for the most frequent message types in the earliest Filter nodes. However, the eighth message type must always pass through eight Filter nodes.

If you can group the message types (for example, if the message type is numeric, and you can test for all types greater than four and not greater than four), you can reduce the number of Filter nodes required. The first Filter node tests for greater than four, and passes the message on to two further Filter nodes (attached to the true and false terminals) that test for less than two and less than six respectively. An additional four Filter nodes can then test for one or two, three or four, and so on. Although the actual number of Filter nodes required is the same, the number of nodes that each message passes through is reduced.

You might find that using a RouteToLabel node with a set of Label nodes provides a better alternative to a sequence of Filter nodes. Each message passes through a smaller number of nodes, improving throughput. However, you must also consider using a RouteToLabel node means using a Compute node: the increase in the amount of processing required in the broker that is caused by the node might outweigh the advantages. If you are dealing with a limited number of message types, a small number of Filter nodes is more efficient.

The following sample demonstrates how you can use the RouteToLabel and Label nodes instead of using multiple Filter nodes in the XML_PassengerQuery message flow.

- Airline Reservations sample

The following sample demonstrates how you can store routing information in a database table in an in-memory cache in the message flow.

- Message Routing sample

You can view samples only when you use the information center that is integrated with the Message Broker Toolkit.

If your message flow includes loops

Avoid loops of repeating nodes; these can be very inefficient and can cause performance and stack problems. You might find that a Compute node with multiple PROPAGATE statements avoids the need to loop round a series of nodes.

The efficiency of the ESQL

Check all the ESQL code that you have created for your message flow nodes. As you develop and test a node, you might maintain statements that are not required when you have finalized your message processing. You might also find that something you have coded as two statements can be coded as one. Taking the time to review and check your ESQL code might provide simplification and performance improvements.

If you have imported message flows from a previous release, check your ESQL statements against the ESQL available in Version 5.0 to see if you can use new functions or statements to improve its efficiency.

The use of persistent and transactional messages

Persistent messages are saved to disk during message flow processing. This situation is avoided if you can specify that messages either on input, output, or both, are non-persistent. If your message flow is handling only non-persistent messages, check the configuration of the nodes and the message flow itself; if your messages are non-persistent, transactional support might be unnecessary. The default configuration of some nodes enforces transactionality; if you update these properties and redeploy the message flow, response times might improve.

Message size

A larger message takes longer to process. If you can split large messages into smaller chunks of information, you might be able to improve the speed at which they are handled by the message flow. The following sample demonstrates how to minimize the virtual memory requirements for the message flow to improve a message flow's performance when processing potentially large messages.

- Large Messaging sample

You can view samples only when you use the information center that is integrated with the Message Broker Toolkit.

Message format

Although WebSphere Message Broker supports multiple message formats, and provides facilities that you can use to transform from one format to another, this transformation increases the amount of processing required in the broker. Make sure that you do not perform any unnecessary conversions or transformations.

You can find more information on improving the performance of a message flow in this developerWorks article on message flow performance.

System considerations for message flow development

Ensuring you configure your message flows to make the best use of your computer's resources is of paramount importance, especially if you are going to be processing large messages. As well as designing your message flow to optimize throughput, you need to ensure that particular areas of storage are efficiently used so that your system does not suffer from capacity issues or processes abend due to lack of resources.

Consider the following storage issues when developing your message flows:

- "Stack storage"
- "JVM heap sizing" on page 161

Stack storage

When a message flow thread starts, it requires storage to perform the instructions that are defined by the message flow nodes. This storage comes from the execution group's heap and stack size. The default stack size that is allocated to a message flow thread depends on the operating system that is used.

Windows On Windows, each message flow thread is allocated 1 MB of stack space.

Linux On Linux, each message flow thread is allocated 8 MB of stack space.

UNIX

On UNIX, each message flow thread is allocated 1 MB of stack space.

z/OS

On z/OS, each message flow thread is allocated 512 KB of downward stack space and 50 KB of upward stack space.

In a message flow, a node typically uses 2 KB of the stack space. A typical message flow can therefore include 250 nodes on z/OS, 500 nodes on UNIX systems and 500 nodes on Windows. This amount can be higher or lower depending on the type of nodes used and the processing that they perform.

In WebSphere Message Broker, any processing that involves nested or recursive processing can cause extensive usage of the stack. For example, in the following situations you might need to increase the stack size:

- When a message flow is processing a message that contains a large number of repetitions or complex nesting
- When a message flow is executing ESQL that calls the same procedure or function recursively, or when an operator (for example, the concatenation operator) is used repeatedly in an ESQL statement

You can increase the stack size to improve performance. For details, see:

- Increasing the stack size on Windows, Linux, and UNIX systems.
- Increasing the stack size on z/OS.

JVM heap sizing

The Java Virtual Machine (JVM) heap is an independent memory allocation that can reduce the capacity of the main memory heap.

Every execution group creates its own Java Virtual Machine (JVM). The execution group uses the JVM to execute the internal administration threads that require Java. This usage is typically minimal. The primary use of the JVM is for IBM primitive nodes that make use of Java functionality. These primitives include:

- Java user-defined plugin nodes
- Publish/subscribe nodes together with some publish/subscribe functionality
- XSLT nodes
- HTTPRequest nodes
- Real-time nodes

From WebSphere Message Broker Version 6.1 onwards, the JVM is created with a minimum of 32 MB of space, and a maximum of 256 MB, allocated and reserved for its use. As with any JVM, you can pass parameters in to set the minimum and maximum heap sizes.

You might need to increase the maximum heap size allocated if you plan to run large messages through the Java primitive nodes listed above.

To give more capacity to a message flow that is going to process large messages, reduce the minimum JVM heap size to allow the main memory heap to occupy more address space. For details of how to reduce the minimum JVM heap size, see [Setting the JVM heap size](#).

Creating destination lists

Create a list of destinations to indicate where a message is sent.

Before you start:

Read the concept topic “Message flow nodes” on page 5.

You can include a Compute node in your message flow, and configure it to create a destination list within the LocalEnvironment subtree. You can then use the destination list in the following nodes:

- The MQOutput and JMSOutput nodes, to put output messages to a specified list of destinations.
- The RouteToLabel node, to pass messages to Label nodes.

For details about how this technique is used, look at the following sample:

- Airline Reservations sample

You can view samples only when you use the information center that is integrated with the Message Broker Toolkit.

For more information about accessing the LocalEnvironment subtree, destination list contents, and example procedures for setting values for each of these scenarios, see “Accessing the LocalEnvironment tree” on page 308.

For more information about how to populate destination in the LocalEnvironment subtree, and how to build JMS destination lists, see “Populating Destination in the LocalEnvironment tree” on page 311.

You might find it useful to create the contents of the destination list from an external database that is accessed by the Compute node. You can then update the destinations without needing to update and redeploy the message flow.

The use of the destination list to define which applications receive the output messages is in contrast to the publish/subscribe application model, in which the recipients of the publications are those subscribers that are currently registered with the broker. The processing that is completed by the message flow does not have any effect on the current list of subscribers.

Using WebSphere MQ cluster queues for input and output

Design your broker domain to use WebSphere MQ queues, if appropriate for your business needs.

The use of queue manager clusters brings the following significant benefits:

1. Reduced system administration
Clusters need fewer definitions to establish a network; you can set up and change your network more quickly and easily.
2. Increased availability and workload balancing
You can benefit by defining instances of the same queue to more than one queue manager, thus distributing the workload through the cluster.

If you use clusters with WebSphere Message Broker, consider the following queues:

For SYSTEM.BROKER queues:

The SYSTEM.BROKER queues are defined for you when you create WebSphere Message Broker components, and are not defined as cluster queues. Do not change this attribute.

For broker, Configuration Manager, and User Name Server connectivity:

If you define the queue managers that support your brokers, the Configuration Manager, and the User Name Server to a cluster, you can benefit from the simplified administration provided by WebSphere MQ clusters. You might find this particularly relevant for the brokers in a collective, which must all have WebSphere MQ interconnections.

For message flow input queues:

If you define an input queue as a cluster queue, consider the implications for the order of messages or the segments of a segmented message. The implications are the same as they are for any WebSphere MQ cluster queue. In particular, the application must ensure that, if it is sending segmented messages, all segments are processed by the same target queue, and therefore by the same instance of the message flow at the same broker.

For message flow output queues:

- WebSphere Message Broker always specifies MQOO_BIND_AS_Q_DEF when it opens a queue for output. If you expect segmented messages to be put to an output queue, or want a series of messages to be handled by the same process, you must specify DEFBIND(OPEN) when you define that queue. This option ensures that all segments of a single message, or all messages within a sequence, are put to the same target queue and are processed by the same instance of the receiving application.
- If you create your own output nodes, specify MQOO_BIND_AS_Q_DEF when you open the output queue, and DEFBIND(OPEN) when you define the queue, if you need to guarantee message order, or to ensure a single target for segmented messages.

For publish/subscribe applications:

- If the target queue for a publication is a cluster queue, you must deploy the publish/subscribe message flow to all the brokers on queue managers in the cluster. However, the cluster does not provide any of the failover function to the broker domain topology and function. If a broker to which a message is published, or a subscriber registers, is unavailable, the distribution of the publication or registration is not taken over by another broker.
- When a client registers a subscription with a broker that is running on a queue manager that is a member of a cluster, the broker forwards a proxy registration to its neighbors within the broker domain; the registration details are not advertised to other members of the cluster.
- A client might choose to become a clustered subscriber, so that its subscriber queue is one of a set of clustered queues that receive any given publication. In this case, when registering a subscription, use the name of an "imaginary" queue manager that is associated with the cluster; this is not the queue manager to which the publication will be sent, but an alias for the broker to use. As an administrative activity, a blank queue manager alias definition is made for this queue manager on the broker that satisfies this subscription for all clustered subscribers. When the broker publishes to a subscriber queue that names this queue manager, resolution of the queue manager name results in the

publication being sent to any queue manager that hosts the subscriber cluster queue, and only one clustered subscriber receives the publication. For example, if the clustered subscriber queue was SUBS_QUEUE and the "imaginary" subscriber queue manager was CLUSTER_QM, the broker definition would be:

```
DEFINE QREMOTE(CLUSTER_QM) RQMNAME(' ') RNAME(' ')
```

This sends broker publications for SUBS_QUEUE on CLUSTER_QM to one instance of the cluster queue named SUBS_QUEUE anywhere in the cluster.

To understand more about clusters, and the implications of using cluster queues, see the *Queue Manager Clusters* section of the WebSphere MQ Version 6 information center online.

Using WebSphere MQ shared queues for input and output (z/OS)

On z/OS systems, you can define WebSphere MQ shared queues as input and output queues for message flows.

Use the WebSphere MQ for z/OS product facilities to define these queues and specify that they are shared.

For more information about configuring on z/OS, refer to the *z/OS Concepts and Planning* section of the WebSphere MQ Version 6 information center online.

If you use shared queues, you can provide failover support between different images running WebSphere Message Broker on a sysplex.

You cannot use shared queues for broker or User Name Server component queues such as SYSTEM.BROKER.CONTROL.QUEUE.

Shared queues are available only on z/OS.

Validating messages

The broker provides validation based on the message set for predefined messages.

Before you start:

Read the concept topics about message flows and parsers, especially "MRM parser and domain" on page 98 and "XMLNSC parser" on page 85.

Validation applies only to messages that you have modeled and deployed to the broker. Specifically, the message domains that support validation are MRM, XMLNSC, SOAP, and IDOC.

The broker does not provide any validation for self-defining messages. The MRM and IDOC parsers validate predefined messages against the message dictionary generated from a message set. The XMLNSC and SOAP domains validate predefined messages directly against XML Schema generated from a message set.

Message flows are designed to transform and route messages that conform to certain rules. By default, parsers perform some validity checking on a message, but only to ensure the integrity of the parsing operation. However, you can validate a

message more stringently against the message model contained in the message set, by specifying validation options on certain nodes in your message flow.

You can use validation options to validate the following messages:

- Input messages that are received by an input node
- Output messages that are created, for example, by a Compute, Mapping, or JavaCompute node

These validation options can guarantee the validity of data entering and leaving the message flow. The options provide you with some degree of control over the validation performed to:

- Maintain a balance between performance requirements and security requirements
- Validate at different stages of message flow execution; for example, on input of a message, before a message is output, or at any point in-between
- Cope with messages that your message model does not fully describe

You can also specify what action to take when validation fails.

Message validation involves navigating a message tree, and checking the tree's validity.

Message validation is an extension of tree creation when the input message is parsed, and of bit stream creation when the output message is written.

Validation options are available on the following nodes:

Node type	Nodes with validation options
Input node	MQInput, SCADAInput, HTTPInput, JMSInput, TimeoutNotification, SOAPInput, FileInput
Output node	MQOutput, MQReply, SCADAOutput, HTTPReply, JMSOutput, JMSReply, FileOutput, SOAPReply
Other nodes	Compute, Mapping, JavaCompute, Validate, ResetContentDescriptor, MQGet, HTTPRequest, XSLTransform, DatabaseRetrieve, SOAPRequest, SOAPAsyncResponse

Validation options can also be specified on the ESQL CREATE statement and the ASBITSTREAM function.

To validate input messages that are received on an input node, you can specify validation properties on the input node. The input message is then validated when the message bit stream is parsed to form the message tree.

You can also use the Parse Timing property of the input node to control whether the entire message is parsed and validated at this time, or whether individual fields in the message are parsed and validated only when referenced.

To validate output messages that are created by a transformation node, specify validation properties either on the node itself, or on the output node that sends the message. The validation takes place when the message bit stream is created from the message tree by the output node.

Alternatively, use a Validate node to validate a message tree at a particular place in your message flow, or use the ESQL ASBITSTREAM function within a Compute, Filter, or Database node.

A limited amount of validation occurs by default if you leave the validation settings unaltered. At this default level, an exception is thrown if one of the following is true:

- There is a data mismatch; for example, the parser cannot interpret the data that is provided for the field type specified.
- The order of elements in the output message does not match the order of elements in the logical message tree (MRM, CWF and TDS fixed length models only).

Additionally, the MRM parser performs limited remedial action under the following circumstances:

- Extraneous fields are discarded on output for fixed formats (CWF and TDS fixed length models only).
- If mandatory content is missing, defaults are supplied, if available, on output for fixed formats (CWF and TDS fixed length models only).
- If an element's data type in the tree does not match that specified in the dictionary, the data type is converted on output to match the dictionary definition, if possible, for all formats.

However, by using validation options you can request more thorough validation of messages. For example, you might want to validate one or more of the following conditions, and throw an exception or log the errors:

- The whole message at the start of the message flow
- That complex elements have the correct Composition and Content Validation
- That all data fields contain the correct type of data
- That data fields conform to the value constraints in the message model
- That all mandatory fields are present in the message
- That only the expected fields are present in the message
- That message elements are in the correct order

The samples in the Samples Gallery illustrate some of these validation options.

When using validation options, it is important to understand the following behavior:

- The Parse Timing property, which controls whether 'on demand' parsing (sometimes called partial parsing) takes place, has an effect on the timing of the validation of input messages, including message headers.

For more information about the Parse Timing property, see "Parsing on demand" on page 1363.

- If a message tree is passed to an output node, by default, the output node inherits the validation options in force for the message tree. You can override these options by specifying a new set of validation options on the output node.
- If a message tree is passed as input to a Compute, Mapping, XSLTransform, DatabaseRetrieve, or JavaCompute node, any new output message trees that are created by the node have the validation options specified by the node itself (even if the whole message is copied). You can override this behavior, and specify that the messages that are created by the node inherit the validation options of the input message tree.

- (MRM domain only) When the bit stream is written, and validation options are applied, the entire message is validated. The message tree might contain an unresolved type (for example, if a Compute node copied an unresolved type from an input message to an output message without resolving it). If such a type is encountered, a validation error occurs because it is not possible to validate the type. To prevent this, ensure that all unresolved types are resolved before they are copied to output messages.
- (MRM domain only) You must not select the Truncate fixed length strings check box, because validation is done before truncation, and a fixed length field fails validation if its length exceeds the length that is defined in the message set. For more information about the Truncate fixed length strings property, see Custom Wire Format message set properties and TDS Format message set properties.

For information about how you can control validation by using different properties, see “Validation properties” on page 1359.

Viewing the logical message tree in trace output

To view the structure of the logical message tree at any point in the message flow, include a Trace node and write some or all of the message (including headers and all four message trees) to the trace output destination.

You might find trace output useful to check or record the content of a message before and after a node has made changes to it, or on its receipt by the input node. For example, if you include a Compute node that builds a destination list in LocalEnvironment, you might want a record of the structure that it has created as part of an audit trail, or you might just want to check that the Compute node is working as you expect it to.

1. Switch to the Broker Application Development perspective.
2. Open the message flow for which you want to view messages. Open an existing message flow, or create a new message flow.
3. Include a Trace node wherever you want to view part or all of the message tree structure. You can include as many Trace nodes as you choose; however, each node introduces some overhead to the message flow processing.
4. Set the Trace node properties to trace the message, or parts of the message, that you want to view. Specify the parts of the message using ESQL field references. Several examples are included below.
5. If you have added a Trace node to investigate a particular behavior of your message flow, and have now resolved your concerns or checked that the message flow is working correctly, remove the Trace node or nodes, and redeploy the message flow.

Assume that you have configured a message flow that receives an XML message on a WebSphere MQ queue in an MQInput node. The input message includes an MQRFH2 header. The message content is shown below:

```
<Trade type='buy'
  Company='IBM'
  Price='200.20'
  Date='2000-01-01'
  Quantity='1000' />
```

You can include and configure a Trace node to produce output that shows one or more of the trees created from this message: the message body, Environment, LocalEnvironment, and Exception trees. If you choose to record the content of the message body, the Properties tree and the contents of all headers (in this example,

at least an MQMD and an MQRFH2) are included. You specify what you want to be recorded when you set the Trace node property Pattern. You can use most of the correlation names to define this pattern (you cannot use those names that are specific to the Compute node).

Message body

If you want the Trace node to write the message body tree including Properties and all headers, set Pattern to \$Root. If you want only the message data, set Pattern to \${Body}.

The trace output generated for the message tree of the message shown above with Pattern set to \$Root would look something like:

```
Root
  Properties
    CreationTime=GMTTIMESTAMP '1999-11-24 13:10:00'      (a GMT timestamp field)
  ... and other fields ...
  MQMD
    PutDate=DATE '19991124'                               (a date field)
    PutTime=GMTTIME '131000'                              (a GMTTIME field)
  ... and other fields ...
  MQRFH
    mcd
    msd='xml'                                             (a character string field)
  .. and other fields ...
  XML
    Trade
    type='buy'                                            (a character string field)
    Company='IBM'                                         (a character string field)
    Price='200'                                           (a character string field)
    Date='2000-01-01'                                     (a character string field)
    Quantity='1000'                                       (a character string field)
```

Environment

To trace any data in the environment tree, set Pattern to \${Environment}. This setting produces output similar to the following:

```
(0x1000000)Environment = (
  (0x1000000)Variables = (
    (0x1000000)MyVariable1 = (
      (0x2000000) = '3'
    )
    (0x1000000)MyVariable2 = (
      (0x2000000) = 'Hello'
    )
  )
)
```

To trace particular variables in the variables folder of the environment tree, you can use a more specific pattern, for example \${Environment.Variables.MyVariable1}. This setting returns the value only (for example, it returns just the value 3).

LocalEnvironment

To trace data in the LocalEnvironment tree, set Pattern to \${LocalEnvironment}. The output you get is similar to the following example, which shows that a destination list has been created within the LocalEnvironment tree:

```
(0x1000000)Destination = (  
  (0x1000000)MQ = (  
    (0x1000000)DestinationData = (  
      (0x3000000)queueName = 'MQOUT'  
    )  
  )  
  (0x1000000)MQDestinationList = (  
    (0x1000000)DestinationData = (  
      (0x3000000)queueName = 'OLDMQOUT'  
    )  
  )  
  (0x1000000)RouterList = (  
    (0x1000000)DestinationData = (  
      (0x3000000)labelName = 'continue'  
    )  
    (0x1000000)DestinationData = (  
      (0x3000000)labelName = 'custdetails'  
    )  
    (0x1000000)DestinationData = (  
      (0x3000000)labelName = 'trade'  
    )  
  )  
)
```

Another example, shown below, includes a WrittenDestination folder. This example represents a trace that has been written by a Trace node that is included after an MQOutput node, where the Out terminal of the MQOutput node is connected to a sequence of nodes including the Trace node. When an Out terminal is connected, the LocalEnvironment is augmented with information about the action that the output node has performed.

```
(0x1000000)Destination = (  
  (0x1000000)MQ = (  
    (0x1000000)DestinationData = (  
      (0x3000000)queueName = 'MQOUT'  
    )  
  )  
  (0x1000000)WrittenDestination = (  
    (0x1000000)MQ = (  
      (0x1000000)DestinationData = (  
        (0x3000000)queueName = 'MQOUT'  
        (0x3000000)queueManagerName = 'MQSI_SAMPLE_QM'  
        (0x3000000)replyIdentifier = X'414d51204d5153495f53414d504c455f1f442f3b12600100'  
        (0x3000000)msgId = X'414d51204d5153495f53414d504c455f1f442f3b12600100'  
        (0x3000000)correlId = X'0000000000000000000000000000000000000000000000000000000000000000'  
      )  
      (0x03000000):GroupId = X'414d512042524f4b4552322020202020203f59934620001803'  
    )  
  )  
)
```

ExceptionList

To trace data in the exception list, set Pattern to \${ExceptionList}.

You can also view message structure within the message flow, and other information, when you use the flow debugger.

Accessing databases from message flows

This topic describes how you can create and configure message flows to access user databases.

Before you start:

Complete the following tasks:

- “Creating a message flow” on page 218
- Configuring databases

Read the following concept topic:

- “Message flow nodes” on page 5

You can access information in a database to enhance or influence the operation of the message flow. You can also modify the contents of a database by inserting new information or by removing or replacing existing information.

You can access a database from a message flow using the following nodes:

- Compute
- Database
- DatabaseRetrieve
- DatabaseRoute
- DataInsert
- DataDelete
- DataUpdate
- Filter
- JavaCompute
- Mapping
- Warehouse

For more details of these nodes, and how to configure them in message flows, see “Built-in nodes” on page 822.

If you want the actions that the message flow takes against the database to be coordinated with other actions, configure the message flow to support global coordination of transactions. For information about how to do this, see “Configuring globally coordinated message flows” on page 173.

To access a database from a message flow:

1. Identify the database that you want to access. You can access an existing database or a new one that has been created for this purpose. See “Data sources on z/OS” on page 1448 for more information on what to call a z/OS user database.

If you want to create a new database, follow the instructions given in Creating the databases.

If you want to use a database other than DB2[®], refer to the database product documentation for detailed instructions on how to do this.

Supported databases lists the database managers that are supported by WebSphere Message Broker.

2. Define a connection to the data source name (DSN) to enable a connection to the database, if one does not already exist:
 - a. Define a JDBC connection if you want to interact with a database directly from a Java application. You can code Java in both a JavaCompute node and in a Java user-defined node.

For more information, see Enabling JDBC connections to the databases.

- b. Define an ODBC connection if you want to interact with a database in a node that supports ESQL, including a JavaCompute node in which use the `MbSQLStatement` interface.

For more information, see Enabling ODBC connections to the databases.

3. Authorize the broker to access the database.

Access to a user database from within a message flow is controlled by user ID and password.

z/OS On z/OS, you can specify these values:

- When you create the broker.

The broker started task ID is used to access user databases, irrespective of the user ID and password specified on the `mqsicreatebroker` command in the `BIPCRBK JCL` in the customization data set `<hlq>.SBIPPROC`.

- After you have created the broker.

Use the `BIPSDBP JCL` in the customization data set `<hlq>.SBIPPROC` to customize the `mqsisetdbparms` command to specify a user ID and password for a specific database. This changes the default values that were set when you created the broker (described above).

You can create a user ID and password for any database (identified by DSN) that is accessed by a message flow. You can, therefore, control access to a database at an individual level if you choose. This includes databases that you have created and configured on distributed systems that are accessed by z/OS DB2 remote database access.

On distributed systems, you can specify these values:

- When you create the broker.

The `mqsicreatebroker` command has two parameters `-u DataSourceUserid` and `-p DataSourcePassword` that you can use to identify the user ID that the broker uses to access its own database. If you specify these parameters, they are used as the default access control parameters for user databases that are accessed by message flows.

If you do not specify `DataSourceUserid` and `DataSourcePassword`, the broker uses the values specified for the parameters `-i ServiceUserID` and `-a ServicePassword` (which identify the user under which the broker runs) as the default values.

- After you have created the broker.

Use the `mqsisetdbparms` command to specify a user ID and password pair. This changes the defaults that were set when you created the broker (described above).

You can create a user ID and password pair for any database (identified by DSN) that is accessed by a message flow. You can therefore control access to a database at an individual level if you choose. This includes databases that you have created and configured on z/OS that are accessed by brokers on distributed systems.

If the user that created a table in a database is not the user that the broker is using to access the database, you must specify the user ID that created the database as the schema name in relevant ESQL statements, unless you have set up an alias or synonym.

If you access a database from a message flow using a Compute, Database, or Filter node, use the New Database Definition File wizard to enable a connection to the appropriate database. See “Adding database definitions to the Message Broker Toolkit” on page 494 for further details.

The following samples access databases from message flows:

- Message Routing sample
- Data Warehouse sample
- Error Handler sample
- Airline Reservations sample

The Message Routing sample and the Data Warehouse sample use Compute nodes to access the database, the Error Handler uses Database nodes to access the database, and the Airline Reservations sample uses both Compute and Database nodes. You can view samples only when you use the information center that is integrated with the Message Broker Toolkit.

Accessing databases from ESQL

You can create and configure ESQL in message flows to access user databases.

Before you start:

- Create a message flow.
- Ensure that the databases are configured.

You can use a number of ESQL statements and functions to access databases:

INSERT statement

The INSERT statement adds a row to a database table.

UPDATE statement

The UPDATE statement changes one or more values stored in zero or more rows.

DELETE FROM statement

The DELETE FROM statement removes zero or more rows.

SELECT function

The SELECT function retrieves data from a table.

CALL statement

The CALL statement invokes a stored procedure.

PASSTHRU statement

The PASSTHRU statement can be used to invoke administrative operations, such as creating a table.

PASSTHRU function

The PASSTHRU function can be used to invoke complex selects.

You can access user databases from Compute, Database, and Filter nodes; you can use the same ESQL statements and functions to access databases in all three types of node. A single node can access multiple databases but the following restrictions apply:

- Any node that accesses one or more databases must have its Data source property set with the ODBC data source name (DSN) of a database; the database must be accessible and operational, and the broker must be authorized to connect to it.

- All databases that are accessed from a single node must be compatible with each other. If you use the same database manager on the same platform at the same service level for all the databases, the data sources will be compatible. For example, two DB2 database instances at the same DB2 fix pack level are compatible but a DB2 database and an Oracle database are not compatible. If you use data sources that are not compatible, when you put a message through the message flow to test it, the message flow throws an error. If your data sources are not compatible, you cannot access them from a single node; if this is the case, use additional nodes in your message flow.
- All tables that are referred to in a single SELECT function's FROM clause must be in the same database.

To access databases, you must ensure that suitable ODBC data source names (DSN) have been defined on the system on which the broker is running. On Linux (zSeries platform) and Linux (POWER™ platform), the only supported database manager is DB2 and ODBC is not used; the broker and message flows connect to the databases directly. When you configure message flows, use the DB2 alias of the database as the DSN.

If you have used the `mqsisetdbparms` command to set a user ID and password for a particular database, the broker uses these values to connect to the database. If you have not set values for a particular database, the broker uses the default database user ID and password that you supplied on the `mqsicreatebroker` command, or the user ID and password details that you specified if you have modified the broker using the `mqsichangebroker` command.

z/OS On z/OS systems, the broker uses the broker started-task ID to connect to the database. You must also ensure that the database user IDs have sufficient privileges to perform the operations your flow requires. If they do not have the required privileges, errors will occur at run time.

For a description of database transactional issues, see *The Transactional model*.

Select the **Throw exception on database error** property check box and the **Treat warnings as errors** property check box, and set the **Transaction** property to **Automatic**, to provide maximum flexibility.

Configuring globally coordinated message flows

A coordinated message flow executes within a single transaction, which is started when a message is received by an input node, and can be committed or rolled back when all processing has completed. You can also control how database errors are handled by the node that interacts with the database.

Before you start:

You must have completed the following tasks:

1. Configuring databases for global coordination of transactions.
2. Configuring global coordination of transactions (two-phase commit).
3. "Creating a message flow" on page 218.

If you want the actions of a message flow to be globally coordinated (that is, it must complete all processing successfully, or complete none), ensure that your configuration supports this action. For more information about global coordination of message flow transactions, see *The Transactional model*.

The following sample demonstrates the use of globally-coordinated transactions, and the differences in the message flow when database updates are coordinated (the main flow) and when they are not (the error flow).

- Error Handler sample

You can view samples only when you use the information center that is integrated with the Message Broker Toolkit.

To configure a message flow for global coordination:

1. In the Message Broker Toolkit, switch to the Broker Application Development perspective.
2. Open the message flow that you want to configure.
3. Set the Transaction property for the following nodes if they appear in this message flow:
 - Compute node
 - Database node
 - DataDelete node
 - DataInsert node
 - DataUpdate node
 - Filter node
 - Mapping node
 - Warehouse node

You can set the Transaction property to the following values:

Automatic

Any updates, deletions, and additions performed by the node are committed or rolled back when the message flow processing completes. If the message flow completes successfully, all changes are committed. If the message flow does not complete successfully, all changes are rolled back.

If you want all of the processing by the message flow to be coordinated, you must select this value.

Commit

The action taken depends on the system to which the message flow has been deployed:

- On distributed systems, any work that has been done to this data source in this message flow to date, including any actions taken in this node, is committed regardless of the subsequent success or failure of the message flow.

Note: On systems other than z/OS, individual relational databases might or might not support this mode of operation.

- **z/OS** On z/OS, actions that are taken in this node only are committed, regardless of the subsequent success or failure of the message flow. Any actions that are taken before this node, under automatic transactionality, are not committed, but remain within a unit of work, and might either be committed or rolled back, depending on the success of the message flow.

To mix nodes with Automatic and Commit transactionality in the same message flow, where the nodes operate on the same external database, use separate ODBC connections: one for the nodes that are not to commit until the completion of the message flow, and one for the nodes that are to commit immediately. If you do not, the nodes that commit immediately will also commit all operations that are carried out by preceding Automatic nodes.

Note: On systems other than z/OS, individual relational databases might or might not support this mode of operation.

If you define more than one ODBC connection you might get database locking problems. In particular, if a node with Automatic transactionality carries out an operation, such as an INSERT or an UPDATE, that causes a database object (such as a table) to be locked, and a subsequent node tries to access that database object using a different ODBC connection, an infinite lock (deadlock) occurs.

The second node waits for the lock acquired by the first to be released, but the first node will not commit its operations and release its lock until the message flow completes; this will never happen because the second node is waiting for the first node's database lock to be released.

Such a situation cannot be detected by any DBMS automatic deadlock-avoidance routines because the two operations are interfering with each other indirectly using the broker.

There are two ways to avoid this type of locking problem:

- Design your message flow so that uncommitted (automatic) operations do not lock database objects that subsequent operations using a different ODBC connection need to access.
- Configure your database's lock timeout parameter so that an attempt to acquire a lock fails after a specified length of time. If a database operation fails because of a lock timeout, an exception is thrown that the broker handles in the usual way.

For information concerning which database objects are locked by particular operations, and how to configure your database's lock timeout parameter, consult your database product documentation.

4. Set the Transaction Mode property for the following nodes, if they are in this message flow:
 - MQInput node
 - MQOutput node
 - MQReply node
 - SCADAInput node
 - JMSInput node
 - JMSOutput node

The following table provides a summary of the actions taken in response to specific property settings for the input and output nodes.

Message persistence ^a	Input node Transaction Mode	MQOutput or MQReply node Transaction Mode	Message flow is globally coordinated?
Yes	Yes	Automatic	Yes
No	Yes	Automatic	Yes
Yes	No	Automatic	No
No	No	Automatic	No
Yes	Automatic	Automatic	Yes
No	Automatic	Automatic	No
Any ^b	Any ^b	Yes	Yes
Any ^b	Any ^b	No	No

Notes:

- a. Persistence is relevant only for messages received across the WebSphere MQ Enterprise Transport, WebSphere MQ Mobile Transport, and WebSphere MQ Telemetry Transport protocols.
- b. The MQOutput or MQReply node property setting overrides the value set here.
- c. The Transaction Mode settings of the JMSInput and JMSOutput nodes are set differently to the preceding table. See “JMSInput node” on page 949 and “JMSOutput node” on page 961.

The default on each input node is Yes, which means that the incoming messages are processed under syncpoint. In addition, messages sent to the output node are delivered under syncpoint. You can change this behavior if the output node is an MQOutput or MQReply node, both of which have a Transaction Mode property.

If you set the Transaction Mode on an input node to Automatic, the incoming messages are processed under syncpoint only if they are defined as persistent. Messages sent to the MQOutput node are delivered under syncpoint unless you explicitly change the Transaction Mode in the MQOutput node.

5. Set the Treat warnings as errors and Throw exception on database error for each node that accesses a database to indicate how you want that node to handle database warnings and errors. Whether you select these properties, and how you connect the failure terminals of the nodes, also affect the way in which database updates are committed or rolled back.
6. Switch to the Broker Administration perspective.
7. Add the message flow to a broker archive.
8. Select the **Configure** tab below the broker archive editor view and select the message flow. This displays the configurable properties for the message flow within the broker archive. Select coordinatedTransaction to configure the message flow as globally coordinated.

z/OS On z/OS, transactions are always globally coordinated. The setting of the coordinatedTransaction property for a message flow is ignored. Coordination is always provided by RRS.

The message flow is now configured for global coordination.

Now, you can deploy the message flow to the broker. Ensure that the broker environment (including the broker’s queue manager) and databases are correctly configured for global coordination before you deploy the message flow.

If the broker environment and the databases are not correctly configured for global coordination, the message flow transactions will not be globally coordinated.

Configuring JMSInput and JMSOutput nodes to support global transactions

If you want to include JMSInput and JMSOutput nodes in globally-coordinated transactions, additional configuration is required.

Complete the following steps:

1. Switch to the Broker Application Development perspective.
2. Set the message flow property Coordinated Transaction to yes in the bar file properties.
3. For each JMSInput or JMSOutput node required in the global transaction, set the Advanced property Transaction mode to Global in the message flow editor.

4. Create a Queue Connection Factory and either use the default name, *recoverXAQCF*, or supply your own name. See the JMSInput or JMSOutput node for further details about creating JNDI administered objects.
5. On distributed systems, you must set up a stanza for each JMS provider that you want to use, prior to deployment.

The following table shows the switch files that are provided on each platform.

Platform	32-bit file	64-bit file
Linux (x86 platform)	libJMSSwitch.so	
Windows	JMSSwitch.dll	
HP-UX (PA-RISC platform)	libJMSSwitch.sl	libJMSSwitch64.sl
AIX Linux (x86-64 platform) Solaris (SPARC platform)	libJMSSwitch.so	libJMSSwitch64.so
HP-UX (Integrity platform) Linux (POWER platform) Linux (zSeries platform) Solaris (x86-64 platform)		libJMSSwitch.so

Select the appropriate link for details of this task on the platform, or platforms, that your enterprise uses:

- [Linux](#) [UNIX](#) Linux and UNIX systems
- [Windows](#) Windows systems

For further information, see:

- “Configuring for coordinated transactions” on page 952 within the JMSInput node topic
- “Configuring for coordinated transactions” on page 966 within the JMSOutput node topic

[z/OS](#) On z/OS, the only JMS provider supported is the IBM WebSphere MQ Java Client and the only transport mode supported for that client is BIND mode; no further configuration steps are required.

The JMS provider might supply additional jar files that are required for transactional support; see the documentation supplied with the JMS provider for more information. For example, on distributed systems, the WebSphere MQ JMS provider supplies an extra jar file `com.ibm.mqetclient.jar`.

You must add any additional jar files to the broker `shared_classes` directory. On Windows, this directory is `C:\Documents and Settings\All Users\Application Data\IBM\MQSI\shared-classes`. For more information, see the section on making the JMS provider client available to the JMS Nodes in “JMSInput node” on page 949.

Choice of JMS Provider

Any JMS provider that conforms to the Java Message Service Specification, version 1.1 and that supports the JMS XAResource API through the JMS session can be used if transaction coordination is required.

If the message designer has specified a non XA-compliant provider, the non transactional mode only is supported. In this case, you must set the Transaction mode property to None for all JMSInput and JMSOutput nodes.

Linux and UNIX systems: configuring the queue manager to coordinate JMS resources

Edit the queue manager qm.ini file to configure the queue manager.

You must specify a stanza in the broker's queue manager .ini file for each JMS provider that you want to use. Include one stanza for each new JMS provider, where the JMS provider can be specified by any JMSInput or JMSOutput node that is included in a message flow that is running on a broker.

The parameters that are supplied on XAOpenString are comma delimited and positional. Represent missing optional parameters by a comma if you have included other parameters later in the string.

The following stanza entry is an example you can add when using WebSphere MQ Java as the JMS provider:

```
XAResourceManager:
  Name=WBIWMQJMS
  SwitchFile=/<Installation Path>/lib/JMSSwitch.so
  XAOpenString=<Initial Context Factory>,
               <location of JNDI bindings>'
               <LDAP Principal>,
               <LDAP Credentials>,
               <Recovery Connection Factory Name>,
               <JMS Principal>,
               <JMS Credentials>
  ThreadOfControl=THREAD
```

where:

<Installation Path>

Is the location of the WebSphere Message Broker installation. This value is mandatory where the LDAP parameters are omitted, but a user-defined Queue Connection Factory is specified for recovery.

<Initial Context Factory>

Is the Initial Context Factory identifier for the JMS provider; this value is required.

<Location of JNDI bindings>

Is either the file path to the bindings file, or the LDAP directory location of the JNDI administered objects that can be used to create an initial context factory for the JMS connection. When supplying the file path to the bindings file, do not include the file name. See the JMSInput or JMSOutput node for further details on creating the JNDI administered objects; this value is required.

<LDAP Principal>

Is an optional parameter used to specify the principal (user ID) that might be required when an LDAP database is used to hold the JNDI administered objects.

<LDAP Credentials>

Is an optional parameter used to specify the Credentials (password) that might be required if a password protected LDAP database is used to hold the JNDI administered objects.

<Recovery Connection Factory Name>

Is an optional parameter used to specify the name of a Queue Connection Factory object in the JNDI administered objects for recovery purposes, when the non default name is required.

<JMS Principal>

Is an optional parameter for the user ID required to connect to a JMS provider, using a secure JMS Connection Factory.

<JMS Credentials>

Is an optional parameter for the password required to connect to the same JMS provider in conjunction with the JMS principal.

The values for the Initial Context factory and Location of JNDI bindings in the stanza must match those specified in the JMSInput or JMSOutput nodes in the message flows.

Any LDAP parameters must match those that have been specified by using the mqsicreatebroker or mqsicchangebroker command.

The Recovery Factory Name must match a Queue Connection Factory name that is created in the JNDI administered objects. If this is omitted, a default factory called recoverXAQCF is used. In either case, this value must refer to a JNDI administered object that has already been created.

The JMS Principal and JMS Credentials must be configured together

The following example shows the format of a stanza in the `qm.ini` file that describes a JMS provider for global transactions:

```
XAResourceManager:
  Name=XAJMS_PROVIDER1
  SwitchFile=/opt/var/mqsi/lib/JMSSwitch.so
  XAOpenString= com.sun.jndi.fscontext.RefFSContextFactory,
                /Bindings/JMSProvider1_Bindings_Directory,
                ,
                ,
                ,
                myJMSuser1,
                passwd
                ThreadOfControl=THREAD
```

where:

XAJMS_PROVIDER1

Is the user-defined name for the resource manager

/opt/var/mqsi

Is the <Installation Path>

com.sun.jndi.fscontext.RefFSContextFactory

Is the <Initial Context Factory>

/Bindings/JMSProvider1_Bindings_Directory

Is the location of the bindings

myJMSuser1

Is the <JMS Principal>

passwd

Is the password used in <JMS Credentials>

In this example, the optional fields <LDAP Principal>, <LDAP Credentials>, and <Recovery Connection Factory Name> are not required, therefore the positional comma delimiters only are configured in the XAOpenString stanza.

Windows systems: configure the queue manager to coordinate JMS resources

Use WebSphere MQ Explorer to configure the queue manager.

You must specify a stanza in the broker's queue manager .ini file for each JMS provider that you want to use. Include one stanza for each new JMS provider, where the JMS provider can be specified by any JMSInput or JMSOutput node that is included in a message flow that is running on a broker.

The parameters that are supplied on XAOpenString are comma delimited and positional. Represent missing optional parameters by a comma if you have included other parameters later in the string.

The extra entry, called the XACloseString, should match the values provided for the XAOpenString.

The following stanza entry is an example you can add when using WebSphere MQ Java as the JMS provider:

```
XAResourceManager:
Name=WBIWMQJMS
SwitchFile=<Installation Path>\lib\JMSSwitch.dll
XAOpenString=<Initial Context Factory>,
               <location of JNDI bindings>'
               <LDAP Principal>,
               <LDAP Credentials>,
               <Recovery Connection Factory Name>,
               <JMS Principal>,
               <JMS Credentials>
ThreadOfControl=THREAD
```

where:

<Installation Path>

Is the location of the WebSphere Message Broker installation. This value is mandatory where the LDAP parameters are omitted, but a user-defined Queue Connection Factory is specified for recovery.

<Initial Context Factory>

Is the Initial Context Factory identifier for the JMS provider; this value is required.

<Location of JNDI bindings>

Is either the file path to the bindings file, or the LDAP directory location of the JNDI administered objects that can be used to create an initial context factory for the JMS connection. When supplying the file path to the bindings file, do not include the file name. See the JMSInput or JMSOutput node for further details on creating the JNDI administered objects; this value is required.

<LDAP Principal>

Is an optional parameter used to specify the principal (user ID) that might be required when an LDAP database is used to hold the JNDI administered objects.

<LDAP Credentials>

Is an optional parameter used to specify the Credentials (password) that might be required if a password protected LDAP database is used to hold the JNDI administered objects.

<Recovery Connection Factory Name>

Is an optional parameter used to specify the name of a Queue Connection Factory object in the JNDI administered objects for recovery purposes, when the non default name is required.

<JMS Principal>

Is an optional parameter for the user ID required to connect to a JMS provider, using a secure JMS Connection Factory.

<JMS Credentials>

Is an optional parameter for the password required to connect to the same JMS provider in conjunction with the JMS principal.

The values for the Initial Context factory and Location of JNDI bindings in the stanza must match those specified in the JMSInput or JMSOutput nodes in the message flows.

Any LDAP parameters must match those that have been specified by using the mqsicreatebroker or mqsichangebroker command.

The Recovery Factory Name must match a Queue Connection Factory name that is created in the JNDI administered objects. If this is omitted, a default factory called recoverXAQCF is used. In either case, this value must refer to a JNDI administered object that has already been created.

The JMS Principal and JMS Credentials must be configured together

The following example shows the format of a stanza in the `qm.ini` file that describes a JMS provider for global transactions:

```
XAResourceManager:  
  Name=XAJMS_PROVIDER1  
  SwitchFile=/opt/var/mqsi/lib/JMSSwitch.so  
  XAOpenString= com.sun.jndi.fscontext.RefFSContextFactory,  
                /Bindings/JMSProvider1_Bindings_Directory,  
                ,  
                ,  
                ,  
                myJMSuser1,  
                passwd  
  ThreadOfControl=THREAD
```

where:

XAJMS_PROVIDER1

Is the user-defined name for the resource manager

/opt/var/mqsi

Is the <Installation Path>

com.sun.jndi.fscontext.RefFSContextFactory

Is the <Initial Context Factory>

/Bindings/JMSProvider1_Bindings_Directory

Is the location of the bindings

myJMSuser1

Is the <JMS Principal>

passwd

Is the password used in <JMS Credentials>

In this example, the optional fields <LDAP Principal>, <LDAP Credentials>, and <Recovery Connection Factory Name> are not required, therefore the positional comma delimiters only are configured in the XAOpenString stanza.

Configuring the broker to enable a JMS provider's proprietary API

Some JMS providers provide an alternative interface to the standard JMS specification for particular JMS API calls. In these cases, IBM supplies a Java class to interface with that proprietary API.

For example, BEA WebLogic uses a component called a *Client Interposed Transaction Manager* to allow a JMS client to obtain a reference to the XAResource that is associated with a user transaction.

If the WebSphere Message Broker JMS nodes use BEA WebLogic as the JMS provider, and the nodes have to participate in a globally coordinated message flow, you must modify the configurable services properties that are associated with that vendor. The following table shows the properties that have been added to the configurable service for BEA WebLogic.

JMS provider	Property	Purpose	Default value
BEA_WebLogic	proprietaryAPIHandler	The name of the IBM-supplied Java class to interface with a JMS provider's proprietary API.	com.ibm.broker.apihandler. BEAWebLogicAPIHandler
	proprietaryAPIAttr1	The Initial Context Factory class name for the vendor	weblogic.jndi. WLInitialContextFactory
	proprietaryAPIAttr2	The URL of the WebLogic bindings	<i>URL JNDI bindings</i>
	proprietaryAPIAttr3	The DNS name of the JMS server	<i>Server name</i>

In the list of JMS provider configurable services, the name of the IBM-supplied Java class is set to the default value for the proprietaryAPIHandler property. Typically, you do not need to change this value, unless you are instructed to do so by an IBM Service team representative.

- Use the `mqsischangeproperties` command to modify values of the properties for this JMS provider.

The following example shows how to change the values of the properties `proprietaryAPIAttr2` and `proprietaryAPIAttr3` for the JMS provider configurable service definition called `BEA_Weblogic`, where these properties represent the URL of the WebLogic bindings and the DNS Server name of the BEA WebLogic JMS Server:

```
mqsischangeproperties WBRK61_DEFAULT_BROKER -c JMSProviders -o BEA_Weblogic
-n proprietaryAPIAttr2,proprietaryAPIAttr3 -v t3://9.20.94.16:7001,BEAServerName
```

- Use the `mqsireportproperties` command to display the properties for a JMS provider.

The following example shows how to display the properties for all the broker's JMS provider resources (the default JMS provider resources and those configurable services that are defined with the `mqsicreateconfigurable-service` command):

```
mqsireportproperties WBRK61_DEFAULT_BROKER -c JMSProviders -o BEA_WebLogic -r
```

The result of this command has the following format:

```
ReportableEntityName=''
JMSProviders
  BEA_Weblogic=''
  jarsURL='default_Path'
  nativeLibs='default_Path'
  proprietaryAPIAttr1='weblogic.jndi.WLInitialContextFactory'
  proprietaryAPIAttr2='t3://9.20.94.16:7001'
  proprietaryAPIAttr3='BEAServerName'
  proprietaryAPIAttr4='default_none'
  proprietaryAPIAttr5='default_none'
  proprietaryAPIHandler='com.ibm.broker.apihandler.BEAWebLogicAPIHandler'
```

The default location for the JMS provider JAR files is the broker's shared-classes directory. You can specify an alternative location for the JAR files by using the `mqsichangeproperties` command, as shown in the following example:

```
mqsichangeproperties WBRK61_DEFAULT_BROKER -c JMSProviders -o BEA_WebLogic -n jarsURL
-v /var/mqsi/WebLogic
```

- Use the `mqsicreateconfigurableservice` command to add a JMS provider.

The following example shows how to add a JMS provider called BEAV91 for broker WBRK61_DEFAULT_BROKER, specifying the name of an IBM-supplied Java class called `com.ibm.broker.apihandler.BEAWebLogicAPIHandler` to handle vendor-specific API calls:

```
mqsicreateconfigurableservice WBRK61_DEFAULT_BROKER -c JMSProviders -o BEAV91
-n proprietaryAPIHandler,proprietaryAPIAttr1,proprietaryAPIAttr2,proprietaryAPIAttr3
-v com.ibm.broker.apihandler.BEAWebLogicAPIHandler,weblogic.jndi.WLInitialContextFactory,
t3://9.20.94.16:7001,BEAServerName
```

- If you have defined a user-defined JMS provider configurable service, set the value for the `proprietaryAPIHandler` property manually.

Configuring message flows for data conversion

If you exchange messages between applications that run on systems that are incompatible in some way, you can configure your system to provide data conversion as the message passes through the broker.

Data conversion might be necessary if either of the following two values are different on the sending and receiving systems:

1. **CCSID.** The Coded Character Set Identifier refers to a set of coded characters and their code point assignments. WebSphere Message Broker can process and construct application messages in any code page for which WebSphere MQ provides conversion to and from Unicode, on all operating systems. For more information about code page support, see the *Application Programming Reference* section of the WebSphere MQ Version 6 information center online.

This behavior might be affected by the use of other products in conjunction with WebSphere Message Broker. Check the documentation for other products, including any databases that you use, for further code page support information.

2. **Encoding.** This setting defines the way in which a machine encodes numbers; that is, binary integers, packed-decimal integers, and floating point numbers. Numbers that are represented as characters are handled in the same way as all other string data.

If the native CCSID and encoding on the sending and receiving systems are the same, you do not need to call data conversion processes.

WebSphere Message Broker and WebSphere MQ provide data conversion facilities to support message exchange between unlike systems. Your choice of which facilities to use depends on the characteristics of the messages that are processed by your message flows:

- Messages that contain text only
- Message that include numerics
- Messages that are self-defining

Messages that contain text only

Read this section if your messages are WebSphere MQ messages that contain all text (character data or string).

If WebSphere MQ supports the systems on which both sending and receiving applications are running for data conversion, use WebSphere MQ facilities which provide the most efficient data conversion option.

The default behavior of WebSphere MQ is to put messages to queues specifying the local system CCSID and encoding. Applications issuing MQGET can request that the queue manager provides conversion to their local CCSID and encoding as part of get processing.

To use this option:

1. Design messages to be text-only. If you are using COBOL, move numeric fields to USAGE DISPLAY to put them into string form.
2. Set the Format field in the MQMD to MQFMT_STRING (value MQSTR).
3. Issue MQGET with MQGMO_CONVERT in the receiving application. If you prefer, you can convert when the message is received by the broker, by setting the Convert property of the MQInput node to yes (by selecting the check box).

If you require more sophisticated data conversion than WebSphere MQ provides in this way (for example, to an unsupported code page), use WebSphere MQ data conversion exits. For more information about these, see the *Application Programming Reference* section of the WebSphere MQ Version 6 information center online.

Messages that include numerics

Read this section if your messages include numeric data, or are text only but are not WebSphere MQ messages.

If these messages can be predefined (that is, their content and structure is known and predictable), use the facilities provided by WebSphere Message Broker and the MRM.

All application messages are handled by the broker in Unicode, to which they are converted on input, and from which they are converted on output. You can configure message flows to influence the way in which output messages are constructed.

To use this option:

1. Define the output message in the MRM domain. You can create this definition in one of the following ways:
 - Import an external message definition (for example a C header or COBOL copybook).
 - Create the message model in the message definition editor.
2. Configure a message flow to receive and process this message:

- a. If you include an MQInput node, do not request conversion by this node.
- b. Include a Compute node in the message flow to create the output message with the required content:
 - If the output message is a WebSphere MQ message, code ESQL in the Compute node to set the CCSID and encoding for the target system in the MQMD.
For example, to set values for a target z/OS system running with CCSID of 37 and encoding of 785:

```
SET OutputRoot.MQMD.CodedCharSetId = 37;
SET OutputRoot.MQMD.Encoding = 785;
```
 - If the output message is not a WebSphere MQ message, code ESQL in the Compute node to set the CCSID and encoding for the target system in the Properties folder.

Messages that are self-defining

Read this section if your messages are self-defining.

Self-defining messages are supported in the XML and JMS domains. These messages are all text and can be handled by WebSphere MQ, if they originate from, or are destined for, WebSphere MQ applications. If not, use WebSphere Message Broker facilities by setting the CCSID and Encoding fields in the Properties folder in the message when it passes through a Compute node.

Using MQGet nodes

The following topics explain how the MQGet node processes messages, and how you might use an MQGet node in a request-response flow:

- “How the MQGet node processes messages”
- “A request-response scenario using an MQGet node” on page 189

How the MQGet node processes messages

The MQGet node processes each message that it receives.

This topic contains the following sections:

- “Propagating the message”
- “Constructing OutputLocalEnvironment” on page 187
- “Constructing the Output message” on page 188

Propagating the message

1. If an MQ Message Descriptor header (MQMD) is present in the input tree, the MQGet node uses it. If not, the node creates a default MQMD.
2. The node also creates a default MQ Get Message Options (MQGMO) structure based on the values that you have set for the node properties. If an MQGMO is present in the input tree, the node uses its content to modify the default one.

When you include an MQGMO to override the default one, you must specify all the options that you are replacing. For example, if you set the option field to MQGMO_CONVERT, that value overrides all options that you set with the workbench. If you do not use an overriding MQGMO, WebSphere Message Broker uses the following values:

- If Wait interval is not zero, MQGMO_WAIT is set; otherwise, MQGMO_NOWAIT is used.
- If Transaction mode is set to Yes, MQGMO_SYNCPOINT is used.

- If Transaction mode is set to No, MQGMO_NOSYNCPOINT is used.
 - If Transaction mode is set to Automatic, MQGMO_SYNCPOINT_IF_PERSISTENT is used.
 - The only other option that is used by default in the node properties is MQGMO_COMPLETE_MSG, which is set if Transaction mode is set to Yes or No. This option is not set when your broker is running on z/OS.
 - No other options are used by default.
3. The node makes the MQGet call to WebSphere MQ.
 4. The node analyzes the completion code (CC), and propagates the message to the appropriate terminal:
 - OK** The node creates the output LocalEnvironment and the output message trees using standard message-parsing techniques, then propagates the message to the Out terminal.

Warning

The node creates the output LocalEnvironment and the output message trees using BLOB as the message body type, then propagates the message to the Warning terminal, if it is connected. If the Warning terminal is not connected, no propagation occurs, and the flow ends.

Fail (no message)

The node creates the output LocalEnvironment and the output message trees by copying the input trees, then propagates the message to the No Message terminal, if it is connected. If the No Message terminal is not connected, no propagation occurs. The output message that is propagated to the No Message terminal is constructed from the input message only, according to the values of the Generate Mode property, and the Copy Message or Copy Local Environment properties.

Fail (other)

The node propagates the message to the Failure terminal. If the Failure terminal is not connected, the broker throws an exception and returns control to the closest previous node that can process it. For more information, see “Handling errors in message flows” on page 203.

The following diagram shows this processing:

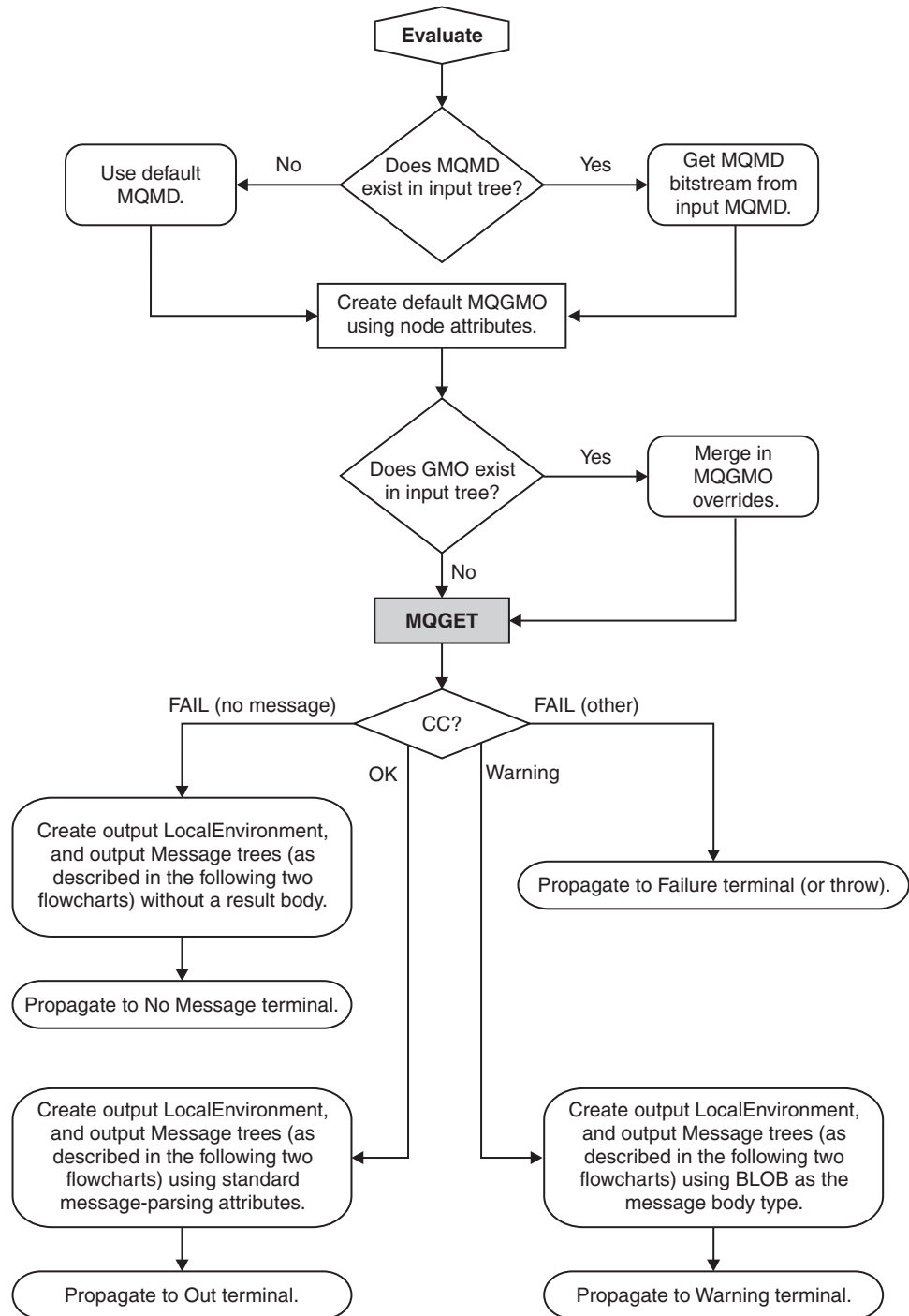

Constructing OutputLocalEnvironment

1. If the Generate Mode property on the MQGet node is set to an option that does not include LocalEnvironment, the node copies the input LocalEnvironment tree to the output LocalEnvironment tree.
If this copy is made, any updates that are made in this node to the output LocalEnvironment tree are not propagated downstream.
2. If the Copy Local Environment property is set to an option other than None, the node copies the input LocalEnvironment tree to the output LocalEnvironment tree.

3. If the output data location points to the output LocalEnvironment tree, the node applies changes in that tree by copying from the result tree.
4. The LocalEnvironment tree is propagated.

The following diagram shows this processing:

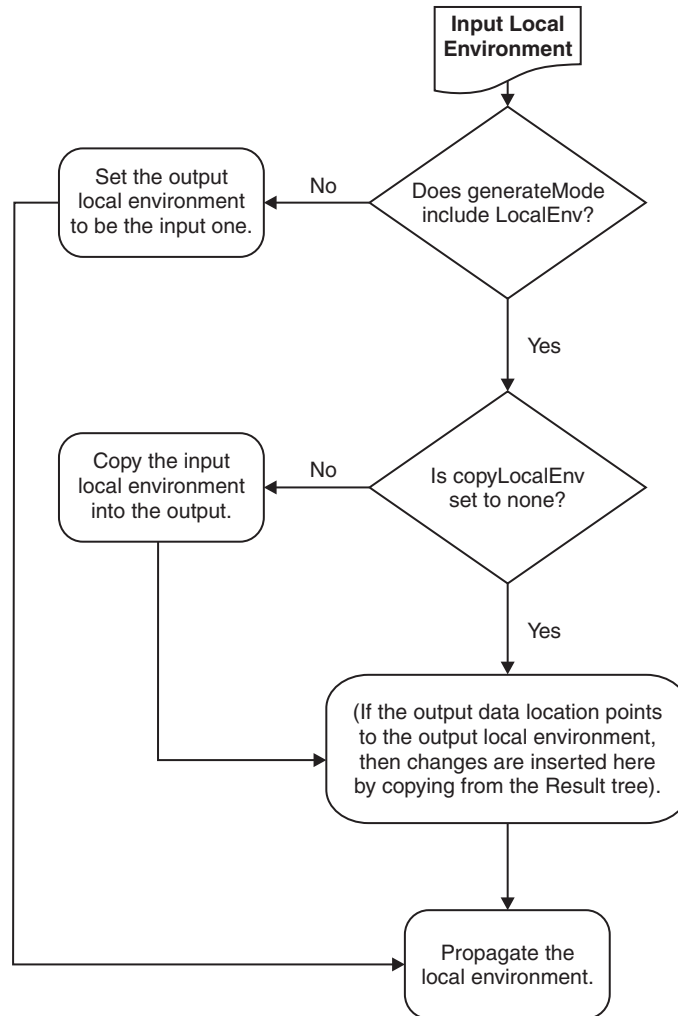

Constructing the Output message

1. If the Generate Mode property on the MQGet node is set to an option that does not include Message, the node copies the input message tree to the output message tree. Go to step 5.
2. If the Output Data Location property is set to OutputRoot, the node creates the output message tree entirely from the result tree. Go to step 5.
3. If the Copy Message property is set to a value other than None, the node copies the input message tree to the output message tree.
4. If the Output Data Location property points to a part of the output message tree, the node applies changes in that tree by copying from the result tree at the point that is defined by the Result Data Location property.
5. The message tree is propagated.

The following diagram shows this processing:

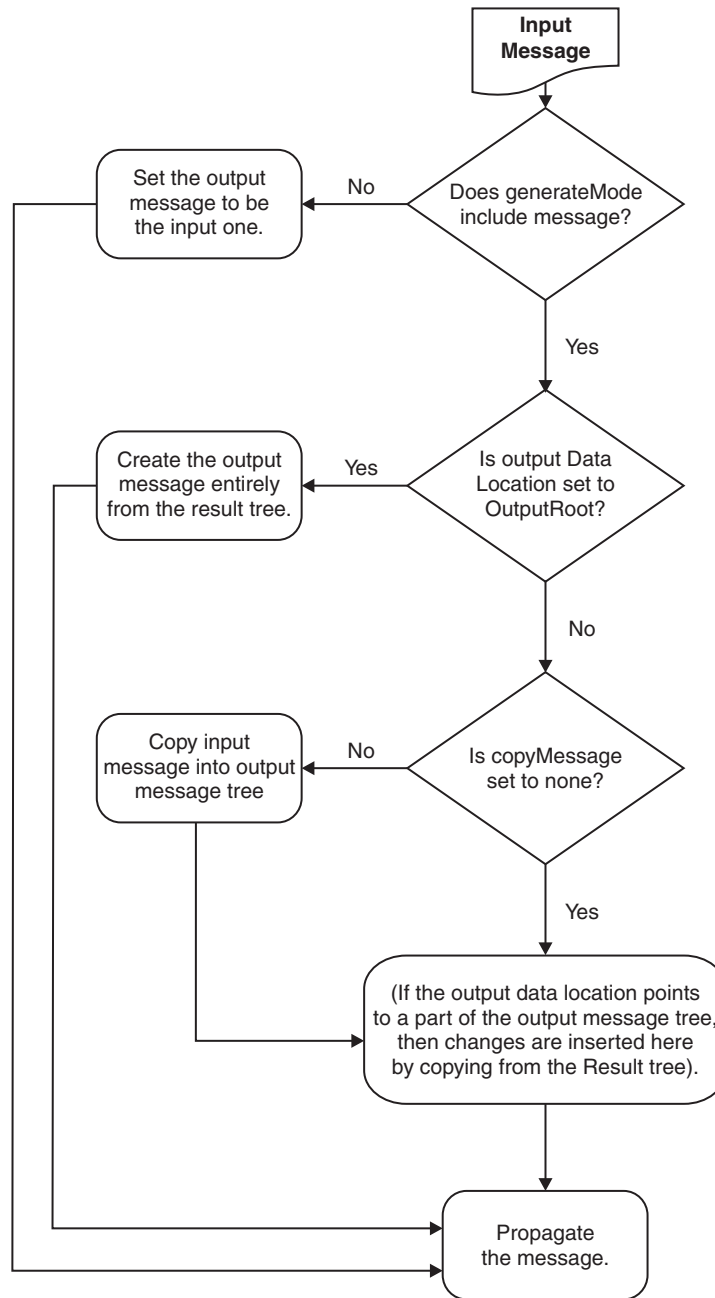

For an example of how this processing is implemented in a message flow, see “A request-response scenario using an MQGet node.”

A request-response scenario using an MQGet node

This topic describes a scenario in which an MQGet node is used in a request-response flow, and explains how the node processes the input messages to construct the output messages, based on both the content of the LocalEnvironment tree and the input parameters that you set.

A request-response flow is a specialized form of a point-to-point application. For a general description of these applications, see Application communication models. For an example of a request-response message flow, see the following sample:

- Coordinated Request Reply sample

You can view samples only when you use the information center that is integrated with the Message Broker Toolkit.

You can include an MQGet node anywhere in a message flow, including a flow that implements a request-response scenario. The node receives an input message on its input terminal from the preceding node in the message flow. It issues an MQGET call to retrieve a message from the WebSphere MQ queue that you have configured in its properties, and builds a result message tree. Finally, it uses the input tree and the result tree to create an output tree that is then propagated to its Output, Warning, or Failure terminal, depending on the configuration of the node and the result of the MQGET operation.

How the MQGet node handles the LocalEnvironment:

The MQGet node examines the LocalEnvironment tree that is propagated from the preceding node. It uses the content related to the MQGMO (MQ Get Message Options) and the MQMD (MQ Message Descriptor header), and updates the LocalEnvironment:

- The node reads the MQGMO structure from `${inputMQParmsLocation}.MQGMO.*`.
- The node copies the WebSphere MQ completion and reason codes to `${outputMQParmsLocation}.CC` and `${outputMQParmsLocation}.RC`.
- The node writes the complete MQGMO that is used for the MQGET call into `${outputMQParmsLocation}.MQGMO` if `${inputMQParmsLocation}.MQGMO` exists in the input tree.
- The node writes the MQMD that is passed to the MQGET call (that contains the values that are specified in the input message or are generated by the node) into `${inputMQParmsLocation}.MQMD`, deleting any existing content.

Set the value to `${inputMQParmsLocation}` in the MQGet node property Input MQ Parameters Location on the **Request Properties** tab.

Set the value to `${outputMQParmsLocation}` in the MQGet node property Output MQ Parameters Location on the **Result Properties** tab.

For more information about these properties, see “MQGet node” on page 993.

In summary:

`${inputMQParmsLocation}`

- *QueueName*: Optional override for MQGet node *Queue Name* property
- *InitialBufferSize*: Optional override for MQGet node *Initial Buffer Size* property
- *MQGMO.**: Optional MQGET message options that are used by the MQGet node

`${outputMQParmsLocation}`

- *CC*: MQGET call completion code
- *RC*: MQGET call result code
- *MQGMO.**: MQGET message options that are used if present in `${inputMQParmsLocation}`
- *MQMD*: unparsed MQ Message Descriptor for received messages¹
- *Browsed*: Set to true if the message is browsed. Not present if the message is removed from the queue

You can parse the MQMD (for example, using ESQL), where
\${outputMQParmsLocation} is LocalEnvironment.MQ.GET:

```
DECLARE ptr REFERENCE TO OutputLocalEnvironment.MyMQParms;  
CREATE FIRSTCHILD OF ptr DOMAIN('MQMD') PARSE(InputLocalEnvironment.MQ.GET.MQMD)
```

How the MQMD for the MQGET call is constructed:

- A default MQMD is prepared. For further information about the MQMD, see the *Application Programming Reference* section in the WebSphere MQ Version 6 information center online.
- If you do not supply an input MQMD, the default MQMD is used.
- If you do supply an input MQMD, the default MQMD is used after the following modifications:
 - If the property Use all input MQMD fields is set, all MQMD fields supplied are copied into the default MQMD from the input MQMD.
 - If the property Use all input MQMD fields is not set and the properties Get by Message ID or Get by Correlation ID are selected, the respective IDs are copied into the default MQMD from the input MQMD.

The following diagram shows how the MQGet node constructs the MQMD that is used on the call to WebSphere MQ:

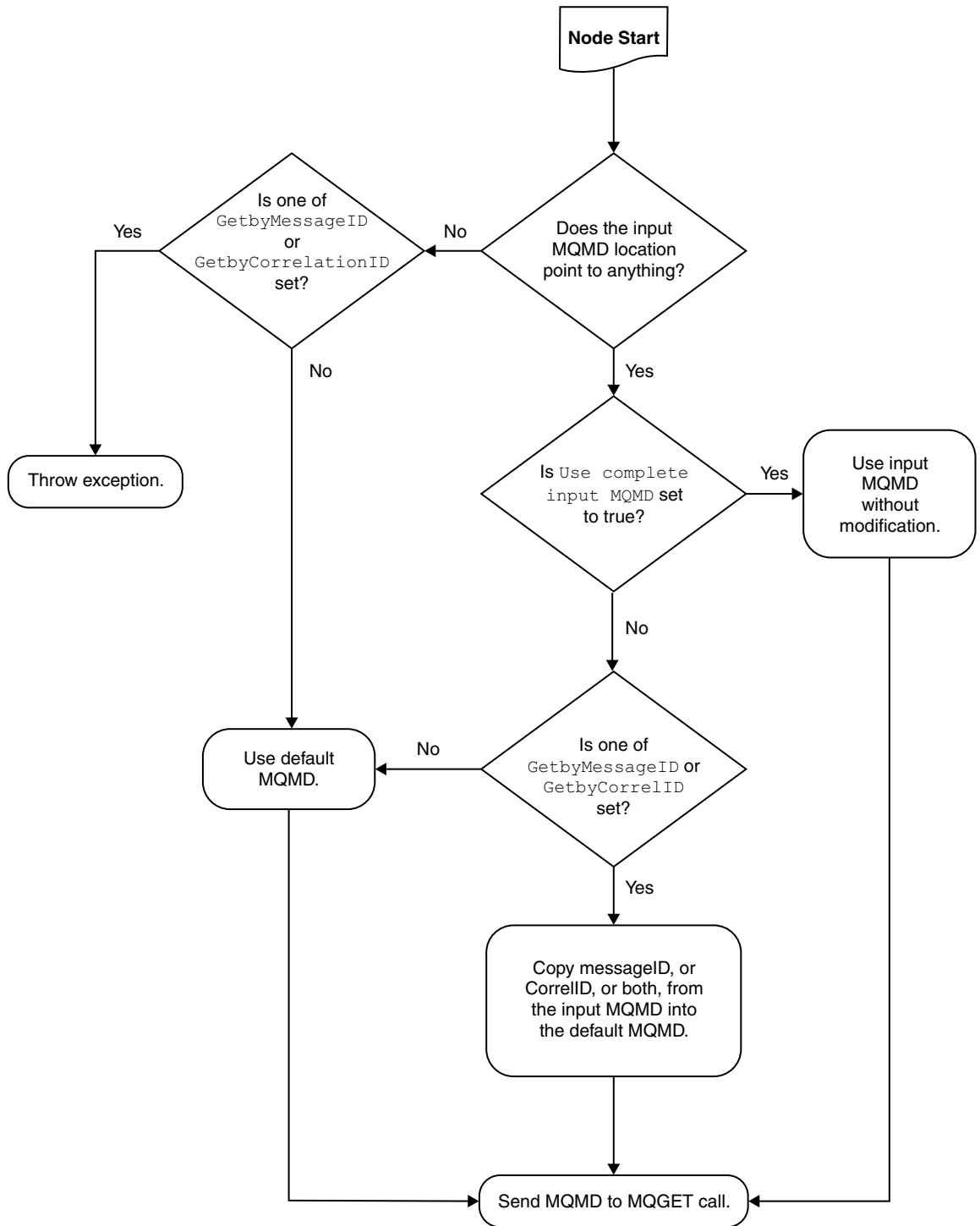

How the output message tree is constructed:

The following diagram outlines how the MQGet node constructs the output message tree, combining the input tree from the previous node with the result tree from the MQGET call:

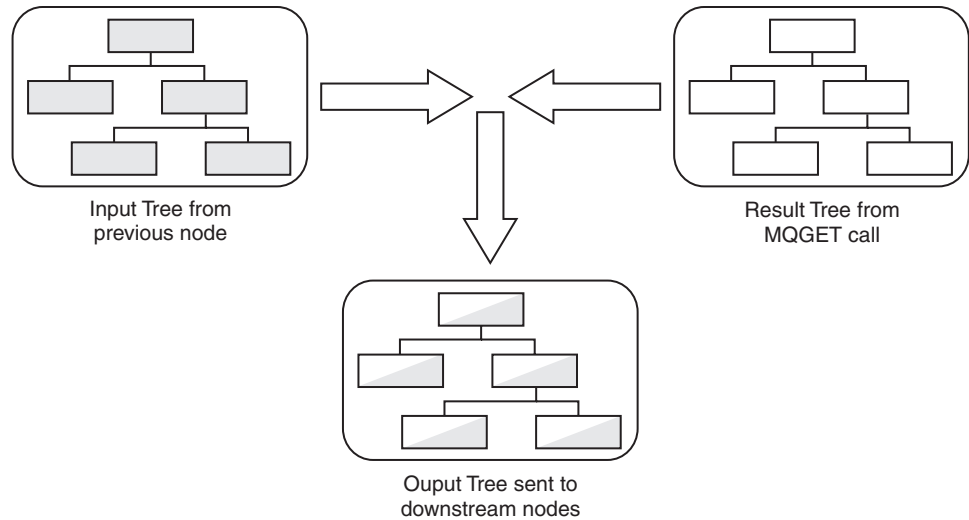

In this example, the MQGet node properties are configured as shown in the following table.

Property	Action
Copy Message	Copy Entire Message
Generate Mode	Message
Output Data Location	OutputRoot.XMLNS.A
Result Data Location	ResultRoot.XMLNS.C

The MQGet node constructs the output tree according to the following sequence:

1. The whole of the input tree is copied to the output tree, including the XML branch with child A, and A's child B.
2. From the result tree, the XML branch's child C, and C's child D, are put into the output tree at position OutputRoot.XMLNS.A. Any previous content of A (values and children) is lost, and replaced with C's content, including all values and children it has, in this case child D.
3. The position in the output tree retains the name A.

The following diagram illustrates this:

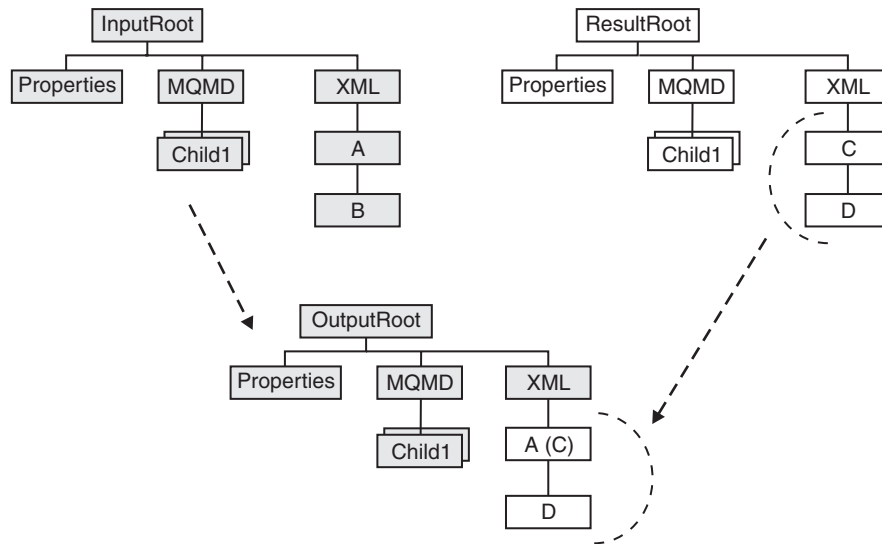

For some examples of message trees that are constructed by the MQGet node according to the rules described above, see “MQGet node message tree examples.”

MQGet node message tree examples:

The tables below show examples of message trees that are constructed by the MQGet node according to the rules described in “A request-response scenario using an MQGet node” on page 189.

With a message assembly like this:	The message that the MQGet node returns is:
<p>InputRoot</p> <ul style="list-style-type: none"> MQMD {input message MQMD} MQRFH2 {input message MQRFH2} XMLNS {input message body} <p>InputLocalEnvironment</p> <ul style="list-style-type: none"> MQ GET MQGMO MatchOptions = MQMO_MATCH_CORREL_ID MQMD (with no children) <p>MyData</p> <ul style="list-style-type: none"> MQMD {input MQMD} (with CorrelID = {correct Correlation ID as binary}) 	<p>ResultRoot</p> <ul style="list-style-type: none"> MQMD {result message MQMD} MQRFH2 {result message MQRFH2} XML {result message body}

With the following node property settings:	The resulting output message assembly is:
<p>Input MQMD Location InputLocalEnvironment.MyData.MQMD</p> <p>Copy Message Copy Entire Message</p> <p>Copy Local Environment Copy Entire LocalEnvironment</p> <p>Generate Mode Message and LocalEnvironment</p> <p>Output Data Location InputLocalEnvironment.MyData.ReturnedMessage</p>	<p>OutputRoot</p> <p>MQMD {input message MQMD}</p> <p>MQRFH2 {input message MQRFH2}</p> <p>XMLNS {input message body}</p> <p>OutputLocalEnvironment</p> <p>MQ</p> <p>GET</p> <p>MQGMO {MQGMO used for MQGET}</p> <p>MQMD {MQMD used for MQGET}</p> <p>CC = 0</p> <p>RC = 0</p> <p>MyData</p> <p>MQMD {input MQMD} (with CorrelID = {correct Correlation ID as binary})</p> <p>ReturnedMessage</p> <p>MQMD {result message MQMD}</p> <p>MQRFH2 {result message MQRFH2}</p> <p>XML {result message body}</p>

With the following node property settings:	The resulting output message assembly is:
<p>Result Data Location ResultRoot.XML</p>	<p>OutputRoot</p> <ul style="list-style-type: none"> MQMD {input message MQMD} MQRFH2 {input message MQRFH2} XMLNS {input message body} <p>OutputLocalEnvironment</p> <ul style="list-style-type: none"> MQ <ul style="list-style-type: none"> GET <ul style="list-style-type: none"> MQGMO {MQGMO used for MQGET} MQMD {MQMD used for MQGET} CC = 0 RC = 0 MyData <ul style="list-style-type: none"> MQMD {input MQMD} (with CorrelID = {correct Correlation ID as binary}) ReturnedMessage (with any attributes and value from ResultRoot.XML) {result message body} <p>This tree is effectively the result of doing an assignment from \${resultDataLocation} to \${outputDataLocation}. The value of the source element is copied, as are all children including attributes.</p>

With the following node property settings:	The resulting output message assembly is:
<p>Copy Local Environment None</p>	<pre> OutputRoot MQMD {input message MQMD} MQRFH2 {input message MQRFH2} XMLNS {input message body} OutputLocalEnvironment MQ GET MQGMO {MQGMO used for MQGET} MQMD {MQMD used for MQGET} CC = 0 RC = 0 MyData ReturnedMessage (with any attributes and value from ResultRoot.XML) {result message body} </pre> <p>This tree has the MQMD that is used for the MQGET call in the OutputLocalEnvironment, because the input MQ parameters location had an MQMD element under it. Even though the input tree is not copied, the presence of the MQMD element causes the MQMD that is used for the MQGET call to be placed in the output tree.</p>

With the following node property settings:	The resulting output message assembly is:
<p>Output Data Location <blank></p> <p>Copy Local Environment Copy Entire Local Environment</p>	<pre> OutputRoot MQMD {result message MQMD} MQRFH2 {result message MQRFH2} XMLNS {result message body} OutputLocalEnvironment MQ GET MQGMO {MQGMO used for MQGET} MQMD {MQMD used for MQGET} CC = 0 RC = 0 MyData MQMD {input MQMD} (with CorrelID = {correct Correlation ID as binary}) </pre> <p>The value that you set for the Copy Message property makes no difference to the eventual output tree in this case.</p>

Exploiting user exits

Your message flows can benefit from user exits.

Before you start:

- Read “User exits” on page 129.
- Read Why use a user exit?

The following diagram illustrates how a user exit works. The numbered events are described after the diagram. The MQInput node is used as an example, but the function applies to all input nodes, including user-defined input nodes. Similarly, the Compute and MQOutput nodes could be replaced by any equivalent nodes.

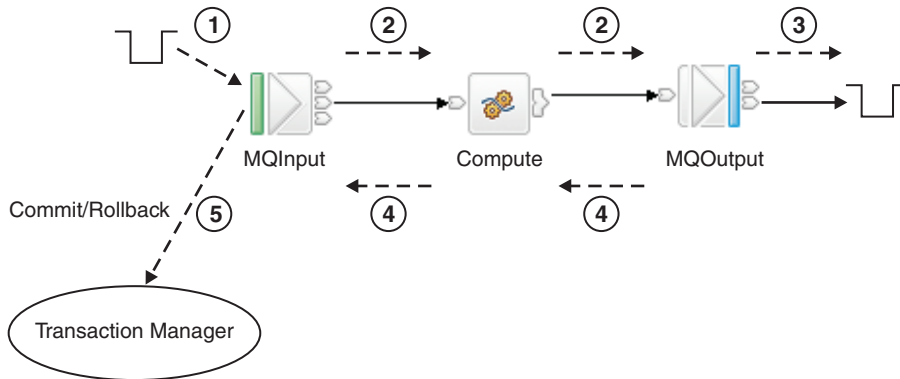

1. (cciInputMessageCallback) The message is dequeued from the input source (read into the flow).
Built-in nodes and user-defined nodes differ slightly in the way in which user exits are called. For built-in input nodes, the user exit is called as soon as possible after the data has been read from the external source. For user-defined input nodes, the user exit is called just before the node propagates the message.
2. (cciPropagatedMessageCallback) The message is propagated to the node for processing.
3. (cciOutputMessageCallback). A request message is sent to the output node's transport, and transport-specific destination information is written to WrittenDestination in the LocalEnvironment (for example, this information includes the queueName and msgId for an MQ message). The call is made when a node successfully puts a message to a transport, from either an output or a request node. The outputMessageEvent is called by built-in nodes only. The topic for each node that supports WrittenDestination information contains details about the data that it contains.
4. (cciNodeCompletionCallback) Node processing completes.
5. (cciTransactionEventCallback) The user exit is called after the transaction has completed, so that user exit processing is not part of that transaction. The user exit is invoked even if no transactional processing is completed by the flow.
Where the message flow property Commit Count is greater than one, many-to-one ratios exist between events 1 and 5. This ratio also exists for some scenarios that are specific to the particular input node; for example, when an MQInput node is configured with the Commit by Message Group property selected.

You can write a user exit to track any number of these events. For each of these events, the following data is available to the user exit. All access is read-only, unless stated otherwise:

- The message is dequeued:
 - Bit stream
 - Input node
 - Environment tree (read and write)
- The message is propagated to the node:
 - Message tree (body element read and write)
 - LocalEnvironment tree (read and write)
 - Exception list
 - Environment tree (read and write)
 - Source node

- Target node
- A message is sent to a transport:
 - Message tree (body element read and write)
 - LocalEnvironment tree (read and write)
 - Exception list
 - Environment tree (read and write)
 - Output or request node
- Node processing completes:
 - Message tree (body element read and write)
 - LocalEnvironment tree (read and write)
 - Exception list
 - Environment tree (read and write)
 - Node
 - Upstream node
 - Exception (if any)
- The end of the transaction:
 - Input node
 - Exception (if any)
 - Environment tree (read and write)

You can register multiple user exits, and, if they are registered, they are invoked in a defined order (see `mqsischangeuserexits` command). Any changes that are made to the message assembly (the message and environment) by a user exit are visible to subsequent user exits.

When the user exit is invoked, it can query the following information:

- Message flow information:
 - Message flow name
 - Broker name
 - Broker's queue manager name
 - Execution group name
 - Message flow's commit count property
 - Message flow's commit interval property
 - Message flow's coordinated transaction property
- Node information:
 - Node name
 - Node type
 - Terminal name
 - Node properties

The user exit can also perform the following tasks:

- Navigate and read the message assembly (Message, LocalEnvironment, ExceptionList, Environment)
- Navigate and write the Message body, LocalEnvironment, and Environment tree

You can register the user exits on a dynamic basis, without needing to redeploy the configuration.

Ensuring that messages are not lost

Messages that flow through your broker domain represent business data that you want to safeguard.

Messages that are generated both by your applications and by runtime components for inter-component communication are important to the operation of your brokers.

Messages used internally between components always use the WebSphere MQ protocol. Application messages can use all supported transport protocols.

For application and internal messages traveling across WebSphere MQ, two techniques protect against message loss:

- Message persistence
If a message is persistent, WebSphere MQ ensures that it is not lost when a failure occurs, by copying it to disk.
- Syncpoint control
An application can request that a message is processed in a synchronized unit-of-work (UOW)

For more information about how to use these options, refer to the *System Administration Guide* section of the WebSphere MQ Version 6 information center online.

Internal messages

WebSphere Message Broker components use WebSphere MQ messages to communicate events and data between broker processes and subsystems, and the Configuration Manager and User Name Server. The components ensure that the WebSphere MQ features are exploited to protect against message loss. You do not need to take any additional steps to configure WebSphere MQ or WebSphere Message Broker to protect against loss of internal messages.

Application messages

If delivery of application messages is critical, you must design application programs and the message flows that they use to ensure that messages are not lost. The techniques used depend on the protocol used by the applications.

WebSphere MQ Enterprise Transport and WebSphere MQ Mobile Transport

If you are using the built-in input nodes that accept messages across the WebSphere MQ or WebSphere MQ Everyplace protocols, you can use the following guidelines and recommendations:

- Using persistent messages
WebSphere MQ messaging products provide *message persistence*, which defines the longevity of the message in the system and guarantees message integrity. Nonpersistent messages are lost in the event of system or queue manager failure. Persistent messages are always recovered if a failure occurs.

You can control message persistence in the following ways:

- Program your applications that put messages to a queue using the MQI or AMI to indicate that the messages are persistent.
- Define the input queue with message persistence as the default setting.
- Configure the output node to handle persistent messages.
- Program your subscriber applications to request message persistence.

When an input node reads a message is read from an input queue, the default action is to use the persistence defined in the WebSphere MQ message header (MQMD), that has been set either by the application creating the message, or by the default persistence of the input queue. The message retains this persistence throughout the message flow, unless it is changed in a subsequent message processing node.

You can override the persistence value of each message when the message flow terminates at an output node. This node has a property that allows you to specify the message persistence of each message when it is put to the output queue, either as the required value, or as a default value. If you specify the default, the message takes the persistence value defined for the queues to which the messages are written.

If a message passes through a Publication node, the persistence of messages sent to subscribers is determined by the subscribers' registration options. If a subscriber has requested persistent message delivery, and is authorized to do so by explicit or implicit (inherited) ACL, the message is delivered persistently regardless of its existing persistence property. Also, if the user has requested nonpersistent message delivery, the message is delivered nonpersistent regardless of its existing persistence property.

If a message flow creates a new message (for example, in a Compute node), the persistence in the MQMD of the new message is copied from the persistence in the MQMD of the incoming message.

- Processing messages under syncpoint control

The default action of a message flow is to process incoming messages under syncpoint in a broker-controlled transaction. This means that a message that fails to be processed for any reason is backed out by the broker. Because it was received under syncpoint, the failing message is reinstated on the input queue and can be processed again. If the processing fails, the error handling procedures that are in place for this message flow (defined either by how you have configured the message flow, or by the broker) are executed.

For full details of input node processing, see "Managing errors in the input node" on page 206.

WebSphere MQ Telemetry Transport

If you are using the SCADAInput node that accepts messages from telemetry devices across the MQIsdp protocol, this protocol does not have a concept of queues. Clients connect to a SCADAInput node by specifying the port number on which the node is listening. Messages are sent to clients using a `clientId`. However, you can specify a maximum QoS (Quality of Service) within a SCADA subscription message, which is similar to persistence:

- **QoS0** Nonpersistent.
- **QoS1** Persistent, but might be delivered more than once
- **QoS2** Once and once only delivery

If a persistent SCADA message is published, it might be downgraded to the highest level that the client can accept. In some circumstances, the message might become nonpersistent.

WebSphere MQ Real-time Transport, WebSphere MQ Multicast Transport, and WebSphere MQ Web Services Transport

If you are using the Real-timeInput and Real-timeOptimizedFlow nodes that accept messages from JMS and multicast applications, or you are using the HTTPInput, HTTPRequest, SOAPInput, SOAPRequest nodes, or a SOAPAsyncRequest and SOAPAsyncResponse node pair that accept messages from Web services applications, no facilities are available to protect against message loss. You can, however, provide recovery procedures by configuring the message flow to handle its own errors.

Other transports and protocols

If you have created your own user-defined input nodes that receive messages from another transport protocol, you must rely on the support provided by that transport protocol, or provide your own recovery procedures.

Providing user-defined properties to control behavior

User-defined properties can be set at design time, deployment time, or run time.

For example, user-defined properties can be queried, discovered, and set at run time to dynamically change the behavior of a message flow. You can use the Configuration Manager Proxy (CMP) API to manipulate these properties, which can be used by a systems monitoring tool to perform automated actions in response to situations that it detects in the monitored systems.

- You can use the Message Flow editor to define a user-defined property when you construct a message flow. For more information, see *Message Flow editor*.
- You can set user-defined properties at deployment time to configure a message flow, as described in “Configuring a message flow at deployment time using UDPs” on page 410.
- You can use the Configuration Manager Proxy (CMP) API to manipulate user-defined properties on a message flow dynamically at run time, as described in *Setting user-defined properties dynamically at run time*.

Handling errors in message flows

The broker provides basic error handling for all your message flows. If basic processing is not sufficient, and you want to take specific action in response to certain error conditions and situations, you can enhance your message flows to provide your own error handling.

For example, you might design a message flow that expects certain errors that you want to process in a particular way, or a flow that updates a database and must roll back those updates if other processing does not complete successfully.

The options that you can use to do this are quite complex in some cases. The options that are provided for MQInput and TimeoutNotification nodes are extensive because these nodes deal with persistent messages and transactions. The MQInput node is also affected by configuration options for WebSphere MQ.

Because you can decide to handle different errors in different ways, there are no fixed procedures to describe. This section provides information about the principles of error handling, and the options that are available, and you must decide what combination of choices that you need in each situation based on the details that are provided in this section.

You can choose one or more of these options in your message flows:

- Connect the failure terminal of any node to a sequence of nodes that processes the node’s internal exception (the fail flow).
- Connect the catch terminal of the input node or a TryCatch node to a sequence of nodes that processes exceptions that are generated beyond it (the catch flow).
- Insert one or more TryCatch nodes at specific points in the message flow to catch and process exceptions that are generated by the flow connected to the try terminal.

- Include a Throw node, or code an ESQL THROW statement, to generate an exception.
- Connect the catch terminal of the AggregateReply node to process aggregation exceptions if you are using aggregation.
- Ensure that all of the messages received by an MQInput node are processed within a transaction, or are not processed within a transaction.
- Ensure that all of the messages received by an MQInput node are persistent, or are not persistent.

If you include user-defined nodes in your message flow, you must refer to the information provided with the node to understand how you might handle errors with these nodes. The descriptions in this section cover only the built-in nodes.

When you design your error handling approach, consider the following factors:

- Most of the built-in nodes have failure terminals. The exceptions are the AggregateControl, AggregateRequest, Input, Label, Output, Passthrough, Publication, Real-timeInput, Real-timeOptimizedFlow, Throw, Trace, and TryCatch nodes.

When an exception is detected within a node, the message and the exception information are propagated to the node's failure terminal. If the node does not have a failure terminal, or it is not connected, the broker throws an exception and returns control to the closest previous node that can process it. This might be a TryCatch node, an AggregateReply node, or the input node.

If an MQInput node detects an internal error, its behavior is slightly different; if the failure terminal is not connected, it attempts to put the message to the input queue's backout requeue queue, or (if that is not defined) to the dead letter queue of the broker's queue manager.

For more information, see "Handling MQInput errors" on page 208.

- A small number of built-in nodes have catch terminals. These are the AggregateReply, HTTPInput, MQInput, SCADAInput, JMSInput, JMSOutput, TimeoutNotification, and TryCatch nodes.

A message is propagated to a catch terminal only if it has first been propagated beyond the node (for example, to the nodes connected to the out terminal).

- When a message is propagated to the failure or catch terminal, the node creates and populates a new ExceptionList with an exception that represents the error that has occurred. The ExceptionList is propagated as part of the message tree.
- The MQInput and TimeoutNotification nodes have additional processing for transactional messages (other input nodes do not handle transactional messages).

For more information, see "Handling MQInput errors" on page 208 and "Handling TimeoutNotification errors" on page 211.

- If you include a Trace node that specifies \$Root or \$Body, the complete message is parsed. This might generate parser errors that are not otherwise detected.

The general principles of error handling are:

- If you connect the catch terminal of the input node, you are indicating that the flow handles all of the exceptions that are generated anywhere in the out flow. The broker performs no rollback and takes no action unless there is an exception on the catch flow. If you want any rollback action after an exception has been raised and caught, you must provide this in the catch flow.

- If you do not connect the catch terminal of the MQInput or the HTTPInput node, you can connect the failure terminal and provide a fail flow to handle exceptions generated by the node. The fail flow is started immediately when an exception occurs in the node.

The fail flow is also started if an exception is generated beyond the MQInput node (in either out or catch flows), the message is transactional, and the reinstatement of the message on the input queue causes the backout count to reach the backout threshold.

The HTTPInput and SCADAInput nodes do not propagate the message to the failure terminal if an exception is generated beyond the node and you have not connected the catch terminal.

- If a node propagates a message to a catch flow, and another exception occurs that returns control to the same node again, the node handles the message as though the catch terminal is not connected.
- If you do not connect either the failure or catch terminals of the input node, the broker provides default processing (which varies with the type of input node).
- If you need a more comprehensive error and recovery approach, include one or more TryCatch nodes to provide more localized areas of error handling.
- If you have a common procedure for handling particular errors, you might find it appropriate to create a subflow that includes the sequence of nodes required. Include this subflow wherever you need that action to be taken.

For more information, see “Connecting failure terminals” on page 206, “Managing errors in the input node” on page 206, and “Catching exceptions in a TryCatch node” on page 212.

If your message flows include database updates, the way in which you configure the nodes that interact with those databases can also affect the way that errors are handled:

- You can specify whether updates are committed or rolled back. You can set the node property Transaction to specify whether database updates are committed or rolled back with the message flow (option Automatic), or are committed or rolled back when the node itself terminates (option Commit). You must ensure that the combination of these property settings and the message flow error processing give the correct result.
- You can specify how database errors are handled. You can set the properties Treat warnings as errors and Throw exception on database error to change the default behavior of database error handling.

For more information about coordinated database updates, see “Configuring globally coordinated message flows” on page 173.

Message flows for aggregation involve additional considerations that are not discussed in this topic. For information about message flows for aggregation, see “Handling exceptions in aggregation flows” on page 588.

The following sample demonstrates how to use an error handling routine to trap information about errors and to store that information in a database. The error handling routine is a subflow that you can add, unchanged, to any message flow. The sample also demonstrates how to configure message flows to control transactionality; in particular, the use of globally coordinated transactions to ensure overall data integrity.

- Error Handler sample

You can view samples only when you use the information center that is integrated with the Message Broker Toolkit.

Connecting failure terminals

When a node that has a failure terminal detects an internal error, it propagates the message to that terminal. If it does not have a failure terminal, or if you have not connected the failure terminal, the broker generates an exception.

The nodes sometimes generate errors that you can predict, and it is in these cases that you might want to consider connecting the failure terminal to a sequence of nodes that can take sensible actions in response to the expected errors.

Examples of expected errors are:

- Temporary errors when the input node retrieves the message.
- Validation errors detected by an MQInput, Compute, or Mapping node.
- Messages with an internal or format error that cannot be recognized or processed by the input node.
- Acceptable errors when a node accesses a database, and you choose not to configure the node to handle those errors.
- ESQL errors during message flow development (some ESQL errors cannot be detected by the editor, but are recognized only by the broker; these cause an exception if you have not connected the failure terminal. You can remove the fail flow when you have completely tested the runtime ESQL code).

You can also connect the failure terminal if you do not want WebSphere MQ to retry a message or put it to a backout or dead letter queue.

Managing errors in the input node

When you design your message flow, consider which terminals on the input node to connect.

- If the node detects an error, it always propagates the message to the Failure terminal if the node has one and if you have connected a fail flow.
- If you connect the Catch terminal (if the node has one), this action indicates that you want to handle all exceptions that are generated in the out flow. This method handles errors that can be expected in the out flow. The broker does not take any action unless there is an exception on the catch flow and the message is transactional. Connect the Failure terminal to handle this case if you choose.
- If you do not connect the Catch terminal, or the node does not have a Catch terminal, the broker provides default processing, which depends on the node and whether the message is transactional. Processing for non-transactional messages is described in this topic. Refer to “Handling MQInput errors” on page 208, and “Handling TimeoutNotification errors” on page 211 for details of how these nodes handle transactional messages (other input nodes do not support transactional messages).

All input nodes process non-transactional, non-persistent messages. The built-in input nodes handle failures and exceptions associated with these messages in this way:

- If the node detects an internal error:
 - If you have not connected the Failure terminal, the node logs the error in the local error log and discards the message.

The Real-timeInput and Real-timeOptimizedFlow nodes retry once before they discard the message; that is, they retrieve the message again and attempt to process it.

- If you have connected the Failure terminal, you are responsible for handling the error in the fail flow. The broker creates a new ExceptionList to represent the error and this is propagated to the Failure terminal as part of the message tree, but neither the node nor the broker provide any further failure processing.
- If the node has successfully propagated the message to the Out terminal and a later exception results in the message being returned to the input node:
 - If you have not connected the Catch terminal or the node does not have a Catch terminal, the node logs the error in the local error log and discards the message.
 - If you have connected the Catch terminal, you are responsible for handling the error in the catch flow. The broker creates a new ExceptionList to represent the error and this is propagated to the Catch terminal as part of the message tree, but neither the node nor the broker provide any further exception processing.
- If the node has already propagated the message to the Catch terminal and an exception is thrown in the catch flow:
 - If you have not connected the Failure terminal, or the input node does not have a Failure terminal, the node logs the error in the local error log and discards the message.
 - If you have connected the Failure terminal, you are responsible for handling the error in the fail flow. The broker creates a new ExceptionList to represent the error and this is propagated to the Failure terminal as part of the message tree, but neither the node nor the broker provide any further failure processing.

The HTTPInput and SCADAInput nodes do not propagate the message to the Failure terminal if an exception is generated in the catch flow. The node logs the error in the local error log and discards the message.

- If the node has propagated the message to the Failure terminal and an exception is thrown in the fail flow, the node logs the error in the local error log and discards the message.

In every situation in which it discards the message, the HTTPInput node waits until the time specified by the node property Maximum client wait time expires, and returns an error to the Web services client.

This action is summarized in the table below:

Error event	Failure terminal connected	Failure terminal not connected	Catch terminal connected	Catch terminal not connected
Node detects internal error	Fail flow handles the error	Node logs the error and discards the message	Not applicable	Not applicable
Node propagates message to Out terminal, exception occurs in out flow	Not applicable	Not applicable	Catch flow handles the error	Node logs the error and discards the message

Error event	Failure terminal connected	Failure terminal not connected	Catch terminal connected	Catch terminal not connected
Node propagates message to Catch terminal, exception occurs in catch flow	Fail flow handles the error (not HTTPInput or SCADAInput)	Node logs the error and discards the message	Not applicable	Not applicable
Node propagates message to Failure terminal, exception occurs in fail flow	Not applicable	Not applicable	Node logs the error and discards the message	Node logs the error and discards the message

Handling MQInput errors:

The MQInput node takes the following actions when it handles errors with persistent and transactional messages. Errors encountered with non-transactional messages are handled as described in “Managing errors in the input node” on page 206.

- The MQInput node detects an internal error in the following situations:
 - A message validation error occurs when the associated message parser is initialized.
 - A warning is received on an MQGET.
 - The backout threshold is reached when the message is rolled back to the input queue.
- If the MQInput node detects an internal error, one of the following actions occur:
 - If you have not connected the Failure terminal, the MQInput node attempts to put the message to the input queue’s backout requeue queue, or (if that is not defined) to the dead letter queue of the broker’s queue manager. If the put attempt fails, the message is rolled back to the input queue. The MQInput node writes the original error and the MQPUT error to the local error log. The MQInput node now invokes the retry logic, described in “Retry processing” on page 209.
 - If you have connected the Failure terminal, you are responsible for handling the error in the flow connected to the Failure terminal. The broker creates a new ExceptionList to represent the error and this is propagated to the Failure terminal as part of the message tree, but neither the MQInput node nor the broker provide any further failure processing.
- If the MQInput node has successfully propagated the message to the out terminal and an exception is thrown in the out flow, the message is returned to the MQInput node:
 - If you have not connected the Catch terminal, the message is rolled back to the input queue. The MQInput node writes the error to the local error log and invokes the retry logic, described in “Retry processing” on page 209.
 - If you have connected the Catch terminal, you are responsible for handling the error in the flow connected to the Catch terminal. The broker creates a new ExceptionList to represent the error and this is propagated to the Catch terminal as part of the message tree, but neither the MQInput node nor the broker provide any further failure processing.
- If the MQInput node has already propagated the message to the Catch terminal and an exception is thrown in the flow connected to the Catch terminal, the message is returned to the MQInput node:

- The MQInput node writes the error to the local error log.
- The message is rolled back to the input queue.
- If the MQInput node has already propagated the message to the Failure terminal and an exception is thrown in the flow connected to the Failure terminal, the message is returned to the MQInput node and rolled back to the input queue. The MQInput node writes the error to the local error log and invokes the retry logic, described in “Retry processing.” The message is not propagated to the Catch terminal, even if that is connected.

This action is summarized in the table below:

Error event	Failure terminal connected	Failure terminal not connected	Catch terminal connected	Catch terminal not connected
Node detects internal error	Flow connected to the Failure terminal handles the error	Message put to alternative queue; node retries if the put fails	Not applicable	Not applicable
Node propagates message to out terminal, exception occurs in out flow	Not applicable	Not applicable	Flow connected to the Catch terminal handles the error	Node retries
Node propagates message to Catch terminal, exception occurs in flow connected to the Catch terminal	Error logged, message rolled back	Error logged, message rolled back	Not applicable	Not applicable
Node propagates message to Failure terminal, exception occurs in flow connected to the Failure terminal	Not applicable	Not applicable	Node retries	Node retries

Retry processing:

The node attempts retry processing when a message is rolled back to the input queue. It checks whether the message has been backed out before, and if it has, whether the backout count has reached (equalled) the backout threshold. The backout count for each message is maintained by WebSphere MQ in the MQMD.

You specify (or allow to default to 0) the backout threshold attribute *BOTHRESH* when you create the queue. If you accept the default value of 0, the node increases this to 1. The node also sets the value to 1 if it cannot detect the current value. This means that if a message has not been backed out before, it is backed out and retried at least once.

1. If the node has propagated a message to the out terminal many times following repeated failed attempts in the out flow, and the number of retries has reached the backout threshold limit, it attempts to propagate the message through the Failure terminal if that is connected. If you have not connected the Failure terminal, the node attempts to put the message to another queue.

If a failure occurs beyond the Failure terminal, further retries are made until the backout count field in the MQMD reaches twice the backout threshold set for the input queue. When this limit is reached, the node attempts to put the message to another queue.

2. If the backout threshold has not been reached, the node gets the message from the queue again. If this fails, this is handled as an internal error (described above). If it succeeds, the node propagates the message to the out flow.
3. If the backout threshold has been reached:
 - If you have connected the Failure terminal, node propagates the message to that terminal. You must handle the error on the flow connected to the Failure terminal.
 - If you have not connected the Failure terminal, the node attempts to put the message on an available queue, in order of preference:
 - a. The message is put on the input queue's backout requeue name (queue attribute *BOQNAME*), if one is defined.
 - b. If the backout queue is not defined, or it cannot be identified by the node, the message is put on the dead letter queue (DLQ), if one is defined. (If the broker's queue manager has been defined by the **mqsicreatebroker** command, a DLQ with a default name of *SYSTEM.DEAD.LETTER.QUEUE* has been defined and is enabled for this queue manager.)
 - c. If the message cannot be put on either of these queues because there is an MQPUT error (including queue does not exist), or because they cannot be identified by the node, it cannot be handled safely without risk of loss.
The message cannot be discarded, therefore the message flow continues to attempt to backout the message. It records the error situation by writing errors to the local error log. A second indication of this error is the continual incrementing of the *BackoutCount* of the message in the input queue.
If this situation has occurred because neither queue exists, you can define one of the backout queues mentioned above. If the condition preventing the message from being processed has cleared, you can temporarily increase the value of the *BOTHRESH* attribute. This forces the message through normal processing.
4. If twice the backout threshold has been reached or exceeded, the node attempts to put the message on an available queue, in order of preference, as defined in the previous step.

Handling message group errors:

WebSphere MQ supports message groups. You can specify that a message belongs to a group and its processing is then completed with reference to the other messages in the group (that is, either all messages are committed or all messages are rolled back). When you send grouped messages to a broker, this condition is upheld if you have configured the message flow correctly, and errors do not occur during group message processing.

To configure the message flow to handle grouped messages correctly, follow the actions described in the "MQInput node" on page 1007. However, correct processing of the message group cannot be guaranteed if an error occurs while one of the messages is being processed.

If you have configured the MQInput node as described, under normal circumstances all messages in the group are processed in a single unit of work

which is committed when the last message in the group has been successfully processed. However, if an error occurs before the last message in the group is processed, the unit of work that includes the messages up to and including the message that generates the error is subject to the error handling defined by the rules documented here, which might result in the unit of work being backed out.

However, any of the remaining messages within the group might be successfully read and processed by the message flow, and therefore are handled and committed in a new unit of work. A commit is issued when the last message is encountered and processed. Therefore if an error occurs within a group, but not on the first or last message, it is possible that part of the group is backed out and another part committed.

If your message processing requirements demand that this situation is handled in a particular way, you must provide additional error handling to handle errors within message groups. For example, you could record the failure of the message group within a database, and include a check on the database when you retrieve each message, forcing a rollback if the current group has already encountered an error. This would ensure that the whole group of messages is backed out and not processed unless all are successful.

Handling TimeoutNotification errors: The TimeoutNotification node takes the following actions when it handles errors with transactional messages. Errors encountered with non-transactional messages are handled as described in “Managing errors in the input node” on page 206.

- If the TimeoutNotification node detects an internal error, one of the following actions occur:
 - If you have not connected the Failure terminal the following happens:
 1. The TimeoutNotification node writes the error to the local error log.
 2. The TimeoutNotification node repeatedly tries to process the request until the problem has been resolved.
 - If you have connected the Failure terminal, you are responsible for handling the error in the flow connected to the Failure terminal. The broker creates a new ExceptionList to represent the error and this is propagated to the Failure terminal as part of the message tree, but neither the TimeoutNotification node nor the broker provide any further failure processing. The message is written to the Failure terminal as part of the same transaction, and if the failure flow handles the error successfully the transaction is committed.
- If the TimeoutNotification node has successfully propagated the message to the Out terminal and an exception is thrown in the flow connected to the Out terminal, the message is returned to the TimeoutNotification node. The TimeoutNotification node writes the error to the local error log and does one of the following:
 - If you have not connected the Catch terminal, the TimeoutNotification node tries to process the message again until the problem is resolved.
 - If you have connected the Catch terminal, you are responsible for handling the error in the flow connected to the Catch terminal. The broker creates a new ExceptionList to represent the error and this is propagated to the Catch terminal as part of the message tree, but neither the TimeoutNotification node nor the broker provide any further failure processing. The message is written to the Catch terminal as part of the same transaction, and if the flow connected to the Catch terminal handles the error successfully the transaction is committed.

- If the TimeoutNotification node has already propagated the message to the Catch terminal and an exception is thrown in the flow connected to the Catch terminal, the message is returned to the TimeoutNotification node. The TimeoutNotification node writes the error to the local error log and tries to process the message again.
- If the TimeoutNotification node has already propagated the message to the Failure terminal and an exception is thrown in the flow connected to the Failure terminal, the message is returned to the TimeoutNotification node. The TimeoutNotification node writes the error to the local error log and tries to process the message again. The message is not propagated to the Catch terminal, even if that is connected.

This action is summarized in the table below:

Error event	Failure terminal connected	Failure terminal not connected	Catch terminal connected	Catch terminal not connected
Node detects internal error	Flow connected to the Failure terminal handles the error	Error logged, node retries	Not applicable	Not applicable
Node propagates message to out terminal, exception occurs in out flow	Not applicable	Not applicable	Flow connected to the Catch terminal handles the error	Error logged, node retries
Node propagates message to Catch terminal, exception occurs in flow connected to the Catch terminal	Error logged, node retries	Error logged, node retries	Not applicable	Not applicable
Node propagates message to Failure terminal, exception occurs in flow connected to the Failure terminal	Not applicable	Not applicable	Error logged, node retries	Error logged, node retries

Catching exceptions in a TryCatch node

You can design a message flow to catch exceptions before they are returned to the input node. Within a single flow, you can include one or more TryCatch nodes to provide a single point of failure for a sequence of nodes. With this technique, you can provide very specific error processing and recovery.

A TryCatch node does not process a message in any way, it represents only a decision point in a message flow. When the TryCatch node receives a message, it propagates it to the Try terminal. The broker passes control to the sequence of nodes connected to that terminal (the try flow).

If an exception is thrown in the try flow, the broker returns control to the TryCatch node. The node writes the current contents of the ExceptionList tree to the local error log, then writes the information for the current exception to ExceptionList, overwriting the information stored there.

The node now propagates the message to the sequence of nodes connected to the Catch terminal (the catch flow). The content of the message tree that is propagated is identical to the content that was propagated to the Try terminal, which is the content of the tree when the TryCatch node first received it. It enhances this tree with the new exception information which it has written to ExceptionList. Any modifications or additions the nodes in try flow made to the message tree are not present in the message tree that is propagated to the catch flow.

However, if the try flow has completed processing that involves updates to external databases, these are not lost. The updates persist while the message is processed by the catch flow, and the decision about whether the updates are committed or rolled back is made on the configuration of your message flow and the individual nodes that interact with the databases. If the updates are committed because of the configuration you have set, you must include logic in your catch flow that rolls back the changes that were made.

To review the options for configuration, see “Configuring globally coordinated message flows” on page 173.

The broker returns control to the next catch point in the message flow (which might be another TryCatch node, but is always, in the last case, the input node) if one of the following conditions is true:

- An exception is thrown in the catch flow of the TryCatch node (for example, if you include a Throw node, or code an ESQL THROW statement, or if the broker generates the exception).
- You do not connect the Catch terminal of the TryCatch node.

The following example shows how you can configure the flow to catch exceptions in the input node. The MQInput node’s Catch terminal is connected to a Trace node to record the error.

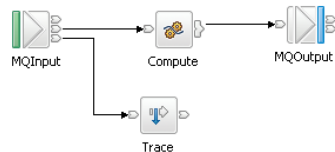

In the following example, the message flow has two separate processing flows connected to the Filter node’s True and False terminals. Here a TryCatch node is included on each of the two routes that the message can take. The Catch terminal of both TryCatch nodes is connected to a common error processing subflow.

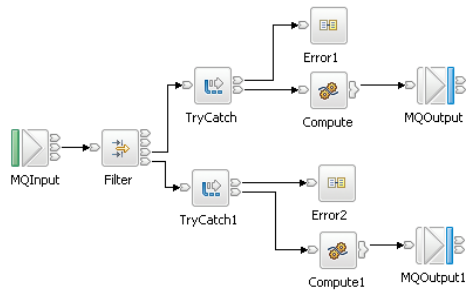

If the input node in your message flow does not have a Catch terminal (for example, Real-timeInput), and you want to process errors in the flow, you must include a TryCatch node. The following example shows how you could connect a flow to provide this error processing. In this example, you could configure the ESQL in the Compute node on the catch flow to examine the exception that has been caught and set the output queue name dynamically.

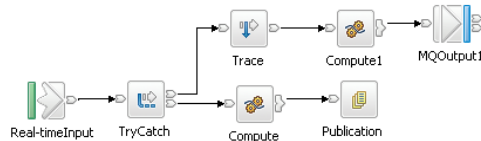

Managing message flows

How you can use tasks to manage message flows.

- “Creating a message flow project” on page 215
- “Deleting a message flow project” on page 216
- “Creating a broker schema” on page 217
- “Creating a message flow” on page 218
- “Opening an existing message flow” on page 219
- “Copying a message flow using copy” on page 220
- “Renaming a message flow” on page 221
- “Moving a message flow” on page 222
- “Deleting a message flow” on page 223
- “Version and keyword information for deployable objects” on page 224
- “Saving a message flow” on page 225

To learn more about message flows look at the following sample:

- Airline Reservations sample

In the previous sample you can explore message flow resources, and learn how to create, delete, or rename the resources. You can view samples only when you use the information center that is integrated with the Message Broker Toolkit.

For a basic introduction to developing message flows, see the IBM Redbooks publication WebSphere Message Broker Basics.

Creating a message flow project

Before you start:

Read the concept topic about message flow projects.

A message flow project is a container for message flows; you must create a project before you can create a message flow.

The project and its resources are stored in a file system or in a shared repository. If you are using a file system, this can be the local file system or a shared drive. If you store files in a repository, you can use any of the available repositories that are supported by Eclipse, for example CVS.

To create a message flow project and other resource files that you need to start developing applications, you can use a Quick Start wizard.

To create only a message flow project, perform the following actions:

1. Switch to the Broker Application Development perspective.
2. Click **File** → **New** → **Message Flow Project** or right-click any resource in the Broker Development view and click **New** → **Message Flow Project**.
You can also press Ctrl+N. This displays a dialog that allows you to select the wizard to create a new object. Click Message Brokers in the left view; the right view displays a list of objects that you can create for WebSphere Message Broker. Click Message Flow Project in the right view, then click **Next**. The New Message Flow Project wizard displays.
3. Enter a name for the project. Choose a project name that reflects the message flows that it contains. For example, if you want to use this project for financial processing message flows, you might give it the name Finance_Flows.
4. Leave the *Use default* check box checked (it is checked when the dialog opens) This applies if you want to use the default location for the new message project directory, that is, in the \workspace subdirectory of your current installation. You cannot edit the *Directory* entry field.
 - a. Alternatively, clear the *Use default* check box and specify a location for the new message flow project files in the *Directory* entry field. This applies if you do not want to use the default location.
 - b. Use the **Browse** button to find the desired location or type the location in.
5. Click **Next** if you want to specify that this message flow project depends on other message flow projects, or on message set projects,

You are presented with a list of current projects. Select one or more message flow projects, or one or more message set projects, or both, from the list to indicate this new message flow project's dependencies. Message flow projects and message set projects are filtered to only show artifacts in the active working set.

This message flow project depends on another message flow project if you intend to use common resources within it. Common resources that you can share between message flow projects are:

- a. ESQL subroutines (defined in broker schemas)
- b. Mappings
- c. Message sets
- d. Subflows

For example, you might want to reuse a subflow that provides standard error processing such as writing the message to a database, or recording a trace entry.

This message flow project depends on a message set project if you intend to refer to the message it defines within ESQL within the message flow nodes.

You can add dependencies after you have created the message flow project by right-clicking the project in the Broker Development view and clicking **Properties**. Click **References** and select the dependent message flow or message set project from the list of projects displayed.

6. Click **Finish** to complete the task.

The project file is created within a directory that has the same name as your message flow project in the specified location. All other files that you create (or cause to be created) related to this message flow project are created in this same directory.

A default broker schema (default) is also created within the project. You can create and use different schemas within a single project to organize message flow resources, and to provide the scope of resource names to ensure uniqueness.

Next: create a message flow

Deleting a message flow project

A message flow project is the container in which you create and maintain all the resources associated with one or more message flows. These resources are created as files, and are displayed within the project in the Broker Development view. If you do not want to retain a message flow project, you can delete it.

Before you start:

- Create a message flow project
- Read the concept topic about message flow projects

Deleting a message flow project in the workbench deletes the project and its resources; the Configuration Manager does not hold a copy. If you are using a shared repository, the repository might retain a copy of a deleted resource.

In previous releases you could remove resources from the Control Center, which removed the reference in your workspace, but retained the resource in the Configuration Manager repository.

To delete a message flow project:

1. Switch to the Broker Application Development perspective.
2. Highlight the message flow project that you want to delete and click **Edit** → **Delete**. You can also press **Del**, or right-click the project in the Broker Development view and click **Delete**.
3. You must choose if you want the contents of the message flow project folder deleted with this action on the displayed confirmation dialog. The dialog contains two buttons:
 - a. The first confirms that all contents are to be deleted.
 - b. The second requests that the directory contents are not deleted. The default action is not to delete the contents, and the second button is selected by default when the dialog is initially displayed.

- a. Select the appropriate button. If you choose not to delete the contents of the message flow project directory, all the files and the directory itself are retained.

If you later create another project with the same name, and specify the same location for the project (or accept this as the default value), you can access the files previously created.

If you choose to delete all the contents, all files and the directory itself are deleted.

4. Click **Yes** to complete the delete request, or **No** to terminate the delete request.

When you click **Yes**, the requested objects are deleted.

If you maintain resources in a shared repository, a copy is retained in that repository. You can follow the instructions provided by the repository supplier to retrieve the resource if required.

If you are using the local drive or a shared drive to store your resources, no copy of the resource is retained. Be very careful to select the correct resource when you complete this task.

Creating a broker schema

If you want to organize your message flow project resources, and to define the scope of resource names to ensure uniqueness, you can create broker schemas. A default schema is created when you create the message flow project, but you can create additional schemas if you choose.

Before you start:

- Create a message flow project
- Read the concept topic about broker schemas

To create a broker schema:

1. Switch to the Broker Application Development perspective.
2. Click **File** → **New** → **BrokerSchema** or right-click any resource in the Broker Development view and click **New** → **BrokerSchema**.

You can also press Ctrl+N. This displays a dialog that allows you to select the wizard to create a new object. Click Message Brokers in the left view. The right view displays a list of objects that you can create for WebSphere Message Broker. Click Broker Schema in the right view, then click **Next**. The New Broker Schema wizard displays.

3. Enter the message flow project in which you want the new schema to be created. If you have a message flow project or one of its resources highlighted when you invoke the wizard, that project name appears in the dialog. If a name does not appear in this field, or if you want to create the schema in another project, click **Browse** and select the correct project from the displayed list. The message flow project list is filtered to only show projects in the active working set.

You can type the project name in, but you must enter a valid name. The dialog displays a red cross and the error message The specified project does not exist if your entry is not a valid project. You must specify a message flow project; if you select a message set project, the **Finish** button remains disabled.

4. Enter a name for the schema. Choose a name that reflects the resources that it contains. For example, if you want to use this schema for message flows for retail applications, you might give it the name Retail.

A broker schema name must be a character string that starts with a Unicode character followed by zero or more Unicode characters or digits, and the underscore. You can use the period to provide a structure to the name, for example Stock.Common.

5. Click **Finish** to complete the task.

The schema directory is created in the project directory. If the schema is structured using periods, further subdirectories are defined. For example, the broker schema Stock.Common results in a directory Common within a directory Stock within the message flow project directory.

Creating a message flow

Create a message flow to specify how to process messages in the broker. You can create any number of message flows and deploy them to one or more brokers.

Before you start:

- Complete the following task: “Creating a message flow project” on page 215.
- Read the concept topic about “Broker schemas” on page 114.

The mode that your broker is working in can affect the number of message flows that you can use; see Restrictions that apply in each operation mode.

The message flow and its resources are stored in a file system or in a shared repository. If you are using a file system, this can be the local drive or a shared drive. If you store files in a repository, you can use any of the available repositories that are supported by Eclipse, for example CVS.

Use this process to create a complete message flow that you can deploy, or a subflow that provides a subset of function (for example, a reusable error processing routine) that you cannot deploy on its own.

To create a message flow and other resource files that you need to start developing applications, you can use a Quick Start wizard.

To create only a message flow, perform the following actions:

1. Switch to the Broker Application Development perspective.
2. If you have not already created the message flow project in which you want to create the message flow, then you can either create it now, see “Creating a message flow project” on page 215, or you can create the message flow project as an optional step in creating the message flow (see step 4). The project can be empty, or can have message flows defined in it.
3. Perform one of the following actions to open a new message flow:
 - Click **File** → **New** → **Message Flow**.
 - Right-click any resource in the Broker Development view and click **New** → **Message Flow**.
 - Press Ctrl+N. This action displays a dialog box in which you can select the wizard to create a new object:
 - a. Click **Message Brokers** in the left view. The right view displays a list of objects that you can create for WebSphere Message Broker.

- b. Click **Message Flow** in the right view, then click **Next**. The New Message Flow wizard displays.
4. Identify the project in which you want to define the message flow. This field is filtered to only show resources in the active working set.
 - If you have a resource selected in the Broker Development view, the name of the corresponding project is displayed in the Message Flow Project field.
 - If you do not have a resource selected, the first field is blank.
 - If you have already created the message flow project for this message flow, you can perform either of the following actions:
 - Type the name of the project into the field.
 - Click the down-arrow and select the appropriate project from the list displayed.
 - If you have not already created the message flow project, select **New**. The New Message Flow Project wizard starts, and you can use it to create the message flow project for your new message flow, see “Creating a message flow project” on page 215. When you have finished creating the new message flow project, the New Message Flow Project wizard closes, and the name of your new message flow project is displayed in the Message Flow Project field of the New Message Flow window.

If your entry is not a valid project name, the window displays a red cross and the error message `The specified project does not exist`.

5. In the Message flow **Name** field, enter the name of the new message flow. You can use any valid character for the name, but it is helpful to choose a name that reflects its function, for example, `OrderProcessing`.
6. Decide whether you want to use the default broker schema. When you create a message flow project, a default schema is created within it, and this default value is assumed unless you deselect it. You can create and use different schemas within a single project to organize message flow resources, and to provide the scope of resource names to ensure uniqueness.
 - If you want the message flow to be created in the default broker schema, ensure that you select **Use default** in the Flow organization section.
 - If you want to use a different broker schema, deselect **Use default**. You can now perform either of the following actions:
 - Enter the name of the broker schema into the **Schema** field.
 - Click **Browse** to select from any of the broker schemas in the message flow project.
7. Click **Finish**.

The new message flow (`<message_flow_name>.msgflow`) is displayed within its project in the Broker Development view. The Editor view is empty and ready to receive your input.

Next, you can do either of the following tasks:

- “Saving a message flow” on page 225
- “Defining message flow content” on page 227

Opening an existing message flow

Open an existing message flow to change or update its contents, or to add or remove nodes.

Before you start

You must have completed the following task:

- “Creating a message flow” on page 218

To open an existing message flow:

1. Switch to the Broker Application Development perspective. The Broker Development view is populated with all the message flow and message set projects that you have access to. A message flow is contained in a file called `<message_flow_name>.msgflow`.
2. Right-click the message flow that you want to work with, and click **Open**. Alternatively you can double-click the message flow in the Broker Development view.

The graphical view of the message flow is displayed in the editor view. You can now work with this message flow; for example, you can add or remove nodes, change connections between nodes, or modify node properties.

3. Click **Open ESQL** for any node in the flow that requires ESQL, or double-click the ESQL file (the `.esql` file) in the Broker Development view to open it, if you want to work with the ESQL file for this message flow.
4. Click **Open Mappings** for any node in the flow that requires mappings, or double-click the mappings file (the `.msgmap` file) in the Broker Development view to open it, if you want to work with the mappings file for this message flow.
5. Click **Open Java** for any JavaCompute node in the flow, or double-click the Java file in the Broker Development view to open it, if you want to work with the Java file for this message flow.

Copying a message flow using copy

You might find it useful to copy a message flow as a starting point for a new message flow that has similar function. For example, you might want to replace or remove one or two nodes to process messages in a different way.

Before you start

To complete this task, you must have completed the following task:

- “Creating a message flow” on page 218

To copy a message flow:

1. Switch to the Broker Application Development perspective.
2. Select the message flow (`<message_flow_name>.msgflow`) that you want to copy in the Broker Development view.
 - a. Right-click the file and click **Copy** from the menu.
3. Right-click the broker schema within the message flow project to which you want to copy the message flow and click **Paste**. You can copy the message flow within the same broker schema within the same message flow, or to a different broker schema within the same message flow project, or to a broker schema in a different message flow project.

When you copy a message flow, the associated files (ESQL and mapping, if present) are not automatically copied to the same target message flow project. If you want these files copied as well, you must do this explicitly following this procedure.

You might also need to update nodes that have associated ESQL or mappings, to ensure that modules are unique.

For example, if you have created a message flow (Test1 for example) that contains a single Compute node, and you copy message flow Test1 and its associated .esql file to the same broker schema within the same message flow project (and give the new copy a different name, for example Test2), there are now two modules named Test1_Compute within the single schema. One is within Test1.esql, the second within Test2.esql.

This is not supported, and an error message is written to the Tasks view when you have completed the copy action. You must rename the associated ESQL modules within the .esql file and update the matching node properties to ensure that every module within a broker schema is unique.

The message flow is copied with all property settings intact. If you intend to use this copy of the message flow for another purpose, for example to retrieve messages from a different input queue, you might have to modify its properties.

You can also use **File** → **Save As** to copy a message flow. This is described in “Saving a message flow” on page 225.

Renaming a message flow

You can rename a message flow. You might want to do this if you have modified the message flow to provide a different function and you want the name of the message flow to reflect this new function.

Before you start

To complete this task, you must have completed the following task:

- “Creating a message flow” on page 218

To rename a message flow:

1. Switch to the Broker Application Development perspective.
2. Right-click the message flow that you want to rename (<message_flow_name>.msgflow) in the Broker Development view, and click **Rename**, or click **File** → **Rename**. If you have the message flow selected, you can also press F2. The Rename Resource dialog is displayed.
3. Type in the new name for the message flow.
4. Click **OK** to complete this action, or **Cancel** to cancel the request. If you click **OK**, the message flow is renamed.

After you have renamed the message flow, any references that you have to this message flow (for example, if it is embedded in another message flow) are no longer valid.

5. You must open the affected message flows and correct the references if you are not sure where you have embedded this message flow.
 - a. Click **File** → **Save All**. The save action saves and validates all resources. Unresolved references are displayed in the Tasks view, and you can click each error listed.

This opens the message flow that makes a non-valid reference in the editor view
 - b. Right click the subflow icon and click **Locate Subflow**. The Locate Subflow dialog is displayed, listing the available message flow projects.
 - c. Expand the list and explore the resources available to locate the required subflow.

- d. Select the correct subflow and click **OK**. All references in the current message flow are updated for you and the errors removed from the Tasks view.

Moving a message flow

You can move a message flow from one broker schema to another within the same project or to a broker schema in another project. You might want to do this, for example, if you are reorganizing the resources in your projects.

Before you start:

Complete the following task:



- “Creating a message flow” on page 218

To move a message flow:

1. Switch to the Broker Application Development perspective.
2. Drag the message flow that you want to move from its current location to a broker schema in the same or another message flow project. If the target location that you have chosen is not valid, a black no-entry icon appears over the target, an error dialog box is displayed, and the message flow is not moved.

You can move a message flow to another schema in the same project or to a schema in another message flow project.

Alternatively, you can use the following method:

- a. Right-click the message flow that you want to move (*message_flow_name.msgflow*) in the Broker Development view and click **Move**, or **File** → **Move**. The Move dialog box is displayed. This contains a list of all valid projects to which you can move this message flow.
 - b. Select the project and the broker schema in the project to which you want to move the message flow. You can move a message flow to another schema in the same project or to a schema in another message flow project.
 - c. Click **OK** to complete the move, or **Cancel** to cancel the move. If you click **OK**, the message flow is moved to its new location.
3. Check the Tasks view for any errors (indicated by the error icon ) or warnings (indicated by the warning icon ) that are generated by the move. The errors in the Tasks view include those that are caused by broker references. When the move is complete, all references to this message flow (for example, if this is a reusable error message flow that you have embedded in another message flow) are checked.
If you have moved the message flow within the same broker schema (in the same or another project), all references are still valid. However, if you move the message flow from one broker schema to another (in the same or a different project), the references are broken because the resources are linked by a fully-qualified name of which the broker schema is a part. Information about any broken references is written to the Tasks view; for example, Linked or nested flow mflow1 cannot be located.
 4. Double-click each error or warning to correct it. The message flow that contains the error is opened in the editor view and the node in error is highlighted.

When you move a message flow, the associated files (for example, any ESQL or mapping files) are not automatically moved to the target broker schema. If you want to move these files as well, you must do so explicitly by following the procedure in this topic.

Deleting a message flow

You can delete a message flow that you have created in a message flow project if you no longer need it.

Deleting a message flow in the workbench deletes the project and its resources, and the Configuration Manager does not hold a copy. If you are using a shared repository, the repository might retain a copy of a deleted resource.

In previous releases you could remove resources from the Control Center, which removed the reference in your workspace, but retained the resource in the Configuration Manager repository.

Before you start

To complete this task, you must have completed the following task:

- “Creating a message flow” on page 218

To delete a message flow:

1. Switch to the Broker Application Development perspective.
2. Select the message flow in the Broker Development view (<message_flow_name>.msgflow) and press the Delete key. A confirmation dialog is displayed.

You can also right-click the message flow in the Broker Development view and click **Delete**, or click **Edit** → **Delete**. The same dialog is displayed.

3. Click **Yes** to delete the message flow definition file or **No** to cancel the delete request. When you click **Yes**, the requested objects are deleted.

If you maintain resources in a shared repository, a copy is retained in that repository. You can follow the instructions provided by the repository supplier to retrieve the resource if required.

If you are using the local file system or a shared file system to store your resources, no copy of the resource is retained. Be very careful to select the correct resource when you complete this task.

4. Check the Tasks view for any errors that are caused by the deletion. Errors are generated if you delete a message flow that is embedded within another flow because the reference is no longer valid.
 - a. Click the error in the Tasks view This opens the message flow that now has a non-valid reference.
 - b. Either remove the node that represents the deleted message flow from the parent message flow, or create a new message flow with the same name to provide whatever processing is required.

When you delete the message flow, the files that are associated with the message flow (the ESQL and mapping files, if present) are not deleted by this action. If you want to delete these files also, you must do so explicitly.

Deleting a broker schema

You can delete a broker schema that you have created in a message flow project if you no longer need it.

Before you start:

- Create a broker schema
- Read the concept topic about broker schemas

To delete a broker schema:

1. Switch to the Broker Application Development perspective.
2. Select the broker schema in the Broker Development view and press the Delete key. A confirmation dialog box is displayed.

You can also right-click the broker schema in the Broker Development view and click **Delete**, or click **Edit** → **Delete**. The same dialog box is displayed.

If the broker schema contains resources, the **Delete** menu option is disabled, and the Delete key has no effect. You must delete all resources within the schema before you can delete the schema.

3. Click **Yes** to delete the broker schema directory or **No** to cancel the delete request. When you click **Yes**, the requested objects are deleted.

If you maintain resources in a shared repository, a copy is retained in that repository. You can follow the instructions provided by the repository supplier to retrieve the resource, if required.

If you are using the local file system or a shared file system to store your resources, no copy of the resource is retained. Be very careful to select the correct resource when you complete this task.

Version and keyword information for deployable objects

This topic contains information about how to view the version and keyword information of deployable objects.

- “Displaying object version in the Broker Archive editor”
- “Displaying version, deploy time, and keywords of deployed objects” on page 225

This topic also contains information on populating the Comment and Path columns; see “Populating the Comment and Path columns” on page 225.

Displaying object version in the Broker Archive editor

A column in the Broker Archive editor called Version displays the version tag for all objects that have a defined version. These are:

- .dictionary files
- .cmf files
- Embedded JAR files with a version defined in a META-INF/keywords.txt file

You cannot edit the Version column.

You can use the `mqswireadbar` command to list the keywords that are defined for each deployable file within a deployable archive file.

Displaying version, deploy time, and keywords of deployed objects

The Properties View displays, for any deployed object:

- Version
- Deploy Time
- All defined keywords

For example, if you deploy a message flow with these literal strings:

- `$MQSI_VERSION=v1.0 MQSI$`
- `$MQSI Author=fred MQSI$`
- `$MQSI Subflow 1 Version=v1.3.2 MQSI$`

the Properties View displays:

Deployment Time	Date and time of deployment
Modification Time	Date and time of modification
Version	v1.0
Author	fred
Subflow 1 Version	v1.3.2

You are given a reason if the keyword information is not available. For example, if keyword resolution has not been enabled at deploy time, the Properties View displays the message Deployed with keyword search disabled. Also, if you deploy to a Configuration Manager that is an earlier version than Version 6.0, the properties view displays Keywords not available on this Configuration Manager.

Populating the Comment and Path columns

If you add source files, the Path column is populated automatically.

To add a comment, double click on the Comment column and type the text that you require.

Saving a message flow

You might want to save your message flow when you want to:

- Close the workbench.
- Work with another resource.
- Validate the contents of the message flow.

Before you start:

To complete this task, you must have completed the following task:

- “Creating a message flow” on page 218

To save a message flow:

1. Switch to the Broker Application Development perspective.
2. Select the editor view that contains the open message flow that you want to save.

3. If you want to save the message flow without closing it in the editor view, press Ctrl+S or click **File** → **Save name** on the taskbar menu (where *name* is the name of this message flow). You can also choose to save everything by clicking **File** → **Save All**.

The message flow is saved and the message flow validator is invoked to validate its contents. The validator provides a report of any errors that it finds in the Tasks view. The message flow remains open in the editor view.

For example, if you save a message flow and have not set a mandatory property, an error message appears in the Tasks view and the editor marks the

node with the error icon . The message flow in the Broker Development view is also marked with the error icon. This can occur if you have not edited the properties of an MQInput node to define the queue from which the input node retrieves its input messages.

(If you edit the properties of a node, you cannot click **OK** unless you have set all mandatory properties. Therefore this situation can arise only if you have never set any properties.)

You might also get warnings when you save a message flow. These are

indicated by the warning icon . This informs you that, although there is not an explicit error in the configuration of the message flow, there is a situation that might result in unexpected results when the message flow completes. For example, if you have included an input node in your message flow that you have not connected to any other node, you get a warning. In this situation, the editor marks the node with the warning icon. The message flow in the Broker Development view is also marked with a warning icon.

4. If you save a message flow that includes a subflow, and the subflow is no longer available, three error messages are added to the Tasks view that indicate that the input and output terminals and the subflow itself cannot be located. This can occur if the subflow has been moved or renamed.

To resolve this situation, right-click the subflow node in error and click **Locate Subflow**. The Locate Subflow dialog is displayed, listing the available message flow projects. Expand the list and explore the resources available to locate the required subflow. Select the correct subflow and click **OK**. All references in the current message flow are updated for you and the errors removed from the Tasks view.

5. If you want to save the message flow when you close it, click the close view icon  on the editor view tab for this message flow or click **File** → **Close** on the taskbar menu. The editor view is closed and the file saved. The same validation occurs and any errors and warnings are written to the Tasks view.

For information about using the **File** → **Save As** option to take a copy of the current message flow, see “Copying a message flow using save.”

See “Correcting errors from saving a message flow” on page 227 for information about handling errors from the save action.

Copying a message flow using save

You can copy a message flow by using the **File** → **Save As** option.

1. Click **File** → **Save name As**.

2. Specify the message flow project in which you want to save a copy of the message flow. The project name defaults to the current project. You can accept this name, or choose another name from the valid options that are displayed in the File Save dialog.
3. Specify the name for the new copy of the message flow. If you want to save this message flow in the same project, you must either give it another name, or confirm that you want to overwrite the current copy (that is, copy the flow to itself).

If you want to save this message flow in another project, the project must already exist (you can only select from the list of existing projects). You can save the flow with the same or another name in another project.
4. Click **OK**. The message flow is saved and the message flow editor validates its contents. The editor provides a report of any errors that it finds in the Tasks view. See “Correcting errors from saving a message flow” for information about handling errors from the save action.

Correcting errors from saving a message flow

Correct the errors that are reported when you save a message flow.

To correct errors from the save or save as action:

1. Examine the list of errors and warnings that the validator has generated in the Tasks view.
2. Double-click each entry in turn. The message flow is displayed in the editor view (if it is not already there), and the editor selects the node in which the error was detected. If the error has been generated because you have not set a mandatory property, the editor also opens the Properties view or dialog box for that node.

If you have included a user-defined node in your message flow, and have defined one or more of its properties as configurable, you might get a warning about a custom property editor. If you define a property as configurable, and you have specified that it uses a custom property editor, the bar editor cannot handle the custom property editor and handles the property as if it is type String. This restricts your ability to make changes to this property at deploy time.

3. Correct the error that is indicated by the message. For example, provide a value for the mandatory property.
4. When you have corrected all the errors, you can save again. The editor validates all the resources that you have changed, removes any corrected errors from the Tasks view, and removes the corresponding graphical indication from the nodes that you have modified successfully.

You do not have to correct every error to save your work. The editor saves your resources even if it detects errors or warnings, so that you can continue to work with them at a later date. However, you cannot deploy any resource that has a validation error. You must correct every error before you deploy a resource. Warnings do not prevent successful deployment.

Defining message flow content

This topic describes how to create the contents of the message flow.

When you create a new message flow, the editor view is initially empty. You must create the contents of the message flow by:

- “Adding a message flow node” on page 231
- “Adding a subflow” on page 234
- “Renaming a message flow node” on page 234
- “Configuring a message flow node” on page 235
- “Connecting message flow nodes” on page 239
- “Adding a bend point” on page 242
- “Aligning and arranging nodes” on page 244

When you finalize the content of the message flow, you might also need to perform the following tasks:

- “Removing a message flow node” on page 238
- “Removing a node connection” on page 242
- “Removing a bend point” on page 243

To learn more about message flow content, you can import either of the following samples:

- Airline Reservations sample
- Error Handler sample

Follow the supplied instructions to build the sample yourself. You can also try adding and deleting nodes, adding subflows, and connecting nodes together. You can view samples only when you use the information center that is integrated with the Message Broker Toolkit.

For a basic introduction to developing message flows, see the IBM Redbooks publication *WebSphere Message Broker Basics*.

Using the node palette

Before you start:

Read the concept topic about the node palette.

The node palette contains all of the built-in nodes, which are organized into categories. You can add the nodes that you use most often to the Favorites category by following the instructions in “Adding nodes to the Favorites category on the palette” on page 230.

You can change the palette preferences in the Message Broker Toolkit. The changes that you can make are described in the following topics.

- “Changing the palette layout”
- “Changing the palette settings” on page 229
- “Customizing the palette” on page 229

Changing the palette layout

You can change the layout of the palette in the Message Flow editor and the Broker Topology editor.

1. Switch to the Broker Application Development perspective
2. Right-click the palette to display the pop-up menu.

3. Click **Layout**.
4. Click one of the available views:

Columns

Displays named icons in one or more columns. Change the number of columns by clicking on the right edge of the palette and dragging.

List Displays named icons in a single-column list. The list view is the default layout.

Icons Only

Displays a list of icons only.

Details

Displays descriptions of the icons.

Changing the palette settings

Change the palette settings in the Message Flow editor and the Broker Topology editor using the **Palette Settings** dialog box.

1. Switch to the Broker Application Development perspective.
2. Right-click the palette to display the pop-up menu.
3. Click **Settings**. The **Palette Settings** dialog box opens.
4. Use the dialog to change the appropriate setting:
 - Click **Change** to change the font on the palette.
 - Click **Restore Default** to restore the default palette settings.
 - In the **Layout** list, click the appropriate radio button to change the palette layout. (See “Changing the palette layout” on page 228 for more information.)
 - Select **User large icons** to toggle between large and small icons in the palette.
 - In the **Drawer options** list, click the appropriate radio button to change the way that drawers are handled in the palette. A drawer is a container for a list of icons, such as the **Favorites** drawer on the Message Flow editor’s palette, or the **Entity** drawer on the Broker Topology editor’s palette.

Customizing the palette

If you customize the message flow node palette, you can make it easier to find the nodes that you use most often, saving time and on-screen space. For example:

- Change the order of the drawers in the palette so that the ones that you use most often are at the top.
- Hide any drawers that you do not use, to save on-screen space.
- Pin open the drawers that contain the nodes that you use most often.
- Create your own drawers to hold user-defined nodes that you create.

Customize the palette for the Message Flow editor using the **Customize Palette** dialog box:

1. Switch to the Broker Application Development perspective.
2. Right-click the palette, then click **Customize**. The **Customize Palette** dialog box opens.
 - To change the order of entries and drawers in the palette, click the appropriate item in the list to highlight it, then click **Move Down** or **Move Up**. You cannot move any category above the Favorites category.

- To hide an entry or drawer, click the appropriate item in the list to highlight it, then select the **Hide** check box.
 - To create a new separator, click **New** → **Separator**.
 - To create a new drawer:
 - a. Click **New** → **Drawer**.
 - b. Type a name and description for the drawer.
 - c. If required, select the **Open drawer at start-up** check box.
 - d. If required, select the **Pin drawer open at start-up** check box.
3. Click **OK** or **Apply** to save your changes.

You have customized the message flow node palette.

Adding nodes to the Favorites category on the palette

Before you start:

Read the concept topic about the message flow node palette.

The nodes on the palette are organized in categories. The first category is Favorites, which is usually empty. You can drag the nodes that you use most often to the Favorites category.

1. Switch to the Broker Application Development perspective.
2. On the palette, open the Favorites category.
3. On the palette, open the category that contains the node that you want to add to the Favorites category.
4. Use the mouse to drag the node into the Favorites category, as shown in the following example:

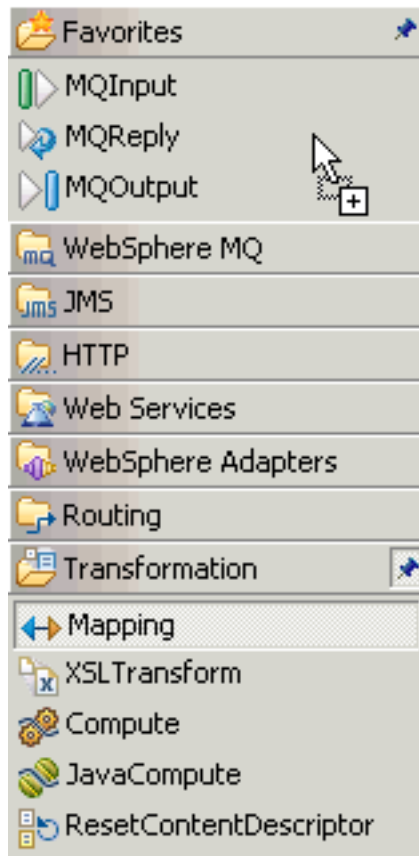

Alternatively, right-click the palette and choose the appropriate option to add or remove nodes from the Favorites category.

Adding a message flow node

When you have created a new message flow, add nodes to define its function.

Before you start:

- Create a message flow or open an existing message flow
- Read the concept topic about message flow nodes

To add a node to a message flow:

1. Switch to the Broker Application Development perspective.
2. Open the message flow with which you want to work.
3. Open the Palette.
 - Hover the mouse over the palette bar while it is in collapsed mode. The palette bar expands. When you move the mouse away from the palette bar, it collapses again.
 - Click the **Show Palette** icon at the top of the palette bar. The palette bar expands and it remains expanded when the mouse is moved away from the palette bar. To collapse the palette bar again, click the **Hide Palette** icon at the top of the palette bar while it is in expanded mode.
4. Click **Selection** above the palette of nodes.
5. Decide which node you want to add: a built-in node or a user-defined node. You can select any of the nodes that appear in the node palette, but you can add only one node at a time.

Nodes are grouped in categories according to the function that they provide. To see descriptions of the nodes in the palette, either hover the mouse over a node in the palette, or switch to the Details view by following the instructions in “Changing the palette layout” on page 228.

6. Drag the node from the node palette onto the canvas.
When you add a node to the canvas, the editor automatically assigns a name to the node, but the name is highlighted and you can change it by entering a name of your choice. If you do not change the default name at this time, you can change it later. The default name is set to the type of node for the first instance. For example, if you add an MQInput node to the canvas, it is given the name MQInput; if you add a second MQInput node, the default name is MQInput1; the third is MQInput2, and so on.
7. Repeat steps 5 on page 231 and 6 to add further nodes.
8. You can also add nodes from other flows into this flow:
 - a. Open the other message flow.
 - b. Select the node or nodes that you want to copy from the editor or outline views, and press Ctrl+C or click **Edit** → **Copy**.
 - c. Return to the flow with which you are currently working.
 - d. Press Ctrl+V or click **Edit** → **Paste**. This action copies the node or nodes into your current flow. The node names and properties are preserved in the new copy.

When you have added the nodes that you want in this message flow, you can connect them to specify the flow of control through the message flow, and you can configure their properties.

Next: configure the nodes.

Adding a node using the keyboard

Before you start:

- Create a message flow or open an existing message flow
- Read the concept topic about message flow nodes

You can use the keyboard to perform tasks in the Message Flow editor, such as adding a node to the canvas.

1. Switch to the Broker Application Development perspective.
2. Open the message flow to which you want to add a node.
3. Open the Palette view or the Palette bar.
4. Select a node in the Palette view or Palette bar using the up and down arrows to highlight the node that you want to add to the canvas.
5. Add the Node to the canvas using one of the following methods:
 - Press **Alt + L**, then press **N**.
 - Press **Shift + F10** to open the context-sensitive menu for the Palette, and press **N**.

The node that you selected in the Palette bar or Palette view is placed on the canvas in the Editor view.

When you add a node to the canvas, the editor automatically assigns a name to the node, but the name is highlighted and you can change it by entering a name of your choice. If you do not change the default name at this time, you can change it later. The default name is set to the type of node for the first instance. For example, if you add an MQInput node to the canvas, it is given

the name MQInput; if you add a second MQInput node, the default name is MQInput1; the third is MQInput2, and so on.

You can move the node that you have placed on the canvas using the keyboard controls described in Message Broker Toolkit keyboard shortcuts.

Dragging a resource from the Broker Development view

Drag a node or a related resource into the Message Flow editor.

Before you start:

- Create a message flow or open an existing message flow
- Read about message flow nodes

Drag a resource from the Broker Development view to an empty canvas to create a new node, or drag a resource onto an existing node to modify that node. The following resources are supported:

- An Adapter file
- An ESQL file
- A Java file
- A subflow
- A WSDL file
- An XSL file

1. Switch to the Broker Application Development perspective.
2. Open the message flow with which you want to work.
3. Drag one of the supported resources from the Broker Development view onto the canvas.

- If you drop the resource on an empty canvas, a node is created and configured automatically.

The following table shows the results when you drag a resource from the Broker Development view onto an empty canvas:

Resource	Node created	Property set
Adapter file	A "PeopleSoftInput node" on page 1036, "SAPInput node" on page 1061, or "SiebelInput node" on page 1076 is created	Adapter component
ESQL file	A "Compute node" on page 838 is created	ESQL Module
Java file	A "JavaCompute node" on page 943 is created	Java Class
WSDL file	A "SOAPInput node" on page 1104 or "SOAPRequest node" on page 1116 is created	WSDL file name
XSL file	An "XSLTransform node" on page 1216 is created	Stylesheet

- If you drop the resource onto an existing node, the relevant node property is updated with the name of the resource file. For example, if you drop a Java file onto a JavaCompute node, the Java Class property is set to the class name of the Java file that you are dropping. If you drop an ESQL file over any node that uses ESQL, such as a Database node, the ESQL Module property is set.

Adding a subflow

Within a message flow, you might want to include an embedded message flow, also known as a subflow. For example, you might define a subflow that provides error handling, and include it in a message flow connected to a failure terminal on a node that can generate an error in some situations.

Before you start

To complete this task, you must have completed one of the following tasks:

- “Creating a message flow” on page 218
- “Opening an existing message flow” on page 219

When you add a subflow, it appears in the editor view as a single node.

You can embed subflows into your message flow if either of the following statements is true:

- The flow that you want to embed is defined in the same message flow project.
- The flow is defined in a different message flow project, and you have specified the dependency of the current message flow project on that other project.

To add a subflow to a message flow:

1. Switch to the Broker Application Development perspective.
2. Open the message flow that you want to work with.
3. Drag and drop the message flow from the Navigator view into the editor view. Alternatively, highlight the embedding message flow and click **Edit** → **Add subflow**, which displays a list of valid flows that you can add to the current flow.
4. Select the flow that you want to add from the list. The subflow icon is displayed with the terminals that represent the Input and Output nodes that you have included in the subflow.
5. Click **OK**.
6. Repeat steps 3, 4, and 5 to add further subflow nodes.
7. Select and open (double-click) the flow by name in the Navigator view, or right-click the embedded flow icon and select **Open Subflow** to work with the contents of the embedded flow

When you have added the nodes that you want in this message flow, you can connect them to specify the flow of control through the message flow, and you can modify their properties.

Renaming a message flow node

Before you start:

- Create a message flow
- Read the concept topic about message flow nodes

You can change the name of any type of node (a built-in node, user-defined node, or subflow node) to reflect its purpose. When you first add a node to the canvas, the editor automatically assigns a name to the node, but the name is highlighted and you can change it by entering a name of your choice. If you do not change the default name at this time, you can change it later, as described in this topic. For

example, you might include a Compute node to calculate the price of a specific part within an order, and you could change the name of the node to be Calculate_Price.

When you rename a node, use only the supported characters for this entity. The editor prevents you from entering unsupported characters.

To rename a node:

1. Switch to the Broker Application Development perspective.
2. Open the message flow with which you want to work.
3. You can rename a node in three ways:
 - Right-click the node and click **Rename**. The name is highlighted; enter a name of your choice and press Enter.
 - Click the node to select it, then click the node's name so that it is highlighted; enter a name of your choice and press Enter.
 - Click the node to select it, then on the Description tab of the Properties view, enter a name of your choice in the Node name field.

The name that you enter must be unique within the message flow.

If you generate ESQL code for a Compute, Database, or Filter node, the code is contained within a module that is associated with the node. The name of the module within the ESQL file must match the name specified for the module in the *ESQL Module* property of the corresponding node. Although you can modify the module name, and change it from its default value (which is the name of the message flow, concatenated with the name of the node with which the module is associated), ensure that the module in the ESQL file matches the node property.

Configuring a message flow node

When you have included an instance of a node in your message flow, you can configure its properties to customize how it works.

Before you start:

- Read the concept topic about message flow nodes
- Add a node

Viewing a node's properties

To view a node's properties:

1. Switch to the Broker Application Development perspective.
2. Open the message flow with which you want to work.
3. Open the palette.
4. Click **Selection** above the node palette.
5. Right-click a node and click **Properties** to open the Properties view.

For nodes that do not have an associated resource, you can also double-click the node to display the properties. However, if you double-click any of the nodes in the following table, you open the associated resource.

Node	Result of double-clicking the node
"Compute node" on page 838	Opens an ESQL file

Node	Result of double-clicking the node
"Database node" on page 846	Opens an ESQL file
"DataDelete node" on page 866	Opens the New Message Map dialog box
"DataInsert node" on page 869	Opens the New Message Map dialog box
"DataUpdate node" on page 872	Opens the New Message Map dialog box
"Extract node" on page 884	Opens the New Message Map dialog box
"JavaCompute node" on page 943	Opens the New JavaCompute Node Class wizard
"Mapping node" on page 978	Opens the New Message Map dialog box
"SOAPAsyncRequest node" on page 1082	Opens the WSDL Selection dialog box
"SOAPInput node" on page 1104	Opens the WSDL Selection dialog box
"SOAPRequest node" on page 1116	Opens the WSDL Selection dialog box
"Warehouse node" on page 1213	Opens the New Message Map dialog box
WebSphere Adapters nodes	Opens the Adapter Component Selection dialog box
"XSLTransform node" on page 1216	Opens the XSL Selection dialog box

The selected node's properties are displayed.

Editing a node's properties

Properties are organized into related groups and displayed on tabs. Each tab is listed on the left of the Properties view. Click each tab to view the properties that you can edit.

- Every node has at least one tab, **Description**, where you can change the name of the node and enter short and long descriptions. The description fields are optional because they are used only for documentation purposes.
- If a property is mandatory, that is, one for which you must enter a value, the property name is marked with an asterisk, as shown in the following example:
Queue Name* _____

For details of how to configure each individual built-in node, see the node description. You can find a list of the nodes, with links to the individual topics, in "Built-in nodes" on page 822.

If you have included a user-defined node, refer to the documentation that came with the node to understand if, and how, you can configure its properties.

Editing complex properties

A complex property is a property to which you can assign multiple values. Complex properties are displayed in a table in the Properties view, where you can add, edit, and delete values, and change the order of the values in the table. This example shows the Query elements complex property of the DatabaseRoute node.

Query elements*

Table name	Column name	Operator	Value Type

Buttons: Add..., Edit..., Delete, Up, Down

- To add a value to a complex property, click **Add**, enter the required fields in the dialog box that opens, then click **OK**. The values appear in the table. Repeat this step to enter as many values as are required.
- To edit a value, click any element in a row, click **Edit**, edit any of the values in the dialog box, then click **OK**.
- To delete a value, click any element in a row and click **Delete**. The entire row is deleted.
- To change the order of values in the table, click any element in a row and click

the up icon  or down icon  to move the row.

Promoting properties

You can promote node properties to their containing message flow; for more information, see “Promoting a property” on page 554. Use this technique to set some values at the message flow level, without having to change individual nodes. This can be useful, for example, when you embed a message flow in another flow, and want to override some property such as output queue or data source with a value that is correct in this context. You cannot promote complex properties. For a full list of properties that are unavailable for promotion, as well as instructions for how to promote properties, see “Promoting a property” on page 554.

Overriding properties at deployment time

You can override a small number of node property values when you deploy a message flow. These property values are known as configurable properties, and you can use them to modify some characteristics of a deployed message flow without changing the message flow definitions. For example, you can update queue manager and data source information.

Even though you can set values for configurable properties at deployment time, you must set values for these properties within the message flow if they are mandatory. Each built-in node reference topic contains a table of properties, which identifies the configurable and mandatory properties.

Next: connect the nodes.

Using dynamic terminals

You can add, rename, and remove dynamic terminals on a node in the Message Flow editor.

Before you start:

- Add a node that supports dynamic terminals; for more details, see “Adding a message flow node” on page 231 and “Message flow node terminals” on page 52.

Some message flow nodes support dynamic input or output terminals, including the Collector, Route, and DatabaseRoute nodes. When you have added a node to the flow editor, you can add, remove, or change dynamic terminals.

- **Adding a dynamic terminal**

1. Right-click the node and click **Add Input Terminal** or **Add Output Terminal**.
2. Enter a name for the new terminal and click **OK**. The name must be unique for the terminal type. For example, if an input terminal called *In* already exists, you cannot create a dynamic input terminal with the name *In*.

The new terminal is displayed on the node. If a node has five or more terminals, they are displayed as a terminal group. The following example



shows a Route node with more than four output terminals. To connect a particular output terminal, click the terminal group to open the Terminal Selection dialog box, or right-click the node and select **Create Connection**.

- **Renaming a dynamic terminal**

1. Right-click the node and click **Rename Input Terminal** or **Rename Output Terminal**. These options are available only if you have added one or more appropriate terminals to this node.
2. Select from the list the name of the terminal that you want to change. Only dynamic terminals are listed because you cannot change the name of a static terminal.
3. Enter a new name for the terminal and click **OK**. Do not rename a dynamic terminal if one of the node properties is configured to use that name.

- **Removing a dynamic terminal**

1. Right-click the node and click **Remove Input Terminal** or **Remove Output Terminal**. These options are available only if you have added one or more appropriate terminals to this node.
2. Select from the list the name of the terminal that you want to remove and click **OK**. Only dynamic terminals are listed because you cannot remove a static terminal. Do not remove a dynamic terminal if one of the node properties is configured to use that terminal.

When you have added dynamic terminals to a node, connect them to other nodes in the message flow; for more information, see “Connecting message flow nodes” on page 239.

Removing a message flow node

When you have created and populated a message flow, you might need to remove a node to change the function of the flow, or to replace it with another more appropriate node. The node can be a built-in node, a user-defined node, or a subflow node.

Before you start:

- Add a node
- Add a subflow

- Read the concept topic about message flow nodes

To remove a node:

1. Switch to the Broker Application Development perspective.
2. Open the message flow that you want to work with.
3. Select the node in the editor view and press the Delete key.
4. Highlight the node and click **Edit** → **Delete**

You can also right-click the node in the editor view and click **Delete**, or right-click the node in the Outline view and click **Delete**. The editor removes the node. If you have created any connections between that node and any other node, those connections are also deleted when you delete the node.

5. If you delete a node in error, you can restore it by right-clicking in the editor view and clicking **Undo Delete**. The node and its connections, if any, are restored.

6.

You can also click **Edit** → **Undo Delete** or press Ctrl+Z.

7. If you undo the delete, but decide it is the correct delete action, you can right-click in the editor view and click **Redo Delete**.

You can also click **Edit** → **Redo Delete**.

Connecting message flow nodes

When you include more than one node in your message flow, you must connect the nodes to indicate how the flow of control passes from input to output. The nodes can be built-in nodes, user-defined nodes, or subflow nodes.

Before you start:

- Add a node
- Add a subflow
- Read the concept topic about connections

Your message flow might contain just one MQInput node, one Compute node, and one MQOutput node. Or it might involve a large number of nodes, and perhaps embedded message flows, that provide a number of paths through which a message can travel depending on its content. You might also have some error processing routines included in the flow. You might also need to control the order of processing.

You can connect a single output terminal of one node to the input terminal of more than one node (this is known as fan-out). If you do this, the same message is propagated to all target nodes, but you have no control over the order in which the subsequent paths through the message flow are executed (except with the FlowOrder node).

You can also connect the output terminal of several nodes to a single node input terminal (this is known as fan-in). Again, the messages that are received by the target node are not received in any guaranteed order.

When you have completed a connection, it is displayed as a black line, and is drawn as close as possible to a straight line between the connected terminals. This might result in the connection passing across other nodes. To avoid this, you can add bend points to the connection.

In the Message Flow editor, you can display node and connection metadata by hovering the mouse over a node or subflow in a message flow. To view metadata information for a node, subflow, or connection:

1. Switch to the Broker Application Development perspective.
2. Open a message flow.
3. In the Message Flow editor, hover the mouse over a node, a subflow, or a node connection in the open message flow by placing the mouse over the element.

A custom tooltip is displayed below the element.

- To turn the pop-up window into a scrollable window, press **F2**.
- To hide the pop-up window, either press **Esc** or move the mouse away from the node.

If you define a complex message flow, you might have to create a large number of connections. The principle is the same for every connection. You create connections either by using the mouse, or by using the Terminal Selection dialog. See “Creating node connections with the mouse” and “Creating node connections with the Terminal Selection dialog box” on page 241 for more information.

Creating node connections with the mouse

Use the mouse to connect one node to another.

Before you start:

Read the concept topic about connections.

1. Switch to the Broker Application Development perspective.
2. Open the message flow with which you want to work.
3. Click the terminal from which the connection is to be made; that is, the terminal from which the message is propagated from the current node.

For example, you can click the Failure, Out, or Catch terminal of the MQInput node. Hover the mouse over each terminal to see the name of the terminal. You do not need to keep the mouse button pressed.

Alternatively, click **Connection** on the palette, then click the node from which the connection is to be made. The Terminal Selection dialog box opens for you to choose the terminal from which to make a connection. Click **OK**. If a node has five or more input or output terminals (for example, if you have added dynamic terminals), they are displayed in a group. The following example



shows a node with more than four output nodes. To select a particular output terminal, click the grouped output terminal to open the Terminal Selection dialog box.

4. Click the input terminal of the next node in the message flow (to which the message passes for further processing). The connection is made when you click a valid input terminal. The connection appears as a black line between the two terminals.

In the Message Flow editor, you can display node and connection metadata by hovering the mouse over a node or subflow in a message flow. To view metadata information for a node, subflow, or connection:

1. Switch to the Broker Application Development perspective.
2. Open a message flow.

3. In the Message Flow editor, hover the mouse over a node, a subflow, or a node connection in the open message flow by placing the mouse over the element.

A custom tooltip is displayed below the element.

- To turn the pop-up window into a scrollable window, press **F2**.
- To hide the pop-up window, either press Esc or move the mouse away from the node.

Next: add a bend point, as described in “Adding a bend point” on page 242.

Creating node connections with the Terminal Selection dialog box

Use the Terminal Selection dialog box to connect one node to another.

Before you start:

Read the concept topic about connections.

1. Switch to the Broker Application Development perspective.
2. Open the message flow with which you want to work.
3. Click **Connection** above the node palette.
4. Click the node from which you want the connection to be made. The Terminal Selection dialog box is displayed.
5. Select the terminal from the list of valid terminals on this node. Click **OK**. The dialog box closes.
6. Click the node to which to make the connection. If this node has only one input terminal, the connection is made immediately. If this node has more than one input terminal, the Terminal Selection dialog box is displayed again, listing the input terminals of the selected node. Click the correct terminal and click **OK**.

Alternatively, you can make a connection in the following way:

1. Click **Selection** above the node palette.
2. Right-click the node from which you want to make the connection and click **Create Connection**. The Terminal Selection dialog box is displayed.
3. Select the terminal from the list of valid terminals on this node. Click **OK**. The dialog box closes.
4. Click the node to which to make the connection. If this node has only one input terminal, the connection is made immediately. If this node has more than one input terminal, the Terminal Selection dialog box is displayed again, listing the input terminals of the selected node. Click the correct terminal and click **OK**.

In the Message Flow editor, you can display node and connection metadata by hovering the mouse over a node or subflow in a message flow. To view metadata information for a node, subflow, or connection:

1. Switch to the Broker Application Development perspective.
2. Open a message flow.
3. In the Message Flow editor, hover the mouse over a node, a subflow, or a node connection in the open message flow by placing the mouse over the element.

A custom tooltip is displayed below the element.

- To turn the pop-up window into a scrollable window, press **F2**.

- To hide the pop-up window, either press Esc or move the mouse away from the node.

Next: add a bend point, as described in “Adding a bend point.”

Removing a node connection

The message flow editor displays the nodes and connections in the editor view. You can remove connections to change the way in which the message flow processes messages.

Before you start:

- Connect the nodes
- Read the concept topic about connections

If you want to remove a connection that you have created between two nodes:

1. Switch to the Broker Application Development perspective.
2. Open the message flow that you want to work with.
3. Click **Selection** above the node palette.
4. Select the connection that you want to delete. When you hover your mouse pointer over the connection, the editor highlights the connection that you have selected by thickening its line, adding an arrowhead at the target terminal end, and annotating the connection with the name of the two terminals connected, for example Out->In.

When you select the connection, the editor appends a small black square at each end and at every bend point of the connection, and a small arrowhead at the target terminal end. The annotation disappears when you select the connection.

5. Check that the selected connection is the one that you want to delete.
6. Right-click the connection and click **Delete**, press the Delete key, or click **Edit** → **Delete**. If you want to delete further connections, repeat these actions from step 4.
7. If you delete a connection in error, you can restore it by right-clicking in the editor view and clicking **Undo Delete**. The connection is restored.
8. If you undo the delete, but decide that it is the correct delete action, you can right-click in the editor view and click **Redo Delete**. You can also delete a connection by selecting it in the Outline view and pressing the Delete key.

If you delete a node, its connections are automatically removed; you do not have to do this as a separate task.

Adding a bend point

When you are working with a message flow, and connecting your chosen nodes together to determine the flow of control, you might find that a connection that you have made crosses over an intervening node and makes the flow of control difficult to follow.

To help you to display the message flow nodes and their connections in a clear way, you can add bend points to the connections that you have made to improve the organization of the display. The addition of bend points has no effect on the execution of the nodes or the operation of the message flow.

Before you start:

- Connect the nodes
- Read the concept topic about bend points

To add a bend point:

1. Switch to the Broker Application Development perspective.
2. Open the message flow that you want to work with.
3. Click **Selection** above the node palette.
4. Select the connection to which you want to add a bend point. The editor appends a small black square to each end of the connection to highlight it.
 - a. Check that this is the correct connection. The editor also adds a small point (a handle) in the connection halfway between the in and out terminals that are joined by this connection.
5. Hover your mouse pointer over this point until the editor displays a black cross to indicate that you now have control of this bend point.
 - a. Hold down the left mouse button and move your mouse to move the black cross and bend point across the editor view.
6. As you drag your mouse, the connection is updated, retaining its start and end points with a bend point at the drag point. You can move this anywhere within the editor view to improve the layout of your message flow.
7. Release the mouse button when the connection is in the correct place. The editor now displays the bend point that you have created with a small square (like those at the ends of the connection), and displays another two small points within the connection, one between your newly-created bend point and the out terminal, the other between the new bend point and the in terminal.

If you want to add more than one bend point to the same connection, repeat these actions from step 4 using the additional small points inserted into the connection.

Next: align and arrange the nodes.

Removing a bend point

When you are working with a message flow in the editor view, you might want to simplify the display of the message flow by removing a bend point that you previously added to a connection between two nodes.

Before you start:

- Add a bend point
- Read the concept topic about bend points

To remove a bend point:

1. Switch to the Broker Application Development perspective.
2. Open the message flow that you want to work with.
3. Click **Selection** above the node palette.
4. Select the connection from which you want to remove the bend point. The editor highlights the connection and its current bend points by thickening its line and appending a small black square to each end of the connection, and by indicating each bend point with a small black square. Check that this is the correct connection.
5. Right-click over the selected connection, if you added this bend point in the current edit session.

a. Click **Undo Create Bend Point**.

The editor removes the selected bend point.

If you right-click in the editor view without a connection being selected, you can also click **Undo Create Bend Point** from the menu. However, this removes the last bend point that you created in any connection, which might not be the one that you want to remove.

6. Move the bend point to straighten the line if you added this bend point in a previous edit session, because you cannot use the undo action. When the line is straight, the bend point is removed automatically.

When the bend point has been removed, the connection remains highlighted. Both ends of the connection, and any remaining bend points, remain displayed as small black squares. The editor also inserts small points (handles) into the connection between each bend point and between each terminal and its adjacent bend point, which you can use to add more bend points if you choose.

7. If you want to remove another bend point from the same connection, repeat these actions from step 4 on page 243.

Aligning and arranging nodes

When you are working in the Message Flow editor, you can decide how your nodes are aligned within the editor view.

This option is closely linked to the way in which your nodes are arranged. Again, the default for this is left to right, which means that the in terminal of a node appears on its left edge, and its out terminals appear on its right edge. You can also change this characteristic of a node by rotating the icon display to right to left, top to bottom, and bottom to top.

Before you start

To complete this task, you must have completed the following task:

- “Adding a message flow node” on page 231

To modify the way in which nodes and connections are displayed in the editor:

1. Switch to the Broker Application Development perspective.
2. Open the message flow that you want to work with.
3. Click **Selection** above the node palette.
4. Right-click in the editor window and select **Manhattan Layout** if you want the connections between the nodes to be displayed in Manhattan style; that is with horizontal and vertical lines joined at right angles.
5. If you want to change the layout of the complete message flow:
 - a. Right-click in the editor view and click **Layout**. The default for the alignment is left to right, such that your message flow starts (with an input node) on the left and control passes to the right.
 - b. From the four further options displayed, **Left to Right**, **Right to Left**, **Top to Bottom**, and **Bottom to Top**, click the option that you want for this message flow. The message flow display is updated to reflect your choice. As a result of the change in alignment, all the nodes within the message flow are also realigned.

For example, if you have changed from a left to right display (the default) to a right to left display, each node in the flow has now also changed to right to left (that is, the in terminal now appears on the right edge, the out terminals appear on the left edge).

6. You might want to arrange an individual node in a different direction from that in which the remaining nodes are arranged within the message flow, To do this:
 - a. Right-click the node that you want to change and click **Rotate**. This gives you four further options: **Left to Right**, **Right to Left**, **Top to Bottom**, and **Bottom to Top**.
 - b. Click the option that you want for this node. The option that represents the current arrangement of the node is not available for selection.

If you change the alignment of the message flow, or the arrangement of an individual node, or both, these settings are saved when you save the message flow. They are applied when another user accesses this same message flow, either through a shared repository or through shared files or import and export. When you reopen the message flow, you see these changed characteristics. The alignment and arrangement that you have selected for this message flow have no impact on the alignment and arrangement of any other message flow.

In the Message Broker Toolkit Version 5.1 you can adjust the zoom by right-clicking in the editor view and clicking **Zoom in** or **Zoom out**. Alternatively, you can use the drop-down list on the editor toolbar to specify a zoom percentage.

You can also access the editor toolbar to select other options related to the display and arrangement of nodes, for example, snap to grid. These are defined in Message Flow editor.

Developing message flow applications using WebSphere Adapters

For information about how to develop message flow applications that use WebSphere Adapters, see the following topics.

- “Preparing your system to use WebSphere Adapters nodes”
- “Activating IBM Tivoli License Manager for WebSphere Adapters” on page 246
- “Adding external software dependencies for SAP” on page 247
- “Configuring the SAP server to work with the adapter” on page 248
- “Adding external software dependencies for Siebel” on page 250
- “Configuring the Siebel application to work with the adapter” on page 251
- “Adding external software dependencies for PeopleSoft” on page 253
- “Creating a custom event project in PeopleTools” on page 254
- “Connecting to an EIS using the Adapter Connection wizard” on page 256

Preparing your system to use WebSphere Adapters nodes

Before you can connect to an Enterprise Information System (EIS), you must prepare your system by adding external software dependencies and configuring the EIS to work with the WebSphere Adapter.

Before you start:

- For general background information, read “WebSphere Adapters nodes” on page 7
- Check for the latest information about WebSphere Adapters at WebSphere Adapters technotes.

- Check for the latest information about support for adapters on different operating systems at WebSphere Message Broker Requirements.
- Check the mode of your broker, because it can affect the number of execution groups and message flows that you can deploy, and the types of node that you can use. For more information, see Restrictions that apply in each operation mode and Checking the operation mode of your broker.
- Enable the WebSphere Adapters nodes in the broker runtime environment; see Preparing the environment for WebSphere Adapters nodes.
- If you want to use the IBM Tivoli® License Manager (ITLM), perform the steps in “Activating IBM Tivoli License Manager for WebSphere Adapters.”
- To see how the WebSphere Adapters work, look at the following samples:
 - Twineball Example EIS Adapter sample
 - SAP Connectivity sample
 You can view samples only when you use the information center that is integrated with the Message Broker Toolkit.

Perform™ the following steps, in the order shown, to prepare your system to use WebSphere Adapter nodes.

- **SAP**
 1. Follow the instructions in “Adding external software dependencies for SAP” on page 247.
 2. Follow the instructions in “Configuring the SAP server to work with the adapter” on page 248.
- **Siebel**
 1. Follow the instructions in “Adding external software dependencies for Siebel” on page 250.
 2. Follow the instructions in “Creating the event store manually” on page 252.
- **PeopleSoft**
 1. Follow the instructions in “Adding external software dependencies for PeopleSoft” on page 253.
 2. Follow the instructions in “Creating a custom event project in PeopleTools” on page 254.

After you have prepared your system, connect to an EIS by following the instructions in “Connecting to an EIS using the Adapter Connection wizard” on page 256.

Activating IBM Tivoli License Manager for WebSphere Adapters

If you want to use IBM Tivoli License Manager (ITLM), you must activate it for each of the WebSphere Adapters.

ITLM enables you to monitor the usage of IBM (and other) software products. For more information, see the IBM Tivoli License Manager information center or the IBM Tivoli License Manager Web site.

The following steps describe how to activate the ITLM file for each of the adapters.

1. Locate the ITLM directory for the adapter.
 - For SAP: *install_dir*/itlm/SAP
 - For Siebel: *install_dir*/itlm/Siebel

- For PeopleSoft: *install_dir*/itlm/PeopleSoft
2. Remove the inactive file extension from the file in the ITLM directory so that it ends with `.sys2`.

After you have performed these steps, when you run ITLM, the adapter is visible.

Adding external software dependencies for SAP

Before you can develop message flows that use WebSphere Adapters nodes, you must add prerequisite files to the runtime environment.

Before you start:

Ensure that you have the relevant prerequisite files for your SAP system:

- `sapjco.jar`
- On Windows:
 - `sapjcorfc.dll`
 - `librfc32.dll`
- On z/OS:
 - `libsapjcorfc.so`
 - `librfccm.so`

Download these files for your operating system from the external SAP Web site, SAP Service Marketplace, and save them to a directory, such as `C:\SAP_LIB`. You must have an SAPNet account to be able to access this Web site.

- On Windows, download the `.dll` files that come with the SAP JCo download.
- On z/OS, Linux, and UNIX, download the `.so` and `.o` files that come with the SAP JCo download.

Locating the SAP support files in the runtime environment on Windows

To add the SAP prerequisite files to the runtime environment, take the following steps.

1. Ensure that the broker has started.
2. Either open the Command Console, or open a Windows command prompt and enter `mqsiprofile` to initialize the environment.
3. Enter the following command to display the locations of the prerequisite JAR files and native libraries:

```
mqsireportproperties WBRK61_DEFAULT_BROKER -c AllTypes -o AllReportableEntityNames -r
```

The following example shows what typically is displayed when you run this command:

```
ReportableEntityName=''
EISProviders
  PeopleSoft=''
    jarsURL='default_path'
    nativeLibs='default_path'
  SAP=''
    jarsURL='default_path'
    nativeLibs='default_path'
  Siebel=''
    jarsURL='default_path'
    nativeLibs='default_path'
  Twineball=''
    jarsURL='default_path'
    nativeLibs='default_path'
```

4. Set the location of the SAP prerequisite files using the following command:

```
mqsichangeproperties WBRK61_DEFAULT_BROKER -c EISProviders -o SAP -n jarsURL -v C:\SAP_LIB
mqsichangeproperties WBRK61_DEFAULT_BROKER -c EISProviders -o SAP -n nativeLibs -v C:\SAP_LIB
```

5. To check that the values have been set correctly, run the following command:
`mqsireportproperties WBRK61_DEFAULT_BROKER -c EISProviders -o SAP -r`

The following example shows what is displayed by the `mqsireportproperties` command.

```
ReportableEntityName=' '
EISProviders
SAP=' '
  jarsURL='C:\SAP_LIB'
  nativeLibs='C:\SAP_LIB'
```

BIP8071I: Successful command completion.

6. Restart the broker.

Next: configure the SAP system to work with the adapter

Configuring the SAP server to work with the adapter

Before you configure the WebSphere Adapter for SAP Software for Application Link Enabling (ALE) processing, you must register a Remote Function Call (RFC) destination on the SAP server, and configure a receiver port, logical system, distribution model, and partner profile on the SAP server. Ask your system administrator if these items have been configured.

Before you start:

Add the required external software dependencies for SAP.

Perform the following steps on the SAP server using the SAP graphical user interface.

1. Register an RFC program ID:
 - a. Open transaction **SM59** (Display and Maintain RFC Destinations).
 - b. Click **Create**.
 - c. Type a name for the RFC destination.
 - d. In the **Connection Type** field, select **T**.
 - e. In the **Activation Type** field, select **Registered Server Program**.
 - f. Type a Program ID.

You use this program ID when you configure the adapter. This value indicates to the SAP gateway which RFC-enabled functions the program ID listens for.
 - g. Enter a description in **Description 1**, such as RFC for Test Sample.
 - h. Enter a description in **Description 2**, such as your name.
 - i. Click **MDMP & Unicode**, and in the Communication Type with Target System section, click **Unicode**.
 - j. Save your entry.
2. Set up a receiver port:
 - a. Open transaction **WE21** (Ports in IDoc processing).
 - b. Select **Transactional RFC**, click **Ports**, and click the **Create** icon.
 - c. Type a name for the port and click **OK**.
 - d. Type the name of the destination that you created in the previous task (or select it from the list).

- e. Save your entry.
3. Specify a logical system:
 - a. Open transaction **BD54** (Change View Logical Systems).
 - b. Click **New Entries**.
 - c. Type a name for the logical system and click the **Save** icon.
 - d. If you see the Prompts for Workbench request, click the **New Request** icon. Then enter a short description and click **Save**.
 - e. Click the **Continue** icon.
4. Configure a distribution model:
 - a. Open transaction **BD64** (Maintenance of Distribution Model).
 - b. Click **Distribution Model** → **Switch processing model**.
 - c. Click **Create model view**.
 - d. Type a name for the model view and click the **Continue** icon.
 - e. Select the distribution model that you created and click **Add message type**.
 - f. For outbound processing, type the logical system name that you created in the previous task as **Sender**, and type the logical name of the SAP server as **Receiver**, then select a message type (for example, **MATMAS**) and click the **Continue** icon.
 - g. Select the distribution model again and click **Add message type**.
 - h. For inbound processing, type the logical name of the SAP server as **Sender**, and the logical system name that you created in the previous task as **Receiver**, then select a message type (for example, **MATMAS**) and click the **Continue** icon.
 - i. Save your entry.
5. Set up a partner profile:
 - a. Open transaction **WE20** (Partner Profiles).
 - b. Click the **Create** icon.
 - c. Type the name of the logical system that you created in the earlier task and, for **Partner Type**, select **LS**.
 - d. For **Post Processing: permitted agent**, type **US** and your user ID.
 - e. Click the **Save** icon.
 - f. In the Outbound parameters section, click the **Create outbound parameter** icon.
 - g. In the Outbound parameters window, type a message type (for example, **MATMAS05**), select the receiver port that you created in the earlier task, and select **Transfer IDoc immed**.
 - h. Click the **Save** icon.
 - i. Press **F3** to return to the Partner Profiles view.
 - j. In the Inbound parameters section, click the **Create inbound parameter** icon.
 - k. In the Inbound parameters window, type a message type (for example, **MATMAS**), and a process code (for example, **MATM**).
 - l. Click the **Save** icon.
 - m. Press **F3** to return to the Partner Profiles view.
 - n. In the Inbound parameters section, click the **Create inbound parameter** icon.
 - o. In the Inbound parameters window, type the following values: **ALEAUD** for **Message Type**, and **AUD1** for **Process Code**.
 - p. Click the **Save** icon.

- q. Press **F3** to return to the Partner Profiles view.
- r. Click the **Save** icon.

Next: connect to an EIS using the Adapter Connection wizard.

Adding external software dependencies for Siebel

Before you can develop message flows that use WebSphere Adapters nodes, you must add prerequisite files to the runtime environment.

Before you start:

Ensure that you have the relevant prerequisite files for your Siebel system.

- Siebel Business Applications Versions 7.5 and earlier
 - SiebelJI_language_code.jar (for example, SiebelJI_enu.jar)
 - SiebelJI_Common.jar
- Siebel Business Applications Versions 7.7x, 7.8x, and 8.0
 - Siebel.jar
 - SiebelJI_language_code.jar (for example, SiebelJI_enu.jar)

Download these files from the Siebel application, and save them to a directory, such as C:\Siebel_LIB.

The sample resources that you need to set up the Siebel system so that it can communicate with the broker are in the following directory: *install_dir*\ResrouceAdapters\Siebel_6.1.0.0\samples

Locating the Siebel support files in the runtime environment on Windows

To add the Siebel prerequisite files to the runtime environment, take the following steps.

1. Ensure that the broker has started.
2. Either open the Command Console, or open a Windows command prompt and enter `mqsiprofile` to initialize the environment.
3. Enter the following command to display the locations of the prerequisite JAR files and native libraries:

```
mqsireportproperties WBRK61_DEFAULT_BROKER -c AllTypes -o AllReportableEntityNames -r
```

The following example shows what typically is displayed when you run this command:

```
ReportableEntityName=''
EISProviders
PeopleSoft=''
  jarsURL='default_Path'
  nativeLibs='default_Path'
SAP=''
  jarsURL='default_Path'
  nativeLibs='default_Path'
Siebel=''
  jarsURL='default_Path'
  nativeLibs='default_Path'
Twineball=''
  jarsURL='default_Path'
  nativeLibs='default_Path'
```

4. Set the location of the Siebel prerequisite files using the following command:

```
mqsichangeproperties WBRK61_DEFAULT_BROKER -c EISProviders -o Siebel -n jarsURL -v C:\Siebel_LIB
mqsichangeproperties WBRK61_DEFAULT_BROKER -c EISProviders -o Siebel -n nativeLibs -v C:\Siebel_LIB
```

5. To check that the values have been set correctly, run the following command:
`mqsireportproperties WBRK61_DEFAULT_BROKER -c EISProviders -o Siebel -r`

The following example shows what is displayed by the `mqsireportproperties` command.

```
ReportableEntityName=' '  
EISProviders  
Siebel=' '  
  jarsURL='C:\Siebel_LIB'  
  nativeLibs='C:\Siebel_LIB'
```

BIP8071I: Successful command completion.

6. Restart the broker.

Next: configure the Siebel application to work with the adapter.

Configuring the Siebel application to work with the adapter

To configure the Siebel application, create an event table and a Siebel business object.

Before you start:

1. Add the required external software dependencies for Siebel.
2. Before you configure the Siebel application to work with WebSphere Adapter for Siebel Business Applications, you must create a user name and password so that the Adapter Connection wizard can connect to Siebel Business Applications to perform outbound operations, and retrieve Siebel business objects and services.

You perform this task on the Siebel server, therefore ensure that you are familiar with the Siebel tools that are required to complete it. For information about using Siebel tools, refer to the Siebel tools documentation.

To open Siebel Sales Enterprise on your local database, you must have administrative privileges.

To configure the Siebel application, you must create an event table and a Siebel business object. WebSphere Message Broker contains resources that help you to create the event components and triggers. This topic describes how to use those resources. You can also create the event table and Siebel business object manually; for more information, see “Creating the event store manually” on page 252.

1. Locate the samples folder at `install_dir/WMBT610/ResourceAdapters/Siebel/samples`.

The samples folder contains two folders: Siebel7.x.x and Siebel8.0. Each version has an `Event_pkg` folder, which contains a `.sif` file and a number of `.js` scripts. You use the `.sif` file to create the event components; it can add business objects, views, and all other Siebel objects to the Siebel repository. The `.js` scripts help you to create Siebel triggers.

2. To use the `.sif` file:
 - a. Open Siebel tools and click **Tools** → **Import**.
 - b. Import the `.sif` file.
 - c. Merge the differences between the `.sif` file and the Siebel repository.
 - d. Recompile the repository into a Siebel repository file (`.srf` file).
3. Use the `.js` scripts to create Siebel triggers. The provided samples show how to create entries in the inbound table when new Account objects are created.

Creating the event store manually

To configure the Siebel application, create an event table and a Siebel business object.

“Configuring the Siebel application to work with the adapter” on page 251 describes how to use the samples that are supplied with WebSphere Message Broker to configure the Siebel application. This topic describes how to create the event store manually.

The following steps describe how to create the event store to be used for inbound operations in the Siebel application. You can substitute all references to Siebel Sales Enterprise with the name of the Siebel application that you are using.

1. Create a project called IBM, and lock the project with Siebel tools.
2. Using the object wizard, create an event table called CX_IBM_EVENT in which to store the events.
 - a. In the event table, create the columns that are shown in the following table.

Column Name	Type	Length	Data Type	Required	Nullable	Status
DESCRIPTION	Data (public)	255	Varchar	No	Yes	Active
EVENT_ID	Data (public)	30	Varchar	Yes	No	Active
EVENT_TYPE	Data (public)	20	Varchar	Yes	No	Active
OBJECT_KEY	Data (public)	255	Varchar	Yes	No	Active
OBJECT_NAME	Data (public)	255	Varchar	Yes	No	Active
PRIORITY	Data (public)	10	Varchar	No	Yes	Active
STATUS	Data (public)	20	Varchar	Yes	No	Active
XID	Data (public)	255	Varchar	Yes	No	Active

- b. Create a new business component called IBM Event.
 - c. Create a new time stamp called Field Event, and map it to the CREATED column from CX_IBM_EVENT. Make the Type of this field DTYPE_UTCDATETIME.
 - d. Create a new business object called IBM Event.
 - e. Associate the IBM event business component to the IBM Event business object.
 - f. Create an applet called IBM Event List Applet, and base it on the IBM Event business component that you have created.
 - g. Create a view called IBM Event List View, and base it on the IBM Event business object that you have created.
 - h. Create a screen called IBM Event Screen, and associate it with the IBM Event List View in the Siebel tools.
 3. Create a page tab.
 - a. Click **Start Application** → **Siebel Sales Enterprise**.
 - b. Right-click the **Page** tab, and click **New Record**.
 - c. Specify IBM Event as the screen name, and IBM Event for the **Text - String Override** field.
 - d. Leave the **Inactive** field blank.
 4. Create a new business object called Schema Version for your IBM project and associate it with the Schema Version business component.

- a. Apply the physical schema for the new tables to your local database by querying for the new table, CX_IBM_EVENT_Q and selecting the current query to create a physical schema. Leave the table space and index space blank.
- b. Click **Activate** to activate the new schema.
5. Add or modify the Siebel VB or e-scripts for the business component that corresponds to the business objects that are used at your site. Siebel scripts trigger event notification for business objects. Samples are located in the Samples folder in your adapter installation.
6. Create a new Siebel repository file by compiling the updated and locked projects on your local database. The new repository file has an extension of .srf.
7. Create and populate a new responsibility.
 - a. Open Siebel Sales Enterprise on your local database.
 - b. Create a new responsibility called IBM Responsibility for IBM Event List View.
 - c. Add the employees or teams who are responsible for reviewing events to the newly created IBM Responsibility.
 - d. Create a user name called IBMCONN (or another user name to be used by the adapter later). Add the user name to the newly created IBM Responsibility and also to the Administrative Responsibility.
8. Test the application in your local environment to ensure that you can see the IBM Event List View. An event is generated in the view after you create a record in the supported object. As part of the test, create a new Account business component instance in Siebel. Confirm that a new Account event is shown in the IBM Event List View (assuming that you have added the e-script trigger to the Account business component). If a new Account event is not displayed in the view, check for an error and fix it. For more information on the errors that might be generated, check either the Siebel support site or Siebel documentation.
9. When the test that you perform in Step 8 is successful, add your new and updated projects to your development server.
10. Activate the new table in the development server.
11. Compile a new Siebel repository (.srf) file on the server.
12. Back up the original repository file on the server.
13. Stop the Siebel server and replace the original repository file with the newly created one.
14. Restart the Siebel server.

Adding external software dependencies for PeopleSoft

Before you can develop message flows that use WebSphere Adapters nodes, you must add prerequisite files to the runtime environment.

Before you start:

Ensure that you have the relevant prerequisite files for your PeopleSoft system.

- psjoa.jar
- A JAR file that contains the component interface API classes

Save both support files to a directory such as C:\PeopleSoft_LIB. You can find the psjoa.jar file in the following location on the PeopleSoft Application Server:

peopleTools_installation_directory\web\PSJOA\psjoa.jar. Use PeopleTools to generate the component interface JAR file for your business objects.

The sample resources that you need to set up the PeopleSoft system so that it can communicate with the broker are in *install_dir*\ResrouceAdapters\PeopleSoft_6.1.0.0\samples.

Locating the PeopleSoft support files in the run time on Windows

To add the PeopleSoft prerequisite files to the run time, follow the steps below.

1. Ensure that the broker has started.
2. Either open the Command Console, or open a Windows command prompt and enter `mqsiprofile` to initialize the environment.
3. Enter the following command to display the locations of the prerequisite JAR files and native libraries:

```
mqsireportproperties WBRK61_DEFAULT_BROKER -c AllTypes -o AllReportableEntityNames -r
```

The following example shows what typically is displayed when you run this command:

```
ReportableEntityName=' '  
EISProviders  
  PeopleSoft=' '  
    jarsURL='default_Path'  
    nativeLibs='default_Path'  
  SAP=' '  
    jarsURL='default_Path'  
    nativeLibs='default_Path'  
  Siebel=' '  
    jarsURL='default_Path'  
    nativeLibs='default_Path'  
  Twineball=' '  
    jarsURL='default_Path'  
    nativeLibs='default_Path'
```

4. Set the location of the PeopleSoft prerequisite files using the following command:

```
mqsichangeproperties WBRK61_DEFAULT_BROKER -c EISProviders -o PeopleSoft -n jarsURL -v C:\PeopleSoft_LIB
```

5. To check that the values have been set correctly, run the following command:

```
mqsireportproperties WBRK61_DEFAULT_BROKER -c EISProviders -o PeopleSoft -r
```

The following example shows what is displayed by the `mqsireportproperties` command.

```
ReportableEntityName=' '  
EISProviders  
  PeopleSoft=' '  
    jarsURL='C:\PeopleSoft_LIB'
```

```
BIP8071I: Successful command completion.
```

6. Restart the broker.

Next: create a custom event project in PeopleTools.

Creating a custom event project in PeopleTools

The WebSphere Adapter requires an event project in PeopleSoft to perform asynchronous inbound event processing. Use PeopleTools to create the custom event project.

Before you start:

Add the required external software dependencies for PeopleSoft.

If your environment requires inbound event support, you must use a custom event project in PeopleSoft. A sample event project, IBM_EVENT_V600, is provided with the adapter. You can modify and use the sample project, or you can create your own project using PeopleTools. If you create your own project, make sure that you complete the steps below.

1. Use PeopleTools Application Designer to create and name a new project.
2. Create the fields for the new project as described in the following table:

Field name	Field description
IBM_EVENT_ID	A numeric value that is retrieved from IBM_FETCH_ID record. This value is a unique ID for the event.
IBM_OBJECT_NAME	The name of the corresponding business graph.
IBM_OBJECT_KEYS	The get key property names in the Component Interface, followed by the key values in name-value pairs. This information is used for the component's retrieval from the EIS.
IBM_EVENT_STATUS	If the event is ready to be polled, the status is set to 0 and the IBMPublishEvent function is called.
IBM_OBJECT_VERB	The verb that is set on the business object graph that contains the retrieved business object.
IBM_EVENT_DTTM	The date on which the event is created. For a future dated event, this is the effective date.
IBM_NEXT_EVENT_ID	The field that has the latest event ID under the record IBM_FETCH_ID. This field is incremented for each event that is added to the IBM_EVENT_TBL, and it populates the IBM_EVENT_ID field within that table.
IBM_XID	The transaction ID that is needed to provide assured event delivery.

3. Create a record named IBM_EVENT_TBL and add to it all the fields that you have just created, except IBM_NEXT_EVENT_ID.
4. Create a record named IBM_FETCH_ID and add to it only the IBM_NEXT_EVENT_ID field.
5. Open the IBM_FETCH_ID record, select the IBM_NEXT_EVENT_ID field, view the PeopleCode, and select **fieldformula**.
6. Copy the PeopleCode for a custom event project from "PeopleCode for a custom event project" on page 1311 to the project that you are creating.
7. Create a page under your project that contains the fields of the IBM_EVENT_TBL record at level 0. The page can have any name.
8. Create a component under your project that contains the page that you have just created. The component can have any name.

9. Create a Component Interface against this component and give it any name. Confirm that you want to default the properties that are based on the underlying component definition.
10. Build the entire project, selecting all create options.
11. Test and confirm that the Component Interface works, using the Component Interface tester.
12. Generate the Java APIs for the Component Interface, then add the generated classes to the adapter classpath. For complete information about building a PeopleTools project and testing the PeopleSoft Component Interface, refer to PeopleSoft documentation.

Connecting to an EIS using the Adapter Connection wizard

Use the Adapter Connection wizard to create the resources that enable the WebSphere Adapters to connect to an Enterprise Information System (EIS).

Before you start:

- Read “WebSphere Adapters nodes” on page 7
- Prepare the environment for WebSphere Adapters nodes
- Perform the preparatory tasks listed in “Developing message flow applications using WebSphere Adapters” on page 245

A message flow application that uses one of the WebSphere Adapters requires the following resources:

- One or more message flows that contain one or more WebSphere Adapters nodes
- A message set that contains the XML Schema Definitions (XSD) for the business objects in the Enterprise Information System (EIS)
- An adapter component file for the WebSphere Adapter that is being used

The Adapter Connection wizard creates these resources automatically.

The following steps describe how to connect to an EIS.

1. Before you run the wizard, you need to gather the following information from the EIS.
 - **SAP**
 - SAP system user name
 - SAP system password
 - SAP host name or IP address
 - SAP Client ID (for example, 001)
 - SAP system number (for example, 00)
 - Language code (for example, EN)

For more information, see “SAP connection properties for the Adapter Connection wizard” on page 1234.

- **Siebel**
 - Siebel user name
 - Siebel password
 - Siebel host name or IP address
 - Language code

For more information, see “Siebel connection properties for the Adapter Connection wizard” on page 1291.

- **PeopleSoft**
 - PeopleSoft user name
 - PeopleSoft password
 - PeopleSoft host name or IP address
 - Port number (for example, 9000)
 - Language code (for example, ENG)

For more information, see “PeopleSoft connection properties for the Adapter Connection wizard” on page 1315.

2. Switch to the Broker Application Development perspective.
3. Click **File** → **New** → **Adapter Connection**. The Adapter Connection wizard opens.
4. Follow the instructions in the wizard. To see a description of each field within the wizard, hover the mouse over the field.

Ensure that inbound and outbound SAP IDocs have different names if they are stored in the same message set. For more information, see *An error is issued when you use the message set that is generated by the Adapter Connection wizard*.

When you have completed the steps in the wizard, the specified message set project contains a message set with a message type for each business object that is to be used, and the specified message flow project references the message set project.

When the Adapter Connection wizard completes, the workbench displays a message that prompts you to drag the adapter component onto the message flow canvas.

1. Ensure that a message flow is open in the Message Flow editor so that the message flow canvas is available.
2. In the Broker Development view, expand the folders beneath the message set until you see the adapter component, which will have a suffix of *inadapter* or *outadapter*.
3. Drag the adapter component onto the message flow canvas. The component appears as a message flow node.
4. Configure the node, as described in “Configuring a message flow node” on page 235.

Developing ESQL

When you use the built-in nodes Compute, Database, and Filter, you must customize them to determine the exact processing that they provide. To do this, you must create, for each node, an ESQL module in which you code the ESQL statements and functions to tailor the behavior of the node, referring to message content, or database content, or both, to achieve the results that you require. ESQL modules are maintained in ESQL files, managed through the Broker Application Development perspective.

This section provides information on:

- “ESQL overview” on page 258
- “Managing ESQL files” on page 268
- “Writing ESQL” on page 280

You can use the ESQL debugger, which is part of the flow debugger, to debug the code that you write. The debugger steps through ESQL code statement by statement, so that you can view and check the results of every line of code that is executed.

Note: In previous releases there were several types of debugger, each of which handled a specific type of code, such as ESQL, message flows, or Java. In Version 6, these are integrated into a single debugger, which is known simply as “the debugger”, and which handles all types of code.

ESQL overview

Extended Structured Query Language (ESQL) is a programming language defined by WebSphere Message Broker to define and manipulate data within a message flow.

This section contains introductory information about ESQL.

- For descriptions of ESQL user tasks, see “Writing ESQL” on page 280.
- For reference information about ESQL, see “ESQL reference” on page 1451.

Read the following information before you proceed:

- An overview of message flows, see “Message flows overview” on page 4.
- An overview of message trees, see “The message tree” on page 53, and the topics within this container, paying special attention to “Logical tree structure” on page 60.

ESQL is based on Structured Query Language (SQL) which is in common usage with relational databases such as DB2. ESQL extends the constructs of the SQL language to provide support for you to work with message and database content to define the behavior of nodes in a message flow.

The ESQL code that you create to customize nodes within a message flow is defined in an ESQL file, typically named <message_flow_name>.esql,, which is associated with the message flow project. You can use ESQL in the following built-in nodes:

- “Compute node” on page 838
- “Database node” on page 846
- “Filter node” on page 910

You can also use ESQL to create functions and procedures that you can use in the following built-in nodes:

- “DataDelete node” on page 866
- “DataInsert node” on page 869
- “DataUpdate node” on page 872
- “Extract node” on page 884
- “Mapping node” on page 978
- “Warehouse node” on page 1213

To use ESQL correctly and efficiently in your message flows, you must also understand the following concepts:

- Data types
- Variables
- Field references
- Operators
- Statements

- Functions
- Procedures
- Modules

Use the ESQL debugger, which is part of the flow debugger, to debug the code that you write. The debugger steps through ESQL code statement by statement, so that you can view and check the results of every line of code that is executed.

Note: In previous releases there were several types of debugger, each of which handled a specific type of code, such as ESQL, message flows, or Java. In Version 6, these separate debuggers are integrated into a single debugger, which is known simply as “the debugger”, and which handles all types of code.

ESQL data types

A data type defines the characteristics of an item of data, and determines how that data is processed. ESQL supports six data types, listed below. Data that is retrieved from databases, received in a self-defining message, or defined in a message model (using MRM data types), is mapped to one of these basic ESQL types when it is processed in ESQL expressions.

Within a broker, the fields of a message contain data that has a definite data type. It is also possible to use intermediate variables to help process a message. You must declare all such variables with a data type before use. A variable’s data type is fixed; if you try to assign values of a different type you get either an implicit cast or an exception. Message fields do not have a fixed data type, and you can assign values of a different type. The field adopts the new value and type.

It is not always possible to predict the data type that results from evaluating an expression. This is because expressions are compiled without reference to any kind of message schema, and so some type errors are not caught until runtime.

ESQL defines the following categories of data. Each category contains one or more data types.

- Boolean
- Datetime
- Null
- Numeric
- Reference
- String

ESQL variables

An ESQL variable is a data field that is used to help process a message.

You must declare a variable and state its type before you can use it. A variable’s data type is fixed; if you code ESQL that assigns a value of a different type, either an implicit cast to the data type of the target is implemented or an exception is raised (if the implicit cast is not supported).

To define a variable and give it a name, use the DECLARE statement.

The names of ESQL variables are case sensitive; therefore, make sure that you use the correct case in all places. The simplest way to guarantee that you are using the correct case is always to define variables using uppercase names.

The workbench marks variables that have not been defined. Remove all these warnings before deploying a message flow.

You can assign an initial value to the variable on the DECLARE statement. If an initial value is not specified, scalar variables are initialized with the special value NULL, and ROW variables are initialized to an empty state. Subsequently, you can change the variable's value using the SET statement.

Three types of built-in node can contain ESQL code and therefore support the use of ESQL variables:

- "Compute node" on page 838
- "Database node" on page 846
- "Filter node" on page 910

Variable scope, lifetime, and sharing

How widespread and for how long a particular ESQL variable is available, is described by its scope, lifetime, and sharing:

A variable's scope

is a measure of the range over which it is visible. In the broker environment, the scope of variables is normally limited to the individual node.

A variable's lifetime

is a measure of the time for which it retains its value. In the broker environment, the lifetime of a variable varies but is typically restricted to the life of a thread within a node.

A variable's sharing characteristics

indicate whether each thread has its own copy of the variable or one variable is shared between many threads. In the broker environment, variables are typically not shared.

Types of variable

External

External variables (defined with the EXTERNAL keyword) are also known as *user-defined properties* (see "User-defined properties in ESQL" on page 261). They exist for the entire lifetime of a message flow and are visible to all messages passing through the flow. You can define external variables only at the module and schema level. You can modify their initial values (optionally set by the DECLARE statement) at design time, using the Message Flow editor, or at deployment time, using the BAR editor. You can query and set the values of user-defined properties at run time by using the Configuration Manager Proxy (CMP) API. For more information, see Setting user-defined properties dynamically at run time.

Normal

"Normal" variables have a lifetime of just one message passing through a node. They are visible to that message only. To define a "normal" variable, omit both the EXTERNAL and SHARED keywords.

Shared

Shared variables can be used to implement an in-memory cache in the message flow (see "Optimizing message flow response times" on page 158). Shared variables have a long lifetime and are visible to multiple messages passing through a flow (see "Long-lived variables" on page 261). They exist for the lifetime of the execution group process, the lifetime of

the flow or node, or the lifetime of the node's SQL that declares the variable (whichever is the shortest). They are initialized when the first message passes through the flow or node after each broker startup.

See also the ATOMIC option of the "BEGIN ... END statement" on page 1482. The BEGIN ATOMIC construct is useful when a number of changes need to be made to a shared variable and it is important to prevent other instances seeing the intermediate states of the data.

For information about specific types of variable, see:

- "User-defined properties in ESQL" (external variables)
- "Long-lived variables" (shared variables)

User-defined properties in ESQL:

User-defined properties (UDPs) can be accessed as variables in your ESQL program by specifying the EXTERNAL keyword on a DECLARE statement. For example, the ESQL statement DECLARE today EXTERNAL CHARACTER 'monday' defines a user-defined property called today with an initial value 'monday'.

Before you can use a user-defined property, you must also define the property when you construct a message flow that uses it by using the Message Flow editor. When you define a UDP using the Message Flow editor, a value and property type are also defined. The value might be a default value, which varies according to the UDP's type. The value that is assigned to the UDP in the Message Flow editor takes precedence over any value that you have assigned to the UDP in your ESQL program.

Before you deploy the message flow that uses the UDP, you can change the value of the UDP by using the Broker Archive editor. If you try to deploy a message flow that contains a UDP that has had no value assigned to it, a deployment failure occurs. For more information, see "Configuring a message flow at deployment time using UDPs" on page 410.

You can use UDPs to set configuration data and use them like typical properties. No external calls to user-written plug-ins or parsing of environment trees are involved, and parsing costs of reading data out of trees are removed. The value of the UDP is stamped into the variable at deployment time.

UDPs can be queried, discovered, and set at run time to dynamically change the behavior of a message flow. For more information, see "User-defined properties" on page 111.

You can declare UDPs only in modules or schemas.

UDPs can be accessed by any of the following built-in nodes that use ESQL:

- Compute
- Database
- Filter
- Nodes that are derived from these node-types; for example, DataInsert, DataDelete, and DataUpdate

For a description of how to access a UDP from a JavaCompute node, see "Accessing user-defined properties from a JavaCompute node" on page 466.

Long-lived variables:

You can use appropriate long-lived ESQL data types to provide an in-memory cache of the data for a certain period of time.

It is sometimes desirable to store data for longer than the lifetime of a single message passing through a flow. One way to do this, is to store the data in a database. Using a database is good for long-term persistence and transactionality, but access (particularly write access) is slow.

Alternatively, you can use appropriate long-lived ESQL data types to provide an in-memory cache of the data for a certain period of time. Using long-lived ESQL data types makes access faster than from a database, though this is at the expense of shorter persistence and no transactionality.

Long-lifetime variables are created by using the SHARED keyword on the DECLARE statement. For further information see “DECLARE statement” on page 1525.

The following sample demonstrates how to define shared variables using the DECLARE statement. The sample demonstrates how to store routing information in a database table and use shared variables to store the database table in memory in the message flow to improve performance.

- Message Routing sample

You can view samples only when you use the information center that is integrated with the Message Broker Toolkit.

Long-lived data types have an extended lifetime beyond that of a single message passing through a node. Long-lived data types are shared between threads and exist for the life of a message flow (strictly speaking the time between configuration changes to a message flow), as described in this table:

	Scope	Life	Shared
Short lifetime variables			
Schema & Module	Node	Thread within node	Not at all
Routine Local	Node	Thread within routine	Not at all
Block Local	Node	Thread within block	Not at all

Long lifetime variables			
Node Shared	Node	Life of node	All threads of flow
Flow Shared	Flow	Life of flow	All threads of flow

Features of long-lived ESQL data types include:

- The ability to handle large amounts of long-lifetime data.
- The joining of data to messages is fast.
- On multiple processor machines, multiple threads are able to access the same data simultaneously.
- Subsequent messages can access the data left by a previous message.
- Long lifetime read-write data can be shared between threads, because there is no long term association between threads and messages.

- In contrast to data stored in database tables in the environment, this type of data is stored privately; that is, within the broker.
- The use of ROW variables can be used to create a modifiable copy of the input message. See “ESQL ROW data type” on page 1460.
- It is possible to create shared constants.

A typical use of these data types might be in a flow in which data tables are ‘read-only’ as far as the flow is concerned. Although the table data is not actually static, the flow does not change it, and thousands of messages pass through the flow before there is any change to the table data.

An example is a table which contains a day’s credit card transactions. The table is created each day and that day’s messages are run against it. Then the flow is stopped, the table updated and the next day’s messages run. These flows might perform better if they cache the table data rather than read it from a database for each message.

Another use of these data types might be the accumulation and integration of data from multiple messages.

Broker properties

For each broker, WebSphere Message Broker maintains a set of properties. You can access some of these properties from your ESQL programs. A subset of the properties is also accessible from Java code. It can be useful, during the runtime of your code, to have real-time access to details of a specific node, flow, or broker.

Four categories of broker properties exist.

- Properties relating to a specific node
- Properties relating to nodes in general
- Properties relating to a message flow
- Properties relating to the execution group

For a description of the broker, flow, and node properties that are accessible from ESQL and Java, see “Broker properties that are accessible from ESQL and Java” on page 1663.

Broker properties have the following characteristics.

- They are grouped by broker, execution group, flow, and node.
- They are case sensitive. Their names always start with an uppercase letter.
- They return NULL if they do not contain a value.

All nodes that allow user programs to edit ESQL support access to broker properties. These nodes are:

- Compute nodes
- Database nodes
- Filter nodes
- All derivatives of these nodes

User-defined properties can be queried, discovered, and set at run time to dynamically change the behavior of a message flow. You can use the Configuration Manager Proxy (CMP) API to manipulate these properties, which can be used by a systems monitoring tool to perform automated actions in response to situations that it detects in the monitored systems. For more information, see “User-defined properties” on page 111.

A *complex property* is a property to which you can assign multiple values. Complex properties are displayed in a table in the Properties view, where you can add, edit, and delete values, and change the order of the values in the table. You cannot promote complex properties; therefore, they do not appear in the Promote properties dialog box. Nor can you configure complex properties; therefore, they are not supported in the Broker Archive editor. For an example of a complex property, see the Query elements property of the DatabaseRoute node.

For more information about editing a node's properties, see "Configuring a message flow node" on page 235.

ESQL field references

An ESQL field reference is a sequence of period-separated values that identify a specific field (which might be a structure) within a message tree or a database table. The path from the root of the information to the specific field is traced using the parent/child relationships.

A field reference is used in an ESQL statement to identify the field that is to be referenced, updated, or created within the message or database table. For example, you might use the following identifier as a message field reference:

```
Body.Invoice.Payment
```

You can use an ESQL variable of type REFERENCE to set up a dynamic pointer to contain a field reference. This might be useful in creating a fixed reference to a commonly-referenced point within a message; for example the start of a particular structure that contains repeating fields.

A field reference can also specify element types, XML namespace identifications, indexes and a type constraint. These are discussed in detail later.

The first name in a field reference is sometimes known as a *Correlation name*.

ESQL operators

An ESQL operator is a character or symbol that you can use in expressions to specify relationships between fields or values.

ESQL supports the following groups of operators:

- Comparison operators, to compare one value to another value (for example, less than). Refer to "ESQL simple comparison operators" on page 1472 for details of the supported operators and their use.
- Logical operators, to perform logical operations on one or two terms (for example, AND). Refer to "ESQL logical operators" on page 1476 for details of the supported operators and their use.
- Numeric operators, to indicate operations on numeric data (for example, +). Refer to "ESQL numeric operators" on page 1477 for details of the supported operators and their use.

There are some restrictions on the application of some operators to data types; not all lead to a meaningful operation. These are documented where they apply to each operator.

Operators that return a Boolean value (TRUE or FALSE), for example the greater than operator, are also known as predicates.

ESQL statements

An ESQL statement is an instruction that represents a step in a sequence of actions or a set of declarations.

ESQL provides a large number of different statements that perform different types of operation. All ESQL statements start with a keyword that identifies the type of statement and end with a semicolon. An ESQL program consists of a number of statements that are processed in the order they are written.

As an example, consider the following ESQL program:

```
DECLARE x INTEGER;  
SET x = 42;
```

This program consists of two statements. The first starts with the keyword DECLARE and ends at the first semicolon. The second statement starts with the keyword SET and ends at the second semicolon. These two statements are written on separate lines and it is conventional (but not required) that they be so. You will notice that the language keywords are written in capital letters. This is also the convention but is not required; mixed and lower case are acceptable.

The first statement declares a variable called x of type INTEGER, that is, it reserves a space in the computer's memory large enough to hold an integer value and allows this space to be subsequently referred to in the program by the name x. The second statement sets the value of the variable x to 42. A number appearing in an ESQL program without decimal point and not within quotes is known as an integer literal.

ESQL has a number of data types and each has its own way of writing literal values. These are described in "ESQL data types" on page 259.

For a full description of all the ESQL statements, see "ESQL statements" on page 1478.

ESQL nested statements: An ESQL nested statement is a statement that is contained within another statement.

Consider the following ESQL program fragment:

```
IF Size > 100.00 THEN  
  SET X = 0;  
  SET Y = 0;  
  SET REVERSE = FALSE;  
ELSE  
  SET X = 639;  
  SET Y = 479;  
  SET REVERSE = TRUE;  
END IF;
```

In this example, you can see a single IF statement containing the optional ELSE clause. Both the IF and ELSE portions contain three nested statements. Those within the IF clause are executed if the operator > (greater than) returns the value TRUE (that is, if Size has a value greater than 100.00); otherwise, those within the ELSE clause are processed.

Many statements can have expressions nested within them, but only a few can have statements nested within them. The key difference between an expression and

a statement is that an expression calculates a value to be used, whereas a statement performs an action (usually changing the state of the program) but does not produce a value.

ESQL functions

A function is an ESQL construct that calculates a value from a number of given input values.

A function usually has input parameters and can, but does not usually have, output parameters. It returns a value calculated by the algorithm described by its statement. This statement is usually a compound statement, such as BEGIN... END, because this allows an unlimited number of nested statements to be used to implement the algorithm.

ESQL provides a number of predefined, or “built-in”, functions which you can use freely within expressions. You can also use the CREATE FUNCTION statement to define your own functions.

When you define a function, you must give it a unique name. The name is handled in a case insensitive way (that is, use of the name with any combination of upper and lower case letters matches the declaration). This is in contrast to the names that you declare for schemas, constants, variables, and labels, which are handled in a case sensitive way, and which you must specify exactly as you declared them.

Consider the following ESQL program fragment:

```
SET Diameter = SQRT(Area / 3.142) * 2;
```

In this example, the function SQRT (square root) is given the value inside the brackets (itself the result of an expression, a divide operation) and its result is used in a further expression, a multiply operation. Its return value is assigned to the variable Diameter. See “Calling ESQL functions” on page 1567 for information about all the built-in ESQL functions.

In addition, an ESQL expression can refer to a function in another broker schema (that is, a function defined by a CREATE FUNCTION statement in an ESQL file in the same or in a different dependent project). To resolve the name of the called function, you must do one of the following:

- Specify the fully-qualified name (<SchemaName>.<FunctionName>) of the called function.
- Include a PATH statement to make all functions from the named schema visible. Note that this technique only works if the schemas do not contain identically-named functions. The PATH statement must be coded in the same ESQL file, but not within any MODULE.

Note that you cannot define a function within an EVAL statement or an EVAL function.

ESQL procedures

An procedure is a subroutine that has no return value. It can accept input parameters from, and return output parameters to, the caller.

Procedures are very similar to functions. The main difference between them is that, unlike functions, procedures have no return value. Thus they cannot form part of an expression and are invoked by using the CALL statement. Procedures commonly have output parameters

You can implement a procedure in ESQL (an internal procedure) or as a database stored procedure (an external procedure). The ESQL procedure must be a single ESQL statement, although that statement can be a compound statement such as BEGIN END. You cannot define a procedure within an EVAL statement or an EVAL function.

When you define a procedure, give it a name. The name is handled in a case insensitive way (that is, use of the name with any combination of upper and lower case letters matches the declaration). That is in contrast to the names that you declare for schemas, constants, variables, and labels, which are handled in a case sensitive way, and which you must specify exactly as you declared them.

An ESQL expression can include a reference to a procedure in another broker schema (defined in an ESQL file in the same or a different dependent project). If you want to use this technique, either fully qualify the procedure, or include a PATH statement that sets the qualifier. The PATH statement must be coded in the same ESQL file, but not within a MODULE.

An external database procedure is indicated by the keyword EXTERNAL and the external procedure name. This procedure must be defined in the database and in the broker, and the name specified with the EXTERNAL keyword and the name of the stored database procedure must be the same, although parameter names do not have to match. The ESQL procedure name can be different to the external name it defines.

Overloaded procedures are not supported to any database. (An overloaded procedure is one that has the same name as another procedure in the same database schema which has a different number of parameters, or parameters with different types.) If the broker detects that a procedure has been overloaded, it raises an exception.

Dynamic schema name resolution for stored procedures is supported; when you define the procedure you must specify a wildcard for the schema that is resolved before invocation of the procedure by ESQL. This is explained further in “Invoking stored procedures” on page 332.

ESQL modules

A module is a sequence of declarations that define variables and their initialization, and a sequence of subroutine (function and procedure) declarations that define a specific behavior for a message flow node.

A module must begin with the CREATE node_type MODULE statement and end with an END MODULE statement. The node_type must be one of COMPUTE, DATABASE, or FILTER. The entry point of the ESQL code is the function named MAIN, which has MODULE scope.

Each module is identified by a name which follows CREATE node_type MODULE. The name might be created for you with a default value, which you can modify, or you can create it yourself. The name is handled in a case insensitive way (that is, use of the name with any combination of upper and lower case letters matches the declaration). That is in contrast to the names that you declare for schemas,

constants, variables, and labels, which are handled in a case sensitive way, and which you must specify exactly as you declared them.

You must create the code for a module in an ESQL file which has a suffix of `.esql`. You must create this file in the same broker schema as the node that references it. There must be one module of the correct type for each corresponding node, and it is specific to that node and cannot be used by any other node.

When you create an ESQL file (or complete a task that creates one), you indicate the message flow project and broker schema with which the file is associated as well as specifying the name for the file.

Within the ESQL file, the name of each module is determined by the value of the corresponding property of the message flow node. For example, the property *ESQL Module* for the Compute node specifies the name of the node's module in the ESQL file. The default value for this property is the name of the node. You can specify a different name, but you must ensure that the value of the property and the name of the module that provides the required function are the same.

The module must contain the function `MAIN`, which is the entry point for the module. This is included automatically if the module is created for you. Within `MAIN`, you can code ESQL to configure the behavior of the node. If you include ESQL within the module that declares variables, constants, functions, and procedures, these are of local scope only and can be used within this single module.

If you want to reuse ESQL constants, functions, or procedures, you must declare them at broker schema level. You can then refer to these from any resource within that broker schema, in the same or another project. If you want to use this technique, either fully qualify the procedure, or include a `PATH` statement that sets the qualifier. The `PATH` statement must be coded in the same ESQL file, but not within any `MODULE`.

Managing ESQL files

Within a message flow project, you can create ESQL files to contain the ESQL code that you provide to modify or customize the behavior of Compute, Database, or Filter nodes.

The ESQL code is contained within a module that is associated with the node. Each module must be created within an ESQL file. The name of the module within the ESQL file must match the name specified for the module in the *ESQL Module* property of the corresponding node. Although you can modify the module name, and change it from its default value (which is the name of the message flow, concatenated with the name of the node with which the module is associated), ensure that the module in the ESQL file matches the node property.

The following topics describe how you can manage these files:

- “Creating an ESQL file” on page 269
- “Opening an existing ESQL file” on page 270
- “Creating ESQL for a node” on page 271
- “Modifying ESQL for a node” on page 273
- “Saving an ESQL file” on page 274
- “Copying an ESQL file” on page 275
- “Renaming an ESQL file” on page 276
- “Moving an ESQL file” on page 277

- “Changing ESQL preferences” on page 277
- “Deleting ESQL for a node” on page 279
- “Deleting an ESQL file” on page 279

Creating an ESQL file

When you include a node in your message flow that requires ESQL to customize its function (the Compute, Database, and Filter nodes), you must code the ESQL statements that provide the customization in an ESQL module within an ESQL file. You can use the same ESQL file for more than one module, if you choose.

Before you start

To complete this task, you must have completed the following task:

- “Creating a message flow project” on page 215

ESQL files are stored in a file system or in a shared repository. If you are using a file system, this can be the local file system or a shared drive. If you store files in a repository, you can use any of the available repositories that are supported by Eclipse, for example CVS.

To create an ESQL file:

1. Switch to the Broker Application Development perspective.
2. Click **File** → **New** → **Message Flow ESQL File**.

You can also press Ctrl+N. This displays a dialog box that allows you to select the wizard to create a new object. Click Message Brokers in the left view; the right view displays a list of objects that you can create for WebSphere Message Broker. Click Message Flow ESQL File in the right view, then click **Next**. The New Message Flow ESQL File wizard is displayed.

3. Enter the name of the message flow project in which to create the ESQL file. You must enter the name of an existing message flow project. The dialog box is displayed with the current project name entered in the project name field. You can accept this value or change it to specify a different project. You can also click **Browse** to view a list of valid projects (projects that are defined and displayed in the Navigator view), and select the appropriate value from that list. The list is filtered to only show projects in the active working set.

If you type in the name of a project that does not exist, the error message The specified project does not exist is displayed in the dialog box and you cannot continue until you specify a valid project name.

4. If you want the ESQL file to be defined within a specific broker schema, enter the name of the broker schema in the appropriate entry field, or click **Browse** to select the broker schema from the list of valid broker schema for this project. (If only the default broker schema is defined in this project, **Browse** is disabled.)
5. Enter a name for the new ESQL file. If you enter a name that is already in use for an ESQL file in this project, the error message The resource <name>.esql already exists is displayed in the dialog box and you cannot continue until you specify a valid name.

When creating ESQL files, the overall file path length must not exceed 256 characters, due to a Windows file system limitation. If you try to add a message flow to a broker archive file with ESQL or mapping files with a path length that exceeds 256 characters, the compiled message flow will not be

generated and cannot be deployed. Therefore, make sure that the names of your ESQL files, mapping files, projects, and broker schema are as short as possible.

An ESQL file can also be created automatically for you. If you select **Open ESQL** from the menu displayed when you right-click a Compute, Database, or Filter node, and the module identified by the appropriate property does not already exist within the broker schema, a module is automatically created for you. This is created in the file `<message_flow_name>.esql` in the same broker schema within the same project as the `<message_flow_name>.msgflow` file. If that ESQL file does not already exist, that is also created for you.

The contents of a single ESQL file do not have any specific relationship with message flows and nodes. It is your decision which modules are created in which files (unless the specified module, identified by the appropriate property, is created by default in the file `<message_flow_name>.esql` as described above). Monitor the size and complexity of the ESQL within each file, and split the file if it becomes difficult to view or manage.

If you create reusable subroutines (at broker schema level) within an ESQL file, you might want to refer to these routines from ESQL modules in another project. To do this, specify that the project that wants to invoke the subroutines depends on the project in which the ESQL file containing them is defined. You can specify this when you create the second project, or you can update project dependencies by selecting the project, clicking **Properties**, and updating the dependencies in the Project Reference page of the Properties dialog box.

Opening an existing ESQL file

You can add to and modify ESQL code that you have created in an ESQL file in a message flow project.

Before you start

To complete this task, you must have completed the following task:

- “Creating an ESQL file” on page 269

To open an existing ESQL file:

1. Switch to the Broker Application Development perspective.
2. In the Broker Development view, double-click the ESQL file that you want to open. The file is opened in the editor view.
3. Work with the contents of file to make your changes. The file can contain modules relating to specific nodes in a message flow, PATH statements, and declarations at broker schema level such as reusable constants and procedures. Scroll through the file to find the specific content that you want to work with.
4. You can select the content that you want to work with by selecting its name in the Outline view. The code for the selected resource is highlighted.

You can also open an ESQL file when you have a message flow open in the editor view by selecting an appropriate node (of type Compute, Database, or Filter), right-clicking, and selecting **Open ESQL**. In this case, the ESQL file that contains this module is opened, and the module for the selected node is highlighted in the editor view.

Creating ESQL for a node

Create ESQL to customize the behavior of a Compute, Database, or Filter node within an ESQL file.

Before you start

Complete the following task:

- “Creating an ESQL file” on page 269

Within the ESQL file, create a module that is associated with a node in your message flow. A module can be associated with only one node of a particular type (Compute, Database, or Filter). Within the module you can create and use functions and procedures as well as the supplied statements and functions. You can also create local constants and variables.

If you have created constants, functions, or procedures at the broker schema level, you can also refer to these within the module. You can define routines at a level at which many different modules can use them, which can save you development time and maintenance effort.

To create ESQL for a node:

1. Switch to the Broker Application Development perspective.
2. In the Broker Development view, double-click the message flow that includes the node for which you want to create ESQL. The message flow opens in the editor view.
3. Right-click the node (which must be Compute, Database, or Filter) and then click **Open ESQL**. The default ESQL file for this message flow, *message_flow_name.esql*, is opened in the editor view. The file is created if it does not already exist.

If you have already created the file, it is opened in the editor view and a new module is created and highlighted. If the file is created for you, it contains a skeleton module for this node at the end. Its exact content depends on the type of node.

The following module is created for a Compute node:

```
CREATE COMPUTE MODULE module_name
  CREATE FUNCTION Main() RETURNS BOOLEAN
  BEGIN
    -- CALL CopyMessageHeaders();
    -- CALL CopyEntireMessage();
    RETURN TRUE;
  END;

  CREATE PROCEDURE CopyMessageHeaders() BEGIN
    DECLARE I INTEGER 1;
    DECLARE J INTEGER CARDINALITY(InputRoot.*[]);
    WHILE I < J DO
      SET OutputRoot.*[I] = InputRoot.*[I];
      SET I = I + 1;
    END WHILE;
  END;

  CREATE PROCEDURE CopyEntireMessage() BEGIN
    SET OutputRoot = InputRoot;
  END;
END MODULE;
```

The module name is determined by the value that you have set for the corresponding node property. The default is *message_flow_name_node_type*. The Main function contains calls to two procedures, described below, that are declared within the Compute node module following the function Main. These calls are commented out. If you want to include the function that they provide, uncomment the lines and place them at the appropriate point in the ESQL that you create for Main.

CopyMessageHeaders

This procedure loops through the headers contained in the input message and copies each one to the output message.

CopyEntireMessage

This procedure copies the entire contents of the input message, including the headers, to the output message.

If you create an ESQL module for a Database node, the following module is created:

```
CREATE DATABASE MODULE module_name
  CREATE FUNCTION Main() RETURNS BOOLEAN
  BEGIN
    RETURN TRUE;
  END;
END MODULE;
```

For a Filter node, the module is identical to that created for the Database node except for the first line, which reads:

```
CREATE FILTER MODULE module_name
```

4. Add ESQL to this file to customize the behavior of the node.

Start by adding ESQL statements within the Main function, that is after the BEGIN statement, and before RETURN TRUE. You can add DECLARE statements within the module that are not within the Main function. To add a new line into the file, press Enter.

To help you to code valid ESQL, the editor displays a list of valid statements and functions at the point of the cursor. To invoke this assistance, click **Edit** → **Content Assist**. On some systems, you can use the key combination Ctrl+Space. Scroll through the list displayed to find and highlight the one that you want, and press Enter. The appropriate code is inserted into your module, and the list disappears.

Content assistance is provided in the following areas:

- Applicable keywords, based on language syntax.
- Blocks of code that go together, such as BEGIN END;.
- Constants that you have defined, identifiers, labels, functions, and procedures that can be used, where the routines can be in any projects, even if the current project does not reference them.
- Database schema and table names after the database correlation name, as well as table column names in INSERT, UPDATE, DELETE, and SELECT statements, and, in most cases, the WHERE clauses of those statements.
- Elements of message field reference: runtime domain (parser) names, format of type expression, namespace identifiers, namespace-qualified element and attribute names, and format of index expression.
- Content in the Properties folder under the output message root.

- For the DECLARE NAMESPACE statement, target namespaces of message sets and schema names.

Content assistance works only if the ESQL can be parsed correctly. Errors such as END missing after BEGIN, and other unterminated block statements, cause parser failures and no content assistance is provided. Try content assistance in other areas around the statement where it does not work to narrow down the point of error. Alternatively, save the ESQL file; saving the file causes validation and all syntax errors are written to the Tasks view. Refer to the errors reported to understand and correct the ESQL syntax. If you use content assistance to generate most statements (such as block statements), these are correctly entered and there is less opportunity for error.

5. When you have finished working with this module, you can close the ESQL file. Save the file before you close it to retain all your changes and validate your ESQL.

If you prefer, you can open the ESQL file directly and create the module within that file using the editor. To do this:

1. Switch to the Broker Application Development perspective.
2. Select the ESQL file in which you want to create the module. Either double-click to open this file in the editor view, or right-click and click **Open**.
3. In the editor view, position your cursor on a new line and use content assistance to select the appropriate module skeleton for this type of node, for example CREATE COMPUTE MODULE END MODULE;. You can type this in yourself if you prefer, but you must ensure that what you type is consistent with the required skeleton, shown above. Use content assistance to give you additional help by inserting only valid ESQL, and by inserting matching end statements (for example, END MODULE;) where these are required.
4. Complete the coding of the module as appropriate.

Whichever method you use to open the ESQL file, be aware that the editor provides functions to help you to code ESQL. This section refers to content assistance; other functions are available. For information about these functions, see ESQL editor.

Modifying ESQL for a node

If you want to change the customization of a node that requires ESQL (Compute, Database, or Filter), you can modify the ESQL statements within the module that you created for that node.

Before you start

To complete this task, you must have completed the following task:

- “Creating ESQL for a node” on page 271

To modify ESQL code:

1. Switch to the Broker Application Development perspective.
2. In the Broker Development view, select the message flow that you want to work with and double-click it. The message flow is opened in the editor view.
3. Right-click the node corresponding to the ESQL module that you want to modify and click **Open ESQL**. The ESQL file is opened in the editor view. The module for this node is highlighted.
4. Make the changes that you want in the module, by entering new statements (remember that you can use Content Assist, available from the Edit menu or, on

some systems, by pressing Ctrl+Space), changing existing statements by overtyping, or deleting statements using the Delete or backspace keys. Note that, to get Content Assist to work with message references, you must set up a project reference from the project containing the ESQL to the project containing the message set. For information about setting up a project reference, see Project references.

5. You can change the name of the module that you are working with, by over-typing the current name with the new one. Remember that, if you do that, you must also change the node property *ESQL Module* to reflect the new name to ensure that the correct ESQL code is deployed with the node.
6. When you have finished working with this module, you can close the ESQL file. Save the file before you close it to retain all your changes and validate your ESQL.

If you prefer, you can open the ESQL file directly by double-clicking it in the Broker Development view. You can select the module that you want to work with from the Outline view.

The editor provides functions that you can use to help you modify your ESQL code. These functions are described in ESQL editor.

You can also modify the ESQL source by selecting **Source** → **Format**. This option formats all selected lines of code (unless only partially selected, when they are ignored), or, if no lines are selected, formats the entire file (correcting alignments and indentation).

Adding comments to ESQL:

You can add comments to and remove comments from your ESQL code:

1. To change an existing line of code into a comment line, click **Source** → **Comment**.
2. To change a comment line to a code line, click **Source** → **Uncomment**.
3. To create a new comment line, press Enter to create a new line and either type the comment identifier `--` or click **Source** → **Comment**. You can enter any text after the identifier: everything you type is ignored by the ESQL editor.

Saving an ESQL file

When you edit your ESQL file, you can save it both to preserve the additions and modifications that you have made and to force the editor to validate the file's content.

Before you start

To complete this task, you must have completed the following task:

- “Creating an ESQL file” on page 269

To save an ESQL file:

1. Switch to the Broker Application Development perspective.
2. Create a new ESQL file or open an existing ESQL file.
3. Make the changes to the contents of the ESQL file.
4. When you have finished working, save the file to retain all your changes by clicking **File** → **Save <filename>.esql** or **File** → **Save All** (the menu always shows the current filename correctly).

When you save the file, the validator is invoked by the editor to check that the ESQL obeys all grammar and syntax rules (specified by the syntax diagrams and explanations in “ESQL reference” on page 1451).

You can request additional validation when you set ESQL preferences. Click **Window** → **Preferences**. The Preferences dialog is displayed:

5. Expand the item for ESQL and Mapping on the left and click Validation. You can choose a value of warning (the default), error, or ignore for the following four categories of error:
 - a. Unresolved identifiers
 - b. Message references do not match message definitions
 - c. Database references do not match database schema
 - d. Use of deprecated keywords

Validating message definitions can impact response times in the editor, particularly if you have complicated ESQL that makes many references to a complex message definition. You might choose to delay this validation. Invoke validation when you have finished developing the message flow and are about to deploy it, to avoid runtime errors. For each error found, the editor writes an entry in the Tasks view, providing both the code line number and the reason for the error.

6. If you double-click the error, the editor positions your cursor on the line in which it found that error. The line is also highlighted by the error icon  in the margin to the left.

The editor might also find potential error situations, that it highlights as

warnings (with the warning icon ), which it also writes to the tasks view. For example, you might have included a BROKER SCHEMA statement that references an invalid schema (namespace).

Check your code, and make the corrections required by that statement or function.

Save As:

You can save a copy of this ESQL file by using **File** → **Save As...**

1. Click **File** → **Save <name> As...**
2. Specify the message flow project in which you want to save a copy of the ESQL file. The project name defaults to the current project. You can accept this name, or choose another name from the valid options that are displayed in the File Save dialog.
3. Specify the name for the new copy of the ESQL file. If you want to save this ESQL file in the same project, you must either give it another name, or confirm that you want to overwrite the current copy (that is, copy the file to itself).

If you want to save this ESQL file in another project, the project must already exist (you can only select from the list of existing projects). You can save the file with the same or another name in another project.
4. Click **OK**. The message flow is saved and the message flow editor validates its contents. The editor provides a report of any errors that it finds in the Tasks view.

Copying an ESQL file

You might find it useful to copy an ESQL file as a starting point for a new ESQL file that has similar function.

Before you start

To complete this task, you must have completed the following task:

- “Creating an ESQL file” on page 269

To copy an ESQL file:

1. Switch to the Broker Application Development perspective.
2. In the Broker Development view, select the ESQL file (<message_flow_name>.esql) that you want to copy. Right-click the file and click **Copy** from the menu.
3. Right-click the broker schema within the message flow project to which you want to copy the ESQL file and click **Paste**. You can copy the ESQL file to the same broker schema within the same message flow project, or to a different broker schema within the same message flow project, or to a broker schema in a different message flow project.

When you copy an ESQL file, the associated files (message flow, and mapping if present) are not automatically copied to the same target message flow project. If you want these files copied as well, you must do this explicitly following this procedure.

If you want to use this ESQL file with another message flow, ensure that the modules within the ESQL file match the nodes that you have in the message flow, and that the node properties are set correctly.

You can also use **File** → **Save As** to copy an ESQL file. This is described in “Saving an ESQL file” on page 274.

Renaming an ESQL file

You can rename an ESQL file within the message flow project. You might want to do this, for example, if you have renamed the message flow with which it is associated.

Before you start

To complete this task, you must have completed the following task:

- “Creating an ESQL file” on page 269

To rename an ESQL file:

1. Switch to the Broker Application Development perspective.
2. In the Broker Development view, right-click the ESQL file that you want to rename. Its default name is <message_flow_name>.esql. Click **Rename** or click **File** → **Rename**. If you have selected the ESQL file, you can press F2. The Rename Resource dialog is displayed.
3. Enter the new name for the ESQL file. Click **OK** to complete the action, or **Cancel** to cancel the request. If you click **OK**, the ESQL file is renamed.

When the rename is done, any references that you have to this ESQL file are no longer valid and you must correct them. If you are unsure where the references are, click **File** → **Save All**. This saves and validates all resources. Unresolved references are listed in the Tasks view, and you can click each error listed to locate and update the references.

Moving an ESQL file

If you move a message flow from one broker schema to another, or from one project to another, you might want to move any ESQL file that is associated with that message flow.

Before you start

To complete this task, you must have completed the following task:

- “Creating an ESQL file” on page 269



To move an ESQL file:

1. Switch to the Broker Application Development perspective.
2. Move the ESQL file in one of the following ways:
 - a. Drag and drop the ESQL file that you want to move from its current location to a broker schema within the same or another message flow project.

If the target location that you have chosen is not valid (for example, if an ESQL file of this name already exists in the broker schema), the invalid icon is displayed and the move is not completed.
 - b. Right-click the ESQL file and click **Move**, or click **File** → **Move**. The Move dialog is displayed.

Select the project and the broker schema from the list of valid targets that is shown in the dialog.

Click **OK** to complete the move, or **Cancel** to cancel the request.

If you click **OK**, the ESQL file is moved to its new location.
3. Check the Tasks view for any errors (indicated by the error icon ) or warnings (indicated by the warning icon ) generated by the move.

The errors in the Tasks view include those caused by broken references. When the move is completed, all references to this ESQL file are checked. If you have moved the file within the same named broker schema within the same message flow project, all references are still valid. If you have moved the file to another broker schema in the same or another message flow project, the references are broken. If you have moved the file to the same named broker schema in another message flow project, the references might be broken if the project references are not set correctly to recognize external references in this file. These errors occur because resources are linked by a fully-qualified name.
4. Double-click each error or warning to correct it. This opens the message flow that has the error in the editor view and highlights the node in error.

When you move an ESQL file, its associated files (for example, the message flow file) are not automatically moved to the same target broker schema. You must move these files yourself.

Changing ESQL preferences

You can modify the way in which ESQL is displayed in the editor and validated by the editor:

- “Changing ESQL editor settings”
- “Changing ESQL validation settings” on page 278

Changing ESQL editor settings:

When you open an ESQL file in the editor view, you can tailor the editor appearance by changing editor settings.

To change ESQL editor settings:

1. Switch to the Broker Application Development perspective.
2. Click **Window** → **Preferences**. The Preferences dialog is displayed.
3. Expand the item for ESQL on the left and click ESQL Editor.
4. Update the settings available for tab width and colors:
 - Click the General tab to change the displayed tab width within the ESQL editor.
 - Click the Colors tab to change the color of the editor view background, and of the entities displayed in the editor view. These include comments and keywords within your ESQL code.
5. When you have completed your changes, click **Apply** to close the Preferences dialog, apply your changes and leave the Preferences dialog open. Click **OK** to apply your changes and close the dialog. Click **Cancel** to close the dialog and discard your changes.
6. If you want to return your ESQL editor settings to the initial values, click **Restore Defaults**. All values are reset to the original settings.

If you change the editor settings when you have an editor session active, the changes are implemented immediately. If you do not have an editor session open, you see the changes when you next edit an ESQL file.

To change font settings for the ESQL editor:

1. Click **Window** → **Preferences**. The Preferences dialog is displayed.
2. Expand the item for Workbench on the left of the Preferences dialog, and click Colors and Fonts.
3. Expand Basic in the Colors and Fonts tab
4. Select a font or text color option and click on **Change** . The Font dialog will be displayed.
5. When you have completed your changes, click **Apply** to close the Preferences dialog, apply your changes and leave the Preferences dialog open. Click **OK** to apply your changes and close the dialog. Click **Cancel** to close the dialog and discard your changes.
6. If you want to return your ESQL editor settings to the initial values, click **Restore Defaults**.

Changing ESQL validation settings:

You can specify the level of validation that the ESQL editor performs when you save a .esql file. If the validation you have requested results in warnings, you can deploy a bar file containing this message flow. However, if errors are reported, you cannot deploy the bar file.

To change ESQL validation settings:

1. Switch to the Broker Application Development perspective.
2. Click **Window** → **Preferences**. The Preferences dialog is displayed.
3. Expand the item for ESQL on the left and click Validation.
4. Update the settings for what is validated, and for what warnings or errors are reported. See ESQL editor for details of the settings and their values.

5. When you have completed your changes, click **Apply** to close the Preferences dialog, apply your changes and leave the Preferences dialog open. Click **OK** to apply your changes and close the dialog. Click **Cancel** to close the dialog and discard your changes.
6. If you want to return your ESQL editor preferences to the initial values, click **Restore Defaults**. All values are reset to the original settings.

If you make changes to the validation settings, the changes are implemented immediately for currently open edit sessions and for subsequent edit sessions.

Deleting ESQL for a node

If you delete a node from a message flow, you can delete the ESQL module that you created to customize its function.

Before you start

To complete this task, you must have completed the following task:

- “Creating ESQL for a node” on page 271

To delete ESQL code:

1. Switch to the Broker Application Development perspective.
2. Open the message flow that you want to work with by double-clicking it in the Broker Development view. The message flow is opened in the editor view.
3. Select the node for which you want to delete the ESQL module, right-click and click **Open ESQL**. The ESQL file is opened in the editor view, with the module for this node highlighted.
4. Press the Delete or backspace key to delete the whole module.
5. When you have finished working with this module, you can close the ESQL file. Save the file before you close it to retain all your changes. Save also validates your ESQL: see “Saving an ESQL file” on page 274.

If you prefer, you can open the ESQL file directly by double-clicking it in the Broker Development view. The ESQL file is opened in the editor view. Select the module that you want to delete from the Outline view and delete it as described above. You can also right-click on the module name in the Broker Development view (the modules in the ESQL file are visible if you expand the view of the file by clicking the + beside the file name) and click **Delete**.

Deleting an ESQL file

If you delete a message flow, or if you have deleted all the ESQL code in an ESQL file, you can delete the ESQL file.

Before you start

To complete this task, you must have completed the following task:

- “Creating an ESQL file” on page 269

To delete an ESQL file:

1. Switch to the Broker Application Development perspective.
2. Within the Broker Development view, right-click the ESQL file that you want to delete, and click **Delete**. A dialog is displayed that asks you to confirm the deletion.

You can also select the file in the Broker Development view, and click **Edit** → **Delete**. A dialog is displayed that asks you to confirm the deletion.

3. Click **Yes** to delete the file, or **No** to cancel the delete request.

If you maintain resources in a shared repository, a copy is retained in that repository. You can follow the instructions provided by the repository supplier to retrieve the file if required.

If you are using the local file system or a shared file system to store your resources, no copy of the file is retained. Be careful to select the correct file when you complete this task.

Writing ESQL

How you can use ESQL to customize nodes.

When you create a message flow, you include input nodes that receive the messages and, optionally, output nodes that send out new or updated messages. If required by the processing that must be performed on the message, you can include other nodes after the input node that complete the actions that your applications need.

Some of the built-in nodes enable you to customize the processing that they provide. The Compute, Database, and Filter nodes require you to provide a minimum level of ESQL, and you can provide much more than the minimum to control precisely the behavior of each node. This set of topics discusses ESQL and the ways in which you can use it to customize these nodes.

The DataDelete, DataInsert, DataUpdate, Extract, Mapping, and Warehouse nodes provide a mapping interface with which you can customize their function. The ways in which you can use the mapping functions associated with these nodes are described in developing message mappings, see “Developing message mappings” on page 472.

ESQL provides a rich and flexible syntax for statements and functions that enable you to check and manipulate message and database content. You can:

- Read the contents of the input message
- Modify message content with data from databases
- Modify database content with data from messages
- Construct new output messages created from all, part, or none of the input message (in the Compute node only)

The following topics provide more information about these and other tasks that you can perform with ESQL. Unless otherwise stated, these guidelines apply to messages in all message domains except the BLOB domain, for which you can implement a limited set of actions.

- “Tailoring ESQL code for different node types” on page 282
- “Manipulating message body content” on page 283
- “Manipulating other parts of the message tree” on page 303
- “Transforming from one data type to another” on page 314
- “Adding keywords to ESQL files” on page 322
- “Interaction with databases using ESQL” on page 322
- “Coding ESQL to handle errors” on page 334
- “Accessing broker properties from ESQL” on page 409
- “Configuring a message flow at deployment time using UDPs” on page 410

The following topics provide additional information specific to the parser that you have specified for the input message:

- “Manipulating messages in the MRM domain” on page 387
- “Manipulating messages in the XML domain” on page 387
- “Manipulating messages in the XMLNS domain” on page 378
- “Manipulating messages in the XMLNSC domain” on page 364
- “Manipulating messages in the JMS domains” on page 404
- “Manipulating messages in the IDOC domain” on page 404
- “Manipulating messages in the MIME domain” on page 405
- “Manipulating messages in the BLOB domain” on page 407

ESQL examples

Most of the examples included in the topics listed previously show parser-independent ESQL. If examples include a reference to MRM, they assume that you have modeled the message in the MRM and that you have set the names of the MRM objects to be identical to the names of the corresponding tags or attributes in the XML source message. Some examples are also shown for the XML domain. Unless stated otherwise, the principals illustrated are the same for all message domains. For domain-specific information, use the appropriate link in the previous list.

Most of the topics that include example ESQL use the ESQL sample message, *Invoice*, as the input message to the logic. This message is provided in XML source format (with tags and attributes), see “Example message” on page 1671. The example message is shown in the following diagram.

The topics specific to the MRM domain use the message that is created in the following sample:

- Video Rental sample

You can view samples only when you use the information center that is integrated with the Message Broker Toolkit.

A few other input messages are used to show ESQL that provides function on messages with a structure or content that is not included in the *Invoice* or *Video* samples. Where this occurs, the input message is included in the topic that refers to it.

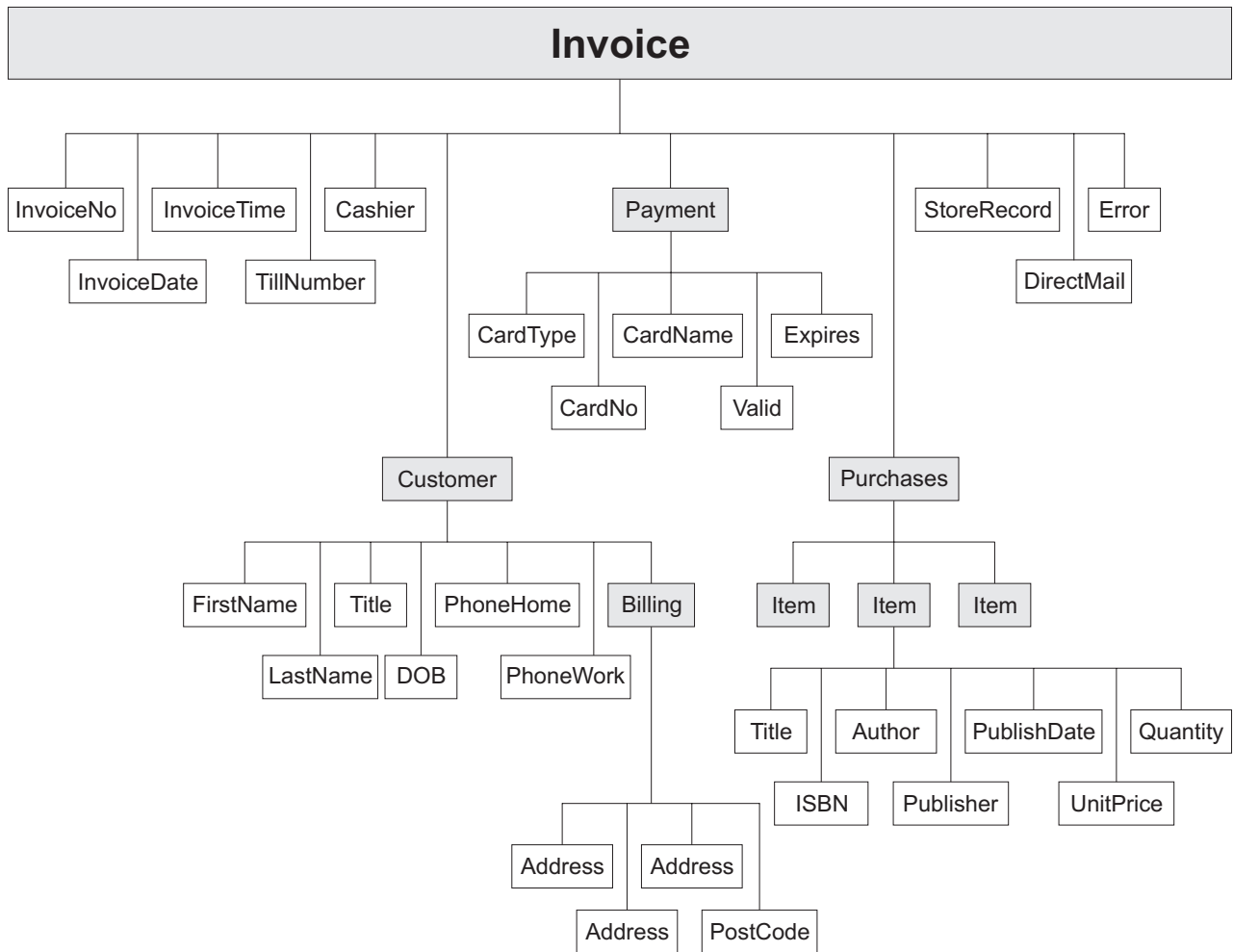

Tailoring ESQL code for different node types

When you code ESQL to configure Compute, Database, and Filter node behavior, be aware of the limitations of each type of node:

Compute node

You can configure the Compute node to do any of the following operations:

- Update data in a database.
- Insert data into a database.
- Delete data from a database.
- Update the Environment tree.
- Update the LocalEnvironment tree.
- Create one or more output messages, with none, some, or all the content of the input message, and propagate these new messages to the next node in the message flow.

If you want to propagate the input LocalEnvironment to the output LocalEnvironment, remember to set the Compute node property *Compute mode* to an appropriate value. The Environment is always propagated in the output message.

Database node

You can configure the Database node to do any of the following operations:

- Update data in a database.
- Insert data into a database.
- Delete data from a database.
- Update the Environment tree.
- Update the LocalEnvironment tree.
- Propagate the input message to the next node in the message flow.

Filter node

You can configure the Filter node to do any of the following operations:

- Update data in a database.
- Insert data into a database.
- Delete data from a database.
- Update the Environment tree.
- Update the LocalEnvironment tree.
- Propagate the input message to the next node in the message flow (the terminal through which the message is propagated depends on the result of the filter expression).

View the remaining tasks in this section to find the details of how you can perform these operations.

Manipulating message body content

The message body is always the last child of root, and is identified by its parser name, for example XML or MRM.

The following topics describe how you can refer to, modify, and create message body data. The information provided here is domain independent.

- “Referencing field types”
- “Accessing elements in the message body” on page 284
- “Accessing known multiple occurrences of an element” on page 288
- “Accessing unknown multiple occurrences of an element” on page 289
- “Using anonymous field references” on page 290
- “Creating dynamic field references” on page 291
- “Creating new fields” on page 292
- “Generating multiple output messages” on page 294
- “Using numeric operators with datetime values” on page 295
- “Calculating a time interval” on page 296
- “Selecting a subfield from a larger field” on page 297
- “Copying repeating fields” on page 298
- “Manipulating repeating fields in a message tree” on page 302

Referencing field types:

Some message parsers have complex models in which it is not enough to identify a field simply by its name and an array subscript. In these cases, you associate an optional field type with an element of data in the tree format.

Each element within the parsed tree can be one of three types:

Name element

A name element has a string, which is the name of the element, associated with it. An example of a name element is `XMLElement`, described in “XML element” on page 1438.

Value element

A value element has a value associated with it. An example of a value element is `XMLContent`, described in “XML content” on page 1438.

Name-value element

A name-value element is an optimization of the case where a name element contains only a value element and nothing else. The element contains both a name and a value. An example of a name-value element is `XMLAttribute`, described in “XML attribute” on page 1436.

Accessing elements in the message body:

When you want to access the contents of a message, for reading or writing, use the structure and arrangement of the elements in the tree that is created by the parser from the input bit stream. Follow the relevant parent and child relationships from the top of the tree downwards, until you reach the required element.

- If you are referring to the input message tree to interrogate its content in a Compute node, use correlation name `InputBody` followed by the path to the element to which you are referring. `InputBody` is equivalent to `InputRoot` followed by the parser name (for example, `InputRoot.MRM`), which you can use if you prefer.
- If you are referring to the output message tree to set or modify its content in the Compute node, use correlation name `OutputRoot` followed by the parser name (for example, `OutputRoot.MRM`).
- If you are referring to the input message to interrogate its contents in a Database or Filter node, use correlation name `Body` to refer to the start of the message. `Body` is equivalent to `Root` followed by the parser name (for example, `Root.XMLNS`), which you can use if you prefer.

You must use these different correlation names because there is only one message to which to refer in a Database or Filter node; you cannot create a new output message in these nodes. Use a Compute node to create a new output message.

When you construct field references, the names that you use must be valid ESQL identifiers that conform to ESQL rules. If you enclose anything in double quotation marks, ESQL interprets it as an identifier. If you enclose anything in single quotation marks, ESQL interprets it as a character literal. You must enclose all strings (character strings, byte strings, or binary (bit) strings) in quotation marks, as shown in the examples below. To include a single or double quotation mark within a string, include two consecutive single or double quotation marks.

Important: For a full description of field reference syntax, see “ESQL field references” on page 1465.

For more information about ESQL data types, see “ESQL data types in message flows” on page 1452.

Assume that you have created a message flow that handles the message `Invoice`, shown in the figure in “Writing ESQL” on page 280. If, for example, you want to interrogate the element `CardType` from within a Compute node, use the following statement:

```
IF InputBody.Invoice.Payment.CardType='Visa' THEN
  DO;
  -- more ESQL --
END IF;
```

If you want to make the same test in a Database or Filter node (where the reference is to the single input message), code:

```
IF Body.Invoice.Payment.CardType='Visa' THEN
  DO;
  -- more ESQL --
END IF;
```

If you want to copy an element from an input XML message to an output message in the Compute node without changing it, use the following ESQL:

```
SET OutputRoot.XMLNS.Invoice.Customer.FirstName =
  InputBody.Invoice.Customer.FirstName;
```

If you want to copy an element from an input XML message to an output message and update it, for example by folding to uppercase or by calculating a new value, code:

```
SET OutputRoot.XMLNS.Invoice.Customer.FirstName =
  UPPER(InputBody.Invoice.Customer.FirstName);
SET OutputRoot.XMLNS.Invoice.InvoiceNo = InputBody.Invoice.InvoiceNo + 1000;
```

If you want to set a STRING element to a constant value, code:

```
SET OutputRoot.XMLNS.Invoice.Customer.Title = 'Mr';
```

You can also use the equivalent statement:

```
SET OutputRoot.XMLNS.Invoice.Customer.Title VALUE = 'Mr';
```

If you want to update an INTEGER or DECIMAL, for example the element `TillNumber`, with the value 26, use the following assignment (valid in the Compute node only):

```
SET OutputRoot.MRM.Invoice.TillNumber=26;
```

The integer data type stores numbers using the 64-bit twos complement form, allowing numbers in the range -9223372036854775808 to 9223372036854775807. You can specify hexadecimal notation for integers as well as normal integer literal format. The hexadecimal letters A to F can be written in upper or lower case, as can the X after the initial zero, which is required. The example below produces the same result as the example shown above:

```
SET OutputRoot.MRM.Invoice.TillNumber= 0x1A;
```

The following examples show SET statements for element types that do not appear in the example Invoice message.

To set a FLOAT element to a non-integer value, code:

```
SET OutputRoot.MRM.FloatElement1 = 1.2345e2;
```

To set a BINARY element to a constant value, code:

```
SET OutputRoot.MRM.BinaryElement1 = X'F1F1';
```

For BINARY values, you must use an initial character X (upper or lower case) and enclose the hexadecimal characters (also upper or lower case) in single quotation marks, as shown.

To set a BOOLEAN element to a constant value (the value 1 equates to true, 0 equates to false), code:

```
SET OutputRoot.MRM.BooleanElement1 = true;
```

or

```
SET OutputRoot.MRM.BooleanElement1 = 1;
```

You can use the SELECT statement to filter records from an input message without reformatting the records, and without any knowledge of the complete format of each record. Consider the following example:

```
-- Declare local variable
DECLARE CurrentCustomer CHAR 'Smith';

-- Loop through the input message
SET OutputRoot.XMLNS.Invoice[] =
  (SELECT I FROM InputRoot.XMLNS.Invoice[] AS I
   WHERE I.Customer.LastName = CurrentCustomer
  );
```

This writes all records from the input Invoice message to the output message if the WHERE condition (LastName = Smith) is met. All records that do not meet the condition are not copied from input to output. I is used as an alias for the correlation name InputRoot.XMLNS.Invoice[].

The declared variable CurrentCustomer is initialized on the DECLARE statement: this is the most efficient way of declaring a variable for which the initial value is known.

You can use this alias technique with other SELECT constructs. For example, if you want to select all the records of the input Invoice message, and create an additional record:

```
-- Loop through the input message
SET OutputRoot.XMLNS.Invoice[] =
  (SELECT I, 'Customer' || I.Customer.LastName AS ExtraField
   FROM InputRoot.XMLNS.Invoice[] AS I
  );
```

You could also include an AS clause to place records in a subfolder in the message tree:

```
-- Loop through the input message
SET OutputRoot.XMLNS.Invoice[] =
  (SELECT I AS Order
   FROM InputRoot.XMLNS.Invoice[] AS I
  );
```

If you are querying or setting elements that contain, or might contain, null values, be aware of the following considerations:

Querying null values

When you compare an element to the ESQL keyword NULL, this tests

whether the element is present in the logical tree that has been created from the input message by the parser.

For example, you can check if an invoice number is included in the current Invoice message with the following statement:

```
IF InputRoot.XMLNS.Invoice.InvoiceNo IS NULL THEN
  DO;
  -- more ESQL --
END IF;
```

You can also use an ESQL reference. The following example illustrates this.

```
DECLARE cursor REFERENCE TO InputRoot.MRM.InvoiceNo;

IF LASTMOVE(cursor) = FALSE THEN
  SET OutputRoot.MRM.Analysis = 'InvoiceNo does not exist in logical tree';
ELSEIF FIELDVALUE(cursor) IS NULL THEN
  SET OutputRoot.MRM.Analysis =
    'InvoiceNo does exist in logical tree but is defined as an MRM NULL value';
ELSE
  SET OutputRoot.MRM.Analysis = 'InvoiceNo does exist and has a value';
END IF;
```

For more information about declaring and using references, see “Creating dynamic field references” on page 291. For a description of the LASTMOVE and FIELDVALUE functions, see “LASTMOVE function” on page 1612 and “FIELDTYPE function” on page 1608.

If the message is in the MRM domain, there are additional considerations for querying null elements that depend on the physical format. For further details, see “Querying null values in a message in the MRM domain” on page 396.

Setting null values

There are two statements that you can use to set null values.

1. If you set the element to NULL using the following statement, the element is deleted from the message tree:

```
SET OutputRoot.XMLNS.Invoice.Customer.Title = NULL;
```

If the message is in the MRM domain, there are additional considerations for null values that depend on the physical format. For further details, see “Setting null values in a message in the MRM domain” on page 397.

This is called implicit null processing.

2. If you set the value of this element to NULL as follows:

```
SET OutputRoot.XMLNS.Invoice.Customer.Title VALUE = NULL;
```

the element is not deleted from the message tree. Instead, a special value of NULL is assigned to the element.

```
SET OutputRoot.XMLNS.Invoice.Customer.Title = NULL;
```

If the message is in the MRM domain, the content of the output bit stream depends on the settings of the physical format null handling properties. For further details, see “Setting null values in a message in the MRM domain” on page 397.

This is called explicit null processing.

If you set an MRM complex element or an XML, XMLNS, or JMS parent element to NULL without using the VALUE keyword, that element and all its children are deleted from the logical tree.

Accessing known multiple occurrences of an element:

When you refer to or create the content of messages, it is very likely that the data contains repeating fields. If you know how many instances there are of a repeating field, and you want to access a specific instance of such a field, you can use an array index as part of a field reference.

For example, you might want to filter on the first line of an address, to expedite the delivery of an order. Three instances of the element Billing.Address are always present in the sample message. To test the first line, write an expression such as:

```
IF Body.Invoice.Customer.Billing.Address[1] = 'Patent Office' THEN
  DO;
  -- more ESQL --
END IF;
```

The array index [1] indicates that it is the first instance of the repeating field that you are interested in (array indices start at 1). An array index such as this can be used at any point in a field reference, so you could, for example, filter on the following test:

```
IF Body.Invoice."Item"[1].Quantity > 2 THEN
  DO;
  -- more ESQL --
END IF;
```

You can refer to the last instance of a repeating field using the special [<] array index, and to instances relative to the last (for example, the second to last) as follows:

- Field[<] indicates the last element.
- Field[<1] indicates the last element.
- Field[<2] indicates the last but one element (the penultimate element).

You can also use the array index [>] to represent the first element, and elements relative to the first element in a similar way.

- Field[>] indicates the first element. This is equivalent to Field[1].

The following examples refer to the Invoice message using these indexes:

```
IF Body.Invoice.Customer.Billing.Address[<] = 'Hampshire' THEN
  DO;
  -- more ESQL --
END IF;
IF Body.Invoice.Customer.Billing.Address[<2 ] = 'Southampton' THEN
  DO;
  -- more ESQL --
END IF;
```

You can also use these special indexes for elements that repeat an unknown number of times.

Deleting repeating fields:

If you pass a message with several repeats of an element through a message flow and you want to delete some of the repeats, be aware that the numbering of the repeats is reordered after each delete. For example, if you have a message with five repeats of a particular element, and in the message flow you have the following ESQL:

```
SET OutputRoot.MRM.e_PersonName[1] = NULL;  
SET OutputRoot.MRM.e_PersonName[4] = NULL;
```

You might expect elements one and four to be deleted. However, because repeating elements are stored on a stack, when you delete one, the one above it takes its place. This means that, in the above example, elements one and five are deleted. To avoid this problem, delete in reverse order, that is, delete element four first, then delete element one.

Accessing unknown multiple occurrences of an element:

You are very likely to deal with messages that contain repeating fields with an unknown number of repeats. This is the situation with the `Item` field in the example message in “Example message” on page 1671.

To write a filter that takes into account all instances of the `Item` field, you need to use a construct that can iterate over all instances of a repeating field. The quantified predicate allows you to execute a predicate against all instances of a repeating field, and collate the results.

For example, you might want to verify that none of the items that are being ordered has a quantity greater than 50. To do this you could write:

```
FOR ALL Body.Invoice.Purchases."Item" []  
  AS I (I.Quantity <= 50)
```

With the quantified predicate, the first thing to note is the brackets `[]` on the end of the field reference after `FOR ALL`. These tell you that you are iterating over all instances of the `Item` field.

In some cases, this syntax appears unnecessary because you can get that information from the context, but it is done for consistency with other pieces of syntax.

The `AS` clause associates the name `I` with the current instance of the repeating field. This is similar to the concept of iterator classes used in some object oriented languages such as C++. The expression in parentheses is a predicate that is evaluated for each instance of the `Item` field.

A description of this example is:

Iterate over all instances of the field `Item` inside `Body.Invoice`. For each iteration:

1. Bind the name `I` to the current instance of `Item`.
2. Evaluate the predicate `I.Quantity <= 50`. If the predicate:
 - Evaluates to `TRUE` for all instances of `Item`, return `TRUE`.
 - Is `FALSE` for any instance of `Item`, return `FALSE`.
 - For a mixture of `TRUE` and `UNKNOWN`, return `UNKNOWN`.

The above is a description of how the predicate is evaluated if you use the ALL keyword. An alternative is to specify SOME, or ANY, which are equivalent. In this case the quantified predicate returns TRUE if the sub-predicate returns TRUE for any instance of the repeating field. Only if the sub-predicate returns FALSE for all instances of the repeating field does the quantified predicate return FALSE. If a mixture of FALSE and UNKNOWN values are returned from the sub-predicate, an overall value of UNKNOWN is returned.

In the following filter expression:

```
FOR ANY Body.Invoice.Purchases."Item" []
  AS I (I.Title = 'The XML Companion')
```

the sub-predicate evaluates to TRUE. However this next expression returns FALSE:

```
FOR ANY Body.Invoice.Purchases."Item" []
  AS I (I.Title = 'C Primer')
```

because the C Primer is not included on this invoice. If some of the items in the invoice do not include a book title field, the sub-predicate returns UNKNOWN, and the quantified predicate returns the value UNKNOWN.

To deal with the possibility of null values appearing, write this filter with an explicit check on the existence of the field, as follows:

```
FOR ANY Body.Invoice.Purchases."Item" []
  AS I (I.Book IS NOT NULL AND I.Book.Title = 'C Primer')
```

The predicate IS NOT NULL ensures that, if an Item field does not contain a Book, a FALSE value is returned from the sub-predicate.

You can also manipulate arbitrary repeats of fields within a message by using a SELECT expression, as described in “Referencing columns in a database” on page 324.

You can refer to the first and last instances of a repeating field using the [>] and [<] array indexes, and to instances relative to the first and last, even if you do not know how many instances there are. These indexes are described in “Accessing known multiple occurrences of an element” on page 288.

Alternatively, you can use the CARDINALITY function to determine how many instances of a repeating field there are. For example:

```
DECLARE I INTEGER CARDINALITY(Body.Invoice.Purchases."Item" [])
```

Using anonymous field references:

You can refer to the array of all children of a particular element by using a path element of *. So, for example:

```
InputRoot.*[]
```

is a path that identifies the array of all children of InputRoot. This is often used in conjunction with an array subscript to refer to a particular child of an entity by position, rather than by name. For example:

InputRoot.*[<]

Refers to the last child of the root of the input message, that is, the body of the message.

InputRoot.*[1]

Refers to the first child of the root of the input message, the message properties.

You might want to find out the name of an element that has been identified with a path of this kind. To do this, use the FIELDNAME function, which is described in "FIELDNAME function" on page 1607.

Creating dynamic field references:

You can use a variable of type REFERENCE as a dynamic reference to navigate a message tree. This acts in a similar way to a message cursor or a variable pointer. It is generally simpler and more efficient to use reference variables in preference to array indexes when you access repeating structures. Reference variables are accepted everywhere. Field references are accepted and come with a set of statements and functions to allow detailed manipulation of message trees.

You must declare a dynamic reference before you can use it. A dynamic reference is declared and initialized in a single statement. The following example shows how to create and use a reference.

```
-- Declare the dynamic reference
DECLARE myref REFERENCE TO OutputRoot.XMLNS.Invoice.Purchases.Item[1];

-- Continue processing for each item in the array
WHILE LASTMOVE(myref)=TRUE
DO
-- Add 1 to each item in the array
  SET myref = myref + 1;
-- Move the dynamic reference to the next item in the array
  MOVE myref NEXTSIBLING;
END WHILE;
```

This example declares a dynamic reference, *myref*, which points to the first item in the array within Purchases. The value in the first item is incremented by one, and the pointer (dynamic reference) is moved to the next item. Once again the item value is incremented by one. This process continues until the pointer moves outside the scope of the message array (all the items in this array have been processed) and the LASTMOVE function returns FALSE.

The examples below show further examples.

```
DECLARE ref1 REFERENCE TO InputBody.Invoice.Purchases.Item[1];

DECLARE ref2 REFERENCE TO
  InputBody.Invoice.Purchases.NonExistentField;

DECLARE scalar1 CHARACTER;
DECLARE ref3 REFERENCE TO scalar1;
```

In the second example, *ref2* is set to point to *InputBody* because the specified field does not exist.

With the exception of the MOVE statement, which changes the position of the dynamic reference, you can use a dynamic reference anywhere that you can use a static reference. The value of the dynamic reference in any expression or statement

is the value of the field or variable to which it currently points. For example, using the message in “Example message” on page 1671, the value of `Invoice.Customer.FirstName` is Andrew. If the dynamic reference `myref` is set to point at the `FirstName` field as follows:

```
DECLARE myref REFERENCE TO Invoice.Customer;
```

the value of `myref` is Andrew. You can extend this dynamic reference as follows:

```
SET myref.Billing.Address[1] = 'Oaklands';
```

This changes the address in the example to Oaklands Hursley Village Hampshire SO213JR.

The position of a dynamic reference remains fixed even if a tree is modified. To illustrate this point the steps that follow use the message in “Example message” on page 1671 as their input message and create a modified version of this message as an output message:

1. Copy the input message to the output message.
2. To modify the output message, first declare a dynamic reference `ref1` that points at the first item, The XML Companion.

```
DECLARE ref1 REFERENCE TO  
OutputRoot.XMLNS.Invoice.Purchases.Item[1];
```

The dynamic reference is now equivalent to the static reference `OutputRoot.XMLNS.Invoice.Purchases.Item[1]`.

3. Use a create statement to insert a new first item for this purchase.

```
CREATE PREVIOUSIBLING OF ref1 VALUES 'Item';
```

The dynamic reference is now equivalent to the static reference `OutputRoot.XMLNS.Invoice.Purchases.Item[2]`.

Creating new fields:

This topic provides example ESQL code for a Compute node that creates a new output message based on the input message, to which are added a number of additional fields.

The input message received by the Compute node within the message flow is an XML message, and has the following content:

```
<TestCase description="This is my TestCase">  
  <Identifier>ES03B305_T1</Identifier>  
  <Sport>Football</Sport>  
  <Date>01/02/2000</Date>  
  <Type>LEAGUE</Type>  
</TestCase>
```

The Compute node is configured and an ESQL module is created that includes the following ESQL. The code shown below copies the headers from the input message to the new output message, then creates the entire content of the output message body.

```

-- copy headers
DECLARE i INTEGER 1;
DECLARE numHeaders INTEGER CARDINALITY(InputRoot.*[]);

WHILE i < numHeaders DO
    SET OutputRoot.*[i] = InputRoot.*[i];
    SET i = i + 1;
END WHILE;

CREATE FIELD OutputRoot.XMLNS.TestCase.description TYPE NameValue VALUE 'This is my TestCase';
CREATE FIRSTCHILD OF OutputRoot.XMLNS.TestCase Domain('XMLNS') NAME 'Identifier'
    VALUE InputRoot.XMLNS.TestCase.Identifier;
CREATE LASTCHILD OF OutputRoot.XMLNS.TestCase Domain('XMLNS') NAME 'Sport'
    VALUE InputRoot.XMLNS.TestCase.Sport;
CREATE LASTCHILD OF OutputRoot.XMLNS.TestCase Domain('XMLNS') NAME 'Date'
    VALUE InputRoot.XMLNS.TestCase.Date;
CREATE LASTCHILD OF OutputRoot.XMLNS.TestCase Domain('XMLNS') NAME 'Type'
    VALUE InputRoot.XMLNS.TestCase.Type;
CREATE FIELD OutputRoot.XMLNS.TestCase.Division[1].Number TYPE NameValue
    VALUE 'Premiership';
CREATE FIELD OutputRoot.XMLNS.TestCase.Division[1].Result[1].Number TYPE NameValue VALUE '1';
CREATE FIELD OutputRoot.XMLNS.TestCase.Division[1].Result[1].Home TYPE Name;
CREATE LASTCHILD OF OutputRoot.XMLNS.TestCase.Division[1].Result[1].Home NAME 'Team'
    VALUE 'Liverpool' ;
CREATE LASTCHILD OF OutputRoot.XMLNS.TestCase.Division[1].Result[1].Home NAME 'Score'
    VALUE '4';
CREATE FIELD OutputRoot.XMLNS.TestCase.Division[1].Result[1].Away TYPE Name;
CREATE LASTCHILD OF OutputRoot.XMLNS.TestCase.Division[1].Result[1].Away NAME 'Team'
    VALUE 'Everton';
CREATE LASTCHILD OF OutputRoot.XMLNS.TestCase.Division[1].Result[1].Away NAME 'Score'
    VALUE '0';

CREATE FIELD OutputRoot.XMLNS.TestCase.Division[1].Result[2].Number TYPE NameValue VALUE '2';
CREATE FIELD OutputRoot.XMLNS.TestCase.Division[1].Result[2].Home TYPE Name;
CREATE LASTCHILD OF OutputRoot.XMLNS.TestCase.Division[1].Result[2].Home NAME 'Team'
    VALUE 'Manchester United';
CREATE LASTCHILD OF OutputRoot.XMLNS.TestCase.Division[1].Result[2].Home NAME 'Score'
    VALUE '2';
CREATE FIELD OutputRoot.XMLNS.TestCase.Division[1].Result[2].Away TYPE Name;
CREATE LASTCHILD OF OutputRoot.XMLNS.TestCase.Division[1].Result[2].Away NAME 'Team'
    VALUE 'Arsenal';
CREATE LASTCHILD OF OutputRoot.XMLNS.TestCase.Division[1].Result[2].Away NAME 'Score'
    VALUE '3';

CREATE FIELD OutputRoot.XMLNS.TestCase.Division[2].Number TYPE NameValue
    VALUE '2';
CREATE FIELD OutputRoot.XMLNS.TestCase.Division[2].Result[1].Number TYPE NameValue
    VALUE '1';
CREATE FIELD OutputRoot.XMLNS.TestCase.Division[2].Result[1].Home TYPE Name;
CREATE LASTCHILD OF OutputRoot.XMLNS.TestCase.Division[2].Result[1].Home NAME 'Team'
    VALUE 'Port Vale';
CREATE LASTCHILD OF OutputRoot.XMLNS.TestCase.Division[2].Result[1].Home NAME 'Score'
    VALUE '9' ;
CREATE FIELD OutputRoot.XMLNS.TestCase.Division[2].Result[1].Away TYPE Name;
CREATE LASTCHILD OF OutputRoot.XMLNS.TestCase.Division[2].Result[1].Away NAME 'Team'
    VALUE 'Brentford';
CREATE LASTCHILD OF OutputRoot.XMLNS.TestCase.Division[2].Result[1].Away NAME 'Score'
    VALUE '5';

```

The output message that results from the ESQL shown above has the following structure and content:

```

<TestCase description="This is my TestCase">
  <Identifier>ES03B305_T1</Identifier>
  <Sport>Football</Sport>
  <Date>01/02/2000</Date>
  <Type>LEAGUE</Type>
  <Division Number="Premiership">
    <Result Number="1">
      <Home>
        <Team>Liverpool</Team>
        <Score>4</Score>
      </Home>
      <Away>
        <Team>Everton</Team>
        <Score>0</Score>
      </Away>
    </Result>
    <Result Number="2">
      <Home>
        <Team>Manchester United</Team>
        <Score>2</Score>
      </Home>
      <Away>
        <Team>Arsenal</Team>
        <Score>3</Score>
      </Away>
    </Result>
  </Division>
  <Division Number="2">
    <Result Number="1">
      <Home>
        <Team>Port Vale</Team>
        <Score>9</Score>
      </Home>
      <Away>
        <Team>Brentford</Team>
        <Score>5</Score>
      </Away>
    </Result>
  </Division>
</TestCase>

```

Generating multiple output messages:

You can use the PROPAGATE statement to generate multiple output messages in the Compute node. The output messages that you generate can have the same or different content. You can also direct output messages to any of the four alternate output terminals of the Compute node, or to a Label node.

For example, if you want to create three copies of the input message received by the Compute node, and send one to the standard "Out" terminal of the Compute node, one to the first alternate "out1" terminal of the Compute node, and one to the Label node "ThirdCopy", code the following ESQL:

```

SET OutputRoot = InputRoot;
PROPAGATE;
SET OutputRoot = InputRoot;
PROPAGATE TO TERMINAL 'out1';
SET OutputRoot = InputRoot;
PROPAGATE TO LABEL 'ThirdCopy';

```

In the above example, the content of OutputRoot is reset before each PROPAGATE, because by default the node clears the output message buffer and reclaims the memory when the PROPAGATE statement completes. An alternative method is to instruct the node not to clear the output message on the first two PROPAGATE

statements, so that the message is available for routing to the next destination. The code to do this is:

```
SET OutputRoot = InputRoot;
PROPAGATE DELETE NONE;
SET OutputRoot = InputRoot;
PROPAGATE TO TERMINAL 'out1' DELETE NONE;
SET OutputRoot = InputRoot;
PROPAGATE TO LABEL 'ThirdCopy';
```

If you do not initialize the output buffer, an empty message is generated, and the message flow detects an error and throws an exception.

Also ensure that you copy all required message headers to the output message buffer for each output message that you propagate.

If you want to modify the output message content before propagating each message, code the appropriate ESQL to make the changes that you want before you code the PROPAGATE statement.

If you set up the contents of the last output message that you want to generate, and propagate it as the final action of the Compute node, you do not have to include the final PROPAGATE statement. The default action of the Compute node is to propagate the contents of the output buffer when it terminates. This is implemented by the RETURN TRUE statement, included as the final statement in the module skeleton.

For example, if you want to generate three copies of the input message, and not perform any further action, include this code immediately before the RETURN TRUE statement:

```
SET OutputRoot = InputRoot;
PROPAGATE DELETE NONE;
PROPAGATE DELETE NONE;
```

Alternatively, you can modify the default behavior of the node by changing RETURN TRUE to RETURN FALSE:

```
SET OutputRoot = InputRoot;
PROPAGATE DELETE NONE;
PROPAGATE DELETE NONE;
PROPAGATE;
RETURN FALSE;
```

Three output messages are generated by the three PROPAGATE statements. The final RETURN FALSE statement causes the node to terminate but not propagate a final output message. Note that the final PROPAGATE statement does not include the DELETE NONE clause, because the node must release the memory at this stage.

Using numeric operators with datetime values:

The following examples show the ESQL that you can code to manipulate datetime values with numeric operators.

Adding an interval to a datetime value

The simplest operation that you can perform is to add an interval to, or subtract an interval from, a datetime value. For example, you could write

the following expressions:

```
DATE '2000-03-29' + INTERVAL '1' MONTH  
TIMESTAMP '1999-12-31 23:59:59' + INTERVAL '1' SECOND
```

The following example shows how to calculate a retirement date by adding the retirement age to the birth date.

```
DECLARE retAge CHARACTER '65';  
DECLARE birthDate DATE DATE '1953-06-01';  
  
SET OutputRoot.XML.Test.retirementDate = birthDate + CAST(retAge AS INTERVAL YEAR);
```

The repetition of the word DATE in the above example is intentional. The first occurrence of DATE specifies the data type of the declared variable, birthDate. The second occurrence initializes the same variable with the constant character string that is enclosed in quotes as a DATE.

Adding or subtracting two intervals

You can combine two interval values using addition or subtraction. The two interval values must be of compatible types. It is not valid to add a year-month interval to a day-second interval as shown in the following example:

```
INTERVAL '1-06' YEAR TO MONTH + INTERVAL '20' DAY
```

The interval qualifier of the resultant interval is sufficient to encompass all the fields that are present in the two operand intervals. For example:

```
INTERVAL '2 01' DAY TO HOUR + INTERVAL '123:59' MINUTE TO SECOND
```

results in an interval with qualifier DAY TO SECOND, because both day and second fields are present in at least one of the operand values.

Subtracting two datetime values

You can subtract two datetime values to return an interval. You must include an interval qualifier in the expression to indicate what precision the result should be returned in. For example:

```
(CURRENT_DATE - DATE '1776-07-04') DAY
```

returns the number of days since the 4th July 1776, whereas:

```
(CURRENT_TIME - TIME '00:00:00') MINUTE TO SECOND
```

returns the age of the day in minutes and seconds.

Scaling intervals

You can multiply or divide an interval value by an integer factor:

```
INTERVAL '2:30' MINUTE TO SECOND / 4
```

Calculating a time interval:

This ESQL example calculates the time interval between an input WebSphere MQ message being put on the input queue, and the time that it is processed in the current Compute node.

(When you make a call to a CURRENT_ datetime function, the value that is returned is identical to the value returned to another call in the same node. This ensures that you can use the function consistently within a single node.)

```
CALL CopyMessageHeaders();
Declare PutTime INTERVAL;

SET PutTime = (CURRENT_GMTIME - InputRoot.MQMD.PutTime) MINUTE TO SECOND;

SET OutputRoot.XMLNS.Test.PutTime = PutTime;
```

The output message has the format (although actual values vary):

```
<Test>
  <PutTime>INTERVAL &apos;1:21.862&apos; MINUTE TO SECOND</PutTime>
</Test>
```

The following code snippet sets a timer, to be triggered after a specified interval from the start of processing, in order to check that processing has completed. If processing has not completed within the elapsed time, the firing of the timer might, for example, trigger some recovery processing.

The StartTime field of the timeout request message is set to the current time plus the allowed delay period, which is defined by a user-defined property on the flow. (The user-defined property has been set to a string of the form "HH:MM:SS" by the administrator.)

```
DECLARE StartDelyIntervalStr EXTERNAL CHARACTER '01:15:05';

CREATE PROCEDURE ValidateTimeoutRequest() BEGIN

  -- Set the timeout period
  DECLARE timeoutStartTimeRef REFERENCE TO
    OutputRoot.XMLNSC.Envelope.Header.TimeoutRequest.StartTime;
  IF LASTMOVE(timeoutStartTimeRef)
  THEN
    -- Already set
  ELSE
    -- Set it from the UDP StartDelyIntervalStr
    DECLARE startAtTime TIME CURRENT_TIME
      + CAST(StartDelyIntervalStr AS INTERVAL HOUR TO SECOND);

    -- Convert "TIME 'hh.mm.ss.fff'" to hh.mm.ss format
    -- needed in StartTime field
    DECLARE startAtTimeStr CHAR;
    SET startAtTimeStr = startAtTime;
    SET startAtTimeStr = SUBSTRING(startAtTimeStr FROM 7 FOR 8);
    SET OutputRoot.XMLNSC.Envelope.Header.TimeoutRequest.StartTime
      = startAtTimeStr;
  END IF;
END;
```

Selecting a subfield from a larger field:

You might have a message flow that processes a message containing delimited subfields. You can code ESQL to extract a subfield from the surrounding content if you know the delimiters of the subfield.

If you create a function that performs this task, or a similar one, you can invoke it both from ESQL modules (for Compute, Database, and Filter nodes) and from mapping files (used by DataDelete, DataInsert, DataUpdate, Extract, Mapping, and Warehouse nodes).

The following function example extracts a particular subfield of a message that is delimited by a specific character.

```
CREATE FUNCTION SelectSubField
    (SourceString CHAR, Delimiter CHAR, TargetStringPosition INT)
    RETURNS CHAR
-- This function returns a substring at parameter position TargetStringPosition within the
-- passed parameter SourceString. An example of use might be:
-- SelectSubField(MySourceField,' ',2) which will select the second subfield from the
-- field MySourceField delimited by a blank. If MySourceField has the value
-- "First Second Third" the function will return the value "Second"
BEGIN
    DECLARE DelimiterPosition INT;
    DECLARE CurrentFieldPosition INT 1;
    DECLARE StartNewString INT 1;
    DECLARE WorkingSource CHAR SourceString;
    SET DelimiterPosition = POSITION(Delimiter IN SourceString);
    WHILE CurrentFieldPosition < TargetStringPosition
        DO
            IF DelimiterPosition = 0 THEN
                -- DelimiterPosition will be 0 if the delimiter is not found
                -- exit the loop
                SET CurrentFieldPosition = TargetStringPosition;
            ELSE
                SET StartNewString = DelimiterPosition + 1;
                SET WorkingSource = SUBSTRING(WorkingSource FROM StartNewString);
                SET DelimiterPosition = POSITION(Delimiter IN WorkingSource);
                SET CurrentFieldPosition = CurrentFieldPosition + 1;
            END IF;
        END WHILE;
    IF DelimiterPosition > 0 THEN
        -- Remove anything following the delimiter from the string
        SET WorkingSource = SUBSTRING(WorkingSource FROM 1 FOR DelimiterPosition);
        SET WorkingSource = TRIM(TRAILING Delimiter FROM WorkingSource);
    END IF;
    RETURN WorkingSource;
END;
```

Copying repeating fields:

You can configure a node with ESQL to copy repeating fields in several ways.

Consider an input XML message that contains a repeating structure:

```
...
<Field_top>
  <field1></field1>
  <field1></field1>
  <field1></field1>
  <field1></field1>
  <field1></field1>
</Field_top>
.....
```

You cannot copy this whole structure field with the following statement:

```
SET OutputRoot.XMLNS.Output_top.Outfield1 = InputRoot.XMLNS.Field_top.field1;
```

That statement copies only the first repeat, and therefore produces the same result as this statement:

```
SET OutputRoot.XMLNS.Output_top.Outfield1[1] = InputRoot.XMLNS.Field_top.field1[1];
```

You can copy the fields within a loop, controlling the iterations with the **CARDINALITY** of the input field:

```

SET I = 1;
SET J = CARDINALITY(InputRoot.XMLNS.Field_top.field1[]);
WHILE I <= J DO
  SET OutputRoot.XMLNS.Output_top.Outfield1[I] = InputRoot.XMLNS.Field_top.field1[I];
  SET I = I + 1;
END WHILE;

```

This might be appropriate if you want to modify each field in the output message as you copy it from the input field (for example, add a number to it, or fold its contents to uppercase), or after it has been copied. If the output message already contained more Field1 fields than existed in the input message, the surplus fields would not be modified by the loop and would remain in the output message.

The following single statement copies the iterations of the input fields to the output fields, and deletes any surplus fields in the output message.

```

SET OutputRoot.XMLNS.Output_top.Outfield1.[] = InputRoot.XMLNS.Field_top.field1[];

```

The example below shows how you can rename the elements when you copy them into the output tree. This statement does not copy across the source element name, therefore each field1 element becomes a Target element.

```

SET OutputRoot.XMLNS.Output_top.Outfield1.Target[] =
  (SELECT I FROM InputRoot.XMLNS.Field_top.field1[] AS I );

```

The next example shows a different way to do the same operation; it produces the same end result.

```

SET OutputRoot.XMLNS.Output_top.Outfield2.Target[]
  = InputRoot.XMLNS.Field_top.field1[];

```

The following example copies across the source element name. Each field1 element is retained as a field1 element under the Target element.

```

SET OutputRoot.XMLNS.Output_top.Outfield3.Target.[]
  = InputRoot.XMLNS.Field_top.field1[];

```

This example is an alternative way to achieve the same result, with field1 elements created under the Target element.

```

SET OutputRoot.XMLNS.Output_top.Outfield4.Target.*[]
  = InputRoot.XMLNS.Field_top.field1[];

```

These examples show that there are several ways in which you can code ESQL to copy repeating fields from source to target. Select the most appropriate method to achieve the results that you require.

The principals shown here apply equally to all areas of the message tree to which you can write data, not just the output message tree.

A note about copying fields:

Be aware that, when copying an input message element to an output element, not only the *value* of the output element but also its *type* is set to that of the input element. This means that if, for example, you have an input XML document with an attribute, and you want to set a Field element (rather than an attribute) in your output message to the value of the input attribute, you have to include a TYPE clause cast to change the element-type from attribute to Field.

For example, given an input like:

```

<Field01 Attrib01='Attrib01_Value'>Field01_Value</Field01>

```

To create an output like:

```
<MyField_A MyAttrib_A='Attrib01_Value' MyAttrib_B='Field01_Value' >
  <MyField_B>Field01_Value</MyField_BC>
  <MyField_C>Attrib01_Value</MyField_C>
</MyField_A'>
```

You would use the following ESQL:

```
-- Create output attribute from input attribute
SET OutputRoot.XMLNSC.MyField_A.MyAttrib_A = InputRoot.XMLNSC.Field01.Attrib01;
-- Create output field from input field
SET OutputRoot.XMLNSC.MyField_A.MyField_B = InputRoot.XMLNSC.Field01;

-- Create output attribute from input field value, noting we have to
-- "cast" back to an attribute element
SET OutputRoot.XMLNSC.MyField_A.(XMLNSC.Attribute)MyAttrib_B =
    InputRoot.XMLNSC.Field01;

-- Create output field from input attribute value, noting we have to
-- "cast" back to a field element
SET OutputRoot.XMLNSC.MyField_A.(XMLNSC.Field)MyField_C =
    InputRoot.XMLNSC.Field01.Attrib01;
```

Working with elements of type list:

The XML Schema specification allows an element, or attribute, to contain a list of values that are based on a simple type, with the individual values separated by white space. In the message tree, an `xsd:list` element is represented as a name node, with an anonymous child node for each list item. Repeating lists can be handled without any loss of information.

Consider the following XML input message:

```
<message1>
  <listE1>one two three</listE1>
</message1>
```

This XML element produces the following message tree:

```
MRM
listE1 (Name)
  "one" (Value)
  "two" (Value)
  "three" (Value)
```

Individual list items can be accessed as `ElementName.*[n]`.

For example, use the following ESQL to access the third item of `listE1`:

```
SET X = FIELDVALUE (InputBody.message1.listE1.*[3]);
```

An attribute can also be of type `xsd:list`.

Consider the following XML input message:

```
<message1>
  <Element listAttr="one two three"/>
</message1>
```

This XML element produces the following message tree:

```
MRM
Element (Name)
  listAttr (Name)
    "one" (Value)
    "two" (Value)
    "three" (Value)
```

As before, individual list items can be accessed as `AttrName.*[n]`.

For example, use the following ESQL to access the third item of `listAttr`:

```
SET X = FIELDVALUE (InputBody.message1.Element.listAttr.*[3]);
```

A list element can occur more than once.

Consider the following XML message:

```
<message1>
<listE1>one two three/listE1>
<listE1>four five six/listE1>
</message1>
```

The message tree for this XML message is:

```
MRM
listE1 (Name)
  "one" (Value)
  "two" (Value)
  "three" (Value)
listE1 (Name)
  "four" (Value)
  "five" (Value)
  "six" (Value)
```

Code the following ESQL to access the first item in the second occurrence of the list:

```
SET X = FIELDVALUE (InputBody.message1.listE1[2].*[1]);
```

Mapping between a list and a repeating element:

Consider the form of the following XML input message:

```
<MRM>
  <inner>abcde fghij 12345</inner>
</MRM>
```

where the element `inner` is of type `xsd:list`, and therefore has three associated string values, rather than a single value.

To copy the three values into an output message, where each value is associated with an instance of repeating elements as shown here:

```
<MRM>
  <str1>abcde</str1>
  <str1>fghij</str1>
  <str1>12345</str1>
</MRM>
```

you might expect that the following ESQL syntax works:

```
DECLARE D INTEGER;
SET D = CARDINALITY(InputBody.str1.*[]);
DECLARE M INTEGER 1;
```

```

WHILE M <= D DO
  SET OutputRoot.MRM.str1[M] = InputBody.inner.*[M];
  SET M = M + 1;
END WHILE;

```

However, the statement:

```

SET OutputRoot.MRM.str1[M] = InputBody.inner.*[M];

```

requests a tree copy from source to target. Because the target element does not yet exist, the statement creates it, and its value and type are set from the source.

Therefore, to create the output message with the required format, given an input element which is of type `xsd:list`, use the “FIELDVALUE function” on page 1610 to explicitly retrieve only the value of the source element:

```

SET OutputRoot.MRM.str1[M] = FIELDVALUE(InputBody.inner.*[M]);

```

Manipulating repeating fields in a message tree:

This topic describes the use of the SELECT function, and other column functions, to manipulate repeating fields in a message tree.

Suppose that you want to perform a special action on invoices that have a total order value greater than a certain amount. To calculate the total order value of an Invoice field, you must multiply the Price fields by the Quantity fields in all the Items in the message, and total the result. You can do this using a SELECT expression as follows:

```

(
  SELECT SUM( CAST(I.Price AS DECIMAL) * CAST(I.Quantity AS INTEGER) )
  FROM Body.Invoice.Purchases."Item"[] AS I
)

```

The example assumes that you need to use CAST expressions to cast the string values of the fields Price and Quantity into the correct data types. The cast of the Price field into a decimal produces a decimal value with the *natural* scale and precision, that is, whatever scale and precision is necessary to represent the number. These CASTs would not be necessary if the data were already in an appropriate data type.

The SELECT expression works in a similar way to the quantified predicate, and in much the same way that a SELECT works in standard database SQL. The FROM clause specifies what is being iterated, in this case, all Item fields in Invoice, and establishes that the current instance of Item can be referred to using I. This form of SELECT involves a column function, in this case the SUM function, so the SELECT is evaluated by adding together the results of evaluating the expression inside the SUM function for each Item field in the Invoice. As with standard SQL, NULL values are ignored by column functions, with the exception of the COUNT column function explained below, and a NULL value is returned by the column function only if there are no non-NULL values to combine.

The other column functions that are provided are MAX, MIN, and COUNT. The COUNT function has two forms that work in different ways with regard to NULLs. In the first form you use it much like the SUM function above, for example:

```
SELECT COUNT(I.Quantity)
  FROM Body.Invoice.Purchases."Item"[] AS I
```

This expression returns the number of Item fields for which the Quantity field is non-NULL. That is, the COUNT function counts non-NULL values, in the same way that the SUM function adds non-NULL values. The alternative way of using the COUNT function is as follows:

```
SELECT COUNT(*)
  FROM Body.Invoice.Purchases."Item"[] AS I
```

Using COUNT(*) counts the total number of Item fields, regardless of whether any of the fields is NULL. The above example is in fact equivalent to using the CARDINALITY function, as in the following:

```
CARDINALITY(Body.Invoice.Purchases."Item"[])
```

In all the examples of SELECT given here, just as in standard SQL, you could use a WHERE clause to provide filtering on the fields.

Manipulating other parts of the message tree

The following topics describe how you can access parts of the message tree other than the message body data. These parts of the logical tree are independent of the domain in which the message exists, and all these topics apply to messages in the BLOB domain in addition to all other supported domains.

- “Accessing headers”
- “Accessing the Properties tree” on page 307
- “Accessing the LocalEnvironment tree” on page 308
- “Accessing the Environment tree” on page 312
- “Accessing the ExceptionList tree” on page 313

Accessing headers:

If the input message received by an input node includes message headers that are recognized by the input node, the node invokes the correct parser for each header. You can access these headers using ESQL.

Parsers are supplied for most WebSphere MQ headers. The topics listed below provide some guidance for accessing the information in the MQMD, MQRFH2, and MQPCF headers, which you can follow as general guidance for accessing other headers also present in your messages.

Every header has its own correlation name, for example, MQMD, and you must use this name in all ESQL statements that refer to or set the content of this tree:

- “Accessing the MQMD header” on page 304
- “Accessing the MQRFH2 header” on page 304
- “Accessing the MQCFH header” on page 305

For further details of the contents of these and other WebSphere MQ headers for which WebSphere Message Broker provides a parser, see “Element definitions for message parsers” on page 1399.

Accessing transport headers:

You can manipulate WebSphere MQ, HTTP, and JMS transport headers and their properties without writing Compute nodes:

- Use the MQHeader node to add, modify, or delete MQ Message Descriptor (MQMD) and MQ Dead Letter Header (MQDLH) headers.
- Use the HTTPHeader node to add, modify, or delete HTTP headers such as HTTPRequest and HTTPReply.
- Use the JMSHeader node to modify contents of the JMS Header_Values and Application properties so that you can control the node's output without programming.

Accessing the MQMD header:

Code ESQL statements to access the fields of the MQMD header.

WebSphere MQ, WebSphere MQ Everyplace, and SCADA messages include an MQMD header. You can refer to the fields within the MQMD, and you can update them in a Compute node.

For example, you might want to copy the message identifier MSGID in the MQMD to another field in your output message. To do that, code:

```
SET OutputRoot.MRM.Identifier = InputRoot.MQMD.MsgId;
```

If you send a message to an EBCDIC system from a distributed system, you might need to convert the message to a compatible CodedCharSetId and Encoding. To do this conversion, code the following ESQL in the Compute node:

```
SET OutputRoot.MQMD.CodedCharSetId = 500;  
SET OutputRoot.MQMD.Encoding = 785;
```

The MQMD properties of CodedCharSetId and Encoding define the code page and encoding of the section of the message that follows (typically this is either the MQRFH2 header or the message body itself).

Differences exist in the way the Properties folder and the MQMD folder are treated with respect to which folder takes precedence for the same fields. For more information, see "Properties versus MQMD folder behavior for various transports" on page 57.

Accessing the MQRFH2 header:

Code ESQL statements to access the fields of the MQRFH2 header.

When you construct an MQRFH2 header in a Compute node, it includes two types of fields:

- Fields in the MQRFH2 header structure; for example, Format and NameValueCCSID.
- Fields in the MQRFH2 NameValue buffer; for example, mcd and psc.

To differentiate between these two field types, insert a value in front of the referenced field in the MQRFH2 field to identify its type; a value for the NameValue buffer is not required because this is the default. The value that you specify for the header structure is (MQRFH2.Field).

For example:

- To create or change an MQRFH2 Format field, specify the following ESQL:

```
SET OutputRoot.MQRFH2.(MQRFH2.Field)Format = 'MQSTR  ';
```

- To create or change the psc folder with a topic:

```
SET OutputRoot.MQRFH2.psc.Topic = 'department';
```

- To add an MQRFH2 header to an outgoing message that is to be used to make a subscription request:

```
DECLARE I INTEGER 1;
DECLARE J INTEGER CARDINALITY(InputRoot.*[]);

WHILE I < J DO
  SET OutputRoot.*[I] = InputRoot.*[I];
  SET I=I+1;
END WHILE;

SET OutputRoot.MQRFH2.(MQRFH2.Field)Version = 2;
SET OutputRoot.MQRFH2.(MQRFH2.Field)Format = 'MQSTR';
SET OutputRoot.MQRFH2.(MQRFH2.Field)NameValueCCSID = 1208;
SET OutputRoot.MQRFH2.psc.Command = 'RegSub';
SET OutputRoot.MQRFH2.psc.Topic = "InputRoot"."MRM"."topel";
SET OutputRoot.MQRFH2.psc.QMgrName = 'DebugQM';
SET OutputRoot.MQRFH2.psc.QName = 'PUBOUT';
SET OutputRoot.MQRFH2.psc.RegOpt = 'PersAsPub';
```

Variable J is initialized to the value of the cardinality of the existing headers in the message. Using a variable is more efficient than calculating the cardinality on each iteration of the loop, which happens if you code the following WHILE statement:

```
WHILE I < CARDINALITY(InputRoot.*[]) DO
```

The MQRFH2 header can be parsed using either the MQRFH2 parser or the MQRFH2C compact parser. To consume less memory, use the MQRFH2C compact parser by selecting the Use MQRFH2C compact parser for MQRFH2 Header check box on the input node of the message flow. This results in paths that contain MQRFH2C instead of MQRFH2; for example: SET OutputRoot.MQRFH2C.psc.Topic = 'department';

Target MQRFH2 fields are created only if the headers are copied, and the MQRFH2C parser option is not selected on the MQInput node. In all other circumstances, an MQRFH2C field is created on output.

Accessing the MQCFH header:

Code ESQL statements to access the fields of the MQCFH header (root name MQPCF).

Messages that are of PCF format (MQPCF, MQADMIN, and MQEVENT) include the MQCFH header. You can process the contents of the MQCFH header, accessing parameters, parameter lists, strings and groups.

- To access or to construct parameters in the header, use the following syntax:

```
SET OutputRoot.MQPCF.Parameter[nn] =
  Integer parameter ID
```

If you access a 64-bit parameter, use the following syntax to differentiate from 32-bit parameters:

```
SET OutputRoot.MQPCF.Parameter64[nn] =  
  Integer parameter ID
```

For example:

```
SET OutputRoot.MQPCF.Parameter[1] =  
  MQCACF_AUTH_PROFILE_NAME;
```

- For parameter lists, use the following syntax:

```
SET OutputRoot.MQPCF.ParameterList64[nn] =  
  Integer parameter ID  
SET OutputRoot.MQPCF.ParameterList64[nn].*[xx] =  
  Integer parameter values
```

For example:

```
SET OutputRoot.MQPCF.ParameterList[1] =  
  MQIACF_AUTH_ADD_AUTHS;  
SET OutputRoot.MQPCF.ParameterList[1].*[1] =  
  MQAUTH_SET;  
SET OutputRoot.MQPCF.ParameterList[1].*[2] =  
  MQAUTH_SET_ALL_CONTEXT;
```

- A byte string is a byte array data type, and is supported with this syntax:

```
SET OutputRoot.MQPCF.Parameter[nn] =  
  Integer parameter ID  
SET OutputRoot.MQPCF.Parameter[nn].* =  
  Integer, String or ByteArray Parameter value
```

- A group is implemented as a folder containing more PCF, and requires the following syntax:

```
SET OutputRoot.MQPCF.Group[xx] =  
  Group Parameter ID
```

For example:

```
SET OutputRoot.MQPCF.Group[1] =  
  MQGACF_Q_ACCOUNTING_DATA;  
SET OutputRoot.MQPCF.Group[1].Parameter[1] =  
  MQCA_CREATION_DATE;  
SET OutputRoot.MQPCF.Group[1].Parameter[1].* =  
  '2007-02-05';
```

You can also use nested groups; for example;

```
SET OutputRoot.MQPCF.Group[1].Group[1] =  
  MQGACF_Q_ACCOUNTING_DATA;  
SET OutputRoot.MQPCF.Group[1].Group[1].Parameter[1] =  
  MQCA_CREATION_DATE;  
SET OutputRoot.MQPCF.Group[1].Group[1].Parameter[1].* =  
  '2007-02-05';
```

- A filter is almost identical to a parameter, but it also includes an operator. Therefore the syntax is a tree with named values:

```
SET OutputRoot.MQPCF.Filter[xx] =  
  Integer parameter ID  
SET OutputRoot.MQPCF.Filter[xx].Operator =  
  Integer Filter name  
SET OutputRoot.MQPCF.Filter[xx].Value =  
  Byte, Integer or String Filter Value
```

- The following is sample code that can be used as an example to create an MQPCF message in a Compute node:

```

| CREATE NEXTSIBLING OF OutputRoot.Properties DOMAIN 'MQMD';
| CREATE NEXTSIBLING OF OutputRoot.MQMD DOMAIN 'MQADMIN'
| NAME 'MQPCF';
| CREATE FIELD OutputRoot.MQPCF;
| SET OutputRoot.MQMD.MsgType = MQMT_REQUEST;
| SET OutputRoot.MQMD.ReplyToQ = 'REPLYQ';
| DECLARE refRequest REFERENCE TO OutputRoot.MQPCF;
| SET refRequest.Type = 16; --MQCFT_COMMAND_XR z/OS
| SET refRequest.StrucLength = MQCFH_STRUC_LENGTH;
| SET refRequest.Version = 3; -- required for z/OS
| SET refRequest.Command = MQCMD_INQUIRE_Q;
| SET refRequest.MsgSeqNumber = 1;
| SET refRequest.Control = MQCFC_LAST;
| /* First parameter: Queue Name. */
| SET refRequest.Parameter[1] = MQCA_Q_NAME;
| SET refRequest.Parameter[1].* = 'QUEUENAME.*';
| SET refRequest.ParameterList[1] = MQIACF_Q_ATTRS;
| SET refRequest.ParameterList[1].* = MQIACF_ALL;

```

Accessing the Properties tree:

The Properties tree has its own correlation name, Properties, and you must use this in all ESQL statements that refer to or set the content of this tree.

The fields in the Properties tree contain values that define the characteristics of the message. For example, the Properties tree contains a field for the message domain, and fields for the encoding and CCSID in which message data is encoded. For a full list of fields in this tree, see “Data types for elements in the Properties subtree” on page 1400.

You can interrogate and update these fields using the appropriate ESQL statements. If you create a new output message in the Compute node, you must set values for the message properties.

Setting output message properties:

If you use the Compute node to generate a new output message, you must set its properties in the Properties tree. The output message properties do not have to be the same as the input message properties.

For example, to set the output message properties for an output MRM message, set the following properties:

Property	Value
Message domain	MRM
Message set	Message set identifier
Message type	Message name ¹
Message format	Physical format name ²

Notes:

1. For details of the syntax of Message type, see Specifying namespaces in the Message Type property.
2. The name that you specify for the physical layer must match the name that you have defined for it. The default physical layer names are Binary1, XML1, and Text1.

This ESQL procedure sets message properties to values passed in by the calling statement. You might find that you have to perform this task frequently, and you can use a procedure such as this in many different nodes and message flows. If you prefer, you can code ESQL that sets specific values.

```
CREATE PROCEDURE setMessageProperties(IN OutputRoot REFERENCE, IN setName char,
                                     IN typeName char, IN formatName char) BEGIN
  /*****
  * A procedure that sets the message properties
  *****/
  set OutputRoot.Properties.MessageSet = setName;
  set OutputRoot.Properties.MessageType = typeName;
  set OutputRoot.Properties.MessageFormat = formatName;
END;
```

To set the output message domain, you can set the message property, or you can code ESQL statements that refer to the required domain in the second qualifier of the SET statement, the parser field. For example, the ESQL statement sets the domain to MRM:

```
SET OutputRoot.MRM.Field1 = 'field1 data';
```

This ESQL statement sets the domain to XMLNS:

```
SET OutputRoot.XMLNS.Field1 = 'field1 data';
```

Do not specify more than one domain in the ESQL for any single message. However, if you use PROPAGATE statements to generate several output messages, you can set a different domain for each message.

For information about the full list of elements in the Properties tree, see “Data types for elements in the Properties subtree” on page 1400.

Differences exist in the way the Properties folder and the MQMD folder are treated with respect to which folder takes precedence for the same fields. For more information, see “Properties versus MQMD folder behavior for various transports” on page 57.

Accessing the LocalEnvironment tree:

The LocalEnvironment tree has its own correlation name, LocalEnvironment, and you must use this name in all ESQL statements that refer to or set the content of this tree.

The LocalEnvironment tree is used by the broker, and you can refer to and modify this information. You can also extend the tree to contain information that you create yourself. You can create subtrees within this tree that you can use as a scratchpad or working area.

The message flow sets up information in two subtrees, Destination and WrittenDestination, below the LocalEnvironment root. You can refer to the content of both of these, and you can write to the Destination tree to influence the way in which the message flow processes your message. However, if you write to the Destination tree, follow the defined structure to ensure that the tree remains valid.

The WrittenDestination subtree contains the addresses to which the message has been written. Its name is fixed and it is created by the message flow when a message is propagated through the Out terminal of a request, output, or reply

|
|
|

node. The subtree includes transport-specific information (for example, if the output message has been put to a WebSphere MQ queue, it includes the queue manager and queue names). You can use one of the following methods to obtain information about the details of a message after it has been sent by the nodes:

- Connect a Compute node to the Out terminal.
- Configure a user exit to process an output message callback event, as described in “Exploiting user exits” on page 198.

The topic for each node that supports WrittenDestination information contains details about the data that it contains.

If you want the LocalEnvironment tree to be included in the output message that is propagated by the Compute node, you must set the Compute node property Compute mode to a value that includes LocalEnvironment (for example, All). If you do not, the LocalEnvironment tree is not copied to the output message.

The information that you insert into DestinationData or Defaults depends on the characteristic of the corresponding node property:

- If a node property is represented by a check box (for example, New Message ID), set the Defaults or DestinationData element to Yes (equivalent to selecting the check box) or No (equivalent to clearing the check box).
- If a node property is represented by a drop-down list (for example, Transaction Mode), set the Defaults or DestinationData element to the appropriate character string (for example Automatic).
- If a node property is represented by a text entry field (for example, Queue Manager Name), set the Defaults or DestinationData element to the character string that you would enter in this field.

If necessary, configure the sending node to indicate where the destination information is. For example, for the output node MQOutput, set Destination Mode:

- If you set Destination Mode to Queue Name, the output message is sent to the queue identified in the output node properties Queue Name and Queue Manager Name. Destination is not referenced by the node.
- If you set Destination Mode to Destination List, the node extracts the destination information from the Destination subtree. If you use this value you can send a single message to multiple destinations, if you configure Destination and a single output node correctly. The node checks the node properties only if a value is not available in Destination (as described above).
- If you set Destination Mode to Reply To Queue, the message is sent to the reply-to queue identified in the MQMD in this message (field ReplyToQ). Destination is not referenced by the node.

To find more information about ESQL procedures that perform typical updates to the LocalEnvironment see “Populating Destination in the LocalEnvironment tree” on page 311. Review the ESQL statements in these procedures to see how to modify LocalEnvironment. You can use these procedures unchanged, or modify them for your own requirements.

To find more information about how to extend the contents of this tree for your own purposes see “Using scratchpad areas in LocalEnvironment” on page 310.

For another example of how you can use LocalEnvironment to modify the behavior of a message flow, refer to the XML_PassengerQuery message flow in the following sample program:

- Airline Reservations sample

The Compute node in this message flow writes a list of destinations in the RouterList subtree of Destination that are used as labels by a later RouteToLabel node that propagates the message to the corresponding Label node. You can view samples only when you use the information center that is integrated with the Message Broker Toolkit.

Using scratchpad areas in LocalEnvironment:

The LocalEnvironment tree includes a subtree called Variables. This is always created, but is never populated by the message flow. Use this area for your own purposes, for example to pass information from one node to another. You can create other subtrees in the LocalEnvironment tree if you choose.

The advantage of creating your own data in a scratchpad in the LocalEnvironment is that this data can be propagated as part of the logical tree to subsequent nodes in the message flow. If you create a new output message in a Compute node, you can also include all or part of the LocalEnvironment tree from the input message in the new output message.

To ensure that the information in the LocalEnvironment is propagated further down the flow, the *Compute mode* property of the Compute node must be set to include LocalEnvironment as part of the output tree (for example, specify LocalEnvironment and Message). See “Setting the mode” on page 841 for further details about *Compute mode*.

However, any data updates or additions that you make in one node are not retained if the message flows backwards through the message flow (for example, if an exception is thrown). If you create your own data, and want that data to be preserved throughout the message flow, you must use the Environment tree.

You can set values in the Variables subtree in a Compute node that are used later by another node (Compute, Database, or Filter) for some purpose that you determine when you configure the message flow.

Because LocalEnvironment is not in scope in a Compute node, InputLocalEnvironment and OutputLocalEnvironment must be used instead.

For example, you might use the scratchpad in the LocalEnvironment to propagate the destination of an output message to subsequent nodes in a message flow. Your first Compute node determines that the output messages from this message flow must go to WebSphere MQ queues. Include the following ESQL to insert this information into the LocalEnvironment by setting the value of *OutputLocation* in the OutputLocalEnvironment:

```
SET OutputLocalEnvironment.Variables.OutputLocation = 'MQ';
```

Your second Compute node can access this information from its input message. In the ESQL in this node, use the correlation name InputLocalEnvironment to identify the LocalEnvironment tree within the input message that contains this data. The following ESQL sets *queueManagerName* and *queueName* based on the content of *OutputLocation* in the LocalEnvironment, using InputLocalEnvironment:

```
IF InputLocalEnvironment.Variables.OutputLocation = 'MQ' THEN
  SET OutputLocalEnvironment.Destination.MQ.DestinationData.queueManagerName = 'myQManagerName';
  SET OutputLocalEnvironment.Destination.MQ.DestinationData.queueName = 'myQueueName';
END IF;
```

In the example *queueManagerName* and *queueName* are set for the Destination subtree in the output message. The Compute mode of the second compute node must be set to include the LocalEnvironment tree in the output message. Configure the MQOutput node to use the destination list that you have created in the LocalEnvironment tree by setting property *Destination Mode* to Destination List.

For information about the full list of elements in the DestinationData subtree, see “Data types for elements in the DestinationData subtree” on page 1401.

Populating Destination in the LocalEnvironment tree:

Use the Destination subtree to set up the target destinations that are used by output nodes, the HTTPRequest node, SOAPRequest node, the SOAPAsyncRequest, and the RouteToLabel node. The following examples show how you can create and use an ESQL procedure to perform the task of setting up values for each of these uses.

Copy and use these procedures as shown, or you can modify or extend them to perform similar tasks.

Adding a queue name for the MQOutput node

```
CREATE PROCEDURE addToMQDestinationList(IN LocalEnvironment REFERENCE, IN newQueue char) BEGIN
  /*****
  * A procedure that will add a queue name to the MQ destination list
  * in the local environment.
  * This list is used by a MQOutput node that has its mode set to Destination list.
  *
  * IN LocalEnvironment: LocalEnvironment to be modified.
  * Set this to OutputLocalEnvironment when calling this procedure
  * IN queue:    queue to be added to the list
  *
  *****/
  DECLARE I INTEGER CARDINALITY(LocalEnvironment.Destination.MQ.DestinationData[]);
  IF I = 0 THEN
    SET LocalEnvironment.Destination.MQ.DestinationData[1].queueName = newQueue;
  ELSE
    SET LocalEnvironment.Destination.MQ.DestinationData[I+1].queueName = newQueue;
  END IF;
END;
```

Changing the default URL for a SOAPRequest node or a SOAPAsyncRequest node request

```
|
| CREATE PROCEDURE overrideDefaultSOAPRequestURL(IN LocalEnvironment REFERENCE, IN newUrl char) BEGIN
|   /*****
|   * A procedure that will change the URL to which the SOAPRequest node or
|   * SOAPAsyncRequest node will send the request.
|   *
|   * IN LocalEnvironment: LocalEnvironment to be modified.
|   * Set this to OutputLocalEnvironment when calling this procedure
|   * IN queue:    URL to send the request to.
|   *
|   *****/
|   set OutputLocalEnvironment.Destination.SOAP.Request.Transport.HTTP.WebServiceURL= newUrl;
| END;
```

Changing the default URL for an HTTPRequest node request

```

CREATE PROCEDURE overrideDefaultHTTPRequestURL(IN LocalEnvironment REFERENCE, IN newUrl char) BEGIN
  /*****
  * A procedure that will change the URL to which the HTTPRequest node will send the request.
  *
  * IN LocalEnvironment: LocalEnvironment to be modified.
  * Set this to OutputLocalEnvironment when calling this procedure
  * IN queue: URL to send the request to.
  *
  *****/
  set LocalEnvironment.Destination.HTTPRequestURL = newUrl;
END;

```

Adding a label for the RouteToLabel node

```

CREATE PROCEDURE addToRouteToLabelList(IN LocalEnvironment REFERENCE, IN newLabel char) BEGIN
  /*****
  * A procedure that will add a label name to the RouteToLabel list
  * in the local environment.
  * This list is used by a RoteToLabel node.
  *
  * IN LocalEnvironment: LocalEnvironment to be modified.
  * Set this to OutputLocalEnvironment when calling this procedure
  * IN label: label to be added to the list
  *
  *****/
  if LocalEnvironment.Destination.RouterList.DestinationData is null then
    set LocalEnvironment.Destination.RouterList.DestinationData."label" = newLabel;
  else
    create LASTCHILD OF LocalEnvironment.Destination.RouterList.DestinationData
      NAME 'label' VALUE newLabel;
  end if;
END;

```

Setting up JMS destination lists

The following example shows how to set up JMS destination lists in the LocalEnvironment tree.

```

CREATE PROCEDURE CreateJMSDestinationList() BEGIN
  SET OutputLocalEnvironment.Destination.JMSDestinationList.DestinationData[1] = 'jndi://TestDestQueue1';
  SET OutputLocalEnvironment.Destination.JMSDestinationList.DestinationData[2] = 'jndi://TestDestQueue2';
  SET OutputLocalEnvironment.Destination.JMSDestinationList.DestinationData[3] = 'jndi://TestDestQueue3';
END;

```

Accessing the Environment tree:

The Environment tree has its own correlation name, Environment, and you must use this name in all ESQL statements that refer to, or set, the content of this tree.

The Environment tree is always created when the logical tree is created for an input message. However, the message flow neither populates it, nor uses its contents. You can use this tree for your own purposes, for example, to pass information from one node to another. You can use the whole tree as a scratchpad or working area.

The advantage of creating your own data in Environment is that this data is propagated as part of the logical tree to subsequent nodes in the message flow. If you create a new output message in a Compute node, the Environment tree is also copied from the input message to the new output message. (In contrast to the LocalEnvironment tree, which is only included in the output message if you explicitly request that it is).

Only one Environment tree is present for the duration of the message flow. Any data updates, or additions, that you make in one node are retained, and all of the nodes in the message flow have access to the latest copy of this tree. Even if the message flows back through the message flow (for example, if an exception is thrown, or if the message is processed through the second terminal of the FlowOrder node), the latest state is retained. (In contrast to the LocalEnvironment tree, which reverts to its previous state if the message flows back through the message flow.)

You can use this tree for any purpose you choose. For example, you can use the following ESQL statements to create fields in the tree:

```
SET Environment.Variables =  
    ROW('granary' AS bread, 'reisling' AS wine, 'stilton' AS cheese);  
SET Environment.Variables.Colors[] =  
    LIST{'yellow', 'green', 'blue', 'red', 'black'};  
SET Environment.Variables.Country[] = LIST{ROW('UK' AS name, 'pound' AS currency),  
    ROW('USA' AS name, 'dollar' AS currency)};
```

This information is now available to all nodes to which a message is propagated, regardless of their relative position in the message flow.

For another example of how you can use Environment to store information used by other nodes in the message flow, look at the Reservation message flow in the following sample:

- Airline Reservations sample

The Compute node in this message flow writes information to the subtree Environment.Variables that it has extracted from a database according to the value of a field in the input message.

You can view samples only when you use the information center that is integrated with the Message Broker Toolkit.

Accessing the ExceptionList tree:

The ExceptionList tree has its own correlation name, ExceptionList, and you must use this in all ESQL statements that refer to or set the content of this tree.

This tree is created with the logical tree when an input message is parsed. It is initially empty, and is only populated if an exception occurs during message flow processing. It is possible that more than one exception can occur; if more than one exception occurs, the ExceptionList tree contains a subtree for each exception.

You can access the ExceptionList tree in Compute, Database, and Filter nodes, and you can update it in a Compute node. You must use the appropriate correlation name; ExceptionList for a Database or Filter node, and InputExceptionList for a Compute node.

You might want to access this tree in a node in an error handling procedure. For example, you might want to route the message to a different path based on the type of exception, for example one that you have explicitly generated using an ESQL THROW statement, or one that the broker has generated.

The following ESQL shows how you can access the ExceptionList and process each child that it contains:

```

-- Declare a reference for the ExceptionList
-- (in a Compute node use InputExceptionList)
DECLARE start REFERENCE TO ExceptionList.*[1];

-- Loop through the exception list children
WHILE start.Number IS NOT NULL DO
  -- more ESQL

  -- Move start to the last child of the field to which it currently points
  MOVE start LASTCHILD;
END WHILE;

```

The following example shows an extract of ESQL that has been coded for a Compute node to loop through the exception list to the last (nested) exception description and extract the error number. This error relates to the original cause of the problem and normally provides the most precise information. Subsequent action taken by the message flow can be decided by the error number retrieved in this way.

```

CREATE PROCEDURE getLastExceptionDetail(IN InputTree reference,OUT messageNumber integer,
OUT messageText char)
  /*****
  * A procedure that will get the details of the last exception from a message
  * IN InputTree: The incoming exception list
  * IN messageNumber: The last message numberr.
  * IN messageText: The last message text.
  *****/
BEGIN
  -- Create a reference to the first child of the exception list
  declare ptrException reference to InputTree.*[1];
  -- keep looping while the moves to the child of exception list work
  WHILE lastmove(ptrException) DO
  -- store the current values for the error number and text
  IF ptrException.Number is not null THEN
    SET messageNumber = ptrException.Number;
    SET messageText = ptrException.Text;
  END IF;
  -- now move to the last child which should be the next exceptionlist
  move ptrException lastchild;
  END WHILE;
END;

```

For more information about the use of ExceptionList, look at the subflow in the following sample which includes ESQL that interrogates the ExceptionList structure and takes specific action according to its content:

- Error Handler sample

You can view samples only when you use the information center that is integrated with the Message Broker Toolkit.

Transforming from one data type to another

You can use ESQL to transform messages and data types in many ways. The following topics provide guidance about the following:

- “Casting data from message fields”
- “Converting code page and message encoding” on page 315
- “Converting EBCDIC NL to ASCII CR LF” on page 318
- “Changing message format” on page 320

Casting data from message fields:

When you compare an element with another element, variable or constant, ensure that the value with which you are comparing the element is consistent (for example, character with character). If the values are not consistent, the broker generates a runtime error if it cannot provide an implicit casting to resolve the inconsistency. For details of what implicit casts are supported, see “Implicit casts” on page 1652.

You can use the CAST function to transform the data type of one value to match the data type of the other. For example, you can use the CAST function when you process generic XML messages. All fields in an XML message have character values, so if you want to perform arithmetic calculations or datetime comparisons, for example, you must convert the string value of the field into a value of the appropriate type using CAST.

In the Invoice message, the field InvoiceDate contains the date of the invoice. If you want to refer to or manipulate this field, you must CAST it to the correct format first. For example, to refer to this field in a test:

```
IF CAST(Body.Invoice.InvoiceDate AS DATE) = CURRENT_DATE THEN
```

This converts the string value of the InvoiceDate field into a date value, and compares it to the current date.

Another example is casting from integer to character:

```
DECLARE I INTEGER 1;
DECLARE C CHARACTER;

-- The following statement generates an error
SET C = I;

-- The following statement is valid
SET C = CAST(I AS CHARACTER);
```

Converting code page and message encoding:

You can use ESQL within a Compute node to convert data for code page and message encoding. If your message flow is processing WebSphere MQ messages, you can use WebSphere MQ facilities (including get and put options and WebSphere MQ data conversion exits) to provide these conversions. If you are not processing WebSphere MQ messages, or you choose not to use WebSphere MQ facilities, you can use WebSphere Message Broker facilities by coding the appropriate ESQL in a Compute node in your message flow.

The contents of the MQMD, the MQRFH2, and the message body of a message in the MRM domain that has been modeled with a CWF physical format can be subject to code page and encoding conversion. The contents of a message body of a message in the XML, XMLNS, and JMS domains, and those messages in the MRM domain that have been modeled with an XML or TDS physical format, are treated as strings. Only code page conversion applies; no encoding conversion is required.

For messages in the MRM domain modeled with a CWF physical format, you can set the MQMD CCSID and Encoding fields of the output message, plus the CCSID and Encoding of any additional headers, to the required target value.

For messages in the MRM domain modeled with an XML or TDS physical format, you can set the MQMD CCSID field of the output message, plus the CCSID of any additional headers. XML and TDS data is handled as strings and is therefore subject to CCSID conversion only.

An example WebSphere MQ message has an MQMD header, an MQRFH2 header, and a message body. To convert this message to a mainframe CodedCharSetId and Encoding, code the following ESQL in the Compute node:

```
SET OutputRoot.MQMD.CodedCharSetId = 500;  
SET OutputRoot.MQMD.Encoding = 785;  
SET OutputRoot.MQRFH2.CodedCharSetId = 500;  
SET OutputRoot.MQRFH2.Encoding = 785;
```

The following example illustrates what you must do to modify a CWF message so that it can be passed from WebSphere Message Broker to IMS[™] on z/OS.

1. You have defined the input message in XML and are using an MQRFH2 header. Remove the header before passing the message to IMS.
2. The message passed to IMS must have MQIIH header, and must be in the z/OS code page. This message is modeled in the MRM and has the name IMS1. Define the PIC X fields in this message as logical type string for conversions between EBCDIC and ASCII to take place. If they are logical type binary, no data conversion occurs; binary data is ignored when a CWF message is parsed by the MRM parser.
3. The message received from IMS is also defined in the MRM and has the name IMS2. Define the PIC X fields in this message as logical type string for conversions between EBCDIC and ASCII to take place. If they are logical type binary, no data conversion occurs; binary data is ignored when a CWF message is parsed by the MRM parser.
4. Convert the reply message to the Windows code page. The MQIIH header is retained on this message.
5. You have created a message flow that contains the following nodes: :
 - a. The outbound flow, **MQInput1 --> Compute1 --> MQOutput1**.
 - b. The inbound flow, **MQInput2 --> Compute2 --> MQOutput2**.
6. Code ESQL in Compute1 (outbound) node as follows, specifying the relevant MessageSet id. This code shows the use of the default CWF physical layer name. You must use the name that matches your model definitions. If you specify an incorrect value, the broker fails with message BIP5431.

```

-- Loop to copy message headers
DECLARE I INTEGER 1;
DECLARE J INTEGER CARDINALITY(InputRoot.*[]);

WHILE I < J - 1 DO
    SET OutputRoot.*[I] = InputRoot.*[I];
    SET I=I+1;
END WHILE;

SET OutputRoot.MQMD.CodedCharSetId = 500;
SET OutputRoot.MQMD.Encoding = 785;
SET OutputRoot.MQMD.Format = 'MQIMS  ';
SET OutputRoot.MQIIH.Version = 1;
SET OutputRoot.MQIIH.StrucLength = 84;
SET OutputRoot.MQIIH.Encoding = 785;
SET OutputRoot.MQIIH.CodedCharSetId = 500;
SET OutputRoot.MQIIH.Format = 'MQIMSVS ';
SET OutputRoot.MQIIH.Flags = 0;
SET OutputRoot.MQIIH.LTermOverride = '      ';
SET OutputRoot.MQIIH.MFSMapName = '      ';
SET OutputRoot.MQIIH.ReplyToFormat = 'MQIMSVS ';
SET OutputRoot.MQIIH.Authenticator = '      ';
SET OutputRoot.MQIIH.TranInstanceId = X'00000000000000000000000000000000';
SET OutputRoot.MQIIH.TranState = ' ';
SET OutputRoot.MQIIH.CommitMode = '0';
SET OutputRoot.MQIIH.SecurityScope = 'C';
SET OutputRoot.MQIIH.Reserved = ' ';
SET OutputRoot.MRM.e_eLen08 = 30;
SET OutputRoot.MRM.e_eLen09 = 0;
SET OutputRoot.MRM.e_string08 = InputBody.e_string01;
SET OutputRoot.MRM.e_binary02 = X'31323334353637383940';
SET OutputRoot.Properties.MessageDomain = 'MRM';
SET OutputRoot.Properties.MessageSet = 'DHCJOEG072001';
SET OutputRoot.Properties.MessageType = 'IMS1';
SET OutputRoot.Properties.MessageFormat = 'Binary1';

```

Note the use of a variable, J, that is initialized to the value of the cardinality of the existing headers in the message. This is more efficient than calculating the cardinality on each iteration of the loop, which happens if you code the following WHILE statement:

```
WHILE I < CARDINALITY(InputRoot.*[]) DO
```

7. Create ESQL in Compute2 (inbound) node as follows, specifying the relevant MessageSet id. This code shows the use of the default CWF physical layer name. You must use the name that matches your model definition. If you specify an incorrect value, the broker fails with message BIP5431.

```

-- Loop to copy message headers
DECLARE I INTEGER 1;
DECLARE J INTEGER CARDINALITY(InputRoot.*[]);

WHILE I < J DO
    SET OutputRoot.*[I] = InputRoot.*[I];
    SET I=I+1;
END WHILE;

SET OutputRoot.MQMD.CodedCharSetId = 437;
SET OutputRoot.MQMD.Encoding = 546;
SET OutputRoot.MQMD.Format = 'MQIMS  ';
SET OutputRoot.MQIIH.CodedCharSetId = 437;
SET OutputRoot.MQIIH.Encoding = 546;
SET OutputRoot.MQIIH.Format = '      ';
SET OutputRoot.MRM = InputBody;
SET OutputRoot.Properties.MessageDomain = 'MRM';
SET OutputRoot.Properties.MessageSet = 'DHCJOEG072001';
SET OutputRoot.Properties.MessageType = 'IMS2';
SET OutputRoot.Properties.MessageFormat = 'Binary1';

```

You do not have to set any specific values for the MQInput1 node properties, because the message and message set are identified in the MQRFH2 header, and no conversion is required.

You must set values for message domain, set, type, and format in the MQInput node for the inbound message flow (MQInput2). You do not need to set conversion parameters.

One specific situation in which you might need to convert data in one code page to another is when messages contain new line indicators and are passing between EBCDIC and ASCII systems. The required conversion for this situation is described in “Converting EBCDIC NL to ASCII CR LF.”

Converting EBCDIC NL to ASCII CR LF:

This topic describes an example task that changes new line (NL) characters in a text message to carriage return (CR) and line feed (LF) character pairs.

This conversion might be useful if messages from an EBCDIC platform (for example, using CCSID 1047) are sent to an ASCII platform (for example, using CCSID 437). Problems can arise because the EBCDIC NL character hex '15' is converted to the undefined ASCII character hex '7F'. There is no corresponding code point for the NL character in the ASCII code page.

In this example, a message flow is created that interprets the input message as a message in the BLOB domain. This is passed into a ResetContentDescriptor node to reset the data to a message in the MRM domain. The message is called msg_nl (a set of repeating string elements delimited by EBCDIC NL characters). A Compute node is then used to create an output based on another message in the MRM domain called msg_crlf (a set of repeating string elements delimited by CR LF pairs). The message domain is then changed back to BLOB in another ResetContentDescriptor node. This message flow is illustrated below.

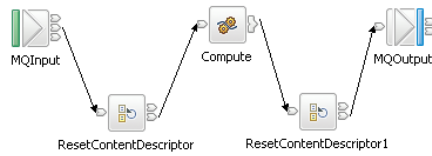

The following instructions show how to create the messages and configure the message flow.

1. Create the message models for the messages in the MRM domain:
 - a. Create a message set project called myProj.
 - b. Create a message set called myMessageSet with a TDS physical format (the default name is Text1).
 - c. Create an element string1 of type xsd:string.
 - d. Create a complex type called t_msg_nl and specify the following complex type properties:
 - *Composition* = Ordered Set
 - *Content Validation* = Closed
 - *Data Element Separation* = All Elements Delimited
 - *Delimiter* = <U+0085> (hex '0085' is the UTF-16 representation of a NL character)
 - *Repeat* = Yes
 - *Min Occurs* = 1
 - *Max Occurs* = 50 (the text of the message is assumed to consist of no more than 50 lines)
 - e. Add Element string1 and set the following property:
 - *Repeating Element Delimiter* = <U+0085>
 - f. Create a Message msg_nl and set its associated complex type to t_msg_nl
 - g. Create a complex type called t_msg_crlf and specify the following complex type properties:
 - *Composition* = Ordered Set
 - *Content Validation* = Closed
 - *Data Element Separation* = All Elements Delimited
 - *Delimiter* <CR><LF> (<CR> and <LF> are the mnemonics for the CR and LF characters)
 - *Repeat* = Yes
 - *Min Occurs* = 1
 - *Max Occurs* = 50
 - h. Add Element string1 and set the following property:
 - *Repeating Element Delimiter* = <CR><LF>
 - i. Create a Message msg_crlf and set complex type to t_msg_crlf.
2. Configure the message flow shown in the figure above:
 - a. Start with the MQInput node:
 - Set *Message Domain* = BLOB
 - Set *Queue Name* = <Your input message queue name>
 - b. Add the ResetContentDescriptor node, connected to the out terminal of MQInput:
 - Set *Message Domain* = MRM
 - Select *Reset Message Domain*

- Set *Message Set* = <Your Message Set ID> (this has a maximum of 13 characters)
 - Select *Reset Message Set*
 - Set *Message Type* = msg_n1
 - Select *Reset Message Type*
 - Set *Message Format* = Text1
 - Select *Reset Message Format*
- c. Add the Compute node, connected to the out terminal of ResetContentDescriptor:
- Enter a name for the *ESQL Module* for this node, or accept the default (<message flow name>_Compute).
 - Right-click the Compute node and select **Open ESQL**. Code the following ESQL in the module:

```
-- Declare local working variables
DECLARE I INTEGER 1;
DECLARE J INTEGER CARDINALITY(InputRoot.*[]);

-- Loop to copy all message headers from input to output message
WHILE I < J DO
  SET OutputRoot.*[I] = InputRoot.*[I];
  SET I=I+1;
END WHILE;

-- Set new output message type which uses CRLF delimiter
SET OutputRoot.Properties.MessageType = 't_msg_crlf';

-- Loop to copy each instance of string1 child within message body
SET I = 1;
SET J = CARDINALITY("InputBody"."string1"[]);
WHILE I <= J DO
  SET "OutputRoot"."MRM"."string1"[I] = "InputBody"."string1"[I];
  SET I=I+1;
END WHILE;
```

Note the use of a variable, J, initialized to the value of the cardinality of the existing headers in the message. This is more efficient than calculating the cardinality on each iteration of the loop, which happens if you code the following WHILE statement:

```
WHILE I < CARDINALITY(InputRoot.*[]) DO
```

- d. Add the ResetContentDescriptor1 node, connected to the out terminal of the Compute node:
 - Set *Message Domain* = BLOB
 - Select *Reset Message Domain*.
- e. Finally, add the MQOutput node, connected to the out terminal of the ResetContentDescriptor1 node. Configure its properties to direct the output message to the required queue or queues.

Changing message format:

Use the Compute node to copy part of an input message to an output message. The results of such a copy depend on the type of input and output parsers involved.

Like parsers:

Where both the source and target messages have the same folder structure at root level, a **like-parser-copy** is performed. For example:

```
SET OutputRoot.MQMD = InputRoot.MQMD;
```

This statement copies all the children in the MQMD folder of the input message to the MQMD folder of the output message.

Another example of a tree structure that supports a like-parser-copy is:

```
SET OutputRoot.XMLNS.Data.Account = InputRoot.XMLNS.Customer.Bank.Data;
```

To transform an input message in the MRM domain to an output message also in the MRM domain, you can use either the Compute or the Mapping node. The Mapping node can interpret the action that is required because it knows the format of both messages. Content Assist in the ESQL module for the Compute node can also use the message definitions for those messages. If the messages are not in the same namespace, you must use the Compute node.

To use Content Assist with message references, you must set up a project reference from the project containing the ESQL to the project containing the message set. For information about setting up a project reference, see Project references.

If both input and output messages are not in the MRM domain, you must use the Compute node and specify the structure of the messages yourself.

Unlike parsers:

Where the source and target messages have different folder structures at root level, you cannot make an exact copy of the message source. Instead, the **unlike-parser-copy** views the source message as a set of nested folders terminated by a leaf name-value pair. For example, copying the following message from XML to MRM:

```
<Name3><Name31>Value31</Name31>Value32</Name3>
```

produces a name element Name3, and a name-value element called Name31 with the value Value31. The second XML pcdta (Value32) cannot be represented and is discarded.

The unlike-parser-copy scans the source tree, and copies folders, also known as name elements, and leaf name-value pairs. Everything else, including elements flagged as *special* by the source parser, is not copied.

An example of a tree structure that results in an unlike-parser-copy is:

```
SET OutputRoot.MRM.Data.Account = InputRoot.XMLNS.Data.Account;
```

If the algorithm used to make an unlike-parser-copy does not suit your tree structure, you should further qualify the source field to restrict the amount of tree copied.

Be careful when you copy information from input messages to output messages in different domains. You could code ESQL that creates a message structure or content that is not completely consistent with the rules of the parser that processes the output message. This action can result in an output message not being created, or being created with unexpected content. If you believe that the output message

generated by a particular message flow does not contain the correct content, or have the expected form, check the ESQL that creates the output message, and look for potential mismatches of structure, field types, field names, and field values.

When copying trees between unlike parsers, you should set the message format of the target parser. For example, if a message set has been defined with XMLNS and CWF formats, the following commands are required to copy an input XMLNS stream to the MRM parser and set the latter to be generated in CWF format:

```
-- Copy message to the output, moving from XMLNS to MRM domains
SET OutputRoot.MRM = InputRoot.XMLNS.rootElement;

-- Set the CWF format for output by the MRM domain
SET OutputRoot.Properties.MessageType = '<MessageTypeName>';
SET OutputRoot.Properties.MessageSet = '<MessageSetName>';
SET OutputRoot.Properties.MessageFormat = 'CWF';
```

Adding keywords to ESQL files

You can add keywords to ESQL files to contain information that you want to associate with a message flow.

Use one or more of the following methods:

Comment fields

Add the keyword as a comment in the ESQL file:

```
-- $MQSI compiled by = John MQSI$
```

Static strings

Include the keyword as part of a static string in the ESQL file:

```
SET target = '$MQSI_target = production only MQSI$'
```

Variable string

Include the keyword value as a variable string in the ESQL file:

```
$MQSI_VERSION=$id$MQSI$
```

In this example, when the message flow source is extracted from the file repository, the repository's plug-in has been configured to substitute the identifier *\$id\$* with the actual version number. The identifier value that is required depends on the capability and configuration of the repository, and is not part of WebSphere Message Broker.

Restrictions within keywords

Do not use the following characters within keywords, because they cause unpredictable behavior:

```
^$.|\<>?+*=&[]
```

You can use these characters in the values that are associated with keywords; for example:

- `$MQSI RCSVER=$id$ MQSI$` is acceptable
- `$MQSI $name=Fred MQSI$` is not acceptable

Interaction with databases using ESQL

How to use ESQL statements and functions to access databases.

ESQL has a number of statements and functions for accessing databases:

- The “CALL statement” on page 1487 invokes a stored procedure.

- The “DELETE FROM statement” on page 1531 removes rows from a database table.
- The “INSERT statement” on page 1538 adds a row to a database table.
- The “PASSTHRU function” on page 1659 can be used to make complex selections.
- The “PASSTHRU statement” on page 1547 can be used to invoke administrative operations (for example, creating a table).
- The “SELECT function” on page 1632 retrieves data from a table.
- The “UPDATE statement” on page 1560 changes one or more values stored in zero or more rows.

You can access user databases from Compute, Database, and Filter nodes.

Note: There is no difference between the database access capabilities of these nodes; their names are partly historical and partly based on typical usage. You can use the data in the databases to update or create messages; or use the data in the message to update or create data in the databases.

- Any node that uses any of the ESQL database statements or functions must have its Data Source property set with the name (that is, the ODBC DSN) of a database. The database must be accessible, operational, and allow the broker to connect to it.
- All databases accessed from the same node must have the same ODBC functionality as the database specified on the node’s Data Source property. This requirement is always satisfied if the databases are of the same type (for example, DB2 or Oracle), at the same level (for example, release 8.1 CSD3), and on the same platform. Other database combinations may or may not have the same ODBC functionality. If a node tries to access a database that does not have the same ODBC functionality as the database specified on the node’s Data Source property, the broker issues an error message.
- All tables referred to in a single SELECT FROM clause must be in the same database.

You must ensure that suitable ODBC data sources have been created on the system on which the broker is running. If you have used the `mqsisetdbparms` command to set a user ID and password for a particular database, the broker uses these values to connect to the database. If you have not set a user ID and password, the broker uses the default database user ID and password that you supplied on the `mqsicreatebroker` command (as modified by any subsequent `mqsichangebroker` commands).

z/OS On z/OS systems, use the JCL member BIPSDBP in the customization data set `<hlq>.SBIPPROC` to perform the **`mqsisetdbparms`** command.

You must also ensure that the database user IDs have sufficient privileges to perform the operations your flow requires. Otherwise errors will occur at runtime.

Select the **Throw exception on database error** property check box and the **Treat warnings as errors** property check box, and set the **Transaction** property to **Automatic**, to provide maximum flexibility.

- “Referencing columns in a database” on page 324
- “Selecting data from database columns” on page 325
- “Accessing multiple database tables” on page 329
- “Changing database content” on page 330
- “Checking returns to SELECT” on page 331

- “Committing database updates” on page 332
- “Invoking stored procedures” on page 332

Referencing columns in a database:

While the standard SQL SELECT syntax is supported for queries to an external database, there are a number of points to be borne in mind. You must prefix the name of the table with the keyword Database to indicate that the SELECT is to be targeted at the external database, rather than at a repeating structure in the message.

The basic form of database SELECT is:

```
SELECT ...
  FROM Database.TABLE1
 WHERE ...
```

If necessary, you can specify a schema name:

```
SELECT ...
  FROM Database.SCHEMA.TABLE1
 WHERE ...
```

where SCHEMA is the name of the schema in which the table TABLE1 is defined. Include the schema if the user ID under which you are running does not match the schema. For example, if your userID is USER1, the expression Database.TABLE1 is equivalent to Database.USER1.TABLE1. However, if the schema associated with the table in the database is db2admin, you must specify Database.db2admin.TABLE1. If you do not include the schema, and this does not match your current user ID, the broker generates a runtime error when a message is processed by the message flow.

If, as in the two previous examples, a data source is not specified, TABLE1 must be a table in the default database specified by the node’s data source property. To access data in a database other than the default specified on the node’s data source property, you must specify the data source explicitly. For example:

```
SELECT ...
  FROM Database.DataSource.SCHEMA.TABLE1
 WHERE ...
```

Qualify references to column names with either the table name or the correlation name defined for the table by the FROM clause. So, where you could normally execute a query such as:

```
SELECT column1, column2 FROM table1
```

you must write one of the following two forms:

```
SELECT T.column1, T.column2 FROM Database.table1 AS T
```

```
SELECT table1.column1, table1.column2 FROM Database.table1
```

This is necessary in order to distinguish references to database columns from any references to fields in a message that might also appear in the SELECT:

```
SELECT T.column1, T.column2 FROM Database.table1
  AS T WHERE T.column3 = Body.Field2
```

You can use the AS clause to rename the columns returned. For example:

```
SELECT T.column1 AS price, T.column2 AS item
FROM Database.table1 AS T WHERE...
```

The standard select all SQL option is supported in the SELECT clause. If you use this option, you must qualify the column names with either the table name or the correlation name defined for the table. For example:

```
SELECT T.* FROM Database.Table1 AS T
```

When you use ESQL procedure and function names within a database query, the positioning of these within the call affects how these names are processed. If it is determined that the procedure or function affects the results returned by the query, it is not processed as ESQL and is passed as part of the database call.

This applies when attempting to use a function or procedure name with the column identifiers within the SELECT statement.

For example, if you use a CAST statement on a column identifier specified in the Select clause, this is used during the database query to determine the data type of the data being returned for that column. An ESQL CAST is not performed to that ESQL data type, and the data returned is affected by the database interaction's interpretation of that data type.

If you use a function or procedure on a column identifier specified in the WHERE clause, this is passed directly to the database manager for processing.

The examples in the subsequent topics illustrate how the results sets of external database queries are represented in WebSphere Message Broker. The results of database queries are assigned to fields in a message using a Compute node.

A column function is a function that takes the values of a single column in all the selected rows of a table or message and returns a single scalar result.

Selecting data from database columns:

You can configure a Compute, Filter, or Database node to select data from database columns and include it in an output message.

The following example assumes that you have a database table called USERTABLE with two char(6) data type columns (or equivalent), called Column1 and Column2. The table contains two rows:

	Column1	Column2
Row 1	value1	value2
Row 2	value3	value4

Configure the Compute, Filter, or Database node to identify the database in which you have defined the table. For example, if you are using the default database (specified on the data source property of the node), right-click the node, select **Open ESQL**, and code the following ESQL statements in the module for this node:

```

SET OutputRoot = InputRoot;
DELETE FIELD OutputRoot.*[<];
SET OutputRoot.XML.Test.Result[] =
  (SELECT T.Column1, T.Column2 FROM Database.USERTABLE AS T);

```

This produces the following output message:

```

<Test>
  <Result>
    <Column1>value1</Column1>
    <Column2>value2</Column2>
  </Result>
  <Result>
    <Column1>value3</Column1>
    <Column2>value4</Column2>
  </Result>
</Test>

```

Figure 3. Output message

To trigger the SELECT, send a trigger message with an XML body that is of the following form:

```

<Test>
  <Result>
    <Column1></Column1>
    <Column2></Column2>
  </Result>
  <Result>
    <Column1></Column1>
    <Column2></Column2>
  </Result>
</Test>

```

The exact structure of the XML is not important, but the enclosing tag must be <Test> to match the reference in the ESQL. If the enclosing tag is not <Test>, the ESQL statements result in top-level enclosing tags being formed, which is not valid XML.

If you want to create an output message that includes all the columns of all the rows that meet a particular condition, use the SELECT statement with a WHERE clause:

```

-- Declare and initialize a variable to hold the
--   test value (in this case the surname Smith)
DECLARE CurrentCustomer STRING 'Smith';

-- Loop through table records to extract matching information
SET OutputRoot.XML.Invoice[] =
  (SELECT R FROM Database.USERTABLE AS R
    WHERE R.Customer.LastName = CurrentCustomer
  );

```

The message fields are created in the same order as the columns occur in the table.

If you are familiar with SQL in a database environment, you might expect to code SELECT *. This is not accepted by the broker because you must start all references to columns with a correlation name. This avoids ambiguities with declared variables. Also, if you code SELECT I.*, this is accepted by the broker but the * is interpreted as the first child element, not all elements, as you might expect from other database SQL.

The assignment of the result set of a database into a parser-owned message tree requires the result set to exactly match the message definition. Because the generic XML parser is self-defining, the example creates a new subtree off the Invoice folder, and the parser can parse the new elements in the subtree. If the structure of the result set exactly matches the message definition, the result set can be assigned directly into the OutputRoot message body tree.

If the structure of the result set does not exactly match the MRM message definition, you must first assign the result set into a ROW data type, or an Environment tree that doesn't have any parsers associated with it.

The required data can then be assigned to OutputRoot to build a message tree that conforms to the message definition.

Selecting data from a table in a case-sensitive database system:

If the database system is case-sensitive, you must use an alternative approach. This approach is also necessary if you want to change the name of the generated field to something different:

```
SET OutputRoot = InputRoot;
SET OutputRoot.XML.Test.Result[] =
  (SELECT T.Column1 AS Column1, T.Column2 AS Column2
   FROM Database.USERTABLE AS T);
```

This example produces the same Figure 3 on page 326 shown above. Ensure that references to the database columns (in this example, T.Column1 and T.Column2) are specified in the correct case to match the database definitions exactly. If you do not match the database definitions exactly (for example if you specify T.COLUMN1), the broker generates a runtime error. Note the use of Column1 and Column2 in the SELECT statement. You can use any values here; the values do not have to match the names of the columns that you have defined in the database as they do in this example.

Selecting bitstream data from a database:

These samples show how to retrieve XML bitstream data from a database and include it in an output message. See "INSERT statement" on page 1538 for examples that show how you can insert bitstream data into a database.

In the following example, bitstream data is held in a database column with a BLOB data type. Note that the database table used in the example (TABLE1) is the one created in the "INSERT statement" on page 1538 examples, and the table contains the following columns:

- MSGDATA
- MSGCCSID
- MSGENCODING

If the bit stream from the database does not need to be interrogated or manipulated by the message flow, the output message can be constructed in the BLOB domain without any alteration.

In the following example, the message data, along with the MQMD header, is held in a database column with a BLOB data type. To recreate the message tree, including the MQMD header, from the bit stream, you can use a CREATE statement with a PARSE clause and DOMAIN('MQMD'). The output message can then be modified by the message flow:

```

SET Environment.Variables.DBResult = THE( SELECT T.* FROM Database.TABLE1 AS T);
DECLARE resultRef REFERENCE TO Environment.Variables.DBResult;

IF LASTMOVE(resultRef) THEN

    DECLARE outMsg BLOB resultRef.MSGDATA ;
    DECLARE outCCSID INT resultRef.MSGCCSID;
    DECLARE outEncoding INT resultRef.MSGENCODING;
    DECLARE outMsgPriority INT resultRef.MSGPRIORITY;
    DECLARE outMsgSeqNum INT resultRef.MSGSEQNUMBER;

    SET OutputRoot.Properties.CodedCharSetId = outCCSID;
    SET OutputRoot.Properties.Encoding = outEncoding ;

    CREATE LASTCHILD OF OutputRoot DOMAIN('MQMD') PARSE(outMsg, outEncoding, outCCSID);

    SET OutputRoot.MQMD.StrucId = MQMD_STRUC_ID;
    SET OutputRoot.MQMD.Version = MQMD_VERSION_2;

    SET OutputRoot.MQMD.Priority = outMsgPriority;
    SET OutputRoot.MQMD.MsgSeqNumber = outMsgSeqNum;

    DECLARE HDRL INT ;
    SET HDRL = LENGTH(BITSTREAM(OutputRoot.MQMD));
    CREATE FIELD OutputRoot."BLOB"."BLOB";
    DECLARE MSGB BLOB;
    SET MSGB = SUBSTRING(outMsg FROM HDRL +1);
    SET OutputRoot."BLOB"."BLOB" = MSGB;

END IF;

```

If you want to interrogate or manipulate a bit stream extracted from a database, you must re-create the original message tree. To re-create the XML message tree from the bit stream you can use a CREATE statement with a PARSE clause. The output message can then be modified by the message flow. The following example shows how to re-create the message tree in the XMLNS domain:

```

CALL CopyMessageHeaders();
SET Environment.Variables.DBResult = THE( SELECT T.* FROM Database.TABLE1 AS T);
DECLARE resultRef REFERENCE TO Environment.Variables.DBResult;
IF LASTMOVE(resultRef) THEN
    DECLARE outCCSID INT resultRef.MSGCCSID;
    DECLARE outEncoding INT resultRef.MSGENCODING;
    DECLARE outMsg BLOB resultRef.MSGDATA;
    SET OutputRoot.Properties.CodedCharSetId = outCCSID;
    SET OutputRoot.Properties.Encoding = outEncoding;
    CREATE LASTCHILD OF OutputRoot DOMAIN('XMLNS') PARSE(outMsg, outEncoding, outCCSID);
    -- Now modify the message tree fields
    SET OutputRoot.XMLNS.A.B = 4;
    SET OutputRoot.XMLNS.A.E = 5;
END IF;

```

In the following example, the data is held in a database column with a character data type, such as CHAR or VARCHAR. A cast is used to convert the data extracted from the database into BLOB format. If the bitstream data from the database does not need to be interrogated or manipulated by the message flow, the output message can be constructed in the BLOB domain, without any alteration.

```

CALL CopyMessageHeaders();
SET Environment.Variables.DBResult = THE( SELECT T.* FROM Database.TABLE1 AS T);
DECLARE resultRef REFERENCE TO Environment.Variables.DBResult;
IF LASTMOVE(resultRef) THEN
    DECLARE outCCSID INT resultRef.MSGCCSID;
    DECLARE outMsg BLOB CAST(resultRef.MSGDATA AS BLOB CCSID outCCSID);

```



```

SET OutputRoot.Properties.CodedCharSetId = outCCSID;
SET OutputRoot.Properties.Encoding = resultRef.MSGENCODING;
SET OutputRoot.BLOB.BLOB = outMsg;
END IF;

```

In the following example, the data is held in a database column with a character data type, such as CHAR or VARCHAR. A cast is used to convert the data extracted from the database into BLOB format. To manipulate or interrogate this data within the message flow, you must re-create the original message tree. In this example, a CREATE statement with a PARSE clause is used to re-create the XML message tree in the XMLNS domain.

```

CALL CopyMessageHeaders();
SET Environment.Variables.DBResult = THE( SELECT T.* FROM Database.TABLE1 AS T);
DECLARE resultRef REFERENCE TO Environment.Variables.DBResult;
IF LASTMOVE(resultRef) THEN
  DECLARE outCCSID INT resultRef.MSGCCSID;
  DECLARE outEncoding INT resultRef.MSGENCODING;
  DECLARE outMsg BLOB CAST(resultRef.MSGDATA AS BLOB CCSID outCCSID);
  SET OutputRoot.Properties.CodedCharSetId = outCCSID;
  SET OutputRoot.Properties.Encoding = outEncoding;
  CREATE LASTCHILD OF OutputRoot DOMAIN('XMLNS') PARSE(outMsg, outEncoding, outCCSID);
  -- Now modify the message tree fields
  SET OutputRoot.XMLNS.A.B = 4;
  SET OutputRoot.XMLNS.A.E = 5;
END IF;

```

Accessing multiple database tables:

You can refer to multiple tables that you have created in the same database. Use the FROM clause on the SELECT statement to join the data from the two tables.

The following example assumes that you have two database tables called USERTABLE1 and USERTABLE2. Both tables have two char(6) data type columns (or equivalent).

USERTABLE1 contains two rows:

	Column1	Column2
Row 1	value1	value2
Row 2	value3	value4

USERTABLE2 contains two rows:

	Column3	Column4
Row 1	value5	value6
Row 2	value7	value8

All tables referenced by a single SELECT function must be in the same database. The database can be either the default (specified on the “data source” property of the node) or another database (specified on the FROM clause of the SELECT function).

Configure the Compute, Filter, or Database node that you’re using to identify the database in which you have defined the tables. For example, if you’re using the default database, right-click the node, select **Open ESQL**, and code the following

ESQL statements in the module for this node:

```
SET OutputRoot.XML.Test.Result[] =
    (SELECT A.Column1 AS FirstColumn,
           A.Column2 AS SecondColumn,
           B.Column3 AS ThirdColumn,
           B.Column4 AS FourthColumn
     FROM Database.USERTABLE1 AS A,
           Database.USERTABLE2 AS B
     WHERE A.Column1 = 'value1' AND
           B.Column4 = 'value8'
    );
```

This results in the following output message content:

```
<Test>
  <Result>
    <FirstColumn>value1</FirstColumn>
    <SecondColumn>value2</SecondColumn>
    <ThirdColumn>value7</ThirdColumn>
    <FourthColumn>value8</FourthColumn>
  </Result>
</Test>
```

The example above shows how to access data from two database tables. You can code more complex FROM clauses to access multiple database tables (although all the tables must be in the same database). You can also refer to one or more message trees, and can use SELECT to join tables with tables, messages with messages, or tables with messages. “Joining data from messages and database tables” on page 351 provides an example of how to merge message data with data in a database table.

(defined by the *data source* property of the node).

If you specify an ESQL function or procedure on the column identifier in the WHERE clause, this is processed as part of the database query and not as ESQL.

Consider the following example:

```
SET OutputRoot.XML.Test.Result =
    THE(SELECT ITEM T.Column1 FROM Database.USERTABLE1 AS T
     WHERE UPPER(T.Column2) = 'VALUE2');
```

This attempts to return the rows where the value of Column2 converted to upper case is VALUE2. However, only the database manager can determine the value of T.Column2 for any given row, and therefore it cannot be processed by ESQL before the database query is issued, because the WHERE clause determines the rows that are returned to the message flow.

Therefore, the UPPER is passed to the database manager to be included as part of its processing. However, if the database manager cannot process the token within the select statement, an error is returned.

Changing database content:

You can code ESQL in the Compute, Database, and Filter nodes to change the contents of a database in the following ways:

- Update data in a database
- Insert data into a database
- Delete data from a database

The following ESQL code includes statements that show all three operations. This code is appropriate for a Database and Filter node; if you create this code for a Compute node, use the correlation name InputRoot in place of Root.

```

IF Root.XMLNS.TestCase.Action = 'INSERT' THEN
  INSERT INTO Database.STOCK (STOCK_ID, STOCK_DESC, STOCK_QTY_HELD,
    BROKER_BUY_PRICE, BROKER_SELL_PRICE, STOCK_HIGH_PRICE, STOCK_HIGH_DATE,
    STOCK_HIGH_TIME) VALUES
    (CAST(Root.XMLNS.TestCase.stock_id AS INTEGER),
     Root.XMLNS.TestCase.stock_desc,
     CAST(Root.XMLNS.TestCase.stock_qty_held AS DECIMAL),
     CAST(Root.XMLNS.TestCase.broker_buy_price AS DECIMAL),
     CAST(Root.XMLNS.TestCase.broker_sell_price AS DECIMAL),
     Root.XMLNS.TestCase.stock_high_price,
     CURRENT_DATE,
     CURRENT_TIME);

ELSEIF Root.XMLNS.TestCase.Action = 'DELETE' THEN

  DELETE FROM Database.STOCK WHERE STOCK.STOCK_ID =
    CAST(Root.XMLNS.TestCase.stock_id AS INTEGER);

ELSEIF Root.XMLNS.TestCase.Action = 'UPDATE' THEN

  UPDATE Database.STOCK as A SET STOCK_DESC = Root.XMLNS.TestCase.stock_desc
    WHERE A.STOCK_ID = CAST(Root.XMLNS.TestCase.stock_id AS INTEGER);
END IF;

```

Checking returns to SELECT:

If a SELECT function returns no data, or no further data, this result is handled as a normal situation and no error code is set in SQLCODE, regardless of the setting of the Throw Exception On Database Error and Treat Warnings As Errors properties on the current node.

To recognize that a SELECT function has returned no data, include ESQL that checks what has been returned. You can use various methods:

1. EXISTS

This ESQL returns a Boolean value that indicates if a SELECT function returned one or more values (TRUE), or none (FALSE).

```

IF EXISTS(SELECT T.MYCOL FROM Database.MYTABLE) THEN
  ...

```

2. CARDINALITY

If you expect an array in response to a SELECT, you can use CARDINALITY to calculate how many entries have been received.

```

SET OutputRoot.XMLNS.Testcase.Results[] = (
  SELECT T.MYCOL FROM Database.MYTABLE)
.....
IF CARDINALITY (OutputRoot.XMLNS.Testcase.Results[])> 0 THEN
  .....

```

3. IS NULL

If you have used either THE or ITEM keywords in your SELECT function, a scalar value is returned. If no rows have been returned, the value set is NULL. However, it is possible that the value NULL is contained within the column, and you might want to distinguish between these two cases.

Distinguish between cases by including COALESCE in the SELECT function, for example:

```
SET OutputRoot.XMLNS.Testcase.Results VALUE = THE (  
  SELECT ITEM COALESCE(T.MYCOL, 'WAS NULL')  
  FROM Database.MYTABLE);
```

If this example returns the character string `WAS NULL`, it indicates that the column contained `NULL`, and not that no rows were returned.

In previous releases, an `SQLCODE` of 100 was set in most cases if no data, or no further data, was returned. An exception was raised by the broker if you chose to handle database errors in the message flow.

Committing database updates:

When you create a message flow that interacts with databases, you can choose whether the updates that you make are committed when the current node has completed processing, or when the current invocation of the message flow has terminated.

For each node, select the appropriate option for the *Transaction* property to specify when its database updates are to be committed:

- Choose `Automatic` (the default) if you want updates made in this node to be committed or rolled back as part of the whole message flow. The actions that you define in the `ESQL` module are performed on the message and it continues through the message flow. If the message flow completes successfully, the updates are committed. If the message flow fails, the message and the database updates are rolled back.
- Choose `Commit` if you want to commit the action of the node on the database, irrespective of the success or failure of the message flow as a whole. The database update is committed when the node processing is successfully completed, that is, after all `ESQL` has been processed, even if the message flow itself detects an error in a subsequent node that causes the message to be rolled back.

The value that you choose is implemented for the database tables that you have updated. You cannot select a different value for each table.

If you have set *Transaction* to `Commit`, the behavior of the message flow and the commitment of database updates can be affected by the use of the `PROPAGATE` statement.

If you choose to include a `PROPAGATE` statement in the node's `ESQL` that generates one or more output message from the node, the processing of the `PROPAGATE` statement is not considered complete until the entire path that the output message takes has completed. This path might include several other nodes, including one or more output nodes. Only then does the node that issues the `PROPAGATE` statement receive control back and its `ESQL` terminate. At that point, a database commit is performed, if appropriate.

If one of the nodes on the propagated path detects an error and throws an exception, the processing of the node in which you have coded the `PROPAGATE` statement never completes. If the error processing results in a rollback, the message flow *and the database update in this node* are rolled back. This behavior is consistent with the stated operation of the `Commit` option, but might not be the behavior that you expect.

Invoking stored procedures:

To invoke a procedure that is stored in a database, use the ESQL CALL statement. The stored procedure must be defined by a “CREATE PROCEDURE statement” on page 1511 that has:

- A Language clause of DATABASE
- An EXTERNAL NAME clause that identifies the name of the procedure in the database and, optionally, the database schema to which it belongs.

When you invoke a stored procedure with the CALL statement, the broker ensures that the ESQL definition and the database definition match:

- The external name of the procedure must match a procedure in the database.
- The number of parameters must be the same.
- The type of each parameter must be the same.
- The direction of each parameter (IN, OUT, INOUT) must be the same.

The following restrictions apply to the use of stored procedures:

- Overloaded procedures are not supported. (An overloaded procedure is one that has the same name as another procedure in the same database schema with a different number of parameters, or parameters with different types.) If the broker detects that a procedure has been overloaded, it raises an exception.
- In an Oracle stored procedure declaration, you are not permitted to constrain CHAR and VARCHAR2 parameters with a length, and NUMBER parameters with a precision or scale, or both. Use %TYPE when you declare CHAR, VARCHAR and NUMBER parameters to provide constraints on a formal parameter.

Creating a stored procedure in ESQL:

When you define an ESQL procedure that corresponds to a database stored procedure, you can specify either a qualified name (where the qualifier is a database schema) or an unqualified name.

To create a stored procedure:

1. Code a statement similar to this example to create an unqualified procedure:

```
CREATE PROCEDURE myProc1(IN p1 CHAR) LANGUAGE DATABASE EXTERNAL NAME "myProc";
```

The EXTERNAL NAME that you specify must match the definition you have created in the database, but you can specify any name you choose for the corresponding ESQL procedure.
2. Code a statement similar to this example to create a qualified procedure:

```
CREATE PROCEDURE myProc2(IN p1 CHAR) LANGUAGE DATABASE EXTERNAL NAME "Schema1.myProc";
```
3. Code a statement similar to this example to create a qualified procedure in an Oracle package:

```
CREATE PROCEDURE myProc3(IN p1 CHAR) LANGUAGE DATABASE EXTERNAL  
NAME "mySchema.myPackage.myProc";
```

For examples of stored procedure definitions in the database, see the “CREATE PROCEDURE statement” on page 1511.

Calling a stored procedure:

1. Code a statement similar to this example to invoke an unqualified procedure:

```
CALL myProc1('HelloWorld');
```

Because it is not defined explicitly as belonging to any schema, the myProc1 procedure must exist in the default schema (the name of which is the user name used to connect to the data source) or the command fails.

- The following example calls the myProc procedure in schema Schema1.

```
CALL myProc2('HelloWorld');
```
- Code a statement similar to this example to invoke an unqualified procedure with a dynamic schema:

```
DECLARE Schema2 char 'mySchema2';
CALL myProc1('HelloWorld') IN Database.{ 'Schema2'};
```

This statement calls the myProc1 procedure in database Schema2, overriding the default “username” schema.

Calling a stored procedure that returns two result sets:

To call a stored procedure that takes one input parameter and returns one output parameter and two result sets:

- Define the procedure with a CREATE PROCEDURE statement that specifies one input parameter, one output parameter, and two result sets:

```
CREATE PROCEDURE myProc1 (IN P1 INT, OUT P2 INT)
LANGUAGE DATABASE
DYNAMIC RESULT SETS 2
EXTERNAL NAME "myschema.myproc1";
```

- To invoke the myProc1 procedure using a field reference, code:

```
/* using a field reference */
CALL myProc1(InVar1, OutVar2, Environment.ResultSet1[],
            OutputRoot.XMLNS.Test.ResultSet2[]);
```

- To invoke the myProc1 procedure using a reference variable, code:

```
/* using a reference variable*/
DECLARE cursor REFERENCE TO OutputRoot.XMLNS.Test;

CALL myProc1(InVar1, cursor.OutVar2, cursor.ResultSet1[],
            cursor.ResultSet2[]);
```

Coding ESQL to handle errors

When you process messages in a message flow, errors can have a number of different causes and the message flow designer must decide how to handle those errors.

Introduction

When you process messages in message flows, errors can have the following causes:

- External causes; for example, the incoming message is syntactically invalid, a database used by the flow has been shut down, or the power supply to the machine on which the broker is running fails.
- Internal causes; for example, an attempt to insert a row into a database table fails because of a constraint check, or a character string that is read from a database cannot be converted to a number because it contains alphabetic characters.

Internal errors can be caused by programs storing invalid data in the database, or by a flaw in the logic of a flow.

The message flow designer must decide how to handle errors.

Using default error-handling

The simplest strategy for handling ESQL errors is to do nothing and use the broker’s default behavior. The default behavior is to cut short the processing of the

failing message and to proceed to the next message. Input and output nodes provide options to control exactly what happens when processing is cut short.

If the input and output nodes are set to transactional mode, the broker restores the state prior to the message being processed:

1. The input message that has apparently been taken from the input queue is put back.
2. Any output messages that the flow has apparently written to output queues are discarded.

If the input and output nodes are not set to transactional mode:

1. The input message that was taken from the input queue is not put back.
2. Any output messages that the flow has written to output queues remain on the output queues.

Each of these strategies has its advantages. The transactional model preserves the consistency of data, while the non-transactional model maximizes the continuity of message processing. In the transactional model, the failing input message is put back onto the input queue, and the broker attempts to process it again. The most likely outcome of this scenario is that the message continues to fail until the retry limit is reached, at which point the message is placed on a dead letter queue. The reason for the failure to process the message is logged to the system event log (Windows) or syslog (UNIX). Therefore, the failing message holds up the processing of subsequent valid messages, and is left unprocessed by the broker.

Most databases operate transactionally so that all changes that are made to database tables are committed if the processing of the message succeeds, or rolled back if it fails, therefore maintaining the integrity of data. An exception to this situation is if the broker itself, or a database, fails (for example, the power to the computers on which they are running is interrupted). In these cases, changes might be committed in some databases, but not in others, or the database changes might be committed but the input and output messages are not committed. If these possibilities concern you, make the flow coordinated and configure the databases that are involved.

Using customized error handling: The following list contains some general tips for creating customized error handlers.

- If you require something better than default error handling, the first step is to use a handler; see “DECLARE HANDLER statement” on page 1530. Create one handler per node to intercept all possible exceptions (or as many exceptions as can be foreseen).
- Having intercepted an error, the error handler can use whatever logic is appropriate to handle it. Alternatively, it can use a THROW statement or node to create an exception, which could be handled higher in the flow logic, or even reach the input node, causing the transaction to be rolled back; see “Throwing an exception” on page 338.
- If a node generates an exception that is not caught by the handler, the flow is diverted to the Failure terminal, if one is connected, or handled by default error-handling if no Failure terminal is connected.

Use Failure terminals to catch unhandled errors. Attach a simple logic flow to the Failure terminal. This logic flow could consist of a database or Compute node that writes a log record to a database (possibly including the message’s bit stream), or writes a record to the event log. The flow could also contain an output node that writes the message to a special queue.

The full exception tree is passed to any node that is connected to a Failure terminal; see “Exception list tree structure” on page 67.

- Your error handlers are responsible for logging each error in an appropriate place, such as the system event log.

For a detailed description of the options that you can use to process errors in a message flow, see “Handling errors in message flows” on page 203. For examples of what you can do, see “Throwing an exception” on page 338 and “Capturing database state” on page 339.

Writing code to detect errors

The following sections assume that the broker detects the error. It is possible, however, for the logic of the flow to detect an error. For example, when coding the flow logic, you could use the following elements:

- IF statements that are inserted specifically to detect situations that should not occur
- The ELSE clause of a case expression or statement to trap routes through the code that should not be possible

As an example of a flow logic-detected error, consider a field that has a range of possible integer values that indicate the type of message. It would not be good practice to leave to chance what would happen if a message were to arrive in which the field’s value did not correspond to any known type of message. One way this situation could occur is if the system is upgraded to support extra types of message, but one part of the system is not upgraded.

Using your own logic to handle input messages that are not valid

Input messages that are syntactically invalid (and input messages that appear to be not valid because of erroneous message format information) are difficult to deal with because the broker has no idea what the message contains. Typically, the best way of dealing with these messages is to configure the input node to fully parse and validate the message. However, this configuration applies only to predefined messages, that is MRM or IDoc.

If the input node is configured in this way, the following results are guaranteed if the input message cannot be parsed successfully:

- The input message never emerges from the node’s normal output terminal (it goes to the Failure terminal).
- The input message never enters the main part of the message flow.
- The input message never causes any database updates.
- No messages are written to any output queues.

To deal with a failing message, connect a simple logic flow to the Failure terminal. The only disadvantage to this strategy is that if the normal flow does not require access to all of the message’s fields, the forcing of complete parsing of the message affects performance.

Using your own logic to handle database errors

Database errors fall into three categories:

- The database is not working at all (for example, it’s off line).
- The database is working but refuses your request (for example, a lock contention occurs).

- The database is working but what you ask it to do is impossible (for example, to read from a non-existent table).

If you require something better than default error handling, the first step is to use a handler (see “DECLARE HANDLER statement” on page 1530) to intercept the exception. The handler can determine the nature of the failure from the SQL state that is returned by the database.

A database is not working

If a database is not working at all, and is essential to the processing of messages, there is typically not much that you can do. The handler, having determined the cause, might perform any of the following actions:

- Use the RESIGNAL statement to re-throw the original error, therefore allowing the default error handler to take over
- Use a different database
- Write the message to a special output queue

However, take care with this sort of strategy. The handler absorbs the exception, therefore any changes to other databases, or writes to queues, are committed.

A database refuses your request

The situation when a lock contention occurs is similar to the “Database not working” case because the database will have backed out *all* the database changes that you have made for the current message, not just the failing request. Therefore, unless you are sure that this was the only update, default error-handling is typically the best strategy, except possibly logging the error or passing the message to a special queue.

Impossible requests

The case where the database is working but what you ask it to do is impossible covers a wide variety of problems.

If, as in the example, the database simply does not have a table of the name that the flow expects, default error-handling is typically the best strategy, except possibly logging the error or passing the message to a special queue. Many other errors might be handled successfully, however. For example, an attempt to insert a row might fail because there is already such a row and the new row would be a duplicate. Or an attempt to update a row might fail because there is no such row (that is, the update updated zero rows). In these cases, the handler can incorporate whatever logic you think fit. It might insert the missing row or utilize the existing one (possibly making sure the values in it are suitable).

Note: For an update of zero rows to be reported as an error, the Treat warnings as errors node property must be set to true, which is not the default setting.

Using your own logic to handle errors in output nodes

Errors that occur in MQOutput nodes report the nature of the error in the SQL state and give additional information in the *SQL native error* variable. Therefore, if something better than default error handling is required, the first step is to use a handler (see “DECLARE HANDLER statement” on page 1530) to intercept the exception. Such a handler typically surrounds only a single PROPAGATE statement.

Using your own logic to handle other errors

Besides those errors covered above, a variety of other errors can occur. For example, an arithmetic calculation might overflow, a cast might fail because of the unsuitability of the data, or an access to a message field might fail because of a type constraint. The broker offers two programming strategies for dealing with these types of error.

- The error causes an exception that is either handled or left to roll back the transaction.
- The failure is recorded as a special value that is tested for later.

In the absence of a type constraint, an attempt to access a non-existent message field results in the value null. Null values propagate through expressions, making the result null. Therefore, if an expression, however complex, does not return a null value, you know that all the values that it needed to calculate its result were not null.

Cast expressions can have a default clause. If there is a default clause, casts fail quietly; instead of throwing an exception, they simply return the default value. The default value could be an innocuous number (for example, zero for an integer), or a value that is clearly invalid in the context (for example, -1 for a customer number). Null might be particularly suitable because it is a value that is different from all others, and it will propagate through expressions without any possibility of the error condition being masked.

Handling errors in other nodes

Exceptions that occur in other nodes (that is, downstream of a PROPAGATE statement) might be caught by handlers in the normal way. Handling such errors intelligently, however, poses a problem: another node was involved in the original error, therefore another node, and not necessarily the originator of the exception, is likely to be involved in handling the error.

To help in these situations, the Database and Compute nodes have four terminals called Out1, Out2, Out3, and Out4. In addition, the syntax of the PROPAGATE statement includes target expression, message source, and control clauses to give more control over these terminals.

Throwing an exception:

If you detect an error or other situation in your message flow in which you want message processing to be ended, you can throw an exception in a message flow in two ways:

1. Use the ESQL THROW EXCEPTION statement.
Include the THROW statement anywhere in the ESQL module for a Compute, Database, or Filter node. Use the options on the statement to code your own data to be inserted into the exception.
2. Include a THROW node in your message flow.
Set the node properties to identify the source and content of the exception.

Using either statement options or node properties, you can specify a message identifier and values that are inserted into the message text to give additional information and identification to users who interpret the exception. You can specify any message in any catalog that is available to the broker. See Using event logging from a user-defined extension for more information.

The situations in which you might want to throw an exception are determined by the behavior of the message flow; decide when you design the message flow where this action might be appropriate. For example, you might want to examine the content of the input message to ensure that it meets criteria that cannot be detected by the input node (which might check that a particular message format is received).

The example below uses the example Invoice message to show how you can use the ESQL THROW statement. If you want to check that the invoice number is within a particular range, throw an exception for any invoice message received that does not fall in the valid range.

```
--Check for invoice number lower than permitted range
IF Body.Invoice.InvoiceNo < 100000 THEN
  THROW USER EXCEPTION CATALOG 'MyCatalog' MESSAGE 1234 VALUES
  ('Invoice number too low', Body.Invoice.InvoiceNo);

-- Check for invoice number higher than permitted range
ELSEIF Body.InvoiceNo> 500000 THEN
  THROW USER EXCEPTION CATALOG 'MyCatalog' MESSAGE 1235 VALUES
  ('Invoice number too high', Body.Invoice.InvoiceNo);

ELSE DO
  -- invoice number is within permitted range
  -- complete normal processing
ENDIF;
```

Capturing database state:

This topic describes your options if an error occurs when accessing an external database.

If an error occurs when accessing an external database, you have two options:

- Let the broker throw an exception during node processing
- Process the exception within the node itself using ESQL statements

The first option is the default; ESQL processing in the current node is abandoned. The exception is then propagated backwards through the message flow until an enclosing catch node, or the input node for this message flow, is reached. If the exception reaches the input node, any transaction is rolled back.

The second option requires an understanding of database return codes and a logical course of action to take when an error occurs. To enable this inline database error processing, you must clear the Filter, Database, or Compute node's Throw Exception On Database Error property. If you do this, the node sets the database state indicators SQLCODE, SQLSTATE, SQLNATIVEERROR, and SQLERRORTXT, with appropriate information from the database manager instead of throwing an exception.

The indicators contain information only when an error (not a warning) occurs, unless you have selected the Treat Warnings As Errors property. In the case of successful and success with information database operations, the indicators contain their default success values.

You can use the values contained in these indicators in ESQL statements to make decisions about the action to take. You can access these indicators with the SQLCODE, SQLSTATE, SQLNATIVEERROR, and SQLERRORTXT functions.

If you are attempting inline error processing, you must check the state indicators after each database statement is executed to ensure that you catch and assess all errors. When processing the indicators, if you meet an error that you cannot handle inline, you can raise a new exception either to deal with it upstream in a catch node, or to let it through to the input node so that the transaction is rolled back. You can use the `ESQL THROW` statement to do this.

You might want to check for the special case in which a `SELECT` returns no data. This situation is not considered an error and `SQLCODE` is not set, so you must test explicitly for it. This is described in “Checking returns to `SELECT`” on page 331.

Using ESQL to access database state indicators

The following ESQL example shows how to use the four database state functions, and how to include the error information that is returned in an exception:

```
DECLARE SQLState1 CHARACTER;
DECLARE SQLErrorText1 CHARACTER;
DECLARE SQLCode1 INTEGER;
DECLARE SQLNativeError1 INTEGER;

-- Make a database insert to a table that does not exist --
INSERT INTO Database.DB2ADMIN.NONEXISTENTTABLE (KEY,QMGR,QNAME)
        VALUES (45,'REG356','my TESTING 2');

--Retrieve the database return codes --
SET SQLState1 = SQLSTATE;
SET SQLCode1 = SQLCODE;
SET SQLErrorText1 = SQLERRORTXT;
SET SQLNativeError1 = SQLNATIVEERROR;

--Use the THROW statement to back out the database and issue a user exception--
THROW USER EXCEPTION MESSAGE 2950 VALUES
( 'The SQL State' , SQLState1 , SQLCode1 , SQLNativeError1 ,
  SQLErrorText1 );
```

You do not have to throw an exception when you detect a database error; you might prefer to save the error information returned in the `LocalEnvironment` tree, and include a `Filter` node in your message flow that routes the message to error or success subflows according to the values saved.

The following sample program provides another example of ESQL that uses these database functions:

- Airline Reservations sample

You can view samples only when you use the information center that is integrated with the Message Broker Toolkit.

Using the SELECT function

The `SELECT` function is a convenient and powerful tool for accessing fields and transforming data in a message tree.

The following topics show by example how to use the `SELECT` function to transform a variety of messages. The examples are based on an XML input message that has been parsed in the XMLNS domain. However, the techniques shown in these topics can be applied to any message tree.

- “Transforming a simple message” on page 341
- “Transforming a complex message” on page 344
- “Returning a scalar value in a message” on page 346

- “Joining data in a message” on page 348
- “Translating data in a message” on page 349
- “Joining data from messages and database tables” on page 351

Transforming a simple message:

When you code the ESQL for a Compute node, use the SELECT function to transform simple messages.

This topic provides examples of simple message transformation. Review the examples and modify them for your own use. They are all based on the Invoice message as input.

Consider the following ESQL:

```
SET OutputRoot.XMLNS.Data.Output[] =
  (SELECT R.Quantity, R.Author FROM InputRoot.XMLNS.Invoice.Purchases.Item[] AS R
  );
```

When this ESQL code processes the Invoice message, it produces the following output message:

```
<Data>
  <Output>
    <Quantity>2</Quantity>
    <Author>Neil Bradley</Author>
  </Output>
  <Output>
    <Quantity>1</Quantity>
    <Author>Don Chamberlin</Author>
  </Output>
  <Output>
    <Quantity>1</Quantity>
    <Author>Philip Heller, Simon Roberts</Author>
  </Output>
</Data>
```

Three Output fields are present, one for each Item field, because SELECT creates an item in its result list for each item described by its FROM list. Within each Output field, a Field is created for each field named in the SELECT clause. These fields are in the order in which they are specified within the SELECT clause, not in the order in which they appear in the incoming message.

The R that is introduced by the final AS keyword is known as a correlation name. It is a local variable that represents in turn each of the fields addressed by the FROM clause. The name chosen has no significance. In summary, this simple transform does two things:

1. It discards unwanted fields.
2. It guarantees the order of the fields.

You can perform the same transform with a procedural algorithm:

```

DECLARE i INTEGER 1;
DECLARE count INTEGER CARDINALITY(InputRoot.XMLNS.Invoice.Purchases.Item[]);

WHILE (i <= count)
  SET OutputRoot.XMLNS.Data.Output[i].Quantity = InputRoot.XMLNS.Invoice.Purchases.Item[i].Quantity;
  SET OutputRoot.XMLNS.Data.Output[i].Author = InputRoot.XMLNS.Invoice.Purchases.Item[i].Author;
  SET i = i+1;
END WHILE;

```

These examples show that the SELECT version of the transform is much more concise. It also executes faster.

The following example shows a more advanced transformation:

```

SET OutputRoot.XMLNS.Data.Output[] =
  (SELECT R.Quantity AS Book.Quantity,
         R.Author AS Book.Author
   FROM InputRoot.XMLNS.Invoice.Purchases.Item[] AS R
  );

```

In this transform, an AS clause is associated with each item in the SELECT clause. This clause gives each field in the result an explicit name rather than a field name that is inherited from the input. These names can be paths (that is, a dot-separated list of names), as shown in the example. The structure of the output message structure can be different from the input message. Using the same Invoice message, the result is:

```

<Data>
  <Output>
    <Book>
      <Quantity>2</Quantity>
      <Author>Neil Bradley</Author>
    </Book>
  </Output>
</Data>

<Data>
  <Output>
    <Book>
      <Quantity>2</Quantity>
      <Author>Neil Bradley</Author>
    </Book>
  </Output>
  <Output>
    <Book>
      <Quantity>1</Quantity>
      <Author>Don Chamberlin</Author>
    </Book>
  </Output>
  <Output>
    <Book>
      <Quantity>1</Quantity>
      <Author>Philip Heller, Simon Roberts</Author>
    </Book>
  </Output>
</Data>

```

The expressions in the SELECT clause can be of any complexity and there are no special restrictions. They can include operators, functions, and literals, and they can refer to variables or fields that are not related to the correlation name. The following example shows more complex expressions:

```

SET OutputRoot.XMLNS.Data.Output[] =
  (SELECT 'Start' AS Header,
         'Number of books:' || R.Quantity AS Book.Quantity,
         R.Author || ':Name and Surname' AS Book.Author,
         'End' AS Trailer
   FROM InputRoot.XMLNS.Invoice.Purchases.Item[] AS R
  );

```

Using the same Invoice message, the result in this case is:

```

<Data>
  <Output>
    <Header>Start</Header>
    <Book>
      <Quantity>Number of books:2</Quantity>
      <Author>Neil Bradley:Name and Surname</Author>
    </Book>
    <Trailer>End</Trailer>
  </Output>
  <Output>
    <Header>Start</Header>
    <Book>
      <Quantity>Number of books:1</Quantity>
      <Author>Don Chamberlin:Name and Surname</Author>
    </Book>
    <Trailer>End</Trailer>
  </Output>
  <Output>
    <Header>Start</Header>
    <Book>
      <Quantity>Number of books:1</Quantity>
      <Author>Philip Heller, Simon Roberts:Name and Surname</Author>
    </Book>
    <Trailer>End</Trailer>
  </Output>
</Data>

```

As shown above, the AS clauses of the SELECT clause contain a path that describes the full name of the field that is to be created in the result. These paths can also specify (as is normal for paths) the type of field that is to be created. The following example transform specifies the field types. In this case, XML tagged data is transformed to XML attributes:

```

SET OutputRoot.XMLNS.Data.Output[] =
  (SELECT R.Quantity.* AS Book.(XML.Attribute)Quantity,
         R.Author.* AS Book.(XML.Attribute)Author
   FROM InputRoot.XMLNS.Invoice.Purchases.Item[] AS R
  );

```

Using the same Invoice message, the result is:

```

<Data>
  <Output>
    <Book Quantity="2" Author="Neil Bradley"/>
  </Output>
  <Output>
    <Book Quantity="1" Author="Don Chamberlin"/>
  </Output>
  <Output>
    <Book Quantity="1" Author="Philip Heller, Simon Roberts"/>
  </Output>
</Data>

```

Finally, you can use a WHERE clause to eliminate some of the results. In the following example a WHERE clause is used to remove results in which a specific criterion is met. An entire result is either included or excluded:

```
SET OutputRoot.XMLNS.Data.Output[] =
  (SELECT R.Quantity AS Book.Quantity,
         R.Author AS Book.Author
   FROM InputRoot.XMLNS.Invoice.Purchases.Item[] AS R
   WHERE R.Quantity = 2
  );
```

Using the same input message, the result is:

```
<Data>
  <Output>
    <Book>
      <Quantity>2</Quantity>
      <Author>Neil Bradley</Author>
    </Book>
  </Output>
</Data>
```

Transforming a complex message:

When you code the ESQL for a Compute node, use the SELECT function for complex message transformation.

This topic provides examples of complex message transformation. Review the examples and modify them for your own use. They are all based on the Invoice message as input.

In this example, Invoice contains a variable number of Items. The transform is shown below:

```
SET OutputRoot.XMLNS.Data.Statement[] =
  (SELECT I.Customer.Title AS Customer.Title,
         I.Customer.FirstName || ' ' || I.Customer.LastName AS Customer.Name,
         COALESCE(I.Customer.PhoneHome, '') AS Customer.Phone,
         (SELECT II.Title AS Desc,
          CAST(II.UnitPrice AS FLOAT) * 1.6 AS Cost,
          II.Quantity AS Qty
        FROM I.Purchases.Item[] AS II
        WHERE II.UnitPrice > 0.0
        ) AS Purchases.Article[],
         (SELECT SUM( CAST(II.UnitPrice AS FLOAT) *
          CAST(II.Quantity AS FLOAT) *
          1.6
        )
        FROM I.Purchases.Item[] AS II
        ) AS Amount,
         'Dollars' AS Amount.(XML.Attribute)Currency
  FROM InputRoot.XMLNS.Invoice[] AS I
  WHERE I.Customer.LastName <> 'Brown'
  );
```

The output message that is generated is:

```

<Data>
<Statement>
  <Customer>
    <Title>Mr</Title>
    <Name>Andrew Smith</Name>
    <Phone>01962818000</Phone>
  </Customer>
  <Purchases>
    <Article>
      <Desc Category="Computer" Form="Paperback" Edition="2">The XML Companion</Desc>
      <Cost>4.472E+1</Cost>
      <Qty>2</Qty>
    </Article>
    <Article>
      <Desc Category="Computer" Form="Paperback" Edition="2">
        A Complete Guide to DB2 Universal Database</Desc>
      <Cost>6.872E+1</Cost>
      <Qty>1</Qty>
    </Article>
    <Article>
      <Desc Category="Computer" Form="Hardcover" Edition="0">JAVA 2 Developers Handbook</Desc>
      <Cost>9.5984E+1</Cost>
      <Qty>1</Qty>
    </Article>
  </Purchases>
  <Amount Currency="Dollars">2.54144E+2</Amount>
</Statement>
</Data>

```

This transform has nested SELECT clauses. The outer statement operates on the list of Invoices. The inner statement operates on the list of Items. The AS clause that is associated with the inner SELECT clause expects an array:

```

(SELECT II.Title AS Desc,
      CAST(II.UnitPrice AS FLOAT) * 1.6 AS Cost,
      II.Quantity AS Qty
 FROM I.Purchases.Item[] AS II
 WHERE II.UnitPrice > 0.0
 )
-- Note the use of [] in the next expression
AS Purchases.Article[],

```

This statement tells the outer SELECT clause to expect a variable number of Items in each result. Each SELECT clause has its own correlation name: I for the outer SELECT clause and II for the inner one. Each SELECT clause typically uses its own correlation name, but the FROM clause in the inner SELECT clause refers to the correlation name of the outer SELECT clause:

```

(SELECT II.Title AS Desc,
      CAST(II.UnitPrice AS FLOAT) * 1.6 AS Cost,
      II.Quantity AS Qty
-- Note the use of I.Purchases.Item in the next expression
 FROM I.Purchases.Item[] AS II
 WHERE II.UnitPrice > 0.0
 ) AS Purchases.Article[],

```

This statement tells the inner SELECT clause to work with the current Invoice's Items. Both SELECT clauses contain WHERE clauses. The outer one uses one criterion to discard certain Customers, and the inner one uses a different criterion to discard certain Items. The example also shows the use of COALESCE to prevent missing input fields from causing the corresponding output field to be missing. Finally, it also uses the column function SUM to add together the value of all Items in each Invoice. Column functions are discussed in "Referencing columns in a database" on page 324.

When the fields Desc are created, the whole of the input Title field is copied: the XML attributes and the field value. If you do not want these attributes in the output message, use the FIELDVALUE function to discard them; for example, code the following ESQL:

```
SET OutputRoot.XMLNS.Data.Statement[] =
  (SELECT I.Customer.Title AS Customer.Title,
    I.Customer.FirstName || ' ' || I.Customer.LastName AS Customer.Name,
    COALESCE(I.Customer.PhoneHome, '') AS Customer.Phone,
    (SELECT FIELDVALUE(II.Title) AS Desc,
      CAST(II.UnitPrice AS FLOAT) * 1.6 AS Cost,
      II.Quantity AS Qty
    FROM I.Purchases.Item[] AS II
    WHERE II.UnitPrice > 0.0 ) AS Purchases.Article[],
    (SELECT SUM( CAST(II.UnitPrice AS FLOAT) *
      CAST(II.Quantity AS FLOAT) *
      1.6 )
    FROM I.Purchases.Item[] AS II ) AS Amount,
    'Dollars' AS Amount.(XML.Attribute)Currency

  FROM InputRoot.XMLNS.Invoice[] AS I
  WHERE I.Customer.LastName <> 'Brown'
  );
```

That code generates the following output message:

```
<Data>
  <Statement>
    <Customer>
      <Title>Mr</Title>
      <Name>Andrew Smith</Name>
      <Phone>01962818000</Phone>
    </Customer>
    <Purchases>
      <Article>
        <Desc>The XML Companion</Desc>
        <Cost>4.472E+1</Cost>
        <Qty>2</Qty>
      </Article>
      <Article>
        <Desc>A Complete Guide to DB2 Universal Database</Desc>
        <Cost>6.872E+1</Cost>
        <Qty>1</Qty>
      </Article>
      <Article>
        <Desc>JAVA 2 Developers Handbook</Desc>
        <Cost>9.5984E+1</Cost>
        <Qty>1</Qty>
      </Article>
    </Purchases>
    <Amount Currency="Dollars">2.54144E+2</Amount>
  </Statement>
</Data>
```

Returning a scalar value in a message:

Use a SELECT statement to return a scalar value by including both the THE and ITEM keywords.

For example:

```
1 + THE(SELECT ITEM T.a FROM Body.Test.A[] AS T WHERE T.b = '123')
```

Use of the ITEM keyword:

The following example shows the use of the ITEM keyword to select one item and create a single value.

```
SET OutputRoot.MQMD = InputRoot.MQMD;

SET OutputRoot.XMLNS.Test.Result[] =
  (SELECT ITEM T.UnitPrice FROM InputBody.Invoice.Purchases.Item[] AS T);
```

When the Invoice message is received as input, the ESQL shown generates the following output message:

```
<Test>
  <Result>27.95</Result>
  <Result>42.95</Result>
  <Result>59.99</Result>
</Test>
```

When the ITEM keyword is specified, the output message includes a list of scalar values. Compare this message to the one that is produced if the ITEM keyword is omitted, in which a list of fields (name-value pairs) is generated:

```
<Test>
  <Result>
    <UnitPrice>27.95</UnitPrice>
  </Result>
  <Result>
    <UnitPrice>42.95</UnitPrice>
  </Result>
  <Result>
    <UnitPrice>59.99</UnitPrice>
  </Result>
</Test>
```

Effects of the THE keyword:

The THE keyword converts a list containing one item to the item itself.

The two previous examples both specified a list as the source of the SELECT in the FROM clause (the field reference has [] at the end to indicate an array), so typically the SELECT function generates a list of results. Because of this behavior, you must specify a list as the target of the assignment (thus the "Result[]" as the target of the assignment). However, you often know that the WHERE clause that you specify as part of the SELECT returns TRUE for only one item in the list. In this case use the THE keyword.

The following example shows the effect of using the THE keyword:

```
SET OutputRoot.MQMD = InputRoot.MQMD;

SET OutputRoot.XMLNS.Test.Result =
  THE (SELECT T.Publisher, T.Author FROM InputBody.Invoice.Purchases.Item[]
      AS T WHERE T.UnitPrice = 42.95);
```

The THE keyword means that the target of the assignment becomes OutputRoot.XMLNS.Test.Result (the "[]" is not permitted). Its use generates the following output message:

```
<Test>
  <Result>
    <Publisher>Morgan Kaufmann Publishers</Publisher>
    <Author>Don Chamberlin</Author>
  </Result>
</Test>
```

Selecting from a list of scalars:

Consider the following sample input message:

```
<Test>
  <A>1</A>
  <A>2</A>
  <A>3</A>
  <A>4</A>
  <A>5</A>
</Test>
```

If you code the following ESQL statements to process this message:

```
SET OutputRoot.XMLNS.Test.A[] =
  (SELECT ITEM A from InputBody.Test.A[]
   WHERE CAST(A AS INTEGER) BETWEEN 2 AND 4);
```

the following output message is generated:

```
<A>2</A>
<A>3</A>
<A>4</A>
```

Joining data in a message:

The FROM clause of a SELECT function is not restricted to having one item. Specifying multiple items in the FROM clause produces the typical Cartesian product joining effect, in which the result includes an item for all combinations of items in the two lists.

Using the FROM clause in this way produces the same joining effect as standard SQL.

The Invoice message includes a set of customer details, payment details, and details of the purchases that the customer makes. Code the following ESQL to process the input Invoice message:

```
SET OutputRoot.XMLNS.Items.Item[] =
  (SELECT D.LastName, D.Billing,
         P.UnitPrice, P.Quantity
   FROM InputBody.Invoice.Customer[] AS D,
        InputBody.Invoice.Purchases.Item[] AS P);
```

The following output message is generated:

```

<Items>
  <Item>
    <LastName>Smith</LastName>
    <Billing>
      <Address>14 High Street</Address>
      <Address>Hursley Village</Address>
      <Address>Hampshire</Address>
      <PostCode>S0213JR</PostCode>
    </Billing>
    <UnitPrice>27.95</UnitPrice>
    <Quantity>2</Quantity>
  </Item>
  <Item>
    <LastName>Smith</LastName>
    <Billing>
      <Address>14 High Street</Address>
      <Address>Hursley Village</Address>
      <Address>Hampshire</Address>
      <PostCode>S0213JR</PostCode>
    </Billing>
    <UnitPrice>42.95</UnitPrice>
    <Quantity>1</Quantity>
  </Item>
  <Item>
    <LastName>Smith</LastName>
    <Billing>
      <Address>14 High Street</Address>
      <Address>Hursley Village</Address>
      <Address>Hampshire</Address>
      <PostCode>S0213JR</PostCode>
    </Billing>
    <UnitPrice>59.99</UnitPrice>
    <Quantity>1</Quantity>
  </Item>
</Items>

```

Three results are produced, giving the number of descriptions in the first list (one) multiplied by the number of prices in the second (three). The results systematically work through all the combinations of the two lists. You can see this by looking at the *LastName* and *UnitPrice* fields selected from each result:

```

LastName Smith    UnitPrice 27.95
LastName Smith    UnitPrice 42.95
LastName Smith    UnitPrice 59.99

```

You can join data that occurs in a list and a non-list, or in two non-lists, and so on. For example:

```

OutputRoot.XMLNS.Test.Result1[] =
  (SELECT ... FROM InputBody.Test.A[], InputBody.Test.b);
OutputRoot.XMLNS.Test.Result1 =
  (SELECT ... FROM InputBody.Test.A, InputBody.Test.b);

```

The location of the [] in each case is significant. Any number of items can be specified in the FROM clause, not just one or two. If any of the items specify [] to indicate a list of items, the SELECT function returns a list of results (the list might contain only one item, but the SELECT function can return a list of items).

The target of the assignment must specify a list (so must end in []), or you must use the “THE function” on page 1615 if you know that the WHERE clause guarantees that only one combination is matched.

Translating data in a message:

You can translate data from one form to another.

A typical example of the requirement to translate data is if the items are known in one message by names, and in another message by numbers. For example:

Type Name	Type Code
Confectionary	2000
Newspapers	3000
Hardware	4000

Consider the following input message:

```
<Data>
  <Items>
    <Item>
      <Cat>1000</Cat>
      <Description>Milk Chocolate Bar</Description>
      <Type>Confectionary</Type>
    </Item>
    <Item>
      <Cat>1001</Cat>
      <Description>Daily Newspaper</Description>
      <Type>NewsPapers</Type>
    </Item>
    <Item>
      <Cat>1002</Cat>
      <Description>Kitchen Sink</Description>
      <Type>Hardware</Type>
    </Item>
  </Items>
  <TranslateTable>
    <Translate>
      <Name>Confectionary</Name>
      <Number>2000</Number>
    </Translate>
    <Translate>
      <Name>NewsPapers</Name>
      <Number>3000</Number>
    </Translate>
    <Translate>
      <Name>Hardware</Name>
      <Number>4000</Number>
    </Translate>
  </TranslateTable>
</Data>
```

This message has two sections; the first section is a list of items in which each item has a catalogue number and a type; the second section is a table for translating between descriptive type names and numeric type codes. Include a Compute node with the following transform:

```
SET OutputRoot.XMLNS.Result.Items.Item[] =
  (SELECT M.Cat, M.Description, T.Number As Type
   FROM
     InputRoot.XMLNS.Data.Items.Item[]           As M,
     InputRoot.XMLNS.Data.TranslateTable.Translate[] As T
   WHERE M.Type = T.Name
  );
```

The following output message is generated:

```

<Result>
  <Items>
    <Item>
      <Cat>1000</Cat>
      <Description>Milk Chocolate Bar</Description>
      <Type>2000</Type>
    </Item>
    <Item>
      <Cat>1001</Cat>
      <Description>Daily Newspaper</Description>
      <Type>3000</Type>
    </Item>
    <Item>
      <Cat>1002</Cat>
      <Description>Kitchen Sink</Description>
      <Type>4000</Type>
    </Item>
  </Items>
</Result>

```

In the result, each type name has been converted to its corresponding code. In this example, both the data and the translate table were in the same message tree, although this is not a requirement. For example, the translate table could be coded in a database, or might have been set up in LocalEnvironment by a previous Compute node.

Joining data from messages and database tables:

You can use SELECT functions that interact with both message data and databases.

You can also nest a SELECT function that interacts with one type of data within a SELECT clause that interacts with the other type.

Consider the following input message, which contains invoice information for two customers:

```

<Data>
  <Invoice>
    <CustomerNumber>1234</CustomerNumber>
    <Item>
      <PartNumber>1</PartNumber>
      <Quantity>9876</Quantity>
    </Item>
    <Item>
      <PartNumber>2</PartNumber>
      <Quantity>8765</Quantity>
    </Item>
  </Invoice>
  <Invoice>
    <CustomerNumber>2345</CustomerNumber>
    <Item>
      <PartNumber>2</PartNumber>
      <Quantity>7654</Quantity>
    </Item>
    <Item>
      <PartNumber>1</PartNumber>
      <Quantity>6543</Quantity>
    </Item>
  </Invoice>
</Data>

```

Consider the following database tables, Prices and Addresses, and their contents:

PARTNO	PRICE
1	+2.50000E+001
2	+6.50000E+00

PARTNO	STREET	CITY	COUNTRY
1234	22 Railway Cuttings	East Cheam	England
2345	The Warren	Watership Down	England

If you code the following ESQL transform:

```
-- Create a valid output message
SET OutputRoot.MQMD = InputRoot.MQMD;

-- Select suitable invoices
SET OutputRoot.XMLNS.Data.Statement[] =
  (SELECT I.CustomerNumber           AS Customer.Number,
        A.Street                     AS Customer.Street,
        A.City                        AS Customer.Town,
        A.Country                     AS Customer.Country,

        -- Select suitable items
        (SELECT II.PartNumber AS PartNumber,
              II.Quantity   AS Quantity,
              PI.Price      AS Price
        FROM Database.db2admin.Prices AS PI,
              I.Item[]       AS II
        WHERE II.PartNumber = PI.PartNo ) AS Purchases.Item[]

        FROM Database.db2admin.Addresses AS A,
              InputRoot.XMLNS.Data.Invoice[] AS I

        WHERE I.CustomerNumber = A.PartNo
  );
```

the following output message is generated. The input message is augmented with the price and address information from the database table:

```

<Data>
  <Statement>
    <Customer>
      <Number>1234</Number>
      <Street>22 Railway Cuttings</Street>
      <Town>East Cheam</Town>
      <Country>England</Country>
    </Customer>
    <Purchases>
      <Item>
        <PartNumber>1</PartNumber>
        <Quantity>9876</Quantity>
        <Price>2.5E+1</Price>
      </Item>
      <Item>
        <PartNumber>2</PartNumber>
        <Quantity>8765</Quantity>
        <Price>6.5E+1</Price>
      </Item>
    </Purchases>
  </Statement>
  <Statement>
    <Customer>
      <Number>2345</Number>
      <Street>The Warren</Street>
      <Town>Watership Down</Town>
      <Country>England</Country>
    </Customer>
    <Purchases>
      <Item>
        <PartNumber>1</PartNumber>
        <Quantity>6543</Quantity>
        <Price>2.5E+1</Price></Item>
      <Item>
        <PartNumber>2</PartNumber>
        <Quantity>7654</Quantity>
        <Price>6.5E+1</Price>
      </Item>
    </Purchases>
  </Statement>
</Data>

```

You can nest the database SELECT clause within the message SELECT clause. In most cases, the code is not as efficient as the previous example, but you might find that it is better if the messages are small and the database tables are large.

```

-- Create a valid output message
SET OutputRoot.MQMD = InputRoot.MQMD;

-- Select suitable invoices
SET OutputRoot.XMLNS.Data.Statement[] =
  (SELECT I.CustomerNumber           AS Customer.Number,

    -- Look up the address
    THE ( SELECT
          A.Street,
          A.City   AS Town,
          A.Country
        FROM Database.db2admin.Addresses AS A
        WHERE A.PartNo = I.CustomerNumber
      )
      AS Customer,

    -- Select suitable items
    (SELECT
      II.PartNumber AS PartNumber,
      II.Quantity  AS Quantity,

      -- Look up the price
      THE (SELECT ITEM P.Price
          FROM Database.db2admin.Prices AS P
          WHERE P.PartNo = II.PartNumber
        )
      AS Price

    FROM I.Item[] AS II           ) AS Purchases.Item[]

  FROM InputRoot.XMLNS.Data.Invoice[] AS I
);

```

Manipulating messages in the XML domains

The following topics contain instructions on manipulating messages in the XMLNSC, XMLNS, and XML domains.

- “Working with XML messages”
- “Manipulating messages in the XMLNSC domain” on page 364
- “Manipulating messages in the XMLNS domain” on page 378
- “Manipulating messages in the XML domain” on page 387

For information about dealing with MRM XML messages, see “Manipulating messages in the MRM domain” on page 387.

Working with XML messages:

The following topics provide information about typical tasks for processing XML messages.

Some of this information is available publicly in Web pages and online tutorials. If you are new to XML, you will find it useful to also read about the XML standard.

- “Constructing an XML message tree” on page 355
- “Working with namespaces” on page 355
- “Working with binary data” on page 356
- “XMLNSC: Working with CData” on page 358
- “XMLNSC: Working with XML messages and bit streams” on page 360
- “Working with large XML messages” on page 361

For details about XML Schema, see XML Schema Part 0: Primer on the World Wide Web Consortium (W3C) Web site.

Constructing an XML message tree:

Order of fields in the message tree

When you create an XML output message in a Compute node, the order of your lines of ESQL code is important, because the message elements are created in the order that you code them.

Consider the following XML message:

```
<Order>
  <ItemNo>1</ItemNo>
  <Quantity>2</Quantity>
</Order>
```

If you want to add a DocType Declaration to this, insert the DocType Declaration before you copy the input message to the output message.

For example:

```
SET OutputRoot.XMLNS.(XML.XmlDecl) = '';
SET OutputRoot.XMLNS.(XML.XmlDecl).(XML.Version) = '1.0';
SET OutputRoot.XMLNS.(XML.DocTypeDecl)Order = '';
SET OutputRoot.XMLNS.(XML.DocTypeDecl).(XML.SystemId) = 'NewDtdName.dtd';
SET OutputRoot = InputRoot;
-- more ESQL --
```

If you put the last statement to copy the input message before the XML-specific statements, the following XML is generated for the output message.

```
<Order>
  <ItemNo>1</ItemNo>
  <Quantity>2</Quantity>
</Order>
<?xml version="1.0"?>
```

This is not well-formed XML and causes an error when it is written from the message tree to a bit stream in the output node.

Setting the field type

If you copy a message tree from input to output without changing the domain, most of the syntax elements will be created by the parser (XMLNSC or XMLNS) and their field types will be correct. However, if you construct your message tree from a database query, or from another parser's message tree, you must ensure that you identify each syntax element correctly using its field type. You can find full details of the field type constants used by XMLNSC and XMLNS in the following topics:

- "XMLNSC: Using field types" on page 366
- "XML constructs" on page 1433

Working with namespaces:

The following example shows how to use ESQL to work with namespaces.

Namespace constants are declared at the start of the main module so that you can use prefixes in the ESQL statements instead of the full URIs of the namespaces.

The namespace constants affect only the ESQL; they do not control the prefixes that are generated in the output message. The prefixes in the generated output message are controlled by namespace declarations in the message tree. You can include namespace declarations in the tree using the XML.NamespaceDecl field type. These elements are then used to generate namespace declarations in the output message.

When the output message is generated, if the parser encounters a namespace for which it has no corresponding namespace declaration, a prefix is automatically generated using prefixes of the form NSn where n is a positive integer.

```
CREATE COMPUTE MODULE xmlns_doc_flow_Compute
CREATE FUNCTION Main() RETURNS BOOLEAN
BEGIN
CALL CopyMessageHeaders();
-- Declaration of namespace constants --
These are only used by ESQL

DECLARE sp1 NAMESPACE 'http://www.ibm.com/space1';
DECLARE sp2 NAMESPACE 'http://www.ibm.com/space2';
DECLARE sp3 NAMESPACE 'http://www.ibm.com/space3';

-- Namespace declaration for prefix 'space1'
SET OutputRoot.XMLNS.message.(XML.NamespaceDecl)xmlns:space1 = 'http://www.ibm.com/space1';
SET OutputRoot.XMLNS.message.sp1:data1 = 'Hello!';

-- Default namespace declaration ( empty prefix )
SET OutputRoot.XMLNS.message.sp2:data2.(XML.NamespaceDecl)xmlns = 'http://www.ibm.com/space2';
SET OutputRoot.XMLNS.message.sp2:data2.sp2:subData1 = 'Ho!a!';
SET OutputRoot.XMLNS.message.sp2:data2.sp2:subData2 = 'Guten Tag!';
SET OutputRoot.XMLNS.message.sp3:data3 = 'Bonjour!';
SET OutputRoot.Properties.MessageDomain = 'XMLNS';
RETURN TRUE;
END;

CREATE PROCEDURE CopyMessageHeaders()
BEGIN
DECLARE I INTEGER 1;
DECLARE J INTEGER CARDINALITY(InputRoot.*[]);
WHILE I < J DO SET OutputRoot.*[I] = InputRoot.*[I];
    SET I = I + 1;
END WHILE;
END;
END MODULE;
```

When this ESQL is processed, the following output message is generated:

```
<message xmlns:space1="http://www.ibm.com/space1">
  <space1:data1>Hello!</space1:data1>
  <data2 xmlns="http://www.ibm.com/space2">
    <subData1>Ho!a!</subData1>
    <subData2>Guten Tag!</subData2>
  </data2>
  <NS1:data3 xmlns="http://www.ibm.com/space3">Bonjour!</NS1:data3>
</message>
```

Working with binary data:

Binary encodings for XML

If you need to include binary data or illegal characters in your XML documents, the safest method is to encode the data as a binary string.

There are two methods of encoding binary data in an XML document.

hexBinary: <nonXMLChars>0001020304050607080B0C0E0F</nonXMLChars>

base64Binary: <nonXMLChars>AAECAwQFBgcICwwODw==</nonXMLChars>

The base64Binary encoding makes better use of the available XML characters, and on average a base64-encoded binary field is 2/3 the size of its hexBinary equivalent. Base64Binary is widely used by the MIME format and by various XML-based standards.

You might prefer to use the simpler hexBinary encoding if you are sending data to applications that cannot decode base64 data, and if the increase in message size is not important.

Parsing binary data

The most straightforward way to parse any binary data is to use the XMLNSC parser with a message set.

1. Locate or construct an XML Schema that describes your input XML.
2. Import the XML Schema to create a message definition file.
3. In your message flow, set the node properties as follows:
 - On the Default page, set *Message Domain* to XMLNSC and *Message Set* to the name of your message set.
 - On the Validation page, set *Validation* to Content and Value.
 - In the XMLNSC properties, select the check box option *Build tree using XML Schema types*.

The XMLNSC parser automatically decodes your hexBinary or base64Binary data, being guided by the simple type of the element or attribute that contains the binary data. The message tree will contain the decoded BLOB value.

If you are using the XMLNS domain, you must parse the binary data as a string. It will appear in the message tree as a CHARACTER value. If the data is encoded as hexBinary, you can use the ESQL CAST function to convert to a BLOB value. If the data is encoded as base64Binary, the easiest approach is to call a static Java method from ESQL to decode the base64 data into a BLOB value.

Generating binary data

You can generate binary data in your output XML in either hexBinary or base64Binary encoding.

For hexBinary, use the ESQL CAST statement to convert your BLOB data to a hexBinary string.

For base64Binary, you have two options:

- Call a static Java method to encode your BLOB data as base64.
- Use the XMLNSC parser, and modify the type field on the syntax element, as shown in this example:

```
-- ESQL code to generate base64-encoded binary data
DECLARE myBLOB BLOB;
-- Populate myBLOB with your binary data
CREATE LASTCHILD OF OutputRoot.XMLNSC.message
  NAME myBase64Element
  TYPE XMLNSC.Attribute + XMLNSC.base64Binary
  VALUE myBLOB;
```

XMLNSC: Working with CData:

What is a CData section?

An XML element can contain text content:

```
<element>text content</element>
```

However, some characters cannot appear in that content. In particular, '<' and '&' both have special meaning to an XML parser. If they are included in the text content of an element, they change the meaning of the XML document.

For example, this is a badly formed XML document:

```
<element><text><content></element>
```

There are two ways to make the XML well-formed:

1. Use character entities:

```
<element>&lt;text&gt;&lt;content&gt;</element>
```

2. Use a CData section:

```
<element><![CDATA[<text><content>]]></element>
```

What can you use a CData section for?

In a CData section, you can include XML markup in the value of an element. However, non-valid XML characters cannot be included. Binary data also cannot be included in a CData section.

The most common use for CData is to embed one XML document within another. For example:

```
<outer>
  <embedXML>
    <![CDATA[<innerMsg></innerMsg>]]>
  </embedXML>
</outer>
```

You can even embed a badly-formed XML document in this way, because the XML parser does not attempt to parse the content of a CData section.

```
<outer>
  <embedXML>
    <![CDATA[<badXML></wrongClosingTag>]]>
  </embedXML>
</outer>
```

The following are not valid within a CData section:

- Non-valid XML characters (see <http://www.w3.org/TR/2006/REC-xml-20060816/#charsets>)
- The text string ']]>' (because this terminates the CData section)

Because of these restrictions, do not use a CData section to include arbitrary text in your XML document, and do not try to use a CData section to hold binary data (unless it is encoded as hexBinary or base64Binary).

How do you add a CData section to an output XML message?

Consider the following input message :

```

<TestCase>
  <Folder>
    <Field1>Value1</Field1>
    <Field2>Value2</Field2>
    <Field3>Value3</Field3>
  </Folder>
  <Folder2>
    <Field1>Value1</Field1>
    <Field2>Value2</Field2>
    <Field3>Value3</Field3>
  </Folder2>
</TestCase>

```

The ESQL below shows how to serialize both a whole message and a folder:

```

DECLARE wholeMsgBlob BLOB
  ASBITSTREAM(InputRoot.XMLNSC,
              InputRoot.Properties.Encoding,
              InputRoot.Properties.CodedCharSetId );
DECLARE folderBlob BLOB
  ASBITSTREAM(InputRoot.XMLNSC.TestCase.Folder,
              InputRoot.Properties.Encoding,
              InputRoot.Properties.CodedCharSetId,
              '', '', '', FolderBitStream);
DECLARE wholeMsgChar CHAR
  CAST(wholeMsgBlob AS CHAR CCSID InputRoot.Properties.CodedCharSetId);
DECLARE folderChar CHAR
  CAST(folderBlob AS CHAR CCSID InputRoot.Properties.CodedCharSetId);
SET OutputRoot.XMLNSC.Output.Field1.(XMLNSC.CDataField) = wholeMsgChar;
SET OutputRoot.XMLNSC.Output.Field2.(XMLNSC.CDataField) = folderChar;

```

This example serializes both the InputRoot.XMLNSC and InputRoot.XMLNSC.TestCase.Folder portions of the message tree.

The InputRoot.XMLNSC portion is the entire message; therefore, you do not need to specify the FolderBitStream option.

The field InputRoot.XMLNSC.TestCase.Folder is not the root of the message; therefore the option FolderBitStream should be specified. Because this is the seventh parameter in the list, the messageSet, messageType and messageFormat parameters were required ('','',''). Because the input was not in the MRM domain, these just need to be zero length strings. The ASBITSTREAM function serializes these as BLOBs and a CAST is needed to convert them into character strings that can be inserted into the output message tree.

If the output message tree were examined before an MQoutput node, this would show :

```

(0x01000010):XML          = (
  (0x01000000):Output = (
    (0x01000000):Field1 = (
      (0x02000001): = '<TestCase><Folder><Field1>Value1</Field1><Field2>Value2</Field2>
        <Field3>Value3</Field3></Folder><Folder2><Field1>Value1</Field1>
          <Field2>Value2</Field2><Field3>Value3</Field3><Folder2></Testcase>'
      )
    (0x01000000):Field2 = (
      (0x02000001): = '<Folder><Field1>Value 1<Field2>Value2</Field2>
        <Field3>Value 3</Field3></Folder>'
    )
  )
)

```

As can be seen, each CData section contains a single scalar value that is the character representation of the portions of the XML message that are required.

This tree produces the following XML output message :

```
<Output>
  <Field1><![CDATA[<TestCase><Folder><Field1>Value 1</Field1>
                                <Field2>Value 2</Field2>
                                <Field3>Value 3</Field3></Folder>
                                <Folder2><Field1>Value 1</Field1>
                                <Field2>Value 2</Field2>
                                <Field3>Value 3</Field3></Folder2>
                                </TestCase>]]
  <Field2><![CDATA[<Folder><Field1>Value 1</Field1>
                                <Field2>Value 2</Field2>
                                <Field3>Value 3</Field3></Folder>
                                <Folder2><Field1>Value 1</Field1>
                                <Field2>Value 2</Field2>
                                <Field3>Value 3</Field3>
                                </Folder2>]]
</Output>
```

XMLNSC: Working with XML messages and bit streams:

Use the ASBITSTREAM function and the CREATE statement to manage XML message content.

The ASBITSTREAM function

If you code the ASBITSTREAM function with the parser mode option set to RootBitStream to parse a message tree to a bit stream, the result is an XML document that is built from the children of the target element in the normal way. This algorithm is identical to that used to generate the normal output bit stream. Because the target element is not included in the output bit stream, you must ensure that the children of the element follow the constraints for an XML document.

One constraint is that there must be only one body element in the message. You can use a well-formed bit stream obtained in this way to recreate the original tree using a CREATE statement with a PARSE clause.

If you code the ASBITSTREAM function with the parser mode option set to FolderBitStream to parse a message tree to a bit stream, the generated bit stream is an XML document built from the target element and its children. Any DocTypeDecl or XmlDecl elements are ignored, and the target element itself is included in the generated bit stream.

The advantage of this mode is that the target element becomes the body element of the document, and that body element can have multiple elements nested within it. Use this mode to obtain a bit stream description of arbitrary sub-trees owned by an XML parser. You can use bit streams obtained in this way to recreate the original tree using a CREATE statement with a PARSE clause, and a mode of FolderBitStream.

For further information about the ASBITSTREAM function, and some examples of its use, see "ASBITSTREAM function" on page 1603.

The CREATE statement with a PARSE clause

If you code a CREATE statement with a PARSE clause with the parser mode option set to RootBitStream to parse a bit stream to a message tree, the expected bit stream is a normal XML document. A field in the tree is created for each field

in the document. This algorithm is identical to that used when parsing a bit stream from an input node. In particular, an element named 'XML', 'XMLNS', or 'XMLNSC' is created as the root element of the tree, and all the content in the message is created as children of that root.

If you code a CREATE statement with a PARSE clause with the parser mode option set to FolderBitStream to parse a bit stream to a message tree, the expected bit stream is a normal XML document. Any content outside the body element (such as an XML declaration or doctype) is discarded. The first element created during the parse corresponds to the body of the XML document, and from there the parse proceeds as normal.

For further information about the CREATE statement, and examples of its use, see "CREATE statement" on page 1492.

Working with large XML messages:

When an input bit stream is parsed and a logical tree is created, the tree representation of an XML message is typically bigger, and in some cases much bigger, than the corresponding bit stream.

The reasons for this expansion include:

- The addition of the pointers that link the objects together
- Translation of character data into Unicode, which can double the size
- The inclusion of field names that might have been implicit in the bit stream
- The presence of control data that is associated with the broker's operation

Manipulating a large message tree can require a lot of storage. If you design a message flow that handles large messages that are made up of repeating structures, you can code ESQL statements that help to reduce the storage load on the broker. These statements support both random and sequential access to the message, but assume that you do not need access to the whole message at one time.

These ESQL statements cause the broker to perform limited parsing of the message, and to keep in storage at one time, only that part of the message tree that reflects a single record. If your processing requires you to retain information from record to record (for example, to calculate a total price from a repeating structure of items in an order), you can either declare, initialize, and maintain ESQL variables, or you can save values in another part of the message tree; for example, in LocalEnvironment.

This technique reduces the memory that is used by the broker to that needed to hold the full input and output bit streams, plus that needed for the message trees of just one record. This technique also provides memory savings when even a small number of repeats is encountered in the message. The broker uses partial parsing and the ability to parse specified parts of the message tree, to and from the corresponding part of the bit stream.

To use these techniques in your Compute node, apply these general techniques:

- Copy the body of the input message as a bit stream to a special folder in the output message. The copy creates a modifiable copy of the input message that is not parsed and that therefore uses a minimum amount of memory.
- Avoid any inspection of the input message, which avoids the need to parse the message.

- Use a loop and a reference variable to step through the message one record at a time. For each record:
 - Use normal transforms to build a corresponding output subtree in a second special folder.
 - Use the ASBITSTREAM function to generate a bit stream for the output subtree. The generated bit stream is stored in a BitStream element that is placed in the position in the output subtree that corresponds to its required position in the final bit stream.
 - Use the DELETE statement to delete both the current input and output record message trees when you have completed their manipulation.
 - When you have completed the processing of all records, detach the special folders so that they do not appear in the output bit stream.

You can vary these techniques to suit the processing that is required for your messages.

The following ESQL code provides an example of one implementation, and is a modification of the ESQL example in “Transforming a complex message” on page 344. It uses a single SET statement with nested SELECT functions to transform a message that contains nested, repeating structures.

```
-- Copy the MQMD header
SET OutputRoot.MQMD = InputRoot.MQMD;

-- Create a special folder in the output message to hold the input tree
-- Note : SourceMessageTree is the root element of an XML parser
CREATE LASTCHILD OF OutputRoot.XMLNS.Data DOMAIN 'XMLNS' NAME 'SourceMessageTree';

-- Copy the input message to a special folder in the output message
-- Note : This is a root to root copy which will therefore not build trees
SET OutputRoot.XMLNS.Data.SourceMessageTree = InputRoot.XMLNS;

-- Create a special folder in the output message to hold the output tree
CREATE FIELD OutputRoot.XMLNS.Data.TargetMessageTree;

-- Prepare to loop through the purchased items
DECLARE sourceCursor REFERENCE TO OutputRoot.XMLNS.Data.SourceMessageTree.Invoice;
DECLARE targetCursor REFERENCE TO OutputRoot.XMLNS.Data.TargetMessageTree;
DECLARE resultCursor REFERENCE TO OutputRoot.XMLNS.Data;
DECLARE grandTotal FLOAT 0.0e0;

-- Create a block so that it's easy to abandon processing
ProcessInvoice: BEGIN
-- If there are no Invoices in the input message, there is nothing to do
IF NOT LASTMOVE(sourceCursor) THEN
  LEAVE ProcessInvoice;
END IF;

-- Loop through the invoices in the source tree
InvoiceLoop : LOOP
-- Inspect the current invoice and create a matching Statement
SET targetCursor.Statement = THE (SELECT 'Monthly' AS (XML.Attribute)Type,
'Full' AS (0x03000000)Style[1],
I.Customer.FirstName AS Customer.Name,
I.Customer.LastName AS Customer.Surname,
(SELECT
  FIELDVALUE(II.Title) AS Title,
  CAST(II.UnitPrice AS FLOAT) * 1.6 AS Cost,
  II.Quantity AS Qty
FROM I.Purchases.Item[] AS II
WHERE II.UnitPrice> 0.0) AS Purchases.Article[],
(SELECT
  SUM( CAST(II.UnitPrice AS FLOAT) *
```

```

        CAST(II.Quantity AS FLOAT) *
        1.6
    )
    FROM I.Purchases.Item[] AS II) AS Amount,
    'Dollars' AS Amount.(XML.Attribute)Currency
FROM sourceCursor AS I
WHERE I.Customer.LastName <> 'White');

-- Turn the current Statement into a bit stream
DECLARE StatementBitStream BLOB
    CAST(ASBITSTREAM(targetCursor.Statement OPTIONS
        FolderBitStream) AS BLOB);

-- If the SELECT produced a result
-- (that is, it was not filtered out by the WHERE clause),
-- process the Statement
IF StatementBitStream IS NOT NULL THEN
    -- create a field to hold the bit stream in the result tree
    CREATE LASTCHILD OF resultCursor
        Type XML.BitStream
        NAME 'StatementBitStream'
        VALUE StatementBitStream;

    -- Add the current Statement's Amount to the grand total
    -- Note that the cast is necessary because of the behavior
    -- of the XML syntax element
    SET grandTotal = grandTotal
    + CAST(targetCursor.Statement.Amount AS FLOAT);
END IF;

-- Delete the real Statement tree leaving only the bit stream version
DELETE FIELD targetCursor.Statement;

-- Step onto the next Invoice,
-- removing the previous invoice and any
-- text elements that might have been
-- interspersed with the Invoices

REPEAT
    MOVE sourceCursor NEXTSIBLING;
    DELETE PREVIOUSSIBLING OF sourceCursor;
UNTIL (FIELDNAME(sourceCursor) = 'Invoice')
    OR (LASTMOVE(sourceCursor) = FALSE)
END REPEAT;

-- If there are no more invoices to process, abandon the loop
LEAVE InvoiceLoop;
END IF;

END LOOP InvoiceLoop;
END ProcessInvoice;

-- Remove the temporary source and target folders
DELETE FIELD OutputRoot.XMLNS.Data.SourceMessageTree;
DELETE FIELD OutputRoot.XMLNS.Data.TargetMessageTree;

-- Finally add the grand total
SET resultCursor.GrandTotal = grandTotal;

```

This ESQL code produces the following output message:

```

<Data>
<Statement Type="Monthly" Style="Full">
  <Customer>
    <Name>Andrew</Name>
    <Surname>Smith</Surname>
    <Title>Mr</Title>
  </Customer>

```

```

<Purchases>
  <Article>
    <Title>The XML Companion</Title>
    <Cost>4.472E+1</Cost>
    <Qty>2</Qty>
  </Article>
  <Article>
    <Title>A Complete Guide to DB2 Universal Database</Title>
    <Cost>6.872E+1</Cost>
    <Qty>1</Qty>
  </Article>
  <Article>
    <Title>JAVA 2 Developers Handbook</Title>
    <Cost>9.5984E+1</Cost>
    <Qty>1</Qty>
  </Article>
</Purchases>
<Amount Currency="Dollars">2.54144E+2</Amount>
</Statement>
<GrandTotal>2.54144E+2</GrandTotal>
</Data>

```

Manipulating messages in the XMLNSC domain:

This topic provides information about on how to write ESQL for processing messages that belong to the XMLNSC domain, and that are parsed by the XMLNSC parser. Refer to “XMLNSC parser” on page 85 for background information.

The following topics provide detailed information about the structure of the message tree that the XMLNSC parser builds, and the field types that it uses.

- “XMLNSC: The XML declaration”
- “XMLNSC: The inline DTD” on page 365
- “XMLNSC: The message body” on page 366
- “XMLNSC: XML Schema support” on page 374

Information for users who are migrating from XML, XMLNS, or MRM XML is available in “Migrating to XMLNSC” on page 377.

Further information about processing XML messages can be found in “Working with XML messages” on page 354.

XMLNSC: The XML declaration:

The XML declaration is represented in the message tree by a syntax element with field type XMLNSC.XMLDeclaration.

If an XML declaration is created by the XMLNSC parser, its name is ‘XmlDeclaration’. However, when a message tree is being output the name is not important: the XMLNSC parser recognizes this syntax element by its field type only. The following example shows a typical declaration:

```

<?xml version="1.0" encoding="UTF-8" standalone="yes"?>
<!DOCTYPE s1 PUBLIC "http://www.ibm.com/example.dtd" "example.dtd">
<s1>.....</s1>

```

The XML Declaration has three optional attributes; Version, Standalone, and Encoding. The XMLNSC parser does not define special field types for these attributes. Instead, they are identified by their name, and by their position as a child of the XML Declaration element.

ESQL example code to create an XML declaration

To construct the XML declaration that is shown in the previous example, code the following ESQL statements:

```
| CREATE FIRSTCHILD OF OutputRoot.XMLNSC TYPE XMLNSC.XmlDeclaration;  
| SET OutputRoot.XMLNSC.(XMLNSC.XmlDeclaration)*.(XMLNSC.Attribute)Version = '1.0';  
| SET OutputRoot.XMLNSC.(XMLNSC.XmlDeclaration)*.(XMLNSC.Attribute)Encoding = 'UTF-8';  
| SET OutputRoot.XMLNSC.(XMLNSC.XmlDeclaration)*.(XMLNSC.Attribute)StandAlone = 'yes';
```

The first line is optional; if it is omitted, the XMLNSC.XMLDeclaration element is automatically created when it is referenced by the second line.

Java example code to create an XML declaration

To construct the XML declaration that is shown in the previous example, write the following Java code:

```
//Create the XML domain root node  
MElement xmlRoot =  
    root.createElementAsLastChild(MbXMLNSC.PARSER_NAME);  
//Create the XML declaration parent node  
MElement xmlDecl =  
    xmlRoot.createElementAsFirstChild(MbXMLNSC.XML_DECLARATION);  
  
xmlDecl.setName("XmlDeclaration");  
  
MElement version =  
    xmlDecl.createElementAsFirstChild(MbXMLNSC.ATTRIBUTE, "Version", "1.0");  
MElement encoding =  
    xmlDecl.createElementAsFirstChild(MbXMLNSC.ATTRIBUTE, "Encoding", "utf-8");  
MElement standalone =  
    xmlDecl.createElementAsFirstChild(MbXMLNSC.ATTRIBUTE, "Standalone", "yes");
```

Note: In both the ESQL example and the Java example, 'Version', 'StandAlone', and 'Encoding' can all be written in lowercase.

XMLNSC: The inline DTD:

When parsing an XML document that has an inline DTD, the XMLNSC parser does not put the DTD information into the message tree. However, using ESQL you can add XML entity definitions to the message tree, and these are used when the message tree is output by the XMLNSC parser.

ESQL example code for entity definition and entity reference

This example assumes that InputRoot.XMLNSC has been created from the following XML message:

```
<BookInfo dtn="BookInfo" edn="author" edv="A.N.Other"/>
```

The following output message is generated:

```
<!DOCTYPE BookInfo [<!ENTITY author "A.N.Other">]>  
<BookInfo><entref>&author;</entref></BookInfo>
```

The ESQL to create the output message is:

```
DECLARE cursor REFERENCE TO InputRoot.XMLNSC.BookInfo;  
-- Create <!DOCTYPE BOOKInfo ...  
SET OutputRoot.XMLNSC.(XMLNSC.DocumentType)* NAME = cursor.dtn;  
-- Create <!ENTITY author "A.N.Other" > ...  
SET
```

```
OutputRoot.XMLNSC.(XMLNSC.DocumentType)* NAME = 'author' VALUE = cursor.edv;  
-- Create the entity reference  
SET OutputRoot.XMLNSC.BookInfo.(XMLNSC.EntityReference)entref = 'author';
```

Java example code to create an XML declaration

To construct the XML declaration that is shown above, the following Java is required:

```
//Create the XML domain root node  
MBElement xmlRoot =  
    root.createElementAsLastChild(MbXMLNSC.PARSER_NAME);  
//Create the XML declaration parent node  
MBElement xmlDecl =  
    xmlRoot.createElementAsFirstChild(MbXMLNSC.XML_DECLARATION);  
  
xmlDecl.setName("XmlDeclaration");  
  
MBElement version =  
    xmlDecl.createElementAsFirstChild(MbXMLNSC.ATTRIBUTE, "Version", "1.0");  
MBElement encoding =  
    xmlDecl.createElementAsFirstChild(MbXMLNSC.ATTRIBUTE, "Encoding", "utf-8");  
MBElement standalone =  
    xmlDecl.createElementAsFirstChild(MbXMLNSC.ATTRIBUTE, "Standalone", "Yes");
```

XMLNSC: The message body:

The XMLNSC parser builds a message tree from the body of an XML document.

The following topics describe how the XMLNSC parser builds a message tree from the body of an XML document:

- “XMLNSC: Using field types”
- “XMLNSC: Attributes and elements” on page 369
- “XMLNSC: Namespace declarations” on page 370
- “XMLNSC: Element values and mixed content” on page 371
- “XMLNSC: Comments and Processing Instructions” on page 373

XMLNSC: Using field types:

The XMLNSC parser sets the field type on every syntax element that it creates.

The field type indicates the type of XML construct that the element represents. The XMLNSC parser uses the field type when writing a message tree. The field type can be set using ESQL or Java to control the output XML. The field types that are used by the XMLNSC parser must be referenced using constants with names prefixed by ‘XMLNSC.’

Tip: Field type constants that have the prefix ‘XML.’ are for use with the XMLNS and XML parsers only. They are not valid with the XMLNSC or MRM parsers.

Field types for creating syntax elements

Use the following field type constants to create syntax elements in the message tree. The XMLNSC parser uses these values when creating a message tree from an input message.

XML construct	XMLNSC Field Type constant	Value
Simple Element	XMLNSC.PCDataField XMLNSC.CDataField	0x03000000 0x03000001
Attribute	XMLNSC.SingleAttribute XMLNSC.DoubleAttribute	0x03000101 0x03000100
Mixed content	XMLNSC.PCDataValue XMLNSC.CDataValue	0x02000000 0x02000001
Namespace Declaration	XMLNSC.SingleNamespaceDecl XMLNSC.DoubleNamespaceDecl	0x03000102 0x03000103
Complex element	XMLNSC.Folder	0x01000000
Inline DTD	XMLNSC.DocumentType	0x01000300
XML declaration	XMLNSC.XmlDeclaration	0x01000400
Entity reference	XMLNSC.EntityReference	0x02000100
Entity definition	XMLNSC.SingleEntityDefinition XMLNSC.DoubleEntityDefinition	0x03000301 0x03000300
Comment	XMLNSC.Comment	0x03000400
Processing Instruction	XMLNSC.ProcessingInstruction	0x03000401

Field types for path expressions (generic field types)

Use the field type constants that are listed below when querying the message tree using a path expression. For example:

```
SET str = FIELDVALUE(InputRoot.e1.(XMLNSC.Attribute)attr1)
```

It is good practice to specify field types when querying a message tree built by the XMLNSC parser. This makes your ESQL code more specific and more readable, and it avoids incorrect results in some cases. However, care is required when choosing which field type constant to use. When you use the XMLNSC parser, use a generic field type constant when querying the message tree. This allows your path expression to tolerate variations in the input XML.

The generic field type constants are listed below:

XML construct	XMLNSC Field Type constant	Purpose
Element	XMLNSC.Field	Matches normal text, CData, or a mixture of both
Attribute	XMLNSC.Attribute	Matches single-quoted and double-quoted attributes
Mixed content	XMLNSC.Value	Matches normal text, CData, or a mixture of both
XML Declaration	XMLNSC.NamespaceDecl	Matches single- and double-quoted declarations

If you write

```
InputRoot.e1.(XMLNSC.DoubleAttribute)attrName
```

your path expression does not match a single-quoted attribute. If you use the generic field type constant *XMLNSC.Attribute*, your message flow works with either single-quoted or double-quoted attributes.

Note that you should always use the field type constants and not their numeric values.

Field types for controlling output format

The following field types are provided for XML Schema and base64 support. Do not use these field type constants in path expressions; use them in conjunction with *XMLNSC.Attribute* and *XMLNSC.Field* to indicate the required output format for DATE and BLOB values. See “XMLNSC: XML Schema support” on page 374 for further information.

XMLNSC Field Type constant	Purpose	Value
XMLNSC.gYear	Value must be a DATE. If the field type includes this value, the DATE value is output using the XML Schema gYear format.	0x00000010
XMLNSC.gYearMonth	Value must be a DATE. If the field type includes this value, the DATE value is output using the XML Schema gYearMonth format.	0x00000040
XMLNSC.gMonth	Value must be a DATE. If the field type includes this value, the DATE value is output using the XML Schema gMonth format.	0x00000020
XMLNSC.gMonthDay	Value must be a DATE. If the field type includes this value, the DATE value is output using the XML Schema gMonthDay format.	0x00000050
XMLNSC.gDay	Value must be a DATE. If the field type includes this value, the DATE value is output using the XML Schema gDay format.	0x00000030
XMLNSC.base64Binary	Value must be a BLOB. Value is output with base64 encoding.	0x00000060
XMLNSC.List	Element must be <i>XMLNSC.Attribute</i> or <i>XMLNSC.Field</i> . If the field type includes this value, the values of all child elements in the message tree are output as a space-separated list.	0x00000070

Field types for direct output

The following field types allow you to output pre-constructed segments of an XML document. No character escaping is done and, if you are not careful, you can construct a badly-formed output document. Only use these constants after carefully exploring alternative solutions.

XMLNSC Field Type constant	Purpose	Value
XMLNSC.Bitstream	Value of syntax element must be a BLOB. The value is written directly to the output bit stream. See “Working with large XML messages” on page 361 for more information about its usage.	0x03000200
XMLNSC.AsisElementContent	Value of syntax element must be CHARACTER. The value is written directly to the output bit stream. No character substitutions are performed. Use this with care.	0x03000600

XMLNSC: Attributes and elements:

The XMLNSC parser uses the following field types to represent attributes and elements.

Use the field type constants that are listed below when creating your own syntax elements in the message tree.

Table 10. Specific field type constants

XML Construct	XMLNSC Field Type constant	Value
Complex element	XMLNSC.Folder	0x01000000
Simple element	XMLNSC.PCDataField XMLNSC.CDataField	0x02000000 0x02000001
Attribute	XMLNSC.SingleAttribute XMLNSC.DoubleAttribute	0x03000100 0x03000101

When accessing elements and attributes in the message tree, use generic field type constants which match all of the alternative values. Because there is only one type of Folder element, it is safe to use XMLNSC.Folder when querying the message tree.

Table 11. Generic field type constants

XML Construct	XMLNSC Field Type constant	Purpose
Element	XMLNSC.Field	Matches elements that contain normal text, CData, or a mixture of both
Attribute	XMLNSC.Attribute	Matches both single-quoted and double-quoted attributes

ESQL code examples

The following examples use this XML message:

```
<root id="12345">
  <id>ABCDE</id>
</root>
```

Note that the message contains an attribute and an element with the same name.

Example 1 : Query the value of an XML element

```
SET value = FIELDVALUE(InputRoot.XMLNSC.root.(XMLNSC.Field)id)
```

The result is that value is set to 'ABCDE'.

Example 2 : Query the value of an XML attribute

```
SET value = FIELDVALUE(InputRoot.XMLNSC.root.(XMLNSC.Attribute)id)
```

The result is that value is set to '12345'.

Example 3 : Create the example message using ESQL

```
CREATE LASTCHILD OF OutputRoot.XMLNSC Name 'root' Type 'XMLNSC.Folder';
-- Note : XMLNSC.Attribute could be used here as well.
SET OuputRoot.XMLNSC.root.(XMLNSC.DoubleAttribute)id = '12345';
SET OuputRoot.XMLNSC.root.(XMLNSC.Field)id = 'ABCDE';
```

The first line is optional because the element 'root' is created automatically by the following line if it does not already exist.

XMLNSC: Namespace declarations:

The XMLNSC parser provides full support for namespaces.

The XMLNSC parser sets the correct namespace on every syntax element that it creates while parsing a message, and stores namespace declarations in the message tree. The parser uses the namespace declarations to select the appropriate prefixes when outputting the message tree.

The XMLNSC parser uses the following field types to represent namespace declarations. You should use the field type constants that are listed below when creating your own namespace declarations in the message tree.

Table 12. Specific field type constants

XML construct	XMLNSC field type constant	Value
Namespace declaration	XMLNSC.SingleNamespaceDec1	0x03000102
	XMLNSC.DoubleNamespaceDec1	0x03000103

When accessing elements and attributes in the message tree, do not use the constants in the previous table. Instead, use the generic field type constant that matches both of the values in the table above.

Table 13. Generic field type constants

XML construct	XMLNSC field type constant	Purpose
Namespace declaration	XMLNSC.NamespaceDecl	Matches both single-quoted and double-quoted namespace declarations

ESQL code examples

Example 1 : Declaring a non-empty prefix

```
DECLARE space1 NAMESPACE 'namespace1';
SET OuputRoot.XMLNSC.root.(XMLNSC.NamespaceDecl)xmlns:ns1 = 'namespace1';
SET OuputRoot.XMLNSC.root.space1:example = 'ABCDE';
```

This creates the following XML message:

```
<root xmlns:ns1="namespace1">
  <ns1:example>ABCDE</ns1:example>
</root>
```

Note that the ESQL namespace constant 'space1' is only ever used by ESQL; it does not affect the namespace prefix in the output message.

Example 2 : Declaring an empty prefix

```
DECLARE space1 NAMESPACE 'namespace1';
SET OuputRoot.XMLNSC.root.(XMLNSC.NamespaceDecl)xmlns = 'namespace1';
SET OuputRoot.XMLNSC.root.space1:example = 'ABCDE';
```

This creates the following XML message:

```
<root xmlns="namespace1">
  <example>ABCDE</example>
</root>
```

Note that the syntax element 'example' must have a non-empty namespace. The default namespace declaration means that any child element without a prefix is in the namespace 'namespace1'.

Example 3 : Example of incorrect usage

```
DECLARE space1 NAMESPACE 'namespace1';
SET OuputRoot.XMLNSC.root.(XMLNSC.NamespaceDecl)xmlns = 'namespace1';
SET OuputRoot.XMLNSC.root.example = 'ABCDE';
```

This causes the XMLNSC parser to issue the message BIP5014 when the it attempts to output the message tree. The element 'example' must not have an empty namespace because it exists within the scope of a default namespace declaration.

XMLNSC: Element values and mixed content:

The XMLNSC parser is a compact parser so an element with single content is parsed as a single syntax element; when an element has both child elements and some text, the text is called 'mixed content'.

Element with simple content

This means that the following XML fragment with a single content is parsed as a single syntax element:

```
<simpleElement>simpleValue</simpleElement>
```

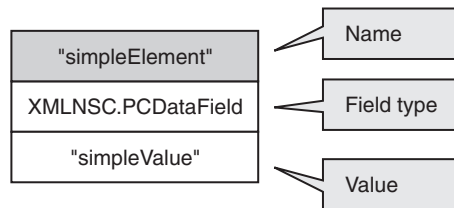

The value of this element can be queried with this ESQL:

```
SET val = FIELDVALUE(InputRoot.XMLNSC.(XMLNSC.Field)simpleElement);
```

To generate an element with simple content in the output:

```
SET OutputRoot.XMLNSC.(PCDataField)simpleElement VALUE = 'simpleValue';
```

Note that XMLNSC.Field is used when querying the message tree, but XMLNSC.PCDataField is specified when constructing the output message. XMLNSC.PCDataField can be used to query the message tree; however, that would not work if the input message used a CData section, as shown below:

```
<simpleElement><![CDATA[simpleValue]]></simpleElement>
```

Element with mixed content

If an element has child elements, it is typically a 'folder', and does not have a value. When an element has both child elements and some text, the text is called 'mixed content'.

```
<element>mixed1<child/>mixed2</element>
```

By default, mixed content is discarded because it is typically just formatting white space and has no business meaning. Mixed content can be preserved if you select the *Retain mixed content* check box on the Parser Options page of the node properties.

If mixed content is being preserved, the XMLNSC parser creates a Value child element for each distinct item of mixed content.

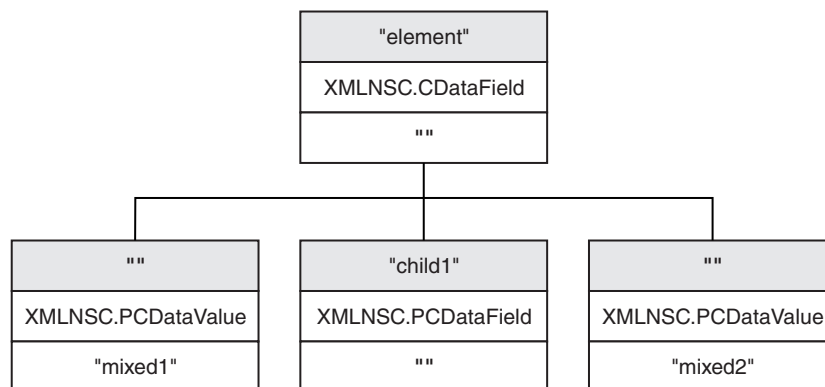

The mixed content can be queried with this ESQL:

```
SET mixed1 = FIELDVALUE(InputRoot.XMLNSC.(element).*[1];
```

The ESQL to construct the above XML fragment is:

```
CREATE ref REFERENCE TO OutputRoot.XMLNSC.element;
CREATE FIRSTCHILD OF ref TYPE XMLNSC.PCDataValue VALUE 'mixed1';
CREATE LASTCHILD OF ref NAME 'child1' TYPE XMLNSC.PCDataField VALUE '';
CREATE LASTSTCHILD OF ref TYPE XMLNSC.PCDataValue VALUE 'mixed2';
```

The following ESQL enables the *Retain mixed content* option:

```
DECLARE X BLOB;
-- assume that X contains an XML document
CREATE LASTCHILD OF OutputRoot
    PARSE(X OPTIONS XMLNSC.MixedContentRetainAll);
```

Element containing a CDATA section

A CDATA section is an XML notation that allows XML markup characters to be included in the content of an element.

The following two XML fragments are identical in their meaning:

```
<simpleElement>simpleValue</simpleElement>
<simpleElement><![CDATA[simpleValue]]></simpleElement>
```

If the CDATA section is the only text content, the XMLNSC parser remembers that the input document contained a CDATA section by setting the field type to XMLNSC.CDataField instead of XMLNSC.PCDataField.

If the CDATA section is not the only text content, it is created as a child value element, with other child value elements representing the remaining text content. An example is shown below:

```
<simpleElement><![CDATA[CDATAValue]]>normalText</simpleElement>
```

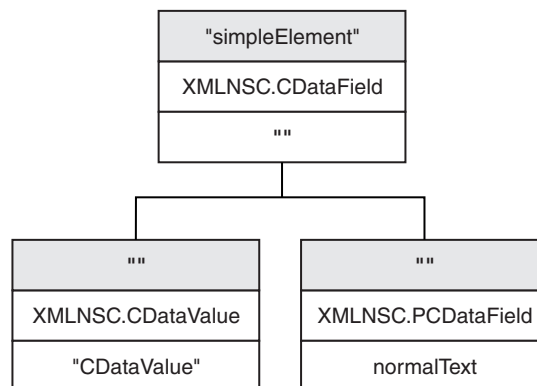

See “XMLNSC: Working with CDATA” on page 358 for more information about the correct use of CDATA in XML documents.

XMLNSC: Comments and Processing Instructions:

The XMLNSC parser discards comments and processing instructions because both comments and processing instructions are auxiliary information with no business meaning.

Comments

Comments can be preserved if you select the *Retain comments* check box on the Parser Options page of the node properties.

If *Retain comments* is selected, each comment in the input document is represented by a single syntax element with field type XMLNSC.Comment. The *Retain comments* option can also be accessed using the following ESQL:

```
DECLARE X BLOB;
-- assume that X contains an XML document
CREATE LASTCHILD OF OutputRoot.XMLNSC
  PARSE(X DOMAIN XMLNSC
        NAME preserveComments
        OPTIONS XMLNSC.CommentsRetainAll);

-- do it again, this time discarding comments
CREATE LASTCHILD OF OutputRoot.XMLNSC
  PARSE(X DOMAIN XMLNSC
        NAME discardComments
        OPTIONS XMLNSC.CommentsRetainNone);
```

Processing Instructions

Processing instructions can be preserved if you select the *Retain processing instructions* check box on the Parser Options page of the node properties.

If *Retain processing instructions* is selected, each processing instruction the input document is represented by a single syntax element with field type XMLNSC.ProcessingInstruction. The *Retain processing instructions* option can also be accessed using the following ESQL:

```
DECLARE X BLOB;
-- assume that X contains an XML document
CREATE LASTCHILD OF OutputRoot.XMLNSC
  PARSE(X DOMAIN XMLNSC
        NAME preserveProcessingInstructions
        OPTIONS XMLNSC.ProcessingInstructionsRetainAll);

-- do it again, this time discarding processing instructions
CREATE LASTCHILD OF OutputRoot.XMLNSC
  PARSE(X DOMAIN XMLNSC
        NAME discardProcessingInstructions
        OPTIONS XMLNSC.ProcessingInstructionsRetainNone);
```

XMLNSC: XML Schema support:

The XMLNSC parser can parse and validate using an XML Schema.

See “XMLNSC parser” on page 85 for information about how to configure the XMLNSC parser to use an XML Schema.

The following topics describe how the XMLNSC parser uses the field type to hold information about XML Schema simple types. This enables the parser to output dates and binary elements in the same form in which they were parsed, and according to the XML Schema specification. It also allows the message flow developer to output dates, lists and binary data in the correct XML Schema format.

- “XMLNSC: base64 support” on page 375
- “XMLNSC: XML Schema date formatting” on page 375
- “XMLNSC: XML List type support” on page 376

XMLNSC: base64 support:

The XMLNSC parser can output binary data in base64-encoded format.

If Validation is set to Content and Value, and Build tree using schema types is enabled, the XMLNSC parser automatically decodes base64 data and creates a BLOB value in the message tree. When outputting a message tree, the XMLNSC parser will 'base64-encode' a BLOB if the field type includes the constant *XMLNSC.base64Binary*.

ESQL code example to output base64 data

```
DECLARE Base64Data BLOB '0102030405060708090A0B0C0D0E0F';  
-- Add in the base64Binary field type  
DECLARE base64FieldType INTEGER XMLNSC.Field + XMLNSC.base64Binary;  
CREATE LASTCHILD OF OutputRoot DOMAIN 'XMLNSC' NAME 'XMLNSC';  
CREATE LASTCHILD OF OutputRoot.XMLNSC TYPE base64FieldType NAME 'myBinaryData' VALUE Base64Data;
```

Result : <myBinaryData>AQIDBAUGBwgJCgsMDQ4P</myBinaryData>

Note that this example does not depend on validation. The XMLNSC parser can output base64 binary data even if Validation is set to None.

XMLNSC: XML Schema date formatting:

The XMLNSC parser can parse and write all of the XML Schema simple types.

The rarely used types gYear, gYearMonth, gMonth, gMonthDay, and gDay do not map directly to a message broker data type. For these simple types, the XMLNSC parser adds one of the following constant values to the field type. This allows the parser to output the data in the same format as it was received.

Field types for controlling date format

The following field types are provided for XML Schema date format support. Do not use these field type constants in path expressions. Use them in conjunction with constants XMLNSC.Attribute and XMLNSC.Field to indicate the required output format for DATE values.

XMLNSC Field Type constant	Purpose	Value
XMLNSC.gYear	Value must be a DATE. If the field type includes this value, the DATE value is output using the XML Schema gYear format.	0x00000010
XMLNSC.gYearMonth	Value must be a DATE. If the field type includes this value, the DATE value is output using the XML Schema gYearMonth format.	0x00000040
XMLNSC.gMonth	Value must be a DATE. If the field type includes this value, the DATE value is output using the XML Schema gMonth format.	0x00000020

XMLNSC Field Type constant	Purpose	Value
XMLNSC.gMonthDay	Value must be a DATE. If the field type includes this value, the DATE value is output using the XML Schema gMonthDay format.	0x00000050
XMLNSC.gDay	Value must be a DATE. If the field type includes this value, the DATE value is output using the XML Schema gDay format.	0x00000030

ESQL code example

```

DECLARE gYear DATE '2007-01-01';
-- Add in the gYear field type
DECLARE gYearFieldType INTEGER XMLNSC.Field + XMLNSC.gYear;
CREATE LASTCHILD OF OutputRoot DOMAIN 'XMLNSC' NAME 'XMLNSC';
CREATE LASTCHILD OF OutputRoot.XMLNSC TYPE gYearFieldType NAME 'gYear' VALUE gYear;

```

Result : <gYear>2007</gYear>

XMLNSC: XML List type support:

The XMLNSC parser can automatically parse a space-separated list of values into individual syntax elements in the message tree if you select certain options.

An element or an attribute can have multiple values separated by spaces, as shown in the examples below:

```

<listElement>one two three</listElement>
<element listAttribute="1 2 3"><childEL1/></element>

```

If your XML schema specifies a list type for an element or an attribute, and Validation is set to Content and Value, and Build tree using schema types is enabled, the XMLNSC parser automatically parses the space-separated list of values into individual syntax elements in the message tree. The resulting message tree looks like this:

and for an attribute with a list value it looks like this:

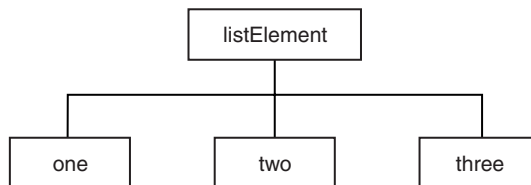

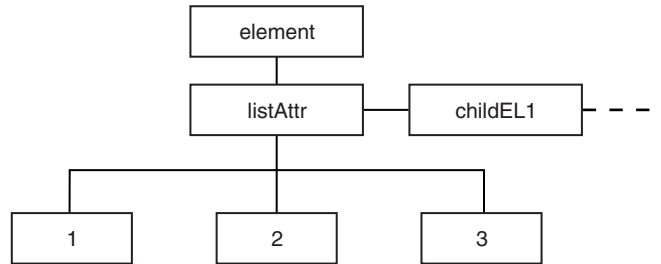

ESQL code examples

Access the individual values in a list

```
SET val = InputRoot.XMLNSC.listElement.*[1];
```

Result : val = 'one'

```
SET val = InputRoot.XMLNSC.element.(XMLNSC.Attribute)listAttr.*[3];
```

Result : val='3'

Create a list element in the message tree

```
CREATE LASTCHILD OF OutputRoot.XMLNSC
  Name 'listElement'
  Type XMLNSC.List;
DECLARE listE1 REFERENCE TO OutputRoot.XMLNSC.listElement;
DECLARE listValType INTEGER XMLNSC.PCDataValue;
CREATE LASTCHILD OF listE1 TYPE listValType VALUE 'one';
CREATE LASTCHILD OF listE1 TYPE listValType VALUE 'two';
CREATE LASTCHILD OF listE1 TYPE listValType VALUE 'three';
```

Migrating to XMLNSC:

Reasons to migrate

The XMLNSC parser now offers the best combination of features and performance for most applications. If your message flow uses the XMLNS or XML domain, you might want to migrate a message flow to XMLNSC to take advantage of the XML schema validation. If your message flow uses the MRM domain, you might want to migrate to XMLNSC to obtain standards-compliant validation, and a large reduction in CPU usage.

Migrating from the XMLNS or XML domain

The XMLNSC parser differs from the XMLNS parser in the following ways:

- The XMLNSC parser builds a compact message tree.
- It uses different field type constants.
- It discards inline DTDs

In most cases, the compact message tree has no affect on ESQL paths or XPath expressions. Typically, a simple message tree query produces the same results in XMLNSC as in the XMLNS or XML domain. Merely changing the correlation name from XMLNS to XMLNSC is usually sufficient, but care must be taken with complex XPath expressions that navigate to the value of an element and then to its parent in a single query. These might produce different results in the XMLNSC domain.

The field type constants that are used by the XMLNSC parser are completely different from those used by XMLNS or XML. Every occurrence of XML.Attribute, XML.XmlDecl, for example, must be changed to use the equivalent XMLNSC field type constant.

The discarding of inline DTDs only affects message flows that process the DTD.

Migrating from MRM XML

The XMLNSC parser differs from the MRM XML parser in the following ways:

- The XMLNSC parser uses field types to identify the XML constructs in the message tree. The MRM parser distinguishes attributes from elements by matching the message tree against the message definition.
- When writing a message tree, the XMLNSC parser selects namespace prefixes by detecting and using xmlns attributes in the message tree. The MRM XML parser uses a table in the message set properties.
- The MRM parser does not include the root tag of the XML document in the message tree.

Migrating a message flow from MRM to XMLNSC typically requires extensive changes to your message flow. However, the migration usually delivers a large reduction in CPU usage, and allows much more accurate control of the output XML.

Manipulating messages in the XMLNS domain:

This topic provides information about how to write ESQL for processing messages that belong to the XMLNS domain, and that are parsed by the XMLNS parser. Most of the information in this topic, and the topics mentioned below, also applies to the XML domain, unless it refers to features that are not supported in the XML domain.

Refer to “XMLNS parser” on page 94 for background information.

The following topics provided detailed information about the structure of the message tree that the XMLNS parser builds, and the field types that it uses.

- “XMLNS: The XML declaration”
- “XMLNS: The DTD” on page 380
- “XMLNS: The XML message body” on page 381

More information about processing XML messages can be found in “Working with XML messages” on page 354.

XMLNS: The XML declaration:

The beginning of an XML message can contain an XML declaration.

An example of a declaration is shown below:

```
<?xml version="1.0" encoding="UTF-8" standalone="no"?>
<!DOCTYPE s1 PUBLIC "http://www.ibm.com/example.dtd" "example.dtd">
<s1>.....</s1>
```

The XML Declaration is represented by the following types of syntax element:

- “XML.XMLDecl” on page 379

- "XML.version"
- "XML.encoding"
- "XML.standalone"

"XMLNS: XML declaration example" on page 380 includes another example of an XML declaration and the tree structure that it forms.

XML.XMLDecl:

The XML Declaration is represented in the message tree by a syntax element with field type 'XML.XMLDecl'.

If the XML declaration is created by the XMLNS parser its name is 'XMLDecl'. However, when a message tree is being output the name is not important; only the field type is used by the parser.

An example of a declaration is shown below:

```
<?xml version="1.0" encoding="UTF-8" standalone="no"?>
<!DOCTYPE s1 PUBLIC "http://www.ibm.com/example.dtd" "example.dtd">
<s1>.....</s1>
```

XML.version:

The XML version attribute in the XML declaration is represented in the message tree by a syntax element with field type 'XML.version'.

The value of the XML version attribute is the value of the version attribute. It is always a child of an XML.XmlDecl syntax element. In the example below, the version element contains the string value 1.0:

```
<?xml version="1.0" encoding="UTF-8" standalone="no"?>
<!DOCTYPE s1 PUBLIC "http://www.ibm.com/example.dtd" "example.dtd">
<s1>.....</s1>
```

XML.encoding:

The encoding attribute is represented by a syntax element with field type 'XML.encoding', and is always a child of an XML.XmlDecl syntax element.

In the example shown below, the encoding attribute has a value of UTF-8.

```
<?xml version="1.0" encoding="UTF-8" standalone="no"?>
<!DOCTYPE s1 PUBLIC "http://www.ibm.com/example.dtd" "example.dtd">
<s1>.....</s1>
```

You cannot specify WebSphere MQ encodings in this element.

In your ESQL, (XML,"Encoding") must include quotation marks, because Encoding is a reserved word.

XML.standalone:

The XML standalone element defines the existence of an externally-defined DTD. In the message tree it is represented by a syntax element with field type XML.standalone.

The value of the XML standalone element is the value of the standalone attribute in the XML declaration. It is always a child of an XML.XmlDecl syntax element. The only valid values for the standalone element are yes and no. An example is shown below:

```
<?xml version="1.0" encoding="UTF-8" standalone="no"?>
<!DOCTYPE s1 PUBLIC "http://www.ibm.com/example.dtd" "example.dtd">
<s1>.....</s1>
```

A value of no indicates that this XML document is not standalone, and depends on an externally-defined DTD. A value of yes indicates that the XML document is self-contained. However, because the current release of WebSphere Message Broker does not resolve externally-defined DTDs, the setting of standalone is irrelevant, and is ignored.

XMLNS: XML declaration example:

The following example shows an XML declaration in an XML document:

```
<?xml version="1.0" encoding="UTF-8" standalone="yes"?>
```

The following figure shows the tree structure that the XMLNS parser creates for this declaration:

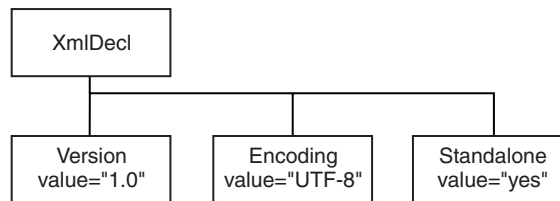

XMLNS: The DTD:

The document type declaration (DTD) of an XML message is represented by a syntax element with field type XML.DocTypeDecl, and its children. These comprise the DOCTYPE construct.

Only internal (inline) DTD subsets are represented in the syntax element tree. An inline DTD is a DTD that is declared within the XML document itself. It can be a complete DTD definition, or it can extend the definition in an external DTD.

External DTD subsets (identified by the SystemID or PublicId elements described below) can be referenced in the message, but those referenced are not resolved by the broker.

The following field type constants can be used to reference the various parts of a DTD in the message tree:

- "XML DocTypeDecl" on page 1440
- "XML NotationDecl" on page 1441
- "XML entities" on page 1441
- "XML ElementDef" on page 1443
- "XML AttributeList" on page 1443
- "XML AttributeDef" on page 1443
- "XML DocTypePI" on page 1444

- “XML WhiteSpace and DocTypeWhiteSpace” on page 1445
- “XML DocTypeComment” on page 1444

“XML DTD example” on page 1445 shows an example of an XML DTD.

See “XML document type declaration” on page 1440 for more information about handling an inline DTD.

XMLNS: The XML message body:

Every XML message must have a body. The body consists of a hierarchy of XML elements and other XML constructs that represent the message data.

The XMLNS parser assigns a field type to every syntax element that it creates. The value of the field type indicates the XML construct that it represents. In the following topics, each field type is discussed, with a series of example XML fragments.

The following common element types are discussed:

- “XML.element” on page 383
- “XML.Attribute” on page 383
- “XML.content” on page 384

“XML message body example” on page 387 provides an example of an XML message body and the tree structure that is created from it using the syntax elements types that are listed above.

More complex XML messages might use some of the following syntax element types:

- “XML.CDataSection” on page 384
- “XML.EntityReferenceStart and XML.EntityReferenceEnd” on page 385
- “XML.comment” on page 385
- “XML.ProcessingInstruction” on page 386
- “XML.AsisElementContent” on page 386
- “XML.BitStream” on page 387

Accessing attributes and elements:

The XMLNS parser sets the field type on every message tree element that it creates.

The field type indicates the type of XML construct that the element represents. The field types used by the XMLNS parser can be referenced using constants with names prefixed with ‘XML.’ Field type constants with prefix ‘XML.’ are for use with the XMLNS and XML parsers only; they do not work with the XMLNSC or MRM parsers.

	XMLNS Field Type constant
Tag	XML.Element
Attribute	XML.Attribute XML.Attr

By using the field type in this way, the XMLNS parser can distinguish between an element and an attribute that have the same name.

Example XML

```
<parent id="12345">
  <id>ABCDE</id>
</parent>
```

Example ESQL

```
SET value = FIELDVALUE(InputRoot.XMLNS.parent.(XML.Element)id)
Result : value is 'ABCDE'
```

```
SET value = FIELDVALUE(InputRoot.XMLNS.parent.(XML.Attr)id)
Result : value is '12345'
```

Example using SELECT to access multiple attributes

In the example Invoice message, the element Title within each Item element has three attributes: Category, Form, and Edition. For example, the first Title element contains:

```
<Title Category="Computer" Form="Paperback" Edition="2">The XML Companion</Title>
```

The element `InputRoot.XML.Invoice.Purchases.Item[1].Title` has four children in the logical tree: Category, Form, Edition, and the element value, which is “The XML Companion”.

If you want to access the attributes for this element, you can code the following ESQL. This extract of code retrieves the attributes from the input message and creates them as elements in the output message. It does not process the value of the element itself in this example.

```
-- Set the cursor to the first XML.Attribute of the Title.
-- Note the * after (XML.Attribute) meaning any name, because the name might not be known
DECLARE cursor REFERENCE TO InputRoot.XMLNS.Invoice.Purchases.Item[1].Title.(XML.Attribute)*;
WHILE LASTMOVE(cursor) DO
  -- Create a field with the same name as the XML.Attribute
  -- and set its value to the value of the XML.Attribute
  SET OutputRoot.XML.Data.Attributes.{FIELDNAME(cursor)} = FIELDVALUE(cursor);
  -- Move to the next sibling of the same TYPE to avoid the Title value
  -- which is not an XML.Attribute
  MOVE cursor NEXTSIBLING REPEAT TYPE;
END WHILE;
```

When this ESQL is processed by the Compute node, the following output message is generated:

```
<Data>
  <Attributes>
    <Category>Computer</Category>
    <Form>Paperback</Form>
    <Edition>2</Edition>
  </Attributes>
</Data>
```

You can also use a SELECT statement:

```
SET OutputRoot.XMLNS.Data.Attributes[] =
  (SELECT FIELDVALUE(I.Title) AS title,
    FIELDVALUE(I.Title.(XML.Attribute)Category) AS category,
    FIELDVALUE(I.Title.(XML.Attribute)Form) AS form,
    FIELDVALUE(I.Title.(XML.Attribute)Edition) AS edition
  FROM InputRoot.XML.Invoice.Purchases.Item[] AS I);
```

This statement generates the following output message:

```
<Data>
  <Attributes>
    <title>The XML Companion</title>
    <category>Computer</category>
    <form>Paperback</form>
    <edition>2</edition>
  </Attributes>
  <Attributes>
    <title>A Complete Guide to DB2 Universal Database</title>
    <category>Computer</category>
    <form>Paperback</form>
    <edition>2</edition>
  </Attributes>
  <Attributes>
    <title>JAVA 2 Developers Handbook</title>
    <category>Computer</category>
    <form>Hardcover</form>
    <edition>0</edition>
  </Attributes>
</Data>
```

You can qualify the SELECT with a WHERE statement to narrow down the results to obtain the same output message as the one that is generated by the WHILE statement. This second example shows that you can create the same results with less, and less complex, ESQL.

```
SET OutputRoot.XMLNS.Data.Attributes[] =
  (SELECT FIELDVALUE(I.Title.(XML.Attribute)Category) AS category,
          FIELDVALUE(I.Title.(XML.Attribute)Form) AS form,
          FIELDVALUE(I.Title.(XML.Attribute)Edition) AS edition
   FROM InputRoot.XML.Invoice.Purchases.Item[] AS I)
 WHERE I.Title = 'The XML Companion');
```

This statement generates the following output message:

```
<Data>
  <Attributes>
    <Category>Computer</Category>
    <Form>Paperback</Form>
    <Edition>2</Edition>
  </Attributes>
</Data>
```

XML.element: This syntax element represents an XML element (a tag). The name of the syntax element corresponds to the name of the XML element in the message. This element can have many children in the message tree, including attributes, elements, and content.

XML.tag is supported as an alternative to XML.element for compatibility with earlier versions of WebSphere Message Broker. Use XML.element in any new message flows that you create.

XML.Attribute: **Parsing**

The XMLNS parser uses this field type for syntax elements that represent an XML attribute. The name and value of the syntax element correspond to the name and value of the XML attribute that is represented. Attribute elements have no children, and must always be children of an element.

Writing

When the XMLNS parser generates a bit stream from a message tree, occurrences of ampersand (&), less than (<), greater than (>), double quotation mark ("), and apostrophe ('), within the attribute value, are replaced by the predefined XML entities &, <, >, ", and '.

The XML.attr field type constant is also supported for compatibility with earlier versions of WebSphere Message Broker.

XML.content: The XMLNS parser uses this syntax element to represent character data (including an XML attribute). The name and value of the syntax element correspond to the name and value of the XML attribute that is represented. Attribute elements have no children, and must always be children of an element.

Writing

When the XMLNS parser generates a bit stream from a message tree, occurrences of ampersand (&), less than (<), greater than (>), double quotation mark ("), and apostrophe ('), within the attribute value, are replaced by the predefined XML entities &, <, >, ", and '.

XML.CDataSection: CData sections in the XML message are represented by a syntax element with field type XML.CdataSection. The content of the CDataSection element is the value of the CDataSection element without the <![CDATA[that marks its beginning, and the]]> that marks its end.

For example, the following CData section

```
<![CDATA[<greeting>Hello, world!</greeting>]]>
```

is represented by a CDataSection element with a string value of:

```
"<greeting>Hello, world!</greeting>"
```

Unlike Content, occurrences of <, >, &, ", and ' are not translated to their XML character entities (<, >, and &) when the CDataSection is output.

When to use XML.CDataSection

A CData section is often used to embed one XML message within another. Using a CData section ensures that the XML reserved characters (<, >, and &) are not replaced with XML character entities.

XML.AsIsElementContent also allows the output of unmodified character data, but XML.CDataSection is usually a better choice because it protects the outer message from errors in the embedded message.

Parsing the contents of a CDataSection

A common requirement is to parse the contents of a CData section to create a message tree. This can be achieved by using the ESQL statement CREATE with the PARSE clause. See "XMLNSC: Working with XML messages and bit streams" on page 360.

XML.NamespaceDecl:

A namespace declaration is represented by a syntax element with field type XML.NamespaceDecl.

Namespace declarations take one of two forms in the message tree:

- **Declaration using a namespace prefix**

```
<ns1:e1 xmlns:ns1="namespace1"/>
```

In the message tree, the syntax element for this namespace declaration is shown in the following table:

Namespace	http://www.w3.org/2000/xmlns/
Name	ns1
Value	namespace1

- **Declaration of a default namespace**

A default namespace declaration is an xmlns attribute that defines an empty prefix

```
<e1 xmlns="namespace1"/>
```

In the message tree, the syntax element for this namespace declaration is shown in the following table:

Namespace	""
Name	xmlns
Value	namespace1

Note that, in both cases, element 'e1' is in namespace 'namespace1'.

XML.EntityReferenceStart and XML.EntityReferenceEnd: When an entity reference is encountered in the XML message, both the expanded form and the original entity name are stored in the syntax element tree. The name of the entity is stored as the value of the EntityReferenceStart and EntityReferenceEnd syntax elements, and any syntax elements between contain the entity expansion. Examples of the XML entity references in an XML document, and in tree structure form, are shown below:

```
<?xml version="1.0" encoding="UTF-8" standalone="yes"?>
<!DOCTYPE example [ <!ENTITY entityName "eValue"> ]>
<example>Test: &entityName;</example>
```

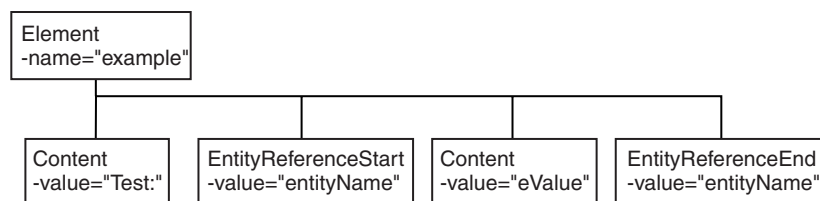

The XML declaration and the document type declaration are not shown here. Refer to “XMLNS: The XML declaration” on page 378 and “XMLNS: The DTD” on page 380 for details of those sections of the syntax element tree.

XML.comment: An XML.comment that is encountered outside the document type declaration is represented by a syntax element with field type XML.comment. The value of the element is the comment text from the XML message.

If the value of the element contains the character sequence -->, the sequence is replaced with the text -->. This ensures that the contents of the comment cannot prematurely terminate the comment. Occurrences of <, >, &, ", and ' are not translated to their escape sequences.

An example of the XML comment in an XML document is shown below:

```
<example><!-- This is a comment --></example>
```

XML.ProcessingInstruction: A processing instruction that is encountered outside the document type declaration is represented by a syntax element with field type XML.ProcessingInstruction. This is a name-value element; the name of the syntax element is the processing instruction target name, and the value of the syntax element is the character data of the processing instruction. The value of the syntax element must not be empty. The name cannot be 'XML' in either uppercase or lowercase.

If the value of the element contains the character sequence ?>, the sequence is replaced with the text ?>. This ensures that the content of the processing instruction cannot prematurely terminate the processing instruction. Occurrences of <,>, &, ", and ' are not translated to their escape sequences.

An example of the XML processing instruction in an XML document is shown below:

```
<example><?target This is a PI.??></example>
```

XML.AsIsElementContent: XML.AsIsElementContent is a special field type. Use it in a message flow to precisely control the XML that is generated in an output message, without the safeguards of the Element, Attribute, and Content syntax elements. The XMLNS parser never creates elements with this field type.

Try to avoid using AsIsElementContent; there is usually a safer alternative approach. If you do use AsIsElementContent, it is your responsibility to ensure that the output message is well-formed XML.

You might choose to use this syntax element if, for example, you want to suppress the normal behavior in which occurrences of ampersand (&), less than (<), greater than (>), quotation mark ("), and apostrophe (') are replaced by the predefined XML entities &, <, >, ", and '.

The following example illustrates the use of AsIsElementContent. The statement:

```
Set OutputRoot.XMLNS.(XML.Element)Message.(XML.Content) = '<rawMarkup>';
```

generates the following XML in an output message:

```
<Message>&lt;rawMarkup&gt;</Message>
```

However, the statement

```
Set OutputRoot.XMLNS.(XML.Element)Message.(XML.AsIsElementContent) = '<rawMarkup>';
```

generates the following XML in an output message:

```
<Message><rawMarkup></Message>
```

This shows that the value of an AsIsElementContent syntax element is not modified before it is written to the output message.

XML.BitStream: XML.BitStream is a special field type. When writing an XML message, the value of the BitStream element is written directly into the message, and the name is not important. The BitStream element might be the only element in the message tree.

The value of the element must be of type BLOB; any other data type generates an error when writing the element. Ensure that the content of the element is appropriate for use in the output message; pay special attention to the CCSID and the encoding of the XML text in the BLOB.

Use of the BitStream element is similar to the use of the AsisElementContent element, except that the AsisElementContent type converts its value into a string, whereas the BitStream element uses its BLOB value directly. This is a specialized element designed to aid the processing of very large messages.

The following ESQL excerpts demonstrate some typical use of this element. First, declare the element:

```
DECLARE StatementBitStream BLOB
```

Initialize the contents of StatementBitStream from an appropriate source, such as an input message. If the source field is not of type BLOB, use the CAST statement to convert the contents to BLOB. Then create the new field in the output message; for example:

```
CREATE LASTCHILD OF resultCursor
  Type XML.BitStream
  NAME 'StatementBitStream'
  VALUE StatementBitstream;
```

XML message body example: This topic shows the message tree that the XMLNS parser creates for the following snippet from a simple XML document:

```
<Person age="32" height="172cm">
  <Name>Cormac Keogh</Name>
</Person>
```

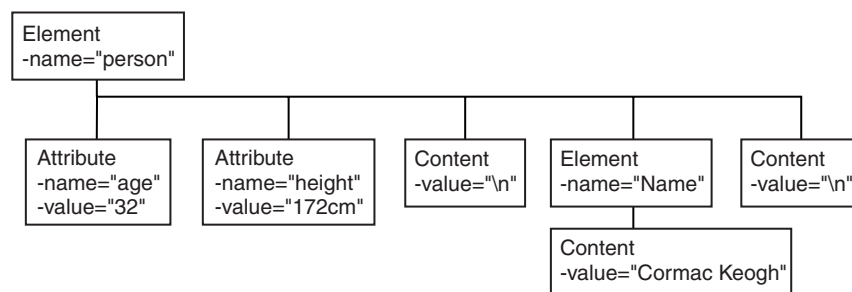

Manipulating messages in the XML domain:

The XML parser is very similar to the XMLNS parser, but it has no support for namespaces or opaque parsing. For information about how to work with the XML parser, refer to “Manipulating messages in the XMLNS domain” on page 378.

Manipulating messages in the MRM domain

Find out how to use messages that have been modeled in the MRM domain, and that are parsed by the MRM parser.

The following topics show you how to deal with messages that have been modeled in the MRM domain, and that are parsed by the MRM parser. The physical formats associated with the message models do not affect this information unless specifically stated. Use this information in conjunction with the information about manipulating message body content; see “Manipulating message body content” on page 283.

- “Accessing elements in a message in the MRM domain” on page 389
- “Accessing multiple occurrences of an element in a message in the MRM domain” on page 389
- “Accessing attributes in a message in the MRM domain” on page 390
- “Accessing elements within groups in a message in the MRM domain” on page 392
- “Accessing mixed content in a message in the MRM domain” on page 393
- “Accessing embedded messages in the MRM domain” on page 395
- “Accessing the content of a message in the MRM domain with namespace support enabled” on page 396
- “Querying null values in a message in the MRM domain” on page 396
- “Setting null values in a message in the MRM domain” on page 397
- “Working with MRM messages and bit streams” on page 398
- “Handling large MRM messages” on page 401

The following diagram shows the structure of the message, Customer, that is used in the following sample:

- Video Rental sample

The message is used in the samples in the topics listed previously to show ESQL that manipulates the objects that can be defined in a message model. You can view samples only when you use the information center that is integrated with the Message Broker Toolkit.

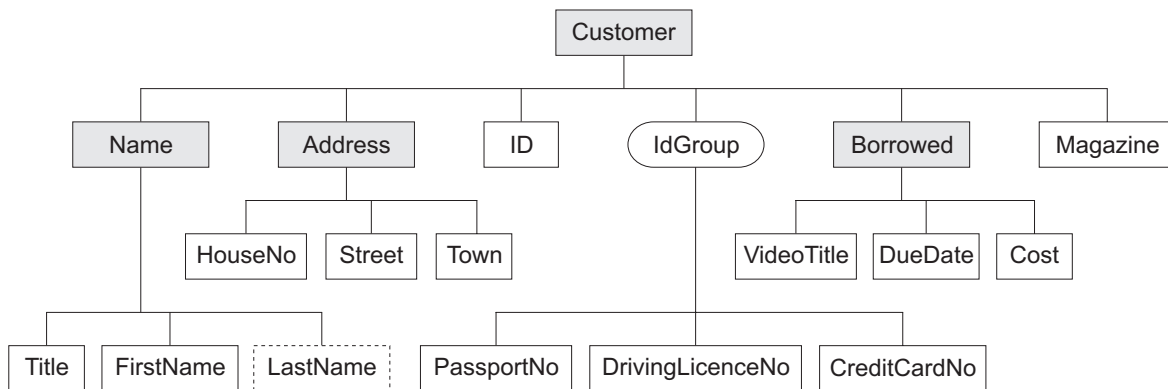

The message includes a variety of structures that demonstrate how you can classify metadata to the MRM. Within an MRM message set, you can define the following objects: messages, types, groups, elements, and attributes. Folder icons that represent each of these types of objects are displayed for each message definition file in the Broker Application Development perspective.

Each message definition file can contribute to a namespace; in this sample, each namespace is completely defined by a single message definition file. You can combine several message definition files to form a complete message dictionary, which you can then deploy to a broker.

The video sample has three message definition files:

Customer.mxsd

Resides in the no target namespace

Address.mxsd

Resides in the namespace `http://www.ibm.com/AddressDetails`

Borrowed.mxsd

Resides in the namespace `http://www.ibm.com/BorrowedDetails`

Look at the video rental message structure sample for detailed information about the objects that are defined in this message model:

- Video Rental sample

You can view samples only when you use the information center that is integrated with the Message Broker Toolkit.

Accessing elements in a message in the MRM domain:

You can use ESQL to manipulate the logical tree that represents a message in the message flow. This topic describes how to access data for elements in a message in the MRM domain.

You can populate an element with data with the SET statement:

```
SET OutputRoot.MRM.Name = UPPER(InputRoot.MRM.Name);
```

The field reference on the left hand side of the expression refers to the element called Name within the MRM message domain. This statement takes the input value for the Name field, converts it to uppercase, and assigns the result to the same element in the output message.

The Name element is defined in the noTarget namespace. No namespace prefix is specified in front of the Name part of the field reference in the example above. If you have defined an MRM element in a namespace other than the noTarget namespace, you must also specify a namespace prefix in the statement. For example:

```
DECLARE brw NAMESPACE 'http://www.ibm.com/Borrowed';  
SET OutputRoot.MRM.brw:Borrowed.VideoTitle = 'MRM Greatest Hits';
```

For more information about using namespaces with messages in the MRM domain, see “Accessing the content of a message in the MRM domain with namespace support enabled” on page 396.

Accessing multiple occurrences of an element in a message in the MRM domain:

You can access MRM domain elements following the general guidance given in “Accessing known multiple occurrences of an element” on page 288 and “Accessing unknown multiple occurrences of an element” on page 289. Further information specific to MRM domain messages is provided in this topic.

Consider the following statements:

```

DECLARE brw NAMESPACE 'http://www.ibm.com/Borrowed';

SET OutputRoot.MRM.brw:Borrowed[1].VideoTitle = 'MRM Greatest Hits Volume 1';
SET OutputRoot.MRM.brw:Borrowed[2].VideoTitle = 'MRM Greatest Hits Volume 2';

```

The above SET statements operate on two occurrences of the element Borrowed. Each statement sets the value of the child VideoTitle. The array index indicates which occurrence of the repeating element you are interested in.

When you define child elements of a complex type (which has its *Composition* property set to Sequence) in a message set, you can add the same element to the complex type more than once. These instances do not have to be contiguous, but you must use the same method (array notation) to refer to them in ESQL.

For example, if you create a complex type with a *Composition* of Sequence that contains the following elements:

```

StringElement1
IntegerElement1
StringElement1

```

use the following ESQL to set the value of StringElement1:

```

SET OutputRoot.MRM.StringElement1[1] =
    'This is the first occurrence of StringElement1';
SET OutputRoot.MRM.StringElement1[2] =
    'This is the second occurrence of StringElement1';

```

You can also use the arrow notation (the greater than (>) and less than (<) symbols) to indicate the direction of search and the index to be specified:

```

SET OutputRoot.MRM.StringElement1[>] =
    'This is the first occurrence of StringElement1';
SET OutputRoot.MRM.StringElement1[<2] =
    'This is the last but one occurrence of
    StringElement1';
SET OutputRoot.MRM.StringElement1[<1] =
    'This is the last occurrence of StringElement1';

```

Refer to “Accessing known multiple occurrences of an element” on page 288 and “Accessing unknown multiple occurrences of an element” on page 289 for additional detail.

Accessing attributes in a message in the MRM domain:

When an MRM message is parsed into a logical tree, attributes and the data that they contain are created as name-value pairs in the same way that MRM elements are. The ESQL that you code to interrogate and update the data held in attributes refers to the attributes in a similar manner.

Consider the Video Rental sample MRM message. The attribute LastName is defined as a child of the Name element in the Customer message. Here is an example input XML message:

```

<Customer xmlns:addr="http://www.ibm.com/AddressDetails"
xmlns:brw="http://www.ibm.com/BorrowedDetails">
  <Name LastName="Bloggs">
    <Title>Mr</Title>
    <FirstName>Fred</FirstName>
  </Name>
  <addr:Address>
    <HouseNo>13</HouseNo>
    <Street>Oak Street</Street>
    <Town>Southampton</Town>
  </addr:Address>
  <ID>P</ID>
  <PassportNo>J123456TT</PassportNo>
  <brw:Borrowed>
    <VideoTitle>Fast Cars</VideoTitle>
    <DueDate>2003-05-23T01:00:00</DueDate>
    <Cost>3.50</Cost>
  </brw:Borrowed>
  <brw:Borrowed>
    <VideoTitle>Cut To The Chase</VideoTitle>
    <DueDate>2003-05-23T01:00:00</DueDate>
    <Cost>3.00</Cost>
  </brw:Borrowed>
  <Magazine>0</Magazine>
</Customer>

```

When the input message is parsed, values are stored in the logical tree as shown in the following section of user trace:

```

(0x0100001B):MRM = (
  (0x01000013):Name = (
    (0x0300000B):LastName = 'Bloggs'
    (0x0300000B):Title = 'Mr'
    (0x0300000B):FirstName = 'Fred'
  )
  (0x01000013)http://www.ibm.com/AddressDetails:Address = (
    (0x0300000B):HouseNo = 13
    (0x0300000B):Street = 'Oak Street'
    (0x0300000B):Town = 'Southampton'
  )
  (0x0300000B):ID = 'P'
  (0x0300000B):PassportNo = 'J123456TT'
  (0x01000013)http://www.ibm.com/BorrowedDetails:Borrowed = (
    (0x0300000B):VideoTitle = 'Fast Cars'
    (0x0300000B):DueDate = TIMESTAMP '2003-05-23 00:00:00'
    (0x0300000B):Cost = 3.50
  )
  (0x01000013)http://www.ibm.com/BorrowedDetails:Borrowed = (
    (0x0300000B):VideoTitle = 'Cut To The Chase '
    (0x0300000B):DueDate = TIMESTAMP '2003-05-23 00:00:00'
    (0x0300000B):Cost = 3.00
  )
  (0x0300000B):Magazine = FALSE
)

```

The following ESQL changes the value of the LastName attribute in the output message:

```
SET OutputRoot.MRM.Name.LastName = 'Smith';
```

Be aware of the ordering of attributes when you code ESQL. When attributes are parsed, the logical tree inserts the corresponding name-value before the MRM element's child elements. In the previous example, the child elements Title and FirstName appear in the logical message tree after the attribute LastName. In the

Broker Application Development perspective, the Outline view displays attributes after the elements. When you code ESQL to construct output messages, you must define name-value pairs for attributes before any child elements.

Accessing elements within groups in a message in the MRM domain:

When an input message is parsed, structures that you have defined as groups in your message set are not represented in the logical tree, but its children are. If you want to refer to or update values for elements that are children of a groups, do not include the group in the ESQL statement. Groups do not have tags that appear in instance messages, and do not appear in user trace of the logical message tree.

Consider the following Video message:

```
<Customer xmlns:addr="http://www.ibm.com/AddressDetails"
xmlns:brw="http://www.ibm.com/BorrowedDetails">
  <Name LastName="Bloggs">
    <Title>Mr</Title>
    <FirstName>Fred</FirstName>
  </Name>
  <addr:Address>
    <HouseNo>13</HouseNo>
    <Street>Oak Street</Street>
    <Town>Southampton</Town>
  </addr:Address>
  <ID>P</ID>
  <PassportNo>J123456TT</PassportNo>
  <brw:Borrowed>
    <VideoTitle>Fast Cars</VideoTitle>
    <DueDate>2003-05-23T01:00:00</DueDate>
    <Cost>3.50</Cost>
  </brw:Borrowed>
  <brw:Borrowed>
    <VideoTitle>Cut To The Chase</VideoTitle>
    <DueDate>2003-05-23T01:00:00</DueDate>
    <Cost>3.00</Cost>
  </brw:Borrowed>
  <Magazine>0</Magazine>
</Customer>
```

When the input message is parsed, values are stored in the logical tree as shown in the following section of user trace:

```

(0x0100001B):MRM = (
  (0x01000013):Name = (
    (0x0300000B):LastName = 'Bloggs'
    (0x0300000B):Title = 'Mr'
    (0x0300000B):FirstName = 'Fred'
  )
  (0x01000013)http://www.ibm.com/AddressDetails:Address = (
    (0x0300000B):HouseNo = 13
    (0x0300000B):Street = 'Oak Street'
    (0x0300000B):Town = 'Southampton'
  )
  (0x0300000B):ID = 'P'
  (0x0300000B):PassportNo = 'J123456TT'
  (0x01000013)http://www.ibm.com/BorrowedDetails:Borrowed = (
    (0x0300000B):VideoTitle = 'Fast Cars'
    (0x0300000B):DueDate = TIMESTAMP '2003-05-23 00:00:00'
    (0x0300000B):Cost = 3.50
  )
  (0x01000013)http://www.ibm.com/BorrowedDetails:Borrowed = (
    (0x0300000B):VideoTitle = 'Cut To The Chase '
    (0x0300000B):DueDate = TIMESTAMP '2003-05-23 00:00:00'
    (0x0300000B):Cost = 3.00
  )
  (0x0300000B):Magazine = FALSE

```

Immediately following the element named ID, the MRM message definition uses a group which has a *Composition* of Choice. The group is defined with three children: PassportNo, DrivingLicenceNo, and CreditCardNo. The choice composition dictates that instance documents must use only one of these three possible alternatives. The example shown above uses the PassportNo element.

When you refer to this element in ESQL statements, you do not specify the group to which the element belongs. For example:

```
SET OutputRoot.MRM.PassportNo = 'J999999TT';
```

If you define messages within message sets that include XML and TDS physical formats, you can determine from the message data which option of a choice has been taken, because the tags in the message represent one of the choice's options. However, if your messages have CWF physical format, or are non-tagged TDS messages, it is not clear from the message data, and the application programs processing the message must determine which option of the choice has been selected. This is known as *unresolved choice handling*. For further information, see the description of the value of Choice in Complex type logical properties.

Accessing mixed content in a message in the MRM domain:

When you define a complex type in a message model, you can optionally specify its content to be mixed. This setting, in support of mixed content in XML Schema, allows you to manipulate data that is included between elements in the message.

Consider the following example:

```

<MRM>
  <Mess1>
    abc
    <Elem1>def</Elem1>
    ghi
    <Elem2>jk1</Elem2>
    mno
    <Elem3>pqr</Elem3>
  </Mess1>
</MRM>

```

The strings *abc*, *ghi*, and *mno* do not represent the value of a particular element (unlike *def*, for example, which is the value of element *Elem1*). The presence of these strings means that you must model *Mess1* with mixed content. You can model this XML message in the MRM using the following objects:

Message

The message *Name* property is set to *Mess1* to match the XML tag.

The *Type* property is set to *tMess1*.

Type The complex type *Name* property is set to *tMess1*.

The *Composition* property is set to *OrderedSet*.

The complex type has mixed content.

The complex type contains the following objects:

Element

The *Name* property is set to *Elem1* to match the XML tag.

The *Type* property is set to simple type *xsd:string*.

Element

The *Name* property is set to *Elem2* to match the XML tag.

The *Type* property is set to simple type *xsd:string*.

Element

The *Name* property is set to *Elem3* to match the XML tag.

The *Type* property is set to simple type *xsd:string*.

If you code the following ESQL:

```

SET OutputRoot.MRM.*[1] = InputBody.Elem3;
SET OutputRoot.MRM.Elem1 = InputBody.*[5];
SET OutputRoot.MRM.*[3] = InputBody.Elem2;
SET OutputRoot.MRM.Elem2 = InputBody.*[3];
SET OutputRoot.MRM.*[5] = InputBody.Elem1;
SET OutputRoot.MRM.Elem3 = InputBody*[1];

```

the mixed content is successfully mapped to the following output message:

```

<MRM>
  <Mess1>
    pqr
    <Elem1>mno</Elem1>
    jk1
    <Elem2>ghi</Elem2>
    def
    <Elem3>abc</Elem3>
  </Mess1>
</MRM>

```

Accessing embedded messages in the MRM domain:

If you have defined a multipart message, you have at least one message embedded within another. Within the overall complex type that represents the outer messages, you can model the inner message in one of the following ways:

- An element (named E_outer1 in the following example) with its *Type* property set to a complex type that has been defined with its *Composition* property set to Message
- A complex type with its *Composition* property set to Message (named t_Embedded in the following example)

The ESQL that you need to write to manipulate the inner message varies depending on which of the above models you have used. For example, assume that you have defined:

- An outer message M_outer that has its *Type* property set to t_Outer.
- An inner message M_inner1 that has its *Type* set to t_Inner1
- An inner message M_inner2 that has its *Type* set to t_Inner2
- Type t_Outer that has its first child element named E_outer1 and its second child defined as a complex type named t_Embedded
- Type t_Embedded that has its *Composition* property set to Message
- Type t_Inner1 that has its first child element named E_inner11
- Type t_Inner2 that has its first child element named E_inner21
- Type t_outer1 that has its *Composition* property set to Message
- Element E_outer1 that has its *Type* property set to t_outer1

If you want to set the value of E_inner11, code the following ESQL:

```
SET OutputRoot.MRM.E_outer1.M_inner1.E_inner11 = 'FRED';
```

If you want to set the value of E_inner21, code the following ESQL:

```
SET OutputRoot.MRM.M_inner2.E_inner21 = 'FRED';
```

If you copy message headers from the input message to the output message, and your input message type contains a path, only the outermost name in the path is copied to the output message type.

When you configure a message flow to handle embedded messages, you can specify the path of a message type in either an MQRFH2 header (if one is present in the input message) or in the input node *Message Type* property in place of a name (for example, for the message modeled above, the path could be specified as M_Outer/M_Inner1/M_Inner2 instead of just M_Outer).

If you have specified that the input message has a physical format of either CWF or XML, any message type prefix is concatenated in front of the message type from the MQRFH2 or input node, giving a final path to use (for more information refer to Multipart messages). The MRM uses the first item in the path as the outermost message type, then progressively works inwards when it finds a complex type with its *Composition* property set to Message.

If you have specified that the input message has a physical format of TDS, a different process that uses message keys is implemented. This is described in TDS format: Multipart messages.

For more information about path concatenations, see Message set properties.

Accessing the content of a message in the MRM domain with namespace support enabled:

Use namespaces where appropriate for messages that are parsed by the MRM parser.

When you want to access elements of a message and namespaces are enabled, you must include the namespace when you code the ESQL reference to the element. If you do not do so, the broker searches the no target namespace. If the element is not found in the no target namespace, the broker searches all other known namespaces in the message dictionary (that is, within the deployed message set). For performance and integrity reasons, specify namespaces wherever they apply.

The most efficient way to refer to elements when namespaces are enabled is to define a namespace constant, and use this in the appropriate ESQL statements. This technique makes your ESQL code much easier to read and maintain.

Define a constant using the DECLARE NAMESPACE statement:

```
DECLARE ns01 NAMESPACE 'http://www.ns01.com'
.
.
SET OutputRoot.MRM.Element1 = InputBody.ns01:Element1;
```

ns01 is interpreted correctly as a namespace because of the way that it is declared.

You can also use a CHARACTER variable to declare a namespace:

```
DECLARE ns02 CHARACTER 'http://www.ns02.com'
.
.
SET OutputRoot.MRM.Element2 = InputBody.{ns02}:Element2;
```

If you use this method, you must surround the declared variable with braces to ensure that it is interpreted as a namespace.

If you are concerned that a CHARACTER variable might get changed, you can use a CONSTANT CHARACTER declaration:

```
DECLARE ns03 CONSTANT CHARACTER 'http://www.ns03.com'
.
.
SET OutputRoot.MRM.Element3 = InputBody.{ns03}:Element3;
```

You can declare a namespace, constant, and variable within a module or function. However, you can declare only a namespace or constant in schema scope (that is, outside a module scope).

The following sample provides further examples of the use of namespaces:

- Video Rental sample

You can view samples only when you use the information center that is integrated with the Message Broker Toolkit.

Querying null values in a message in the MRM domain:

If you want to compare an element to NULL, code the statement:

```
IF InputRoot.MRM.Element2.Child1 IS NULL THEN
  DO:
    -- more ESQL --
END IF;
```

If nulls are permitted for this element, this statement tests whether the element exists in the input message, or whether it exists and contains the MRM-supplied null value. The behavior of this test depends on the physical format:

- For an XML element, if the XML tag or attribute is not in the bit stream, this test returns TRUE.
- For an XML element, if the XML tag or attribute is in the bit stream and contains the MRM null value, this test returns TRUE.
- For an XML element, if the XML tag or attribute is in the bit stream and does not contain the MRM null value, this test returns FALSE.
- For a delimited TDS element, if the element has no value between the previous delimiter and its delimiter, this test returns TRUE.
- For a delimited TDS element, if the element has a value between the previous delimiter and its delimiter that is the same as the MRM-defined null value for this element, this test returns TRUE.
- For a delimited TDS element, if the element has a value between the previous delimiter and its delimiter that is not the MRM-defined null value, this test returns FALSE.
- For a CWF or fixed length TDS element, if the element's value is the same as the MRM-defined null value for this element, this test returns TRUE.
- For a CWF or fixed length TDS element, if the element's value is not the same as the MRM-defined null value, this test returns FALSE.

If you want to determine if the field is missing, rather than present but with null value, you can use the ESQL CARDINALITY function.

Setting null values in a message in the MRM domain:

To set a value of an element in an output message, you normally code an ESQL statement similar to the following:

```
SET OutputRoot.MRM.Element2.Child1 = 'xyz';
```

or its equivalent statement:

```
SET OutputRoot.MRM.Element2.Child1 VALUE = 'xyz';
```

If you set the element to a non-null value, these two statements give identical results. However, if you want to set the value to null, these two statements do not give the same result:

1. If you set the element to NULL using the following statement, the element is deleted from the message tree:

```
SET OutputRoot.MRM.Element2.Child1 = NULL;
```

The content of the output bit stream depends on the physical format:

- For an XML element, neither the XML tag or attribute nor its value are included in the output bit stream.

- For a Delimited TDS element, neither the tag (if appropriate) nor its value are included in the output bit stream. The absence of the element is typically conveyed by two adjacent delimiters.
- For a CWF or Fixed Length TDS element, the content of the output bit stream depends on whether you have set the *Default Value* property for the element. If you have set this property, the default value is included in the bit stream. If you have not set the property, an exception is raised.

This is called implicit null processing.

2. If you set the value of this element to NULL as follows:

```
SET OutputRoot.MRM.Elem2.Child1 VALUE = NULL;
```

the element is not deleted from the message tree. Instead, a special value of NULL is assigned to the element. The content of the output bit stream depends on the settings of the physical format null-handling properties.

This is called explicit null processing.

Setting a complex element to NULL deletes that element and all its children.

Working with MRM messages and bit streams:

When you use the ASBITSTREAM function or the CREATE FIELD statement with a PARSE clause note the following points.

The ASBITSTREAM function

If you code the ASBITSTREAM function with the parser mode option set to *RootBitStream*, to parse a message tree to a bit stream, the result is an MRM document in the format specified by the message format that is built from the children of the target element in the normal way.

The target element must be a predefined message defined within the message set, or can be a self-defined message if using an XML physical format. This algorithm is identical to that used to generate the normal output bit stream. A well formed bit stream obtained in this way can be used to recreate the original tree using a CREATE statement with a PARSE clause.

If you code the ASBITSTREAM function with the parser mode option set to *FolderBitStream*, to parse a message tree to a bit stream, the generated bit stream is an MRM element built from the target element and its children. Unlike *RootBitStream* mode the target element does not have to represent a message; it can represent a predefined element within a message or self-defined element within a message.

So that the MRM parser can correctly parse the message, the path from the message to the target element within the message must be specified in the *Message Type*. The format of the path is the same as that used by message paths except that the message type prefix is not used.

For example, suppose the following message structure is used:

```
Message
  elem1
    elem11
    elem12
```

To serialize the subtree representing element `elem12` and its children, specify the message path `'message/elem1/elem12'` in the *Message Type*.

If an element in the path is qualified by a namespace, specify the namespace URI between `{}` characters in the message path. For example if element `elem1` is qualified by namespace `'http://www.ibm.com/temp'`, specify the message path as `'message/{http://www.ibm.com/temp}elem1/elem12'`

This mode can be used to obtain a bit stream description of arbitrary sub-trees owned by an MRM parser. When in this mode, with a physical format of XML, the XML bit stream generated is not enclosed by the 'Root Tag Name' specified for the Message in the Message Set. No XML declaration is created, even if not suppressed in the message set properties.

Bit streams obtained in this way can be used to recreate the original tree using a CREATE statement with a PARSE clause (using a mode of *FolderBitStream*).

The CREATE statement with a PARSE clause

If you code a CREATE statement with a PARSE clause, with the parser mode option set to *RootBitStream*, to parse a bit stream to a message tree, the expected bit stream is a normal MRM document. A field in the tree is created for each field in the document. This algorithm is identical to that used when parsing a bit stream from an input node

If you code a CREATE statement with a PARSE clause, with the parser mode option set to *FolderBitStream*, to parse a bit stream to a message tree, the expected bit stream is a document in the format specified by the Message Format, which is either specified directly or inherited. Unlike *RootBitStream* mode the root of the document does not have to represent an MRM message; it can represent a predefined element within a message or self-defined element within a message.

So that the MRM parser can correctly parse the message the path from the message to the target element within the message must be specified in the *Message Type*. The format of the message path is the same as that used for the ASBITSTREAM function described above.

Example of using the ASBITSTREAM function and CREATE statement with a PARSE clause in FolderBitStream mode

The following ESQL uses the message definition described above. The ESQL serializes part of the input tree using the ASBITSTREAM function, and then uses the CREATE statement with a PARSE clause to recreate the subtree in the output tree. The Input message and corresponding Output message are shown below the ESQL.

```
CREATE COMPUTE MODULE DocSampleFlow_Compute
CREATE FUNCTION Main() RETURNS BOOLEAN
BEGIN
  CALL CopyMessageHeaders();

  -- Set the options to be used by ASBITSTREAM and CREATE ... PARSE
  -- to be FolderBitStream and enable validation
  DECLARE parseOptions INTEGER BITOR(FolderBitStream, ValidateContent,
    ValidateValue, ValidateLocalError);

  -- Serialise the elem12 element and its children from the input bitstream
  -- into a variable
  DECLARE subBitStream BLOB
```

```

CAST(ASBITSTREAM(InputRoot.MRM.elem1.elem12
  OPTIONS parseOptions
  SET 'DocSample'
  TYPE 'message/element/element2'
  FORMAT 'XML1') AS BLOB);

-- Set the value of the first element in the output tree
SET OutputRoot.MRM.elem1.elem11 = 'val11';

-- Parse the serialized sub-tree into the output tree
IF subBitStream IS NOT NULL THEN
  CREATE LASTCHILD OF OutputRoot.MRM.elem1
    PARSE ( subBitStream
      OPTIONS parseOptions
      SET 'DocSample'
      TYPE 'message/element/element2'
      FORMAT 'XML1');
END IF;

-- Convert the children of elem12 in the output tree to uppercase
SET OutputRoot.MRM.elem1.elem12.elem121 =
  UCASE(OutputRoot.MRM.elem1.elem12.elem121);

SET OutputRoot.MRM.elem1.elem12.elem122 =
  UCASE(OutputRoot.MRM.elem1.elem12.elem122);

-- Set the value of the last element in the output tree
SET OutputRoot.MRM.elem1.elem13 = 'val13';

RETURN TRUE;
END;

CREATE PROCEDURE CopyMessageHeaders() BEGIN
  DECLARE I INTEGER 1;
  DECLARE J INTEGER CARDINALITY(InputRoot.*[]);
  WHILE I < J DO
    SET OutputRoot.*[I] = InputRoot.*[I];
    SET I = I + 1;
  END WHILE;
END;

END MODULE;

```

Input message :

```

<message>
  <elem1>
    <elem11>value11</elem11>
    <elem12>
      <elem121>value121</elem121>
      <elem122>value122</elem122>
    </elem12>
    <elem13>value13</elem13>
  </elem1>
</message>

```

Output message :

```

<message>
  <elem1>
    <elem11>val11</elem11>
    <elem12>
      <elem121>VALUE121</elem121>
      <elem122>VALUE122</elem122>
    </elem12>
    <elem13>val13</elem13>
  </elem1>
</message>

```

Handling large MRM messages:

When an input bit stream is parsed, and a logical tree created, the tree representation of an MRM message is typically larger, and in some cases much larger, than the corresponding bit stream. The reasons for this include:

- The addition of the pointers that link the objects together.
- Translation of character data into Unicode that can double the original size.
- The inclusion of field names that can be contained implicitly within the bit stream.
- The presence of control data that is associated with the broker's operation

Manipulation of a large message tree can, therefore, demand a great deal of storage. If you design a message flow that handles large messages made up of repeating structures, you can code specific ESQL statements that help to reduce the storage load on the broker. These statements support both random and sequential access to the message, but assume that you do not need access to the whole message at one time.

These ESQL statements cause the broker to perform limited parsing of the message, and to keep only that part of the message tree that reflects a single record in storage at a time. If your processing requires you to retain information from record to record (for example, to calculate a total price from a repeating structure of items in an order), you can either declare, initialize, and maintain ESQL variables, or you can save values in another part of the message tree, for example `LocalEnvironment`.

This technique reduces the memory used by the broker to that needed to hold the full input and output bit streams, plus that required for one record's trees. It provides memory savings when even a small number of repeats is encountered in the message. The broker makes use of partial parsing, and the ability to parse specified parts of the message tree, to and from the corresponding part of the bit stream.

To use these techniques in your Compute node apply these general techniques:

- Copy the body of the input message as a bit stream to a special folder in the output message. This creates a modifiable copy of the input message that is not parsed and which therefore uses a minimum amount of memory.
- Avoid any inspection of the input message; this avoids the need to parse the message.
- Use a loop and a reference variable to step through the message one record at a time. For each record:
 - Use normal transforms to build a corresponding output subtree in a second special folder.
 - Use the `ASBITSTREAM` function to generate a bit stream for the output subtree that is stored in a *BitStream* element, placed in the position in the tree, that corresponds to its required position in the final bit stream.
 - Use the `DELETE` statement to delete both the current input and the output record message trees when you complete their manipulation.
 - When you complete the processing of all records, detach the special folders so that they do not appear in the output bit stream.

You can vary these techniques to suit the processing that is required for your messages. The following ESQL provides an example of one implementation.

The ESQL is dependant on a message set called LargeMessageExample that has been created to define messages for both the Invoice input format and the Statement output format. A message called AllInvoices has been created that contains a global element called Invoice that can repeat one or more times, and a message called Data that contains a global element called Statement that can repeat one or more times.

The definitions of the elements and attributes have been given the correct data types, therefore, the CAST statements used by the ESQL in the XML example are no longer required. An XML physical format with name XML1 has been created in the message set which allows an XML message corresponding to these messages to be parsed by the MRM.

When the Statement tree is serialized using the ASBITSTREAM function the *Message Set*, *Message Type*, and *Message Format* are specified as parameters. The *Message Type* parameter contains the path from the message to the element being serialized which, in this case, is Data/Statement because the Statement element is a direct child of the Data message.

The input message to the flow is the same Invoice example message used in other parts of the documentation except that it is contained between the tags:

```
<AllInvoices> .... </AllInvoices>
```

```
CREATE COMPUTE MODULE LargeMessageExampleFlow_Compute
CREATE FUNCTION Main() RETURNS BOOLEAN
BEGIN
  CALL CopyMessageHeaders();
  -- Create a special folder in the output message to hold the input tree
  -- Note : SourceMessageTree is the root element of an MRM parser
  CREATE LASTCHILD OF OutputRoot.MRM DOMAIN 'MRM' NAME 'SourceMessageTree';

  -- Copy the input message to a special folder in the output message
  -- Note : This is a root to root copy which will therefore not build trees
  SET OutputRoot.MRM.SourceMessageTree = InputRoot.MRM;

  -- Create a special folder in the output message to hold the output tree
  CREATE FIELD OutputRoot.MRM.TargetMessageTree;

  -- Prepare to loop through the purchased items
  DECLARE sourceCursor REFERENCE TO OutputRoot.MRM.SourceMessageTree.Invoice;
  DECLARE targetCursor REFERENCE TO OutputRoot.MRM.TargetMessageTree;
  DECLARE resultCursor REFERENCE TO OutputRoot.MRM;
  DECLARE grandTotal FLOAT 0.0e0;

  -- Create a block so that it's easy to abandon processing
  ProcessInvoice: BEGIN
    -- If there are no Invoices in the input message, there is nothing to do
    IF NOT LASTMOVE(sourceCursor) THEN
      LEAVE ProcessInvoice;
    END IF;

    -- Loop through the invoices in the source tree
    InvoiceLoop : LOOP
      -- Inspect the current invoice and create a matching Statement
      SET targetCursor.Statement =
        THE (
          SELECT
            'Monthly' AS Type,
            'Full' AS Style,
            I.Customer.FirstName AS Customer.Name,
            I.Customer.LastName AS Customer.Surname,
            I.Customer.Title AS Customer.Title,
            (SELECT
```

```

        FIELDVALUE(II.Title)      AS Title,
        II.UnitPrice * 1.6      AS Cost,
        II.Quantity             AS Qty
FROM I.Purchases.Item[] AS II
WHERE II.UnitPrice > 0.0      ) AS Purchases.Article[],
(SELECT
    SUM( II.UnitPrice *
        II.Quantity *
        1.6
    )
FROM I.Purchases.Item[] AS II
'Dollars'
AS Amount.Currency
WHERE I.Customer.LastName <> 'White'
);

-- Turn the current Statement into a bit stream
-- The SET parameter is set to the name of the message set
-- containing the MRM definition
-- The TYPE parameter contains the path from the from the message
-- to element being serialized
-- The FORMAT parameter contains the name of the physical format
-- name defined in the message
DECLARE StatementBitStream BLOB
CAST(ASBITSTREAM(targetCursor.Statement
    OPTIONS FolderBitStream
    SET 'LargeMessageExample'
    TYPE 'Data/Statement'
    FORMAT 'XML1') AS BLOB);

-- If the SELECT produced a result (that is, it was not filtered
-- out by the WHERE clause), process the Statement
IF StatementBitStream IS NOT NULL THEN
    -- create a field to hold the bit stream in the result tree
    -- The Type of the element is set to MRM.BitStream to indicate
    -- to the MRM Parser that this is a bitstream
    CREATE LASTCHILD OF resultCursor
        Type MRM.BitStream
        NAME 'Statement'
        VALUE StatementBitStream;

    -- Add the current Statement's Amount to the grand total
    SET grandTotal = grandTotal + targetCursor.Statement.Amount;
END IF;

-- Delete the real Statement tree leaving only the bit stream version
DELETE FIELD targetCursor.Statement;

-- Step onto the next Invoice, removing the previous invoice and any
-- text elements that might have been interspersed with the Invoices
REPEAT
    MOVE sourceCursor NEXTSIBLING;
    DELETE PREVIOUSIBLING OF sourceCursor;
UNTIL (FIELDNAME(sourceCursor) = 'Invoice')
    OR (LASTMOVE(sourceCursor) = FALSE)
END REPEAT;

-- If there are no more invoices to process, abandon the loop
IF NOT LASTMOVE(sourceCursor) THEN
    LEAVE InvoiceLoop;
END IF;

END LOOP InvoiceLoop;
END ProcessInvoice;

-- Remove the temporary source and target folders
DELETE FIELD OutputRoot.MRM.SourceMessageTree;
DELETE FIELD OutputRoot.MRM.TargetMessageTree;

```

```

-- Finally add the grand total
SET resultCursor.GrandTotal = grandTotal;

-- Set the output MessageType property to be 'Data'
SET OutputRoot.Properties.MessageType = 'Data';

RETURN TRUE;
END;

CREATE PROCEDURE CopyMessageHeaders() BEGIN
  DECLARE I INTEGER 1;
  DECLARE J INTEGER CARDINALITY(InputRoot.*[]);
  WHILE I < J DO
    SET OutputRoot.*[I] = InputRoot.*[I];
    SET I = I + 1;
  END WHILE;
END;

END MODULE;

```

Manipulating messages in the JMS domains

This topic provides information specific to dealing with messages that belong to the JMSMap and JMSStream domains. These messages are parsed by the generic XML parser.

Messages that belong to the JMS domains are processed by the XML parser, so you can follow the guidance provided for XML messages in “Manipulating messages in the XML domain” on page 387, in conjunction with the information in “Manipulating message body content” on page 283.

The JMSMap and JMSStream domains support MapMessage and StreamMessage messages. Other kinds of JMS message are supported by other domains. For further information about using JMS messages with WebSphere Message Broker, see WebSphere Broker JMS Transport.

Manipulating messages in the IDOC domain

Use ESQL from a Compute node to copy the incoming IDoc to the outgoing IDoc, and manipulate the message.

A valid IDoc message flows out of SAP and is sent to the MQSeries link for R/3.

When this IDoc has been committed successfully to the outbound WebSphere MQ queue, the input node of the message flow reads it from that queue and generates the syntax element tree.

The Compute node manipulates this syntax element tree and, when it has finished, passes the output message to subsequent nodes in the message flow. When the message reaches the output node, the IDOC parser is called to rebuild the bit stream from the tree.

The message flow must create an output message in a similar format to the input message.

See Field names of the IDOC parser structures for the field names in the DC (Control Structure) and DD (Data Structure) that are recognized by the IDOC parser

Use the following ESQL example from a Compute node:

```
SET OutputRoot = InputRoot;
SET OutputRoot.IDOC.DC[1].tabnam = 'EDI_DC40 ';
SET OutputRoot.IDOC.DD[2].sdatatag.MRM.maktx = 'Buzzing all day';
```

The first line of the code copies the incoming IDoc to the outgoing IDoc.

The second line sets the *tablename* of the first DC.

The third line uses the second DD segment, which in this example is of type E2MAKTM001, and sets the *maktx* field.

Accessing fields of the IDoc using ESQL:

Use the ESQL editor Content Assist to fill in the SAP-defined fields of the IDoc.

After the *sdatatag* tag in an ESQL statement, the next tag is *MRM*, which you must enter manually, followed by the field name that is to be manipulated. Specify the name of the field within the message segment here, not the name of the message segment.

For example, the following code sets the segment name of the IDoc:

```
SET OutputRoot.IDOC.DD[I].segnam = 'E2MAKTM001';
```

The following example sets the *msgfn* field within the E2MAKTM001 segment:

```
SET OutputRoot.IDOC.DD[I].sdatatag.MRM.msgfn = '006';
```

Manipulating messages in the MIME domain

This topic explains how to deal with messages that belong to the MIME domain, and are parsed by the MIME parser. Use this information in conjunction with the information in “Manipulating message body content” on page 283.

A MIME message does not need to be received over a particular transport. For example, a message can be received over HTTP using an HTTPInput node, or over WebSphere MQ using an MQInput node. The MIME parser is used to process a message if one of the following conditions applies:

- The message domain is set to MIME in the input node properties.
- You are using WebSphere MQ, and the MQRFH2 header has a message domain of MIME.

You can manipulate the logical tree using ESQL before passing the message on to other nodes in the message flow. A message flow can also create a MIME domain tree using ESQL. When a MIME domain message reaches an output node, the MIME parser is called to rebuild the bit stream from the logical tree.

The following examples show how to manipulate MIME messages:

- “Creating a new MIME tree”
- “Modifying an existing MIME tree” on page 406
- “Managing Content-Type” on page 407

Creating a new MIME tree

A message flow often receives, modifies, and returns a MIME message. In this case, you can work with the valid MIME tree that is created when the input message is parsed. If a message flow receives input from another domain, such as

XMLNS, and returns a MIME message, you must create a valid MIME tree. Use the following ESQL example in a Compute node to create the top-level structure for a single-part MIME tree:

```
CREATE FIELD OutputRoot.MIME TYPE Name;  
DECLARE M REFERENCE TO OutputRoot.MIME;  
CREATE LASTCHILD OF M TYPE Name NAME 'Data';
```

The message flow must also ensure that the MIME Content-Type is set correctly, as explained in “Managing Content-Type” on page 407. The flow must then add the message data into the MIME tree. The following ESQL examples show how you can do this. In each case, a Data element is created with the domain BLOB.

- A bit stream from another part of the tree is used. This example shows how a bit stream could be created from an XML message that is received by the message flow. The flow then invokes the BLOB parser to store the data under the Data element.

```
DECLARE partData BLOB ASBITSTREAM(InputRoot.XMLNS);  
CREATE LASTCHILD OF M.Data DOMAIN('BLOB') PARSE(partData);
```

- Instead of parsing the bit stream, create the new structure, then attach the data to it, as shown in this ESQL example:

```
DECLARE partData BLOB ASBITSTREAM(InputRoot.XMLNS);  
CREATE LASTCHILD OF M.Data DOMAIN('BLOB') NAME 'BLOB';  
CREATE LASTCHILD OF M.Data.BLOB NAME 'BLOB' VALUE partData;
```

Both of these approaches create the same tree structure. The first approach is better because explicit knowledge of the tree structure that the BLOB parser requires is not built into the flow.

More commonly, the Compute node must build a tree for a multipart MIME document. The following ESQL example shows how you can do this, including setting the top-level Content-Type property.

```
DECLARE part1Data BLOB ASBITSTREAM(InputRoot.XMLNS, InputProperties.Encoding, InputProperties.CodedCharSetId);  
  
SET OutputRoot.Properties.ContentType = 'multipart/related; boundary=myBoundary';  
  
CREATE FIELD OutputRoot.MIME TYPE Name;  
DECLARE M REFERENCE TO OutputRoot.MIME;  
CREATE LASTCHILD OF M TYPE Name NAME 'Parts';  
CREATE LASTCHILD OF M.Parts TYPE Name NAME 'Part';  
DECLARE P1 REFERENCE TO M.Parts.Part[1];  
CREATE FIELD P1."Content-Type" TYPE NameValue VALUE 'text/plain';  
CREATE FIELD P1."Content-Id" TYPE NameValue VALUE 'part one';  
CREATE LASTCHILD OF P1 TYPE Name NAME 'Data';  
CREATE LASTCHILD OF P1.Data DOMAIN('BLOB') PARSE(part1Data);  
  
CREATE LASTCHILD OF M.Parts TYPE Name NAME 'Part';  
DECLARE P2 REFERENCE TO M.Parts.Part[2];  
CREATE FIELD P2."Content-Type" TYPE NameValue VALUE 'text/plain';  
CREATE FIELD P2."Content-Id" TYPE NameValue VALUE 'part two';  
CREATE LASTCHILD OF P2 TYPE Name NAME 'Data';  
CREATE LASTCHILD OF P2.Data DOMAIN('BLOB') PARSE(part2Data);
```

Modifying an existing MIME tree

This ESQL example adds a new MIME part to an existing multipart MIME message. If the message is not multipart, it is not modified.

```

SET OutputRoot = InputRoot;

-- Check to see if the MIME message is multipart or not.
IF LOWER(InputProperties.ContentType) LIKE 'multipart/%'
THEN
    CREATE LASTCHILD OF OutputRoot.MIME.Parts NAME 'Part';

    DECLARE P REFERENCE TO OutputRoot.MIME.Parts.[<];
    CREATE FIELD P."Content-Type" TYPE NameValue VALUE 'text/xml';
    CREATE FIELD P."Content-ID" TYPE NameValue VALUE 'new part';
    CREATE LASTCHILD OF P TYPE Name NAME 'Data';

    -- This is an artificial way of creating some BLOB data.
    DECLARE newBlob BLOB '4f6e652074776f2074687265650d0a';
    CREATE LASTCHILD OF P.Data DOMAIN('BLOB') PARSE(newBlob);
END IF;

```

Managing Content-Type

When you create a new MIME message tree, or when you modify the value of the MIME boundary string, make sure that the MIME Content-Type header is set correctly by setting the ContentType value in the broker Properties subtree. The following example shows how to set the ContentType value for a MIME part with simple content:

```
SET OutputRoot.Properties.ContentType = 'text/plain';
```

Do not set the Content-Type value directly in the MIME tree or HTTP trees because the value is ignored or used inconsistently.

Manipulating messages in the BLOB domain

This topic provides information specific to dealing with messages that belong to the BLOB domain, and that are parsed by the BLOB parser.

You cannot manipulate the contents of a BLOB message, because it has no predefined structure. However, you can refer to its contents using its known position within the bit stream, and process the message with a minimum of knowledge about its contents.

The BLOB message body parser does not create a tree structure in the same way that other message body parsers do. It has a root element BLOB, that has a child element, also called BLOB, that contains the data.

You can refer to message content using substrings if you know the location of a particular piece of information within the BLOB data. For example, the following expression identifies the tenth byte of the message body:

```
InputBody.BLOB.BLOB[10]
```

The following expression references 10 bytes of the message data starting at offset 10:

```
SUBSTRING(InputBody.BLOB.BLOB from 10 for 10)
```

You can use the Mapping node to map to and from a predefined BLOB message, and to map to and from items of BLOB data.

Simple example to write a string in the output message:

The following simple example allows you to write some character data in your ESQL (for example, if you have read some character fields from a database) out as a BLOB:

```
CALL CopyMessageHeaders();  
-- CALL CopyEntireMessage();  
DECLARE mystring CHARACTER;  
SET mystring='hello';  
SET OutputRoot.BLOB.BLOB=CAST (mystring AS BLOB CCSID 1208);
```

Using the CALL statement to invoke a user-written routine

The ESQL CALL statement invokes routines that have created and implemented in different ways.

A routine is a user-defined function or procedure that has been defined by one of the following statements:

- CREATE FUNCTION
- CREATE PROCEDURE

You can use the CALL statement to invoke a routine that has been implemented in any of the following ways:

- ESQL.
- Java.
- As a stored procedure in a database.
- As a built-in (broker-provided) function.

(Although you can use CALL to invoke built-in (broker-provided) functions and user-defined SQL functions, typically you would use their names in expressions directly.)

For details of the syntax and parameters of the CALL statement, see “CALL statement” on page 1487. For an example of the use of CALL, see the examples in “CREATE PROCEDURE statement” on page 1511.

Calling an ESQL routine:

A routine is invoked as an ESQL method if the routine’s definition specifies a LANGUAGE clause of ESQL or if the routine is a built-in function.

An exact one-to-one matching of the data types and directions of each parameter, between the definition and the CALL, is required.

An ESQL routine is allowed to return any ESQL data type, excluding List and Row.

Calling a Java routine:

A routine is invoked as a Java method if the routine’s definition specifies a LANGUAGE clause of JAVA.

An exact one-to-one matching of the data types and directions of each parameter, between the definition and the CALL, is required.

If the Java method has a void return type, the INTO clause cannot be used because there is no value to return.

A Java routine can return any data type in the “ESQL-to-Java data-type mapping table” on page 1462. Note that this excludes List and Row.

Calling a database stored procedure:

A routine is invoked as a database stored procedure if the routine's definition has a LANGUAGE clause of DATABASE.

When a call is made to a database stored procedure, the broker searches for a definition (created by a CREATE PROCEDURE statement) that matches the procedure's local name. The broker then uses the following sequence to resolve the name by which the procedure is known in the database and the database schema to which it belongs:

1. If the CALL statement specifies an IN clause, the name of the data source, the database schema, or both, is taken from the IN clause.
2. If the name of the data source is not provided by an IN clause on the CALL statement, it is taken from the DATASOURCE attribute of the node.
3. If the database schema is not provided by an IN clause on the CALL statement, but is specified on the EXTERNAL NAME clause of the CREATE PROCEDURE statement, it is taken from the EXTERNAL NAME clause.
4. If no database schema is specified on the EXTERNAL NAME clause of the CREATE PROCEDURE statement, the database's user name is used as the schema name. If a matching procedure is found, the routine is invoked.

The chief use of the CALL statement's IN clause is that it allows the data source, the database schema, or both to be chosen dynamically at run time. (The EXTERNAL SCHEMA clause also allows the database schema which contains the stored procedure to be chosen dynamically, but it is not as flexible as the IN clause and is retained only for compatibility with earlier versions. Its use in new applications is deprecated.)

If the called routine has any DYNAMIC RESULT SETS specified in its definition, the number of expressions in the CALL statement's *ParameterList* must match the number of actual parameters to the routine, plus the number of DYNAMIC RESULT SETS. For example, if the routine has three parameters and two DYNAMIC RESULT SETS, the CALL statement must pass five parameters to the called routine. The parameters passed for the two DYNAMIC RESULT SETS must be list parameters; that is, they must be field references qualified with array brackets []; for example, Environment.ResultSet1[].

A database stored procedure is allowed to return any ESQL data type, excluding Interval, List, and Row.

Accessing broker properties from ESQL

It can be useful, during the runtime of your code, to have real-time access to details of a specific node, flow, or broker. For an overview of broker properties, see "Broker properties" on page 109.

You can use broker properties on the right side of regular SET statements. For example:

```
DECLARE mybroker CHARACTER;  
SET mybroker = BrokerName;
```

where BrokerName is the broker property that contains the broker's name. However, you cannot use broker properties on the left-hand side of SET statements. This is because, at runtime, broker properties are constants: they cannot be assigned to,

and so their values cannot be changed by SET statements. If a program tries to change the value of a broker property, the error message Cannot assign to a symbolic constant is issued.

Broker properties:

- Are grouped by broker, execution group, flow, and node.
- Are case sensitive. Their names always start with an uppercase letter.
- Return NULL if they do not contain a value.

If your ESQL code already contains a variable with the same name as one of the broker properties, your variable takes precedence; that is, your variable masks the broker property. To access the broker property, use the form SQL.<broker_property_name>. For example: SQL.BrokerName.

“Broker properties that are accessible from ESQL and Java” on page 1663 shows the broker, flow, and node properties that are accessible from ESQL and indicates which properties are also accessible from Java.

Configuring a message flow at deployment time using UDPs

User-defined properties (UDPs) give you the opportunity to configure message flows at deployment time, without modifying program code. You can give the UDP an initial value when you declare it in your program, or when you use the Message Flow editor to create or modify a message flow.

For an overview of user-defined properties, see “User-defined properties” on page 111.

See the “DECLARE statement” on page 1525 for an example of how to code a UDP statement.

In ESQL, you can define UDPs at the module or schema level.

After a UDP has been defined by the Message Flow editor, you can modify its value before you deploy it.

To configure UDPs:

1. Switch to the Broker Administration perspective.
2. Double-click the bar file in the Navigator view. The contents of the bar file are shown in the Content editor.
3. Click the **Configure** tab at the bottom of the Content editor. This pane shows the names of your message flows, which you can expand to show the individual nodes that are contained in the flow.
4. Click a message flow name. The UDPs that are defined in that message flow are displayed with their values.
5. If the value of the UDP is unsuitable for your current environment or task, change it to the value that you want. The value of the UDP is set at the flow level and is the same for all eligible nodes that are contained in the flow. If a subflow includes a UDP that has the same name as a UDP in the main flow, the value of the UDP in the subflow is not changed.

Now you are ready to deploy the message flow. See “Deploying a broker archive file” on page 763.

Using XPath

XPath provides an alternative method to ESQL of entering expressions in the property fields of specific built-in nodes.

In addition to ESQL as a message processing transformation language, WebSphere Message Broker supports the entry of an alternative expression grammar in property fields. For more information, see “ESQL-to-XPath mapping table” on page 1463.

You can use ESQL or XPath expressions in certain built-in nodes in your message flows to query or update message trees that are specified as accessible, and that you expect to be processed by a given node.

The following nodes support XPath in their properties:

- Collector node
- DatabaseRoute node
- DatabaseRetrieve node
- EmailOutput node
- FileOutput node
- HTTPInput node
- JavaCompute node
- JMSInput node
- MQInput node
- Route node
- SOAPEnvelope node
- SOAPExtract node
- SOAPInput node
- SOAPReply node
- SOAPRequest node
- SOAPAsyncRequest node
- SOAPAsyncResponse node
- WebSphere Adapter Request nodes
- WebSphere Service Registry and Repository EndpointLookup node
- WebSphere Service Registry and Repository RegistryLookup node

For more information about the associated properties in the nodes that use XPath, see “Multi-language node property fields” on page 412.

This section provides information on:

- “XPath overview”
- “Namespace support” on page 415
- “XPath Expression Builder” on page 416
- “Creating XPath expressions” on page 419
- “Selecting the grammar mode” on page 420

XPath overview

The XML Path Language (XPath) is a language used to uniquely identify or address parts of an XML document. An XPath expression can be used to search through an XML document, and extract information from the nodes (any part of the document, such as an element or attribute) in it. XPath can be used alone or in conjunction with XSLT.

Some of the built-in nodes provided in the Message Broker Toolkit can use XPath expressions to specify the part of a message that is processed by the node. For

example, you can use an XPath expression to identify fields in a message and determine if they match a specified value, or to set the field value, updating it with the results of a database query.

For more information about the fields, in the built-in nodes, that can use XPath in their properties, see “Multi-language node property fields.”

For further information on XPath 1.0 see XPath.

You can use the XPath Expression Builder to visually build XPath expressions to set the relevant properties in your nodes. You launch the XPath Expression Builder from buttons located along side property fields present in the Properties viewer, for those nodes that support the use of XPath expressions as property values.

The XPath files in WebSphere Message Broker are supplied in three property editors; see “XPath property editors” on page 1464 for more details.

The XPath editor supports both content-assist directly on the text field and also an **Edit...** button that launches the XPath builder dialog. The dialog gives you a larger area on which to build your XPath expressions.

The content assist based control contains two different proposal lists in the following order:

1. Nodes and Variables
2. Functions and Operators

The node and variable proposals are displayed the first time that you use the XPath editor. In this view, the status bar reads Press **Ctrl+Space** to show Function and Operation Proposals.

Selecting **Ctrl+Space** in the function and operator level proposals selects the Node and Variable proposals.

Multi-language node property fields

You can use ESQL or XPath expressions to specify the part of a message that is processed by the node in the properties of some built-in nodes in the Message Broker Toolkit.

The following list shows the nodes and associated properties that you can set using ESQL or XPath expressions:

- WebSphere AdapterRequest node
 - **OutputDataLocation**
- Collector node
 - **Correlation path**; there is one for each dynamic input terminal.
- DatabaseRetrieve node
 - On the **Basic** tab:
 - **Value**; when ValueType is set to Element.
 - On the **Data Element Table** tab:
 - **MessageElement**
- DatabaseRoute node
 - On the **Basic** tab:
 - **Value**; when ValueType is set to Element.

On the **Filter Expression Table** tab:

- **filterPattern**
- EmailOutput node
 - **Attachment**
- FileOutput node
 - **DataLocation**
 - **Request directory property location**
 - **Request file name property location**
- HTTPInput, JMSInput, and MQInput nodes

On the **Security** tab:

- **Identity Token location**
- **Identity Password location**
- **Identity issued by**

- Route node

On the **Basic** tab:

- **filterPattern**
- SOAPEnvelope node
 - **Envelope location**
- SOAPExtract node
 - **Envelope destination**
 - **Destination path mode**
- SOAPInput, SOAPReply, SOAPRequest, SOAPAsyncRequest, SOAPAsyncResponse nodes

On the **WSSecurity** tab:

- **MessagePartReference**
- WebSphere Service Registry and Repository nodes
 - RegistryLookup node - **User properties**
 - EndpointLookup node - **User properties**

For further information on these fields, see “Built-in nodes” on page 822 and follow the link to the appropriate node.

The categories of field required to support XPath 1.0 and ESQL are:

- Read only path location.
 - This category is subdivided into:
 - **Fixed language:** ESQL read-only path (field reference) field property.
 - **Fixed language:** XPath 1.0 read-only path (path location) field property.
 - **Mixed language:** ESQL or XPath 1.0 read-only path location field property
- Read write path location.
 - This category is subdivided into:
 - **Fixed language:** ESQL read-write path (field reference) field property.
 - **Fixed language:** XPath 1.0 read-write path (path location) field property.
 - **Mixed language:** ESQL or XPath 1.0 read-write path location field property
- Expression.
 - This category is subdivided into:
 - **Fixed language:** XPath 1.0 expression field property.

The mapping between ESQL and XPath for the expression-field property category is described in “ESQL-to-XPath mapping table” on page 1463.

A restricted set of expressions is supported by default to enable you to use either XPath or ESQL; see “XPath expressions supported by default.”

If you want to use the full supported capabilities of the runtime in either language you can change this setting; see “Selecting the grammar mode” on page 420 for instructions on how to do this.

XPath expressions supported by default

XPath supports the following expressions by default:

Read-only fields

```
$Root, $Body, $Properties, $LocalEnvironment, $DestinationList,
$ExceptionList, $InputRoot , $InputBody, $InputProperties,
$InputLocalEnvironment, $InputDestinationList,
$InputExceptionList,$Environment.
```

To exclude variables for a node property from the default list, specify a comma separated string of variables. For example, specifying:

```
"com.ibm.etools.mft.ibmnodes.editors.xpath.XPathReadOnlyPropertyEditor", "InputRoot ,
InputBody, InputProperties, InputLocalEnvironment, InputDestinationList,
InputExceptionList"
```

restricts the XPath field to support only:

```
$Root, $Body, $Properties, $LocalEnvironment, $DestinationList, $ExceptionList'
$Environment
```

Read-write fields

```
$InputRoot , $InputBody, $InputProperties, $InputLocalEnvironment,
$InputDestinationList, $InputExceptionList, $OutputRoot ,
$OutputLocalEnvironment, $OutputDestinationList,
$OutputExceptionList, $Environment.
```

To exclude variables for a node property from the default list, specify a comma separated string of variables. For example, specifying:

```
"com.ibm.etools.mft.ibmnodes.editors.xpath.XPathReadWritePropertyEditor", "InputRoot ,
InputBody, InputProperties, InputLocalEnvironment, InputDestinationList,
InputExceptionList"
```

restricts the XPath field to support only:

```
$OutputRoot, $OutputLocalEnvironment, $OutputDestinationList, $OutputExceptionList,
$Environment
```

Expression fields

```
$Root, $Body, $Properties, $LocalEnvironment, $DestinationList,
$ExceptionList, $InputRoot , $InputBody, $InputProperties,
$InputLocalEnvironment, $InputDestinationList, $InputExceptionList,
$OutputRoot , $OutputLocalEnvironment, $OutputDestinationList,
$OutputExceptionList, $Environment.
```

To exclude variables for a node property from the default list, specify a comma separated string of variables. For example, specifying:

```
"com.ibm.etools.mft.ibmnodes.editors.xpath.XPathPropertyEditor", "InputRoot ,
InputBody, InputProperties, InputLocalEnvironment, InputDestinationList,
InputExceptionList, OutputRoot , OutputLocalEnvironment, OutputDestinationList,
OutputExceptionList"
```

restricts the XPath field to support only:

\$Root, \$Body, \$Properties, \$LocalEnvironment, \$DestinationList, \$ExceptionList, \$Environment.

Namespace support

The XPath Expression builder dialog contains a namespace settings table that:

- Supports simplified expressions that enable qualified namespace matching at runtime
- Can be auto-generated based on imported schema definitions and generated expressions (based on selections made in the dialog when you build an expression)
- Allows you to add your own entries to the table

The table encapsulates deployable data passed to the runtime, as part of the nodes attribute data, and is used by the node to modify expressions through prefix to URI substitution. The final expressions support namespace matching as they are exercised against a target tree when employed by their associated message processing engine, that is, the XPath 1.0 runtime engine or ESQL runtime engine.

When you enter an ESQL field reference expression in a read-only path or read-write path field, or an XPath 1.0 path expression in a read-only, read-write path field or general expression field (general expressions can contain zero or more path expressions) - WebSphere Message Broker understands the language from the syntax you use.

XPath is the default for general expression fields that are validated by ensuring they conform to the XPath 1.0 grammar. For path expression fields XPath is assumed if the expression is valid and begins with a \$ sign.

Note that the language you can use is dictated by the property editor in use for a node's property field.

Namespace prefixes are used in an XPath or ESQL expression to make the statements shorter and easier to understand, while still supporting the ability to qualify an element name match by also matching on its associated namespace URI.

For example, consider the message below where namespace prefix 'b' is overridden through an inner declaration

```
<b:a xmlns:b='xyz'>
  <!-- the namespace of elements 'a' and 'c' using prefix 'b' is xyz -->
  <b:c>
    <b:d xmlns:b='qrs'>
      <!-- the namespace of elements 'd' and 'e' using prefix 'b' is now qrs -->
      <b:e>100</b:e>
    </b:d>
  </b:c>
</b:a>
```

Note that the scope of a namespace declaration declaring a prefix extends from the beginning of the start tag in which it appears to the end of the corresponding end tag, excluding the scope of any inner declarations with the same namespace prefix. In the case of an empty tag, the scope is the tag itself. >.

To navigate to element 'e' in the above message use the following human readable XPath expression:

```
/b:a/b:c/b2:d/b2:e
```

Note, that to prevent the auto-generated prefix to the URI map produced in the expression dialog overloading the same prefix (in this case b), the inner 'b' prefix is appended with a numeric value to distinguish it from the outer 'b' prefix. This strategy is repeated for each prefix name clash.

This notation is similar to the equivalent human readable ESQL expression:

```
Root.b:a.b:c.b2:d.b2:e
```

In order to support namespace prefixes within expressions, the XPath Expression Builder Dialog auto-generates (based on the content of imported schema definitions, through which expressions are generated) a prefix to a URI namespace settings table.

Without the use of namespace prefixes to URI mapping data in this table, the runtime would be forced to resort to a less desirable approach, where portable but verbose XPath expressions would be required by it in order to provide namespace matching support.

The previous expression:

```
/b:a/b:c/b2:d/b2:e
```

would take the form:

```
/*[namespace-uri()='xyz' and local-name()='a']/*[namespace-uri()='xyz'  
and local-name()='c']/*[namespace-uri()='qrs' and  
local-name()='d']/*[namespace-uri()='qrs' and local-name()='e']
```

XPath Expression Builder

You can launch the XPath Expression builder in general, but not in all cases (for example, the collector node) from any property field that supports or expects XPath expressions as a value that can be entered into the field. The fields that are supported by XPath specific property editors are listed in “Multi-language node property fields” on page 412.

The use of the XPath Expression builder is optional, in that it is an aid to you in developing message flow applications. The XPath Expression builder helps you to construct message processing expressions in a given language, either XPath or ESQL. You are free to enter expressions by hand, or use the XPath Expression builder to help construct such expressions.

You can populate the fields, regardless of the state of the node; that is whether the node is detached or connected, or fully, partially, or completely unconfigured.

You launch the XPath Expression Builder from buttons that are within:

- Table cells, located to the right of the text entry field within the cell.
- **Add** or **Edit** dialogs used to construct rows within tables, located to right of the property field concerned.
- Tabs in the property viewer for a node, to the right of a property field.

Variables (or in ESQL terminology, correlation names) provide a list of all message tree start points that are applicable for the property field concerned from which the dialog was launched.

If a field is a read-only or a read-write path field, any expression must first start with such a variable in order to indicate which tree in which message assembly the path expression is mapping onto.

For XPath the variable names map to existing correlation names found in ESQL field reference expressions, but to conform to the grammar they are signaled as variable reference through the prefixing of the \$ character.

For example:

ESQL Root.XMLNSC.CUST_DETAILS.NAME

XPATH

\$Root/XMLNSC/CUST_DETAILS/NAME

The variable indicates which tree and where in the tree the expression is anchored.

The XPath Expression builder dialog supports validation, which you can turn off on the XPath preferences page by removing the check from the **Validate when creating XPath expressions** check box.

There are three main views when functions are supported.

Note, that what is provided in each view, or whether the view is even displayed, is dependant on what type of property editor you have used to launch the dialog, and its tailored settings; for example for path type fields you do not see a functions pane. What operators are supported is variable as is the list of applicable variables.

1. Data Types Viewer; this view shows the different schema types, elements, and attributes that can be used within the XPath expression being created, as well as the allowable variable references.
2. XPath Function; this view shows four main top level categories, which are:
 - String
 - Boolean
 - Numeric
 - NodeSet.

For information on the format of XPath 1.0 expressions see XPath and go to the appropriate section, as follows:

String section-String-Functions

Boolean
section-Boolean-Functions

Numeric
section-Number-Functions

Nodeset
section-Node-Set-Functions

3. Operators; this view shows a list of all of the available operators that can be used within the given XPath expression

Namespace settings

If you expand **Namespace settings** in the XPath Expression Builder dialog you see a table of Prefix and Namespace pair strings; this table is automatically updated

when XPath expressions are created. If the default prefix generated is not what you want, you can change it by clicking the **Change Prefix** button.

To add a prefix and namespace map entry click the **Add** button and complete the fields in the dialog.

To edit or delete an entry in the table, select the item and click the **Edit** or **Delete** buttons respectively.

The **Edit** button opens another field dialog allowing you to change the prefix and namespace.

For information on the preferences supplied with the XPath editor, see “XPath editor preferences.”

XPath editor preferences

This topic describes the possible options available to you when you use the XPath editor.

The following lists describe the custom preferences used in the XPath editor.

- Validation option:

Validation when building XPath expressions

Default: checked.

This option is used to perform validation each time you update the XPath expression. As validation requires re-parsing the expression against the XML Schema document you can turn this option off, for example, if you are dealing with very large complex XPath expressions.

- Content Assist display options:

Show XML Schema model groups

Default: not checked.

This option allows you to view XML schema model groups, or not.

Show type in XML Schema tree

Default: checked.

This option allows you to view the <type name> in both the Content Assist view and the XPath expression builder, or not.

Show function parameters

Default: checked.

This option allows you to have function parameters shown, or not.

Show function return type

Default: checked.

This option allows you to have function return types shown, or not.

Show content assist description

Default: checked.

This option allows you to view the description of a given selected entry in the Content Assist view, or not..

- Auto-Activation option:

Enable auto activation

Default: checked.

When this option is active, the Content Assist field appears whenever the cursor is after one of the following:

- / - Forward slash character
- [- left bracket character
- (- Left parentheses character
- , - Comma character

You set the delay time, before the Content Assist field appears, in the **Auto activation delay** field. The time is in milliseconds and the range is a positive number between zero and 9999.

- Content assist color options:

This preference allows you to customize the background and foreground colors for the Content Assist fields. The default background color is (red, green, blue - 254, 241, 233) and the default foreground color is (red, green, blue - 0, 0, 0) - black.

Creating XPath expressions

A number of built-in primitive nodes have properties that can be specified using an XPath 1.0 expression; most common is where this language is used to form a path expression to locate incoming message body elements received by a node.

Other less common node property fields support the entry of general XPath 1.0 expressions that support a wider range of the language to perform more complex evaluations in the broker's XPath 1.0 runtime engine.

The XPath Expression Builder provides a tree view of an expected message layout, and supports the automatic generation of an XPath 1.0 path expression, through the selection of an element within the given tree.

You can use XPath 1.0 path expressions in your flow to access specific parts of an incoming message, create or locate parts of an outgoing message, and perform complex message processing expression evaluations that might involve values present in message trees accessible by a node. You can then process the message; for example you can transform, filter or retrieve values from a message.

The Route node applies XPath 1.0 general expressions to the content of message trees associated with the incoming message assembly for this node. Following evaluation of an expression the result is cast as a Boolean (true or false) result, and this in turn is used to determine if a copy of the incoming message is routed down an output terminal associated with the processed expression.

If you have any XML schema definitions (.xsd) files present in your workspace, then any elements, attributes or data types defined in such definitions can be loaded into the Data types viewer and selected to automatically generate a path expressions mapping to the definition concerned.

Equally, depending on the XPath expressions supported by the property concerned, you can select XPath functions and operators to include in an expression or you can build your own expressions manually.

The Data types viewer contains a list of variables relating to trees that can be accessed by expressions for the node property concerned.

For example, `$InputRoot` gives access to the incoming message tree. The fixed format of standard folders you can expect to exist under this tree, for example, `Properties` and `MQMD` are described without the need to import an `.mxsd` definition for them. These structures can be navigated in the viewer and, on selection of an element within them, a path expressions is built automatically that maps to the element in question through the XPath 1.0 language.

The **Schema Viewer** section provides a tree view of the input message. To visually build your XPath expression follow these steps:

1. Add the relevant node to your message flow
2. In the Properties viewer, enter the correlation name, or press **Ctrl + Space** to bring up content assist, or press **Edit** to use the Expression editor. Content assist is also brought up by simply typing, for example, `$` in cell-based property fields. See “Correlation names” on page 71 for further information on correlation names.
3. Expand the tree, navigate to the field for which you want to build the expression, and click to select it. A field is either an element, or an attribute. Double click the field to add it to the **XPath Expression** below. You can also drag and drop fields, functions, and operators to the desired spots in the XPath Expression when using the XPath Expression builder.
4. To set conditions, enter them in as you would a normal XPath Expression.

The complete XPath expression is shown either:

- In the **XPath Expression** pane if you are using the XPath Expression builder. The Expression builder dialog is an optional aid to generating expressions that, once complete, form the value in a node’s property field. If you do not use the Expression builder dialog, the expressions entered manually are validated using the property editor.
- In the **Property** field if it is in the node itself.

Note the messages displayed at the top of the XPath Editor window. These messages alert you to the fact that a path or expression you have entered is not valid even though the editor allows you to enter the expression, and even save it.

Example

Here is the corresponding XPath expression built in the XPath Expression Builder to filter the Employee business objects for all employees who are managers: **`$Body/getEmployeeInfo/Emp[isManager=true()]`**.

- **`$Body`**: The body section of the message, that is, the last child of root.
- **`/getEmployeeInfo`**: The name of the operation in the interface.
- **`/Emp`**: The name of the input message type.
- **`[isManager=true()]`**: Checks whether the `isManager` field is set to true.

In this case the same expression works for both request and response flows, because the input and output messages for the operation are identical.

See XPath for more information on XPath 1.0.

Selecting the grammar mode

WebSphere Message Broker supports the following field categories:

- Read-only path field

- Read-write path field
- Expression field

Each of these field types can be either fixed or mixed language, that is, ESQL or XPath.

To see if you can use XPath on a property see “Multi-language node property fields” on page 412.

If you use XPath syntax and the expressions are not supported for the property you are using, the syntax is rejected during the validation process.

ESQL and XPath have similar restrictions on the syntax that is permitted for the first two of these field types. There are restrictions to the third field type as well, but as this type of field supports general expressions that can be used in either language, the range of syntax available is greater than the first two.

WebSphere Message Broker uses code assistance in the grammar management of XPath 1.0 to validate the syntax of expressions entered. This assistance is available, regardless of the grammar mode you are using.

By default, you are operating in the restricted grammar mode.

Code assistance enables you to construct syntactically correct expressions but it does not validate those expressions. Validation is performed by property editors in which such expressions are entered.

If you attempt to use syntax that is not valid the property editor marks those expressions as such, either from a syntax or schema validation perspective.

You receive error or warning messages depending upon the preference choices you set in **Windows>Preferences>Broker Development>XPath>Validation** .

If particular checks are to be marked as errors under the above validation settings then, when found, error markers are posted under the problems viewer. This results in a message flow being marked as broken, and the flow is made unavailable for import and compilation within a deployable bar file using the broker archive editor.

If you want to use the appropriate unrestricted grammar to input in a specific field type, property editors will not force a restricted form of ESQL or XPath 1.0 expressions to be entered for such fields that expect them.

Instead, you can enter the full range of syntax in the context of the field category concerned, namely, path of general expression, without coming across the validation checks applied. This means that you can deploy the full range of syntax, if you need to, supported by the ESQL or XPath 1.0 runtime engines. Note, however, that such expressions might not be in a form that can be converted to the other language.

To use unrestricted grammar carry out the following procedure:

1. Select the Broker Administration perspective in the workbench.
2. Select **Window -> Preferences** and expand **Broker Development**.
3. Expand **XPath** and click on **Grammar**.
4. Remove the check from **Use XPath and ESQL equivalent grammar**.

Note that expressions are still validated for valid syntax appropriate in the context of the field type, but can now be in the full range of grammar as supported by the runtime environment.

Using TCP/IP in message flows

You can use Message Broker to connect to applications that use raw TCP/IP sockets for transferring data.

If you have existing applications that use raw TCP/IP sockets for transferring data, you can use the Message Broker TCP/IP nodes to connect to the applications, without needing to enable them for WebSphere MQ. This helps you to develop a Message Broker solution quickly.

Message Broker implements access to the TCP/IP input and output streams through the following nodes:

- “TCPIPClientInput node” on page 1126
- “TCPIPClientOutput node” on page 1137
- “TCPIPClientReceive node” on page 1146
- “TCPIPServerInput node” on page 1158
- “TCPIPServerOutput node” on page 1169
- “TCPIPServerReceive node” on page 1177.

For information on some of the ways in which you can use the Message Broker TCP/IP support, see “Working with TCP/IP” on page 434.

The following topics contain information that you need to understand to use TCP/IP in a Message Broker application:

- “TCP/IP overview”
- “TCP/IP nodes” on page 425
- “Connection management” on page 428
- “Scenarios for Message Broker and TCP/IP” on page 430.

TCP/IP overview

TCP/IP sockets provide a simple way of connecting computer programs together, and this type of interface is commonly added to existing standalone applications.

TCP/IP provides a mechanism for transferring data between two applications, which can be running on different computers. The transfer of data is bidirectional and, as long as the TCP/IP connection is maintained, no data is lost and the sequence of the data is kept. A significant advantage of using TCP/IP directly is that it is very quick and simple to configure, which makes it a useful mechanism for processes that do not require message persistence (for example, monitoring). However, the use of TCP/IP sockets for transferring information between programs does have some limitations:

- It is non-transactional
- It is not persistent (the data is written to an in-memory buffer between sender and receiver)
- It has no built-in security
- It provides no standard way of signalling the start and end of a message.

For these reasons, it can be preferable (where possible) to use a transport mechanism like WebSphere MQ, which has none of these limitations. However, if you have existing applications that use raw TCP/IP sockets for transferring data, you can use the Message Broker TCP/IP nodes to connect to the applications, without needing to enable them for WebSphere MQ. This allows you to develop a Message Broker solution quickly.

A TCP/IP connection between two applications has a client end and a server end, which means that one application acts as a server and the other as a client. The terms client and server refer only to the mechanism used to establish a connection; they do not refer to the pattern of data exchange. When the connection has been established, both client and server can perform the same operations, and can both send and receive data. The following diagram illustrates the locations of client and server applications:

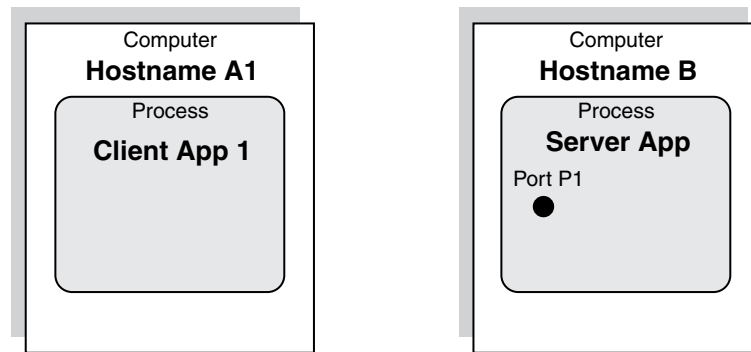

The server application listens on a local port (on the computer that is running the application) for requests for connections to be made by a client application. The client application requests a connection from the server port, which the server then accepts. When the server accepts the request, a port is created on the client computer and is connected to the server port. A socket is created on both ends of the connection, and the details of the connection are encapsulated by the socket. The server port remains available to listen for further connection requests:

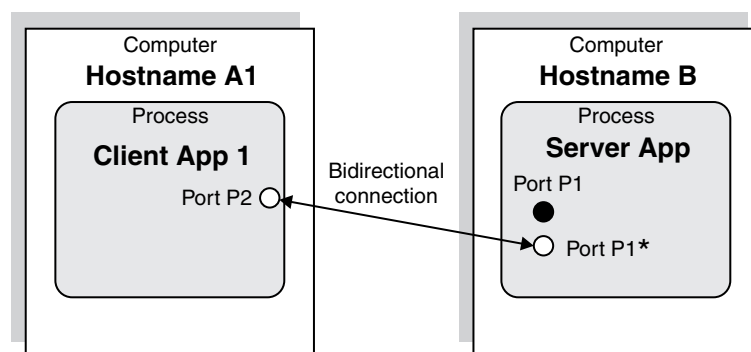

The server can accept more connections from other client applications. These connections can be in the same process, in a different process on the same computer, or on a different computer:

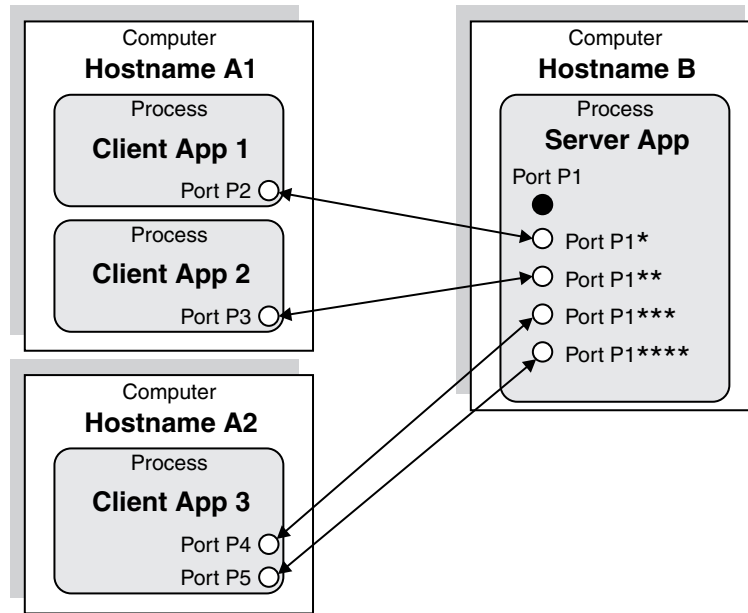

There can be only one server application, but any number of different client processes can connect to the server application. Any of these applications (client or server) can be multithreaded, which enables them to use multiple connections.

When the connection has been established, two data streams exist: one for inbound data and another for outbound data:

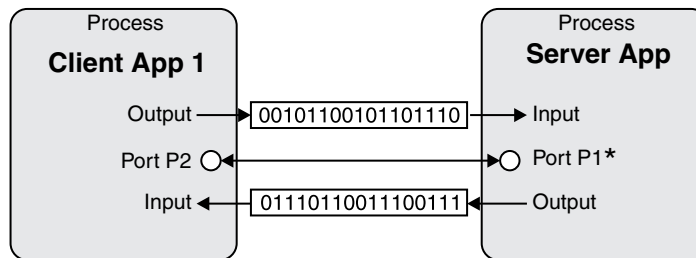

The client and server ends of the connection are identical and both can perform the same operations. The only difference between them is that the client's output stream is the server's input stream, and the client's input stream is the server's output stream.

These two streams of data are completely independent and can be accessed simultaneously from both ends. It is not necessary for the client to send data before the server.

The previous diagram can be simplified in the following way, showing that the client and server have access to a socket that has an input stream and an output stream:

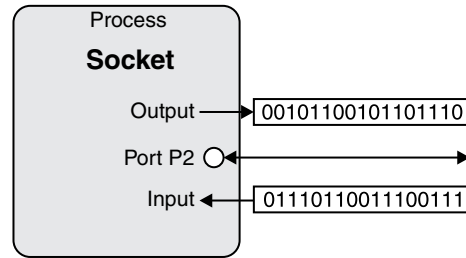

TCP/IP nodes

Message broker implements access to the TCP/IP input and output streams through a series of nodes.

There are two sets of TCP/IP nodes: server nodes and client nodes. Both sets have identical function in terms of accessing the data streams; the only difference between them is that one set uses client connections and the other set uses server connections. This means that there is a difference between them in establishing the connections, but there is no difference in the way they use the streams when the connections have been established.

The main difference between the properties of the nodes is that the server nodes do not allow the hostname to be changed (because it must always be localhost). All server nodes using the same port must be in the same execution group because the port is tied to the running process. Client nodes on the same port can be used in different execution groups but client connections cannot be shared, because the client connections are tied to a particular execution group (which maps to a process). Within the two sets of nodes (client and server) there are three types of nodes:

- TCPIPServerInput and TCPIPClientInput
- TCPIPServerReceive and TCPIPClientReceive
- TCPIPServerOutput and TCPIPClientOutput.

The input and receive nodes access the input stream to retrieve data, and the output nodes access the output stream to send data. There is no single node that can access both streams at the same time. To access both streams simultaneously, multiple nodes must be connected together in a message flow.

Input nodes

The input node allows access to a connection's input stream. It is triggered by the arrival of data in the stream and starts processing the message flow. The input node controls thread and transaction management. Even though the TCP/IP nodes are not transactional in the way they interact with TCP/IP, other nodes in the same flow can still be transactional (for example MQ and DB2). The input node does not create a thread for every connection being used but instead waits for two requirements to be met:

- A connection is available that still has an open input stream
- There is data available on the input stream (at least 1 byte).

For example, 1,000 TCP/IP connections can be handled by one input node that has only one additional instance. This is possible because the node does not poll the connections but gets triggered when the specified conditions are met.

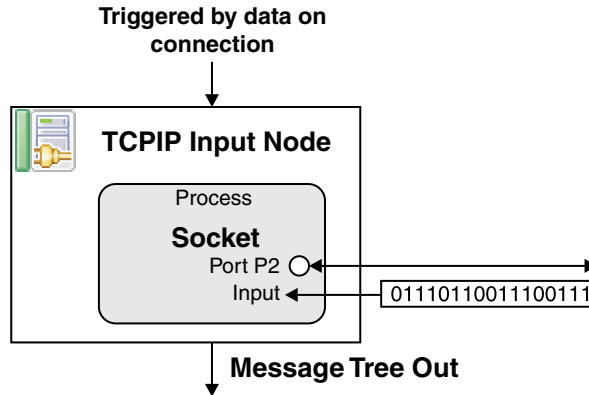

Receive nodes

The receive node is triggered to read data from a connection when a message arrives on its In terminal. It waits for data to arrive and then sends it to the Out terminal. The receive node can be configured to use a particular connection (by specifying a connection's ID) or to use any available connection. If it is configured to use any available connection it receives data from the first connection that has data available.

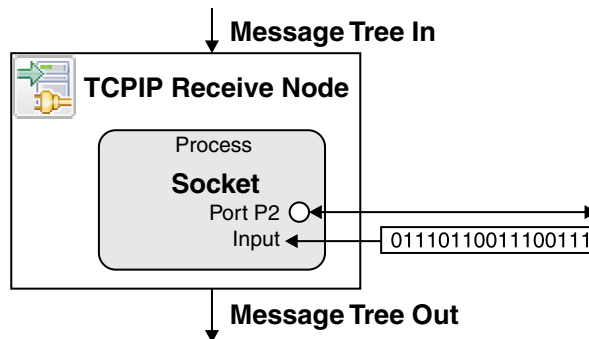

Output nodes

The output node sends data to a connection. It is triggered by a message arriving on its In terminal and then sends the data contained in the message to the stream. The same message that is received in the node is sent out to the Out terminal.

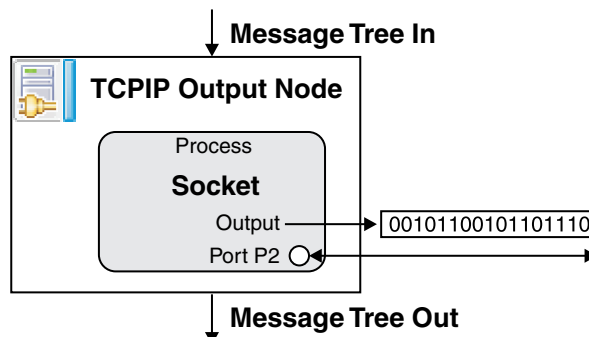

Combining nodes

The six client and server nodes can be combined to provide more complex function. For example, an output node followed by a receive node allows for a synchronous request of data:

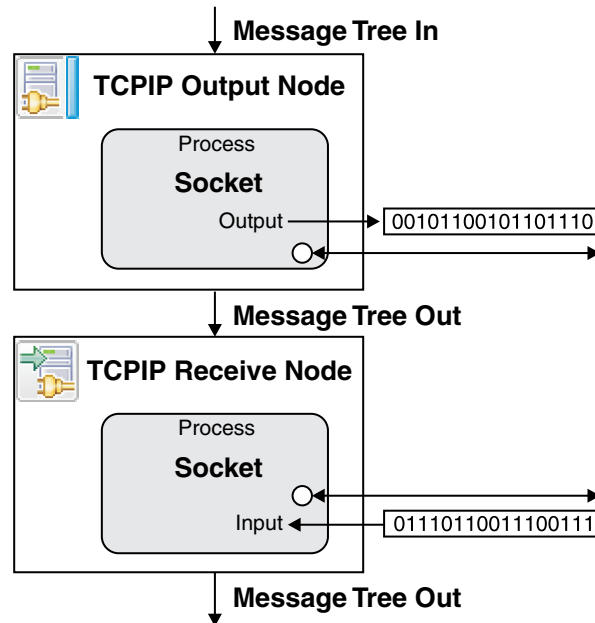

If the message flows used are single threaded and there is only ever one connection, this combination of nodes requires no further configuration. Two additional mechanisms are included to allow multithreading and multiple connections:

- A connection ID to ensure that the same connection is used by multiple nodes
- The ability to reserve connections so that they can be accessed only when the ID is specified.

One connection in multiple nodes

Every connection has a unique identifier assigned to it when it is created. Whenever a node uses a connection, the ID used is written to the local environment. Any nodes that use it later in the flow can access the same connection by specifying the ID; the receive and output nodes find the ID by searching in a specified location in the local environment. By default, the location a node writes its connection details to is different from the location in which the next node looks to see if there is an ID to use. The nodes can be configured to use the ID that was output by a previous node. For example, the combination of the output and receive nodes shown in “Combining nodes” could be configured so that the receive node uses the `WrittenDestination` data from the preceding output node.

The use of the ID enables a series of nodes to access the same connection, but does not prevent two message flow threads accessing the same connection. When a connection is used for the first time it can be reserved so that no other nodes can access it unless they know the ID. For example, the combination of the output and receive nodes shown in “Combining nodes” reserves the connection so that no

other threads can access it before the receive node uses it. By default, the receive node then releases the connection when it has finished.

The ability to reserve connections (and access them by specifying the correct ID) enables you to build up complex interactions with TCP/IP connections that span whole flows and even multiple flows. This allows the TCP/IP interactions to be used with other asynchronous transport mechanisms like WebSphere MQ.

Reserved connections must be released at some point, otherwise they remain unavailable indefinitely. For more information about reserved and available connections, see “Connection management.”

Correlating replies across flows

The TCP/IP nodes can be used in asynchronous patterns, in which data is sent out through a TCP/IP output node and received back through a TCP/IP input node. These span two message flows, which means that any state in the first flow is lost and is not accessible from the second flow. The TCP/IP nodes allow you to store some reply details on a connection, and these are then available for the input node to use when a new event arrives on the same connection. By default this data is taken from the local environment, but you can configure the nodes to take the data from any location, including the Correlid field and message IDs in WebSphere MQ headers.

Connection management

TCP/IP connections are requested by the client connection manager and accepted by the server connection manager.

The execution group process contains the connection manager, which makes the connections. This means that only one execution group can have server nodes using a specific port at any given time; deployment to a second execution group would cause a deployment error. It also means that client nodes can be deployed to different execution groups, but each execution group has its own pool of connections (and therefore its own minimum and maximum number of connections).

TCP/IP nodes do not directly create or manage any TCP/IP connections, but acquire them from the connection manager’s internal pool. For example, two output nodes using the same connection details share the same connection manager. The TCP/IP nodes can define the connection details to be used by specifying one of the following things:

- Hostname and port
- Name of a configurable service.

If a hostname and port are specified, the node uses these values when requesting connections. If a configurable service is specified, the node obtains the values for the port and hostname from the values defined in the configurable service. The connection manager allows other configurable parameters in addition to the hostname and port, and all of these can be defined when using a configurable service. When the hostname and port are specified on the node, the connection manager obtains the rest of the required values from the default configurable service. However, if there is a configurable service defined that is using the hostname and port number, the values from that configurable service are used.

The connection manager is created when the first node that requires connections from it is deployed. The connection manager is destroyed when the last remaining node using it has been removed from the execution group (so the connection manager is no longer being used by any deployed nodes). For example, this can happen when existing flows are redeployed, because redeployment involves deleting all existing nodes before recreating them.

Server connections

The server connection manager starts listening for server connections when it starts, and keeps accepting connections until the maximum number of connections (set in the configurable service) is reached. Any attempts to make connections after this point are refused. TCP/IP servers do not create connections; they only accept connection requests from other applications. This means that it is not possible to force the creation of connections within a message flow.

Client connections

The client connection manager starts up, makes a client connection, and keeps doing so until the minimum number of connections (defined in the configurable service) is reached. By default the minimum is zero, which means that no connections are made. Whenever the number of connections drops below the minimum value, the connection manager starts creating more client connections. The client output and receive nodes initiate the creation of new client connections whenever there are none available for them to use, unless the maximum number (defined in the configurable service) has been reached.

Reserving and releasing connections

Each connection has an input stream and an output stream, both of which have two main states within the connection manager: available or reserved.

When a node requests a connection for input or output, without specifying the ID of a particular connection, it is given any available connection on the required stream. If no connections are available, and if the node is a client node, a new connection is made, but only if the maximum number of connections has not yet been reached. Any connection in the available state can be used by only one node at a time, but when a node has finished using it, any other node (from any flow or thread) can access it.

You can restrict access to a stream on a connection by reserving the connection. When a connection is in the reserved state, no other node can access the stream without specifying the ID of the connection. For example, an input node can request an available connection, and, when it has finished reading the data, put the stream into the reserved state. While the stream is in the reserved state, no input node (including the node that put the stream into the reserved state) can access it, because input nodes can access only available streams. The only nodes that can access the stream must be passed the connection ID, which is written to the outgoing local environment when the data is passed down the message flow. This enables receive nodes to read more data on the same connection, as long as the receive node is configured to use the ID from the input node's local environment.

When a connection is reserved, ownership of the connection is given to a current thread of processing. This processing can span separate message flows, if required.

The reserve mechanism provides the following options:

- Leave unchanged
- Reserve
- Release
- Reserve and release at the end of the flow.

By default, the stream is left available (not reserved). This is the case for all nodes, and, for many types of processing, this default can be left unchanged (for example, when moving data from an input stream to a file). The main purpose of reserving a stream is to allow a series of nodes to be connected together to give complex processing on a stream in an ordered, controlled, synchronous sequence. If you need to reserve a connection, the Reserve and release at end of flow option has the benefit of ensuring that the connection's stream is released when one iteration of the flow has finished processing (including any error conditions that might occur).

A situation in which you would need to reserve a stream without releasing it at the end of the flow is when the processing must span multiple message flows (for example, for asynchronous request and reply). See the TCPIP Client Nodes sample for an example of how to do this. A possible disadvantage of reserving a stream between message flows is that there is the potential for a stream never to be released. To avoid this, set an expiry time on the connection so that it is closed after a specified period of inactivity.

Another benefit of reserving an input stream is that the connection cannot be closed until it is either released or expired, even if an end application closes its end of the connection. This is useful when the end of the stream is being used to delimit messages in the stream.

Scenarios for Message Broker and TCP/IP

The following topics include example scenarios in which TCP/IP and Message Broker might be used as part of a business solution:

- "Scenarios: TCP/IP"
- "Scenarios: Message Broker using TCP/IP" on page 433.

Scenarios: TCP/IP

This topic outlines two different scenarios to illustrate how TCP/IP might be used as part of a business solution:

- "Expense submission"
- "Price-change notification" on page 432.

Expense submission

Scenario:

A company has an expense submission system based on a central expense processing application that receives completed expense forms from end users. The users complete the forms using a local application, which stores the form until it is completed. When it has been completed, the form needs to be transferred to the central system where it is processed. Any further notifications are sent to the user by e-mail.

How TCP/IP is used:

There is one client application for each end user and one central application processing all of the expense forms. Each client application connects to a TCP/IP server port on the server application and sends the expense form in a fixed field size structure similar to a COBOL structure. The flow of processing is:

1. The user enters information into the form in the client expense application:

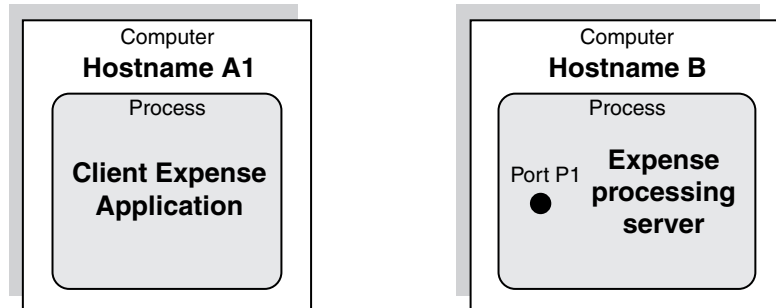

2. The user submits the completed form and the client application connects to the server:

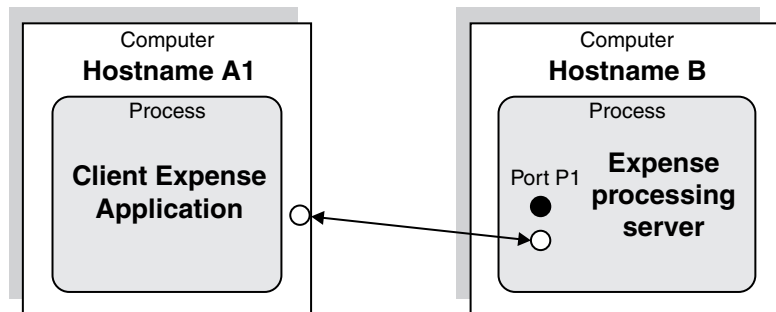

3. The client application sends the data to the server and receives an acknowledgement:

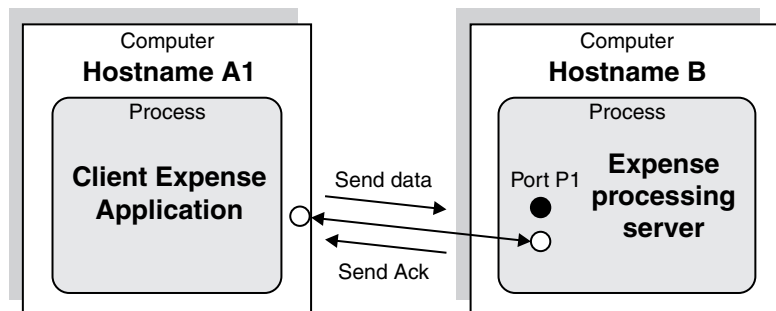

4. The connection is closed by the client:

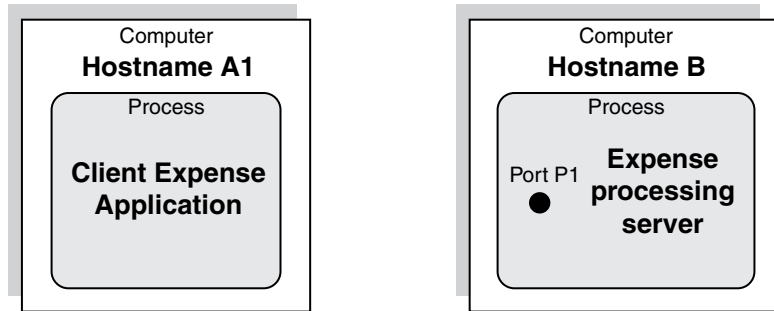

Price-change notification

Scenario:

A company has a central server, which stores the catalogue price of everything that the company sells. This information is required by all Point of Sale (PoS) terminals in all the stores, and each PoS terminal must be notified when any price changes. The PoS terminals connect to the central server and wait for any process changes. The server sends any process changes to all connected client applications.

How TCP/IP is used:

1. When the PoS application starts up it connects to the central server:

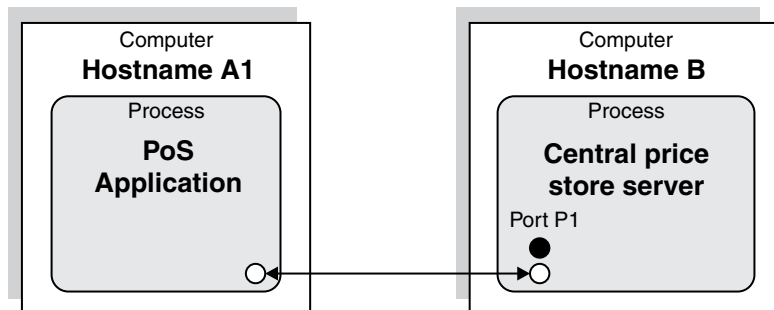

2. Whenever the server has a new price it publishes it to all connected clients:

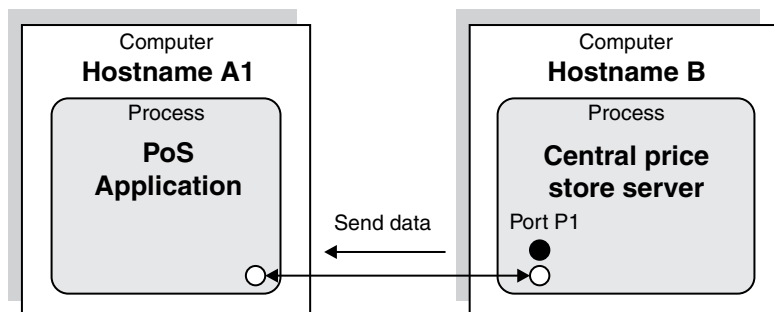

3. The PoS stays connected until it shuts down.

See "Scenarios: Message Broker using TCP/IP" on page 433 for an example of how these scenarios can be modified to use WebSphere Message Broker.

Scenarios: Message Broker using TCP/IP

This topic shows how Message Broker can be added to systems that use TCP/IP for transport, to generate a more flexible architecture for communication between components.

The scenarios in the “Scenarios: TCP/IP” on page 430 topic show how systems might be created to use TCP/IP as a transport mechanism. The following sections show how Message Broker can be added to those systems to generate a more flexible architecture for communication between components:

- “Expense submission” illustrates TCP/IP to TCP/IP routing
- “Price-change notification” illustrates routing and transformation to other formats.

Expense submission

The expense submission scenario shown in the “Scenarios: TCP/IP” on page 430 topic requires a direct connection from the client applications to the end server. With that model it is difficult to add new consumers of the expense submission information, and it is also difficult to change the end application that processes them. However, by adding Message Broker as an intermediary router, the two systems can be separated without any changes to their interfaces, as shown in the following diagram:

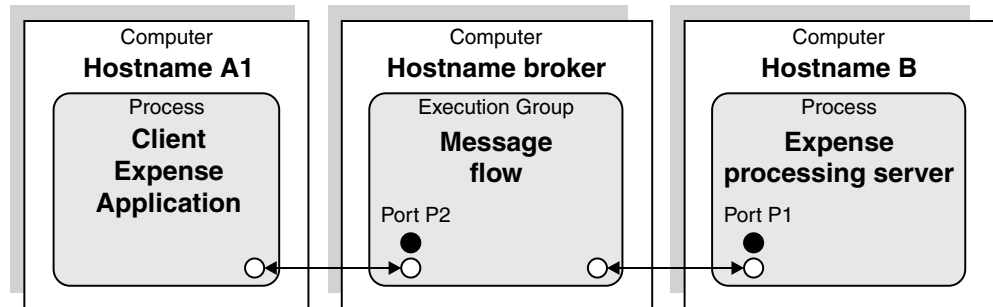

Price-change notification

The price change notification scenario shown in the “Scenarios: TCP/IP” on page 430 topic can be modified to use Message Broker for routing and transformation. It could also allow support for other protocols like WebSphere MQ, which would allow new applications to be written to different interfaces without having to change the current client or server applications:

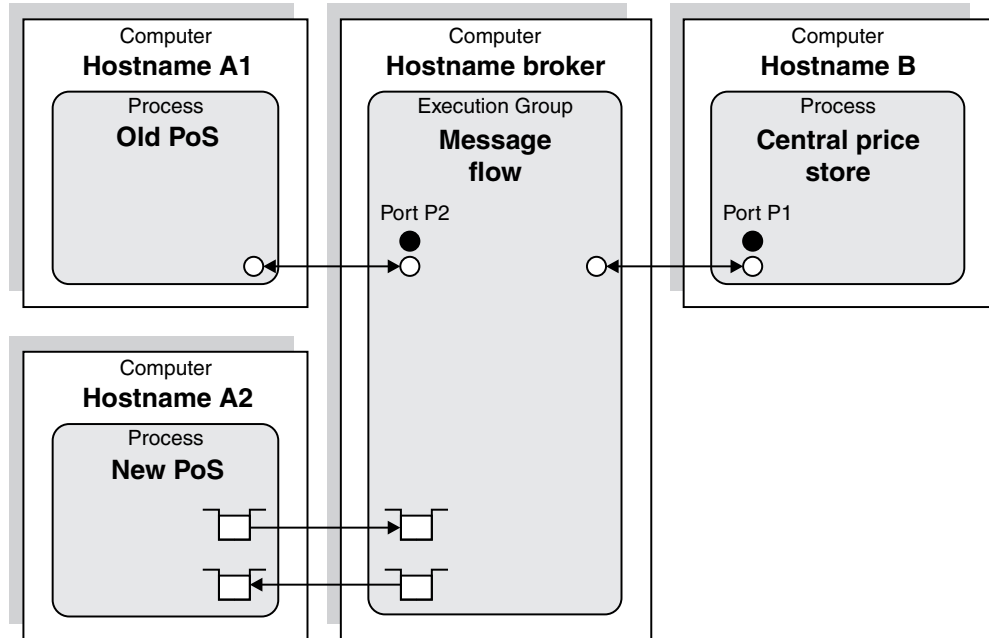

Working with TCP/IP

This topic introduces the tasks that you can perform using Message Broker TCP/IP support.

The following are some of the tasks that you can perform using the Message Broker TCP/IP nodes and TCP/IP configurable services:

- “Transferring XML data from a TCP/IP server socket to a WebSphere MQ queue” on page 435
- “Transferring binary (CWF) data from a TCP/IP server socket to a flat file” on page 435
- “Receiving data on a TCP/IP server socket and sending data back to the same connection” on page 436
- “Sending XML data from a WebSphere MQ queue to a TCP/IP client socket” on page 437
- “Sending CWF data from a flat file to a TCP/IP client socket” on page 438
- “Sending data to a TCP/IP client connection and receiving data back on the same connection (synchronous)” on page 439
- “Sending data to a TCP/IP client connection and receiving data back on the same connection (asynchronous)” on page 440
- “Broadcasting data to all currently available connections” on page 441
- “Configuring a server socket so that connections expire after a specified time” on page 441
- “Configuring a client socket to make 100 connections at deployment or startup time” on page 442
- “Configuring a server socket to receive XML data ending in a null character” on page 442
- “Configuring a server socket to receive XML data and find the end of a record (using the message model)” on page 443
- “Configuring a server output node to close all connections” on page 443

- “Configuring a client socket to store reply correlation details” on page 444
- “Writing close connection details to a file” on page 444
- “Configuring a client node to dynamically call a port” on page 445
- “Configuring a server receive node to wait for data on a specified port” on page 446
- “Sending and receiving data through a TCP/IP client connection, delimiting the record by closing the output stream (asynchronous)” on page 447
- “Sending and receiving data on the same TCP/IP client connection, closing input and output streams (synchronous)” on page 448.

Transferring XML data from a TCP/IP server socket to a WebSphere MQ queue

Transfer XML data from a TCP/IP server socket to a WebSphere MQ queue, by creating a message flow with TCPIPServerInput and MQOutput nodes.

Scenario:

A client application opens a TCP/IP socket and sends an XML document. The end of the document is signalled by the closure of the client connection.

The following steps describe how to write a message flow that can receive the XML document and write it to a WebSphere MQ queue:

1. Create a message flow called TCPIP_Task1 using a TCPIPServerInput node and an MQOutput node. For information on how to do this, see “Creating a message flow” on page 218.
2. Connect the Out terminal of the TCPIPServerInput node to the In terminal of the MQOutput node.

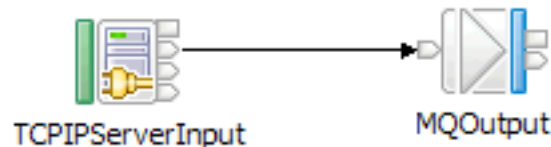

3. Set the following properties of the TCPIPServerInput node:
 - a. On the **Basic** tab, set the Connection details property to 14141
 - b. On the **Input Message Parsing** tab, set the Message domain property to XMLNSC.
4. On the MQOutput node, set the Queue name property (on the **Basic** tab) to TCPIP.TASK1.OUT1
5. Save the message flow.

Transferring binary (CWF) data from a TCP/IP server socket to a flat file

Transfer binary Custom Wire Format (CWF) data from a TCP/IP server socket to a flat file, using a message set and a message flow with TCPIPServerInput and FileOutput nodes.

Scenario:

A client application opens a TCP/IP socket and sends a binary (CWF) document. The end of the document is signalled by the closure of the client connection.

The following steps describe how to write a message flow that can receive the binary document and write it to a flat file. Each message is written to a separate file, whose name is based on the ID of the connection.

1. Create a message set called Task2_MsgSet. For information on how to do this, see *Creating a message set*.
2. Create a message flow called TCPIP_Task2 using a TCPIPServerInput node and a FileOutput node. For information on how to do this, see “*Creating a message flow*” on page 218.
3. Connect the Out terminal of the TCPIPServerInput node to the In terminal of the FileOutput node.

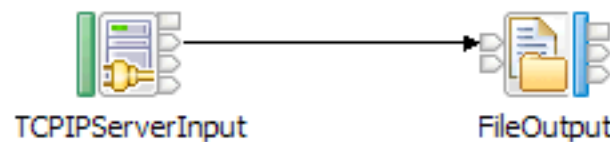

4. Set the following properties of the TCPIPServerInput node:
 - a. On the **Basic** tab, set the Connection details property to 14142
 - b. On the **Input Message Parsing** tab, set the following properties:
 - Set the Message domain property to MRM
 - Set the Message set property to Task2_MsgSet
 - Set the Message type property to Task2_MsgType
 - Set the Message format property to CWF1
5. Set the following properties of the FileOutput node:
 - a. On the **Basic** tab, set the following properties:
 - Set the Directory property to c:\temp\task2
 - Set the File name or pattern property to Task2.out
 - b. On the **Request** tab, set the Request file name property location property to \$LocalEnvironment/TCPIP/Input/ConnectionDetails/Id
6. Save the message flow.
7. Create a project reference between the message flow project and the message set project:
 - a. Right-click the message flow project and then click **Properties**.
 - b. Click **Project References**.
 - c. Select the message set project that contains your message set (Task2_MsgSet).
 - d. Click **OK**.

Receiving data on a TCP/IP server socket and sending data back to the same connection

Receive data on a TCP/IP server socket and then send the data back to the same connection, using a message flow with TCPIPServerInput and TCPIPServerOutput nodes.

Scenario:

A client application opens a TCP/IP socket and sends an undefined document (of any format or size). The end of the document is signalled by the client closing the output stream (but not the connection) and then waiting for the same data to be sent back.

The following steps describe how to write a message flow that can receive the data and echo it back to the same connection:

1. Create a message flow called TCPIP_Task3 with a TCPIPServerInput node and a TCPIPServerOutput node. For information on how to do this, see “Creating a message flow” on page 218.
2. Connect the Out terminal of the TCPIPServerInput node to the In terminal of the TCPIPServerOutput node.

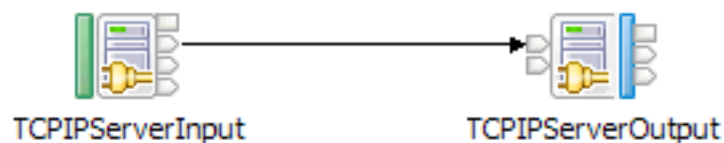

3. Set the following properties of the TCPIPServerInput node:
 - a. On the **Basic** tab, set the Connection details property to 14143
 - b. On the **Advanced** tab, set the Input stream modification property to Reserve input stream and release at end of flow.
4. Set the following properties of the TCPIPServerOutput node:
 - a. On the **Basic** tab, set the Connection details property to 14143
 - b. On the **Request** tab, set the ID location property to LocalEnvironment/TCPIP/Input/ConnectionDetails/Id
 - c. On the **Advanced** tab, set the Close connection property to After data has been sent.
5. Save the message flow.

Sending XML data from a WebSphere MQ queue to a TCP/IP client socket

Send XML data from a WebSphere MQ queue to a TCP/IP client socket, using a message flow with MQInput and TCPIPClientOutput nodes.

Scenario:

A server application listens on a TCP/IP socket and waits for a TCP/IP client to connect and send data. The end of the document is signalled by the client closing the connection.

The following steps describe how to write a message flow that can take a message from a WebSphere MQ queue, make the client connection, and send the data to the server application:

1. Create a message flow called TCPIP_Task4 with an MQInput node and a TCPIPClientOutput node. For information on how to do this, see “Creating a message flow” on page 218.

2. Connect the Out terminal of the MQInput node to the In terminal of the TCPIPClientOutput node.

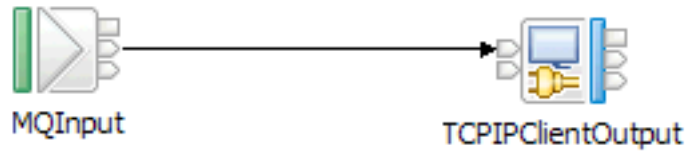

3. Set the following properties of the MQInput node:
 - a. On the **Basic** tab, set the Queue name property to TCPIP.TASK4.IN1
 - b. On the **Input message parsing** tab, set the Message domain property to XMLNSC.
4. Set the following properties of the TCPIPClientOutput node:
 - a. On the **Basic** tab, set the Connection details property to 14144
 - b. On the **Advanced** tab, set the Close connection property to After data has been sent.
5. Save the message flow.

Sending CWF data from a flat file to a TCP/IP client socket

Send Custom Wire Format (CWF) data from a flat file to a TCP/IP client socket, using a message flow with FileInput and TCPIPClientOutput nodes.

Scenario:

An application writes 100-byte binary records into a flat file.

The following steps describe how to open a new client TCP/IP connection and send the binary data with a binary termination character x'00FF'. When the whole file is finished the client connection is closed:

1. Create a message flow called TCPIP_Task5 with a FileInput node and a TCPIPClientOutput node. For information on how to do this, see "Creating a message flow" on page 218.
2. Connect the Out terminal of the FileInput node to the In terminal of the TCPIPClientOutput node.
3. Connect the End of Data terminal of the FileInput node to the Close terminal of the TCPIPClientOutput node.

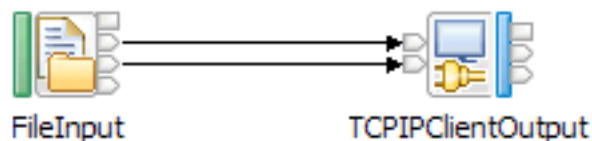

4. Set the following properties of the FileInput node:
 - a. On the **Basic** tab, set the Input directory property to c:\temp\task5
 - b. On the **Records and elements** tab, set the following properties:
 - Set the Record detection property to Fixed length
 - Set the Length property to 100
5. Set the following properties of the TCPIPClientOutput node:

- a. On the **Basic** tab, set the Connection details property to 14145
 - b. On the **Advanced** tab, set the Close connection property to After data has been sent
 - c. On the **Records and elements** tab, set the following properties:
 - Set the Record definition property to Record is delimited data
 - Set the Delimiter property to Custom delimiter (Hexadecimal)
 - Set the Custom delimiter property to 00FF
6. Save the message flow.

Sending data to a TCP/IP client connection and receiving data back on the same connection (synchronous)

Send fixed size data to a TCP/IP client connection and receive fixed size data back again on the same connection (synchronously), using a message flow with MQInput, TCPIPClientOutput, TCPIPClientReceive, and MQOutput nodes.

The following steps describe how to create a message flow that sends data out through a client connection and waits on the same connection for a reply to be returned. The request is synchronous within the same flow, because the TCPIPClientReceive node waits for data to be returned.

1. Create a message flow called TCPIP_Task6 with an MQInput node, a TCPIPClientOutput node, a TCPIPClientReceive node, and an MQOutput node. For information on how to do this, see “Creating a message flow” on page 218.
2. Connect the Out terminal of the MQInput node to the In terminal of the TCPIPClientOutput node.
3. Connect the Out terminal of the TCPIPClientOutput node to the In terminal of the TCPIPClientReceive node.
4. Connect the Out terminal of the TCPIPClientReceive node to the In terminal of the MQOutput node.

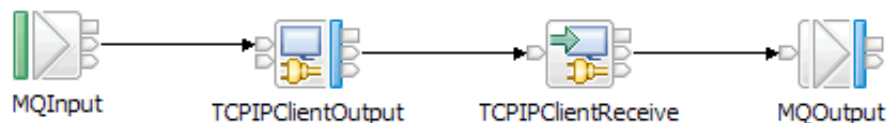

5. On the MQInput node, set the Queue name property (on the **Basic** tab) to TCPIP.TASK6.IN1
6. Set the following properties of the TCPIPClientOutput node:
 - a. On the **Basic** tab, set the Connection details property to 14146
 - b. On the **Records and elements** tab, set the following properties:
 - Set the Record detection property to Fixed length
 - Set the Length property to 100
7. Set the following properties of the TCPIPClientReceive node:
 - a. On the **Basic** tab, set the Connection details property to 14146
 - b. On the **Advanced** tab, set the following properties:
 - Set the Output stream modification property to Reserve output stream and release at end of flow
 - Set the Input stream modification property to Reserve input stream and release at end of flow

- c. On the **Request** tab, set the ID location property to `$LocalEnvironment/WrittenDestination/TCPIP/Output/ConnectionDetails[1]/Id`
- d. On the **Records and elements** tab, set the following properties:
 - Set the Record detection property to Fixed length
 - Set the Length property to 100
8. On the MQOutput node, set the Queue name property (on the **Basic** tab) to `TCPIP.TASK6.OUT1`
9. Save the message flow.

See the TCPIP Client Nodes sample for more information.

Sending data to a TCP/IP client connection and receiving data back on the same connection (asynchronous)

Send fixed size data to a TCP/IP client connection and receive fixed size data back on the same connection (asynchronously), using a message flow with MQInput, TCPIPClientOutput, TCPIPClientInput, and MQOutput nodes.

The following steps describe how to create a message flow to send data through a client connection and wait on the same connection for a reply to be returned. The request is performed asynchronously in two different flows (the TCPIPClientInput does not wait for data to be returned on this connection, but instead it monitors all available connections).

1. Create a message flow called `TCPIP_Task7` with an MQInput node, a TCPIPClientOutput node, a TCPIPClientInput node, and an MQOutput node . For information on how to do this, see “Creating a message flow” on page 218.
2. Connect the Out terminal of the MQInput node to the In terminal of the TCPIPClientOutput node.
3. Connect the Out terminal of the TCPIPClientInput node to the In terminal of the MQOutput node.

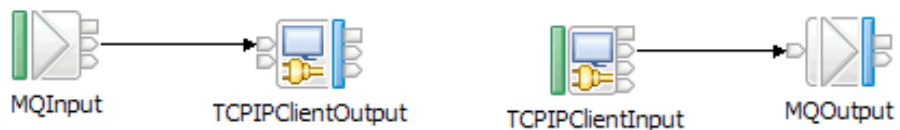

4. On the MQInput node, set the Queue name property (on the **Basic** tab) to `TCPIP.TASK7.IN1`
5. Set the following properties of the TCPIPClientOutput node:
 - a. On the **Basic** tab, set the Connection details property to 14147
 - b. On the **Advanced** tab, set the Output stream modification property to Reserve output stream
 - c. On the **Records and elements** tab, set the following properties:
 - Set the Record definition property to Fixed length
 - Set the Length property to 100
6. Set the following properties of the TCPIPClientInput node:
 - a. On the **Basic** tab, set the Connection details property to 14147
 - b. On the **Advanced** tab, set the Output stream modification property to Release output stream and reset Reply ID
 - c. On the **Records and elements** tab, set the following properties:

- Set the Record detection property to Fixed length
 - Set the Length property to 100
7. On the MQOutput node, set the Queue name property (on the **Basic** tab) to TCPIP.TASK7.OUT1
 8. Save the message flow.

See the TCPIP Client Nodes sample for more information.

Broadcasting data to all currently available connections

Broadcast data to all current connections, using a message flow with MQInput and TCPIPServerOutput nodes.

Scenario:

Several applications connect into the message flow and wait to be sent data.

The following steps describe how to send data to all the connected client applications:

1. Create a message flow called TCPIP_Task8 with an MQInput node and a TCPIPServerOutput node. For information on how to do this, see “Creating a message flow” on page 218.
2. Connect the Out terminal of the MQInput node to the In terminal of the TCPIPServerOutput node.

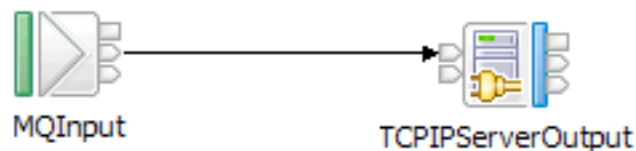

3. On the MQInput node, set the Queue name property (on the **Basic** tab) to TCPIP.TASK8.IN1
4. Set the following properties of the TCPIPServerOutput node:
 - a. On the **Basic** tab, set the Connection details property to 14148
 - b. On the **Advanced** tab, set the Send to: property (in the **Broadcast options** group) to All available connections.
5. Save the message flow.

Configuring a server socket so that connections expire after a specified time

Configure a TCP/IP server socket so that connections expire after a specified time, using the mqsicreateconfigurable service command.

Use the mqsicreateconfigurable service command to set up connections that expire when they have not been used for a specified length of time. The TCP/IP node can specify either the port to be used or the name of the configurable service. For example:

```
mqsicreateconfigurable service BRK6 -c TCPIPServer -o Task9
-n Port,ExpireConnectionSec -v 14149,5
```

In this example, the TCPIPService configurable service called Task9 is configured to run on port 14149. The connections expire when they have not been used for 5 seconds.

Configuring a client socket to make 100 connections at deployment or startup time

Configure a TCP/IP client socket to make 100 connections at deployment or startup time, using the `mqsicreateconfigurable-service` command.

Use the `mqsicreateconfigurable-service` command to set up the client configuration manager to establish 100 connections when it is created. By default the client connections are not made until they are required by one of the TCP/IP nodes. For example:

```
mqsicreateconfigurable-service BRK6 -c TCPClient -o Task10  
-n Port,MinimumConnections -v 14150,100
```

In this example, the TCPClient configurable service called Task10 is configured to run on port 14150, and 100 connections are created.

Configuring a server socket to receive XML data ending in a null character

Configure a server TCP/IP socket to receive XML data ending in a null character, using a message flow with TCPIPServiceInput and MQOutput nodes.

Scenario:

A client application sends XML data that is delimited by a null character (hex code '00').

The following steps describe how to break the record up based on the null character and then parse the data.

1. Create a message flow called TCPIP_Task11 with a TCPIPServiceInput node and an MQOutput node. For information on how to do this, see “Creating a message flow” on page 218.
2. Connect the Out terminal of the TCPIPServiceInput node to the In terminal of the MQOutput node.

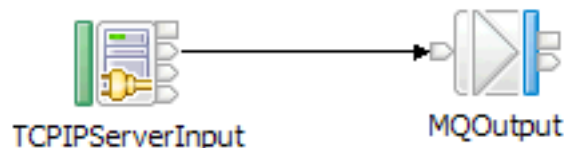

3. Set the following properties of the TCPIPServiceInput node:
 - a. On the **Basic** tab, set the Connection details property to 14151
 - b. On the **Input Message Parsing** tab, set the Message domain property to XMLNSC.
 - c. On the **Records and elements** tab, set the following properties:
 - Set the Record detection property to Delimited
 - Set the Delimiter property to Custom delimiter
 - Set the Custom delimiter property to 00

4. On the MQOutput node, set the Queue name property (on the **Basic** tab) to TCPIP.TASK11.IN1
5. Save the message flow.

Configuring a server socket to receive XML data and find the end of a record (using the message model)

Configure a server socket to receive XML data and use the message model to determine the end of a record, using a message flow with TCPIPServerInput and MQOutput nodes.

Scenario:

A client application sends an XML document with no clear indication of the end of the record.

The following steps show how to break up the record using the XML parser to signal when the whole XML document has been received. It uses the end XML tag to signal the end of the message.

1. Create a message flow called TCPIP_Task12 with a TCPIPServerInput node and an MQOutput node. For information on how to do this, see “Creating a message flow” on page 218.
2. Connect the Out terminal of the TCPIPServerInput node to the In terminal of the MQOutput node.

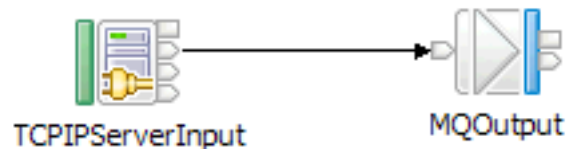

3. Set the following properties of the TCPIPServerInput node:
 - a. On the **Basic** tab, set the Connection details property to 14151
 - b. On the **Input Message Parsing** tab, set the Message domain property to XMLNSC.
 - c. On the **Records and elements** tab, set the Record detection property to Parsed record sequence
4. On the MQOutput node, set the Queue name property (on the **Basic** tab) to TCPIP.TASK12.IN1
5. Save the message flow.

Configuring a server output node to close all connections

Configure a server output node to close all connections on a specified port.

The following steps show how to create a message flow that closes all TCP/IP connections on port 14153:

1. Create a message flow called TCPIP_Task13 with an MQInput node and a TCPIPServerOutput node. For information on how to do this, see “Creating a message flow” on page 218.
2. Connect the Out terminal of the MQInput node to the Close terminal of the TCPIPServerOutput node.

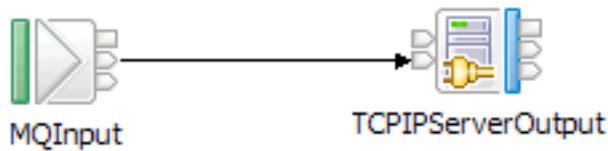

3. On the MQInput node, set the Queue name property (on the **Basic** tab) to TCPIP.TASK13.IN1
4. Set the following properties of the TCPIPServerOutput node:
 - a. On the **Basic** tab, set the Connection details property to 14153
 - b. On the **Advanced** tab, set the Send to: property (in the **Broadcast options** group) to All available connections.
5. Save the message flow.

Configuring a client socket to store reply correlation details

Configure a client TCP/IP socket to store reply correlation details, using a message flow with MQInput and TCPIPClientOutput nodes.

The following steps show how to set the Reply ID on a connection, which can be used when a response is returned on the input stream:

1. Create a message flow called TCPIP_Task14 with an MQInput node and a TCPIPClientOutput node. For information on how to do this, see “Creating a message flow” on page 218.
2. Connect the Out terminal of the MQInput node to the In terminal of the TCPIPClientOutput node.

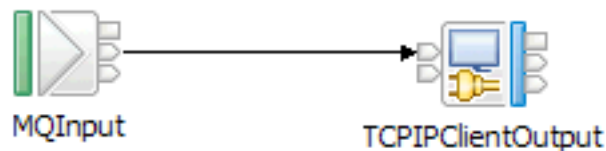

3. On the MQInput node, set the Queue name property (on the **Basic** tab) to TCPIP.TASK14.IN1
4. Set the following properties of the TCPIPClientOutput node:
 - a. On the **Basic** tab, set the Connection details property to 14154
 - b. On the **Request** tab, set the Reply ID location property to \$Root/MQMD/MsgId
5. Save the message flow.

Writing close connection details to a file

Configure a message flow to write details of a connection closure to a file, using TCPIPServerInput, Compute, and FileOutput nodes.

The following steps show how to configure a message flow to write details of the closure of any connection to a file:

1. Create a message flow called TCPIP_Task15 with a TCPIPServerInput node, a Compute node, and a FileOutput node. For information on how to do this, see “Creating a message flow” on page 218.
2. Connect the Close terminal of the TCPIPServerInput node to the In terminal of the Compute node.
3. Connect the Out terminal of the Compute node to the In terminal of the FileOutput node.

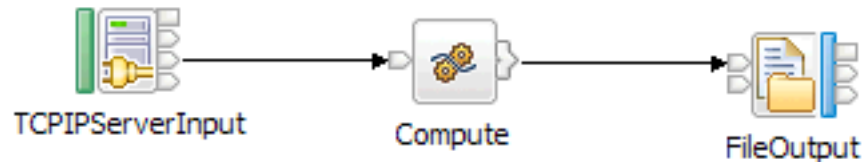

4. On the TCPIPServerInput node, set the Connection details property (on the **Basic** tab) to 14155
5. On the Compute node, set the ESQL property (on the **Basic** tab) to:

```
BROKER SCHEMA Tasks
```

```
CREATE COMPUTE MODULE TCPIP_Task15_Compute
CREATE FUNCTION Main() RETURNS BOOLEAN
BEGIN
  -- CALL CopyMessageHeaders();
  -- CALL CopyEntireMessage();
  Set OutputRoot.XMLNSC.CloseEvent = InputLocalEnvironment.TCPIP;
  RETURN TRUE;
END;

CREATE PROCEDURE CopyMessageHeaders() BEGIN
  DECLARE I INTEGER 1;
  DECLARE J INTEGER;
  SET J = CARDINALITY(InputRoot.*[]);
  WHILE I < J DO
    SET OutputRoot.*[I] = InputRoot.*[I];
    SET I = I + 1;
  END WHILE;
END;

CREATE PROCEDURE CopyEntireMessage() BEGIN
  SET OutputRoot = InputRoot;
END;
END MODULE;
```

6. Set the following properties of the FileOutput node:
 - a. On the **Basic** tab, set the following properties:
 - Set the Directory property to c:\temp\Task15
 - Set the File name or pattern property to CloseEvents.txt
 - b. On the **Records and elements** tab, set the Record definition property to Record is unmodified data.
7. Save the message flow.

Configuring a client node to dynamically call a port

Configure a client node to dynamically use a port and hostname set up in the local environment, using a message flow with MQInput, Compute, and TCPIPClientOutput nodes.

The following steps show how to override the connection details specified on a client output node to dynamically use a port and hostname that are specified in the local environment:

1. Create a message flow called TCPIP_Task16 with an MQInput node, a Compute node, and a TCPIPClientOutput node. For information on how to do this, see “Creating a message flow” on page 218.
2. Connect the Out terminal of the MQInput node to the In terminal of the Compute node.
3. Connect the Out terminal of the Compute node to the In terminal of the TCPIPClientOutput node.



4. On the MQInput node, set the Queue name property (on the **Basic** tab) to TCPIP.TASK16.IN1
5. On the Compute node, set the ESQL property (on the **Basic** tab) to:

```

BROKER SCHEMA Tasks
CREATE COMPUTE MODULE TCPIP_Task16_Compute
CREATE FUNCTION Main() RETURNS BOOLEAN
BEGIN
  -- CALL CopyMessageHeaders();
  CALL CopyEntireMessage();
  set InputLocalEnvironment.Destination.TCPIP.Output.Hostname = 'localhost';
  set InputLocalEnvironment.Destination.TCPIP.Output.Port = 14156;
  RETURN TRUE;
END;

CREATE PROCEDURE CopyMessageHeaders() BEGIN
  DECLARE I INTEGER 1;
  DECLARE J INTEGER;
  SET J = CARDINALITY(InputRoot.*[]);
  WHILE I < J DO
    SET OutputRoot.*[I] = InputRoot.*[I];
    SET I = I + 1;
  END WHILE;
END;

CREATE PROCEDURE CopyEntireMessage() BEGIN
  SET OutputRoot = InputRoot;
END;
END MODULE;

```

6. On the TCPIPClientOutput node, set the Connection details property (on the **Basic** tab) to 9999.
7. Save the message flow.

Configuring a server receive node to wait for data on a specified port

Configure a TCPIPServerReceive node to block the message flow and wait for data to arrive on any connection.

The following steps show how to configure a TCPIPServerReceive node to wait for data on port 14157:

1. Create a message flow called TCPIP_Task17 with an MQInput node and a TCPIPServerReceive node. For information on how to do this, see “Creating a message flow” on page 218.
2. Connect the Out terminal of the MQInput node to the In terminal of the TCPIPServerReceive node.

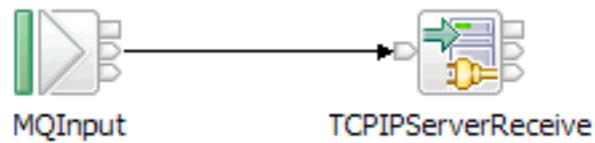

3. On the MQInput node, set the Queue name property (on the **Basic** tab) to TCPIP.TASK17.IN1
4. On the TCPIPServerReceive node, set the Connection details property (on the **Basic** tab) to 14157
5. Save the message flow.

Sending and receiving data through a TCP/IP client connection, delimiting the record by closing the output stream (asynchronous)

Send data through a TCP/IP client connection and receive data back on the same connection (asynchronously), using a message flow with MQInput, TCPIPClientOutput, TCPIPClientInput, and MQOutput nodes.

The following steps describe how to create a message flow to send data through a client connection and wait on the same connection for a reply to be returned. The request is performed asynchronously in two different flows; the TCPIPClientInput node does not wait for data to be returned on this connection, but monitors all available connections. The outgoing record is delimited by closing the output stream, and the reply message is delimited by the closing of the input stream by the remote server. The connection is then completely closed by the node.

1. Create a message flow called TCPIP_Task18 with an MQInput node, a TCPIPClientOutput, a TCPIPClientInput node, and an MQOutput node. For information on how to do this, see “Creating a message flow” on page 218.
2. Connect the Out terminal of the MQInput node to the In terminal of the TCPIPClientOutput node.
3. Connect the Out terminal of the TCPIPClientInput node to the In terminal of the MQOutput node.

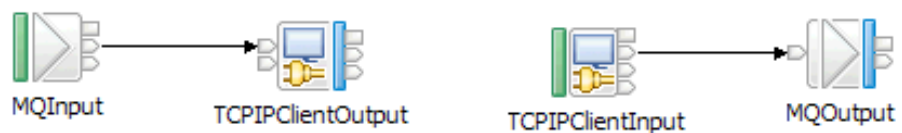

4. On the MQInput node, set the Queue name property (on the **Basic** tab) to TCPIP.TASK18.IN1
5. Set the following properties of the TCPIPClientOutput node:
 - a. On the **Basic** tab, set the Connection details property to 14158
 - b. On the **Advanced** tab, select Close output stream after a record has been sent.

- c. On the **Records and elements** tab, set the Record definition property to Record is unmodified data.
6. Set the following properties of the TCPIPClientInput node:
 - a. On the **Basic** tab, set the Connection details property to 14158
 - b. On the **Advanced** tab, set the Close connection property to After data has been received.
 - c. On the **Records and elements** tab, set the Record detection property to End of stream
7. On the MQOutput node, set the Queue name property (on the **Basic** tab) to TCPIP.TASK18.OUT1
8. Save the message flow.

Sending and receiving data on the same TCP/IP client connection, closing input and output streams (synchronous)

Send data through a TCP/IP client connection and wait on the same connection for a reply to be returned, using a message flow with MQInput, TCPIPClientOutput, TCPIPClientReceive, and MQOutput nodes.

The following steps describe how to create a message flow that sends out data through a client connection and waits on the same connection for a reply to be returned. The request is synchronous within the same flow, as a result of the TCPIPClientReceive node waiting for data to be returned. The outgoing message is delimited by closing the output stream, and the reply data is delimited by the remote application closing the input stream.

1. Create a message flow called TCPIP_Task19 with an MQInput node, a TCPIPClientOutput node, a TCPIPClientReceive node, and an MQOutput node. For information on how to do this, see “Creating a message flow” on page 218.
2. Connect the Out terminal of the MQInput node to the In terminal of the TCPIPClientOutput node.
3. Connect the Out terminal of the TCPIPClientOutput node to the In terminal of the TCPIPClientReceive node.
4. Connect the Out terminal of the TCPIPClientReceive node to the In terminal of the MQOutput node.

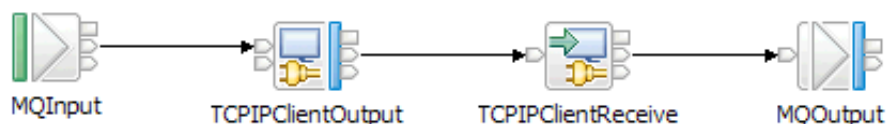

5. On the MQInput node, set the Queue name property (on the **Basic** tab) to TCPIP.TASK19.IN1
6. Set the following properties of the TCPIPClientOutput node:
 - a. On the **Basic** tab, set the Connection details property to 14159
 - b. On the **Advanced** tab, set the following properties:
 - Select Close output stream after a record has been sent
 - Set the Input stream modification property to Reserve input stream and release at end of flow. It is important to reserve the input stream so that it is not closed before the receive node processes the return data.
 - c. On the **Records and elements** tab, set the Record definition property to Record is Unmodified Data.

7. Set the following properties of the TCPIPClientReceive node:
 - a. On the **Basic** tab, set the Connection details property to 14159
 - b. On the **Advanced** tab, set the Close connection property to After data has been received.
 - c. On the **Request** tab, set the ID location property to `$LocalEnvironment/WrittenDestination/TCPIP/Output/ConnectionDetails[1]/Id`
 - d. On the **Records and elements** tab, set the Record detection property to Connection closed.
8. On the MQOutput node, set the Queue name property (on the **Basic** tab) to `TCPIP.TASK19.OUT1`
9. Save the message flow.

Developing Java

When you use the JavaCompute node, you customize it to determine the exact processing that it provides.

To tailor the behavior of each node, create a Java class file that provides the processing that you want. You manage Java files through the Java perspective.

You can add any valid Java code to a JavaCompute node, making full use of the Java user-defined node API to process an incoming message. You can use the Java editing facilities of the Eclipse platform to develop your Java code. These facilities include:

- Code completion
- Integrated Javadoc documentation
- Automatic compilation

The Java user-defined node API includes some extra methods that simplify tasks that involve message routing and transformation. These tasks include accessing named elements in a message tree, setting their values, and creating elements, without the need to navigate the tree explicitly.

Use the Debug perspective to debug a message flow that contains a JavaCompute node. When control passes to a JavaCompute node during debugging, the perspective opens the Java debugger, and you can step through the Java class code for the node.

This section provides the following information on developing Java:

- “Managing Java Files”
- “Writing Java” on page 454

Managing Java Files

The Java code that you provide to modify or customize the behavior of a JavaCompute node is stored in a Java project. WebSphere Message Broker uses the Eclipse Java perspective for developing and administering Java files.

This section contains topics that describe how to manage these files:

- “Creating Java code for a JavaCompute node” on page 450
- “Opening an existing Java file” on page 451
- “Saving a Java file” on page 451

- “Adding Java code dependencies” on page 452
- “Deploying JavaCompute node code” on page 453

Creating Java code for a JavaCompute node

Use these instructions to associate Java code with your JavaCompute node.

Before you start

To complete this task, you must have already created a JavaCompute node in your message flow.

To associate Java code with a JavaCompute node, use one of the following methods:

- Use the New Java Compute Node Class wizard to create template code. This is a preferred method.
 1. Right-click the node, click **Open Java**.
 2. Navigate the New Java Compute Node Class wizard until you reach the Java Compute Node Class Template page. On the Java Compute Node Class Template page choose one of the following options:
 - For a filter node template code, choose **Filtering message class**.
 - To change an incoming message, choose **Modifying message class**.
 - To create a new message, choose **Creating message class**.

You have created template code for your JavaCompute node.

- Associate a JavaCompute node with an existing Java class that the wizard has previously generated, which allows you to share the same Java code between multiple nodes. This is a preferred method. To associate a JavaCompute nodes with an existing Java class perform the following steps:
 1. Right-click the JavaCompute node, click **Properties**.
 2. Enter the name of the Java class in the **Java Class** field.
 3. Click **OK**.

You have associated your JavaCompute node with an existing Java class.

- Create a Java project from scratch. Before any classes are added to the project you must perform the following steps:
 1. Open the .project file in the text editor and ensure that the following builders and natures are set:

```
<buildSpec>
  <buildCommand>
    <name>org.eclipse.jdt.core.javabuilder</name>
    <arguments>
    </arguments>
  </buildCommand>
  <buildCommand>
    <name>com.ibm.etools.mft.java.builder.javabuilder</name>
    <arguments>
    </arguments>
  </buildCommand>
  <buildCommand>
    <name>com.ibm.etools.mft.jcn.jcnbuilder</name>
    <arguments>
    </arguments>
  </buildCommand>
  <buildCommand>
    <name>com.ibm.etools.mft.bar.barbuilder</name>
    <arguments>
```

```

|         </arguments>
|         </buildCommand>
|     </buildSpec>
|     <natures>
|         <nature>org.eclipse.jdt.core.javanature</nature>
|         <nature>com.ibm.etools.mft.bar.barnature</nature>
|         <nature>com.ibm.etools.mft.jcn.jcnnature</nature>
|     </natures>

```

2. Add the following plug-ins to the build path of the Java project:
 - <MB Installation Directory>\IBM\SDP70Shared\plugins\com.ibm.etools.mft.jcn_6.1.0.v<pick the latest version of this plug-in>\javacompute.jar
 - <MB Installation Directory>\IBM\SDP70Shared\plugins\com.ibm.etools.mft.jcn_6.1.0.v<pick the latest version of this plug-in>\jplugin2.jar
3. Create the appropriate Java class and ensure that it extends from com.ibm.broker.javacompute.MbJavaComputeNode.

You have created your Java project.

You can now perform the following tasks:

- “Opening an existing Java file”
- “Saving a Java file”
- “Adding Java code dependencies” on page 452

Opening an existing Java file

You can add to and modify Java code that you have created in a Java project.

Before you start

Before you start this task, complete the following tasks:

- Add a “JavaCompute node” on page 943 to your message flow.
- “Creating Java code for a JavaCompute node” on page 450

To open an existing Java file:

1. Switch to the Java perspective.
2. In the Package Explorer view, double-click the Java file that you want to open. The file is opened in the editor view.
3. Work with the contents of the file to make your changes.

You can also open a Java file when you have a message flow open in the editor view. Select the JavaCompute node, right-click and then select **Open Java** to open the file.

Next:

You can now perform the following tasks:

- “Saving a Java file”
- “Adding Java code dependencies” on page 452

Saving a Java file

When you edit your Java files, save them to preserve the additions and modifications that you have made.

Before you start

To complete this task, you must have completed the following tasks:

- Add a “JavaCompute node” on page 943 to your message flow.
- “Creating Java code for a JavaCompute node” on page 450

To save a Java file:

1. Switch to the Java perspective.
2. Create a new Java file or open an existing Java file.
3. Make the changes to the contents of the Java file.
4. When you have finished working, click **File** → **Save** or **File** → **Save All** to save the file and retain all your changes.

Next:

You can now perform the following task:

- “Adding Java code dependencies”

Adding Java code dependencies

When you write your Java code for a JavaCompute node, you can include references to other Java projects and JAR files.

Before you start

To complete this task, you must have completed the following tasks:

- Add a “JavaCompute node” on page 943 to your message flow.
- “Creating Java code for a JavaCompute node” on page 450

The Java code in a JavaCompute node might contain references to other Java projects in your Eclipse workspace (internal dependencies), or to external JAR files, for example the JavaMail API (external dependencies). If other JAR files are referenced, you must add the files to the project class path.

1. Right-click the project folder of the project that you are working on and click **Properties**.
2. Click **Java Build Path** on the left pane.
3. Click the **Libraries** tab.
4. Perform one of the following steps:
 - To add an internal dependency, click **Add JARs...**, select the JAR file that you want to add then click **OK**.
 - To add an external dependency, click **Add External JARs...**, select the JAR file that you want to add, then click **Open**. Copy the file to *WorkPath*/shared-classes where *WorkPath* is the full path to the working directory of the broker. If you do not copy the external dependencies here `ClassNotFoundException` exceptions are generated at run time.

Tip:

The default value for *WorkPath* is one of the following values:

- **Windows** For Windows systems, the default workpath is `c:\Documents and Settings\All Users\Application Data\IBM\MQSI`.
- **UNIX** For UNIX systems, the default workpath is `/var/mqsi`.

- **Linux** For Linux systems, the default workpath is `/var/mqsi`.

You have now added a code dependency.

Deploying JavaCompute node code

The Message Broker Toolkit handles the deploying of JavaCompute node code automatically. When you create a bar file and add the message flow, the Message Broker Toolkit packages the compiled Java code and its dependencies into the bar file.

JavaCompute node classloading

When you include one or more JavaCompute nodes in a broker archive (bar) file, the JAR files are loaded in a separate classloader. The classloader loads all classes that are packaged within the deployed bar. These classes override any classes that are in the shared classes directory or the CLASSPATH environment variable.

The broker uses the following classloader tree:

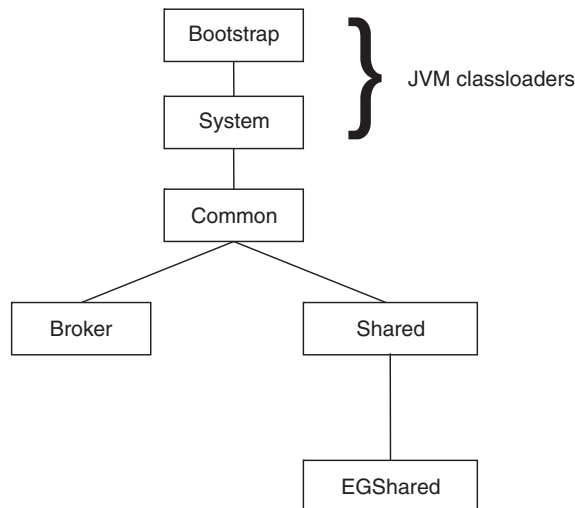

These components are in the classloader tree:

- **Common classloader:** loads the classes that are shared between the broker and user code. For example, the classes that are contained in `jplugin2.jar` are common to the broker and the user code.
- **Broker classloader:** loads the broker internal classes. These classes cannot be accessed by user classes.
- **Shared classloader :** loads classes from JAR files that have been placed in the `workpath/shared-classes/` directory, and from the CLASSPATH environment variable. These classes are available to all Java user-defined nodes and JavaCompute nodes within the broker.

The CLASSPATH environment variable can contain the wildcard character (*) at the end of a directory path specifier. The wildcard is expanded to include all files in that directory with the extension `.jar` or `.JAR`.

- **EGShared classloader:** loads all classes that are deployed to the execution group in the broker archive (bar) file, either by a JavaCompute node or an ESQL-to-Java mapping.

This is used to support the deployment mechanism for the JavaCompute node. Each time a BAR file is deployed, a new instance of the EGShared classloader is

created and the old instance is discarded. This action allows the JavaCompute node to reload modified versions of the same class without the need to restart the broker.

The broker uses the following search path to find JavaCompute node classes:

1. The deployed JAR file
2. <WorkPath>/shared-classes/ to locate any JAR files
3. The CLASSPATH environment variable

Writing Java

When you create a message flow, you include input nodes that receive messages and, optionally, output nodes that send out new or updated messages. If the processing that must be performed on the message requires it, you can include other nodes after the input node that are customized in Java to complete the actions that your applications need.

Some of the built-in nodes allow you to customize the processing that they provide. In a JavaCompute node, you can provide Java code that controls precisely the behavior of the node. This set of topics discusses how you can use Java to customize the JavaCompute node.

Using a JavaCompute node you can check and manipulate message content. You can:

- Read the contents of the input message
- Construct new output messages that are created from all, part, or none of the input message

Use the Debug perspective to debug a message flow that contains a JavaCompute node. When control passes to a JavaCompute node during debugging, the perspective opens the Java debugger, allowing you to step through the Java class code for the node.

This section provides more information about writing Java:

- Manipulating message body data
- Manipulating other parts of the message tree
- Accessing broker properties
- Accessing user-defined properties
- “Adding keywords to JAR files” on page 466
- Interacting with databases
- “Calling an Enterprise Java Bean” on page 470
- Handling exceptions
- Logging errors

Manipulating message body data using a JavaCompute node

The message body is always the last child of root, and its parser name identifies it, for example XML or MRM.

The following topics describe how to refer to, modify, and create message body data. The information provided here is domain independent:

- “Accessing elements in a message tree from a JavaCompute node” on page 455
- “Transforming a message using a JavaCompute node” on page 457

- “Creating a simple filter using a JavaCompute node” on page 459
- “Propagating a message to the JavaCompute node Out and Alternate terminals” on page 460
- “Extracting information from a message using XPath 1.0 and a JavaCompute node” on page 460

Accessing elements in a message tree from a JavaCompute node:

Access the contents of a message, for reading or writing, using the structure and arrangement of the elements in the tree that the parser creates from the input bit stream.

Follow the relevant parent and child relationships from the top of the tree downwards until you reach the required element.

The message tree is passed to a JavaCompute node as an argument of the evaluate method. The argument is an MbMessageAssembly object. MbMessageAssembly contains four message objects:

- Message
- Local Environment
- Global Environment
- Exception List

These objects are read-only, except for Global Environment. If you try to write to the read-only objects, an MbReadOnlyException is issued.

This topic contains the following information about accessing elements in a message tree:

- “Traversing the element tree”
- “Accessing information about an element” on page 456

Traversing the element tree:

The following table shows the Java methods that you can use to access element trees, and the equivalent ESQL field type constant for each point in the tree.

Java accessor from MbMessageAssembly	ESQL field type constant
getMessage().getRootElement()	InputRoot
getMessage().getRootElement().getLastChild()	InputBody
getLocalEnvironment().getRootElement()	InputLocalEnvironment
getGlobalEnvironment().getRootElement()	Environment
getExceptionList().getRootElement()	InputExceptionList

Use the following methods to traverse a message tree from an element of type MbElement:

getParent()

returns the parent of the current element

getPreviousSibling()

returns the previous sibling of the current element

getNextSibling()

returns the next sibling of the current element

getFirstChild()

returns the first child of the current element

getLastChild()

returns the last child of the current element

The following example shows a simple XML message and the logical tree that would be created from the message. The message has been sent using WebSphere MQ. The logical tree diagram also shows the methods to call in order to navigate around the tree.

```
<document>
  <chapter title='Introduction'>
    Some text
  </chapter>
</document>
```

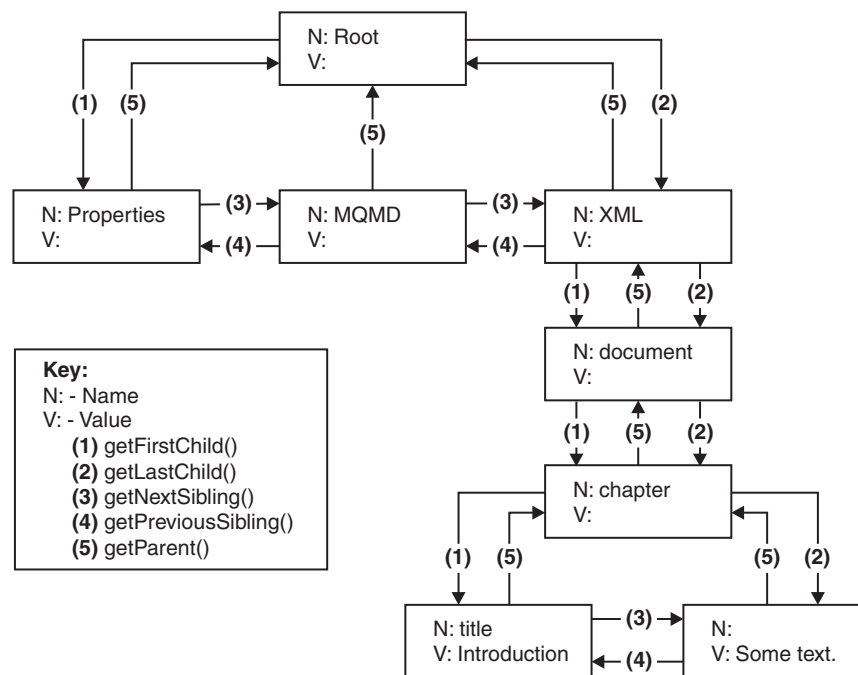

The following Java code accesses the chapter element in the logical tree for an XML message that does not contain white spaces. The XML parser retains white space in the parsed tree, but the XMLNS and XMLNSC parsers do not.

```
MbElement root = assembly.getMessage().getRootElement();
MbElement chapter = root.getLastChild().getFirstChild().getFirstChild();
```

Accessing information about an element:

Use the following methods to return information about the referenced element:

getName()

returns the element name as a java.lang.String

getValue()

returns the element value

getType()

returns the generic type, which is one of the following types:

- NAME: an element of this type has a name, but no value.

- VALUE: an element of this type has a value, but no name.
- NAME/VALUE: an element of this type has both a value and a name.

getSpecificType()

returns the parser-specific type of the element

getNamespace()

returns the namespace URI of this element

Transforming a message using a JavaCompute node: These topics describe how to transform messages using a JavaCompute node:

- “Creating a new message using a JavaCompute node”
- “Copying a message using a JavaCompute node”
- “Setting, copying, and moving message elements using a JavaCompute node” on page 458
- “Creating new elements using a JavaCompute node” on page 458

Creating a new message using a JavaCompute node:

Many message transformation scenarios require a new outgoing message to be built. The *Create Message Class* template in the JavaCompute node wizard generates template code for this.

In the template code, the default constructor of `MbMessage` is called to create a blank message, as shown in the following Java code:

```
MbMessage outMessage = new MbMessage();
```

The headers can be copied from the incoming message using the supplied utility method, `copyMessageHeaders()`, as shown in this Java code:

```
copyMessageHeaders(inMessage, outMessage);
```

The new message body can now be created. First, add the top level parser element. For XML, this is:

```
MbElement outRoot = outMessage.getRootElement();
MbElement outBody = outRoot.createElementAsLastChild(MbXMLNSC.PARSER_NAME);
```

The remainder of the message can then be built up using the `createElement` methods and the extended syntax of the broker XPath implementation.

When you wish to create a BLOB message, that is handled as a single byte string using the BLOB parser domain. The message data is added as a byte array to the single element named “BLOB” under the parser level element as described below:

```
String myMsg = "The Message Data";
MbElement outRoot = outMessage.getRootElement();
// Create the Broker Blob Parser element
MbElement outParser = outRoot.createElementAsLastChild(MbBLOB.PARSER_NAME);
// Create the BLOB element in the Blob parser domain with the required text
MbElement outBodyE12 = outParser.createElementAsLastChild(MbElement.TYPE_NAME_VALUE, "BLOB", myMsg.getBytes());
```

Copying a message using a JavaCompute node:

The incoming message and message assembly are read-only. In order to modify a message, a copy of the incoming message must be made. The *Modifying Message Class* template in the JavaCompute node wizard generates this copy. The following copy constructors are called:

```
MbMessage outMessage = new MbMessage(inAssembly.getMessage());
MbMessageAssembly outAssembly = new MbMessageAssembly(inAssembly, outMessage);
```

The new `outAssembly` object is propagated to the next node.

Setting, copying, and moving message elements using a JavaCompute node:

Transform elements in the message as it passes through a JavaCompute node in the message flow.

- “Setting information about an element”
- “Moving and copying elements”

The Java API reference information provides details about each of the methods used in the sections below.

Setting information about an element:

Use these methods to set information about the referenced element:

setName()

Sets the name of the element

setValue()

Sets the value of the element

setSpecificType()

Sets the parser-specific type of the element

setNamespace()

Sets the namespace URI of the element

Moving and copying elements:

Use a JavaCompute node to copy or detach an element from a message tree using the following methods:

detach()

The element is detached from its parent and siblings, but any child elements are left attached

copy() A copy of the element and its attached children is created

Use one of four methods to attach an element or subtree that you have copied on to another tree:

addAsFirstChild(*element*)

Adds an unattached element as the first child of *element*

addAsLastChild(*element*)

Adds an unattached element as the last child of *element*

addBefore(*element*)

Adds an unattached element as the previous sibling of *element*

addAfter(*element*)

Adds an unattached element as the next sibling of *element*

Creating new elements using a JavaCompute node:

Use the following methods in a JavaCompute node to create new elements in a message tree:

- createElementAsFirstChild()
- createElementAsLastChild()
- createElementBefore()
- createElementAfter()

The method returns a reference to the newly-created element. Each method has three overloaded forms:

createElement...(int type)

Creates a blank element of the specified type. Valid generic types are:

- MbElement.TYPE_NAME. This type of element has only a name, for example an XML element.
- MbElement.TYPE_VALUE. This type of element has only a value, for example XML text that is not contained within an XML element.
- MbElement.TYPE_NAME_VALUE. This type of element has both a name and a value, for example an XML attribute.

Specific type values can also be assigned. The meaning of this type information is dependent on the parser. Element name and value information must be assigned using the setName() and setValue() methods.

createElement...(int type, String name, Object value)

Method for setting the name and value of the element at creation time.

createElement...(String parserName)

A special form of createElement...() that is only used to create top-level parser elements.

This example Java code adds a new chapter element to the XML example given in “Accessing elements in a message tree from a JavaCompute node” on page 455:

```
MbElement root = outMessage.getRootElement();
MbElement document = root.getLastChild().getFirstChild();
MbElement chapter2 = document.createElementAsLastChild(MbElement.TYPE_NAME, "Chapter", null);

// add title attribute
MbElement title2 = chapter2.createElementAsFirstChild(MbElement.TYPE_NAME_VALUE,
    "title", "Message Flows");
```

This produces the following XML output:

```
<document>
  <chapter title="Introduction">
    Some text.
  </chapter>
  <chapter title="Message Flows"/>
</document>
```

Creating a simple filter using a JavaCompute node:

Before you start

To complete this task, you must have added a “JavaCompute node” on page 943 to your message flow.

The JavaCompute node has two output terminals, Out and Alternate. To use the JavaCompute node as a filter node, propagate a message to either the Out or Alternate terminal based on the message content. Use the JavaCompute node creation wizard to generate template code for a filter node:

Select the *Filtering Message Class* template in the JavaCompute node creation wizard to create a filter node.

The following template code is produced. It passes the input message to the Out terminal without doing any processing on the message.

```
public class jcn2 extends MbJavaComputeNode {

    public void evaluate(MbMessageAssembly assembly) throws MbException {
        MbOutputTerminal out = getOutputTerminal("out");
        MbOutputTerminal alt = getOutputTerminal("alternate");

        MbMessage message = assembly.getMessage();

        // -----
        // Add user code below

        // End of user code
        // -----

        // The following should only be changed
        // if not propagating message to the 'out' terminal

        out.propagate(assembly);
    }
}
```

The template produces a partial implementation of a method called evaluate(). The broker calls evaluate() once for each message that passes through the node. The parameter that is passed to evaluate() is the message assembly. The message assembly encapsulates the message that is passed on from the previous node in the message flow.

Add custom code to the template, and propagate messages to both the Out and Alternate terminals to create a message filter.

Propagating a message to the JavaCompute node Out and Alternate terminals:

The JavaCompute node has two output terminals, Out and Alternate. Therefore, you can use the node both as a filter node and as a message transformation node. After you have processed the message, propagate the message to an output terminal using a propagate() method. To propagate the message assembly to the Out terminal use the following method:

```
out.propagate(assembly);
```

To propagate the message assembly to the Alternate terminal, use the following method:

```
alt.propagate(assembly);
```

Extracting information from a message using XPath 1.0 and a JavaCompute node:

XPath is a query language designed for use with XML documents, but you can use it with any tree structure to query contents.

WebSphere Message Broker uses XPath to select elements from the logical message tree regardless of the format of the bit stream. The terminology used in this topic is based on the terminology used in the W3C definition of XPath 1.0. For more information about XPath, see "Using XPath" on page 411; and for more

information about the W3C definition of the XPath 1.0 standard, see XPath. For examples of XPath use, see the MbXPath topic in the Java user-defined node API documentation.

This topic contains the following information:

- “Using the evaluateXPath method to extract message information”
- “XPath variable binding”
- “XPath namespace support”
- “Updating a message using XPath extensions” on page 462

Using the evaluateXPath method to extract message information

The evaluateXPath() method is included in the Java user-defined node API. It supports XPath 1.0, with the following exceptions:

- Namespace axis and namespace node type. The namespace axis returns the actual XML namespace declaration nodes for a particular element. You can therefore manipulate XML prefix or URI declarations within an XPath expression. This axis returns an empty node set for bit streams that are not XML.
- If you use the id() function it throws an MbRecoverableException.

The evaluateXPath() method can be called on a MbMessage object (for absolute paths), or on a MbElement object (for relative paths). The XPath expression is passed to the method as a string parameter. A second form of this method is provided that takes an MbXPath object. This object encapsulates an XPath expression along with variable bindings and namespace mappings, if these are required.

The evaluateXPath() method returns an object of one of these four types, depending on the expression return type:

- java.lang.Boolean, representing the XPath Boolean type
- java.lang.Double, representing the XPath number type
- java.lang.String, representing the XPath string type
- java.util.List, representing the XPath node set. The List interface represents an ordered sequence of objects, in this case MbElements. It allows direct access to the elements, or the ability to get an Iterator or an MbElement array.

XPath variable binding

XPath 1.0 supports the ability to refer to variables that have been assigned before the expression that contains them is evaluated. The MbXPath class has three methods for assigning and removing these variable bindings from user Java code. The value must be one of the four XPath 1.0 supported types:

- Boolean
- node set
- number
- string

XPath namespace support

For XML messages, namespaces are referred to using a mapping from an abbreviated namespace prefix to the full namespace URI, as shown in the following XML example:

```

<ns1:aaa xmlns:ns1='http://mydomain.com/namespace1'
          xmlns:ns2='http://mydomain.com/namespace2'>
  <ns2:aaa>
    <ns1:bbb/>
  </ns2:aaa>
</ns1:aaa>

```

The namespace prefix is convenient for representing the namespace, but is meaningful only within the document that defines that mapping. The namespace URI defines the global meaning. Also, the concept of a namespace prefix is not meaningful for documents that are generated in a message flow, because a namespace URI can be assigned to a syntax element without an XMLNS mapping having been defined.

For this reason, the XMLNSC and MRM parsers expose only the namespace URI to the broker and to user code (ESQL or user-defined code). Using ESQL, you can set up your own mappings to create abbreviations to these potentially long URIs. These mappings are not related in any way to the prefixes that are defined in the XML document (although they can be the same name).

Using the XPath processor you can map namespace abbreviations on to URIs that are expanded at evaluation time. The MbXPath class contains methods to assign and remove these namespace mappings. The XML example can be addressed using the following code:

```

MbMessage msg = assembly.getMessage();
List chapters= (List)msg.evaluateXPath("/document/chapter");
// this returns a list of all chapters in the document (length 1)

MbElement chapter = (MbElement)chapters.get(0); // the first one

// values can also be extracted directly using XPath
String title = (String)msg.evaluateXPath("string(/document/chapter/@title)");
String chapterText = (String)msg.evaluateXPath("string(/document/chapter/text())");

```

Updating a message using XPath extensions

The XPath implementation in WebSphere Message Broker provides the following extra functions for modifying the message tree:

set-local-name(object)

Sets the local part of the expanded name of the context node to the value specified in the argument. *object* can be any valid expression, and is converted to a string as if a call to the string function is used.

set-namespace-uri(object)

Sets the namespace URI part of the expanded name of the context node to the value specified in the argument. *object* can be any valid expression, and is converted to a string as if a call to the string function is used.

set-value(object)

This function sets the string value of the context node to the value specified in the argument. *object* can be any valid expression, and is converted to a string as if a call to the string function is used.

To allow for syntax element trees to be built as well as modified, the following axis is available in addition to the 13 that are defined in the XPath 1.0 specification:

select-or-create::name or ?name

?name is equivalent to select-or-create::name. If name is @name, an attribute

is created or selected. This selects child nodes matching the specified name, or creates new nodes according to the following rules:

- `?name` selects children called `name` if they exist. If a child called `name` does not exist, `?name` creates it as the last child, then selects it.
- `?$name` creates `name` as the last child, then selects it.
- `?^name` creates `name` as the first child, then selects it.
- `?>name` creates `name` as the next sibling, then selects it.
- `?<name` creates `name` as the previous sibling, then selects it.

Manipulating other parts of the message tree using a JavaCompute node

The following topics describe how to access parts of the message tree other than the message body data. These parts of the logical tree are independent of the domain in which the message exists, and all these topics apply to messages in all supported domains, including the BLOB domain. You can access all parts of the message tree using a JavaCompute node, including the Properties tree described in “Message tree structure” on page 61, and the ExceptionList tree. Elements of the message tree can be accessed in the same way as the message body data, using a JavaCompute node.

- “Accessing headers using a JavaCompute node”
- “Updating the LocalEnvironment with the JavaCompute node” on page 464
- “Updating the Global Environment with the JavaCompute node” on page 465

Accessing headers using a JavaCompute node:

If an input node receives an input message that includes message headers that the input node recognizes, the node invokes the correct parser for each header. Parsers are supplied for most WebSphere MQ headers. The topics listed below provide guidance for accessing the information in the MQMD and MQRFH2 headers that you can follow when accessing other headers that are present in your messages.

- “Copying message headers using a JavaCompute node”
- “Accessing the MQMD header using a JavaCompute node”
- “Accessing the MQRFH2 header using a JavaCompute node” on page 464

For further details of the contents of these and other WebSphere MQ headers for which WebSphere Message Broker provides a parser, see “Element definitions for message parsers” on page 1399.

Copying message headers using a JavaCompute node: The *Modifying Message Class* template in the JavaCompute node wizard generates the following code to copy message headers using a JavaCompute node:

```
public void copyMessageHeaders(MbMessage inMessage, MbMessage outMessage) throws MbException
{
    MbElement outRoot = outMessage.getRootElement();
    MbElement header = inMessage.getRootElement().getFirstChild();

    while(header != null && header.getNextSibling() != null)
    {
        outRoot.addAsLastChild(header.copy());
        header = header.getNextSibling();
    }
}
```

Accessing the MQMD header using a JavaCompute node:

WebSphere MQ, WebSphere MQ Everywhere, and SCADA messages include an MQMD header. You can use a JavaCompute node to refer to the fields within the MQMD, and to update them.

The following Java code shows how to add an MQMD header to your message:

```
public void addMqmd(MbMessage msg) throws MbException
{
    MbElement root = msg.getRootElement();

    // create a top level 'parser' element with parser class name
    MbElement mqmd = root.createElementAsFirstChild("MQHMD");

    // specify next parser in chain
    mqmd.createElementAsFirstChild(MbElement.TYPE_NAME_VALUE,
        "Format",
        "XMLNS");
}
```

Accessing the MQRFH2 header using a JavaCompute node:

When you construct MQRFH2 headers in a JavaCompute node, there are two types of field:

- Fields in the MQRFH2 header structure (for example, Format and NameValueCCSID)
- Fields in the MQRFH2 NameValue buffer (for example mcd and psc)

The following code adds an MQRFH2 header to an outgoing message that is to be used to make a subscription request:

```
public void addRfh2(MbMessage msg) throws MbException
{
    MbElement root = msg.getRootElement();
    MbElement body = root.getLastChild();

    // insert new header before the message body
    MbElement rfh2 = body.createElementBefore("MQHRF2");

    rfh2.createElementAsFirstChild(MbElement.TYPE_NAME_VALUE, "Version", new Integer(2));
    rfh2.createElementAsFirstChild(MbElement.TYPE_NAME_VALUE, "Format", "MQSTR");
    rfh2.createElementAsFirstChild(MbElement.TYPE_NAME_VALUE, "NameValueCCSID", new Integer(1208));

    MbElement psc = rfh2.createElementAsFirstChild(MbElement.TYPE_NAME, "psc", null);
    psc.createElementAsFirstChild(MbElement.TYPE_NAME, "Command", "RegSub");
    psc.createElementAsFirstChild(MbElement.TYPE_NAME, "Topic", "department");
    psc.createElementAsFirstChild(MbElement.TYPE_NAME, "QMgrName", "QM1");
    psc.createElementAsFirstChild(MbElement.TYPE_NAME, "QName", "PUBOUT");
    psc.createElementAsFirstChild(MbElement.TYPE_NAME, "RegOpt", "PersAsPub");

    MbXPath xp = new MbXPath("/MQMD/Format" + "[set-value('MQHRF2')]", root);
    root.evaluateXPath(xp);
}
```

Updating the LocalEnvironment with the JavaCompute node:

The LocalEnvironment tree is part of the logical message tree in which you can store information while the message flow processes the message.

The following information shows how to update the LocalEnvironment:

1. Make a new copy of the local environment to update it. Use the full version of the copy constructor to create a new MbMessageAssembly object, as shown in the following example:

```

MbMessage env = assembly.getLocalEnvironment();
MbMessage newEnv = new MbMessage(env);

newEnv.getRootElement().createElementAsFirstChild(
    MbElement.TYPE_NAME_VALUE,
    "Status",
    "Success");

MbMessageAssembly outAssembly = new MbMessageAssembly(
    assembly,
    newEnv,
    assembly.getExceptionList(),
    assembly.getMessage());

getOutputTerminal("out").propagate(outAssembly);

```

2. Edit the copy to update the LocalEnvironment.

Updating the Global Environment with the JavaCompute node:

The Global Environment tree is always created when the logical tree is created for an input message. However, the message flow neither populates it nor uses its contents. You can use this tree for your own purposes, for example to pass information from one node to another. You can use the whole tree as a scratchpad or working area.

The Global Environment can be altered across the message flow, therefore do not make a copy of it to alter. The following Java code shows how to alter the Global Environment:

```

MbMessage env = assembly.getGlobalEnvironment();
env.getRootElement().createElementAsFirstChild(MbElement.TYPE_NAME_VALUE, "Status", "Success");

getOutputTerminal("out").propagate(assembly);

```

Accessing broker properties from the JavaCompute node

For each broker, WebSphere Message Broker maintains a set of properties. You can access some of these properties from your Java programs. It can be useful, during the run time of your code, to have real-time access to details of a specific node, flow, or broker.

There are four categories of broker property:

- Those relating to a specific node
- Those relating to nodes in general
- Those relating to a message flow
- Those relating to the execution group

“Broker properties that are accessible from ESQL and Java” on page 1663 includes a table that shows the groups of properties that are accessible from Java. The table also indicates if the properties are accessible from ESQL.

Broker properties:

- Are grouped by broker, execution group, flow, and node.
- Are case sensitive. Their names always start with an uppercase letter.
- Return NULL if they do not contain a value.

To access broker properties in a JavaCompute node, call methods on the following classes:

- MbBroker
- MbExecutionGroup
- MbMessageFlow
- MbNode

For example:

```
String brokerName = getBroker().getName();
```

Accessing user-defined properties from a JavaCompute node

Customize a JavaCompute node to access properties that you have associated with the message flow in which the node is included.

To access these properties from a JavaCompute node, use the `getUserDefinedAttribute(name)` method, where *name* is the name of the property that you are accessing. The type of the object that is returned depends on the type of the property that you are accessing. The object has one of a set of types:

- MbDate
- MbTime
- MbTimestamp
- Boolean
- byte[]
- String
- Integer 32-bit values
- Long 64-bit values
- Double
- BigDecimal
- BitSet

You can use the Configuration Manager Proxy (CMP) API to change the value of user-defined properties. Use the `getUserDefinedPropertyNames()`, `getUserDefinedProperty()`, and `setUserDefinedProperty()` methods to query, discover, and set user-defined properties, as described in Setting user-defined properties dynamically at run time.

Adding keywords to JAR files

If a bar file contains JAR files, you can associate keywords with the JAR files.

1. Add a file called META-INF/keywords.txt to the root of the JAR file.
2. Add your keywords to the META-INF/keywords.txt file, because this file is parsed for keywords when it is deployed. Keywords have this format:

```
$MQSI keyword = value MQSI$
```

For example, a deployed bar file contains *compute.jar*, and *compute.jar* contains the file META-INF/keywords.txt with the following contents:

```
# META-INF/keywords.txt
$MQSI modified date = 3 Nov MQSI$
$MQSI author = john MQSI$
```

This content means that the keywords “modified date” and “author” are associated with the deployed file *compute.jar* in the Configuration Manager Proxy and in the Message Broker Toolkit.

You have now added keywords to your JAR file.

Next:

When you have added keywords to your JAR file, you can see this information in the bar file editor.

Interacting with databases using the JavaCompute node

Access databases from Java code included in the JavaCompute node.

Choose from the following options for database interaction:

- Broker JDBCProvider for type 4 connections
- MbSQLStatement
- JDBC API in an unmanaged environment
- SQLJ

If you use JDBCProvider for type 4 connections or MbSQLStatement, the databases that you access can participate in globally coordinated transactions. In all other cases, database access cannot be globally coordinated.

Broker JDBCProvider for type 4 connections:

You can establish JDBC type 4 connections to interact with databases from your JavaCompute nodes. The broker supports type 4 drivers, but does not supply them. You must obtain these drivers from your database vendor; for information about supported drivers, see Supported databases.

Use the broker JDBCProvider for type 4 connections to benefit from the following advantages:

- Use broker configuration facilities to define the connection, and to provide optional security, in preference to coding these actions.
- Configure the broker and the databases to coordinate access and updates with other resources that you access from your message flows, except when the broker is running on z/OS.
- Use the broker Java API `getJDBCTyp4Connection` to initiate the connection, and then perform SQL operations using the standard JDBC APIs. The broker manages the connections, thread affinity, connection pooling, and life cycle. If a connection is idle for approximately one minute, or if the message flow completes, the broker closes the connection.

If the broker is running on a distributed system, you can configure the databases and the connections to be coordinated with other resource activity. Global coordination on distributed systems is provided by WebSphere MQ, and can include interactions with local or remote databases, including remote databases that are defined on z/OS systems. If you establish a JDBC type 4 connection to a database from a broker that is running on z/OS, coordination is not provided. For information about setting up connections and coordination, see Enabling JDBC connections to the databases.

Before you can include this function in the code that you write for the node, you must configure the required environment. Decide whether your database requires security of access, and whether you want the database updates to participate in globally coordinated transactions. For the required and optional tasks, see Enabling JDBC connections to the databases.

When you have configured the JDBCProvider, you can establish a JDBC type 4 connection to the database using the getJDBCType4Connection call on the MbNode interface. The following code provides an example of its use:

```

public class MyJavaCompute extends MbJavaComputeNode {
{
    public void evaluate(MbMessageAssembly inAssembly) throws MbException {
        MbOutputTerminal out = getOutputTerminal("out");
        MbMessage inMessage = inAssembly.getMessage();

        // create new message
        MbMessage outMessage = new MbMessage(inMessage);
        MbMessageAssembly outAssembly = new MbMessageAssembly(inAssembly,outMessage);

        try {
            // Obtain a java.sql.Connection using a JDBC Type4 datasource - in this example for a
            // JDBC broker configurable service called "MyDB2"

            Connection conn = getJDBCType4Connection("MyDB2",JDBC_TransactionType.MB_TRANSACTION_AUTO);

            // Example of using the Connection to create a java.sql.Statement
            Statement stmt = conn.createStatement(
                ResultSet.TYPE_SCROLL_INSENSITIVE,
                ResultSet.CONCUR_READ_ONLY);
            ResultSet srs0 = stmt.executeQuery(
                "SELECT NAME, CITY FROM MySchema.MyTable");

            stmt.executeUpdate("UPDATE MySchema.MyTable SET CITY = \"Springfield\" WHERE Name = \"Bart\"");
            // Perform other database updates

        } catch (SQLException sqx ){
            sqx.printStackTrace();
        } finally {
            // clear the outMessage
            outMessage.clearMessage();
        }
    }
}

```

In this example:

- *MyDB2* is the name of the JDBCProvider configurable service. Use the name of the service that you have created to connect to your database.
- *MySchema* is the name of the database schema (not the name of the database).
- MB_TRANSACTION_AUTO defines the level of transaction coordination that is required by the node. Only this value is supported, and indicates that the coordination in the node is inherited from that configured at message flow level.

Because the broker is managing the connections, your code must comply with the following restrictions:

- Do not include any code that performs a COMMIT or a ROLLBACK function.
- Do not close the connection to the database.

Return a code that indicates success or failure of the actions taken by the node when control is returned.

MbSQLStatement:

The MbSQLStatement class provides full transactional database access using ESQL and ODBC. The broker resource manager coordinates database access when using

MbSQLStatement. Global coordination is provided by WebSphere MQ on distributed platforms, and by RRS on z/OS. For information about how to set up the ODBC resources that are required, see Enabling ODBC connections to the databases.

Create instances of the MbSQLStatement class using the createSQLStatement() method of MbNode, passing to the method the ODBC data source, a broker EQSL statement, and, optionally, the transaction mode.

- Calling select() on this object returns the results of the query.
- Calling execute() on this object executes a query where no results are returned, such as updating a table.

The following Java code shows how to access a database using MbSQLStatement:

```
MbMessage newMsg = new MbMessage(assembly.getMessage());
MbMessageAssembly newAssembly = new MbMessageAssembly(assembly, newMsg);

String table = "dbTable";

MbSQLStatement state = createSQLStatement( "dbName",
    "SET OutputRoot.XMLNS.integer[] = PASSTHRU('SELECT * FROM " + table + "');" );

state.setThrowExceptionOnDatabaseError(false);
state.setTreatWarningsAsErrors(true);
state.select( assembly, newAssembly );

int sqlCode = state.getSQLCode();
if(sqlCode != 0)
{
    // Do error handling here
}

getOutputTerminal("out").propagate(assembly);
```

JDBC API in an unmanaged environment:

You can access standard Java APIs in the code that you write for your JavaCompute nodes, including JDBC calls. You can therefore use JDBC APIs to connect to a database, write to or read from the database, and disconnect from the database. The broker allows your JDBC connection code to invoke both type 2 and type 4 JDBC drivers in this environment, but does not supply them. You must obtain these drivers from your database vendor.

If you choose this method to access databases, the broker does not provide any support for managing the transactions; your code must manage the local commit and rollback of database changes. Your code must also manage the connection life cycle, connection thread affinity, and connection pooling. You must also monitor the access to databases when you use this technique to ensure that these connections do not cause any interference with connections made by the broker. In particular, be aware that type 2 drivers bridge to an ODBC connection that might be in use in message flows that access databases from ESQJL.

SQLJ:

SQLJ is a Java extension that you can use to embed static SQL statements within Java code. Create SQLJ files using the workbench. The broker resource manager does not coordinate database access when using SQLJ.

1. Enable SQLJ capability in the workbench:
 - a. Switch to the Broker Application Development perspective.
 - b. Select **Window** → **Preferences**.

- c. Expand **Workbench**.
 - d. Select **Capabilities**.
 - e. Expand **Database Developer**.
 - f. Select **SQLJ Development**.
 - g. Click **OK**.
2. Create a new SQLJ file within a Java project:
 - a. Right-click the *Java project* in which you want to create the file.
 - b. Select **New** → **Other**.
 - c. Expand **Data**.
 - d. Expand **SQLJ**.
 - e. Select **SQLJ File**.
 - f. Click **Next**.
 - g. Follow the directions given by the New SQLJ File wizard to generate the SQLJ file.

You can now reference the class in this SQLJ file from a JavaCompute node class in this project or in another referenced project.

Calling an Enterprise Java Bean

You can call an Enterprise Java Bean (EJB) from a JavaCompute node.

Before you start:

- Ensure that all required Java classes are in WebSphere Message Broker's shared-classes directory, or are referenced in the CLASSPATH environment variable. You can use the wildcard character (*) at the end of a directory path specifier to load all JARs in that directory path.
- Ensure that the user JAR files that are needed for EJB access are referenced in CLASSPATH. For more information, see the documentation for the application server that is hosting the EJB.
- If you are using a version of WebSphere Message Broker before Version 6.0 Fix Pack 3, you must set the context loader by including the following statement in the node's Java code before the InitialContext is set:

```
Thread.currentThread().setContextClassLoader(this.getClass().getClassLoader());
```

The following example shows how to call an EJB from a JavaCompute node:

```
public class CallAckNoAckEJB_JavaCompute extends MbJavaComputeNode {

    public void evaluate(MbMessageAssembly inAssembly) throws MbException {
        MbOutputTerminal out = getOutputTerminal("out");
        MbOutputTerminal alt = getOutputTerminal("alternate");

        MbMessage inMessage = inAssembly.getMessage();

        // create new message
        MbMessage outMessage = new MbMessage(inMessage);
        MbMessageAssembly outAssembly = new MbMessageAssembly(inAssembly,outMessage);

        try {
            // -----
            // Add user code below

            String response = null;
            String responseMessage = null;

            Properties properties = new Properties();
```

```

        properties.put(Context.PROVIDER_URL, "iiop://localhost:2809");
        properties.put(Context.INITIAL_CONTEXT_FACTORY, "com.ibm.websphere.naming.
WsnInitialContextFactory");

        try {

            Context initialContext = new InitialContext(properties);
            Object obj = initialContext.lookup("ejb/com/acme/ejbs/AckNoAckHome");
            AckNoAckHome ejbHome = (AckNoAckHome)javax.rmi.PortableRemoteObject.
narrow(obj,AckNoAckHome.class);

            AckNoAck ackNoAck = ejbHome.create();
            responseMessage = ackNoAck.getAck();
            response = "Ack";
        } catch(Exception e) {
            responseMessage = e.getMessage();
            response = "NoAck";
        }

        MbElement cursor = outMessage.getRootElement().getFirstElementByPath("/XML/AckNoAck");
        cursor.createElementAsLastChild(MbElement.TYPE_NAME,"Response",null);
        cursor.getLastChild().createElementAsLastChild(MbElement.TYPE_NAME,response,null);
        cursor.getLastChild().getLastChild().createElementAsLastChild(MbElement.TYPE_VALUE,null,
responseMessage);

        // End of user code
        // -----

        // The following should only be changed
        // if not propagating message to the 'out' terminal
        out.propagate(outAssembly);

    } finally {
        // clear the outMessage
        outMessage.clearMessage();
    }
}
}
}

```

JavaCompute node Exception handling and the Failure terminal

You do not need to catch exceptions that are thrown in a JavaCompute node. The broker handles exceptions automatically. If you catch an exception in your code, throw it again, allowing the broker to construct an exception list and propagate the message to the failure terminal, if one is connected. If you have not connected the failure terminal, the exception is thrown back to a Catch node or an input node.

Logging errors with the JavaCompute node

The MbService class contains a number of static methods for writing to the event log or syslog. Define message catalogs using Java resource bundles to store the message text.

Three levels of severity are supported:

- Information
- Warning
- Error

The following sample demonstrates the use of resource bundles and logging:

- JavaCompute Node sample

You can view samples only when you use the information center that is integrated with the Message Broker Toolkit.

Developing message mappings

Message mappings define the blueprint for creating a message. The topics in this section describe message mappings and explain how to develop them.

Concept topics:

- “Message mappings overview” on page 473
- “Message flows, ESQL, and mappings” on page 49
- “Advanced schema structures” on page 475

Task topics:

- “Creating message mappings” on page 476
- “Creating a message map file in the Broker Development view” on page 476
- “Creating a message map file from a Mapping node” on page 477
- “Configuring message mappings” on page 478
- “Mapping from source: by selection” on page 480
- “Mapping from source: by name” on page 480
- “Mapping a target element from source message elements” on page 481
- “Setting the value of a target element to a constant” on page 483
- “Setting the value of a target element to a WebSphere MQ constant” on page 483
- “Setting the value of a target element using an expression or function” on page 485
- “Deleting a source or target element” on page 486
- “Configuring conditional mappings” on page 487
- “Configuring mappings for repeating elements” on page 488
- “Populating a message map” on page 489
- “Configuring the LocalEnvironment” on page 490
- “Mapping headers and folders” on page 490
- “Adding messages or message components to the source or target” on page 492
- “Adding a database as a source or target” on page 492
- “Modifying databases using message mappings” on page 494
- “Creating and calling submaps and subroutines” on page 502
- “Transforming a SOAP request message” on page 510
- “Editing a default-generated map manually” on page 511
- “Message mapping tips and restrictions” on page 512
- “Message mapping scenarios” on page 515

There is also a section of topics that contain reference information about message mapping:

- “Message mappings” on page 1410
- “Message Mapping editor” on page 1410
- “Mapping node” on page 1420
- “Migrating message mappings from Version 5.0” on page 1428

Message mappings overview

Message mappings define the blueprint for creating a message, where the created message is known as the target message. Messages can contain the following components:

- simple elements and attributes
- complex elements (structures)
- repeating simple or complex elements
- other (embedded) messages

Messages can contain protocol-specific headers, which might need to be manipulated by WebSphere Message Broker. Dynamic setting of a message destination (routing) within the WebSphere Message Broker might also be required. Values for target message elements can be derived from:

- input message elements (the input message is also known as the source message)
- database tables
- constant values
- WebSphere MQ constants
- functions supplied by the Mapping node
- user-defined functions

The logic to derive values can be simple or complex; conditional statements might be needed, as might loops, summations and other functions. All of the above mappings can be achieved using a Mapping node.

You can also create a reusable form of message map known as a submap. Submaps can be called from message maps and ESQL code.

You must have message definitions for any messages that you want to include in a message mapping. You can select the messages from your existing message definitions when you create a new message map. The Mapping node supports the following message domains:

MRM
XMLNSC
XMLNS
MIME
JMSMap
JMSStream
XML
BLOB

If you use an unsupported parser to perform mappings, for example IDOC or a user-defined parser, error messages might be generated when messages pass through your message flow. See “Change the target message domain” on page 512 for information about setting the message domain for the target message.

Find out more about message flows, ESQL, and mappings.

This section also contains information about “Advanced schema structures” on page 475.

Message flows, ESQL, and mappings

A message flow represents the set of actions performed on a message when it is received and processed by a broker. The content and behavior of a message flow is defined by a set of files that you create when you complete your definition and configuration of the message flow content and structure:

- The message flow definition file <message_flow_name>.msgflow. This is a required file and is created automatically for you. It contains details about the message flow characteristics and contents (for example, what nodes it includes, its promoted properties, and so on).
- The ESQL resources file <message_flow_name>.esql. This file is required only if your message flow includes one or more of the nodes that must be customized using ESQL modules. You can create this file yourself, or you can cause it to be created for you by requesting specific actions against a node.

You can customize the following built-in nodes by creating free-form ESQL statements that use the built-in ESQL statements and functions, and your own user-defined functions:

- Compute
- Database
- Filter

- The message mappings file <message_flow_name><_nodename>.msgmap. This file is required only if your message flow contains one or more of the nodes that must be customized using mappings. You can create this file yourself, or you can cause it to be created for you by requesting specific actions against a node. A different file is required for each node in the message flow that uses the Message Mapping editor.

You can customize the following built-in nodes by specifying how input values map to output values:

Node	Usage
“DataDelete node” on page 866	Use this node to delete one or more rows from a database table without creating an output message.
“DataInsert node” on page 869	Use this node to insert one or more rows in a database table without creating an output message.
“DataUpdate node” on page 872	Use this node to update one or more rows in a database table without creating an output message.
“Extract node” on page 884	Use this node to create a new output message that contains a subset of the contents of the input message. Use the Extract node only if no database is involved in the map. The Extract node is deprecated in WebSphere Message Broker Version 6.0. Although message flows that contain an Extract node remain valid in WebSphere Message Broker Version 6.0, where possible, redesign your message flows so that any Extract node is replaced by a Mapping node.
“Mapping node” on page 978	Use this node to construct output messages and populate them with information that is new, modified from the input message, or taken from a database. You can also use the Mapping node to update, insert or delete rows in a database table.
“Warehouse node” on page 1213	Use this node to store all or part of a message in a database table without creating an output message.

You can use built-in ESQL functions and statements to define message mappings, and you can use your own ESQL functions.

Advanced schema structures

This section contains information about the following subjects:

- “Substitution groups”
- “Wildcards”
- “Derived types”
- “List types”
- “Union types” on page 476

Substitution groups: A substitution group is an XML Schema feature that provides a means of substituting one element for another in an XML message. The element that can be substituted is called the *head* element, and the substitution group is the list of elements that can be used in its place.

The head element and any mapped substitutions are shown by default in the Source and Target panes of the Message Mapping editor. The mapped substitutions are listed beneath the head element. You can show and hide the substituting elements displayed in the Source and Target panes by selecting **Show Substituting Elements**. You create mappings to or from members of substitution groups in the same way as you would map other elements.

An abstract head element of a substitution group is not displayed and when substitution is blocked, the substitution group folder is not displayed.

Wildcards: Any mapping that you perform to or from a wildcard results in a submap call. Specify the wildcard replacement when you choose the parameter of a submap call.

A wildcard element or attribute can be instantiated only with another element or attribute. The Message Mapping editor allows only a global element or attribute as a wildcard replacement.

Derived types: For an element of a given type, the base type and the mapped derived types are shown by default in the Source and Target panes of the Message Mapping editor. All attributes and elements of the base and derived types are listed under each type respectively. You can show and hide the derived types displayed in the Source and Target panes by selecting **Show Derived Types**.

You create mappings to or from a derived type and its contents in the same way that you would map any type or type content. When you map a derived type element, the Message Mapping editor generates ESQL code with the appropriate `xsi:type` attribute.

List types: A list type is a way of rendering a repeating simple value. The notation is more compact than the notation for a repeating element and provides a way to have multi-valued attributes.

You map list type attributes or elements in the same way that you would map any other simple type attribute or element. Mapping between two list type elements is the same as mapping between any two simple type elements.

To transform between a list type and a non-list type, such as a repeating element, write an ESQL function, then package the function as a map. The Message Mapping editor automatically selects this submap as the default transformation for the list type.

Union types: A union type is the same as a union of two or more other simple types and it allows a value to conform to any one of several different simple types.

Use the Message Mapping editor to create mappings to or from union type attributes or elements in the same way as you would map atomic simple type attributes or elements, as demonstrated in the following diagram:

```
<xsd:simpleType name="zipUnion">
  <xsd:union memberTypes="USState listOfMyIntType"/>
</xsd:simpleType>
<xsd:element name=zip type=zipUnion/>
```

Creating message mappings

The topics in this section describe how to create message mappings. Most actions can be achieved either by using the menu bar, or by right-clicking and choosing an action from a drop-down menu. For consistency, the following topics describe the menu bar method.

- “Creating a message map file in the Broker Development view”
- “Creating a message map file from a Mapping node” on page 477
- “Configuring message mappings” on page 478
- “Mapping from source: by selection” on page 480
- “Mapping from source: by name” on page 480
- “Mapping a target element from source message elements” on page 481
- “Setting the value of a target element to a constant” on page 483
- “Setting the value of a target element to a WebSphere MQ constant” on page 483
- “Setting the value of a target element using an expression or function” on page 485
- “Creating a BLOB output message using a message map” on page 485
- “Mapping from a BLOB message to an output message” on page 486
- “Deleting a source or target element” on page 486
- “Configuring conditional mappings” on page 487
- “Configuring mappings for repeating elements” on page 488
- “Populating a message map” on page 489
- “Configuring the LocalEnvironment” on page 490
- “Mapping headers and folders” on page 490
- “Adding messages or message components to the source or target” on page 492
- “Adding a database as a source or target” on page 492
- “Modifying databases using message mappings” on page 494
- “Creating and calling submaps and subroutines” on page 502
- “Transforming a SOAP request message” on page 510
- “Editing a default-generated map manually” on page 511

Creating a message map file in the Broker Development view

You can create a message map file for use in your message flows in the Broker Development view. If you want to add a database to your message map file, you must have created a database definition for the database.

To create a message map (.msgmap) file in the Broker Development view:

1. From the Broker Application Development perspective, click **File** → **New** → **Message Map**.

Alternatively, in the Broker Development view, right-click the message flow project that you want to create the message map in and click **New** → **Message Map**.

The New Message Map wizard opens.

2. Specify the Project, Name and Schema for the message map. The project list is filtered to only show projects in the active working set.
3. Follow the on-screen instructions to complete the New Message Map wizard:
 - a. On the Select map kind and its source and target pane, select the type of map you want to create.
 - If you select the option **Message map called by a message flow node**, a message map is created that can be accessed from a node. Properties are associated with any source or target messages, and you can select to include message headers and the LocalEnvironment with the message body.
 - If you select the option **Submap called by another map**, a message map is created that can be referenced from another message map. This is known as a submap and can contain components of a message body such as global elements, global attributes, and global types. A submap does not contain Properties, message headers or the LocalEnvironment.
 - b. Select the combination of Messages, Message Components or Data Sources that you want to use as sources for your map from **Select map sources** and select the combination of Messages, Message Components or Data Targets that you want to use as targets for your map from **Select map targets**. Messages and data targets are filtered to only show artifacts from the active working set.

If you cannot find the Messages, Message Components, Data Sources or Data Targets that you expect, select the **Show all resources in workspace** check box.
4. Select **Finish** to create the new message map. The “Message Mapping editor” on page 1410 opens with the selected sources and targets.

After you have created a message map file, configure the message mappings. You must also configure the **Mapping routine** property on your mapping node to match the name of your new mapping file.

Creating a message map file from a Mapping node

You can use a Mapping node to create a message map with messages and databases as both sources and targets.

Before creating a message map file, ensure you complete the following tasks:

1. “Creating a message flow project” on page 215
2. “Creating a message flow” on page 218
3. Define message flow content that includes a Mapping node, see “Defining message flow content” on page 227.

To create a message map (.msgmap) file from a Mapping node:

1. Open your message flow from the Broker Application Development perspective.
2. Double-click the Mapping node, or right-click the Mapping node and click **Open Map**. The New Message Map for Mapping Node wizard opens.

3. Select the combination of Messages, Data Sources, or both, that you want to use as sources for your map from Select map sources. Select the combination of Messages, Data Targets, or both, that you want to use as targets for your map from Select map targets.

If you cannot find the Messages, Data Sources or Data Targets that you expect, select the **Show all resources in workspace** check box.

4. Click **OK** to create the new message map. The Message Mapping editor opens with the selected sources and targets, for more information see “Message Mapping editor” on page 1410.

After you have created a message map file, you can configure the message mappings, see “Configuring message mappings.”

Configuring message mappings

Use the Message Mapping editor to configure a message mapping. The editor provides the ability to set values for:

- Message destination
- Message content
- Message headers

See the “Mapping node” on page 978 topic for more information about how to set the properties of a Mapping node.

Wizards and dialog boxes are provided for tasks such as adding mappable elements and working with submaps. Mappings that are created with the Message Mapping editor are validated and compiled automatically, ready to be added to a broker archive (bar) file, and for subsequent deployment to WebSphere Message Broker.

Use the Message Mapping editor to perform the following tasks.

Common tasks:

- “Mapping a target element from source message elements” on page 481
- “Mapping a target element from database tables” on page 498
- “Setting the value of a target element to a constant” on page 483
- “Setting the value of a target element using an expression or function” on page 485
- “Configuring conditional mappings” on page 487
- “Configuring mappings for repeating elements” on page 488

Message destination tasks: You might choose to map a destination so that the destination can be set dynamically; to do this, set values in `LocalEnvironment.Destination`. You can also retrieve information after a message has been sent, by accessing information in `LocalEnvironment.WrittenDestination`.

- “Configuring the LocalEnvironment” on page 490
- “Mapping headers and folders” on page 490

Message content tasks:

- “Adding messages or message components to the source or target” on page 492
- “Adding a database as a source or target” on page 492
- “Showing or hiding substituting elements in the Message Mapping editor” on page 479

- “Showing or hiding derived types in the Message Mapping editor”

Message header tasks:

- “Configuring message headers” on page 490
- “Mapping headers and folders” on page 490

Showing or hiding substituting elements in the Message Mapping editor:

You can use the **Show Substituting Elements** dialog box to show and hide substituting elements in the Message Mapping editor.

The head element and any mapped substitutions are shown by default in the Message Mapping editor. You can use the **Show Substituting Elements** dialog to show and hide the substituting elements in the Source and Target panes of the Message Mapping editor. To show or hide substituting elements:

1. In either the Source or the Target pane, right click the element that you want to show or hide the substituted elements for. If an element has substituted elements, it is displayed as a substitutions folder in the Source or the Target pane.
2. Click **Show Substituting Elements** on the context menu. The Show Substituting Elements dialog box is displayed.
3. In the Show Substituting Elements dialog box, select elements to show them in the Message Mapping editor, or clear them to hide them in the Message Mapping editor. You cannot hide any element that is already used in a mapping.
4. Click **OK**.

The elements that you have chosen to show or to hide are stored as preferences in your workspace.

Showing or hiding derived types in the Message Mapping editor:

You can use the **Show Derived Types** dialog box to show and hide derived types in the Message Mapping editor.

For an element of a given type, only the base type and any mapped derived types are shown in the Message Mapping editor. You can use the **Show Derived Types** dialog to show and hide derived types in the Source and Target panes of the Message Mapping editor. To show or hide derived types in the Message Mapping editor:

1. In either the Source or the Target pane, right click the element that you want to show or hide the derived types for. If an element has derived types it is displayed as a specializations folder in the Source or the Target pane.
2. Click **Show Derived Types** on the context menu. The Show Derived Types dialog box is displayed.
3. In the Show Derived Types dialog box, select elements to show them in the Message Mapping editor, or clear them to hide them in the Message Mapping editor. You cannot hide any element that is already used in a mapping.
4. Click **OK**.

The elements that you have chosen to show or to hide are stored as preferences in your workspace.

Mapping from source: by selection

The following steps describe how to map from source using Map from Source, or using the drag and drop method.

Using Map from Source

1. Select the source and target elements that you want to map by clicking them. (Ctrl+click to select multiple source or target elements.)

2. Click **Map** → **Map from Source**.

There are four possible scenarios that result in mapping by selection using Map from Source.

- If more than one mappable source element is selected, the selected sources are mapped to the selected target.
- If more than one mappable target element is selected, the selected source is mapped to the selected targets.
- If one mappable source and one mappable target are selected, and neither element has any children, the selected source is mapped to the selected target.
- If one mappable source and one mappable target are selected, where both the elements have children and the same type definition, the selected source is mapped to the selected target.

Using the drag and drop method

Drag the appropriate source element or elements onto the target element or elements (Ctrl+click to select multiple source or target elements.)

When you use the drag and drop method to map from source, mapping by selection is always performed. You can use the drag and drop method in the following scenarios:

- More than one mappable source element is selected. In this case, the selected sources are mapped to the selected target.
- More than one mappable target element is selected. In this case, the selected source is mapped to the selected targets.
- One mappable source and one mappable target are selected, and neither element has any children. In this case, the selected source is mapped to the selected target.
- The selected source and target elements have the same type definition, or when the source type is derived from the target type. In this case the entire structure below the element is copied.

In other scenarios, when a mapping by selection is not possible, the Map by Name wizard opens to enable a Map by Name mapping to be performed instead.

Mapping from source: by name

The Map by Name wizard is used to map complex types by examining the names of source and target elements to create mappings if the names match. The Map by Name wizard can also be used to map database columns. The following steps describe how to map from source using the Map by Name wizard.

Using the Map from Source wizard

1. Select the source and target complex elements, database, schema or table that you want to map by clicking them.
2. Click **Map** → **Map by Name**. The Map by Name wizard opens to allow you to perform mapping by name.
3. Choose the appropriate option from the Map from Source wizard:
 - **Map leaves**. This option maps only the parts of the structure below the element that match each other.
 - **Map immediate children**. This option maps only the immediate children of the source element to the immediate children of the target element that match each other. This option is available only when the selected source and target elements have immediate children that are mappable.
4. After selecting the **Map leaves** or **Map immediate children** option, specify how names are matched.
 - **Map items of same names only**. This option matches items of the same name, and is selected by default. Two names are considered to be the same if they contain the same alphanumeric characters in the same order. This comparison is not case sensitive, so `FIRST_NAME` and `FirstName` are considered to be a match.
 - **Map items of same and similar names**. This option matches items with similar names. Two names are considered to be similar if one name is a truncation of the other, such as `first_name` and `name`, or `PART_NUMBER` and `partNum`. Also, if one name is a contraction of another, such as `November` and `nvmbnr`, they are considered to be similar.
5. Verify that the mappings are relevant and edit them manually if necessary. You might need to delete unwanted mappings and add extra mappings.

The Map by Name wizard opens automatically when you use the drag and drop method to map from source where the source and target are complex types with different type definitions or where the source type is not derived from the target type.

Mapping a target element from source message elements

You can map:

- simple source elements to simple target elements
- source structures to target structures (where the source and target are of the same type)
- source structures to target structures (where the source and target are of a different type)
- multiple simple source elements to a simple target element

The following sections describe how to perform mapping for these particular scenarios using the Message Mapping editor.

Mapping simple source elements to simple target elements

In the following example, the source element called `Name` does not contain the same children as the target element called `Name`:

Source	Target
Name Title First_name Middle_name Last_name	Name Title First_names Last_name

To map one of the child elements, drag the element from the Source pane onto the corresponding element in the Target pane; for example, drag the Last_name source element onto the Last_name target element.

The mapping is represented by a line between the source element and the target element and an entry for the mapping in Xpath format appears in the Spreadsheet pane. A triangular icon indicates which elements in the Source and Target panes have been mapped.

Mapping source structures to target structures (where the source and target are of the same type)

In the following example, the source element called Name has the same structure as the target element called Name:

Source	Target
Name Title First_name Middle_name Last_name	Name Title First_name Middle_name Last_name

To map the entire source structure to the target structure, drag the parent element (Name) from the Source pane onto the corresponding element (Name) in the Target pane. All the child elements are mapped.

Mapping source structures to target structures (where the source and target are of a different type)

In the following example, the source element called Name has a different structure to the target element called DifferentName:

Source	Target
Name Title First_name Middle_name Last_name	DifferentName Title FirstName LastName

To map the entire source structure to the target structure, drag the parent element (Name) from the Source pane onto the corresponding element (DifferentName) in the Target pane. The Map By Name wizards opens. Select **Map leaves** and **Map items of same and similar names** to map all child elements in the target. The source element Middle_name will not be mapped, as there is no target element with the same or a similar name.

Mapping multiple source elements to a simple target element

In the following example, you want to concatenate the First_name and Middle_name source elements to form a single target element called First_names:

Source	Target
Name Title First_name Middle_name Last_name	Name Title First_names Last_name

To map multiple source elements to a simple target element, Ctrl+click the appropriate source elements (First_name and Middle_name) and the target element (First_names), then click **Map** → **Map from Source**. A concatenate function appears in the Spreadsheet pane; you can edit this function to define how the concatenated target element looks, for example, by adding a white space between the two source elements.

To customize the target element (for example, to make the target value equal to the source value plus one), see “Setting the value of a target element using an expression or function” on page 485. You cannot map a simple element if one of its ancestors also has a mapping. For example, you cannot map Properties from source to target, then map Properties/MessageFormat.

Setting the value of a target element to a constant

Use the Message Mapping editor to set the value of a target element to a constant.

1. In the Target pane, right-click the target element or attribute and click **Enter Expression**. If the target element or attribute has a default value, this value is added to the Edit pane.
2. Enter the required constant in the Edit pane and click **Enter**. When entering the constant, observe the following rules:
 - Enclose string element values in single quotation marks.
 - Enter numeric element values without quotation marks.
 - For boolean element values enter 0 for false or 1 for true, without quotation marks. Alternatively, you can enter the fn:false() function for false, or the fn:true() function for true.

The Spreadsheet pane is updated with the value that you have defined.

You cannot set a value for a simple element if one of its ancestors also has a mapping. For example, you cannot map Properties from source to target, then set a value for Properties/MessageFormat.

You can also set a target element to a WebSphere MQ constant or an ESQL constant.

Setting the value of a target element to a WebSphere MQ constant

There are two ways to set the value of a target element to a WebSphere MQ constant, depending on whether the target element has an entry in the Map Script column of the Message Mapping editor Spreadsheet pane:

- If the target element has an entry in the Map Script column:
 1. In the Spreadsheet pane, select the target element.
 2. Enter \$mq: followed by the WebSphere MQ constant in the Edit pane.
 3. Press **Enter**.

The Spreadsheet pane is updated with the expression for a WebSphere MQ constant.

- If the target element does not have an entry in the Map Script column:

1. In the Target pane, right-click the target element and click **Enter Expression**.
2. Enter \$mq: followed by the WebSphere MQ constant in the Edit pane.
3. Press **Enter**.

The Spreadsheet pane is updated with the expression for a WebSphere MQ constant.

The following examples demonstrate how to enter a WebSphere MQ constant in the Edit pane:

```
$mq:MQ_MSG_HEADER_LENGTH
$mq:MQMD_CURRENT_VERSION
```

When the map is saved a warning message is displayed if the expression entered for the WebSphere MQ constant is incorrect, for example the constant is not recognized. This is an example of the warning message: The target "\$target/purchaseOrder/comment" is not referencing a valid variable.

Content Assist (**Edit** → **Content Assist**) provides a list of the WebSphere MQ constants available.

1. Select \$mq: (MQ constants)
2. Select **Edit** → **Content Assist** again to display a list of the available constants.

WebSphere MQ constants that can be used as values for target elements, grouped by the parameter or field to which they relate, can be found in the *WebSphere MQ Constants* book.

Setting the value of a target element to an ESQL constant

There are two ways to set the value of a target element to an ESQL constant, depending on whether the target element has an entry in the Map Script column of the Message Mapping editor Spreadsheet pane.

- If the target element has an entry in the Map Script column:
 1. In the Spreadsheet pane, select the target element.
 2. Enter \$esql: followed by the ESQL constant in the Edit pane.
 3. Press **Enter**.

The Spreadsheet pane is updated with the expression for a WebSphere MQ constant.

- If the target element does not have an entry in the Map Script column:
 1. In the Target pane, right-click the target element and click **Enter Expression**.
 2. Enter \$esql: followed by the ESQL constant in the Edit pane.
 3. Press **Enter**.

The Spreadsheet pane is updated with the expression for a WebSphere MQ constant.

The following examples demonstrate how to enter an ESQL constant in the Edit pane:

```
$esql:ValidateLocalError
$esql:ParseComplete
```

When the map is saved a warning message is displayed if the expression entered for the ESQL constant is incorrect, for example the constant is not recognized. This is an example of the warning message: The target "\$target/purchaseOrder/comment" is not referencing a valid variable.

Content Assist (**Edit** → **Content Assist**) provides a list of the WebSphere MQ constants available.

1. Select `$esql: (ESQL Constants)`
2. Select **Edit** → **Content Assist** again to display a list of the available constants.

Setting the value of a target element using an expression or function

There are two ways to set the value of a target element to an expression, depending on whether the target element has an entry in the Map Script column of the Message Mapping editor Spreadsheet pane:

- If the target element has an entry in the Map Script column:
 1. In the Spreadsheet pane, select the target element.
 2. Enter the required expression in the Edit pane.
 3. Press **Enter**.

The Spreadsheet pane is updated with the value or expression.

- If the target element does not have an entry in the Map Script column:
 1. In the Target pane, right-click the target element and click **Enter Expression**. If the target element has a default value, this value is added to the Edit pane.
 2. Enter the required expression in the Edit pane.
 3. Press **Enter**.

The Spreadsheet pane is updated with the value or expression.

The following examples demonstrate techniques for entering mapping expressions in the Edit pane.

- If the target element is derived from a source element, drag the source element or elements onto the Edit pane; for example:

```
$source/Properties/MessageSet
```

- Use arithmetic expressions, such as:

```
$source/Properties/Priority + 1
```

- Use mapping, Xpath or ESQL function names. Content Assist (**Edit** → **Content Assist**) provides a list of available functions. For example:

```
esql:upper($source/Properties/ReplyIdentifier)
```

- You can perform casting in the Edit pane; for example:

```
xs:string($source/Properties/CodedCharSetId)
```

You cannot enter an expression for a simple element if one of its ancestors also has a mapping. For example, you cannot map Properties from source to target, then set a value of Properties/MessageFormat.

Creating a BLOB output message using a message map

Use the Message Mapping editor to create a bit stream from a message source, and output it as a BLOB message.

Before you start:

Create a mapping that includes a BLOB message as a target; see “Creating a message map file from a Mapping node” on page 477.

Take the following steps.

1. Right-click the BLOB message that you want to map in the Target pane, and select **Enter Expression** from the menu.

-
2. In the Edit pane, type `esql:asbitstream()`.
3. Drag the source field to the Edit pane, placing it between the parentheses, for example

```
esql:asbitstream($source/po:purchaseOrder)
```

Alternatively, you can use content assist to select the `esql:asbitstream` function. In the Edit pane press `Ctrl+Space` to display a list of available functions and associated parameters. The `asbitstream` function is an ESQL Field function. The function can take other parameters; see “Predefined ESQL mapping functions” on page 1422.

When you move the cursor out of the Edit pane, or press `Enter`, the mapping is displayed between the fields in the Source and Target panes.

Mapping from a BLOB message to an output message

Use the Message Mapping editor to parse a BLOB message.

Before you start:

Create a mapping; see “Creating a message map file from a Mapping node” on page 477.

Take the following steps.

1. Right-click the element in the target pane, and select **Enter Expression** from the menu.
2. In the Edit pane, type `msgmap:element-from-bitstream()`.
3. Drag the BLOB to the Edit pane, placing it between the parentheses, for example

```
msgmap:element-from-bitstream($source/BLOB)
```

Alternatively, you can use content assist to select the `msgmap:element-from-bitstream` function. In the Edit pane press `Ctrl+Space` to display a list of available functions and associated parameters. The function can take other parameters; see “Predefined mapping functions” on page 1426. When you move the cursor out of the Edit pane, or press `Enter`, the mapping is displayed between the fields in the Source and Target panes.

Deleting a source or target element

The following steps describe how to delete source and target elements using the “Message Mapping editor” on page 1410:

- To delete a source path, modify the expression so that it no longer uses the source value to compute the target.
If this is the last use of the source path, the line linking the source and target is removed. If the expression no longer has any value, the target becomes unmapped.
- To delete a target from the Edit pane, click the target and click **Delete**.
The target structure is preserved if possible.
 - If you delete a “for” row, clicking **Delete** removes the single row.
 - If you delete a “condition” or “else” row, clicking **Delete**:
 - removes the entire block if there is at least one other “condition” or “else” row within the same “if” row

- removes the "if" row and the "condition" or "else" row, but preserves the content of the "condition" or "else" row when the selected "condition" or "else" row is the last one within the "if" row

Deleting the "if" row preserves the content of the last "condition" or "else" row within the "if" row and deletes everything else in the "if" row.

- To delete a database source, click the SELECT statement then remove all references to the source manually. Alternatively, delete the SELECT source in the Source pane then remove all references to the source manually.
- To delete a database target, delete the INSERT, UPDATE or DELETE statement. Alternatively, update or delete the statement in the Target pane.

Configuring conditional mappings

To set the value of a target element conditionally in a Mapping node:

1. In the Spreadsheet pane of the Message Mapping editor, select the target element and click **Map** → **If**.

Two rows are added to the Spreadsheet pane, above the target element:

- In the first row, Map Script is set to 'if'. You cannot enter anything in the Value column of this row.
- In the second row, Map Script is set to 'condition'. Its value is an expression that is evaluated to see whether it is true. If true, the target element is set to the value specified in its 'Value' column. Initially, its Value column is set to 'fn:true()', which means that the condition is always met, and the target element is always set to the Value column.

2. Change the expression in the condition row's Value column by selecting the cell, or the condition row, in the Spreadsheet pane and setting the value in the Edit pane.

Amend the expression in the Edit pane to specify the correct condition for the statement by performing the following steps:

- a. Select any database columns that are pertinent to the condition, and drag them from the Source pane into the Edit pane.
- b. Select any source message elements with values that are pertinent to the condition, and drag them from the Source pane into the Edit pane.
- c. Open Content Assist by clicking **Edit** → **Content Assist** and select the functions to be applied to the condition.

3. Add further conditions by selecting the condition row in the Spreadsheet pane, and clicking **Map** → **Condition**.

Two rows are added to Spreadsheet pane, below the target element:

- In the first row, Map Script is set to 'condition'. Process this as described in Step 2.
- In the second row, Map Script is set to the target element. Its Value cell is initially blank. Set this value as described in "Setting the value of a target element to a constant" on page 483, and "Setting the value of a target element using an expression or function" on page 485.

4. To set the value of a target element when the 'If' condition is not true, select the condition for the target element in the Spreadsheet pane, and click **Map** → **Else**.

Two rows are added to Spreadsheet pane, below the target element:

- In the first row, Map Script is set to 'else'. You cannot enter anything in the Value column of this row.

- In the second row, Map Script is set to the target element. Its value is initially blank. Set this value as described in “Setting the value of a target element to a constant” on page 483, and “Setting the value of a target element using an expression or function” on page 485.

Configuring mappings for repeating elements

To configure the Mapping node to process repeating elements, use the ‘For’ option in the Message Mapping editor Spreadsheet pane. The following combinations of repeating elements are possible:

- repeating source and non-repeating target
- non-repeating source and repeating target
- repeating source and repeating target

By default, if the source is a database, it is processed as a repeating source.

Configuring a repeating source and a non-repeating target:

To map a repeating source element to a non-repeating target element, drag elements between the Message Mapping editor Source and Target panes. The following items appear in the Spreadsheet pane:

- A ‘for’ row with Value set to the repeating source element.
- An ‘if’ row.
- A ‘condition’ row with Value set to `msgmap:occurrence($source/...) = 1`.
- A row with Map Script set to the target field and Value set to the source field.

The first occurrence of the source field is mapped to the target field. The ‘for’ row specifies that a loop is to be iterated for the specified repeating element. The ‘if’ and ‘condition’ rows restrict the logic to a single occurrence of the repeating element (see “Configuring conditional mappings” on page 487 for more information on conditional logic in a mapping node).

1. To map an occurrence other than the first, change the expression in the ‘condition’ row to `msgmap:occurrence($source/...) = n`, where *n* is the occurrence that you want to map.

If the repeating source field is within one or more repeating structures, a hierarchy of ‘for’, ‘if’, and ‘condition’ rows is placed in the Spreadsheet pane, one for each level of repetition.

2. If the source field contains a numeric data type, mapping all occurrences of a repeating source field to a non-repeating target results in the sum of all the source elements. Perform this mapping by selecting the source element and target element and clicking **Map** → **Accumulate**.

This action sets the following value in the Spreadsheet pane for the target element:

```
fn:sum($source/...)
```

The result of the accumulate action is a numeric value. If your target has a different data type, then you must cast the result to the appropriate type for the selected target. For example, if your target is `xs:string` type, you must alter the results of the accumulate action from `fn:sum($source/x/y/z)` to `xs:string(fn:sum($source/x/y/z))`, in order to cast the result to the correct data type for your target.

You cannot map different occurrences of a repeating source element to different non-repeating target elements.

Configuring a non-repeating source and a repeating target:

To map a non-repeating source element to a repeating target element, drag elements between the Message Mapping editor Source and Target panes. The first occurrence of the target element is set to the value of the source element.

To map to an occurrence other than the first, complete the following steps:

1. If the target element is not shown in the Spreadsheet pane, right-click its lowest ancestor row, then click **Populate**. Repeat this action until the target element is shown.
2. Right-click the target element and click **Insert After** or **Insert Before** to select the location to insert the repeating target elements. The **Insert After** or **Insert Before** options are disabled if there is nothing valid to be inserted at the selected location. Selecting either of these opens the Insert Statement wizard.
3. Select the element to insert from the list of valid items.
4. Enter the number of instances to be added and click **OK**. The number of instances to be added must be less than or equal to the maximum occurrence specified for the selected element.

The specified number of instances of the repeating target element are added to the Spreadsheet pane. The inserted statements do not have a mapping expression and any children are not displayed. Right-click each element, then click **Populate** to display any child elements.

By repeating the **Insert After** and **Insert Before** action, it is possible to insert more repeating elements in the target than the maximum occurrence specifies. Verify that the number of repeating elements is valid, and delete any unwanted entries.

Configuring a repeating source and a repeating target:

To map a repeating source element to a repeating target element drag elements between the Message Mapping editor Source and Target panes. The following items appear in the Spreadsheet pane:

- A 'for' row with Value set to the repeating source element.
- A row with Map Script set to the target field and Value set to the source field.

All occurrences of the source element are mapped to the respective occurrences of the target element. You can map repeating source structures to repeating target structures if the source and target are of the same complex type.

Populating a message map

You can use the Populate wizard to add elements from the Target pane to the Spreadsheet pane. The Populate wizard creates child structures for the selected parent structure. When you add a message target to a message map, \$target in the Spreadsheet pane is populated by default with Properties and the message body root. The Properties fields MessageSet, MessageType and MessageFormat, are added together with their default values, unless the selected message is in the BLOB domain. Other message elements and their children can be added to the Spreadsheet pane without creating mappings by using the Populate wizard. The following steps show how to populate the Spreadsheet pane with other message elements using the Populate wizard:

Using the Populate wizard

1. Right-click a parent element in the Spreadsheet pane and click **Populate**. The Populate wizard is displayed.
2. Select the items you wish to create mappings for. Items required in the target message are selected by default. The selected items are added to the Spreadsheet pane.
3. Repeat **Populate** to add further child elements to the Spreadsheet pane.

If any target elements are missing warning messages are displayed in the Message Mapping Editor. These warning messages indicate the name and expected position of the missing elements. You can use the Populate wizard to add the missing elements.

You can also use the Populate wizard to add target elements to the Spreadsheet pane when there are existing mappings. Any existing mappings are not altered by the wizard.

If the target map is a submap the Spreadsheet pane is populated by default with the selected element or attribute root. You can use the Populate wizard in the submap to add any child elements to the Spreadsheet pane in the same way.

Configuring the LocalEnvironment

You can set values in the LocalEnvironment in the same way as setting values in other elements of a message. Add the LocalEnvironment to your message map using the **Add or Remove Headers and Folders** dialog as described in “Mapping headers and folders.” If you set any values in the target LocalEnvironment, set the mapping mode property for the Mapping node to a value that contains LocalEnvironment. To do this, select the mapping node in your message flow and click **Properties** → **Basic** → **Mapping Mode**.

You cannot map Local Environment objects that are not listed.

Configuring message headers

You can set values for headers in the same way as setting values in other elements of a message.

Add the appropriate headers to your message map using the **Add or Remove Headers and Folders** dialog as described in “Mapping headers and folders.” If you set any values in the target LocalEnvironment, set the Mapping mode property for the Mapping node to a value that contains LocalEnvironment. To do this, select the mapping node in your message flow and click **Properties** → **Basic** → **Mapping Mode**.

You cannot map headers that are not listed.

Mapping headers and folders

The following types of message headers and folders can be included for source and target messages in a message map (note that a submap does not include message headers):

- LocalEnvironment
- Properties
- MQ Headers
- HTTP Headers
- JMS Transport Header

- Email Headers

If you choose not to map message headers or the LocalEnvironment explicitly in your message map, then the output message is produced with the same message headers as the input message. When you Populate the message map, the Properties folder for the source and target are displayed in the message map, with MessageSet and MessageType initially set based on the target message. MessageFormat is set to the default wire format of the message set if the parser domain is MRM. The other properties are blank initially, and the message headers are copied from the input message.

Alternatively, if you choose to map any message headers or the LocalEnvironment in your message map, then no message headers are copied from the input message. You must add mappings for these headers to ensure that the target message contains appropriate headers to make a valid output message.

If your target message contains an MQRFH2 header, you must select from either the MQRFH2 or MQRFH2C parser in the Add or Remove Headers and Folders dialog. For more information about the MQRFH2 and MQRFH2C parsers, see “The MQRFH2 and MQRFH2C parsers” on page 1407.

Before mapping headers and folders, ensure you do the following:

1. Create a message flow project
2. Create a message flow
3. Define message flow content
4. Create a message map file from the navigator or create a message map from a node.

To add message headers or other folders to a message map:

1. Right-click your message map in the Broker Development view and select **Open** or right-click your mapping node and select **Open Map** to open the Message Mapping editor.
2. Right-click \$source in the Source pane and select **Add or Remove Headers and Folders** to add message headers or other folders to the source message. The Add or Remove Headers and Folders dialog opens.
3. Ensure that **Selected headers and other folders** is selected. If **No folders (map body element only)** is selected your map is a submap, and can not have headers associated with it. You can change the submap to a message map by selecting **Selected headers and other folders**.
4. Select the headers that you want to map from the list. If you want to map MQ Headers or HTTP Headers, you must select individual headers by expanding the list. If you are using MQ Headers you must include the MQMD, therefore this is automatically selected for you.
5. Click **OK** to add the selected message headers or folders to the message map.
6. Right-click \$target in the Target pane and select **Add or Remove Headers and Folders** to add message headers or other folders to the output message.
7. Repeat step 3 to 5 to add the headers and folders that you require to the target message.
8. Configure the message header and folder mappings in the same way as other mappings.

You can use **Add or Remove Headers and Folders** to remove message headers or the LocalEnvironment folder. Right-click on either the \$source or the \$target to

open the Select Message Headers dialog. Clear the headers or other folders to remove them from the message map. Removing a message header or other folder from the message map removes any associated mappings that you have created. You can remove the Properties folder from the message map, but note that all built-in parsers require some values in the Properties folder for the output message.

You can map multiple instances of a header by right clicking on the header in the Message Mapping editor Spreadsheet pane and selecting **Insert Before** or **Insert After** . Select the header from the Insert Statement dialog.

Adding messages or message components to the source or target

You can add additional messages or message components as sources or targets in your message map. To add a message or message component to a source or target:

1. From the Message Mapping editor, click **Map** → **Add Sources and Targets**

The Add Map Sources and Targets wizard opens.

Alternatively, right-click in the Source pane and click **Add Sources** or right-click in the Target pane and click **Add Targets**.

2. Select messages or message components from the message sets that are in your Message Broker Toolkit workspace.

If you cannot find the messages or message components that you expect, select the **Show all resources in workspace** check box.

If one does not already exist, a project reference is created from your message flow project to the message set project that contains the selected messages or message components.

You can also add sources and targets by dragging the resources from the Broker Development view in the Broker Application Development perspective onto the source or target pane of your message map. Select resources under Messages or Elements and Attributes or Types from your Message Definitions and drag them onto the source or target pane. If you add a message to the message map, Properties are also added. If you add an element, attribute or type to the to the message map a global element for a submap is created. Your message map must use messages, global elements or global types, but not a combination of more than one type.

A Mapping node can have only one source message, but can have several target messages. Therefore, you cannot add a source message if one already exists.

Adding a database as a source or target

You can add a database as a source and database tables as targets to message maps that support database mappings. You must have created a database definition for your database before you can add it or the associated tables to a message map.

There are a number of different ways to add database sources and targets:

- You can specify the databases and database tables you want to use in the New Message Map wizard when you create a new message map.
 1. Create a new message map file in the Broker Application Development perspective using **File** → **New** → **Message Map** or by right-clicking on your mapping node and selecting **Open Map**.
 2. From **Select map sources**, select the Database Sources for your message map.

3. From **Select map targets**, select the database tables to use as targets in your message map. If you are not creating a message map from a DataDelete, DataInsert or DataUpdate node, expand the relevant database operation and select from the list of tables. You can select from the following database operations:
 - **Table Inserts**
 - **Table Updates**
 - **Table Deletes**

If you cannot find the Data Sources or Data Targets that you expect, select the **Show all resources in workspace** check box.

- In an existing message map a database can be added as a source and database tables added as a target using **Add Sources and Targets**.
 1. From the Message Mapping editor, click **Map** → **Add Sources and Targets**. Alternatively, right-click in the Source pane and click **Add Sources** or right-click in the Target pane and click **Add Targets**.
 2. From **Select map sources**, select the Database Sources for your message map.
 3. From Data Targets, in **Select map targets**, select the database tables to use as targets in your message map. If you are not creating a message map from a DataDelete, DataInsert or DataUpdate node, expand the relevant database operation and select from the list of tables. You can select from the following database operations:
 - **Table Inserts**
 - **Table Updates**
 - **Table Deletes**

If you cannot find the Data Sources or Data Targets that you expect, select the **Show all resources in workspace** check box.

- Alternatively, in an existing message map, a database can be added as a source using **Select Data Source**
 1. Select the location to add a database table source to your mapping in the Spreadsheet pane. For example, select \$target.
 2. Click **Map** → **Select Data Source**. Alternatively, right-click in the Spreadsheet pane and click **Select Data Source**. The Select Database As Mapping Source wizard opens.
 3. Select your database from the list. If you cannot find the Data Sources or Data Targets that you expect, select the **Show all resources in workspace** check box.
- You can also add database sources and database table targets to your message by dragging them from the Broker Development view in the Broker Application Development perspective onto your message map.
 1. From the Broker Application Development perspective, expand your Database Connections category in the Broker Development view.
 2. Open your message map.
 3. To add a database as a source in your message map, drag your database file from Database Connections onto the Source pane. The database file is called <connectionname_database>.dbxmi. A \$db:select is added to the source pane of your message map.
 4. To add a database table as a target in your message map, drag your database table file from Database Connections onto the Target pane. The database table file is called <connectionname_schema_table>.tblxmi. A \$db:insert is added to the target pane of your message map. If you want to perform a

database operation other than insert on your database table, you must change the database operation of the message map.

When the database has been added to the source:

- The Source pane contains a \$db:select entry.
- The Spreadsheet pane contains a \$db:select entry.

When the database table has been added as a target:

- The Target pane and Spreadsheet pane contain one of the following:
 - a \$db:insert entry
 - a \$db:update entry
 - a \$db:delete entry

You can change the database operation on a selected table by using the **Change Database Operation** dialog.

You cannot add a database as a source or a target to an Extract node.

Modifying databases using message mappings

The following topics describe how to work with databases using message mappings:

- “Adding database definitions to the Message Broker Toolkit”
- “Creating a message map file from a DataInsert node” on page 495
- “Creating a message map file from a DataUpdate node” on page 496
- “Creating a message map file from a DataDelete node” on page 496
- “Change database operation of a message map” on page 497
- “Mapping from a message and database” on page 497
- “Mapping a target element from database tables” on page 498
- “Deleting data from a database with a mapping node” on page 500
- “Creating a database to database mapping” on page 501
- “Adding a database as a source or target” on page 492

Adding database definitions to the Message Broker Toolkit:

Use the New Database Definition File wizard to add database definitions to the Message Broker Toolkit.

You must have a database definition defined in the Message Broker Toolkit to create database mappings. Database definitions are also used by other nodes such as the Compute node to validate references to database sources and tables. Database definitions are stored in a data design project. You must associate the data design project with any message flow projects that you want to use the database definitions with. The following steps describe how to add a database definition to the Message Broker Toolkit:

1. Switch to the Broker Application Development perspective.
2. Click **File** → **New** → **Database Definition**. The New Database Definition File wizard is displayed.
3. Select an existing data design project or click **New** to create a new data design project.

4. Select the database type and version that you want to connect to from the Database and Version list. Ensure that you select a supported database from the list. For a list of supported databases, see Supported databases.
5. Click **Next**.
6. Either select to create a new database connection or select a connection to use from the list of existing connections. If you select to use an existing connection, the existing database definition is overwritten.
7. Click **Next**.
8. If you selected to create a new connection:
 - a. Optional: You can enter a custom value for the Connection Name if you clear the Use default naming convention check box.
 - b. Enter values for the Connection to the database, for example, Database name, Host name and Port number.
 - c. Enter values for the User ID and Password to connect to the database. You can use the **Test Connection** button to verify the settings you have selected for your database. The default Port number for a DB2 database is 50000. If the connection fails, you can try to enter other values such as 50001, 50002 and so on, for the Port number, and then test the connection again.
 - d. Click **Next**. An error is generated if any of the connection details are wrong. If you specify a Database that already has a database definition in the data design project, click **Yes** in the Confirm file overwrite window to overwrite the existing database definition.
9. Alternatively, if you selected to use an existing connection:
 - a. Click **Yes** in the Confirm file overwrite window to overwrite the existing database definition.
 - b. Enter values for the User ID and Password to connect to the database and then Click **Next**.
10. Select one or more database schemas from the list and click **Next**.
11. Click **Finish**.
12. Add the data design project as a reference to the message flow project:
 - a. Right-click on the message flow project and click **Properties**.
 - b. Click **Project References**, and select the data design project from the list to add as a referenced project.
 - c. Click **OK**.

A new database definition file is added to your data design project. The database definition file name has the following format:<database>.dbm. Database definition files are associated with the Data Project Explorer view and the Database Explorer view. Tools are available in these views for working with your databases.

Database definition files in the Message Broker Toolkit are not automatically updated. If a change is made to your database you must recreate the database definition files.

Creating a message map file from a DataInsert node:

You can use a DataInsert node to create mappings to insert new data into a database from a message, another database or both.

Before creating a message map file, ensure you do the following:

1. Create a message flow project

2. Create a message flow
3. Define message flow content that includes a DataInsert node
4. Create a database definition

To create a message map (.msgmap) file from a DataInsert node:

1. From the Broker Application Development perspective, open your message flow, right-click your DataInsert node, and click **Open Map**. The New Message Map for Data Insert Node wizard opens.
2. Select the combination of Messages, Data Sources or both that you want to use as sources for your map from Select map sources.
If you cannot find the Messages or Data Sources that you expect, select the **Show all resources in workspace** check box.
3. From the Select map targets pane, select the tables under Table Inserts into which you want to insert new data. The tables that you select are added to the new message map as targets.
4. Select **OK** to create the new message map. The “Message Mapping editor” on page 1410 opens with the selected sources and targets.

After you have created a message map file, you can now configure the message mappings.

Creating a message map file from a DataUpdate node:

You can use a DataUpdate node to create mappings to update existing data in a database from a message, another database or both.

Before creating a message map file, ensure you do the following:

1. Create a message flow project
2. Create a message flow
3. Define message flow content that includes a DataUpdate node
4. Create a database definition

To create a message map (.msgmap) file from a DataUpdate node:

1. From the Broker Application Development perspective, open your message flow, right-click your DataUpdate node, and click **Open Map**. The New Message Map for Data Update Node wizard opens.
2. Select the combination of Messages, Data Sources or both that you want to use as sources for your map from Select map sources.
If you cannot find the Messages or Data Sources that you expect, select the **Show all resources in workspace** check box.
3. From the Select map targets pane, select the tables under Table Updates in which you want to update data. The tables that you select are added to the new message map as targets.
4. Select **OK** to create the new message map. The “Message Mapping editor” on page 1410 opens with the selected sources and targets.

After you have created a message map file, you can now configure the message mappings.

Creating a message map file from a DataDelete node:

You can use a DataDelete node to create mappings to delete data from a database based on information from an input message, another database or both.

Before creating a message map file, ensure you do the following:

1. Create a message flow project
2. Create a message flow
3. Define message flow content that includes a DataDelete node
4. Create a database definition

To create a message map (.msgmap) file from a DataDelete node:

1. From the Broker Application Development perspective, open your message flow, right-click your DataDelete node, and click **Open Map**. The New Message Map for Data Delete Node wizard opens.
2. Select the combination of Messages, Data Sources or both that you want to use as sources for your map from Select map sources.
If you cannot find the Messages or Data Sources that you expect, select the **Show all resources in workspace** check box.
3. From the Select map targets pane, select the tables under Table Deletes from which you want to delete data. The tables that you select are added to the new message map as targets.
4. Select **OK** to create the new message map. The “Message Mapping editor” on page 1410 opens with the selected sources and targets.

After you have created a message map file, you can now configure the message mappings.

Change database operation of a message map:

If you have created a message map that performs a database operation such as data insert, data update or data delete on a database table you might want to change the database operation that the map performs. You might also have created a database mapping by dragging a table from the Broker Development view onto a message map and want to change the default insert operation to another database operation.

To change the database operation of a database table in your message map:

1. From the Broker Application Development perspective, open your message map.
2. Right-click on the target database table in the target pane and click **Change Database Operation**. The Select Database Operation dialog is displayed.
3. Select the database operation you want to perform on the selected table:
 - Insert
 - Update
 - Delete
4. Click **OK** to change the database operation on the selected table.

If you change the database operation of your message map to or from data delete you must recreate any mappings to your target database columns.

Mapping from a message and database:

You can create a message map that uses both a message and a database as a source.

Before creating a message map file, ensure you do the following:

1. Create a message flow project
2. Create a message flow
3. Define message flow content
4. Create database definitions

The following instructions describe how to specify a message and a database as the data source.

1. Right-click a node that supports mapping, such as the Mapping node, and click **Open Map**.
2. Follow the on-screen instructions to complete the New Message Map wizard:
 - a. Select the combination of Messages and Data Sources that you want to use as sources for your message map from Select map sources.
 - b. Select the combination of Messages, Data Targets or both that you want to use as targets for your map from Select map targets.
3. Perform mapping as usual from the source message.
4. Follow the guidance in “Mapping a target element from database tables” to create the mappings from the source database to the target message or database table.

Mapping a target element from database tables:

To map a target element from a database table, set up the Mapping node to:

- retrieve the relevant rows from the database
- populate the message target elements with values from database

There are a number of ways to add a database as a source for a mapping, as described in “Adding a database as a source or target” on page 492. After you have added a database to the mapping, the Spreadsheet pane contains a \$db:select entry in the Map Script column. By default, its value is fn:true(), which means that all rows are retrieved from the database table. In database SQL, you would restrict the number of rows by adding a WHERE clause to a database call. In the Mapping node the equivalent method of restricting the number of selected rows is to use a \$db:select expression.

These steps show the equivalent method of restricting the number of rows selected in a Mapping node:

1. In the Spreadsheet pane, click the \$db:select row. This causes fn:true() to be put into the Edit pane.
2. Edit the expression in the Edit pane to specify the correct condition for the database call. To help you achieve this, you can:
 - a. Select any database columns that are relevant to the rows that are retrieved, and drag them from the Source pane to the Edit pane. These are the database column names that are used in an SQL WHERE clause.
 - b. Select any source message elements with values that are relevant to the rows that are retrieved, and drag them from the Source pane into the Edit pane. These are values against which the selected database columns can be matched.
 - c. Open Content Assist by clicking **Edit** → **Content Assist**.

- d. From Content Assist, select the functions to apply to message elements in the database call.

Here is an example of a \$db:select entry where a database column is matched against a constant or a field from an input message:

```
$db:select_1.BROKER50.JDOE.RESOLVEASSESSOR.ASSESSORTYPE = 'WBI' or $db:select_1.BROKER50.JDOE.RESOLVEASSESSOR.ASSESSORTYPE = $source/tns:msg_tagIA81CONF/AssessorType
```

A \$db:select entry retrieves all qualifying rows, so it is possible that more than one row is retrieved. By default, the selection is treated as repeating, which is indicated by the 'for' row below \$db:select in the Spreadsheet pane.

After you have configured the \$db:select, populate the target message from the database by dragging the database column from the Source Pane to the message element in the Target pane. The mapping is indicated by a line between the database column in the Source pane and the element in the Target pane. An entry for this map in Xpath format also appears in the Spreadsheet pane. Triangular icons appear in the Source and Target panes next to objects that have been mapped.

Using database selects

By default a \$db:select entry is accompanied by a 'for' row that iterates over the select result set. Ensure that your 'for' row is in the correct position for your mapping. The behavior of the map is determined by the position of the 'for' row in the Spreadsheet pane. For example, if the results of the \$db:select statement matched 5 rows in the database and the 'for' row is located above the \$target entry in the Spreadsheet pane, then 5 complete messages are output by the mapping node. If the 'for' row is positioned within the message body, then one message is generated with 5 repeating elements in the message body.

A mapping can contain multiple 'for' rows associated with a \$db:select entry that perform a single database select and iterate over the results multiple times. For example, multiple 'for' rows can be used in conditional mappings, where an individual 'for' row is used with a 'condition' or an 'else'.

A 'for' row is not always required and can be deleted in the following circumstances:

- If the database select returns only one row
- If you use an aggregate Xpath function on the select results

For example: fn:sum or fn:count.

Any \$db:select expression must be within the scope of the \$db:select entry in the Spreadsheet pane, meaning that it must be a descendant of the select statement. If a \$db:select expression is out of scope the Message Mapping editor moves the \$db:select entry to a position where the \$db:select expression is in scope. Ensure that the position of the \$db:select entry is correct for your message mapping.

Database table join

Database table join is supported for tables within the same database. For example, consider the following two tables where PRODUCT_ID and PART_NUMBER match:

Table	Column	Row 1	Row 2	Row 3	Row 4
ORDER	PRODUCT_ID	456	456	345	123
	QUANTITY	100	200	300	400

PRODUCT	PART_NUMBER	123	456	789	012
	PART_NAME	pen	pencil	paperclip	glue
	PRICE	0.25	0.15	0.02	0.99

A `$db:select` expression with the following syntax joins the tables:

```
$db:select.MY_DB.SCHEMA1.ORDER.PRODUCT_ID=$db:select.MY_DB.SCHEMA2.PRODUCT.PART_NUMBER
```

The `$db:select` expression in the example generates the following result set:

	Row 1	Row 2	Row 3
PRODUCT_ID	456	456	123
QUANTITY	100	200	400
PART_NUMBER	456	456	123
PART_NAME	pencil	pencil	pen
PRICE	0.15	0.15	0.25

You can then use the 'for' row to iterate through the results set in the same way as results from a single table.

Deleting data from a database with a mapping node:

You can use a `DataDelete` or a `Mapping` node to delete data from a database, based on information from an input message, another database or both.

You must do the following before you can delete data from a database using a mapping node:

1. Create a message flow project
2. Create a message flow
3. Define message flow content that includes a `DataDelete` or a `Mapping` node
4. Create a message map file from a `DataDelete` node or Create a message map file from a `Mapping` node

You cannot create mappings to delete data from a database by dragging from the source to the target. Instead, you select rows to delete based on the content of the source. You can use an expression to match the content of the source to the target field, for example, use the following instructions to delete all rows in the database that match the content of a field from the input message:

1. Right-click your `DataDelete` or `Mapping` node, and click **Open Map**. The "Message Mapping editor" on page 1410 opens with your selected sources and targets.
2. Select `$db:delete` in the Spreadsheet pane.
3. Drag the appropriate source element from the message in the Source pane to the Edit pane. For example, `$source/shipTo/accNum`.
4. Drag the appropriate target database field from the Target pane to the Edit pane. For example, `$db:delete.SAMPLE.MYSCHEMA.CUSTOMER.CONTACT_ID`.
5. Change the expression in the Edit pane to set the target field to be equal to the source element. For example, `$source/shipTo/accNum = $db:delete.SAMPLE.MYSCHEMA.CUSTOMER.CONTACT_ID`.

You can use conditional mappings such as `If` statements to create more complex mappings that define which data to delete from a database. You can also use conditional statements in a `Mapping` node to perform different database operations depending on the content of the input message. For example, you can add a `Table Inserts` target, a `Table Updates` target and a `Table Deletes` target to a message map, and then use conditional statements to define which of the operations to perform.

Creating a database to database mapping:

You can create a message map that uses a database as both the source and target. The contents of the source database can be used to interact with the same or a different database table. The message map can also include a message as a source, but a message is not required. You can, for example, use a timer node to schedule regular updates to a database.

Before creating a message map file with a database to database mapping, ensure you do the following:

1. Create a message flow project
2. Create a message flow
3. Define message flow content
4. Create database definitions

To create a database to database mapping:

1. Right-click a node that supports database mapping in your flow, such as the Mapping node, and click **Open Map**. The New Message Map wizard opens for your node.
2. Select the Data Sources and any Messages that you want to use as sources for your map from **Select map sources**.

If you cannot find the Messages or Data Sources that you expect, select the **Show all resources in workspace** check box.

3. From Select map targets expand the database operation that you want to perform. You can select from the following database operations:
 - Table Inserts
 - Table Updates
 - Table Deletes
4. Select the database tables that you want to map.

You can create a message map that performs a combination of database inserts, updates or deletes by selecting database tables from different database operations. For example, if you want to create a conditional mapping that updates data in a database if it already exists, but inserts the data if it does not already exist in the database, then you can select the same database table under Table Inserts and Table Updates.

5. Select **OK** to create the new message map. The “Message Mapping editor” on page 1410 opens with the selected sources and targets.

After you have created a message map file, you can now configure the message mappings.

Storing a BLOB message in a database table using a message map:

Use the Message Mapping editor to create a bit stream from a BLOB message, and store it in a database table.

Before you start:

Create a mapping; see “Creating a message map file from a Mapping node” on page 477.

Take the following steps.

1. In the Target pane, right-click the column that will store the bitstream, and select **Enter Expression** from the menu.
2. In the Edit pane, type `esql:asbitstream()`. You can use content assist; `asbitstream` is a *Field function*.
3. Drag the source field, for example `$source/po:purchaseOrder`, to the Edit pane, placing it between the parentheses. The entry in the Edit pane looks like this:

```
esql:asbitstream($source/po:purchaseOrder, 'purchaseOrder',
'PurchaseOrder', 'XML1', 0, 0, $esql:FolderBitStream)
```

Alternatively, you can use content assist to select the `esql:asbitstream` function. In the Edit pane press `Ctrl+Space` to display a list of available functions and associated parameters. The `asbitstream` function is an ESQL Field function. The function can take other parameters; see “Predefined ESQL mapping functions” on page 1422.

When you move the cursor out of the Edit pane, or press `Enter`, the mapping is displayed between the fields in the Source and Target panes.

Mapping from a BLOB field in a database table to an output message:

Use the Message Mapping editor to parse a bit stream from a field in a database table into a folder in a target message.

Before you start:

Create a mapping; see “Creating a message map file from a Mapping node” on page 477.

Take the following steps.

1. Right-click the element in the target pane, and select **Enter Expression** from the menu.
2. In the Edit pane, type `msgmap:element-from-bitstream()`.
3. Drag the field from the database table to the Edit pane, placing it between the parentheses, for example:

```
msgmap:element-from-bitstream($db:select.RESERVDB.USER.XMLFLIGHTTB.FLIGHTDATE)
```

Alternatively, you can use content assist to select the `msgmap:element-from-bitstream` function. In the Edit pane press `Ctrl+Space` to display a list of available functions and associated parameters. The function can take other parameters; see “Predefined mapping functions” on page 1426. For example:

```
msgmap:element-from-bitstream($db:select.RESERVDB.USER.XMLFLIGHTTB.FLIGHTDATE,
'ReserveMessageSet', 'FlightMessage', 'XML1', 0, 0, $esql:FolderBitStream)
```

When you move the cursor out of the Edit pane, or press `Enter`, the mapping is displayed between the fields in the Source and Target panes.

Creating and calling submaps and subroutines

The following topics describe how to work with submaps and ESQL subroutines:

- “Creating a new submap” on page 503
- “Creating a new submap for a wildcard source” on page 504
- “Creating a submap to modify a database” on page 504
- “Converting a message map to a submap” on page 505
- “Converting an inline mapping to a submap” on page 506
- “Calling a submap” on page 506

- “Calling a submap from ESQL” on page 507
- “Calling an ESQL routine” on page 508
- “Creating and calling your own user-defined ESQL routine” on page 508

Creating a new submap:

This topic describes how to create a new submap. There are three ways to create a new submap:

- **Using File → New → Message Map**

1. From the Broker Application Development perspective, click **File → New → Message Map**. The New Message Map wizard opens.
2. Specify the project name and the name for the new submap.
3. Specify that the new map is a submap by selecting the option: **Submap called by another map**.
4. Select the combination of Message Components or Data Sources that you want to use as sources for your map from **Select map sources** and select the combination of Message Components or Data Targets that you want to use as targets for your map from **Select map targets**.

If you cannot find the Message Components, Data Sources or Data Targets that you expect, select the **Show all resources in workspace** check box.

5. Click **Finish**.

The new submap opens in the Message Mapping editor.

- **Using Create new submap**

1. From the Broker Application Development perspective, open the message map for the required node.
2. In the Source pane, expand the tree and select the source.
3. In the Target pane, expand the tree and select the target.
4. Right-click either the source or target, then click **Create New Submap**.

The new submap opens in the Message Mapping editor. If the original map file was called `simple_mapping.msgmap`, the new submap is called `simple_mapping_submap0.msgmap`.

- **Using Convert to submap**

1. From the Broker Application Development perspective, open the message map.
2. Select one of the following types of submap to create a new submap from an inline mapping:
 - Element statement that maps a global element or an element of global type
 - Attribute statement that maps either a global attribute or an attribute of a global type
 - Database insert statement
 - Database update statement
 - Database delete statement
3. Right-click the mapping statement that you want to convert to a submap or database submap in the Script pane, and click **Convert to submap**. A new submap is created and a statement is added to the original message map to call the new submap.

The new submap opens in the Message Mapping editor. If the original map file was called `simple_mapping.msgmap`, the new submap is called `simple_mapping_submap0.msgmap`.

Creating a new submap for a wildcard source:

This topic describes how to map a wildcard value in the source to a wildcard value in the target. You might expect a wild card in a Mapping node for example, when you are using a SOAP message (where the Body element contains a wildcard). This type of wildcard represents the payload of the message, where the payload is a message that is defined elsewhere in the message set. The submap can involve from 0 to n source wildcards and 0 or 1 target wildcards.

The “Message Mapping editor” on page 1410 shows three kinds of wildcard, all of which allow you to create a submap:

Mapper construct	Message model construct	Choose concrete item for submap
Wildcard element	Wildcard element	Global element
Wildcard attribute	Wildcard attribute	Global attribute
Message with Wildcard Message child	Group with Composition of Message and Content Validation of Open or Open Defined	Message

1. Switch to the Broker Application Development perspective.
2. Open the message map for the required node.
3. In the Source pane, expand the tree and select the source wildcard.
4. In the Target pane, expand the tree and select the target wildcard.
5. Right-click either the source or the target wildcard, and click **Create new submap**. The Wildcard Specification wizard opens.
6. From the Wildcard Specification wizard, select the concrete item that will replace the source wildcard, according to the values shown in the table at the beginning of this topic.
7. Click **Next**.
8. From the Wildcard Specification wizard, select the concrete item that will replace the target wildcard, according to the values shown in the table at the beginning of this topic.
9. Click **Finish**.
10. Click **OK**. The submap opens in the Message Mapping editor.
11. From the submap, map the source message elements to the target message elements as required.
12. Click **OK**.

Creating a submap to modify a database:

Use the Create New Database Submap wizard to create a submap to modify a database.

You must have an existing message map from which to call the submap. The following steps describe how to create a submap to modify a database:

1. In the Broker Application Development perspective, open the calling message map.

2. In the Source pane, right-click the message component containing the fields to be used to modify the database and click **Create New Database Submap**. The source can be a wildcard, an element, or an attribute. The Create New Database Submap wizard opens.
3. If the selected source is a wildcard, select a message or message component for the source wildcard from **Select a defined item to replace the source wildcard** pane. If you cannot find the message components that you expect, select the **Show all resources in workspace** check box.
4. From **Select database submap targets** expand the database operation that you want to perform. You can select from the following database operations:
 - **Table Inserts**
 - **Table Updates**
 - **Table Deletes**
5. Select the database tables that you want to map. If you cannot find the Data Targets that you expect, select the **Show all resources in workspace** check box.
6. Click **OK**. A new submap is created with the selected message or message component in the Source pane, and the database table in the Target pane. In the calling message map `$db:call` is added to the Target pane.

After you have created the submap file, configure the message mappings for the database table.

Converting a message map to a submap:

You can convert between a message map and a submap in order to change the usage of the map. You might convert a message map to a submap because you want to reuse the same mappings for multiple nodes. Use the following instructions to convert a message map to a submap for each message in the message map.

1. From the Broker Application Development perspective right-click your message map and click **Open**.
2. Right-click `$source` in the Source pane and select **Add or Remove Headers and Folders**. The Add or Remove Headers and Folders dialog opens.
3. Select **No folders (map body element only)**. Any previously selected headers or folders are cleared.
4. Click **OK** to remove the headers and folders.
5. Repeat steps 2 to 4 to select to map body element only from your target message under `$target` in the Target pane.
6. Delete target map statements for existing mappings to properties, message headers or other folders such as `LocalEnvironment`. These mappings are flagged with warning messages after the headers are removed.
7. Remove the reference to the new submap from any mapping nodes. If a reference to the submap exists in the Mapping Routine property of a mapping node an error message is displayed on the message flow.
8. Save the submap, and check for any broken references as indicated by errors or warnings in the Problems view.

The submap is now ready to be used. See calling a submap for more information.

To convert a submap to a message map, click **Add or Remove Headers and Folders** for the source and target messages, and select to map **Selected headers**. You must ensure that no other maps call the changed map, check for errors in the

Problems view to indicate this problem. See mapping headers and folders for more information about mapping headers, Properties and the LocalEnvironment.

Converting an inline mapping to a submap:

You can convert between inline mappings in a message map and a submap in order to change the usage of the map.

You might convert parts of an existing message map to a submap because you want to reuse the same mappings for multiple nodes. You can convert inline mappings to submaps from messages or databases. You must select one of the following types of statement to create a submap or a database submap:

- Element statement that maps a global element or an element of global type
- Attribute statement that maps either a global attribute or an attribute of a global type
- Database insert statement
- Database update statement
- Database delete statement

The target that is added to the new submap is the global element, attribute, type, or database insert, update, or delete that you select. The source that is added to the new submap is the appropriate global element or type from the source from the selected mappings that are included in the submap. If mappings included in the selected statement do not reference any source, then only a target is added to the submap. If the source contains a database select that is not referenced by any other part of the original message map, a database select is added as a source to the submap, and removed from the original message map. However, if the source contains a database select that is referenced by any other part of the original message map, then the original message map retains the select, and the submap performs a separate select. If you do not want to perform two database select operations, do not use a database submap under these conditions.

Use the following instructions to convert inline mappings in a message map to a submap or database submap:

1. From the Broker Application Development perspective right-click your message map and click **Open**.
2. Right-click the mapping statement that you want to convert to a submap or database submap in the Script pane, and click **Convert to submap**. A new submap is created and a statement is added to the original message map to call the new submap.

The submap is now ready to be used.

Calling a submap:

Use the Call Existing Submap wizard to call a submap. The submap must already be in the workspace.

If a submap does not exist, use the **Create New Submap** menu option to create a submap that you can call. This action creates the new submap in the same folder as the calling map. It also allocates a default map operation name to the new submap. If the source or target in the calling map is a wildcard, a wizard allows you to choose a replacement element.

You can also map from a wildcard to a wildcard.

The following steps describe how to call a submap:

1. In the Broker Application Development perspective, open the calling map.
2. In the Source and Target panes, select one or more sources and one target. Any of the sources or the target can be a wildcard, an element, or an attribute.
3. Click **Map** → **Call Existing Submap**. The Call Existing Submap wizard opens.
4. Complete the wizard, following the on-screen instructions.

The call to the submap takes the following format:

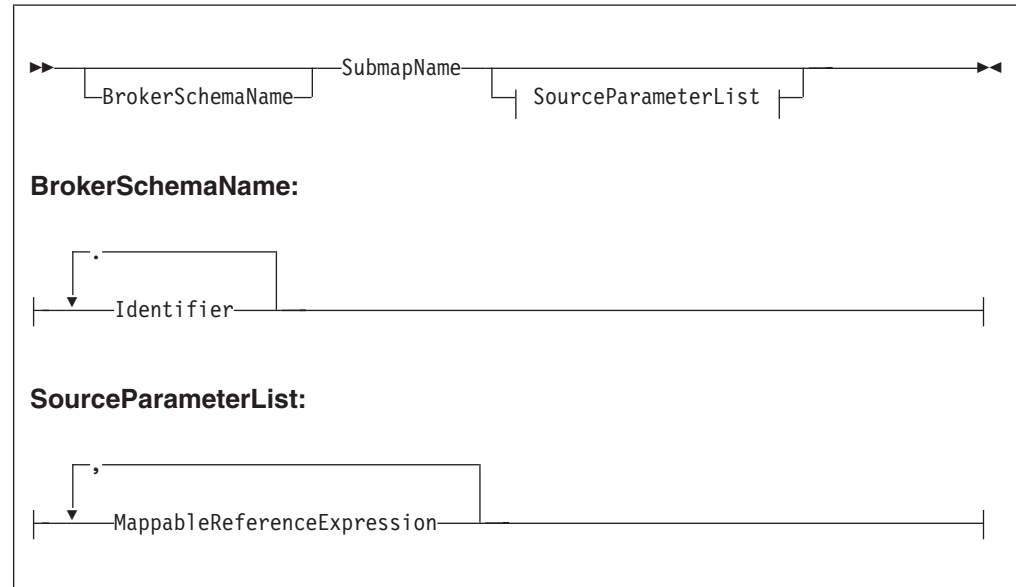

Only source parameters appear in the call and only message parameters appear in the list.

Calling a submap from ESQL:

You can use the Message Mapping editor to perform mappings to a certain level of complexity. To create even more complex mappings, use ESQL. ESQL is particularly suitable for interacting with databases.

If a submap does not already exist, create one.

The following steps describe how to call a submap from ESQL. Calling a submap from ESQL uses different parameters to when you call a submap from another map due to this extra level of complexity (when calling a submap from ESQL, the two local environment parameters are added at the end of the CALL statement).

1. Switch to the Broker Application Development perspective.
2. Right-click a node that supports ESQL and click **Open ESQL**. The ESQL file opens for that node.
3. Add a CALL statement to call a submap. Alternatively, press Ctrl+Space to access ESQL content assist, which provides a drop-down list that includes the submap name and expected parameters.

The following syntax diagram demonstrates the CALL statement:

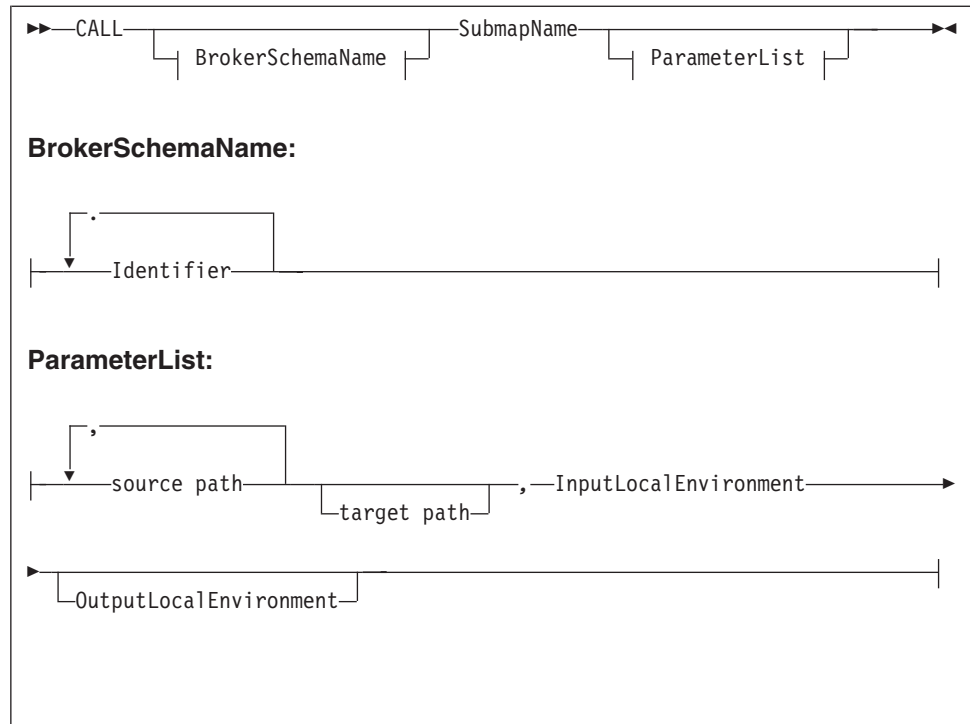

Notes:

1. Only source parameters appear in the call and only message parameters appear in the list.
2. If the submap builds a message target, include the target path and OutputLocalEnvironment parameters. If the submap does not build a message target (for example, if the submap interacts with a database), these two parameters do not appear.

Calling an ESQL routine:

To call an existing ESQL routine from a mapping, select the routine from the Call Existing ESQL Routine wizard. The ESQL routine must already exist in the workspace.

1. Switch to the Broker Application Development perspective.
2. Open the required mapping.
3. In the Source pane, select the required source.
4. In the Target pane, select the required target.
5. Right-click either the Source or Target pane and click **Call ESQL Routine**. The Call ESQL routine wizard opens.
6. Select the routine where the parameters and return types match the source and target selection.
7. Click **OK**.

Creating and calling your own user-defined ESQL routine:

For complex mappings you can create user-defined ESQL functions that can be called from the Message Mapping editor. This topic describes how to create a user-defined ESQL function and how to use it in an existing message map.

1. Switch to the Broker Application Development perspective.
2. Create a new ESQL file, or open an existing ESQL file.

3. Enter your ESQL function in the ESQL file. Ensure that you do not enter the ESQL in any existing modules.
4. Save the ESQL file.
5. Right-click your Mapping node and click **Open Map** to open your message map in the Message Mapping editor.
6. Select the target that you want to generate using your ESQL function from the appropriate target message or target database table.
7. In the Edit pane, enter the expression to call the ESQL function and any parameters to pass to the function. For example:

```
esql:concatValues($source/Pager/Text, ' Powered by IBM.')
```

 Where `concatValues` is the name of the user-defined ESQL function and the following parameters:
 - `$source/Pager/Text` is a field in the source message
 - `' Powered by IBM.'` is text
 The following is the ESQL used for the user-defined ESQL function in the preceding example:

```
CREATE FUNCTION concatValues(IN val INTEGER, IN str CHAR) RETURNS CHAR
  BEGIN
    return str || ' plus int val ' || CAST(val AS CHAR);
  END;
```

 You can also use **Edit** → **Content Assist** to select user-defined ESQL functions. The user-defined ESQL functions are located at the end of the list of ESQL functions.
8. Save the message map file by clicking **File** → **Save**.

Calling a Java method:

To call an existing Java method from a mapping node, select the method from the Call Existing Java Method wizard, or enter an XPath expression in the Edit pane.

See “Message mapping tips and restrictions” on page 512 for information about the type of methods that are available through the wizard, and through content assist.

Using the wizard:

To use the Call Existing Java Method wizard, take the following steps:

1. Switch to the Broker Application Development perspective.
2. Open the required message map.
3. If the method requires input parameters, select one or more fields in the Source pane. Your choice determines which methods are subsequently displayed in the wizard. If you select no source fields, the wizard shows only methods that take no parameter. If you select two fields, the wizard displays only methods that take two parameters, and so on.
4. In the Target pane, select the required target field to be mapped to the return value of the Java method. The target field must be a simple, non-wildcard type.
5. Right-click either the Source or Target pane and click **Call Java Method**. The Call Existing Java Method wizard opens.
6. Select the method and then click **OK**.

Entering an XPath expression:

You can enter the expression directly, without using content assist. Enter a function call expression, with the following syntax:

```
java:package_name.class_name.method_name (parameters)
```

You can omit the package name if there is no package, or you are using a default package.

To use content assist, take the following steps:

1. Switch to the Broker Application Development perspective.
2. Open the required message map.
3. In the Edit pane, click **Edit** → **Content Assist**.
4. Select **java: (Java Methods)**, and then click **Edit** → **Content Assist**. All qualifying Java methods are displayed.
5. Select the method.
6. If the method requires input parameters, drag the appropriate source fields to the method's parameter area. The number of source fields included must match the number of input parameters that the method takes.

This is an example of a method that takes one input parameter:

```
java:mypackage1.MyClass1.myMethod1($source/po:purchaseOrder/po:comment)
```

Separate parameters by a comma:

```
java:mypackage1.MyClass1.myMethod1($source/po:purchaseOrder/name,  
$source/po:purchaseOrder/phone)
```

Transforming a SOAP request message

SOAP is an XML-based language defined by the W3C for sending data between applications. A SOAP message comprises an envelope containing:

- An optional header (containing one or more header blocks)
- A mandatory body.

For common envelope message formats, such as SOAP, where both the envelope and the messages that can appear within that envelope have to be modeled, use the Message Mapping editor to select from available messages at points in the model that are defined with **Composition="message"** and **Content validation="open"** or **"open defined"**.

Define the mappings by selecting from the allowed constituent messages. For example, in the case of SOAP, the outer level message is called Envelope and has one mandatory child element called Body, which is modeled with **Composition="message"**. If the permitted content of Body is modeled by separate messages Msg1 ... MsgN, define mappings for each separate message (Envelope.Body.Msg1 to Envelope.Body.MsgN).

For complex type elements with type composition message, the Message Mapping editor follows these rules:

Content validation	Messages offered
Closed	Messages available in any message sets in the workspace
Open defined	Any message defined within the current message set

Content validation	Messages offered
Open	The Message Mapping editor does not support open or open defined content when the type composition is NOT message

Mapping an embedded message

When you are working with type composition message, with content open or open-defined (and no children defined), map the embedded message using a submap:

1. In the main map, expand the levels (both source and target) of Envelope and Body until you find the wildcard message, and select this on both the source and target sides.
2. Right-click either the source or target and click **Create New Submap**.
3. From the dialog box, select a source (for example reqmess) and a target (for example rspmess).
4. With the submap open in the Message Mapping editor, make the appropriate mappings between the source (reqmess) and target (rspmess).

Editing a default-generated map manually

Sometimes, the map that is generated by the Message Mapping editor does not do everything that you want. If this is the case, there are a number of things that you can change manually. You can edit the structure directly by inserting, moving, copying, pasting, and deleting rows. The context menu provides a list of available editing actions with their keyboard equivalents. Here are some specific operations that you might want to perform:

- “Creating message headers”
- “Creating conditional mappings”

Creating message headers:

When you create a map from a mapping node or if you select the option **Message map called by a message flow node** from the New Message Map wizard, the map that is created allows additional elements including MQ, HTTP, and JMS headers to be mapped.

If you use a Mapping node for a database to message mapping without specifying a source message, the Message Mapping editor cannot generate an output header for the map file that is created. To ensure that an output header is created perform one of the following steps:

- When you create the message map add message headers to the target message and ensure that all mandatory fields in the header are set.
- Add an additional source message to the map. The source message must be the same message as the intended target message. You do not need to create any mappings from the source message because the headers from the source message are automatically copied to the output message tree.

Creating conditional mappings:

When a mapping involves one of the following items:

- schema choice group
- derived type element

- substitution group member
- wildcard
- repeating element

the default mapping that is generated by the Message Mapping editor might be placed under a "condition" statement. If the condition is not what you had expected, edit the statements; here are the changes that you can make:

- Move statements in or out of a conditional block.
- Reorder conditions within an "if" statement.
- Create new conditions inside an "if" statement.
- Create new "if" statements.

See the "Configuring conditional mappings" on page 487 topic for more information about conditional mappings.

Message mapping tips and restrictions

This topic contains information to help you use message mapping.

These tips assume that you have created a mapping node within the message flow, opened the Message Mapping editor, and selected both a source and a target message:

- "Source is a list and target is a list from source, but with a new entry at the top of the list"
- "Change the target message domain"
- "Override the database schema name" on page 513
- "Map batch messages" on page 513
- "Mapping restrictions" on page 514
- "Requirements for calling a Java method" on page 514

Source is a list and target is a list from source, but with a new entry at the top of the list

1. Expand the target to display the element for which you want to create a new first instance. This might be a structure or a simple element.
2. Right-click the element and click **If**. A condition line appears immediately below.
3. Right-click the element and click **Copy**. Move to the condition line and click **Paste**. There are now two entries in the spreadsheet for your element.
4. Set the first of these entries to values of your choice.
5. Right-click the second entry and click **For**. A 'for' line appears in the spreadsheet.
6. Set the second entry to the value or values mapped from the source.
7. Set the 'for' entry to the looping condition.
8. Click **For**, then drag the source field that represents the loop condition to the Expression editor.

Change the target message domain

When you first create a mapping, you nominate a message set for the target message. The parser that is associated with the output message is determined by the Message Domain property of the message set. For example, when a message

set is first created, the default message domain is MRM. Therefore, the Mapping node generates ESQL with the following format:

```
SET OutputRoot.MRM.Fielda...
```

If you change the runtime parser to XMLNSC, for example, the Mapping node generates ESQL with the following format:

```
SET OutputRoot.XMLNSC.MessageA.FieldA...
```

The parser of the source message is determined by the contents of the MQRFH2 header or by the properties of the input node. The Mapping node generates a target message with a parser that matches the message domain of the message set. The Mapping node supports the following message domains:

- MRM
- XMLNSC
- XMLNS
- MIME
- JMSMap
- JMSStream
- XML
- BLOB

To change the message domain property of your message set:

1. Open the message set file messageset.mset.
2. Change the Message Domain property to a supported domain.
3. Save your message set, and save any message flows and message maps that reference your message set, if they have not already been saved. Saving these files generates updated ESQL for mapping the changed message set.

If you have made no updates to your flows or message maps after changing the message domain of your message set, you must clean the related message flow projects so that updated ESQL code can be generated:

- a. Select a project and click **Project** → **Clean Project**.
- b. Select **Clean all projects** or **Clean selected projects**.
- c. Click **OK**.
4. Deploy the changed message set.
5. Deploy the message flow that contains the mappings, and test your ESQL in a Compute node and in other nodes to ensure that the message flow still functions as expected.

Override the database schema name

To change the database schema name that is generated in ESQL, use the Override Database Schema wizard in the Specify Runtime Schema dialog box. The default name is the schema name of the database definitions that are imported into the Message Broker Toolkit. Use the Specify Runtime Schema dialog box to change the value.

Map batch messages

You can configure a message mapping that sorts, orders, and splits the components of a multipart message into a series of batch messages. These components can be

messages or objects, and they can have different formats; in this case, each component is converted and the message is reassembled before being forwarded.

1. Use a “RouteToLabel node” on page 1059 in the message flow to receive multipart messages as input.
The RouteToLabel node is the next node in sequence after the “Mapping node” on page 978, and causes the flow to jump automatically to the specified label. You can specify a single RouteToLabel value in a splitting map for all maps that output a message assembly. You can also use conditions to set the RouteToLabel value, depending on the values in the source message.
2. Use the “Message Mapping editor” on page 1410 to build maps that transform and propagate batch messages using a single node, without having to define an intermediate data structure.

Multipart messages can also contain repeating embedded messages, where each repeated instance of a message is propagated separately. Embedded messages must be from the same message set as the parent message.

Mapping restrictions

Unless stated explicitly, you can achieve the required functionality by calling an ESQL function or procedure. The following restrictions apply:

- Mixed content fields cannot be mapped.
- Exceptions cannot be thrown directly in mapping nodes.
- Self-defined elements cannot be manipulated in mapping nodes (support for wildcards is limited if the wildcards represent embedded messages).
- The Environment tree cannot be manipulated in the Mapping node.
- User variables cannot be defined or set.
- CASE expressions cannot be emulated; you must use IF ... ELSE.
- Trees cannot be copied from input to output in order to modify elements within the copied tree. For example, the following ESQL cannot be modeled in a Mapping node:

```
SET OutputRoot.MQMD = InputRoot.MQMD; SET OutputRoot.MQMD.ReplyToQ = 'NEW.QUEUE';
```

You must set each field in the structure individually if you intend to modify one or more sibling fields.

Requirements for calling a Java method

All of the following conditions must be satisfied for the method to be shown in the Call Existing Java Method wizard, or in content assist:

- The method must be public static, in a Java project.
- The default scope of the search is all methods in .java source files in the workspace, excluding application libraries and application JAR files in the Java build path, and all the JRE system libraries. To change the scope, change the preferences in the Toolkit:
 1. Click **Window** → **Preferences**.
 2. Expand the **Broker Development** node, and then click **Message Map Editor**.
 3. Select and clear the check boxes as appropriate.
- The method must have a return value.
- Return values and Java parameters must be one of the following data types:

Data types	Equivalent XML schema type for mapping	Comments
java.lang.Long	byte, unsignedShort, long, unsignedByte, short, int, unsignedInt	
java.lang.Double	float, double	
java.math.BigDecimal	nonNegativeInteger, negativeInteger, integer, nonPositiveInteger, positiveInteger, unsignedLong, decimal	
java.lang.String	NCName, Name, IDREF, normalizedString, string, anyURI, NOTATION, token, NMTOKEN, language, ID, ENTITIES, QName, ENTITY	
byte[]	base64Binary, hexBinary	
com.ibm.broker.plugin.MbDate	date, gYear, gMonth, gDay, gYearMonth, gMonthDay	
com.ibm.broker.plugin.MbTime	time	
com.ibm.broker.plugin.MbTimestamp	dateTime	
java.lang.Boolean	boolean	
com.ibm.broker.plugin.MbElement	A complex type	Valid only for input parameters, not return values.

- The method must not have a throws clause.
- The number of source fields selected must match the number of input parameters that the method takes.
- If you are using a working set, only the methods in the current working set are displayed. Select the check box **Show all resources in workspace** to display all the methods in the workspace. If you are not using a working set, all the methods in the entire workspace are displayed. Content assist shows all methods in the workspace, whether you are using a working set or not.

When you create the bar file you must select the Java project or JAR file that contains the method that you are calling.

Message mapping scenarios

This section contains some message mapping scenarios that demonstrate how to make the most of the message mapping functions:

- “Scenario A: Mapping an airline message”
- “Scenario B: Simple message enrichment” on page 524
- “Scenario C: Using a broker as auditor” on page 530
- “Scenario D: Complex message enrichment” on page 534
- “Scenario E: Resolving a choice with alternative message data” on page 552
- “Scenario F: Updating the value of a message element” on page 553

Scenario A: Mapping an airline message

This scenario demonstrates how to create, configure, and deploy a new message mapping. The message flow that is used in this example reads an XML input message (an airline message), then uses a Mapping node to achieve the following transformations:

- Convert the input message from XML to COBOL

- Modify an element in the input message from the results that are obtained by a database lookup
- Concatenate two elements in the input message to form a single element in the output message

Here are the steps that are involved in this scenario:

1. "Example names and values"
2. "Connect to the database and obtain the definition files" on page 518
3. "Create the message flow" on page 519
4. "Create the mapping file" on page 519
5. "Configure the mapping file" on page 520
6. "Deploy the mapping" on page 523

Now go to "Example names and values."

Example names and values:

View the resources that are created for the airline message scenario.

The following table describes the names and definitions of the resources that are created.

Resource	Name	Definition
Airline state codes database table file	.tblxmi file	Contains the database table that holds the two-character airline state codes (for example, IL for Illinois)
Alias name	AIRLINEDBALIAS	The same as connection name and database name in this case
Broker archive (bar) file name	AIRLINE	Contains the message flow and message set projects, and the mapping file, and is deployed to the default execution group for the run time
COBOL copybook	AirlineRequest.cbl	Controls the structure of the COBOL output message
Connection name	AIRLINECONN	The same as alias name and connection name in this case
Database	AIRLINEDB	Contains the table XREF and is the same as the connection name and the alias name in this case
Database table (table tree)	XREF	Contains lookup information (in this case the two-code airline city code abbreviations STATE=Illinois, ABBREV=IL)
Default project	AIRLINE_MFP	The default message flow project. You copy the database definitions to this project.
Default queue manager	WBRK6_DEFAULT_QUEUE_MANAGER	The default queue manager that controls the message queue
ESQL select operation	\$db:select.AIRLINEDB.AIRLINE_SCHEMTREE.XREF.ABBERV	The ESQL select operation that performs a qualified database select operation
Input (XML) message	c:\airline\data\AirlineRequest.xml	The input message (in this case an XML message)

Resource	Name	Definition
Input message source fields	FirstName,LastName	The source elements in the input message that are concatenated
Input queue name property	AIRLINE_Mapping_IN	The input queue
Mapping node rename	XML_TO_COBOL	The name of the node in the message flow that performs the mapping (the node was renamed from its default name)
Message mapping file name	AIRLINE.msgmap	The file that contains the mapping configuration used by the Mapping node
Message Set property	AIRLINE_MSP2	The message set project name
Message Type property	msg_AIRLINEREQUEST	The message type
Message Format	CWF1	The custom wire format (CWF) for COBOL output message
Message flow name	AIRLINE_Mapping	The name of the message flow
Message flow project	AIRLINE_MFP	The name of the message flow project
Message set projects	AIRLINE_MSP1,AIRLINE_MSP2	The names of the message set projects
Msg Domain node property	MRM	The message domain node property
Msg Set Name node property	AIRLINE_MSP1	The message set name node property
Msg Type property	AirlineRequest	The message type property
Msg Format node property	XML1	The input message format
Output message target field	NAME	The result of concatenating FirstName and LastName in the input message. NAME is the element that is created in the output message.
Output queue name property	AIRLINE_Mapping_OUT	The output queue name
Resource folder	airline\resources	The folder where the mapping resources are stored
Schema tree	AIRLINE_SCHEMTREE	The name of the schema tree
Source	ABBREV	The source
Source tree	\$source/AirlineRequest	The source tree
Source message	AirlineRequest	The source message
Target	STATE	The target
Target message	AIRLINEREQUEST	The target message
Target tree	\$target/AIRLINEREQUEST	The target tree

Resource	Name	Definition
XPath concatenation function	<code>fn:concat(fn:concat(\$source/AirlineRequest/Purchase/Customer/FirstName, ' '), \$source/AirlineRequest/Purchase/Customer/LastName)</code>	The XPath function that concatenates FirstName and LastName

Now go to “Connect to the database and obtain the definition files.”

Connect to the database and obtain the definition files:

Before you start:

Create a message flow project.

This topic demonstrates how to define a database connection to enable a message flow to access a database table. The database must be defined to the Message Broker Toolkit.

The Database Definition Wizard uses the JDBC interface to communicate with the database server, so you need to ensure that the database client jar file on your local or workbench host is at a compatible level to allow communication with the database server. If necessary, consult your database vendor for further advice.

1. Switch to the Broker Application Development perspective.
2. Select the message flow project you want to create the database definition files in and click **File** → **New** → **Database Definition**. The New Database Definition File wizard opens.
3. Select an existing Data design project or click **New** to create a new Data design project.
4. Select the database type and version that you want to connect to from the Database and Version list.
5. Click **Next**.
6. Select to create a new database connection and click **Next**.
7. Clear the Use default naming convention check box, and enter a connection name, for example AIRLINEDBALIAS.
8. Enter values for the Connection to the database, for example, Database name, Host name and Port number.
9. Enter values for the User ID and Password to connect to the database. You can use the **Test Connection** button to verify the settings you have selected for your database. The default Port number for a DB2 database is 50000. If the connection fails, you can try to enter other values such as 50001, 50002 and so on, for the Port number, and then test the connection again.
10. Click **Next**.
11. Select one or more database schemas from the list and click **Next**.
12. Click **Finish**.
13. Add the data design project as a reference to the message flow project:
 - a. Right-click on the message flow project and click **Properties**.
 - b. Click **Project References**, and select the data design project from the list to add as a referenced project.
 - c. Click **OK**.

The database definition is added to a new Data design project. You have now defined the database to the mapping tools.

Now go to “Create the message flow.”

Create the message flow:

Before you start:

1. Create a message flow project.
2. “Connect to the database and obtain the definition files” on page 518.
3. Create a message flow by adding an MQInput node, and renaming the node (for example, to AIRLINE_Mapping_IN).
4. Set the queue name property (for example, to AIRLINE_Mapping_IN).
5. Add an MQOutput node to the message flow, and rename the node (for example, to AIRLINE_Mapping_OUT).

This topic demonstrates how to specify a message flow project, add a Mapping node, wire the nodes, and set the node properties.

1. Switch to the Broker Application Development perspective.
2. Open the message flow (for example, AIRLINE_Mapping) within the message flow project (for example, AIRLINE_MFP). This message flow forms the starting point for the mapping task.
3. Open the palette of nodes and add a Mapping node to the message flow. You might need to scroll down to find the Mapping node.
4. Rename the Mapping node (for example, to XML_TO_COBOL) by right-clicking the node and clicking **Rename**.
5. Wire the node terminals (for example, AIRLINE_Mapping_IN> XML_TO_COBOL> AIRLINE_Mapping_OUT).
6. Modify the properties of the MQInput node (for example, AIRLINE_Mapping_IN) by right-clicking the node and clicking **Properties**.
7. Click **OK**.
8. Modify the properties of the Mapping node (for example, XML_TO_COBOL).
9. Set the data source as the database name (for example, AIRLINEDBALIAS)
10. Click **OK**.

You have now created the required message flow, wired the nodes, and set the node properties.

Now go to “Create the mapping file.”

Create the mapping file:

Before you start:

Follow the instructions in these topics:

1. “Connect to the database and obtain the definition files” on page 518
2. “Create the message flow”

This topic demonstrates how to create a new mapping file, specify how it will be used, and specify the source and target mappable elements.

1. Switch to the Broker Application Development perspective.

2. From the message flow, right-click the mapping node (for example XML_TO_COBOL) and click **Open Map**. The New Message Map wizard opens.
3. Select the combination of Messages, Data Sources or both that you want to use as sources for your map from **Select map sources** (for example, AirlineRequest) from the first message set project (for example, AIRLINE_MSP1). If you cannot find the Messages, Data Sources or Data Targets that you expect, select the **Show all resources in workspace** check box.
4. Select the combination of Messages, Data Targets or both that you want to use as targets for your map from **Select map targets** (for example, AIRLINEREQUEST) from the second message set project (for example, AIRLINE_MSP2).
5. Click **Finish**.

You have now created the mapping file, defined its usage, and specified the source and target mappable elements.

Now go to “Configure the mapping file.”

Configure the mapping file:

Before you start:

Follow the instructions in these topics:

1. “Connect to the database and obtain the definition files” on page 518
2. “Create the message flow” on page 519
3. “Create the mapping file” on page 519

This set of topics demonstrates how to configure the mapping file by:

1. Specifying a data source
2. Mapping the message properties
3. Writing an XPath function that concatenates the elements in the input message
4. Specifying an ESQL select command

Now go to “Specify the data source.”

Specify the data source:

Before you start:

Follow the instructions in these topics:

1. “Connect to the database and obtain the definition files” on page 518
2. “Create the message flow” on page 519
3. “Create the mapping file” on page 519

This topic demonstrates how to specify the database to use as the source for the mapping.

1. From the Message Mapping editor Spreadsheet pane, select an item. The item that you select determines the scope of the \$db:select entry that is created by the action. For example, you can select \$target, an element, an attribute, a For condition, or another \$db:select entry. The Select database as mapping source dialog box opens.
2. Right-click and click **Select data source**.

3. From the Select Database as mapping source page, select a database (for example, AIRLINEDB) and click **Finish**. The Message Mapping editor adds the sources of the database table (for example, the XREF table) to the tree in the Message Mapping editor Source pane.

You have now added the data source to the Message Mapping editor Source pane.

Now go to “Map the message properties.”

Map the message properties:

This topic demonstrates how to map the message set, message type and message format properties.

Before you map the message properties, ensure you do the following:

1. “Connect to the database and obtain the definition files” on page 518
2. “Create the message flow” on page 519
3. “Create the mapping file” on page 519
4. “Specify the data source” on page 520

To map the message properties:

1. From the Message Mapping editor Spreadsheet pane, expand the entries by clicking + to reveal the message properties.
2. Right-click \$target and click **Populate**.
3. Right-click Properties and click **Populate**. The MessageSet, MessageType and MessageFormat properties contain default values for the target message.
4. To change the format of the output message, change the MessageFormat property to the appropriate value. You must use quotation marks around the value of MessageFormat, because the values are string literals and without quotation marks, the values will be interpreted as XPath locations.
5. From the Message Mapping editor Source pane, expand the properties for the \$source tree, and for each remaining property, map the source element to its corresponding target element by dragging from source to target. Alternatively, select Properties in both the source and the target panes and use **Map by Name** to map all of the properties.
6. Save the map by clicking **File** → **Save**.

You have now mapped message set, message type and message format properties.

Now go to “Add the XPath concatenate function.”

Add the XPath concatenate function:

Before you start:

Follow the instructions in these topics:

1. “Connect to the database and obtain the definition files” on page 518
2. “Create the message flow” on page 519
3. “Create the mapping file” on page 519
4. “Specify the data source” on page 520
5. “Map the message properties”

This topic demonstrates how to write an XPath function that concatenates the FirstName and LastName from the input message, and adds a white space separator in the target NAME element. When you add the XPath expression and save the map, link lines are automatically generated between the source and target to indicate that these elements are mapped.

1. From the Message Mapping editor Source pane, select the first source to concatenate (for example, FirstName), Ctrl+click to select the second source to concatenate (for example, LastName), and drag both elements onto the target (for example, NAME) in the Target pane.
2. From the Message Mapping editor Spreadsheet pane, select the target (for example, NAME).
3. From the Edit pane, enter the XPath function (for example, `fn:concat($source/AirlineRequest/Purchase/Customer/FirstName, ' ', $source/AirlineRequest/Purchase/Customer/LastName)`
4. Save the map by clicking **File** → **Save**.

You have now added an XPath function that concatenates the two source elements in the input message into a single target element in the output message.

Now go to “Add the database Select operation.”

Add the database Select operation:

Before you start:

Follow the instructions in these topics:

1. “Connect to the database and obtain the definition files” on page 518
2. “Create the message flow” on page 519
3. “Create the mapping file” on page 519
4. “Specify the data source” on page 520
5. “Map the message properties” on page 521
6. “Add the XPath concatenate function” on page 521

This topic provides instructions on how to add a database select operation that makes a qualified selection from a data source. In the spreadsheet pane the `$db:select` statement has the default value `fn:true()`, which returns all entries in the table. You must therefore replace this value with one that qualifies the selection, for example:

```
$db:select.LAB13STA.ARGOSTR.XREF.STATE=$source/AirlineRequest/Purchase/Customer/State
```

The XPath in this example selects only the records from the database where the value in the STATE column for each record matches the value of the State field from the input message. In the spreadsheet pane the `$db:select` statement is associated with a For entry which is used to iterate over the mappings for the target message. For each row in the database matching the `$db:select` statement a separate target message is created with the mappings beneath `$target`.

The following steps describe how to create message mappings to generate a target message based on records in a database matching the contents of an input message:

1. In the spreadsheet pane replace the existing value `fn:true()` with the value to match in the database (for example a field in the input message as shown in the preceding example).

2. Create mappings from the database fields in the Source pane to include in the target message, by dragging them from the source pane onto the target elements. A `$db:select` statement is added to the value column in the spreadsheet pane (for example, `$db:select.AIRLINEDB.AIRLINE_SCHEMTREE.XREF.ABBREV`).
3. Create any mappings you require from the source message to the target message.
4. Save the mapping by clicking **File** → **Save**.
5. Save the message flow.
6. Check for any errors in the Problems view.

You have now made a qualified selection from the database.

Now go to “Deploy the mapping.”

Deploy the mapping:

Before you start:

Follow the instructions in these topics:

1. “Connect to the database and obtain the definition files” on page 518
2. “Create the message flow” on page 519
3. “Create the mapping file” on page 519
4. “Configure the mapping file” on page 520

This topic demonstrates how to deploy the mapping to the run time by creating a broker archive (bar) file, which contains the message flow and message set projects (including the mapping file), then deploying the bar file to the default execution group.

1. From the Broker Administration perspective, right-click the project under the Broker Archives heading.
2. Click **New** → **Message Broker Archive**.
3. Name the bar file (for example, AIRLINE).
4. Click **Add to**. The Add to broker archive page is displayed.
5. Select the message flow project and message set projects that are used by this flow (for example, AIRLINE_MFP, AIRLINE_MSP1, AIRLINE_MSP2) and click **OK**. The projects are added to the bar file. A status indicator and message panel show when the process is complete.
6. Check to ensure that the required projects have been included in the bar file.
7. Save the bar file by clicking **File** → **Save**.
8. To deploy the bar file, right-click the bar file and click **Deploy File**. The Deploy a bar file page is displayed.
9. Select the default execution group, and click **OK**. A message in the Broker Administration message dialog box indicates successful deployment, and the deployed message flow project and message set projects appear in the Domains view. A message in the Event log also indicates successful deployment.

You have completed this scenario.

Scenario B: Simple message enrichment

This scenario demonstrates simple message enrichment and uses the Message Broker Toolkit to create message flows and message sets, and to create and deploy broker archive (bar) files. The scenario also involves creating a Configuration Manager and a broker, and inputting instance messages that can contain MQRFH2 headers.

This scenario uses repeating instances and requires the following mapping functions:

- MRM in, MRM out (non-namespace)
- Map a simple and Complex element source - target
- Map the same element source - target
- Map a different element source - target
- Map an attribute source - target
- Map a one-sided element (edit mapping)
- Map a one-sided attribute (edit mapping)
- Perform arithmetic on numeric field mapping
- Map a repeating simple element - single instance
- Map all instances of a repeating simple element
- No MQRFH2 header

The names and values used for message flows, message sets, elements and attributes, and the expressions and code samples are for illustrative purposes only.

Here are the steps that are involved in this scenario:

1. “Develop a message flow and message model for simple and complex element mapping”
2. “Develop a message flow and message model for a target-only element” on page 526
3. “Develop a message flow and message model for dealing with repeating elements” on page 527
4. “Develop a message flow and message model for a simple message without an MQRFH2 header” on page 529

Develop a message flow and message model for simple and complex element mapping:

This is the first stage of the scenario to perform simple message enrichment. This topic demonstrates how to develop a message flow and message model for simple and complex element mapping, where there is the same source and target, a different source and target, or an attribute source and target. This task also involves changing field values and creating an instance document.

1. From the Broker Application Development perspective, create the following resources:
 - a. a message set project (for more details, see Creating a message set).
 - b. a message set called MAPPING3_SIMPLE_messages. Ensure that the message set is namespace enabled with XML wire format.
 - c. a message definition file (no target namespace) called SIMPLE.
2. Create a message called addev1 that has the following structure:

```
addev1
    ssat          (xsd:string) local attribute
    ssel          (xsd:string) local element
```

```

dsel1      (xsd:string) local element
atel       local complex element
  latt     (xsd:string) attribute
cell1      local complex element
  intel    (xsd:int) local element
  stre1    (xsd:string) local element
dsel2      (xsd:string) global element
cel2       (cel2ct) global complex type
  intel    (xsd:int) local element
  fltel    (xsd:float) local element

```

3. Create a message flow project called MAPPING3_SIMPLE_flows.
4. Create a message flow called addev1 that contains the following mapping: MQInput -> Mapping -> MQOutput.
5. Open the map in the Message Mapping editor and select message addev1 as both source and target
6. Expand all levels of both messages and wire the elements as shown:

```

ssat --- ssat
ssel --- ssel
dsel1 -- dsel2
latt ---- latt
cell1 --- cell1
dsel2 -- dsel1
(cel2)
  intel ---- fltel
  fltel ---- intel

```

7. In the Spreadsheet pane, set the following expression:

```

dsel1 | esql:upper($source/addev1/dsel2)
@latt | esql:upper($source/addev1/atel/@latt)
(cel2)
  intel | $source/addev1/cel2/fltel + 10
  fltel | $source/addev1/cel2/intel div 10

```

8. Create an instance document with the appropriate RFH2 header and the following data:

```

<addev1 ssatt="hello">
<ssel>this</ssel>
<dsel1>first</dsel1>
<atel latt="attrib"/>
<cell1>
<intel>2</intel>
<stre1>lcomp</stre1>
</cell1>
<dsel2>second</dsel2>
<cel2>
<intel>252</intel>
<fltel>3.89E+1</fltel>
</cel2>
</addev1>

```

You have created the following resources:

- message set MAPPING3_SIMPLE_messages, which you have populated with message addev1
- message flow addev1 in project MAPPING3_SIMPLE_flows, which contains the mapping addev1_Mapping.msgmap
- a file that contains an instance message

Now deploy the message set and message flow.

Deploy the message set and message flow:

This is the second stage of the scenario to perform simple message enrichment. This topic demonstrates how to deploy the message set and message flow and run the data through the broker.

1. Create a broker archive (bar) file called addev1.
2. Add the message set MAPPING3_SIMPLE_messages and the message flow addev1 to the bar file.
3. Deploy the bar file to the broker.
4. Put the instance document on the input queue.

The output message looks like this:

```
<addev1 ssat="hello">
<sse1>this</sse1>
<dse1>SECOND</dse1>
<ate1 latt="ATTRIB"/>
<cel1>
<intel>2</intel>
<stre1>lcomp</stre1>
</cel1>
<dse12>first</dse12>
<cel2>
<intel>48</intel>
<fltel>2.5E+1</fltel>
</cel2>
</addev1>
```

Now go to “Develop a message flow and message model for a target-only element.”

Develop a message flow and message model for a target-only element:

Before you start

Perform the steps in the following topic:

1. “Develop a message flow and message model for simple and complex element mapping” on page 524

This is the third stage of the scenario to perform simple message enrichment. This topic demonstrates how to develop a message flow and message model for a target-only element. It also involves attributing a mapping and creating an instance document.

1. Create a message called addev2, which has the following structure:

```
addev2
  matt          (xsd:string) local attribute
  sse1          (xsd:string) local element
  cse1          local complex element
  elatt        (xsd:string) local attribute
```

2. Create a second message called trigger, which has the following structure:

```
trigger
  start          (xsd:string) local element
```

3. Create a message flow called addev2, which contains the following mapping: MQInput -> Mapping -> MQOutput.
4. Open the map and select trigger as the source and addev2 as the target.
5. In the Spreadsheet pane, expand the target message fully and set the target fields as shown:

```
matt | 'first attribute'
ssel | 'string element'
elatt | 'second attribute'
```

6. Expand the Properties folder in the Spreadsheet pane and set the following value:

```
MessageType | 'addev2'
```

7. Create an instance document with the appropriate RFH2 header and the following data:

```
<trigger>
<start>yes</start>
</trigger>
```

You have created the following resources:

- two messages called addev2 and trigger
- a message flow called addev2, which contains the mapping addev2_Mapping.msgmap
- a file that contains an instance message

Now deploy the message set and message flow.

Deploy the message set and message flow:

This is the fourth stage of the scenario to perform simple message enrichment. This topic demonstrates how to deploy the message set and message flow and run the data through the broker.

1. Create a broker archive (bar) file called addev2.
2. Add the message set MAPPING3_SIMPLE_messages and the message flow addev2 to the bar file.
3. Deploy the bar file to the broker.
4. Put the instance document on the input queue.

The output message looks like this:

```
<addev2 matt="first attribute">
<ssel>string element</ssel>
<csel elatt="second attribute"></csel>
</addev2>
```

Now go to “Develop a message flow and message model for dealing with repeating elements.”

Develop a message flow and message model for dealing with repeating elements:

Before you start

Perform the steps in the following topics:

1. “Develop a message flow and message model for simple and complex element mapping” on page 524
2. “Develop a message flow and message model for a target-only element” on page 526

This is the fifth stage of the scenario to perform simple message enrichment. This topic demonstrates how to develop a message flow and message model for dealing with repeating elements, a single instance and all instances.

1. Create a message called addev3, which has the following structure:

```

addev3
  frepstr      (xsd:string) local element, minOccurs=3, maxOccurs=3
  vrepstr      (xsd:string) local element, minOccurs=1, maxOccurs=4
  urepstr      (xsd:string) local element, minOccurs=1, maxOccurs=-1

```

2. Create a message flow called `addev3`, which contains the following mapping: MQInput -> Mapping -> MQOutput.
3. Open the map and select `addev3` as both source and target
4. In the upper pane, map each source to the corresponding target, as illustrated in this example:

```

frepstr --- frepstr
vrepstr --- vrepstr
urepstr --- urepstr

```

5. In the Spreadsheet pane, expand fully the target `addev3`.
6. Highlight and delete the For item above the `vrepstr` entry.
7. Create an instance message with the appropriate RFH2 header and the following data:

```

<addev3>
<frepstr>this</frepstr>
<frepstr>that</frepstr>
<frepstr>other</frepstr>
<vrepstr>only one</vrepstr>
<vrepstr>extra</vrepstr>
<urepstr>first</urepstr>
<urepstr>second</urepstr>
<urepstr>third</urepstr>
<urepstr>fourth</urepstr>
<urepstr>fifth</urepstr>
</addev3>

```

You have created the following resources:

- a message called `addev3`
- a message flow called `addev3`, which contains the mapping `addev3_Mapping.msgmap`
- a file that contains an instance message

Now deploy the message set and message flow.

Deploy the message set and message flow:

This is the sixth stage of the scenario to perform simple message enrichment. This topic demonstrates how to deploy the message set and message flow and run the data through the broker.

1. Create a broker archive (bar) file called `addev3`.
2. Add the message set `MAPPING3_SIMPLE_messages` and the message flow `addev3` to the bar file.
3. Deploy the bar file to the broker.
4. Put the instance document on the input queue.

The output message looks like this:

```

<addev3>
<frepstr>this</frepstr>
<frepstr>that</frepstr>
<frepstr>other</frepstr>
<vrepstr>only one</vrepstr>
<urepstr>first</urepstr>
<urepstr>second</urepstr>

```



```

<urepstr>third</urepstr>
<urepstr>fourth</urepstr>
<urepstr>fifth</urepstr>
</addev3>

```

Now go to “Develop a message flow and message model for a simple message without an MQRFH2 header.”

Develop a message flow and message model for a simple message without an MQRFH2 header:

Before you start

You must complete the following tasks:

1. “Develop a message flow and message model for simple and complex element mapping” on page 524
2. “Develop a message flow and message model for a target-only element” on page 526
3. “Develop a message flow and message model for dealing with repeating elements” on page 527

This is the seventh stage of the scenario to perform simple message enrichment. This topic demonstrates how to develop a message flow and message model for a simple message without an MQRFH2 header.

1. Create a message set called MAPPING3_SIMPLE_xml. A message set project is also automatically created; this message set project has the same name as the message set that you created.
2. On the message set parameters page, set the *Message Domain* property to XML.
3. Create a message definition file called SIMPLE.
4. Create a message called addev4 that has the following structure:

```

addev4
  str1          (xsd:string) local element
  cel          local complex element
    int1       (xsd:int) local element
    bool1     (xsd:boolean) local element

```

5. Create a message flow called addev4 that contains the following connected nodes: MQInput -> Mapping -> MQOutput.
6. Select the Input Message Parsing properties tab of the MQInput node, and set the *Message Domain* property to XML.
7. Open the map and select addev4 as both source and target.
8. Map the inputs to the corresponding outputs, as shown in this example:

```

str1 --- str1
int1 --- int1
bool1 --- bool1

```

9. Create an instance message that has no MQRFH2 header, but contains the following data:

```

<addev4>
<str1>this</str1>
<cel>
<int1>452</int1>
<bool1>0</bool1>
</cel>
</addev4>

```

You have created the following resources:

- A message set called MAPPING3_SIMPLE_xml that contains the message addev4
- A message flow called addev4 that contains the mapping addev4_Mapping.msgmap
- A file that contains an instance message

Now deploy the message set and message flow.

Deploy the message set and message flow:

This is the final stage of the scenario to perform simple message enrichment. This section describes how to deploy the message set and message flow, and how to run the data through the broker.

1. Create a broker archive (bar) file called addev4.
2. Add the message flow called addev4 to the bar file.
3. Deploy the bar file to the broker.
4. Put the instance document on the input queue.

The output message has the following content:

```
<addev4>
<str1>this</str1>
<ce1>
<int1>452</int1>
<bool1>0</bool1>
</ce1>
</addev4>
```

You have completed the scenario.

Scenario C: Using a broker as auditor

This scenario demonstrates how to use a broker as an auditor and uses the Message Broker Toolkit to create message flows and message sets, and to create and deploy broker archive (bar) files. It also involves creating a Configuration Manager and a broker, and inputting instance messages that can contain MQRFH2 headers.

The scenario uses database updates that have been defined using mappings. The broker receives a confirmation for a provisional booking, the message flow inserts a row into a database table representing the confirmation, updates a counter in another table representing the key of the confirmation, and deletes the provisional booking from a third table.

This scenario uses the DataDelete, DataInsert and DataUpdate nodes in the message flow, and requires the following mapping functions:

- Mapping in DataInsert node
- Combine input data into single insert
- Mapping in DataUpdate node
- Mapping in DataDelete node
- Bar file to override datasource

The names and values used for message flows, message sets, elements and attributes, and the expressions and code samples are for illustrative purposes only.

Here are the steps that are involved in this scenario:

1. "Develop a message flow" on page 531

2. "Deploy the message set and message flow" on page 532
3. "Override the data source of one of the nodes" on page 533
4. "Create a bar file, edit the configuration and deploy" on page 533

Develop a message flow:

This is the first stage of the scenario to use a broker as an auditor. This topic demonstrates how to develop a message flow to map several fields of input data into a single insert record for a database. It also involves updating another table and deleting a third table, as well as developing corresponding message models and instance messages.

1. Create a database called MAPDB and a table called CONFIRMATION, which contains the following columns:

RESID	INTEGER
-------	---------

2. Populate the CONFIRMATION table with the value shown:

9052

3. Create another table called RESERVATION, which contains the following columns:

RESID	INTEGER
NAME	VARCHAR(20)
PARTY	INTEGER
PAYMENT	DECIMAL(8,2)

4. Populate the RESERVATION table with the values shown:

8214, 'ARCHIBALD', 2, 0.0
 2618, 'HENRY', 4, 120.0
 9052, 'THAW', 3, 85.0

5. Create another table called PROVISIONAL, which contains the following columns:

RESID	INTEGER
-------	---------

6. Populate the PROVISIONAL table with the values shown:

8214 2618

7. Create a Windows ODBC Data Source Name for the database, and then create a definition for the database in the workbench by clicking **File** → **New** → **Database Definition File**.

8. Create a message set project and a message set called MAPPING3_AUDIT_messages (ensuring that the message set is namespace enabled, with XML wire format) and create a message definition file called AUDIT.

9. Create a message called addev1, which has the structure:

```
addev1
  id          (xsd:int) local element
  status      (xsd:string) local element
  name        (xsd:string) local element
  size        (xsd:int) local element
  payment     (xsd:decimal) local element
```

10. Create a message flow project called MAPPING3_AUDIT_flows.
11. Create a message flow called addev1, which contains the following mapping: MQInput -> DataInsert -> DataUpdate -> DataDelete -> MQOutput.
12. For the DataInsert node, set the Data Source property to MAPDB.
13. Open the mapping for the DataInsert node and select MAPPING3_AUDIT_messages addev1 as the source, and MAPDB.SCHEMA.CONFIRMATION as the target.
14. Wire the source to the target as shown:

```

addev1          MAPDB
  id ----- RESID

```

15. For the DataUpdate node, set the Data Source property to MAPDB.
16. Open the mapping for the DataUpdate node and select MAPPING3_AUDIT_messages addev1 as the source, and MAPDB.SCHEMA.RESERVATION as the target.
17. Wire the source to the target as shown:

```

addev1          MAPDB
  id ----- RESID
  name ----- NAME
  size ----- PARTY
  payment ----- PAYMENT

```

18. In the Spreadsheet pane, select \$db:update and change fn:true() to \$db:update.MAPDB.MQSI.RESERVATION.RESID = \$source/addev1/id and \$source/addev1/status = 'CONFIRM'.
19. For the DataDelete node, set the Data Source property to MAPDB.
20. Open the mapping for the DataDelete node and select MAPPING3_AUDIT_messages addev1 as the source, and MAPDB.SCHEMA.PROVISIONAL as the target.
21. In the Spreadsheet pane, select \$db:delete and change fn:false() to \$db:delete.MAPDB.MQSI.PROVISIONAL.RESID = \$source/addev1/id.
22. Create the following instance message with appropriate RFH2 headers:

```

<addev1>
<id>8214</id>
<status>CONFIRM</status>
<name>ARCHIBALD</name>
<size>2</size>
<payment>1038.0</payment>
</addev1>

```

You have created the following resources:

- a message set called MAPPING3_AUDIT_messages, which is populated with the message addev1
- a message flow called addev1 in project MAPPING3_AUDIT_flows, which contains the mapping files addev1_DataInsert.msgmap, addev1_DataUpdate.msgmap, and addev1_DataDelete.msgmap
- the database MAPDB with populated tables CONFIRMATION, RESERVATION, and PROVISIONAL
- a file that contains an instance message for test.

Now go to “Deploy the message set and message flow.”

Deploy the message set and message flow:

Before you start

Perform the steps in the topic “Develop a message flow” on page 531.

This is the second stage of the scenario to use a broker as an auditor. This topic demonstrates how to deploy the message set and message flow and run the instance messages through the broker.

1. Create a bar file called addev1.
2. Add the message set MAPPING3_AUDIT_messages and the message flow addev1 to the bar file.

3. Deploy the bar file to the broker.
4. Put the instance document on the input queue.

The output messages are the same as the input. Database table contents look like this:

```
CONFIRMATION
RESID
-----
      9052
      8214

RESERVATION
RESID      NAME                PARTY      PAYMENT
-----
      8214 ARCHIBALD                2      1038.00
      2618 HENRY                    4       120.00
      9052 THAW                      3        85.00

PROVISIONAL
RESID
-----
      2618
```

Now go to “Override the data source of one of the nodes.”

Override the data source of one of the nodes:

Before you start

Perform the steps in the following topics:

1. “Develop a message flow” on page 531
2. “Deploy the message set and message flow” on page 532

This is the third stage of the scenario to use a broker as an auditor. This topic demonstrates how to override the data source of one of the nodes by changing the configuration of its broker archive (bar) file.

1. Create a database called ALTDB, and a table called CONFIRMATION, which contains the following columns:
RESID INTEGER
2. Create a Windows ODBC Data Source Name for the database, then register the database with the Configuration Manager by clicking **File** → **New** → **Database Definition File**.

You have created a database called ALTDB with a table called CONFIRMATION.

Now go to “Create a bar file, edit the configuration and deploy.”

Create a bar file, edit the configuration and deploy:

Before you start

Perform the steps in the following topics:

1. “Develop a message flow” on page 531
2. “Deploy the message set and message flow” on page 532
3. “Override the data source of one of the nodes”

This is the final stage of the scenario to use a broker as an auditor. This topic demonstrates how to create a broker archive (bar) file, edit the configuration and deploy.

1. Add the message flow addev1 to the bar file again.
2. Select the Configure tab of the bar file editor and click the DataInsert icon.
3. Change the Data Source field from MAPDB to ALTDB, and save the bar file.
4. Deploy the bar file to the broker.
5. Put the instance document on the input queue.

The output message is the same as the input. In the ALTDB database the table contents look like this:

```
CONFIRMATION
RESID
-----
      8214
```

You have completed this scenario.

Scenario D: Complex message enrichment

This scenario demonstrates complex message enrichment and uses complex message manipulation. Use the Message Broker Toolkit to create message flows and message sets, and to create and deploy broker archive (bar) files. The scenario also involves creating a Configuration Manager and a broker, and inputting instance messages that can contain MQRFH2 headers.

This scenario requires the following mapping functions:

- MRM in, MRM out (namespace)
- Other nodes required to complete message
- Conditional mapping
- CASE mapping (both syntax formats)
- If/condition
- Combining multiple source fields into a single target field (inter namespace)
- Nested repeating complex and simple elements
- Target data derived from database
- String, numeric, datetime functions
- User-defined ESQL procedures and functions
- User-defined Java routines

The names and values used for message flows, message sets, elements and attributes, and the expressions and code samples are for illustrative purposes only.

Here are the steps that are involved in this scenario:

1. "Develop a message flow that contains other nodes" on page 535
2. "Develop a message flow to map target fields from multiple other fields" on page 537
3. "Develop a message flow and message model for mapping a complex nested, repeating message" on page 539
4. "Develop a message flow for populating a target from a database" on page 545
5. "Develop a message flow using a user-defined ESQL function" on page 547
6. "Develop a message flow using a user-defined Java procedure" on page 549

Develop a message flow that contains other nodes:

This is the first stage of the scenario to perform complex message enrichment. This topic demonstrates the following procedures:

- developing a message flow that contains other nodes (for example, a Filter node)
- using mappings with conditions
- developing corresponding message models, which use all main data types, and instance messages

1. From the Broker Application Development perspective, create the following resources:

- a message set project and a message set called MAPPING3_COMPLEX_messages, ensuring that the message set is namespace enabled with XML wire format
- a message definition file called COMPLEX, which has a target namespace www.complex.net, with prefix comp

2. Create messages addev1, addev1s and addev1n with the following structures:

```
addev1
  bool      (xsd:boolean) local element
  bin       (xsd:hexBinary) local element
  dat       (xsd:dateTime) local element
  dec       (xsd:decimal) local element
  dur       (xsd:duration) local element
  flt       (xsd:float) local element
  int       (xsd:int) local element
  str       (xsd:string) local element

addev1s
  bin       (xsd:hexBinary) local element
  dat       (xsd:dateTime) local element
  dur       (xsd:duration) local element
  str       (xsd:string) local element

addev1n
  dec       (xsd:decimal) local element
  flt       (xsd:float) local element
  int       (xsd:int) local element
```

3. Create a message flow project called MAPPING3_COMPLEX_flows.

4. Create a message flow called addev1 which contains:

```
MQInput -> Filter -> Mapping -> Compute
                        \-----> RCD -> MQOutput
                        \-> Mapping1-----/
```

5. In the Filter node, set the following ESQL:

```
IF Body.bool THEN
    RETURN TRUE;
ELSE
    RETURN FALSE;
END IF;
```

6. In the Mapping node that is connected to the Filter true terminal (Mapping1), open the map and select addev1 as source and addev1s as target.

7. Wire the source to target as shown:

```
bin --- bin
dat --- dat
dur --- dur
str --- str
```

8. In the Spreadsheet pane, expand Properties and set the following values:

```
MessageType | 'addev1s'
```

9. Right-click the target dat and click **If**.

10. Replace the condition `fn:true()` with `$source/comp:addev1/str = 'dat'`.
11. Set the value for `dat` to `$source/comp:addev1/dat + xs:duration("P3M")`.
12. Right-click the condition and click **Else**.
13. Right-click the target `dur` and click **If**.
14. Replace the condition `fn:true()` with `$source/comp:addev1/str = 'dur'`.
15. Set the value for `dur` to `$source/comp:addev1/dur + xs:duration("P1Y")`.
16. Right-click the condition and click **Else**.
17. Open the map for the node that is connected to the false terminal of the Filter node (Mapping) and select `addev1` as source and `addev1n` as target.
18. Wire the source to target as shown:

```
dec --- dec
flt --- flt
int --- int
```

19. In the Spreadsheet pane, expand Properties and set the following values:

```
MessageType | 'addev1n'
```

20. Set the ESQL in the Compute node to:

```
CALL CopyMessageHeaders();
SET OutputRoot.MRM.dec = InputBody.dec * 10;
SET OutputRoot.MRM.flt = InputBody.flt * 10;
SET OutputRoot.MRM.int = InputBody.int * 10;
```

21. In the `ResetContentDescriptor` node, set the Message Domain to XMLNS and select the **Reset Message Domain** check box.

22. Create three instance messages with the appropriate RFH2 headers:

```
<comp:addev1 xmlns:comp="http://www.complex.net">
<bool>1</bool>
<bin><![CDATA[010203]]></bin>
<dat>2005-05-06T00:00:00+00:00</dat>
<dec>19.34</dec>
<dur>P2Y4M</dur>
<flt>3.245E+2</flt>
<int>2104</int>
<str>dat</str>
</comp:addev1>

<comp:addev1 xmlns:comp="http://www.complex.net">
<bool>1</bool>
<bin><![CDATA[010203]]></bin>
<dat>2005-05-06T00:00:00+00:00</dat>
<dec>19.34</dec>
<dur>P2Y4M</dur>
<flt>3.245E+2</flt>
<int>2104</int>
<str>dur</str>
</comp:addev1>

<comp:addev1 xmlns:comp="http://www.complex.net">
<bool>0</bool>
<bin><![CDATA[010203]]></bin>
<dat>2005-05-06T00:00:00+00:00</dat>
<dec>19.34</dec>
<dur>P2Y4M</dur>
<flt>3.245E+2</flt>
<int>2104</int>
<str>dat</str>
</comp:addev1>
```

You have created the following resources:

- a message set called `MAPPING3_COMPLEX_messages`, which is populated with the messages `addev1`, `addev1s` and `addev1n`

- a message flow called addev1 in the project MAPPING3_COMPLEX_flows, which contains the mapping files addev1_Mapping.msgmap and addev1_Mapping1.msgmap
- files that contain instance messages for test

Now deploy the message set and message flow.

Deploy the message set and message flow:

This is the second stage of the scenario to perform complex message enrichment. This topic demonstrates how to deploy the message set and message flow and run the instance messages through the broker.

1. Create a bar file called addev1.
2. Add the message set MAPPING3_COMPLEX_messages and the message flow addev1 to the bar file.
3. Deploy the bar file to the broker.
4. Put the instance documents on the input queue.

The output messages look like this:

```
<comp:addev1s xmlns:comp="http://www.complex.net">
<bin><![CDATA[010203]]></bin>
<dat>2005-08-06T00:00:00-01:00</dat>
<dur>P2Y4M</dur>
<str>dat</str>
</comp:addev1s>
```

Now go to “Develop a message flow to map target fields from multiple other fields.”

Develop a message flow to map target fields from multiple other fields:

Before you start

Perform the steps in the following topic:

1. “Develop a message flow that contains other nodes” on page 535

This is the third stage of the scenario to perform complex message enrichment. This topic demonstrates how to develop a message flow to map target fields from multiple other fields and also involves developing corresponding message models and instance documents.

1. In the COMPLEX message definition, in namespace www.complex.net, create a message called addev2, which has the following structure:

```
addev2
  firstname      (xsd:string) local element
  lastname       (xsd:string) local element
  branch         (xsd:string) local element
  accountno      (xsd:string) local element
  balance        (xsd:decimal) local element
  transvalue     local complex element, base type xsd:decimal
  transdir       (xsd:string) local attribute
```

2. In the message set MAPPING3_COMPLEX_messages, create a new message definition file called COMP2, which has the target namespace www.comp2.net, with prefix c2.
3. In the COMP2 message definition, create a message called addev2out, which has the structure:

```

addev2out
  accountdetails      (xsd:string) local element
  transvalue          (xsd:decimal) local element
  balance              (xsd:decimal) local element

```

4. Create a message flow called addev2, which contains the following mapping: MQInput -> Mapping -> MQOutput.
5. Open the map and select addev2 as the source and addev2out as the target.
6. Wire the source to target as shown:

```

accountno --- accountdetails
balance --- balance
transvalue --- transvalue

```
7. In the Spreadsheet pane, expand Properties and set the following values:

```

MessageType | 'addev2out'

```
8. Set the accountdetails target to `fn:concat($source/comp:addev2/accountno, $source/comp:addev2/branch, $source/comp:addev2/lastname, $source/comp:addev2/firstname)`.
9. Right-click the target transvalue and click **If**.
10. Change the condition from `fn:true()` to `$source/comp:addev2/transvalue/@transdir = 'DEBIT'`.
11. Select transvalue and set its value to `$source/comp:addev2/transvalue * (-1)`.
12. Right-click the condition and click **Else**.
13. Right-click the target balance and click **If**.
14. Change the condition from `fn:true()` to `$source/comp:addev2/transvalue/@transdir = 'DEBIT'`.
15. Select balance and set its value to `$source/comp:addev2/balance - $source/comp:addev2/transvalue`.
16. Right-click the condition and click **Condition**.
17. Change the condition from `fn:true()` to `$source/comp:addev2/transvalue/@transdir = 'CREDIT'`.
18. Select balance following the second condition and set its Value to `$source/comp:addev2/balance + $source/comp:addev2/transvalue`.
19. Create two instance messages with the appropriate RFH2 headers:

```

<comp:addev2 xmlns:comp="http://www.complex.net">
<firstname>Brian</firstname>
<lastname>Benn</lastname>
<branch>52-84-02</branch>
<accountno>567432876543</accountno>
<balance>1543.56</balance>
<transvalue transdir="DEBIT">25.28</transvalue>
</comp:addev2>

<comp:addev2 xmlns:comp="http://www.complex.net">
<firstname>Brian</firstname>
<lastname>Benn</lastname>
<branch>52-84-02</branch>
<accountno>567432876543</accountno>
<balance>1543.56</balance>
<transvalue transdir="CREDIT">25.28</transvalue>
</comp:addev2>

```

You have created the following resources:

- a message called addev2 in the message definition called COMPLEX
- a message called addev2out in the message definition called COMP2
- a message flow called addev2, which contains the mapping file addev2_Mapping.msgmap

- files that contain instance messages for test

Now deploy the message set and message flow

Deploy the message set and message flow:

This is the fourth stage of the scenario to perform complex message enrichment. This topic demonstrates how to deploy the message set and message flow and run the instance messages through the broker.

1. Create a bar file called addev2.
2. Add the message set MAPPING3_COMPLEX_messages and the message flow addev2 to the bar file.
3. Deploy the bar file to the broker.
4. Put the instance documents on the input queue.

The output messages look like this:

```
<c2:addev2out xmlns:c2="http://www.comp2.net" xmlns:comp="http://www.complex.net">
<accountdetails>567432876543 52-84-02 Benn Brian</accountdetails>
<transvalue>-25.28</transvalue>
<balance>1518.28</balance>
</c2:addev2out>
```

Now go to “Develop a message flow and message model for mapping a complex nested, repeating message.”

Develop a message flow and message model for mapping a complex nested, repeating message:

Before you start

Perform the steps in the following topics:

1. “Develop a message flow that contains other nodes” on page 535
2. “Develop a message flow to map target fields from multiple other fields” on page 537

This is the fifth stage of the scenario to perform simple message enrichment. This topic demonstrates how to develop a message flow and message model for mapping a complex nested, repeating message. It also involves developing corresponding instance documents.

1. In the COMPLEX message definition, in namespace ‘www.complex.net’, create a message called addev3, which has the following structure:

```
addev3
choice
  sstr                (xsd:string) local element
  intrep              (xsd:int) local element, min0cc=2, max0cc=6
  dur                 (xsd:duration) local element
choice
  comp1               local complex element
  dat1                (xsd:date) local element
  sval                (xsd:string) local element
  comp2               local complex element
  boo1                (xsd:boolean) local element
  dat2                (xsd:date) local element
  comprep             local complex element, min0cc=1, max0cc=4
  int1                (xsd:int) local element
  dec1                (xsd:decimal) local element
  bine1              (xsd:hexBinary) local element
  lelem               local complex element, base type xsd:string
  latt                (xsd:int) local attribute
```

```

lcomp          local complex element
  head         (xsd:string) local element
  incomp       local complex element
    count      (xsd:int) local element
      comp:gcompel  global complex element, minOccurs=0, maxOccurs=-1
        fstr     (xsd:string) local element
          multel  local complex element
            in1   (xsd:boolean) local element
            in2   (xsd:string) local element
            in3   (xsd:float) local element
          footer  (xsd:string) local element
        repstr   (xsd:string) local element, minOccurs=1, maxOccurs=-1

```

2. Create a message flow called addev3, which contains the following mapping: MQInput> Mapping> MQOutput.
3. Open the map and select addev3 as the source and target.
4. Map each source element to its corresponding target element:

```

sstr --- sstr
intrep --- intrep
dur --- dur
dat1 --- dat1
sval --- sval
bool1 --- bool1
dat2 --- dat2
int1 --- int1
decl --- decl
binel --- binel
lelem --- lelem
latt --- latt
head --- head
count --- count
fstr --- fstr
multel --- multel
footer --- footer
repstr --- repstr

```

5. In the Spreadsheet pane, for the first condition, change fn:true() to fn:exists(\$source/comp:sstr).
6. For the second condition, change fn:true() to fn:exists(\$source/comp:addev3/intrep).
7. For the third condition, change fn:true() to fn:exists(\$source/comp:addev3/dur).
8. For the first complex choice condition, change fn:true() to fn:exists(\$source/comp:addev3/comp1).
9. For the second complex choice condition, change fn:true() to fn:exists(\$source/comp:addev3/comp2).
10. For the third complex choice condition, change fn:true() to fn:exists(\$source/comp:addev3/comp3).
11. Create the following instance messages, with appropriate RFH2 headers:

```

<comp:addev3 xmlns:comp="http://www.complex.net">
  <sstr>first</sstr>
  <comp1>
    <dat1>2005-06-24</dat1>
    <sval>date value</sval>
  </comp1>
  <binel><![CDATA[3132333435]]></binel>
  <lelem latt="24">twenty four</lelem>
</comp>
<head>nesting start</head>
<incomp>
  <count>3</count>
  <comp:gcompel>

```

```

<fstr>first</fstr>
<multel>
<in1>1</in1>
<in2>C</in2>
<in3>2.45E+1</in3>
</multel>
</comp:gcompel>
<comp:gcompel>
<fstr>second</fstr>
<multel>
<in1>1</in1>
<in2>D</in2>
<in3>7.625E+3</in3>
</multel>
</comp:gcompel>
<comp:gcompel>
<fstr>third</fstr>
<multel>
<in1>0</in1>
<in2>C</in2>
<in3>4.9E+0</in3>
</multel>
</comp:gcompel>
</incomp>
<footer>nesting end</footer>
</lcomp>
<repstr>abc</repstr>
<repstr>def</repstr>
<repstr>ghi</repstr>
<repstr>jkl</repstr>
<repstr>mno</repstr>
</comp:addev3>

<comp:addev3 xmlns:comp="http://www.complex.net">
<intrep>45</intrep>
<intrep>12</intrep>
<intrep>920</intrep>
<comp2>
<bool1>1</bool1>
<dat2>2005-06-24</dat2>
</comp2>
<binel><![CDATA[3132333435]]></binel>
<lelem latt="24">twenty four</lelem>
<lcomp>
<head>nesting start</head>
<incomp>
<count>5</count>
<comp:gcompel>
<fstr>first</fstr>
<multel>
<in1>1</in1>
<in2>C</in2>
<in3>2.45E+1</in3>
</multel>
</comp:gcompel>
<comp:gcompel>
<fstr>second</fstr>
<multel>
<in1>1</in1>
<in2>D</in2>
<in3>7.625E+3</in3>
</multel>
</comp:gcompel>
<comp:gcompel>
<fstr>third</fstr>
<multel>
<in1>0</in1>
<in2>C</in2>

```

```

<in3>4.9E+0</in3>
</multel>
</comp:gcompel>
<comp:gcompel>
<fstr>fourth</fstr>
<multel>
<in1>1</in1>
<in2>F</in2>
<in3>2.98E+1</in3>
</multel>
</comp:gcompel>
<comp:gcompel>
<fstr>fifth</fstr>
<multel>
<in1>0</in1>
<in2>D</in2>
<in3>8.57E-2</in3>
</multel>
</comp:gcompel>
</incomp>
<footer>nesting end</footer>
</lcomp>
<repstr>abc</repstr>
</comp:addev3>

<comp:addev3 xmlns:comp="http://www.complex.net">
<dur>P2Y2M</dur>
<comp3>
<int1>6</int1>
<dec1>2821.54</dec1>
</comp3>
<comp3>
<int1>41</int1>
<dec1>0.02</dec1>
</comp3>
<binel><![CDATA[3132333435]]></binel>
<lelem latt="24">twenty four</lelem>
<lcomp>
<head>nesting start</head>
<incomp>
<count>0</count>
</incomp>
<footer>nesting end</footer>
</lcomp>
<repstr>abc</repstr>
<repstr>def</repstr>
<repstr>ghi</repstr>
<repstr>jkl</repstr>
<repstr>mno</repstr>
<repstr>pqr</repstr>
<repstr>stu</repstr>
<repstr>vwx</repstr>
</comp:addev3>

```

You have created the following resources:

- a message called addev3 in the message definition COMPLEX
- a message flow called addev3, which contains the mapping file addev3_Mapping.msgmap
- files that contain instance messages for test

Now deploy the message set and message flow.

Deploy the message set and message flow:

This is the sixth stage of the scenario to perform simple message enrichment. This topic demonstrates how to deploy the message set and message flow and run the instance messages through the broker.

1. Create a bar file called addev3.
2. Add the message set MAPPING3_COMPLEX_messages and the message flow addev3 to the bar file.
3. Deploy the bar file to the broker.
4. Put the instance documents on the input queue.

The output messages look like this:

```
<comp:addev3 xmlns:comp="http://www.complex.net">
  <sstr>first</sstr>
  <comp1>
    <dat1>2005-06-24</dat1>
    <sval>date value</sval>
  </comp1>
  <binel><![CDATA[3132333435]]></binel>
  <lelem latt="24">twenty four</lelem>
  <lcomp>
    <head>nesting start</head>
    <incomp>
      <count>3</count>
      <comp:gcompel>
        <fstr>first</fstr>
        <multel>
          <in1>1</in1>
          <in2>C</in2>
          <in3>2.45E+1</in3>
        </multel>
      </comp:gcompel>
      <comp:gcompel>
        <fstr>second</fstr>
        <multel>
          <in1>1</in1>
          <in2>D</in2>
          <in3>7.625E+3</in3>
        </multel>
      </comp:gcompel>
      <comp:gcompel>
        <fstr>third</fstr>
        <multel>
          <in1>0</in1>
          <in2>C</in2>
          <in3>4.9E+0</in3>
        </multel>
      </comp:gcompel>
    </incomp>
    <footer>nesting end</footer>
  </lcomp>
  <repstr>abc</repstr>
  <repstr>def</repstr>
  <repstr>ghi</repstr>
  <repstr>jkl</repstr>
  <repstr>mno</repstr>
</comp:addev3>

<comp:addev3 xmlns:comp="http://www.complex.net">
  <intrep>45</intrep>
  <intrep>12</intrep>
  <intrep>920</intrep>
  <comp2>
    <bool1>1</bool1>
    <dat2>2005-06-24</dat2>
  </comp2>
```

```

<binel><![CDATA[3132333435]]></binel>
<lelem latt="24">twenty four</lelem>
<lcomp>
<head>nesting start</head>
<incomp>
<count>5</count>
<comp:gcompel>
<fstr>first</fstr>
<multel>
<in1>1</in1>
<in2>C</in2>
<in3>2.45E+1</in3>
</multel>
</comp:gcompel>
<comp:gcompel>
<fstr>second</fstr>
<multel>
<in1>1</in1>
<in2>D</in2>
<in3>7.625E+3</in3>
</multel>
</comp:gcompel>
<comp:gcompel>
<fstr>third</fstr>
<multel>
<in1>0</in1>
<in2>C</in2>
<in3>4.9E+0</in3>
</multel>
</comp:gcompel>
<comp:gcompel>
<fstr>fourth</fstr>
<multel>
<in1>1</in1>
<in2>F</in2>
<in3>2.98E+1</in3>
</multel>
</comp:gcompel>
<comp:gcompel>
<fstr>fifth</fstr>
<multel>
<in1>0</in1>
<in2>D</in2>
<in3>8.57E-2</in3>
</multel>
</comp:gcompel>
</incomp>
<footer>nesting end</footer>
</lcomp>
<repstr>abc</repstr>
</comp:addev3>
<comp:addev3 xmlns:comp="http://www.complex.net">
<dur>P2Y2M</dur>
<comp3>
<int1>6</int1>
<dec1>2821.54</dec1>
</comp3>
<comp3>
<int1>41</int1>
<dec1>0.02</dec1>
</comp3>
<binel><![CDATA[3132333435]]></binel>
<lelem latt="24">twenty four</lelem>
<lcomp>
<head>nesting start</head>
<incomp>
<count>0</count>

```



```

</incomp>
<footer>nesting end</footer>
</lcomp>
<repstr>abc</repstr>
<repstr>def</repstr>
<repstr>ghi</repstr>
<repstr>jkl</repstr>
<repstr>mno</repstr>
<repstr>pqr</repstr>
<repstr>stu</repstr>
<repstr>vwx</repstr>
</comp:addev3>

```

Now go to “Develop a message flow for populating a target from a database.”

Develop a message flow for populating a target from a database:

Before you start

Perform the steps in the following topics:

1. “Develop a message flow that contains other nodes” on page 535
2. “Develop a message flow to map target fields from multiple other fields” on page 537
3. “Develop a message flow and message model for mapping a complex nested, repeating message” on page 539

This is the seventh stage of the scenario to perform complex message enrichment. This topic demonstrates how to develop a message flow for populating a target from a database. It also involves developing a corresponding message model and instance documents.

1. Create a database called MAPDB and create a table called TRANSACTION, which has the following columns:

ACCOUNT	VARCHAR(12)
TDATE	DATE
VALUE	DECIMAL(8,2)

2. Populate the database with the values shown:

```

'12345678901', '2005-04-25', -14.25
'12345678901', '2005-04-25', 100.00
'12345678901', '2005-05-15', 2891.30
'12345678901', '2005-06-11', -215.28

```

3. Create a Windows ODBC Data Source Name for the database and then add a definition for the database to the workbench by clicking **File** → **New** → **Database Definition File**.

4. In the COMPLEX message definition, in namespace www.complex.net, create a message called addev4in, which has the following structure:

```

addev4in
  account          (xsd:string) local element
  tdate            (xsd:date) local element

```

5. In the COMP2 message definition, in namespace www.comp2.net, create a message called addev4out, which has the following structure:

```

addev4out
  account          (xsd:string) local element
  tdate            (xsd:date) local element
  value            (xsd:decimal) local element, min0cc=0, max0cc=-1

```

6. Create a message flow called addev4, which contains the following mapping: MQInput> Mapping> MQOutput.

7. Open the map and select addev4in as the source and addev4out as the target.
8. Map the input to outputs as shown:

```
account --- account
tdate --- tdate
```
9. In the Spreadsheet pane, right-click the target value and click **Select Data Source**.
10. Select MAPDB from the dialog box and click **Finish**.
11. In the top pane, expand the MAPDB tree and wire the values as shown:

```
VALUE --- value
```
12. In the Spreadsheet pane, select the target \$db:select and change fn:true() to:

```
$db:select.MAPDB.SCHEMA.TRANSACTION.ACCOUNT=$source/comp:addev4in/
account and $db:select.MAPDB.SCHEMA.TRANSACTION.TDATE=$source/
comp:addev4in/tdate
```
13. Expand the Properties tree and set the following values:

```
MessageType | 'addev4out'
```
14. Set the data source property for the Mapping node to MAPDB.
15. Create the following instance messages with appropriate RFH2 headers:

```
<comp:addev4in xmlns:comp="http://www.complex.net">
<account>12345678901</account>
<tdate>2005-05-15</tdate>
</comp:addev4in>

<comp:addev4in xmlns:comp="http://www.complex.net">
<account>12345678901</account>
<tdate>2005-04-25</tdate>
</comp:addev4in>
```

You have created the following resources:

- a message called addev4in in a message definition called COMPLEX
- a message called addev4out in a message definition called COMP
- a message flow called addev4, which contains the mapping file addev4_Mapping.msgmap
- files that contain instance messages

Now deploy the message set and message flow.

Deploy the message set and message flow:

This is the eighth stage of the scenario to perform complex message enrichment. This topic demonstrates how to deploy the message set and message flow and run the instance messages through the broker.

1. Create a bar file called addev4.
2. Add the message set MAPPING3_COMPLEX_messages and the message flow addev4 to the bar file.
3. Deploy the bar file to the broker.
4. Put the instance documents on the input queue.

The output messages look like this:

```
<c2:addev4out xmlns:c2="http://www.comp2.net" xmlns:comp="http://www.complex.net" >
<account>12345678901</account>
<tdate>2005-05-15</tdate>
<value>2891.3</value>
</c2:addev4out>
```

Now go to “Develop a message flow using a user-defined ESQL function.”

Develop a message flow using a user-defined ESQL function:

Before you start

Perform the steps in the following topics:

1. “Develop a message flow that contains other nodes” on page 535
2. “Develop a message flow to map target fields from multiple other fields” on page 537
3. “Develop a message flow and message model for mapping a complex nested, repeating message” on page 539
4. “Develop a message flow for populating a target from a database” on page 545

This is the ninth stage of the scenario to perform simple message enrichment. This topic demonstrates how to develop a message flow using a user-defined ESQL function. It also involves developing corresponding message models and instance documents.

1. In the COMPLEX message definition, in namespace `www.complex.net`, create messages called `addev5in` and `addev5out`, which have the following structures:

```
addev5in
  value1                (xsd:decimal) local element
  operator              (xsd:string) local element
  value2                (xsd:decimal) local element
  rate                  (xsd:decimal) local element

addev5out
  grossvalue           (xsd:decimal) local element
  netvalue             (xsd:decimal) local element
```

2. Create a message flow called `addev5`, which contains the following mapping:
`MQInput> Mapping> MQOutput`.
3. Open the map and select `addev5in` as the source and `addev5out` as the target.
4. In the `MAPPING3_COMPLEX_flows` project, create an ESQL file called `addev5` and put these functions in it:

```
CREATE FUNCTION calcGrossvalue(IN value1 DECIMAL, IN operator CHAR,
  IN value2 DECIMAL) RETURNS DECIMAL
  BEGIN
    DECLARE outval DECIMAL;
    CASE operator
      WHEN 'PLUS' THEN
        SET outval = value1 + value2;
      WHEN 'MINUS' THEN
        SET outval = value1 - value2;
      WHEN 'MULTIPLY' THEN
        SET outval = value1 * value2;
      WHEN 'DIVIDE' THEN
        SET outval = value1 / value2;
      ELSE
        THROW USER EXCEPTION MESSAGE 2949 VALUES('Invalid Operator', operator);
        SET outval = -999999;
    END CASE;
    RETURN outval;
  END;

CREATE FUNCTION calcNetvalue(IN value1 DECIMAL, IN operator CHAR, IN value2 DECIMAL,
  IN rate DECIMAL) RETURNS DECIMAL
  BEGIN
```

```

        DECLARE grossvalue DECIMAL;
        SET grossvalue=calcGrossvalue(value1, operator, value2);
        RETURN (grossvalue * rate );
    END;

```

5. In the Message Mapping editor Spreadsheet pane, expand the message and select grossvalue.

6. In the Expression pane, enter the expression:

```

esql:calcGrossvalue($source/comp:addev5in/value1,
$source/comp:addev5in/operator,
$source/comp:addev5in/value2)

```

7. Select the target netvalue, and in the Expression pane, enter the following expression:

```

esql:calcNetvalue($source/comp:addev5in/value1,
$source/comp:addev5in/operator,
$source/comp:addev5in/value2,
$source/comp:addev5in/rate)

```

8. Expand the Properties tree and set the following values:

```

MessageType | 'addev5out'

```

9. Create the following instance messages, with appropriate RFH2 headers:

```

<comp:addev5in xmlns:comp="http://www.complex.net">
<value1>125.32</value1>
<operator>PLUS</operator>
<value2>25.86</value2>
<rate>0.60</rate>
</comp:addev5in>

```

```

<comp:addev5in xmlns:comp="http://www.complex.net">
<value1>118.00</value1>
<operator>MINUS</operator>
<value2>245.01</value2>
<rate>0.30</rate>
</comp:addev5in>

```

```

<comp:addev5in xmlns:comp="http://www.complex.net">
<value1>254.02</value1>
<operator>MULTIPLY</operator>
<value2>3.21</value2>
<rate>0.75</rate>
</comp:addev5in>

```

```

<comp:addev5in xmlns:comp="http://www.complex.net">
<value1>1456.33</value1>
<operator>DIVIDE</operator>
<value2>18.58</value2>
<rate>0.92</rate>
</comp:addev5in>

```

```

<comp:addev5in xmlns:comp="http://www.complex.net">
<value1>254.02</value1>
<operator>MOD</operator>
<value2>3.21</value2>
<rate>0.75</rate>
</comp:addev5in>

```

You have created the following resources:

- messages called addev5in and addev5out in a message definition called COMPLEX
- a message flow called addev5, which contains the mapping file addev5_Mapping.msgmap and ESQL file addev5.esql
- files containing instance messages

Now deploy the message set and message flow.

Deploy the message set and message flow:

This is the tenth stage of the scenario to perform simple message enrichment. This topic demonstrates how to deploy the message set and message flow and run the instance messages through the broker.

1. Create a bar file called addev5.
2. Add the message set MAPPING3_COMPLEX_messages and the message flow addev5 to the bar file.
3. Deploy the bar file to the broker.
4. Put the instance documents on the input queue.

The output messages look like this:

```
<comp:addev5out xmlns:comp="http://www.complex.net">
<grossvalue>151.18</grossvalue>
<netvalue>90.708</netvalue>
</comp:addev5out>
<comp:addev5out xmlns:comp="http://www.complex.net">
<grossvalue>-127.01</grossvalue>
<netvalue>-38.103</netvalue>
</comp:addev5out>
<comp:addev5out xmlns:comp="http://www.complex.net">
<grossvalue>815.4042</grossvalue>
<netvalue>611.55315</netvalue>
</comp:addev5out>
<comp:addev5out xmlns:comp="http://www.complex.net">
<grossvalue>78.38159311087190527448869752421959</grossvalue>
<netvalue>72.11106566200215285252960172228202</netvalue>
</comp:addev5out>
```

If there is no message output look for an entry in the event log like this:

```
BIP2949 ( BRK.default ) A user generated ESQL exception has been thrown. The additional
information provided with this exception is: ''Invalid Operator'' ''MOD''
'addev5.Mapping.ComIbmCompute' '%5' '%6' '%7' '%8' '%9' '%10' '%11'
```

This exception was thrown by a THROW EXCEPTION statement. This is the normal behavior of the THROW statement; this is a user-generated exception, so the user action is determined by the message flow and the type of exception that is thrown.

Now go to “Develop a message flow using a user-defined Java procedure.”

Develop a message flow using a user-defined Java procedure:

Before you start

Perform the steps in the following topics:

1. “Develop a message flow that contains other nodes” on page 535
2. “Develop a message flow to map target fields from multiple other fields” on page 537
3. “Develop a message flow and message model for mapping a complex nested, repeating message” on page 539
4. “Develop a message flow for populating a target from a database” on page 545
5. “Develop a message flow using a user-defined ESQL function” on page 547

This is the eleventh stage of the scenario to perform simple message enrichment. This topic demonstrates how to develop a message flow using a user-defined Java procedure. It also involves developing corresponding message models and instance documents.

1. In the COMPLEX message definition, in namespace `www.complex.net`, create messages called `addev6in` and `addev6out`, which have the following structures:

```
addev6in
  hexdata                (xsd:hexBinary) local element
addev6out
  decval                 (xsd:decimal) local element
  fltval                 (xsd:float) local element
  intval                 (xsd:int) local element
```

2. Create a message flow called `addev6`, which contains the following mapping: `MQInput`> `Mapping`> `MQOutput`.
3. Open the map and select `addev6in` as the source and `addev6out` as the target.
4. In the `MAPPING3_COMPLEX_flows` project, create an ESQL file called `addev6` and put these functions in it:

```
CREATE PROCEDURE decFromBinary( IN hexval BLOB )
  RETURNS DECIMAL
  LANGUAGE JAVA
  EXTERNAL NAME "addev6.decFromBinary";

CREATE PROCEDURE fltFromBinary( IN hexval BLOB )
  RETURNS DECIMAL
  LANGUAGE JAVA
  EXTERNAL NAME "addev6.fltFromBinary";

CREATE PROCEDURE intFromBinary( IN hexval BLOB )
  RETURNS DECIMAL
  LANGUAGE JAVA
  EXTERNAL NAME "addev6.intFromBinary";
```

5. Create a java source file called `addev6.java`, which has the following contents:

```
import java.lang.*;
import java.math.*;

public class addev6 {
  //
  // Return decimal element from binary string
  //
  public static BigDecimal decFromBinary( byte[] hexval ) {
    // Look for element named decval
    String search = "decval";
    String sval = findElement(hexval ,search );
    // Convert the value to decimal type
    BigDecimal numval = new BigDecimal(sval);
    return numval;
  }
  //
  // Return float element from binary string
  //
  public static Double fltFromBinary( byte[] hexval ) {
    // Look for element named fltval
    String search = "fltval";
    String sval = findElement(hexval ,search );
    // Convert the value to float type
    Double numval = new Double(sval);
    return numval;
  }
  //
  // Return integer element from binary string
  //
  public static Long intFromBinary( byte[] hexval ) {
```

```

// Look for element named intval
String search = "intval";
String sval = findElement(hexval ,search );
// Convert the value to integer type
Long numval = new Long(sval);
return numval;
}
//
// Locate the named element and its value in the binary data
//
private static String findElement( byte[] hexval, String search ) {
// Convert bytes to string
String hexstr = new String(hexval);
// Fixed length label/value pairs (length=14)
int nvals = hexstr.length() / 14;
String numval = "";
String[] label = new String[nvals];
String[] value = new String[nvals];
// Loop over number of label/value pairs
for ( int i=0; i < nvals; i ++ ) {
// get start position
int st = i * 14;
// label is length 6
int endl = st + 6;
// value is length 8
int endv = endl + 8;
// extract label and value from string
label[i] = hexstr.substring( st, endl);
value[i] = hexstr.substring( (endl+1), endv);
// Check whether the current pair has the label requested
if ( label[i].compareTo( search) == 0 ) {
// trim padding from the value
numval = value[i].trim();
}
}
return numval;
}
}

```

6. Compile the java code and add the location of the class file to the system classpath. You might need to restart Windows if you edit the CLASSPATH.
7. In the Spreadsheet pane of the Message Mapping editor, expand the target message and set the target decval to the value esql:decFromBinary(\$source/comp:addev6in/bval).
8. Set the target fltval to esql:fltFromBinary(\$source/comp:addev6in/bval).
9. Set the target intval to esql:intFromBinary(\$source/comp:addev6in/bval).
10. Expand the Properties target and set the values shown:

```

MessageType      |      'addev6out

```

11. Create the following instance message, with appropriate RFH2 headers:

```

<comp:addev6in xmlns:comp="http://www.complex.net">
<bval>
<![CDATA[64656376616c20202031342e3238666c7476616c
2020312e34452b32696e7476616c2020202020313230]]>
</bval>
</comp:addev6in>

```

You have created the following resources:

- messages called addev6in and addev6out in a message definition called COMPLEX
- a message flow called addev6, which contains the mapping file addev6_Mapping.msgmap and ESQl file addev6.esql

- a Java source file called addev6.java and a compiled class file called addev6.class in a place where the system CLASSPATH can find it
- files that contain instance messages

Now deploy the message set and message flow.

Deploy the message set and message flow:

This is the final stage of the scenario to perform simple message enrichment. This topic demonstrates how to deploy the message set and message flow and run the instance message through the broker.

1. Create a bar file called addev6.
2. Add the message set MAPPING3_COMPLEX_messages and the message flow addev6 to the bar file.
3. Deploy the bar file to the broker.
4. Put the instance documents on the input queue.

The output message looks like this:

```
<comp:addev6out xmlns:comp="http://www.complex.net">
<decval>14.28</decval>
<fltval>1.4E+2</fltval>
<intval>120</intval>
</comp:addev6out>
```

You have completed this scenario.

Scenario E: Resolving a choice with alternative message data

Before you start:

1. Create the appropriate message model, either by using the tooling or by importing the message structure files (for example, C header or XML Schema Definition files).
2. Create a message flow that has the following structure:
MQInput> Mapping node> MQOutput

This scenario demonstrates how to resolve a choice with alternative message data. The message model used in this example is:

```
chsmess (message)
  head (xsd:string)
  choice (group)
    str1 (xsd:string)
    int1 (xsd:int)
    dur1 (xsd:duration)
  footer (xsd:string)
```

1. Switch to the Broker Application Development perspective.
2. Right-click the Mapping node and click **Open Map**.
3. Accept the default project and name, and click **Next**.
4. Accept the default usage and click **Next**.
5. Clear the **Based on records in a database** check box and click **Next**.
6. Select chsmess as the source message and the target message, and click **OK**.
7. In the Connection pane, open the source and target trees by clicking on the addition (+) icons.
8. Open the chsmess tree in the Source and Target panes in the same way.

9. In both Source and Target panes, click the addition (+) icon adjacent to the choice group.
10. Click head in the Message Mapping editor Source pane and drag it onto head in the Target pane. A line joins them.
11. Repeat Step 10 for each corresponding element (str1, int1, dur1, and footer.)
12. In the Map Script | Value table, open the tree by clicking the \$target + box.
13. Open the chsmess tree, then open the if. A set of condition elements appears.
14. Open each condition. One condition exists for each choice. Each condition has the function fn:true().
15. Click the first function (for example, for str1) and change it in the Edit pane to: \$source/chsmess/head='str1'. If the input element head has a value str1, the assignment str1 <- \$source/chsmess/str1 takes place.
16. Click the second function (for example, for int1) and change it in the Expression editor to: \$source/chsmess/head='int1'. If the input element head has a value int1, the assignment int1 <- \$source/chsmess/int1 takes place.
17. Click the third function (for example, for dur1) and change it in the Expression editor to: \$source/chsmess/head='dur1'. If the input element head has a value dur1, the assignment dur1 <- \$source/chsmess/dur1 takes place.
18. Save the mapping by clicking **File** → **Save**.

You have completed this scenario. The message model contains a choice that has been resolved using other data in the instance message.

Scenario F: Updating the value of a message element

Before you start:

1. Create the appropriate message model, either by using the tooling or by importing the message structure files (for example, C header or XML Schema Definition files).
2. Create a message flow that has the following structure:
MQInput> Mapping node> MQOutput

This scenario demonstrates how to update the value of a message element. The message model used in this example is:

```
simple (message)
  int (xsd:int)
  str (xsd:str)
```

1. Switch to the Broker Application Development perspective.
2. Right-click the Mapping node and click **Open Map**.
3. Select simple as the source message and the target message and click **OK**.
4. In the connection pane, open the source and target trees by clicking the addition (+) icons.
5. Open the simple trees on both sides in the same way.
6. Select int in the Message Mapping editor Source pane, and drag it onto int in the Target pane. A line joins them.
7. Select str in the Message Mapping editor Source pane and drag it onto str in the Target pane. A line joins them.
8. In the Map Script | Value table, open the tree by clicking the \$target + box
9. Open the simple tree in the same way; both int and str have values (for example, int \$source/simple/int str \$source/simple/str).
10. Select the value for int. The value appears in the Expression Editing pane.

11. Edit the value so that it is: `$source/simple/int + 1` and press **Enter**. The value in the table is updated (this increments the input value).
12. Select the value for `str` and edit it so that it is: `esql:upper($source/simple/str)`, and press **Enter**. The value in the table is updated (this converts the input value to upper case).
13. Save the mapping by clicking **File> Save**.

You have completed this scenario. The input and output messages have the same structure and format, but the element values have been modified.

Defining a promoted property

Before you start:

Read the concept topic about promoted properties.

When you create a message flow, you can promote properties from individual nodes within that message flow to the message flow level. Properties promoted in this way override the property values that you have set for the individual nodes. You can perform the following tasks related to promoting properties:

- “Promoting a property”
- “Renaming a promoted property” on page 557
- “Removing a promoted property” on page 558
- “Converging multiple properties” on page 559

Some of the properties that you can promote to the message flow are also configurable; you can modify them when you deploy the broker archive file in which you have stored the message flow to each broker. If you set values for configurable properties when you deploy a broker archive file, the values that you set override values set in the individual nodes, and those that you have promoted.

Promoting a property

You can promote a node property to the message flow level to simplify the maintenance of the message flow and its nodes, and to provide common values for multiple nodes within the flow by converging promoted properties.

Before you start:

- Create a message flow
- Read the concept topic about promoted properties

The majority of message flow node properties are available for promotion, but you cannot promote the following properties:

- Properties that name mapping modules
- A property group (but you can promote an individual property)
- A property that you cannot edit (for example, the `Fix` property of the `MQInput` node)
- The description properties (Short Description and Long Description)
- Complex properties (for example, the `Query elements` property of the `DatabaseRoute` node, or the `Opaque elements` property of the `MQInput` and several other nodes)

To promote message flow node properties to the message flow level, perform these steps.

1. Switch to the Broker Application Development perspective.
2. Open the message flow for which you want to promote properties.
3. Right-click the node whose properties you want to promote and click **Promote Property**.

The Promote Property dialog box is displayed.

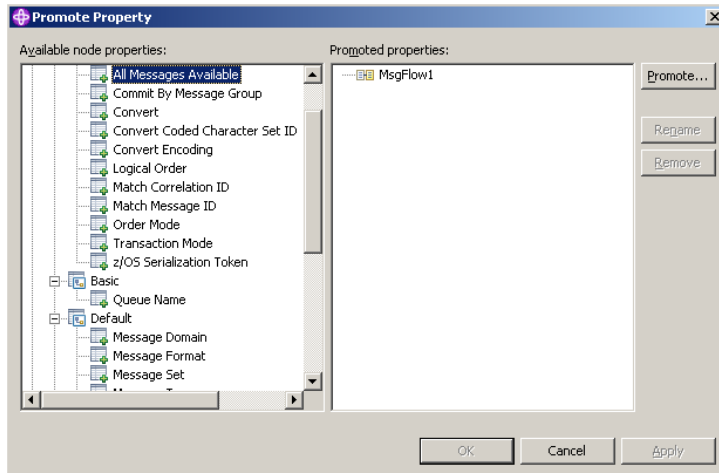

The left side of the dialog box lists all available properties for all the nodes within the message flow. The properties for the node that you clicked are expanded. You can expand the properties for all the nodes in the open message flow, regardless of the node that you clicked initially.

The right side of the dialog box displays the name of the open message flow and all the properties that are currently promoted to the message flow. If you have not yet promoted any properties, only the message flow name is displayed as the root of the promoted property tree, as shown in the example above. If you have already promoted properties from this node, the properties appear on the right, but not on the left.

4. Select the property or properties that you want to promote to the message flow. You can select multiple properties by holding down Ctrl and selecting the properties.
5. Click **Promote**. The Target Selection dialog box opens and displays valid targets for the promotion.

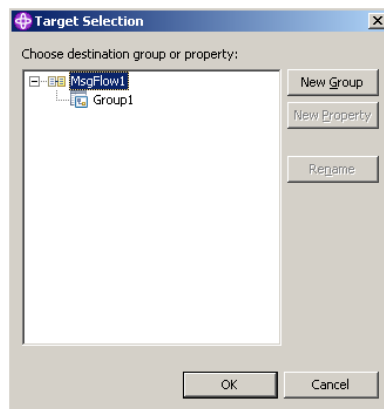

6. Select the destination group or property for the properties that you want to promote. You can group together related properties from the same or different nodes in the message flow by dropping the selected properties onto a group or

property that already exists, or you can create a new target for the promotion by clicking **New Group** or **New Property**. You can rename groups and properties by selecting them and clicking **Rename**.

7. Click **OK** to confirm your selections and close the Target Selection dialog box. If you create a new group or property using the Target Selection dialog box, the changes persist even if you select **Cancel** in the dialog box. When the dialog box closes, groups or properties that you have created using the Target Selection dialog box appear in the Promote Property dialog box. You can remove any of these properties from the Promote Property dialog box by selecting them and clicking **Remove**.
8. Click **OK** to commit your changes and close the Promoted Property dialog box. If you click **Apply**, the changes are committed but the dialog box remains open.

The message flow node properties are promoted to the message flow. When you have promoted a property, you can no longer make any changes to that property at the node level; you can update its value only at the message flow level. To view the message flow's properties, click the message flow (not the individual nodes) in the Message Flow editor to display the properties in the Properties view. The properties that you have promoted are organized in the groups that you created. If you now set a value for one of these properties, that value appears as the default value for the property whenever the message flow is included in other message flows.

When you select an embedded message flow within another message flow (a subflow) and view its properties, you see the promoted property values. If you look inside the embedded flow (by selecting **Open Subflow**), you see the original values for the properties. The value of a promoted property does not replace the original property, but it takes precedence when you deploy the message flow.

Promoting properties by dragging

You can also promote properties from the Promote Property dialog box by dragging the selected property or properties from the left pane of the Promote Property dialog box to the right pane, as described in the following steps.

1. Select the property that you want to promote. You can select multiple properties by holding down Ctrl, and selecting the properties.
2. You can promote the selected properties using the following methods:

- Drop the selected property or properties in an empty space.

A new group is created automatically for the message flow, and the property is placed in it, with the original name of the property and the name of the message flow node from which it came displayed beneath the property entry.

The name of the first group that is created is Group1 by default. If a group called Group1 already exists, the group is given the name Group2, and so on. You can rename the group by double-clicking it and entering new text, or by selecting the group in the Promoted properties pane and clicking **Rename**.

When you create a new promoted property, the name that you enter is the name by which the property is known within the system, and must meet certain Java and XML naming restrictions. These restrictions are enforced by the dialog box, and a message is displayed if you enter a name that includes a non-valid character. For example, you cannot include a space or the double quote symbol, ".

If you are developing a message flow in a user-defined project that will be delivered as an Eclipse plug-in, you can add translations for the promoted properties that you have added. Translated names can contain characters,

such as space, that are restricted for system names. The option to provide translated strings for promoted properties is not available if you are working with a message flow in a message flow project.

- Drop the selected property or properties onto a group that already exists, to group together related properties from the same or different nodes in the message flow.

For example, you might want to group all promoted properties that relate to database interactions. You can change the groups to which promoted properties belong at any time by selecting a property in the Promoted properties pane and dragging it onto a different group.

- Drop the selected property or properties onto a property that already exists, to converge related properties from the same or different nodes in the message flow.

For example, you might want to create a single promoted property that overrides the property on each node that defines a data source.

For more information on converging properties, see “Converging multiple properties” on page 559.

Promoting mandatory properties

If you promote a property that is mandatory (that is, an asterisk appears beside the name in the Properties view), the mandatory characteristic of the property is preserved. When a mandatory property is promoted, its value does not need to be set at the node level. If the flow that contains the mandatory promoted property is included as a subflow within another flow, the property must be populated for the subflow node.

Promoting properties through a hierarchy of message flows

You can repeat the process of promoting message flow node properties through several levels of message flow. You can promote properties from any level in the hierarchy to the next level above, and so on through the hierarchy to the top level. The value of a property is propagated from the highest point in the hierarchy at which it is set down to the original message flow node when the message flow is deployed to a broker. The value of that property on the original message flow node is overridden.

Renaming a promoted property

If you have promoted a property from the node to the message flow level, it is initially assigned the same name that it has at the node level. You can rename the property to have a more meaningful name in the context of the message flow.

Before you start:

- Promote a property
- Read the concept topic about promoted properties

To rename a promoted property :

1. Switch to the Broker Application Development perspective.
2. Open the message flow for which you want to promote properties by double-clicking the message flow in the Broker Development view. You can also open the message flow by right-clicking it in the Broker Development view and clicking **Open**. The message flow contents are displayed in the editor view.

If this is the first message flow that you have opened, the message flow control window and the list of available built-in message flow nodes are also displayed, to the left of the editor view.

3. In the editor view, right-click the symbol of the message flow node whose properties you want to promote.
4. Select **Promote Property**.

The Promote Property dialog is displayed.

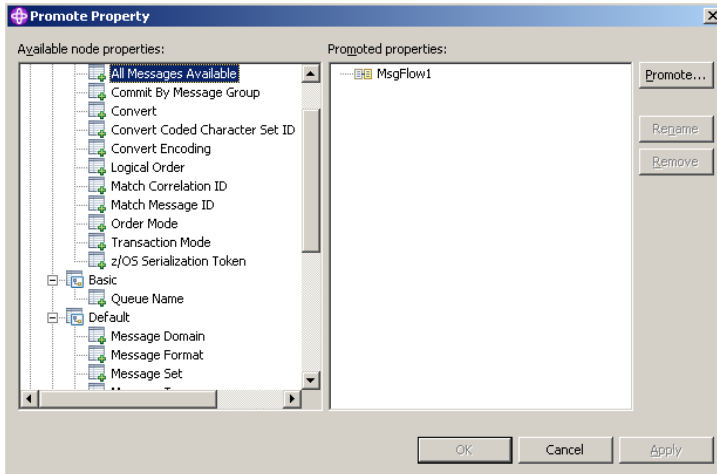

5. Promoted properties are shown in the Promoted properties pane on the right of the Promote property dialog. Double-click the promoted property in the list of properties that are currently promoted to the message flow level, or select the property you want to rename and click **Rename**. The name is highlighted, and you can edit it. Modify the existing text or enter new text to give the property a new name, and press Enter.
6. Click **Apply** to commit this change without closing the Property Promotion dialog. Click **OK** to complete your updates and close the dialog.

Removing a promoted property

If you have promoted a property from the node to the message flow level, you can remove (delete) it if you no longer want to specify its value at the message flow level. The property reverts to the value that you specified at the node level. If you remove a promoted property that is a mandatory property, ensure that you have set a value at the node level. If you have not, you cannot successfully deploy a broker archive file that includes this message flow.

Before you start:

- Promote a property
- Read the concept topic about promoted properties

If you have promoted one or more message flow node properties, and want to delete them:

1. Switch to the Broker Application Development perspective.
2. Open the message flow for which you want to promote properties by double-clicking the message flow in the Broker Development view. You can also open the message flow by right-clicking it in the Broker Development view and clicking **Open**. The message flow contents are displayed in the editor view.

If this is the first message flow that you have opened, the message flow control window and the list of available built-in message flow nodes are also displayed, to the left of the editor view.

3. In the Editor view, right-click the symbol of the message flow node whose properties you want to promote.
4. Select **Promote Property**.

The Promote Property dialog is displayed.

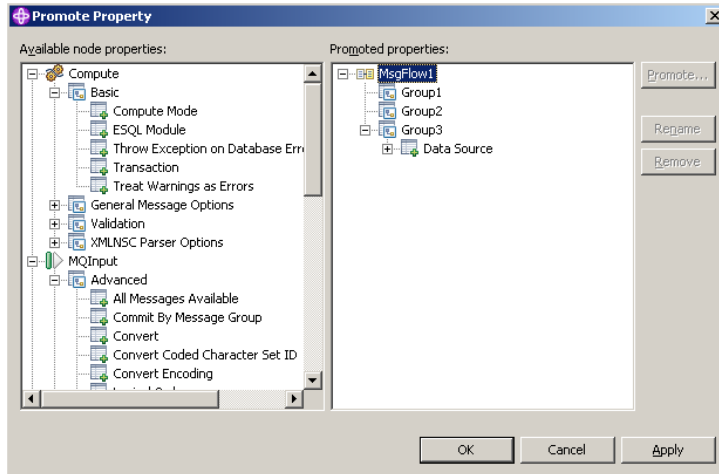

5. Select the promoted property that you want to remove in the list of properties on the right of the dialog, and click **Remove**. The property is removed from the list on the right. It is restored to the list on the left, in its appropriate place in the tree of properties for the node from which you promoted it. You can promote this property again if you choose.
6. If you want to delete all the promoted properties within a single group, select the group in the list on the right and click **Remove**. The group and all the properties it contains are deleted from this list: the individual properties that you promoted are restored to the nodes from which you promoted them.
7. Click **Apply** to commit this change without closing the Property Promotion dialog. Click **OK** to complete your updates and close the dialog.

If you have included this message flow in a higher-level message flow, and have set a value for a promoted property that you have now deleted, the embedding flow is not automatically updated to reflect the deletion. However, when you deploy that embedding message flow in the broker domain, the deleted property is ignored.

Converging multiple properties

You can promote properties from several nodes in a message flow to define a single promoted property, which applies to all those nodes.

Before you start:

- Create a message flow
- Read the concept topic about promoted properties

One example for the use of promoting properties is for database access. If a message flow contains two Database nodes that each refer to the same physical database, you can define the physical database just once on the message flow by

promoting the Data Source property of each Database node to the message flow, and setting the property at the message flow (promoted) level.

To converge multiple node properties to a single promoted property:

1. Switch to the Broker Application Development perspective.
2. Open the message flow in the Message Flow editor.
3. Right-click the node whose properties you want to promote, then click **Promote Property**.

The Promote Property dialog box is displayed.

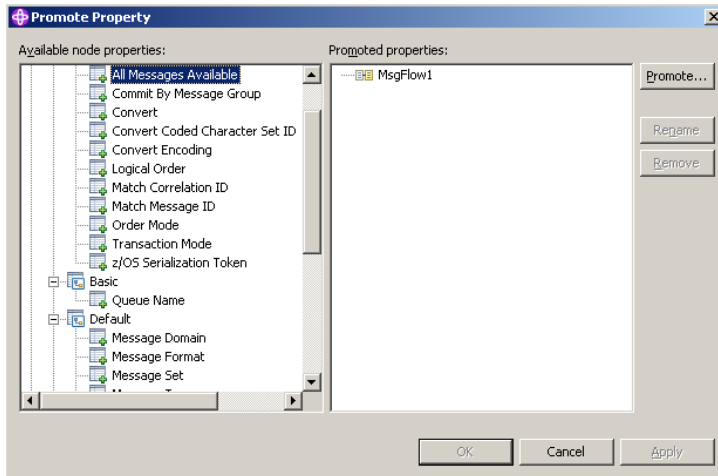

4. Select the property that you want to converge. The list on the left initially shows the expanded list of all available properties for the selected node. If you have already promoted properties from this node, they do not appear on the left, but on the right.

The list on the left also includes the other nodes in the open message flow. You can expand the properties listed under each node and work with all these properties at the same time. You do not have to close the dialog box and select another node from the Message Flow editor to continue promoting properties.

You can select multiple properties to promote by selecting a property, holding down Ctrl, and selecting one or more other properties.

If you have you selected multiple properties to converge, all the properties that you have selected must be available for promotion. If one or more of the selected properties is not available for promotion, the entire selection becomes unavailable for promotion, and the **Promote** button in the right pane is disabled.

5. Click the **Promote** button to promote the property or properties



The Target Selection dialog box opens:

The Target Selection dialog box displays only the valid targets for the promotion of the previously selected property or properties and allows you to create a new target for the promotion, such as to a new group or to a new property.

6. To converge properties from the same or different nodes in the message flow, expand the tree and click on a property that already exists. You can rename the properties by selecting them and clicking **Rename**, or by double-clicking the group or property.
7. Click **OK** to confirm your selections.

Note: If you create a new group or property using the Target Selection dialog box, the changes persist even if you select **Cancel** in the dialog box. When the dialog box closes, groups or properties that you have created using the Target Selection dialog box appear in the Promote properties dialog box.

8. Expand the property trees for all the nodes for which you want to promote properties.
9. Drag the first instance of the property that you want to converge from the list on the left, and drop it onto the appropriate group in the list on the right.
 - If the group already contains one or more promoted properties, the new property is added at the end of the group. You can rename the new property by double-clicking the property, or by selecting the property and clicking **Rename**.
 - If you want the promoted property to appear in a new group, drag the property into an empty space below the existing groups to create a new group. Alternatively:
 - a. Select the property that you want to promote, and click **Promote**. The Target Selection dialog box opens.
 - b. Click **New Group**, and enter the name of the new group.
 - c. Click **OK** to confirm your changes.
 - If you drag the property onto an existing promoted property of a different type, a no-entry icon is displayed and you cannot drop the property. You must create this as a new promoted property, or drop it onto a compatible existing promoted property. Properties must be associated with the same property editor to be compatible. For example, if you are using built-in nodes, you can converge only like properties (string with string, Boolean with Boolean).

If you are using user-defined nodes, you must check the compatibility of the property editors for the properties that you want to converge. If you have

written compiler classes for a node, you must also ensure that converged properties have the same compiler class.

10. Drag all remaining instances of the property from each of the nodes in the list on the left onto the existing promoted property. The new property is added under the existing promoted property, and is not created as a new promoted property.
11. Click **Apply** to commit this change without closing the Property Promotion dialog box. Click **OK** to complete your updates and close the dialog box.
You can also converge properties from the Promote property dialog box by dragging the selected property or properties from the left pane of the Promote Property dialog box to the right pane:
 - a. Select the property that you want to promote. You can select multiple properties to promote by selecting a property, holding down Ctrl, and selecting one or more other properties.
 - b. Drop the selected property or properties onto a property in the right pane to converge related properties from the same or different nodes in the message flow.

For example, you might want to create a single promoted property that overrides the property on each node that defines a data source.

You have promoted properties from several nodes to define a single promoted property, which is used for all those nodes.

Configure monitoring events for message flows

Use the `mqsicchange-flow-monitoring` command and create a monitoring profile to configure your message flow to emit event messages that can be used for monitoring.

Before you start:

Read the following concept topic:

- “Generating events for monitoring” on page 116
- “Monitoring basics” on page 117

You can enable events to be produced from message flows for monitoring using the `mqsicchange-flow-monitoring` command. You can also specify a monitoring profile to be used by specific message flows. You can choose to use the default monitoring profile, or you can create your own monitoring profile.

Use the following instructions to enable events for monitoring to be generated for specific message flows:

1. If you want to use the default monitoring profile, you can skip this step. If you do not want to use the default monitoring profile you must create a new monitoring profile. To create a new monitoring profile:
 - a. Use the `mqsiccreate-configurable-service` command to create a configurable service for the monitoring profile. If you have previously created a configurable service for the monitoring profile you do not need to perform this step. In the following command example, replace *myBroker* with the name of your broker, and *myMonitoringProfile* with the name of your monitoring profile.

```
mqsiccreate-configurable-service myBroker -c MonitoringProfiles -o myMonitoringProfile
```

- b. Create an XML file containing the properties for the monitoring profile. This XML file must conform to the monitoring profile schema. For information about the properties you can define in the monitoring profile, see “Monitoring profile” on page 1375. For details of the monitoring profile schema, see “Monitoring profile schema” on page 1379.
- c. Use the `mqsichangeproperties` command to populate the monitoring profile from the XML file. In the following command example, replace *myBroker* with the name of your broker, *myMonitoringProfile* with the name of your monitoring profile, and *myMonitoringProfile.xml* with the name of the XML file containing the properties for the monitoring profile.

```
mqsichangeproperties myBroker -c MonitoringProfiles -o myMonitoringProfile
-n profileProperties -p myMonitoringProfile.xml
```

2. You can use the `mqsichangeflowmonitoring` command or the broker archive editor to associate a monitoring profile with a message flow.

- Use the `mqsichangeflowmonitoring` command to change the monitoring settings for the message flows that you want to monitor.

The following examples show how to enable and modify monitoring for a single message flow, or for a selection of message flows.

- Enable monitoring events, using the default monitoring profile, for all message flows in all execution groups :

```
mqsichangeflowmonitoring myBroker -g -j -c active
```

- Modify the monitoring profile used by all message flows in all execution groups:

```
mqsichangeflowmonitoring myBroker -g -j -m myMonitoringProfile
```

- Modify the monitoring profile used by a single message flow *messageflow1* in execution group *EG1*:

```
mqsichangeflowmonitoring myBroker -e EG1 -f messageflow1 -m myMonitoringProfile
```

- Enable monitoring for all message flows in execution group *EG1*:

```
mqsichangeflowmonitoring myBroker -e EG1 -j -c active
```

- Use the Monitoring Profile Name field in the broker archive editor to associate a monitoring profile with message flows that you want to monitor.
 - a. Switch to the Broker Application Development perspective.
 - b. In the Broker Development view, right-click the bar file and then click **Open with > Broker Archive Editor**.
 - c. Click the **Configure** tab.
 - d. Click the flow on which you want to set the monitoring profile.
 - e. In the **Monitoring Profile Name** field, enter the name of a monitoring profile.
 - f. Save the bar file.

When you have run the `mqsichangeflowmonitoring` successfully, the message flows are configured to emit events using the new settings. You must run the `mqsichangeflowmonitoring` command again if you update the settings in the monitoring profile.

You can change the monitoring profile used by a message flow using the same steps. To change the monitoring profile associated with your message flow:

1. Run the `mqsdeleteconfigurable-service` command if you need to create a new configurable service.
2. Run the `mqsichangeproperties` command to populate the monitoring profile from the XML source file.

3. Run the `mqsichangeflowmonitoring` command to associate the monitoring profile with your message flow.
4. If your message flow is already deployed to an execution group you must run the `mqsireload` to load the new changes.

If you want to change the contents of an existing profile that is already associated with a message flow, run the commands in steps 2 and 4. The following example shows the commands to update the contents of the `myMonitoringProfile`:

```
mqsichangeproperties myBroker -c MonitoringProfiles -o myMonitoringProfile -n profileProperties  
-p myMonitoringProfile.xml  
  
mqsireload myBroker -e EG1
```

You can remove a monitoring profile from a broker using the `mqsdeleteconfigurable` command. A monitoring profile is deleted in the following example:

```
mqsdeleteconfigurable myBroker -c MonitoringProfiles -o myMonitoringProfile
```

Message flows that were using the removed monitoring profile continue to emit events. To trigger a refresh of the monitoring settings, you must use the `mqsichangeflowmonitoring` command with the `-c` parameter to disable and re-enable monitoring. Monitoring is disabled for message flow `messageFlow1` in the following example:

```
mqsichangeflowmonitoring myBroker -e EG1 -f messageFlow1 -c inactive
```

Collecting message flow accounting and statistics data

Before you start:

Read the concept topic about message flow accounting and statistics data.

You can collect statistics on message flow behavior.

The following topics describe the tasks that you can complete to control collection of message flow accounting and statistics data:

- “Starting to collect message flow accounting and statistics data”
- “Stopping message flow accounting and statistics data collection” on page 567
- “Viewing message flow accounting and statistics data collection parameters” on page 568
- “Modifying message flow accounting and statistics data collection parameters” on page 569
- “Resetting message flow accounting and statistics archive data” on page 569

The topics listed here show examples of how to issue the accounting and statistics commands. The examples for z/OS are shown for SDSF; if you are using another interface, you must modify the example shown according to the requirements of that interface. For details of other z/OS options, see Issuing commands to the z/OS console.

Starting to collect message flow accounting and statistics data

Before you start:

- Create a message flow

- Deploy a broker archive file
- Read the concept topic about message flow accounting and statistics collection options

You can start collecting message flow accounting and statistics data for an active broker at any time.

Select the granularity of the data that you want to be collected by specifying the appropriate parameters on the `mqsichangeflowstats` command. You must request statistics collection on a broker basis. If you want to collect information for more than one broker, you must issue the corresponding number of commands.

To start collecting message flow accounting and statistics data:

1. Identify the broker for which you want to collect statistics .
2. Decide the resource for which you want to collect statistics. You can collect statistics for a specific execution group, or for all execution groups for the specified broker.
 - If you indicate a specific execution group, you can request that data is recorded for a specific message flow or all message flows in that group.
 - If you specify all execution groups, you must specify all message flows.
3. Decide if you want to collect thread related statistics.
4. Decide if you want to collect node related statistics. If you do, you can also collect information about terminals for the nodes.
5. Decide if you want to associate data collection with a particular accounting origin. This option is valid for snapshot and archive data, and for message flows and execution groups. However, when active, you must set its origin value in each message flow to which it refers. If you do not configure the participating message flows to set the appropriate origin identifier, the data collected for that message flow is collected with the origin set to `Anonymous`. See “Setting message flow accounting and statistics accounting origin” on page 566 for further details.
6. Decide the target destination:
 - User trace log. This is the default setting. The output data can be processed using `mqsireadlog` and `mqsiformatlog`.
 - XML format publication message. If you chose this as your target destination, register the following topic for the subscriber:

`$/SYS/Broker/brokerName/StatisticsAccounting/recordType/executionGroupLabel/messageFlowLabel`

Where, *brokerName*, *executionGroupLabel*, and *messageFlowLabel* are the broker, execution group and message flow on which you want to receive data. *recordType* is the type of data collection on which you want to receive publications (snapshot, archive, or # to receive both snapshot and archive).

- `z/OS` SMF (on z/OS only)
7. Decide the type of data collection that you want:
 - Snapshot
 - Archive

You can collect snapshot and archive data at the same time, but you have to configure them separately.
 8. Issue the `mqsichangeflowstats` command with the appropriate parameters to reflect the decisions that you have made.

For example, to turn on snapshot data for all message flows in the default execution group for `BrokerA`, and include node data with the basic message flow statistics, enter:

```
mqsichangeflowstats BrokerA -s -e default -j -c active -n basic
```

z/OS Using SDSF on z/OS, enter:

```
/F BrokerA,cs s=yes,e=default,j=yes,c=active,n=basic
```

Refer to the `mqsichangeflowstats` command for further examples.

When the command completes successfully, data collection for the specified resources is started:

- If you have requested snapshot data, information is collected for approximately 20 seconds, and the results are written to the specified output.
- If you have requested archive data, information is collected for the interval defined for the broker (on the `mqsicreatebroker` or `mqsichangebroker` command, or by the external timer facility ENF). The results are written to the specified output, the interval is reset, and data collection starts again.

Next:

You can now perform the following tasks:

- “Setting message flow accounting and statistics accounting origin”
- “Stopping message flow accounting and statistics data collection” on page 567
- “Viewing message flow accounting and statistics data collection parameters” on page 568
- “Modifying message flow accounting and statistics data collection parameters” on page 569
- “Resetting message flow accounting and statistics archive data” on page 569

Setting message flow accounting and statistics accounting origin

Before you start:

- Create a message flow
- Read the concept topic about message flow accounting and statistics accounting origin

Accounting and statistics data is associated with an accounting origin.

When you request accounting origin support for collecting message flow accounting and statistics data on the `mqsichangeflowstats` command, you must also configure your message flows to provide the correct identification values that indicate what the data is associated with. You can set a different value for every message flow for which data collection is active, or the same value for a group of message flows (for example, those in a single execution group, or associated with a particular client, department, or application suite).

The accounting origin setting is not used until you deploy the message flow or flows to the brokers on which they are to run. You can activate data collection, or modify it to request accounting origin support, before or after you deploy the message flow. You do not have to stop collecting data when you deploy a message flow that changes accounting origin.

To configure a message flow to specify a particular accounting origin:

1. Switch to the Broker Application Development perspective.
2. Open the message flow that you want to work with.
3. Click **Selection** above the palette of nodes.

4. Right-click a Compute, Database, or Filter node in the editor view, and click **Open ESQL**. The associated ESQL file is opened in the editor view, and your cursor is positioned at the start of the correct module. You can include the required ESQL in any of these nodes, so decide which node in each message flow is the most appropriate for this action.

If you want to take advantage of the accounting origin support, you must include one of these nodes in each message flow for which you want a specific origin set. If you have not configured one of these three nodes in the message flow, you must add one at a suitable point (for example, immediately following the input node) and connect it to other nodes in the flow.

5. Update the ESQL in the node's module to set an accounting origin. The broker uses the origin identifier that is set in the Environment tree. You must set a value in the field with correlation name `Environment.Broker.Accounting.Origin`. This field is not created automatically in the Environment tree when the message is first received in the broker. It is created only when you set it in an ESQL module associated with a node in the message flow.

If you do not set a value in the message flow, the default value `Anonymous` is used for all output. If you set a value in more than one place in the message flow, the value that you set immediately before the message flow terminates is used in the output data.

The code that you need to add is of the form:

```
SET Environment.Broker.Accounting.Origin = "value";
```

You can set the identifier to a fixed value if you choose (as shown above), or you can determine its value based on a dynamic value that is known only at runtime. The value must be character data, and can be a maximum of 32 bytes. For example, you might set its value to the contents of a particular field in the message that is being processed (if you are coding ESQL for a Compute node, you must use correlation name `InputBody` in place of `Body` in the following example):

```
IF Body.DepartmentName <> NULL THEN
  SET Environment.Broker.Accounting.Origin = Body.DepartmentName;
END IF;
```

6. Save the ESQL module, and check that you have not introduced any errors.
7. Save the message flow, and check again for errors.

You are now ready to deploy the updated message flow. Accounting and statistics data records that are collected after the message flow has been deployed will include the origin identifier that you have set.

Stopping message flow accounting and statistics data collection

You can stop collecting data for message flow accounting and statistics at any time. You do not have to stop the message flow, execution group, or broker to make this change, nor do you have to redeploy the message flow.

Before you start:

- Start to collect message flow accounting and statistics data
- Read the concept topic about message flow accounting and statistics data

You can stop collecting data for message flow accounting and statistics at any time. You do not have to stop the message flow, execution group, or broker to make this change, nor do you have to redeploy the message flow.

You can modify the parameters that are currently in force for collecting message flow accounting and statistics data without stopping data collection. See “Modifying message flow accounting and statistics data collection parameters” on page 569 for further details.

To stop collecting data:

1. Check the resources for which you want to stop collecting data.

You do not have to stop all active data collection. If you choose, you can stop a subset of data collection. For example, if you started collecting statistics for all message flows in a particular execution group, you can stop doing so for a specific message flow in that execution group. Data collection for all other message flows in that execution group continues.

2. Issue the `mqsichangeflowstats` command with the appropriate parameters to stop collecting data for some or all resources.

For example, to switch off snapshot data for all message flows in all execution groups for BrokerA, enter:

```
mqsichangeflowstats BrokerA -s -g -j -c inactive
```

z/OS Using SDSF on z/OS, enter:

```
/F BrokerA,cs s=yes g=yes j=yes c=inactive
```

Refer to the `mqsichangeflowstats` command for further examples.

When the command completes successfully, data collection for the specified resources is stopped. Any outstanding data that has been collected is written to the output destination when you issue this command, to ensure the integrity of data collection.

Viewing message flow accounting and statistics data collection parameters

You can review and check the parameters that are currently in effect for message flow accounting and statistics data collection.

Before you start:

- Start to collect message flow accounting and statistics data
- Read the concept topic about message flow accounting and statistics data

To view message flow accounting and statistics data collection parameters:

Issue the `mqsireportflowstats` command with the appropriate parameters to view the parameters that are currently being used by the broker to control archive data collection or snapshot data collection.

You can view the parameters in force for a broker, an execution group, or an individual message flow.

For example, to view parameters for snapshot data for all message flows in all execution groups for BrokerA, enter:

```
mqsireportflowstats BrokerA -s -g -j
```

z/OS Using SDSF on z/OS, enter:

```
/F BrokerA,rs s=yes,g=yes,j=yes
```

Refer to the `mqsireportflowstats` command for further examples.

The command displays the current status, for example:

```
BIP8187I: Statistics Snapshot settings for flow MyFlow1 in execution
group default - On?: inactive,
ThreadDataLevel: basic, NodeDataLevel: basic,
OutputFormat: usertrace, AccountingOrigin: basic
```

Next:

You can now modify the data collection parameters.

Modifying message flow accounting and statistics data collection parameters

You can modify the parameters that you have set for message flow accounting and statistics data collection. For example, you can start collecting data for a new message flow that you have deployed to an execution group for which you are already collecting data.

You can modify parameters while data collection is active; you do not have to stop data collection and restart it.

Before you start:

- Start to collect message flow accounting and statistics data
- Read the concept topic about message flow accounting and statistics data

To modify message flow accounting and statistics parameters:

1. Decide which data collection parameters you want to change. You can modify the parameters that are in force for a broker, an execution group, or an individual message flow.
2. Issue the `mqsichangeflowstats` command with the appropriate parameters to modify the parameters that are currently being used by the broker to control archive data collection or snapshot data collection.

For example, to modify parameters to extend snapshot data collection to a new message flow MFlow2 in execution group EG2 for BrokerA, enter:

```
mqsichangeflowstats BrokerA -s -e EG2 -f MFlow2 -c active
```

z/OS Using SDSF on z/OS, enter:

```
/F BrokerA,cs s=yes,e=EG2,f=MFlow2,c=active
```

If you want to specify an accounting origin for archive data for a particular message flow in an execution group, enter:

```
mqsichangeflowstats BrokerA -a -e EG4 -f MFlowX -b basic
```

z/OS Using SDSF on z/OS, enter:

```
/F BrokerA,cs a=yes,e=EG4,f=MFlowX,b=basic
```

Refer to the `mqsichangeflowstats` command for further examples.

When the command completes successfully, the new parameters that you have specified for data collection are in force. These parameters remain in force until you stop data collection or make further modifications.

Resetting message flow accounting and statistics archive data

You can reset message flow accounting and statistics archive data to purge any accounting and statistics data not yet reported for that collecting interval. This

removes unwanted data. You can request this at any time; you do not have to stop data collection and restart it to perform reset. You cannot reset snapshot data.

Before you start:

- Start to collect message flow accounting and statistics data
- Read the concept topic about message flow accounting and statistics data

To reset message flow accounting and statistics archive data:

1. Identify the broker, and optionally the execution group, for which you want to reset archive data. You cannot reset archive data on a message flow basis.
2. Issue the `mqsichangeflowstats` command with the appropriate parameters to reset archive data.

For example, to reset archive data for BrokerA, enter:

```
mqsichangeflowstats BrokerA -a -g -j -r
```

z/OS Using SDSF on z/OS, enter:

```
/F BrokerA,cs a=yes,g=yes,j=yes,r=yes
```

When this command completes, all accounting and statistics data accumulated so far for this interval are purged and will not be included in the reports. Data collection is restarted from this point. All archive data for all flows (indicated by `-j` or `j=yes`) in all execution groups (indicated by `-g` or `g=yes`) is reset.

This command has a minimal effect on snapshot data because the accumulation interval is much shorter than for archive data. It does not effect the settings for archive or snapshot data collection that are currently in force. When the command has completed, data collection resumes according to the current settings.

You can change any other options that are currently in effect when you reset archive data, for example accounting origin settings or output type.

Developing a user exit

To develop a user exit, follow these steps:

1. Declare the user exit.
 - Declare a user exit by using the `bipInitializeUserExits` function to specify the following properties:
 - a. Name (used to register and control the active state of the exit)
 - b. User context storage
 - c. A function to be invoked (for one or more Event Types)
2. Implement the user exit behavior.

When the user exit is declared, a set of functions is registered, and these functions are invoked when specific events occur. The behavior of the user exit is provided by implementing these functions. The following table lists the events and their associated functions:

Event	Function
A message is dequeued from the input source	<code>cciInputMessageCallback</code>
A message is propagated to the node for processing	<code>cciPropagatedMessageCallback</code>
A request message is sent to the output node's transport, and transport-specific destination information is written to "WrittenDestination" in the LocalEnvironment	<code>cciOutputMessageCallback</code>

Event	Function
The node completes processing	cciNodeCompletionCallback
The transaction ends	cciTransactionEventCallback

3. Your user exit code must implement the cleanup function.
The user exit library must implement the `bipTerminateUserExits` function. This function is invoked as the `ExecutionGroup`'s process is ending, and your user exit must clear up any resources allocated during the `bipInitializeUserExits` function.
4. Compile.
Use your existing process for your environment to compile your user exit. The supported C compilers are shown in *Optional software support*. See *Compiling a C user-defined extension* for more details.

Deploying a user exit

Deploy your user exit to the broker.

Before you start:

- Write and compile the user exit code. See “Developing a user exit” on page 570.
- Ensure that the exit:
 1. Is in a library that has the extension `.lel`
 2. Exports the functions `bipInitializeUserExits` and `bipTerminateUserExits`

You can set the state of the user exit dynamically to active, or inactive, on a per-message flow basis without restarting the broker.

To deploy the user exit:

1. Install the user exit code on a broker.

The library containing the user exit code must be installed on a file system that can be accessed by the broker. For example, the file must have read and execute authority for the user ID under which the broker runs. The broker looks in the following places for libraries containing user exits:

- The broker property `UserExitPath` defines a list of directories separated by colons (semi-colons on Windows). Use the `-x` flag on the `mqsicreatebroker` or `mqsichangebroker` command to set this property for 32-bit execution groups for each broker.

Alternatively, you can append the directory containing the directory that holds the extension files to the environment variable `MQSI_USER_EXIT_PATH` associated with the environment in which the broker is running.

If both are set, the environment variable takes precedence. All the directories in the environment variable are searched in the order in which they appear in the variable, then all the directories in the broker property are searched in the order in which they appear in the property.

- For 64-bit extensions, you cannot use the `-x` parameter to modify the exit path. Append the directory containing the directory that holds the extension files to the environment variable `MQSI_USER_EXIT_PATH64`.

2. Load the user exit library into the broker's processes.

When the user exit library has been installed on the broker, you must load it in one of the following ways:

- Stop and restart the broker.
 - Run the `mqsireload` command to restart the execution group processes.
3. Activate the user exit.
- User exits can be active or inactive, and are inactive by default. You can change the state of a user exit dynamically by using the `mqsichangeflowuserexits` command on a per-flow basis, without having to restart the broker. You can also change the default state for a set of user exits to active on a per-broker basis by using the `mqsichangebroker` command; in this case, you do not have to restart the broker.

To set the default user exit state for a broker:

- a. Stop the broker.
- b. Set the `activeUserExits` property of the broker by using the `mqsichangebroker` command.
- c. Start the broker and check the system log to ensure that all execution groups start without error. If any invalid user exit names are specified (that is, the user exit is not provided by any library loaded by the execution group), a BIP2314 message is written to the system log and all flows in the execution groups fail to start unless you take one of the following actions:
 - Provide a library in the user exit path that implements the exit; then run the `mqsireload` command, or restart the broker, to load an exit from the library.
 - Run the `mqsichangeflowuserexits` command to remove the exit from both the active and inactive lists.

You can also override the default user exit state for a broker. You can use the `mqsichangeflowuserexits` command to activate, or deactivate, user exits on a per-execution group or per-message flow basis, with the order of precedence being message flow then execution group. When multiple exits are active for a given flow, the broker starts them in the order that is defined by the `mqsichangeflowuserexits` command.

Configuring aggregation flows

This topic describes how to configure aggregation flows.

Before you start:

Read the following concept topic:

- “Message flow aggregation” on page 124

Aggregation message flows let you generate and fan-out a number of related requests, fan-in the corresponding replies, and compile those replies into a single aggregated reply message, using the `AggregateControl`, `AggregateRequest`, and `AggregateReply` nodes. For an overview of using aggregation in message flows, see “Message flow aggregation” on page 124.

To configure aggregation flows see the following topics:

- “Creating the aggregation fan-out flow” on page 573
- “Creating the aggregation fan-in flow” on page 577
- “Associating fan-out and fan-in aggregation flows” on page 581
- “Setting timeouts for aggregation” on page 583
- “Using multiple `AggregateControl` nodes” on page 584
- “Correlating input request and output response aggregation messages” on page 585

- “Using control messages in aggregation flows” on page 585
- “Handling exceptions in aggregation flows” on page 588

The following sample demonstrates the use of aggregation message flows:

Airline Reservations sample

You can view samples only when you use the information center that is integrated with the Message Broker Toolkit.

Creating the aggregation fan-out flow

The aggregation fan-out flow receives the initial input message and restructures it to present a number of requests to a number of target applications.

Before you start:

- Read the aggregation overview.
- Create a message flow project.

You can include the fan-out and fan-in flow within the same message flow. However, you might prefer to create two separate flows. For more information about the benefits of configuring separate message flows, see “Associating fan-out and fan-in aggregation flows” on page 581.

To review an example of a fan-out flow that is supplied with WebSphere Message Broker, see the following sample:

- Airline Reservations sample

You can view samples only when you use the information center that is integrated with the Message Broker Toolkit.

To create the fan-out flow:

1. Switch to the Broker Application Development perspective.
2. Create a new message flow to provide the fan-out processing.
3. Add the following nodes in the editor view and configure and connect them as described:

Input node

The input node receives an input message from which multiple request messages are generated. This node can be any one of the built-in nodes, or a user-defined input node.

- a. Select the input node to open the Properties view. The node properties are displayed.
- b. Specify the source of input messages for this node. For example, specify the name of a WebSphere MQ queue in the Basic property Queue Name from which the MQInput node retrieves messages.
- c. Optional: specify values for any other properties that you want to configure for this node. For example, set the Advanced property Transaction mode to the default Yes, to ensure that aggregate request messages are put under syncpoint. This option avoids the situation where the AggregateReply node receives response messages before it has received the control message that informs it of the aggregation instance. Putting the fan-out flow under transactional control ensures that the fan-out flow completes before any response messages get to the AggregateReply.

- d. Connect the input node's Out terminal to the In terminal of an AggregateControl node. This option represents the simplest configuration; if appropriate, you can include other nodes between the input node and the AggregateControl node. For example, you might want to store the request for audit purposes (in a Warehouse node), or add a unique identifier to the message (in a Compute node).
- e. Optional: if your fan-out and fan-in flows are combined within one message flow, modify the Order Mode property on the **Advanced** tab. Select the **By Queue Order** option and ensure that the **Logical Order** option is also selected. These options force the input node to be single threaded in order to maintain the logical order of the messages that arrive on the queue. Any additional instance threads that you make available are then shared amongst only the fan-in input nodes to improve the performance of aggregation. If your fan-in and fan-out flows are in separate message flows this step is not required because you can make additional threads available specifically to the fan-in flow.

AggregateControl node

The AggregateControl node updates the LocalEnvironment associated with the input message with information required by the AggregateRequest node. The AggregateControl node creates the LocalEnvironment.ComIbmAggregateControlNode folder. This folder and the fields within it are for internal use by WebSphere Message Broker and you should not rely on their existence or values when developing your message flows.

- a. Select the AggregateControl node to open the Properties view. The node properties are displayed.
- b. Set the Aggregate Name property of the AggregateControl node to identify this particular aggregation. It is used later to associate this AggregateControl node with a specific AggregateReply node. The Aggregate Name that you specify must be contextually unique within a broker.
- c. Optional: set the Timeout property to specify how long the broker waits for replies to arrive before taking some action (described in "Setting timeouts for aggregation" on page 583). If a timeout is not set on the AggregateControl node then aggregate requests stored internally will not be removed unless all aggregate reply messages return. This situation might lead to a gradual build up of messages on the internal queues. To avoid this situation, set the timeout to a value other than zero (zero means never timeout) so that when the timeout is reached the requests are removed and the queues do not fill up with redundant requests. Even if timeouts are not required or expected, it is good practice to set the timeout value to a large value (for example: 864000 seconds which is 24 hours) so that the queues occasionally get cleared of old aggregations.
- d. Connect the Out terminal of the AggregateControl node to the In terminal of one or more Compute nodes that provide the analysis and breakdown of the request in the input message that is propagated on this terminal.

Attention: The Control terminal of the AggregateControl node has been deprecated at Version 6.0 and by default any connections from this terminal to the AggregateReply node (either direct or indirect) are ignored. This configuration maximizes the efficiency of aggregation flows and does not damage the reliability of aggregations. This configuration is the optimum configuration.

However, if you do want a control message to be sent from the AggregateControl node to the AggregateReply node, you must connect the Control terminal to the corresponding AggregateReply node on the fan-in flow (either directly or indirectly, as described in “Associating fan-out and fan-in aggregation flows” on page 581). If you connect it indirectly to the AggregateReply node, for example through an MQOutput node, you must include a Compute node to add the appropriate headers to the message to ensure that it can be safely transmitted.

In addition, for the Control terminal and connections from it to be recognized, you must enable the environment variable MQSI_AGGR_COMPAT_MODE. However, choosing this option has implications regarding the performance and behavior of message aggregations. For a full description of these implications and the environment variable, see “Using control messages in aggregation flows” on page 585.

Compute node

The Compute node extracts information from the input message and constructs a new output message.

If the target applications that handle the subtask requests can extract the information that they require from the single input message, you do not need to include a Compute node to split the message. You can pass the whole input message to all target applications.

If your target applications expect to receive an individual request, not the whole input message, you must include a Compute node to generate each individual subtask output message from the input message. Configure each Compute node in the following way, copying the appropriate subset of the input message to each output message:

- a. Select the Compute node to open the Properties view. The node properties are displayed.
- b. Select a value for the Basic property Compute Mode. This property specifies which sections of the message tree are modified by the node. The AggregateControl node inserts elements into the LocalEnvironment tree in the input message that the AggregateRequest node reads when the message reaches it. Ensure that the LocalEnvironment is copied from the input message to the output message in the Compute node. This configuration happens automatically unless you specify a value that includes LocalEnvironment (one of All, LocalEnvironment, LocalEnvironment and Message, or Exception and LocalEnvironment).

If you specify one of these values, the broker assumes that you are customizing the Compute node with ESQL that writes to LocalEnvironment, and that you will copy over any elements within that tree that are required in the output message.

If you want to modify LocalEnvironment, add the following statement to copy the required aggregate information from input message to output message:

```
SET OutputLocalEnvironment.ComIbmAggregateControlNode =  
InputLocalEnvironment.ComIbmAggregateControlNode;
```

- c. Optional: specify values for any other properties that you want to configure for this node.
- d. Connect the Out terminal of each Compute node to the In terminal of the output node that represents the destination of the output request message that you have created from the input message in this node.

Output node

Include an output node for each output message that you generate in your fan-out flow. Configure each node as described below, with the appropriate modifications for each destination.

The output node must be an output node that supports the request/reply model, such as an MQOutput node, or a mixture of these nodes (depending on the requirements of the target applications).

- a. Select the output node to open the Properties view. The node properties are displayed.
- b. Specify the destination for the output messages for this node. For example, specify the name of a WebSphere MQ queue in the Basic property Queue Name to which the MQOutput node sends messages. The target application must process its request, and send the response to the reply destination indicated in its input message (for example the WebSphere MQ ReplyToQueue).
- c. Click Request in the left view and set values for these properties to specify that replies are sent to the fan-in flow's input queue.
- d. Optional: specify values for any other properties that you want to configure for this node.
- e. Connect the Out terminal of the output node to the In terminal of an AggregateRequest node. When the message is propagated through the output node's Out terminal, the built-in output node updates the WrittenDestination folder within the associated LocalEnvironment with additional information required by the AggregateRequest node.

The information written by the built-in nodes is queue name, queue manager name, message ID and correlation ID (from the MQMD), and message reply identifier (set to the same value as message ID).

AggregateRequest node

Include an AggregateRequest node for each output message that you generate in your fan-out flow.

- a. Select the AggregateRequest node to open the Properties view. The node properties are displayed.
- b. Set the Basic property Folder Name to a value that identifies the type of request that has been sent out. This value is used by the AggregateReply node to match up with the reply message when it is received in the fan-in flow. The folder name that you specify for each request that the fan-out flow generates must be unique.

The `AggregateRequest` node writes a record in WebSphere MQ for each message that it processes. This record enables the `AggregateReply` node to identify which request each response is associated with. If your output nodes are non-transactional, the response message might arrive at the fan-in flow before this database update is committed. For details on how you can use timeouts to avoid this situation, see “Setting timeouts for aggregation” on page 583.

CAUTION:

Although the use of timeouts can help to avoid this situation described above, configure your fan-out flow to be transaction so that response messages cannot get to the fan-in flow before the corresponding `AggregateRequest` nodes have committed their database updates.

4. Press Ctrl-S or click **File** → **Save** *name* on the taskbar menu (where *name* is the name of this message flow) to save the message flow and validate its configuration.

To collect the aggregation responses initiated by your fan-out flow, create your fan-in flow.

Creating the aggregation fan-in flow

The aggregation fan-in flow receives the responses to the request messages that are sent out by the fan-out flow, and constructs a combined response message containing all the responses received.

Before you start:

- Read the aggregation overview.
- Create a message flow project.

You can include the fan-out and fan-in flow within the same message flow. However, you might prefer to create two separate flows. For more information about the benefits of configuring separate message flows, see “Associating fan-out and fan-in aggregation flows” on page 581. Do not deploy multiple copies of the same fan-in flow either to the same or to different execution groups.

If you do not configure the fan-out flow to be transactional, the timeout values that you have specified might result in the combined response message being generated before the fan-in flow has received all the replies. For more information, see “Creating the aggregation fan-out flow” on page 573.

To review an example of a fan-in flow see the following sample:

- Airline Reservations sample

You can view samples only when you use the information center that is integrated with the Message Broker Toolkit.

To create the fan-in flow:

1. Switch to the Broker Application Development perspective.
2. Create a message flow to provide the fan-in processing.
3. Add the following nodes in the editor view and configure and connect them as described:

Input node

The input node receives the responses to the multiple request messages that are generated from the fan-out flow.

This node must be an input node that supports the request/reply model, such as an MQInput node, or a mixture of these nodes (depending on the requirements of the applications that send these responses). The response that is received by each input node must be sent across the same protocol as the request to which it corresponds. For example, if you include an MQOutput node in the fan-out flow, the response to that request must be received by an MQInput node in this fan-in flow.

- a. Select the input node to open the Properties view. The node properties are displayed.
- b. Specify the source of input messages for this node. For example, specify the name of a WebSphere MQ queue in the Basic property Queue Name from which the MQInput node retrieves messages.
- c. Optional: specify values for any other properties that you want to configure for this node.
- d. Connect the input node's Out terminal to the In terminal of an AggregateReply node.

Connect the terminals in this way to create the simplest configuration; if appropriate, you can include other nodes between the input node and the AggregateReply node. For example, you might want to store the replies for audit purposes (in a Warehouse node).

Include just one input node that receives all the aggregation response messages at the beginnings of the fan-in flow as described above. If you have multiple input nodes, threads that are started by a specific reply input node can complete the aggregation and execution of the message flow, while the others are sending their response messages to the AggregateReply node, which subsequently become eligible to timeout. A single input node creates a more sequential processing of the replies for each aggregation; specify additional instances to provide more processing power through this one node, see "Configurable message flow properties" on page 1372.

AggregateReply node

The AggregateReply node receives the inbound responses from the input node through its In terminal. The AggregateReply node stores each reply message for subsequent processing.

When all the replies for a particular group of aggregation requests have been collected, the AggregateReply node creates an aggregated reply message and propagates it through the Out terminal.

- a. Select the AggregateReply node to open the Properties view. The node properties are displayed.
- b. Set the Aggregate Name property of the AggregateReply node to identify this aggregation. Set this value to be the same value that you set for the Aggregate Name property in the corresponding AggregateControl node in the fan-out flow.
- c. Optional: to retain an unrecognized message before propagating it to the Unknown terminal, set a value for the Unknown Message

Timeout. If you are using separate fan-out and fan-in flows, set this value to a non-zero number if the control message might be delayed.

- d. Optional: to explicitly handle unrecognized messages, connect the Unknown terminal to another node, or sequence of nodes. If you do not connect this terminal to another node in the message flow, messages propagated through this terminal are discarded.
- e. Optional: if you have specified a timeout value for this aggregation in the AggregateControl node, and you want to explicitly handle timeouts that expire before all replies are received, connect the Timeout terminal to another node, or sequence of nodes. Partially complete aggregated replies are sent to the Timeout terminal if the timer expires. If you do not connect this terminal to another node in the message flow, messages propagated through this terminal are discarded.
- f. Optional: specify values for any other properties that you want to configure for this node.
- g. Connect the Out terminal of the AggregateReply node to the In terminal of a Compute node.

Attention: The Control terminal of the AggregateReply node was deprecated at Version 6.0, and by default any connections to this terminal (either direct or indirect) are ignored. This change maximizes the efficiency of aggregation flows and does not damage the reliability of aggregations. This configuration provides the optimum content.

However, if you want the AggregateReply node to receive, on its Control terminal, the control message that was sent by the corresponding AggregateControl node on the fan-out flow, you must make the necessary connections as described in “Creating the aggregation fan-out flow” on page 573. Keep the path from the AggregateReply node to the output node as direct as possible to maximize the performance of aggregations. Do not modify the content of this control message.

In addition, for the Control terminal and connections to it to be recognized, you must enable the environment variable MQSI_AGGR_COMPAT_MODE. If you choose this option, the performance and behavior of message aggregations might be impacted; for a full description of these implications and the environment variable, see “Using control messages in aggregation flows” on page 585.

Aggregated messages which are sent from the AggregateReply node output terminals (Out and Timeout) are not validated. Any validation of data should be done before messages are sent to the AggregateReply node, as it ignores validation options when reconstructing the stored messages.

Compute node

The Compute node receives the message that contains the combined responses. Typically, the format of this combined message is not valid for output, because the aggregated reply message has an unusual structure and cannot be parsed into the bit stream required by some nodes, for example the MQOutput node. The Out and Timeout

terminals always propagate an aggregated reply message, which always requires further processing before it can be propagated to an MQOutput node. Therefore you must include a Compute node and configure this node to create a valid output message.

- a. Select the Compute node to open the Properties view. The node properties are displayed.
- b. Specify in the Basic property ESQL Module the name of the ESQL module that customizes the function of this node .
- c. Right-click the node and click **Open ESQL** to open the ESQL file that contains the module for this node. The module is highlighted in the ESQL editor view.
- d. Code the ESQL to create a single output message from the aggregated replies in the input message.

The structure of the aggregated reply message that is propagated through the Out terminal. Information on how you can access its contents are provided in “Accessing the combined message contents.”

- e. Optional: specify values for any other properties that you want to configure for this node.
- f. Connect the Out terminal of the Compute node to the In terminal of the output node that represents the destination of the single response message.

Output node

Include an output node for your fan-in flow. This node can be any of the built-in nodes, or a user-defined output node.

- a. Select the output node to open the Properties view. The node properties are displayed.
 - b. Specify the destination for the output message for this node. For example, specify in the Basic property Queue Name the name of a WebSphere MQ queue to which the MQOutput node sends messages.
 - c. Optional: specify values for any other properties that you want to configure for this node.
4. Press Ctrl-S or click **File** → **Save name** on the taskbar menu (where *name* is the name of this message flow) to save the message flow and validate its configuration.

Accessing the combined message contents

The AggregateReply node creates a folder in the combined message tree below Root, called ComIbmAggregateReplyBody. Below this, the node creates a number of subfolders using the names that you set in the AggregateRequest nodes. These subfolders are populated with the associated reply messages.

For example, the request messages might have folder names:

- TAXI
- HOTEL

The resulting aggregated reply message created by the AggregateReply node might have a structure similar to that shown below:

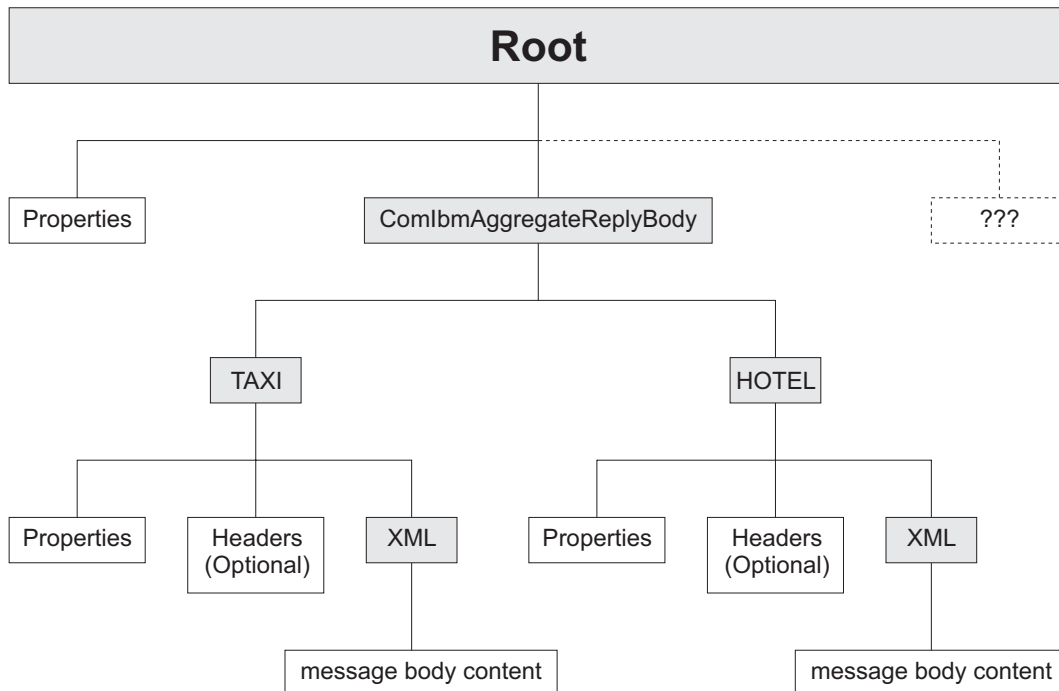

Use ESQL within a Compute node to access the reply from the taxi company using the following correlation name:

```
InputRoot.ComIbmAggregateReplyBody.TAXI.xyz
```

The folder name does not have to be unique. If you have multiple requests with the folder name TAXI, you can access the separate replies using the array subscript notation, for example:

```
InputRoot.ComIbmAggregateReplyBody.TAXI[1].xyz
InputRoot.ComIbmAggregateReplyBody.TAXI[2].xyz
```

Associating fan-out and fan-in aggregation flows

Associate the fan-out message flow processing with its corresponding fan-in message flow processing by setting the Aggregate Name property of the AggregateControl and AggregateReply nodes in your aggregation flow to the same value.

If you did not configure this property when you created your fan-in and fan-out flows, you must complete this task.

Before you start:

You must have completed the following tasks:

- “Creating the aggregation fan-out flow” on page 573
- “Creating the aggregation fan-in flow” on page 577

The Aggregate Name must be contextually unique within a broker. You can have only one AggregateControl node and one AggregateReply node with a particular Aggregate Name, although you can have more than one AggregateControl node with the same Aggregate Name, as described in “Using multiple AggregateControl nodes” on page 584. Do not deploy a fan-in flow to multiple execution groups on the same broker; results are unpredictable.

You can either create the fan-out and fan-in flows in the same message flow, or in two different message flows. In either case, the two parts of the aggregation are associated when you set the Aggregate Name property.

The way in which you configure your aggregation flow depends on a number of factors:

- The design of your message flow.
- The hardware on which the broker is running.
- The timeout values that you choose (refer to “Setting timeouts for aggregation” on page 583).
- How you expect to maintain the message flows.

You can include the fan-out and fan-in flow within the same message flow. However, you might prefer to create two separate flows. The advantages of creating separate fan-out and fan-in flows are:

- You can modify the two flows independently.
- You can start and stop the two flows independently.
- You can deploy the two flows to separate execution groups to take advantage of multiprocessor systems, or to provide data segregation for security or integrity purposes.
- You can allocate different numbers of additional threads to the two flows, as appropriate, to maintain a suitable processing ratio.

The following sample shows the use of two flows for aggregation:

- Airline Reservations sample

You can view samples only when you use the information center that is integrated with the Message Broker Toolkit.

To associate the fan-out flow with the fan-in flow:

1. Switch to the Broker Application Development perspective.
2. Open the message flow that contains your fan-out flow.
3. Select the AggregateControl node to open the Properties view. The node properties are displayed.
4. Set the Aggregate Name property of the AggregateControl node to identify this aggregation. The Aggregate Name that you specify must be contextually unique within a broker.
5. If you have separate fan-out and fan-in flows:
 - a. Press Ctrl-S or click **File** → **Save name** on the taskbar menu (where *name* is the name of this message flow) to save the message flow and validate its configuration.
 - b. Open the message flow that contains your fan-in flow.
6. Select the AggregateControl node to open the Properties view. The node properties are displayed.
7. Set the Aggregate Name property of the AggregateReply node to the same value that you set for the Aggregate Name property in the corresponding AggregateControl node in the fan-out flow.
8. Press Ctrl-S or click **File** → **Save name** to save the message flow and validate its configuration.

In WebSphere Message Broker, fan-out and fan-in flows were also associated by sending control messages from the AggregateControl node to the AggregateReply

node. This facility is no longer available. For optimum performance, do not connect the `AggregateControl` and `AggregateReply` node. However, if you do want to use control messages in your aggregations, and you want to connect these two nodes, refer to “Using control messages in aggregation flows” on page 585.

Setting timeouts for aggregation

You can use two properties of the aggregation nodes to set timeout values for aggregated message processing.

Before you start:

To complete this task, you must have completed the following tasks:

- “Creating the aggregation fan-out flow” on page 573
- “Creating the aggregation fan-in flow” on page 577

There are two situations that might require the use of timeouts:

1. In certain situations you might need to receive an aggregated reply message within a certain time. Some reply messages might be slow to return, or might never arrive. For these situations:
 - a. Switch to the Broker Application Development perspective.
 - b. Open the fan-out message flow.
 - c. Set the *Timeout* property of the `AggregateControl` node to specify how long (in seconds) the broker must wait for replies. By default, this property is set to 0, which means that there is no timeout and the broker waits indefinitely.

If the timeout interval passes without all the replies arriving, the replies that have arrived are turned into an aggregated reply message by the corresponding `AggregateReply` node, and propagated to its timeout terminal. If you choose, you can process this partial response message in the same way as a complete aggregated reply message. If you prefer, you can provide special processing for incomplete aggregated replies.

2. When a message arrives at the in terminal of an `AggregateReply` node, it is examined to see if it is an expected reply message. If it is not recognized, it is propagated to the unknown terminal. You might want the broker to wait for a given period of time before doing this, because:
 - The reply message might arrive before the work performed by the `AggregateRequest` node has been transactionally committed. This situation can be avoided by configuring the *Transaction mode* property of the Input node as described in “Creating the aggregation fan-out flow” on page 573.
 - The reply message might arrive before the control message. This situation can be avoided by leaving the control terminal of the `AggregateControl` node unconnected. For further information about the implications of connecting the control terminal, see “Using control messages in aggregation flows” on page 585.

These situations are most likely to happen if you send the request messages out of syncpoint, and might result in valid replies being sent to the unknown terminal. To reduce the chance of this event:

- a. Switch to the Broker Application Development perspective.
- b. Open the fan-in message flow.
- c. Set the *Unknown Message Timeout* property on the `AggregateReply` node. When you set this property, a message that cannot be recognized immediately as a valid reply is held persistently within the broker for the number of seconds that you specify for this property .

If the unknown timeout interval expires, and the message is recognized, it is processed. The node also checks to see if this previously unknown message is the last reply needed to make an aggregation complete. If it is, the aggregated reply message is constructed and propagated.

If the unknown timeout interval expires and the message is still not recognized, the message is propagated to the unknown terminal.

Using multiple AggregateControl nodes

You might find it useful to design a fan-out flow with multiple AggregateControl nodes, all with the same value set for the property *Aggregate Name*, but with different values for the *Timeout* property. This is the only situation in which you can reuse an Aggregate Name.

Before you start:

To complete this task, you must have completed the following task:

- “Creating a message flow project” on page 215

For example, if you have created an aggregation flow that books a business trip, you might have some requests that need a reply within two days, but other, more urgent requests, that need a reply within two hours.

To configure an aggregation flow that uses multiple AggregateControl nodes:

1. Switch to the Broker Application Development perspective.
2. Create or open the fan-out message flow.
3. Configure the required number of AggregateControl nodes. Set the Basic property *Aggregate Name* of each node to the same value. For example, include two nodes and enter the name JOURNEY as the *Aggregate Name* for both.
4. Set the value for the *Timeout* property in each node to a different value. For example, set the *Timeout* in one node to two hours; set the *Timeout* in the second node to two days.
5. Configure a Filter node to receive incoming requests, check their content, and route them to the correct AggregateControl node.
6. Connect the nodes together to achieve the required result. For example, if you have configured the Filter node to test for requests with a priority field set to urgent, connect the true terminal to the AggregateControl node with the short timeout. Connect the false terminal to the AggregateControl node with the longer timeout. Connect the out terminals of the AggregateControl nodes to the following nodes in the fan-out flow.

You must connect the two AggregateControl nodes in parallel, not in sequence. This means that you must connect both to the Filter node (one to the true terminal, one to the false), and both to the downstream nodes that handle the requests for the fan-out. Each input message must pass through only one of the AggregateControl nodes. If you connect the nodes such that a single message is processed by more than one AggregateControl node, duplicate records are created in the database by the AggregateRequest node and subsequent processing results are unpredictable.

The following diagram shows an example fan-out message flow that uses this technique.

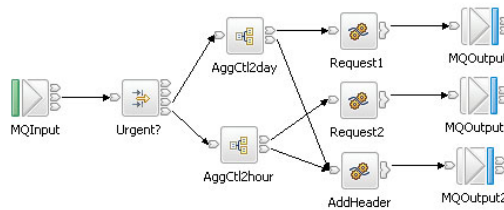

Correlating input request and output response aggregation messages

If you want to correlate initial request messages with their combined response messages, you can do so using the ReplyIdentifier in the Properties folder of the response message.

Before you start:

To complete this task, you must have completed the following tasks:

- “Creating the aggregation fan-out flow” on page 573
- “Creating the aggregation fan-in flow” on page 577

In some cases you might want to correlate aggregation request messages with the combined response message produced by your fan-in flow, there are two ways of doing this:

- Store some correlation information in one of the requests sent out as part of the aggregation.
- Send the original request message directly back to the AggregateReply node as one of the aggregation requests. To do this, the CorrelId must be set to the MsgId, and the MQOutput node must have its MessageContext set to ‘Pass all’.

Using control messages in aggregation flows

In WebSphere Message Broker the default behavior is that connections between AggregateControl and AggregateReply nodes for sending control messages are ignored. This configuration optimizes performance and removes the possibility that response messages will be received by the AggregateReply node before the control message.

Before you start:

To complete this task, you must have completed the following tasks:

- “Creating the aggregation fan-out flow” on page 573
- “Creating the aggregation fan-in flow” on page 577

Control messages are not necessary to make aggregations work correctly. However, it is still possible for you to send control messages in your aggregation flows if it is necessary. To send control messages in a message flow created in WebSphere Message Broker Version 6.0, see “Configuring message flows to send control messages” on page 586 and “Configuring a broker environment to send control messages” on page 587.

Important: If you created message flows in Version 5.0 and configured them to use control messages, and you want to continue using control messages, see “Configuring a broker environment to send control messages” on page 587. Unless you complete this task, the connections between the AggregateControl and AggregateReply nodes that were created in earlier versions of the product will be ignored in Version 6.1.

For a working example of aggregation (without the use of control messages), see the following sample:

- Airline Reservations sample

You can view samples only when you use the information center that is integrated with the Message Broker Toolkit.

Configuring message flows to send control messages

To configure message flows to send control messages from an AggregateControl node to an AggregateReply node:

1. Switch to the Broker Application Development perspective.
2. If you have created the fan-out and fan-in flows in a single message flow:
 - a. Open the aggregation message flow.
 - b. Connect the Control terminal of the AggregateControl node to the Control terminal of the AggregateReply node to make the association.

This connection is referred to as a direct connection between the two aggregation nodes.

3. If you have created separate fan-out and fan-in message flows:
 - a. Open the fan-out message flow.
 - b. Configure the AggregateControl node as described in “Creating the aggregation fan-out flow” on page 573.
 - c. At this stage, you can configure a Compute node that creates a valid output message that contains the control message. For example, to pass the control message to an MQOutput node, configure the Compute node to add an MQMD to the message and complete the required fields in that header. For example, you can code the following ESQL:

```
SET OutputRoot.MQMD.Version = MQMD_CURRENT_VERSION;  
SET OutputRoot.MQMD.Format = MQFMT_STRING;
```

- d. Configure an output node that represents the intermediate destination for the control message. For example, to send the control message to an intermediate WebSphere MQ queue, include an MQOutput node and identify the target queue in the Basic properties Queue Manager Name and Queue Name.
- e. Connect the Control terminal of the AggregateControl node to the In terminal of the Compute node, and connect the Out terminal of the Compute node to the In terminal of the output node that represents the intermediate destination for the control message.
- f. Open the fan-in message flow.
- g. Configure one input node to receive the reply messages, as described in “Creating the aggregation fan-in flow” on page 577. This input node also receives the control information from the AggregateControl node. For example, set the Basic property Queue Name of the MQInput node to receive the response and control message from an intermediate WebSphere MQ queue.

- h. Add a Filter node to your fan-in flow after the input node and before the AggregateReply node, as described in “Avoiding thread starvation on fan-in flows” on page 588.
- i. Connect the Out terminal of the input node to the In terminal of the Filter node.
- j. Connect the Out terminals of the Filter node to the Control terminal and in terminal of the AggregateReply node.

This connection is referred to as an indirect connection between the two aggregation nodes.

Configuring a broker environment to send control messages

By default, in WebSphere Message Broker Version 6.1, any connections from the Control terminal of the AggregateRequest node to the AggregateReply node are ignored. For these connections to be active, create the MQSI_AGGR_COMPAT_MODE environment variable in the broker’s environment. By default, the environment variable does not exist. The existence of the environment variable means that connections from the AggregateControl node are active, regardless of the value to which the environment variable is set.

When the MQSI_AGGR_COMPAT_MODE environment variable has not been created, the default behavior for aggregation fan-out flows is used. If the Control terminal of the AggregateControl node is connected, either directly or indirectly, to the In terminal of the AggregateReply node, this connection is ignored and no control message is sent.

If the MQSI_AGGR_COMPAT_MODE environment variable is created, the default behavior for aggregation fan-out flows is not used, allowing you to send control messages from the AggregateControl node to the AggregateReply node. If the Control terminal of the AggregateControl node is connected, either directly or indirectly, to the In terminal of the AggregateReply node, as described in “Creating the aggregation fan-out flow” on page 573, this connection is recognized and a control message is sent. Please note that this is not the optimal configuration and might decrease performance.

To create the MQSI_AGGR_COMPAT_MODE variable to allow connections between AggregateControl and AggregateReply nodes to be recognized:

- **Windows** On Windows:
 1. Open System Properties by clicking **Start** → **Control Panel** → **System**.
 2. Click the **Advanced** tab.
 3. Click **Environment Variables**.
 4. In the System variables pane, click **New**.
 5. Under **Variable name** type MQSI_AGGR_COMPAT_MODE.
 6. (Optional) You can type in the **Variable value** or leave it blank.
 7. For the environment variable to take effect, restart the computer.
- **Linux** **UNIX** **z/OS** On Linux, UNIX and z/OS:
 1. Edit the profile of the broker userid and include the following code: `export MQSI_AGGR_COMPAT_MODE=`
 2. Reload the profile.
 3. Restart the broker.

Avoiding thread starvation on fan-in flows

Follow this guidance to avoid thread starvation on fan-in flows if the Control terminal of the AggregateControl node in your fan-out flow is connected to output control messages to a queue.

By not connecting the Control terminal, you can overcome the issues that are discussed here. For further information about connecting the Control terminal of the AggregateControl node, see “Using control messages in aggregation flows” on page 585.

The Aggregate Reply node has two input terminals: In and Control. The use of the Control terminal is optional. If you use both of these terminals, the MQInput nodes that supply the two terminals must not use threads from the message flow additional instance pool. If the nodes do use these threads, they compete for resources, and the Control terminal’s MQInput node typically takes all available threads because it is activated before the In terminal.

Configure each MQInput node to use additional instances that are defined on the node, not at the message flow level.

Handling exceptions in aggregation flows

When you use aggregation flows, exceptions might occur.

Before you start:

Complete the following tasks:

- “Creating the aggregation fan-out flow” on page 573
- “Creating the aggregation fan-in flow” on page 577

Dealing with exceptions

If an error is detected downstream of an AggregateReply node, the broker issues an exception. Another node in the message flow might also issue an exception using the ESQL THROW statement. In either case, when an exception occurs, it is caught in one of two places:

- The input node on which the replies arrive
- The AggregateReply node

The following table lists events and describes what happens to an exception that occurs downstream of the AggregateReply node.

Event	Message propagated	Output terminal	Exception caught at
An expected reply arrives at the input node and is passed to the In terminal of the AggregateReply node. The reply is the last one that is needed to make an aggregation complete.	An aggregated reply message that contains all the replies	Out	Input node
An unexpected reply arrives at the input node and is passed to the AggregateReply node. The reply is not recognized as a valid reply, and the Unknown Message Timeout property is set to 0.	Message received	Unknown	Input node

Event	Message propagated	Output terminal	Exception caught at
A timeout occurs because all the replies for an aggregation have not yet arrived.	An aggregated reply message that contains all the replies that have been received	Timeout	AggregateReply node
An unknown timeout occurs because a retained message is not identified as a valid reply.	Retained message	Unknown	AggregateReply node
An aggregation is discovered to be complete at some time other than when the last reply arrived.	An aggregated reply message that contains all the replies	Out	AggregateReply node

To handle errors that occur in aggregation flows, you must catch these exceptions at all instances of each of these nodes in the message flow.

1. Switch to the Broker Application Development perspective.
2. Open the message flow with which you want to work.
3. To handle these exceptions yourself, connect the Catch terminal of each input and AggregateReply node to a sequence of nodes that handles the error that has occurred.

For a unified approach to error handling, connect the Catch terminals of all these nodes to a single sequence of nodes, or create a subflow that handles errors in a single consistent manner, and connect that subflow to each Catch terminal.

4. If you want the broker to handle these exceptions using default error handling, do not connect the Catch terminals of these nodes.

If you connect the Catch terminal of the AggregateReply node, and want to send the message that is propagated through this terminal to a destination from which it can be retrieved for later processing, include a Compute node in the catch flow to provide any transport-specific processing. For example, you must add an MQMD header if you want to put the message to a WebSphere MQ queue from an MQOutput node.

The ESQL example below shows you how to add an MQMD header and pass on the replies that are received by the AggregateReply node:

```
-- Add MQMD
SET OutputRoot.MQMD.Version = 2;
.
-- Include consolidated replies in the output message
SET OutputRoot.XMLNS.Data.Parsed = InputRoot.ComIbmAggregateReplyBody;
.
```

To propagate the information about the exception in the output message, set the Compute mode property of the Compute node to a value that includes Exception.

Exceptions when dealing with unknown and timeout messages

When timeout messages or unknown messages from unknown timeout processing are produced from an AggregateReply node they originate from an internal queue and not from an MQInput node. This effects how the error handling should be performed.

If a message sent down the timeout thread causes an exception, the message rolls back to the AggregateReply node and is sent to the catch terminal. If this terminal is either unattached or an exception occurs while processing the message, the timeout is rolled back onto the internal queue and is reprocessed. Potentially, this will lead to an infinite loop which can only be stopped either by removing the timeout message from the internal queue (not recommended), or by deploying a version of the messages flow that fixes the problem.

To avoid this infinite loop take the following actions.

- Connect the catch terminal up to a error handling set of nodes.
- Ensure the error handling nodes cannot throw an exception by ensuring that they perform very simple operations, for example, converting the message to a blob and then writing it to a queue, or add in extra TryCatch nodes.

Note: The failure terminal is currently not used and messages will never be passed to this terminal.

Using WebSphere MQ to store state in aggregation nodes

Before you start:

Read the concept topic about message flow aggregation.

To use WebSphere MQ to store state in aggregation nodes, perform the following steps:

1. Migrate an existing broker or create a new broker.
2. Configure the broker environment to use WebSphere MQ for aggregation nodes.

When you have performed these steps, aggregation will function as it did before, but you might notice the following differences:

- Aggregation is much faster.
- Error messages reflect the use of WebSphere MQ instead of a database table.
- No control messages are sent between the request flow and the reply flow. If required, you can force a control message to be sent. It is no longer necessary to connect the AggregationControl node control terminal to the AggregateReply node control terminal.

Migrating a broker for use with aggregation nodes

This topic describes how to migrate a broker for use with aggregation nodes that use WebSphere MQ to store state. The aggregation nodes need new queues to be created to store aggregation information. If you create a new broker, the queues are created automatically. If you are using an existing broker, perform the following steps:

Windows, Linux, and UNIX:

1. Stop the broker by issuing the **mqsistop** command.
2. Migrate the queues by issuing the **mqsigratequeues** command.
3. Start the broker by issuing the **mqsistart**.

z/OS:

1. Stop the broker.

2. Re-run the `mqsicustomize` command.
3. Re-run the queue creation JCL (BIP\$MQ01).
4. Start the broker.

Configuring a broker environment to use WebSphere MQ for aggregation nodes

By default, all execution groups use a database table for storing aggregation requests. If you prefer to use WebSphere MQ to store aggregation requests, set the `MQSI_AGGR_MQ` environment variable. Use this variable to list the execution groups that use WebSphere MQ instead of a database. The format of the value of the variable is:

<List of Brokers>/<List of Execution groups>

where <List of Brokers> is a comma-separated list of brokers to use, and <List of Execution groups> is a comma-separated list of execution groups. If an execution group is running under a broker in the list and has an entry in the execution list, it uses WebSphere MQ to store state for aggregations. You can use an asterisk (*) as a wildcard in either the <List of Brokers> or the <List of Execution groups>. If the wildcard appears in the list, any broker or execution group is matched. The following table includes some examples that show how to use the `MQSI_AGGR_MQ` variable:

Value	Result
/	All execution groups on the computer are enabled.
BROKER1/*	All execution groups running on BROKER1 are enabled.
*/default	All execution groups called "default" are enabled.
BROKER1/default,eg1,eg2	Execution groups called "default", "eg1", and "eg2" on BROKER1 are enabled.
BROKER1,BROKER2/default,eg1,eg2	Execution groups called "default", "eg1", and "eg2" on BROKER1 and on BROKER2 are enabled.

To create the `MQSI_AGGR_MQ` variable and configure it to use WebSphere MQ to store aggregation state:

Windows:

1. Open the System properties by clicking **Start** → **Control Panel** → **System**.
2. Click the **Advanced** tab.
3. Click **Environment Variables**.
4. In the System variables pane, click **New**.
5. Under Variable name, enter `MQSI_AGGR_MQ`.
6. Set the value of the variable to specify which execution groups use WebSphere MQ (refer to the examples in the table).
7. Restart the computer.

Linux and UNIX:

1. Edit the profile of the broker user ID and refer to the examples in the table to set the value of the `MQSI_AGGR_MQ` variable:

```
export MQSI_AGGR_MQ=value
```
2. Reload the profile.
3. Restart the broker.

z/OS:

1. Edit the broker ENVFILE and refer to the examples in the table to set the value of the MQSI_AGGR_MQ variable:
`MQSI_AGGR_MQ=value`
2. Reload the profile.
3. Restart the broker.

Configuring a broker environment to send control messages

By default, when you use WebSphere MQ to store state, any connections from the control terminal of the AggregateRequest node to the AggregateReply node are ignored. For these connections to be active, create the MQSI_AGGR_COMPAT_MODE environment variable in the broker's environment. By default, the environment variable does not exist. When you create this environment variable, connections from the AggregateControl node are active, regardless of the value of the environment variable.

When the MQSI_AGGR_COMPAT_MODE environment variable has not been created, the default behavior for aggregation fan-out flows is used. If the control terminal of the AggregateControl node is connected to the in terminal of the AggregateReply node, either directly or indirectly, this connection is ignored and no control message is sent.

If the MQSI_AGGR_COMPAT_MODE environment variable is created, the default behavior for aggregation fan-out flows is not used, allowing you to send control messages from the AggregateControl node to the AggregateReply node, but this configuration might have an adverse effect on performance.

To create the MQSI_AGGR_COMPAT_MODE variable to allow connections between AggregateControl and AggregateReply nodes to be recognized:

Windows:

1. Open the System properties by clicking **Start** → **Control Panel** → **System**.
2. Click the **Advanced** tab.
3. Click **Environment Variables**.
4. On the System variables pane, click **New**.
5. Under the Variable name, enter MQSI_AGGR_COMPAT_MODE.
6. Optional: Enter the variable value.
7. Restart the computer.

Linux and UNIX:

- Edit the profile of the broker user ID and include the following information:
`export MQSI_AGGR_COMPAT_MODE=true`
- Reload the profile.
- Restart the broker.

z/OS:

- Edit the profile ENVFILE and include the following information:
`MQSI_AGGR_COMPAT_MODE=true`
- Restart the broker.

Configuring flows for message collection

You can use the Collector node in a message flow to generate a message collection.

Before you start:

Read the concept topic about message collections.

You can use a Collector node to group together related messages from one or more sources, into a single message known as a message collection. The messages are added to the message collection based on conditions that you configure in the Collector node. The message collection can then be routed for further processing to other nodes in the message flow. You can also build a message collection manually using a Compute node or JavaCompute node.

See the following topics for instructions on configuring message flows to generate message collections:

- “Creating a flow for message collection”
- “Configuring the Collector node” on page 595
- “Using control messages with the Collector node” on page 602

The Collector node sample demonstrates the use of the Collector node for message collection.

Creating a flow for message collection

Use a Collector node in your message flows to group messages from one or more sources into a message collection. You can add dynamic input terminals to your Collector node for each message source you want to configure for your message flow.

Before you start:

To complete this task, you must have completed the following task:

- “Creating a message flow project” on page 215

Before completing this task, read the overview about message collection; see “Message collection” on page 126.

To review an example of a message flow that uses message collections, see the Collector node sample that is supplied with WebSphere Message Broker.

To create a message flow to generate and process message collections:

1. Switch to the Broker Application Development perspective.
2. Create a new message flow.
3. Add the following nodes in the editor view, and configure and connect them as described:

Input nodes

The input nodes receive the messages from which message collections are generated. You can use any of the built-in nodes, or user-defined input nodes.

- a. Add an input node for each source of input messages for your message flow, for example an MQInput node and a JMSInput node.
- b. Select each input node to display its properties in the Properties view.

- c. Specify the source of input messages for this node. For example, specify the name of a WebSphere MQ queue in the Basic property Queue Name from which the MQInput node retrieves messages.
- d. Optional: specify values for any other properties that you want to configure for this node.

Collector node

The Collector node receives messages from input nodes or other nodes in the message flow. You must add a dynamic input terminal to the Collector node for each input message source before you can connect the input nodes or any upstream nodes to the Collector node.

- a. Add a Collector node to your message flow.
- b. Right-click on the Collector node and click **Add Input Terminal** to add a new dynamic input terminal to the Collector node. Add a new input terminal for each input source that you plan to add to your message flow; for more information about adding dynamic input see “Adding an input terminal for each input source” on page 595.
- c. Connect the out terminal of each input node to one of the dynamic input terminals of the Collector node. Repeat this step for each input node, connecting each input node to a different input terminal on the Collector node. This represents the simplest configuration; if appropriate, you can include other nodes between the input node and the Collector node. For example, you might want to store the request for audit purposes (in a Warehouse node), or add a unique identifier to the message (in a Compute node).

Processing nodes

You can process message collections from a Collector node using the following nodes only:

- Compute
- JavaCompute

You must connect either a Compute node or a JavaCompute node to the Collector node in your message flow. Use these nodes to process the message collection and propagate other messages. You can use ESQL or XPATH to access the contents of the individual messages in the message collection for processing

To process a message collection:

- a. Add a Compute node or a JavaCompute node to your message flow.
- b. Code your ESQL or Java to create single output messages from the message collection.
- c. Optional: specify values for any other properties that you want to configure for this processing node.
- d. Connect the out terminal of the processing node to the in terminal of an output node or other processing node.
- e. Optional: add other nodes to your message flow for further processing.

Output node

Include one or more output nodes for your message flow. This can be any of the built-in nodes, or a user-defined output node. An output node can not process a message collection, therefore ensure that you connect the output node to a processing node that propagates single output messages.

To configure an output node:

- a. Select each output node to display its properties in the Properties view.

- b. Specify the destination properties for this node. For example, specify the name of a WebSphere MQ queue in the Basic property Queue Name to which the MQOutput node sends messages.
- c. Optional: specify values for any other properties that you want to configure for this node.

Error handling nodes

Include processing for handling errors and expired message collections:

- a. Optional: add processing nodes to your message flow to handle expired message collections. Connect these nodes to the **Expire** terminal.
- b. Optional: add processing or error handling nodes to handle any exceptions in your message flow. Connect these nodes to the **Catch** terminal.

If an error is detected downstream of the Collector node, the broker throws an exception. The message collection is propagated to the Collector node's Catch terminal. Connect the Catch terminal to a sequence of nodes that handles the errors to avoid losing any data, and ensure that no further exceptions can be generated during error processing. The node connected to the Catch terminal must be either a Compute node or a JavaCompute node to handle the message collection.

4. Press Ctrl-S or click **File** → **Save name** on the taskbar menu (where *name* is the name of this message flow) to save the message flow and validate its configuration.

If you want to control when complete message collections are propagated, you must also add additional nodes to your message flow. For information about using control messages, see “Using control messages with the Collector node” on page 602.

Next: Configure the Collector node.

Configuring the Collector node

You can configure the Collector node to determine how messages are added to message collections. You can also use properties on the Collector node to control when message collections are propagated.

Before you start:

To complete this task, you must have completed the following task:

- “Creating a message flow project” on page 215
- Configure a flow for message collection

Use the following topics to configure the Collector node:

- “Adding an input terminal for each input source”
- “Setting event handler properties” on page 596
- “Setting the collection expiry” on page 599
- “Setting the collection name” on page 599
- “Setting the event coordination property” on page 600
- “Setting the persistence mode property” on page 601

Adding an input terminal for each input source

Add new dynamic input terminals to the Collector node for all of the sources of messages for your message collections.

Before you start:

To complete this task, you must have completed the following tasks:

- “Creating a message flow project” on page 215
- “Creating a flow for message collection” on page 593

To add a dynamic input terminal to the Collector node for each message source:

1. Right click the Collector node and select **Add Input Terminal**.
2. In the dialog box that is displayed, enter a name of your choice for the terminal, and click **OK**. The name that you give to the input terminal is used as the folder name in the message collection.
3. Repeat steps 1 and 2 to add further input terminals.

When you have created all the required input terminals on the Collector node, you can set the event handler properties. For more information see, “Setting event handler properties.”

Setting event handler properties

You can configure event handler properties for each dynamic input terminal on a Collector node. These event handler properties determine how the messages received by each terminal are added to message collections.

Before you start:

To complete this task, you must have completed the following tasks:

- “Creating a message flow project” on page 215
- “Creating a flow for message collection” on page 593
- “Adding an input terminal for each input source” on page 595

You can use one or more of the event handler properties to control the way that messages are added to message collections, for each input terminal that you added to the Collector node. Incomplete message collections are stored on a WebSphere MQ queue. The message collections are stored in the order that they are generated by the Collector node (first in, first out). Each message collection has an event handler instance for each of the input terminals. The event handler determines whether an incoming message on that terminal is added to a message collection. The event handler instance maintains information about the state of the collection, the number of messages received, the timer, and the correlation string. When a new message is received on an input terminal, it is offered to the event handler for each message collection waiting on the queue in turn. When the message is accepted by one of the event handlers, it is added to the message collection. The accepted message is not offered to any other message collections. If all the event handlers reject the message, it is added to a new message collection, which is added to the end of the queue.

The first message accepted into a collection determines the correlation string for that message collection, if it is configured. Subsequent messages offered to that message collection are only accepted if their correlation string matches that of the collection. The first message accepted by each event handler starts the timeout timer, if it is configured. Each message accepted by each event handler increments the quantity count. An event handler becomes satisfied when the number of messages accepted equals the configured quantity, or when the timeout value is reached. When an event handler is satisfied, the event handler does not accept any

more messages. A message collection is complete only when all of the message collection's event handlers are satisfied. The message collection is then ready for propagation.

You can configure the event handler properties using the **Collection Definition** table, on the Basic tab of the Properties view.

To configure the event handler properties on the Collector node:

1. Switch to the Broker Application Development perspective.
2. Open the message flow with the Collector node.
3. Right-click the Collector node and select **Properties**.
4. Click on the **Basic** tab.
5. Use the following instructions to configure the event handler properties that you want to set for each input terminal:
 - If you want to add a set number of messages to each message collection from one or more of the terminals, you must enter a value for *Quantity* in the Collection Definition table. This value is used to specify the number of messages that each configured input terminal accepts to complete a collection. For example, if you have set *Quantity* to wait for 2 messages, on three of the input terminals, the message collection is not complete until 2 messages have been received on each of the three input terminals. The complete message collection contains 6 messages, 2 from each of the three terminals. As soon as more than 2 messages are received on one of the input terminals, the next message is added to a new message collection.
 - a. In the Collection Definition table, click in the row for the selected input terminal within the *Quantity* column.
 - b. Enter a value for the number of input messages that you want to add to a message collection. If you select Zero or choose to unset this property, there is no limit to the number of messages accepted. In this case the value set on the *Timeout* property must be greater than zero. If you accept the default value of 1; only one message from the selected terminal is added to a collection.

You must enter a value for *Quantity* if *Timeout* is not set.

- If you want to collect messages for a set amount of time before the message collection is propagated you must enter a value for *Timeout*. This value is used to specify the maximum time in seconds that the selected input terminal accepts messages for, before completing a message collection. The timeout interval starts when the first message has arrived at the selected terminal. Any subsequent messages are added to the same message collection. When the timeout interval ends, no more messages are added to the message collection from this terminal. When the conditions on all the terminals are satisfied, then the message collection is ready for propagation. When the next message reaches the selected input terminal, a new message collection is created and the timeout interval starts again. If a timeout is set on multiple input terminals, each terminal collects messages for the configured amount of time. During the timeout, messages from all the terminals are added to the same message collection.
 - a. In the Collection Definition table, click in the row for the selected input terminal within the *Timeout* column.
 - b. Enter a value for the length of time in seconds that you want to wait to add messages to a message collection. For example, to wait for messages to add to a message collection for an hour, enter a value of 3600. If you accept the default value Zero, the timeout is disabled and there is no

limit on the time to wait for messages. In this case the value set on the *Quantity* property must be greater than zero.

You must enter a value for *Timeout* if *Quantity* is not set.

- If you want to add messages to different message collections based on the content of the message you must enter an XPath value for the *Correlation path*. This value is used to specify the path in the incoming message from which to extract the correlation string. The correlation string is the value that is extracted by the correlation path. If a correlation pattern is specified, then the correlation string is matched against the correlation pattern. Messages are only accepted into a message collection with the same correlation string. If you specify a * in the name of the message collection, it is replaced by the correlation string.

- a. In the Collection Definition table, click in the row for the selected input terminal within the *Correlation path* column.
- b. Either select a predefined correlation path from the list, or enter your own correlation path using XPath. The correlation path must begin with a correlation name, which can be followed by zero or more path fields. For more information about correlation names, see “Correlation names” on page 71. For example, in the following message the correlation string is foo in the name field:

```
<library>
  <name>foo</name>
  <more>
  ...
</more>
</library>
```

In this example, the correlation path using XPath is `$Body/library/name`. The variables `$Root`, `$LocalEnvironment` and `$Environment` are available to allow the path to start at the roots of the message, local environment, environment trees and message body.

If the correlation path evaluates to an empty string the unmatched message is added to a default unnamed message collection.

If you define a value for *Correlation path*, you can optionally configure a *Correlation pattern*.

- If you want to match a substring of the message content from the *Correlation path*, you can define a pattern to match in the message using *Correlation pattern*. The Correlation pattern contains a single wildcard character and optional text. The correlation string, used for the name of the message collection, is the part of the substring that matches the wildcard. For example, if the correlation path contains the filename `part1.dat` in a file header, and the correlation pattern is specified as `*.dat`, the correlation string is `part1`.

If this property is set, only messages that have the same correlation string are added to the same message collection. The first message added to a message collection determines the correlation string that must be matched by all other messages in that message collection.

- a. In the Collection Definition table, click in the row for the selected input terminal within the *Correlation pattern* column.
- b. Enter a value for the correlation pattern. The Correlation pattern must contain a single wildcard character: `*`. This wildcard character can optionally be surrounded by other text.

If the correlation pattern fails to match the wildcard to a substring, then the unmatched message is added to a default unnamed message collection.

6. Repeat step 5 on page 597 for each of the input terminals that you added to your Collector node. You can configure different event handlers for different input sources.

Note: Ensure that you set the event handler properties across different terminals carefully to match the expected delivery of messages to the terminals on the Collector node.

Next: Configure the collection expiry.

Setting the collection expiry

The collection expiry is a property on the Collector node to set a maximum timeout for adding messages to a message collection.

Before you start:

To complete this task, you must have completed the following tasks:

- “Creating a message flow project” on page 215
- “Creating a flow for message collection” on page 593

When messages are added to a message collection, the incomplete message collection is stored on a queue. If the message collection’s event handlers are not satisfied, then the incomplete message collection is stored on the queue indefinitely, and not propagated for further processing. If a Collector node has 2 input terminals, and one of the terminals stops receiving messages, for example if the source application is not running, there is the potential for the queue of incomplete message collections to grow indefinitely. To ensure that these incomplete message collections are released after an appropriate amount of time, configure the *Collection Expiry* property. You can configure this timeout, as a value in seconds, in the *Collection Expiry* property on the Collector node. The collection expiry timeout starts when the first message is accepted into a message collection. The collection expiry overrides any individual event handler timers. When the collection expiry timeout has passed for a message collection, the incomplete message collection is propagated to the **Expire** terminal. Connect appropriate processing nodes to the **Expire** terminal, to handle any expired message collections in your message flow.

To configure a collection expiry:

1. Switch to the Broker Application Development perspective.
2. Open the message flow with the Collector node.
3. Right-click the Collector node and select **Properties**.
4. Click on the **Basic** tab.
5. In Collection Expiry, enter a time in seconds for the collection expiry timeout.

Next: Configure the collection name.

Setting the collection name

You can set a default name, or use a correlation string, for the name of your message collections, using the Collection name property on the Collector node.

Before you start:

To carry out this task, you must first have completed the following tasks:

- “Creating a message flow project” on page 215

- “Creating a flow for message collection” on page 593

Each message collection produced by the Collector node has a name. The collection name is the value associated with the `CollectionName` attribute in the message collection tree structure. Each message collection has only one name.

You can either use *Collection name* to set a default name to be used for each message collection, or you can use the event handler properties to create a correlation string to use for the message collection name. You can use the correlation string to generate a unique name for the message collection, based on the content of the input messages. To use the correlation string for the collection name, you must enter the wildcard symbol `*`. If you leave *Collection name* blank, or if it is set to `*` and the value of the correlation string is empty, the `CollectionName` attribute of the message collection is set to an empty value.

Any `*` characters in the collection name are replaced with the correlation string. The correlation string for each message collection is also copied into the `LocalEnvironment` message associated with the propagated message collection. The location of the correlation string in the `LocalEnvironment` is `Wildcard/WildcardMatch`.

To configure the message collection name:

1. Switch to the Broker Application Development perspective.
2. Open the message flow with the Collector node.
3. Right-click the Collector node and select **Properties**.
4. Click on the **Basic** tab.
5. Enter a name, in *Collection name*, for the message collections generated by the Collector node. If you have set a value for *Correlation path* on your input terminals, you can use the `*` in the *Collection name* field to substitute the correlation string into the collection name value. Leave the collection name blank if you want to set your message collection name to an empty value.

Next: “Setting the event coordination property.”

Setting the event coordination property

Use the *Event coordination* property for controlling how message collections are propagated from the Collector node.

Before you start:

To complete this task, you must have completed the following tasks:

- “Creating a message flow project” on page 215
- “Creating a flow for message collection” on page 593

In addition to the dynamic input terminals that you can add to the Collector node, there is a static input terminal called **Control**. The purpose of this terminal is to allow an external resource to trigger the output from the collector node. Details are controlled via the Event coordination property settings.

Incomplete message collections that have exceeded the value for the *Collection expiry* timeout are immediately propagated to the `Expire` terminal, regardless of how you configure the *Event coordination* property.

To configure *Event coordination*:

1. Switch to the Broker Application Development perspective.
2. Open the message flow with the Collector node.
3. Right-click the Collector node and select **Properties**.
4. Click on the **Advanced** tab.
5. Set the *Event coordination* property on the Collector node. Select from the following options:
 - If you select *Disabled*, messages to the **Control** terminal are ignored and message collections are propagated when they are complete.
 - If you select *All complete collections*, complete message collections are held on a queue. When a message is received on the **Control** terminal, all message collections on the queue are propagated to the **Out** terminal.
 - If you select *First complete collection*, complete message collections are held on a queue. When a message is received on the **Control** terminal, the first message collection on the queue is propagated to the **Out** terminal. If the queue is empty when a message arrives on the **Control** terminal, the next message collection that is completed is propagated to the **Out** terminal.

You have completed configuration of the Collector node.

Next: if you have configured your Collector node to use control messages, see “Using control messages with the Collector node” on page 602.

Setting the persistence mode property

Use the *Persistence Mode* property to control whether incomplete message collections are stored persistently on the Collector node’s queues.

Before you start:

To complete this task, you must have completed the following tasks:

- “Creating a message flow project” on page 215
- “Creating a flow for message collection” on page 593

The storage of incoming messages and the Collector node state is handled internally using WebSphere MQ queues. By default incomplete message collections are stored non-persistently. This means that incomplete message collections persist if you restart your broker, but not if you restart your queue manager.

You can use the *Persistence Mode* property on the Collector node to store incomplete message collections on a queue persistently. If you set the *Persistence Mode* property to *Persistent*, incomplete message collections are not lost if you restart your queue manager. However, if you do set the property to *Persistent*, the overall performance of the Collector node might be reduced.

To configure the *Persistence Mode*:

1. Switch to the Broker Application Development perspective.
2. Open the message flow with the Collector node.
3. Right-click the Collector node and select **Properties**.
4. Click on the **Advanced** tab.
5. Set the *Persistence Mode* property on the Collector node. Select from the following options:
 - If you select *Non Persistent*, messages and collection state are stored by the broker’s queue manager as non-persistent messages.

- If you select *Persistent*, messages and collection state are stored by the broker's queue manager as persistent messages.

You have completed configuration of the Collector node.

Using control messages with the Collector node

You can send control messages to the Collector node in order to control how complete message collections are propagated to other nodes in your message flow.

Before you start:

To complete this task, you must have completed the following tasks:

- "Creating a message flow project" on page 215
- "Creating a flow for message collection" on page 593
- "Setting the event coordination property" on page 600

You can control when complete message collections are propagated to other nodes for processing, using messages sent to the **Control** terminal. The exact behavior depends on the settings that you have chosen for the *Event coordination* property on the Collector node. If you want to use control messages to propagate completed message collections you must set the *Event coordination* property to one of the following:

- All complete collections
- First complete collection

In these cases, the complete message collections are held on a queue until a control message is received. If you set *Event coordination* to All complete collections, all the message collections held on the queue are propagated to the **Out** terminal. If you set *Event coordination* to First complete collection, only the first message collection on the queue is propagated to the **Out** terminal. If there are no complete message collections on the queue, the next message collection to complete is immediately propagated to the **Out** terminal.

Incomplete message collections that have exceeded the value for *Collection expiry* are immediately propagated to the **Expire** terminal regardless of the setting of *Event coordination*.

If you want to propagate any complete message collections after a set amount of time for further processing, connect a `TimeoutNotification` node to the **Control** terminal of the Collector node. You can use the `TimeoutNotification` node to send a control message to propagate the message collections to ensure that messages are processing within a reasonable time, or to schedule processing tasks.

For more information about driving a message flow using the `TimeoutNotification` node, see "Automatically generating messages to drive a flow" on page 608.

Alternatively, you can propagate complete message collections using a message from another application or message flow by connecting an input node to the **Control** terminal of the Collector node.

You can send any message to the **Control** terminal of the Collector node. The message received on the **Control** terminal is not examined by the broker and is discarded on receipt.

Configuring timeout flows

Use the TimeoutControl and TimeoutNotification nodes in message flows to process timeout requests or to generate timeout notifications at specified intervals.

The following scenarios show how these nodes can be used in a message flow:

- “Sending a message after a timed interval” on page 605
- “Sending a message multiple times after a specified start time” on page 606
- “Automatically generating messages to drive a flow” on page 608

Sending timeout request messages

To set a controlled timeout, send a message with a set of elements with well known names to a TimeoutControl node. These elements control the properties of the timeout to be created or deleted.

Elements and format

The following example shows the elements and format of a timeout request message, showing the well known names and permissible values.

```
<TimeoutRequest>
  <Action>SET | CANCEL</Action>
  <Identifier>String (any alphanumeric string)</Identifier>
  <StartDate>String (TODAY | yyyy-mm-dd)</StartDate>
  <StartTime>String (NOW | hh:mm:ss)</StartTime>
  <Interval>Integer (seconds)</Interval>
  <Count>Integer (greater than 0 or -1)</Count>
  <IgnoreMissed>TRUE | FALSE</IgnoreMissed>
  <AllowOverwrite>TRUE | FALSE</AllowOverwrite>
</TimeoutRequest>
```

Message fields

The following table describes the fields in the message. The column headed M indicates whether the property is mandatory, and the column headed C indicates whether the property is configurable.

Property	M	C	Default	Description
Action	Yes	No	None	Set this element to either SET or CANCEL. An error is generated if you omit this element or set it to a different value. If you set it to CANCEL, the only other element that is required is the Identifier, which must match the Identifier of the TimeoutRequest that is to be canceled.
Identifier	Yes	No	None	Enter an alphanumeric string. An error is generated if you omit this element.
StartDate	No	No	TODAY	Set this element to TODAY or to a date specified in yyyy-mm-dd format. The default value is TODAY.

Property	M	C	Default	Description
StartTime	No	No	NOW	<p>Set this element to NOW or to a time in the future specified in hh:mm:ss format. The default value is NOW. StartTime is assumed to be the broker's local time.</p> <p>The start time can be calculated by adding an interval to the current time. If a delay occurs between the node that calculates the start time and the TimeoutControl node, the start time in the message will have passed by the time it reaches the TimeoutControl node. If the start time is more than approximately five minutes in the past, a warning is issued and the TimeoutControl node rejects the timeout request. If the start time is less than five minutes in the past, the node processes the request as if it were immediate. Therefore, ensure that the start time in the timeout request message is now or a time in the future.</p>
Interval	No	Yes	0	Set this element to an integer that specifies the number of seconds between propagations of the message. The default value is 0.
Count	No	Yes	1	Set this element to an integer value that is either greater than 0 or is -1 (which specifies a timeout request that never expires). The default value is 1.
IgnoreMissed	Yes	No	TRUE	<p>Set this element to TRUE or FALSE to control whether timeouts that occur while either the broker or the timeout notification flow is stopped, are processed the next time that the broker or timeout notification flow is started. The default value is TRUE, which means that missed timeouts are ignored by the TimeoutNotification node when the broker or message flow is started. If this value is set to FALSE, the missed timeouts are all processed immediately by the TimeoutNotification node when the flow is started.</p> <p>You must set the Request Persistence property of the TimeoutControl node to Yes or Automatic (with the originating request message being persistent) for the stored timeouts to persist beyond the restart of the broker or the timeout notification flow.</p>
AllowOverwrite	N	N	TRUE	Set this element to TRUE or FALSE, to specify whether subsequent timeout requests with a matching Identifier can overwrite this timeout request. The default value is TRUE.

How the TimeoutControl node uses these values

Set the Request Location on the TimeoutControl node to InputRoot.XML.TimeoutRequest to read these properties. If you want to obtain properties from a different part of your message, specify the appropriate correlation name for the parent element for the properties. The correlation name for the parent element can be in the LocalEnvironment.

For details of how the TimeoutControl uses these values, see "TimeoutControl node" on page 1191

Working with the predefined schema definition of an XML timeout request message

A predefined schema definition of an XML timeout request message is provided in the workbench.

Take the following steps to review the definition or to define it within a message set.

1. Create or select a message set project that contains the message set.

2. Create a new message definition file (File → New → Message Definition File From...).
3. Select **IBM supplied message** and click **Next**.
4. Expand the tree for **Message Brokers IBM supplied Message Definitions**.
5. Select **Message Broker Timeout Request** and click **Finish**.

Example XML timeout request message

The format used here is XML, but you can use any format that is supported by an installed parser.

```
<TimeoutRequest>
  <Action>SET</Action>
  <Identifier>TenTimes</Identifier>
  <StartDate>TODAY</StartDate>
  <StartTime>NOW</StartTime>
  <Interval>10</Interval>
  <Count>10</Count>
  <IgnoreMissed>TRUE</IgnoreMissed>
  <AllowOverwrite>TRUE</AllowOverwrite>
</TimeoutRequest>
```

For another example of a timeout request message, and for details of how to use the timeout nodes to add timeouts to message flows, see the timeout processing sample:

- [Timeout Processing sample](#)

You can view samples only when you use the information center that is integrated with the Message Broker Toolkit.

Sending a message after a timed interval

This topic describes how to use TimeoutControl and TimeoutNotification nodes to send a message into a message flow after a timed interval.

Aim

Use TimeoutControl and TimeoutNotification nodes to send a message into a message flow 60 seconds after the message is received.

Description of the flow

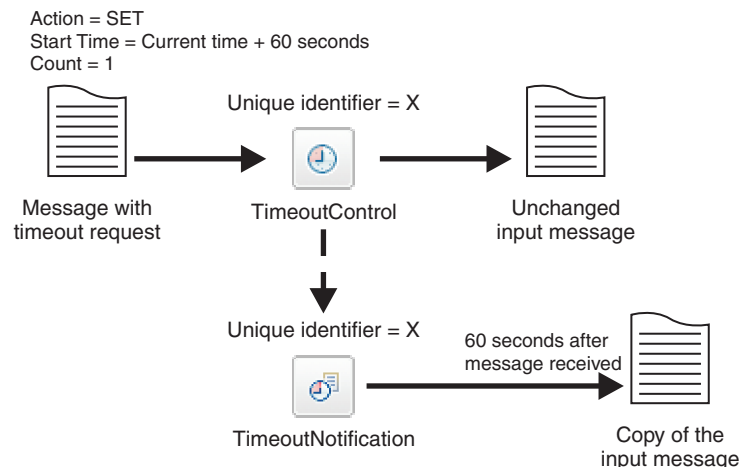

The diagram shows the path of a message that contains a timeout request through a TimeoutControl node. A TimeoutNotification node with an identifier matching the TimeoutControl node then processes the timeout request. The diagram also shows the message that the TimeoutNotification node produces after processing the timeout request.

The message comes into the TimeoutControl node with the following values set in the timeout request section of the message:

Action set to *SET*
Start Time set to *current time + 60*
Count set to *1*

The TimeoutControl node validates the timeout request; default values are assumed for properties that are not explicitly defined. The original message is then sent on to the next node in the message flow. If the request is valid, the TimeoutNotification node with the same Unique identifier as the TimeoutControl node propagates a copy of the message to the message flow 60 seconds after the message was received.

If a delay occurs between the node that calculates the start time and the TimeoutControl node, the start time in the message will have passed by the time it reaches the TimeoutControl node. If the start time is more than approximately five minutes in the past, a warning is issued and the TimeoutControl node rejects the timeout request. If the start time is less than five minutes in the past, the node processes the request as if it were immediate. Therefore, ensure that the start time in the timeout request message is a time in the future.

Refer to the following sample for further details on constructing this type of message flow.

- Timeout Processing sample

You can view samples only when you use the information center that is integrated with the Message Broker Toolkit.

Sending a message multiple times after a specified start time

This topic describes how to use TimeoutControl and TimeoutNotification nodes to send a message into a message flow multiple times after a specified start time.

Aim

Use TimeoutControl and TimeoutNotification nodes to send a message into a message flow at 17:00 hours and then send the message again every 5 minutes until the message has been sent 10 times.

Description of the flow

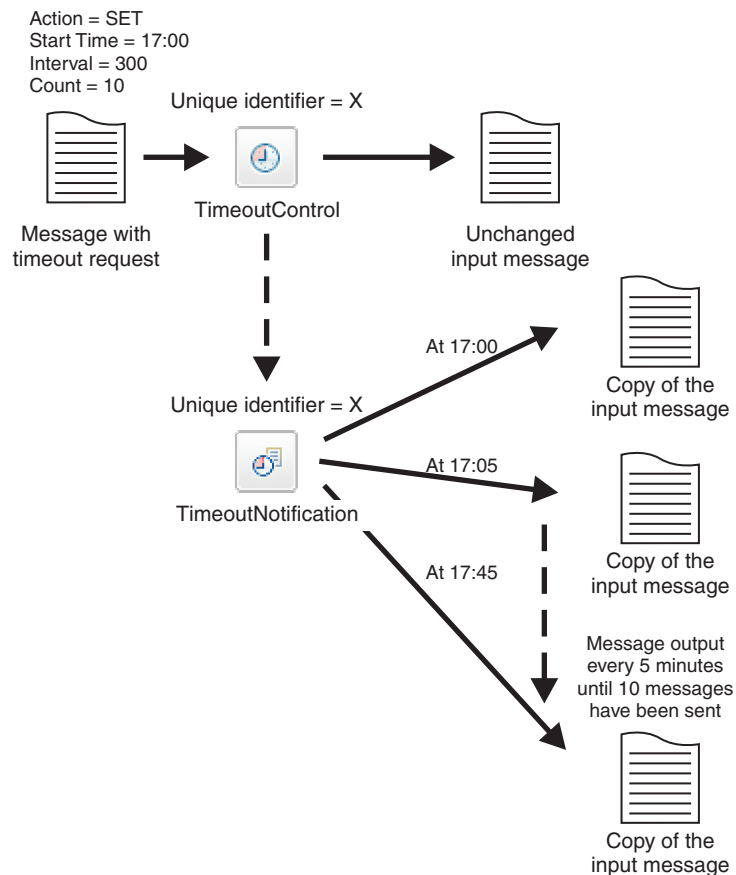

The diagram shows the path of a message that contains a timeout request through a TimeoutControl node. A TimeoutNotification node with an identifier matching the TimeoutControl node then processes the timeout request. The diagram also shows the message that the TimeoutNotification node produces after processing the timeout request.

The message comes into the TimeoutControl node with the following values set in the timeout request section of the message:

Action set to SET
Start Time set to 17:00
Interval set to 300
Count set to 10

The TimeoutControl node validates the timeout request; default values are assumed for properties that are not explicitly defined. The original message is then sent on to the next node in the message flow. If the request is valid, the TimeoutNotification node with the same Unique identifier as the TimeoutControl node propagates a copy of the message to the message flow at 17:00. The message is sent again after an interval of 300 seconds, at 17:05, and every 300 seconds until the message has been sent 10 times, as the Count value in the timeout request specifies.

Refer to the following sample for further details on constructing this type of message flow.

- Timeout Processing sample

You can view samples only when you use the information center that is integrated with the Message Broker Toolkit.

Automatically generating messages to drive a flow

This topic describes using the TimeoutNotification node to automatically send a message into a message flow.

Aim

Use the TimeoutNotification node to automatically send a message into a message flow every 10 minutes.

Description of the flow

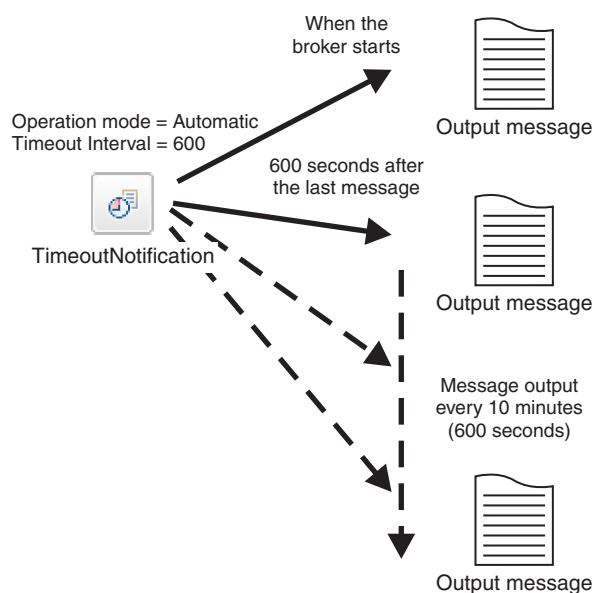

The diagram shows a TimeoutNotification node automatically generating messages and propagating them every 10 minutes. To get the TimeoutNotification node to automatically generate messages, set the Operation Mode property of the node to automatic and specify a value for the Timeout Interval property. In this example the TimeoutNotification node has the following properties:

- Operation Mode set to automatic
- Timeout Interval set to 600

When the broker has started, the TimeoutNotification node sends a message every 10 minutes (600 seconds). This message contains only a properties folder and a LocalEnvironment folder. A Compute node can then process this message to create a more meaningful message.

In the above example, the relevant property is IgnoreMissed, and for an automatic timeout this is implicitly set to TRUE. This means that if one of the period events is missed the event will not be resent, but instead the broker will trigger the event on the next scheduled timeout. If you want to be notified when events are missed, set a controlled timeout instead. For details of the properties you can set for a controlled timeout, see "Sending timeout request messages" on page 603.

Refer to the following sample for further details on constructing this type of message flow.

- Timeout Processing sample

You can view samples only when you use the information center that is integrated with the Message Broker Toolkit.

Performance considerations for timeout flows

When you design timeout flows, the decisions that you make can affect the performance of your brokers and applications.

You can use the timeout nodes `TimeoutControl` and `TimeoutNotification` in your message flows to control the way in which your message flows operate:

- Set the `Operation Mode` property of the `TimeoutNotification` node to `Automatic`. This setting causes a flow to be invoked at the interval that you specify in the `Timeout Value` property. If the downstream processing is intensive, and the flow is still busy when the next timeout occurs, the flow is not started for that timeout instance. The flow is notified to start again only if it is free when a particular timeout occurs.

The value of the `Additional Instances` property of the message flow is ignored downstream of a `TimeoutNotification` node, and you cannot use this property to change the behavior of the flow.

- Use two associated flows to perform user-defined timeout processing. Set a timeout with a `TimeoutControl` node, and notify the flow using a `TimeoutNotification` node (which behaves like an input node to start a new message flow thread). If the downstream processing from the `TimeoutNotification` node is significant, requests that are set up in the `TimeoutControl` node can build up. You can specify that the timeout messages are generated only when the flow that starts with the `TimeoutNotification` node becomes free again.

You cannot increase the `Additional Instances` property of the message flow if it starts with a `TimeoutNotification` node, therefore you cannot apply more threads to increase the capacity of the flow.

Although you can use a `TimeoutNotification` node to cause nodes in a message flow to poll for the next item of work, this approach forces a delay between each transaction, and typically does not provide an efficient solution. If you want to periodically check a resource for the next piece of work, and process it immediately, consider one or more of the following alternative solutions:

- Use a built-in input node.
- Write your own input node by using the user-defined node API (in Java or C).
- Consider purchasing an IBM or vendor-provided adapter which polls the subsystem you want, and triggers the flow.

A message flow that uses these options can process more work overall than it can if you implement a timeout solution, and incurs lower CPU cost, although your initial development costs might be slightly higher.

Configuring flows to handle WebSphere MQ message groups

WebSphere MQ allows multiple messages to be treated as a group, or as segments of one larger message. WebSphere Message Broker provides support for WebSphere MQ message grouping and partial support for message segmenting.

You can use the MQInput and MQOutput nodes to receive and send messages that are part of a WebSphere MQ message group. You can use the MQOutput node to send messages that are segments of a larger message.

For guidance about configuring the MQInput and MQOutput nodes to receive and send messages that are part of a WebSphere MQ message group, see:

- “Receiving messages in a WebSphere MQ message group”
- “Sending messages in a WebSphere MQ message group” on page 611
- “Sending message segments in a WebSphere MQ message” on page 612

For more information about WebSphere MQ message groups, see the Application Programming Guide section of the WebSphere MQ Version 6 information center online.

Receiving messages in a WebSphere MQ message group

You can configure the MQInput node to receive messages that are in a WebSphere MQ message group.

The following properties on the MQInput node control the processing of messages in a WebSphere MQ message group:

- Logical order
- Order mode
- All messages available
- Commit by message group

To ensure that your message flow receives group messages in the order that has been assigned by the sending application, select the Logical order check box. If you do not select this check box, messages that are sent as part of a group are not received in any predetermined order. This property maps to the MQGMO_LOGICAL_ORDER option of the MQGMO of the MQI. More information about the options to which this property maps is available in the *Application Programming Reference* section of the WebSphere MQ Version 6 information center online.

If you specify a value of By Queue Order on the Order mode property, the message flow processes the messages in the group in the order that is defined by the queue attributes; this order is guaranteed to be preserved when the messages are processed. This behavior is identical to the behavior that is exhibited if the Additional instances property is set to zero. The message flow processes the messages on a single thread of execution, and a message is processed to completion before the next message is retrieved from the queue. If you do not specify this value, it is possible that multiple threads within a single message flow are processing multiple messages, and the final message in a group, which prompts the commit or roll back action, is not guaranteed to be processed to completion after all other messages in the group.

To ensure that only a single instance of the message flow processes the group messages in the order that has been assigned by the sending application, select Logical order **and** specify a value of By Queue Order on the Order mode property.

If you select All messages available, message retrieval and processing is performed only when all messages in a single group are available. This means that messages in a group are not received until and unless all the messages in the group are present on the input queue. It is good practice to select this check box when your

message flow needs to process group messages. If you do not select this check box, the message flow receives the messages as they arrive on the input queue; if a message in the group fails to arrive on the input queue, the message flow waits for it and is unable to process any further messages until this message arrives. This property maps to the MQGMO_ALL_MESSAGES_AVAILABLE option of the MQGMO of the MQI. More information about the options to which this property maps is available in the *Application Programming Reference* section of the WebSphere MQ Version 6 information center online.

If you select Commit by message group, message processing is committed only after the final message of a group has been received and processed. If you leave this check box cleared, a commit is performed after each message has been propagated completely through the message flow. This property is relevant only if you have selected Logical order. It is good practise to select this check box in conjunction with the All messages available check box as this ensures that the complete message group is retrieved and processed in the same unit of work without risk of the message flow waiting indefinitely for messages in the group to arrive on the input queue.

In order to ensure that the message flow which processes group messages does not wait for unavailable messages, it is good practice to:

- Avoid having multiple message flows reading from the same input queue when group messages are being retrieved.
- Avoid deploying additional instances of a flow that retrieves group messages.
- Avoid using expired messages in message groups.
- In cases where expired messages are to be used, ensure that all messages have the same expiry time or that the first message in the group is set to expire before the rest of the group. If the first message in a group cannot be retrieved, the group can never be started in logical order.

If a message flow waits for a group message that does not arrive within the wait interval, a BIP2675 warning message is issued. From that point on, the message flow always attempts to retrieve the next group message and does not process any other input messages until it is received.

Therefore, if the expected group message does not arrive, or has expired, the message flow must be stopped manually, and any incomplete message group cleared from the input queue.

A message flow cannot receive all of the messages in a group at once.

If you specify a value of Yes or No on the Transaction mode property, all the segments in a message are received in the message flow as a single message. As a result, the message flow might receive very large messages which might lead to storage problems in the broker. If you specify a value of Automatic on this property, message segments are received as individual messages.

Sending messages in a WebSphere MQ message group

The MQOutput node can send multiple messages that are intended to form a WebSphere MQ message group.

The message flow must set the following MQMD fields:

- GroupId
- MsgSeqNumber

Part 2. Working with Web services

Working with Web services	615	WebSphere Message Broker compliance with	
WebSphere Message Broker and Web services	615	Web services standards	686
What is a Web service?	616	Message flows for Web services	689
What is SOAP?.	617	SOAP domain message flows	689
The structure of a SOAP message	617	XML domain message flows	696
SOAP nodes.	621	Web services scenarios	700
WebSphere Message Broker SOAP nodes	622		
SOAP applications.	623		
Using the SOAP parser	624		
What is WSDL?	629		
WSDL validation	630		
Using WSDL to configure message flows	632		
What is SOAP MTOM?	633		
Using SOAP MTOM with the SOAPReply,			
SOAPRequest, and SOAPAsyncRequest nodes	634		
WS-Addressing.	635		
How to use WS-Addressing	637		
WS-Addressing with the SOAPInput node	638		
WS-Addressing with the SOAPReply node	639		
WS-Addressing with the SOAPRequest node	639		
WS-Addressing with the SOAPAsyncRequest			
and SOAPAsyncResponse nodes	640		
WS-Addressing information in the			
LocalEnvironment	642		
WS-Security	645		
WS-Security mechanisms	647		
Policy sets	648		
Message flow security and security profiles	658		
WS-Security capabilities	659		
WebSphere Service Registry and Repository	666		
Configuration parameters for the WebSphere			
Service Registry and Repository nodes	667		
Displaying the configuration parameters for the			
WebSphere Service Registry and Repository			
nodes	668		
Changing the configuration parameters for the			
WebSphere Service Registry and Repository			
nodes	669		
Accessing a secure WebSphere Service Registry			
and Repository	670		
Caching artefacts from the WebSphere Service			
Registry and Repository	672		
The LocalEnvironment	677		
External standards.	681		
SOAP 1.1 and 1.2	681		
SOAP with Attachments.	682		
SOAP MTOM	682		
WSDL Version 1.1	683		
WS-I Simple SOAP Binding Profile Version 1.0	683		
WS-I Basic Profile Version 1.1	683		
WSDL 1.1 Binding Extension for SOAP 1.2	684		
XML-Binary Optimised Packaging (XOP)	684		
SOAP Binding for MTOM 1.0	685		
Web Services Security: SOAP Message Security	685		
XML Encryption Syntax and Processing	685		
XML-Signature Syntax and Processing	686		

Working with Web services

Start here to find out how WebSphere Message Broker supports Web services.

A Web service is a software system designed to support interoperable machine-to-machine interaction over a network. It has an interface described in a machine-processable format (specifically, Web Service Definition Language, or WSDL).

Web services fulfill a specific task or a set of tasks. A Web service is described using a standard, formal XML notion, called its service description, that provides all of the details necessary to interact with the service, including message formats (that detail the operations), transport protocols, and location.

The nature of the interface hides the implementation details of the service so that it can be used independently of the hardware or software platform on which it is implemented and independently of the programming language in which it is written.

This allows and encourages Web service based applications to be loosely coupled, component oriented, cross-technology implementations. Web services can be used alone or in conjunction with other Web services to carry out a complex aggregation or a business transaction.

The following topics describe how to work with Web services:

- “WebSphere Message Broker and Web services”
- “What is SOAP?” on page 617
- “What is WSDL?” on page 629
- “What is SOAP MTOM?” on page 633
- “WS-Addressing” on page 635
- “WS-Security” on page 645
- “WebSphere Service Registry and Repository” on page 666
- “External standards” on page 681
- “Message flows for Web services” on page 689

WebSphere Message Broker and Web services

A WebSphere Message Broker application can participate in a Web services environment as a service requester, as a service provider, or both.

The SOAP domain supports these formats:

- Common Web services message formats SOAP 1.1, SOAP 1.2, SOAP with Attachments (SwA), and MTOM.
- Consistent SOAP logical tree format, which is independent of the exact message format.
- WS-Addressing and WS-Security standards.

The following nodes are provided for use in the SOAP domain:

- “SOAPInput node” on page 1104

- “SOAPReply node” on page 1114
- “SOAPRequest node” on page 1116
- “SOAPAsyncRequest node” on page 1082
- “SOAPAsyncResponse node” on page 1092
- “SOAPEnvelope node” on page 1096
- “SOAPExtract node” on page 1099

Use the SOAP domain where possible. Alternatively, regular transport nodes can be used with the XMLNSC domain or MRM/XML domain. Using these might be appropriate in the following situations:

- Message flows that will never require Web Services Addressing (WS-Addressing) or WS-Security support.
- Message flows that require Web services support over a different transport, for example, MQ or JMS.

Web services support conforms to the following open standards:

- SOAP 1.1 and 1.2
- SOAP Messages with Attachments
- MTOM
- HTTP 1.1
- WSDL 1.1
- WS-Addressing (new SOAP domain only)
- WS-Security (new SOAP domain only)

WSDL is also validated against the WS-I Basic Profile Version 1.1. Conformance to the guidelines in this specification improves interoperability with other applications.

For more information about how a WebSphere Message Broker application can participate in a Web services environment, see the WebSphere Message Broker Web page on developerWorks.

What is a Web service?

A Web service is defined by the World Wide Web Consortium (W3C) as a software system designed to support interoperable machine-to-machine interaction over a network.

A Web service has an interface described in a machine-processable format, specifically Web Services Description Language (WSDL). Other systems interact with the Web service in a manner prescribed by its description using SOAP-messages, typically conveyed using HTTP with an XML serialization in conjunction with other Web-related standards.

A Web service fulfills a specific task or a set of tasks, and is described by a service description in a standard XML notation called WSDL. The service description provides all of the details necessary to interact with the service, including message formats (that detail the operations), transport protocols, and location.

The WSDL interface hides the implementation details of the service so that it can be used independently of the hardware or software platform on which it is implemented, and independently of the programming language in which it is written.

Applications that are based on Web services are loosely coupled, component oriented, cross-technology implementations. Web services can be used alone, or in conjunction with other Web services to carry out a complex aggregation or a business transaction.

What is SOAP?

SOAP is an XML message format used in Web service interactions. SOAP messages are typically sent over HTTP, but other transport protocols can be used. The use of SOAP in a specific Web service is described by a WSDL definition.

There are two versions of SOAP in common use: SOAP 1.1 and SOAP 1.2. Both are supported in WebSphere Message Broker. SOAP is defined in the following documents issued by World Wide Web Consortium (W3C):

- Simple Object Access Protocol (SOAP) 1.1 (W3C note).
- SOAP Version 1.2 Part 0: Primer (W3C recommendation).
- SOAP Version 1.2 Part 1: Messaging Framework (W3C recommendation).
- SOAP Version 1.2 Part 2: Adjuncts (W3C recommendation).

Support for SOAP in WebSphere Message Broker includes:

- SOAP parser and domain. See “SOAP parser and domain” on page 78.
- SOAP nodes to send and receive messages in SOAP format. See “SOAP nodes” on page 621.
- IBM supplied message definitions for SOAP 1.1 and SOAP 1.2. These message definitions support validation, ESQL content assist, and the creation of message maps for use with SOAP messages, in the SOAP and other XML domains. See IBM supplied messages that you can import.

The structure of a SOAP message

A SOAP message is encoded as an XML document, consisting of an <Envelope> element, which contains an optional <Header> element, and a mandatory <Body> element. The <Fault> element, contained within <Body>, is used for reporting errors.

The SOAP envelope

<Envelope> is the root element in every SOAP message, and contains two child elements, an optional <Header> element, and a mandatory <Body> element.

The SOAP header

<Header> is an optional sub-element of the SOAP envelope, and is used to pass application-related information that is to be processed by SOAP nodes along the message path. See “The SOAP header” on page 618.

The SOAP body

<Body> is a mandatory sub-element of the SOAP envelope, which contains information intended for the ultimate recipient of the message. See “The SOAP body” on page 620.

The SOAP fault

<Fault> is a sub-element of the SOAP body, which is used for reporting errors. See “The SOAP fault” on page 620.

XML elements within <Header> and <Body> are defined by the applications that make use of them, although the SOAP specification imposes some constraints on

their structure. The following diagram shows the structure of a SOAP message.

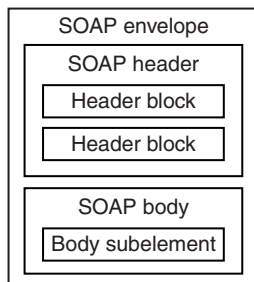

The following code is an example of a SOAP message that contains header blocks (the `<m:reservation>` and `<n:passenger>` elements) and a body (containing the `<p:itinerary>` element).

```
<?xml version='1.0' Encoding='UTF-8' ?>
<env:Envelope xmlns:env="http://www.w3.org/2003/05/soap-envelope">
  <env:Header>
    <m:reservation xmlns:m="http://travelcompany.example.org/reservation"
      env:role="http://www.w3.org/2003/05/soap-envelope/role/next"
      env:mustUnderstand="true">
      <m:reference>uid:093a2da1-q345-739r-ba5d-pqff98fe8j7d</m:reference>
      <m:dateAndTime>2007-11-29T13:20:00.000-05:00</m:dateAndTime>
    </m:reservation>
    <n:passenger xmlns:n="http://mycompany.example.com/employees"
      env:role="http://www.w3.org/2003/05/soap-envelope/role/next"
      env:mustUnderstand="true">
      <n:name>Fred Bloggs</n:name>
    </n:passenger>
  </env:Header>
  <env:Body>
    <p:itinerary xmlns:p="http://travelcompany.example.org/reservation/travel">
      <p:departure>
        <p:departing>New York</p:departing>
        <p:arriving>Los Angeles</p:arriving>
        <p:departureDate>2007-12-14</p:departureDate>
        <p:departureTime>late afternoon</p:departureTime>
        <p:seatPreference>aisle</p:seatPreference>
      </p:departure>
      <p:return>
        <p:departing>Los Angeles</p:departing>
        <p:arriving>New York</p:arriving>
        <p:departureDate>2007-12-20</p:departureDate>
        <p:departureTime>mid-morning</p:departureTime>
        <p:seatPreference></p:seatPreference>
      </p:return>
    </p:itinerary>
  </env:Body>
</env:Envelope>
```

The SOAP header

The SOAP header (the `<Header>` element) is an optional sub-element of the SOAP envelope, and is used to pass application-related information that is processed by SOAP nodes along the message flow.

The immediate child elements of the header are called *header blocks*. A header block is an application-defined XML element, and represents a logical grouping of data which can be targeted at SOAP nodes that might be encountered in the path of a message from a sender to an ultimate receiver.

SOAP header blocks can be processed by SOAP intermediary nodes, and by the ultimate SOAP receiver node. However, in a real application, not every node processes every header block. Each node is typically designed to process particular header blocks, and each header block is processed by particular nodes.

The SOAP header enables you to add features to a SOAP message in a decentralized manner without prior agreement between the communicating parties. SOAP defines some attributes that can be used to indicate what can deal with a feature and whether it is optional or mandatory. Such control information includes, for example, passing directives or contextual information related to the processing of the message. This control information enables a SOAP message to be extended in an application-specific manner.

Although the header blocks are application-defined, SOAP-defined attributes on the header blocks indicate how the header blocks must be processed by the SOAP nodes. SOAP-defined attributes include:

encodingStyle

Indicates the rules used to encode the parts of a SOAP message. SOAP defines a narrower set of rules for encoding data than the flexible encoding that XML enables.

actor (SOAP 1.1) or role (SOAP 1.2)

In SOAP 1.2, the role attribute specifies whether a particular node will operate on a message. If the role specified for the node matches the role attribute of the header block, the node processes the header. If the roles do not match, the node does not process the header block. In SOAP 1.1, the actor attribute performs the same function.

Roles can be defined by the application, and are designated by a URI. For example, `http://example.com/Log` might designate the role of a node which performs logging. Header blocks that are processed by this node specify `env:role="http://example.com/Log"` (where the namespace prefix `env` is associated with the SOAP namespace name of `http://www.w3.org/2003/05/soap-envelope`).

The SOAP 1.2 specification defines three standard roles in addition to those which are defined by the application:

`http://www.w3.org/2003/05/soap-envelope/none`

None of the SOAP nodes on the message path should process the header block directly. Header blocks with this role can be used to carry data that is required for processing of other SOAP header blocks.

`http://www.w3.org/2003/05/soap-envelope/next`

All SOAP nodes on the message path are expected to examine the header block (provided that the header has not been removed by a node earlier in the message path).

`http://www.w3.org/2003/05/soap-envelope/ultimateReceiver`

Only the ultimate receiver node is expected to examine the header block.

mustUnderstand

This attribute is used to ensure that SOAP nodes do not ignore header blocks which are important to the overall purpose of the application. If a SOAP node determines, by using the **role** or **actor** attribute, that it should process a header block, then the action taken depends on the value of the **mustUnderstand** attribute.

- 1 (SOAP 1.1) or true (SOAP 1.2): The node must either process the header block in a manner consistent with its specification, or not at all (and throw a fault).
- 0 (SOAP 1.1) or false (SOAP 1.2): The node is not obliged to process the header block.

In effect, the **mustUnderstand** attribute indicates whether processing of the header block is mandatory or optional.

relay (SOAP 1.2 only)

When a SOAP intermediary node processes a header block, the SOAP intermediary node removes the header block from the SOAP message. By default, the SOAP intermediary node also removes all header blocks that it ignored (because the **mustUnderstand** attribute had a value of false). However, when the relay attribute is specified with a value of true, the SOAP intermediary node retains the unprocessed header block in the message.

The SOAP body

The SOAP body (the <Body> element) is a mandatory sub-element of the SOAP envelope, which contains information intended for the ultimate recipient of the message.

The body element and its associated child elements are used to exchange information between the initial SOAP sender and the ultimate SOAP receiver. SOAP defines one child element for the body: the <Fault> element, which is used for reporting errors. Other elements within the body are defined by the Web service that uses them.

The SOAP fault

The SOAP fault (the <Fault> element) is a sub-element of the SOAP body, which is used for reporting errors.

If present, the SOAP fault element must appear as a body entry and must not appear more than once within a body element. The sub-elements of the SOAP fault element are different in SOAP 1.1 and SOAP 1.2.

SOAP 1.1

In SOAP 1.1, the SOAP fault contains the following sub-elements:

<faultcode>

The <faultcode> element is a mandatory element within the <Fault> element. It provides information about the fault in a form that can be processed by software. SOAP defines a small set of SOAP fault codes covering basic SOAP faults, and this set can be extended by applications.

<faultstring>

The <faultstring> element is a mandatory element within the <Fault> element. It provides information about the fault in a form intended for a human reader.

<faultactor>

The <faultactor> element contains the URI of the SOAP node that generated the fault. A SOAP node that is not the ultimate SOAP receiver must include the <faultactor> element when it creates a fault; an ultimate SOAP receiver is not obliged to include this element, but might do so.

<detail>

The <detail> element carries application-specific error information related to the <Body> element. It must be present if the contents of the <Body> element were not successfully processed. The <detail> element must not be used to carry information about error information belonging to header entries. Detailed error information belonging to header entries must be carried within header entries.

SOAP 1.2

In SOAP 1.2, the SOAP fault contains the following sub-elements:

<Code> The <Code> element is a mandatory element within the <Fault> element. It provides information about the fault in a form that can be processed by software. It contains a <Value> element and an optional <Subcode> element.

<Reason>

The <Reason> element is a mandatory element within the <Fault> element. It provides information about the fault in a form intended for a human reader. The <Reason> element contains one or more <Text> elements, each of which contains information about the fault in a different language.

<Node> The <Node> element contains the URI of the SOAP node that generated the fault. A SOAP node that is not the ultimate SOAP receiver must include the <Node> element when it creates a fault; an ultimate SOAP receiver is not obliged to include this element, but might do so.

<Role> The <Role> element contains a URI that identifies the role in which the node was operating at the point the fault occurred.

<Detail>

The <Detail> element is an optional element, which contains application-specific error information related to the SOAP fault codes describing the fault. The presence of the <Detail> element has no significance as to which parts of the faulty SOAP message were processed.

SOAP nodes

A SOAP node is the processing logic which operates on a SOAP message.

A SOAP node can:

- Transmit a SOAP message
- Receive a SOAP message
- Process a SOAP message
- Relay a SOAP message

A SOAP node can be a:

SOAP sender

A SOAP node that transmits a SOAP message.

SOAP receiver

A SOAP node that accepts a SOAP message.

Initial SOAP sender

The SOAP sender that originates a SOAP message at the starting point of a SOAP message path.

SOAP intermediary

A SOAP intermediary is both a SOAP receiver and a SOAP sender and is

targetable from within a SOAP message. It processes the SOAP header blocks targeted at it and acts to forward a SOAP message toward an ultimate SOAP receiver.

Ultimate SOAP receiver

The SOAP receiver that is a final destination of a SOAP message. It is responsible for processing the contents of the SOAP body and any SOAP header blocks targeted at it. In some circumstances, a SOAP message might not reach an ultimate SOAP receiver, for example because of a problem at a SOAP intermediary.

Note: A SOAP node is not the same as a WebSphere Message Broker SOAP node. Typically references to "SOAP nodes" in the WebSphere Message Broker Information Center are referring to WebSphere Message Broker SOAP nodes; see "WebSphere Message Broker SOAP nodes."

WebSphere Message Broker SOAP nodes

The SOAP nodes act as points in the flow where Web service processing is configured and applied. Properties on the SOAP nodes control the processing carried out and can be configured by supplying a WSDL definition, or by manually configuring properties, or both.

SOAP nodes

- The SOAPInput and SOAPReply nodes are analogous to the HTTPInput and HTTPReply nodes and are used in a message flow which implements a Web service. These SOAP nodes are used to construct a message flow that implements a Web service provider. The SOAPInput node listens for incoming Web service requests, and the SOAPReply sends responses back to the client. See "SOAPInput node" on page 1104 and "SOAPReply node" on page 1114.
- The SOAPRequest node is analogous to the HTTPRequest node and is used in a message flow to call a Web service provider synchronously. Calling a Web service synchronously means the node sends a Web service request and waits, blocking the message flow, for the associated Web service response to be received before the message flow continues. See "SOAPRequest node" on page 1116.
- The SOAPAsyncRequest and SOAPAsyncResponse nodes are used to construct a message flow (or pair of flows) which calls a Web service asynchronously. Calling a Web service asynchronously means the SOAPAsyncRequest node sends a Web service request, but the request does not block the message flow by waiting for the associated Web service response to be received because the Web service response is received at the SOAPAsyncResponse node which is in a separate flow. The Node Correlator identifies the logical pairing of the responses against the original requests. Multiple requests can, therefore, be handled in parallel. See "SOAPAsyncRequest node" on page 1082 and "SOAPAsyncResponse node" on page 1092.
- The SOAPExtract and SOAPEnvelope nodes enable you to work on the payload of the SOAP body. The SOAPExtract node can interoperate with the SOAP domain. The SOAP nodes do not require the SOAPEnvelope node, because they can directly handle non-SOAP messages (and look at the LocalEnvironment) but the SOAPEnvelope node is still required for the HTTP nodes. See "SOAPExtract node" on page 1099 and "SOAPEnvelope node" on page 1096.

Note: WebSphere Message Broker SOAP nodes are not the same as the SOAP nodes; see "SOAP nodes" on page 621. Typically references to "SOAP nodes"

in the WebSphere Message Broker Information Center are referring to WebSphere Message Broker SOAP nodes.

SOAP applications

SOAP is an XML based language defined by the World Wide Web Consortium (W3C) for sending data between applications. SOAP is transport and platform neutral.

SOAP message

A SOAP message comprises an envelope containing:

- An optional header (containing one or more header blocks).
- A mandatory body.

The content of the header and body is typically defined by WSDL.

SOAP style

SOAP defines two types of style:

RPC The SOAP body corresponds to a method call.

document

The SOAP body is typically a coarser-grained XML document and is defined explicitly by XML Schema.

SOAP encodings

SOAP defines two types of encoding:

SOAP encoding

With SOAP encoding the content is defined using an encoding scheme which implies a specific mapping to language-specific types.

literal With literal encoding the SOAP content is defined explicitly by some schema (generally XML Schema).

SOAP style and encoding combinations

Three of the four possible SOAP style and encoding combinations are supported by the WSDL importer and the WSDL generator:

- RPC and SOAP encoded (supported for the WSDL importer only).
- RPC and literal.
- Document and literal.

SOAP versions

Two versions of SOAP are available:

- SOAP 1.1
- SOAP 1.2

SOAP 1.1 has some interoperability issues, mainly concerned with the use of SOAP encoding, which are addressed by a separate standard: the WS-I Basic Profile.

Further information

For more information about WSDL 1.1 refer to the World Wide Web Consortium (W3C), and in particular the SOAP 1.1 and SOAP 1.2 documents at:

- <http://www.w3.org>
- <http://www.w3.org/TR/soap>

For more information about the WS-I Basic Profile refer to the WS-I, and in particular the WS-I Basic Profile document:

- <http://www.ws-i.org/>
- <http://www.ws-i.org/deliverables>

Using the SOAP parser

This topic lists the steps you need to set up a sample message flow using the SOAP parser with WebSphere Message Broker and how you test the flow.

The following set of topics takes you through the process of setting up:

1. A main message flow that includes various SOAP nodes, together with:
 - A Filter node
 - A WebSphere MQ MQOutput node
 - Various Mapping nodes

See “Building the main message flow”

2. How you test the message flow using the integrated test client; see “Testing the message flow using the integrated test client” on page 628.
3. How you deploy the message flow and test the flow using HTTP; see “Testing the message flow using HTTP” on page 629.

Building the main message flow

This is the first one of a set of instructions on setting up your system to use the SOAP parser with WebSphere Message Broker and explains how you set up a message flow to use this feature.

This task topic describes the construction of a sample main message flow when using the SOAP parser:

1. Switch to the Broker Application Development perspective.
2. Create a message flow and message set projects using the **Start from WSDL and/or XSD files** wizard. See “Creating an application based on WSDL or XSD files” on page 132 for details on how to do this.

You need one port for the input to and response from the message flow named, for example, `OrderService` and one port defining a web service that is called from the message flow named for example, `ShippingService`.

3. To import the database files you need, select the project name you are using and press the right mouse button.
 - a. Select **New->Database Definition Files** to start the Database Definition wizard. See “Adding database definitions to the Message Broker Toolkit” on page 494 for details on how to do this.
4. Select the WSDL file you require, called `OrderService`, under **Deployable WSDL** from the Active Working Set.
 - a. Drag the mouse pointer to the message flow editor.
 - b. Release the left mouse button. The **Configure New Web Service Usage** wizard starts.

- c. See “Creating an application using the Configure New Web Service Usage wizard” on page 135 for further information. Ensure that you select:
 - **Expose message flow as web service** on page one of the wizard.
 - **SOAP nodes** on page two of the wizard.

When you select **Finish** a skeleton message flow is generated, consisting of a:

- SOAPInput node that is pre-configured for the web service, connected to a
 - SOAPExtract node to remove the SOAP envelope from the incoming message
 - SOAPReply node
5. Select the **Construction** folder on the message flow palette to display the contents.
 6. Select a Trace node and move the mouse to the right of the SOAPExtract node.
 - a. Click the left mouse button to add the node to the message flow. The name is selected automatically.
 - b. Press the **Enter** key to accept the default name.
 - c. Wire the submitPORequest terminal of the SOAPExtract node to the In terminal of the Trace node.
 7. Select the Trace node to display the properties.
 - a. Use the drop down menu to set **Destination** to File
 - b. Set the **File path** you require.
 - c. Enter the **Pattern** you require.
 8. Expand the **Routing** folder on the palette and select **Filter**.
 9. Add the Filter node to the right of the Trace node
 - a. Type in the name for the node you require and press the **Enter** key.
 - b. Wire the out terminal of the Trace node to the in terminal of the Filter node.
 10. Select the Filter node to display the properties.
 - a. Enter the **Data source** name you require.
 - b. Change the name of **Filter expression** to the name you selected for the filter node.
 - c. Remove the check from the **Throw exception on database error** check box.
 11. Select the Filter node and double click the left mouse button to open the ESQL editor. Create or change the ESQL for the node; see “Creating ESQL for a node” on page 271 and “Modifying ESQL for a node” on page 273.
 12. Expand the **Transformation** folder on the palette and select a **Mapping** node.
 13. Add the Mapping node to the right of the Filter node
 - a. Type in the name for the node you require and press the **Enter** key.
 - b. Wire the false terminal of the Filter node to the in terminal of the Mapping node.
 14. Select the Mapping node to display the properties.
 - a. Change the name of **Mapping routine** to the name you selected for the mapping node.
 15. Select the Mapping node and double click the left mouse button to open the mapping editor.
 - a. Select the map source and map target you require.

- b. Select **OK**
 - c. Select **OK** on the tip that displays to open the mapping editor.
- See “Creating a message map file from a Mapping node” on page 477 for further information.
16. Select **Properties** in both the **source** and **target** pane.
 - a. Press the right mouse button.
 - b. Select **Map by Name** from the menu.
 - c. Map the source properties to the target properties using drag and drop mapping. The **Map by Name** dialog appears.
 - d. Select **OK** to perform the mapping.
 17. Expand the **WebSphere MQ** folder on the palette and select an **MQOutput** node.
 18. Add the MQOutput node to the right of the Mapping node.
 - a. Type in the name for the node you require and press the **Enter** key.
 - b. Wire the out terminal of the Mapping node to the in terminal of the MQOutput node.
 19. Select the MQOutput node to display the properties.
 - a. Enter the **Queue name** you require.
 - b. If necessary, select the **Advanced tab** to change any of the fields on the next panel.
 20. Expand the **Transformation** folder on the palette and select a **Mapping** node.
 21. Add the second Mapping node underneath the first Mapping node.
 - a. Type in the name for the node you require and press the **Enter** key.
 - b. Wire the false terminal of the Filter node to the in terminal of this Mapping node.
 22. Add the Mapping node to the right of the Filter node
 - a. Type in the name for the node you require and press the **Enter** key.
 - b. Wire the false terminal of the Filter node to the in terminal of the Mapping node.
 - c. Wire the out terminal of the Mapping node to the in terminal of the SOAPReply node.
 23. Select the Mapping node to display the properties.
 - a. Change the name of **Mapping routine** to the name you selected for the mapping node.
 24. Select the second Mapping node and double click the left mouse button to open the mapping editor. The reply message is a SOAP message. As the input message has been processed by a SOAPExtract node it does not contain a SOAP envelope.
 - a. Select **submitPORequest** as the source message.
 - b. Select **SOAP_Domain_Msg** as the target message.
 - c. Select **OK**
 - d. Select **OK** on the tip that displays to open the mapping editor.

See “Creating a message map file from a Mapping node” on page 477 for further information.
 25. Select **Properties** in both the **source** and **target** pane.
 - a. Press the right mouse button.
 - b. Select **Map by Name** from the menu.

- c. Map the source properties to the target properties using drag and drop mapping. The **Map by Name** dialog appears.
- d. Select **OK** to perform the mapping.
26. Expand the **SOAP_Domain_Msg**, then **Body** and **message items** in the target pane.
27. Select the **tns:submitPORequest** item in the source pane.
28. Select the **Wildcard Message** item in the target pane.
 - a. Press the right mouse button.
 - b. Select **Create new Submap** from the menu.
 - c. Expand the **Wildcard** item.
 - d. Scroll down to and select the **submitPOResponse** item.
 - e. Press **OK** to create the submap.
29. Use drag and drop mapping to select the items you require in the **Source** pane.
30. Select the first item you require in the **Target** pane.
 - a. Press the right mouse button.
 - b. Select **Enter Expression** from the menu.
 - c. Enter the value you require in the expression editor and press the **Enter** key to complete the mapping. You must enclose any expression that is a string of characters in single quotation marks.

Repeat the above steps for all the items you require in the **Target** pane and save the submap and map by using **Ctrl+S**.

31. Set up another flow that uses a Mapping node to build a ship request message, a SOAPRequest node to send the request to the ShippingService Web service and another Mapping node to create the response message back to the original requester.
 - a. Repeat the instructions in the preceding steps that tell you how to set up a Mapping node and a sub map. Connect the True terminal of the Filter node to the In terminal of the new Mapping node.
 - b. Select the ShippingService.wsdl file under the **Deployable WSDL** folder in the MessageSet project. you are using.
 - c. While holding down the left mouse button, move the mouse pointer to the right of the new mapping node and release the left mouse button; the New Web Service Usage wizard starts.
 - d. Change the **Web service usage** to **Invoke web service from message flow** and select **SOAP nodes** on the next panel.
 - e. Click **Finish** to create a SOAPRequest node. For more details on using this wizard, see “Creating an application using the Configure New Web Service Usage wizard” on page 135.
Connect the Out terminal of the new mapping node to the In terminal of the SOAPRequest node.
 - f. Repeat the instructions in the preceding steps again that tell you how to set up a Mapping node and a sub map. Connect the:
 - shipPartResponse terminal of the SOAPRequest node to the In terminal of the second new Mapping node.
 - The Out terminal of the new mapping node to the In terminal of the SOAPReply node
32. Save the entire message flow.

Testing the message flow using the integrated test client

This is the second of a set of instructions on setting up your system to use the SOAP parser with WebSphere Message Broker and illustrates the testing of the message flow.

Prior to carrying out this task you must have imported a message flow into the workbench. For example, to import a zip file:

1. Select **File->Import**
2. Expand the **Other** folder, select **Project Interchange** and click **Next**
3. Click the **Browse** button next to the **From zip file** text box.
4. Navigate to the directory you are using, select the zip file you require, and click the **Open** button.
5. Select the check box next to the displayed project and click the **Finish** button to perform the import.

This task topic describes the testing of the message flow you have already constructed. In this scenario you use the integrated test client.

1. Select the SOAPInput node, press the right mouse button and select **Test** from the menu.
2. Enter the data you require into the test message.
3. Save the values you entered in a pool for later reuse.
 - a. Select the **Envelope** data element.
 - b. Press the right mouse button
 - c. Select **Add value to Pool**
 - d. Enter a name for the value in the text box and click **OK** to save the current values.
4. Select the **Configuration** tab in the lower left corner of the test client.
5. Select **Message Flows** in the left column and click **Add** in the right hand column.
6. Select the message flow you require in the Resources pane and click **OK**.
7. To deploy the message flow you have just selected when you test the new message flow:
 - a. Select **Deployment** in the left hand column.
 - b. Select the **Only rebuild and deploy broker archive when changes occur** radio button in the right hand column.
 - c. Select **MQ Settings** in the left hand column. Review the settings and ensure the **Stop testing when message reaches first output monitor** check box is not selected.
 - d. Select the **Events** tab to return to the main tab and click the **Send Message** button to initiate a test.
8. You see extra screens the first time the message flow is deployed. Use the **New server** button if no server has been previously defined. These instructions show the case where a server has already been defined:
 - a. Expand the **Deployment locations**.
 - b. Select the desired execution group.
 - c. Click **Finish** to deploy and process the flow.

A progress indicator displays and when the test is complete you see an event indicating a response was received as well as the data in the response message.

Testing the message flow using HTTP

This is the third of a set of instructions on setting up your system to use the SOAP parser with WebSphere Message Broker and illustrates the testing of the message flow using HTTP.

Before you carry out this task you must deploy the message flow to the runtime environment; see “Deploying the message flows” on page 694 for further details on this procedure.

This task topic describes the testing of the message flow you have already constructed. In this scenario you use a tool that uses HTTP protocol rather than WebSphere MQ. You can use any tool that has the facilities described in the following procedure.

1. Start the tool and select `http://localhost:nnnn/` where `nnnn` is the address of the port you are using.
2. As the SOAPInput node expects a SOAPAction entry in the HTTP headers you must add one.
 - a. press the **Add New Header** button
 - b. Select the **Value** part of the header. Enter the value you require.
 - c. Select **New Header** in the **Name** pane.
 - d. Change the name from **New Header** to **SOAPAction** and press the **Enter** key.
3. Select **Load File** and go to the directory containing the XML file you want to use.
4. Select the file and press the **Open** button.
5. Set the URL to the host, port and selection for the deployed flow. The SOAPInput nodes listen on a different port from the HTTP nodes and the listener is built into the execution group itself rather than using a different process.

If you define additional execution groups each one has a different port assigned.
6. Press the **Send** button to test the flow. The response appears in the right hand pane.

What is WSDL?

WSDL is an XML notation for describing a Web service. A WSDL definition tells a client how to compose a Web services request and describes the interface that is provided by the Web service provider.

WebSphere Message Broker supports WSDL 1.1 as defined in the following document issued by the World Wide Web Consortium (W3C): Web Services Description Language (WSDL) 1.1. WebSphere Message Broker support for WSDL also adheres to the Web Services Interoperability Organization (WS-I) Basic profile 1.1, see Basic Profile 1.1.

A WSDL definition is divided into separate sections that specify the logical interface and the physical details of a Web service. The physical details include both endpoint information such as HTTP port number, and binding information which specifies how the SOAP payload is represented and which transport is used.

Support for WSDL in WebSphere Message Broker includes:

- Import of WSDL to create message definitions in a message set, see Importing from WSDL.

- Generation of WSDL from a message set, see WSDL generation.
- WSDL editor with text and graphical design views.
- Use of WSDL to configure nodes in the SOAP domain, for example you can drag-and-drop WSDL onto a node. For more details on how to do this, see “Using WSDL to configure message flows” on page 632
- Use to WSDL to create a skeleton message flow by dragging-and-dropping WSDL onto the message flow editor canvas. For more details on how to do this, see “Using WSDL to configure message flows” on page 632.

When you import or generate WSDL, the WSDL is validated against the WS-I Basic Profile. Validation errors must be fixed before the message set can be deployed. Validation warnings do not prevent deployment, but can indicate potential interoperability problems. The validated WSDL becomes an integral part of the message set. The WSDL editor supports a graphical design view that allows you to navigate from the WSDL to its associated message definitions. The message set then contains all the message definitions required by message flows working with the Web service described by the WSDL. At development time, the message definitions support ESQL content assist and the creation of mappings. At runtime, the deployed message set supports schema validation in the SOAP, XMLNSC and MRM domains. In the SOAP domain, runtime checks are also made against the WSDL itself, and WSDL information is included in the SOAP logical tree.

WSDL validation

The WS-I Validator can be used to check your WSDL definitions against the Basic Profile.

For more information about the WS-I Basic Profile refer to the WS-I, and in particular the WS-I Basic Profile document:

- Web Services Interoperability Organization (WS-I)
- WS-I deliverables index

You can use the WS-I Validator to check your WSDL definitions against the Basic Profile; see “WS-I Basic Profile Version 1.1” on page 683.

You can run the validator in either of the following ways:

- Manually against a specific .wsdl resource in the workbench.
This option enables you to investigate and fix any WS-I compliance problems; any validation issues are displayed as task list errors and warnings.
- Automatically, when WSDL is imported or generated.
WSDL can be imported using the WSDL Quick Start wizard, the WSDL Importer wizard, or the `mqsicreatemsgdefsfromwsdl` command.
WSDL can be generated from a message set using the WSDL Generator wizard.

You can control the behavior of the validator using **Preferences > Web services > Profile Compliance and Validation**. The significant settings are:

- WS-I AP compliance level (WS-I Attachments Profile 1.0)
- WS-I SSBP compliance level (WS-I Simple SOAP Binding Profile 1.0)

You can select one of the following values:

Suggest

Run the validator with errors treated as unrecoverable, but warnings only notified. This is the default setting.

Require

Run the validator with errors and warnings treated as unrecoverable.

Ignore Do not run the validator.

Note that the AP selection applies automatically to the SSBP field, so Ignore is not explicitly selectable unless the AP selection is set to Ignore.

The following terms refer to the three broad categories of WSDL definition:

- `document-literal` means the combination `style="document"` and `use="literal"`
- `rpc-literal` means the combination `style="rpc"` and `use="literal"`
- `rpc-encoded` means the combination `style="rpc"` and `use="encoded"`

Common validation problems, using the preceding terminology, are listed below:

Your WSDL is `rpc-encoded`

WSDL with `use="encoded"` is not WS-I compliant and can lead to operational problems because products of different vendors can make different assumptions about the expected SOAP payload.

WS-I: (BP2406) The use attribute of a `soapbind:body`, `soapbind:fault`, `soapbind:header`, and `soapbind:headerfault` does not have the value of "literal".

Your WSDL is `document-literal`, but one or more WSDL part definitions refer to XML Schema types.

In `document-literal` WSDL, the SOAP body payload is the XML Schema element that is referred to by the appropriate WSDL part.

If a type is specified instead of an element, the SOAP payload is potentially ambiguous (the payload name is not defined) and interoperability problems are likely.

WS-I: (BP2012) A `document-literal` binding contains `soapbind:body` elements that refer to message part elements that do not have the element attribute.

Your WSDL is `rpc-literal` or `rpc-encoded`, but one or more WSDL part definitions refer to XML Schema elements.

In `rpc-style` WSDL, the SOAP body payload is the WSDL operation name, and its children are the WSDL parts that are specified for that operation.

If an element is specified instead of a type, the SOAP message payload is potentially ambiguous (the payload name might be the WSDL part name or the XML Schema element name), and interoperability problems are likely.

WS-I: (BP2013) An `rpc-literal` binding contains `soapbind:body` elements that refer to message part elements that do not have the type attribute.

Your WSDL includes SOAP header, headerfault or fault definitions that refer to XML Schema types.

In `rpc-style` WSDL, the SOAP body is correctly defined through XML Schema types as described above.

SOAP headers and faults, however, do not correspond to an `rpc` function call in the same way as the body.

In particular, there is no concept of 'parameters' to a header or fault, and a header or fault must always be defined in terms of XML Schema elements to avoid potential ambiguity. Effectively, header and fault definitions in WSDL are always `document-literal`.

WS-I: (BP2113) The `soapbind:header`, `soapbind:headerfault`, or `soapbind:fault` elements refer to `wsd:part` elements that are not defined using only the "element" attribute.

Your WSDL is `rpc-literal` or `rpc-encoded`, but no namespace was specified for an operation.

In `rpc-style` WSDL, the SOAP message payload is the WSDL operation name, qualified by a namespace that is specified as part of the WSDL binding.

If no namespace is specified then the SOAP message payload is potentially ambiguous (the payload name might be in no namespace, or might default to use a different namespace, such as the target namespace of the WSDL definition) and interoperability problems are likely.

WS-I: (BP2020) An `rpc-literal` binding contains `soapbind:body` elements that either do not have a namespace attribute, or have a namespace attribute value that is not an absolute URI.

Note that web service interoperability is improved by:

- Using `document-style` WSDL whenever possible.
- Using literal encoding, if `rpc-style` WSDL is necessary.
- Ensuring that the WSDL operation definitions are qualified by a valid namespace attribute, if `rpc-encoded` WSDL must be used.

Using WSDL to configure message flows

How you can use WSDL to configure message flows.

Message flows working with Web services typically use the SOAP nodes. For details about the SOAP nodes, see "WebSphere Message Broker and Web services" on page 615.

The SOAP nodes are configured using WSDL that was previously imported or generated in a message set, and appears under **Deployable WSDL** in the workbench. You can drag the WSDL onto a SOAP node, or specify it by using the WSDL file name property on the node. You must always select a specific WSDL binding.

If you supply a service definition, then endpoint properties are set automatically, but you can also set or override these properties manually.

WSDL definitions can optionally be split into multiple files. The typical arrangement is that a top-level service definition file imports a binding file, the binding file imports an interface file, and this interface file imports or includes schema definition files.

A WSDL `portType` (the logical WSDL interface) is not sufficient on its own to configure a SOAP node; a specific binding is required so that the SOAP payload is well-defined at runtime.

A binding defines a use, which may be document (the default) or rpc. If the use is document then the SOAP payload is described by an XML Schema element in the WSDL. If the use is rpc then the SOAP payload is the WSDL operation name in a specified namespace.

Often you will want to create your own message flow and then configure the nodes as just described. However, you can create a new skeleton message flow by dragging a WSDL definition onto a blank **Message Flow Editor** canvas, and selecting a specific WSDL binding. You can also choose the type of flow (service provider or consumer) and the operations to be handled by the flow.

The key nodes and properties in the generated message flow are configured, but you need to complete the configuration and add any other nodes you require before deploying the flow. For details about configuring a new Web service using the wizard, see *Configure New Web Service Usage wizard*.

Configuring the SOAP nodes

The following nodes are configured explicitly by WSDL:

- “SOAPInput node” on page 1104
- “SOAPRequest node” on page 1116
- “SOAPAsyncRequest node” on page 1082

The following nodes are configured implicitly by WSDL, because they inherit the WSDL configuration of the node with which they are paired:

- “SOAPReply node” on page 1114
- “SOAPAsyncResponse node” on page 1092

A SOAPReply node is always used in conjunction with a SOAPInput node. For details of Web service scenarios, see “Web services scenarios” on page 700.

A SOAPAsyncResponse node is always used in conjunction with a SOAPAsyncRequest node, associated by the Unique Identifier property. For SOAP node usage patterns, see “Web services scenarios” on page 700.

What is SOAP MTOM?

SOAP Message Transmission Optimization Mechanism (MTOM) is the use of MIME to optimize the bitstream transmission of SOAP messages that contain significantly large base64Binary elements.

The MTOM message format allows bitstream compression of binary data. Data which would otherwise have to be encoded in the SOAP message is instead transmitted as raw binary data in a separate MIME part. A large chunk of binary data takes up less space than its encoded representation, so MTOM can reduce transmission time, although it does incur a certain amount of processing overhead. Candidate elements to be transmitted in this way are defined as base64Binary in the WSDL (XML Schema).

An MTOM message is identified by a Content-Type with a type of `application/xop+xml`.

The SOAP domain handles inbound MTOM messages automatically, any MTOM parts being automatically reincorporated into the SOAP Body.

The use of outbound MTOM messages can be configured on the SOAPReply, SOAPRequest, and SOAPAsyncRequest nodes. For details, see “Using SOAP MTOM with the SOAPReply, SOAPRequest, and SOAPAsyncRequest nodes.”

For details of the external specification published by the World Wide Web Consortium (W3C), see “SOAP MTOM” on page 682.

Using SOAP MTOM with the SOAPReply, SOAPRequest, and SOAPAsyncRequest nodes

The use of outbound MTOM messages can be configured on the SOAPReply, SOAPRequest, and SOAPAsyncRequest nodes.

The nodes have a property called Allow MTOM which defines whether MTOM can be used.

An MTOM output message is written if all of the following are true:

- The Allow MTOM option is checked on the WS Extensions tab
- Validation is enabled. Be aware that the Validate property on the SOAPRequest and SOAPAsyncRequest nodes controls validation of the anticipated response message and not validation of the outgoing request. MTOM output is therefore suppressed unless you set Validate to Content and value on a preceding input node or transformation node.
- There are no children below SOAP.Attachment in the logical tree. If children are present, SOAP with Attachments (SwA) is used.
- There are elements in the output message that are identified as base64Binary in the associated XML Schema and whose length does not fall below a default threshold size of 1000 bytes.

A LocalEnvironment setting called MTOMThreshold provides you with the capability to override the MTOM element size threshold. The MTOM element size threshold is set to a default value of 1 000 bytes.

The Allow MTOM node option and the MTOMThreshold can both be overridden in the LocalEnvironment.

The overrides that apply at a SOAPReply node are:

- LocalEnvironment.Destination.SOAP.Reply.AllowMTOM which can have a value of true or false.
- LocalEnvironment.Destination.SOAP.Reply.MTOMThreshold which is an integer value in bytes.

The equivalent overrides for a SOAPRequest or SOAPAsyncRequest node are:

- LocalEnvironment.Destination.SOAP.Request.AllowMTOM which can have a value of true or false.
- LocalEnvironment.Destination.SOAP.Request.MTOMThreshold which is an integer value in bytes.

WS-Addressing

Web Services Addressing (WS-Addressing) is a Worldwide Web Consortium (W3C) specification that aids interoperability between Web services by defining a standard way to address Web services and provide addressing information in messages. Start here to find out how WebSphere Message Broker supports WS-addressing.

The WS-Addressing specification introduces two primary concepts: endpoint references, and message addressing properties. This topic contains an overview of each concept. For further details, select the following links to access the WS-Addressing specifications:

- W3C WS-Addressing specifications
- W3C submission WS-Addressing specification

Endpoint references (EPRs)

EPRs provide a standard mechanism to encapsulate information about specific endpoints. EPRs can be propagated to other parties and then used to target the Web service endpoint that they represent. The following table summarizes the information model for EPRs.

Table 14. Information model for endpoint references

Abstract Property name	Property type	Multiplicity	Description
[address]	xs:anyURI	1..1	The absolute URI that specifies the address of the endpoint.
[reference parameters]*	xs:any	0..unbounded	Namespace qualified element information items that are required to interact with the endpoint.
[metadata]	xs:any	0..unbounded	Description of the behavior, policies and capabilities of the endpoint.

The following prefix and corresponding namespace is used in the previous table.

Table 15. Prefix and corresponding namespace

Prefix	Namespace
xs	http://www.w3.org/2001/XMLSchema

The following XML fragment illustrates an endpoint reference. This element references the endpoint at the URI `http://example.com/fabrikam/acct`, has metadata specifying the interface to which the endpoint reference refers, and has application-defined reference parameters of the `http://example.com/fabrikam` namespace.

```
<wsa:EndpointReference xmlns:wsa="http://www.w3.org/2005/08/addressing"
  xmlns:wsaw="http://www.w3.org/2006/05/addressing/wsdl"
  xmlns:fabrikam="http://example.com/fabrikam"
  xmlns:wsdli="http://www.w3.org/2005/08/wsdli-instance"
  wsdl:wsdlLocation="http://example.com/fabrikam
  http://example.com/fabrikam/fabrikam.wsdl">
  <wsa:Address>http://example.com/fabrikam/acct</wsa:Address>
  <wsa:Metadata>
    <wsaw:InterfaceName>fabrikam:Inventory</wsaw:InterfaceName>
  </wsa:Metadata>
  <wsa:ReferenceParameters>
```

```

    <fabrikam:CustomerKey>123456789</fabrikam:CustomerKey>
    <fabrikam:ShoppingCart>ABCDEFG</fabrikam:ShoppingCart>
  </wsa:ReferenceParameters>
</wsa:EndpointReference>

```

Message addressing properties (MAPs)

MAPs are a set of well defined WS-Addressing properties that can be represented as elements in SOAP headers and provide a standard way of conveying information, such as the endpoint to which message replies should be directed, or information about the relationship that the message has with other messages. The MAPs that are defined by the WS-Addressing specification are summarized in the following table.

Table 16. Message addressing properties defined by the WS-Addressing specification

Abstract WS-Addressing MAP name	MAP content type	Multiplicity	Description
[action]	xs:anyURI	1..1	An absolute URI that uniquely identifies the semantics of the message. This property corresponds to the [address] property of the endpoint reference to which the message is addressed. This value is required.
[destination]	xs:anyURI	1..1	The absolute URI that specifies the address of the intended receiver of this message. This value is optional because, if not present, it defaults to the anonymous URI that is defined in the specification, indicating that the address is defined by the underpinning protocol.
[reference parameters]*	xs:any	0..unbounded	Correspond to the [reference parameters] property of the endpoint reference to which the message is addressed. This value is optional.
[source endpoint]	EndpointReference	0..1	A reference to the endpoint from which the message originated. This value is optional.
[reply endpoint]	EndpointReference	0..1	An endpoint reference for the intended receiver of replies to this message. This value is optional.
[fault endpoint]	EndpointReference	0..1	An endpoint reference for the intended receiver of faults relating to this message. This value is optional.
[relationship]*	xs:anyURI plus optional attribute of type xs:anyURI	0..unbounded	A pair of values that indicate how this message relates to another message. The content of this element conveys the [message id] of the related message. An optional attribute conveys the relationship type. This value is optional.
[message id]	xs:anyURI		An absolute URI that uniquely identifies the message. This value is optional.

The abstract names in the previous tables are used to refer to the MAPs throughout this documentation.

The following example of a SOAP message contains WS-Addressing MAPs:

```

<S:Envelope xmlns:S="http://www.w3.org/2003/05/soap-envelope"
  xmlns:wsa="http://www.w3.org/2005/08/addressing"
  xmlns:fabrikam="http://example.com/fabrikam">
  <S:Header>
    ...
    <wsa:To>http://example.com/fabrikam/acct</wsa:To>
    <wsa:ReplyTo>
    <wsa:Address> http://example.com/fabrikam/acct</wsa:address>
    </wsa:ReplyTo>
    <wsa:Action>...</wsa:Action>
    <fabrikam:CustomerKey wsa:IsReferenceParameter='true'>123456789
    </fabrikam:CustomerKey>
    <fabrikam:ShoppingCart wsa:IsReferenceParameter='true'>ABCDEFGF
    </fabrikam:ShoppingCart>
    ...
  </S:Header>
  <S:Body>
    ...
  </S:Body>
</S:Envelope>

```

How to use WS-Addressing

An overview of how you use WS-Addressing with WebSphere Message Broker.

Sending a message to an endpoint reference (EPR)

When sending a message to an endpoint reference, the following processes take place:

- The [destination] message addressing property (MAP) is filled in from the [address] property in the EPR.
- [reference parameters] are copied to top level SOAP headers from the [reference parameters] property of the EPR.
- The [action] property is required, but is not populated from the EPR. In this context, action is an absolute Internationalized Resource Identifier (IRI) that uniquely identifies the semantics implied by this message and it must be the same as the HTTP SOAPAction if a non-empty SOAPAction is specified.
- The [message id] property must be specified if this message is part of a request-response Message Exchange Pattern (MEP); the message id is generated by default.

When replying with a non-fault message, the following processes take place:

- The EPR to reply to is selected from the [reply endpoint] MAP.
 - If this property contains the special address none, no reply is sent.
 - If this property contains the special address anonymous, the reply is sent on the return channel of the transport on which the request was received. This is the default value in the absence of any other supplied EPR.
 - Otherwise, the reply is sent to the [address] property in the Reply EPR,
- The [message id] property of the inbound message request is placed into the [relationship] property of the response, along with the predefined relationship of `http://www.w3.org/2005/08/addressing/reply` - the Reply Universal Resource Identifier (URI) - which indicates that this message is a reply.
- A new [message id] property is specified for the reply, and this is generated by default.

WS-Addressing with the SOAPInput node

This topic describes the options when using WS-Addressing with the SOAPInput node.

The SOAPInput node has a property for processing WS-Addressing information present in the incoming message called Use WS-Addressing.

If you select this property, the WS-Addressing information is processed and the process itself is called engaging WS-Addressing. The default is that WS-Addressing is not engaged.

You can also specify this property in the WSDL and this is configurable from the WSDL, automatically by the tooling, when the WSDL is dropped onto the node. The behavior of the node when WS-Addressing is engaged or not is as follows:

Addressing not engaged

No WS-Addressing processing is performed. If a message is received that contains any WS-Addressing headers they are ignored, and no WS-Addressing processing of any kind is performed, unless they are marked as MustUnderstand.

The inbound WS Addressing headers in this case are visible in the message as it leaves the SOAPInput node under the Header folder of the SOAP parser in the message tree. In the case where there are WS-Addressing headers in the incoming message and they meet both of the following criteria:

- Marked as MustUnderstand
- Targeted at the role the SOAPInput node is operating in

then a fault is returned to the client.

Engaging WS-Addressing is how you instruct the node to 'understand' the WS-Addressing headers. In this case the WS-Addressing headers remain in the SOAP Header section of the SOAP Parser and no other SOAP node acts upon them. In all cases, they are treated as a SOAP header with no special meaning assigned to them.

Addressing engaged:

WS-Addressing processing is performed as stated in the WS-Addressing specification. This processing means that messages containing either submission addressing headers or final addressing headers are accepted.

A fault is returned if both submission and final headers are present and either of the following conditions is met:

- Neither is marked with a role
- They are both marked with same role and the SOAPInput node is acting in that role.

Assuming the WS-Addressing headers are valid and the Place WS-Addressing Headers into LocalEnvironment checkbox is selected on the SOAPInput node, all headers (including detectable inbound reference parameters) are removed from the inbound message tree and are placed into the LocalEnvironment tree under the SOAP.Input.WSA folder. Moving the WS-Addressing headers to the LocalEnvironment indicates that they have been processed by the broker. They are removed from the message tree because they have been processed on input otherwise they would be invalid if the message tree was sent out without further changes. They are stored in the LocalEnvironment to allow you to inspect them.

Note that only reference parameters from the final specification are detectable because they have an attribute called `IsReferenceParameter` that allows them to be detected. As submission reference parameter headers do not have this attribute they are not detectable, and therefore are not moved into the `LocalEnvironment` tree from the message tree.

You can change WS-Addressing reply headers before the `SOAPReply` node is reached. For more information about changing WS-Addressing information in the `LocalEnvironment`, see “WS-Addressing information in the `LocalEnvironment`” on page 642.

WS-Addressing with the `SOAPReply` node

This topic describes the options when using WS-Addressing with the `SOAPReply` node.

The `SOAPReply` node uses WS-Addressing if WS-Addressing is engaged on the `SOAPInput` node that is referenced by the reply identifier of the message entering the reply node.

The `SOAPReply` node uses addressing information in the `Destination.SOAP.Reply.WSA` folder of the `LocalEnvironment` to determine where to send the reply and with what MAPs.

If the `Destination.SOAP.Reply.WSA` does not exist, or is completely empty, when inspected by the `SOAPReply` node, the node uses the default addressing headers that were part of the incoming message. This means that you do not have to propagate the `LocalEnvironment` in the default case, and addressing still works as expected.

In the case where there are folders beneath the `Reply.WSA` folder, these are used to update the output message. This allows you to change, add, or remove parts of the default reply information generated by the input node because any changes you made to the tree are reflected in the outgoing message by the `SOAPReply` node. For details about WS-Addressing information in the `LocalEnvironment`, see “WS-Addressing information in the `LocalEnvironment`” on page 642.

If WS-Addressing is not engaged, this node does not perform any WS-Addressing processing.

WS-Addressing with the `SOAPRequest` node

This topic describes the options when using WS-Addressing with the `SOAPRequest` node.

The `SOAPRequest` node has a property for processing WS-Addressing information present in the incoming message called `Use WS-Addressing`.

If you select this property, the WS-Addressing information is processed and the process itself is called engaging WS-Addressing. The default is that WS-Addressing is not engaged.

You can also specify this property in the WSDL and this is configurable from the WSDL, automatically by the tooling, when the WSDL is dragged onto the node. The behavior of the node when WS-Addressing is engaged or not is as follows:

Addressing not engaged

The node does not add any WS-Addressing headers to the outgoing

message and does not process any WS-Addressing headers that might be present in the response message received by the node.

Addressing engaged:

The node first looks at the `Destination.SOAP.Request.WSA` folder in the `LocalEnvironment`. If this folder is empty, the node automatically generates all required WS-Addressing MAPs in the outgoing message, using the following defaults:

- `Action`, from the WSDL configuration file. If this is not explicitly specified, this defaults to the value defined in the WSDL Binding specification.
- `To`, from the Web Service URL node property.
- `ReplyTo`, using the special `Anonymous` address (assuming that the Operation being used is not a one-way message exchange program, in which case a `ReplyTo` using the special `None` address is specified).
- `MessageID` A unique UUID is used.

If the `Destination.SOAP.Request.WSA` folder in the `LocalEnvironment` is not empty, any user supplied MAPs override the default ones listed previously on a property by property basis.

If the `Destination.SOAP.Request.WSA` folder in the `Local Environment` is not empty, any user supplied MAPs override the default ones listed previously on a property by property basis.

After the response to the request is received and if the `Place WS-Addressing Headers into LocalEnvironment` checkbox is selected on the `SOAPRequest` node, the `SOAPRequest` node removes all WS-Addressing headers from the response message and places them in the `SOAP.Response.WSA` folder. This folder allows you to query the headers in a similar manner to the way the `SOAPInput` node deals with the `Input WS-Addressing` headers.

WS-Addressing with the SOAPAsyncRequest and SOAPAsyncResponse nodes

This topic describes the options when using WS-Addressing with the `SOAPAsyncRequest` and `SOAPAsyncResponse` nodes.

The `SOAPAsyncRequest` and `SOAPAsyncResponse` nodes require WS-Addressing in order to work. Therefore the remote web service must understand WS-Addressing in order to correctly process the WS-Addressing headers that are sent from the `SOAPAsyncRequest` node, and to allow the response to be sent back to the corresponding `SOAPAsyncResponse` node, which is specified in the `address` property of the `ReplyTo` message addressing property (MAP).

SOAPAsyncRequest node

The `SOAPAsyncRequest` node has a property called `Use WS-Addressing` which is read-only and defaults to `true`; this action is to inform you that WS-Addressing is mandatory for this node. This property has the effect of permanently engaging WS-Addressing for this node and cannot be changed by the node, or by the WSDL used to configure this node.

The node first looks at the `Destination.SOAP.Request.WSA` folder in the `LocalEnvironment`. If this folder is empty, the node automatically generates all required WS-Addressing MAPs in the outgoing message, using the following defaults:

- `Action`, from the WSDL configuration file. If this is not explicitly specified, this defaults to the value defined by the WSDL Binding specification.
- `To`, from the Web Service URL node property.
- `ReplyTo`, the address of the corresponding `SOAPAsyncRequest` node.
- `MessageID` A unique UUID is used.

If the `Destination.SOAP.Request.WSA` folder in the `LocalEnvironment` is not empty, any user supplied MAPs override the default ones listed previously on a property by property basis.

However, because of the nature of the SOAP asynchronous node pair, you cannot specify the address property of the `ReplyTo` message exchange program (MEP), and this is ignored if specified.

When the main MAPs are generated, the node looks in several places to obtain various pieces of context information to send in a `<wmb:context>` element under the `ReferenceParameters` section of the `ReplyTo` endpoint reference. If these locations exist and are not empty, the additional information below is added to the `<wmb:context>`:

- `Destination.SOAP.Request.UserContext`
This is added under a subfolder called `UserContext`.
- `Destination.SOAP.Reply.ReplyIdentifier`
This is added under a subfolder called `ReplyID`.

The `UserContext` allows you to specify an arbitrary amount of data that will be sent along with the message from the `SOAPAsyncRequest` to the `SOAPAsyncResponse` node. This allows you to pass state from one node to the other. Be careful to ensure the amount of data you send is small as this data is placed in the message.

The `ReplyIdentifier` allows you to automatically correlate a `SOAPInput` node in the flow containing the `SOAPAsyncRequest` node with a `SOAPReply` node in the flow containing the `SOAPAsyncResponse` node.

SOAPAsyncResponse node

After the response to the request is received, the `SOAPAsyncResponse` node removes all WS-Addressing headers from the response message and places them in the `SOAP.Response.WSA` folder. This allows you to query the headers.

If the response message contains a `UserContext` that was specified by the `SOAPAsyncRequest` node, this is placed in the `SOAP.Response.UserContext` folder in the `LocalEnvironment`.

If the response message contains a `ReplyIdentifier` that was specified by the `SOAPAsyncRequest` node, this is placed in the `SOAP.Reply.ReplyIdentifier` folder in the `LocalEnvironment`.

WS-Addressing information in the LocalEnvironment

WS-Addressing header information can be placed in the LocalEnvironment tree where it is visible to a message flow. WS-Addressing header information is only processed by the SOAP nodes.

Inbound messages

Inbound information is placed in the LocalEnvironment by the SOAP node only if addressing is engaged on the node and you select the Place WS-Addressing Headers into LocalEnvironment option on either the SOAPInput, SOAPAsyncResponse, or SOAPRequest nodes.

The following table describes the node specific WS-Addressing information in the LocalEnvironment tree.

Node	Populates LocalEnvironment property
SOAPInput	LocalEnvironment.SOAP.Input.WSA.type
SOAPAsyncResponse	LocalEnvironment.SOAP.Response.WSA.type
SOAPRequest	LocalEnvironment.SOAP.Response.WSA.type

Where *type* is the structure of the subsection of the LocalEnvironment WS-Addressing XML schema. For details about how *type* maps to the WS-Addressing properties defined by the WS-Addressing specification, see *LocalEnvironment property type* below.

The LocalEnvironment information for inbound messages is for your information only. If you engage addressing on the node, and select the Place WS-Addressing Headers into LocalEnvironment option on the node, WS-Addressing information is available for you to look at and use in your flow. The WS-Addressing properties are placed in to the LocalEnvironment after processing by the node. Note that the WS-Addressing folder and all its children are owned by an XMLNSC parser. This allows you to copy elements directly into any other tree owned by an XMLNSC parser. However you should be aware that if you copy this folder (or any of its children) to a tree not owned by an XMLNSC parser then information in the tree will be discarded unless you create an XMLNSC parser in the target tree first. This can happen if you, for example, copy from the InputLocalEnvironment tree to the OutputLocalEnvironment tree.

Outbound messages

You can place outbound WS-Addressing header information in the LocalEnvironment, however this is only necessary to override the defaults automatically generated by the node. Outbound addressing headers are only created if WS-Addressing is enabled on the node.

The following table describes the node specific WS-Addressing information in the LocalEnvironment tree that can be used to override the defaults for outbound messages.

Node	Populates LocalEnvironment property
SOAPReply	LocalEnvironment.Destination.SOAP.Reply.WSA.type
SOAPRequest	LocalEnvironment.Destination.SOAP.Request.WSA.type
SOAPAsyncRequest	LocalEnvironment.Destination.SOAP.Request.WSA.type

Where *type* is the structure of the subsection of the LocalEnvironment WS-Addressing XML schema. For details about how the *type* maps to the WS-Addressing properties defined by the WS-Addressing specification, see *LocalEnvironment property type* below.

You can modify LocalEnvironment information for outbound messages. The SOAPReply, SOAPRequest, and SOAPAsyncRequest nodes generate default LocalEnvironment settings that you can override. There is one exception to this table; any attempt to override the WS-Addressing ReplyTo address on the SOAPAsyncRequest node will be ignored.

LocalEnvironment property *type*

The LocalEnvironment property *type* in the above tables corresponds to the WS-Addressing part of the LocalEnvironment XML schema. The following table shows the corresponding message addressing properties (MAPs) of the WS-Addressing LocalEnvironment schema for all nodes.

Element	Corresponds to abstract WS-Addressing MAP name
To	[destination endpoint]
From	[source endpoint]
ReplyTo	[reply endpoint]
FaultTo	[fault endpoint]
Action	[action]
MessageId	[message id]
RelatesTo	[relationship]
ReferenceParameters	[reference parameters]
Version	Not a MAP, but used to identify the version of WS-Addressing. There are two main versions of WS-Addressing called Submission and Final. The default used by all nodes is Final. Therefore, for outbound messages you only need to set this element if you want the version to be Submission. For incoming messages this element is automatically populated with the version of the WS-Addressing headers the inbound message used.

For more details about the message addressing properties defined by the WS-Addressing specification, see Table 16 on page 636 in “WS-Addressing” on page 635.

In the case of outbound WS-Addressing, an additional LocalEnvironment property can be set.

Element	Description
AddMustUnderstandAttribute	This places the SOAPmustUnderstand attribute on each WS-Addressing header before the message is sent.

Example use of WS-Addressing information in the LocalEnvironment

This example shows the setting of reference parameters in the LocalEnvironment along with the corresponding messages as they appear on the wire.

In this example the Web service exposes a simple ping operation.

ESQL to add reference parameters

The following ESQL example shows how to specify addressing headers in the LocalEnvironment.

```
DECLARE Example_ns NAMESPACE 'http://ibm.namespace';
SET OutputLocalEnvironment.Destination.SOAP.Request.WSA.ReplyTo.ReferenceParameters.Parameter1 = 'Message Broker';
SET OutputLocalEnvironment.Destination.SOAP.Request.WSA.ReplyTo.ReferenceParameters.Example_ns:Parameter2.
  (SOAP.NamespaceDecl)xmlns:Example_ns = 'http://ibm.namespace';
SET OutputLocalEnvironment.Destination.SOAP.Request.WSA.ReplyTo.ReferenceParameters.Example_ns:Parameter2 = 'Ping';
SET OutputLocalEnvironment.Destination.SOAP.Request.WSA.FaultTo.ReferenceParameters.Parameter1 = 'Ping';
SET OutputLocalEnvironment.Destination.SOAP.Request.WSA.FaultTo.ReferenceParameters.Example_ns:Parameter2.
  (SOAP.NamespaceDecl)xmlns:Example_ns = 'http://ibm.namespace';
SET OutputLocalEnvironment.Destination.SOAP.Request.WSA.FaultTo.ReferenceParameters.gns:Parameter2 = 'FAULT';
```

Request message

Below is an example of an outgoing SOAP envelope in a message from a SOAPRequest node with ReplyTo and FaultTo reference parameters generated after using the above ESQL. It also shows the other message addressing properties (MAPs) that are not set in the LocalEnvironment, but are generated automatically by the node as a result of engaging WS-Addressing.

```
<NS1:Envelope xmlns:NS1="http://www.w3.org/2003/05/soap-envelope" xmlns:wsa="http://www.w3.org/2005/08/addressing">
  <NS1:Header>
    <wsa:To>http://localhost:7801/Service</wsa:To>
    <wsa:ReplyTo>
      <wsa:Address>http://www.w3.org/2005/08/addressing/anonymous</wsa:Address>
      <wsa:ReferenceParameters>
        <Example_ns:Parameter2 xmlns:Example_ns="http://ibm.namespace">Ping</Example_ns:Parameter2>
        <Parameter1>Message Broker</Parameter1>
      </wsa:ReferenceParameters>
    </wsa:ReplyTo>
    <wsa:FaultTo>
      <wsa:Address>http://www.w3.org/2005/08/addressing/anonymous</wsa:Address>
      <wsa:ReferenceParameters>
        <Example_ns:Parameter2 xmlns:Example_ns="http://ibm.namespace">FAULT</Example_ns:Parameter2>
        <Parameter1>Ping</Parameter1>
      </wsa:ReferenceParameters>
    </wsa:FaultTo>
    <wsa:MessageID>urn:uuid:020C911C16EB130A8F1204119836321</wsa:MessageID>
    <wsa:Action>http://ibm.com/Service/Ping</wsa:Action>
  </NS1:Header>
  <NS1:Body>
    <NS2:Ping xmlns:NS2="http://ibm.com"></NS2:Ping>
  </NS1:Body>
</NS1:Envelope>
```

In the above example, reference parameters are set for the ReplyTo and FaultTo endpoint references (EPRs). If this message is sent to a SOAPInput node with WS-Addressing engaged, these ReferenceParameters are placed in the LocalEnvironment of the flow containing the SOAPInput node for use by the flow if the Place WS-Addressing Headers into LocalEnvironment option is selected. Note that this option only changes what is placed in the LocalEnvironment, it does not change the contents of the response message in any way.

Response message

The following SOAP envelope is a response to the outgoing message above as sent by a SOAPReply node. This shows the MAP processing that happens automatically by the SOAPReply node. In this example, the FaultTo reference parameters are not present as the reply is not a SOAP fault. This response also shows where the reference parameters that belonged to the ReplyTo EPR appear in the response message.

```
<soapenv:Envelope xmlns:soapenv="http://schemas.xmlsoap.org/soap/envelope/" xmlns:wsa="http://www.w3.org/2005/08/addressing">
  <soapenv:Header>
    <wsa:To>http://www.w3.org/2005/08/addressing/anonymous</wsa:To>
    <Example_ns:Parameter2 wsa:IsReferenceParameter="true" xmlns:Example_ns="http://ibm.namespace">Ping</Example_ns:Parameter2>
    <Parameter1 wsa:IsReferenceParameter="true">Message Broker</Parameter1>
    <wsa:ReplyTo>
      <wsa:Address>http://www.w3.org/2005/08/addressing/anonymous</wsa:Address>
    </wsa:ReplyTo>
    <wsa:Action>http://ibm.com/Service/PingResponse</wsa:Action>
    <wsa:RelatesTo RelationshipType="http://www.w3.org/2005/08/addressing/reply">urn:uuid:020C911C16EB130A8F120411983632</wsa:RelatesTo>
  </soapenv:Header>
  <soapenv:Body>
    <NS1:PingResponse xmlns:NS1="http://ibm.com">
      <NS1:PingResult>Ping</NS1:PingResult>
    </NS1:PingResponse>
  </soapenv:Body>
</soapenv:Envelope>
```

WS-Security

Web Services Security (WS-Security) describes enhancements to SOAP messaging to provide quality of protection through message integrity, message confidentiality, and single message authentication. WS-Security mechanisms can be used to accommodate a wide variety of security models and encryption technologies.

WS-Security is a message-level standard that is based on securing SOAP messages through XML digital signature, confidentiality through XML encryption, and credential propagation through security tokens. The Web services security specification defines the core facilities for protecting the integrity and confidentiality of a message and provides mechanisms for associating security-related claims with the message.

WS-Security provides a general-purpose mechanism for associating security tokens with messages. No specific type of security token is required by WS-Security. It is designed to be extensible, for example, to support multiple security token formats.

WS-Security also describes how to encode binary security tokens and attach them to SOAP messages. Specifically, the WS-Security profile specifications describe how to encode Username Tokens and X.509 Tokens. With WS-Security, the domain of these mechanisms can be extended by carrying authentication information in Web services requests. WS-Security also includes extensibility mechanisms that can be used to further describe the credentials that are included with a message. WS-Security is a building block that can be used in conjunction with other Web service protocols to address a wide variety of application security requirements.

There are numerous advantages to using WS-Security.

- Different parts of a message can be secured in a variety of ways. For example, you can use integrity on the security token (user ID and password) and confidentiality on the SOAP message body.
- Intermediaries can be used and end-to-end message-level security can be provided through any number of intermediaries.
- WS-Security works across multiple transports and is independent of the underlying transport protocol.
- Authentication of both individual users and multiple party identities is possible.

Traditional Web security mechanisms, such as HTTPS, might be insufficient to manage the security requirements of all Web service scenarios. For example, when an application sends a SOAP message using HTTPS, the message is secured only for the HTTPS connection, meaning during the transport of the message between the service requester (the client) and the service. However, the application might require that the message data be secured beyond the HTTPS connection, or even beyond the transport layer. By securing Web services at the message level, message-level security is capable of meeting these expanded requirements.

Message-level security, or securing Web services at the message level, addresses the same security requirements as for traditional Web security. These security requirements include: identity, authentication, authorization, integrity, confidentiality, nonrepudiation, basic message exchange, and so forth. Both traditional Web and message-level security share many of the same mechanisms for handling security, including digital certificates, encryption, and digital signatures.

With message-level security, the SOAP message itself either contains the information needed to secure the message or it contains information about where to get that information to handle security needs. The SOAP message also contains information relevant to the protocols and procedures for processing the specified message-level security. However, message-level security is not tied to any particular transport mechanism. Because the security information is part of the message, it is independent of a transport protocol, such as HTTPS.

The client adds to the SOAP message header security information that applies to that particular message. When the message is received, the Web service endpoint, using the security information in the header, verifies the secured message and validates it against the policy. For example, the service endpoint might verify the message signature and check that the message has not been tampered with. It is possible to add signature and encryption information to the SOAP message headers, as well as other information such as security tokens for identity (for example, an X.509 certificate) that are bound to the SOAP message content.

Without message-level security, the SOAP message is sent in clear text, and personal information such as a user ID or an account number is not protected. Without applying message-level security, there is only a SOAP body under the SOAP envelope in the SOAP message. By applying features from the WS-Security specification, the SOAP security header is inserted under the SOAP envelope in the SOAP message when the SOAP body is signed and encrypted.

To keep the integrity or confidentiality of the message, digital signatures and encryption are typically applied.

- Confidentiality specifies the confidentiality constraints that are applied to generated messages. This includes specifying which message parts within the

generated message must be encrypted, and the message parts to attach encrypted Nonce and time stamp elements to.

- Integrity is provided by applying a digital signature to a SOAP message. Confidentiality is applied by SOAP message encryption.

You can add an authentication mechanism by inserting various types of security tokens, such as the Username token (element). When the Username token is received by the Web service server, the user name and password are extracted and verified. Only when the user name and password combination is valid, will the message be accepted and processed at the server. Using the Username token is just one of the ways of implementing authentication. This mechanism is also known as basic authentication.

The OASIS Web Services Security Specification provides a set of mechanisms to help developers of Web Services secure SOAP message exchanges. For details of the OASIS Web Services Security Specification, see OASIS Standard for WS-Security Specification.

WS-Security mechanisms

The WS-Security specification provides three mechanisms for securing Web services at the message level. The three mechanisms are authentication, integrity, and confidentiality.

Authentication

This mechanism uses a security token to validate the user and determine whether a client is valid in a particular context. A client can be an end user, machine, or application. Without authentication, an attacker can use spoofing techniques to send a modified SOAP message to the service provider.

In authentication, a security token is inserted in the request message. Depending on the type of security token that is being used, the security token may also be inserted in the response message. These types of security tokens are supported for authentication:

- Username tokens
- X.509 tokens

Username tokens are used to simply validate user names and passwords. When a Web service server receives a username token, the user name and password are extracted and passed to a user registry for verification. If the user name and password combination is valid, the result is returned to the server and the message is accepted and processed. When used in authentication, username tokens are typically passed only in the request message, not the response message.

X.509 tokens are validated using a certificate path.

Both types of tokens must be protected. For this reason, if you send them over an untrusted network, take one of the following actions:

- Use HTTPS.
- Configure the policy set to protect the appropriate elements in the SOAP header.

Integrity

This mechanism uses message signing to ensure that information is not changed, altered, or lost in an accidental way. When integrity is implemented, an XML digital signature is generated on the contents of a SOAP message. If the message data changes illegally, the signature is not validated. Without integrity, an attacker can use tampering techniques to intercept a SOAP message between the Web service client and server and then modify it.

Confidentiality

This mechanism uses message encryption to ensure that no party or process can access or disclose the information in the message. When a SOAP message is encrypted, only a service that knows the appropriate key can decrypt and read the message.

Policy sets

Policy sets and bindings define and configure your WS-Security requirements, supported by WebSphere Message Broker, for the SOAPInput, SOAPReply, SOAPRequest, SOAPAsyncRequest, and SOAPAsyncResponse nodes.

A *policy set* is a container for the WS-Security policy type.

A policy set *binding* is associated with a policy set and contains information that is specific to the environment and platform, such as information about keys.

Use policy sets and bindings to define the following items for both request and response SOAP messages:

- Authentication for both UserNameToken and X.509 certificates
- Asymmetric encryption (confidentiality)
- Asymmetric signature (integrity)

Either the whole SOAP message body, or specific parts of the SOAP message header and body can be encrypted and signed.

You administer policy sets and bindings from the toolkit, which can add, delete, display and edit policy sets and bindings. Any changes to policy sets or bindings in the toolkit are saved directly to the associated broker. You must stop and then restart the message flow for the new configuration information to take effect.

You can also export and import policy sets and bindings from a broker.

- “Exporting a policy set and policy binding” on page 657
- “Importing a policy set and policy set binding” on page 658

Policy sets and their associated bindings must be saved and restored together.

Policy sets are associated with a message flow, a node or both in the Broker Archive editor. For convenience, you can specify settings for *provider* and *consumer* at the message flow level. The provider setting applies to all SOAPInput and SOAPReply nodes in the message flow. The consumer setting applies to all SOAPRequest, SOAPAsyncRequest, and SOAPAsyncResponse nodes. Individual policy set and binding assignments can be applied at the node level in the Broker Archive editor, and these take precedence over the flow-level provider and consumer settings. The default setting is *none*, meaning that no policy set and bindings are to be used.

Several nodes in the same message flow can refer to the same policy set and bindings. It is the responsibility of the administrator to ensure that the required policy sets are available to the broker at runtime. An error is reported if the broker cannot find the associated policy set or bindings.

The rest of this topic describes some of the terms that you will meet when configuring policy sets and bindings.

Default policy set and bindings

When a broker is created, a default policy set and bindings are created called WSS10Default. This default contains a limited security policy which specifies that a User Name Token is present in request messages (inbound) to SOAPInput nodes in the associated message flow. The default policy set binding refers to the default policy set. Neither are editable.

Consumer and provider nodes

Nodes are either consumers or providers.

Consumer nodes

- SOAPRequest
- SOAPAsyncRequest
- SOAPAsyncResponse

Provider nodes

- SOAPInput
- SOAPReply

Request and response

Request and response is a message exchange pattern (MEP). It describes a client that sends a SOAP Request message to a Web services server, which in turn sends a Response SOAP message back to the client. The Request message is always the SOAP message from the client to the server, and the Response message is always the SOAP message reply from server to the client. The following table describes this pattern in relation to the WebSphere Message Broker SOAP nodes:

Node	Broker viewpoint	Request	Response
SOAPInput	SOAP message inbound	Inbound message	Not applicable
SOAPReply	SOAP message outbound	Not applicable	Outbound message
SOAPRequest	SOAP message outbound followed by a SOAP message inbound	Outbound message	Inbound message
SOAPAsyncRequest	SOAP message outbound	Outbound message	Not applicable
SOAPAsyncResponse	SOAP message inbound	Not applicable	Inbound message

Initiator and recipient

Initiator and recipient are roles defined in the exchange of SOAP messages.

Initiator

The role that sends the initial message in a message exchange.

Recipient

The targeted role to process the initial message in a message exchange.

The following table describes these roles in relation to the Message Broker SOAP nodes:

Node	Broker viewpoint	Initiator	Recipient
SOAPInput	SOAP message inbound	External client sending SOAP message to the broker.	SOAPInput node
SOAPReply	SOAP message outbound	External client that sent the original SOAP message to the broker.	SOAPReply node
SOAPRequest (outbound)	SOAP message outbound followed by a SOAP message inbound	SOAPRequest node	External provider receiving the SOAP message
SOAPRequest (inbound)	SOAP message outbound followed by a SOAP message inbound	SOAPRequest node	External provider receiving the SOAP message
SOAPAsyncRequest	SOAP message outbound	SOAPAsyncRequest node	External provider receiving the SOAP message
SOAPAsyncResponse	SOAP message inbound	SOAPAsyncRequest node	External provider receiving the SOAP message

Asynchronous SOAP nodes

This diagram shows the broker acting as an initiator. It uses the asynchronous SOAP nodes to make a request to an external provider (the recipient). Inbound and outbound messages are signed and encrypted.

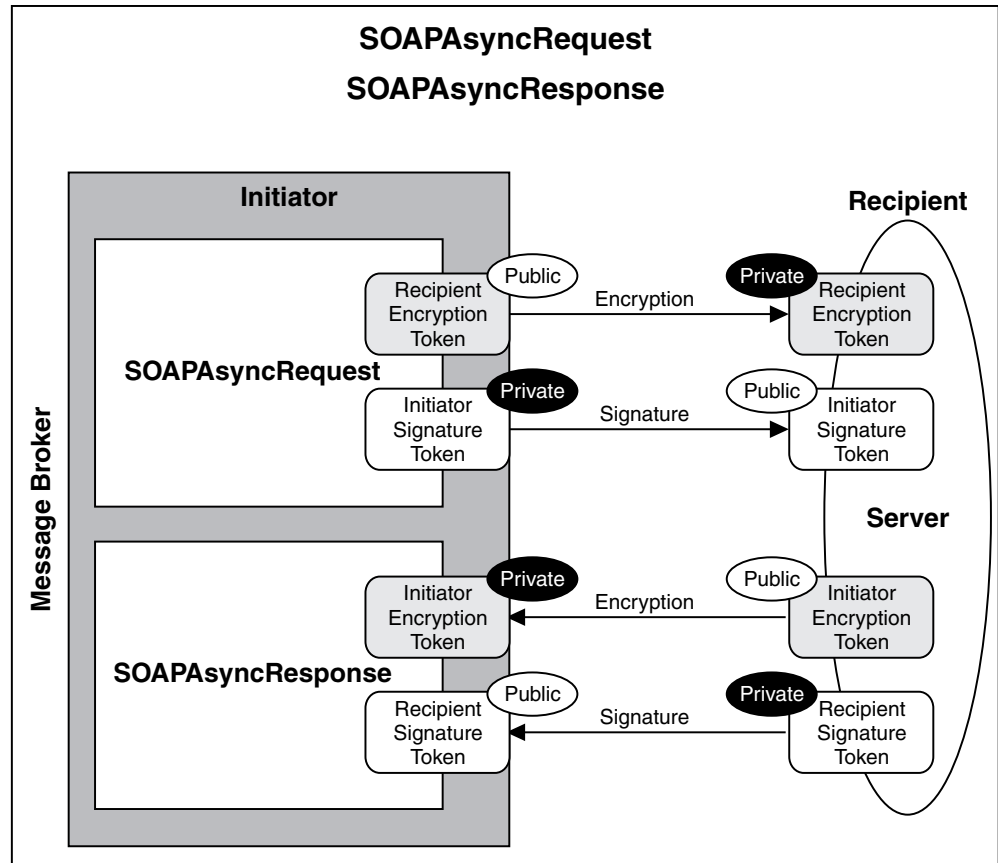

In the request:

- The broker uses the recipient's public encryption token to encrypt the message, and its own private signature token to sign the message.
- The recipient uses its own private encryption token to decrypt the message, and the broker's public signature token to verify the signature.

In the response:

- The recipient uses the broker's public encryption token to encrypt the message, and its own private signature token to sign the message.
- The broker uses its own private encryption token to decrypt the message, and the initiator's public signature token to verify the signature.

SOAPInput and SOAPReply nodes

In this diagram, the broker acts as recipient. A SOAPInput node receives a message from a client (initiator). A SOAPReply node replies. Inbound and outbound messages are signed and encrypted.

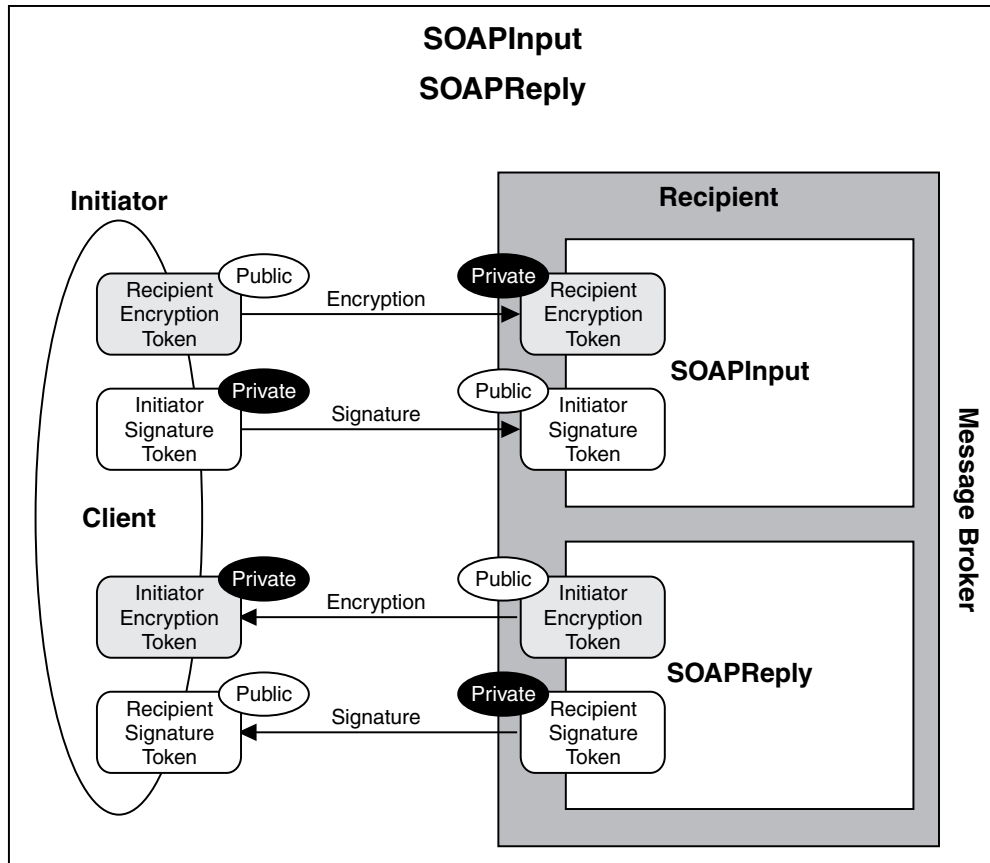

In the request:

- The initiator uses the broker’s public encryption token to encrypt the message, and its own private signature token to sign it.
- The broker uses its own private encryption token to decrypt the message, and the initiator’s public signature token to verify the signature.

In the response:

- The broker uses the initiator’s public encryption token to encrypt the message, and its own private signature token to sign the message.
- The initiator uses its own private encryption token to decrypt the message, and the broker’s public signature token to verify the signature.

SOAPRequest node

This diagram shows the broker acting as an initiator. It uses the SOAPRequest node to make a synchronous request to an external provider (the recipient). Inbound and outbound messages are signed and encrypted. Use of tokens is similar to the example of the asynchronous SOAP nodes, shown earlier.

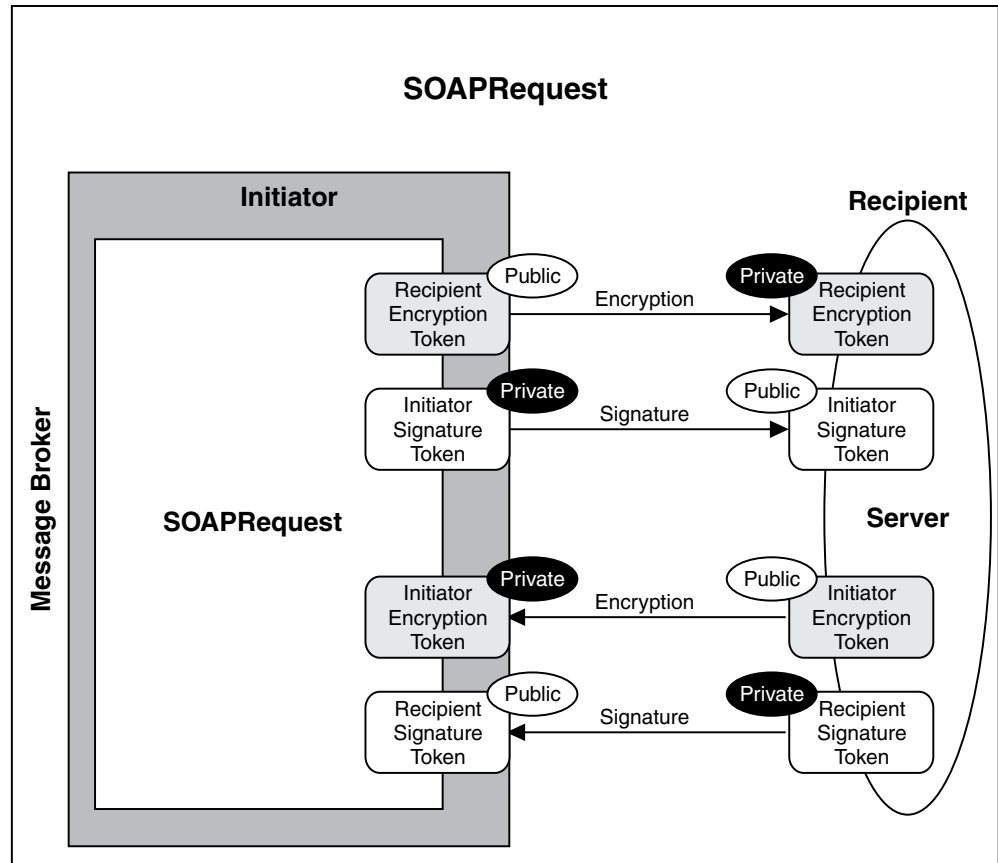

In the request:

- The broker uses the recipient's public encryption token to encrypt the message, and its own private signature token to sign the message.
- The recipient uses its own private encryption token to decrypt the message, and the broker's public signature token to verify the signature.

In the response:

- The recipient uses the broker's public encryption token to encrypt the message, and its own private signature token to sign the message.
- The broker uses its own private encryption token to decrypt the message, and the initiator's public signature token to verify the signature.

Viewing and setting keystore and truststore runtime properties

Configure the message broker to refer to a keystore, a truststore, or both, before deploying any message flows that require policy set or bindings for signature, encryption or X.509 Authentication.

Keystores and truststores are both keystores. They differ only in the way they are used.

Put all private keys and public key certificates (PKC) in the keystore.

Put all trusted root certificate authority (CA) certificates in the truststore. These certificates are used to establish the trust of any inbound public key certificates.

The only supported type of store is Java keystore (JKS).

Each instance of a broker can be configured to refer to one keystore and one truststore.

The following properties of the broker registry component must be defined correctly for policy sets and bindings:

brokerKeystoreFile

The directory and file location of the keystore.

brokerTruststoreFile

The directory and file location of the truststore.

Listing existing broker registry entries:

To display all broker registry values, run the command:

```
mqsi reportproperties broker_name -o BrokerRegistry -a
```

This returns entries like these:

```
BrokerRegistry=''  
  uuid='BrokerRegistry'  
  brokerKeystoreType='JKS'  
  brokerKeystoreFile=' '  
  brokerKeystorePass='brokerKeystore::password'  
  brokerTruststoreType='JKS'  
  brokerTruststoreFile=' '  
  brokerTruststorePass='brokerTruststore::password'  
  httpConnectorPortRange=' '  
  httpsConnectorPortRange=' '
```

Updating the broker reference to a keystore:

To update the broker reference to a keystore, use the following command:

```
mqsi changeproperties broker_name -o BrokerRegistry  
  -n brokerKeystoreFile  
  -v c:\keystore\server.keystore
```

Where `c:\keystore\server.keystore` is the keystore to be referenced.

Updating the broker reference to a truststore:

To update the broker reference to a truststore, use the following command:

```
mqsi changeproperties broker_name -o BrokerRegistry  
  -n brokerTruststoreFile  
  -v c:\truststore\server.truststore
```

Where `c:\truststore\server.truststore` is the truststore to be referenced.

Updating the broker with the keystore password:

Keystores and truststores normally require passwords for access. Use the `mqsisetdbparms` command to add these passwords to the broker runtime component.

```
mqsisetdbparms broker_name  
  -n brokerKeystore::password  
  -u temp -p pa55word
```

The user ID, which can be any value, is not required to access the keystore.

Updating the broker with the truststore password:

To update the broker with the truststore password, use the following command:

```
mqsisetdbparms broker_name
-n brokerTruststore::password
-u temp -p pa55word
```

The user ID, which can be any value, is not required to access the keystore.

Updating the broker with a private key password:

Private keys in the keystore might have their own individual passwords. These can be configured based on the alias name that is specified for the key in the Policy sets and bindings editor. If a key password based on the alias is not found, the keystore password is used. The following command updates the broker with the private key password for the key whose alias is *encKey*.

```
mqsisetdbparms broker_name
-n brokerTruststore::keypass::encKey
-u temp -p pa55word
```

The user ID, which can be any value, is not required to access the keystore.

Implementing WS-Security

What you need to do to configure authentication, XML encryption and XML signature for your system.

You use the Policy Sets and Policy Set Bindings editor in the workbench to configure the following aspects of WS-Security:

“Authentication”

“Confidentiality” on page 656

“Integrity” on page 656

“Expiration” on page 656

Authentication using an external security provider. Define WS-Security tokens for use by the broker security manager; see “Message flow security and security profiles” on page 658.

Authentication:

Both username and X.509 tokens are supported.

Configuring authentication with username tokens

1. In the workbench, switch to the Broker Administration perspective.
2. Create UserName and X.509 authentication tokens; see Policy Sets and Policy Set Bindings editor: Authentication tokens panel.
3. Further configure any X.509 authentication tokens defined in the associated policy set; see Policy Sets and Policy Set Bindings editor: Authentication and Protection Tokens panel.
4. Configure a security profile; see “Message flow security and security profiles” on page 658.
5. Associate the policy set with a message flow or node; see “Associating policy sets and bindings with message flows and nodes” on page 657.

Configuring authentication with X.509 tokens

1. If you are using the broker truststore, configure the keystore and truststore; see “Viewing and setting keystore and truststore runtime properties” on page 653.
2. In the workbench, switch to the Broker Administration perspective.

3. Create UserName and X.509 authentication tokens; see Policy Sets and Policy Set Bindings editor: Authentication tokens panel.
4. Configure the certificate mode for either broker truststore or an external security provider; see Policy Sets and Policy Set Bindings editor: Authentication and Protection Tokens panel.
5. If you are using an external security provider, configure a security profile; see “Message flow security and security profiles” on page 658.
6. Associate the policy set with a message flow or node; see “Associating policy sets and bindings with message flows and nodes” on page 657

Confidentiality:

Confidentiality is provided by XML encryption, and requires X.509 tokens. To configure XML encryption:

1. Configure the keystore and truststore; see “Viewing and setting keystore and truststore runtime properties” on page 653.
2. In the workbench, switch to the Broker Administration perspective.
3. Enable XML encryption, create encryption tokens, and select the encryption algorithms that you will use; see Policy Sets and Policy Set Bindings editor: Message Level Protection panel.
4. Define which parts of a message are to be encrypted; see Policy Sets and Policy Set Bindings editor: Message Part Protection panel.
5. Further configure message part encryption; see Policy Sets and Policy Set Bindings editor: Message Part Policies panel.
6. Further configure the keystore and truststore; see Policy Sets and Policy Set Bindings editor: Key Information panel.
7. Associate the policy set with a message flow or node; see “Associating policy sets and bindings with message flows and nodes” on page 657.

Integrity:

Integrity is provided by XML signature, and requires X.509 tokens. To configure XML signature:

1. Configure the keystore and truststore; see “Viewing and setting keystore and truststore runtime properties” on page 653.
2. In the workbench, switch to the Broker Administration perspective.
3. Enable XML signature and create signature tokens ; see Policy Sets and Policy Set Bindings editor: Message Level Protection panel.
4. Define which parts of a message are to be signed ; see Policy Sets and Policy Set Bindings editor: Message Part Protection panel.
5. Further configure message part signature ; see Policy Sets and Policy Set Bindings editor: Message Part Policies panel.
6. Further configure the keystore and truststore ; see Policy Sets and Policy Set Bindings editor: Key Information panel.
7. Associate the policy set with a message flow or node; see “Associating policy sets and bindings with message flows and nodes” on page 657.

Expiration:

To configure message expiration, ; see Policy Sets and Policy Set Bindings editor: Message Expiration panel.

Associating policy sets and bindings with message flows and nodes

Use the Broker Archive editor to associate policy sets and bindings with message flows and nodes, so that they are available to the broker at runtime.

Before you start

Use the Policy Sets and Policy Set Bindings editor to create and configure policy sets and bindings.

Associations can be made between policy sets and message flow, or specific nodes. Associations made with a flow apply to all nodes described in the Policy Set and Bindings file. Associations at the flow level are defined as being either for consumer or provider nodes.

An association at the node level overrides any association made at the flow level. You do not enter information about consumer or provider for an association at node level.

1. In the workbench, switch to the Broker Administration perspective.
2. Open the bar file in the Broker Archive editor.
3. Click the **Configure** tab.
4. Click the message flow or node that you want to associate with a policy set and binding.
5. If you are configuring a message flow, enter values in the following fields, as appropriate:

Provider Policy Set Bindings

Provider Policy Set

Consumer Policy Set Bindings

Consumer Policy Set

6. If you are configuring a node, enter values in the following fields:

Policy Set

Policy Set Bindings

For new associations to take effect, the bar file must be redeployed and the message flows stopped and restarted.

Exporting a policy set and policy binding

Use the `mqsiexportproperties` command to export a policy set and associated binding to a file.

This topic shows how to export policy set *myPolicySet* from broker *myBroker* to a file called *myPolicySet.xml*. The associated binding is *myPolicySetBinding*, which you export to *myPolicySetBinding.xml*.

1. Export the policy set to a file:

```
mqsiexportproperties myBroker -c PolicySets -o myPolicySet -n ws-security -p myPolicySet.xml
```

2. Export the policy set binding to a file:

```
mqsiexportproperties myBroker -c PolicySetBindings -o myPolicySetBinding  
-n ws-security -p myPolicySetBinding.xml
```

Make a note of the policy set that is associated to the binding; you will need this information when you import the policy set and binding. This command displays the policy set associated with a binding:

```
mqsireportproperties myBroker -c PolicySetBindings -o myPolicySetBinding -n associatedPolicySet
```

This displays:

```
PolicySetBindings myPolicySetBinding associatedPolicySet='myPolicySet'  
BIP8071I: Successful command completion.
```

Importing a policy set and policy set binding

Use the `mqsichangeproperties` command to import a policy set and associated binding.

This topic shows how to import policy set *myPolicySet* to broker *myBroker* from a file called *myPolicySet.xml*. The associated binding is *myPolicySetBinding*, which you import from *myPolicySetBinding.xml*.

1. Create a configurable service for the policy set, if one does not already exist.

```
mqsicreateconfigurableservice myBroker -c PolicySets -o myPolicySet  
BIP8071I: Successful command completion.
```

2. Create a configurable service for the policy set binding, if one does not already exist.

```
mqsicreateconfigurableservice myBroker -c PolicySetBindings -o myPolicySetBinding  
BIP8071I: Successful command completion.
```

3. Import the policy set.

```
mqsichangeproperties myBroker -c PolicySets -o myPolicySet -n ws-security -p myPolicySet.xml
```

4. Import the policy set binding.

```
mqsichangeproperties myBroker -c PolicySetBindings -o myPolicySetBinding  
-n ws-security -p myPolicySetBinding.xml
```

5. Change the value of the `associatedPolicySet` attribute. Set it to the name of the policy set with which this policy set binding was originally associated.

```
mqsichangeproperties myBroker -c PolicySetBindings -o myPolicySetBinding  
-n associatedPolicySet -v myPolicySet
```

Message flow security and security profiles

This topic describes message flow security and security profiles.

WebSphere Message Broker provides a Security Manager for implementing message flow security so that end-to-end processing of a message through a message flow is secured based on an identity carried in that message instance.

The Security Manager enables access to message flows to be controlled per message and includes the ability to:

- Extract the identity from an inbound message.
- Authenticate an inbound message using an external security provider.
- Map the identity to an alternative identity using an external security provider.
- Check that the alternative identity or the original identity is authorized to access the message flow using an external security provider.
- Propagate the inbound or alternative identity.

For details of the supported external providers and the operation of the Security Manager, see [Message flow security](#).

When the message flow is a Web service implemented using “SOAP nodes” on page 621 and the identity is to be taken from the “WS-Security” on page 645 SOAP headers, the SOAP nodes are the Policy Enforcement Point (PEP) and the external provider defined by the Security profiles is the Policy Decision Point (PDP).

The following configuration is required to implement message flow security based on an identity carried in WS_Security tokens.

- “Policy sets” on page 648 define the type of tokens used for the identity.
 - For working with a Username and Password identity, configure the policy and binding for Username token “Authentication” on page 655.
 - For working with a X.509 Certificate identity, configure the policy and binding for X.509 certificate token “Authentication” on page 655.

In the Policy Set Binding, set the X.509 certificate Authentication Token certificates mode to Trust Any. You set it this way (and not to Trust Store) so that the certificate is passed to the security provider defined by the Security Profile. Setting it to Trust Store will cause the certificate to be validated in the local Broker Trust Store. For more details, see Policy Sets and Policy Set Bindings editor: Authentication and Protection Tokens panel.

- The message flow security operation and external provider are defined by the Security profiles

For WS-Security Signing and Encryption the local broker, the truststore must be configured. For details, see “Viewing and setting keystore and truststore runtime properties” on page 653.

Additionally the broker truststore can be used as a local PDP for X.509 Certificate Authentication, as an alternative to message flow security and an external PDP. For details, see Policy Sets and Policy Set Bindings editor: Authentication and Protection Tokens panel.

WS-Security capabilities

This topic explains Web service security capabilities supported by the broker.

Web service security mechanisms are defined by OASIS standards. See OASIS Standard for WS-Security Specification

For information about the Username Token Profile and X.509 Certificate Token Profile standards, see:

- OASIS Web Services Security Username Token Profile
- OASIS Web Services Security X.509 Certificate Token Profile

For details of broker capabilities using the username token profile, see “Username token capabilities”

For details of using the X.509 certificate token profile, see “X.509 certificate token capabilities” on page 661

Username token capabilities

This topic describes WS-Security username token capabilities of the broker.

For details of using WS-Security username token, see the following capabilities:

- “Username token capabilities for encryption, decryption, signing, and verifying” on page 660
- “Username token capabilities for authentication and authorization” on page 660
- “Username token capabilities for identity mapping” on page 660
- “Username token capabilities for extraction and propagation” on page 661

Username token capabilities for encryption, decryption, signing, and verifying:

This topic describes broker Web services capability for encryption, decryption, signing, and verifying using username tokens.

The username token is not applicable, or supported, for the following in any configuration or direction:

- Encryption
- Decryption
- Signing
- Verifying

Username token capabilities for authentication and authorization:

This topic describes broker Web services capability for authentication, authorization, or both using a username token.

The username token “Authentication” on page 647 and Authorization is supported only in the following configuration:

Capability

- Authenticate
- Authorize

Policy Enforcement Point (PEP) and direction

- In (provider)
 - “SOAPInput node” on page 1104

Configured with a security policy and binding which defines that a username token is present for authentication; see “Authentication” on page 655. You can use the default policy and binding WSS10Default; see “Default policy set and bindings” on page 649.

Configured with a security profile defining the Policy Decision Point (PDP); see the PDP section that follows.

Trust Store or PDP

- LDAP
 - Configured using an LDAP security profile specifying authentication, authorization, or both; see Creating a security profile for LDAP.
- TFIM
 - Configured using an TFIM security profile specifying authentication, authorization or both; see Creating a security profile for TFIM.

Username token capabilities for identity mapping:

This topic describes broker Web services capability for identity mapping using a username token.

Identity mapping from a username identity token to a mapped username identity token is supported only in the following configurations:

Capability

- Identity mapping

Policy Enforcement Point (PEP) and direction

- In (provider)

“SOAPInput node” on page 1104

Configured with a security policy and binding which defines that a username taken is present. You can use the default policy and binding WSS10Default; see “Default policy set and bindings” on page 649.

Configured with a security profile defining the external Policy Decision Point (PDP); see the PDP section that follows.

Trust store or PDP

- TFIM

Configured using a TFIM security profile specifying identity mapping; see Creating a security profile for TFIM.

Username token capabilities for extraction and propagation:

This topic describes broker capability for extraction, propagation, or both using a username token in Web services.

The extraction of username into the Properties folder source Identity fields, is supported in the following configurations:

Capability

- Extraction

Policy Enforcement Point (PEP) and direction

- In (provider)

“SOAPInput node” on page 1104

Configured with a security policy and binding which defines that a username taken is present. You can use the default policy and binding WSS10Default; see “Default policy set and bindings” on page 649.

Configured with a security profile that defines propagation; see Creating a security profile

The propagation of a username token into the SOAP WS-Security header, from the token present in either the mapped or the source identity fields in the properties folder, is supported in the following configuration. See Identity.

Capability

- Propagate

Policy Enforcement Point (PEP) and direction

- Out (consumer)

“SOAPRequest node” on page 1116

“SOAPAsyncRequest node” on page 1082

Configured with a security profile that defines propagation; for example, Default Propagation. See Security profiles

X.509 certificate token capabilities

This topic describes the broker capabilities for the WS-Services Security X.509 certificate token profile standards.

For details of using the X.509 certificates, see the following capabilities:

- “X.509 certificate token capabilities for encryption”
- “X.509 certificate token capabilities for decryption”
- “X.509 certificate token capabilities for signing” on page 663
- “X.509 certificate token capabilities for verifying” on page 663
- “X.509 certificate token capabilities for authentication” on page 664
- “X.509 certificate token capabilities for authorization” on page 664
- “X.509 certificate token capabilities for identity mapping” on page 665
- “X.509 certificate token capabilities for extraction and propagation” on page 665

X.509 certificate token capabilities for encryption:

This topic describes broker Web services capability for encryption using an X.509 certificate token.

X.509 certificate token encryption for providing message “Confidentiality” on page 648 on outgoing SOAP messages from the broker is supported in the following configurations:

Capability

- Encrypt (Using partner public key)

Policy Enforcement Point (PEP) and direction

- Out (consumer)
 - “SOAPRequest node” on page 1116
 - “SOAPAsyncRequest node” on page 1082
- Out (provider)
 - “SOAPReply node” on page 1114
 - Configured with a policy set and binding defining the message “Confidentiality” on page 656.

Trust Store or Policy Decision Point (PDP)

- Broker Truststore. For more details see “Viewing and setting keystore and truststore runtime properties” on page 653

Encryption is not supported with external PDPs such as TFIM or LDAP.

X.509 certificate token capabilities for decryption:

This topic describes broker Web services capability for decryption using an X.509 certificate token.

X.509 certificate token decryption for incoming SOAP message “Confidentiality” on page 648 is supported in the following configurations:

Capability

- Decrypt (Using broker private key)

Policy Enforcement Point (PEP) and direction.

- In (provider)
 - “SOAPInput node” on page 1104

- In (consumer)
 - “SOAPRequest node” on page 1116
 - “SOAPAsyncResponse node” on page 1092
 Configured with a policy set and binding defining the message “Confidentiality” on page 656.

Trust Store or Policy Decision Point (PDP).

- Broker Truststore. For details see “Viewing and setting keystore and truststore runtime properties” on page 653

Decryption is not supported with external PDPs such as TFIM or LDAP.

X.509 certificate token capabilities for signing:

This topic describes broker Web services capability for signing using an X.509 certificate token.

X.509 certificate token signing for outgoing SOAP message “Integrity” on page 648 is supported in the following configurations:

Capability

- Sign (using broker private key)

Policy Enforcement Point (PEP) and direction

- Out (consumer)
 - “SOAPRequest node” on page 1116
 - “SOAPAsyncRequest node” on page 1082
- Out (provider)
 - “SOAPReply node” on page 1114
 Configured with a policy set and binding defining the message “Integrity” on page 656

Trust Store or Policy Decision Point (PDP)

- Broker Truststore. For details see “Viewing and setting keystore and truststore runtime properties” on page 653

Signing is not supported with an external PDP such as TFIM or LDAP.

X.509 certificate token capabilities for verifying:

This topic describes broker Web services capability for verifying a signing using an X.509 certificate token profile.

X.509 certificate token verification of the “Integrity” on page 648 of a signed incoming SOAP message is supported in the following configurations:

Capability

- Verify signature (using partner public key)

Policy Enforcement Point (PEP) and direction

- In (provider)
 - “SOAPInput node” on page 1104

- In (consumer)
 - “SOAPRequest node” on page 1116
 - “SOAPAsyncResponse node” on page 1092
 Configured with a policy set and binding defining the message “Integrity” on page 656

Trust Store or Policy Decision Point (PDP)

- Broker Trust store. For details, see “Viewing and setting keystore and truststore runtime properties” on page 653
- Signature verification is not supported with an external PDP such as TFIM or LDAP.

X.509 certificate token capabilities for authentication:

This topic describes broker Web services capability for authentication using an X.509 certificate token.

The X.509 certificate token “Authentication” on page 647 of an incoming SOAP message is supported in the following configurations:

Capability

- Authenticate

Policy Enforcement Point (PEP) and direction

- In (provider)
 - “SOAPInput node” on page 1104
 Configured with a policy set and binding defining the certificate “Authentication” on page 655.
 - Optionally configured with a security profile defining an external Policy Decision Point (PDP); see the PDP section that follows.

Trust Store or PDP

- Broker Trust store. For details, see “Viewing and setting keystore and truststore runtime properties” on page 653
- TFIM
 - Configured using a TFIM security profile specifying authentication. For details, see Creating a security profile for TFIM.

Certificate authentication with an external LDAP PDP is not supported.

X.509 certificate token capabilities for authorization:

This topic describes broker Web services capability for authorization using an X.509 certificate token.

The X.509 certificate token profile Authorization for access to a SOAP message flow is supported in the following configurations:

Capability

- Authorize

Policy Enforcement Point (PEP) and direction

- In (provider)
 - “SOAPInput node” on page 1104
 - Configured with a policy set and binding defining the certificate “Authentication” on page 655.
 - Configured with a security profile defining an external Policy Decision Point (PDP); see the PDP section that follows.

Trust Store or PDP

- TFIM
 - Configured using a TFIM security profile specifying authorization. For details, see Creating a security profile for TFIM

Certificate authorization with an external LDAP PDP is not supported.

X.509 certificate token capabilities for identity mapping:

This topic describes broker Web services capability for identity mapping using an X.509 certificate token.

The broker supports Identity mapping from an X.509 certificate token in an incoming SOAP message header to username tokens in the following configurations:

Capability

- Identity mapping

Policy Enforcement Point (PEP) and direction

- In (provider)
 - “SOAPInput node” on page 1104
 - Configured with a policy set and binding defining the certificate “Authentication” on page 655.
 - Configured with a security profile defining an external Policy Decision Point (PDP); see the PDP section that follows.

Trust Store or PDP

- TFIM
 - Configured using a TFIM security profile specifying identity mapping. For details, see Creating a security profile for TFIM.

Identity mapping is not supported with LDAP, or at outbound nodes.

Username tokens only can be propagated.

X.509 certificate token capabilities for extraction and propagation:

This topic describes broker Web services capability for extraction and propagation X.509 certificate token.

The broker does not support propagation of an X.509 certificate.

The X.509 certificate token extraction is supported in the following configurations:

Capability

- Extraction

Policy Enforcement Point (PEP) and direction

- In (provider)

“SOAPInput node” on page 1104

Configured with a policy set and binding defining the X.509 certificate is present; see “Implementing WS-Security” on page 655.

Configured with a security profile defining propagation; see the Security profiles.

WebSphere Service Registry and Repository

The WebSphere Service Registry and Repository (WSRR) is a central repository of documents describing services, service interfaces (for example, SOAP over HTTP), and associated policies that control access mechanisms (for example, WS-Policy documents associated with either of the previous two).

The WebSphere Service Registry and Repository allows a message flow to dynamically retrieve artefacts from the WebSphere Service Registry and Repository at run time, and to use and expose those artefacts within the message flow. Therefore deferring the decision about which artefacts you want to use until run time, rather than making the decision at deployment time.

Generic XML documents, WSDL, SCDL, and all other formats that are supported by the WebSphere Service Registry and Repository, can be stored in the WebSphere Service Registry and Repository. However, some queries that you might submit to the WebSphere Service Registry and Repository might only apply to certain document types, for example, a query for a port type can only be applied to WSDL documents.

Use the WebSphere Service Registry and Repository nodes (the EndpointLookup and RegistryLookup nodes) to create message flows that use the WebSphere Service Registry and Repository, and to retrieve artefacts dynamically from the WebSphere Service Registry and Repository according to the search criteria provided either on the node, or dynamically within the LocalEnvironment. Thus allowing the succeeding nodes to use the information retrieved from the WebSphere Service Registry and Repository.

Important: WebSphere Message Broker V6.1.0.2 only supports WebSphere Service Registry and Repository V6.1. Previous versions of the product are not supported.

The topics in this section provide further information about working with the WebSphere Service Registry and Repository:

- “Configuration parameters for the WebSphere Service Registry and Repository nodes” on page 667
- “Displaying the configuration parameters for the WebSphere Service Registry and Repository nodes” on page 668
- “Changing the configuration parameters for the WebSphere Service Registry and Repository nodes” on page 669
- “Accessing a secure WebSphere Service Registry and Repository” on page 670
- “Caching artefacts from the WebSphere Service Registry and Repository” on page 672
 - “Configuring the cache loading options” on page 673
 - “Setting up Cache Notification” on page 675

- “The LocalEnvironment” on page 677
 - “Dynamically defining the search criteria” on page 677
 - “EndpointLookup node” on page 881
 - “EndpointLookup node output” on page 678
 - “RegistryLookup node” on page 1048
 - “RegistryLookup node output” on page 680

Configuration parameters for the WebSphere Service Registry and Repository nodes

These parameters affect the brokers configuration when interfacing with WebSphere Service Registry and Repository (WSRR).

The following table describes the parameters for Base Configuration that are configured by using the `mqsichangeproperties` command.

Configuration Setting Name	Default value	Description
endpointAddress	<code>http://host.name:9080/WSRRCoreSD0/services/WSRRCoreSDOPort</code>	Location or endpoint of the WSRR server. Where <i>host.name</i> is variable.

The following table describes the parameters for Cache that are configured by using the `mqsichangeproperties` command.

Configuration Setting Name	Default value	Description
needCache	True	Enable WebSphere Message Broker WSRR cache.
timeout	10000000	The timeout value for the cache. The cache expiry time in milliseconds. (The default value of 10000000 milliseconds is approximately 166 minutes).

The following table describes the parameters for Cache Notification that are configured by using the `mqsichangeproperties` command.

Configuration Setting Name	Default value	Description
enableCacheNotification	False	Enable WebSphere Message Broker WSRR Cache Notification.
predefinedCacheQueries	" (two single quotation marks)	List of semicolon-separated queries with which to initialize the WebSphere Message Broker WSRR cache. This query is defined by the WSRR query language.
refreshQueriesAfterNotification	True	When a notification is received from WSRR, if <code>refreshQueriesAfterNotification</code> is set to True the cache is updated with the new version of the object immediately; if False, the cache will be updated on the next request.
connectionFactoryName	<code>jms/SRConnectionFactory</code>	The name of the WSRR WebSphere Application Server JMS provider JMS connection factory for Cache Notification.

Configuration Setting Name	Default value	Description
initialContextFactory	com.ibm.websphere.naming.WsnInitialContextFactory	The name of the WSRR WebSphere Application Server JMS provider JMS context factory for Cache Notification.
locationJNDIBinding	iiop://host.name:2809/	The URL to the WebSphere Application Server JMS provider JNDI bindings. Where <i>host.name</i> is variable.
subscriptionTopic	jms/SuccessTopic	The topic name used to receive WebSphere Application Server JMS provider Cache Notification.

The following table describes the parameters for Security that are configured by using the `mqsisetdbparms` command.

Configuration Setting Name	Default value	Description
Userid	None	The user name used to access the secure WebSphere Application Server.
Password	None	The password to used access the secure WebSphere Application Server.
brokerKeystorePass	None	The SSL configuration for the key password.
brokerTruststorePass	None	The SSL configuration for the trust password.

The following table describes the parameters for Security that are configured by using the `mqsichangeproperties` command.

Configuration Setting Name	Default value	Description
brokerKeystoreFile	None	The SSL configuration for the file path to the ClientKeyFile.
brokerTruststoreFile	None	The SSL configuration for the file path to the ClientTrustFile.

Displaying the configuration parameters for the WebSphere Service Registry and Repository nodes

Use the `mqsireportproperties` command to display all of the configuration parameters of the default WebSphere Service Registry and Repository (WSRR) profile, `DefaultWSRR`.

The `DefaultWSRR` is a Service Registries configurable service that is supplied for each broker, see `Configurable services properties`.

To display the configuration parameters of the default WebSphere Service Registry and Repository profile `DefaultWSRR`, complete the following steps:

1. Ensure that the broker is running. If it is not, use the `mqsistart` command to start it.
2. Enter the following command (where `WBRK_BROKER` is the name of your broker):

```
mqsireportproperties WBRK_BROKER -c ServiceRegistries -o DefaultWSRR -r
```

where:

- c specifies the configurable service (in this case, ServiceRegistries)
- o specifies the name of the object (in this case, DefaultWSRR)
- r specifies that all property values of the object are displayed, including the child values if appropriate.

The command produces a response similar to this:

```
ReportableEntityName=''
ServiceRegistries
DefaultWSRR=''
  connectionFactoryName = 'jms/SRConnectionFactory'
  enableCacheNotification = 'false'
  endpointAddress = 'http://localhost:9080/WSRRCoreSDO/services/WSRRCoreSDOPort'
  initialContextFactory = 'com.ibm.websphere.naming.WsnInitialContextFactory'
  locationJNDIBinding = 'iiop://localhost:2809/'
  needCache = 'true'
  predefinedCacheQueries = ''
  refreshQueriesAfterNotification = 'true'
  subscriptionTopic = 'jms/SuccessTopic'
  timeout = '10000000'
```

Changing the configuration parameters for the WebSphere Service Registry and Repository nodes

Use the `mqsichangeproperties` command to change the configuration parameters of the default WebSphere Service Registry and Repository (WSRR) profile `DefaultWSRR`.

For details about configuration parameters that affect WebSphere Service Registry and Repository use, see “Configuration parameters for the WebSphere Service Registry and Repository nodes” on page 667.

To update the default WebSphere Service Registry and Repository profile `DefaultWSRR` with a new `endpointAddress` value, and, if required, a new cache timeout value, complete the following steps:

1. Ensure that the broker is running. If it is not, use the `mqsistart` command to start it.
2. Enter the following command to change the `endpointAddress` value and point to your WebSphere Service Registry and Repository server:

```
mqsichangeproperties WBRK_BROKER -c ServiceRegistries -o DefaultWSRR
-n endpointAddress
-v http://localhost:9080/WSRRCoreSDO/services/WSRRCoreSDOPort
```

where:

- c specifies the configurable service (in this case, ServiceRegistries)
 - o specifies the name of the object (in this case, DefaultWSRR)
 - n specifies the names of the properties to be changed (in this case, `endpointAddress`)
 - v specifies the values of properties defined by the `-n` parameter (in this case, `http://localhost:9080/WSRRCoreSDO/services/WSRRCoreSDOPort`)
3. (Optional) Enter the following command to change the timeout value:

```
mqsichangeproperties WBRK_BROKER -c ServiceRegistries -o DefaultWSRR
-n timeout -v 10000000
```

where:

- c specifies the configurable service (in this case, ServiceRegistries)
- o specifies the name of the object (in this case, DefaultWSRR)
- n specifies the names of the properties to be changed (in this case, timeout)
- v specifies the values of properties defined by the -n parameter (in this case, 10000000)

4. Restart the broker, by using the mqsisstop command to stop the broker, followed by the mqsisstart command to start it.

Accessing a secure WebSphere Service Registry and Repository

To access a secure WebSphere Service Registry and Repository, you must set the configuration parameters by using the mqsischangeproperties command.

You must connect over HTTPS, not HTTP.

For more information about the configuration parameters, see “Configuration parameters for the WebSphere Service Registry and Repository nodes” on page 667.

To access a secure WebSphere Service Registry and Repository, enter the following sequence of commands:

1. Ensure that the broker is running. If it is not, use the mqsisstart command to start it.
2. Display the configuration parameters of the BrokerRegistry by using the following command:

```
mqsisreportproperties WBRK_BROKER -o BrokerRegistry -r
```

where:

- o specifies the name of the object (in this case, BrokerRegistry)
- r specifies that all property values of the object are displayed, including the child values if appropriate.

3. Change the endpointAddress configuration parameters for the DefaultWSRR of the ServiceRegistries configurable service by using the following command:

```
mqsischangeproperties WBRK_BROKER -c ServiceRegistries -o DefaultWSRR  
-n endpointAddress  
-v https://localhost:9443/WSRRCoreSDO/services/WSRRCoreSDOPort
```

where:

- c specifies the configurable service (in this case, ServiceRegistries)
- o specifies the name of the object (in this case, DefaultWSRR)
- n specifies the names of the properties to be changed (in this case, endpointAddress)
- v specifies the values of properties defined by the -n parameter (in this case, https://localhost:9443/WSRRCoreSDO/services/WSRRCoreSDOPort)

4. Change the brokerKeystoreFile configuration parameters for the BrokerRegistry by using the following command:

```
mqsischangeproperties WBRK_BROKER -o BrokerRegistry  
-n brokerKeystoreFile -v C:\WSRR\SSL\DummyClientKeyFile.jks
```

where:

- o specifies the name of the object (in this case, BrokerRegistry)
- n specifies the names of the properties to be changed (in this case, brokerKeystoreFile)
- v specifies the values of properties defined by the -n parameter (in this case, C:\WSRR\SSL\DummyClientKeyFile.jks)

5. Change the brokerTruststoreFile configuration parameters for the BrokerRegistry by using the following command:

```
mqsichangeproperties WBRK_BROKER -o BrokerRegistry  
-n brokerTruststoreFile -v C:\WSRR\SSL\DummyClientTrustFile.jks
```

where:

- o specifies the name of the object (in this case, BrokerRegistry)
- n specifies the names of the properties to be changed (in this case, brokerTruststoreFile)
- v specifies the values of properties defined by the -n parameter (in this case, C:\WSRR\SSL\DummyClientTrustFile.jks)

6. Stop the broker by using the mqsistop command.
7. Set the WebSphere Application Server user name and password by using the following command:

```
mqsisetdbparms WBRK_BROKER -n DefaultWSRR::WSRR -u wasuser -p waspass
```

where:

- n specifies the name of the data source (in this case, DefaultWSRR::WSRR)
- u specifies the user ID to be associated with this data source (in this case, wasuser)
- p specifies the password to be associated with this data source (in this case, waspass)

8. Set the brokerKeystore user name and password by using the following command:

```
mqsisetdbparms WBRK_BROKER -n brokerKeystore::password -u dummy -p WebAS
```

where:

- n specifies the name of the data source (in this case, brokerKeystore::password)
- u specifies the user ID to be associated with this data source (in this case, dummy)
- p specifies the password to be associated with this data source (in this case, WebAS)

9. Set the brokerTrustStore user name and password by using the following command:

```
mqsisetdbparms WBRK_BROKER -n brokerTruststore::password -u dummy  
-p WebAS
```

where:

- n specifies the name of the data source (in this case, brokerTruststore::password)
- u specifies the user ID to be associated with this data source

(in this case, dummy)

`-p` specifies the password to be associated with this data source
(in this case, WebAS)

10. Restart the broker by using the `mqsisstop` command to stop the broker, followed by the `mqsisstart` command to start it.

Caching artefacts from the WebSphere Service Registry and Repository

An internal cache is used to store query strings, and their associated documents, that are retrieved from the WebSphere Service Registry and Repository.

A query does not have to be submitted to the WebSphere Service Registry and Repository for every message that passes through one of the WebSphere Service Registry and Repository nodes because the documents or artefacts can be cached and retrieved locally, therefore improving performance and message throughput.

The WebSphere Service Registry and Repository cache is configured individually for each broker. You can configure the loading strategy for the WebSphere Service Registry and Repository cache by using the pre-defined Service Registries configurable service; see Configurable services properties. Use the `mqsichangeproperties` command to update these values.

Configuring the cache is optional and does not have to be enabled for the WebSphere Service Registry and Repository nodes (the EndpointLookup and RegistryLookup nodes) to function.

Caching data

You can cache the data that you retrieve from the WebSphere Service Registry and Repository in the following ways:

- No Cache. Every time a message goes through a WebSphere Service Registry and Repository node the broker goes to the WebSphere Service Registry and Repository to retrieve the documents that are stored within the WebSphere Service Registry and Repository. The WebSphere Service Registry and Repository nodes can retrieve and store the documents within the LocalEnvironment for the message tree.

- Cache Timeout. This option is enabled as the default. Configure this option using the `needCache` and `timeout` parameters. If `needCache` is set to true, the broker retrieves the documents from the WebSphere Service Registry and Repository the first time the message flows through a WebSphere Service Registry and Repository node and stores the documents in an internal cache. The next time the message goes through the flow, the documents are retrieved from the cache, not the WebSphere Service Registry and Repository. This option improves performance.

If the Cache Timeout interval is exceeded, the broker marks its internal cache data as not valid and refreshes the documents from the WebSphere Service Registry and Repository the next time a message passes through the WebSphere Service Registry and Repository node. If the Cache Timeout interval is exceeded for a given artefact it forces the WebSphere Service Registry and Repository node to submit the query directly to the WebSphere Service Registry and Repository, allowing the current artefact to be retrieved, inserted into the cache, and then propagated within the message tree of the LocalEnvironment.

- Cache Notification. Instead of using the timeout value to invalidate artefacts after a given period of time, the broker can be configured to use Cache

Notification. Cache Notification allows the cache to subscribe to events occurring within the WebSphere Service Registry and Repository, for example, when a document or artefact is updated or deleted. When these events are received by the cache, the cache can immediately invalidate, update, or both invalidate and update, the documents and artefacts within the cache, therefore allowing the cache to always contain an up-to-date copy of the artefact or document. Configure this option using the `enableCacheNotification` parameter if you want to be notified every time the WebSphere Service Registry and Repository is updated. Set `enableCacheNotification` to true to tell the broker to subscribe to the `publish/subscribe` topic.

Cache loading strategy

The cache loading strategy determines how and when content from the WebSphere Service Registry and Repository is retrieved and subsequently stored in the cache. The cache loading strategy is set by using the `predefinedCacheQueries` broker property.

Three options for loading can be specified:

- **No Load.** The cache is not used. All queries are sent to the WebSphere Service Registry and Repository for processing and none of the results obtained are cached. This behavior is the default behavior when `needCache` is set to false.
- **Lazy Load.** The cache stores documents from the WebSphere Service Registry and Repository when it is queried for the first time by a client. Thereafter the documents are stored in the cache and returned from the cache when subsequent queries for the same documents occur. The documents are retained in the cache until the documents are no longer valid. This behavior is the default behavior when `needCache` is set to true.
- **Preload.** The cache stores documents from the WebSphere Service Registry and Repository before it is queried by a client. The `predefinedCacheQueries` broker property controls the documents that are preinstalled by specifying the classification, or the set of classifications, to which the documents belong. The documents are retained in the cache until the documents are no longer valid.

To configure the cache loading options, see “Configuring the cache loading options.”

Configuring the cache loading options:

Set the cache loading options for the cache loading strategy for the WebSphere Service Registry and Repository.

The cache loading strategy is set by using the `predefinedCacheQueries` broker property. The cache loading options are:

- No Load
- Lazy Load
- Preload

To configure the cache loading option that you require complete the steps for the option that you require:

- To specify No Load:
 1. Ensure that the broker is running. If it is not, use the `mqsistart` command to start it.
 2. Set the `needCache` configuration parameters for the `DefaultWSRR` of the Service Registries configurable service by using the following command:

```
mqsischangeproperties WBRK_BROKER -c ServiceRegistries
-o DefaultWSRR -n needCache -v false
```

where:

-c specifies the configurable service (in this case, ServiceRegistries)
-o specifies the name of the object (in this case, DefaultWSRR)
-n specifies the names of the properties to be changed
(in this case, needCache)
-v specifies the values of properties defined by the **-n** parameter
(in this case, false)

3. Restart the broker by using the mqsisstop command to stop the broker, followed by the mqsisstart command to start it.

- To specify Lazy Load:

1. Ensure that the broker is running. If it is not, use the mqsisstart command to start it.
2. Ensure that needCache is set to true (the default) in the broker properties. To display the configuration parameters, see “Displaying the configuration parameters for the WebSphere Service Registry and Repository nodes” on page 668.

If needCache is not set to true, set the needCache configuration parameters for the DefaultWSRR of the Service Registries configurable service by using the following command:

```
mqsischangeproperties WBRK_BROKER -c ServiceRegistries
-o DefaultWSRR -n needCache -v true
```

where:

-c specifies the configurable service (in this case, ServiceRegistries)
-o specifies the name of the object (in this case, DefaultWSRR)
-n specifies the names of the properties to be changed
(in this case, needCache)
-v specifies the values of properties defined by the **-n** parameter
(in this case, true)

3. Set the predefinedCacheQueries configuration parameters for the DefaultWSRR of the Service Registries configurable service to be blank by using the following command:

```
mqsischangeproperties WBRK_BROKER -c ServiceRegistries
-o DefaultWSRR -n predefinedCacheQueries -v ""
```

where:

-c specifies the configurable service (in this case, ServiceRegistries)
-o specifies the name of the object (in this case, DefaultWSRR)
-n specifies the names of the properties to be changed
(in this case, predefinedCacheQueries)
-v specifies the values of properties defined by the **-n** parameter
(in this case, "" [two quotation marks])

4. Restart the broker by using the mqsisstop command to stop the broker, followed by the mqsisstart command to start it.

- To specify Preload:

1. Ensure that the broker is running. If it is not, use the mqsisstart command to start it.

2. Ensure that needCache is set to true (the default) in the broker properties. To display the configuration parameters, see "Displaying the configuration parameters for the WebSphere Service Registry and Repository nodes" on page 668.

If needCache is not set to true, set the needCache configuration parameters for the DefaultWSRR of the Service Registries configurable service by using the following command:

```
mqsichangeproperties WBRK_BROKER -c ServiceRegistries
-o DefaultWSRR -n needCache -v true
```

where:

- c specifies the configurable service (in this case, ServiceRegistries)
- o specifies the name of the object (in this case, DefaultWSRR)
- n specifies the names of the properties to be changed (in this case, needCache)
- v specifies the values of properties defined by the -n parameter (in this case, true)

3. To specify the WebSphere Service Registry and Repository entities that are preinstalled, choose the predefinedCacheQueries value that is needed to load the required entities.

```
mqsichangeproperties WBRK_BROKER -c ServiceRegistries -o DefaultWSRR
-n predefinedCacheQueries -v <WSRR details>
```

where:

- c specifies the configurable service (in this case, ServiceRegistries)
- o specifies the name of the object (in this case, DefaultWSRR)
- n specifies the names of the properties to be changed (in this case, predefinedCacheQueries)
- v specifies the values of properties defined by the -n parameter (in this case, <WSRR details>)

For example:

```
mqsichangeproperties WBRK_BROKER -c ServiceRegistries -o DefaultWSRR
-n predefinedCacheQueries
-v "/WSRR/WSDLService/ports[binding/portType [@name='DemoCustomer'
and @namespace='http://demo.sr.eis.ibm.com']]"
```

4. Restart the broker by using the mqsistop command to stop the broker, followed by the mqsistart command to start it.

Setting up Cache Notification

WebSphere Service Registry and Repository publishes notification events by using WebSphere Application Server.

Cache Notification allows the cache to subscribe to events occurring within WebSphere Service Registry and Repository, for example, when a document or artefact is updated or deleted. When these events are received by the cache, the cache can immediately invalidate, update, or both invalidate and update, the documents and artefacts within the cache, therefore allowing the cache to always contain an up-to-date copy of the artefact or document.

Configure this option using the enableCacheNotification parameter if you want to be notified every time the WebSphere Service Registry and Repository is updated. Set enableCacheNotification to true to tell the broker to subscribe to the publish/subscribe topic.

To enable Cache Notification complete the following steps to change the relevant broker properties, and to add a user ID and password if you are connecting to a secure WebSphere Application Server:

1. Ensure that the broker is running. If it is not, use the `mqsistart` command to start it.
2. Issue the `mqsichangeproperties` command to change the `enableCacheNotification` property to true. For example:

```
mqsichangeproperties WBRK_BROKER -c ServiceRegistries -o DefaultWSRR  
-n enableCacheNotification -v true
```

where:

- c specifies the configurable service (in this case, `ServiceRegistries`)
- o specifies the name of the object (in this case, `DefaultWSRR`)
- n specifies the names of the properties to be changed (in this case, `enableCacheNotification`)
- v specifies the values of properties defined by the -n parameter (in this case, `true`)

3. Issue the `mqsichangeproperties` command to change the `locationJNDIBinding` property to the value that you require. For example:

```
mqsichangeproperties WBRK_BROKER -c ServiceRegistries -o DefaultWSRR  
-n locationJNDIBinding -v iiop://localhost.hursley.ibm.com:2809/
```

where:

- c specifies the configurable service (in this case, `ServiceRegistries`)
- o specifies the name of the object (in this case, `DefaultWSRR`)
- n specifies the names of the properties to be changed (in this case, `locationJNDIBinding`)
- v specifies the values of properties defined by the -n parameter (in this case, `iiop://localhost.hursley.ibm.com:2809/`)

4. (Optional) If you are connecting to a secure WebSphere Application Server you must use a user ID and password. To set the user ID and password follow these steps:

- a. Stop the broker by using the `mqsistop` command.
- b. Issue the `mqsisetdbparms` command to set up your user ID and password. For example:

```
mqsisetdbparms WBRK_BROKER -n jms::DefaultWSRR@jms/SRConnectionFactory  
-u <userid> -p <password>
```

where:

- n specifies the name of the data source (in this case, `jms::DefaultWSRR@jms/SRConnectionFactory`)
- u specifies the user ID to be associated with this data source (in this case, `<userid>`)
- p specifies the password to be associated with this data source (in this case, `<password>`)

- c. Restart the broker by using the `mqsistop` command to stop the broker, followed by the `mqsistart` command to start it.

The LocalEnvironment

The LocalEnvironment is used for passing messages into the WebSphere Service Registry and Repository nodes and it is also updated by the WebSphere Service Registry and Repository nodes. The WebSphere Service Registry and Repository nodes do not change the body of the message, but the LocalEnvironment is updated to reflect the search results.

The LocalEnvironment is used within the WebSphere Service Registry and Repository nodes for overriding the properties and search criteria that is defined on the nodes themselves. You can, therefore, dynamically update or change the search criteria that is used by the WebSphere Service Registry and Repository nodes to query the WebSphere Service Registry and Repository.

The LocalEnvironment is also updated when the message tree is propagated from of one of the output terminals of the WebSphere Service Registry and Repository nodes where the required artefacts or endpoint references (depending upon the node being used) are placed within the LocalEnvironment of the message tree.

The following topics tell you more about using the LocalEnvironment with the WebSphere Service Registry and Repository:

- “Dynamically defining the search criteria”
- “EndpointLookup node” on page 881
- “EndpointLookup node output” on page 678
- “RegistryLookup node” on page 1048
- “RegistryLookup node output” on page 680

Dynamically defining the search criteria

You can use the RegistryLookup and EndpointLookup nodes to accept queries specified within the LocalEnvironment. The LocalEnvironment overrides the search criteria properties set on the preceding WebSphere Service Registry and Repository node.

Use the EndpointLookup node to define a query dynamically within the message. Both the EndpointLookup and the RegistryLookup nodes can accept a query specified within the LocalEnvironment. All of the values within the LocalEnvironment are treated as strings.

Unlike the User Properties defined on the EndpointLookup and RegistryLookup nodes, XPath and ESQL expressions are not supported when overriding the properties from the LocalEnvironment.

If you use the LocalEnvironment to override the properties set in the preceding node, you can define the properties at runtime, or while a message is being processed, rather than defining them at development time. If you set the properties using the LocalEnvironment the properties and search criteria defined on the node are overridden. You must set at least one of the properties on the preceding node for either the Name, Namespace, or Version property, otherwise the flow cannot be deployed.

You can define the following properties in the LocalEnvironment:

```
LocalEnvironment.ServiceRegistryLookupProperties.Name  
LocalEnvironment.ServiceRegistryLookupProperties.Namespace  
LocalEnvironment.ServiceRegistryLookupProperties.Version
```

```

LocalEnvironment.ServiceRegistryLookupProperties.Template
LocalEnvironment.ServiceRegistryLookupProperties.MatchPolicy
LocalEnvironment.ServiceRegistryLookupProperties.UserProperties.
  <Property Name>
LocalEnvironment.ServiceRegistryLookupProperties.Classification.
  <Classification name>

```

The following code is an alternative representation of the properties of the LocalEnvironment:

```

|
| LocalEnvironment
|   ServiceRegistryLookupProperties = (
|     Name = 'xyz'
|     Namespace = 'xyz'
|     Version = 'xyz'
|     Template = 'xyz' [Only valid for the RegistryLookup node,
| this property will be ignored by the
| EndpointLookup node]
|     MatchPolicy = "One" or "All"
|     UserProperties = (
|       <Property Name>= 'xyz' [repeat as many time as required]
|     Classification = 'xyz' [repeat as many time as required]
|   ))

```

The following code is an example of how to use the User Properties and Classification properties:

```

|
| LocalEnvironment
|   ServiceRegistryLookupProperties = (
|     Name = 'DemoCustomer'
|     Namespace = 'http://mb.sr.eis.ibm.com'
|     Version = '1.0'
|     UserProperties = (
|       WSRREncoding= 'DEFAULT'
|     Classification =
| 'http://localhost:9081/DemoCustomerWeb/services/DemoCustomer2'
|   ))

```

Repeating values of the User Properties property are appended to the current User Properties value defined in the RegistryLookup or EndpointLookup node unless the value is NULL, in which case the User Properties value is removed. For the Classification property, repeating values are always appended; you cannot remove a value that is set in the WebSphere Service Registry and Repository node properties.

The LocalEnvironment tree structure is independent of the node you are using. However, LocalEnvironment.ServiceRegistryLookupProperties.Template is supported on the RegistryLookup node only.

EndpointLookup node output

Use an EndpointLookup node to set the endpoint address when the destination is either a SOAPRequest, SOAPAsyncRequest, or HTTPRequest node. When you use the EndpointLookup node, the endpoint reference and the associated metadata matching the required search criteria is stored within the LocalEnvironment.

The actual message is not changed by the EndpointLookup node, although the LocalEnvironment is updated to reflect the search results.

EndpointLookup node output if the Match Policy property is set to One

If the Match Policy property of the node is set to One then the node also inserts the endpoint reference into

LocalEnvironment.Destination.SOAP.Request.Transport.HTTP.WebServiceURL and LocalEnvironment.Destination.HTTP.RequestURL. These settings override the Web service URL property of the SOAPRequest, SOAPAsyncRequest, and HTTPRequest nodes allowing a dynamic call to a Web service provider. The LocalEnvironment tree is populated with output that is compatible with the SOAPRequest, SOAPAsyncRequest, or HTTPRequest nodes at the same time. Therefore, no configuration is required on the EndpointLookup node to propagate to a SOAPRequest, SOAPAsyncRequest, or HTTPRequest node.

The LocalEnvironment.Destination.SOAP and LocalEnvironment.Destination.HTTP properties are used to override the properties of the SOAPRequest, SOAPAsyncRequest, and HTTPRequest nodes, which allows the EndpointLookup node, when Match Policy is set to One, to be followed immediately by a SOAPRequest, SOAPAsyncRequest, or HTTPRequest node. The properties of this request node are set at runtime. See “Populating Destination in the LocalEnvironment tree” on page 311.

The following example shows typical output from the EndpointLookup node when the Match Policy is set to One.

```
<LocalEnvironment>
  <Destination>
    <SOAP>
      <Request>
        <Transport>
          <HTTP>
            <WebServiceURL>http://localhost:9081/DemoCustomerWeb/
services/DemoCustomer</WebServiceURL>
          </HTTP>
        </Transport>
      </Request>
    </SOAP>
    <HTTP>
      <RequestURL>http://localhost:9081/DemoCustomerWeb/
services/DemoCustomer
      </RequestURL>
    </HTTP>
  </Destination>
  <ServiceRegistry>
    <ITService>
      <Endpoint>
        <Address>http://localhost:9081/DemoCustomerWeb/
services/DemoCustomer</Address>
        <PortType>
          <name>DemoCustomer</name>
          <namespace>http://demo.sr.eis.ibm.com</namespace>
          <version>1.0</version>
        </PortType>
        <Property>
          <name>policy</name>
          <value>RM</value>
        </Property>
        <Property>
          <name>country</name>
          <value>China</value>
        </Property>
        <Classification>http://eis.ibm.com/ServiceRegistry/
GenericObjecttypes#Routing</Classification>
      </Endpoint>
    </ITService>
  </ServiceRegistry></LocalEnvironment>
```

EndpointLookup node output if the Match Policy property is set to All

The following example shows typical output from the EndpointLookup node when the Match Policy is set to All. (Other entries might exist in the LocalEnvironment depending on previous processing within the flow.)

```
<LocalEnvironment>
  <ServiceRegistry>
    <ITService>
      <Endpoint>
        <Address>http://localhost:9081/DemoCustomerWeb/
services/DemoCustomer</Address>
        <PortType>
          <name>DemoCustomer</name>
          <namespace>http://demo.sr.eis.ibm.com</namespace>
          <version>1.0</version>
        </PortType>
        <Property>
          <name>policy</name>
          <value>RM</value>
        </Property>
        <Property>
          <name>country</name>
          <value>China</value>
        </Property>
        <Classification>http://eis.ibm.com/ServiceRegistry/
GenericObjecttypes#Routing</Classification>
      </Endpoint>
    </ITService>
    <ITService>
      <Endpoint>
        <Address>http://localhost:9081/DemoCustomerWeb/
services/DemoCustomer2</Address>
        <PortType>
          <name>DemoCustomer2</name></PortType></Endpoint></ITService>
  </ServiceRegistry></LocalEnvironment>
```

RegistryLookup node output

Use the RegistryLookup node to retrieve any type of entity stored within the WebSphere Service Registry and Repository. When you use this node, the entire entity matching the required search criteria is stored within the LocalEnvironment.

The actual message is not changed by the RegistryLookup node, although, the LocalEnvironment is updated to reflect the search results.

When the Match Policy property value is set to One you get one arbitrary result, which might not be the most up-to-date result. You must, therefore, set the Match Policy property value to All.

The following example shows typical output from the RegistryLookup node when the Match Policy property value is set to All.

```
<LocalEnvironment>
  <ServiceRegistry>
    <Entity>
      <type><sdo:PolicyDocument>
      <bsrURI>db281cdb-e3d3-431b.bc68.1880de18688d</bsrURI>
      <name>RMAssertionPolicy</name>
      <namespace>http://mb.sr.eis.ibm.com</namespace>
      <version>1.0.0</version>
      <owner>UNAUTHENTICATED</owner>
      <lastModified>1186669896155</lastModified>
      <creationTimestamp>1182369015417</creationTimestamp>
      <lastModifiedBy>UNAUTHENTICATED</lastModifiedBy>
      <content><wsp:Policy wsp:Id=&quot;RMAssertion&quot;
TargetNamespace=&quot;http://mb.sr.eis.ibm.com&quot;&gt;&lt;/content>
      <location>RMAssertion.xml</location>
```



```

    <classificationURIs>http://www.ibm.com/xmlns/prod/serviceregistry/6/0/
governance/DefaultLifecycle#InitialState</classificationURIs>
    <userDefinedProperties>
      <name>grade</name>
      <value>Gold</value>
    </userDefinedProperties>
    <userDefinedProperties>
      <name>WSRRencoding</name>
      <value>DEFAULT</value>
    </userDefinedProperties>
  </sdo:PolicyDocument></type></Entity>
<Entity>
  <type><sdo:PolicyDocument2>
    <bsrURI>db281cdb-e3d3-431b.bc68.1880de18688e</bsrURI>
    <name>RMAssertionPolicy2</name></sdo:PolicyDocument2></type></Entity></
ServiceRegistry></LocalEnvironment>

```

External standards

WebSphere Message Broker support for Web services conforms to a number of industry standards and specifications.

This section contains the topics that describe the WebSphere Message Broker support for web services.

- “SOAP 1.1 and 1.2”
- “SOAP with Attachments” on page 682
- “SOAP MTOM” on page 682
- “WSDL Version 1.1” on page 683
- “WS-I Simple SOAP Binding Profile Version 1.0” on page 683
- “WS-I Basic Profile Version 1.1” on page 683
- “WSDL 1.1 Binding Extension for SOAP 1.2” on page 684
- “XML-Binary Optimised Packaging (XOP)” on page 684
- “SOAP Binding for MTOM 1.0” on page 685
- “Web Services Security: SOAP Message Security” on page 685
- “XML Encryption Syntax and Processing” on page 685
- “XML-Signature Syntax and Processing” on page 686
- “WebSphere Message Broker compliance with Web services standards” on page 686

SOAP 1.1 and 1.2

SOAP is a lightweight, XML-based, protocol for exchange of information in a decentralized, distributed environment.

The protocol consists of three parts:

- An envelope that defines a framework for describing what is in a message and how to process it.
- A set of encoding rules for expressing instances of application-defined data types.
- A convention for representing remote procedure calls and responses.

SOAP can be used with other protocols, such as HTTP.

The specifications for SOAP are published by the World Wide Web Consortium (W3C).

- World Wide Web Consortium (W3C)

The specification for SOAP 1.1 is described in:

- Simple Object Access Protocol 1.1

This specification has not been endorsed by the W3C, but forms the basis for the SOAP 1.2 specification. The specification for SOAP 1.1 expands the SOAP acronym to Simple Object Access Protocol.

SOAP 1.2 is a W3C recommendation and is published in two parts:

- Part 1: Messaging Framework.
- Part 2: Adjuncts.

The specification also includes a primer that is intended to provide a tutorial on the features of the SOAP Version 1.2 specification, including usage scenarios. The specification for SOAP 1.2 does not expand the acronym. The primer is published at:

- SOAP 1.2 Primer

SOAP with Attachments

SOAP with Attachments (SwA) allows you to use SOAP 1.1 or SOAP 1.2 messages wrapped by MIME.

The SOAP with Attachments (SwA) specification is published as a formal submission by the World Wide Web Consortium (W3C):

- World Wide Web Consortium (W3C)

SwA uses the following specifications, described at:

- <http://www.w3.org/TR/2000/NOTE-SOAP-attachments-20001211>
- <http://www.ws-i.org/Profiles/AttachmentsProfile-1.0.html>

SOAP MTOM

SOAP Message Transmission Optimization Mechanism (MTOM) is one of a related pair of specifications that define conceptually how to optimize the transmission and format of a SOAP message.

MTOM defines:

- How to optimize the transmission of base64binary data in SOAP messages in abstract terms
- How to implement optimized MIME multipart serialization of SOAP messages in a binding independent way using XOP

The implementation of MTOM relies on the related XML-binary Optimized Packaging (XOP) specification. Because these two specifications are so closely linked, they are normally referred to as MTOM/XOP.

The specification is published by the World Wide Web Consortium (W3C) as a W3C Recommendation at SOAP Message Transmission Optimization Mechanism. For further information refer to the following links:

- World Wide web Consortium (W3C)
- SOAP Message Transmission Optimization Mechanism

WSDL Version 1.1

Web Services Description Language (WSDL) is an XML format for describing network services as a set of endpoints operating on messages containing either document-oriented or procedure-oriented information.

The operations and messages are described abstractly, and then bound to a concrete network protocol and message format to define an endpoint. Related concrete end points are combined into abstract endpoints (services).

WSDL is extensible to allow the description of endpoints and their messages regardless of what message formats or network protocols are used to communicate. The WSDL 1.1 specification only defines bindings that describe how to use WSDL in conjunction with:

- SOAP 1.1
- HTTP GET
- HTTP POST
- MIME

The specification for WSDL 1.1 is published by the World Wide Web Consortium (W3C) as a W3C Note at WSDL Version 1.1.

- World Wide Web Consortium (W3C)
- WSDL Version 1.1

WS-I Simple SOAP Binding Profile Version 1.0

WS-I Simple SOAP Binding Profile Version 1.0 (SSBP 1.0) is a set of non-proprietary Web services specifications, along with clarifications and amendments to those specifications which promote interoperability.

The SSBP 1.0 is derived from the WS-I Basic Profile 1.0 requirements that relate to the serialization of the envelope and its representation in the message.

WS-I Basic Profile 1.0 is split into two separately published profiles. These profiles are:

- WS-I Basic Profile Version 1.1
- WS-I Simple SOAP Binding Profile Version 1.0

Together these two profiles supersede the WS-I Basic Profile Version 1.0.

The specification for SSBP 1.0 is published by the Web Services Interoperability Organization (WS-I):

- Web Services Interoperability Organization (WS-I)

The specification for SSBP 1.0 can be found at:

- WS-I Simple SOAP Binding Profile Version 1.0

WS-I Basic Profile Version 1.1

WS-I Basic Profile Version 1.1 (WS-I BP 1.1) is a set of non-proprietary Web services specifications, along with clarifications and amendments to those specifications, which together promote interoperability between different implementations of Web services.

The WS-I BP 1.1 is derived from Basic Profile Version 1.0 by incorporating its published errata and separating out the requirements that relate to the serialization of envelopes and their representation in messages. These requirements are now part of the Simple SOAP Binding Profile Version 1.0.

To summarize, the WS-I Basic Profile Version 1.0 is split into two separately published profiles. These profiles are:

- WS-I Basic Profile Version 1.1
- WS-I Simple SOAP Binding Profile Version 1.0

Together these two profiles supersede the WS-I Basic Profile Version 1.0.

The reason for this separation is to enable the Basic Profile 1.1 to be composed with any profile that specifies envelope serialization, including the Simple SOAP Binding Profile 1.0.

The specification for WS-I BP 1.1 is published by the Web Services Interoperability Organization (WS-I):

- Web Services Interoperability Organization (WS-I)

The specification for WS-I BP 1.1 can be found at:

- WS-I Basic Profile Version 1.1

WSDL 1.1 Binding Extension for SOAP 1.2

WSDL 1.1 Binding Extension for SOAP 1.2 is a specification that defines the binding extensions that are required to indicate that Web service messages are bound to the SOAP 1.2 protocol.

The aim of this specification is to provide functionality that is comparable with the binding for SOAP 1.1.

This specification is published as a formal submission request by the World Wide Web Consortium (W3C):

- World Wide Web Consortium (W3C)

The WSDL 1.1 Binding Extension for SOAP 1.2 specification is described at:

- <http://www.w3.org/Submission/wsdl11soap12/>

XML-Binary Optimised Packaging (XOP)

XML-binary Optimized Packaging (XOP) is one of a related pair of specifications that define how to efficiently serialize XML Infosets that have certain types of content.

XOP defines how to efficiently serialize XML Infosets that have certain types of content by:

- Packaging the XML in some format. This is called the XOP package. The specification mentions MIME Multipart/Related but does not limit it to this format.
- Re-encoding all or part of base64binary content to reduce its size.
- Placing the base64binary content elsewhere in the package and replacing the encoded content with XML that references it.

XOP is used as an implementation of the MTOM specification, which defines the optimization of SOAP messages. Because these two specifications are so closely linked, they are normally referred to as MTOM/XOP.

The specification is published by the World Wide Web Consortium (W3C) as a W3C Recommendation XML-binary Optimized Packaging (XOP):

- World Wide Web Consortium (W3C)
- XML-binary Optimized Packaging (XOP)

SOAP Binding for MTOM 1.0

SOAP 1.1 Binding for MTOM 1.0 is a specification that describes how to use the SOAP Message Transmission Optimization Mechanism (MTOM) and XML-binary Optimized Packaging (XOP) specifications with SOAP 1.1.

This specification defines the minimum changes required to enable MTOM and XOP to be used interoperably with SOAP 1.1 and to reuse the SOAP 1.2 MTOM/XOP implementation.

The SOAP 1.1 Binding for MTOM 1.0 specification is published as a formal submission by the World Wide Web Consortium (W3C):

- World Wide Web Consortium (W3C)

The SOAP 1.1 Binding for MTOM 1.0 specification is described at:

- <http://www.w3.org/Submission/soap11mtom10/>

Web Services Security: SOAP Message Security

Web Services Security (WSS): SOAP Message Security is a set of enhancements to SOAP messaging that provides message integrity and confidentiality. WSS: SOAP Message Security is extensible, and can accommodate a variety of security models and encryption technologies.

WSS: SOAP Message Security provides three main mechanisms that can be used independently or together:

- The ability to send security tokens as part of a message, and for associating the security tokens with message content
- The ability to protect the contents of a message from unauthorized and undetected modification (message integrity)
- The ability to protect the contents of a message from unauthorized disclosure (message confidentiality).

WSS: SOAP Message Security can be used in conjunction with other Web service extensions and application-specific protocols to satisfy a variety of security requirements.

The specification is published by the Organization for the Advancement of Structures Standards (OASIS). The specification is called Web Services Security: SOAP Message Security 1.0 (WS-Security 2004).

- Organization for the Advancement of Structured Information Standards (OASIS)
- Web Services Security: SOAP Message Security 1.0 (WS-Security 2004)

XML Encryption Syntax and Processing

XML Encryption Syntax and Processing specifies a process for encrypting data and representing the result in XML. The data can be arbitrary data (including an XML

document), an XML element, or XML element content. The result of encrypting data is an XML Encryption element that contains or references the cipher data.

XML Encryption Syntax and Processing is a recommendation of the World Wide Web Consortium (W3C):

- World Wide Web Consortium (W3C)

The XML Encryption Syntax and Processing recommendation is published at:

- XML Encryption Syntax and Processing

XML-Signature Syntax and Processing

XML-Signature Syntax and Processing specifies the processing rules and syntax for XML digital signatures.

XML digital signatures provide integrity, message authentication, and signer authentication services for data of any type, whether located within the XML that includes the signature or elsewhere.

The recommendation for XML-Signature Syntax and Processing is published by the World Wide Web Consortium (W3C):

- World Wide Web Consortium (W3C)

The XML-Signature Syntax and Processing recommendation is published at:

- XML-Signature Syntax and Processing

WebSphere Message Broker compliance with Web services standards

WebSphere Message Broker complies with the supported Web services standards and specifications, in that you can generate and deploy Web services that are compliant.

However, WebSphere Message Broker does not enforce this compliancy. For example, in the case of support for the WS-I Basic Profile 1.1 specification, you can apply additional qualities of service to your Web service that might break the interoperability outlined in this Profile.

The topics in this section describe how WebSphere Message Broker complies with Web services standards.

- “How WebSphere Message Broker complies with Web Service Security specifications”

How WebSphere Message Broker complies with Web Service Security specifications

WebSphere Message Broker conditionally complies with Web Services Security: SOAP Message Security and related specifications by supporting the following aspects.

Compliance with Web Services Security: SOAP Message Security

Security header

The <wsse:Security> header provides a mechanism, in the form of a SOAP actor or role, for attaching security-related information that is targeted at a specific recipient. The recipient can be the ultimate recipient of the message or an intermediary. The following attributes are supported in WebSphere Message Broker:

- S11:actor (for an intermediary)
- S11:mustUnderstand
- S12:role (for an intermediary)
- S12:mustUnderstand

Security tokens

The following security tokens are supported in the security header:

- User name and password
- Binary security token (X.509 certificate)

Token references

A security token conveys a set of claims. Sometimes these claims reside elsewhere and need to be accessed by the receiving application. The <wsse:SecurityTokenReference> element provides an extensible mechanism for referencing security tokens. The following mechanisms are supported:

- Direct reference
- Key identifier
- Key name
- Embedded reference

Signature algorithms

This specification builds on XML Signature and therefore has the same algorithm requirements as those specified in the XML Signature specification. WebSphere Message Broker supports the signature algorithms as shown in the following table:

Algorithm type	Algorithm	URI
Digest	SHA1	http://www.w3.org/2000/09/xmlsig#sha1
Signature	DSA with SHA1 (validation only)	http://www.w3.org/2000/09/xmlsig#dsa-sha1
Signature	RSA with SHA1	http://www.w3.org/2000/09/xmlsig#rsa-sha1
Canonicalization	Exclusive XML canonicalization (without comments)	http://www.w3.org/2001/10/xml-exc-c14n#

Signature signed parts

WebSphere Message Broker allows the following SOAP elements to be signed:

- The SOAP message body
- The identity token (a type of security token) that is used as an asserted identity

Encryption algorithms

The data encryption algorithms that are supported are shown in the following table:

Algorithm	URI
Triple Data Encryption Standard algorithm (Triple DES)	http://www.w3.org/2001/04/xmlenc#tripledes-cbc
Advanced Encryption Standard (AES) algorithm with a key length of 128 bits	http://www.w3.org/2001/04/xmlenc#aes128-cbc

Algorithm	URI
Advanced Encryption Standard (AES) algorithm with a key length of 192 bits	http://www.w3.org/2001/04/xmlenc#aes192-cbc
Advanced Encryption Standard (AES) algorithm with a key length of 256 bits	http://www.w3.org/2001/04/xmlenc#aes256-cbc

The key encryption algorithm that is supported is shown in the following table:

Algorithm	URI
Key transport (public key cryptography) RSA Version 1.5	http://www.w3.org/2001/04/xmlenc#rsa-1_5

Encryption message parts

WebSphere Message Broker allow the following SOAP elements to be encrypted:

- The SOAP body

Timestamp

The <wsu:Timestamp> element provides a mechanism for expressing the creation and expiration times of the security semantics in a message. WebSphere Message Broker tolerates the use of timestamps within the Web services security header on inbound SOAP messages.

Error handling

WebSphere Message Broker generates SOAP fault messages using the standard list of response codes listed in the specification.

Compliance with Web Services Security: UsernameToken Profile 1.0

The following aspects of this specification are supported:

Password types

Text

Token references

Direct reference

Compliance with Web Services Security: X.509 Certificate Token Profile 1.0

The following aspects of this specification are supported:

Token types

- X.509 Version 3: Single certificate.
- X.509 Version 3: X509PKIPathv1 without certificate revocation lists (CRL).
- X.509 Version 3: PKCS7 with or without CRLs. The IBM software development kit (SDK) supports both. The Sun Java Development Kit (JDK) supports PKCS7 without CRL only.

For more information refer to:<http://docs.oasis-open.org/wss/2004/01/oasis-200401-wss-x509-token-profile-1.0.pdf>

Token references

- Key identifier - subject key identifier

- Direct reference
- Custom reference - issuer name and serial number

Aspects that are not supported

The following items are not supported in WebSphere Message Broker:

- Validation of Timestamps for freshness.
- Nonces.
- Web services security for SOAP attachments.
- Security Assertion Markup Language (SAML) token profile, WS-SecurityKerberos token profile, and XrML token profile.
- Web Services Interoperability (WS-I) Basic Security Profile.
- XML enveloping digital signature.
- XML enveloping digital encryption.
- The following transport algorithms for digital signatures:
 - XSLT: <http://www.w3.org/TR/1999/REC-xslt-19991116>.
 - SOAP Message Normalization. For more information, refer to <http://www.w3.org/TR/2003/NOTE-soap12-n11n-20031008>.
- The Diffie-Hellman key agreement algorithm for encryption. For more information, refer to <http://www.w3.org/TR/2002/REC-xmlenc-core-20021210/Overview.html#sec-DHKeyValue>.
- The following canonicalization algorithm for encryption, which is optional in the XML encryption specification:
 - Canonical XML with or without comments
 - Exclusive XML canonicalization with or without comments
- The digest password type in the Username Token Version 1.0 Profile specification.

Message flows for Web services

Message flows that need to work with Web services can use either the SOAP domain or one of the XML domains.

The following topics describe both types of flow.

- “SOAP domain message flows”
- “XML domain message flows” on page 696

The following topic describes fundamental scenarios. Any use of WS-Addressing or WS-Security requires use of the SOAP domain, but otherwise these scenarios apply to both types of message flow.

- “Web services scenarios” on page 700

SOAP domain message flows

SOAP domain message flows use SOAP nodes, WSDL, and a common logical tree format which is independent of the exact format of the Web service message.

The following nodes are provided for use in the SOAP domain:

- “SOAPInput node” on page 1104
- “SOAPReply node” on page 1114
- “SOAPRequest node” on page 1116

- “SOAPAsyncRequest node” on page 1082
- “SOAPAsyncResponse node” on page 1092

The following nodes can also be used to simplify SOAP payload processing within a message flow; these nodes are not specific to the SOAP domain.

- “SOAPEnvelope node” on page 1096
- “SOAPExtract node” on page 1099

The SOAP nodes are used together in the following basic patterns:

- As a Web service provider, for example:

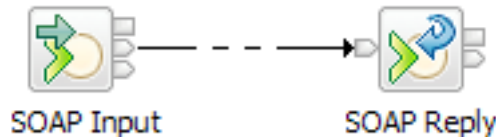

- As a Web service consumer, for example:

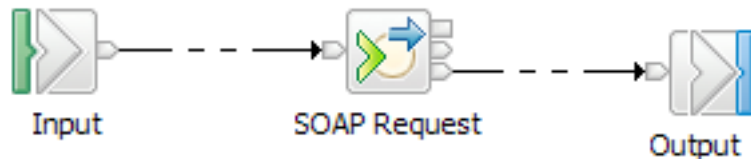

Or:

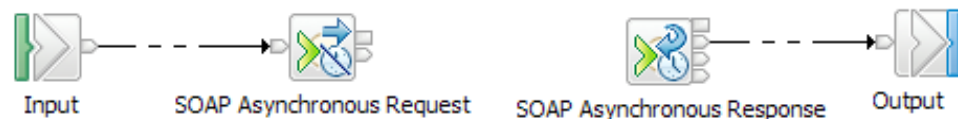

- As a Web service facade, for example, by combining the provider and consumer scenarios:

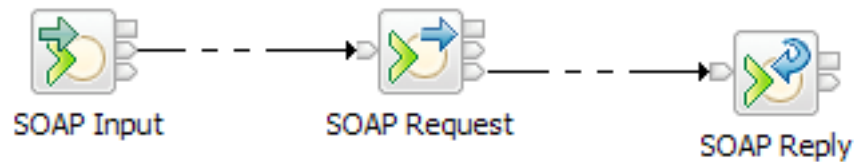

You can use the SOAPExtract and SOAPEnvelope nodes in conjunction with these patterns to respectively extract the SOAP payload and rebuild a SOAP envelope.

The main SOAP domain nodes are configured by WSDL, and a prerequisite for a SOAP domain message flow is a message set containing deployable WSDL. To create a message set containing deployable WSDL, either import existing WSDL or generate WSDL from an existing message set. For more information about creating a new message definition from WSDL, see Importing from WSDL. For more information about generating WSDL from an existing message set, see WSDL generation.

Alternatively you can create a new message set and skeleton message flow in one step using the procedure described in “Creating an application based on WSDL or XSD files” on page 132.

The WSDL then appears in the workbench under **Deployable WSDL** below the message set, although if you have selected Hide Categories on the message set, the category heading itself is not shown.

Deployable WSDL can then be used to configure SOAP nodes. You can do this by dragging the WSDL resource onto the node or by selecting the required WSDL resource from the node properties.

Alternatively a new skeleton message flow can be created by dragging and dropping the WSDL on to a blank message flow editor canvas.

The WSDL is deployed with your completed message flow, enabling the broker to raise exceptions if a Web service message does not correspond to the specified WSDL description.

The SOAP domain uses a common logical tree format which is independent of the exact format of the Web service message. For details of the SOAP tree format, see "SOAP tree overview" on page 80. Useful WSDL information is included in the logical tree under SOAP.Context.

Example usage of WS-Addressing

This topic lists the steps you need to set up a sample message flow using WS-Addressing with WebSphere Message Broker and how you test the flow.

The following set of topics takes you through the process of setting up:

1. A main message flow that includes various SOAP nodes, together with a:

- Filter node and
- Mapping node

See "Building the main message flow"

2. A logging message flow, so that you can send a reply to an address other than the originating client; see "Building the logger message flow" on page 693.

3. How you deploy the message flows; see "Deploying the message flows" on page 694.

4. How you test the message flows, using a tool that uses HTTP. This illustrates that the contents of the SOAP message determine where the replies are routed; see "Testing the message flows" on page 695.

Building the main message flow:

You can construct a sample main message flow to use with WS-Addressing.

These steps are the first in a set of instructions on setting up your system to use WS-Addressing with WebSphere Message Broker; they explain how to set up a message flow to use this feature. This task topic describes the construction of a sample main message flow when using WS-Addressing

1. Switch to the Broker Application Development perspective.
2. Create message flow and message set projects using the Start from WSDL and/or XSD files wizard. See "Creating an application based on WSDL or XSD files" on page 132 for instructions.
3. Select the WSDL file that you need under **Deployable WSDL** from the Active Working Set:
 - a. Drag the mouse pointer to the message flow editor.

- b. Release the left mouse button. The Configure New Web Service Usage wizard starts.
 - c. See “Creating an application using the Configure New Web Service Usage wizard” on page 135 for further information. Ensure that you select:
 - **Expose message flow as web service** on page one of the wizard.
 - **SOAP nodes** on page two of the wizard.
 When you select **Finish** a skeleton message flow is generated, consisting of a:
 - SOAPInput node that is pre-configured for the web service
 - SOAPExtract node to remove the SOAP envelope from the incoming message
 - SOAPReply node
4. Select the **Construction** folder on the message flow palette to display the contents.
 5. Select a Trace node and move the mouse to the right of the SOAPExtract node.
 - a. Click the left mouse button to add the node to the message flow. The name is selected automatically.
 - b. Press **Enter** to accept the default name.
 - c. Wire the submitPORequest terminal of the SOAPExtract node to the In terminal of the Trace node.
 6. Select the Trace node to display the properties.
 - a. Use the menu to set **Destination** to File
 - b. Set the **File path** that you require.
 - c. Enter the **Pattern** ythat ou require.
 7. Expand the **Routing** folder on the palette and select **Filter**.
 8. Add the Filter node to the right of the Trace node
 - a. Type the name for the node that you require and press **Enter**.
 - b. Wire the Out terminal of the Trace node to the In terminal of the Filter node.
 9. Select the Filter node to display the properties.
 - a. Enter the **Data source** name that you require.
 - b. Change the name of **Filter expression** to the name you selected for the Filter node.
 - c. Clear the **Throw exception on database error** check box.
 10. Double-click the Filter node to open the ESQL editor. Create or change the ESQL for the node; for more information, see “Creating ESQL for a node” on page 271 and “Modifying ESQL for a node” on page 273.
 11. Expand the **Transformation** folder on the palette and select a Mapping node.
 12. Add the Mapping node to the right of the Filter node
 - a. Type the name for the node that you require and press **Enter**.
 - b. Wire the True terminal of the Filter node to the In terminal of the Mapping node.
 - c. Wire the Out terminal of the Mapping node to the In terminal of the Reply node.
 13. Select the Mapping node to display the properties.
 - a. Change the name of **Mapping routine** to the name that you selected for the Mapping node.

14. Double-click the Mapping node to open the mapping editor.
 - a. Select **submitPORequest** as the map source.
 - b. Select **SOAP_Domain_msg** as the map target.
 - c. Click **OK**
 - d. Click **OK** on the tip that displays to open the mapping editor.

See “Creating a message map file from a Mapping node” on page 477 for further information.
15. Select **Properties** in both the **source** and **target** pane, right-click, and click **Map by Name**.
 - a. Map the source properties to the target properties using drag-and-drop mapping. The Map by Name dialog box appears.
 - b. Select **OK** to perform the mapping.
16. Expand **SOAP_Domain_Msg**, then **Body** and **message items** in the target pane.
17. Right-click **Wildcard Message** in the target pane, and click **Create new Submap**.
 - a. Expand **Wildcard**.
 - b. Scroll down and click **submitPOResponse**.
 - c. Click **OK** to create the submap.
18. Use drag-and-drop mapping to select the items that you need in the **Source** pane.
19. Select the first item that you need in the **Target** pane, right-click, and **Enter Expression**.
 - a. Enter the value that you require in the expression editor and press **Enter** to complete the mapping.

Repeat the above steps for all the items that you require in the **Target** pane, and save the submap and map by pressing **Ctrl+S**.
20. Expand the **Construction** folder on the message flow editor and select a **Throw** node.
21. Add the **Throw** node above the **Mapping** node
 - a. Type the name for the node that you require and press **Enter**.
 - b. Wire the **False** and **Unknown** terminals of the **Filter** node to the **In** terminal of the **Throw** node.
22. Select the **Throw** node and in the **Node Properties** pane enter the text that you require in **Message text**.
23. Select the **SOAPInput** node to display the **Node Properties**.
 - a. Select the **WS Extensions** tab.
 - b. Select **Use WS-Addressing** .
24. Save the message flow.

Building the logger message flow:

This is the second one of a set of instructions on setting up your system to use WS-Addressing with WebSphere Message Broker and illustrates the use of a reply being sent to an address other than the originating client.

This topic describes the construction of a sample logger message flow when using WS-Addressing This flow echoes back the input while creating a trace entry in a file to indicate that the flow has been invoked.

1. Switch to the Broker Application Development perspective.
2. Select the message flow name that you used in “Building the main message flow” on page 691
3. Press the right mouse button and select **New->MessageFlow** from the pop up menu.
 - a. Enter the name you require for this message flow, for example, Logger.
 - b. Press **Finish** to create the flow.
4. Select the **HTTP** folder on the message flow palette to display the contents.
5. Select an **HTTPInput** node and move the mouse to the left side of the canvas.
 - a. Click the left mouse button to add the node to the message flow and enter the name Logger.
 - b. Press the **Enter** key to finish.
6. Select the **HTTPReply** node from the palette and move the mouse to the right of the HTTPInput node, leaving room for a node in between.
 - a. Click the left mouse button to add the node to the message flow and enter the name you require, for example,Logger.
 - b. Press the **Enter** key to finish.
7. Select the **Construction** folder on the message flow palette to display the contents.
8. Select a **Trace** node and move the mouse to the right of the HTTPINput node.
 - a. Click the left mouse button to add the node to the message flow and enter the name you require, for example Trace.
 - b. Press the **Enter** key.
 - c. Wire the out terminal of the HTTPInput node to the In terminal of the Trace node.
 - d. Wire the out terminal of the Trace node to the In terminal of the HTTPReply node.
9. Select the HTTPInput node to display the properties. In the **Basic** tab:
 - a. Enter the **Data source** name you require.
 - b. Change the name of the input node Logger as the **Path suffix for URL**.
10. Select the **Input Message Parsing** tab.
 - a. Select XMLNSC in the **Message domain** drop down.
11. Select the Trace node to display the properties.
 - a. Use the drop down menu to set **Destination** to File
 - b. Set the **File path** you require.
 - c. Enter the **Pattern** you require.
12. Save the message flow.

Deploying the message flows:

This is the third of a set of instructions on setting up your system to use WS-Addressing with WebSphere Message Broker and illustrates the deployment of the message flows.

This task topic describes the deployment of the message flows you have already constructed

1. Switch to the Broker Administration perspective.
2. Select the **LocalProject** project under **Broker Archives** in the navigator pane.
 - a. Press the right mouse button.

- b. Select **New->message Broker Archive**.
 - c. Use the drop down menu to change the **Project** to LocalProject.
 - d. Enter the name you selected for the main message flow described in “Building the main message flow” on page 691 in **Name**.
 - e. Press the **Finish** button to open the Broker Archive Editor.
3. In the Broker Archive Editor:
 - a. In the **Filter working set** list box select the working set with the name you used for the main message flow.
 - b. In **Message Flows** select the message flow names you used for the main message flow and logger message flow.
 - c. In **Message Sets** select the message set name you used for the main message set.
 - d. Press the **Build broker archive** button and confirm that the build operation was successful.
 - e. Save the updated broker archive.
 4. To deploy the message flows to the default execution groups:
 - a. Select the name of the broker archive file with the name of the message flow you used for the main message flow.
 - b. Press the right mouse button.
 - c. Select **Deploy File** from the menu.
 5. Select the **default** execution group and press **OK** to start the deployment.
 - a. Ensure that you receive a successful response message and press **OK** to dismiss the information dialog.
 6. Use the event log to confirm that the deploy operation was successful:
 - a. Double click the **Event Log** entry on the **Domains** tab to open the Event log editor.
 - b. Confirm that the deployment was successful.

Testing the message flows:

This is the fourth of a set of instructions on setting up your system to use WS-Addressing with WebSphere Message Broker and illustrates the testing of the message flows.

This task topic describes the testing of the message flows you have already constructed. In this scenario you use a tool that uses HTTP protocol rather than WebSphere MQ. You can use any tool that has the facilities described in the following procedure.

1. Start the tool and select `http://localhost:nnnn/` where `nnnn` is the address of the port you are using.
2. Set the URL to the host, port and selection for the deployed flow. The SOAPInput nodes listen on a different port from the HTTP nodes and the listener is built into the execution group itself rather than using a different process.
3. As the SOAPInput node expects a SOAPAction entry in the HTTP headers you must add one.
 - a. press the **Add New Header** button
 - b. Enter the **Value** part of the header. The value must match the SOAPAction attribute of the `SOAP:operation` element in your code.
 - c. Select **New Header** in the **Name** pane.

- d. Change the name from **New Header** to SOAPAction and press the **Enter** key.
4. Select **Load File** and go to the directory containing the XML file you want to use.
5. Select the file and press the **Open** button. Note the following:
 - If the message does not include any WS-Addressing entries, the ReplyTo and FaultTo locations default to anonymous. This means the results are returned on the original client connection.
 - If the message includes a WS-Addressing header (ReplyTo) with a value of anonymous, the reply is returned to the original client using the original TCP/IP connection.
 - If the message includes a WS-Addressing header with a value of FaultTo explicitly included the reply is returned to that address rather than taking the default of using the same location specified in the ReplyTo header.
6. Press the **Send** button to test the flow. The result appears in the right hand pane.

XML domain message flows

If you are not using the SOAP domain then your message flow needs to take account of the actual bitstream format of the Web service messages you are working with. A different logical tree format is used by each domain.

If the messages are SOAP then you can use either the XMLNSC domain or the MRM XML domain. Both domains offer validation. The XMLNSC domain is more efficient, whilst the MRM XML domain can be useful if you have specific message transformation requirements, for example, if your message flow also uses binary data formats.

If the messages use MIME (for example, SOAP with Attachments or MTOM) you can use the MIME domain. In this case your message flow will probably also need to identify at least the MIME part corresponding to the SOAP payload and then explicitly parse this using the XMLNSC or MRM domain as above.

In the SOAP domain, WSDL is used to automatically configure your nodes with the appropriate endpoint information. If you are not using the SOAP domain, then you must select and configure the transport nodes manually. Typical WSDL bindings would be:

- SOAP/HTTP, in which case implement a flow using HTTP nodes. Use the HTTPInput and HTTPReply nodes if a flow implements a Web service, or use the HTTPRequest node if a flow invokes a Web service.
- SOAP/JMS, where you implement a flow using JMS or MQ nodes.

You can configure message flows that receive input messages from clients using one transport, and interact with a Web service or legacy application using another.

You can propagate a message to more than one location. For example, the Web service response to be returned to a client by an HTTPReply node might first be sent to an auditing application using an MQOutput node, after making any required adjustments to the message headers.

Nodes are used together in the following basic patterns, using HTTP nodes as example transports:

- As a Web service provider, for example

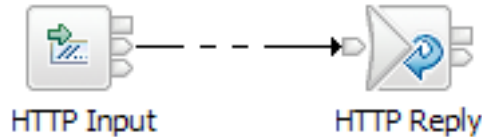

- As a Web service consumer, for example:



- As a Web service facade, for example:



If required, the SOAPExtract and SOAPEnvelope nodes can be used in conjunction with these patterns to respectively extract the SOAP payload and rebuild a SOAP Envelope.

If you want your message flow to validate messages, then an appropriate message set must be deployed with the flow. An appropriate message set is created either by importing existing WSDL or by generating WSDL from an existing message set. For details about importing existing WSDL, see *Importing from WSDL*. For details about generating WSDL from an existing message set, see *WSDL generation*.

You can also create a new message set and flow based on existing WSDL or XSD files. For details, see *“Creating an application based on WSDL or XSD files”* on page 132

The generated message set will contain message definitions for the relevant SOAP Envelope version and for the XML payload data defined by the WSDL. In the XMLNSC or MRM XML domains, messages can be validated against the message set. For details, see *“Validating messages”* on page 164.

Working with HTTP flows

Read this information if you are using HTTP message flows to interact with Web services. You might find it useful to read this in conjunction with the subsequent *“Web services scenarios”* on page 700 section.

HTTPS

For help with using HTTPS see *Implementing SSL authentication*.

Setting the HTTP Status Code for a reply

The default HTTP Status Code is 200, which indicates success. If you want a different status code to be returned, take one of the following actions:

- Set your status code in the field `Destination.HTTP.ReplyStatusCode` in the LocalEnvironment tree (correlation name `OutputLocalEnvironment`). This field overrides any status code that is set in an

HTTPResponseHeader header. This action is the preferred option, because it provides the greatest flexibility.

- Set your status code in the field X-Original-HTTP-Status-Code in the HTTPReplyHeader header.
- Set your status code in the field X-Original-HTTP-Status-Code in the HTTPResponseHeader header. This option is typically useful if you include an HTTPRequest node before the HTTPReply node in your flow, because the HTTPResponseHeader header is created for you. In this scenario, an HTTPResponseHeader header has been created in the logical tree, representing the HTTP headers in the response from another Web service. If you have selected the Generate default HTTP headers from reply or response property in the HTTPReply node, values for the response header are set as default values when the reply message is created.

Using LocalEnvironment.Destination.HTTP.RequestIdentifier

When the HTTPInput node receives an input request message, it sets the LocalEnvironment field Destination.HTTP.RequestIdentifier to a unique value that identifies the Web service client that sent the request. You can refer to this value, and you can save it to another location if appropriate.

For example, if you design a pair of message flows that interact with an existing WebSphere MQ application (as described in “Broker calls existing Web service” on page 701), you can save the identifier value in the request flow, and restore it in the reply flow, to ensure that the correct client receives the reply. If you use this technique, you must not change the data and you must retain the data as a BLOB.

The HTTPReply node extracts the identifier value from the LocalEnvironment tree and sets up the reply so that it is sent to the specific client. However, if you are using an HTTPReply node in a flow that does not have an HTTPInput node, and this field has been deleted or set incorrectly, message BIP3143S is issued.

If you design a message flow that includes both an HTTPInput and an HTTPReply node, the identifier value is set into the LocalEnvironment by the HTTPInput node, but the HTTPReply node does not use it. Therefore, if your message flow includes both nodes and a Compute node in the same flow, you do not have to include the LocalEnvironment tree when you specify which components of the message tree are copied from input message to output message by the Compute node (the Compute mode property).

Setting the HTTPRequest node URL dynamically

You can set the property Default Web service URL on the HTTPRequest node to determine the destination URL for a Web service request. You can configure a Compute node before the HTTPRequest node within the message flow to override the value set in the property. Code ESQL that stores a URL string in LocalEnvironment.Destination.HTTP.RequestURL; the HTTPRequest node retrieves and uses the URL string in place of the node property value.

Although you can also set the request URL in the special header X-Original-HTTP-URL in the HTTPRequestHeader header section of the request message (which overrides all other settings) in a Compute node, use the LocalEnvironment tree content for this purpose for greater flexibility.

Setting Generate default HTTP headers from reply or response for the HTTPReply node

If you select Generate default HTTP headers from reply or response in the HTTPReply node properties, the node includes a minimum set of headers in the response that is sent to the Web service client.

To set any headers explicitly, create them in an HTTPReplyHeader header. For example, a Compute node propagates a message in the XMLNS domain and modifies the Content-Type as follows:

```
CALL CopyMessageHeaders();  
SET OutputRoot.HTTPReplyHeader."Content-Type" = 'text/xml';  
SET OutputRoot.XMLNS = InputRoot.XMLNS;
```

Do not use the ContentType property to set the Content-Type unless you are working in the MIME domain. The ContentType property is specifically intended to set the value of Content-Type used in MIME.

The full set of HTTP headers used in the request is built by selecting the headers using the algorithm defined in the following steps:

1. Select any headers in an HTTPReplyHeader header.
2. If no Content-Type header is yet defined, create one using any non-empty value in the ContentType property.
3. Select any headers in an HTTPResponseHeader header (an HTTPResponseHeader header is propagated on return from an HTTPRequest node).
4. If no Content-Type header is yet defined, create one with the default value text/xml; charset=utf-8.
5. Create or overwrite the Content-Length header.

Attention: The HTTPReply node always rewrites the Content-Length header, even if you have cleared Generate default HTTP headers from reply or response. This action ensures that the content is correct.

If an HTTPReplyHeader header section existed in the message received by the HTTPReply node, and the Output terminal of the HTTPReply node is connected, the HTTPReplyHeader header section is updated with any changed or added values.

Setting Generate default HTTP headers from input for the HTTPRequest node

If you select Generate default HTTP headers from input in the HTTPRequest node properties, the node includes a minimum set of headers in the request that is sent to the server.

To explicitly set headers, create them in an HTTPRequestHeader header. For example, a Compute node propagating a message in the XMLNS domain can modify the Content-Type as follows:

```
CALL CopyMessageHeaders();  
SET OutputRoot.HTTPRequestHeader."Content-Type" = 'text/xml';  
SET OutputRoot.XMLNS = InputRoot.XMLNS;
```

Do not use the ContentType property to set the Content-Type unless you are working in the MIME domain. The ContentType property is specifically intended to set the value of Content-Type used in MIME.

The full set of HTTP headers used in the request is built by selecting the headers using the algorithm defined in the following steps:

1. Set the Host header, based on either the request URL or the incoming HTTPRequestHeader header section of the message.
2. Select any headers in an HTTPRequestHeader header.
3. If no Content-Type header is yet defined, create one using any non-empty value in the ContentType property.
4. Select any headers in an HTTPInputHeader header (an HTTPInputHeader header is created automatically by an HTTPInput node).
5. If no Content-Type header is yet defined, create one with the default value `text/xml; charset=utf-8`
6. If no SOAPAction header is yet defined, create one with the default value `''`.
7. Create or overwrite the Content-Length header.

Attention: The HTTPRequest node always rewrites the Content-Length header, even if you have cleared Generate default HTTP headers from input or request. This action ensures that the content is correct.

If an HTTPRequestHeader header exists in the received message, the HTTPRequestHeader header is updated with any changed or added values.

Collecting HTTPListener trace if you have problems with HTTP

If you have problems with HTTP, you can trace the HTTPListener:

1. Use the `mqsichangetrace` command to start trace with the following options:

```
mqsichangetrace component -t -b
```

where *component* is the broker name.

2. Retrieve the HTTPListener trace log using the `mqsireadlog` command with the HTTPListener qualifier for the `-b` parameter.
3. Format the trace log using the `mqsiformatlog` command so that you can view its contents.

Web services scenarios

This topic describes some common Web services scenarios. It is organized according to the role played by the broker.

A key consideration is whether a WSDL description for the Web service already exists.

In the first two scenarios below, the WSDL description exists and is imported and used by the message flow.

In the remaining two scenarios, the WSDL description is generated in an existing message set. Again, the WSDL is used by the message flow and may also be exported for use by an external client.

These are generic scenarios and can be implemented using the SOAP domain, or by using an appropriate non-SOAP domain (XMLNSC, MRM, MIME) and basic transport nodes. If you need to use WS-Addressing or WS-Security for a particular implementation, you must use the SOAP domain.

You want the broker to invoke an existing Web service:

See “Broker calls existing Web service”

You want the broker to expose an application as a previously defined Web service:

See “Broker implements existing Web service interface” on page 709

You want the broker to expose an application as a new Web service:

See “Broker implements new Web service interface” on page 705

You want the broker to expose a Web service to a non-Web service client:





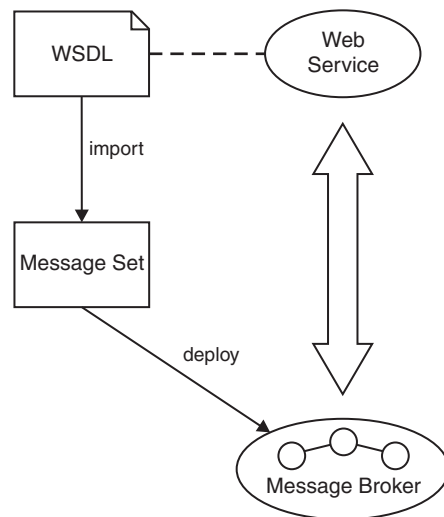

See “Broker implements non-Web-service interface to new Web service” on page 713

Broker calls existing Web service

In this scenario, the broker invokes an existing Web service implementation. The WSDL for the Web service already exists, and is imported to create a message set. A message flow based on this message set sends a Web service request and receives the response, for example using a SOAPRequest node.

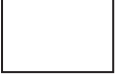
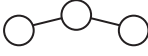

Key to symbols:

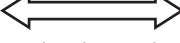
 Executable	 File	 Message set	 Message flow
 association	 design time action. For example, import or deploy	 design time action involving an external toolkit. For example, generating a Web service client.	 run time interaction. For example, message exchange

Possible uses

- You want to call a Web service to do some processing as part of your message flow.

- You have an existing Web service and you want to provide a different interface to it. This could be an alternative Web services interface or a WebSphere MQ interface.
- You have an existing Web service and you want to change its implementation in some way without changing its interface; that is, the broker acts as an intermediary to the Web service. For instance a message flow could be used to enable auditing, or to transparently propagate the Web service response to another application.

Design steps

1. Import WSDL to create a message set containing definitions for the SOAP messages described by the WSDL.
2. Create a message flow to invoke the Web service. If the SOAP domain is used, the message flow uses a SOAPRequest node, SOAPAsyncRequest node or a SOAPAsyncResponse node. The nodes are configured using the WSDL imported in Step 1. If required, a skeleton flow can be created from scratch by dropping the WSDL onto a blank message flow editor canvas. If the SOAP domain is not used, the message flow must be constructed using transport nodes, and an XML or MIME domain. For example, if the WSDL binding specifies HTTP transport, and the request message is SOAP, then an HTTPRequest node can be used with the XMLNSC domain. You can then configure the node manually with the endpoint information for the Web service.
3. Build a broker archive file for deployment. The broker archive file contains your message flow and the message set containing the imported WSDL. The SOAP domain always requires the WSDL to be deployed, because messages are verified against it at runtime; also WSDL information is included in the logical tree. The message set includes XML Schema definitions that can be used for message validation in the SOAP, XMLNSC or MRM domains.

Runtime

Your message flow creates an appropriately formatted Web service request, invokes the Web service, and parses the Web service response. If the SOAP domain is used, your message flow uses the SOAP logical tree model. If the SOAP domain is not used, your message flow uses the logical tree for your selected domain, for example you use the MIME domain if your Web service messages use SOAP with Attachments.

Example 1

Web service intermediary

In this example a client application uses a Web service called Account, which is made available by another organization. The client is widely distributed in your company. The client uses an operation called getBalance, but the Account service is being modified to change the definition of the getBalance operation. You can construct message flows to provide an interface to the Account service, instead of modifying the client. The message flows can call the Account service to do the work, and the new Web service delegates to the original Web service. The client can now continue to use the Account service, using the new message flows.

Examples of typical message flow patterns are shown below. In each case, the intermediate request node calls the Account service:

1. Using SOAPInput, SOAPRequest and SOAPReply nodes:

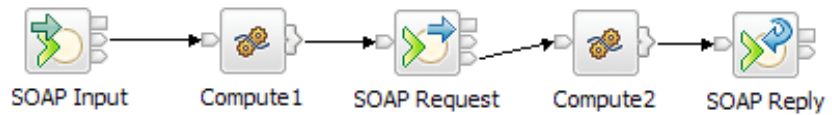

2. Using SOAPInput, SOAPAsyncRequest, SOAPAsyncResponse and SOAPReply nodes:

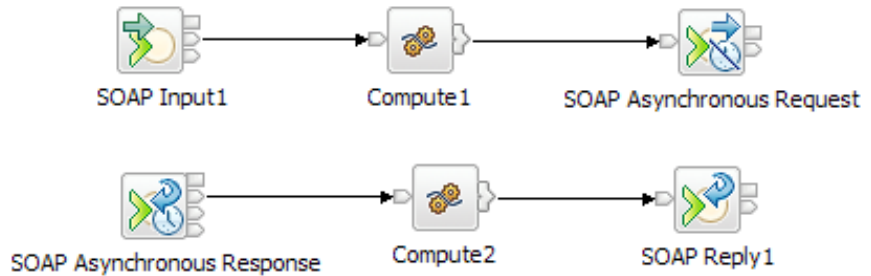

3. Using HTTPInput, HTTPRequest, and HTTPReply nodes:



In the message flows in the example, Compute1 modifies the original getBalance message as required by the modified Account service, whilst Compute2 restores the response message to the original format. If you have imported or generated WSDL then you have a message model for the getBalance operation. If you have a message model defined for the getBalance operation, you can use Mapping nodes instead of Compute nodes.

HTTP details

If you use HTTP transport nodes, as shown in the example, you can configure the HTTPRequest node to generate HTTP headers from the headers that are received by the HTTPInput node. This enables cookies and other application-specific headers to be passed through the message flow. The HTTPReply node can be used task to extract headers from the Web service response, to return to the originating client. To do this, select **Generate default HTTP headers from** on both the HTTPRequest and HTTPReply nodes. In general you do not need the original request message to generate the reply to the client, and can select **Replace input message with Web service response** on the HTTPRequest node. If you do want to preserve any data from the input request, you can store this in the LocalEnvironment in Compute1, and retrieve it in Compute2 for inclusion in the reply.

Example 2

Using a Web service

In this example, a WebSphere MQ message flow implements a process for the Human Resource department of your company. As part of this processing, the message flow calls a Web service to retrieve employee ID numbers. Employee ID numbers are maintained in the company's employee directory, which is accessed through a Web service. Examples of typical message flow patterns are shown below. In each case the intermediate request node retrieves the employee ID:

1. Using MQInput, SOAPRequest and MQOutput nodes:

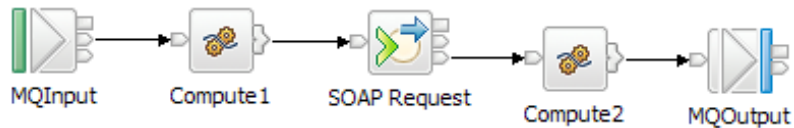

2. Using MQInput, SOAPAsyncRequest, SOAPAsyncResponse and MQOutput nodes:

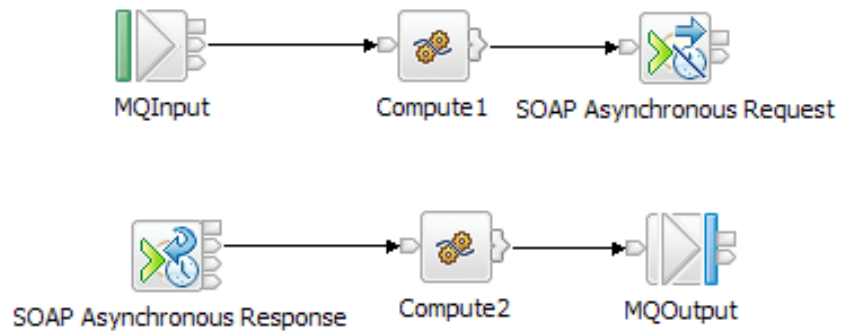

3. Using MQInput, HTTPRequest and MQOutput nodes:

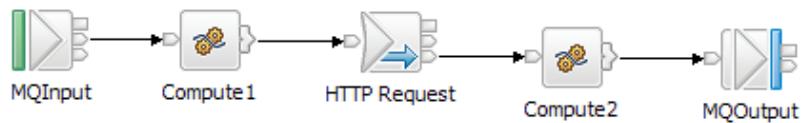

In the message flows in the example, Compute1 prepares the Web service request message and Compute2 processes the response. For example, by incorporating the employee ID in another message. If you have a message model defined, you can use Mapping nodes instead of Compute nodes in these examples.

HTTP details

If you use HTTP transport nodes, as shown in the example, you typically clear the **Replace input message with Web service response** in the

HTTPRequest node properties. The response from the corporate directory server is placed in a temporary location in the message tree. The temporary location is specified in the **Response message location** in tree property in the same node. In Compute2, you can code ESQL to retrieve the result, and update the final message.

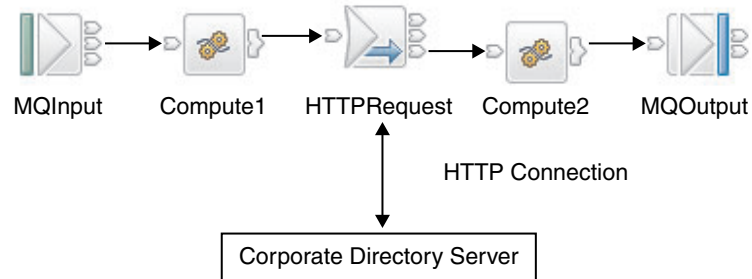





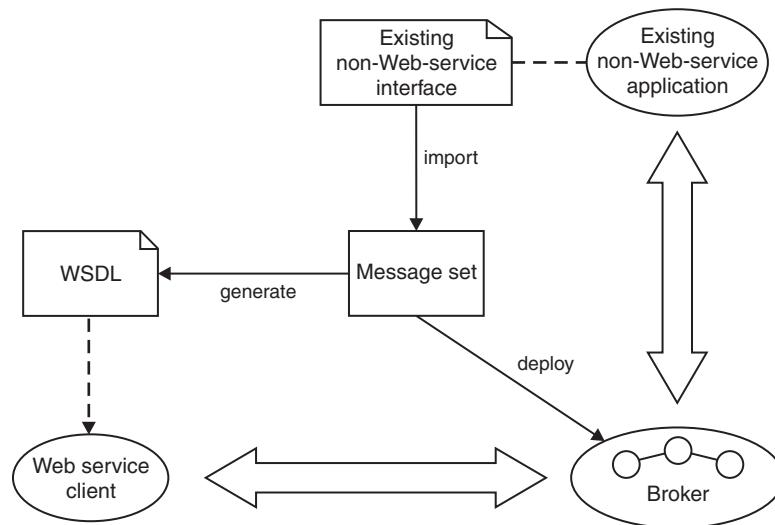

Using the SOAP domain for these scenarios is preferred. For more information about choosing a domain for Web services, see “WebSphere Message Broker and Web services” on page 615.

Broker implements new Web service interface

In this scenario, the broker implements a new Web service interface. The WSDL for the Web service is generated from a message set and made available to clients. A message flow based on this WSDL and message set receives a request and then builds a response message using data obtained from an existing non-Web-service application.

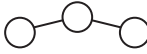

Key to symbols:

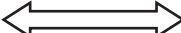
 Executable	 File	 Message set	 Message flow
 association	 design time action. For example, import or deploy	 design time action involving an external toolkit. For example, generating a Web service client.	 run time interaction. For example, message exchange

This scenario is sometimes referred to as a Web service facade. The design of the Web service interface typically involves some regrouping, restriction, or enhancement of the existing interface, and is not constrained by an existing WSDL definition.

Possible uses

- The broker provides a Web services interface to an existing application, optionally providing other mix-in capabilities such as auditing the requests made.
- Over time the implementation can be changed without affecting the interface presented to the Web services client.

Design steps

1. Create a message set for the business messages, possibly by importing an existing interface definition such as a C header file or COBOL copybook.
2. Generate a WSDL definition from the message set.
3. Use a SOAP toolkit such as Rational® Application Developer to create a suitable Web services client based on the WSDL.
4. Develop a message flow to implement the Web service.

Runtime

Your message flow receives a Web service request, converts it into a form expected by the existing application and invokes the existing application. The response from the existing application is converted into a valid Web service response.

Example 1

In this example, an existing message flow is modified to provide a Web service. If the existing message flow models its data in a message set, then a WSDL definition can be generated from that message set and made available to clients.

Most message flows that currently use WebSphere MQ for input or output can be adapted to support Web services as a replacement or additional protocol.

The following are typical message flow patterns. In each case the input and reply nodes replace or complement the original MQInput and MQOutput nodes. The main part of the flow is understood to do some useful processing.

1. Using SOAPInput and SOAPReply nodes:



2. Using HTTPInput and HTTPReply nodes:



If you use the SOAP domain, then the logical tree shape will be different from the original domain and you will need to take account of this in the message flow. If you use the HTTP nodes with the original domain, then the logical tree shape does not change. For information about choosing the domain, see “WebSphere Message Broker and Web services” on page 615.

HTTP details

If you use the HTTP nodes, you can configure the HTTPReply node to generate a set of default HTTP headers for the reply message sent to the client. Generating a set of default HTTP headers reduces the modifications that you must make to convert the message flow from one that processes WebSphere MQ messages to a flow that processes HTTP messages.

Example 2

In this example, a message flow is created to provide asynchronous access to a WebSphere MQ application.

The following are typical message flow patterns. In each case the flow receives the Web service request and build the response using data returned from the application over MQ.

1. Using two message flows with SOAPInput, SOAPReply nodes:

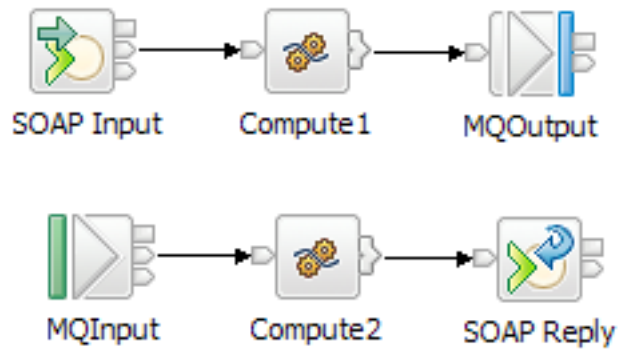

2. Using two message flows with HTTPInput and HTTPReply nodes:

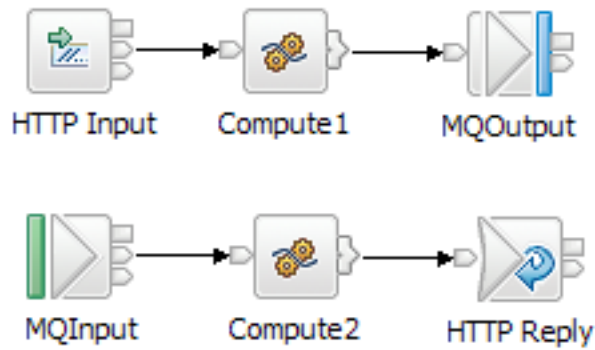

In each case, the first message flow receives inbound requests from a Web service client. The Compute1 node transforms the request and an MQOutput node sends the modified request to the existing application.

In the second message flow, an MQInput node receives the response from the application. The Compute2 node then transforms the message and propagates it to a reply node that responds to the original Web service client.

The Compute1 node must also save some correlation information to be retrieved by the Compute2 node, ensuring that the replies from the WebSphere MQ application are returned to the client that sent the original request.

HTTP details

Using HTTPInput and MQOutput nodes as the outbound message and MQInput and HTTPReply nodes as the response message:

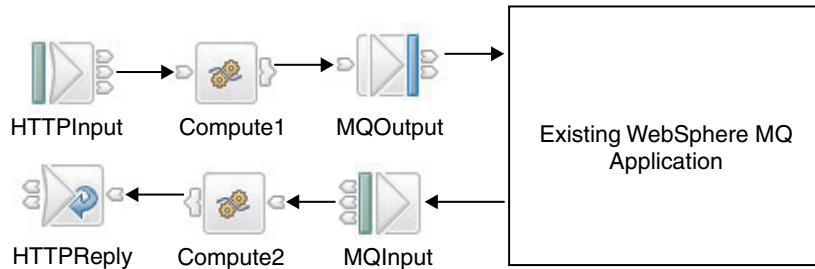

One way to preserve the correlation information is for the Compute1 node to encode the HTTP request identifier in the outbound message. (Alternatively, the request identifier can be stored in a database). The HTTPInput node provides the request identifier as a field in the LocalEnvironment tree called Destination.HTTP.RequestIdentifier and the Compute1 node can read and store this value.

The Compute2 node reads the HTTP request identifier from the message, and sets LocalEnvironment.Destination.HTTP.RequestIdentifier using this value. The HTTPReply node uses the request identifier to ensure that the message reaches the correct HTTP client.

The implementation of this scenario requires correct handling of the MQMD. Any messages coming in across WebSphere MQ must have the MQMD removed before being sent into an HTTPReply or HTTPRequest node (unless including an MQMD in the HTTP stream is desired).

In the ESQL module for the Compute1 node, include a code statement like the following statement:

```
SET OutputRoot.XMLNS.A.MessageID =
    CAST(InputLocalEnvironment.Destination.HTTP.RequestIdentifier AS CHARACTER);
```

In the ESQL module for the Compute2 node, include a code statement like the following statement:





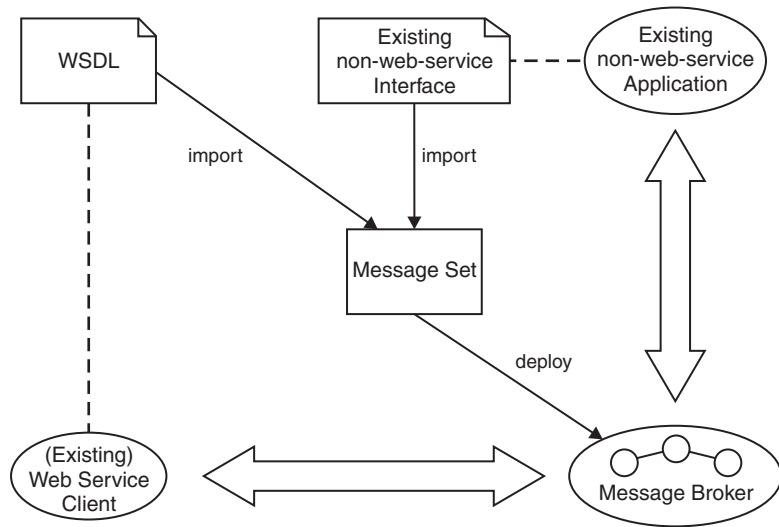

```
SET OutputLocalEnvironment.Destination.HTTP.RequestIdentifier =
    CAST(InputRoot.XMLNS.A.MessageID AS BLOB);
```

Broker implements existing Web service interface

In this scenario, the broker implements an existing Web service interface. The WSDL for the Web service already exists, and is imported to create a message set. A message flow based on this message set receives a request and then builds a response message using data obtained from an existing non-Web-service application.

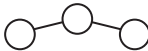

Key to symbols:

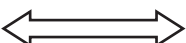
 Executable	 File	 Message set	 Message flow
 association	 design time action. For example, import or deploy	 design time action involving an external toolkit. For example, generating a Web service client.	 run time interaction. For example, message exchange

Possible uses

- The broker provides a Web service implementation with a different quality of service from existing implementations.
- The broker provides a migration strategy for the existing implementation.

Design steps

1. Import WSDL to create a message set containing definitions for the SOAP messages described by the WSDL.
2. Adapt the message set for the required existing interface, possibly by importing an existing interface definition such as a C header file or COBOL copybook.
3. Develop a message flow to implement the Web service.

Runtime

Your message flow receives a Web service request, converts it into a form expected by the existing application and invokes the existing application. The response from the existing application is converted into a valid Web service response.

Example 1

In this example, an existing HTTP Web service client provides information on a given subject (stock prices or exchange rates, for example). You want to replace this service with an inhouse database lookup solution, but want to make no changes to the clients because these are widely deployed.

Typical message flow patterns are shown below. In each case the intermediate request node retrieves the information from the database:

1. Using SOAPInput and SOAPReply nodes:

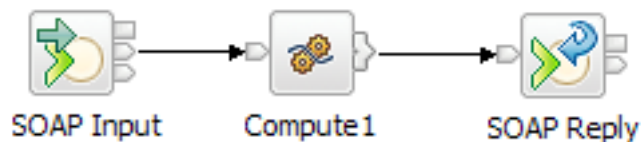

2. Using HTTPInput and HTTPReply nodes:



In the flows above, the input node receives the Web service request. Compute1 then retrieves the required information from the database and generates the required Web service response using this data. The response is returned to the client by the reply node. In the examples you can use Mapping nodes instead of Compute nodes.

Example 2

In this example, an existing application is exposed as a Web service, but there is a constraint on the interface with the Web service, because a widely distributed client already uses a similar service that is defined by an existing WSDL definition. The broker offers the same interface to the client, this might be because the original service offers a different quality of service or is to be discontinued.

Typical message flow patterns are shown below. In each case the message flows receive the Web service request and build the response using data returned from the application over WebSphere MQ.

1. Using SOAPInput, SOAPReply and MQGet nodes:

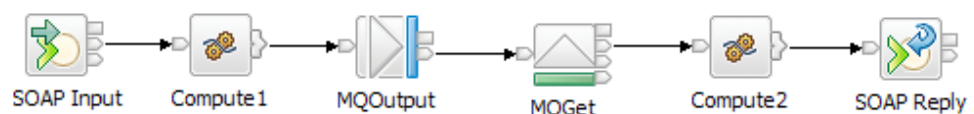

2. Using HTTPInput, HTTPReply and MQGet nodes:

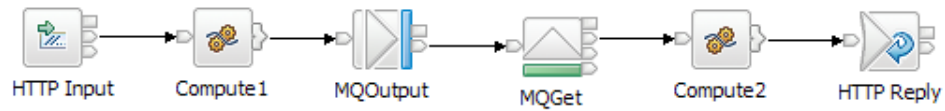

3. Using two message flows with SOAPInput, SOAPReply nodes:

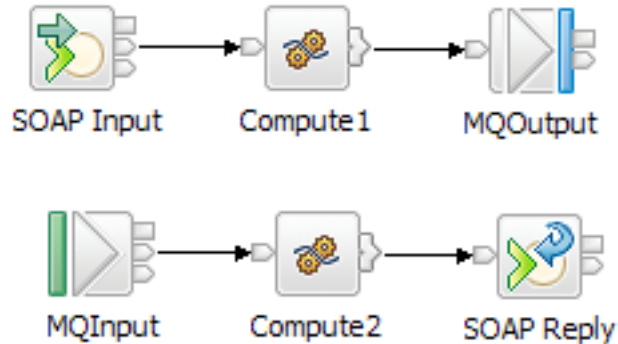

4. Using two message flows with HTTPInput and HTTPReply nodes:

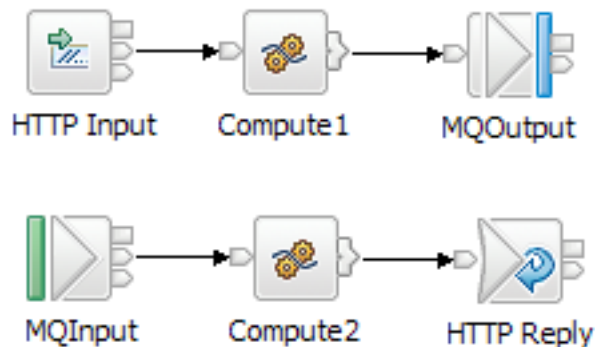

The steps to develop the message flow are:

1. Create a message model for the existing application interface, for example, by importing a C header file for the application.
2. Import an existing WSDL definition for the client.
3. Create a flow using the message set to implement the Web service interface and mediate with the existing application.

Message flows 1 and 2 show a synchronous call to the application using MQOutput and MQGet nodes. You can set a timeout in the MQGet node, to allow for failure of the remote application. The request-reply translation is handled in a single transaction enabling simple rollback and recovery. However, each incoming request has to be fully processed and responded to before moving onto the next request. This might impact performance, if the application cannot respond quickly.

The message flows shown in examples 3 and 4, show an asynchronous equivalent. In each case the first flow stops after sending the message to the application, and becomes available to handle further requests. However, this scenario requires a correlation context to be saved in the request flow, and restored in the reply flow. You can store the correlation context on a queue, and then use an MQGet node in the reply flow to retrieve it. This flow design enables the requests to be dispatched to the application promptly, and replies to be returned in the order that they are received. In the examples you can use Mapping nodes instead of Compute nodes.

Using the SOAP domain for these scenarios is preferred. For more information about choosing a domain for Web services, see “WebSphere Message Broker and Web services” on page 615.

For more information about the asynchronous request-reply scenario, see “A request-response scenario using an MQGet node” on page 189.

The asynchronous request-reply scenario is also detailed in the following sample which can be adapted for Web service usage:

- Coordinated Request Reply sample

Another Web services scenario is described in the sample:

- HTTP Nodes sample





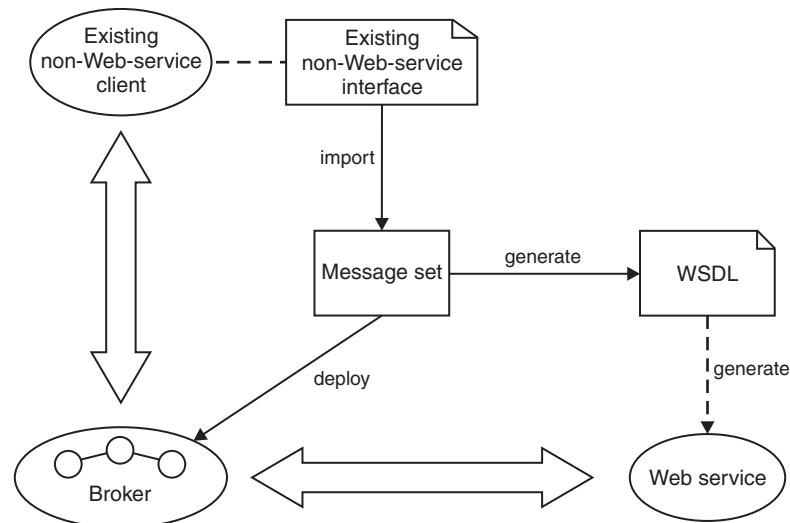

You can view samples only when you use the information center that is integrated with the Message Broker Toolkit.

Broker implements non-Web-service interface to new Web service

In this Web service scenario, the broker provides compatibility with earlier versions for existing non-Web-service clients to invoke a new Web services implementation provided by a SOAP toolkit.

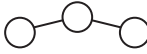

Key to symbols:

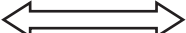
 Executable	 File	 Message set	 Message flow
 association	 design time action. For example, import or deploy	 design time action involving an external toolkit. For example, generating a Web service client.	 run time interaction. For example, message exchange

Possible uses

You want to migrate an application to a Web service implementation, for example an EJB implementation hosted by an application server to offer better scalability.

However, a significant number of your users have existing clients that cannot be immediately replaced. Existing clients can use the broker to use the new Web service implementation.

Design steps

1. Create a message set for the business messages, for example, by importing an existing interface definition such as a C header file or COBOL copybook.
2. Generate a WSDL definition from the message set.
3. Use a SOAP toolkit or application server to create a suitable Web services implementation based on the WSDL.
4. Develop a message flow to mediate between the original existing client and the new Web service.

Runtime

Your message flow receives a request from the existing client, converts it into a Web services request and invokes the Web service. The response from the Web service is converted into a form understood by the existing client.

Part 3. Working with files

Working with files	717
How the broker processes files	717
Recognizing file records as messages to be parsed.	719
How the file nodes and additional instances share access to files	719
Using LocalEnvironment variables with file nodes	721
File name patterns.	724
mqsarchive subdirectory	726
Reading a file	727
Reading a file on your local file system.	727
Reading a file on a remote FTP directory	729
Reading a file, effects of different values in the FileInput node's Record detection property	731
Writing a file	735
Writing a file to your local file system	735
Writing a file to a remote FTP server	737
Writing a file, effects of different values in the FileOutput node's Record definition property	739

Working with files

One of the most common methods of data storage is files. Processes using file transfer form the backbone of many business IT systems. You can create message flows to process data in files, accepting data in files as input message data, and producing output message data for file-based destinations. The following file nodes are provided:

- FileInput node. Use this node to receive messages from files in the broker server's file system. The node generates output message data that can be used by any of the output nodes meaning that messages can be generated for clients using any of the supported transport protocols to connect to the broker. For more information, see "FileInput node" on page 886.
- FileOutput node. Use this node to write messages to a file in the broker's file system. It can create new files and replace existing files. For more information, see "FileOutput node" on page 899.

Using this function, you can also process large files without using excessive storage and simplify the processing of files which have large numbers of repeating entries.

If you want to work with files, read these topics:

- "How the broker processes files"
- "How the file nodes and additional instances share access to files" on page 719
- "Using LocalEnvironment variables with file nodes" on page 721
- "File name patterns" on page 724
- "mqsiarchive subdirectory" on page 726
- "Reading a file" on page 727
- "Writing a file" on page 735

How the broker processes files

This topic describes how the broker processes files with the file nodes, FileInput and FileOutput.

WebSphere Message Broker can read messages from files and write messages to files in the local file system, or on a network file system that appears local to the broker. Two nodes provide this capability:

- FileInput node
- FileOutput node

A file, or record within a file is analogous to a message in a queue. The directory which contains the file is analogous to a message queue.

How the broker reads a file

The FileInput node processes messages which are read from files. It scans a specified directory for files that match a certain specification. This directory is in the file system that is attached to the broker. Optionally, files from a remote FTP server can be moved to the local directory whenever the directory is to be scanned. You specify the file to be searched for with an explicit file name or a file name pattern which includes wildcard characters. When the broker finds a file which matches this specification, it reads the file and propagates a message, or messages,

using the contents of the file. If the file is locked, it is ignored at this directory scan. When the broker has finished reading the file, the file is removed from the input directory.

The broker may start file processing as soon as the file appears in its input directory. If the file is still being written by another program, the broker might read corrupted data. This can be avoided either by arranging that the file is locked until it is finished, or by creating the file elsewhere and moving it into the input directory when ready.

You can specify, using the FileInput node, how the records are derived from the file. The contents of a file can be interpreted as:

- A single record ('whole file')
- Separate records, each of a fixed length ('fixed length records')
- Separate records each delimited by a specified delimiter ('delimited records')
- Separate records that are recognized by a parser that you specify ('parser record sequence')

After the file has been successfully processed, it is either:

- Deleted from the file system, or
- Moved to an archive subdirectory of the specified (local) directory

The message, or messages, propagated from the file can be used as input to any flow and output node. You can create a message flow that receives messages from files and generates messages for clients that use any of the supported transports to connect to the broker.

Whenever a message is propagated from a file, the FileInput node stores certain information about the file in the LocalEnvironment.File message tree. This includes the offset of the record of the message in the file being processed and the record number in that file. In addition, when wildcards are used in a file name pattern, the characters matched in the file name are placed in the WildcardMatch element of the LocalEnvironment tree.

How the broker writes a file

The FileOutput node writes messages to files in the broker's file system. When a message is received on the node's In terminal, it creates and writes a file as a series of one or more records. One record is written to a file for every message received. The name of the file is specified either by a file name pattern in the node or an explicit file name which is either specified in the node or derived from the message.

You can specify how the records are accumulated into files. These can comprise:

- A single record ('whole file'). The file that is created consists of one record.
- Concatenated records ('unmodified records'). The records are neither padded to any required length, nor separated by any delimiter.
- Uniform length ('fixed-length records'). Records that are shorter than the specified length are padded to the required length.
- Separate records ('delimited records'). Records are either terminated or separated by a specified delimiter.

The flow informs the FileOutput node that there are no more records to write by sending a message to its Finish File terminal. At this point, the file is moved to the specified output directory. Optionally, this file may be moved to a directory on a remote FTP server identified by properties of the node. If the node is producing a single record from the file ('whole file'), the file is moved immediately to the output directory without requiring a message to be propagated to the Finish File terminal. In this case, any message sent to the node's Finish File terminal has no effect on any file, though the message will still be propagated to a flow attached to the node's End of Data terminal.

Recognizing file records as messages to be parsed

This topic describes how you can use the FileInput node to segment your input file into messages that are to be parsed. It also describes the special considerations that you must be aware of when using the MRM and XMLNSC parsers.

Use the FileInput node to segment your input file into messages that are to be parsed by one of the following parsers:

- MRM Custom Wire Format
- MRM Tagged Delimited String Format
- XMLNSC

Use the FileInput node's Message domain property to specify which parser you need to use; MRM or XMLNSC. Specify Parsed Record Sequence in the Record detection property so that the node splits the file into messages to be parsed by either the MRM or XMLNSC parser.

If you select the MRM parser, ensure that the message model has a defined message boundary and does not rely on the end of the bitstream to stop the parse. If the final element has a *maxOccurs* value of -1, the parser continues to read bytes until the end of the bitstream or until it encounters bytes that cause a parsing exception. In either case, the parser is unable to identify the end of one message and the start of the next. If you use *Data Element Separation = Use Data Pattern*, ensure that the pattern recognizes a specified number of bytes. Be aware, therefore, that a pattern of * identifies all available characters and so would read an entire input file.

If you use delimited separations with message group indicators and terminators, ensure that the combination of group indicator and terminator does not match a record delimiter. For example, a message might start with a left brace ({) and end with a right brace (}). If there is a delimiter of } { within the message, this matches the boundary between multiple messages; as a result, a message boundary might be identified as a delimiter within the current message. This might cause bytes in a subsequent message to be included in the current message causing parser exceptions or unexpected content in the parse tree.

If you select the XMLNSC parser, be aware that the end of the root tag marks the end of the message. Any XML comments, XML processing instructions and white space which appear after the end of the XML message are discarded. The start of the next XML message is marked either by the next XML root tag or the next XML prolog.

How the file nodes and additional instances share access to files

This topic describes how multiple instances read from and write to files.

When a message flow uses the FileInput or FileOutput node, there might be additional instances associated with the flow. You need to understand how multiple instances read from and write to the files processed by these nodes. The same considerations apply to other message flows in the same execution group if they use file nodes that refer to files in the same directory.

The broker locks the files being read by the FileInput node or being written by the FileOutput node. This prevents other execution groups from reading or changing the files while they are being processed. The broker relinquishes the lock when a FileInput node finishes processing its input file. The broker relinquishes the lock when a FileOutput node finishes the file and moves it from the transit directory to the output directory.

Reading a file

When the FileInput node reads a file, only one instance (of one message flow) is allocated to reading it. Each record in the file is serially processed by this instance. Other instances of the message flow, or other message flows, can simultaneously process other files the names of which match the pattern specified in the node's File name or pattern property. Message flows in the same execution group cooperate to avoid files being processed or accessed multiple times. There is no such cooperation between message flows in different execution groups.

While a file is processed, the facilities of the file system are used to lock the file. This helps to prevent other programs, including other execution groups, from reading, writing, or deleting the file while it being processed by the file nodes.

While a FileInput node is reading a file, the file remains in the local directory until it has been fully processed (or until an unrecoverable error occurs). A subdirectory is then used to accommodate the file once it has been processed if it is retained.

Writing a file

Files created and written by a FileOutput node are placed in the output directory when they are finished. While records are being added to a file, it is kept in the transit (mqsitransit) subdirectory. Each record is written by a single message flow instance and there is no constraint on which instance this can be. All message flow instances that are configured to write records to a specific file can append records to that file. Because instances can run in any order, records that they write might be interleaved. If you need to ensure the sequence of records in the output file, arrange that only one FileOutput node instance uses the file. Achieve this by configuring the flow containing the node to use the node's additional instances pool with zero instances and by ensuring that other flows do not write to the same file.

While a file is processed, the facilities of the file system are used to lock the file. This helps to prevent other programs, including other execution groups, from reading, writing, or deleting the file while it being processed by the file nodes. This lock is retained for a short period after a FileOutput node writes to the file without finishing it, leaving it in the transit directory. If flows that are in the same execution group use the same output file and run sufficiently quickly, the broker does not need to relinquish the lock before the file is finished. However, if the flows have longer intervals between execution, the broker relinquishes the lock and another process or execution group can acquire a lock on the file. If you need to prevent this behavior, do not share output directories across execution groups.

Instances within a single execution group cooperate to ensure that no file system errors occur. When an instance cannot write a record because another instance is currently writing to the file, it waits for a short period and then tries again to write to the file. This might result in message flow exceptions especially when the record being written is large and the file system is slow. Flow retry processing normally allows the record to be regenerated but this can result in an unpredictable order of output records in the file.

Because instances in different execution groups cannot cooperate, the only mechanism available to prevent errors is the file system lock obtained by the FileOutput node. It is good practice to prevent other programs from accessing files in transit subdirectories while flows that might be writing to those files are active. If you need to allow other programs to access a file in the transit directory, for example to correct problems with file processing in a flow, ensure that you stop all of the relevant flows beforehand.

Using the same directory as an input directory and an output directory

You can use a single directory as the input directory of one flow and the output directory of another. In this situation, the archive subdirectories are shared between the flows but the transit and backout subdirectories are not shared. If the message flows are in the same execution group, the message flows cooperate. If the message flows are in separate execution groups, contention might occur which might cause processing exceptions. However, it is not possible for a file to be read by a FileInput node until a FileOutput node has finished with the file, and has then moved it out of the transit directory.

Using LocalEnvironment variables with file nodes

This topic describes the LocalEnvironment variables available to you when you use file nodes to process files.

You can use various fields in the LocalEnvironment to dynamically interrogate and alter file node properties. These fields are available in the following message tree structures:

- LocalEnvironment.File
- LocalEnvironment.WrittenDestination.File
- LocalEnvironment.Wildcard.WildcardMatch

LocalEnvironment.File fields

When you use the FileInput node, it stores information that you can access in the LocalEnvironment.File message tree. The fields in this structure are described in the following table:

Table 17.

Element Name	Element Data Type	Description
Directory	CHARACTER	Absolute directory path of the input directory in the form used by the file system of the broker. For example, on Windows systems, this starts with the drive letter prefix (such as C:).

Table 17. (continued)

Element Name	Element Data Type	Description
Name	CHARACTER	File name and extension.
LastModified	TIMESTAMP	Date and time the file was last modified.
TimeStamp	CHARACTER	Date and time the input node started processing the file in the coordinated universal time (UTC) zone, as a character string. This data is the string used to create archive and backout file names if a timestamp is included.
The following elements contain data about the current record:		
Offset	INTEGER	Start of the record within the file. The first record starts at offset 0. When part of the End of Data message tree, this is the length of the input file.
Record	INTEGER	Number of the record within the file. The first record is record number 1. When part of the End of Data message tree, this is the number of records.
Delimiter	CHARACTER	The characters used to separate this record from the preceding record, if Delimited is specified in Record detection. The first record has a null delimiter. When part of the End of Data message tree, this is the delimiter that follows the last record, if any.
IsEmpty	BOOLEAN	Whether the record propagated by the message flow is empty. It is set to TRUE if the current record is empty. When part of the End of Data message tree, this is always set to TRUE.

This structure is propagated with each message written to the Out terminal of the FileInput node and with the empty message written to the End of data terminal.

LocalEnvironment.WrittenDestination.File fields

When you use the FileOutput node, it stores information that you can access in the LocalEnvironment.WrittenDestination.File message tree. The fields in this structure are described in the following table:

Table 18.

Element Name	Element Data Type	Description
Directory	CHARACTER	Absolute directory path of the output directory in the form used by the file system of the broker. For example, on Windows systems, this starts with the drive letter prefix (such as C:).
Name	CHARACTER	File name of the output file.
Action	CHARACTER	Possible values are: <ul style="list-style-type: none"> • Replace if an output file of the same name is replaced. • Create if a new output file is created. • Append if this is associated with a record that is appended to an output file. • Finish if a Finish File message is received and no file is found to finish (for example, if Record is Whole File is specified and a message is sent to the Finish File terminal). • Transmit if the file was transferred by FTP and the file was not retained.
Timestamp	CHARACTER	The date and time, in character string form, when the node started to process this file. This is the value which prefixes the names of files that are archived if you specify Time Stamp, Archive and Replace Existing File in the Output file action property on the Basic tab.

LocalEnvironment.Wildcard.WildcardMatch field

On the FileInput node, you can specify a file name pattern that contains wildcard characters. The FileInput node copies the characters in the file name matched by wildcards, together with any intermediate characters, to LocalEnvironment.Wildcard.WildcardMatch.

Table 19.

Element Name	Element Data Type	Description
WildcardMatch	CHARACTER	The character string in the file name matched by wildcards in the file name pattern.

For example, if the file name pattern on the FileInput node is specified as file*.txt

and the file that is read has a name of file02.txt, then the value of WildcardMatch becomes 02. If the file name pattern on the FileInput node is specified as file??type.*, and the file that is read has a name of file02type.xml, then the value of WildCardMatch becomes 02type.xml.

On the FileOutput node, you can use a wildcard character in the file name pattern. If you include the single wildcard character, '*', in the file name pattern, the node uses the value that is stored in LocalEnvironment.Wildcard.WildcardMatch. This is useful if you have a message flow where the FileInput and FileOutput nodes are working with the same file; you can preserve the name of the input file on the FileOutput node. You can also use standard methods for manipulating the value of the WildcardMatch element to whatever you want; you do not have to use a FileInput node.

File name patterns

You can specify a file name pattern, using wildcard characters, to identify a file to be read by the FileInput node. You can also specify a file name pattern, using a single wildcard character, to name the file to be created by the FileOutput node.

Using file name patterns with the FileInput node

The FileInput node reads files from a specified directory and propagates messages based on the contents of these files. Only files with names that match a pattern (the input pattern), as specified in the FileInput node's File name or pattern property, are read. This is either a file name or a character sequence (a pattern) that matches a file name. A pattern is a sequence containing at least one of the following wildcard characters:

Wildcard character	Description	Example
*	Any sequence of zero or more characters	*.xml matches all file names with an xml extension
?	Any single character	f?????.csv matches all file names consisting of the letter f followed by six characters and then the sequence .csv.

The default pattern is * which matches all file names.

You cannot specify file names that contain the following characters: the asterisk ('*'), the question mark ('?'), file name separator characters ('/' and '\').

You might want to process files that all have a certain extension, for example xml. If so, set a value of *.xml in the FileInput node's File name or pattern property and the node will process all files in the directory that have this extension.

If you deploy the flow to a Windows server, file names match the pattern irrespective of case. However, if you deploy the flow to a Linux, UNIX, or z/OS server, file names must match the pattern character string and case.

Pattern matching

The FileInput node sets the LocalEnvironment.Wildcard.WildcardMatch element to the string matched by wildcards in the file name. Here are some examples of pattern matching with the value in this element where the value in the File name or pattern property is File????.from*.xml:

- If the FileInput node finds a file with the file name File1234.fromHQ.xml, there is a match. The value in the LocalEnvironment.Wildcard.WildcardMatch element is set to 1234.fromHQ and the node processes the file.
- If the file name is File123.fromHQ.xml, there is no match because there are insufficient characters between the File and .from elements of the file name. The FileInput node ignores this file.
- If the file name is File2345.from.xml, there is a match. The value in the LocalEnvironment.Wildcard.WildcardMatch element is set to 2345.from and the node processes the file. In this example, the * in the character string in the File name or pattern property matches a string of zero characters. If you required the character string between the from and .xml elements of the file name to always have at least one character, you would specify the File name or pattern property with a value of File????.from?* .xml.

Using file name patterns with the FileOutput node

The FileOutput node writes messages to files that it creates or replaces in the broker's file system. Only files with names that match a pattern, as specified in the FileInput node's File name or pattern property, are written. This is either a file name or a character sequence (a pattern) that matches a file name. Only patterns containing a single wildcard character (the asterisk, '*') are allowed in this property. The file name to be used is determined as follows:

- If the File name or pattern property contains no wildcard, then the value of this property is the name of the file created. This must be a valid file name on the file system which hosts the broker to which the message flow is deployed.
- If the File name or pattern property contains a single wildcard, then the value of the element LocalEnvironment.Wildcard.WildcardMatch in the current message replaces the wildcard character, and the resulting value is the name of the file created. This must be a valid file name on the file system which hosts the broker to which the message flow is deployed. If the WildcardMatch value is not found, the wildcard character is replaced by the empty string.

You cannot specify file names that contain the following characters: the asterisk ('*'), the question mark ('?'), file name separator characters ('/' and '\'). The name of the file can be overridden by values in the current message.

If the File name or pattern property is empty, the name must be overridden by the current message. Wildcard substitution occurs only if this property is not overridden in this way.

File names are passed to the file system to which the broker has access and have to respect the conventions of these file systems. For example, file names on Windows systems are not case-sensitive, while, on UNIX systems, file names which differ by case are considered distinct.

FTP considerations

You can use the FileInput node to transfer files from a remote FTP server and process them. Only files with names that match the file name pattern specified in the node are read. If your broker is on a platform that respects case sensitivity, such as UNIX, you might specify a pattern that includes a combination of upper and lower case characters. If you then use this pattern to process files that are in a directory on a remote FTP server, and this is running on a platform which does not respect case sensitivity, such as Windows, file name matching might fail and no files are processed; this is because the file names on the remote server are not in

mixed case. If your broker is on a platform which does not respect case sensitivity, any pattern that you specify might be matched by more than one file on a remote FTP server which is running on a platform on which case sensitivity is significant. Each of these files is then processed sequentially.

You can use the FileOutput node to write files to a remote FTP server. Only files with names that match the pattern specified in the node are written. If your broker is on a platform that respects case sensitivity, such as UNIX, you might specify a pattern that includes a combination of upper and lower case characters. If you then use this pattern to write files to a directory on a remote FTP server, and this is running on a platform which does not respect case sensitivity, such as Windows, the file name written will not be as specified in your pattern; it will be in upper case.

If a name of a file on a remote FTP server contains a character, or characters, which are invalid on the platform on which the broker where you specified the file name pattern is running, the file is not transferred from the FTP server for processing by the FileInput node.

mqsiarchive subdirectory

This topic describes the mqsiarchive subdirectory and the circumstances in which files are placed there.

The input directory of the FileInput node has a subdirectory called **mqsiarchive**. The output directory of the FileOutput node also has a subdirectory called **mqsiarchive**.

FileInput node's mqsiarchive subdirectory

Files that are processed successfully by the FileInput node are moved to the mqsiarchive subdirectory if the FileInput node's Action on successful processing property is set to Move to Archive Subdirectory or Add Timestamp and Move to Archive Subdirectory.

Select the Replace duplicate archive files check box to ensure that should a file of the same name exist already in the mqsiarchive subdirectory as one that is about to be moved to the mqsiarchive subdirectory, the file that exists already is replaced. If you do not set this option, and a file with the same name already exists in the archive subdirectory, the node stops processing files. Every time that the node returns from its polling wait period, it issues a pair of messages, BIP3331 and a more specific one describing the problem. To avoid flooding the broker event log, duplicate messages are suppressed for an increasing period of time, until eventually they are issued about once every hour. In this circumstance, the system administrator must stop the flow, correct the problem, and then restart the flow.

Clear the Replace duplicate archive files check box only if you are sure either that the input files have unique names, or that some other process will remove a file from the archive directory before the FileInput node processes another of the same name. If you cannot ensure this, either specify Add Timestamp and Move to Archive Subdirectory in the Action on successful processing property so that archived files have unique names, or select the Replace duplicate archive files check box

FileOutput node's mqsiarchive subdirectory

Files that are processed successfully by the FileOutput node are moved to the mqsiarchive subdirectory if the FileOutput node's Output file action property is set to Archive and Replace Existing File or Time Stamp, Archive and Replace Existing File.

If you select the Replace duplicate archive files check box, that means that should a file of the same name exist already in the mqsiarchive subdirectory as one that is about to be moved to the mqsiarchive subdirectory, the file that exists already is replaced. If you do not set this option, and a file with the same name already exists in the archive subdirectory, the node experiences an exception when it tries to move the successfully processed file; the file that the node is trying to move to the mqsiarchive subdirectory remains in the transit subdirectory.

Reading a file

This section introduces examples of using a FileInput node to read files. The first example shows you how to read a file on your local file system. The second example shows you how to read a file in a directory on a remote FTP server. The third topic in this section shows a number of examples of how combinations of different values in the Record detection, Delimiter, and Delimiter type properties propagate messages with different structures. This third topic is a series of variations of the examples in the first two topics.

This section contains the following topics:

- "Reading a file on your local file system"
- "Reading a file on a remote FTP directory" on page 729
- "Reading a file, effects of different values in the FileInput node's Record detection property" on page 731

Reading a file on your local file system

This topic gives you an example of how to use a FileInput node to read a file on your local file system and then propagate messages that are based on the contents of that file. It shows how one combination of values in the Record detection, Delimiter, and Delimiter type properties can be used to extract messages from a file.

This example describes the FileInput node of a message flow and assumes that the rest of the flow has already been developed. It is also assumed that a Windows system is being used. To complete this example task, you must first have added a FileInput node to a message flow. You also need to ensure that you have the following resources available:

- An input file. To follow this example scenario, create an input file called test_input1.xml with the following content:

```
<Message>test1</Message>
<Message>testtwo</Message>
<Message>testthree</Message>
```

Each line ends with a line terminator; on a Windows system, this comprises carriage return and line feed characters (X'0D0A'). Put this file into directory C:\FileInput\TestDir.

- A message set. This example uses a message set called xml1 which uses the XMLNSC parser. Message set xml1 models messages of the following form:

<Message>...</Message>

Once you have these resources available, perform the following steps:

1. Set the required node properties on the FileInput node. The following table summarizes the FileInput node properties that you should set, which tab they appear on and the value that you should set in order to follow this example:

Table 20.

Tab	Property	Value
Basic	Input directory	C:\FileInput\TestDir
	File name or pattern	test_input1.xml
	Action on successful processing	Move to Archive Subdirectory
	Replace duplicate archive files	Selected
Input Message Parsing	Message domain	XMLNSC
	Message set	xml1
Polling	Polling interval	3
Retry	Action on failing file	Add Time Stamp and Move to Backout Subdirectory
Records and Elements	Record detection	Delimited
	Delimiter	DOS or UNIX Line End
	Delimiter type	Postfix
FTP	FTP	Not selected

2. Deploy the message flow to the broker.

The following actions occur when you perform these steps:

1. The file is processed. In accordance with the values set in the properties on the **Records and Elements** tab, the FileInput node detects records that end with a DOS or UNIX line end and creates a message for each one that it finds. It propagates three messages to the flow attached to the Out terminal:
 - Message 1:
<Message>test1</Message>
 - Message 2:
<Message>testtwo</Message>
 - Message 3:
<Message>testthree</Message>
2. If there is a flow attached to the End of Data terminal, the End of Data message is propagated after the last record in the file has been processed.
3. On completion of processing, the file test_input1.xml is moved to the mqsiarchive subdirectory, C:\FileInput\TestDir\mqsiarchive\test_input1.xml. If a file called test_input1.xml already exists in the mqsiarchive subdirectory, it is overwritten.
4. If the message flow fails, retry processing is attempted according to the values set in the properties of the FileInput node. In this example task, a time stamp is added to the file name and the file is moved to the mqsibackout directory. Here is an example of the path to such a file: C:\FileInput\TestDir\mqsibackout\20070928_150234_171021_test_input1.xml.

To see the effects of specifying other combinations of values in the Record detection, Delimiter, and Delimiter type properties of the FileInput node, see “Reading a file, effects of different values in the FileInput node’s Record detection property” on page 731.

The following samples also provide examples of how to use this node:

- Batch Processing sample
- WildcardMatch sample

You can view samples only when you use the information center that is integrated with the Message Broker Toolkit.

Reading a file on a remote FTP directory

This topic gives you an example of how to use a FileInput node to read a file in a directory on a remote FTP server and then propagate messages that are based on the contents of that file.

This example is an extension of the example described in “Reading a file on your local file system” on page 727 and it describes the FileInput node of an example message flow. It assumes that the rest of the flow has already been developed and that a Windows system is being used. To complete this example task, you must first have added a FileInput node to a message flow. You also need to ensure that you have the following resources available:

- An FTP server. Ensure that an FTP server exists which has the following settings:

Server ftpserver.hursley.abc.com

Port 21

Working directory
/ftpfileinput

Userid
myuserid

Password
mypassword

These values are for the purposes only of this example. If you use other values, record them so that you can set the appropriate values below. This example uses the values above.

- A security identity. Use the `mqsisetdbparms` command to define a security identity called, in this example, *myidentity* for the user and password details above. For example, use the following command for a broker called MyBroker:

```
mqsisetdbparms MyBroker -n ftp::myidentity -u myuserid -p mypassword
```

Notice the `ftp::` prefix which is required so that file nodes can find the security identity definition.

- An input file. To follow this example scenario, create an input file called `test_input1.xml` with the following content:

```
<Message>test1</Message>  
<Message>testtwo</Message>  
<Message>testthree</Message>
```

Each line ends with a line terminator suitable for system upon which the FTP server resides. Do not put this file in the input directory but, instead, put it on the FTP server directory /ftpfileinput.

- A message set. This example uses a message set called xml1 which uses the XMLNSC parser. Message set xml1 models messages of the following form:
<Message>...</Message>

Once you have these resources available, perform the following steps:

1. Set the required node properties on the FileInput node. The following table summarizes the FileInput node properties that you should set, which tab they appear on, whether they are mandatory and the value that you should set in order to follow this example:

Table 21.

Tab	Property	Value
Basic	Input directory	C:\FileInput\TestDir
	File name or pattern	test_input1.xml
	Action on successful processing	Move to Archive Subdirectory
	Replace duplicate archive files	Selected
Input Message Parsing	Message domain	XMLNSC
	Message set	xml1
Polling	Polling interval	3
Retry	Action on failing file	Add Time Stamp and Move to Backout Subdirectory
Records and Elements	Record detection	Delimited
	Delimiter	DOS or UNIX Line End
	Delimiter type	Postfix
FTP	FTP	Selected
	FTP server and port	ftpsrvr.hursley.abc.com
	Security identity	myidentity
	Server directory	/ftpfileinput
	Transfer mode	ASCII
	Scan delay	45

If you used other values for your FTP server resource, use those values. These settings are identical to those used in the example in “Reading a file on your local file system” on page 727 except that the FTP property has been selected and there are now properties on the FTP tab. If you clear the FTP check box, the node behaves as it does in the example in “Reading a file on your local file system” on page 727; the FTP properties remain set but have no effect.

2. Deploy the message flow to the broker.

The following actions occur when you perform these steps:

1. The file test_input1.xml is transferred from the FTP server directory (/ftpfileinput) to the local directory (C:\FileInput\TestDir). The file is deleted from the FTP server directory.
2. In accordance with the values set in the properties on the **Records and elements** tab, the FileInput node detects records that end with a DOS or UNIX

line end and creates a message for each one that it finds. It propagates three messages to the flow attached to the Out terminal:

- Message 1:
`<Message>test1</Message>`
 - Message 2:
`<Message>testtwo</Message>`
 - Message 3:
`<Message>testthree</Message>`
3. Because the FTP check box is selected, the FTP scan delay of 45 seconds overrides the polling interval of 3 seconds.
 4. If there is a node attached to the End of Data terminal, the End of Data message is propagated after the last record in the file has been processed.
 5. On completion of processing, the file `test_input1.xml` is moved to the `mqsiarchive` subdirectory `C:\FileInput\TestDir\mqsiarchive\test_input1.xml`. If a file called `test_input1.xml` already exists in the `mqsiarchive` subdirectory, it is overwritten.
 6. If the message flow fails, retry processing is attempted according to the values set in the properties of the `FileInput` node. In this example task, a time stamp is added to the file name and the file is moved to the `mqsibackout` directory. Here is an example of the path to such a file: `C:\FileInput\TestDir\mqsibackout\20070928_150234_171021_test_input1.xml`.

To see the effects of specifying other combinations of values in the `Record detection`, `Delimiter`, and `Delimiter type` properties of the `FileInput` node, see “Reading a file, effects of different values in the `FileInput` node’s `Record detection` property.”

The following samples also provide examples of how to use this node:

- `Batch Processing` sample
- `WildcardMatch` sample

You can view samples only when you use the information center that is integrated with the `Message Broker Toolkit`.

Reading a file, effects of different values in the `FileInput` node’s `Record detection` property

This topic demonstrates the effect of different settings of the properties on the `FileInput` node’s `Records and Elements` tab.

The examples described in this topic are based on the examples described in “Reading a file on your local file system” on page 727 and “Reading a file on a remote FTP directory” on page 729. In each case, the input file to use, the property settings, and the expected results are described.

Example 1. Records read are separated by a DOS or UNIX line end

This example is identical to the one described in “Reading a file on your local file system” on page 727 or “Reading a file on a remote FTP directory” on page 729. Create an input file called `test_input1.xml` with the following content:

```
<Message>test1</Message>
<Message>testtwo</Message>
<Message>testthree</Message>
```

Each line ends with a line terminator; on a Windows system, this comprises carriage return and line feed characters (X'0D0A').

The properties to set are:

Table 22.

Tab	Property	Value
Records and Elements	Record detection	Delimited
	Delimiter	DOS or UNIX Line End
	Delimiter type	Postfix

The FileInput node detects records that end with a DOS or UNIX line end and creates a message for each one that it finds.

The result is the propagation of three messages, as follows:

- Message 1:
`<Message>test1</Message>`
- Message 2:
`<Message>testtwo</Message>`
- Message 3:
`<Message>testthree</Message>`

The DOS or UNIX line end is not part of any propagated message.

Example 2. Records read are separated by a custom delimiter

Create an input file called test_input2.xml with the following content:

```
<Message>test01</Message>,<Message>test001</Message>,<Message>test0001</Message>
```

There should be no line terminator at the end of this file data; the XMLNSC parser ignores the line terminator if it is present.

In addition to the property settings described in “Reading a file on your local file system” on page 727 or “Reading a file on a remote FTP directory” on page 729, set these properties:

Table 23.

Tab	Property	Value
Basic	File name or pattern	test_input2.xml
Records and Elements	Record detection	Delimited
	Delimiter	Custom Delimiter
	Custom delimiter	2C
	Delimiter type	Infix

The hexadecimal X'2C' represents a comma in ASCII. On other systems, a different hexadecimal code might need to be used.

The FileInput node detects the comma character and separates records with it. Because the value of the Delimiter type property is Infix, there need not be a comma at the end of the file.

The result is the propagation of three messages, as follows:

- Message 1:
<Message>test01</Message>
- Message 2:
<Message>test001</Message>
- Message 3:
<Message>test0001</Message>

The comma character is not part of any propagated message. There are no commas in the bodies of the message in this example; if there were commas in the message bodies, the records would be split at those points resulting in incorrectly formed messages being propagated to the rest of the flow.

Example 3. Records read are separated by a fixed number of bytes

Create an input file called test_input3.xml with the following content:

```
<Message>123456789</Message><Message>abcdefghi</Message><Message>rstuvwxyz</Message>
```

There should be no line terminator at the end of this file.

In addition to the property settings described in “Reading a file on your local file system” on page 727 or “Reading a file on a remote FTP directory” on page 729, set these properties:

Table 24.

Tab	Property	Value
Basic	File name or pattern	test_input3.xml
Records and Elements	Record detection	Fixed Length
Length	28	

The FileInput node segments the input file into records each 28 bytes in length.

The result is the propagation of three messages, as follows:

- Message 1:
<Message>123456789</Message>
- Message 2:
<Message>abcdefghi</Message>
- Message 3:
<Message>rstuvwxyz</Message>

Each message is 28 bytes long. If the file were to contain trailing bytes, for example a carriage return-line feed pair, these would result in the propagation of a further message containing these bytes; this may or may not be recognized by the message domain, message set and message type assigned to parse the message.

Example 4. Records read are whole files

Create an input file called test_input4.xml with the following content:

```
<Message>Text string of a length decided by you, even including line terminators, as long as it only contains this tag at the end.</Message>
```

There should be no line terminator at the end of this file; if there is one, it has no effect.

In addition to the property settings described in “Reading a file on your local file system” on page 727 or “Reading a file on a remote FTP directory” on page 729, set these properties:

Table 25.

Tab	Property	Value
Basic	File name or pattern	test_input4.xml
Records and Elements	Record detection	Whole File

The FileInput node does not split the file; it supplies all of the file’s content to be parsed by the message domain, message set and message type as specified on the node. In this example, you are using the XMLNSC parser and message set xml1 and the message should be recognized.

The result is the propagation of one message, as follows:

- Message 1:

```
<Message>Text string of a length decided by you, even including line terminators, as long as it only contains this tag at the end.</Message>
```

Trailing bytes (for example, line terminators) are included in this.

Example 5. Records read are recognized as separate messages by the parser specified in the Message domain property

Create an input file called test_input5.xml with the following content:

```
<Message>Text string of a length decided by you</Message><Message>and another</Message>  
<Message>and another on a new line</Message>
```

Line terminators at the end of this file, or at the end of lines, are acceptable.

In addition to the property settings described in “Reading a file on your local file system” on page 727 or “Reading a file on a remote FTP directory” on page 729, set these properties:

Table 26.

Tab	Property	Value
Basic	File name or pattern	test_input5.xml
Records and Elements	Record detection	Parsed Record Sequence

The FileInput node defers to the parser to determine the record boundaries. In this example, message set xml1 in domain XMLNSC should recognize the complete <Message> XML format. XMLNSC absorbs trailing white space (for example, line terminators).

The result is the propagation of three messages, as follows:

- Message 1:

```
<Message>Text string of a length decided by you</Message>
```

- Message 2:

```
<Message>and another</Message>
```

- Message 3:

<Message>and another on a new line</Message>

Trailing white space (for example, line terminators) are included in these.

Writing a file

This section introduces examples of using a FileOutput node to write files. The first example shows you how to write a file to a directory in your local file system. The second example shows you how to write a file to a directory on a remote FTP server. The third topic in this section shows a number of examples of how combinations of different values in the Record definition, Delimiter, and Delimiter type properties, acting on the same input messages, result in the creation of files with different structures. This third topic is a series of variations of the examples in the first two topics.

This section contains the following topics:

- “Writing a file to your local file system”
- “Writing a file to a remote FTP server” on page 737
- “Writing a file, effects of different values in the FileOutput node’s Record definition property” on page 739

Writing a file to your local file system

This topic gives you an example of how to use a FileOutput node to write a file to a specified directory on your local file system. It shows you how one combination of values in the Record definition, Delimiter, and Delimiter type properties result in the creation of a file from multiple messages.

This example describes the FileOutput node of a message flow and assumes that the rest of the flow has been developed. It is also assumed that a Windows system is being used. To complete this example task, you must first have added a FileOutput node to a message flow. You also need to ensure that the following messages are produced by the flow preceding the FileOutput node:

- Three input messages. These are to be sent, in this order, to the In terminal of the FileOutput node:
 - Message 1:
`<Message>test1</Message>`
 - Message 2:
`<Message>testtwo</Message>`
 - Message 3:
`<Message>testthree</Message>`

These can be produced, for example, by the XMLNSC domain with a message set which recognizes XML with the following form:

```
<Message>...</Message>
```

- A final message. This is to be sent to the Finish File terminal of the FileOutput node after the first three messages have been sent:
`<thiscanbe>anything</thiscanbe>`

Once you have these resources available, perform the following steps:

1. Set the required node properties on the FileOutput node. The following table summarizes the FileOutput node properties that you should set, which tab they appear on, and the value that you should set in order to follow this example:

Table 27.

Tab	Property	Value
Basic	Directory	C:\FileOutput\TestDir
	File name or pattern	test_output1.xml
	Output file action	Time Stamp, Archive and Replace Existing File (or Create if File does not Exist)
	Replace duplicate archive files	Selected
Records and Elements	Record definition	Record is Delimited Data
	Delimiter	Broker System Line End
	Delimiter type	Postfix
FTP	FTP	Cleared

2. Deploy the message flow to the broker.
3. Send the first three messages to the In terminal of the FileOutput node.
4. Send the final message to the Finish File terminal of the FileOutput node.

The following actions occur when you perform these steps:

1. The file is processed. In accordance with the values set in the properties of the FileOutput node, the node generates one record per message with a local file system line terminator after each one. The file contains the following data, each line terminated by a carriage return (X'0D') and line feed (X'0A') pair of characters (on a Windows system):

```
<Message>test1</Message>
<Message>testtwo</Message>
<Message>testthree</Message>
```
2. Records are accumulated in a file in the C:\FileOutput\TestDir\mqsitransit directory. This file is named test_output1.xml. When the final message is sent to the Finish File terminal, the file is moved to the output directory, C:\FileOutput\TestDir directory.
3. If a file of the same name already exists in the output directory, the existing file is renamed and moved to the mqsiarchive directory. For example, this might result in the file:

C:\FileOutput\TestDir\mqsiarchive\20070924_155346_312030_test_output1.xml

being created. If a file of this name already exists in this archive directory, it is overwritten in accordance with the Replace duplicate archive files property selected on the FileOutput node.

Now see “Writing a file, effects of different values in the FileOutput node’s Record definition property” on page 739 to see the results of running this task with different values set in the Record definition, Delimiter, and Delimiter type properties of the FileOutput node.

The following samples also provide examples of how to use this node:

- File Output sample
- Batch Processing sample
- WildcardMatch sample

You can view samples only when you use the information center that is integrated with the Message Broker Toolkit.

Writing a file to a remote FTP server

This topic gives you an example of how to use a FileOutput node to write a file to a directory on a remote FTP server. It shows you how one combination of values in the Record definition, Delimiter, and Delimiter type properties result in the creation of a file from multiple messages.

This example is an extension of the example described in “Writing a file to your local file system” on page 735 and it describes the FileOutput node of a message flow. It assumes that the rest of the flow has already been developed and that a Windows system is being used. To complete this example task, you must first have added a FileOutput node to a message flow. You also need to ensure that you have the following resources available:

- An FTP server. Ensure that an FTP server exists and which, in order that you may follow this example scenario, has the following settings:

Server ftpserver.hursley.abc.com

Port 21

Working directory
/ftpfileoutput

Userid
myuserid

Password
mypassword

These values are for the purposes only of this example. If you use other values, record them so that you can set the appropriate values below. This example uses the values above.

- A security identity. Use the mqsisetdbparms command to define a security identity called, in this example, *myidentity* for the user and password details above. For example, use the following command for a broker called MyBroker:

```
mqsisetdbparms MyBroker -n ftp::myidentity -u myuserid -p mypassword
```

Notice the ftp:: prefix which is required so that file nodes can find the security identity definition.

- Arrange for the following messages which to be produced by the flow preceding the FileOutput node:

– Three input messages. These are to be sent, in this order, to the In terminal of the FileOutput node:

- Message 1:

```
<Message>test1</Message>
```

- Message 2:

```
<Message>testtwo</Message>
```

- Message 3:

```
<Message>testthree</Message>
```

These can be produced, for example, by the XMLNSC domain with a message set which recognizes XML with the following form:

```
<Message>...</Message>
```

- A final message. This is to be sent to the Finish File terminal of the FileOutput node after the first three messages have been sent:
`<thiscanbe>anything</thiscanbe>`

Once you have these resources available, perform the following steps:

1. Set the required node properties on the FileOutput node. The following table summarizes the FileOutput node properties that you should set, which tab they appear on, and the value that you should set in order to follow this example:

Table 28.

Tab	Property	Value
Basic	Directory	C:\FileOutput\TestDir
	File name or pattern	test_output1.xml
	Output file action	Time Stamp, Archive and Replace Existing File (or Create if File does not Exist)
	Replace duplicate archive files	Selected
Records and Elements	Record definition	Record is Delimited Data
	Delimiter	Broker System Line End
	Delimiter type	Postfix
FTP	FTP	Selected
	FTP server and port	ftpserver.hursley.abc.com
	Security identity	myidentity
	Server directory	/ftpfileoutput
	Transfer mode	ASCII
	Retain local file after transfer	Selected

If you used other values for your FTP server resource, use those values. These settings are identical to those used in the example in “Writing a file to your local file system” on page 735 except that the FTP property has been selected and there are now properties on the **FTP** tab. If you clear the FTP check box, the node behaves as it does in the example in “Writing a file to your local file system” on page 735; the FTP properties remain set but have no effect.

2. Deploy the message flow to the broker.
3. Send the first three messages to the In terminal of the FileOutput node.
4. Send the final message to the Finish File terminal of the FileOutput node.

The following actions occur when you perform these steps:

1. The file is processed. In accordance with the values set in the properties of the FileOutput node, the node generates one record per message with a local file system line terminator after each one. The file contains the following data, each line terminated by a carriage return (X'0D') and line feed (X'0A') pair of characters (on a Windows system):

```
<Message>test1</Message>
<Message>testtwo</Message>
<Message>testthree</Message>
```

2. Records are accumulated in a file in the C:\FileOutput\TestDir\mqsitransit directory. This file is named test_output1.xml. When the final message is sent to

the Finish File terminal, and because the FTP check box is selected, the file is moved to the remote FTP server directory, resulting in the file/ftpfileoutput/test_output1.xml.

3. If a file of the same name already exists in the remote FTP server directory, the existing file is overwritten.

If the remote FTP server is not running on a Windows system and the Transfer mode property is set to ASCII, the character encoding and line terminator characters can be modified after transfer. For example, on a z/OS FTP server, the ASCII text is normally converted to EBCDIC and the line terminator character pairs replaced by EBCDIC new line character (X'15'). Other FTP servers might treat ASCII transfers differently.

4. Because the Retain local file after transfer check box is selected, the local file is not deleted but is moved from the mqsitransit subdirectory to the output directory, C:\FileOutput\TestDir. If a file of the same name already exists in the output directory, the existing file is renamed and moved to the mqsiarchive directory. For example, this might result in the file:

C:\FileOutput\TestDir\mqsiarchive\20070924_155346_312030_test_output1.xml

being created. However, if a file of this name already exists in this archive directory, it is overwritten in accordance with the value of the Replace duplicate archive files property set on the FileOutput node.

Now see “Writing a file, effects of different values in the FileOutput node’s Record definition property” to see the results of running this task with different values set in the Record definition, Delimiter, and Delimiter type properties of the FileOutput node.

The following samples also provide examples of how to use this node:

- File Output sample
- Batch Processing sample
- WildcardMatch sample

You can view samples only when you use the information center that is integrated with the Message Broker Toolkit.

Writing a file, effects of different values in the FileOutput node’s Record definition property

This topic demonstrates the effect of different settings of the properties on the FileOutput node’s **Records and Elements** tab.

The examples described in this topic are based on the examples described in “Writing a file to your local file system” on page 735 and “Writing a file to a remote FTP server” on page 737. In all examples, it is assumed that the same messages are sent to the FileOutput node; three to the In terminal and one to the Finish File terminal:

- Three input messages. These are to be sent, in this order, to the In terminal of the FileOutput node:
 - Message 1:
<Message>test1</Message>
 - Message 2:
<Message>testtwo</Message>

- Message 3:
`<Message>testthree</Message>`

These can be produced, for example, by the XMLNSC domain with a message set which recognizes XML with the following form:

`<Message>...</Message>`

- A final message. This is to be sent to the Finish File terminal of the FileOutput node after the first three messages have been sent. It does not matter what this message contains

The following examples describe the contents of the file or files produced; the disposition of the files created is as in the “Writing a file to your local file system” on page 735 and “Writing a file to a remote FTP server” on page 737 topics.

Example 1. Records written are separated by a DOS or UNIX line end

This example is identical to the one described in “Writing a file to your local file system” on page 735 or “Writing a file to a remote FTP server” on page 737. Specify the node’s properties as described in “Writing a file to your local file system” on page 735 or “Writing a file to a remote FTP server” on page 737.

This results in one file being written. The file contains three records each terminated by a local system line terminator; on a Windows system, this is a carriage return line feed pair (X’0D0A’).

`<Message>test1</Message>`
`<Message>testtwo</Message>`
`<Message>testthree</Message>`

Example 2. Records written are separated by a custom delimiter

In addition to the property settings described in “Writing a file to your local file system” on page 735 or “Writing a file to a remote FTP server” on page 737, set these properties on the **Records and Elements** tab as follows:

Table 29.

Property	Value
Record definition	Record is Delimited Data
Delimiter	Custom Delimiter
Custom delimiter	0D0A
Delimiter type	Postfix

The hexadecimal X’0D0A’ represents a carriage return character followed by a line feed character. On a Windows system, this results in a file identical to the one created in Example 1. On other systems, the result may differ to the result in Example 1; Example 1 uses local system line end characters, whereas Example 2 always puts the X’0D0A’ sequence at the end of each line.

Example 3. Records written are padded to a fixed length

In addition to the property settings described in “Writing a file to your local file system” on page 735 or “Writing a file to a remote FTP server” on page 737, set these properties on the **Records and Elements** tab as follows:

Table 30.

Property	Value
Record definition	Record is Fixed Length Data
Length (bytes)	30
Padding bytes (hexadecimal)	2A

The hexadecimal character X'2A' represents an asterisk character in ASCII.

The length of each incoming message is 24 bytes, 26 bytes, and 28 bytes respectively. The required fixed length of each record is 30 bytes. Each record is, therefore, padded by an extra 6 bytes, 4 bytes, or 2 bytes, with the hexadecimal character X'2A' which represents an asterisk character in ASCII.

One file is written. It contains a single line:

```
<Message>test1</Message>*****<Message>testtwo</Message>*****<Message>testthree</Message>**
```

Example 4. Records written are not separated by delimiters or padding

In addition to the property settings described in “Writing a file to your local file system” on page 735 or “Writing a file to a remote FTP server” on page 737, set this property on the **Records and Elements** tab as follows:

Table 31.

Property	Value
Record definition	Record is Unmodified Data

The records are concatenated with no padding or delimiters.

One file is written with the following content:

```
<Message>test1</Message><Message>testtwo</Message><Message>testthree</Message>
```

There are no trailing bytes or line terminators.

Example 5. Records are written as whole files

In addition to the property settings described in “Writing a file to your local file system” on page 735 or “Writing a file to a remote FTP server” on page 737, set this property on the **Records and Elements** tab as follows:

Table 32.

Property	Value
Record definition	Record is Whole File

This results in three files being created, each containing one record:

- File 1:
<Message>test1</Message>
- File 2:
<Message>testtwo</Message>
- File 3:
<Message>testthree</Message>

Each of these files is created with the same name, one by one, in the mqsitransit directory. If you are following the example in “Writing a file to a remote FTP server” on page 737, each file is transferred to the remote FTP server. However, because each file overwrites the previous one, only the third file remains when the task is complete.

After optional transfer, if a copy is retained, each file is moved to the output directory, C:\FileOutput\TestDir. In accordance with the properties on the FileOutput node as described in “Writing a file to your local file system” on page 735 or “Writing a file to a remote FTP server” on page 737, the second file moved displaces the first file from the output directory and moved to the mqsiarchive subdirectory; this displaced file is also renamed. When the third file is moved to the output directory, it displaces the second file, causing it to be moved to the mqsiarchive subdirectory and renamed. The final result is files similar to these:

```
C:\FileOutput\TestDir\mqsiarchive\20071101_165346_312030_test_output1.xml  
C:\FileOutput\TestDir\mqsiarchive\20071101_165347_312030_test_output1.xml  
C:\FileOutput\TestDir\test_output1.xml
```

being File 1, File 2, and File 3 respectively. If FTP processing were enabled, File 3 would also be in the remote FTP server directory and called test_output1.xml.

Part 4. Deploying

Deploying	745
Deployment overview	746
Deployment methods.	746
Types of deployment	748
Message flow application deployment	749
Broker configuration deployment.	753
Publish/subscribe topology deployment	753
Publish/subscribe topics hierarchy deployment	754
Cancel deployment	755
Deploying a message flow application	757
Creating a server project.	757
Creating a broker archive	758
Adding files to a broker archive	759
Refreshing the contents of a broker archive	763
Deploying a broker archive file	763
Deploying a message flow application that uses WebSphere Adapters	766
Deploying a broker configuration.	767
Using the Message Broker Toolkit	767
Using the mqsideploy command	767
Using the Configuration Manager Proxy	768
Deploying a publish/subscribe topology	768
Using the Message Broker Toolkit	769
Using the mqsideploy command	769
Using the Configuration Manager Proxy	770
Deploying a publish/subscribe topics hierarchy	770
Using the Message Broker Toolkit	771
Using the mqsideploy command	771
Using the Configuration Manager Proxy API	771
Checking the results of deployment	772
Using the Message Broker Toolkit	772
Using the mqsideploy command	772
Using the Configuration Manager Proxy API	773
Canceling a deployment that is in progress	774
Using the Message Broker Toolkit	774
Using the mqsideploy command	775
Using the Configuration Manager Proxy API	775
Renaming objects that are deployed to execution groups	776
Removing a deployed object from an execution group	776
Using the Message Broker Toolkit	776
Using the mqsideploy command	777
Using the Configuration Manager Proxy API	777

Deploying

Deploy the resources you create in the workbench to one or more brokers in your broker domain.

The mode in which your broker is working, can affect the number of execution groups and message flows that you can deploy, and the types of node that you can use. See Restrictions that apply in each operation mode.

You can deploy resources, such as message flows, to execution groups on brokers. Read the overview section for information about the different ways in which you can deploy resources, and about the different types of deployment:

- “Deployment overview” on page 746
 - “Deployment methods” on page 746
 - “Types of deployment” on page 748
 - “Message flow application deployment” on page 749
 - “Broker archive” on page 751
 - “Configurable properties of a broker archive” on page 752
 - “Version and keyword information for deployable objects” on page 752
 - “Broker configuration deployment” on page 753
 - “Publish/subscribe topology deployment” on page 753
 - “Publish/subscribe topics hierarchy deployment” on page 754
 - “Cancel deployment” on page 755

The following topics describe the basic tasks associated with deployment:

- “Deploying a message flow application” on page 757
 - “Creating a server project” on page 757
 - “Creating a broker archive” on page 758
 - “Adding files to a broker archive” on page 759
 - “Editing a broker archive file manually” on page 760
 - “Editing configurable properties” on page 761
 - “Adding multiple instances of a message flow to a broker archive” on page 761
 - “Configuring a message flow at deployment time using UDPs” on page 762
 - “Refreshing the contents of a broker archive” on page 763
 - “Deploying a broker archive file” on page 763

Learn how to perform other types of deployment:

- “Deploying a broker configuration” on page 767
- “Deploying a publish/subscribe topology” on page 768
- “Deploying a publish/subscribe topics hierarchy” on page 770

Further topics describe other deployment tasks:

- “Checking the results of deployment” on page 772
- “Canceling a deployment that is in progress” on page 774
- “Renaming objects that are deployed to execution groups” on page 776

- “Removing a deployed object from an execution group” on page 776

Deployment overview

Deployment is the process of transferring data to an execution group on a broker so that it can take effect in the broker domain.

When you create application resources such as message flows in the workbench, you must distribute them to the brokers on which you want them to run. Associated with the resources that you create is the configuration associated with those brokers in your broker domain.

You can initiate a deployment in one of three ways; from the workbench, using the `mqsideploy` command, or using functions described by the Configuration Manager Proxy. Depending on your work patterns, you might make use of all three methods at different times. These three options are described in “Deployment methods.”

You can also perform different types of deployment, depending on whether you are working with new resources, or updating existing ones. Most types of deployment can typically be configured to perform in one of two ways:

- Complete deployment; in which all resources are deployed (or redeployed) to the whole domain
- Delta or incremental deployment; made either only to update information or to deploy to selected brokers within the domain, depending on the type of deployment

See “Types of deployment” on page 748 for further information about full and delta deployment.

When you have read these overview topics, find detailed instructions for the tasks that you want to complete in the subsequent topics.

Read the IBM Redbooks publication *WebSphere Message Broker Basics* for further information about deployment.

Deployment methods

Choose the appropriate method of deployment according to that way in which you are working.

The goals of a deployment are the same, regardless of how you initiate it. The method that you choose might have an effect on how the operation is performed:

- If you use the workbench or the Configuration Manager Proxy (CMP), the request is asynchronous. Control returns immediately either to the workbench or to your Java program. You must request the result of the operation at a later time, and take appropriate action.
- If you are using the workbench, switch to the Broker Administration perspective and check the Event Log.

A deployment request always completes, either because the broker has sent a response or the timeout has expired. If you have reason to believe that the deployment might not be successful, for example if you become aware that a problem with the network or the broker might prevent its completion, you can cancel the deploy request. Use this only in exceptional circumstances; cancellation might cause the state of the execution groups to become unpredictable.

- If you are using the Configuration Manager Proxy (CMP), you can request responses to the deployment later in your program.

When the request is received by the broker, it communicates with the execution groups that are affected by the contents of the deployment request. The broker waits for a certain amount of time, during which it expects the execution groups to complete the work. If the execution groups do not indicate that they have finished before the time has expired, the broker sends back a negative response with message BIP2066.

The workbench also known as the Message Broker Toolkit

In the of the Broker Administration perspectiveworkbench, the Domain Navigator view displays all the objects associated with a specific domain. For example, if you expand the Topology view, all the brokers in the domain are displayed; if you expand a Broker view, all the execution groups within that broker are displayed. From the Domain Navigator view you can deploy a topology to all the brokers in the domain or you can deploy all the execution groups to a particular broker. You can also drag a broker archive (bar) file from the Broker Development view onto an execution group within the Domain Navigator view to deploy the contents of the broker archive.

You might typically use the workbench if you are working in a development environment or if you are new to WebSphere Message Broker.

The mqsideploy command

You can deploy from the command line using the mqsideploy command. On the command line, you typically specify the connection details as well as parameters specific to the type of deployment. Each topic describes and provides details of the types of deployment.

If you use the mqsideploy command, the deployment is started and the command waits for a response. It returns control to you (or the script that issued the command) when a response is received by the broker, or when the wait time defined by the **-w** parameter has expired, whichever occurs first. If the time expires before a response is received, the command completes with a warning message that informs you what has happened. The warning does not mean that the command has failed, only that a response was not received during the time for which it waited. You can change the wait interval by specifying a different value for the wait parameter on the command.

You might typically use the mqsideploy command in a script when you are more familiar with WebSphere Message Broker.

WebSphere Message Broker provides two files to help you when writing your own scripts that invoke the mqsideploy command:

- Initialization file mqsicfgutil.ini. This file is a plain text file in the mqsideploy command's working directory that contains configurable variables that are required to connect to the Configuration Manager. For example:

```
hostname = localhost
queueManager = QMNAME
port = 1414
securityExit = test.myExit
```

Information that you do not explicitly specify any of this information as parameters on the mqsideploy command (as shown in the examples in subsequent topics), the information is taken from the mqsicfgutil.ini file.

Alternatively, use the **-n** parameter on the command to specify an XML-format `.configmgr` file that describes the connection parameters to the Configuration Manager.

- **Windows** Batch file `mqsdeploy.bat`. On Windows platforms, use `mqsdeploy.bat` if you want to use the same parameters as those used before Version 6.0. The parameters of the `mqsdeploy` command changed in WebSphere Message Broker Version 6.0.

The Configuration Manager Proxy API

You can control deployment from anyJava program by using functions described by the Configuration Manager Proxy (CMP) API. You can also interrogate the responses from the broker and take appropriate action.

The Java applications can also use the CMP to control other objects in the domain, such as brokers, execution groups, publish/subscribe topologies, topics, subscriptions, and the Configuration Manager and its event log. This means that you can use the CMP to create and manipulate an entire domain programmatically.

Types of deployment

Describes the different types of deployment.

Follow the links to later topics in this section that describe each type of deployment and the situation in which each type should, and should not, be used.

- To deploy message flows, message sets and other deployable objects to an execution group, see [Message flow application deployment](#).

This type deployment uses a broker archive file. You can set the configurable properties for objects in the message flow.

- To deploy configuration details, see [Broker configuration deployment](#).
- In publish/subscribe scenarios, you can deploy topics and topologies:
 - [Topics hierarchy deployment](#)
 - [Topology configuration deployment](#)
- You can also [cancel a deployment](#).

This table lists examples of appropriate ways of deploying in a number of common scenarios.

Scenario	Suggested deployment
Adding a broker to the domain (when not using publish/subscribe)	None required.
Connecting publish/subscribe brokers using connections or a collective	Delta topology deployment.
Modifying the publish/subscribe topic hierarchy	Delta deployment of the topics hierarchy. (The changed elements in the topic hierarchy are deployed to all brokers in the domain.)
Modifying the publish/subscribe topic hierarchy, after adding a new broker to the domain	Complete topics deployment. (The entire topic hierarchy is deployed to all brokers in the domain. The new broker also receives the complete topic hierarchy.)

Scenario	Suggested deployment
Tidying up a broker's resources after removing it from the topology	If the broker is part of a publish/subscribe network, or if you are using the workbench, initiate a delta publish/subscribe topology deployment. Otherwise, no deployment is required.
Creating an execution group	Message flow application deployment using an incremental bar file deployment.
Deleting an execution group	None required.
If a broker is not responding to a deploy request	Ensure that the broker is running. If the broker is not running, cancel the broker deployment. You should cancel a broker deployment only if you are sure that the broker will never respond to the deploy request.

Message flow application deployment

Package all of the resources in your message flow into a broker archive (bar) file, which you can then deploy.

You cannot deploy a message flow application directly to an execution group. Instead, you package all of the relevant resources into a broker archive (bar) file, which you then deploy; see "Broker archive" on page 751. When you add files to the broker archive, they are automatically compiled as part of the process; see "Adding files to a broker archive" on page 759. JAR files that are required by JavaCompute nodes in message flows are added automatically from your Java project; see "JavaCompute node" on page 943.

The broker archive is a compressed file, which is sent to the Configuration Manager, where its contents are extracted and distributed to execution groups. If an execution group has not been initialized on the broker (that is, if the broker has only just been created), the execution group is created as part of the deployment.

The mode in which your broker is working, can affect the number of execution groups and message flows that you can deploy, and the types of node that you can use. See Restrictions that apply in each operation mode.

This diagram shows the flow of events when you deploy a message flow application:

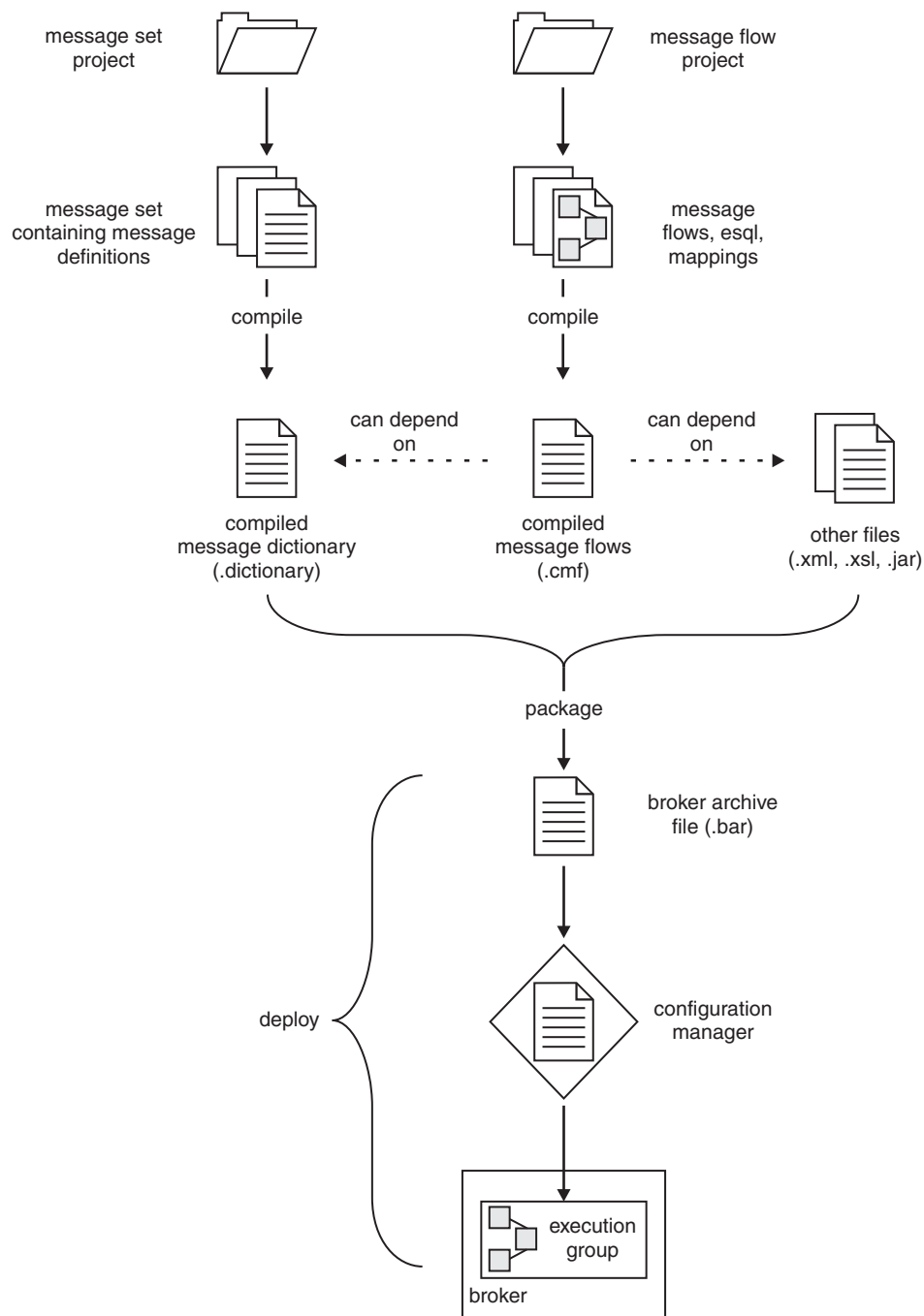

You can deploy a bar file in two ways:

- “Incremental bar file deployment” on page 751. Deployed files are added to the execution group. Files which already exist in the execution group are replaced with the new version.
- “Complete bar file deployment” on page 751. Files that are already deployed to the execution group are removed before the complete contents of the bar file are deployed. Therefore, nothing is left in the execution group from any previous deployment.

Incremental bar file deployment

Incrementally deploying a bar file tells the Configuration Manager to extract the contents of the bar file and to send those contents to an execution group. The following conditions are applied when a file is deployed to the bar file:

- If a file in the bar file has the same name as an object that is already deployed to the execution group, the version that is already deployed is replaced with the version in the bar file.
- If a file in the bar file is of zero length, and a file of that name has already been deployed to the execution group, the deployed file is removed from the execution group.

When to use

- To incrementally deploy message flows, message sets, or other deployable objects to an execution group.

When *not* to use

- To completely clear the contents of the execution group before the bar file is deployed. Instead use a complete bar file deployment.

Complete bar file deployment

Completely deploying a bar file tells the Configuration Manager to extract the deployable content of the bar file and to send the contents to an execution group, first removing any existing deployed contents of the execution group.

When to use

- To deploy message flows, message sets, or other deployable objects to an execution group.

When *not* to use

- To merge the existing contents of the execution group with the contents of the bar file. Instead use an incremental bar file deployment.

Broker archive

The unit of deployment to the broker is the *broker archive* or *bar* file.

The bar file is a compressed file that can contain a number of different files:

-

- A .cmf file for each message flow. This file is a compiled version of the message flow. You can have any number of these files within your bar file.
- A .dictionary file for each message set dictionary. You can have any number of these files within your bar file.
- A broker.xml file. This file is called the *broker deployment descriptor*. You can have only one of these files within your bar file. This file, in XML format, resides in the META-INF folder of the compressed file and can be modified using a text editor or shell script.
- Any number of XML files (.xml) and style sheets (.xsl files) for use with the “XSLTransform node” on page 1216.
- Any number of JAR files for use with the “JavaCompute node” on page 943.
- Any other files that you need that are contained in the compressed file-archive bar file. For example, you might want to include Java source files for future reference.

To deploy XML, XSL, and JAR files inside a broker archive, the connected Configuration Manager and target broker must be Version 6.0 or later.

Configurable properties of a broker archive

System objects that are defined in message flows can have configurable properties that you can update within the broker archive (bar) file before deployment. Configurable properties allow an administrator to update target-dependent properties, such as queue names, queue manager names, and database connections.

By changing configurable properties, you can customize a bar file for a new domain, for example a test system, without needing to edit and rebuild the message flows, message mappings, or ESQL transformation programs. Any properties that you define are contained within the deployment descriptor, META-INF/broker.xml. The deployment descriptor is parsed when the bar file is deployed.

Edit the configurable properties using either the Broker Archive editor or the `mqsipplybaroverride` command from a command prompt.

Although the two methods indicated above are preferable, you can also edit the XML-format deployment descriptor manually using an external text editor or shell script.

Version and keyword information for deployable objects

This topic contains information about how to view the version and keyword information of deployable objects.

- “Displaying object version in the Broker Archive editor”
- “Displaying version, deploy time, and keywords of deployed objects”

This topic also contains information on populating the Comment and Path columns; see “Populating the Comment and Path columns” on page 753.

Displaying object version in the Broker Archive editor

A column in the Broker Archive editor called Version displays the version tag for all objects that have a defined version. These are:

- .dictionary files
- .cmf files
- Embedded JAR files with a version defined in a META-INF/keywords.txt file

You cannot edit the Version column.

You can use the `mqsireadbar` command to list the keywords that are defined for each deployable file within a deployable archive file.

Displaying version, deploy time, and keywords of deployed objects

The Properties View displays, for any deployed object:

- Version
- Deploy Time
- All defined keywords

For example, if you deploy a message flow with these literal strings:

- `$MQSI_VERSION=v1.0 MQSI$`
- `$MQSI Author=fred MQSI$`
- `$MQSI Subflow 1 Version=v1.3.2 MQSI$`

the Properties View displays:

Deployment Time	Date and time of deployment
Modification Time	Date and time of modification
Version	v1.0
Author	fred
Subflow 1 Version	v1.3.2

You are given a reason if the keyword information is not available. For example, if keyword resolution has not been enabled at deploy time, the Properties View displays the message Deployed with keyword search disabled. Also, if you deploy to a Configuration Manager that is an earlier version than Version 6.0, the properties view displays Keywords not available on this Configuration Manager.

Populating the Comment and Path columns

If you add source files, the Path column is populated automatically.

To add a comment, double click on the Comment column and type the text that you require.

Broker configuration deployment

A broker configuration deployment informs a broker of various configuration settings, including a list of execution groups, and multicast and inter-broker settings.

When to use

- If you have modified runtime properties in the Message Brokers Toolkit or in a Configuration Manager Proxy application.

When *not* to use

- If you have used the `mqsichangeproperties` command to change publish/subscribe settings directly on the broker component. In this case, a broker configuration deployment overwrites the changes that you have made to the settings.
- If you are adding execution groups. In this case, the first time that you deploy a broker archive (bar) file, the execution group is automatically initialized.

Publish/subscribe topology deployment

Topology deployment is required only when using publish/subscribe. It informs each broker in the domain of the brokers with which it can share publications and subscriptions.

You can deploy a topology configuration in two ways:

- Complete topology deployment, in which all brokers are told of their neighboring publish/subscribe brokers.
- Delta topology deployment, in which only changes to the publish/subscribe topology are deployed. Such changes are deployed only to those brokers whose neighbor lists have changed since the last successful topology deployment.

Whatever type of deployment you perform, the Configuration Manager attempts to subscribe to the broker's status messages if it is the first deployment to the broker. However only a complete topology deployment initiates a further subscription.

Complete topology deployment

You can deploy a complete topology. Deploying a complete topology has the following effects:

- Each broker in the domain is informed of the set of brokers with which it can share publish/subscribe information.
- The Configuration Manager is forced to subscribe again to the broker's status topics, such as start and stop messages.

When to use

- If the Configuration Manager is not correctly reporting whether it is in a stopped or started state.
- If you have moved a Configuration Manager from one queue manager to another.
- If a broker's publish/subscribe function has become inconsistent. An example of inconsistency would be if one broker is able to share publications with a second broker, but not the other way round.

When *not* to use

- If you are adding brokers to the domain and you are not using publish/subscribe. That is, if you are not connecting brokers together so that they can share publications and subscriptions.
- If you are adding execution groups to a broker.
- If you have changed the publish/subscribe network. In this case, deploy a delta topology, if possible, so that you deploy only to those brokers affected by the changes you have made.
- If you have removed a broker from the domain.

Delta topology deployment

Deploying a delta topology sends updated publish/subscribe network information to any broker with a publish/subscribe configuration that the Configuration Manager determines not to be current.

When to use

- If you have modified a publish/subscribe network.
- If you are using the workbench to remove a broker from the domain. The Configuration Manager automatically requests the broker component to stop message flows that are running and to tidy up any resources in use. If this operation fails, you can again request the broker to tidy up. Deploying a delta topology is the most convenient way to deploy only to those brokers affected by the topology changes.

When *not* to use

- If you are adding brokers to the domain and you are not using publish/subscribe. That is, if you are not connecting brokers together so that they can share publications and subscriptions.
- If you are adding or removing execution groups.

Publish/subscribe topics hierarchy deployment

If you are using publish/subscribe, deploy the topics hierarchy in these situations:

- If you have modified the hierarchy of topics. The deployment communicates the new hierarchy to each broker.
- If you have added a broker to the domain and you want it to use the existing topics hierarchy. The deployment communicates the hierarchy to the new broker.

You can deploy a publish/subscribe topics hierarchy in two ways:

- Complete deployment, in which the complete topics hierarchy is sent to all the brokers in a domain.
- Delta deployment, in which changes to the topics hierarchy (made since the last topics deployment) are sent to all the brokers in a domain.

Complete topics deployment

A complete topics deployment sends the publish/subscribe topics hierarchy to all the brokers in a domain.

When to use

- If you have made changes to the topics hierarchy and one of the brokers has an inconsistent view of the expected topics hierarchy.
- If you have added a new broker to the domain that uses the topics hierarchy.

When *not* to use

- If you have changed the topics hierarchy. In this case, a delta topics deployment is typically sufficient.

Delta topics deployment

A delta topics deployment sends the publish/subscribe topics hierarchy changes to all the brokers in a domain.

When to use

- If you have made changes to the topics hierarchy.

When *not* to use

- If the topics hierarchy has not changed.

Cancel deployment

The Configuration Manager allows only one deployment to be in progress to each broker at any one time. If for some reason a broker does not respond to a deployment request, subsequent requests cannot reach the broker, because, to the Configuration Manager, a deployment is still in progress.

Canceling deployment tells the Configuration Manager to assume that a broker will never respond to an outstanding deployment. In most cases, the action does *not* remove any deployment messages that have been sent to the broker, nor does it alter the running configuration of the broker. (Thus, for any brokers that *have* successfully deployed a configuration, the deployed information remains on the broker.)

If a broker subsequently *does* provide a response to an outstanding deployment that has been canceled, the response is ignored by the Configuration Manager, and an inconsistency subsequently exists between what is running on the broker and the information that is provided by the Configuration Manager.

Because of this risk of inconsistency, cancel a deployment only as a last resort, and only if you are sure that a broker will never be able to process a previous

deployment request. However, before canceling deployment, you can manually remove outstanding deployment messages to ensure that they are not processed.

When canceling deployment across the domain, the locks for all outstanding deployments in the domain are removed. When canceling deployment for a specific broker, the lock for that broker only is removed.

Canceling deployment is the equivalent of the 'force deploy' action in previous versions, except that cancel does not redeploy domain information.

You can cancel a deployment in two ways:

- Cancel deployment to a domain
- Cancel deployment to a broker

Cancel deployment to a domain

Canceling the deployment to a domain tells the Configuration Manager to assume that all brokers in the domain that have outstanding deployments will not respond. If a broker later responds to an outstanding deployment that has been canceled, the response is ignored and there is an inconsistency between what is running on the broker and the information that is provided by the Configuration Manager.

When to use

Cancel a domain deployment only if both of these conditions are met:

- You receive error message BIP1510 when you attempt a deployment.
- None of the brokers that have outstanding deployments are responding.
- The connected Configuration Manager is at Version 6.0 or later. If the version is earlier, canceling deployment to a specific broker has no effect.

When *not* to use

- If a broker is simply taking a long time to respond to a deployment request. The broker might have been temporarily stopped, for example.
- If other users might be deploying to the domain at the same time.
- If only one broker is not responding, or a small number of brokers are not responding. In this case, cancel the broker deployment instead.

Cancel deployment to a broker

Canceling the deployment to a single broker tells the Configuration Manager to assume that a specific broker in the domain that has an outstanding deployment will not respond. If a broker later responds to an outstanding deployment that has been canceled, the response is ignored and there is an inconsistency between what is running on the broker and the information that is provided by the Configuration Manager.

When applied to an individual broker, canceling deployment causes the Configuration Manager to attempt to remove from the broker, deployment messages that have not yet been processed. This succeeds only if the broker and the Configuration Manager share the same queue manager, and if the message has not already been processed by the broker.

When to use

Cancel a domain deployment only if both of these conditions met:

- You receive error message BIP1510 when you attempt a deployment .
- The broker is not responding.

When *not* to use

- If the broker is simply taking a long time to respond to a deployment request. The broker might have been temporarily stopped, for example.
- If the version of the connected Configuration Manager is earlier than Version 6.0. In this case, canceling deployment to a specific broker has no effect; you must cancel the entire domain deployment instead.

Deploying a message flow application

Deploy message flow applications to execution groups by adding required resources, optionally with their source files, to a broker archive (bar) file. The bar file is then deployed by sending it to the appropriate Configuration Manager, where it is unpacked and the individual files are distributed to execution groups on individual brokers.

Before you start:

Before you can deploy a message flow application, you must have created and started a Configuration Manager. You must also start a WebSphere MQ listener for the associated queue manager.

Within the workbench, you must create a domain, add a broker to that domain, and create an execution group within the broker. The broker that you add to the domain is a reference, therefore you must also create and start the physical broker on the target system, and start a WebSphere MQ listener on its queue manager. See the links to related tasks at the end of this topic for help with these actions.

The mode in which your broker is working, can affect the number of execution groups and message flows that you can deploy, and the types of node that you can use. See Restrictions that apply in each operation mode.

The related tasks in this section describe the process:

1. "Creating a server project"
2. "Creating a broker archive" on page 758
3. "Adding files to a broker archive" on page 759
4. "Refreshing the contents of a broker archive" on page 763
5. "Deploying a broker archive file" on page 763
6. "Checking the results of deployment" on page 772

If your message flows include user-defined nodes, you must also distribute the compiled C or Java code for each node to every broker that uses those message flows. For more details, see Developing user-defined extensions.

Creating a server project

Before you can deploy a message flow application, you must create a server project for it.

Before you start:

Save your message flow and message set projects.

Follow these steps to create a server project using the Message Broker Toolkit.

1. Switch to the Broker Administration perspective.
2. Click **File** → **New** → **Other**.

3. Select **Show all wizards**. In the list of wizards, expand **Server** and click **Server Project**.
4. Click **Next**.
5. If you are prompted, click **OK** to enable "Base J2EE Support".
6. Enter the name of your new server project.
7. Click **Finish**.

The folder that is created appears twice in the Navigator view (if **Show empty projects in Navigators** has been selected in the **Broker Administration Preferences** page):

- In the Domain Connections folder
- In the Broker Archives folder

Next:

1. Create a broker archive.
2. Add files to the broker archive.

Creating a broker archive

Create a separate broker archive (bar) file for each configuration that you want to deploy.

You can create a bar file in two ways:

- Using the Message Broker Toolkit
- Using the `mqsicreatebar` command

Using the Message Broker Toolkit

Before you start:

Either create a server project, or ensure that one already exists.

Follow these steps to create a bar file using the workbench:

1. Switch to the Broker Administration perspective.
2. Click **File** → **New** → **Message Broker Archive**.
3. Enter the name of your server project or select one from the displayed list. The list is filtered to only show projects in the active working set.
4. Enter a name for the bar file that you are creating.
5. Click **Finish**.

A file with a `.bar` extension is created and is displayed in the Broker Administration Navigator view, under the Broker Archives folder. The Content editor for the bar file opens.

Next:

Continue by adding files to your broker archive and then deploying it.

Using the `mqsicreatebar` command

Follow these steps to create a bar file using the `mqsicreatebar` command:

1. Open a command window that is configured for your environment.

2. Enter the command, typed on a single line:

```
mqsicreatebar -b barName -cleanBuild -p projectNames -o filePath
```

A file with a .bar extension is created.

Specify the -b (bar file name) and -o (path for included files) parameters. The -p (project names) parameter is optional. The mqsicreatebar topic gives more details.

Use the **-cleanBuild** parameter to refresh all the projects in the broker archive and invoke a clean build if amendments have been made to broker-archive resources using external tools.

Next:

Continue by adding files to your broker archive and then deploying it.

Adding files to a broker archive

To deploy files to a\n execution group, you first include them in a broker archive (bar). The bar file is deployed by sending it to the Configuration Manager and, from there, its contents are sent to the execution group on a broker.

Before you start:

Create a broker archive (bar) file for each execution group that you want to deploy.

You can add message flows and message sets to a bar file only at the project level. However, after you have added the project to the bar file, you can click **Remove** to remove individual message flows or message definitions. Likewise, if you check **Include source files**, the source files for all Message flows, message sets or other items in the project are included; you can manually remove the resources that you do not want.

To deploy XML, XSL, and JAR files inside a broker archive, the connected Configuration Manager and target broker must be Version 6.0 or later.

Subflows are not displayed in the **Build** dialog as separate items and are added automatically, so you have to add only the parent flow to include the subflows.

You can manually add XML, XSL, and JAR files by following these steps. However, JAR files that are required by JavaCompute nodes within message flows are added automatically from your Java project when you add the message flow. Similarly, XML and XSL files are automatically added if they are required by the flow.

You cannot read deployed files back from broker execution groups. Therefore, keep a copy of the deployed bar file, or of the individual files within it.

Follow these steps to add files to a broker archive (bar) file using the Message Broker Toolkit:

1. Switch to either the Broker Administration perspective or the Broker Administration perspective.
2. Double-click your bar file in the Broker Administration Navigator view to open it. The contents of the bar file are shown in the Content editor. (If the bar file is new, this view is empty.)
3. Select the required broker archive resources.
4. Click **Build**.

5. Select the message flows, message sets, and other files that you want to include. (Duplicates within a bar file are automatically removed.)
6. Optional: If you want to include your source files, select **Include source files**.
7. Optional: If you want to compile ESQL so that it is compatible with Version 2.1 brokers, check **Build ESQL for brokers version 2.1**.
8. Optional: if you are adding a flow to a bar for a second time, and have used the Configure tab to change flow parameters, select **Override configurable property values** to control behavior.
 If the box is selected, existing configuration settings are reset when a flow is added again.
 If the box is cleared, existing settings are left in place when a flow is replaced.
9. Click **Build broker archive**.

A list of the files that are now in your bar file is displayed on the **Manage** page. You can choose not to display your source files by clearing the **Show source files** box at the bottom of the **Manage** page.

Next:

The next step is to deploy your broker archive (bar) file, but you might first want to edit configurable properties. You can also edit the contents of your bar file manually.

If you want to have multiple instances of a flow with different values for the configurable properties see “Adding multiple instances of a message flow to a broker archive” on page 761.

Editing a broker archive file manually

This task explains how to manually edit a broker archive (bar) file that already exists.

Before you start:

If you have not already created a bar file, create it now, before continuing.

Follow these steps to edit a bar file manually using the Message Broker Toolkit:

1. Export the bar file.
 - a. From the workbench, click **File** → **Export**. The Export window appears.
 - b. Select the export destination, such as a compressed file with .zip extension, and click **Next**.
 - c. Select the resources that you want to export and click **Next**.
 - d. Complete the destination information and click **Finish**. The file appears at the destination you specified as a compressed file.
2. Extract files from the bar file.
3. Edit the properties that you want to change in an editor of your choice.
4. Save the file.
5. Import the bar file back into the workbench to deploy it.
 - a. From the workbench, click **File** → **Import**. The Import window appears.
 - b. Select **compressed file** from the list.
 - c. Click **Next**.
 - d. Specify the name and location of your bar file.

- e. Select the server project that you want to contain the bar file.
- f. Click **Finish**.

Next:

Continue by deploying your broker archive (bar) file.

Editing configurable properties

You can edit the configurable properties of your broker archive (bar) file deployment descriptor.

Before you start:

If you have not already created a bar file, create it now.

You can edit configurable properties in two ways:

- Using the Message Broker Toolkit
- Using the `mqsipplybaroverride` command

Using the Message Broker Toolkit:

Follow these steps to edit properties using the Message Broker Toolkit:

1. Switch to the Broker Administration perspective.
2. Select the **Configure** tab at the bottom of the Content editor pane. The properties that you can configure are listed.
3. Click the property for which you want to edit the value. The values that can be edited are displayed.
4. Replace the current value with the new value.
5. Save your bar file.

Next:

Continue by deploying your broker archive (bar) file.

Using the `mqsipplybaroverride` command:

Follow these steps to edit properties using the `mqsipplybaroverride` command:

1. Open a command window that is configured for your environment.
2. Create a text file (with a `.properties` file extension).
3. Enter the command, typed on a single line, specifying the location of your bar deployment descriptor (typically `broker.xml`) and the file that contains the properties to be changed: See `mqsipplybaroverride` for examples on how to use the command. A file with a `.bar` extension is created.

Next:

Continue by deploying your broker archive (bar) file.

Adding multiple instances of a message flow to a broker archive

You can edit the name of your files in the broker archive (bar) file so that you can deploy multiple instances of a message flow with different values for the configurable properties.

Before you start:

Add the file to the broker archive. See “Adding files to a broker archive” on page 759.

To deploy multiple instances of the flow with different values for the configurable properties:

1. Rename the message flow file (.cmf) in the broker archive editor.
2. Add the message flow to the bar file again. It is added to the bar file with the original name.
3. Click the Configure tab. You can now edit the configurable properties for both message flows.

Tip: The names assigned in the bar file are also used on the command line; for example, if you run `mqsilist` (list resources) command on your execution group or if you run `mqsichange` command for a message flow.

Next:

Deploy the bar file. Both message flows are deployed to the execution group and use the values for the configurable properties that you set in the bar file.

Configuring a message flow at deployment time using UDPs

User-defined properties (UDPs) give you the opportunity to configure message flows at deployment time, without modifying program code. You can give the UDP an initial value when you declare it in your program, or when you use the Message Flow editor to create or modify a message flow.

For an overview of user-defined properties, see “User-defined properties” on page 111.

See the “DECLARE statement” on page 1525 for an example of how to code a UDP statement.

In ESQL, you can define UDPs at the module or schema level.

After a UDP has been defined by the Message Flow editor, you can modify its value before you deploy it.

To configure UDPs:

1. Switch to the Broker Administration perspective.
2. Double-click the bar file in the Navigator view. The contents of the bar file are shown in the Content editor.
3. Click the **Configure** tab at the bottom of the Content editor. This pane shows the names of your message flows, which you can expand to show the individual nodes that are contained in the flow.
4. Click a message flow name. The UDPs that are defined in that message flow are displayed with their values.
5. If the value of the UDP is unsuitable for your current environment or task, change it to the value that you want. The value of the UDP is set at the flow level and is the same for all eligible nodes that are contained in the flow. If a subflow includes a UDP that has the same name as a UDP in the main flow, the value of the UDP in the subflow is not changed.

Now you are ready to deploy the message flow. See “Deploying a broker archive file” on page 763.

Refreshing the contents of a broker archive

Refresh the contents of a broker archive by removing resources from it and, having made required changes, add them back again. Alternatively, use the Refresh option in the Broker Archive editor.

Before you start:



You should already have created a broker archive and have added resources to it. You are likely to have subsequently made changes to those resources that you want reflected in the archive before you deploy it.

Follow these steps to refresh the contents of a broker archive:

1. Switch to the Broker Administration perspective.

Broker archive (bar) files that need to be refreshed are shown with an 'out-of-synch' icon () in the Navigator view. (The bar file is considered to be inconsistent when any of its deployable workspace files has a time stamp that is later than that of the bar file.)

2. Double-click your bar file in the Navigator view to open it.

The contents of the bar file are shown in the Content editor. Icons indicate resources that are consistent , and those that need to be refreshed .

3. To refresh all the resources in the broker archive, click **Refresh** ()

A dialog box opens, showing progress. When the operation is complete, click **Details** to see information about what was refreshed, what was not, and why. If the refresh process was successful, you see the same information that is placed in the user log by each of the resource compilers.

Alternatively, you can refresh the archive contents by right-clicking a bar file in the Navigator view and selecting **Refresh Archive Contents**. The broker archive is rebuilt in the background.

You can view, and clear , the user and service logs by clicking the appropriate tabs in the Broker Archive editor.

4. (Optional) To view the properties of an individual resource in the Content editor, right-click the resource and click **Show in Properties**.

The Deployable properties view opens (if it is not already in the perspective) and shows details of the resource that you have selected. The view has two fields:

- Workspace Resource, with references to the linked workspace resources .msgflow, (.mset, .xml, and .xslt files, for example).
- Last Compile Status, which shows the user log entry for the last compilation. You can copy text, but you cannot modify it.

Next:

Continue to deploy your bar file.

Deploying a broker archive file

You can deploy your broker archive (bar) file in one of three ways.

Before you start:

You must have created a bar file; see "Creating a broker archive" on page 758.

l

You can deploy a broker archive in three ways:

- Using the Message Broker Toolkit
- Using the mqsideploy command
- Using the Configuration Manager Proxy API
- “Redeploying a broker archive file” on page 766 using these three methods

The mode in which your broker is working, can affect the number of execution groups and message flows that you can deploy, and the types of node that you can use. See Restrictions that apply in each operation mode.

If the execution group to which you want to deploy is restricted by an ACL, you must have appropriate access rights to complete this task.

Using the Message Broker Toolkit

Follow these steps to deploy a bar file using the workbench:

1. Switch to the Broker Administration perspective.
2. Optional. Typically, an incremental bar file deployment is performed. To perform a complete bar file deployment, right-click the target execution group in the Domains view and select **Remove Deployed Children**. Wait for the operation to complete before continuing.

You do not have to remove deployed children if you only want to refresh one or more of the children with the contents of the bar file. For an explanation of the difference between a complete and an incremental bar file deployment, see “Message flow application deployment” on page 749.

3. Click the bar file, shown in the Navigator view, to highlight it.
4. Drag the file onto your target execution group shown in the Domains view.
 - a. Right-click the bar file and click **Deploy file**. A dialog box shows all of the domains, as well as execution groups within those domains to which the workbench is connected. A dialog box shows the execution groups (within their domains) to which you can deploy the bar file.
 - b. Select an execution group and click **OK** to deploy the bar file. (If you select a broker topology that is not connected to a domain, an attempt is made to connect it. If you click **Cancel**, the broker topology remains unconnected to a domain.)

Whichever method you use, you can select (and deploy to) only one execution group at a time.

5. If the bar file has not been saved since it was last edited, you are asked whether you want to save it before deploying. If you click **Cancel**, the bar file is not saved and deployment does not take place.

The bar file is transferred to the Configuration Manager, which deploys the file contents (message flows and message sets, for example) to the execution group. In the Domains view, the assigned message flows and message sets are added to the appropriate execution group.

Next:

Continue by checking the results of the deployment; see “Checking the results of deployment” on page 772.

Using the mqsideploy command

Follow these steps to deploy a bar file using the mqsideploy command.

1. Open a command window that is configured for your environment.
2. Using the following examples, enter the appropriate command:

On distributed platforms:

```
mqsideploy -i ipAddress -p port -q qmgr -b broker -e exngp -a barfile
```

This command performs an incremental deployment. Add the **-m** parameter to perform a complete bar file deployment.

The **-i** (IP address), **-p** (port), and **-q** (queue manager) parameters represent the connection details of the queue manager computer.

You must also specify the **-b** (broker name), **-e** (execution group name), and **-a** (bar file name) parameters.

On z/OS

```
/f MQ01CMGR,dp b=broker e=exngp a=barfile
```

This command performs an incremental deployment. Add the **m=yes** parameter to perform a complete bar file deployment.

In this example, MQ01CMGR is the name of the Configuration Manager component. You must also specify the names of the broker, execution group, and bar file (the **b=**, **e=**, and **a=** parameters).

Next:

Continue by checking the results of the deployment; see “Checking the results of deployment” on page 772.

Using the Configuration Manager Proxy

Use the deploy method of the ExecutionGroupProxy class. By default, the deploy method performs an incremental deployment. To perform a complete deployment, use a variant of the method that includes the Boolean isIncremental parameter. Setting this to false indicates a complete deployment. Setting it to true indicates an incremental deployment.

For example:

```
import com.ibm.broker.config.proxy.*;
import java.io.IOException;

public class DeployBar {
    public static void main(String[] args) {
        ConfigManagerConnectionParameters cmcp = new MQConfigManagerConnectionParameters(
            "localhost", 1414, "QM1");
        try {
            ConfigManagerProxy cmp = ConfigManagerProxy.getInstance(cmcp);
            TopologyProxy t = cmp.getTopology();
            BrokerProxy b = t.getBrokerByName("BROKER1");
            ExecutionGroupProxy e = b.getExecutionGroupByName("default");
            e.deploy("deploy.bar");
        }
        catch (ConfigManagerProxyException cmpe) {
            cmpe.printStackTrace();
        }
        catch (IOException ioe) {
```

```
        ioe.printStackTrace();
    }
}
```

Next:

Continue by checking the results of the deployment; see “Checking the results of deployment” on page 772.

Redeploying a broker archive file

If you make changes to a bar file, and want to propagate those changes to one or more brokers, you can redeploy the updated bar file to one or more execution groups, using any of the deploy methods described previously. You do not have to stop the message flows that you deployed previously; all resources in the execution group or groups that are in the redeployed bar file are replaced and any new resources are applied.

If your updates to the bar file include the deletion of resources, a redeploy does not result in their deletion from the broker. For example, assume your bar file contains message flows F1, F2, and F3. You update the file by removing F2 and adding message flow F4. If you redeploy the bar file, all four flows are available in the execution group when the redeployment has completed. F1 and F3 are replaced by the content of the redeployed bar file.

If you want to clear resources from the execution group that you previously deployed before you redeploy, perhaps because you are deleting resources, use either the `mqsideploy` command with the option `-m -complete` or the appropriate CMP deploy method for the execution group. If you prefer to use the Message Broker Toolkit, select the execution group or groups, click **Remove deployed children**, and then deploy.

If your message flows are not transactional, stop those message flows before you redeploy to be sure that all the applications complete cleanly and are in a known and consistent state. You can stop individual message flows, execution groups, or brokers.

If your message flows are transactional, the processing logic that handles commitment or rollback ensures that resource integrity and consistency are maintained.

Next:

Continue by checking the results of the redeployment; see “Checking the results of deployment” on page 772.

Deploying a message flow application that uses WebSphere Adapters

Deploy the resources that are generated when you run the Adapter Connection wizard by adding them to a broker archive (bar) file.

Before you start:

- Read “WebSphere Adapters nodes” on page 7.
- Perform the steps in Preparing the environment for WebSphere Adapters nodes

- Perform the steps in “Connecting to an EIS using the Adapter Connection wizard” on page 256.

To deploy the message flow successfully, you must deploy the WebSphere Adapters component, either on its own or in the same bar file as your message flow. If the WebSphere Adapters component is not available, deployment of the message flow fails. The following list details the file extensions of the resources that you deploy :

- .msgflow (the message flow)
- .inadapter (the inbound WebSphere Adapters component)
- .outadapter (the outbound WebSphere Adapters component)
- .xsdzip (the message set)

The mode in which your broker is working, can affect the number of execution groups and message flows that you can deploy, and the types of node that you can use. See Restrictions that apply in each operation mode.

1. For details of the steps that you need to perform before you can deploy a message flow application, see “Deploying a message flow application” on page 757.
2. Add the message flow to the bar file. (For a description of how to add files to a bar file, see “Adding files to a broker archive” on page 759.) When you add a message flow that contains one or more WebSphere Adapters nodes to a bar file, a dialog box opens so that you can identify the following resources:
 - One or more WebSphere Adapters components to be used by the WebSphere Adapters nodes
 - One or more message sets that contain an XSD for the business objects that are used by the WebSphere Adapters nodes
3. When you have added the message flow, WebSphere Adapters components, and message set, deploy the bar file.

Deploying a broker configuration

You can deploy a broker configuration in three ways:

- Using the Message Broker Toolkit
- Using the mqsideploy command
- Using the Configuration Manager Proxy API

Using the Message Broker Toolkit

If you modify multicast or interbroker settings in the Broker Administration perspective, a broker configuration deployment starts automatically when you apply the changes. This process is run in the background.

Using the mqsideploy command

Follow these steps to deploy a broker configuration using the mqsideploy command:

1. Open a command window that is configured for your environment.
2. Using the examples below, enter the appropriate command, specifying the broker to which you want to deploy:

On distributed platforms:

```
mqsideploy -i ipAddress -p port -q qmgr -b broker
```

where -i (IP address), -p (port), and -q (queue manager) represent the connection details of the queue manager workstation.

On z/OS:

```
/f MQ01CMGR,dp b=broker
```

where MQ01CMGR is the name of the Configuration Manager component.

If you specify the broker to which you want to deploy (-b or b=), without indicating a bar file (-a), the broker configuration is deployed, rather than a message flow application.

Next:

Continue by checking the results of the deployment.

Using the Configuration Manager Proxy

Use the deploy method of the BrokerProxy class.

For example:

```
import com.ibm.broker.config.proxy.*;

public class DeployBrokerConfig {
    public static void main(String[] args) {
        ConfigManagerConnectionParameters cmcp =
            new MQConfigManagerConnectionParameters
                ("localhost", 1414, "QM1");
        try {
            ConfigManagerProxy cmp = ConfigManagerProxy.getInstance(cmcp);
            TopologyProxy t = cmp.getTopology();
            BrokerProxy b = t.getBrokerByName("BROKER1");
            if (b != null) {
                b.deploy();
            }
        }
        catch (ConfigManagerProxyException e) {
            e.printStackTrace();
        }
    }
}
```

Next:

Continue by checking the results of the deployment.

Deploying a publish/subscribe topology

Before you start:

Make sure that you have configured your broker domain.

The publish/subscribe topology deployment overview explains when you might want to deploy a topology and the difference between a complete and delta deployment.

You can deploy topology information in three ways:

- Using the Message Broker Toolkit
- Using the mqsideploy command
- Using the Configuration Manager Proxy API

You can configure the workbench preferences so that topology information is automatically deployed after a change.

After you have deployed a publish/subscribe topology, you might see an extra execution group process called \$SYS_mqsi in a process listing or in the output from the mqsilist command. When you deploy a publish/subscribe topology for the first time, a new execution group process is started on your broker to handle the publish/subscribe messages. This execution group is only used internally: it does not appear in the workbench and you cannot deploy message flows to it. After you have deployed one or more of your own flows to another execution group, \$SYS_mqsi is removed when the broker is subsequently restarted.

Using the Message Broker Toolkit

Follow these steps to deploy a topology configuration using the workbench:

1. Switch to the Broker Administration perspective.
2. In the Domains view, expand the Domains from where you want to perform the deploy.
3. Right-click **Broker Topology** hierarchy.
4. Click **Deploy Topology Configuration**.
5. Click **Delta** to deploy only the changed items or click **Complete** to deploy the entire configuration.

Alternatively, you can make a change to the Topology document in the Broker Administration perspective, save the changes, and then select **Delta**. This behavior can be modified in the workbench preferences dialog.

The topology is deployed and the Configuration Manager distributes it to the brokers in the domain.

Next:

Continue by checking the results of the deployment.

Using the mqsideploy command

Follow these steps to deploy a topology configuration using the mqsideploy command:

1. Open a command window that is configured for your environment.
2. Using the example below, enter the appropriate command, typed on a single line:

```
z/OS On z/OS:  
/f MQ01CMGR,dp 1=yes
```

This command performs a delta deployment. Add the m=yes parameter to deploy the entire configuration. MQ01CMGR is the name of the Configuration Manager component.

On other platforms:

```
mqsidedeploy -i ipAddress -p port -q qmgr -l
```

This command performs a delta deployment. Add the `-m` parameter to deploy the entire configuration. The `-i` (IP address), `-p` (port), and `-q` (queue manager) parameters represent the connection details of the queue manager workstation.

Next:

Continue by checking the results of the deployment.

Using the Configuration Manager Proxy

Use the `deploy` method of the `TopologyProxy` class. By default, the `deploy` method performs a delta deployment. To deploy the complete hierarchy, use a variant of the method that includes the Boolean `isDelta` parameter; setting this parameter to `false` indicates a complete deployment. (Setting it to `true` indicates a delta deployment.)

For example:

```
import com.ibm.broker.config.proxy.*;

public class DeployTopology {
    public static void main(String[] args) {
        ConfigManagerConnectionParameters cmcp =
            new MQConfigManagerConnectionParameters
                ("localhost", 1414, "QM1");
        try {
            ConfigManagerProxy cmp =
                ConfigManagerProxy.getInstance(cmcp);
            TopologyProxy t = cmp.getTopology();
            t.deploy(false);
        }
        catch (ConfigManagerProxyException e) {
            e.printStackTrace();
        }
    }
}
```

Next:

Continue by checking the results of the deployment.

Deploying a publish/subscribe topics hierarchy

Before you start:

Make sure that you have configured your broker domain.

The topic deployment overview explains when you might want to deploy a topic hierarchy and the difference between a complete and a delta deployment.

You can deploy a topics hierarchy in three ways:

- Using the Message Broker Toolkit
- Using the `mqsidedeploy` command
- Using the Configuration Manager Proxy API

You can configure the workbench preferences so that a topics hierarchy is automatically deployed after you have made a change.

Using the Message Broker Toolkit

Follow these steps to deploy a topics hierarchy using the workbench:

1. Switch to the Broker Administration perspective.
2. In the Domains view, expand the Domains from where you want to perform the deploy.
3. Right-click **Topics** hierarchy.
4. Click **Deploy Topics Configuration**.
5. Click **Delta** to deploy only the changed items, or click **Complete** to deploy the entire configuration.

The topics hierarchy is deployed, and the Configuration Manager distributes the topics to brokers in the domain.

Next:

Continue by checking the results of the deployment.

Using the mqsideploy command

Follow these steps to deploy a topics hierarchy using the mqsideploy command:

1. Open a command window that is configured for your environment.
2. Using the examples below, enter the appropriate command, typed on a single line:

z/OS On z/OS:

```
/f MQ01CMGR,dp t=yes
```

This command performs a delta deployment. Add the `m=yes` parameter to deploy the entire configuration.

On other platforms:

```
mqsideploy -i ipAddress -p port -q qmgr -t
```

This command performs a delta deployment. Add the `-m` parameter to deploy the entire configuration. The `-i` (IP address), `-p` (port), and `-q` (queue manager) parameters represent the connection details of the queue manager workstation.

Next:

Continue by checking the results of the deployment.

Using the Configuration Manager Proxy API

Use the `deploy` method of the `TopicRootProxy` class. By default, the `deploy` method performs a delta deployment. To deploy the complete hierarchy, use a variant of the method that includes the Boolean `isDelta` parameter; setting this parameter to `false` indicates a complete deployment. (Setting it to `true` indicates a delta deployment.)

For example:

```
import com.ibm.broker.config.proxy.*;

public class DeployTopics {
    public static void main(String[] args) {
        ConfigManagerConnectionParameters cmcp =
```

```

        new MQConfigManagerConnectionParameters
            ("localhost", 1414, "QM1");
    try {
        ConfigManagerProxy cmp =
            ConfigManagerProxy.getInstance(cmcp);
        TopicRootProxy t = cmp.getTopicRoot();
        t.deploy(false);
    }
    catch (ConfigManagerProxyException e) {
        e.printStackTrace();
    }
}
}

```

Next:

Continue by checking the results of the deployment.

Checking the results of deployment

After you have made a deployment, check that the operation has completed successfully. You can check the results of a deployment in three ways:

- Using the Message Broker Toolkit
- Using the `mqsidedeploy` command
- Using the Configuration Manager Proxy API

Also, check the system log on the target system where the broker was deployed to make sure that the broker has not reported any errors.

Using the Message Broker Toolkit

Follow these steps to check a deployment using the workbench:

1. Switch to the Broker Administration perspective.
2. Expand the Domains view.
3. Double-click the **Event Log**.

When the deployment is initiated, an information message is displayed, confirming that the request was received by the Configuration Manager:

- BIP0892I

If the deployment completes successfully, you might also see one or more of these additional messages:

- BIP4040I
- BIP4045I
- BIP2056I

Using the `mqsidedeploy` command

The command returns numerical values from the Configuration Manager and all brokers affected by the deployment to indicate the outcome of the deployment. If it completes successfully, it returns 0. Refer to the `mqsidedeploy` topic for details of other values that you might see.

Using the Configuration Manager Proxy API

If you are using a Configuration Manager Proxy application, you can find out the result of a publish/subscribe topology deployment operation, for example, by using code similar to this:

```
TopologyProxy t = cmp.getTopology();

boolean isDelta = true;
long timeToWaitMs = 10000;
DeployResult dr = topology.deploy(isDelta, timeToWaitMs);

System.out.println("Overall result = "+dr.getCompletionCode());

// Display overall log messages
Enumeration logEntries = dr.getLogEntries();
while (logEntries.hasMoreElements()) {
    LogEntry le = (LogEntry)logEntries.nextElement();
    System.out.println("General message: " + le.getDetail());
}

// Display broker specific information
Enumeration e = dr.getDeployedBrokers();
while (e.hasMoreElements()) {

    // Discover the broker
    BrokerProxy b = (BrokerProxy)e.nextElement();

    // Completion code for broker
    System.out.println("Result for broker "+b+" = " +
        dr.getCompletionCodeForBroker(b));

    // Log entries for broker
    Enumeration e2 = dr.getLogEntriesForBroker(b);
    while (e2.hasMoreElements()) {
        LogEntry le = (LogEntry)e2.nextElement();
        System.out.println("Log message for broker " + b +
            le.getDetail());
    }
}
}
```

The `deploy` method blocks any other processes until all affected brokers have responded to the deployment request.

When the method returns, the `DeployResult` object represents the outcome of the deployment at the time when the method returned; the object is not updated by the Configuration Manager Proxy.

If the deployment message could not be sent to the Configuration Manager, a `ConfigManagerProxyLoggedException` exception is thrown at the time of deployment. If the Configuration Manager receives the deployment message, log messages for the overall deployment are displayed, followed by completion codes specific to each broker affected by the deployment. The completion code is one of the following static instances from the `com.ibm.broker.config.proxy.CompletionCodeType` class:

Completion code	DescriptConfigManagerProxy.sendUpdatesion
pending	The deploy is held in a batch and will not be sent until you issue ().
submitted	The deploy message was sent to the Configuration Manager but no response was received before the timeout occurred.

Completion code	DescriptConfigManagerProxy.sendUpdatesion
initiated	i
successSoFar	The Configuration Manager issued the deployment request and some, but not all, brokers responded with a success message before the timeout period expired. No brokers responded negatively.
success	The Configuration Manager issued the deployment request and all relevant brokers responded successfully before the timeout period +++++.
failure	The Configuration Manager issued the deployment request and at least one broker responded negatively. You can use <i>getLogEntriesForBroker</i> for more information on why the deployment failed.
notRequired	A deployment request was submitted to the Configuration Manager involved with the supplied broker, but the request was not sent to the broker because its configuration is already up to date.

Canceling a deployment that is in progress

Before you start:

Canceling a deployment should be used only as a last resort, and you should be sure that a broker, or several brokers in a domain, will never be able to process a previous deployment request. For this reason, make sure that you understand the implications of this action, described in the [Cancel deployment overview](#) topic.

You can cancel all outstanding deployments in the domain, or just those sent to a particular broker:

- When canceling deployment across the domain, you must have full access on the Configuration Manager.
- When canceling deployment to a specific broker, you must have full access on that broker.

To ensure that previous deployment messages are not processed when an affected broker is restarted, first remove any deployment messages:

1. Stop the broker.
2. Check the broker's `SYSTEM.BROKER.ADMIN.QUEUE` and `SYSTEM.BROKER.EXECUTIONGROUP.QUEUE` and manually remove any deployment messages.
3. Proceed to cancel the deployment.

You can cancel a deployment in three ways:

- Using the Message Broker Toolkit
- Using the `mqsideploy` command
- Using the Configuration Manager Proxy API

Using the Message Broker Toolkit

Follow these steps to cancel the deployment to a particular broker or all outstanding deployments in a domain, using the workbench:

1. Switch to the Broker Administration perspective.

2. In the Domains view, right-click either a particular broker or a connected domain.
3. Click **Cancel Deployment**.

Deployments to the broker or domain are canceled.

Next:

Continue by checking the results. A BIP0892I information message is displayed to show that the request was received by the Configuration Manager.

Using the mqsideploy command

Follow these steps to cancel a deployment using the mqsideploy command:

1. Open a command window that is configured for your environment.
2. Using the examples below, enter the appropriate command, typed on a single line:

z/OS On z/OS:

```
/f MQ01CMGR,dp t=yes b=B1
```

This command cancels deployment to the broker called B1. Omit the `b` argument to cancel all outstanding deployments in the domain. MQ01CMGR is the name of the Configuration Manager component.

On other platforms:

```
mqsideploy -i ipAddress -p port -q qmgr -c -b B1
```

This command cancels deployment to the broker called B1. Omit the `-b` parameter to cancel all outstanding deployments in the domain. The `-i` (IP address), `-p` (port), and `-q` (queue manager) parameters represent the connection details of the queue manager workstation.

Next:

Continue by checking the results. A BIP0892I information message is displayed to show that the request was received by the Configuration Manager.

Using the Configuration Manager Proxy API

To cancel all outstanding deployments in a domain

Use the `cancelDeployment` method of the `ConfigManagerProxy` class. For example:

```
public class CancelAllDeploys {
    public static void main(String[] args) {
        ConfigManagerConnectionParameters cmcp =
            new MQConfigManagerConnectionParameters
                ("localhost", 1414, "QM1");
        try {
            ConfigManagerProxy cmp =
                ConfigManagerProxy.getInstance(cmcp);
            cmp.cancelDeployment();
        }
        catch (ConfigManagerProxyException e) {
            e.printStackTrace();
        }
    }
}
```

To cancel deployment to a specific broker in a domain

Use the `cancelDeployment` method of the `BrokerProxy` class. For example, to cancel deployment to a broker called `B1`:

```
import com.ibm.broker.config.proxy.*;

public class CancelDeploy {
    public static void main(String[] args) {
        ConfigManagerConnectionParameters cmcp =
            new MQConfigManagerConnectionParameters
                ("localhost", 1414, "QM1");
        try {
            ConfigManagerProxy cmp =
                ConfigManagerProxy.getInstance(cmcp);
            TopologyProxy t = cmp.getTopology();
            BrokerProxy b = t.getBrokerByName("B1");
            b.cancelDeployment();
        }
        catch (ConfigManagerProxyException e) {
            e.printStackTrace();
        }
    }
}
```

Next:

Continue by checking the results. A BIP0892I information message is displayed to show that the request was received by the Configuration Manager.

Renaming objects that are deployed to execution groups

You cannot rename an object while it is still deployed to an execution group. Instead, first remove the deployed object from the execution group. Then, having renamed it and refreshed it in the broker archive (bar) file, deploy the bar file again.

Removing a deployed object from an execution group

Before you start:

To remove a deployed message flow, first stop the message flow.

You can remove deployed objects from an execution group in three ways:

- Using the Message Broker Toolkit
- Using the `mqsidedeploy` command
- Using the Configuration Manager Proxy API

Using the Message Broker Toolkit

Follow these steps to remove an object from an execution group using the workbench.

1. Switch to the Broker Administration perspective.
2. From the Domains view, right-click the object that you want to remove.
3. Click **Remove** from the pop-up menu, and **OK** to confirm.

An automatic deployment is performed for the updated broker and a BIP08921 information message is produced, which confirms that the request was received by the Configuration Manager.

Using the mqsideploy command

Follow these steps to remove an object from an execution group using the mqsideploy command:

1. Open a command window that is configured for your environment.
2. Using the examples below, enter the appropriate command, typed on a single line:

On z/OS:

```
/f MQ01CMGR,dp t=yes b=broker e=execgroup  
d=file1.cmf:file2.cmf:file3.dictionary:file4.xml
```

where *MQ01CMGR* is the name of the Configuration Manager component.

On distributed platforms:

```
mqsideploy -i ipAddress -p port -q qmgr -b broker -e execgp  
-d file1.cmf:file2.cmf:file3.dictionary:file4.xml
```

where *-i IP address*, *-p port*, and *-q qmgr* specify the connection details of the Configuration Manager workstation.

The *-d* parameter (*d=* on z/OS) is a colon-separated list of files that are to be removed from the named execution group. When you invoke the command, the deployed objects (*file1.cmf*, *file2.cmf*, *file3.dictionary*, *file4.xml*) are removed from the specified execution group and broker.

Optionally, specify the *m=* (z/OS) or *-m* (distributed) option to clear the contents of the execution group. This option tells the execution group to completely clear any existing data before the new bar file is deployed.

The command reports when responses are received from the Configuration Manager and any brokers that are affected by the deployment. If the command completes successfully, it returns 0.

Using the Configuration Manager Proxy API

To remove deployed objects from an execution group, get a handle to the relevant `ExecutionGroupProxy` object, and then invoke the `deleteDeployedObjectsByName()` method. For example:

```
import com.ibm.broker.config.proxy.*;  
  
public class DeleteDeployedObjects {  
    public static void main(String[] args) {  
        ConfigManagerConnectionParameters cmcp =  
            new MQConfigManagerConnectionParameters  
                ("localhost", 1414, "QM1");  
        try {  
            ConfigManagerProxy cmp =  
                ConfigManagerProxy.getInstance(cmcp);  
            TopologyProxy t = cmp.getTopology();  
            BrokerProxy b = t.getBrokerByName("broker1");  
            ExecutionGroupProxy e =  
                b.getExecutionGroupByName("default");  
            e.deleteDeployedObjectsByName(  
                new String[] { "file1.cmf",
```

```
        "file2.cmf",  
        "file3.dictionary",  
        "file4.xml" }, 0);  
    }  
    catch (ConfigManagerProxyException e) {  
        e.printStackTrace();  
    }  
}
```

Next:

If you have deleted one or more message flows, you can now delete the resource files that are associated with and used by those message flows; for example, JAR files.

Part 5. Debugging

Testing and debugging message flow applications	781
Flow debugger overview	781
ESQL nodes and debugging	782
Java nodes and debugging	782
Mapping nodes and debugging	782
Debugging a message flow	783
Starting the debugger	784
Working with breakpoints in the debugger	790
Stepping through flow instances in the debugger	794
Debugging data	799
Managing flows and flow instances during debugging	803
Debugging message flows that contain WebSphere Adapters nodes	805
Testing message flows using the Test Client	806
Test Client overview	807
Testing a message flow	808
Using the Test Client in trace and debug mode	812

Testing and debugging message flow applications

Use the flow debugger to test and error-check your message flows.

This section includes the following topics:

- “Flow debugger overview”

Read this section to learn about the function provided by the flow debugger, and why you might want to use it.

To use the flow debugger effectively, see “Message flows overview” on page 4 to gain a basic understanding of message flows and their representation in the workbench.

- “Debugging a message flow” on page 783

This section describes the tasks that you can follow to start the flow debugger and to set options to test and debug the steps taken by the message flow.

The IBM Redbooks publication WebSphere Message Broker Basics also provides information about using the debugger for your message flows.

When you debug message flows, choose a broker that is set up for test and not for production, because debugging might degrade the performance of all message flows that are deployed to the broker. Other flows in the same execution group, and those in other execution groups defined to the same broker might be affected by potential resource contention.

The following restrictions apply when you debug a message flow:

- You must use the same version of the broker and the Message Broker Toolkit; for example, you cannot use the Message Broker Toolkit Version 6.1 to debug a message flow that you have deployed to a broker at an earlier version.
- Do not debug message flows over the Internet; the security function has not been enabled.

Flow debugger overview

Use the flow debugger in the workbench to test your message flows.

Switch to the Debug perspective to use the flow debugger. Use the actions of the visual interface to catch the flow at any point, and examine or alter the message state, before stepping to the next point.

You can set breakpoints in a flow and then step through the flow. While you are stepping through, you can examine and change the message and the variables used by ESQL code, Java code, and mappings. You can debug a wide variety of error conditions in flows, including:

- Incorrectly-wired activities (for example, outputs that are connected to the wrong inputs)
- Incorrect conditional branching in transition conditions
- Unintended infinite loops in flow

From a single workbench, you can attach the debugger to one or more execution groups, and debug multiple flows in different execution groups (and therefore

multiple messages) at the same time. However, an execution group can be debugged by only one user at a time. Therefore, if you attach your debugger to an execution group, another user cannot attach a debugger to that same execution group until you have ended your debug session.

For more information about the nodes that you can debug, see the following topics:

- ESQL nodes
- Java nodes
- Mapping nodes

Follow the guidance given in “Debugging a message flow” on page 783 to debug your message flows.

For an introduction to the Debug perspective and the views it presents, see Debug perspective.

ESQL nodes and debugging

You can include one or more nodes in a message flow that contain ESQL code modules to modify the behavior of that node.

When you have deployed the message flow, you can use the flow debugger to set a breakpoint just before the node. When the flow pauses at the breakpoint, you can step into the code, and step through it (*step over*) line by line to examine the logic and check the actions taken and their results. You can set additional breakpoints in the ESQL code. You can also examine and change the ESQL variables.

These tasks are described in detail in “Debugging ESQL” on page 800.

You can code ESQL for the following nodes:

- Compute node
- Filter node
- Database node

Java nodes and debugging

You can include one or more nodes in a message flow that contain Java code to modify the behavior of that node.

When you have deployed the message flow, you can use the flow debugger to set a breakpoint just before the node. When the flow pauses at the breakpoint, you can step into the code, and step through it (*step over*) line by line to examine the logic and check the actions taken and their results. You can set additional breakpoints in the Java code. You can also examine and change the Java variables.

These tasks are described in detail in “Debugging Java” on page 801.

You can code Java for the following nodes:

- JavaCompute node
- User-defined node

Mapping nodes and debugging

You can include one or more nodes in a message flow that contain mappings to modify the behavior of that node.

When you have deployed the message flow, you can use the flow debugger to set a breakpoint just before the node. When the flow pauses at the breakpoint, you can step into the mappings, and step through them (*step over*) to examine the logic and check the actions taken and their results. You can set breakpoints on any of the mapping commands. You can view mapping variables, and you can view and alter your own user-defined variables.

These tasks are described in detail in “Debugging mappings” on page 802.

You access and maintain mappings for the following nodes:

- Mapping node
- DataInsert node
- DataUpdate node
- DataDelete node
- Extract node
- Warehouse node

Debugging a message flow

This topic lists the tasks involved in debugging a message flow. If you are new to debugging, see “Flow debugger overview” on page 781 for a conceptual overview.

1. Deploying the message flow:
 - Deploy your message flow to an execution group in a broker and make sure that the broker is running. For further information, see “Deploying” on page 745.
2. Starting the flow debugger:
 - a. “Setting flow debug preferences” on page 784
 - b. Attaching to the flow engine
 - c. “Putting a test message” on page 786
 - d. “Getting a test message” on page 789
3. Working with breakpoints:
 - a. Adding breakpoints
 - b. Restricting breakpoints to specific flow instances
 - c. Disabling breakpoints
 - d. Enabling breakpoints
 - e. Removing breakpoints
4. Stepping through flow instances:
 - a. Resuming flow instance execution
 - b. Running to completion
 - c. Stepping over nodes
 - d. Stepping into subflows
 - e. Stepping out of subflows
 - f. Stepping into source code
 - g. Stepping over source code
 - h. Stepping out of source code
5. Debugging data:
 - a. “Debugging messages” on page 799
 - b. “Debugging ESQL” on page 800
 - c. “Debugging Java” on page 801

- d. “Debugging mappings” on page 802
6. Managing flows and flow instances:
 - a. Querying a broker for deployed flows
 - b. Redeploying a flow
 - c. Terminating a flow instance
 - d. Detaching from the flow engine

Starting the debugger

Before you start:

To complete this task, you must have completed the following tasks:

- “Developing message flows” on page 3
- Deploying the message flow
- Ensuring that the broker where your flow is deployed is running

When you ready to debug a message flow, complete the following tasks to start the debugger:

1. Optional: Setting flow debug preferences
2. Attaching to the flow engine
3. Optional: Putting a test message
4. Optional: Getting a test message

Setting flow debug preferences

The following steps show you how to set your own preferences for the flow debugging environment in the workbench:

1. Click **Run** → **Debug** to display the Create, Manage, and Run configurations panel.
2. In the Create, Manage, and Run configurations panel, select **Message Broker Debug** -> **New Configuration**.
3. Assign new port in **Java Debug Port** and click Select Execution Group to attach the port to an Execution Group from the displayed list.
4. Click **Debug** to launch the debugger or **Close** to close the wizard and your changes are applied.

Now that you have completed this task, you can continue with the next step, Attaching to the flow engine .

Attaching to the flow engine for debugging

Before you can debug your message flow, you must attach the flow debugger to the flow engine (execution group) where your flow is deployed, and start a debug session.

Before you start

To complete this task, you must have completed the following tasks:

- “Developing message flows” on page 3.
- Deploying the message flow.
- Ensure that the broker where your flow is deployed is running.

You can attach the flow debugger to multiple flow engines that are running on the same or on different host computers, and debug their flows simultaneously.

To attach to the flow engine:

1. Restart the broker when the command has completed.
2. Switch to the Broker Administration perspective. Note the name of your message flow as it is displayed in the Domains pane.
3. Set a Java Debug Port number.

To configure the broker JVM with a debug port number to this value, either click **Select Execution Group**, right-click the selected execution group, and click **Preferences**, or issue the following command (all on one line):

```
mqsichangeproperties <broker name> -e <execution group name> -o ComIbmJVManager  
-n jvmDebugPort -v <port number>
```

4. When this command has completed, restart the broker.
5. Open the message flow that you want to debug in the Message Flow editor by double-clicking its name in the Broker Administration Navigator pane.
6. Add a breakpoint to a connection that leads out of the input node of the message flow to ensure that the message flow does not run to completion before you can begin to debug it.

The breakpoint appears as . For information about adding a breakpoint, see “Working with breakpoints in the debugger” on page 790.

7. Switch to the Debug perspective.
8. Click the down-arrow on the **Debug** icon  on the toolbar, and click **Debug** to invoke the Debug (Create, manage, and run configurations) wizard.

You are creating a debug launch configuration. If you have already created one, you can relaunch it by clicking directly on the **Debug** icon  itself. This action generates an error if any of the following conditions are true:

- You have not created a debug launch configuration.
- The broker and execution group to which you previously attached are no longer running.
- The broker and execution group have been restarted and therefore have a new *Process ID* (see below).

9. In the list of configurations, select **Message Broker Debug** and click **New**. A set of tabbed panels appears in the window, beginning with Connect.

You cannot click **Debug** until you complete the fields on the Connect panel. You can then choose to complete the fields on the other panels, or click **Debug** straight away. The panels in the wizard are:

- Java debug setting: use this panel to debug a message flow. The Java port is the port number that is specified for the broker JVM. If you do not specify a port, Java debugging is disabled.
- Deployment Location: click the **Select Execution Group** button to display a list of Execution groups.
- Source: use this panel to tell the debugger where to look for your source files for flow, mapping, ESQL, or Java, during debugging. The lookup path can be an Eclipse project name, an external folder, or a compressed (zipped) file. You can specify multiple locations, but the debugger always looks first in the message flow project that you specified on the Connect panel. If you do not correctly configure the location of the source files, message flow, ESQL and Java files might not be displayed during debugging. If the source

|
|
|

lookup path is not specified for a mapping node, then you might encounter unexpected behavior when you use the debugger to step through the message map.

- Common: this panel is not directly used by the flow debugger; however if you set options on it they do take effect. See the Workbench User Guide for details.
10. Click **Debug**. In the Debug view, the names of the selected host computer and flow engine are displayed.
 11. When the next message comes into your flow and arrives at the breakpoint, the flow pauses, the breakpoint icon changes to , and you can start debugging.
 12. In the Debug view, double-click the message flow that you want to debug. The message flow opens in the Message Flow editor. You can now add more breakpoints, start stepping over the flow, and so on.

From a single workbench, you can attach the debugger to one or more execution groups, and debug multiple flows in different execution groups (and therefore multiple messages) at the same time. However, an execution group can be debugged by only one user at a time. Therefore, if you attach your debugger to an execution group, another user cannot attach a debugger to that same execution group until you have ended your debug session.

The flow debugger can debug runtime brokers from previous versions. Select the version of the broker that you want to debug by checking the corresponding option on the Engine Selection panel in the Debug wizard, as described previously.

When you have completed this task, you can continue with one of the following tasks:

- Optional: “Putting a test message” and “Getting a test message” on page 789. These tasks involve putting messages to, and taking messages from, WebSphere MQ queues and are therefore useful only if your message flow includes MQInput and MQOutput nodes.
- “Working with breakpoints in the debugger” on page 790.

Putting a test message

Put a message to a queue to test a message flow that you are debugging.

Before you start

To complete this task, you must have completed the following tasks:

- “Developing message flows” on page 3
- Deploying the message flow
- Attaching to the flow engine

If your message flow includes MQInput and MQOutput nodes, you might want to trigger the flow by putting a test message onto the input queue for your first MQInput node. Follow the instructions to put a test message by configuring and using an enqueue file in the workbench. This method is a repeatable alternative to using command line interfaces or WebSphere MQ Explorer



- “Configuring and using an enqueue file” on page 787
- “Optional: Adding data to your message” on page 787
- “Optional: Using a file of sample data” on page 788

- “Optional: Creating a file of sample data for the message” on page 788
- “Optional: Importing an existing file of sample data for the message” on page 788

If the message is processed by the message flow and is put to an output queue, you can retrieve it from that queue. See “Getting a test message” on page 789 for details.

Configuring and using an enqueue file:

To configure an enqueue file so that you can use it to send a test message:

1. Switch to the Broker Administration perspective.
2. On the workbench toolbar, click the arrow on the **Put a message onto a queue** icon  .
3. On the drop-down menu, click **Put Message...** to invoke the New Enqueue Message File wizard.
4. Select the message flow project containing the message flow that you are debugging.
5. In the **File name** field, enter a name for the file to create (the extension `.enqueue` is added automatically).
6. Click **Finish**. The enqueue file is created, and a view opens showing its details.
7. Enter the names for the queue manager and the queue for the input node for this flow. Queue manager names are case-sensitive; check that you enter the name correctly.
If you are putting a message on an input queue that is on a remote computer, ensure that the queue manager of the associated broker has a server-connection channel called `SYSTEM.BKR.CONFIG`.
8. If you are putting a message on a remote queue, enter values to identify the host and port of the computer that is hosting the queue.
9. Optional: Click the **MQMD** tab to customize the fields of the MQMD header. Read descriptions of these fields in *Application Programming Reference* section of the WebSphere MQ Version 6 information center online; the constants are listed in the *Constants* section.
10. Click **File** → **Save** to save the enqueue file.
11. Optional: To put the message to the queue immediately from this window, click the **Write to queue** button.
12. Click the arrow on the **Put a message onto a queue** icon  to see your enqueue file listed on the drop-down menu.
13. Click this file on the menu, (or if it is number 1 on the menu, just click the icon itself) to put a message to the queue. If you have set appropriate breakpoints, the flow debugger pauses the flow at the next one.

To find your enqueue file at a later time, switch to the Broker Application Development perspective and expand the navigation tree for your message flow project. Double-click your enqueue file to open it in a view.

Optional: Adding data to your message:

If you want just a small amount of test data in your test message, type the data into a window to quickly add some test data:

1. Open your enqueue file and select the **Browse** tab.
2. Type your test data directly into the “Message data” window.
3. Put the test message by selecting the **General** tab and clicking the **Write to queue** button.

Optional: Using a file of sample data:

If you want your test message to contain a larger quantity of sample data (for example some structured XML), first create or import a file containing that data, then get the enqueue file to use it. Follow the optional steps to use either of these methods of creating and adding data.

To get the enqueue file to use a file that contains sample data:

1. Create or import the message data file, as described below.
2. Open your enqueue file; at **File name** click the **Browse** button.
3. In the “Add a message” window, select your file and click **OK**.
4. Click **File** → **Save** when you have finished.
5. To see the data in your file, select the **Browse** tab at the bottom of the enqueue view. If you want to change the data, either type some text into the “Message data” window, or edit the file by double-clicking it in the Broker Development view.

Tip: If you decide to experiment with using an XML data file instead of text, do not forget to edit the properties for the input node of your message flow and set the **Message Domain** to **XML**. When your message appears in the Flow Debugger in the Variables view, the XML is parsed and expandable in the tree.

Optional: Creating a file of sample data for the message:

To create a new file of sample data:

1. Switch to the Broker Application Development perspective.
2. Click **File** → **New** → **Other...**
3. Click **Simple**, then **File**.
4. In the New File window, select the project in which you want to keep the file, then at **File name** enter a name and extension for your file. If your file contains XML, make sure that the extension is *.XML*.
5. Click **Finish**. The file is created and appears in the Broker Development view. A view opens with an appropriate editor (text or XML) for the file.
6. Edit the file and enter the text or XML data that you want in it.
7. Click **File** → **Save** when you have finished.

You can now select the file as described in the “Optional: Using a file of sample data” section. You can also double-click the file to open it in an appropriate editor.

Optional: Importing an existing file of sample data for the message:

If you already have a file on your computer containing sample data that you want to use in a test message, use these steps to import the data into the workbench. If the file contains XML, make sure that it has the extension *.XML*.

1. Switch to the Broker Application Development perspective.
2. Click **File** → **Import**.

3. In the list of wizards, select **File system** then click **Next**.
4. At **Directory**, click the **Browse** button and navigate to the folder containing your file then click **OK**. A list of the files in the folder appears.
5. In the list of files, select the check box next to the file that you want to import.
6. At **Folder**, click the **Browse** button and select the project in which you want to keep the file.
7. Click **Finish**.

After you have imported the file as described here, a copy of your file is stored in the workbench data space along with all other workbench files for your configuration. Your original file is not used directly again.

The file appears in the Broker Development view in your chosen project, and you can select it as described in the “Optional: Using a file of sample data” on page 788 section on this page. You can also double-click it to open it in an appropriate editor.



Getting a test message

Before you start

To complete this task, you must have completed the following tasks:

- “Developing message flows” on page 3
- Deploying the message flow
- Attaching to the flow engine
- “Putting a test message” on page 786

While you are debugging your message flow, you might want to read a message from the queue on your MQOutput node. This topic tells you how to get a test message by configuring and using a dequeue file in the workbench. This is an easy and repeatable alternative to using command line interfaces or WebSphere MQ Explorer (with WebSphere MQ Version 6) or WebSphere MQ Services (with WebSphere MQ Version 5) to get a message.

1. Switch to the Debug perspective.
2. On the workbench toolbar, click the arrow on the **Get a message from a Queue** icon  .
3. On the drop-down menu, click **Get Message...** to invoke the Dequeue Message window.
4. Enter the names for the queue manager and (output node) queue that you want.
5. Click **Read From Queue** to read a message from the queue.
6. After closing the window, the next time that you click the arrow on the **Get a message from a Queue** icon  , you see the dequeue configuration that you created above listed on the drop-down menu. Click this file on the menu (or if it is number 1 on the menu, just click the icon itself) to get a message from the queue.
7. Optional: While the Dequeue Message window is open, you can save a read message into a file in your message flow project to keep it for later. Click the **Save As...** button, and in the Save Message As window, select the flow project and enter a name for the file, including a .extension if you want one.

Tip: If you saved any messages into files and want to see these saved messages, switch to the Broker Application Development perspective and expand the navigation tree for your flow project. Double-click a saved message file to open it in a view.

When you have successfully put and retrieved test messages, you can use other functions provided by the debugger to debug your flow more comprehensively; continue with “Working with breakpoints in the debugger.”

Working with breakpoints in the debugger

Before you start:

To complete this task, you must have completed the following tasks:

- Attaching to the flow engine

When you have started a debugger session by attaching to the flow engine, you can set breakpoints to control how the message flow is managed:

- Adding breakpoints
- Optional: Restricting breakpoints to specific flow instances
- Optional: Disabling breakpoints
- Optional: Enabling breakpoints
- Optional: Removing breakpoints

When you have set one or more breakpoints in the message flow, continue your debug session with the following tasks:

- Stepping through flow instances
- “Debugging data” on page 799

Adding breakpoints in the flow debugger

How to set breakpoints for the flow debugger.

Before you start:

To complete this task, you must have completed the following tasks:

- Attaching to the flow engine

You can add breakpoints to the connections of a message flow that is open in the Message Flow editor. Every breakpoint is automatically enabled. Each breakpoint that you add to a flow is also automatically added to all other instances of the flow and you do not need to restart any of the instances.

When you add a breakpoint to a connection, the connection is flagged with the enabled breakpoint symbol  .

You must set a breakpoint after the collector node, or any other multithreaded node, manually. When you use the Debug perspective on the node, you see that the thread has been ended.

To add breakpoints to the connections of a message flow:

1. Switch to the Debug perspective.

2. Add breakpoints to the appropriate connections. Use any of the following methods:

Option	Description
Add breakpoints individually to selected connections:	<ol style="list-style-type: none"> 1. In the Message Flow editor, right-click the connection where you want to set the breakpoint. 2. Click Add Breakpoint on the pop-up menu.
Add breakpoints simultaneously to all connections <i>entering</i> a selected node:	<ol style="list-style-type: none"> 1. In the Message Flow editor, right-click the node before which you want to set breakpoints. 2. Click Add Breakpoints Before Node on the pop-up menu.
Add breakpoints simultaneously to all connections <i>leaving</i> a selected node:	<ol style="list-style-type: none"> 1. In the Message Flow editor, right-click the node after which you want to set breakpoints. 2. Click Add Breakpoints After Node on the pop-up menu.

Now that you have added at least one breakpoint to the message flow, you can step through the flow instance and work with data:

- “Stepping through flow instances in the debugger” on page 794
- “Debugging data” on page 799

Restricting breakpoints in the debugger to specific flow instances

Before you start

To complete this task, you must have completed the following tasks:

- Adding breakpoints

When you add a breakpoint to a message flow in the Message Flow editor, the breakpoint automatically applies to all instances of the flow. However, you can choose to restrict a breakpoint to one or more instances of a flow. This enables you to work more easily with just those instances that you are currently interested in, rather than with all instances.

To restrict a breakpoint to one or more flow instances:

1. Switch to the Debug perspective.
2. In the Breakpoints view, right-click the breakpoint that you want to restrict, then click **Properties** to open the Flow Breakpoints Properties window.
3. In the **Restrict to Selected Flow Instance(s)** list box, select the check boxes of those instances to which you want to restrict the breakpoint.

You must have at least one instance active; if not, the **Restrict to Selected Flow Instance(s)** list box is empty.

If any instance is currently paused on the breakpoint, all check boxes in the **Restrict to Selected Flow Instance(s)** list box are grayed out and you cannot select them.

4. Click **OK**.

Now you can add additional breakpoints (if needed), step through the flow instance, and work with data:

- “Stepping through flow instances in the debugger” on page 794
- “Debugging data” on page 799

Disabling breakpoints in the debugger

Before you start

To complete this task, you must have completed the task Adding breakpoints.

You can disable any breakpoints that are currently enabled. The following symbol identifies enabled breakpoints:



To disable breakpoints:

1. Switch to the Debug perspective.
2. In the Breakpoints view, select one or more enabled breakpoints that you want to disable.
3. Right-click the selected breakpoints and click **Disable**. The breakpoints are disabled in all instances of the message flow where they are set.
4. Optional: to disable a single breakpoint, right-click the breakpoint and then click **Properties**. Clear the **Enabled** check box and click **OK**. The breakpoint is disabled in all instances of the message flow where it is set.

When you disable a breakpoint, the breakpoint icon changes to the following symbol:



If you disable all the breakpoints in the message flow, you cannot perform any other debugging tasks until you add a new breakpoint, or enable an existing breakpoint.

If you have finished with your debugging session, continue with “Debug: detaching from the flow engine” on page 805.

Enabling breakpoints in the debugger

Before you start

To complete this task, you must have completed the following tasks:

- Adding breakpoints
- Disabling breakpoints

You can enable any breakpoints that you have disabled. The following symbol identifies disabled breakpoints:



To enable breakpoints:

1. Switch to the Debug perspective.

2. In the Breakpoints view, select one or more disabled breakpoints that you want to enable.
3. Right-click the selected breakpoints and click **Enable**. The breakpoints are enabled in all instances of the message flow where they are set.
4. Optional: to enable a single breakpoint, right-click the breakpoint and click **Properties**. Select **Enabled** and click **OK**. The breakpoint is enabled in all instances of the message flow where it is set.

When you enable a breakpoint, the breakpoint icon changes to the following symbol:



When you have enabled breakpoints, continue with your debug session:

- Stepping through flow instances
- “Debugging data” on page 799

Removing breakpoints in the debugger

Before you start

To complete this task, you must have completed the following tasks:

- Adding breakpoints



You can remove breakpoints either where they are shown on the connections of a message flow that is open in the Message Flow editor, or where they are listed in the Breakpoints view. The following symbol shows the breakpoint:





If you remove a breakpoint from a message flow, it is automatically removed from all other instances of the message flow where it is set.

To remove breakpoints:

1. Switch to the Debug perspective.
2. Remove the breakpoints. Use one of the following methods, depending on how many breakpoints you want to remove:

Option	Description
Remove individual breakpoints from connections in the Message Flow editor:	1. In the Message Flow editor, right-click the breakpoint that you want to remove, then click Remove Breakpoint .
Remove selected breakpoints simultaneously in the Breakpoints view:	1. Click the Flow Breakpoints tab to show the Breakpoints view. 2. Select one or more breakpoints that you want to remove. 3. Click the Remove Selected Breakpoints icon  on the toolbar, or right-click the selected breakpoints and then click  Remove.

Option	Description
Remove all breakpoints simultaneously in the Breakpoints view:	<ol style="list-style-type: none"> 1. Click the Breakpoints tab to show the Breakpoints view. 2. Click the Remove All Breakpoints icon  on the toolbar, or right-click any breakpoint and then click  Remove All.

If you remove all the breakpoints that you have added to your message flow, you cannot perform any other debugging tasks until you add a new breakpoint.

If you have finished with your debugging session, continue with “Debug: detaching from the flow engine” on page 805.

Stepping through flow instances in the debugger

Before you start

To complete this task, you must have completed the following tasks:

- Adding breakpoints

When you have added one or more breakpoints to a deployed message flow, the debugger stops the message flow processing at the first breakpoint encountered. You can then continue with one or more of the following tasks, where appropriate, to continue or stop the message flow processing:

- Resuming flow instance execution
- Running to completion
- Stepping over nodes
- Stepping into subflows
- Stepping out of subflows
- Stepping into source code
- Stepping over source code
- Stepping out of source code

When you have finished stepping through and debugging your message flow, you can remove the breakpoints, or end the debug session:

- Removing breakpoints
- Detaching from the flow engine

Debug: resuming flow instance execution



Before you start

To complete this task, you must have completed the following tasks:

- Adding breakpoints

When message flow processing has paused at a breakpoint, you can resume the flow execution:

1. Switch to the Debug perspective.

2. In the Debug view, click the **Resume Flow Execution** icon  on the toolbar, or right-click the flow stack frame, then click  **Resume**.

When you resume the execution of a flow instance, message flow processing continues until the next breakpoint that is set in the logical processing of the current message . If there is no further breakpoint at which the flow instance can pause, the flow instance runs to completion and is removed from the Debug view.

If you have now completed debugging this message flow, you can remove the breakpoints, or end the debug session:

- Removing breakpoints
- Detaching from the flow engine



Debug: running to completion

Before you start

To complete this task, you must have completed the following tasks:

- Adding breakpoints

When message flow processing has paused at a breakpoint, you can restart processing so that the message flow runs to completion:

1. Switch to the Debug perspective.
2. In the Debug view, click the **Run to completion** icon  on the toolbar, or right-click the flow stack frame, then click  **Run to completion**.

When you run the message flow to completion, the flow instance ignores all breakpoints and continues to its end. The flow instance is automatically removed from the Debug view.

Tip: If you want the flow to continue processing, but you want to stop at the next breakpoint instead of running the flow to completion, see Resuming flow instance execution.

If you have now completed debugging this message flow, you can remove the breakpoints, or end the debug session:

- Removing breakpoints
- Detaching from the flow engine

Debug: stepping over nodes



Before you start

To complete this task, you must have completed the following task:

- Adding breakpoints

When message flow processing has paused at a breakpoint, you can step over the node that is next in sequence:

1. Switch to the Debug perspective.

2. In the Debug view, click the **Step Over Node** icon  on the toolbar, or right-click the flow stack frame, then click  **Step Over Node**.

When you step over a node, message flow processing continues until the next breakpoint that is set in the logical processing of the current message. If no further breakpoints are set, the flow instance runs to completion and is removed from the Debug view.

If you have now completed debugging this message flow, you can remove the breakpoints, or end the debug session:

- Removing breakpoints
- Detaching from the flow engine



Debug: stepping into subflows

Before you start

To complete this task, you must have completed the following task:

- Adding breakpoints

When message flow processing has paused at a breakpoint, you can step into the subflow that follows:

1. Switch to the Debug perspective.
2. In the Debug view, click the **Step Into Subflow** icon  on the toolbar, or right-click the flow stack frame, then click  **Step Into Subflow**. The subflow opens in the Message Flow editor and displaces the parent message flow.

When you step into a subflow, message flow processing continues until the next breakpoint that is set in the logical processing of the current message. If no further breakpoints are set in the subflow or in the parent flow, the flow instance runs to completion and is removed from the Debug view.

If you have now completed debugging this message flow, you can remove the breakpoints, or end the debug session:

- Removing breakpoints
- Detaching from the flow engine

Debug: stepping out of subflows



Before you start

To complete this task, you must have completed the following tasks:

- Adding breakpoints
- Stepping into subflows

When message flow processing has paused at a breakpoint within a subflow, you can step out of the subflow:

1. Switch to the Debug perspective.

2. In the Debug view, click the **Step Out of Subflow** icon  on the toolbar, or right-click the subflow stack frame, then click  **Step Out of Subflow**.

The debugger pauses the flow at the next breakpoint in the subflow, if one is defined. If no further breakpoints are defined in the subflow, the parent flow opens in the Message Flow editor and displaces the subflow. The parent flow is paused at the connection from the output terminal of the subflow.

If you have now completed debugging this message flow, you can remove the breakpoints, or end the debug session:

- Removing breakpoints
- Detaching from the flow engine

Debug: stepping into source code

When message flow processing has paused at a breakpoint on entry to a node that contains ESQL code, Java code, or mappings, you can step into the code.

Before you start

To complete this task, you must have completed the following tasks:

- Adding breakpoints



To step into:

- A map, add a breakpoint to a map using the Map Script panel.
- ESQL code, add a breakpoint in the ESQL code.
- Java code, add a breakpoint in the Java code.

In a message flow there are three types of node that can contain source code:

- Nodes that contain ESQL code: Compute node, Filter node, or Database node.
- Nodes that contain Java code: user-defined node containing Java code, or JavaCompute node.
- Nodes used to access and maintain mappings: a Mapping node, DataInsert node, DataUpdate node, DataDelete node, Extract node, or Warehouse node.

Note: Mapping routines are implemented in ESQL; you can choose either to step through the ESQL code, or step through the mappings.

1. Switch to the Debug perspective.
2. In the Debug view, click the **Step into Source Code** icon  on the toolbar, or right-click the flow stack frame, then click  **Step Into**.

After stepping into the code, you can *step through* the source code, line by line, in an environment that is optimized for source code debugging. This task is described in *Stepping over source code*.

You can also *step out of* the code, as described in *Stepping out of source code*; the message flow continues to run to the next breakpoint, or to completion if no further breakpoints are set.

Debug: stepping over source code

Before you start

To complete this task, you must have completed the following tasks:



- Adding breakpoints
- Stepping into source code

When message flow processing has paused at a breakpoint within ESQL code, Java code, or mappings, you can step over the code.

In a message flow there are three types of node that can contain source code:

- Nodes that contain ESQL code: Compute node, Filter node, or Database node.
- Nodes that contain Java code: user-defined node containing Java code, or JavaCompute node.
- Nodes used to access and maintain mappings: a Mapping node, DataInsert node, DataUpdate node, DataDelete node, Extract node, or Warehouse node.

Note: Mapping routines are implemented in ESQL; if you step into the code, you can choose either to step through the ESQL code, or to step through the mappings.

1. Switch to the Debug perspective.
2. In the Debug view, click the **Step Over** icon  on the toolbar, or right-click the flow stack frame, then click  **Step Over**.

When you step over code, a single line of source code runs and the flow pauses at the next line of code.

What you can do depends on what type of code is contained within the node:

- “Debugging ESQL” on page 800
- “Debugging Java” on page 801
- “Debugging mappings” on page 802

If the debugger is paused before the last line of code when you step over, the last line of code runs and the debugger automatically pauses at the next breakpoint that is set in the logical processing of the current message. If there is no further breakpoint at which the flow instance can pause, the flow instance runs to completion and is removed from the Debug view.

If you do not want to continue stepping through the code, you can step out of the code, as described in Stepping out of source code.

If you have now finished stepping through and debugging this message flow, you can remove the breakpoints, or end the debug session:

- Removing breakpoints
- Detaching from the flow engine

Debug: stepping out of source code

Before you start

To complete this task, you must have completed the following tasks:



- Adding breakpoints
- Stepping into source code

When message flow processing has paused at a breakpoint within ESQL code, Java code, or mappings, you can step out of the code.

In a message flow there are three types of node that can contain source code:

- Nodes that contain ESQL code: Compute node, Filter node, or Database node.
- Nodes that contain Java code: user-defined node containing Java code, or JavaCompute node.
- Nodes used to access and maintain mappings: a Mapping node, DataInsert node, DataUpdate node, DataDelete node, Extract node, or Warehouse node.

Mapping routines are implemented in ESQL; if you step into the code, you can choose either to step through the ESQL code, or to step through the mappings.

1. Switch to the Debug perspective.
2. In the Debug view, click the **Step Return** icon  on the toolbar, or right-click the flow stack frame, then click  **Step Return**.

The source code runs to completion from the current breakpoint and message flow processing continues until the next breakpoint that is set in the logical processing of the current message. If there is no further breakpoint at which the flow instance can pause, the flow instance runs to completion and is removed from the Debug view.

If you have now completed debugging this message flow, you can remove the breakpoints, or end the debug session:

- Removing breakpoints
- Detaching from the flow engine

Debugging data

When you have added one or more breakpoints to a deployed message flow, the debugger stops the message flow processing at each breakpoint. Depending on the context of the breakpoint, you can do one of the following tasks:

- “Debugging messages”
- “Debugging ESQL” on page 800
- “Debugging Java” on page 801
- “Debugging mappings” on page 802

When you have finished debugging this message flow, you can remove the breakpoints, or end the debug session:

- Removing breakpoints
- Detaching from the flow engine

Debugging messages

Before you start

To complete this task, you must have completed the following tasks:

- Adding breakpoints

When message flow processing has paused at a breakpoint in your message flow, you can examine and modify the message content.

1. Switch to the Debug perspective.
2. View the messages in the Variables view.

Tip: The Breakpoints view and the Variables view share the same pane. Click the tab at the bottom to select the view that you want.

3. To alter a message, right-click it and select an option from the menu. You cannot alter the content of exceptions within a message.

When you have viewed message contents, and made any changes that you wanted, message flow processing continues until the next breakpoint that is set in the logical processing of the current message . If there is no further breakpoint at which the flow instance can pause, the flow instance runs to completion and is removed from the Debug view.

If you have now completed debugging this message flow, you can remove the breakpoints, or end the debug session:

- Removing breakpoints
- Detaching from the flow engine

Debugging ESQL

Viewing and altering ESQL variables in the Flow Debugger.

Before you start

To complete this task, you must have completed the following tasks:

- Adding breakpoints
- Stepping into source code

When message flow processing has paused at a breakpoint in source code within a node that contains ESQL code (a Compute, Filter, or Database node), you can browse ESQL variables in the Variables view in the Debug Perspective, and change their associated data values. You can also set breakpoints on lines in the ESQL code. See the following sections for further details:

- “Working with ESQL variables”
- “Using breakpoints on ESQL code lines” on page 801

When you finished working with the ESQL code and variables, message flow processing continues until the next breakpoint that is set in the logical processing of the current message . If there is no further breakpoint at which the flow instance can pause, the flow instance runs to completion and is removed from the Debug view.

If you have now completed debugging this message flow, you can remove the breakpoints, or end the debug session:

- Removing breakpoints
- Detaching from the flow engine

Working with ESQL variables:

1. Switch to the Debug perspective.
2. Open the Variables view. Variables are shown in a tree, using the symbol  .

3. To work with a variable, right-click it and select an option from the pop-up menu.

For example, if you have declared the following ESQL variables:

```
DECLARE myInt INT 0;
DECLARE myFloat FLOAT 0.0e-1;
DECLARE myDecimal DECIMAL 0.1;
DECLARE myInterval INTERVAL DAY TO MONTH;
```

you can update these values in the debugger. However, you cannot update the message trees, or REFERENCE variables.

Using breakpoints on ESQL code lines:

1. Switch to the Debug perspective.
2. Open the ESQL editor.
3. Right-click a line where a breakpoint can be set. You cannot set a breakpoint on a comment line or a blank line.
4. Select from the menu to create, delete, or restrict the breakpoint, in a similar way to normal debugger breakpoints, as described in Working with breakpoints.

Debugging Java

This topic tells you the steps you need to take to enable Java debugging and how you view and alter Java variables in the Flow Debugger.

Before you start

To complete this task, you must have completed the following tasks:

- Adding breakpoints
- Stepping into source code

To enable Java debugging:

1. Start the broker
2. Launch the broker Command Console and type the command:

```
mqsichangeproperties <brokername> -e <executiongroupname> -o ComIbmJVMManger
-n jvmDebugPort <portnumber>
```

For example:

```
mqsichangeproperties TEST -e default -o ComIbmJVMManger -n jvmDebugPort 3920
```

3. Restart the broker.
4. Add a breakpoint in the map where the Java method is called.
5. Add a breakpoint in the Java code itself, if you want to step directly into the Java code during the debugging process.
6. Connect the broker domain in the Broker Administration Perspective and deploy the BAR file, which includes the JAR file.
7. Launch the debug configuration and set the Java Debug Port to the one you set in the jvmDebugPort variable of the mqsichangeproperties command.
8. In the source tab, specify the source file location.
9. Click **Debug** to start the debug process and to run the application.

When message flow processing has paused at a breakpoint in source code within a node that contains Java code (a user-defined node or a JavaCompute node), you can browse Java variables in the Variables view in the Debug Perspective, and change their associated data values.

To work with Java variables:

1. Switch to the Debug perspective.
2. Open the Variables view. Variables are shown in a tree, using the symbol .
3. To work with a variable, right-click it and select an option from the menu.

When you finished working with the Java code and variables, message flow processing continues until the next breakpoint that is set in the logical processing of the current message. If there is no further breakpoint at which the flow instance can pause, the flow instance runs to completion and is removed from the Debug view.

If you have now completed debugging this message flow, you can remove the breakpoints, or end the debug session:

- Removing breakpoints
- Detaching from the flow engine

Debugging mappings



Before you start

To complete this task, you must have completed the following tasks:

- Adding breakpoints
- Stepping into source code

When message flow processing has paused at a breakpoint in source code within a node that contains mapping (a Mapping, DataInsert, DataUpdate, DataDelete, Extract, or Warehouse node), you can view the mapping routines and modify user-defined variables. You can also set breakpoints on lines in the mappings.

Mapping routines are implemented in ESQL; if you step into the code, you can choose either to step through the ESQL code, or to step through the mappings.

1. Switch to the Debug perspective.
2. In the Debug view, click **Step into Source Code**  on the toolbar, or right-click the flow stack frame and click  **Step Into**. The Message Mapping editor opens with the mapping routine highlighted in both the Mapping editor and the Outline view.
3. To use breakpoints on mapping lines:
 - a. In the Message Mapping Editor, select the line for the mapping command that you want to use, right-click the space beside it and select from the menu to add or disable a breakpoint. Alternatively, double-click the same space to add or remove a breakpoint. You cannot set a breakpoint on a comment line or a blank line.
 - b. Select from the menu to create, delete, or restrict the breakpoint, in a similar way to normal debugger breakpoints, as described in Working with breakpoints.

4. Check the mapping routines by performing the various stepping actions (step into, step over, and step return). While you are doing this, in the Debug view, the stack frame shows the list of mapping commands and the current command. The Variables view shows your user-defined mapping variables, along with the input message (that is, the Debug Message). You can alter the user-defined variables.

When you have finished working with the mappings and user-defined variables, message flow processing continues until the next breakpoint that is set in the logical processing of the current message. If no further breakpoints are set at which the flow instance can pause, the flow instance runs to completion and is removed from the Debug view.

If you have now finished debugging this message flow, you can remove the breakpoints, or end the debug session:

- Removing breakpoints
- Detaching from the flow engine

Managing flows and flow instances during debugging

When you have started a session for message flow debugging, you might want to complete one or more of the following associated tasks:

- Querying a broker for deployed flows
- Redeploying a flow
- Terminating a flow instance
- Detaching from the flow engine (to end your debug session)

Debug: querying a broker for deployed flows



Before you start

To complete this task, you must have completed the following tasks:

- Attaching to the flow engine

During an active debug session, you can query a flow engine on a broker to find out what flows are currently deployed on it. The displayed list of message flows that are available in that flow engine is updated. The updated list might include message flows that were not previously deployed, or that were not accessible because the flow was already being accessed by another developer.

To query a flow engine for deployed flows:

1. Switch to the Debug perspective.
2. In the Debug view, select the flow engine  that you want to query.
3. Click the **Refresh Selected Flow Engine to Get More Flow Types** icon  on the toolbar, or right-click the flow engine, then click  **Refresh**.

The Debug view is refreshed with the names of the flows that are currently deployed and available on the flow engine. You can continue your debug session and debug one of the listed message flows, or end your debug session:

- Working with breakpoints
- Detaching from the flow engine



Debug: redeploying a flow

Before you start

To complete this task, you must have completed the following tasks:

- Attaching to the flow engine

During your debug session, you might find a problem in a message flow, or see a behavior that you want to change. You can change the flow to resolve the situation and redeploy the flow to the broker:

1. Switch to the Debug perspective.
2. Detach the debugger from the flow engine by clicking the **Detach from the Selected Flow Engines** icon  on the toolbar.
3. Switch to the Broker Application Development perspective.
4. Edit the flow in the Message Flow editor and save your changes.
5. Switch to the Broker Administration perspective.
6. Double-click the bar file (Broker Archive) that contains your flow, to edit it. Remove the flow, then add it again, and save your changes. See “Adding files to a broker archive” on page 759 for more details.
7. Deploy your bar file by dragging it from the Broker Administration Navigator view and dropping it onto the execution group in the Domains view. Check the event log for messages to make sure that the deploy was successful.
8. Switch to the Debug perspective.
9. Click the down-arrow on the **Debug** icon  on the toolbar, and select **Debug** to invoke the **Debug (Create, manage, and run configurations)** wizard, and attach the flow engine again, following the instructions in Attaching to the flow engine.

The modified message flow has been deployed to the broker, and the debug session is ready for you to debug the new flow logic:

- Working with breakpoints
- Stepping through flow instances



Debug: terminating a flow instance

Before you start

To complete this task, you must have completed the following tasks:

- Attaching to the flow engine

While you are debugging, you might need to terminate a flow instance. For example, you might want to correct an error in your flow or source code. To do this, you must redeploy the flow correctly (see Redeploying a flow). However, you cannot redeploy the flow until you have terminated the flow instance:

1. Switch to the Debug perspective.
2. In the Debug view, click the **Run to completion** icon  on the toolbar, or right-click the flow stack frame, then click  **Run to Completion**. The flow instance ignores all breakpoints while running to the end. The flow instance is automatically removed from the Debug view.

After terminating a flow instance, you can start to debug another message flow, or end your debug session:

- Attaching to the flow engine
- Detaching from the flow engine

Debug: detaching from the flow engine



Before you start

To complete this task, you must have completed the following tasks:

- Attaching to the flow engine

When you have finished debugging a flow, detach the flow debugger from the flow engine. Other developers are then able to attach to the flow engine. Detaching the flow debugger also enhances the performance of your workbench environment.

To detach from the flow engine:

1. Switch to the Debug perspective.
2. In the Debug view, select the name of the flow engine from which you want to detach.
3. Click the **Detach from the Selected Flow Engines** icon  on the toolbar (or right-click the flow engine, then click  **Detach**).

When this task completes, your debug session has been ended. Any all existing flow instances have automatically run to completion and the flow debugger is detached from the flow engine. You can start a new debug session at any time:

- Attaching to the flow engine
- Working with breakpoints

Debugging message flows that contain WebSphere Adapters nodes

You can use various methods to monitor message flows that include WebSphere Adapters nodes.

Before you use any of the methods listed below, ensure that the appropriate jar files and shared libraries are available to the WebSphere Adapters nodes. For more information, see [Preparing the environment for WebSphere Adapters nodes](#).

Also, check for the latest information about WebSphere Adapters at [WebSphere Adapters technotes](#).

- **User and service trace:** You can use user and service trace to trace a message flow that contains WebSphere Adapters nodes. For more information, see [Using trace](#).
- **Flow debugger:** Use the flow debugger to debug a message flow that contains WebSphere Adapters nodes. For more information, see [“Debugging a message flow”](#) on page 783.
- **Adapter event table:** The WebSphere Adapters nodes use an event table to communicate the outcome of operations asynchronously to a calling application. For more information, see [“Creating a custom event project in PeopleTools”](#) on page 254.

Handling exceptions that are raised by a WebSphere Adapters request node

The WebSphere Adapters request nodes raise exceptions that indicate the following Enterprise Information System (EIS) failures.

Message number	Exception type	Explanation
BIP3511	RecordNotFound	The requested record could not be found in the EIS.
BIP3512	DuplicateRecord	An attempt was made to create a record that already exists in the EIS.
BIP3513	MultipleMatchingRecords	A retrieve request matched more than one record. To retrieve multiple records, perform a retrieveall operation.
BIP3515	MatchesExceededLimit	A retrieveall exception returned more entries than the maximum allowed number.
BIP3516	MissingData	The message tree that was sent to the adapter request node does not have all the required fields set.

If an exception occurs that does not fit into the categories in the table, the node raises a general BIP3450 message that describes the problem.

You can use these exceptions to perform special processing when you do not want the exceptions to be treated as errors. For example:

- If a create operation fails because the record already exists, you could modify the request to an update.
- If a retrieve operation fails because the request matches more than one record, you could try a retrieveall operation instead.
- If a retrieve operation fails because the record could not be found, an empty record could be returned.

To handle these exceptions, you could connect a message routing node, Compute node, or JavaCompute node to the Failure terminal of the WebSphere Adapters request node, and route the exception to other processing nodes based on the exception message number.

Testing message flows using the Test Client

You can test your message flows using the Test Client in a safe environment before they are used on a production system.

You can use the Test Client to send test messages to message flows that use WebSphere MQ, JMS, SOAP or HTTP input nodes. The Test Client monitors the output nodes in the message flow, and can provide information about the path that a test message takes through a message flow. The Test Client can also provide information about errors that are generated by the message flow.

You can perform the following tasks using the Test Client:

- “Testing a message flow” on page 808
- “Configuring the test settings” on page 809
- “Creating and editing a test message” on page 810
- “Using the Test Client in trace and debug mode” on page 812

Test Client overview

Use the Test Client to test message flows in a safe environment before they are used on a production system.

You can use the Test Client to put test messages to message flows that use the following nodes:

- WebSphere MQ
- JMS
- HTTP
- SOAP

You can change the content of the test messages that are put to the message flow in the Test Client to help determine if your message flows are working as expected. If the input node in the message flow that you select expects an XML message from an associated message set, the message structure is provided, and it can be edited to produce the appropriate test message. Alternatively, you can create a new test message, or import an existing message from the file system. You can also configure an appropriate header for the test message, if the message format is WebSphere MQ or JMS.

The Test Client monitors output nodes in the message flow so that you can see which nodes output messages are received on. You can also view the content of the output message, or view the content of any error messages that are received when the test message is passed through the message flow. When a message is received on an output node, or when an error is produced when the test message passes through the message flow, a test event is recorded in the Test Client.

The default behavior of the Test Client is to stop the test when the first output message is received. You can configure the Test Client to wait for multiple output messages to be received. In this case, you can stop the test manually. Stopping the test disconnects the monitors that are running, but does not stop the message flow. A synchronous test, such as when the message flow is invoked from an HTTPInput node, is stopped automatically when a reply message is received. An asynchronous test, such as when the message flow is invoked from an MQInput node, can be stopped manually depending on the monitor setting in the configuration panel. All test events are stopped when the Test Client is closed, and any test monitors are removed.

If you change your message flow, you can use the same test configuration to test the changes. The default behavior of the Test Client is to deploy the message flow that you want to test automatically to an execution group, whenever a change is made to the message flow. You can therefore make a change to a message flow, and quickly test the result using the Test Client, without the need to manually deploy your message flows. The first time that you put a test message to the input node on a message flow, you configure the execution group to deploy the message flow by using the Deployment location wizard. You can configure the deployment options to override the default behavior of the Test Client to deploy the message flow manually, or to deploy the message flow every time that you pass a test message to the message flow.

You can run the Test Client using the trace and debug mode to view more information about the path that the message takes through the message flow. A test event is produced when the message passes from one node to the next node in the message flow. The structure of the message is recorded as it leaves each node in

the message flow. The flow debugger is launched in the trace and debug mode so that the test message stops at any breakpoints configured in the message flow.

The details of the test configuration and the test events can be saved as an .mbtest file. You can use this file to repeat the test or to review the results later.

Testing a message flow

You can test your message flows using the Test Client.

Before you can test your message flow, you must have a broker domain configured and running. If you do not have an existing broker domain, you can create one using the Default Configuration wizard; see Using the Default Configuration wizard. If the broker domain is not already configured in the Message Broker Toolkit, you can use the Deployment Location wizard to connect to the broker domain.

To test a message flow, complete the following tasks:

1. "Opening the Test Client editor"
2. "Configuring the test settings" on page 809
3. "Creating and editing a test message" on page 810
4. "Selecting the deployment location for the message flow" on page 811.

The test message is put to the selected input node, the Test Client monitors the output nodes in the message flow, and events are generated as the message passes through the message flow. You might need to stop the test manually, depending on the nodes in the message flow, and the settings that you have configured in the Test Client.

To test the message flow again, right-click **Invoke Message Flow** in the **Message Flow Test Events** pane and click **Invoke** to start a new test; or click **Duplicate** or **Re-run** to re-run the test using the same message.

Opening the Test Client editor

Open the Test Client editor and select a message flow to test.

Before you start:

Ensure that your message flow contains no errors before you open it with the Test Client.

Open the Test Client editor, and ensure that the message flow that you want to test is selected, using one of the following methods:

1. From a message flow file:
 - a. Select the message flow in the Broker Development pane of the Broker Application Development perspective.
 - b. Right-click the selected message flow and click **Test Message Flow**.

The Test Client editor is opened with settings from the message flow.

2. From an input node:
 - a. Open the message flow that you want to test.
 - b. Right-click an input node in the message flow and click **Test**.

The Test Client editor is opened with settings from the message flow, and the input node is selected.

You can now configure a test message to put to the message flow, or configure the Test Client settings.

You can save the Test Client configuration in a .mbtest file:

1. Click **File** → **Save**. The Save Execution Trace window is displayed.
2. In Save Execution Trace, enter a name for the file, and select a project to save the file into.
3. Click **Finish** to save the file.

Configuring the test settings

You can configure the settings in the Test Client to control how your tests are run.

Before you can configure the settings in the Test Client, you must have completed the following tasks:

- “Creating a message flow” on page 218
- “Opening the Test Client editor” on page 808

Use the following topics to help you to configure the settings on the Test Client:

- “Testing a message flow that has WebSphere MQ nodes”
- “Testing a message flow that has JMS nodes” on page 810
- Test Client Configuration tab

You can modify settings that relate to all your test configurations using the Test Client preferences; see Test Client preferences.

Testing a message flow that has WebSphere MQ nodes:

You can configure settings in the Test Client for testing message flows that have WebSphere MQ nodes.

To test a message flow that uses WebSphere MQ nodes:

1. Right-click on your message flow and click **Test Message Flow**. The Test Client opens with the settings from the selected message flow.
2. In the Test Client, click the **Configuration** tab to display the Test Client configuration settings.
3. Click **MQ Settings** and select the appropriate options for your test.
4. Click **MQ Message Header “Default Header”** to view the settings for the message header that is used for the test message. You can edit the options for the default header, or alternatively, you can create a new header to edit:
 - a. Click **MQ Message Headers**.
 - b. Click **Add** and enter a unique name for the header.
 - c. Edit the header settings.
 - d. Click the **Events** tab, and select the appropriate header for your message from the **Header** list.
5. You can use the Test Client to create WebSphere MQ queues that are used in nodes in your message flow. To configure the Test Client to create the queues:
 - a. Click **Window** → **Preferences**.
 - b. Expand **Broker Development** and click **Message Broker Test Client**.
 - c. Ensure **Create queues of input and output nodes of message flows when host name is localhost** is selected and click **OK**.

6. Create a test message to test your message flow, see “Creating and editing a test message.”
7. When you have created your test message, you must select the execution group to deploy the message flow to, see “Selecting the deployment location for the message flow” on page 811.

Testing a message flow that has JMS nodes:

You can configure settings in the Test Client for testing message flows that have JMS nodes.

To test a message flow that uses JMS nodes:

1. Right-click on your message flow and click **Test Message Flow**. The Test Client opens with the settings from the selected message flow.
2. In the Test Client, click the **Configuration** tab to display the Test Client configuration settings.
3. Click **JMS Settings** and select the appropriate options for your test. You can add references to the client JAR files used to create the JMS connection. To add a reference to these JAR files into your test configurations:
 - a. Click **Configure preference settings**. The Test Client preferences are displayed.
 - b. Click **Add** and locate the JAR files in your file system.
 - c. Click **OK** to add the reference to the JAR files.
 - d. Ensure that **Use preference settings** is selected in the **Configuration** tab.
4. Click **JMS Message Headers** to create a JMS header:
 - a. Click **Add** and enter a unique name for the header.
 - b. Edit the header settings.
 - c. Click the **Events** tab, and select the appropriate header for your message from the **Header** list.
5. Create a test message to test your message flow, see “Creating and editing a test message.”
6. When you have created your test message, you must select the execution group to deploy the message flow to, see “Selecting the deployment location for the message flow” on page 811.

Creating and editing a test message

To use the Test Client, you must create or edit a test message to send to your message flow.

Complete these tasks before you edit your test message:

1. “Opening the Test Client editor” on page 808
2. “Configuring the test settings” on page 809

A number of editors are available in the Test Client for creating a test message. The most appropriate editor to use depends upon the type of test message you want to send to your message flow. If the input node that you want to send the message to for the test expects an XML message, and the message flow is associated with a message definition, the **XML Structure** editor is available. If you want to send an XML message, but do not have a message definition defined, then you can use the **XML Source** editor. If you want to create a test message that is not in XML format, then you can use the **Source** editor. Alternatively you can import an existing test

message into one of the source editors, or take the generated source from the **XML Structure** editor and paste it into one of the source editors.

Select from the following options to create and edit a test message:

1. Using the **XML Structure** editor:
 - a. In the Events tab of the Test Client, select **XML Structure** from the **Viewer** list.
 - b. Edit the entries in the **Value** column for each field to change the content of the test message.
 - c. Right-click the fields in the **XML Structure** editor to see additional options for defining the content of the test message. These options include adding message parts and elements, for example if your message has repeating fields.
 - d. You can save your file with the updated test message by clicking **File** → **Save**.
 - e. To view and copy the generated test message, click **Show Generated Source**.
2. Using the **XML Source** editor:
 - a. In the Events tab of the Test Client, select **Source** from the **Viewer** list.
 - b. Click **XML Source** to display the **XML Source** editor.
 - c. Enter the XML for your test message in this editor, or alternatively copy content into the editor from another source by right-clicking in the editor and selecting **Paste**.
 - d. You can save your file with the updated test message by clicking **File** → **Save**.
3. Using the **Source** editor:
 - a. In the Events tab of the Test Client, select **Source** from the **Viewer** list.
 - b. Click **Source** to display the **Source** editor.
 - c. Enter the text content for your test message in this editor, or alternatively copy content into the editor from another source by right-clicking in the editor and selecting **Paste**.
 - d. You can save your file with the updated test message by clicking **File** → **Save**.
4. Importing an existing test message into a source editor:
 - a. In the Events tab of the Test Client, select **Source** from the **Viewer** list.
 - b. Select either the **XML Source** or **Source** editor.
 - c. Click **Import Source**. You can then locate your existing test message from your file system.
 - d. Click **Open** to import the selected file into the Test Client.
 - e. You can save your file with the updated test message by clicking **File** → **Save**.

Ensure that you have selected the correct input node to send the test message to in your message flow. Click **Send Message** to send your test message to the selected input node. If this is the first time you have sent a message using this Test Client file, the Deployment Location wizard opens. See “Selecting the deployment location for the message flow.”

Selecting the deployment location for the message flow

Specify the execution group to deploy a message flow to when you use the Test Client using the Deployment Location wizard.

Before you can test your message flow, you must have configured a broker domain with a broker. The components in the broker domain must all be running. If you do not have an existing broker domain, you can create one using the Default Configuration wizard; see Using the Default Configuration wizard. If the broker domain is not already configured in the Message Broker Toolkit, you can use the Deployment Location wizard to connect to the broker domain by selecting **New Domain Connection**.

When you first send a test message to a message flow using the Test Client, the **Deployment Location** wizard is opened. You can use the wizard to select an execution group to deploy the message flow to.

1. In the Test Client, click **Send Message** to open the **Deployment Location** wizard.
2. If your domain is not connected, click **Connect**. Select the execution group that you want to deploy your message flow to from the list in the wizard. You can also create a new execution group from the **Deployment Location** wizard by clicking **New Exec Group**.
3. Select the **Mode** to run the test in. Select **Run** to monitor the output nodes only. Select **Trace** to receive information about each node that the message passes through in the message flow.
4. Click **Next**.
5. Modify the test settings as required.
6. Click **Finish** to save the settings and deploy the message flow.

You can change the deployment location settings from the **Configuration** tab.

1. Click **Configuration** in the Test Client.
2. Click **Deployment** to display the deployment settings.
3. Click **Change** to open the **Deployment Location** wizard.

Using the Test Client in trace and debug mode

You can run the Test Client in trace and debug mode to trace the path of a test message through a message flow.

Before you can test your message flow, you must have configured a broker domain with a broker. The components in the broker domain must all be running. You must also have created an execution group to deploy your message flows to.

Use the trace and debug mode to:

- Launch the flow debugger and stop the test message at breakpoints in the message flow.
- Trace the message nodes and terminals the test message passes through.
- View how the content of the test message changes as it passes through the message flow.
- View a message node where an exception occurs, and the associated exception message and trace details.

To use the Test Client in trace and debug mode:

1. You must set the Java Debug Port. Use the following instructions to set the Java Debug Port for your execution group:
 - a. Enter the following command on the command line, replacing *Broker* with the name of your broker, *ExecGroup* with the name of your execution group, and *PortNum* with an unused port number:

```
mqschangeproperties Broker -e ExecGroup -o ComIbmJVMManger -n jvmDebugPort -v PortNum
```

- b. Restart your broker using the `mqsistop` and `mqsistart` commands.
2. In the Test Client click **Send Message** to open the Deployment Location wizard.
3. If your domain is not connected, click **Connect**. Select the execution group that you want to deploy your message flow to, from the list in the wizard.
4. Select **Trace and debug**. If you want the test message to stop at a breakpoint after the input node, select **Stop at the beginning of the flow during debug**.
5. Click **Next**.
6. Modify the test settings if required.
7. Click **Finish** to save the settings and deploy the message flow.

You can modify the deployment location settings from run mode to trace and debug mode using the Deployment Location wizard. To reopen the wizard and change the settings:

1. Click **Configuration** in the Test Client.
2. Click **Deployment** to display the deployment settings.
3. Click **Change** to open the Deployment Location wizard.

Part 6. Reference

Message flows	819	RouteToLabel node	1059
Message flow preferences	819	SAPInput node	1061
Description properties for a message flow	819	SAPRequest node	1064
Guidance for defining keywords	820	SCADAInput node	1067
Built-in nodes	822	SCADAOutput node	1074
AggregateControl node	824	SiebelInput node	1076
AggregateReply node	826	SiebelRequest node	1079
AggregateRequest node	829	SOAPAsyncRequest node	1082
Check node	830	SOAPAsyncResponse node	1092
Collector node	833	SOAPEnvelope node	1096
Compute node	838	SOAPExtract node	1099
Database node	846	SOAPInput node	1104
DatabaseRetrieve node	850	SOAPReply node	1114
DatabaseRoute node	859	SOAPRequest node	1116
DataDelete node	866	TCPIPClientInput node	1126
DataInsert node	869	TCPIPClientOutput node	1137
DataUpdate node	872	TCPIPClientReceive node	1146
EmailOutput node	875	TCPIPServerInput node	1158
EndpointLookup node	881	TCPIPServerOutput node	1169
Extract node	884	TCPIPServerReceive node	1177
FileInput node	886	Throw node	1189
FileOutput node	899	TimeoutControl node	1191
Filter node	910	TimeoutNotification node	1194
FlowOrder node	914	Trace node	1198
HTTPHeader node	916	TryCatch node	1202
HTTPInput node	920	TwineballInput node	1204
HTTPReply node	927	TwineballRequest node	1207
HTTPRequest node	929	Validate node	1210
Input node	942	Warehouse node	1213
JavaCompute node	943	XSLTransform node	1216
JMSHeader node	946	User-defined nodes	1225
JMSInput node	949	WebSphere Adapters properties	1225
JMSMQTransform node	960	WebSphere Adapter for SAP properties	1226
JMSOutput node	961	WebSphere Adapter for Siebel properties	1287
JMSReply node	972	WebSphere Adapter for PeopleSoft properties	1309
Label node	976	Supported code pages	1329
Mapping node	978	Chinese code page GB18030	1357
MQeInput node	982	WebSphere MQ connections	1357
MQeOutput node	990	Listing database connections that the broker holds	1358
MQGet node	993	Quiescing a database	1358
MQHeader node	1004	Support for UNICODE and DBCS data in databases	1358
MQInput node	1007	Data integrity within message flows	1359
MQJMSTransform node	1020	Validation properties	1359
MQOptimizedFlow node	1021	Validation tab properties	1360
MQOutput node	1023	Parser Options tab properties	1362
MQReply node	1029	Parsing on demand	1363
Output node	1033	Exception list structure	1364
Passthrough node	1034	Database exception trace output	1366
PeopleSoftInput node	1036	Conversion exception trace output	1368
PeopleSoftRequest node	1039	Parser exception trace output	1370
Publication node	1042	User exception trace output	1370
Real-timeInput node	1044	Configurable message flow properties	1372
Real-timeOptimizedFlow node	1046	Message flow porting considerations	1374
RegistryLookup node	1048	Monitoring profile	1375
ResetContentDescriptor node	1050	Monitoring profile schema	1379
Route node	1056		

Message flow accounting and statistics data . . .	1381	ESQL logical operators	1476
Message flow accounting and statistics details	1381	ESQL numeric operators	1477
Message flow accounting and statistics output		ESQL string operator	1478
formats	1382	Rules for ESQL operator precedence	1478
Example message flow accounting and		ESQL statements	1478
statistics data	1394	ATTACH statement	1480
Coordinated message flows	1398	BEGIN ... END statement	1482
Database connections for coordinated message		BROKER SCHEMA statement	1484
flows	1398	CALL statement	1487
Database support for coordinated message		CASE statement	1490
flows	1399	CREATE statement	1492
Element definitions for message parsers	1399	CREATE FUNCTION statement	1500
Data types of fields and elements	1400	CREATE MODULE statement	1509
The MQCFH parser	1403	CREATE PROCEDURE statement	1511
The MQCIH parser	1403	DECLARE statement	1525
The MQDLH parser	1404	DECLARE HANDLER statement	1530
The MQIIH parser	1405	DELETE FROM statement	1531
The MQMD parser	1405	DELETE statement	1534
The MQMDE parser	1406	DETACH statement	1534
The MQRFH parser	1407	EVAL statement	1535
The MQRFH2 and MQRFH2C parsers	1407	FOR statement	1536
The MQRMH parser	1408	IF statement	1537
The MQSAPH parser	1408	INSERT statement	1538
The MQWIH parser	1409	ITERATE statement	1541
The SMQ_BMH parser	1409	LEAVE statement	1542
Message mappings	1410	LOG statement	1543
Message Mapping editor	1410	LOOP statement	1544
Mapping node	1420	MOVE statement	1545
Migrating message mappings from Version 5.0	1428	PASSTHRU statement	1547
Restrictions on migrating message mappings	1429	PROPAGATE statement	1550
XML constructs	1433	REPEAT statement	1553
Example XML message	1433	RESIGNAL statement	1554
The XML declaration	1434	RETURN statement	1554
The XML message body	1435	SET statement	1557
XML document type declaration	1440	THROW statement	1559
Data sources on z/OS	1448	UPDATE statement	1560
		WHILE statement	1563
ESQL reference.	1451	ESQL functions: reference material, organized by	
Syntax diagrams: available types	1452	function type	1564
ESQL data types in message flows	1452	Calling ESQL functions	1567
ESQL BOOLEAN data type	1452	ESQL database state functions	1567
ESQL datetime data types	1452	ESQL datetime functions	1572
ESQL NULL data type	1457	ESQL numeric functions	1577
ESQL numeric data types	1458	ESQL string manipulation functions	1592
ESQL REFERENCE data type	1460	ESQL field functions	1602
ESQL ROW data type	1460	ESQL list functions	1613
ESQL string data types	1461	Complex ESQL functions	1616
ESQL-to-Java data-type mapping table	1462	Miscellaneous ESQL functions	1658
ESQL-to-XPath mapping table	1463	ESQL constants	1662
XPath property editors	1464	Broker properties that are accessible from ESQL	
ESQL variables	1465	and Java	1663
ESQL field references	1465	Special characters, case sensitivity, and comments	
Namespace	1467	in ESQL	1666
Index	1468	ESQL reserved keywords	1668
Type	1468	ESQL non-reserved keywords	1668
Field references summary	1469	Example message	1671
Target field references	1470		
The effect of setting a field to NULL	1471	Message mappings	1673
ESQL operators	1472	Message Mapping editor	1673
ESQL simple comparison operators	1472	Message Mapping editor Source pane	1674
ESQL complex comparison operators	1473	Message Mapping editor Target pane	1677

Message Mapping editor Edit pane.	1679
Message Mapping editor Spreadsheet pane	1680
Mapping node	1683
Mapping node syntax	1683
Mapping node functions	1685
Mapping node casts	1690
Headers and Mapping node	1691
Migrating message mappings from Version 5.0	1691
Restrictions on migrating message mappings . . .	1692
Flow application debugger.	1697
Flow debugger shortcuts	1697
Debug view	1697
Breakpoints view.	1698
Flow Breakpoint Properties dialog	1698
Variables view.	1698
Flow debugger icons and symbols	1698
Debug perspective	1698
Debug view	1699
Message Flow editor	1699
Breakpoints view.	1700
Variables view.	1700
Java Debugger	1700

Message flows

Message flow reference information is available for:

- “Message flow preferences”
- “Description properties for a message flow”
- “Built-in nodes” on page 822
- “User-defined nodes” on page 1225
- “Supported code pages” on page 1329
- “WebSphere MQ connections” on page 1357
- User database connections
- “Support for UNICODE and DBCS data in databases” on page 1358
- “Data integrity within message flows” on page 1359
- “Validation properties” on page 1359
- “Exception list structure” on page 1364
- “Configurable message flow properties” on page 1372
- “Message flow porting considerations” on page 1374
- FtpServer configurable service properties
- “Monitoring profile” on page 1375
- “Message flow accounting and statistics data” on page 1381
- “Coordinated message flows” on page 1398
- “Element definitions for message parsers” on page 1399
- “Developing message mappings” on page 472
- “XML constructs” on page 1433
- “Data sources on z/OS” on page 1448

Message flow preferences

You can set Message flow preferences from **Window** → **Preferences** then click **Message Flow** in the left pane.

Property	Type	Meaning
Default version tag	String	Provide the default version information you would like to be set in the message flow Version property when you create a new message flow.

Description properties for a message flow

Property	Type	Meaning
Version	String	You can enter a version for the message flow in this field. This allows the version of the message flow to be displayed using the Eclipse properties view. A default for this field can be set in the messages flow preferences.
Short Description	String	You can enter a short description of the message flow in this field.

Property	Type	Meaning
Long Description	String	<p>You can add information to enhance the understanding of the message flow's function in this field.</p> <p>It is a string field and any standard alphanumeric characters can be used.</p> <p>You can also use this field to define a keyword and its value that will display for the deployed message flow in the properties view of Eclipse. An example is: \$MQSI Author=Fred MQSI\$</p> <p>When the properties of the deployed message flow are displayed, this will add a row to the display showing "Author" as the property name and "Fred" as its value.</p> <p>For information on keywords see "Guidance for defining keywords."</p>

To view and edit the properties of a message flow click **Flow** → **Properties**.

Guidance for defining keywords

This topic contains the rules to follow when defining keywords. Keywords and their values are displayed in the properties view of a deployed object.

A number of objects in WebSphere Message Broker can have additional information added to the object. This information can display information about an object after the object has been deployed. The default information that is displayed is the time the object was deployed and the last time the object was modified.

You can define custom keywords, and their values that the Configuration Manager will interpret as additional information to be displayed, in the properties view. For example, you can define keywords for "Author" and "Subflow 1 Version":

```
$MQSI Author=John Smith MQSI$
$MQSI Subflow 1 Version=v1.3.2 MQSI$
```

The information the Configuration Manager shows is:

Object name	
Deployment Time	28-Aug-2004 15:04
Modification Time	28-Aug-2004 14:27
Version	v1.0
Author	John Smith
Subflow 1 Version	v1.3.2

In this display the version information has also been defined using the **Version** property of the object. If the version information had not been defined using the property, it would be omitted from this display.

The syntax for defining a keyword and its associated value is:

```
$MQSI KeywordName = KeywordValue MQSI$
```

Where:

\$MQSI

\$MQSI opens the definition. It can be followed by an optional underscore or white space character that is ignored.

KeywordName

The name of the keyword for which you are setting the value. It can be made up of any sequence of alphanumeric characters apart from the equals (=) sign. It can contain white space characters, but any leading or trailing white space characters are omitted.

= The equals (=) sign is the delimiter between the keyword and the value that you are setting it to.

KeywordValue

The value to which the keyword is set. It can be made up of any sequence of alphanumeric characters. It can contain white space characters, but any leading or trailing white space characters are omitted.

MQSI\$

MQSI\$ closes the keyword definition.

Examples

Example definitions	Interpreted keyword and value	Comments
\$MQSIAuthor=JohnMQSI\$ or \$MQSI Author=John MQSI\$ or \$MQSI Author = John MQSI\$	Keyword = "Author" Value = "John"	Each of these is a basic example of what can be set and shows that the leading and trailing white space characters for the name and value parameters are ignored.
\$MQSI_Author = John MQSI\$	Keyword = "Author" Value = "John"	The first character after \$MQSI can be an underscore character. The underscore character is omitted in the interpreted keyword. If a second underscore character appears, this forms part of the keyword name.
\$MQSI Flow designer = John Smith MQSI\$	Keyword = "Flow designer" Value = "John Smith"	White space characters are accepted for each parameter value.
\$MQSI bar = MQSI\$	Keyword = "bar" Value = ""	The keyword value can be set to an empty ("") string.
\$MQSI_mqsitag=\$MQSI\$MQSI\$	Keyword = "mqsitag" Value = "\$"	This is a poorly formatted definition. After defining the keyword name, the parser is looking to find the delimiters that form the boundary of the value to be set. In this case, the only character prior to the MQSI\$ that closes the definition is a '\$', and that is set as the keyword value.
\$MQSI=barMQSI\$		This pattern is ignored because the keyword name cannot be an empty string.
\$MQSItagbarMQSI\$		This pattern is ignored because there is not a separator (=) between the keyword name and the keyword value.

Do not use the following keywords as described below:

VERSION

When you use the Message Broker Toolkit to edit message flows and dictionaries, it is possible to set the **Version** property in the Properties pane, which you can then view in the Broker Archive file editor. If you set this property, a keyword called VERSION is added to the resulting cmf or dictionary file. For this reason, do not add \$MQSI_VERSION=...MQSI\$ to these files.

BAR The BAR keyword is associated with each object automatically when it is deployed and it contains the full path name of the broker archive file that deployed the object.

The values of both keywords are defined programmatically in the class `com.ibm.broker.config.proxy.DeployedObject`.

Restrictions within keywords

Do not use the following characters within keywords because they cause unpredictable behavior:

`^$.|\<?+*&[]`

You can use these characters in the values that are associated with keywords; for example:

- `$MQSI RCSVER=$id$ MQSI$` is acceptable
- `$MQSI $name=Fred MQSI$` is not acceptable

Built-in nodes

WebSphere Message Broker supplies built-in nodes that you can use to define your message flows.

The mode that your broker is working in can affect the types of node that you can use; see Restrictions that apply in each operation mode.

For information about each of these built-in nodes, use the following links. The nodes are listed in the categories under which they are grouped in the node palette, see “Message flow node palette” on page 47.

WebSphere MQ

- “MQInput node” on page 1007
- “MQOutput node” on page 1023
- “MQReply node” on page 1029
- “MQGet node” on page 993
- “MQOptimizedFlow node” on page 1021
- “MQeInput node” on page 982
- “MQeOutput node” on page 990

JMS

- “JMSInput node” on page 949
- “JMSOutput node” on page 961
- “JMSReply node” on page 972
- “JMSMQTransform node” on page 960
- “MQJMSTransform node” on page 1020

HTTP

- “HTTPInput node” on page 920

- “HTTPReply node” on page 927
- “HTTPRequest node” on page 929

Web Services

- “SOAPInput node” on page 1104
- “SOAPReply node” on page 1114
- “SOAPRequest node” on page 1116
- “SOAPAsyncRequest node” on page 1082
- “SOAPAsyncResponse node” on page 1092
- “SOAPEnvelope node” on page 1096
- “SOAPExtract node” on page 1099
- “RegistryLookup node” on page 1048
- “EndpointLookup node” on page 881

WebSphere Adapters

- “PeopleSoftInput node” on page 1036
- “PeopleSoftRequest node” on page 1039
- “SAPInput node” on page 1061
- “SAPRequest node” on page 1064
- “SiebelInput node” on page 1076
- “SiebelRequest node” on page 1079
- “TwineballInput node” on page 1204
- “TwineballRequest node” on page 1207

Routing

- “Filter node” on page 910
- “Label node” on page 976
- “Publication node” on page 1042
- “RouteToLabel node” on page 1059
- “Route node” on page 1056
- “AggregateControl node” on page 824
- “AggregateReply node” on page 826
- “AggregateRequest node” on page 829
- “Collector node” on page 833

Transformation

- “Mapping node” on page 978
- “XSLTransform node” on page 1216
- “Compute node” on page 838
- “JavaCompute node” on page 943

Construction

- “Input node” on page 942
- “Output node” on page 1033
- “Throw node” on page 1189
- “Trace node” on page 1198
- “TryCatch node” on page 1202
- “FlowOrder node” on page 914
- “Passthrough node” on page 1034
- “ResetContentDescriptor node” on page 1050

Database

- “Database node” on page 846
- “DataDelete node” on page 866
- “DataInsert node” on page 869
- “DataUpdate node” on page 872

- “Warehouse node” on page 1213
- “DatabaseRetrieve node” on page 850
- “DatabaseRoute node” on page 859
- “Extract node” on page 884

File

- “FileInput node” on page 886
- “FileOutput node” on page 899

TCP/IP

- “TCPIPClientInput node” on page 1126
- “TCPIPClientOutput node” on page 1137
- “TCPIPClientReceive node” on page 1146
- “TCPIPServerInput node” on page 1158
- “TCPIPServerOutput node” on page 1169
- “TCPIPServerReceive node” on page 1177

Email

- “EmailOutput node” on page 875

Validation

- “Validate node” on page 1210
- “Check node” on page 830

Timer

- “TimeoutControl node” on page 1191
- “TimeoutNotification node” on page 1194

Additional protocols

- “SCADAInput node” on page 1067
- “SCADAOutput node” on page 1074
- “Real-timeInput node” on page 1044
- “Real-timeOptimizedFlow node” on page 1046

AggregateControl node

Use the AggregateControl node to mark the beginning of a fan-out of requests that are part of an aggregation.

This topic contains the following sections:

- “Purpose”
- “Using this node in a message flow” on page 825
- “Terminals and properties” on page 825

Purpose

Aggregation is an extension of the request/reply application model. It combines the generation and fan-out of a number of related requests with the fan-in of the corresponding replies, and compiles those replies into a single aggregated reply message.

The aggregation function is provided by the following three nodes:

- The AggregateControl node marks the beginning of a fan-out of requests that are part of an aggregation. It sends a control message that is used by the AggregateReply node to match the different requests that have been made. The information that is propagated from the Control terminal includes the broker

identifier, the aggregate name property, and the timeout property. You must not change the aggregation information that is added to the message Environment by the AggregateControl node.

- The AggregateRequest node records the fact that the request messages have been sent. It also collects information that helps the AggregateReply node to construct the aggregated reply message. You must preserve the information that is added to the message Environment by the AggregateControl node, otherwise the aggregation fails.
- The AggregateReply node marks the end of an aggregation fan-in. It collects replies and combines them into a single aggregated reply message.

This node creates the LocalEnvironment.ComIbmAggregateControlNode folder. This folder and the fields within it are for internal use by WebSphere Message Broker and you should not rely on their existence or values when developing your message flows.

The AggregateControl node is contained in the **Routing** drawer of the palette, and is represented in the workbench by the following icon:



Using this node in a message flow

Look at the following samples to see how to use this node:

- Aggregation sample
- Airline Reservations sample

You can view samples only when you use the information center that is integrated with the Message Broker Toolkit.

Terminals and properties

When you have put an instance of the AggregateControl node into a message flow, you can configure it; see “Configuring a message flow node” on page 235. The properties of the node are displayed in the Properties view. All mandatory properties for which you must enter a value (those that do not have a default value defined) are marked with an asterisk.

The AggregateControl node terminals are described in the following table.

Terminal	Description
In	The input terminal that accepts a message for processing by the node.
Out	The output terminal to which the original message is routed when processing completes successfully.
Control	The output terminal to which a control message is routed. The control message is sent to a corresponding AggregateReply node. The Control terminal is deprecated in Version 6.0; to use connections from the Control terminal, see “Using control messages in aggregation flows” on page 585.

The following tables describe the node properties. The column headed M indicates whether the property is *mandatory* (marked with an asterisk if you must enter a

value when no default is defined); the column headed C indicates whether the property is *configurable* (you can change the value when you add the message flow to the bar file to deploy it).

The AggregateControl node Description properties are described in the following table:

Property	M	C	Default	Description
Node name	No	No	The node type (AggregateControl)	The name of the node.
Short Description	No	No		A brief description of the node.
Long Description	No	No		Text that describes the purpose of the node in the message flow.

The AggregateControl node Basic properties are described in the following table:

Property	M	C	Default	Description
Aggregate Name	Yes	Yes		A name that used to associate the fan-out message flow with the fan-in message flow. This value must be contextually unique within a broker.
Timeout (sec)	Yes	No	0	<p>The amount of time, in seconds, that it waits for replies to arrive at the fan-in.</p> <p>The default value is zero; if you accept this default value, the timeout is disabled for fan-outs from this node (that is, it waits for replies indefinitely). If not all responses are received, the message flow continues to wait, and does not complete. Set a value greater than zero to ensure that the message flow can complete, even if not all responses are received. For further information about timeouts, see “AggregateReply node.”</p> <p>z/OS On z/OS, if the Timeout property is not set to zero, set the queue manager parameter EXPRYINT to 5.</p>

AggregateReply node

Use the AggregateReply node to mark the end of an aggregation fan-in. This node collects replies and combines them into a single compound message.

This topic contains the following sections:

- “Purpose”
- “Using this node in a message flow” on page 827
- “Terminals and properties” on page 827

Purpose

Aggregation is an extension of the request/reply application model. It combines the generation and fan-out of a number of related requests with the fan-in of the corresponding replies, and compiles those replies into a single aggregated reply message.

The aggregation function is provided by the following three nodes:

- The AggregateControl node marks the beginning of a fan-out of requests that are part of an aggregation. It sends a control message that is used by the AggregateReply node to match the different requests that have been made. The

information that is propagated from the Control terminal includes the broker identifier, the aggregate name property, and the timeout property. The aggregation information that is added to the message Environment by the AggregateControl node must not be changed.

- The AggregateRequest node records the fact that the request messages have been sent. It also collects information that helps the AggregateReply node to construct the aggregated reply message. The information that is added to the message Environment by the AggregateRequest must be preserved, otherwise the aggregation fails.
- The AggregateReply node marks the end of an aggregation fan-in. It collects replies and combines them into a single aggregated reply message.

The AggregateReply node is contained in the **Routing** drawer of the palette, and is represented in the workbench by the following icon:



When incoming messages are stored by the AggregateReply node before all responses for the aggregation are received, the persistence of the message determines whether the message survives a restart.

If, during an aggregation, one or more of the response messages are not received by the AggregateReply node, the normal timeout or unknown message processing deals with the responses that have been received already.

The MQMD.Expiry value of each AggregateReply message is set to -1 in the compound output message. This value is set because the MQMD.Expiry value has no meaning once the reply message is no longer on the WebSphere MQ Transport and has been stored by the broker during the aggregation process.

Using this node in a message flow

Look at the following samples to see how to use this node:

- Aggregation sample
- Airline Reservations sample

You can view samples only when you use the information center that is integrated with the Message Broker Toolkit.

Terminals and properties

When you have put an instance of the AggregateReply node into a message flow, you can configure it; see “Configuring a message flow node” on page 235. The properties of the node are displayed in the Properties view. All mandatory properties for which you must enter a value (those that do not have a default value defined) are marked with an asterisk.

The AggregateReply node terminals are described in the following table.

Terminal	Description
Control	The input terminal that accepts control messages that are sent by a corresponding AggregateControl node. The Control terminal is deprecated in Version 6.0; to use connections to the Control terminal, see "Using control messages in aggregation flows" on page 585.
In	The input terminal that accepts a message for processing by the node.
Failure	The output terminal to which the message is routed if a failure is detected during processing.
Unknown	The output terminal to which messages are routed when they cannot be identified as valid reply messages.
Out	The output terminal to which the compound message is routed when processing completes successfully.
Timeout	The output terminal to which the incomplete compound message is routed when the timeout interval that is specified in the corresponding AggregateControl node has expired.
Catch	The output terminal to which the message is routed if an exception is thrown downstream and then caught by this node.

The following tables describe the node properties. The column headed M indicates whether the property is *mandatory* (marked with an asterisk if you must enter a value when no default is defined); the column headed C indicates whether the property is *configurable* (you can change the value when you add the message flow to the bar file to deploy it).

The Description properties of the AggregateReply node are described in the following table.

Property	M	C	Default	Description
Node name	No	No	The node type (AggregateReply)	The name of the node.
Short Description	No	No		A brief description of the node.
Long Description	No	No		Text that describes the purpose of the node in the message flow.

The AggregateReply node Basic properties are described in the following table.

Property	M	C	Default	Description
Aggregate Name	Yes	Yes		A name that is used to associate the fan-in message flow with the fan-out message flow. This value must be contextually unique within a broker.
Unknown Message Timeout	No	No	0	The amount of time, in seconds, for which messages that cannot be identified as replies are held before they are propagated to the Unknown terminal. The default value is zero; if you accept this default value, the timeout is disabled and unknown messages are propagated to the Unknown terminal upon receipt. z/OS On z/OS, if the Unknown Message Timeout property is not set to zero, set the queue manager parameter <code>EXPRYINT</code> to 5.

Property	M	C	Default	Description
Transaction Mode	Yes	No	Selected	<p>This property defines the transactional characteristics of this message:</p> <ul style="list-style-type: none"> • If you select the check box (the default), the subsequent message flow is under transaction control. This setting remains true for messages that derive from the output message and are output by an MQOutput node, unless the MQOutput node explicitly overrides the transaction status. No other node can change the transactional characteristics of the output message. • If you clear the check box, the subsequent message flow is not under transaction control. This setting remains true for messages that derive from the output message and are output by an MQOutput node, unless the MQOutput node has specified that the message should be put under syncpoint.

AggregateRequest node

Use the AggregateRequest node to record the fact that request messages have been sent. This node also collects information that helps the AggregateReply node to construct the compound response message.

This topic contains the following sections:

- “Purpose”
- “Using this node in a message flow” on page 830
- “Terminals and properties” on page 830

Purpose

Aggregation is an extension of the request/reply application model. It combines the generation and fan-out of a number of related requests with the fan-in of the corresponding replies, and compiles those replies into a single aggregated reply message.

The aggregation function is provided by the following three nodes:

- The AggregateControl node marks the beginning of a fan-out of requests that are part of an aggregation. It sends a control message that is used by the AggregateReply node to match the different requests that have been made. The information that is propagated from the Control terminal includes the broker identifier, the aggregate name property, and the timeout property. The aggregation information that is added to the message Environment by the AggregateControl node must not be changed.
- The AggregateRequest node records the fact that the request messages have been sent. It also collects information that helps the AggregateReply node to construct the aggregated reply message. The information that is added to the message Environment by the AggregateRequest node must be preserved, otherwise the aggregation fails.
- The AggregateReply node marks the end of an aggregation fan-in. It collects replies and combines them into a single aggregated reply message.

The AggregateRequest node is contained in the **Routing** drawer of the palette, and is represented in the workbench by the following icon:



Using this node in a message flow

Look at the following samples to see how to use this node:

- Aggregation sample
- Airline Reservations sample

You can view samples only when you use the information center that is integrated with the Message Broker Toolkit.

Terminals and properties

When you have put an instance of the AggregateRequest node into a message flow, you can configure it; see “Configuring a message flow node” on page 235. The properties of the node are displayed in the Properties view. All mandatory properties for which you must enter a value (those that do not have a default value defined) are marked with an asterisk.

The AggregateRequest node terminals are described in the following table.

Terminal	Description
In	The input terminal that accepts messages sent as part of an aggregate request.
Out	The output terminal to which the input message is routed when processing completes successfully.

The following tables describe the node properties. The column headed M indicates whether the property is *mandatory* (marked with an asterisk if you must enter a value when no default is defined); the column headed C indicates whether the property is *configurable* (you can change the value when you add the message flow to the bar file to deploy it).

The AggregateRequest node Description properties are described in the following table.

Property	M	C	Default	Description
Node name	No	No	The node type (AggregateRequest)	The name of the node
Short Description	No	No		A brief description of the node.
Long Description	No	No		Text that describes the purpose of the node in the message flow.

The AggregateRequest node Basic property is described in the following table.

Property	M	C	Default	Description
Folder Name	Yes	No		The name that is used as a folder in the AggregateReply node’s compound message to store the reply to this request. You must enter a value for this property, but the value does not need to be unique.

Check node

Use the Check node to compare the template of a message that is arriving on its input terminal with a message template that you supply when you configure the Check node.

Attention: The Check node is deprecated in WebSphere Message Broker Version 6.0 and subsequent versions. Although message flows that contain a Check node remain valid, redesign your message flows where possible to replace Check nodes with Validate nodes.

This topic contains the following sections:

- “Purpose”
- “Using this node in a message flow”
- “Terminals and properties”

Purpose

The message domain, message set, and message type of the message are collectively called the *message template*. The domain defines the parser that is used for the message. The set is the message set to which the message belongs. The type is the structure of the message itself. You can check the incoming message against one or more of these properties. The message property is checked only if you select its corresponding Check property, which means that a message property that contains a null string can be compared.

If the message properties match the specification, the message is propagated to the Match terminal of the node. If the message properties do not match the specification, the message is propagated to the Failure terminal. If the Failure terminal is not connected to some failure handling processing, an exception is generated.

The Check node is contained in the **Validation** drawer of the palette, and is represented in the workbench by the following icon:



Using this node in a message flow

Use the Check node to ensure that the message is routed appropriately through the message flow. For example, you can configure the node to direct a message that requests stock purchases through a different route from that required for a message that requests stock sales.

Another example of this node’s use is for the receipt of electronic messages from staff at your head office. These messages are used for multiple purposes; for example, to request technical support or stationery, or to advise you about new customer leads. These messages can be processed automatically because your staff complete a standard form. If you want these messages to be processed separately from other messages received, use the Check node to ensure that only staff messages with a specific message type are processed by this message flow.

Terminals and properties

When you have put an instance of the Check node into a message flow, node into a message flow, you can configure it. For more information, see “Configuring a message flow node” on page 235. The properties of the node are displayed in the Properties view. All mandatory properties for which you must enter a value (those that do not have a default value defined) are marked with an asterisk.

The Check node terminals are described in the following table.

Terminal	Description
In	The input terminal that accepts a message for processing by the node.
Failure	The output terminal to which the message is routed if the incoming message does not match the specified properties.
Match	The output terminal to which the message is routed if the incoming message matches the specified properties.

The following tables describe the node properties. The column headed M indicates whether the property is *mandatory* (marked with an asterisk if you must enter a value when no default is defined); the column headed C indicates whether the property is *configurable* (you can change the value when you add the message flow to the bar file to deploy it).

The Check node Description properties are described in the following table.

Property	M	C	Default	Description
Node name	No	No	Check	The name of the node
Short description	No	No		A brief description of the node.
Long description	No	No		Text that describes the purpose of the node in the message flow.

The Check node Basic properties are described in the following table.

Property	M	C	Default	Description
Domain	No	No		The name of the domain.
Check domain	Yes	No	Cleared	This property checks that a message belongs to a particular domain. To check the parser that is to be used for the incoming message, select this check box and select one of the values from the Domain list.
Set	No	No		The message set to which the incoming message belongs. If you are using the MRM, IDOC, or XMLNSC parser, check that the incoming message belongs to a particular message set by selecting Check set and entering the name of the message set in Set. Leave Set clear for other parsers. If you set this property, then subsequently update the project dependencies to remove this message set reference, a warning is issued. Either update the Message set property, or restore the reference to this message set project.
Check set	Yes	No	Cleared	If you select this check box, the incoming message is checked against the Set property.
Type	No	No		The message name. If you are using the MRM parser, check that the incoming message is a particular message type by selecting Check type and entering the name of the message in Type. Leave Type clear for other parsers.
Check type	Yes	No	Cleared	If you select this check box, the incoming message is checked against the Type property.

Collector node

Use the Collector node to create message collections based on rules that you configure in the node.

This topic contains the following sections:

- “Purpose”
- “Using this node in a message flow” on page 834
- “Terminals and properties” on page 835

Purpose

Use the Collector node to create a message collection from one or more sources based on configurable criteria. For example, you might need to extract, combine and transform information from three different sources. The messages from these different sources might arrive at the input terminals at different times and in an unknown order. A collection is defined by configuring an event handler for each input terminal. Each event handler controls the acceptance of a message into a collection according to the following properties:

- Number of messages
- Collect messages for a set period of time
- Match the contents of a correlation path
- Match the contents against a correlation pattern

The correlation properties allow collections to be made according to the content of the messages. The content is specified using an XPath expression. The Collector node ensures that each collection contains an identical correlation string across all its inputs. For more information about XPath 1.0 query syntax, see XPath.

A message collection comes into existence when the first message arrives at any of the dynamic input terminals on the Collector node. Message collections are stored on a WebSphere MQ queue.

When the conditions set by the event handlers for a message collection have been met, the message collection is complete and ready to be propagated. For example, if you set the event handlers on the Collector node to wait for 2 messages from each input terminal, the message collection is complete when 2 messages have been received by every terminal. When the next message arrives on an input terminal it is added to a new message collection. You can select from a number of options to determine how the propagation of the message collections are coordinated. You can enable the message collection to be automatically propagated for processing, or alternatively for the message collections to be propagated when a control messages is received.

You can also set an expiry timeout for message collections that fail to be completed in a satisfactory time, using a property on the Collector node. The timeout starts when the first message is added to a message collection. If the timeout expires without the message collection becoming complete, the incomplete message collection is propagated to the **Expire** terminal. Set a value for the collection expiry to ensure that incomplete message collections do not remain stored on a queue indefinitely. Add appropriate processing to your message flow to handle incomplete message collections.

The Collector node is contained in the **Routing** drawer of the message flow node palette, and is represented in the workbench by the following icon:



Using this node in a message flow

Look at the Collector Node sample to see an example of how to use this node. You can view samples only when you use the information center that is integrated with the Message Broker Toolkit.

Use the Collector node to group together messages from different input sources for further processing. A message collection can be processed by the following nodes only:

- Compute
- JavaCompute

Errors might be generated if you try to process a message collection with a node that does not support message collections.

The Collector node has one static input terminal: **Control**, and four static output terminals: **Out**, **Expire**, **Failure** and **Catch**. These static terminals are always present on the node. In addition to the static input and output terminals, you can add dynamic input terminals for each input source that you want to use with the Collector node.

You can add and configure as many input terminals as required to the Collector node. You can configure the properties of each input terminal separately to control how the messages received on each input terminal are added to the appropriate message collection.

You can use the **Control** terminal to trigger the output of completed message collections from the Collector node. Configure the Event coordination property to set the behavior of the Collector node when messages are received on the **Control** terminal.

When a message collection is successfully completed, it is ready to be propagated to the **Out** terminal. If a value greater than zero is set on the Collection expiry property, then any incomplete message collections are propagated to the **Expire** terminal.

A new transaction is created when a message collection is complete, and is propagated to the next node. Any exceptions that are caught from downstream nodes cause the message collection to be propagated to the **Catch** terminal on the Collector node, together with the exception list. If the **Catch** terminal is not connected to any other nodes, then the transaction is caused to rollback. Messages in the message collection are backed out onto the Collector node's queue. The exception list is written to the system log. This step is repeated until the message collection is successfully processed. In order to avoid a situation where an exception in the flow causes the message collection to fail to be propagated successfully, ensure you connect the **Catch** terminal to a flow to handle any exceptions. Also ensure you set an expiry timeout to propagate incomplete message collections.

Configuring the Collector node

1. On the **Advanced** tab:

- a. Enter a value for *Persistence Mode*. This value is used to specify whether messages are stored on the Collector node's queues persistently.

If you use additional instances of a message flow or multiple inputs to the Collector node, you can use the *Correlation path* and *Correlation pattern* properties to ensure that related messages are added to the same message collection. If you use additional instances, or multiple inputs to the Collector node the order of messages in the message collection can be unpredictable. The order of messages is also unpredictable if you use WebSphere MQ cluster queues as inputs to the Collector node.

Terminals and properties

When you have put an instance of the Collector node into a message flow, you can configure it; see "Configuring a message flow node" on page 235. The properties of the node are displayed in the Properties view. All mandatory properties for which you must enter a value (those that do not have a default value defined) are marked with an asterisk.

The Collector node terminals are described in the following table.

Terminal	Description
Control	The static input terminal that accepts control messages. Any message received by the Control terminal is treated as a control message.
Out	The output terminal to which the complete message collection is routed if the received messages satisfy the configured conditions for the message collection.
Expire	The output terminal to which the incomplete message collection is routed if the received messages do not satisfy the configured conditions within the time specified on the Collection expiry property. If you have not set a value for the Collection expiry property this terminal is not used.
Failure	The output terminal to which the message collection is routed if a failure is detected during processing.
Catch	The output terminal to which the message collection is routed if an exception is thrown downstream and caught by this node.

The Collector node can have further dynamic input terminals.

The following tables describe the node properties. The column headed M indicates whether the property is *mandatory* (marked with an asterisk if you must enter a value when no default is defined); the column headed C indicates whether the property is *configurable* (you can change the value when you add the message flow to the bar file to deploy it).

The Collector node Description properties are described in the following table:

Property	M	C	Default	Description
Node name	No	No	The node type, Collector	The name of the node.
Short Description	No	No		A brief description of the node.
Long Description	No	No		Text that describes the purpose of the node in the message flow.

The Collector node has two types of Basic properties. You can set properties for each dynamic input terminal that you add to the Collector node in the Collection Definition table in the Basic properties. The properties in the Collection Definition table define the event handlers for the messages arriving on the individual input terminals. The properties that you can set for each of the dynamic input terminals are described in the following table:

Property	M	C	Default	Description
Terminal	Yes	No	The terminal name	<p>This is not a property of the node, but a label to show the name of the dynamic input terminal.</p> <p>Enter values for the event handler properties for each dynamic input terminal that you have added to the Collector node in the Collection Definition table.</p>
Quantity	Yes	No	1	<p>This property specifies the number of messages that the input terminal accepts to add to a message collection.</p> <p>The default value is 1; if you accept this default value, only one message is added to a collection. If a second message is received on the terminal, a new collection instance is created for it. If you select 0 (zero) or do not specify a value, there is no limit to the number of messages accepted. In this case, the value that is set on the Timeout property must be greater than zero.</p>
Timeout	Yes	No		<p>This property specifies the maximum time in seconds for which the input terminal accepts messages. If you select 0 (zero) or do not specify a value for, the timeout is disabled and there is no limit on the time to wait for messages. In this case, the value that is set on the Quantity property must be greater than zero.</p>
Correlation path	No	No		<p>Messages are only accepted into a message collection if they have the same correlation string. If the message has a different correlation string, it is offered to the next collection in the queue. If none of the collections accept the message, then a new collection is created with correlation string set to the value of the correlation string in the message. Messages are grouped by the value from the correlation path. The correlation path is defined using XPath. You can define your own correlation path using XPath, or select from the following predefined paths:</p> <ul style="list-style-type: none"> • \$Root/Properties/WildcardMatch • \$Root/MQMD/CorrelID • \$LocalEnvironment/FileInput/Name • \$Root/JMSTransport/Transport_Folders/Header_Values/JMSCorrelationID <p>If you define a value for Correlation path, you can optionally configure a Correlation pattern.</p>

Property	M	C	Default	Description
Correlation pattern	No	No		<p>This property specifies a pattern to match the contents of a correlation path value against. You must set the Correlation path property before you set the value for the Correlation pattern property. If you set the correlation pattern, you must use one * character, optionally surrounded by other text. For example, *.dat.</p> <p>If the correlation pattern is blank, the entire text from the correlation path must be matched by the incoming message.</p>

The remaining Basic properties for the Collector node are shown in the following table:

Property	M	C	Default	Description
Collection name	No	No		<p>This property specifies the name of the message collection.</p> <ul style="list-style-type: none"> • If you set this property to contain the wildcard *, the wildcard is replaced by the correlation string from the relevant event handler. • If you leave this property blank or use * and the correlation string is empty, then the collection name is set to an empty string.
Collection expiry	No	Yes	0	<p>The amount of time, in seconds, that the Collector node waits for messages to arrive. After this time an incomplete message collection is expired and propagated to the Expire output terminal.</p> <p>The default value is zero; if you accept this value, the collection expiry is disabled and the Collector node waits for messages indefinitely. Set a value greater than zero to ensure that the message collection is processed, even if not all messages are received. A warning is issued if this property is not set.</p>

Property	M	C	Default	Description
Event coordination	Yes	No	Disabled	<p>This property specifies how messages received on the Control terminal for event coordination processing are handled in the Collector node.</p> <ul style="list-style-type: none"> • If you accept the default value (Disabled), messages to the Control terminal are ignored and collections are propagated when they are complete. • If you select All complete collections, complete message collections are held on a WebSphere MQ queue. When a message is received on the control terminal, all complete message collections on the WebSphere MQ queue are propagated to the Out terminal. • If you select First complete collection, complete message collections are held on a WebSphere MQ queue. When a message is received on the control terminal, the first complete message collection on the WebSphere MQ queue is propagated to the Out terminal. The collections are propagated in the same order that they become complete. If the WebSphere MQ queue is empty when the message is received on the Control terminal, the next complete message collection is immediately propagated to the Out terminal.

Compute node

Use the Compute node to construct one or more new output messages.

This topic contains the following sections:

- “Purpose”
- “Using this node in a message flow” on page 839
- “Configuring the Compute node” on page 839
- “Defining database interaction” on page 839
- “Specifying ESQL” on page 840
- “Setting the mode” on page 841
- “Validating messages” on page 844
- “Terminals and properties” on page 844

Purpose

The output messages that you create in the Compute node might be created by modifying the information that is provided in the input message, or by using only new information which can be taken from a database or from other sources. Elements of the input message (for example, headers, header fields, and body data), its associated environment, and its exception list can be used to create the new output message.

Specify how the new messages are created by coding ESQL in the message flow ESQL resource file. For more information, see “Specifying ESQL” on page 840.

Use the Compute node to:

- Build a new message using a set of assignment statements
- Copy messages between parsers
- Convert messages from one code set to another
- Transform messages from one format to another

The Compute node is contained in the **Transformation** drawer of the palette, and is represented in the workbench by the following icon:



Using this node in a message flow

Look at the following samples to see how to use this node:

- Airline Reservations sample
- Aggregation sample
- JMS Nodes sample
- Large Messaging sample
- Message Routing sample
- Scribble sample
- Timeout Processing sample
- Video Rental sample

You can view samples only when you use the information center that is integrated with the Message Broker Toolkit.

Consider a message flow in which you want to give each order that you receive a unique identifier for audit purposes. The Compute node does not modify its input message; it creates a new, modified copy of the message as an output message. You can use the Compute node to insert a unique identifier for your order into the output message, which can be used by subsequent nodes in the message flow.

Configuring the Compute node

When you have put an instance of the Compute node into a message flow, you can configure it; see “Configuring a message flow node” on page 235. The properties of the node are displayed in the Properties view.

All mandatory properties for which you must enter a value (those that do not have a default value defined) are marked with an asterisk.

Configure the Compute node by:

1. “Defining database interaction”
2. “Specifying ESQL” on page 840
3. “Setting the mode” on page 841
4. “Validating messages” on page 844

Defining database interaction:

To access a database from this node:

- On the **Basic** tab, specify in Data Source the name by which the appropriate database is known on the system on which this message flow is to execute. The broker connects to this database with user ID and password information that you have specified on the `mqsicreatebroker`, `mqsichangebroker`, or `mqsisetdbparms` command.

z/OS

On z/OS systems, the broker uses the broker started task ID, or the user ID and password that were specified on the `mqsisetdbparms` command JCL, BIPSDBP in the customization data set <hlq>.SBIPPROC.

- Select the Transaction setting from the drop-down menu. The values are:

- Automatic (the default). The message flow, of which the Compute node is a part, is committed if it is successful. That is, the actions that you define in the ESQL module are performed on the message and it continues through the message flow. If the message flow fails, it is rolled back. If you choose Automatic, the ability to commit or roll back the action of the Compute node on the database depends on the success or failure of the entire message flow.
- Commit. To commit the action of the Compute node on the database, irrespective of the success or failure of the message flow as a whole, select Commit. The database update is committed even if the message flow itself fails.

The value that you choose is implemented for the one or more database tables that you have added; you cannot select a different value for each table.

- To treat database warning messages as errors and have the node propagate the output message to the Failure terminal, select Treat warnings as errors. The check box is cleared initially.

When you select the check box, the node handles all positive return codes from the database as errors and generates exceptions in the same way as it does for the negative, or more serious, errors.

If you do not select the check box, the node treats warnings as normal return codes, and does not raise any exceptions. The most significant warning raised is not found, which can be handled as a normal return code safely in most circumstances.

- To force the broker to generate an exception when a database error is detected, select Throw exception on database error. The check box is selected initially.

If you clear the check box, you must include ESQL to check for any database error that might be returned after each database call that you make (you can use SQLCODE and SQLSTATE to do this). If an error occurs, you must handle the error in the message flow to ensure the integrity of the broker and the database; the error is ignored if you do not handle it through your own processing because you have chosen not to invoke the default error handling by the broker. For example, you can include the ESQL THROW statement to throw an exception in this node, or you can use the Throw node to generate your own exception at a later point in the message flow.

Specifying ESQL:

Code ESQL statements to customize the behavior of the Compute node. For example, you can customize the node to create a new output message or messages, using input message or database content (unchanged or modified), or new data. For example, you might want to modify a value in the input message by adding a value from a database, and storing the result in a field in the output message.

Code the ESQL statements that you want in an ESQL file that is associated with the message flow in which you have included this instance of the Compute node. The ESQL file, which by default has the name <message_flow_name>.esql, contains ESQL for every node in the message flow that requires it. Each portion of code that is related to a specific node is known as a module.

If an ESQL file does not already exist for this message flow, double-click the Compute node, or right-click the node and click **Open ESQL**. This action creates and opens a new ESQL file in the ESQL editor view. If you prefer, you can open the appropriate ESQL file in the Broker Development view and select this node in the Outline view.

If the file exists already, click **Browse** beside the ESQL Module property to display the Module Selection dialog box, which lists the available Compute node modules defined in the ESQL files that are accessible by this message flow (ESQL files can be defined in other, dependent, projects). Select the appropriate module and click **OK**. If no suitable modules are available, the list is empty.

If the module that you have specified does not exist, it is created for you and the editor displays it. If the file and the module exist already, the editor highlights the correct module.

If a module skeleton is created for this node in a new or existing ESQL file, it consists of the following ESQL. The default module name is shown in this example:

```
CREATE COMPUTE MODULE <flow_name>_Compute
  CREATE FUNCTION Main() RETURNS BOOLEAN
  BEGIN
    -- CALL CopyMessageHeaders();
    -- CALL CopyEntireMessage();
    RETURN TRUE;
  END;

  CREATE PROCEDURE CopyMessageHeaders() BEGIN
    DECLARE I INTEGER 1;
    DECLARE J INTEGER CARDINALITY(InputRoot.*[]);
    WHILE I < J DO
      SET OutputRoot.*[I] = InputRoot.*[I];
      SET I = I + 1;
    END WHILE;
  END;

  CREATE PROCEDURE CopyEntireMessage() BEGIN
    SET OutputRoot = InputRoot;
  END;
END MODULE;
```

If you create your own ESQL module, you must create this skeleton exactly as shown except for the procedure calls and definitions (described below). You can change the default name, but ensure that the name you specify matches the name of the corresponding node property ESQL Module. If you want the module name to include one or more spaces, enclose the name in double quotes in the ESQL Module property.

Add your own ESQL to customize this node after the BEGIN statement that follows CREATE FUNCTION, and before RETURN TRUE. You can use the two calls included in the skeleton, to procedures CopyEntireMessage and CopyMessageHeaders.

These procedures, defined following function Main, provide common functions that you might want when you manipulate messages. The calls in the skeleton are commented out; remove the comment markers if you want to use the procedure. If you do not want to use a procedure, remove both the call and the procedure definition from the module.

Setting the mode:

The Compute Mode property controls which components are used by default in the output message. Select the property to specify whether the Message,

LocalEnvironment (previously specified as DestinationList), and Exception List components that are either generated within the node or contained within the incoming message are used.

This default value is used when the transformed message is routed to the Out terminal when processing in the node is completed. The default value is also used whenever a PROPAGATE statement does not specify the composition of its output message.

Those components that are not included in your selection are passed on unchanged; even if you modify those components, the updates are local to this node.

Conversely, those components that are included in the selection are not passed on and the updates that are made in the node persist.

The seven possible values that the Compute Mode property can take are listed in the following table.

Mode	Description
Message (the default)	The message is generated or passed through by the Compute node as modified within the node.
LocalEnvironment	The LocalEnvironment tree structure is generated or passed through by the Compute node as modified within the node.
LocalEnvironment And Message	The LocalEnvironment tree structure and message are generated or passed through by the Compute node as modified by the node.
Exception	The Exception List is generated or passed through by the Compute node as modified by the node.
Exception And Message	The Exception List and message are generated or passed through by the Compute node as modified by the node.
Exception and LocalEnvironment	The Exception List and LocalEnvironment tree structure are generated or passed through by the Compute node as modified by the node.
All	The message, Exception List, and LocalEnvironment are generated or passed through by the Compute node as modified by the node.

The value of the Compute Mode property specifies which new message trees are propagated from the Compute node. Therefore, for those message trees that are selected, the input messages are discarded unless they are explicitly copied into the new equivalent output message tree.

If All is selected, the Compute node is expecting to generate all three new message trees for the Root, LocalEnvironment, and ExceptionList by populating the OutputRoot, OutputLocalEnvironment, and OutputExceptionList. The input message trees are not passed to the output unless they are copied explicitly from the Input to the Output.

Therefore, if the Compute Mode property is set to All, you must code the following ESQL to allow the input trees to be propagated to the output terminal:

```

SET OutputRoot = InputRoot;
SET OutputLocalEnvironment = InputLocalEnvironment;
SET OutputExceptionList = InputExceptionList;

```

If the ESQL was `CopyEntireMessage()`, the `LocalEnvironment` and `ExceptionList` are not copied across and are not propagated to the output terminal; they are lost at that node in the message flow.

To produce a new or changed output message, and propagate the same `LocalEnvironment` and `ExceptionList`, set the `Compute Mode` property to `Message` so that the `LocalEnvironment` and `ExceptionList` that are passed to the `Compute` or `Mapping` node, are passed on from the `Compute` node.

The `Compute Mode` applies only to propagation from the node. You can create all three output trees in a `Compute` or `Mapping` node and these can be manipulated and exist within the node. However, the `Compute Mode` determines whether such output trees are used on propagation from the node.

On propagation from the node, the following trees are propagated from the `Compute` or `Mapping` node for the following settings.

Compute Mode	Trees propagated
All	OutputRoot, OutputLocalEnvironment, OutputExceptionList
Message	OutputRoot, InputLocalEnvironment, InputExceptionList
LocalEnvironment	InputRoot, OutputLocalEnvironment, InputExceptionList
LocalEnvironment and Message	OutputRoot, OutputLocalEnvironment, InputExceptionList
Exception	InputRoot, InputLocalEnvironment, OutputExceptionList
Exception and Message	OutputRoot, InputLocalEnvironment, OutputExceptionList
Exception and LocalEnvironment	InputRoot, OutputLocalEnvironment, OutputExceptionList

Where an output tree is named, ESQL creates this message tree before propagation. If your ESQL does not create the tree, no tree is propagated for that correlation name, and the input tree is not used in its place because the `Compute Mode` property did not indicate this option. Therefore, dependent on `Compute Mode` property settings and your ESQL, you might delete a tree that was input to the node, because you did not transfer it to the output tree, or propagate a changed tree as you intended.

The converse is also true. If your ESQL interrogates the input trees and does not need to propagate these trees, the `Compute Mode` property value might mean that the message tree propagates when you do not intend it to do so. For example, you might not want to propagate the `LocalEnvironment` and `ExceptionList` from a `Compute` node, but because you selected `Message`, the input versions of the trees are propagated. Even if the ESQL explicitly deletes the `OutputLocalEnvironment` and `OutputExceptionList`, these changes are local to that node because the `Compute Mode` property setting causes the input trees to be propagated.

The `Environment` component of the message tree is not affected by the `Compute Mode` property setting. Its contents, if any, are passed on from this node in the output message.

Set this property to reflect the output message format that you require. If you select an option (or accept the default value) that does not include a particular part of the message, that part of the message is not included in any output message that is constructed.

The Compute node has both an input and output message, so you can use ESQL to refer to fields in either message. You can also work with both `InputLocalEnvironment` and `OutputLocalEnvironment`, and `InputExceptionList` and `OutputExceptionList`, as well as the input and output message bodies.

Validating messages:

Set the validation properties to define how the message that is produced by the Compute node is to be validated. These properties do not cause the input message to be validated. It is expected that, if such validation is required, the validation has already been performed by the input node or a preceding validation node.

For more details, see “Validating messages” on page 164 and “Validation properties” on page 1359.

Terminals and properties

The Compute node terminals are described in the following table.

Terminal	Description
In	The input terminal that accepts a message for processing by the node.
Failure	The output terminal to which the input message is routed if an unhandled exception occurs during the computation.
Out	The output terminal to which the transformed message is routed when processing in the node is completed. The transformed message might also be routed to this terminal by a PROPAGATE statement.
Out1	The first alternative output terminal to which the transformed message might be routed by a PROPAGATE statement.
Out2	The second alternative output terminal to which the transformed message might be routed by a PROPAGATE statement.
Out3	The third alternative output terminal to which the transformed message might be routed by a PROPAGATE statement.
Out4	The fourth alternative output terminal to which the transformed message might be routed by a PROPAGATE statement.

For the syntax of the PROPAGATE statement, see “PROPAGATE statement” on page 1550.

The following tables describe the node properties. The column headed M indicates whether the property is *mandatory* (marked with an asterisk if you must enter a value when no default is defined); the column headed C indicates whether the property is *configurable* (you can change the value when you add the message flow to the bar file to deploy it).

The Compute node Description properties are described in the following table.

Property	M	C	Default	Description
Node name	No	No	The node type	The name of the node.
Short Description	No	No		A brief description of the node.
Long Description	No	No		Text that describes the purpose of the node in the message flow.

The Compute node Basic properties are described in the following table.

Property	M	C	Default	Description
Data Source	No	Yes		The ODBC data source name for the database within which reside any tables to which you refer in the ESQL file that is associated with this message flow (identified in the ESQL Module property). You can specify only one data source for the node. If the ESQL that is associated with this node includes a PASSTHRU statement or SELECT function and a database reference, you must specify a value for the Data Source property.
Transaction	Yes	No	Automatic	The transaction mode for the node. Valid options are Automatic and Commit. The property is valid only if you have selected a database table for input.
ESQL Module	Yes	No	Compute	The name of the module within the ESQL file that contains the statements to execute against the database and input and output messages.
Compute Mode	Yes	No	Message	Choose from: <ul style="list-style-type: none"> • Message • LocalEnvironment • LocalEnvironment And Message • Exception • Exception And Message • Exception And LocalEnvironment • All For more information about setting the mode options, see "Setting the mode" on page 841.
Treat warnings as errors	Yes	No	Cleared	If you select the check box, database SQL warnings are treated as errors.
Throw exception on database error	Yes	No	Selected	If you select this check box, database errors cause the broker to throw an exception.

The Parser Options properties for the Compute node are described in the following table.

Property	M	C	Default	Description
Use XMLNSC Compact Parser for XMLNS Domain	No	No	Cleared	Setting this property causes the outgoing MQRFH2 to specify the XMLNS instead of XMLNSC parser, allowing an external application to remain unchanged. If outgoing messages do not contain MQRFH2 headers this property has no effect.

The Validation properties of the Compute node are described in the following table.

For a full description of these properties, see “Validation properties” on page 1359.

Property	M	C	Default	Description
Validate	No	Yes	None	This property controls whether validation takes place. Valid values are None, Content and Value, Content, and Inherit.
Failure Action	No	No	Exception	This property controls what happens if a validation failure occurs. You can set this property only if Validate is set to Content or Content and Value. Valid values are User Trace, Local Error Log, Exception, and Exception List.

Database node

Use the Database node to interact with a database in the specified ODBC data source.

This topic contains the following sections:

- “Purpose”
- “Using this node in a message flow”
- “Terminals and properties” on page 847

Purpose

You define the nature of the interaction by coding ESQL statements that specify the data from the input message, and perhaps transform it in some way (for example, to perform a calculation), and assign the result to a database table.

You can set a property to control whether the update to the database is committed immediately, or deferred until the message flow completes, at which time the update is committed or rolled back, according to the overall completion status of the message flow.

You can use specialized forms of this node to:

- Update values within a database table (the DataUpdate node)
- Insert rows into a database table (the DataInsert node)
- Delete rows from a database table (the DataDelete node)
- Store the message, or parts of the message, in a warehouse (the Warehouse node)

The Database node is contained in the **Database** drawer of the palette, and is represented in the workbench by the following icon:



Using this node in a message flow

Look at the following samples to see how to use this node:

- Airline Reservations sample
- Error Handler sample

You can view samples only when you use the information center that is integrated with the Message Broker Toolkit.

Consider a situation in which you receive an order for 20 monitors. If you have sufficient numbers of monitors in your warehouse, you want to reduce the stock level on your stock database. You can use the Database node to check that you have enough monitors available, and reduce the value of the quantity field in your database.

Terminals and properties

When you have put an instance of the Database node into a message flow, you can configure it; see “Configuring a message flow node” on page 235. The properties of the node are displayed in the Properties view. All mandatory properties for which you must enter a value (those that do not have a default value defined) are marked with an asterisk.

The terminals of the Database node are described in the following table.

Terminal	Description
In	The input terminal that accepts a message for processing by the node.
Failure	The output terminal to which the input message is propagated if a failure is detected during the computation. If you have selected Treat warnings as errors, the node propagates the message to this terminal even if the processing completes successfully.
Out	The output terminal to which the transformed message is routed when processing in the node is completed. The transformed message might also be routed to this terminal by a PROPAGATE statement.
Out1	The first alternative output terminal to which the transformed message might be routed by a PROPAGATE statement.
Out2	The second alternative output terminal to which the transformed message might be routed by a PROPAGATE statement.
Out3	The third alternative output terminal to which the transformed message might be routed by a PROPAGATE statement.
Out4	The fourth alternative output terminal to which the transformed message might be routed by a PROPAGATE statement.

Note: For the syntax of the PROPAGATE statement, see “PROPAGATE statement” on page 1550.

The following tables describe the node properties. The column headed M indicates whether the property is *mandatory* (marked with an asterisk if you must enter a value when no default is defined); the column headed C indicates whether the property is *configurable* (you can change the value when you add the message flow to the bar file to deploy it).

The Description properties of the Database node are described in the following table.

Property	M	C	Default	Description
Node name	No	No	The node type, Database	The name of the node.

Property	M	C	Default	Description
Short Description	No	No		A brief description of the node.
Long Description	No	No		Text that describes the purpose of the node in the message flow.

The Database node Basic properties are described in the following table.

Property	M	C	Default	Description
Data Source	No	Yes		<p>The ODBC data source name of the database that contains the tables to which you refer in the ESQL that is associated with this node (identified by the Statement property).</p> <p>This name identifies the appropriate database as it is known on the system on which this message flow is to run. The broker connects to this database with user ID and password information that you have specified on the mqsicreatebroker, mqsicchangebroker, or mqsisetdbparms command.</p> <p>z/OS On z/OS systems, the broker uses the broker's started task ID, or the user ID and password that are specified on the mqsisetdbparms command JCL, BIPSDBP in the customization data set <hlq>.SBIPPROC.</p> <p>If the ESQL that is associated with this node includes a PASSTHRU statement or SELECT function and a database reference, you must specify a value for the Data Source property.</p>

Property	M	C	Default	Description
Statement	Yes	No	Database	<p>The name of the module in the ESQL file that contains the statements to use against the database. If you want the module name to include one or more spaces, enclose the name in double quotation marks.</p> <p>The ESQL file, which by default has the name <message_flow_name>.esql, contains ESQL for every node in the message flow that requires it. Each portion of code that is related to a specific node is known as a module. When you code ESQL statements that interact with tables, those tables are assumed to exist within this database. If they do not exist, a database error is generated by the broker at run time.</p> <p>Code ESQL statements to customize the behavior of the Database node in an ESQL file that is associated with the message flow in which you have included this instance of the Database node. If an ESQL file does not exist already for this message flow, double-click the Database node, or right-click the node and click Open ESQL to create and open a new ESQL file in the ESQL editor view.</p> <p>If an ESQL file exists already, click Browse beside the Statement property to display the Module Selection dialog box, which lists the available Database node modules that are defined in the ESQL files that are accessible by this message flow (ESQL files can be defined in other, dependent, projects). Select the appropriate module and click OK. If no suitable modules are available, the list is empty.</p> <p>If the module that you have specified does not exist, it is created for you and the editor displays it. If the file and the module exist already, the editor highlights the correct module. If a module skeleton is created for this node in a new or existing ESQL file, it consists of the following ESQL. The default module name is shown in this example:</p> <pre>CREATE DATABASE MODULE <flow_name>_Database CREATE FUNCTION Main() RETURNS BOOLEAN BEGIN RETURN TRUE; END; END MODULE;</pre> <p>If you create your own ESQL module, create exactly this skeleton. You can update the default name, but ensure that the name that you specify matches the name of the corresponding node property Statement.</p> <p>To customize this node, add your own ESQL after the BEGIN statement and before RETURN TRUE. You can use all the ESQL statements including SET, WHILE, DECLARE, and IF in this module, but (unlike the Compute node) the Database node propagates, unchanged, the message that it receives at its input terminal to its output terminal. Therefore, like the Filter node, you have only one message to refer to in a Database node.</p>

Property	M	C	Default	Description
Transaction	Yes	No	Automatic	<p>The transaction mode for the node. The values are:</p> <ul style="list-style-type: none"> Automatic (the default). The message flow, of which the Database node is a part, is committed if it is successful; that is, the actions that you define in the ESQL module are performed and the message continues through the message flow. If the message flow fails, it is rolled back. If you select Automatic, the ability to commit or roll back the action of the Database node on the database depends on the success or failure of the entire message flow. Commit. To commit any uncommitted actions that are performed in this message flow on the database that is connected to this node, irrespective of the success or failure of the message flow as a whole, select Commit. The changes to the database are committed even if the message flow itself fails.
Treat Warnings as Errors	Yes	No	Cleared	<p>For database warning messages to be treated as errors, and for the node to propagate the output message to the Failure terminal, select Treat Warnings as Errors. The check box is cleared initially.</p> <p>When you select the check box, the node handles all positive return codes from the database as errors and generates exceptions in the same way as it does for the negative, or more serious, errors. If you do not select the check box, the node treats warnings as normal return codes, and does not raise any exceptions. The most significant warning raised is not found, which can be handled safely as a typical return code in most circumstances.</p>
Throw Exception on Database Error	Yes	No	Selected	<p>For the broker to generate an exception when a database error is detected, select Throw Exception on Database Error. The check box is selected initially.</p> <p>If you clear the check box, include ESQL to check for any database error that might be returned after each database call that you make (you can use SQLCODE and SQLSTATE to do this). If an error has occurred, you must handle the error in the message flow to ensure the integrity of the broker and the database; the error is ignored if you do not handle it through your own processing because you have chosen not to use the default error handling by the broker. For example, you can include the ESQL THROW statement to throw an exception in this node, or you can use the Throw node to generate your own exception at a later point.</p>

DatabaseRetrieve node

Use the DatabaseRetrieve node to ensure that information in a message is up to date.

This topic contains the following sections:

- “Purpose” on page 851
- “Using this node in a message flow” on page 851
- “Making the JDBC provider service available to the DatabaseRetrieve node” on page 853
- “Using the Database Explorer view to query data sources” on page 853
- “Configuring the DatabaseRetrieve node” on page 854
- “Example” on page 854
- “Validating messages” on page 855
- “Terminals and properties” on page 856

Purpose

Use the DatabaseRetrieve node to modify a message using information from a database. For example, you can add information to a message using a key that is contained in a message; the key can be an account number.

The DatabaseRetrieve node is contained in the **Database** drawer of the message flow node palette, and is represented in the workbench by the following icon:



Using this node in a message flow

Look at the Simplified Database Routing sample to see how to use this node. You can view samples only when you use the information center that is integrated with the Message Broker Toolkit.

Input parameter values that are acquired from message elements in the incoming message are supported for insertion into prepared statements that are used by this node. These values are acquired from name, value, and name-value elements in the incoming parsed input message. Elements are acquired initially in the form of a `com.ibm.broker.plugin.MbElement` object, therefore the range of supported Java object types that values can take is governed by this object's interface. When values are in the form of Java primitive types or Objects they are converted to their equivalent JDBC data type, as shown in the following table.

Java	JDBC
Integer	INTEGER
Long	BIGINT
Double	DOUBLE
BigDecimal	NUMERIC
Boolean	BIT
byte[]	VARBINARY or LONGVARBINARY
BitSet	VARBINARY or LONGVARBINARY
String	VARCHAR or LONGVARCHAR
MbTime	java.sql.Time
MbTimestamp	java.sql.Timestamp
MbDate	java.sql.Date

Values are used from an element only if the element is of a known type, and its value state is valid, otherwise an exception is issued. Output column values that are acquired in the result set from SQL queries that are carried out by this node are converted first into matching Java types, then into internal message element value types, as shown in the following table.

JDBC	Java	ESQL Type
SMALLINT	Integer	INTEGER
INTEGER	Integer	INTEGER
BIGINT	Long	DECIMAL
DOUBLE	Double	FLOAT

JDBC	Java	ESQL Type
REAL	Double	FLOAT
FLOAT	Double	FLOAT
NUMERIC	BigDecimal	DECIMAL
DECIMAL	BigDecimal	DECIMAL
BIT	Boolean	BOOLEAN
BOOLEAN	Boolean	BOOLEAN
BINARY	byte[]	BLOB
VARBINARY	byte[]	BLOB
LONGVARBINARY	byte[]	BLOB
CHAR	String	CHARACTER
VARCHAR	String	CHARACTER
LONGVARCHAR	String	CHARACTER
TINYINT	byte[1]	BLOB
TIME	java.util.Date	TIME
TIMESTAMP	java.util.Date	TIMESTAMP
DATE	java.util.Date	DATE

You can route a message to the same location, whether or not a query is successful against a given database, by wiring both of the non-failure output terminals to the same output location.

If an error is found in the XPath expression of a pattern, it is reported during validation in the workbench. The reported error message might include the incorrect expression string and its associated unique dynamic or static terminal name, or the string might be marked as broker within the table.

The DatabaseRetrieve node looks up values from a database and stores them as elements in the outgoing message assembly trees. The type of information that is obtained from the database in the form of output column values, which is acquired and passed back in the result set from SQL queries, is converted first into a matching Java type, then into an internal message element value type when it is finally stored in a location in an outgoing message assembly tree. If a message element already exists in the outgoing message tree, the new value overwrites the old value. If the target element does not exist, it is created, and the value is stored.

The node needs query information that is used to form an SQL select query, which can access multiple tables in a database using multiple test conditions. Sometimes, not all the information that you want to retrieve in a result set is in a single database table. To get the column values that you want, you might need to retrieve them from two or more tables. This node supports the use of SELECT statements that facilitate getting columns from one or more tables in a single result set. The normal join syntax that is supported is also referred to as *inner join*.

Inner join information that is collected to form a query includes a list of table qualified column values to retrieve and a list of test conditions, which form the WHERE clause of the SELECT statement. Table qualified column values can form the left hand operand in a test condition. Choose a comparison operator to apply to this operand and, optionally, specify a right hand operand to complete the test condition. The operator could be a NULL comparison test, in which no right hand operand is needed. The value of the right hand operand can be a database type

(such as Integer, Boolean, or Long), another table qualified column, or a value that is acquired from an element in the incoming message, as expressed through an XPath 1.0 general expression.

The application of the expression must result in a single element, double, Boolean, or string being returned, otherwise an exception occurs. If the query returns multiple rows, the first row is chosen and the rest are ignored, unless the Multiple rows option is selected. In this case, all rows are processed, and values in those rows are used to update the outgoing message assembly trees.

It can be useful to combine a DatabaseRetrieve node with other message flow nodes. For example, you can use an XSLTransform node to manipulate data before or after the DatabaseRetrieve node is invoked.

The DatabaseRetrieve node has one input terminal (In) and three output terminals (Out, KeyNotFound, and Failure). If the message is modified successfully, it is routed to the Out terminal. If the message is not modified successfully or a failure is detected during processing, the message is routed to the Failure terminal. If no rows are returned in the result set following execution of a given SQL select query, the original message is routed to the KeyNotFound terminal.

Making the JDBC provider service available to the DatabaseRetrieve node

The DatabaseRetrieve node constructs its JDBC connections using connection details that are stored in the broker's registry as a configurable service. JDBCProvider configurable services are supplied for all supported databases. Use the `mqschangeproperties` command to modify the settings of the supplied service for your chosen database, or create a new service using the `mqscreateconfigurable-service` command. See *Setting up a JDBC provider for type 4 connections* for further information and assistance on working with JDBCProvider services. You must set up a different JDBCProvider service for each database to which you want to connect.

When you have defined the service, set the Data source name property of this node to the name of the JDBCProvider service; the attributes of the service are used to establish connections for the DatabaseRetrieve node.

You must stop and restart the broker for your changes to take effect, unless you intend to create a new execution group on the broker to which you will deploy the message flow that contains this node.

Using the Database Explorer view to query data sources

Use the Database Explorer view to discover the names of tables within a target database, as well as the names of any columns in those tables. You must import database definitions for your databases into the workbench before you can view them in the Database Explorer view; see "Adding database definitions to the Message Broker Toolkit" on page 494.

1. Switch to the Broker Application Development perspective.
2. In the Database Explorer view, expand **Connections**. The database connections are listed.
3. Expand a database connection to list the databases, then expand the appropriate database.
4. Expand **Schemas** to list the schemas, then expand the appropriate schema.

5. Expand **Tables** to list all the tables.
6. Click a table to show its properties in the Properties view.
7. In the Properties view, click the **Columns** tab to view the column names.

Configuring the DatabaseRetrieve node

When you have put an instance of the DatabaseRetrieve node into a message flow, you can configure it. For more information, see “Configuring a message flow node” on page 235. The properties of the node are displayed in the Properties view.

All mandatory properties for which you must enter a value (those that do not have a default value defined) are marked with an asterisk.

Example

The following example adds new elements (surname and wage) to the incoming message structure. This example uses a database table called Employee.

EmployeeNumber	FamilyName	FirstName	Salary
00001	Smith	John	20000
00002	Jones	Harry	26000
00003	Doe	Jane	31000

To make a copy of the incoming message, select Copy message. When this property is selected, the node always creates an outgoing message assembly that is based on the incoming message assembly, and these trees in the new outgoing message assembly are modified and propagated to the node’s Out terminal. This behavior enables modification of the outgoing message tree itself (\$OutputRoot), in addition to the other logical trees in the message assembly:

\$OutputLocalEnvironment, \$OutputDestinationList, \$OutputExceptionList and \$Environment. If the logical trees only in the message assembly are to be modified by this node, for performance reasons do not select Copy message. When this property is not selected, the node always works against the original incoming message assembly, and it expects that no updates are attempted against the message tree. If an XPath expression in the Data Element Table tries to update this message tree through a reference to \$OutputRoot, an MbReadOnlyMessageException occurs. The incoming message is:

```
<EmployeeRecord>
  <EmployeeNumber>00001</EmployeeNumber>
</EmployeeRecord>
```

The Query elements table looks like this:

Table name	Column name	Operator	Value Type	Value
Employee	FamilyName			
Employee	Salary			
Employee	EmployeeNumber	=	Element	\$OutputRoot/XMLNSC/EmpRecord/EmpNumber

and the Data Element Table looks like this:

Column name	Message element

Employee.FamilyName	\$OutputRoot/XMLNSC/EmployeeRecord/Surname
Employee.Salary	\$OutputRoot/XMLNSC/EmployeeRecord/Wage

The DatabaseRetrieve node connects to the Employee database table and extracts the value to compare from each incoming message. The XPath expression that is used to navigate to the message body is \$InputBody/EmployeeRecord/EmployeeNumber. The SQL query is:

```
SELECT Employee.FamilyName, Employee.Salary
FROM Employee
WHERE EmployeeNumber=?
ORDER BY Employee.FamilyName ASC, Employee.Salary ASC
```

where ? is the value that is retrieved from the incoming message, which is located through the Value property in the third row of the Query elements table, which has a Value Type of Element.

- If the value at this location is 00001, information for John Smith is retrieved. The first data element row says get the value of the FamilyName column that is returned from the query, and insert it into a new element named "Surname" under EmployeeRecord. The second data element row says get the value of the Salary column that is returned from the query, and insert it into a new element named "Wage" under EmployeeRecord. The resulting outgoing message is:

```
<EmployeeRecord>
  <EmployeeNumber>00001</EmployeeNumber>
  <Surname>Smith</Surname>
  <Wage>20000</Wage>
</EmployeeRecord>
```

- If the value at this location is 00002, information for Harry Jones is retrieved. The resulting outgoing message is:

```
<EmployeeRecord>
  <EmployeeNumber>00002</EmployeeNumber>
  <Surname>Jones</Surname>
  <Wage>26000</Wage>
</EmployeeRecord>
```

If you select the Multiple rows property, and details of both of the employees are returned from a query in the form of two rows in the result set, the resulting outgoing message is:

```
<EmployeeRecord>
  <EmployeeNumber>00001</EmployeeNumber>
  <Surname>Smith</Surname>
  <Wage>20000</Wage>
  <EmployeeNumber>00002</EmployeeNumber>
  <Surname>Jones</Surname>
  <Wage>26000</Wage>
</EmployeeRecord>
```

Validating messages

Set the Validation properties to define how the message that is produced by the DatabaseRetrieve node is to be validated. These properties do not cause the input message to be validated. It is expected that, if such validation is required, the validation has already been performed by the input node or a preceding validation node.

For more details, see "Validating messages" on page 164 and "Validation properties" on page 1359.

Terminals and properties

The DatabaseRetrieve node terminals are described in the following table.

Terminal	Description
In	The input terminal that accepts a message for processing by the node.
Out	The output terminal to which the outgoing message is routed when it has been modified successfully.
KeyNotFound	The output terminal to which the original message is routed, unchanged, when the result set is empty.
Failure	The output terminal to which the message is routed if a failure is detected during processing.

The following tables describe the node properties. The column headed M indicates whether the property is *mandatory* (marked with an asterisk if you must enter a value when no default is defined); the column headed C indicates whether the property is *configurable* (you can change the value when you add the message flow to the bar file to deploy it).

The DatabaseRetrieve node Description properties are described in the following table.

Property	M	C	Default	Description
Node name	No	No	DatabaseRetrieve	The name of the node.
Short description	No	No		A brief description of the node.
Long description	No	No		Text that describes the purpose of the node in the message flow.

The DatabaseRetrieve node Basic properties are described in the following table.

Property	M	C	Default	Description
Data source name	Yes	Yes	DB2	<p>The alias that is used to locate JDBCProvider service definition that is stored in the broker registry. The alias is used to locate and build the JDBC connection URL that is used to connect to a DBMS. The connection URL is driver specific, but it includes the database name to which to connect.</p> <p>If connection to the database is by a login account and password, the node also uses this property as a lookup key, through which these values can be acquired from an expected matching broker registry DSN entry.</p> <p>If the DBMS is password protected, define the -n parameter on the mqsisetdbparms command for the JDBC unique security key before you deploy the message flow that contains this DatabaseRetrieve node.</p>
Copy message	No	Yes	Cleared	This property indicates if a copy of the original incoming message is required because the message tree is to be updated, possibly in addition to logical trees within the message assembly. By default, this check box is cleared. For performance reasons, select this property only if the input message will be augmented.

Property	M	C	Default	Description
Multiple rows	No	Yes	Cleared	This property indicates if all rows are processed when a query returns multiple rows. If you select Multiple rows, all rows are processed, and values in those rows are used to update the outgoing message assembly trees. If you do not select this property, the first row is chosen and the rest are ignored.
Query elements	Yes	No		A table of query elements that are used to compose a single SQL select statement. The table consists of five columns and one or more rows. The columns are Table name, Column name, Operator, Value Type, and Value. These five properties describe a query element, indicating a table qualified column value to be retrieved from a database. In this case, the element forms part of the SELECT and ORDER BY clauses in the generated query. Otherwise, the query element acts as a test condition that forms a predicate within the WHERE clause in the generated query.
Table name	Yes	No		The name of a database table that forms part of the SQL select statement, including the schema name; for example, <i>myschema.mytable</i> .
Column name	Yes	No		The name of the column in the database table to be retrieved in the results set, as qualified by the value of the Table name property. This SELECT clause can refer to this name as a column value to return from a query or to be referenced in a test condition within the WHERE clause.
Operator	Yes	No		A comparison operator to apply to a left hand operand (the table column that is specified in the row's first two columns) and optionally a right hand operand value. If you specify an Ascending 'ASC' or Descending 'DESC' operator value for this property, this row signifies the declaration of a table qualified column that forms part of the SELECT and ORDER BY clauses in the generated query and optionally can be referenced in future rows as a right hand operand value.
Value Type	Yes	No		A value that is either set to None, or that indicates the type of value that is expressed in the last column of this row. If this property is not set to None, it refers to a row that describes a test condition in the WHERE clause of the SQL select statement.

Property	M	C	Default	Description
Value	Yes	No		A value that is either set to None, or that specifies one of a given set of property types as expressed by the Value Type property. For example, if the Value Type property is set to Element, the Value property collects an XPath 1.0 general expression. The value that is returned from the expression when it is applied to the node's incoming message is used as the right hand operand value to be compared through this predicate. The compared value of the right hand operand must match the type that is retrieved for the table column that is compared against as the left hand operand. Complex expressions are possible, where zero or more values can be acquired from the incoming message, and manipulated to formed a single value for comparison. For example, the sum of multiple field values in the incoming message can be calculated by a general expression that is presented for a value type of Element.

The DatabaseRetrieve node Data Element Table properties are described in the following table.

Property	M	C	Default	Description
Data elements	Yes	No		A list of data elements. A data element is described by the Column name and Message element properties.
Column name	Yes	No		The name of the database column from which to obtain the element value. The list of names is updated dynamically based on the column entries that are entered in the Query elements table.
Message element	Yes	No		An XPath 1.0 read-write path expression that describes the path location of a message element. The message element is where the database value is stored. The XPath expression must evaluate to a single element in the message.

The DatabaseRetrieve node Validation properties are described in the following table.

For a full description of these properties, see "Validation properties" on page 1359.

Property	M	C	Default	Description
Validate	No	Yes	None	This property controls whether validation takes place. Valid values are None, Content and Value, Content, and Inherit.
Failure action	No	No	Exception	This property controls what happens if a validation failure occurs. You can set this property only if Validate is set to Content or Content and Value. Valid values are User Trace, Local Error Log, Exception, and Exception List.

DatabaseRoute node

Use the DatabaseRoute node to route messages using information from a database in conjunction with XPath expressions.

This topic contains the following sections:

- “Purpose”
- “Using this node in a message flow”
- “Making the JDBC provider service available to the DatabaseRoute node” on page 862
- “Using the Database Explorer view to query data sources” on page 863
- “Configuring the DatabaseRoute node” on page 863
- “Example” on page 863
- “Terminals” on page 864
- “Properties” on page 864

Purpose

The DatabaseRoute node uses a collection of named column values from a selected database row and synchronously applies one or more XPath expressions to these acquired values to make routing decisions.

For more information about XPath 1.0 query syntax, see XPath.

The DatabaseRoute node is contained in the **Database** drawer of the message flow node palette, and is represented in the workbench by the following icon:



Using this node in a message flow

Look at the Simplified Database Routing sample to see how to use this node. You can view samples only when you use the information center that is integrated with the Message Broker Toolkit.

Input parameter values that are acquired from message elements in the incoming message are supported for insertion into prepared statements that are used by this node. These values are acquired from name, value, and name-value elements in the incoming parsed input message. Elements are acquired initially in the form of a `com.ibm.broker.plugin.MbElement` object, therefore the range of supported Java object types that values can take is governed by this object's interface. When values are in the form of Java primitive types or Objects they are converted into their equivalent JDBC data type, as shown in the following table.

Java	JDBC
Integer	INTEGER
Long	BIGINT
Double	DOUBLE
BigDecimal	NUMERIC
Boolean	BIT
byte[]	VARBINARY or LONGVARBINARY
BitSet	VARBINARY or LONGVARBINARY

Java	JDBC
String	VARCHAR or LONGVARCHAR
MbTime	java.sql.Time
MbTimestamp	java.sql.Timestamp
MbDate	java.sql.Date

Values are used from an element only if the element is of a known type, and its value state is valid, otherwise an exception is issued. Output column values that are acquired in the result set from SQL queries that are carried out by this node are converted first into matching Java types, then into internal message element value types, as shown in the following table.

JDBC	Java	ESQL Type
SMALLINT	Integer	INTEGER
INTEGER	Integer	INTEGER
BIGINT	Long	DECIMAL
DOUBLE	Double	FLOAT
REAL	Double	FLOAT
FLOAT	Double	FLOAT
NUMERIC	BigDecimal	DECIMAL
DECIMAL	BigDecimal	DECIMAL
BIT	Boolean	BOOLEAN
BOOLEAN	Boolean	BOOLEAN
BINARY	byte[]	BLOB
VARBINARY	byte[]	BLOB
LONGVARBINARY	byte[]	BLOB
CHAR	String	CHARACTER
VARCHAR	String	CHARACTER
LONGVARCHAR	String	CHARACTER
TINYINT	byte[1]	BLOB
TIME	java.util.Date	TIME
TIMESTAMP	java.util.Date	TIMESTAMP
DATE	java.util.Date	DATE

You can route a message to the same location, whether or not a query is successful against a given database, by wiring both of the non-failure output terminals to the same output location.

If an error is found in the XPath expression of a pattern, it is reported during validation in the workbench. The reported error message might include the incorrect expression string and its associated unique dynamic or static terminal name, or the string might be marked as broken within the table.

The node needs query information that is used to form an SQL select query, which can access multiple tables in a database using multiple test conditions. Sometimes, not all the information that you want to retrieve in a result set is in a single database table. To get the column values that you want, you might need to retrieve them from two or more tables. This node supports the use of SELECT statements

that facilitate getting columns from one or more tables in a single result set. The normal join syntax that is supported is also referred to as *inner join*.

Inner join information that is collected to form a query includes a list of table qualified column values to retrieve and a list of test conditions, which form the WHERE clause of the SELECT statement. Table qualified column values can form the left operand in a test condition. Choose a comparison operator to apply to this operand and, optionally, specify a right operand to complete the test condition. The operator could be a NULL comparison test, in which no right operand is needed. The value of the right operand can be a database type (such as Integer, Boolean, or Long), another table qualified column, or a value that is acquired from an element in the incoming message, as expressed through an XPath 1.0 general expression.

When you deploy a DatabaseRoute node in a message flow, you can select a value that is associated with the Data Source Name property. The list of values contains references to existing IBM predefined JDBC provider entries that are defined when a broker is first created. These entries are incomplete, so you must modify them to access the data source definition with which you want to work. If an existing default IBM predefined JDBC provider is already referenced and in use by another JDBC database node that requires different settings, use the `mqsicreateconfigurable` service command to specify a new JDBC provider entry. You can also use the `mqsideleteconfigurable` service command to delete any unwanted JDBC provider entries.

The DatabaseRoute node has one input terminal and a minimum of four output terminals: Match, keyNotFound, Default, and Failure. The keyNotFound, Default, and Failure output terminals are static, so they are always present on the node. The dynamic Match terminal is created automatically each time a new DatabaseRoute node is selected and used in the Message Flow editor. This behavior means that you do not always need to create this node's first dynamic output terminal, which is the minimum number of terminals needed for this node to operate. You can rename this dynamic terminal if "Match" is not an appropriate name.

A message is copied to the Default terminal if none of the filter expressions are true. If an exception occurs during filtering, the message is propagated to the Failure terminal. If the database query that is applied to the node's data source produces an empty result set (that is, no database rows are matched), a message is copied to the keyNotFound terminal. The DatabaseRoute node can define one or more dynamic output terminals. For all terminals, the associated filter expression is applied to the input message and, if the result is true, a copy of the message is routed to the given terminal.

Each filter expression in the Filter table can be applied to:

- The input message
- The collection of named column values that are selected from a matched database row
- Both the input message and the returned column values
- Neither

because expressions can be any valid general XPath 1.0 expression.

As with the Route node, expressions are applied in the order that they are given in the filter table. If the result is true, a copy of the message is routed to its associated

dynamic output terminal. If you set the Distribution Mode property to First, the application of all filter expressions might not occur.

The filter expression can fail if you compare a returned column value to a string literal. How a column entry is stored (for example, a fixed-length character field) determines what is returned for a given column from the database. Whitespace padding occurs for fixed-length character fields that are retrieved from a database, where the value that is stored is less than the specified column character storage length. In this case, padding occurs to the right of the character string that is returned, forming part of the string. You should remember this when comparing such a column value to a string literal, because an equality comparison expression might fail if the literal does not contain the exact same string, including padding characters.

For example, in a table called Employee, a database column called LastName that is defined as char(10) with the value 'Smith', is returned as 'Smith ', therefore the filter expression must be:

```
$Employee_LastName = 'Smith    '
```

which resolves to true. The expression:

```
$Employee_LastName = 'Smith'
```

resolves to false.

Alternatively, the XPath expression can use the following function:

```
Function: string normalize-space(string?)
```

The normalize-space function returns the argument string with whitespace normalized by stripping leading and trailing whitespace and replacing sequences of whitespace characters with a single space. Therefore the expression would be:

```
normalize-space($Employee_LastName) = 'Smith'
```

Making the JDBC provider service available to the DatabaseRoute node

The DatabaseRoute node constructs its JDBC connections using connection details that are stored in the broker's registry as a configurable service. JDBCProvider configurable services are supplied for all supported databases. Use the mqsischangeproperties command to modify the settings of the supplied service for your chosen database, or create a new service using the mqsicreateconfigurable service command. See Setting up a JDBC provider for type 4 connections for further information and assistance on working with JDBCProvider services. You must set up a different JDBCProvider service for each database to which you want to connect.

When you have defined the service, set the Data Source Name property of this node to the name of the JDBCProvider service; the attributes of the service are used to establish connections for the DatabaseRoute node.

You must stop and restart the broker for your changes to take effect, unless you intend to create a new execution group on the broker to which you will deploy the message flow that contains this node.

Using the Database Explorer view to query data sources

Use the Database Explorer view to discover the names of tables within a target database, as well as the names of any columns in those tables. You must import database definitions for your databases into the workbench before you can view them in the Database Explorer view; see “Adding database definitions to the Message Broker Toolkit” on page 494

1. Switch to the Broker Application Development perspective.
2. In the Database Explorer view, expand **Connections**. The database connections are listed.
3. Expand a database connection to list the databases, then expand the appropriate database.
4. Expand **Schemas** to list the schemas, then expand the appropriate schema.
5. Expand **Tables** to list all the tables.
6. Click a table to show its properties in the Properties view.
7. In the Properties view, click the **Columns** tab to view the column names.

Configuring the DatabaseRoute node

When you have put an instance of the DatabaseRoute node into a message flow, you can configure it. For more information, see “Configuring a message flow node” on page 235. The properties of the node are displayed in the Properties view.

All mandatory properties for which you must enter a value (those that do not have a default value defined) are marked with an asterisk.

Example

Consider the following example, which uses a database table called Employee.

EmployeeNumber	FamilyName	FirstName	Salary
00001	Smith	John	20000
00002	Jones	Harry	26000
00003	Doe	Jane	31000

The following DatabaseRoute node properties are set as specified:

Table Name	Column Name	Operator	Value Type	Value
Employee	FamilyName	ASC	None	None
Employee	Salary	ASC	None	None
Employee	EmployeeNumber	=	Element	\$Body/ EmployeeRecord/ EmployeeNumber

The DatabaseRoute node connects to the Employee database table and extracts the value to compare from each incoming message. The XPath expression that is used to navigate to the message body is \$Body/EmployeeRecord/EmployeeNumber. The SQL query is:

```
SELECT Employee.FamilyName, Employee.Salary
FROM Employee
WHERE EmployeeNumber=?
ORDER BY Employee.FamilyName ASC, Employee.Salary ASC
```

where ? is the value that is retrieved from the incoming message. This value is located through the Value property in the third row of the query elements table, which has a value type of Element.

- If the value at this location is *00001*, information for John Smith is retrieved. The first XPath expression, which is associated with the out_expr1 dynamic terminal, is not met, so it does not meet its condition, and no message is propagated to the Out terminal. The second XPath expression is met, so a copy of the input message is routed to the out_expr2 dynamic terminal.
- If the value at this location is *00002*, information for Harry Jones is retrieved. The first XPath expression, which is associated with the out_expr1 dynamic terminal, is met, so a copy of the input message is routed to the out_expr1 terminal. The second XPath expression is not processed because the Distribution Mode property is set to First.

Terminals

The DatabaseRoute node terminals are described in the following table.

Terminal	Description
In	The static input terminal that accepts a message for processing by the node.
Match	A dynamic output terminal to which the original message can be routed when processing completes successfully. You can create additional dynamic terminals; see "Dynamic terminals."
Default	The static output terminal to which the message is routed if no filter expression resolves to true.
keyNotFound	The static output terminal to which the message is copied if no database rows are matched.
Failure	The static output terminal to which the message is routed if a failure is detected during processing.

Dynamic terminals

The DatabaseRoute node can have further dynamic output terminals. Not all dynamic output terminals that are created on a DatabaseRoute node need to be mapped to an expression in the filter table. For unmapped dynamic output terminals, messages are never propagated to them. Several expressions can map to the same single dynamic output terminal. For more information about using dynamic terminals, see "Using dynamic terminals" on page 237.

Properties

The following tables describe the node properties. The column headed M indicates whether the property is *mandatory* (marked with an asterisk if you must enter a value when no default is defined); the column headed C indicates whether the property is *configurable* (you can change the value when you add the message flow to the bar file to deploy it).

The DatabaseRoute node Description properties are described in the following table.

Property	M	C	Default	Description
Node name	No	No	The node type, DatabaseRoute	The name of the node.

Property	M	C	Default	Description
Short Description	No	No		A brief description of the node.
Long Description	No	No		Text that describes the purpose of the node in the message flow.

The DatabaseRoute node Basic properties are described in the following table.

Property	M	C	Default	Description
Data Source Name	Yes	Yes	DB2	<p>The alias that is used to locate JDBCProvider service definition that is stored in the broker registry. The alias is used to locate and build the JDBC connection URL for connection to a DBMS. The connection URL is driver specific, but it includes the database name to which to connect.</p> <p>If connection to the database is by a login account and password, the node also uses this property as a lookup key, through which these values can be acquired from an expected matching broker registry DSN entry.</p> <p>If the DBMS is password protected, define the -n parameter on the mqsisetdbparms command for the JDBC unique security key before you deploy the message flow that contains this DatabaseRoute node.</p>
Query Elements	Yes	No		A table of query elements that are used to compose a single SQL select statement. The table consists of five columns and one or more rows. The columns are Table Name, Column Name, Operator, Value Type, and Value. These five properties describe a query element, indicating a table qualified column value to be retrieved from a database. In this case, the element forms part of the SELECT and ORDER BY clauses in the generated query. Otherwise, the query element acts as a test condition that forms a predicate within the WHERE clause in the generated query.
Table Name	Yes	No		The name of a database table that forms part of the SQL select statement, including the schema name; for example, <i>myschema.mytable</i> .
Column Name	Yes	No		The name of the column in the database table to be retrieved in the results set, as qualified by the value of the Table Name property. This SELECT clause can refer to this name as a column value to return from a query, or to be referenced in a test condition in the WHERE clause.
Operator	Yes	No		A comparison operator to apply to a left operand (the table column that is specified in the row's first two columns) and optionally a right operand value. If you specify an Ascending 'ASC' or Descending 'DESC' operator value for this property, this row signifies the declaration of a table qualified column that forms part of the SELECT and ORDER BY clauses in the generated query and optionally can be referenced in future rows as a right operand value.

Property	M	C	Default	Description
Value Type	Yes	No		A value that is either set to None, or that indicates the type of value that is expressed in the last column of this row. If this property is not set to None, it refers to a row that describes a test condition in the WHERE clause of the SQL select statement.
Value	Yes	No		A value that is either set to None, or that specifies one of a given set of property types as expressed by the Value Type property. For example, if the Value Type property is set to Element, the Value property collects an XPath 1.0 general expression. The value that is returned from the expression when it is applied to the node's incoming message is used as the right operand value to be compared through this predicate. The compared value of the right operand must match the type that is retrieved for the table column that is compared against as the left operand. Complex expressions are possible, where zero or more values can be acquired from the incoming message, and manipulated to form a single value for comparison. For example, the sum of multiple field values in the incoming message can be calculated by a general expression that is presented for a value type of Element.
Distribution mode	No	Yes	All	This property specifies the routing behavior of this node when an inbound message matches multiple expressions. If the Distribution Mode property is set to First, the message is propagated to the first matching output terminal. If the Distribution Mode property is set to All, the message is propagated to all matching output terminals. If there is no matching output terminal, the message is propagated to the Default terminal.

The DatabaseRoute node Filter Expression Table properties are described in the following table.

Property	M	C	Default	Description
Filter table	Yes	No		A table of filters (XPath 1.0 general expressions) and associated terminal names that define any extra filtering that is performed by this node. The table consists of two columns and one or more rows. You must have at least one row in this table so that the node can perform routing logic. As with the Route node, expressions are evaluated in the order in which they appear in the table. To improve performance, put the XPath expressions that are satisfied most frequently at the top of the filter table.

DataDelete node

Use the DataDelete node to interact with a database in the specified ODBC data source.

This topic contains the following sections:

- "Purpose" on page 867

- “Using this node in a message flow”
- “Terminals and properties”

Purpose

The DataDelete node is a specialized form of the Database node, and the interaction is restricted to deleting one or more rows from a table within the database. You specify what is deleted by defining mapping statements that use the data from the input message to identify the action required.

You can set a property to control whether the update to the database is committed immediately, or deferred until the message flow completes, at which time the update is committed or rolled back, according to the overall completion status of the message flow.

The DataDelete node is contained in the **Database** drawer of the palette, and is represented in the workbench by the following icon:



Using this node in a message flow

Consider a situation in which you are running a limited promotion. The goods are available only for the period of the promotion, and each customer can have only one item. When stocks of the sale goods run out, you want to remove their details from the stock database. When a message containing an order for the last item comes in, the DataDelete node is triggered to remove all the details for that item from the database.

Terminals and properties

When you have put an instance of the DataDelete node into a message flow, you can configure it. For more information, see “Configuring a message flow node” on page 235. The properties of the node are displayed in the Properties view. (If you double-click the DataDelete node, you open the New Message Map dialog box.) All mandatory properties for which you must enter a value (those that do not have a default value defined) are marked with an asterisk.

The terminals of the DataDelete node are described in the following table.

Terminal	Description
In	The input terminal that accepts a message for processing by the node.
Failure	The output terminal to which the input message is propagated if a failure is detected during the computation. If you have selected Treat warnings as errors, the node propagates the message to this terminal even if the processing completes successfully.
Out	The output terminal that outputs the message following the execution of the database statement.

The following tables describe the node properties. The column headed M indicates whether the property is *mandatory* (marked with an asterisk if you must enter a value when no default is defined); the column headed C indicates whether the property is *configurable* (you can change the value when you add the message flow to the bar file to deploy it).

The DataDelete node Description properties are described in the following table.

Property	M	C	Default	Description
Node name	No	No	DataDelete	The name of the node.
Short description	No	No		A brief description of the node.
Long description	No	No		Text that describes the purpose of the node in the message flow.

The DataDelete node Basic properties are described in the following table.

Property	M	C	Default	Description
Data source	No	Yes		<p>The ODBC data source name of the database that contains the tables to which you refer in the mappings that are associated with this node (identified by the Statement property). This name identifies the appropriate database on the system on which this message flow is to run. The broker connects to this database with user ID and password information that you have specified on the mqsicreatebroker, mqsischangebroker, or mqsisetdbparms command.</p> <p>z/OS On z/OS systems, the broker uses the broker started task ID, or the user ID and password that are specified on the mqsisetdbparms command JCL, BIPsDBP in the customization data set <hlq>.SBIPPROC.</p>
Statement	Yes	No	DataDelete	<p>The name of the mapping routine that contains the statements that are to be executed against the database or the message tree. The routine is unique to this type of node. By default, the name that is assigned to the mapping routine is identical to the name of the mappings file in which the routine is defined. The default name for the file is the name of the message flow concatenated with the name of the node when you include it in the message flow (for example, MFlow1_DataDelete.msgmap for the first DataDelete node in message flow MFlow1). You cannot specify a value that includes spaces.</p> <p>If you click Browse next to this entry field, a dialog box is displayed that lists all of the available mapping routines that can be accessed by this node. Select the routine that you want and click OK; the routine name is set in Statement.</p> <p>To work with the mapping routine that is associated with this node, double-click the node, or right-click the node and click Open Mappings. If the mapping routine does not exist, it is created for you with the default name in the default file. If the file exists already, you can also open file <i>flow_name_node_name.msgmap</i> in the Broker Development view.</p> <p>A mapping routine is specific to the type of node with which it is associated; you cannot use a mapping routine that you have developed for a DataDelete node with any other node that uses mappings (for example, a DataInsert node). If you create a mapping routine, you cannot call it from any other mapping routine, although you can call it from an ESQL routine.</p> <p>For more information about working with mapping files, and defining their content, see “Developing message mappings” on page 472.</p>

Property	M	C	Default	Description
Transaction	Yes	No	Automatic	<p>The transaction mode for the node. The values are:</p> <ul style="list-style-type: none"> • Automatic (the default). The message flow, of which the DataDelete node is a part, is committed if it is successful; that is, the actions that you define in the mappings are performed and the message continues through the message flow. If the message flow fails, it is rolled back. Therefore, if you select Automatic, the ability to commit or roll back the action of the DataDelete node on the database depends on the success or failure of the entire message flow. • Commit. To commit any uncommitted actions performed in this message flow on the database connected to this node, irrespective of the success or failure of the message flow as a whole, select Commit. The changes to the database are committed even if the message flow itself fails.
Treat warnings as errors	Yes	No	Cleared	<p>For database warning messages to be treated as errors, and the node to propagate the output message to the failure terminal, select Treat warnings as errors. The check box is cleared by default.</p> <p>When you select the check box, the node handles all positive return codes from the database as errors and generates exceptions in the same way as it does for the negative, or more serious, errors.</p> <p>If you do not select the check box, the node treats warnings as typical return codes, and does not raise any exceptions. The most significant warning raised is not found, which can be handled as a typical return code safely in most circumstances.</p>
Throw exception on database error	Yes	No	Selected	<p>For the broker to generate an exception when a database error is detected, select Throw exception on database error. The check box is selected by default.</p> <p>If you clear the check box, you must handle the error in the message flow to ensure the integrity of the broker and the database: the error is ignored if you do not handle it through your own processing because you have chosen not to invoke the default error handling by the broker. For example, you can connect the Failure terminal to an error processing subroutine.</p>

DataInsert node

Use the DataInsert node to interact with a database in the specified ODBC data source.

This topic contains the following sections:

- “Purpose”
- “Using this node in a message flow” on page 870
- “Terminals and properties” on page 870

Purpose

The DataInsert node is a specialized form of the Database node, and the interaction is restricted to inserting one or more rows into a table within the database. You specify what is inserted by defining mapping statements that use the data from the input message to define the action required.

You can set a property to control whether the update to the database is committed immediately, or deferred until the message flow completes, at which time the update is committed, or rolled back according to the overall completion status of the message flow.

The DataInsert node is contained in the **Database** drawer of the palette, and is represented in the workbench by the following icon:



Using this node in a message flow

Consider a situation in which your company has developed a new product. The details about the product have been sent from your engineering department, and you need to extract details from the message and add them as a new row in your stock database.

Terminals and properties

When you have put an instance of the DataInsert node into a message flow, you can configure it. For more information, see “Configuring a message flow node” on page 235. The properties of the node are displayed in the Properties view. (If you double-click the DataInsert node, you open the New Message Map dialog box.) All mandatory properties for which you must enter a value (those that do not have a default value defined) are marked with an asterisk.

The terminals of the DataInsert node are described in the following table.

Terminal	Description
In	The input terminal that accepts a message for processing by the node.
Failure	The output terminal to which the input message is propagated if a failure is detected during the computation. If you have selected Treat warnings as errors, the node propagates the message to this terminal even if the processing completes successfully.
Out	The output terminal that outputs the message following the execution of the database statement.

The following tables describe the node properties. The column headed M indicates whether the property is *mandatory* (marked with an asterisk if you must enter a value when no default is defined); the column headed C indicates whether the property is *configurable* (you can change the value when you add the message flow to the bar file to deploy it).

The DataInsert node Description properties are described in the following table.

Property	M	C	Default	Description
Node name	No	No	DataInsert	The name of the node.
Short description	No	No		A brief description of the node.
Long description	No	No		Text that describes the purpose of the node in the message flow.

The DataInsert node Basic properties are described in the following table.

Property	M	C	Default	Description
Data source	No	Yes		<p>The ODBC data source name of the database that contains the tables to which you refer in the mappings that are associated with this node (identified by the Statement property). This name identifies the appropriate database on the system on which this message flow is to run. The broker connects to this database with user ID and password information that you have specified on the mqsicreatebroker, mqsischangebroker, or mqsisetdbparms command.</p> <p>z/OS On z/OS systems, the broker uses the broker started task ID, or the user ID and password that are specified on the mqsisetdbparms command JCL, BIPSDBP in the customization data set <hlq>.SBIPPROC.</p>
Statement	Yes	No	DataInsert	<p>The name of the mapping routine that contains the statements that are to be executed against the database or the message tree. The routine is unique to this type of node. By default, the name that is assigned to the mapping routine is identical to the name of the mappings file in which the routine is defined. The default name for the file is the name of the message flow concatenated with the name of the node when you include it in the message flow (for example, MFlow1_DataInsert.msgmap for the first DataInsert node in message flow MFlow1). You cannot specify a value that includes spaces.</p> <p>If you click Browse next to this entry field, a dialog box is displayed that lists all of the available mapping routines that can be accessed by this node. Select the routine that you want and click OK; the routine name is set in Statement.</p> <p>To work with the mapping routine that is associated with this node, double-click the node, or right-click the node and select Open Mappings. If the mapping routine does not exist, it is created for you with the default name in the default file. If the file exists already, you can also open file <i>flow_name_node_name.msgmap</i> in the Broker Development view.</p> <p>A mapping routine is specific to the type of node with which it is associated; you cannot use a mapping routine that you have developed for a DataInsert node with any other node that uses mappings (for example, a DataDelete node). If you create a mapping routine, you cannot call it from any other mapping routine, although you can call it from an ESQL routine.</p> <p>For more information about working with mapping files, and defining their content, see “Developing message mappings” on page 472.</p>
Transaction	Yes	No	Automatic	<p>The transaction mode for the node. The values are:</p> <ul style="list-style-type: none"> • Automatic (the default). The message flow, of which the DataInsert node is a part, is committed if it is successful. That is, the actions that you define in the mappings are taken and the message continues through the message flow. If the message flow fails, it is rolled back. Therefore if you select Automatic, the ability to commit or roll back the action of the DataInsert node on the database depends on the success or failure of the entire message flow. • Commit. To commit any uncommitted actions that are taken in this message flow on the database that is connected to this node, irrespective of the success or failure of the message flow as a whole, select Commit. The changes to the database are committed even if the message flow itself fails.

Property	M	C	Default	Description
Treat warnings as errors	Yes	No	Cleared	<p>For database warning messages to be treated as errors, and the node to propagate the output message to the failure terminal, select Treat warnings as errors. The check box is cleared by default.</p> <p>When you select the check box, the node handles all positive return codes from the database as errors and generates exceptions in the same way as it does for the negative, or more serious, errors.</p> <p>If you do not select the check box, the node treats warnings as typical return codes, and does not raise any exceptions. The most significant warning raised is not found, which can be handled as a typical return code safely in most circumstances.</p>
Throw exception on database error	Yes	No	Selected	<p>For the broker to generate an exception when a database error is detected, select Throw exception on database error. The check box is selected by default.</p> <p>If you clear the check box, you must handle the error in the message flow to ensure the integrity of the broker and the database; the error is ignored if you do not handle it through your own processing because you have chosen not to invoke the default error handling by the broker. For example, you can connect the failure terminal to an error processing subroutine.</p>

DataUpdate node

Use the DataUpdate node to interact with a database in the specified ODBC data source.

This topic contains the following sections:

- “Purpose”
- “Using this node in a message flow”
- “Terminals and properties” on page 873

Purpose

The DataUpdate node is a specialized form of the Database node, and the interaction is restricted to updating one or more rows in a table within the database. You define what is updated by defining mapping statements that use the data from the input message to identify the action required.

You can set a property to control whether the update to the database is committed immediately, or deferred until the message flow completes, at which time the update is committed or rolled back according to the overall completion status of the message flow.

The DataUpdate node is contained in the **Database** drawer of the palette, and is represented in the workbench by the following icon:



Using this node in a message flow

Consider a scenario in which you have added the details of a new product, a keyboard, to your stock database. Now you have received a message from the Goods In department that indicates that 500 keyboards have been delivered to

your premises. You can use the DataUpdate node to change the quantity of keyboards in your database from zero to 500.

Terminals and properties

When you have put an instance of the DataUpdate node into a message flow, you can configure it. For more information, see “Configuring a message flow node” on page 235. The properties of the node are displayed in the Properties view. (If you double-click the DataUpdate node, you open the New Message Map dialog box.) All mandatory properties for which you must enter a value (those that do not have a default value defined) are marked with an asterisk.

The terminals of the DataUpdate node are described in the following table.

Terminal	Description
In	The input terminal that accepts a message for processing by the node.
Failure	The output terminal to which the input message is propagated if a failure is detected during the computation. If you have selected Treat warnings as errors, the node propagates the message to this terminal even if the processing completes successfully.
Out	The output terminal that outputs the message following the execution of the database statement.

The following tables describe the node properties. The column headed M indicates whether the property is *mandatory* (marked with an asterisk if you must enter a value when no default is defined); the column headed C indicates whether the property is *configurable* (you can change the value when you add the message flow to the bar file to deploy it).

The DataUpdate node Description properties are described in the following table.

Property	M	C	Default	Description
Node name	No	No	DataUpdate	The name of the node.
Short description	No	No		A brief description of the node.
Long description	No	No		Text that describes the purpose of the node in the message flow.

The DataUpdate node Basic properties are described in the following table.

Property	M	C	Default	Description
Data source	No	Yes		<p>The ODBC data source name of the database that contains the tables to which you refer in the mappings that are associated with this node (identified by the Statement property). This name identifies the appropriate database on the system on which this message flow is to run. The broker connects to this database with user ID and password information that you have specified on the mqsicreatebroker, mqsicchangebroker, or mqsisetdbparms command.</p> <p>z/OS On z/OS systems, the broker uses the broker started task ID, or the user ID and password that are specified on the mqsisetdbparms command JCL, BIPsDBP in the customization data set <hlq>.SBIPPROC.</p>

Property	M	C	Default	Description
Statement	Yes	No	DataUpdate	<p>The name of the mapping routine that contains the statements that are to be executed against the database or the message tree. The routine is unique to this type of node. By default, the name that is assigned to the mapping routine is identical to the name of the mappings file in which the routine is defined. The default name for the file is the name of the message flow concatenated with the name of the node when you include it in the message flow (for example, MFlow1_DataUpdate.msgmap for the first DataUpdate node in message flow MFlow1). You cannot specify a value that includes spaces.</p> <p>If you click Browse next to this entry field, a dialog box is displayed that lists all available mapping routines that can be accessed by this node. Select the routine that you want and click OK; the routine name is set in Statement.</p> <p>To work with the mapping routine that is associated with this node, double-click the node, or right-click the node and click Open Mappings. If the mapping routine does not exist, it is created for you with the default name in the default file. If the file exists already, you can also open file <i>flow_name_node_name.msgmap</i> in the Broker Development view.</p> <p>A mapping routine is specific to the type of node with which it is associated; you cannot use a mapping routine that you have developed for a DataUpdate node with any other node that uses mappings (for example, a DataInsert node). If you create a mapping routine, you cannot call it from any other mapping routine, although you can call it from an ESQL routine.</p> <p>For more information about working with mapping files, and defining their content, see “Developing message mappings” on page 472.</p>
Transaction	Yes	No	Automatic	<p>The transaction mode for the node. The values are:</p> <ul style="list-style-type: none"> • Automatic (the default). The message flow, of which the DataUpdate node is a part, is committed if it is successful. That is, the actions that you define in the mappings are performed and the message continues through the message flow. If the message flow fails, it is rolled back. Therefore, if you choose Automatic, the ability to commit or roll back the action of the DataUpdate node on the database depends on the success or failure of the entire message flow. • Commit. To commit any uncommitted actions that are performed in this message flow on the database that is connected to this node, irrespective of the success or failure of the message flow as a whole, select Commit. The changes to the database are committed even if the message flow itself fails.
Treat warnings as errors	Yes	No	Cleared	<p>For database warning messages to be treated as errors, and the node to propagate the output message to the Failure terminal, select Treat warnings as errors. The check box is cleared by default.</p> <p>When you select the check box, the node handles all positive return codes from the database as errors, and generates exceptions in the same way as it does for the negative, or more serious, errors.</p> <p>If you do not select the check box, the node treats warnings as normal return codes, and does not raise any exceptions. The most significant warning raised is not found, which can be handled safely as a normal return code in most circumstances.</p>

Property	M	C	Default	Description
Throw exception on database error	Yes	No	Selected	<p>For the broker to generate an exception when a database error is detected, select Throw exception on database error. The check box is selected by default.</p> <p>If you clear the check box, you must handle the error in the message flow to ensure the integrity of the broker and the database: the error is ignored if you do not handle it through your own processing, because you have chosen not to invoke the default error handling by the broker. For example, you can connect the Failure terminal to an error processing subroutine.</p>

EmailOutput node

Use the EmailOutput node to send e-mail messages to one or more recipients.

This topic contains the following sections:

- “Purpose”
- “Configuring the EmailOutput node”
- “Terminals and properties” on page 878

Purpose

The EmailOutput node delivers an e-mail message from a message flow to an SMTP serve that you specify.

You can configure the EmailOutput node using the node properties in the Message Broker Toolkit, or dynamically from the LocalEnvironment and e-mail output header (EmailOutputHeader) that are associated with the message.

The EmailOutput node is contained in the **Email** drawer of the message flow node palette, and is represented in the workbench by the following icon:



Look at the E-mail sample to see how to use this node. You can view samples only when you use the information center that is integrated with the Message Broker Toolkit.

Configuring the EmailOutput node

When you have put an instance of the EmailOutput node into a message flow, you can configure it. For more information, see “Configuring a message flow node” on page 235. The properties of the node are displayed in the Properties view.

All mandatory properties for which you must enter a value (those that do not have a default value defined) are marked with an asterisk.

The four levels of configuration of the EmailOutput node are described below.

- Option 1: Configure the EmailOutput node using the node properties in the Message Broker Toolkit to send an e-mail with a statically-defined subject and text to a statically-defined list of recipients. The same e-mail is sent to the same recipients and it has no attachments. This method is useful when you want to test the EmailOutput node, or when notification alone is sufficient.

- Option 2: This option is the same as Option 1 but with the inclusion of an attachment. This option causes the e-mail message to be constructed as a MIME message. The subject, text, and list of recipients remains static, but the content of the attachment is sought dynamically from the message that is passed to the EmailOutput node at run time. The location of the attachment in the message is defined statically.
- Option 3: This option allows for those properties in Options 1 and 2 to be optional, and to be overridden at run time by values that are specified in the LocalEnvironment, the e-mail output header (EmailOutputHeader), or the body of the message. This option allows a dynamic e-mail message to be produced where the SMTP server, list of recipients, subject, text, and multiple attachments are all determined at run time. This option requires previous nodes in the message flow to construct these overrides. Where a text value is not specified in the node properties for the main body of the e-mail, the body of the message that is passed to the EmailOutput node is used.
- Option 4: This option passes a MIME message to the EmailOutput node. The EmailOutput node uses the MIME parser to write the MIME message to a bit stream. This message is then sent to the list of recipients in the SMTP header. LocalEnvironment overrides are not taken into consideration when a MIME message is passed.

E-mail output header

The e-mail output header (EmailOutputHeader) is a child of root. Any values that you specify in this header override any properties that you set on the node. Use the SMTP output header specify any of the e-mail attributes, such as its recipients.

Location	Description
Root.EmailOutputHeader.To	A comma separated list of e-mail addresses.
Root.EmailOutputHeader.Cc	A comma separated list of e-mail addresses.
Root.EmailOutputHeader.Bcc	A comma separated list of e-mail addresses.
Root.EmailOutputHeader.From	A comma separated list of e-mail addresses.
Root.EmailOutputHeader.Reply-To	A comma separated list of e-mail addresses.
Root.EmailOutputHeader.Subject	The subject of the e-mail.

LocalEnvironment

Use the LocalEnvironment to specify overrides to the SMTP server connection information and attachments.

LocalEnvironment	Description
Destination.Email.SMTPServer	The Server:Port of the SMTP server. Port is optional; if you do not specify it, the default value is 25.

LocalEnvironment	Description
Destination.Email.SecurityIdentity	The security identity for authentication with the SMTP server, which can be the name of the userid and password pair that is defined using the <code>mqsisetdbparms</code> command, or it can reference an external resource that has a <code>securityIdentity</code> attribute that references a userid and password that are defined using the <code>mqsisetdbparms</code> command. In both cases, the value is appended after the string "smtp:". For example, if you use the <code>mqsisetdbparms</code> command to create a userid and password of <code>smtp:myUserIdPassword</code> , the <code>securityIdentity</code> that is specified on the node, or indirectly in an external resource, is <code>myUserIdPassword</code> .
Destination.Email.BodyContentType	Identifies that the body of the e-mail message contains HTML rather than plain text. You can set this property to <code>text/plain</code> , <code>text/html</code> , or <code>text/xml</code> ; <code>text/plain</code> is the default value.
Destination.Email.MultiPartContentType	The type of multipart, including related, mixed, and alternative. You can set any value here.
Destination.Email.Attachment.Content	Either the actual attachment (BLOB/text), or an XPath or ESQL expression that references an element; for example, an element in the message tree or LocalEnvironment. The value of the referenced element is taken as the content of the attachment. <ul style="list-style-type: none"> • If the element is a BLOB, it is an attachment. • If the element is text, check to see if it can be resolved to another element in the message tree or LocalEnvironment. If it can be resolved, use that element. If it cannot be resolved, add this element as the attachment.
Destination.Email.Attachment.ContentType	The type of attachment (also known as Internet Media Type), including <code>text/plain</code> , <code>text/html</code> , and <code>text/xml</code> . You can set any value here.
Destination.Email.Attachment.ContentName	The name of the attachment.
Destination.Email.Attachment.ContentEncoding	The encoding of the attachment: 7bit, base64, or quoted-printable. <ul style="list-style-type: none"> • 7bit is the default value that is used for ASCII text. • Base64 is used for non ASCII, whether non English or binary data. This format can be difficult to read. • Quoted-printable is an alternative to Base64, and is appropriate when the majority of the data is ASCII with some non-ASCII parts. This format is more readable; it provides a more compact encoding because the ASCII parts are not encoded.

Broker properties

You can also configure the SMTP server, port number, and security identity as a broker external resource property. To do this, use an alias that is specified in the `SMTPServer` property on the `EmailOutput` node. The security identity references a user ID and password pair that is defined on the broker using the `mqsisetdbparms` command. Use the `mqsicreateconfigurable-service` command to create an SMTP broker external resource for the alias that is specified on the node. Then use the

mqschangeproperties command to create an SMTPServer property with the value in the form of *server:port*. The port value is optional; if you do not specify it, the default value is 25. You can also use the mqschangeproperties command to create an SMTPSecurityIdentity property with a value that is the name of a security identity that can be resolved at run time to a user ID and password for authentication with the SMTP server. For example:

```
mqscreateconfigurable service MY_BROKER -c SMTP -o SMTP_MyAlias
```

followed by:

```
mqschangeproperties MY_BROKER -c SMTP -o SMTP_MyAlias -n serverName -v smtp.hursley.ibm.com:25
```

These commands override the SMTP server and port values that are specified on any nodes that also specify an alias of SMTP_MyAlias. If the LocalEnvironment contains any overrides, they take preference over the broker external resource properties. See also the following example:

```
mqschangeproperties MY_BROKER -c SMTP -o SMTP_MyAlias -n securityIdentity -v mySecurityIdentity
```

You must also use the mqssetdbparms command to define the security identity at the broker run time

Connecting the terminals:

Connect the In terminal to the node from which outbound messages bound are routed.

Connect the Out or Failure terminal of this node to another node in this message flow to process the message further, process errors, or send the message to an additional destination.

If you connect one of these output terminals to another node in the message flow, the LocalEnvironment that is associated with the message is enhanced with the following information for each destination to which the message has been put by this node:

Location	Description
WrittenDestination.Email.smtpServer	The Server:Port of the SMTP server.
WrittenDestination.Email.messageId	The ID of the e-mail sent message.

These values are written in WrittenDestination within the LocalEnvironment tree structure.

If you do not connect either terminal, the LocalEnvironment tree is unchanged.

Terminals and properties

The EmailOutput node terminals are described in the following table.

Terminal	Description
In	The input terminal that accepts a message for processing by the node.
Failure	The output terminal to which the message is routed if a failure is detected when the message is put to the output queue.
Out	The output terminal to which the message is routed if it has been successfully put to the output queue, and if further processing is required within this message flow.

The following tables describe the node properties. The column headed M indicates whether the property is *mandatory* (marked with an asterisk if you must enter a value when no default is defined); the column headed C indicates whether the property is *configurable* (you can change the value when you add the message flow to the bar file to deploy it).

The EmailOutput node Description properties are described in the following table.

Property	M	C	Default	Description
Node name	No	No	The node type, EmailOutput	The name of the node.
Short Description	No	No		A brief description of the node.
Long Description	No	No		Text that describes the purpose of the node in the message flow.

Use the EmailOutput node Basic properties are described in the following table.

Property	M	C	Default	Description
server	No	Yes		<p>This property defines the SMTP server and port to which e-mails are sent from this node, and is in the format <i>server:port</i>; for example: <i>my.smtp.server:25</i>. The port value is optional, but if you do not specify a port value, the default value is 25.</p> <p>You can specify an alias value for this property. If the alias exists at run time, the specified values are used. If the alias does not exist at run time, the broker assumes the value to be a valid SMTP host.</p>

The EmailOutput node Email properties are described in the following table.

Property	M	C	Default	Description
ToAddresses	No	No		The main recipient or recipients of the e-mail. This property can include a single e-mail address or a comma-separated list of e-mail addresses.
CcAddresses	No	No		The carbon copy recipient or recipients of the e-mail. This property can include a single e-mail address or a comma-separated list of e-mail addresses.
BccAddresses	No	No		The blind carbon copy recipient or recipients of the e-mail. This property can include a single e-mail address or a comma-separated list of e-mail addresses.
FromAddress	No	No		The e-mail address of the sender of the e-mail.
Reply-ToAddress	No	No		The e-mail address to which recipients of the e-mail reply.
Subject	No	No		The subject of the e-mail.
MessageText	No	No		The main text of the e-mail. If you do not specify a value for the MessageText property, the text of the e-mail is the body of the message tree that is passed to the EmailOutput node.

Property	M	C	Default	Description
BodyContentType	No	No	text/plain	You can use this property to force the content type for the body of the e-mail message. Valid values are: <ul style="list-style-type: none"> • None • text/plain • text/html • text/xml

The EmailOutput node Security properties are described in the following table.

Property	M	C	Default	Description
securityIdentity	No	Yes		A security identifier to retrieve a user ID and password that are configured at the broker run time.

The EmailOutput node Attachment properties are described in the following table.

Property	M	C	Default	Description
AttachmentContent	No	No		An XPath or ESQL expression that references an element; for example, an element in the message tree, or LocalEnvironment. The content of the attachment is the value of the element that is referenced.
AttachmentContentName	No	No		The name of the attachment that is seen by the recipient of the e-mail. This property is optional. If you do not specify a name, a default name is assigned.
AttachmentContentType	No	No	text/plain	The type of the attachment. This property is optional, even if you have specified an attachment. Valid values are: <ul style="list-style-type: none"> • text/plain is simple text. • text/html is HTML. • text/xml is XML. • application/octet-stream is the default type for non-text and HTML (binary data).
AttachmentContentEncoding	No	No	7bit	The encoding of the attachment. This property is optional. If you do not specify a value, a default encoding is assigned. Valid values are: <ul style="list-style-type: none"> • 7bit is the default value for ASCII text. • base64 is used for non-ASCII data, whether it is non-English or binary data. • quoted-printable is a more readable-alternative to base64. Use quoted-printable when the majority of the data is ASCII text with some non-ASCII parts. This option provides a more compact encoding because the ASCII parts are not encoded.
MultipartContentType	No	No	Mixed	The type of multipart. Valid values are: <ul style="list-style-type: none"> • Mixed: each MIME body part is independent of the others. • Alternative: Each MIME body part is an alternative to the others. • Related: All MIME body parts should be considered in the aggregate only.

The Validation properties of the EmailOutput node are described in the following table.

Refer to “Validation properties” on page 1359 for a full description of these properties.

Property	M	C	Default	Description
Validate	Yes	Yes	Inherit	This property controls whether validation takes place. Valid values are None, Content and Value, Content, and Inherit.
Failure Action	Yes	No	Exception	This property controls what happens if validation fails. You can set this property only if you set Validate to Content or Content and Value. Valid values are User Trace, Local Error Log, Exception, and Exception List.

EndpointLookup node

Use the EndpointLookup node to access service metadata that resides in the WebSphere Service Registry and Repository.

This topic contains the following sections:

- “Purpose”
- “Using this node in a message flow” on page 882
- “Terminals and properties” on page 883

Important: WebSphere Message Broker V6.1.0.2 only supports WebSphere Service Registry and Repository V6.1. Previous versions of the product are not supported.

Purpose

This node is generic in that it retrieves service endpoint information related to a WebSphere Service Registry and Repository service, for example, WSDL. The EndpointLookup node is independent from any other domain context, and support is currently limited to querying endpoints for Web services.

The EndpointLookup node provides a query interface that enables you to select single or all endpoints, and set up environment parameters to enable Web service invocation nodes to submit requests to the selected services.

You can use two nodes to access service metadata that resides in the WebSphere Service Registry and Repository, the EndpointLookup node and the RegistryLookup node. These nodes are designed to be included in message processing flows that mediate between service consumers and service providers in an SOA installation. These nodes are for generic WebSphere Service Registry and Repository access.

The EndpointLookup node supports the SOAPRequest, SOAPAsyncRequest, and HTTPRequest nodes. The EndpointLookup node also generates SOAPRequest, SOAPAsyncRequest, or HTTPRequest node formats.

The EndpointLookup node is contained in the **Web services** drawer of the message flow node palette, and is represented in the workbench by the following icon:



EndpointLookup node processing

The EndpointLookup node processes messages in the following sequence.

1. The EndpointLookup node receives a message.
2. The EndpointLookup node retrieves the IT service endpoint information from the WebSphere Service Registry and Repository using the specified query string.

The EndpointLookup node can be used to define a query dynamically within the message. Both the EndpointLookup and the RegistryLookup nodes can accept a query specified within the LocalEnvironment. Accepting a query specified within the LocalEnvironment overrides any property values set on the node, and all values are strings. XPath and ESQL are not supported when specifying the customer properties using the LocalEnvironment. When you use the LocalEnvironment to set the properties, you can define the properties at runtime, or message processing time, rather than defining them at development time. You must use the format

`LocalEnvironment.ServiceRegistryLookupProperties.Name` where *Name* is the property you want to define. It is still mandatory to set values on the properties of the nodes because the nodes cannot deploy without doing so.

3. If one or more matches are found:
 - If Match Policy is set to One and a single endpoint is matched, the EndpointLookup node sets valid endpoints in the domain so that the existing WebSphere Message Broker built-in nodes, the SOAPRequest, SOAPAsyncRequest, and HTTPRequest nodes, can be used to invoke the service. The EndpointLookup node returns the first result it receives, and sets the endpoint address. However, the first result might not be the most current version.
 - If Match Policy is set to All, the EndpointLookup node adds all matching endpoints information to the message instance, leaving all other message content unchanged. These results are then sent to a JavaCompute node which selects the current version and sets the endpoint address. You must propagate the LocalEnvironment tree with the message. You can use this option to select the most current version of a particular Web service.

Metadata information is propagated to the Out terminal, where it is available for further processing either by ESQL or by a JavaCompute node.

4. If no matches are found, the EndpointLookup node propagates the input message to the NoMatch terminal.

Example usage. The node that precedes an EndpointLookup node receives a message and propagates the message to the EndpointLookup node. The EndpointLookup node uses the information defined within its properties to query the WebSphere Service Registry and Repository. Either one or more results are returned depending on whether you set the Match Policy property value to One or All. The information received is placed into the LocalEnvironment tree and propagated on the Out terminal. If no results are returned a message is propagated on the NoMatch terminal.

Using this node in a message flow

The EndpointLookup node can be used in any message flow that needs to access service metadata that resides in the WebSphere Service Registry and Repository.

Look at the following sample to see how to use this node:

- WSRR Connectivity sample

You can view samples only when you use the information center that is integrated with the Message Broker Toolkit.

Terminals and properties

When you have put an instance of the EndpointLookup node into a message flow, you can configure it; see “Configuring a message flow node” on page 235. The properties of the node are displayed in the Properties view. All mandatory properties for which you must enter a value (those that do not have a default value defined) are marked with an asterisk.

The EndpointLookup node terminals are described in the following table.

Terminal	Description
In	The input terminal that accepts a message for processing by the node.
Failure	The output terminal to which the message is routed if an error occurs.
Out	The output terminal to which matching endpoint information is sent.
NoMatch	The terminal to which the message is sent if no matching entity is found based on the specified values.

The following tables describe the node properties. The column headed M indicates whether the property is *mandatory* (marked with an asterisk if you must enter a value when no default is defined); the column headed C indicates whether the property is *configurable* (you can change the value when you add the message flow to the bar file to deploy it).

The EndpointLookup node Description properties are described in the following table:

Property	M	C	Default	Description
Node name	No	No	The node type	The name of the node.
Short description	No	No	None	A brief description of the node.
Long description	No	No	None	Text that describes the purpose of the node in the message flow.

The EndpointLookup node Basic properties are described in the following table:

Property	M	C	Default	Description
PortType Name	No	Yes	None	Name tuple that uniquely identifies a WebSphere Service Registry and Repository defined WSDL service portType. At least one of the properties is required. If you leave all three property values blank, you will get an error message when you try to save.
PortType Namespace	No	Yes	None	
PortType Version	No	Yes	None	
User Properties	No	No	None	Enables a query to specify user-defined properties for the port. Add User Properties by clicking Add . Enter values for Property Name, Property Type, and Property Value.

Property	M	C	Default	Description
Classification	No	No	None	<p>The Web Ontology Language (OWL) classification system property. Each classifier is a class in OWL, and has a Uniform Resource Identifier (URI). Using classifications in the registry can help to make objects easier to find and can also add meaning to custom objects that are unique to a particular system.</p> <p>Add a Classification by clicking Add and typing the complete fully qualified OWL URI for the OWL classification.</p>
Match Policy	Yes	No	One	<p>The policies to be returned. Select One to match one policy, or All to match all policies to the search criteria. If you request a single Web service by setting Match Policy to One, the EndpointLookup node sets the endpoints so that service information is correctly placed in the domain context ensuring that existing WebSphere Message Broker built-in nodes correctly invoke the service.</p>

Extract node

Use the Extract node to extract the contents of the input message that you want to be processed by later nodes in the message flow.

Attention: The Extract node is deprecated in WebSphere Message Broker Version 6.0 and later releases. Although message flows that contain an Extract node remain valid, redesign your message flows where possible to replace Extract nodes with Mapping nodes.

This topic contains the following sections:

- “Purpose”
- “Using this node in a message flow”
- “Terminals and properties” on page 885

Purpose

Using the Extract node, you can create a new output message that contains only a subset of the contents of the input message. The output message comprises only those elements of the input message that you specify for inclusion when configuring the Extract node, by defining mapping statements.

The Extract node is contained in the **Database** drawer of the palette, and is represented in the workbench by the following icon:



Using this node in a message flow

You might find this node useful if you require only a subset of the message after initial processing of the whole message. For example, you might want to store the whole message for audit purposes (in the Warehouse node), but propagate only a small part of the message (order information, perhaps) for further processing.

For example, you receive orders from new clients and you want to collect their names and addresses for future promotions. Use the Extract node to get this

information from each order, and send it as a new message to head office. These messages are processed at head office so that the customer details can be included in the next marketing campaign.

Terminals and properties

When you have put an instance of the Extract node into a message flow, you can configure it. For more information, see “Configuring a message flow node” on page 235. The properties of the node are displayed in the Properties view. (If you double-click the Extract node, you open the New Message Map dialog box.) All mandatory properties for which you must enter a value (those that do not have a default value defined) are marked with an asterisk.

The Extract node terminals are described in the following table.

Terminal	Description
In	The input terminal that accepts a message for processing by the node.
Failure	The output terminal to which the input message is routed if a failure is detected during extraction.
Out	The output terminal to which the transformed message is routed if the input message is processed successfully.

The following tables describe the node properties. The column headed M indicates whether the property is *mandatory* (marked with an asterisk if you must enter a value when no default is defined), the column headed C indicates whether the property is *configurable* (you can change the value when you add the message flow to the bar file to deploy it).

The Extract node Description properties are described in the following table.

Property	M	C	Default	Description
Node name	No	No	Extract	The name of the node.
Short description	No	No		A brief description of the node.
Long description	No	No		Text that describes the purpose of the node in the message flow.

The Extract node Basic properties are described in the following table.

Property	M	C	Default	Description
Mapping module	Yes	No	Extract	<p>The name of the mapping routine that contains the statements to run against the message tree.</p> <p>By default, the name that is assigned to the mapping routine is identical to the name of the mappings file in which the routine is defined. The default name for the file is the name of the message flow concatenated with the name of the node when you include it in the message flow (for example, MFlow1_Extract.msgmap for the first Extract node in message flow MFlow1). You cannot specify a value that includes spaces.</p> <p>To work with the mapping routine that is associated with this node, right-click the node and click Open Mappings. If the mapping routine does not exist, it is created for you with the default name in the default file. If the file exists already, you can also open file <i>flow_name_node_name.msgmap</i> in the Broker Development view.</p> <p>A mapping routine is specific to the type of node with which it is associated; you cannot use a mapping routine that you have developed for an Extract node with any other node that uses mappings (for example, a DataInsert node). If you create a mapping routine, you cannot call it from any other mapping routine, although you can call it from an ESQL routine.</p> <p>For more information about working with mapping files, and defining their content, see “Developing message mappings” on page 472.</p>

FileInput node

Use the FileInput node to process messages that are read from files.

This topic contains the following sections:

- “Purpose”
- “Using this node in a message flow” on page 888
- “Configuring the FileInput node” on page 889
- “Terminals and properties” on page 894

Purpose

One or more messages can be read from a single file, and each message is propagated as a separate flow transaction. The part of a file that generates one message flow transaction is called a record. A file can be a single record, or a series of records. Properties on the node specify how the FileInput node determines the records in a file.

The FileInput node is contained in the **File** drawer of the palette, and is represented in the workbench by the following icon:



File processing

The FileInput node reads files from a specified directory called the input directory and propagates messages based on the contents of these files. Only files with names that match a specified pattern (the input pattern) are read.

The FileInput node removes each file from the input directory as it is processed.

Optionally, the FileInput node can transfer files from a remote FTP server to process them. If the remote file is successfully transferred, it is deleted from the FTP server and the transferred copy is processed as though it had been placed in the input directory. Only files that match the input pattern are transferred.

The FileInput node uses subdirectories of the input directory to hold files during and after processing. All of these subdirectories begin with the prefix **mqsi**. Among these subdirectories are the archive directory, mqsiarchive, and the backout directory, mqsibackout.

If the message flow processes the file successfully, the message flow transaction commits, and the file is deleted or moved to the archive directory. If processing is unsuccessful, the message flow transaction backs out, and the file is deleted, moved to the backout directory, or moved to the archive directory. You can determine which of these actions is to be taken by specifying properties on the node.

Record processing

As a default, a file is treated as one record and is processed as a single message.

By using properties on the node, you can specify whether the input file is to be split into records, each of which is separately processed. You can specify records as:

- Fixed length. The records are all a specified number of bytes in length, starting with the first byte of the file.
- Delimited. A particular sequence of bytes is specified as a record delimiter. An example of such a sequence is an end-of-line sequence.
- Parsed sequence. A specified message domain parser reads bytes from the start of the file until a complete message is recognized, which is then processed. The same parser reads subsequent bytes for the next message and continues to do so until all of the file is processed.

After the last record of the file is processed successfully, if the End of Data terminal is attached, a further End of Data message is propagated to the End of Data terminal. The End of Data message consists of an empty BLOB message and a LocalEnvironment.File structure, and allows explicit end-of-flow processing to be performed in another part of the flow.

Message structure

The FileInput node handles messages in the following message domains:

- MRM
- XMLNSC
- DataObject
- XMLNS
- JMSTMap
- JMSTStream
- MIME
- BLOB
- XML
- IDOC

When the FileInput node propagates a message, it stores the information in the LocalEnvironment.File message tree. If the input file is empty, the message is empty (assuming it passes any validation). The following table lists the LocalEnvironment.File message tree structure.

Table 33.

Element Name	Element Data Type	Description
Directory	CHARACTER	Absolute directory path of the input directory in the form used by the file system of the broker. For example, on Windows systems, this starts with the drive letter prefix (such as C:).
Name	CHARACTER	File name and extension.
LastModified	TIMESTAMP	Date and time the file was last modified.
TimeStamp	CHARACTER	Date and time the input node started processing the file in the coordinated universal time (UTC) zone, as a character string. This data is the string used to create archive and backout file names if a timestamp is included.
The following elements contain data about the current record:		
Offset	INTEGER	Start of the record within the file. The first record starts at offset 0. When it is part of the End of Data message tree, this is the length of the input file.
Record	INTEGER	Number of the record within the file. The first record is record number 1. When it is part of the End of Data message tree, this is the number of records.
Delimiter	CHARACTER	The characters used to separate this record from the preceding record, if Delimited is specified in Record detection. The first record has a null delimiter. When it is part of the End of Data message tree, this value is the delimiter that follows the last record, if any.
IsEmpty	BOOLEAN	Whether the record that is propagated by the message flow is empty. It is set to TRUE if the current record is empty. When it is part of the End of Data message tree, this property is always set to TRUE.

Using this node in a message flow

The FileInput node can be used in any message flow that must accept messages in files. Look at the following samples to see how to use this node:

- Batch Processing sample
- WildcardMatch sample

You can view samples only when you use the information center that is integrated with the Message Broker Toolkit.

Configuring the FileInput node

When you have put an instance of the FileInput node into a message flow, you can configure it; see “Configuring a message flow node” on page 235. The properties of the node are displayed in the Properties view. All mandatory properties for which you must enter a value (those that do not have a default value defined) are marked with an asterisk.

Configure the FileInput node:

1. Optional: On the **Description** tab, enter a Short description, a Long description, or both. You can also rename the node on this tab.
2. On the **Basic** tab, enter the directories and files to be processed by the FileInput node, together with what to do with any duplicate files encountered.
 - In Input directory, specify the directory from which the FileInput node obtains files. You may specify the directory as an absolute or relative directory path. If the directory path is relative, it is based on the directory specified in the environment variable MQSI_FILENODES_ROOT_DIRECTORY. An example on Windows would be C:\fileinput. An example on UNIX would be /var/fileinput.
 - In File name or pattern, specify a file name pattern. This is either a file name or a character sequence (a pattern) that matches a file name. A pattern is a sequence containing at least one of the following wildcard characters:

Wildcard character	Description	Example
*	Any sequence of zero or more characters	*.xml matches all file names with an xml extension
?	Any single character	f?????.csv matches all file names consisting of the letter f followed by six characters and then the sequence .csv.

Only those files the names of which match the pattern will be processed from the input directory.

- Select Action on successful processing to specify the action the FileInput node takes after successfully processing the file. The action can be to move the file to the archive subdirectory, to augment the file name with a time stamp and move the file to the archive subdirectory, or to delete the file.
 - If you select Move to Archive Subdirectory, the file is moved to the archive subdirectory of the input directory. The subdirectory name is mqsarchive. For example, if the monitored directory is /var/fileinput, the archive subdirectory’s absolute path is /var/fileinput/mqsarchive. If this directory does not exist, the broker creates it when it first tries to move a file there.
 - If you select Add Timestamp and Move to Archive Subdirectory, the current date and time is added to the file name, and the file is then moved to mqsarchive.
 - If you select Delete, the file is deleted after successful processing.

The FileInput node writes a message to the user trace, if user tracing is in operation, whenever it processes a file.

- Select Replace duplicate archive files if you want to replace a file in the archive subdirectory with a successfully processed file of the same name. If

you do not set this option, and a file with the same name already exists in the archive subdirectory, the node will throw an exception when it tries to move the successfully processed file.

3. On the **Input Message Parsing** tab, set values for the properties that the node uses to determine how to parse the incoming message.

- In Message domain, select the name of the parser that you are using from the supplied list. The default is BLOB. You can choose from the following options:
 - MRM
 - XMLNSC
 - DataObject
 - XMLNS
 - JMSMap
 - JMSStream
 - MIME
 - BLOB
 - XML
 - IDOC

You can also specify a user-defined parser, if appropriate.

- If you are using the MRM or IDOC parser, or the XMLNSC parser in validating mode, select the Message set that you want to use. This list is populated with available message sets when you select MRM, XMLNSC, or IDOC as the domain.
- If you are using the MRM parser, select the correct message type from the list in Message type. This list is populated with available message types when you select the MRM parser.
- If you are using the MRM or IDOC parser, select the correct message format from the list in Message format. This list is populated with available message formats when you select the MRM or IDOC parser.
- Specify the message coded character set ID in Message coded character set ID.
- Select the message encoding from the list in Message encoding or specify a numeric encoding value. For more information about encoding, see “Converting data with message flows” on page 128.

4. On the **Parser Options** sub-tab:

- Parse timing is, by default, set to On Demand, which causes parsing of the message to be delayed. To cause the message to be parsed immediately, see “Parsing on demand” on page 1363.
- If you are using the XMLNSC parser, set values for the properties that determine how the XMLNSC parser operates. For more information, see “Manipulating messages in the XMLNSC domain” on page 364.

5. On the **Polling** tab, enter the FileInput node’s Polling interval. This property controls the frequency with which the FileInput node accesses the file system looking for files to process.

After the initial scan of the directory when the flow is started, whenever the directory is found to contain no files that match the input pattern, the FileInput node waits for a period of time defined by this property. This avoids the need for the FileInput node to be continually accessing the file system, and, thereby, consuming large amounts of system resource.

The smaller the value set in this property, the more quickly the FileInput node discovers files that appear in the input directory. This is at a cost of greater use of system resources. A larger value reduces the use of system resource but at the cost of the FileInput node discovering files to process less quickly.

Do not use this property as a means to regulate work, or to schedule processing. If you want the FileInput node to monitor the input directory for selected periods only, you should start and stop the message flow at appropriate times.

If you select FTP processing and set the Scan delay property on the FTP tab, the value that you set overrides the value set for the polling interval.

6. Use the **Retry** tab to define how retry processing is performed when a flow fails. You can set the following:
 - Retry mechanism determines the action that occurs should the flow fail. Choose from the following:
 - Select Failure for the node to report a failure without any retry attempts.
 - Select Short retry for the node to retry before reporting a failure if the condition persists. The number of times that it retries is specified in Retry threshold.
 - Select Short retry and long retry for the node to retry, first using the value in Retry threshold as the number of attempts it should make. If the condition persists after the Retry threshold has been reached, the node then uses the Long retry interval between attempts.
 - Specify the Retry threshold. The number of times the node retries the flow transaction should the Retry mechanism property be set to either Short retry or Short retry and long retry.
 - Specify the Short retry interval. The length of time, in seconds, to wait between short retry attempts.
 - Specify the Long retry interval. The length of time to wait between long retry attempts until a message is successful, the message flow is stopped, or the message flow is redeployed. The broker property **MinLongRetryInterval** defines the minimum value that the Long retry interval can take. If the value is lower than the minimum then the broker value is used.
 - Specify the Action on failing file. This specifies what the node is to do with the input file after all attempts to process its contents fail. Choose from the following:
 - Move to Backout Subdirectory. The file is moved to the backout subdirectory in the input directory. The name of this subdirectory is mqsibackout. If the input directory is /var/fileinput, the absolute path of the backout subdirectory would be /var/fileinput/mqsibackout. If this subdirectory does not exist, the broker creates it when it first tries to move a file there. If the file fails to be moved to this subdirectory, perhaps because a file of the same name already exists there, the node adds the current date and time to the file name and makes a second attempt to move the file. If this second attempt fails, the node stops processing, messages BIP3331 and BIP3325 are issued and these direct you to resolve the problem with the subdirectory or file before attempting to restart the message flow.
 - Delete. The file is deleted after processing fails.
 - Add Time Stamp and Move to Backout Subdirectory. The current date and time are added to the file name, and then the file is moved to the backout subdirectory.

7. Use the **Records and Elements** tab to specify how each file is interpreted as records:
 - Use the Record detection property to determine how the file is split into records, each of which generates a single message. Choose from the following options:
 - Whole File specifies that the whole file is a single record.
 - Fixed Length specifies that each record is a fixed number of bytes in length. Each record should contain the number of bytes specified in the Length property, except possibly a shorter final record in the file.
 - Select Delimited if the records that you are processing are separated, or terminated, by a DOS or UNIX line end or by a sequence of user-defined delimiter bytes. Specify the delimiter and delimiter type in the Delimiter and Delimiter type properties.
 - Select Parsed Record Sequence if the file contains a sequence of one or more records that are serially recognized by the parser specified in Message domain. The node propagates each recognized record as a separate message. If you select this Record detection option, the parser specified in Message domain must be either XMLNSC or MRM (either CWF or TDS physical format).
 - If you specified Fixed Length in Record detection, use Length to specify the required length of the output record. This value must be between 1 byte and 100 MB. The default is 80 bytes.

If you specify Whole File, Fixed Length, or Delimited in Record detection, a limit of 100 MB applies to the length of the records. If you specify Parsed Record Sequence in Record detection, the FileInput node does not determine or limit the length of a record. Nodes that are downstream in the message flow might try to determine the record length or process a very long record. If you intend to process large records in this way, ensure that your broker has sufficient memory. You might need to apply flow techniques described in the Large Messaging sample to best use the available memory.
 - If you specified Delimited in Record detection, use Delimiter to specify the delimiter to be used. Choose from:
 - DOS or UNIX Line End, which, on UNIX systems, specifies the line feed character (<LF>, X'0A'), and, on Windows systems, specifies a carriage return character followed by a line feed character (<CR><LF>, X'0D0A'). The node treats both of these strings as delimiters, irrespective of the system on which the broker is running. If they both appear in the same file, the node recognizes both as delimiters. The node does not recognize X'15' which, on z/OS systems, is the 'newline' byte; specify a value of Custom Delimiter in this property and a value of 15 in the Custom delimiter property if your input file is coded using EBCDIC new lines, such as EBCDIC files from a z/OS system.
 - Custom Delimiter, which permits a sequence of bytes to be specified in Custom delimiter
 - In Custom delimiter, specify the delimiter byte or bytes to be used when Custom delimiter is set in the Delimiter property. Specify this value as an even-numbered string of hexadecimal digits. The default is X'0A' and the maximum length of the string is 16 bytes (represented by 32 hexadecimal digits).
 - If you specified Delimited in Record detection, use Delimiter type to specify the type of delimiter. Permitted values are:

- Infix. If you select this value, each delimiter separates records. If the file ends with a delimiter the (zero length) file content following the final delimiter is still propagated although it contains no data.
 - Postfix. If you specify this value, each delimiter terminates records. If the file ends with a delimiter, no empty record is propagated after the delimiter. If the file does not end with a delimiter, the file is processed as if a delimiter follows the final bytes of the bytes of the file. Postfix is the default value.
- The FileInput node considers each occurrence of the delimiter in the input file as either separating (infix) or terminating (postfix) each record. If the file begins with a delimiter, the node treats the (zero length) file contents preceding that delimiter as a record and propagates an empty record to the flow. The delimiter is never included in the propagated message.
8. Use the **Validation** tab to provide validation based on the message set for predefined messages. For more information about validation, see “Validating messages” on page 164. For information about how to complete this tab, see “Validation tab properties” on page 1360.
 9. On the **FTP** tab, select the FTP check box if you want the node to read files from an FTP server using the File Transfer Protocol properties:
 - In FTP server and port, supply the Internet address and port number of an FTP server to be used. Use the following syntax:
 - <IP address or URL> or
 - <IP address or URL>:<port number>

If you specify the Internet address in IPv6 format, ensure that you enclose it in square brackets, for example:

- [12a::13bd:24cd] or
- [12a::13bd:24cd]:123 where 123 is the port number

If you do not specify a port number, a port number of 21 is assumed.

However, if an FtpServer configurable service is defined, then you can place the name of the configurable service in this field. See FtpServer configurable service properties for information on how an FtpServer configurable service definition and the properties on this tab interact.

- In Security identity, specify the name of a security identity that has been defined using the mqsisetdbparms command. The user identifier and password that are to be used to log on to the FTP server are obtained from this definition, the name of which should have the prefix ftp::. The value in this property is overridden by the value in the FtpServer configurable service property securityIdentity, if it is set.
- In Server directory, specify the directory in the FTP server from which to transfer files. The default is . which means the default directory after logon. If you specify this as a relative path, this directory is based on the default directory after FTP logon. Ensure that the syntax of the of the path conforms to the file system standards in the FTP server. The value in this property is overridden by the value in the FtpServer configurable service property remoteDirectory, if it is set.
- In Transfer mode, specify how files are transferred. Select Binary if the file contents are not to be transformed. Select ASCII if the file is to be transmitted as ASCII. The value in this property is overridden by the value in the FtpServer configurable service property transferMode, if it is set.
- In Scan delay, specify the delay, in seconds, between directory scans. The default is 60 seconds. The value set in this property overrides the value set for the polling interval on the **Polling** tab when the FTP check box is

selected. The value in this property is overridden by the value in the FtpServer configurable service property scanDelay, if it is set.

10. On the **Transactions** tab, set the transaction mode. Although all file operations are non-transactional, the transaction mode on this input node determines whether the rest of the nodes in the flow are to be executed under sync point or not. Select Yes if you want the flow updates to be treated transactionally, if possible, No if you do not. The default for this property is Yes.
11. Optional: On the **Instances** tab, set values for the properties that control the additional instances (threads) that are available for a node. For more details, see “Configurable message flow properties” on page 1372.

Terminals and properties

The FileInput node terminals are described in the following table.

Terminal	Description
Failure	The output terminal to which a message is routed if an error occurs before a message is propagated to the Out terminal. Messages propagated to this terminal are not validated, even if you have specified, using the Validate property, that validation should take place.
Out	The output terminal to which the message is routed if it has been successfully extracted from the input file. If no errors occur within the input node, a message received from an external resource is always sent to the Out terminal first.
End of Data	The output terminal to which the End of Data message is routed after all the messages in a file have been processed. The End of Data message flow transaction is initiated only if this terminal is attached.
Catch	The output terminal to which the message is routed if an exception is thrown downstream and caught by this node. Exceptions are caught only if this terminal is attached.

The following tables describe the node properties. The column headed M indicates whether the property is *mandatory* (marked with an asterisk if you must enter a value when no default is defined); the column headed C indicates whether the property is *configurable* (you can change the value when you add the message flow to the bar file to deploy it).

The FileInput node Description properties are described in the following table:

Property	M	C	Default	Description
Node name	No	No	FileInput	The name of the node.
Short description	No	No	None	A brief description of the node.
Long description	No	No	None	Text that describes the purpose of the node in the message flow.

The FileInput node Basic properties are described in the following table:

Property	M	C	Default	Description
Input directory	Yes	Yes	None	The path of the directory from which input files are processed. The directory is in the file system to which the broker has access.

Property	M	C	Default	Description
File name or pattern	Yes	Yes	*	A file name or string containing optional wildcard characters (* or ?) identifying the file or files to process from the input directory.
Action on successful processing	Yes	No	Delete	The action the node takes on the file after successfully processing the contents. Valid options are: <ul style="list-style-type: none"> • Move to Archive Subdirectory • Add Time Stamp and Move to Archive Subdirectory • Delete
Replace duplicate archive files	Yes	No	Cleared	This property controls whether the node replaces existing archive files with the same name as the input file. It applies only when Action on successful processing is not Delete.

The FileInput node Input Message Parsing properties are described in the following table.

Property	M	C	Default	Description
Message Domain	No	No		The domain that is used to parse the incoming message.
Message Set	No	No		The name or identifier of the message set in which the incoming message is defined. If you set this property, then subsequently update the project dependencies to remove this message set reference, a warning is issued. Either update the Message Set property, or restore the reference to this message set project.
Message Type	No	No		The name of the incoming message.
Message Format	No	No		The name of the physical format of the incoming message.
Message coded character set ID	Yes	No	Broker System Default	The ID of the coded character set used to interpret bytes of the file being read.
Message encoding	Yes	No	Broker System Default	The encoding scheme for numbers and large characters used to interpret bytes of the file being read. Valid values are Broker System Determined or a numeric encoding value. For more information about encoding, see “Converting data with message flows” on page 128.

The FileInput node Parser Options properties are described in the following table.

Property	M	C	Default	Description
Parse timing	No	No	On Demand	This property controls when an input message is parsed. Valid values are: <ul style="list-style-type: none"> • On Demand • Immediate • Complete For a full description of this property, see “Parsing on demand” on page 1363.

Property	M	C	Default	Description
Build tree using XML schema data types	No	No	Cleared	This property controls whether the syntax elements in the message tree have data types taken from the XML Schema.
Use XMLNSC compact parser for XMLNS domain	No	No	Cleared	This property controls whether the XMLNSC Compact Parser is used for messages in the XMLNS Domain. If you set this property, the message data appears under XMLNSC in nodes that are connected to the output terminal when the input MQRFH2 header or Input Message Parsing property, Message Domain, is XMLNS.
Retain mixed content	No	No	Cleared	This property controls whether the XMLNSC parser creates elements in the message tree when it encounters mixed text in an input message. If you select the check box, elements are created for mixed text. If you clear the check box, mixed text is ignored and no elements are created.
Retain comments	No	No	Cleared	This property controls whether the XMLNSC parser creates elements in the message tree when it encounters comments in an input message. If you select the check box, elements are created for comments. If you clear the check box, comments are ignored and no elements are created.
Retain processing instructions	No	No	Cleared	This property controls whether the XMLNSC parser creates elements in the message tree when it encounters processing instructions in an input message. If you select the check box, elements are created for processing instructions. If you clear the check box, processing instructions are ignored and no elements are created.
Opaque elements	No	No	Blank	This property is used to specify a list of elements in the input message that are to be opaquely parsed by the XMLNSC parser. Opaque parsing is performed only if validation is not enabled (that is, if Validate is None); entries that are specified in Opaque Elements are ignored if validation is enabled.

The FileInput node Polling property is described in the following table:

Property	M	C	Default	Description
Polling interval (seconds)	Yes	Yes	5	The polling interval in seconds.

The FileInput node Retry properties are described in the following table:

Property	M	C	Default	Description
Retry mechanism	Yes	No	Failure	How the node handles a flow failure. Valid options are: <ul style="list-style-type: none"> • Failure • Short retry • Short and long retry
Retry threshold	Yes	Yes	0	The number of times to retry the flow transaction when Retry mechanism is Short retry.

Property	M	C	Default	Description
Short retry interval	No	Yes	0	The interval, in seconds, between each retry if Retry threshold is not zero.
Long retry interval	No	Yes	300	The interval between retries, if Retry mechanism is Short and long retry and the retry threshold has been exhausted.
Action on failing file	Yes	Yes	Move to Backout Subdirectory	The action the node takes with the input file after all attempts to process its contents fail. Valid options are: <ul style="list-style-type: none"> • Move to Backout Subdirectory • Delete • Add Time Stamp and Move to Backout Subdirectory

The FileInput node Records and Elements properties are described in the following table:

Property	M	C	Default	Description
Record detection	Yes	No	Whole File	The mechanism used to identify records in the input file. Valid options are: <ul style="list-style-type: none"> • Whole File • Fixed Length • Delimited • Parsed Record Sequence
Length	Yes	No	80	The length of each record, in bytes, when Fixed Length record detection is selected.
Delimiter	Yes	No	DOS or UNIX Line End	The type of delimiter bytes that separate, or terminate, each record when Delimited record detection is selected. Valid options are: <ul style="list-style-type: none"> • DOS or UNIX Line End • Custom Delimiter
Custom delimiter	No	No		The delimiter bytes, expressed in hexadecimal, when Delimited record detection and Custom Delimiter are selected. This property is mandatory only if the Delimiter property is set to Custom Delimiter.
Delimiter type	Yes	No	Postfix	The position of the delimiter when Delimited record detection and Custom Delimiter are selected. Valid options are: <ul style="list-style-type: none"> • Postfix • Infix <p>This property is ignored unless the Delimiter property is set to Custom Delimiter.</p>

The FileInput node Validation properties are described in the following table.

For a full description of these properties, see “Validation properties” on page 1359.

Property	M	C	Default	Description
Validate	No	Yes	None	This property controls whether validation takes place. Valid values are <ul style="list-style-type: none"> • None • Content and Value • Content
Failure action	No	No	Exception	This property controls what happens if validation fails. Valid values are: <ul style="list-style-type: none"> • User Trace • Local Error Log • Exception • Exception List

The FileInput node FTP properties are described in the following table:

Property	M	C	Default	Description
FTP	No	Yes	Cleared	This property defines whether the node uses the File Transfer Protocol (FTP) properties listed on the FTP tab and reads files from an FTP server.
FTP server and port	No	Yes	None	Either the IP address or name (and, optionally, the port number) of a remote FTP server; for example, ftp.server.com:21, or the name of a configurable service of type 'FtpServer'. If a configurable service name is specified, the following FTP properties can be overridden by the configurable service.
Security identity	No	Yes		The name of the user identification used to access the FTP server. This property is overridden by the securityIdentity property, if set, in the FtpServer configurable service.
Server directory	No	Yes	"/"	The directory on the FTP server from which to transfer files. If you specify this property as a relative path, it is relative to the home directory after logon. This property is overridden by the remoteDirectory property, if set, in the FtpServer configurable service.
Transfer mode	No	No	Binary	The FTP transfer mode for transfer of file data. Valid options are: <ul style="list-style-type: none"> • Binary • ASCII This property is overridden by the transferMode property, if set, in the FtpServer configurable service.
Scan delay	No	Yes	60	The delay, in seconds, between remote directory scans. This property overrides the value set for Polling interval when the FTP check box is selected. This property is overridden by the scanDelay property, if set, in the FtpServer configurable service.

The FileInput node Transactions properties are described in the following table:

Property	M	C	Default	Description
Transaction mode	No	Yes	Yes	The transaction mode on this input node determines whether the rest of the nodes in the flow are executed under sync point. Valid options are: <ul style="list-style-type: none"> • Yes • No

The FileInput node Instances properties are described in the following table. For a full description of these properties, see “Configurable message flow properties” on page 1372.

Property	M	C	Default	Description
Additional instances pool	No	Yes	Use Pool Associated with Message Flow	The pool from which additional instances are obtained. <ul style="list-style-type: none"> • If you select Use Pool Associated with Message Flow, additional instances are obtained from the message flow pool. • If you select Use Pool Associated with Node, additional instances are allocated from the node’s additional instances based on the number specified in the Additional instances property.
Additional instances	No	Yes	0	The number of additional instances that the node can start if the Additional instances pool property is set to Use Pool Associated with Node.

FileOutput node

Use the FileOutput node to write messages to files.

This topic contains the following sections:

- “Purpose”
- “Using this node in a message flow” on page 902
- “Configuring the FileOutput node” on page 902
- “Terminals and properties” on page 906

Purpose

One or more messages from message flow transactions can be written to a file in the broker’s file system. Each message, as it is written to a file, is converted to a sequence of bytes called a *record*. Records are accumulated until a process called *finish processing* is triggered. Finish processing happens when there are no more records left to process. At this point, the accumulated file is placed in the specified output directory or a remote FTP server directory. Properties on the node specify how records are accumulated into files and where the files are placed when they are finished.

The FileOutput node is contained in the **File** drawer of the palette and is represented in the workbench by the following icon:



Record processing

The FileOutput node writes files as a sequence of one or more records. Each record is generated from a single message received on the In terminal of the node.

As a default, each file comprises a single record and finish processing occurs immediately after the record is written. In other cases, properties of the FileOutput node specify that the file comprises multiple records and how these records are accumulated in a file. Records can be accumulated in a file in the following ways:

- Simply concatenated. The record from each message is appended, unmodified, to the file.
- Padded. Each record is adjusted to be a specific length and padded with a padding byte, if necessary, before being appended to the file.
- Delimited. A delimiter is used to separate or terminate the records as they are appended to the file.

For each message received, whether on the In terminal or the Finish File terminal, the output directory and the name of the file to be written (or finished) may be modified by the use of elements of the message. You can specify these elements, which, by default, identify elements in the LocalEnvironment, on the **Request** properties tab of the node.

File (finish) processing

The FileOutput node writes accumulated messages to files placed in a specified directory, the output directory, either:

- After each record when the file is to contain a single record. This is achieved by specifying Record is Whole File in the Record definition property on the **Records and Elements** tab, or
- When the Finish File terminal receives a message.

The name of the directory and the name of the file are determined by the node properties that you specify and by elements of the message being processed.

The FileOutput node uses subdirectories of the output directory to create files during processing and to move files after processing. All of these begin with the prefix **mqsi**. Among these are subdirectories called **mqsitransit**, the transit directory, and **mqsiarchive**, the archive directory. Records are not accumulated directly into a file in the output directory but are accumulated in a file in the transit directory. Files are moved from the transit directory to the output directory when finish processing occurs. If a file to be moved to the output directory has the same name as a file already in the output directory, the file in the output directory can be deleted, moved to the archive directory, mqsiarchive, or renamed before being moved to the mqsiarchive directory.

You can specify that the FileOutput node transfer files to a remote FTP server as part of finish processing. If the file is successfully transferred, it may be deleted from the local file system, or, optionally, retained for the rest of finish processing to occur as usual.

When multiple records are written, finish processing does not occur after the writing of each record; it occurs only when a message is received on the Finish File terminal of the node. Any message received on the Finish File terminal causes

finish processing to commence. This takes the file from the transit directory and either moves it to the specified output directory or transfers it to a remote FTP directory.

It is not an error for finish processing to be initiated and for no file to be present in the transit directory.

If you specify Record is Whole File in the Record definition property on the **Records and Elements** tab, finish processing does not occur when a message is received on the Finish File processing; finish processing will already have occurred.

Message propagation

For every message received on the In terminal and successfully processed by the node, a copy is propagated to the Out terminal if this is attached. This allows further processing of the message.

For every message received on the Finish File terminal and successfully processed by the node, a copy is propagated to the End of Data terminal if this is attached. This allows further processing after the finish of a file.

When the FileOutput node propagates a message, either to the Out terminal or to the End of Data terminal, it stores information in the LocalEnvironment.WrittenDestination.File message tree. This table describes the LocalEnvironment.WrittenDestination.File elements:

Table 34.

Element Name	Element Data Type	Description
Directory	CHARACTER	Absolute directory path of the output directory in the form used by the file system of the broker. For example, on Windows systems, this starts with the drive letter prefix (such as C:).
Name	CHARACTER	File name of the output file.
Action	CHARACTER	Possible values are: <ul style="list-style-type: none"> • Replace if an output file of the same name is replaced. • Create if a new output file is created. • Append if this is associated with a record that is appended to an output file. • Finish if a Finish File message is received and no file is found to finish (for example, if Record is Whole File is specified and a message is sent to the Finish File terminal). • Transmit if the file was transferred by FTP and the file was not retained.

Table 34. (continued)

Element Name	Element Data Type	Description
Timestamp	CHARACTER	The date and time, in character string form, when the node started to process this file. This is the value which prefixes the names of files that are archived if you specify Time Stamp, Archive and Replace Existing File in the Output file action property on the Basic tab.

Multiple instances

It is possible that several message flows need to write to the same file. This can happen where there are more than zero additional instances, or where there are multiple flows containing FileOutput nodes. The FileOutput node only permits a single instance, within an execution group and between execution groups, to write to a file at a time. While a record is being written (or while finish processing is being performed), all other instances in the execution group have to wait. The order in which instances gain access is not defined.

For finish processing, the first instance to gain access performs the processing, and other instances will fail to find the file. This is not an error in the flows, and the Action element of the LocalEnvironment.WrittenDestination.File message tree is set to Finish for all instances that fail to discover the file in the transit directory.

Using this node in a message flow

The FileOutput node can be used in any message flow that needs to output messages in files. Look at the following samples to see how to use this node:

- File Output sample
- Batch Processing sample
- WildcardMatch sample

You can view samples only when you use the information center that is integrated with the Message Broker Toolkit.

Configuring the FileOutput node

When you have put an instance of the FileOutput node into a message flow, you can configure it. The properties of the node are displayed in the Properties view. All mandatory properties for which you must enter a value (those that do not have a default value defined) are marked with an asterisk in that view.

To configure the FileOutput node:

1. Optional: On the **Description** tab, enter a short description, a long description, or both. You can also rename the node on this tab.
2. On the **Basic** tab, enter the details of the files created by the FileOutput node.
 - a. In Directory, specify the output directory in which the FileOutput node is to place its files. Specify the directory as an absolute or relative directory path. If the directory path is relative, it is based on the directory specified in the environment variable MQSI_FILENODES_ROOT_DIRECTORY. Examples

are, on Windows, C:\fileoutput, and, on UNIX, /var/fileoutput. If you want to write files in the directory which is itself identified by MQSI_FILENODES_ROOT_DIRECTORY, ensure that you specify a value of . in this property.

The output directory path to be used may be overridden by values in the current message. See the information relating to the Request tab for details about how to do this.

- b. In File name or pattern, specify a file name pattern. This defines the name of the file which is to be created by the FileOutput node. It is either a specific file name or a character sequence, a pattern, that matches a file name. Only patterns with a single wildcard character (the asterisk, '*') are allowed in this property field. The file name to be used is determined as follows:
- If the file name contains no wildcard, then the value of this property is the name of the file created. This must be a valid file name on the file system which hosts the broker to which the message flow is deployed.
 - If the file name contains a single wildcard, then the value of the element LocalEnvironment.Wildcard.WildcardMatch in the current message replaces the wildcard character, and the resulting value is the name of the file created. This must be a valid file name on the file system which hosts the broker to which the message flow is deployed. If the WildcardMatch value is not found, the wildcard character is replaced by the empty string.

The name of the file can be overridden by values in the current message. See the information relating to the Request tab for details about how to do this. If the File name or pattern property is empty, the name must be overridden by the current message. Note that wildcard substitution occurs only if this property is not overridden in this way.

File names are passed to the file system to which the broker has access and have to respect the conventions of these file systems. For example, file names on Windows systems are not case-sensitive, while, on UNIX systems, file names which differ by case are considered distinct.

- c. In Output file action, specify how the file is to be processed when it is finished. Choose from:
- Replace Existing File, the default, to specify that if a file of the same name already exists in the output directory, the new file replaces it.
 - Create File, to specify that a new file is created, and that if a file of the same name already exists in the output directory, the new file remains in the transit directory and an exception is thrown.
 - Archive and Replace Existing File, to specify that if any file of the same name already exists in the output directory, it is moved to the archive directory before the new file is placed in the output directory.
 - Time Stamp, Archive and Replace Existing File, to specify that if a file of the same name already exists in the output directory, its name is augmented with a time stamp (a character-based version of the date and time) before being moved to the archive directory.
- d. Select the Replace duplicate archive files check box to specify that, in cases where Archive and Replace Existing File or Time Stamp, Archive and Replace Existing File is specified in Output file action, files moved to the archive directory replace files that exist there already with the same name. By default, this check box is not selected. If this check box is not selected, it

means that if a file in the archive directory has the same name as a file that is to be moved there, an exception is raised, and the new file remains in the transit directory.

3. On the **Request** tab, specify the location of the data to be written, and any control information overriding the **Basic** tab's Directory and File name or pattern properties. You can specify the properties on this tab as XPath or ESQL expressions. Content-assist is available in the properties pane and also in the XPath Expression Builder which you can invoke by using the **Edit...** button to the right of each property.
 - a. In Data location, specify the input data location. This is the location in the input message tree that contains the record to be written to the output file. The default value is \$Body, meaning the entire message body (\$InputRoot.Body).

When you are specifying this property and the data in the message tree that it identifies is owned by a model-driven parser, such as the MRM parser or XMLNSC parser, be aware of the following considerations:

- If you are using MRM CWF format, ensure that the identified message tree exists as a message definition. If this is defined as a global element only, exceptions BIP5180 and BIP5167 are generated.
 - If you are using MRM TDS format, the serialization of the identified message is successful if the element is defined as a global element or message. However, if the identified field is not found as a global element or message, note that:
 - If this is a leaf field in the message tree, the field is written as self-defining. No validation occurs even if validation is enabled.
 - If this is a complex element, an internal exception is generated, BIP5522, indicating that the logical type cannot be converted to a string.
 - If you are using MRM XML, the events are similar as for the MRM TDS format except that, if the field is a complex element, it is written as self-defining.
 - If you use the XMLNSC parser, no validation occurs even if validation is enabled.
- b. In Request directory property location, specify the location of the value to override the Directory property on the **Basic** tab. If you do not specify a location, the default value is \$LocalEnvironment/Destination/File/Directory. If you specify a location but the element is empty or missing, the Directory property is used. The element is defined as follows:

Element data type	Element attributes
CHARACTER	Absolute or relative directory path. Use the path separator character ('/' or '\') according to the file system on which the broker is executing. Trailing path separator characters are ignored. Relative directory paths are based on the value of the MQSI_FILENODES_ROOT_DIRECTORY environment variable.

- c. In Request file name property location, specify the location of the value to override the File name or pattern property on the **Basic** tab. If you do not specify a location, the default value is \$LocalEnvironment/Destination/File/Name. If you specify a location but the element is empty or missing, the File name or pattern property is used. The element is defined as follows:

Element data type	Element attributes
CHARACTER	Explicit file name. No wildcard substitution occurs for this value.

4. Use the **Records and Elements** tab to specify how the FileOutput node writes the record derived from the message.
 - In Record definition, choose from:
 - Record is Whole File to specify that the file is to contain a single record. The file is finished immediately after the record is written; the FileOutput node does not wait for a message on the Finish File terminal. This is the default.
 - Record is Unmodified Data to specify that records are accumulated in a file with neither padding or delimiters applied. The file is finished only when a message is received on the Finish File terminal.
 - Record is Fixed Length Data to specify that records are padded to a given length if necessary and accumulated in a file by concatenation. You specify this length in the Length property. If the record is longer than the value specified in Length, the node generates an exception. Use the Padding byte property to specify the byte to be used for padding the message to the required length. The file is finished only when a message is received on the Finish File terminal.
 - Record is Delimited Data to specify that records are separated by a delimiter and accumulated by concatenation. The delimiter is specified by the Delimiter, Custom delimiter, and Delimiter type properties. The file is finished only when a message is received on the Finish File terminal.
 - In Length, specify the length (in bytes) of records when Record is Fixed Length Data is specified in Record definition. Records longer than this value cause an exception to be thrown. This must be a value between 1 byte and 100 MB. The default is 80 bytes.
 - When Record is Fixed Length Data is specified in Record definition, use Padding byte to specify the byte to be used when padding records to the specified length if they are shorter than this length. Specify this as 2 hexadecimal digits. The default value is X'20'.
 - In Delimiter, specify the delimiter to be used if you specify Record is Delimited Data in Record definition. Choose from:
 - Broker System Line End to specify that a line end sequence of bytes is used as the delimiter as appropriate for the file system on which the broker is to run. This is the default. For example, on Windows systems, this is a 'carriage-return, line-feed' pair (X'0D0A'); on UNIX systems, this is a single 'line-feed' byte (X'0A'); on z/OS systems, it is a 'newline' byte (X'15').
 - Custom Delimiter to specify that the explicit delimiter sequence defined in the Custom delimiter property is to be used to delimit records.
 - In Custom delimiter, specify the delimiter sequence of bytes to be used to be used to delimit records when Custom Delimiter is specified in the Delimiter property. Specify this as an even-numbered string of hexadecimal digits. The default is X'0A' and the maximum length of the string is 16 bytes.
 - If you specified Record is Delimited Data in Record definition, use Delimiter type to specify how the delimiter is to separate records. Choose from:
 - Postfix to specify that the delimiter is added after each record that is written. This is the default.

- Infix to specify that the delimiter is only inserted between any two adjacent records.
- 5. On the **Validation** tab, specify the parser validation properties of the node. For more information about validation, see “Validating messages” on page 164. For information on how to fill in this tab, see “Validation tab properties” on page 1360.
- 6. On the **FTP** tab, select the FTP check box if you want the node to transfer files to an FTP server using the File Transfer Protocol properties:
 - In FTP server and port, supply the internet address and port number of an FTP server to be used. Use the following syntax:
 - <IP address or URL> or
 - <IP address or URL>:<port number>

If you specify the internet address in IPv6 format, ensure that you enclose it in square brackets, for example:

- [12a::13bd:24cd] or
- [12a::13bd:24cd]:123 where 123 is the port number

If you do not specify a port number, a port number of 21 is assumed. However, if an FtpServer configurable service is defined, then you can place the name of the configurable service in this field. See FtpServer configurable service properties for information on how an FtpServer configurable service definition and the properties on this tab interact.

- In Security identity, specify the name of a security identity that has been defined using the mqsisetdbparms command. The user identifier and password that are to be used to logon to the FTP server are obtained from this definition the name of which should have the prefix ftp::. The value in this property is overridden by the value in the FtpServer configurable service property securityIdentity, if it is set.
- In Server directory, specify the directory in the FTP server to which to transfer files. The default is . which means the default directory after login. If you specify this as a relative path, this directory is based on the default directory after FTP login. Ensure that the syntax of the of the path conforms to the file system standards in the FTP server. The value in this property is overridden by the value in the FtpServer configurable service property remoteDirectory, if it is set.
- In Transfer mode, specify how files are transferred. Select Binary if the file contents are not to be transformed. Select ASCII if the file is to be transmitted as ASCII. The value in this property is overridden by the value in the FtpServer configurable service property transferMode, if it is set.
- Select the Retain local file after transfer check box if you want to retain a local copy of this after the file transfer process has completed. If this check box is selected, the local copies are processed after transfer as are other output files, as specified on the **Basic** tab. If it is not selected, successfully transferred files are not retained locally.

Terminals and properties

The FileOutput node terminals are described in the following table.

Terminal	Description
In	The input terminal that accepts a message for processing by the node.
Finish File	The input terminal that accepts a message that triggers the finishing of a file.

Terminal	Description
Out	The message received on the In terminal is propagated to this terminal if the record is written successfully. The message is unchanged except for status information in the Local Environment.
End of Data	The message received on the Finish File terminal is propagated to this terminal if the file is finished successfully.
Failure	The output terminal to which the message is routed if a failure is detected when the message is propagated.

The following tables describe the node properties. The column headed M indicates whether the property is *mandatory* (marked with an asterisk if you must enter a value when no default is defined); the column headed C indicates whether the property is *configurable* (you can change the value when you add the message flow to the bar file to deploy it).

The FileOutput node Description properties are described in the following table:

Property	M	C	Default	Description
Node name	No	No	FileOutput	The name of the node.
Short Description	No	No		A brief description of the node.
Long Description	No	No		Text that describes the purpose of the node in the message flow.

The FileOutput node Basic properties are described in the following table:

Property	M	C	Default	Description
Directory	No	Yes	None	The directory where the node places its files.
File name or pattern	No	Yes	None	The specific file name or a pattern containing a single wildcard which defines the name of the file to be created.
Output file action	Yes	No	Replace Existing File	Specifies the action to be taken when the output file is finished. Valid options are: <ul style="list-style-type: none"> • Replace Existing File • Create File • Archive and Replace Existing File • Time Stamp, Archive and Replace Existing File
Replace duplicate archive files	Yes	No	Cleared	Specifies whether files in the archive directory can be replaced by files of the same name being moved there.

The FileOutput node Request properties are described in the following table:

Property	M	C	Default	Description
Data location	Yes	No	\$Body	The location in the input message tree containing the record written to the output file.

Property	M	C	Default	Description
Request directory property location	Yes	Yes	\$LocalEnvironment/Destination/File/Directory	The message element location containing the name of the output directory.
Request file name property location	Yes	Yes	\$LocalEnvironment/Destination/File/Name	The message element location containing the name of the output file.

The FileOutput node Records and Elements properties are described in the following table:

Property	M	C	Default	Description
Record definition	Yes	No	Record is Whole File	This property controls how the records are placed in the output file. Valid options are: <ul style="list-style-type: none"> Record is Whole File Record is Unmodified Data Record is Fixed Length Data Record is Delimited Data
Length	Yes	No	80	The required length of the output record. This property applies only when Record is Fixed Length Data is specified in Record definition.
Padding byte	Yes	No	X'20'	The 2-digit hexadecimal byte to be used to pad short messages when Record is Fixed Length Data is specified in Record definition.
Delimiter	Yes	No	Broker System Line End	The delimiter to be used when Record is Delimited Data is specified in Record definition. Valid options are: <ul style="list-style-type: none"> Broker System Line End Custom Delimiter
Custom delimiter	No	No	None	The delimiter byte sequence to be used when Record is Delimited Data is specified in the Record definition property and Custom Delimiter is specified in the Delimiter property.
Delimiter type	Yes	No	Postfix	This property specifies the way in which the delimiters are to be inserted between records when Record is Delimited Data is specified in Record definition. Valid options are: <ul style="list-style-type: none"> Postfix Infix

The FileOutput node Validation properties are described in the following table.

For a full description of these properties, see “Validation properties” on page 1359.

Property	M	C	Default	Description
Validate	No	Yes	Inherit	This property controls whether validation takes place. Valid values are: <ul style="list-style-type: none"> • None • Content and Value • Content • Inherit
Failure action	No	No	Exception	This property controls what happens if validation fails. You can set this property only if you set Validate to Content or Content and Value. Valid values are: <ul style="list-style-type: none"> • User Trace • Local Error Log • Exception • Exception List

The FileOutput node FTP properties are described in the following table:

Property	M	C	Default	Description
FTP	No	No	Cleared	This property defines whether the node uses the File Transfer Protocol (FTP) properties listed on the FTP tab and transfers files to an FTP server.
FTP server and port	No	Yes	None	Either the IP address or name (and, optionally, the port number) of a remote FTP server, for example ftp.server.com:21, or the name of a configurable service of type 'FtpServer'. If a configurable service name is specified, any or all of the following FTP properties can be overridden by the configurable service.
Security identity	No	Yes	None	The name of the user identification used to access the FTP server. This property is overridden by the securityIdentity property, if set, in the FtpServer configurable service.
Server directory	No	Yes	"/"	The directory on the FTP server to which to transfer files. If you specify this as a relative path, this relative to the home directory after login. This property is overridden by the remoteDirectory property, if set, in the FtpServer configurable service.
Transfer mode	No	Yes	Binary	The FTP transfer mode for transfer of file data. Valid options are: <ul style="list-style-type: none"> • Binary • ASCII This property is overridden by the transferMode property, if set, in the FtpServer configurable service.
Retain local file after transfer	No	No	Cleared	If this check box is selected, a local copy of a file that has been transferred to a remote FTP server is retained and placed in the output directory in accordance with the disposition of files as specified on the Basic tab. If this check box is not selected, no local copies of files that have been transferred to a remote FTP server are retained.

Filter node

Use the Filter node to route a message according to message content.

This topic contains the following sections:

- “Purpose”
- “Using this node in a message flow”
- “Terminals and properties” on page 911

Purpose

Create a filter expression in ESQL to define the route that the message is to take. You can include elements of the input message or message properties in the filter expression, and you can use data that is held in an external database to complete the expression. The output terminal to which the message is routed depends on whether the expression evaluates to true, false, or unknown.

Connect the terminals that cover all situations that could result from the filter; if the node propagates the message to a terminal that is not connected, the message is discarded even if it is transactional.

The Filter node accepts ESQL statements in the same way as the Compute and Database nodes. The last statement that is executed must be a `RETURN <expression>` statement, whose expression evaluates to a Boolean value. This Boolean value determines the terminal to which the message is routed. In many cases, the routing algorithm is a simple comparison of message field values. The comparison is described by the expression and the `RETURN` statement is the only statement. If you code `RETURN` without an expression (`RETURN;`) or with a `NULL` expression, the node propagates the message to the Unknown terminal.

If your message flow requires more complex routing options, use the `RouteToLabel` and `Label` nodes.

The Filter node is contained in the **Routing** drawer of the palette, and is represented in the workbench by the following icon:



Using this node in a message flow

Look at the following samples for examples of how to use this node:

- Airline Reservations sample
- Scribble sample
- Error Handler sample
- Large Messaging sample

You can view samples only when you use the information center that is integrated with the Message Broker Toolkit.

Consider a situation in which you have produced an online test with ten multiple choice questions. Each message coming in has a candidate name and address followed by a series of answers. Each answer is checked, and if it is correct, the field `SCORE` is incremented by one. When all the answers have been checked, the field `SCORE` is tested to see if it is greater than five. If it is, the Filter node

propagates the message to the flow that handles successful candidate input; otherwise, the message is filtered into the rejection process, and a rejection message is created.

Terminals and properties

When you have put an instance of the Filter node into a message flow, you can configure it; see “Configuring a message flow node” on page 235. The properties of the node are displayed in the Properties view. All mandatory properties for which you must enter a value (those that do not have a default value defined) are marked with an asterisk.

The Filter node terminals are described in the following table.

Terminal	Description
In	The input terminal that accepts a message for processing by the node
Failure	The output terminal to which the message is routed if a failure is detected during the computation
Unknown	The output terminal to which the message is routed if the specified filter expression evaluates to unknown or null
False	The output terminal to which the message is routed if the specified filter expression evaluates to false
True	The output terminal to which the message is routed if the specified filter expression evaluates to true

The following tables describe the node properties. The column headed M indicates whether the property is *mandatory* (marked with an asterisk if you must enter a value when no default value is defined); the column headed C indicates whether the property is *configurable* (you can change the value when you add the message flow to the bar file to deploy it).

The Filter node Description properties are described in the following table.

Property	M	C	Default	Description
Node name	No	No	The node type	The name of the node.
Short Description	No	No		A brief description of the node
Long Description	No	No		Text that describes the purpose of the node in the message flow

The Filter node Basic properties are described in the following table.

Property	M	C	Default	Description
Data Source	No	Yes		<p>The ODBC data source name of the database that contains the tables to which you refer in the ESQL that is associated with this node (identified by the Filter Expression property). This name identifies the appropriate database on the system on which this message flow is to execute. The broker connects to this database with user ID and password information that you have specified on the mqsicreatebroker, mqsichangebroker, or mqsisetdbparms command.</p> <p>z/OS On z/OS systems, the broker uses the broker started task ID, or the user ID and password that are specified on the mqsisetdbparms command JCL, BIPSDBP, in the customization data set <hlq>.SBIPPROC.</p> <p>If the ESQL that is associated with this node includes a PASSTHRU statement or SELECT function and a database reference, you must specify a value for the Data Source property.</p>
Transaction	Yes	No	Automatic	<p>The transaction mode for the node. The values are:</p> <ul style="list-style-type: none"> • Automatic (the default). The message flow, of which the Filter node is a part, is committed if it is successful. That is, the actions that you define in the ESQL module are performed and the message continues through the message flow. If the message flow fails, it is rolled back. Therefore, if you choose Automatic, the ability to commit or rollback the action of the Filter node on the database depends on the success or failure of the entire message flow. • Commit. To commit any uncommitted actions that are performed in this message flow on the database that is connected to this node, irrespective of the success or failure of the message flow as a whole, select Commit. The changes to the database are committed even if the message flow itself fails.

Property	M	C	Default	Description
Filter Expression	Yes	No	Filter	<p>The name of the module within the ESQL resource (file) that contains the statements to execute against the message that is received in the node The ESQL file, which by default has the name <message_flow_name>.esql, contains ESQL for every node in the message flow that requires it. Each portion of code that is related to a specific node is known as a module. If you want the module name to include one or more spaces, enclose it in double quotes in the Filter Expression property.</p> <p>Code ESQL statements to customize the behavior of the Filter node in an ESQL file that is associated with the message flow in which you have included this instance of the Filter node.</p> <p>If an ESQL file does not already exist for this message flow, double-click the Filter node, or right-click the node and click Open ESQL to create and open a new ESQL file in the ESQL editor view.</p> <p>If the file exists already, click Browse beside the Filter Expression property to display the Module Selection dialog box, which lists the available Filter node modules defined in the ESQL files that can be accessed by this message flow (ESQL files can be defined in other, dependent, projects). Select the appropriate module and click OK; if no suitable modules are available, the list is empty.</p> <p>If the module that you specify does not exist, that module is created for you, and the editor displays it. If the file and the module exist already, the editor highlights the correct module.</p> <p>If a module skeleton is created for this node in a new or existing ESQL file, it consists of the following ESQL. The default module name is shown in this example:</p> <pre>CREATE FILTER MODULE <flow_name> Filter CREATE FUNCTION Main() RETURNS BOOLEAN BEGIN RETURN TRUE; END; END MODULE;</pre> <p>If you create your own ESQL module, you must create this skeleton exactly. You can update the default name, but ensure that the name that you specify matches the name of the corresponding node property Filter Expression.</p> <p>To customize this node, add your own ESQL after the BEGIN statement, and before the RETURN statement. If the expression on the RETURN statement is not TRUE or FALSE, its value is resolved to determine the terminal to which the message is propagated. If the expression resolves to NULL, or you code RETURN;, or you omit the RETURN statement, the node propagates the message to the Unknown terminal.</p> <p>You can use all the ESQL statements including SET, WHILE, DECLARE, and IF in this module, but (unlike the Compute node) the Filter node propagates the message that it receives at its input terminal to its output terminal unchanged. Therefore, in the Filter node, like the Database node, you have only one message to which to refer.</p> <p>The ESQL correlation names that you use in a Filter node are different from those used for a Compute node. For more information about correlation names refer to the related links.</p> <p>You cannot modify any part of any message, so the assignment statement (the SET statement, not the SET clause of the INSERT statement) can assign values only to temporary variables. The scope of actions that you can take with an assignment statement is therefore limited.</p>

Property	M	C	Default	Description
Treat warnings as errors	Yes	No	Cleared	<p>For database warning messages to be treated as errors, and to propagate the output message from the node to the Failure terminal, select Treat warnings as errors. The check box is cleared initially.</p> <p>When you select the check box, the node handles all positive return codes from the database as errors and generates exceptions in the same way as it does for the negative, or more serious, errors.</p> <p>If you do not select the check box, the node treats warnings as normal return codes and does not raise any exceptions. The most significant warning raised is not found, which can be handled safely as a normal return code in most circumstances.</p>
Throw exception on database error	Yes	No	Selected	<p>For the broker to generate an exception when a database error is detected, select Throw exception on database error. The check box is selected initially.</p> <p>If you clear the check box, you must include ESQL to check for any database error that might be returned after each database call that you make (you can use SQLCODE and SQLSTATE to do this). If an error has occurred, you must handle the error in the message flow to ensure the integrity of the broker and the database; the error is ignored if you do not handle it through your own processing because you have chosen not to invoke the default error handling by the broker. For example, you can include the ESQL THROW statement to throw an exception in this node, or you can use the Throw node to generate your own exception at a later point.</p>

FlowOrder node

Use the FlowOrder node to control the order in which a message is processed by a message flow.

This topic contains the following sections:

- “Purpose”
- “Using this node in a message flow” on page 915
- “Connecting the terminals” on page 915
- “Terminals and properties” on page 915

Purpose

The FlowOrder node propagates the input message to the first output terminal, and the sequence of nodes that is connected to this terminal processes the message. When that message processing is complete, control returns to the FlowOrder node. If the message processing completes successfully, the FlowOrder node propagates the input message to the second output terminal, and the sequence of nodes that is connected to this terminal processes the message.

The message that is propagated through the second output terminal is the input message; it is not modified in any way, even if the sequence of nodes that is connected to the first terminal has modified the message.

You can include this node in a message flow at any point where the order of execution of subsequent nodes is important.

If you connect multiple nodes to the first output terminal, the second output terminal, or both, the order in which the multiple connections on each terminal are processed is random and unpredictable. However, the message is propagated to all

target nodes that are connected to the first output terminal, which must all complete successfully, before the message is propagated to any node that is connected to the second output terminal.

Your message flow performance can benefit from including the FlowOrder node in a situation where one sequence of processing that is required for a message is significantly shorter than another sequence of processing. If you connect the shorter sequence to the first terminal, any failure is identified quickly and prevents execution of the second longer sequence of processing.

The FlowOrder node is contained in the **Construction** drawer of the palette, and is represented in the workbench by the following icon:



Using this node in a message flow

For an example of using this node, assume that your company receives orders from customers using the Internet. When the order is received, it is processed by nodes that are connected to the first terminal of a FlowOrder node to debit the stock level in your database and raise an invoice. A check is made to see whether the customer has indicated that his details can be sent to other suppliers. If the customer has indicated that he does not want this information to be divulged, this check fails and no further processing occurs. If the customer is happy for you to share his details with other companies (that is, the test is successful), the input message is propagated to the second terminal so that the customer's details can be added to the mailing list.

Connecting the terminals

The FlowOrder node has no configurable properties that impact its operation. You determine how it operates by connecting the first and second output terminals to subsequent nodes in your message flow.

1. Connect the First terminal to the first node in the sequence of nodes that provide the first phase of processing this message. This sequence can contain one or more nodes that perform any valid processing. The sequence of nodes can optionally conclude with an output node.
2. Connect the Second terminal to the first node in the sequence of nodes that provide the second phase of processing this message. This sequence can contain one or more nodes that perform any valid processing. The sequence of nodes can optionally conclude with an output node.

The message that is propagated through the Second terminal is identical to that propagated through the First terminal. Any changes that you have introduced as a result of the first phase of processing are ignored by this node.

If the first phase of processing fails, the FlowOrder node does not regain control and does not propagate the message through the Second terminal.

Terminals and properties

When you have put an instance of the FlowOrder node into a message flow, you can configure it. For more information, see “Configuring a message flow node” on page 235. The properties of the node are displayed in the Properties view.

The FlowOrder node terminals are described in the following table.

Terminal	Description
In	The input terminal that accepts a message for processing by the node.
Failure	The output terminal to which the message is routed if a failure is detected during the computation.
First	The output terminal to which the input message is routed in the first instance.
Second	The output terminal to which the input message is routed in the second instance. The message is routed to this terminal only if routing to First is successful.

The following table describes the node properties. The column headed M indicates whether the property is *mandatory* (marked with an asterisk if you must enter a value when no default is defined); the column headed C indicates whether the property is *configurable* (you can change the value when you add the message flow to the bar file to deploy it).

The FlowOrder node Description properties are described in the following table.

Property	M	C	Default	Description
Node name	No	No	FlowOrder	The name of the node.
Short description	No	No		A brief description of the node.
Long description	No	No		Text that describes the purpose of the node in the message flow.

HTTPHeader node

Use the HTTPHeader node to add, modify or delete HTTP headers such as HTTPInput, HTTPResponse, HTTPRequest and HTTPReply.

This topic contains the following sections:

- “Purpose”
- “Using this node in a message flow” on page 917
- “Terminals and properties” on page 917

Purpose

The HTTPHeader node provides a toolkit interface to manipulate HTTP headers without any need for coding; it does not modify the message body. You can add or remove a whole header, or selected header properties. You can set the properties to a fixed value, or to a value specified by an XPath expression that accesses a value in one of the message trees. XPath is used to provide a valid location from which a value for a property can be copied. For example, the location can be the body of the message, the local environment tree or exception list.

HTTPInput and HTTPResponse headers can only be deleted or carried forward from the incoming message: their header properties cannot be modified or added to.

The HTTPHeader node is contained in the **HTTP** drawer of the palette, and is represented in the workbench by the following icon:



Using this node in a message flow

Look at the following sample for more details about how to use the node:

- HTTPHeader node sample

You can view samples only when you use the information center that is integrated with the Message Broker Toolkit.

Terminals and properties

When you have put an instance of the node into a message flow, you can configure it; see “Configuring a message flow node” on page 235. This node has no mandatory properties.

HTTPHeader node terminals are described in the following table.

Terminal	Description
In	The input terminal that accepts a message for processing by the node.
Failure	The output terminal to which the input message is routed if a failure is detected during extraction.
Out	The output terminal to which the transformed message is routed if the input message is processed successfully.

The following tables describes the node properties. The column headed M indicates whether the property is *mandatory* (marked with an asterisk if you must enter a value when no default is defined); the column headed C indicates whether the property is *configurable* (you can change the value when you add the message flow to the bar file to deploy it).

The HTTPHeader node Description properties are described in the following table.

Property	M	C	Default	Description
Node name	No	No	HTTPHeader	The name of the node.
Short description	No	No		A brief description of the node.
Long description	No	No		Text that describes the purpose of the node in the message flow.

HTTPInput Header properties are described in the following table.

Property	M	C	Default	Description
HTTPInput Header Options	No	Yes	Carry forward header	Options to control the HTTPInputHeader as a whole. Select Carry forward the header to carry forward values from incoming message if present. Select Delete header to delete the header if present.

HTTPResponse Header properties are described in the following table.

Property	M	C	Default	Description
HTTPResponse Header Options	No	Yes	Carry forward header	Options to control the HTTPResponseHeader as a whole. Select Carry forward the header to carry forward values from incoming message if present. Select Delete header to delete the header if present.

HTTPRequest Header properties are described in the following table.

Property	M	C	Default	Description
HTTPRequest Header Options	No	Yes	Carry forward header	Configure the HTTPRequest header. These options are available. Carry forward header Select this option to carry forward values from an incoming message. Add header Select this option to add new properties to the header, or to modify or delete existing properties. Modify header Select this option to add properties, or modify and delete existing properties. Delete header Select this option to remove the HTTPRequest header and all associated properties from the incoming message.
Clear incoming values	No	Yes	Cleared	This option, which is enabled only if you choose Modify header , removes all property names and associated values from the incoming message if present.

Property	M	C	Default	Description
HTTPRequest Header	No	Yes	No default value	<p>This field is enabled only if you chose Add header or Modify header for the HTTPRequest Header Options. The screen has no predefined properties; you use it to create custom properties and values. Use the property table to add new properties, or modify or delete existing properties, for the header. There is no limit to the number of properties. Each property must have a name, and a type qualifier. The type qualifier can be Value, XPath, or Delete.</p> <p>Value Enter a new valid value for the selected property. A null value or empty string is also considered as a valid value.</p> <p>XPath Specify a valid XPath expression. WebSphere Message Broker supports XPath definitions that start with an XPath variable such as \$Root or \$LocalEnvironment. Only the first occurrence is returned if there are multiple values for the given XPath expression. (Examples of valid XPath expressions are: \$LocalEnvironment/Host, and \$Root/HTTPRequest/Content-Type).</p> <p>Delete Specify the property to be deleted from the incoming message. The value associated with the selected property is also deleted.</p>

HTTPReply Header properties are described in the following table.

Property	M	C	Default	Description
HTTPReply Header Options	No	Yes	Carry forward header	<p>Configure the HTTPReply header. These options are available.</p> <p>Carry forward header Select this option to carry forward values from an incoming message.</p> <p>Add header Select this option to add new properties to the header, or to modify or delete existing properties.</p> <p>Modify header Select this option to add properties, or modify and delete existing properties.</p> <p>Delete header Select this option to remove the HTTPReply header and all associated properties from the incoming message.</p>
Clear incoming values	No	Yes	Cleared	<p>This option, which is enabled only if you choose Modify header, removes all property names and associated values from the incoming message if present.</p>

Property	M	C	Default	Description
HTTPReply Header	No	Yes	No default value	<p>This field is enabled only if you chose Add header or Modify header for HTTPRequest Header Options. The screen has no predefined properties; you use it to create custom properties and values. Use the property table to add new properties, or modify or delete existing properties, for the header. There is no limit to the number of properties. Each property must have a name, and a type qualifier. The type qualifier can be Value, XPath, or Delete.</p> <p>Value Enter a new valid value for the selected property. A null value or empty string is also considered as a valid value.</p> <p>XPath Specify a valid XPath expression. WebSphere Message Broker supports XPath definitions that start with an XPath variable such as \$Root or \$LocalEnvironment. Only the first occurrence is returned if there are multiple values for the given XPath expression. (Examples of valid XPath expressions are: \$LocalEnvironment/Host, and \$Root/HTTPRequest/Content-Type).</p> <p>Delete Specify the property to be deleted from the incoming message. The value associated with the selected property is also deleted.</p>

HTTPInput node

Use the HTTPInput node to receive an HTTP message from an HTTP client for processing by a message flow.

This topic contains the following sections:

- "Purpose"
- "Using this node in a message flow" on page 922
- "Connecting the terminals" on page 923
- "Terminals and properties" on page 923

Purpose

If you use the HTTPInput node with the HTTPReply and HTTPRequest nodes, the broker can act as an intermediary for Web services, and Web service requests can be transformed and routed in the same way as other message formats that are supported by WebSphere Message Broker. Web service requests can be received either in standard HTTP (1.0 or 1.1) format, or in HTTP over SSL (HTTPS) format. Set the Use HTTPS property to choose whether to handle HTTP or HTTPS requests.

If your message flows are processing SOAP messages, use the SOAP nodes in preference to the HTTPInput node to take advantage of enhanced features, including WS-Addressing and WS-Security.

If you include an HTTPInput node in a message flow, you must either include an HTTPReply node in the same flow, or pass the message to another flow that includes an HTTPReply node (for example, through an MQOutput node to a

second flow that starts with an MQInput node). In the latter case, the request from, and reply to, the client are coordinated by the request identifier stored in the LocalEnvironment.

The HTTPInput node handles messages in the following message domains:

- MRM
- XMLNSC
- XMLNS
- MIME
- BLOB
- XML (this domain is deprecated; use XMLNSC)

When the HTTPInput node receives a message from a Web service client, it starts the appropriate parsers to interpret the headers and the body of the message, and to create the message tree that is used internally by the message flow. The node creates a unique identifier for the input message and stores it as a binary array of 24 bytes in the LocalEnvironment tree at LocalEnvironment.Destination.HTTP.RequestIdentifier. This value is used by the HTTPReply node and must not be modified in any way.

HTTP messages are always non-persistent, and have no associated order.

HTTP messages are non-transactional. However, if the message flow interacts with a database or another external resource, such as a WebSphere MQ queue, these interactions are performed in a transaction. The HTTPInput node provides commit or rollback, depending on how the message flow has ended, and how it is configured for error handling (how failure terminals are connected, for example). If the message flow is rolled back by this node, a fault message is generated and returned to the client. The format of the fault is defined by the Fault format property

If an exception occurs downstream in this message flow, and it is not caught but is returned to this node, the node constructs an error reply to the client. This error is derived from the exception and the format of the error is defined by the Fault format property.

If you include an output node in a message flow that starts with an HTTPInput node, it can be any of the supported output nodes (including user-defined output nodes). You can create a message flow that receives messages from Web service clients, and generates messages for clients that use all of the supported transports to connect to the broker. You can configure the message flow to request the broker to provide any conversion that is necessary.

If you create a message flow to use as a subflow, you cannot use a standard input node; you must use an instance of the Input node as the first node to create an In terminal for the subflow.

If your message flow does not receive Web service requests, use any of the other input nodes.

The HTTPInput node is contained in the **HTTP** drawer of the palette, and is represented in the workbench by the following icon:



Using the HTTPInput and HTTPReply nodes to act as a Web server

A broker can support multiple HTTPInput nodes. In the HTTPInput node you must specify the requests to which the node listens. If the broker is listening on address `http://localhost:7080`, for a request `http://localhost:7080/Joe/Mary`, the HTTP listener removes the HTTP address leaving the request (`Joe/Mary`). The listener then matches the request with the information that is specified in the URL selector of the HTTPInput node; this match is done from the most specific to the most generic data. For example, if the following values were specified in HTTPInput nodes:

```
/Joe /Joe/Mary /Joe/* /*
```

this format gets the message if no other node matches the request. So for the request: `http://localhost:777/Joe/Mary`, it matches `Joe/*`. If the request does not match any URL selector, and you do not have an input node with `/*` specified, the HTTPInput node returns a response to the originator. For example:

```
<html>
<head>
  <title>WebSphere MQ Integrator error report
</title>
</head>
<body>
  <h1>HTTP Status 404 - Resource Not Found</h1>
  URI /soap does not map to any message flow in broker VCP1BRK
  <p>
  <h3>WebSphere MQ Integrator 500</h3>
</body>
</html>
```

You can use a URL of `/*` to catch any requests that failed to match the URLs in the HTTPInput nodes, enabling you to send a reply message and take other actions as appropriate.

The broker must be configured to use a port (the default is 7080). The HTTP listener is started in the administration task and listens on this port. When a request comes in, the listener sends the request to the HTTPInput node through a WebSphere MQ message.

The broker starts this listener when a message flow that includes HTTP nodes or Web Services support is started.

The HTTP listener listens on Internet Protocol Version 6 (IPv6) and Internet Protocol Version 4 (IPv4) addresses where supported by the operating system. To enable IPv6 listening on Windows and HP/UX platforms, set the environment variable `_JAVA_OPTIONS` to `-Djava.net.preferIPv4Stack=false`.

You can use the `mqsichangetrace` command to collect trace information for the HTTP listener. To process the log, use the `mqsireadlog` command with *qualifier* set to `httplistener`.

Using this node in a message flow

You can use the HTTPInput node in any message flow that accepts HTTP or HTTPS messages. The most common example is a message flow that implements a Web service.

For more information about Web services, see “Working with Web services” on page 615.

The HTTPInput node supports HTTP POST and HTTP GET. For more information about enabling HTTP GET, see “HTTPRequest node” on page 929.

Connecting the terminals

The HTTPInput node routes each message that it retrieves successfully to the Out terminal. If message validation fails, the message is routed to the Failure terminal; you can connect nodes to this terminal to handle this condition. If you have not connected the Failure terminal, the message is discarded, the Maximum client wait time expires, and the TCP/IP listener returns an error to the client. No other situations exist in which the message is routed to the Failure terminal.

If the message is caught by this node after an exception has been thrown further on in the message flow, the message is routed to the Catch terminal. If you have not connected the Catch terminal, the message is discarded, the Maximum client wait time expires, and the TCP/IP listener returns an error to the client.

Terminals and properties

When you have put an instance of the HTTPInput node into a message flow, you can configure it; see “Configuring a message flow node” on page 235. The properties of the node are displayed in the Properties view. All mandatory properties for which you must enter a value (those that do not have a default value defined) are marked with an asterisk.

The HTTPInput node terminals are described in the following table:

Terminal	Description
Failure	The output terminal to which the message is routed if an error occurs.
Out	The output terminal to which the message is routed if it is successfully retrieved.
Catch	The output terminal to which the message is routed if an exception is thrown downstream and caught by this node.

The following tables describe the node properties. The column headed M indicates whether the property is *mandatory* (marked with an asterisk if you must enter a value when no default is defined); the column headed C indicates whether the property is *configurable* (you can change the value when you add the message flow to the bar file to deploy it).

The HTTPInput node Description properties are described in the following table.

Property	M	C	Default	Description
Node name	No	No	The node type, HTTPInput	The name of the node.
Short description	No	No		A brief description of the node.
Long description	No	No		Text that describes the purpose of the node in the message flow.

The HTTPInput node Basic properties are described in the following table.

Property	M	C	Default	Description
Path suffix for URL	Yes	Yes		This property identifies the location from where Web service requests are retrieved. Do not use the full URL. If the URL that you want is <code>http://<hostname>[:<port>]/[<path>]</code> , specify either <code>/<path></code> or <code>/<path fragment>/*</code> where <code>*</code> is a wild card that you can use to mean match any.
Use HTTPS	No	Yes	Cleared	This property identifies whether the node is to accept secure HTTP. If the node is to accept secure HTTP, select the check box.

The HTTPInput node Input Message Parsing properties are described in the following table.

Property	M	C	Default	Description
Message domain	No	No	BLOB	<p>The domain that is used to parse the incoming message. If you leave this field blank, the default value is BLOB. Select the name of the parser that you are using from the list:</p> <ul style="list-style-type: none"> • MRM • XMLNSC • XMLNS • MIME • BLOB • XML (this domain is deprecated; use XMLNSC) <p>You can also specify a user-defined parser, if appropriate.</p>
Message set	No	No		<p>The name or identifier of the message set in which the incoming message is defined. All available message sets are in the list.</p> <p>If you are using the MRM parser or the XMLNSC parser in validating mode, select the Message set that you want to use. This list is populated with available message sets when you select MRM or XMLNSC as the domain.</p> <p>If you set this property, then subsequently update the project dependencies to remove this message set reference, a warning is issued. Either update the Message set property, or restore the reference to this message set project.</p>
Message type	No	No		<p>The name of the incoming message.</p> <p>If you are using the MRM parser, select the type of message from the list in Message type. This list is populated with messages that are defined in the Message set that you have selected.</p>
Message format	No	No		<p>The name of the physical format of the incoming message.</p> <p>If you are using the MRM parser, select the format of the message from the list in Message format. This list includes all the physical formats that you have defined for this Message set.</p>

The properties of the Parser Options for the HTTPInput node are described in the following table.

Property	M	C	Default	Description
Parse timing	No	No	On Demand	<p>This property controls when an input message is parsed. Valid values are On Demand, Immediate, and Complete.</p> <p>By default, this property is set to On Demand, which causes parsing of the message to be delayed. To cause the message to be parsed immediately, see "Parsing on demand" on page 1363.</p>

Property	M	C	Default	Description
Build tree using XML schema data types	No	No	Cleared	This property controls whether the XMLNSC parser creates syntax elements in the message tree with data types taken from the XML Schema. You can select this property only if you set the Validate property on the Validation tab to Content or Content and Value.
Use XMLNSC compact parser for XMLNS domain	No	No	Cleared	This property controls whether the XMLNSC Compact Parser is used for messages in the XMLNS Domain. If you set this property, the message data appears under XMLNSC in nodes that are connected to the output terminal when the input MQRFH2 header or Input Message Parsing properties Message domain is XMLNS.
Retain mixed content	No	No	Cleared	This property controls whether the XMLNSC parser creates elements in the message tree when it encounters mixed text in an input message. If you select the check box, elements are created for mixed text. If you clear the check box, mixed text is ignored and no elements are created.
Retain comments	No	No	Cleared	This property controls whether the XMLNSC parser creates elements in the message tree when it encounters comments in an input message. If you select the check box, elements are created for comments. If you clear the check box, comments are ignored and no elements are created.
Retain processing instructions	No	No	Cleared	This property controls whether the XMLNSC parser creates elements in the message tree when it encounters processing instructions in an input message. If you select the check box, elements are created for processing instructions. If you clear the check box, processing instructions are ignored and no elements are created.
Opaque elements	No	No	Blank	This property is used to specify a list of elements in the input message that are to be opaquely parsed by the XMLNSC parser. Opaque parsing is performed only if validation is not enabled (that is, if Validate is None); entries that are specified in Opaque Elements are ignored if validation is enabled.

The HTTPInput node Error handling properties are described in the following table:

Property	M	C	Default	Description
Maximum client wait time (sec)	Yes	No	180	The length of time, in seconds, for which the TCP/IP listener that received the input message from the Web service client waits for a response from the HTTPReply node in the message flow. If a response is received within this time, the listener propagates the response to the client. If a response is not received in this time, the listener sends a SOAP Fault message to the client indicating that its timeout has expired. The valid range is zero (which means an indefinite wait) to $(2^{31})-1$.
Fault format	No	Yes	SOAP 1.1	The format of any HTTP errors that are returned to the client. Valid values are SOAP 1.1, SOAP 1.2, and HTML.

The Validation properties of the HTTPInput node are described in the following table:

If a message is propagated to the Failure terminal of the node, it is not validated. For more details, see “Validating messages” on page 164 and “Validation properties” on page 1359.

Property	M	C	Default	Description
Validate	No	Yes	None	This property controls whether validation takes place. Valid values are None, Content and Value, and Content.
Failure action	No	No	Exception	This property controls what happens if validation fails. You can set this property only if you set Validate to Content or Content and Value. Valid values are User Trace, Local Error Log, Exception, and Exception List.

The Security properties of the HTTPInput node are described in the following table.

Set values for the properties that control the extraction of an identity from a message when a security profile is associated with the node. For more information about these properties, see Identity, Configuring identity extraction, Message flow security, and Setting up message flow security.

Property	M	C	Default	Description
Identity token type	No	No	None	This property specifies the type of identity token present in the incoming message. Valid values are: Transport Default, Username, Username + Password, and X.509 Certificate. If this property is not specified, the identity is retrieved from the transport headers and the type is set to Username + Password.
Identity token location	No	No	None	This property specifies where, in the message, the identity can be found. The location is specified as an ESQL field reference or XPath. If this property is not specified, the identity is retrieved from the Authorization Transport headers.
Identity password location	No	No	None	This property specifies where, in the message, the password can be found. The location is specified as an ESQL field reference or XPath. If you do not specify a value for this property, the password is retrieved from the Authorization Transport headers. You can set this property only if the Identity type is set to Username + Password.
Identity IssuedBy location	No	No	None	This property specifies a string or path expression that describes the issuer of the identity. The location is specified as an ESQL field reference or XPath. This property is used in an identity mapper. If you do not specify a value for this property, the default value is the name of the User Agent, or, if this name is not set, the string HTTP.
Treat security exceptions as normal exceptions	No	No	False	This specifies whether to treat security exceptions (such as Access Denied) as normal exceptions, and propagate them down the failure terminal (if wired). This is turned off by default, which ensures that security exceptions cause the message to be backed out even if the failure terminal is wired.

The HTTPInput node Advanced properties are described in the following table.

Property	M	C	Default	Description
Set destination list	No	No	Selected	This property specifies whether to add the method binding name to the route to label destination list. If you select this check box, the method binding name is added so that you can use a RouteToLabel node in the message flow after the HTTPInput node.
Label prefix	No	No	None	The prefix to add to the method name when routing to label. Add a label prefix to avoid a clash of corresponding label nodes when you include multiple WebSphere Message Broker input nodes in the same message flow. By default, there is no label prefix, therefore the method name and label name are identical.

HTTPReply node

Use the HTTPReply node to return a response from the message flow to an HTTP client. This node generates the response to an HTTP client from which the input message was received by the HTTPInput node, and waits for confirmation that it has been sent.

This topic contains the following sections:

- “Purpose”
- “Connecting the output terminals to another node”
- “Terminals and properties”

Purpose

The HTTPReply node can be used in any message flow that needs to accept HTTP or HTTPS messages. The most common example of this is a message flow that implements a Web service.

For more information about Web services, see “Working with Web services” on page 615.

If you include an HTTPReply node in a message flow, you must either include an HTTPInput node in the same flow, or the message must be received from another flow that is running in the same broker, and that started with an HTTPInput node. The response is associated with the reply by a request identifier that is stored in LocalEnvironment by the HTTPInput node.

This node constructs a reply message for the Web service client from the entire input message tree, and returns it to the requestor.

The HTTPReply node is contained in the **HTTP** drawer of the palette, and is represented in the workbench by the following icon:



Connecting the output terminals to another node

Connect the Out or Failure terminal of this node to another node in this message flow if you want to process the message further, process errors, or send the message to an additional destination.

Terminals and properties

When you have put an instance of the HTTPReply node into a message flow, you can configure it; see “Configuring a message flow node” on page 235. The properties of the node are displayed in the Properties view. All mandatory properties for which you must enter a value (those that do not have a default value defined) are marked with an asterisk.

The HTTPReply node terminals are described in the following table.

Terminal	Description
In	The input terminal that accepts a message for processing by the node.

Terminal	Description
Failure	The output terminal to which the message is routed if a failure is detected when the message is propagated.
Out	The output terminal to which the message is routed if it has been propagated successfully, and if further processing is required within this message flow.

The following tables describe the node properties. The column headed M indicates whether the property is *mandatory* (marked with an asterisk if you must enter a value when no default is defined); the column headed C indicates whether the property is *configurable* (you can change the value when you add the message flow to the bar file to deploy it).

The HTTPReply node Description properties are described in the following table.

Property	M	C	Default	Description
Node name	No	No	HTTPReply	The name of the node.
Short description	No	No		A brief description of the node.
Long description	No	No		Text that describes the purpose of the node in the message flow.

The HTTPReply node Basic properties are described in the following table.

Property	M	C	Default	Description
Ignore transport failures	Yes	No	Selected	Select Ignore transport failures if you want transport-related failures to be ignored (for example, if the client is disconnected). If you clear the check box, and a transport-related error occurs, the input message is propagated to the Failure terminal. If you clear the check box, you must supply a value for Reply send timeout (sec).
Reply send timeout (sec)	Yes	No	120	Set the Reply send timeout (sec) value if you are not ignoring transport failures. This property specifies the length of time, in seconds, that the node waits for an acknowledgment that the client has received the reply. If the acknowledgment is received within this time, the input message is propagated through the Out terminal to the rest of the message flow, if it is connected. If an acknowledgment is not received within this time, the input message is propagated through the Failure terminal, if it is connected. If the Failure terminal is not connected, and an acknowledgment is not received in time, an exception is generated. The valid range is zero (which means an indefinite wait) to $(2^{31})-1$. This property is valid only if Ignore transport failures is cleared.
Generate default HTTP headers from reply or response	Yes	No	Selected	Select Generate default HTTP headers from reply or response if you want the default Web service headers to be created using values from the HTTPReplyHeader or the HTTPResponseHeader. If the appropriate header is not present in the input message, default values are used. The node always includes, in the HTTPReplyHeader, a Content-Length header, which is set to the correct calculated value, even if this was not included in the original request.

The Validation properties of the HTTPReply node are described in the following table.

If a message is propagated to the Failure terminal of the node, it is not validated. For a full description of these properties, see “Validation properties” on page 1359.

Property	M	C	Default	Description
Validate	No	Yes	Inherit	This property controls whether validation takes place. Valid values are None, Content and Value, Content, and Inherit.
Failure action	No	No	Exception	This property controls what happens if validation fails. You can set this property only if you set Validate to Content or Content and Value. Valid values are User Trace, Local Error Log, Exception, and Exception List.

HTTPRequest node

Use the HTTPRequest node to interact with a Web service, using all or part of the input message as the request that is sent to that service.

This topic contains the following sections:

- “Purpose”
- “Using the HTTPRequest node to issue a request to a Web service” on page 930
- “Using the HTTPRequest node in a message flow” on page 930
- “Configuring the HTTPRequest node” on page 932
- “Terminals and properties” on page 937
- “LocalEnvironment overrides” on page 941

Purpose

You can also configure the node to create a new output message from the contents of the input message, augmented by the contents of the Web service response, before you propagate the message to subsequent nodes in the message flow.

Depending on the configuration, this node constructs an HTTP or an HTTP over SSL (HTTPS) request from the specified contents of the input message, and sends this request to the Web service. The node receives the response from the Web service, and parses the response for inclusion in the output tree. The node generates HTTP headers if these are required by your configuration.

You can use this node in a message flow that does or does not contain an HTTPInput or HTTPReply node.

The HTTPRequest node handles messages in the following message domains:

- MRM
- XMLNSC
- XMLNS
- MIME
- BLOB
- XML (this domain is deprecated; use XMLNSC)

The HTTPRequest node is contained in the **HTTP** drawer of the palette, and is represented in the workbench by the following icon:



Using the HTTPRequest node to issue a request to a Web service

An HTTP request has two parts:

1. The URL of a service.
2. A stream of data that the remote server processes, then sends back a response, which is often a SOAP or other Web service message in XML.

The URL is of the format `http://<address>[:port]/<function>`; for example, `http://localhost:7080/request`. This URL can be specified statically in the HTTPRequest node parameters as a field in the message itself, or as a field in the LocalEnvironment. The data to be sent to the Web service can be the whole, or a portion of, the message tree, as specified in the HTTPRequest node properties.

The data must be in CCSID 1208 format for most requests. The reply can replace the input message, or be inserted into the message tree; the location is specified in the HTTPRequest node parameters. The domain for the reply is XMLNS. If the request is successful, the HTTPResponse is inserted into the front of the message tree, the reply placed in the specified location in the tree, and the request propagated to the Out terminal. If the HTTPRequest node is not able to issue the request, an ExceptionList is inserted into the message tree and the tree is propagated to the Failure terminal.

If the request is sent successfully by the HTTPRequest node, but the Web service is not successful, the HTTPResponse is inserted into the message tree, and propagated to the Error terminal. The error message location parameter on the HTTPRequest node specifies where in the tree the response is placed, for example `OutputRoot.XMLNS.error`. You might need to use a Compute node to cast this response to an appropriate code page to be able to display the data, for example:

```
Set OutputRoot.XMLNS.error850 = CAST(InputRoot.XMLNS.error.BLOB as CHAR CCSID 850);
```

Standards for HTTP requests (RFC 2616) are available online. For more information about HTTP return codes, see HTTP Response codes.

You can specify a timeout interval, so that if the request takes longer than the specified duration, the request is propagated to the Error terminal with an appropriate message. For each request that the HTTPRequest node processes, it opens a connection, and then closes it when the response is returned. If the timeout interval is specified, the socket is closed after the interval. This closure ensures that a request gets only the correct response, and any response data for a request that has timed out is discarded.

You can use the HTTP proxy to route a request via an intermediate site. You can run tools as a proxy to see the request and the response, and therefore debug your flows. The HTTP destination is as seen by the proxy; if you specify the HTTP destination of localhost, and the HTTP proxy is running on a different computer, the request is routed to the remote proxy computer, not the computer from which the original request was issued.

Using the HTTPRequest node in a message flow

The HTTPRequest node can be used in any message flow that needs to send an HTTP request. The most common example of this is a message flow that invokes a Web service.

For more information about Web services, see “Working with Web services” on page 615.

Handling errors

The node interacts directly with an external service using TCP/IP; it can, therefore, experience the following types of error:

- Errors that are generated by TCP/IP, for example no route to host or connection refused.

If the node detects these errors, it generates an exception, populates the exception list with the error information that is received, and routes the input message unchanged to the Failure terminal.

- Errors that are returned by the Web server. These errors are represented by HTTP status codes that are outside the range 100 to 299. If the node detects these errors, it routes the reply to the Error terminal while following the properties specified on the **Error** tab.

The reply is produced as a BLOB message because the node cannot determine in what format the reply will be. If you have not configured this node to handle redirection, messages with a redirection status code (3xx) are also handled in the same way.

HTTP Response Codes

The HTTPRequest node treats the 100 series status codes as a ‘continue’ response, discards the current response, and waits for another response from the Web server.

The 200 series status codes are treated as success, and the response is routed to the Out terminal of the node, while following the settings on the various tabs on the node for the format of the output message that is generated.

The 300 series status codes are for redirection. If the Follow Redirection property is selected, the node does not resend the request to the new destination that is specified in the response received. If the Follow Redirection property is not selected, the codes are treated as an error, as described in “Using the HTTPRequest node to issue a request to a Web service” on page 930. For more information about HTTP return codes, see HTTP Response codes.

The 400 and 500 series status codes are errors, and are treated as described in “Using the HTTPRequest node to issue a request to a Web service” on page 930. For more information about HTTP return codes, see HTTP Response codes.

Manipulating headers

If you select Replace input message with web-service response or Replace input with error, the header for the input message (the header that belongs to the message when it arrives at the In terminal of the HTTPRequest node) is not propagated with the message that leaves the HTTPRequest node. However, if one of the properties that specifies a location in the message tree is specified, the input message’s headers are propagated.

The HTTPResponse header, which contains the headers that are returned by the remote Web service, is the first header in the message (after Properties) that is propagated from the node. This action is taken regardless of the options that are

chosen. Therefore, for the reply from the HTTPRequest node to be put to a WebSphere MQ queue, manipulate the headers so that an MQMD is the first header (after Properties).

If you are replacing the input message with a response, you can copy the input message's MQMD to the Environment tree before the HTTPRequest node, and then copy it back into the message tree after the HTTPRequest node. If you are specifying a location for the response, in order to maintain existing input message headers, you must move or remove the HTTP Response header so that the MQMD is the first header.

The following example contains ESQL that removes the HTTPHeader:

```
SET OutputRoot = InputRoot;  
SET OutputRoot.HTTPResponseHeader = NULL;
```

The following example contains ESQL for moving the HTTPHeader, and therefore preserving the information that it provides:

```
SET OutputRoot = InputRoot;  
DECLARE HTTPHeaderRef REFERENCE TO OutputRoot.HTTPResponseHeader;  
DETACH HTTPHeaderRef;  
ATTACH HTTPHeaderRef TO OutputRoot.MQMD AS NEXTSIBLING;
```

Configuring the HTTPRequest node

When you have put an instance of the HTTPRequest node into a message flow, you can configure it; see “Configuring a message flow node” on page 235. The properties of the node are displayed in the Properties view.

All mandatory properties for which you must enter a value (those that do not have a default value defined) are marked with an asterisk.

Configure the HTTPRequest node:

1. Optional: On the **Description** tab, enter a Short description, a Long description, or both. You can also rename the node on this tab.
2. On the **Basic** tab:
 - a. The HTTPRequest node determines the URL for the Web service to which it sends a request. Set one of the following three options; the node checks these in the order shown (that is, the first always overrides the second, the second overrides the third):
 - 1) X-Original-HTTP-URL in the HTTPRequest header in the input message
 - 2) LocalEnvironment.Destination.HTTP.RequestURL in the input message
 - 3) The Web service URL property

The first two options provide dynamic methods to set a URL for each input message as it passes through the message flow. To use either of these options, include a Compute node in the message flow, before the HTTPRequest node, to create and initialize the required value.

The third option provides a value that is fixed for every message that is received in this node. Set this property to contain a default setting that is used if the other fields have not been created, or contain a null value. If either field contains a value, the setting of this property is ignored. The Web service URL property must contain a valid URL or the deployment will fail. Ensure that the value that you set in X-Original-HTTP-URL or the LocalEnvironment.Destination.HTTP.RequestURL is also a valid URL; if it is not, the node uses the default setting from the Web service URL property.

If a URL begins `http://`, the request node makes an HTTP request to the specified URL. If the URL begins `https://`, the request node makes an HTTP over SSL (HTTPS) request to the specified URL, using the parameters that are specified on the SSL tab for the node.

- b. Set the value of the Request timeout (sec) property, which is the length of time, in seconds, that the node waits for a response from the Web service. If a response is received within this time, the reply is propagated through the Out terminal to the rest of the message flow. If a response is not received within this time, the input message is propagated through the Failure terminal, if it is connected. If the Failure terminal is not connected, and a response is not received in this time, an exception is generated.
3. On the **HTTP Settings** tab:
 - a. In HTTP(S) proxy location, set the location of the proxy server to which requests are sent.
 - b. Select Follow HTTP(S) redirection to specify how the node handles Web service responses that contain an HTTP status code of 300 to 399:
 - If you select the check box, the node follows the redirection that is provided in the response, and reissues the Web service request to the new URL (included in the message content).
 - If you clear the check box, the node does not follow the redirection provided. The response message is propagated to the Error terminal.
 - c. Select one of the options for the HTTP version property. Valid values are: 1.0 or 1.1.

If you select the HTTP version property value 1.1, you can also select Enable HTTP/1.1 keep-alive.
 - d. Select one of the options for the HTTP method property. Valid values are: POST, GET, PUT, DELETE, and HEAD.
4. On the **SSL** tab, if you want to use HTTP over SSL (HTTPS) requests, set the values for HTTPS requests:
 - a. Specify the Protocol property that you want to use to make the request. Both ends of an SSL connection must agree on the protocol to use, so the chosen protocol must be one that the remote server can accept. The following options are available:
 - SSL. This option is the default. This option tries to connect using the SSLv3 protocol first, but allows the handshake to fall back to the SSLv2 protocol where the SSLv2 protocol is supported by the underlying JSSE provider.
 - SSLv3. This option tries to connect with the SSLv3 protocol only. Fallback to SSLv2 is not allowed.
 - TLS. This option tries to connect with the TLS protocol only. Fallback to SSLv3 or SSLv2 is not allowed.
 - b. Set the Allowed SSL ciphers property. This setting allows you to specify a single cipher (such as `SSL_RSA_FIPS_WITH_3DES_EDE_CBC_SHA`) or a list of ciphers that are the only ones used by the connection. This set of ciphers must include one or more that are accepted by the remote server. A comma is used as a separator between the ciphers. The default value is an empty string, which enables the node to use any, or all, of the available ciphers during the SSL connection handshake. This method gives the greatest scope for making a successful SSL connection.
5. On the **Response Message Parsing** tab, set values for the properties that describe the message domain, message set, message type, and message format that the node uses to determine how to parse the response message returned

by the Web service. If an error message is returned by the Web service, the values of these properties are ignored, and the message is parsed by the BLOB parser.

- a. In Message domain, select the name of the parser that you are using from the list. If the field is blank, the default value is BLOB. Choose from the following options:
 - MRM
 - XMLNSC
 - XMLNS
 - MIME
 - BLOB
 - XML (this domain is deprecated; use XMLNSC)

You can also specify a user-defined parser, if appropriate.

- b. If you are using the MRM parser or the XMLNSC parser in validating mode, select the relevant Message set from the list. This list is populated with available message sets when you select MRM or XMLNSC as the Message domain.
- c. If you are using the MRM parser, select the correct message from the list in Message type. This list is populated with messages that are defined in the Message set that you have selected.
- d. If you are using the MRM parser, select the format of the message from the list in Message format. This list includes all the physical formats that you have defined for this Message set.

6. On the **Parser Options** sub-tab:

- a. Parse timing is, by default, set to On Demand, which causes parsing of the message to be delayed. To cause the message to be parsed immediately, see “Parsing on demand” on page 1363.
- b. If you are using the XMLNSC parser, set values for the properties that determine how the XMLNSC parser operates. For more information, see “Manipulating messages in the XMLNSC domain” on page 364.

7. On the **Error Handling** tab, set values for the properties that determine how an error message returned by the Web service is handled:

- a. For the whole Web service error message to be propagated as the output message, leave Replace input with error selected (the default setting).
For the Web service error message to be included in the output message with part of the input message content, clear Replace input with error and set the Error message location property. If you clear this property, the node copies the input message to the output message and writes the Web service error message over the output message content at the specified location (the input message itself is not modified).

- b. In the Error message location field, enter the start location (within the output message tree) at which the parsed elements from the Web service error message bit stream are stored. This property is required only if you have cleared Replace input with error.

You can enter any valid ESQL field reference, including expressions within the reference and new field references (to create a new node in the message tree for the response). For example, enter:

```
OutputRoot.XMLNSC.ABC.DEF
```

or

```
Environment.WSError
```

If you select Replace input with error, this property is ignored.

8. On the **Advanced** tab, set values for the Advanced properties that describe the structure and content of the Web service request and response:

a. Specify the content of the request message that is sent to the Web service:

- For the request message to be the whole input message body, leave Use whole input message as request selected (the default setting).

For the request message to contain a subset of the input message, clear Use whole input message as request and set the Request message location in tree property.

- In the Request message location in tree field, enter the start location from which the content of the input message tree is copied to the request message. This property is required only if you have cleared Use whole input message as request. The node creates a new request message and copies the specified parts of the input message (the input message itself is not modified).

You can enter any valid ESQL field reference, including expressions within the reference. For example, enter:

```
InputRoot.XMLNSC.ABC
```

If you select Use whole input message as request, this property is ignored.

When the appropriate message tree content is parsed to create a bit stream, the message properties (Message domain, Message set, Message type, and Message format) that are associated with the input message body and stored in the Properties folder are used.

b. Specify the content of the output message that is propagated to the next node in the message flow:

- For the whole Web service response message to be propagated as the output message, leave Replace input message with web-service response selected (the default setting).

For the Web service response message to be included in the output message with part of the input message content, clear Replace input message with web-service response and set the Response message location in tree property. If you clear this property, the node copies the input message to the output message and writes the Web service response message over the output message content at the specified location (the input message itself is not modified).

- In the Response message location in tree field, enter the start location (within the output message tree) at which the parsed elements from the Web service response message bit stream are stored. This property is required only if you have cleared Replace input message with web-service response.

You can enter any valid ESQL field reference, including expressions within the reference, and including new field references (to create a new node in the message tree for the response). For example, enter:

```
OutputRoot.XMLNSC.ABC.DEF
```

or

```
Environment.WSReply
```

If you select Replace input message with web-service response, this property is ignored.

When the response bit stream is parsed to create message tree contents, the message properties (Message domain, Message set, Message type, and

Message format) that you have specified in the nodes Response Message Parsing properties (described later on) are used.

- c. For the node to generate an HTTPRequestHeader for the request message, leave Generate default HTTP headers from input selected (the default setting).

If you do not want the node to generate an HTTPRequestHeader for the request message, clear Generate default HTTP headers from input. To control the contents of the HTTPRequestHeader that is included in the request message, include a Compute node that adds an HTTPRequestHeader to the input message before this HTTPRequest node in the message flow, and clear this check box.

- If you have selected Generate default HTTP headers from input and the input message includes an HTTPRequestHeader, the HTTPRequest node extracts Web service headers from the input HTTPRequestHeader and adds any unique Web service headers, except Host (see the following table), that are present in an HTTPInputHeader, if one exists in the input message. (An HTTPInputHeader might be present if the input message has been received from a Web service by the HTTPInput node.)

The HTTPRequest node also adds the Web service headers shown in the following table, with default values, if these are not present in the HTTPRequestHeader or the HTTPInputHeader.

Header	Default value
SOAPAction	"" (empty string)
Content-Type	text/xml; charset=utf-8
Host	The host name to which the request is to be sent.

The HTTPRequest node also adds the optional header Content-Length with the correct calculated value, even if this is not present in the HTTPRequestHeader or the HTTPInputHeader.

- If you have selected Generate default HTTP headers from input and the input message does not include an HTTPRequestHeader, the HTTPRequest node extracts Web service headers, except Host, from the HTTPInputHeader (if it is present in the input message). The HTTPRequest node adds the required Web service headers with default values, if these are not present in the HTTPInputHeader.
 - If you have cleared Generate default HTTP headers from input and the input message includes an HTTPRequestHeader, the node extracts all Web service headers present in the input HTTPRequestHeader. It does not check for the presence of an HTTPInputHeader in the input message, and it does not add the required Web service headers if they are not supplied by the input HTTPRequestHeader.
 - If you have cleared Generate default HTTP headers from input and the input message does not include an HTTPRequestHeader, no Web service headers are generated. The HTTPRequest node does not check for the presence of an HTTPInputHeader in the input message and does not add any required Web service header. The request message is propagated to the Web service without an HTTPRequestHeader. This action typically causes an error to be generated by the Web service, unless the Web service is configured to handle the message contents.
9. On the **Validation** tab, set Validation properties if you want the parser to validate the body of response messages against the Message set. (If a message is propagated to the Failure terminal of the node, it is not validated.) These

properties do not cause the input message to be validated. It is expected that, if such validation is required, the validation has already been performed by the input node or a preceding validation node.

For more details see “Validating messages” on page 164 and “Validation properties” on page 1359.

Connecting the output terminals to another node

Connect the Out, Error, or Failure terminal of this node to another node in this message flow to process the message further, to process errors, or to send the message to an additional destination. If you do not connect the Error terminal, the message is discarded. If you do not connect the Failure terminal, the broker provides default error processing, see “Handling errors in message flows” on page 203.

Terminals and properties

The HTTPRequest node terminals are described in the following table.

Terminal	Description
In	The input terminal that accepts a message for processing by the node.
Failure	The output terminal to which the message is routed if a failure is detected during processing in the node.
Out	The output terminal to which the message is routed if it represents successful completion of the Web service request, and if further processing is required within this message flow.
Error	The output terminal to which messages that include an HTTP status code that is not in the range 200 through 299, including redirection codes (3xx) if you have not set property Follow HTTP redirection.

The following tables describe the node properties. The column headed M indicates whether the property is *mandatory* (marked with an asterisk on the panel if you must enter a value when no default is defined); the column headed C indicates whether the property is *configurable* (you can change the value when you add the message flow to the bar file to deploy it).

The HTTPRequest node Description properties are described in the following table.

Property	M	C	Default	Description
Node name	No	No	The node type, e.g. HTTPRequest	The name of the node.
Short description	No	No		A brief description of the node.
Long description	No	No		Text that describes the purpose of the node in the message flow.

The HTTPRequest node Basic properties are described in the following table.

Property	M	C	Default	Description
Web service URL	Yes	Yes		The URL for the Web service. You must provide this in the form <code>http://<hostname>[:<port>]/[<path>]</code> where <ul style="list-style-type: none"> <code>http://<hostname></code> must be specified. <code><port></code> has a default of 80. If you specify a value, you must include the <code>:</code> before the port number. <code><path></code> has a default of <code>/</code>. If you specify a value, you must include the <code>/</code> before the path.
Request timeout (sec)	Yes	No	120	The time in seconds that the node waits for a response from the Web service. The valid range is 1 to $(2^{31})-1$. You cannot enter a value that represents an unlimited wait.

The HTTPRequest node HTTP Settings properties are described in the following table.

Property	M	C	Default	Description
HTTP(S) proxy location	No	Yes		The proxy server to which requests are sent. This value must be in the form <code>hostname:port</code> .
Follow HTTP(S) redirection	No	No	Cleared	If you select the check box, redirections are followed. If you clear this check box, redirections are not followed.
HTTP version	No	Yes	1.0	The HTTP version to use for requests. Valid values are 1.0 and 1.1.
Enable HTTP/1.1 keep-alive	No	Yes	Selected (if HTTP version is 1.1)	Use HTTP/1.1 Keep-Alive.
HTTP method	No	No	POST	The HTTP method. Valid values are POST, GET, PUT, DELETE, and HEAD. By default, the HTTPRequest node uses the HTTP POST method when it connects to the remote Web server. HEAD is often used to determine whether a service is available, for example, by a network dispatcher trying to work out which servers are up and available, and will send back the correct headers (including content-length) but no body data.

The HTTPRequest node SSL properties are described in the following table.

Property	M	C	Default	Description
Protocol	No	Yes	SSL	The SSL protocol to use when making an HTTPS request.
Allowed SSL ciphers	No	Yes		A comma-separated list of ciphers to use when making an SSL request. The default value of an empty string means use all available ciphers.

The HTTPRequest node Response Message Parsing properties are described in the following table.

Property	M	C	Default	Description
Message domain	No	No	BLOB	The domain that will be used to parse the response message that is received from the Web service. If the field is blank then the default is BLOB.

Property	M	C	Default	Description
Message set	No	No		The name or identifier of the message set in which the response message is defined. If you set this property, then subsequently update the project dependencies to remove this message set reference, a warning is issued. Either update the Message set property, or restore the reference to this message set project.
Message type	No	No		The name of the response message.
Message format	No	No		The name of the physical format of the response message.

The HTTPRequest node Parser Options properties are described in the following table.

Property	M	C	Default	Description
Parse timing	No	No	On Demand	This property controls when a response message is parsed. Valid values are On Demand, Immediate, and Complete. For a full description of this property, see "Parsing on demand" on page 1363.
Build tree using XML schema data types	No	No	Cleared	This property controls whether the XMLNSC parser creates syntax elements in the message tree with data types taken from the XML Schema. You can select this property only if you set the Validate property on the Validation tab to Content or Content and Value.
Use XMLNSC compact parser for XMLNS domain	No	No	Cleared	This property controls whether the XMLNSC Compact Parser is used for messages in the XMLNS Domain. If you set this property, the response message data appears under XMLNSC in nodes that are connected to the output terminal when the input MQRFH2 header or Response Message Parsing properties Domain is XMLNS.
Retain mixed content	No	No	Cleared	This property controls whether the XMLNSC parser creates elements in the message tree when it encounters mixed text in a response message. If you select the check box, elements are created for mixed text. If you clear the check box, mixed text is ignored and no elements are created.
Retain comments	No	No	Cleared	This property controls whether the XMLNSC parser creates elements in the message tree when it encounters comments in a response message. If you select the check box, elements are created for comments. If you clear the check box, comments are ignored and no elements are created.
Retain processing instructions	No	No	Cleared	This property controls whether the XMLNSC parser creates elements in the message tree when it encounters processing instructions in a response message. If you select the check box, elements are created for processing instructions. If you clear the check box, processing instructions are ignored and no elements are created.

Property	M	C	Default	Description
Opaque elements	No	No	Blank	This property is used to specify a list of elements in the response message that are to be opaquely parsed by the XMLNSC parser. Opaque parsing is performed only if validation is not enabled (that is, if Validate is None); entries that are specified in Opaque Elements are ignored if validation is enabled.

The HTTPRequest node Error Handling properties are described in the following table.

Property	M	C	Default	Description
Replace input with error	No	No	Selected	If you select this check box, the input message content is replaced by the error message content. If you clear this check box, you must specify Error message location.
Error message location	Yes	No	OutputRoot	The start location at which the parsed elements from the Web service error bit stream are stored. This property takes the form of an ESQL field reference.

The HTTPRequest node Advanced properties are described in the following table.

Property	M	C	Default	Description
Use whole input message as request	No	No	Selected	If you select this check box, the whole input message body is to be passed to the Web service. If you clear this check box, you must select Request message location in tree.
Request message location in tree	Yes	No	InputRoot	The start location from which the bit stream is created for sending to the Web service. This property takes the form of an ESQL field reference.
Replace input message with web-service response	No	No	Selected	If you select this check box, the Web service response message replaces the copy of the input message as the content of the output message that is created. If you clear this check box, you must select Response message location in tree.
Response message location in tree	Yes	No	OutputRoot	The start location at which the parsed elements from the Web service response bit stream are stored. This property takes the form of an ESQL field reference.
Generate default HTTP headers from input	No	No	Selected	If you select this check box, an HTTPRequestHeader is generated. If you clear this check box, a valid HTTPRequestHeader must exist in the input message.

The HTTPRequest node Validation properties are described in the following table.

For a full description of these properties see “Validation properties” on page 1359.

Property	M	C	Default	Description
Validate	No	Yes	None	This property controls whether validation takes place. Valid values are None, Content and Value, Content, and Inherit.

Property	M	C	Default	Description
Failure action	No	No	Exception	This property controls what happens if validation fails. You can set this property only if you set Validate to Content or Content and Value. Valid values are User Trace, Local Error Log, Exception, and Exception List.

LocalEnvironment overrides

You can dynamically override set values in the LocalEnvironment in the same way as setting values in other elements of a message. The following can be set under LocalEnvironment.Destination.HTTP.

Setting	Description
RequestURL	Overrides the Web service URL property on the node. For example: SET OutputLocalEnvironment.Destination.HTTP.RequestURL = 'http://ibm.com/abc/';
Timeout	Overrides the Request timeout (sec) property on the node. For example: SET OutputLocalEnvironment.Destination.HTTP.Timeout = 42;
ProxyURL	Overrides the HTTP(S) proxy location property on the node. For example: SET OutputLocalEnvironment.Destination.HTTP.ProxyURL = 'my.proxy';
RequestLine.RequestURI	Overrides the RequestURI, which is the path after the URL and port. For example: SET OutputLocalEnvironment.Destination.HTTP.RequestLine.RequestURI = '/abc/def?x=y&g=h';
RequestLine.HTTPVersion	Overrides the HTTP version property on the node. For example: SET OutputLocalEnvironment.Destination.HTTP.RequestLine.HTTPVersion = 'HTTP/1.1';
KeepAlive	Overrides the Enable HTTP/1.1 keep-alive property on the node. For example: SET OutputLocalEnvironment.Destination.HTTP.KeepAlive = TRUE;
RequestLine.Method	Overrides the HTTP method property on the node. For example: SET OutputLocalEnvironment.Destination.HTTP.RequestLine.Method = 'GET';
SSLProtocol	Overrides the SSLProtocol. For example: SET OutputLocalEnvironment.Destination.HTTP.SSLProtocol = 'TLS'; Valid values are: SSL, SSLv3, and TLS.
SSLCiphers	Overrides the Allowed SSL Ciphers property on the node. For example: SET OutputLocalEnvironment.Destination.HTTP.SSLCiphers = 'SSL_RSA_FIPS_WITH_3DES_EDE_CBC_SHA';
ProxyConnectHeaders	Sets the ProxyConnectHeaders. Set this, when using a proxy server, to send extra HTTP headers when connecting to that server. For example, this allows you to send proxy authentication information to a proxy server. Multiple headers can be sent but each must be separated by a carriage return and a line feed (ASCII 0x0D 0x0A) in accordance with RFC2616. For example: DECLARE CRLF CHAR CAST(X'0D0A' AS CHAR CCSID 1208); SET OutputLocalEnvironment.Destination.HTTP.ProxyConnectHeaders = 'Proxy-Authorization: Basic Zm51cmJsZTpwYXNzd29yZAo=' CRLF 'Proxy-Connection: Keep-Alive' CRLF;
UseFolderMode	Sets the UseFolderMode. Use for bitstream generation; for certain parsers this changes the output bitstream. For example: SET OutputLocalEnvironment.Destination.HTTP.UseFolderMode = TRUE;

Working with WrittenDestination data

After the request has been made, the WrittenDestination folder in the LocalEnvironment is updated with the URI to which the request was sent. A WrittenDestination for an HTTPRequest node has the following format:

```
WrittenDestination = (  
  HTTP = (  
    RequestURL = 'http://server:port/folder/page'  
  )  
)
```

Input node

Use the Input node as an In terminal for an embedded message flow (a subflow).

This topic contains the following sections:

- “Purpose”
- “Using this node in a message flow” on page 943
- “Terminals and properties” on page 943

Purpose

You can use a subflow for a common task that can be represented by a sequence of message flow nodes. For example, you can create a subflow to increment or decrement a loop counter, or to provide error processing that is common to a number of message flows.

You must use an Input node to provide the In terminal to a subflow; you cannot use a standard input node (a built-in input node such as MQInput, or a user-defined input node).

When you have started your subflow with an Input node, you can connect it to any In terminal on any message flow node, including an Output node.

You can include one or more Input nodes in a subflow. Each Input node that you include provides a terminal through which to introduce messages to the subflow. If you include more than one Input node, you cannot predict the order in which the messages are processed through the subflow.

The Input node is contained in the **Construction** drawer of the palette, and is represented in the workbench by the following icon:



When you select and include a subflow in a message flow, it is represented by the following icon:



When you include the subflow in a message flow, this icon shows a terminal for each Input node that you include in the subflow, and the name of the terminal (which you can see when you hover over it) matches the name of that instance of

the Input node. Give your Input nodes meaningful names that you can recognize easily when you use their corresponding terminal on the subflow node in your message flow.

Using this node in a message flow

Look at the following sample to see how to use this node:

- Error Handler sample

You can view samples only when you use the information center that is integrated with the Message Broker Toolkit.

Terminals and properties

When you have put an instance of the Input node into a message flow, you can configure it; see “Configuring a message flow node” on page 235. The properties of the node are displayed in the Properties view.

The Input node terminals are described in the following table.

Terminal	Description
Out	The input terminal that delivers a message to the subflow.

The following table describes the node properties. The column headed M indicates whether the property is *mandatory* (marked with an asterisk if you must enter a value when no default is defined); the column headed C indicates whether the property is *configurable* (you can change the value when you add the message flow to the bar file to deploy it).

The Input node Description properties are described in the following table.

Property	M	C	Default	Description
Node name	No	No	The node type, Input.	The name of the node.
Short Description	No	No		A brief description of the node.
Long Description	No	No		Text that describes the purpose of the node in the message flow.

JavaCompute node

Use the JavaCompute node to work with messages using the Java language.

This topic contains the following sections:

- “Purpose”
- “Using this node in a message flow” on page 944
- “Specifying Java” on page 944
- “Terminals and properties” on page 945

Purpose

Using this node, you can achieve the following tasks:

- Examine an incoming message and, depending on its content, propagate it unchanged to one of the node's two output terminals; the node behaves in a similar way to a Filter node, but uses Java instead of ESQL to decide which output terminal to use.
- Change part of an incoming message and propagate the changed message to one of the output terminals using Java.
- Create and build a new output message that is totally independent of the input message using Java.

The Java code that is used by the node is stored in an Eclipse Java project.

The JavaCompute node is contained in the **Transformation** drawer of the palette, and is represented in the workbench by the following icon:



Using this node in a message flow

The JavaCompute node uses the same execution model as Java user-defined nodes and therefore the restrictions and assumptions associated with Java user-defined nodes also apply to Java code developed for JavaCompute nodes, see *Creating a message processing or output node in Java*. Only one instance of the JavaCompute node is created regardless of the number of threads running against the flow (either as a result of additional instances or multiple input nodes). Therefore all of your user Java code must be threadsafe and reentrant. For more information see *User-defined extensions execution model* and *Threading considerations for user-defined extensions*.

Double-click the JavaCompute node to open the New JavaCompute Node Class wizard. The wizard guides you through the creation of a new Java project and a Java class that contains some skeleton code. This skeleton code is displayed in a Java editor. For more information about creating Java code for a JavaCompute node, and for examples of the skeleton code or template that are provided, see “Creating Java code for a JavaCompute node” on page 450. If it is not the first time that you have double-clicked the node, the Java code is displayed.

Look at the following sample to see how to use this node.

- JavaCompute Node sample

You can view samples only when you use the information center that is integrated with the Message Broker Toolkit.

Specifying Java

Code Java statements to customize the behavior of the JavaCompute node. For example, you can customize the node to create a new output message or messages, using input message or database content (unchanged or modified), or new data. For example, you might want to modify a value in the input message by adding a value from a database, and store the result in a field in the output message.

Code the Java statements that you want in a Java file that is associated with the JavaCompute node.

If a Java file does not already exist for this node, right-click the JavaCompute node and click **Open Java** to create and open a new Java file in the Editor view. If the file exists already, click **Browse** beside the Java Class property to display the JavaCompute Node Type Selection window, which lists the Java classes that can be accessed by this message flow. Select the appropriate Java class and click **OK**. The list of matching types show suitable Java classes when at least one character is entered in the Select field. All Java classes are shown if you enter '*' in the **Select** field.

Restriction: Do not try to create another instance of a JavaCompute node from Java code; this is not supported.

Terminals and properties

When you have put an instance of the JavaCompute node into a message flow, you can configure it; see “Configuring a message flow node” on page 235. To associate an instance of a JavaCompute node with a Java class, configure the node’s properties. The properties of the node are displayed in the Properties view. All mandatory properties for which you must enter a value (those that do not have a default value defined) are marked with an asterisk.

The JavaCompute node terminals are described in the following table.

Terminal	Description
In	The input terminal that accepts a message for processing by the node.
Failure	The output terminal to which the input message is routed if a failure is detected during the computation. (Even if the Validate property is set, messages that are propagated to the Failure terminal of the node are not validated.)
Out	The output terminal to which the transformed message is routed.
Alternate	An alternative output terminal to which the transformed message can be routed, instead of to the Out terminal.

The following tables describe the node properties. The column headed M indicates whether the property is *mandatory* (marked with an asterisk if you must enter a value when no default is defined); the column headed C indicates whether the property is *configurable* (you can change the value when you add the message flow to the bar file to deploy it).

The Description properties of the JavaCompute node are described in the following table.

Property	M	C	Default	Description
Node name	No	No	The node type: JavaCompute	The name of the node.
Short description	No	No		A brief description of the node.
Long description	No	No		Text that describes the purpose of the node in the message flow.

The JavaCompute node has the Basic property that is described in the following table.

Property	M	C	Default	Description
Java class	Yes	No	None	The name of the Java class that is used in this node. This name must be displayed in the list of Java classes that are available in the project references for the message flow project.

The Parser Options properties for the JavaCompute node are described in the following table.

Property	M	C	Default	Description
Use XMLNSC Compact Parser for XMLNS Domain	No	No	Cleared	Setting this property causes the outgoing MQRFH2 to specify the XMLNS instead of XMLNSC parser, allowing an external application to remain unchanged. If outgoing messages do not contain MQRFH2 headers, this property has no effect.

The Validation properties of the JavaCompute node are described in the following table.

Set the validation properties to define how the message that is produced by the JavaCompute node is validated. These properties do not cause the input message to be validated. It is expected that, if such validation is required, the validation has already been performed by the input node or a preceding validation node. For more details, see “Validating messages” on page 164 and “Validation properties” on page 1359.

Property	M	C	Default	Description
Validate	No	Yes	None	This property controls whether validation takes place, and what part of the message is validated. Valid values are None, Content and Value, Content, and Inherit.
Failure action	No	No	Exception	This property controls what happens if a validation failure occurs. You can set this property only if Validate is set to Content or Content and Value. Valid values are User Trace, Local Error Log, Exception, and Exception List.

JMSHeader node

Use the JMSHeader node to modify contents of the JMS Header_Values and Application properties so that you can control the node’s output without programming.

This topic contains the following sections:

- “Purpose”
- “Using this node in a message flow” on page 947
- “Terminals and properties” on page 947

Purpose

Use the node to control the output from a JMSOutput node. A subset of common values can be changed in the JMS Header, and user-chosen properties can be added, changed, or deleted for the Application properties.

For JMS Header_Values properties, the node provides a set of fields that you can modify using predefined values, user-defined values, or XPath expressions. XPath is used to provide a valid location from which a value for a property can be copied. For example, the location can be the body of the message, the local environment tree, or an exception list.

For JMS Application properties, the node provides a way to add, modify, and delete name-value pairs of application properties.

The JMSHeader node is contained in the **JMS** drawer of the palette, and is represented in the workbench by the following icon:



Using this node in a message flow

Look at the following sample for more details about how to use the node:

- JMSHeader node sample

You can view samples only when you use the information center that is integrated with the Message Broker Toolkit.

Terminals and properties

When you have put an instance of the node into a message flow, you can configure it; see “Configuring a message flow node” on page 235. This node has no mandatory properties.

JMSHeader node terminals are described in the following table.

Terminal	Description
In	The input terminal that accepts a message for processing by the node.
Failure	The output terminal to which the input message is routed if a failure is detected during extraction.
Out	The output terminal to which the transformed message is routed if the input message is processed successfully.

The following tables describes the node properties. The column headed M indicates whether the property is *mandatory* (marked with an asterisk if you must enter a value when no default is defined); the column headed C indicates whether the property is *configurable* (you can change the value when you add the message flow to the bar file to deploy it).

The JMSHeader node Description properties are described in the following table.

Property	M	C	Default	Description
Node name	No	No	JMSHeader	The name of the node.
Short description	No	No		A brief description of the node.
Long description	No	No		Text that describes the purpose of the node in the message flow.

The JMSHeader node JMS transport header options are described in the following table.

Property	M	C	Default	Description
JMS header options	No	Yes	Carry forward header	<p>Options to control the JMSTransport header as a whole.</p> <p>Select Carry forward header to carry forward any values that are present in an incoming message.</p> <p>Select Add header to add a new header using the specified property values. If a header already exists, the header is modified using the specified property values. If <i>Inherit from header</i> is specified as a property value and the header does not exist, the default value for the property is used.</p> <p>Select Modify header to change an existing header using the specified property values. If a header does not exist, a new header is added first. If <i>Inherit from header</i> is specified as a property value and the header does not exist, the default value for the property is used.</p> <p>Select Delete header to delete the header, if it exists. Note: The Add header and Modify header options both add a header if it does not exist, and change a header if it does exist. However, the default values offered by each option differ, so use the appropriate option.</p>

The JMSHeader node JMSHeader_Value properties are described in the following table.

Property	M	C	Default	Description
JMS Delivery Mode	No	Yes	Non_Persistent	<p>Filter messages by message delivery mode:</p> <ul style="list-style-type: none"> • Non_Persistent • Persistent.
JMS Message Expiration(ms)	No	Yes	0	<p>Ask the JMS provider to keep the output JMS message for a specified time. Values are in milliseconds; the default value 0 means that the message should not expire.</p>
JMS Message Priority	No	Yes	4	<p>Assign relative importance to the message. A receiving JMS client application or a JMSOutput node can use this value. JMS defines a ten-level priority value, with 0 as the lowest priority and 9 as the highest.</p>
JMS Correlation Identifier	No	Yes	No default value	<p>A client can use the JMS Correlation Identifier header field to link one message with another. A typical use is to link a response message with its request message.</p>
JMS Reply To	No	Yes	No default value	<p>The JMS Reply To header field contains a destination supplied by a client when a message is sent. It is the destination where a reply message should be sent to.</p>

The JMSHeader node Application properties are described in the following table.

Property	M	C	Default	Description
Application Properties	No	Yes	No default value	<p>This screen is enabled only if you chose Add header or Modify header for JMS Transport header. The screen has no predefined properties; you use it to create custom properties and values. Use the property table to add new properties, or modify or delete existing properties, for the header. There is no limit to the number of properties. Each property must have a name, and a type qualifier. The type qualifier can be Value, XPath, or Delete.</p> <p>Value Enter a new valid value for the selected property. A null value or empty string is also considered as a valid value.</p> <p>XPath Specify a valid XPath expression. WebSphere Message Broker supports XPath definitions that start with an XPath variable such as \$Root or \$LocalEnvironment. Only the first occurrence is returned if there are multiple values for the given XPath expression. (Examples of valid XPath expressions are: \$LocalEnvironment/Host, and \$Root/HTTPRequest/Content-Type).</p> <p>Delete Specify the property to be deleted from the incoming message. The value associated with the selected property is also deleted.</p>
Clear incoming values	No	Yes	Cleared	This option, which is enabled only if you choose Modify header , removes all property names and associated values from the incoming message if present.

JMSInput node

Use the JMSInput node to receive messages from JMS destinations. JMS destinations are accessed through a connection to a JMS provider.

This topic contains the following sections:

- “Purpose”
- “Using the JMSInput node in a message flow” on page 950
- “Making the JMS provider client available to the JMS nodes” on page 950
- “Connecting the terminals” on page 951
- “Configuring for coordinated transactions” on page 952
- “Terminals and properties” on page 954

Purpose

The JMSInput node acts as a JMS message consumer and can receive all six message types that are defined in the Java Message Service Specification, version 1.1. Messages are received by using method calls, which are described in the JMS specification.

The JMSInput node is contained in the **JMS** drawer of the palette, and is represented in the workbench by the following icon:



Using the JMSInput node in a message flow

The following sample contains a message flow in which the JMSInput node is used. This sample is an example of how to use the JMSInput node.

- JMS Nodes sample

You can view samples only when you use the information center that is integrated with the Message Broker Toolkit.

The JMSInput node receives and propagates messages with a JMS message tree. You can set the properties of the JMSInput node to control the way in which the JMS messages are received.

The JMSInput node handles messages in the following message domains:

- BLOB
- XMLNSC
- XMLNS
- MRM
- JMSMap
- JMSStream
- MIME
- XML (this domain is deprecated; use XMLNSC)

Message flows that handle messages that are received from connections to JMS providers must always start with a JMSInput node. If you include an output node in a message flow that starts with a JMSInput node, it can be any of the supported output nodes (including user-defined output nodes); you do not need to include a JMSOutput node. However, if you do not include a JMSOutput node, you must include the JMSMQTransform node to transform the message to the format that is expected by the output node.

If you are propagating JMS messages and creating a message flow to use as a subflow, you cannot use a standard input node; you must use an instance of the JMSInput node as the first node in order to create an In terminal for the subflow.

When using 32-bit execution groups in a default 64-bit host environment, you must set the MQ JMS Java library paths on the MQSI_LIBPATH32. For example:

```
export MQSI_LIBPATH32=$MQSI_LIBPATH32:/usr/mqm/lib:/usr/mqm/java/lib
```

Restriction: When the JMSInput node receives publication topics, it internally restricts the message flow property *Additional Instances* to zero to prevent the receipt of duplicate publications.

Making the JMS provider client available to the JMS nodes

Configurable services are defined for a number of JMSPROVIDERS. You can choose one of the predefined services, or you can create a new service for a new provider, or for one of the existing providers. The pre-defined services are listed in Configurable services properties.

- If you want to use the WebSphere MQ JMS Provider, and you have installed WebSphere MQ in the default location on the broker system, the properties are already set and you do not have to make any changes.

- If you want to use the WebSphere MQ JMS Provider, and you have installed WebSphere MQ in a different (non-default) location, or if you want to use one of the other defined services, you must set the jarsURL property to identify the location of the service jar files on the broker system.

Use the mqsiexportproperties command to view the provider properties, and the mqsichangeproperties command to set or modify the properties.

- If no service is defined for your JMS provider, or if you want to create another service for an existing JMS provider, use the mqsicreateconfigurable service command to identify the new service and to set its properties.
- When you configure the node, select the appropriate service from the list of predefined services shown for the JMS provider name property, or type in the name of your new service.
- Some JMS providers provide an alternative interface to the standard JMS specification for particular JMS API calls. In these cases, IBM supplies a Java class to interface with that proprietary API. For example, if the JMS nodes use BEA WebLogic as the JMS provider, and the nodes need to participate in a globally coordinated message flow, you must modify the configurable services properties that are associated with that vendor. For more information, see “Configuring the broker to enable a JMS provider’s proprietary API” on page 182.
- Some JMS providers, such as the BEA WebLogic provider, do not update the optional JMSXDeliveryCount field in the JMS message header; therefore, JMSInput node backout processing is not possible. To cope with any failures in the message flow, connect the Failure terminal of the JMSInput node.

Connecting the terminals

For each message that is received successfully, the JMSInput node routes the message to the Out terminal. If this action fails, the message is retried. If the retry threshold is reached, where the threshold is defined by the Backout threshold property of the node, the message is routed to the Failure terminal. You can connect nodes to the Failure terminal to handle this condition.

If an exception occurs in the failure path, the path is retried until the number of attempts is twice the Backout threshold. If that limit is exceeded, the message is put to the Backout destination.

If you have not connected nodes to the Failure terminal, the message is written to the Backout destination. If you have not specified a Backout destination, the node issues a BIP4669 error message and stops processing further input.

If processing is not resumed after you restart the broker or execution group, check the event log for a cause, such as an incorrect parser being specified in the node properties. Correct the problem and redeploy the message flow. If the message itself is not valid, remove the message from the input queue to resume processing.

If the message is caught by the JMSInput node after an exception has been generated elsewhere in the message flow, the message is routed to the Catch terminal. If you have not connected nodes to the Catch terminal, the node backs out messages for re-delivery until the problem is resolved, or the Backout threshold is reached. If you do not define a Backout destination, the node issues a BIP4669 error message and stops processing further input.

Configuring for coordinated transactions

When you include a JMSInput node in a message flow, the value that you set for Transaction mode defines whether messages are received under sync point.

- If you set this property to Global, the message is received under external sync point coordination; that is, within a WebSphere MQ unit of work. Any messages that are sent subsequently by an output node in the same instance of the message flow are put under sync point, unless the output node overrides this setting explicitly.
- If you set this property to Local, the message is received under the local sync point control of the JMSInput node. Any messages that are sent subsequently by an output node in the flow are not put under local sync point, unless an individual output node specifies that the message must be put under local sync point.
- If you set this property to None, the message is not received under sync point. Any messages that are sent subsequently by an output node in the flow are not put under sync point, unless an individual output node specifies that the message must be put under sync point.

To receive messages under external sync point, you must take additional configuration steps, which need be applied only the first time that a JMSOutput or JMSInput node is deployed to the broker for a particular JMS provider.

- On distributed systems, the external sync point coordinator for the broker is WebSphere MQ. Before you deploy a message flow in which the Transaction mode property is set to Global, modify the queue manager .ini file to include extra definitions for each JMS provider resource manager that participates in globally-coordinated transactions.

- **Windows** On Windows systems:
 1. Start WebSphere MQ Explorer.
 2. Right-click the queue manager name in the left pane and click **Properties**.
 3. Click **XA resource managers** in the left pane.
 4. Set the SwitchFile property to the following value:

```
install_dir/bin/ JMSSwitch.dll
XAOpenString=Initial Context,location JNDI,Optional_parms
ThreadOfControl=THREAD
```

For more information, see the *System Administration Guide* section of the WebSphere MQ Version 6 information center online.

- **Linux** **UNIX** On Linux and UNIX systems, add a stanza to the queue manager .ini file for each JMS provider.

For example:

```
XAResourceManager:
Name=Jms_Provider_Name
SwitchFile=/install_dir/bin/ JMSSwitch.so
XAOpenString=Initial Context,location JNDI,Optional_parms
ThreadOfControl=THREAD
```

Where:

Name is an installation defined name that identifies a JMS provider resource manager.

SwitchFile

is the file system path to the JMSSwitch library that is supplied in the bin directory of the broker.

XAOpenString can have the following values:

- *Initial Context* is the value that is set in the JMSInput node property Initial context factory.
- *location JNDI* is the value that is set in the JMSInput node property Location JNDI bindings. This value must include the leading keyword, which is one of file://, iiop://, or ldap://.

The following parameters are optional:

- LDAP Principal matches the value that is set for the broker by using the mqsicreatebroker or mqsichangebroker commands.
- LDAP Credentials matches the value that is set for the broker by using the mqsicreatebroker or mqsichangebroker commands.
- Recovery Connection Factory Name is the JNDI administered connection factory that is defined in the bindings file . If a value is not specified, you must add a default value for recoverXAQCF to the bindings file. In either case, the Recovery Connection Factory must be defined as an XA Queue Connection Factory for the JMS provider that is associated with the Initial context factory.

The optional parameters are comma separated and are positional. Therefore, any parameters that are missing must be represented by a comma.

1. Update the Java CLASSPATH environment variable for the broker's queue manager to include a reference to xarecovery.jar; for example:

```
install_dir/classes/xarecovery.jar
```

2. Update the Java PATH environment variable for the broker's queue manager to point to the bin directory in which the SwitchFile is located; for example:

```
install_dir/bin
```

Finally, ensure that you have taken the following configuration steps:

- In the message flow, ensure that the co-ordinated property is enabled by using the Broker Archive editor.
- Ensure that each node that must be part of the XA transaction is set to the global transaction mode.
- Ensure that the service ID that is used for the broker and the queue manager is the same user ID.
- Ensure that the JNDI connection factory objects that the JMS nodes use for a global transaction are configured to be of the type MQXAConnectionFactory, MQXAQueueConnectionFactory, or MQXATopicConnectionFactory.

For more information, see the *System Administration Guide* section of the WebSphere MQ Version 6 information center online.

To use the same queue manager for both the broker and the JMS provider, ensure that your WebSphere MQ installation is at the minimum required level: WebSphere MQ Version 6.0 Fix Pack 1 or above is required for XA to use the same queue manager for both the broker and the provider.

- **z/OS** On z/OS, the external sync point manager is Resource Recovery Services (RRS). The only JMS provider that is supported on z/OS is WebSphere MQ JMS. The only transport option that is supported for WebSphere MQ JMS on z/OS is the bind option.

sync point control for the JMS provider is managed with RRS sync point coordination of the queue manager of the broker. You do not need to modify the .ini file.

Terminals and properties

When you have put an instance of the JMSInput node into a message flow, you can configure it; see “Configuring a message flow node” on page 235. The properties of the node are displayed in the Properties view. All mandatory properties that do not have a default value defined are marked with an asterisk.

The terminals of the JMSInput node are described in the following table.

Terminal	Description
Failure	The output terminal to which the message is routed if an error occurs. Even if the Validation property is set, messages that are propagated to this terminal are not validated.
Out	The output terminal to which the message is routed if it is retrieved successfully.
Catch	The output terminal to which the message is routed if an exception is generated downstream and caught by this node.

The following tables describe the node properties. The column headed M indicates whether the property is *mandatory* (marked with an asterisk if you must enter a value when no default is defined); the column headed C indicates whether the property is *configurable* (you can change the value when you add the message flow to the bar file to deploy it).

The Description properties of the JMSInput node are described in the following table.

Property	M	C	Default	Description
Node name	No	No	The node type, JMSInput	The name of the node.
Short description	No	No		A brief description of the node.
Long description	No	No		Text that describes the purpose of the node in the message flow.

The Basic properties of the JMSInput node are described in the following table.

Property	M	C	Default	Description
Source queue	No	No	Selected	The name of the queue from which the node receives incoming messages. If the node is to read from a queue (point-to-point), select Source queue and enter the name of the source queue, which is the JMS queue that is listed in the bindings file. This property is mutually exclusive with Subscription topic.
Subscription topic	No	No	Cleared	The name of the topic to which the node is subscribed. If the node is to read from a Subscription topic (publish/subscribe), select Subscription topic and enter the name of the subscription topic. <ul style="list-style-type: none"> • If you select Subscription topic, the node operates in the publish/subscribe message domain only. • This property is mutually exclusive with Source queue. • The Subscription topic name must conform to the standards of the JMS provider that is being used by the node.

Property	M	C	Default	Description
Durable subscription ID	No	No		<p>The identifier for a durable subscription topic. If the node is to receive publications from a durable subscription topic, enter a Durable subscription ID.</p> <ul style="list-style-type: none"> Removing a durable subscription is a separate administration task. For information about removing a durable subscription see the JMS provider documentation. This property is valid only when a Subscription topic string has been specified.

The JMS Connection properties of the JMSInput node are described in the following table.

Property	M	C	Default	Description
JMS provider name	Yes	No	WebSphere MQ	<p>Select a JMS vendor name from the list, or enter a name of your choice. When you select a name from the list, the Initial context factory property is updated automatically with the relevant java class. If you enter your own JMS provider name, you must also enter a value for the Initial context factory The name must match the name of a configurable service that is defined for the broker to which you deploy the message flow.</p>
Initial context factory	Yes	Yes	com.sun.jndi.fscontext.RefFSContextFactory	<p>The starting point for a JNDI name space.</p> <p>A JMS application uses the initial context to obtain and look up the connection factory and queue or topic objects for the JMS provider. If you select a JMS provider name from the list in JMS provider name, the Initial context factory property is updated automatically with the relevant Java class. If you enter your own JMS provider name, you must also enter a value for the Initial context factory. The default value is <code>com.sun.jndi.fscontext.RefFSContextFactory</code>, which defines the file-based Initial context factory for the WebSphere MQ JMS provider.</p>
Location JNDI bindings	Yes	Yes		<p>The system path or the LDAP location for the bindings file. The bindings file contains definitions for the JNDI administered objects that are used by the JMSInput node.</p> <p>When you enter a value for Location JNDI bindings, ensure that it complies with the following instructions:</p> <ul style="list-style-type: none"> Construct the bindings file before you deploy a message flow that contains a JMSInput node. Do not include the file name of the bindings file in this field. If you have specified an LDAP location that requires authentication, configure the LDAP principal (userid) and LDAP credentials (password) separately. These values are configured at broker level. For information about configuring these values, see <code>mqscreatebroker</code> command and <code>mqschangebroker</code> command. The string value must include the leading keyword, which must be one of the following options: <ul style="list-style-type: none"> <code>file://</code> <code>iio://</code> <code>ldap://</code> <p>For information about constructing the JNDI administered objects bindings file, see the JMS provider documentation.</p>

Property	M	C	Default	Description
Connection factory name	Yes	Yes		The name of the connection factory that is used by the JMSInput node to create a connection to the JMS provider. This name must already exist in the bindings file. The Connection factory name can be a JMS QueueConnectionFactory or a JMS TopicConnectionFactory, but it must match the message model that is used by the node. Alternatively, you can specify the generic JMS ConnectionFactory, which can be used for both JMS queue or JMS topic destinations.
Backout destination	No	Yes		The JMSInput node sends input messages to this destination when errors prevent the message flow from processing the message, and the message must be removed from the input destination. The backout destination name must exist in the bindings file.
Backout threshold	No	Yes	0	The value that controls when a re-delivered message is put to the backout destination. For example, if the value is 3, the JMS provider attempts to deliver the message to the input destination three times. After the third attempted delivery, the message is removed from the input destination and is sent to the Backout destination.

The Input Message Parsing properties of the JMSInput node are described in the following table.

Property	M	C	Default	Description
Message domain	No	No		<p>The domain that is used to parse the incoming message.</p> <ul style="list-style-type: none"> • MRM • XMLNSC • XMLNS • JMSTMap • JMSTStream • MIME • BLOB • XML (this domain is deprecated; use XMLNSC) <p>You can also specify a user-defined parser, if appropriate.</p> <p>The Message domain that is set on the node takes precedence except when the Message domain is set to blank on the node property. If Message domain is left blank, the JMSInput node determines the message domain in one of two ways:</p> <ul style="list-style-type: none"> • By checking for the presence of data in the JMSType header value of the JMS input message • Based upon the Java Class of the JMS message <p>For more information, see Order of precedence for deriving the message domain.</p>
Message set	No	No		<p>The name or identifier of the message set in which the incoming message is defined. If you are using the MRM parser or the XMLNSC parser in validating mode, select the Message set that you want to use. This list is populated with available message sets when you select MRM or XMLNSC as the Message domain.</p> <p>If you set this property, then subsequently update the project dependencies to remove this message set reference, a warning is issued. Either update the Message set property, or restore the reference to this message set project.</p>

Property	M	C	Default	Description
Message type	No	No		The name of the incoming message. If you are using the MRM parser, select the message that you want from the list in Message type. This list is populated with messages that are defined in the Message set that you have selected.
Message format	No	No		The name of the physical format of the incoming message. If you are using the MRM parser, select the format of the message from the list in Message format. This list includes all of the physical formats that you have defined for this Message set.

The properties of the Parser Options for the JMSInput node are described in the following table.

Property	M	C	Default	Description
Parse timing	No	No	On Demand	This property controls when an input message is parsed. Valid values are: <ul style="list-style-type: none"> • On Demand • Immediate • Complete Parse timing is, by default, set to On Demand, which causes parsing of the message to be delayed. To cause the message to be parsed immediately, see "Parsing on demand" on page 1363.
Build tree using XML schema data types	No	No	Cleared	This property controls whether the XMLNSC parser creates syntax elements in the message tree with data types taken from the XML Schema. <p>For more information about how the XMLNSC parser operates, see "Manipulating messages in the XMLNSC domain" on page 364.</p>
Use XMLNSC compact parser for XMLNS domain	No	No	Cleared	This property controls whether the XMLNSC Compact Parser is used for messages in the XMLNS Domain. If you set this property, the message data appears under XMLNSC in nodes that are connected to the output terminal when the input MQRFH2 header or Input Message Parsing properties Message domain is XMLNS.
Retain mixed content	No	No	Cleared	This property controls whether the XMLNSC parser creates elements in the message tree when it encounters mixed text in an input message. If you select the check box, elements are created for mixed text. If you clear the check box, mixed text is ignored and no elements are created.
Retain comments	No	No	Cleared	This property controls whether the XMLNSC parser creates elements in the message tree when it encounters comments in an input message. If you select the check box, elements are created for comments. If you clear the check box, comments are ignored and no elements are created.
Retain processing instructions	No	No	Cleared	This property controls whether the XMLNSC parser creates elements in the message tree when it encounters processing instructions in an input message. If you select the check box, elements are created for processing instructions. If you clear the check box, processing instructions are ignored and no elements are created.
Opaque elements	No	No	Blank	This property is used to specify a list of elements in the input message that are to be opaquely parsed by the XMLNSC parser. Opaque parsing is performed only if validation is not enabled (that is, if Validate is None); entries that are specified in Opaque Elements are ignored if validation is enabled.

The Message Selectors properties of the JMSInput node are described in the following table. Set these properties if you need to filter messages.

Property	M	C	Default	Description
Application property	No	Yes		<p>The message selector that filters messages according to the application property value.</p> <p>If the JMS provider is required to filter messages, based on message properties that are set by the originating JMS client application, enter a value for Application property, specifying both the property name and the selection conditions; for example, <code>OrderValue > 200</code>.</p> <p>Leave Application property blank if you do not want the input node to make a selection based on application property. For a description of how to construct the JMS message selector, see JMS message selector.</p>
Timestamp	No	Yes		<p>The message selector that filters messages according to the JMSTimestamp.</p> <p>If the JMS provider is required to filter messages that have been generated at specific times, enter a value for Timestamp, where the value is an unqualified Java millisecond time; for example, <code>105757642321</code>. Qualify the selector with operators, such as BETWEEN or AND.</p> <p>Leave Timestamp blank if you do not want the input node to make a selection based on the JMSTimeStamp.</p>
Delivery mode	No	Yes	All	<p>The message selector that filters messages according to the message delivery mode.</p> <p>If the JMS provider is required to filter messages based on the JMSDeliveryMode header value in the JMS messages, select an option for Delivery mode from the list:</p> <ul style="list-style-type: none"> • Select Non Persistent to receive messages that are marked as non persistent by the originating JMS client application. • Select Persistent to receive messages that are marked as persistent by the originating JMS client application. • Select All to receive both persistent and non persistent messages. (This value is the default.)
Priority	No	Yes		<p>The message selector that filters messages according to the message priority.</p> <p>If the JMS provider is required to filter messages based on the JMSPriority header value in the JMS message, enter a value for Priority.</p> <p>Valid values for Priority are from 0 (lowest) to 9 (highest); for example, enter 5 to receive messages of priority 5. You can also qualify the selector; for example, <code>> 4</code> to receive messages with a priority greater than 4, or <code>BETWEEN 4 AND 8</code> to receive messages with a priority in the range 4 to 8.</p> <p>Leave Priority blank if you do not want the input node to make a selection based on the JMSPriority.</p>

Property	M	C	Default	Description
Message ID	No	Yes		<p>The message selector that filters messages according to the message ID.</p> <p>If the JMS provider is required to filter messages based on the <code>JMSMessageID</code> header, enter a value for Message ID.</p> <p>Enter a specific Message ID or enter a conditional selector; for example, enter <code>> WMBRK123456</code> to return messages where the Message ID is greater than <code>WMBRK123456</code>.</p> <p>Leave Message ID blank if you do not want the input node to make a selection based on <code>JMSMessageID</code>.</p>
Redelivered	No	Yes		<p>If the JMS provider is required to filter messages based on the <code>JMSRedelivered</code> header, enter a value for Redelivered:</p> <ul style="list-style-type: none"> • Enter <code>FALSE</code> if the input node accepts only messages that have not been redelivered by the JMS provider. • Enter <code>TRUE</code> if the input node accepts only messages that have been redelivered by the JMS provider. • Leave Redelivered blank if you do not want the input node to make a selection based on <code>JMSRedelivered</code>.
Correlation ID	No	Yes		<p>The message selector that filters messages according to the correlation ID.</p> <p>If the JMS provider is required to filter messages based on the <code>JMSCorrelationID</code> header, enter a value for Correlation ID.</p> <p>Enter a specific Correlation ID or enter a conditional string; for example, <code>WMBRKABCDEFGH</code> returns messages with a Correlation ID that matches this value.</p> <p>Leave Correlation ID blank if you do not want the input node to make a selection based on <code>JMSCorrelationID</code>.</p>

The Advanced properties of the `JMSInput` node are described in the following table.

Property	M	C	Default	Description
Transaction mode	Yes	No	none	<p>This property controls whether the incoming message is received under external sync point, local sync point, or out of sync point.</p> <ul style="list-style-type: none"> • Select <code>None</code> if the incoming message is to be treated as non persistent. If you select this value, the message is received using a non-transacted JMS session that is created using the <code>Session.AUTO_ACKNOWLEDGE</code> flag. • Select <code>Local</code> if the <code>JMSInput</code> node must coordinate the commit or roll back of JMS messages that are received by the node, along with any other resources such as <code>DB2</code> or <code>WebSphere MQ</code> that perform work within the message flow. If you select this value, the node uses a transacted JMS session. • Select <code>Global</code> if the <code>JMSInput</code> node must participate in a global message flow transaction that is managed by the broker's external sync point coordinator. The sync point coordinator is the broker's queue manager on distributed systems and <code>RRS (Resource Recovery Services)</code> on <code>z/OS</code>. If you select this value, any messages that are received by the node are globally coordinated using an <code>XA JMS</code> session.

The Validation properties of the `JMSInput` node are described in the following table. For more details, see "Validating messages" on page 164 and "Validation properties" on page 1359.

Property	M	C	Default	Description
Validate	No	Yes	None	This property controls whether validation takes place. Valid values are: <ul style="list-style-type: none"> • None • Content and Value • Content If you select Content or Content and Value, select an option from the Failure action list.
Failure action	No	No	Exception	This property controls what happens if validation fails. You can set this property only if you set Validate to Content or Content and Value. Valid values are: <ul style="list-style-type: none"> • User Trace • Local Error Log • Exception (The default value) • Exception List

JMSMQTransform node

Use the JMSMQTransform node to transform a message with a JMS message tree into a message that has a message tree structure that is compatible with the format of messages that are produced by the WebSphere MQ JMS provider.

This topic contains the following sections:

- “Purpose”
- “Using the JMSMQTransform node in a message flow”
- “Terminals and properties” on page 961

Purpose

You can use the JMSMQTransform node to send messages to legacy message flows and to interoperate with WebSphere MQ JMS and WebSphere Message Broker publish/subscribe.

The JMSMQTransform node handles messages in all supported message domains.

The JMSMQTransform node is contained in the **JMS** drawer of the palette, and is represented in the workbench by the following icon:



Using the JMSMQTransform node in a message flow

The following sample contains a message flow in which the JMSMQTransform node is used. Refer to this sample for an example of how to use the JMSMQTransform node.

- JMS Nodes sample

You can view samples only when you use the information center that is integrated with the Message Broker Toolkit.

Terminals and properties

When you have put an instance of the JMSMQTransform node into a message flow, you can configure it; see “Configuring a message flow node” on page 235. The properties of the node are displayed in the Properties view.

The terminals of the JMSMQTransform node are described in the following table.

Terminal	Description
Failure	The output terminal to which the message is routed if an error occurs. Even if the Validation property is set, messages that are propagated to this terminal are not validated.
Out	The output terminal to which the message is routed if it is successfully retrieved from the JMS destination.
In	The input terminal that accepts a message for processing by the node.

The following table describes the node properties. The column headed M indicates whether the property is *mandatory* (marked with an asterisk if you must enter a value when no default is defined); the column headed C indicates whether the property is *configurable* (you can change the value when you add the message flow to the bar file to deploy it).

The JMSMQTransform node Description properties are described in the following table.

Property	M	C	Default	Description
Node name	No	No	The node type, JMSMQTransform	The name of the node.
Short Description	No	No		A brief description of the node.
Long Description	No	No		Text that describes the purpose of the node in the message flow.

JMSOutput node

Use the JMSOutput node to send messages to JMS destinations.

This topic contains the following sections:

- “Purpose” on page 962
- “Using the JMSOutput node in a message flow” on page 962
- “Controlling the type of the JMS output message” on page 962
- “Sending a JMS message to a destination list” on page 962
- “Making the JMS provider client available to the JMS nodes” on page 963
- “Using the Message Destination Mode” on page 963
- “Working with the JMS message ID” on page 965
- “Configuring for coordinated transactions” on page 966
- “Connecting the terminals” on page 967
- “Terminals and properties” on page 968

Purpose

The JMSOutput node acts as a JMS message producer, and can publish all six message types that are defined in the Java Message Service Specification, version 1.1. Messages are published by using method calls, which are described in the JMS specification.

The JMSOutput node is contained in the **JMS** drawer of the palette, and is represented in the workbench by the following icon:



Using the JMSOutput node in a message flow

The following sample contains a message flow in which the JMSOutput node is used. Look at this sample for an example of how to use the JMSOutput node.

- JMS Nodes sample

You can view samples only when you use the information center that is integrated with the Message Broker Toolkit.

Message flows that handle messages that are received from connections to JMS providers must always start with a JMSInput node. If you include the JMSOutput node in a message flow, you do not need to include a JMSInput node; but if you do not include a JMSInput node, you must include the MQJMSTransform node to transform the message to the format that is expected by the JMSOutput node.

If you are propagating JMS messages and creating a message flow to use as a subflow, use an instance of the JMSOutput node as the last node to create an out terminal for the subflow.

Controlling the type of the JMS output message

In the JMS message tree, the JMS message type is represented by the PayloadType field of the Message_MetaData subfolder. To control the type of JMS message that is created by the JMSOutput node, use ESQL code to set the Payload value, as shown in the following example:

```
SET OutputRoot.JMSTransport.Transport_Folders.Message_MetaData.PayloadType=Payload value
```

For more information about the JMS message tree and payload values, see Representation of messages across the JMS Transport.

Sending a JMS message to a destination list

To send a JMS message to a destination list, ensure that the following conditions are met.

- Select Send to destination list in local environment on the **Basic** properties tab of the JMSOutput node.
- Set up the list in the LocalEnvironment, as shown in the following example.

```
CREATE PROCEDURE CreateJMSDestinationList() BEGIN
  SET OutputLocalEnvironment.Destination.JMSDestinationList.DestinationData[1] = 'jndi://TestDestQueue1';
  SET OutputLocalEnvironment.Destination.JMSDestinationList.DestinationData[2] = 'jndi://TestDestQueue2';
  SET OutputLocalEnvironment.Destination.JMSDestinationList.DestinationData[3] = 'jndi://TestDestQueue3';
END;
```

- Ensure that the message model (point-to-point or publish/subscribe) matches the model that is used by the JMSOutput node. In this case, the model is point-to-point.
- If the destination name in the list is prefixed with the string “jndi://”, it indicates to the JMSOutput node that the value represents the name of a JNDI administered object, which needs to be looked up. Alternatively, if the JMS provider-specific format for a destination is known, it can be used; for example, queue://qmgrname/queueName for WebSphere MQ. Otherwise, the value is used to create a temporary destination.
- The items to which the JMS destination list refers represent JMS destinations that can be either JMS queues or JMS topics. These destination types must be consistent with the connection factory type that is specified in the JMSOutput node that will process the destination list. For example, a JMS queue destination can be processed by a JMS QueueConnectionFactory or a generic JMS ConnectionFactory. Similarly, a JMS topic destination can be processed using a JMS TopicConnectionFactory or a generic JMS ConnectionFactory.

Making the JMS provider client available to the JMS nodes

Configurable services are defined for a number of JMSProviders. You can choose one of the pre-defined services, or you can create a new service for a new provider, or for one of the existing providers. The pre-defined services are listed in Configurable services properties.

- If you want to use the WebSphere MQ JMS Provider, and you have installed WebSphere MQ in the default location on the broker system, the properties are already set and you do not have to make any changes.
- If you want to use the WebSphere MQ JMS Provider, and you have installed WebSphere MQ in a different (non-default) location, or if you want to use one of the other defined services, you must set the jarsURL property to identify the location of the service jar files on the broker system.

Use the mqsiqueryproperties command to view the provider properties, and the mqsiupdateproperties command to set or modify the properties.

- If no service is defined for your JMS provider, or if you want to create another service for an existing JMS provider, use the mqsiaddconfigurablecommand command to identify the new service and set its properties.
- When you configure the node, select the appropriate service from the list of predefined services shown for the JMS provider name property, or type in the name of your new service.
- Some JMS providers provide an alternative interface from the standard JMS specification for particular JMS API calls. In these cases, IBM supplies a Java JAR file to interface with that proprietary API. For example, if the JMS nodes use BEA WebLogic as the JMS provider, and the nodes need to participate in a globally coordinated message flow, you must modify the configurable services properties that are associated with that vendor. For more information, see “Configuring the broker to enable a JMS provider’s proprietary API” on page 182.

Using the Message Destination Mode

The JMSOutput node acts as a message producer and supports the following message scenarios:

- “Sending a datagram message” on page 964
- “Sending a reply message” on page 964
- “Sending a request message” on page 965

For more information about how to build JMS destination lists, see “Populating Destination in the LocalEnvironment tree” on page 311.

Sending a datagram message

A *datagram* is a self-contained, independent entity of data that carries sufficient information to be routed from the source to the destination computer, without reliance on earlier exchanges between the source and destination computer and the transporting network. The following instructions describe how to send a datagram message:

1. On the **Basic** tab, set the message destination depending on the message model that is being used. Set one of the following properties to a valid JNDI administered object name:
 - Publication Topic
 - Destination Queue
2. Leave the Reply To Destination field blank.

The node resolves the name of the JNDI administered object, which is supplied in either Publication Topic or Destination Queue, and sends the message to that JMS Destination.

Sending a reply message

The sender of a message might want the recipient to reply to the message. In this case, the JMSOutput message can treat the outgoing message as a reply, and route it according to the value that is obtained from the JMSReplyTo property from the request message. You can modify the value of the JMSReplyTo property in the MbMessage; for example, using a Compute node or a JavaCompute node. This action allows dynamic routing of messages from the JMSOutput node. The node sends the message to the JMS Destination name that is set in the JMSReplyTo field of the MbMessage Tree.

The JMSReplyTo value in the MbMessage Tree represents the name of the JMS Destination that is resolved from JNDI. For example:

```
queue://QM_mn2/myJMSQueue4
```

In this case, the value is the JMS-provider specific representation of a JMS Destination for the WebSphere MQ JMS provider.

If you do not want to specify a resolved JMS destination name, the JMSOutput node can also accept a JNDI administered object name in the JMSReplyTo field. However, the node must resolve an administered object name through JNDI before it can route the message to the underlying JMS Destination. In this case, the value in the JMSReplyTo field must be prefixed with the string: `jndi:\`. For example:

```
jndi:\\jmsQ4
```

where `jmsQ4` is the name of the JNDI-administered object.

Performance might be slightly impacted when you use this method because of the need to look up the administered object in JNDI.

Sending a request message

The JMSOutput node can send a message to a JMS Destination with the expectation of a response from the message consumer that processes the request. The following instructions describe how to send a request message:

1. On the **Basic** tab, set the message destination depending on the message model that is being used. Set one of the following properties to a valid JNDI-administered object name:
 - Publication Topic
 - Destination Queue
2. The JMSReplyTo destination in the outgoing message can be derived from the JMSReplyTo field of the MbMessage Tree that is passed to the node. Alternatively, this value can be overridden by a JNDI-administered object name that is set in the Reply To Destination node property.

To allow the JMSOutput node to set the JMSReplyTo property dynamically in the outgoing message, leave the Reply To Destination field blank on the **Basic** tab, and set the JMSReplyTo value in the MbMessage using a Compute node or a JavaCompute node.

The node looks first for a value in the JMSReplyTo field of the MbMessage. If the node finds the value, it passes this value into the JMSReplyTo field of the outgoing message. However, if the Reply To Destination field of the **Basic** tab has been specified, this value overrides anything that is set previously in the JMSReplyTo property of the outgoing message, after first resolving the name of the JNDI-administered object.

The node resolves the name of the JNDI-administered object that is supplied in either Publication Topic or Destination Queue, and sends the message to that JMS Destination.

Working with the JMS message ID

The JMS message ID is generated by the JMS provider when a message is sent by the JMSOutput node. You cannot set the message ID in the message flow, but you can use one of the following methods to obtain the generated ID after the message has been sent:

- Connect a Compute node to the Out terminal.

Connect a Compute node to the Out terminal of a JMSOutput node and interrogate the WrittenDestination List. For more information, see “Viewing the logical message tree in trace output” on page 167.

An entry for a JMSOutput node has the following format:

```
WrittenDestination = (  
  JMS = (  
    DestinationData = (  
      destinationName = 'queue://jmsQueue1'  
      initialContext = 'com.sun.jndi.fscontext.RefFSContextFactory'  
      JMSMessageID = ID:414d512054657374514d20202020202020206ab98b4520017a02'  
      JMSCorrelationID = 'ABCDEFGHJKLMNOPQRSTUVWXYZ'  
    )  
  )  
)
```

- Configure a user exit to process an output message callback event. For more information, see “Exploiting user exits” on page 198.

Configuring for coordinated transactions

When you include a JMSOutput node in a message flow, the value that you set for Transaction Mode defines whether messages are sent under syncpoint.

- If you set the Transaction Mode to Global, the message is sent under external syncpoint coordination; that is, within a WebSphere MQ unit of work. Any messages that are sent subsequently by an output node in the same instance of the message flow are put under syncpoint, unless the output node overrides this setting explicitly.
- If you set the Transaction Mode to Local, the message is sent under the local syncpoint control of the JMSOutput node. Any messages that are sent subsequently by an output node in the flow are not put under local syncpoint, unless an individual output node specifies that the message must be put under local syncpoint.
- If you set the Transaction Mode to None, the message is not sent under syncpoint. Any messages that are sent subsequently by an output node in the flow are not put under syncpoint, unless an individual output node specifies that the message must be put under syncpoint.

When you want to send messages under external syncpoint, you must perform additional configuration steps, which need to be applied only the first time that a JMSOutput or JMSInput is deployed to the broker for a particular JMS provider:

- On distributed systems, the external syncpoint coordinator for the broker is WebSphere MQ. Before you deploy a message flow in which the Transaction Mode is set to Global, modify the queue manager .ini file to include extra definitions for each JMS provider resource manager that participates in globally coordinated transactions:

- **Windows** On Windows systems:
 1. Start WebSphere MQ Explorer.
 2. Right-click the queue manager name in the left pane and click **Properties**.
 3. Click **XA resource managers** in the left pane.
 4. Set the SwitchFile property to the following value:

```
install_dir/bin/ JMSSwitch.dll
XAOpenString=Initial Context,location JNDI,Optional_parms
ThreadOfControl=THREAD
```

For more information, see the *WebSphere MQ System Administration Guide* section of the WebSphere MQ Version 6 information center online.

- **Linux** **UNIX** On Linux and UNIX systems, add a stanza to the queue manager's .ini file for each JMS provider.

For example:

```
XAResourceManager:
Name=Jms_Provider_Name
SwitchFile=/install_dir/bin/ JMSSwitch.so
XAOpenString=Initial Context,location JNDI,Optional_parms
ThreadOfControl=THREAD
```

Where:

Name is an installation-defined name that identifies a JMS provider resource manager.

SwitchFile

is the file system path to the JMSSwitch library that is supplied in the bin directory of the broker.

XAOpenString can have the following values:

- *Initial Context* is the value that is set in the JMSInput node basic property Initial context factory.
- *location JNDI* is the value that is set in the JMSInput node basic property Location of JNDI. This value must include the leading keyword, which is `file://`, `iiop://` or `ldap://`

The following parameters are optional:

- LDAP Principal matches the value that is set for the broker by using the `mqsicreatebroker` or `mqsichangebroker` commands.
- LDAP Credentials matches the value that is set for the broker by using the `mqsicreatebroker` or `mqsichangebroker` commands.
- Recovery Connection Factory Name is the JNDI administered connection factory that is defined in the bindings file. If a value is not specified, a default value for `recoverXAQCF` must be added to the bindings file. In either case, the Recovery Connection Factory must be defined as an XA Queue Connection Factory for the JMS provider that is associated with the Initial Context Factory.

The optional parameters are comma-separated and are positional. Therefore, any parameters that are missing must be represented by a comma.

1. Update the Java CLASSPATH environment variable for the broker's queue manager to include a reference to `xarecovery.jar`; for example:

```
install_dir/classes/xarecovery.jar
```

2. Update the Java PATH environment variable for the broker's queue manager to point to the bin directory, which is where the switch file is located; for example:

```
install_dir/bin
```

For more information, see the *System Administration Guide* section of the WebSphere MQ Version 6 information center online.

To use the same queue manager for both the broker and the JMS provider, ensure that your WebSphere MQ installation is at the minimum required level: Version 6.0 Fix Pack 1. WebSphere MQ Version 6.0 Fix Pack 1 or above is required for XA to use the same queue manager for both the broker and the provider.

- **z/OS** On z/OS, the external syncpoint manager is Resource Recovery Services (RRS). The only JMS provider that is supported on z/OS is WebSphere MQ JMS. The only transport option that is supported for WebSphere MQ JMS on z/OS is the `bind` option.

Syncpoint control for the JMS provider is managed with RRS syncpoint coordination of the queue manager of the broker. You do not need to modify the `.ini` file.

If the JMSOutput node uses BEA WebLogic as the JMS provider, and the nodes need to participate in a globally coordinated message flow, see "Making the JMS provider client available to the JMS nodes" on page 963 for more information.

Connecting the terminals

Connect the In terminal of the JMSOutput node to the node from which outbound messages are routed.

Connect the Out terminal of the JMSOutput node to another node in the message flow to process the message further, to process errors, or to send the message to an additional destination.

Terminals and properties

When you have put an instance of the JMSOutput node into a message flow, you can configure it; see “Configuring a message flow node” on page 235. The properties of the node are displayed in the Properties view. All mandatory properties that do not have a default value defined are marked with an asterisk.

The terminals of the JMSOutput node are described in the following table.

Terminal	Description
In	The input terminal that accepts a message for processing by the node.
Failure	The output terminal to which the message is routed if an error occurs. Even if the Validation property is set, messages that are propagated to this terminal are not validated.
Out	The output terminal to which the message is routed if it is successfully retrieved from the WebSphere MQ queue.
Catch	The output terminal to which the message is routed if an exception is thrown downstream and caught by this node.

The following tables describe the node properties. The column headed M indicates whether the property is mandatory (marked with an asterisk if you must enter a value when no default is defined), the column headed C indicates whether the property is configurable (you can change the value when you add the message flow to the bar file to deploy it).

The Description properties of the JMSOutput node are described in the following table.

Property	M	C	Default	Description
Node name	No	No	The node type, JMSOutput	The name of the node.
Short Description	No	No		A brief description of the node.
Long Description	No	No		Text that describes the purpose of the node in the message flow.

The Basic properties of the JMSOutput node are described in the following table.

Property	M	C	Default	Description
Destination Queue	No	Yes		The name of the queue to which the node publishes outgoing messages. If the JMSOutput node is to be used to send point-to-point messages, enter the Destination queue name for the JMS queue name that is listed in the bindings file.

Property	M	C	Default	Description
Publication Topic	No	Yes		<p>The name of the topic from which the node receives published messages.</p> <ul style="list-style-type: none"> • If this property is configured, the node operates only in the publish/subscribe message domain. • This property is mutually exclusive with the Destination queue property. • The Publication Topic name must conform to the standards of the JMS provider that is being used by the node.
Reply to destination	No	Yes		<p>The name of the JMS destination to which the receiving application must send a reply message. For a reply message to be returned to this JMS destination, the JMS destination name must be known to the domain of the JMS provider that is used by the receiving client. You can enter a JMS destination, which can be either a subscription queue or a destination topic.</p> <p>The default value is blank, in which case the JMS output message can be regarded as a datagram. If the field is blank, the JMSOutput node does not expect a reply from the receiving JMS client.</p>
Send to destination list in local environment	No	Yes	Cleared	<p>When you have built a list of JMS destinations in the LocalEnvironment, select this check box to use the destination list. If you do not select this check box, the node uses the configured JMS destination. If you select this check box but you have not built a list of JMS destination in the LocalEnvironment, the node uses the configured JMS destination.</p>
Message type	No	Yes	Determine output message type from the JMS Message Tree	<p>Select a value from the list to configure the type of JMS message that is produced by the JMSOutput node. If you do not set a value for this property, the node assumes the output type from the metadata PayloadType field in the JMS message tree, as indicated by the default value, Determine output message type from the JMS Message Tree. Valid values are:</p> <ul style="list-style-type: none"> • Determine output message type from the JMS Message Tree • TextMessage • BytesMessage • MapMessage • StreamMessage • ObjectMessage • Base JMS message with no payload

The JMS Connection properties of the JMSOutput node are described in the following table.

Property	M	C	Default	Description
JMS provider name	Yes	No	WebSphere MQ	<p>Select a JMS vendor name from the list, or enter a name of your choice. When you select a name from the list, the Initial Context Factory property is updated automatically with the relevant java class. If you enter your own JMS provider name, you must also enter a value for the Initial Context Factory. The name must match the name of a configurable service defined for the broker to which you deploy the message flow.</p>

Property	M	C	Default	Description
Initial Context Factory	Yes	Yes	com.sun.jndi.fscontext.ReffFSContextFactory	<p>This property is the starting point for a JNDI name space. A JMS application uses the initial context to obtain and look up the connection factory and queue or topic objects for the JMS provider.</p> <p>If you select a JMS provider name from the list in JMS provider name, the Initial Context Factory property is updated automatically with the relevant Java class. If you enter your own JMS provider name, you must also enter a value for the Initial Context Factory. The default value is <code>com.sun.jndi.fscontext.ReffFSContextFactory</code>, which defines the file-based initial context factory for the WebSphere MQ JMS provider.</p>
Location JNDI Bindings	No	Yes		<p>The system path or the LDAP location for the bindings file. The bindings file contains definitions for the JNDI-administered objects that are used by the JMSOutput node.</p> <p>When you enter a value for Location JNDI Bindings, ensure that it complies with the following instructions:</p> <ul style="list-style-type: none"> • Construct the bindings file before you deploy a message flow that contains a JMSOutput node. • Do not include the file name of the bindings file in this field. • If you have specified an LDAP location that requires authentication, configure both the LDAP principal (userid) and LDAP credentials (password) separately. These values are configured at broker level. For information about configuring these values, see <code>mqsicreatebroker</code> command and <code>mqsichangebroker</code> command. • The string value must include the leading keyword, which is one of: <ul style="list-style-type: none"> - <code>file://</code> - <code>iiop://</code> - <code>ldap://</code> <p>For information about constructing the JNDI-administered objects bindings file, see the documentation that is supplied with the JMS provider.</p>
Connection Factory Name	No	Yes		<p>The name of the connection factory that is used by the JMSOutput node to create a connection to the JMS provider. This name must already exist in the bindings file. The Connection factory can be a JMS QueueConnectionFactory or a JMS TopicConnectionFactory, but it must match the message model that is used by the node. Alternatively, you can specify the generic JMS ConnectionFactory, which can be used for both JMS queue or JMS topic destinations.</p>

The Advanced properties of the JMSOutput node are described in the following table.

Property	M	C	Default	Description
New Correlation ID	No	Yes		<p>If the JMSOutput node is required to generate a new Correlation ID for the message, select New Correlation ID. If you leave the check box cleared, the Correlation ID of the output message is taken from the JMSCorrelationID field in the JMSTransport_Header_Values section of the message tree.</p>

Property	M	C	Default	Description
Transaction Mode	Yes	No	None	This property controls whether the incoming message is received under syncpoint. <ul style="list-style-type: none"> • Select None if the outgoing message is to be treated as non persistent. If you select this value, the message is sent using a non-transacted JMS session that is created using the <code>Session.AUTO_ACKNOWLEDGE</code> flag. • Select Local if the input node that received the message must coordinate the commit or roll-back of JMS messages that have been sent by the JMSOutput node, along with any other resources, such as DB2 or WebSphere MQ, that perform work within the message flow. If you select this value, the node uses a transacted JMS session. • Select Global if the JMSOutput node must participate in a global message flow transaction that is managed by the broker's external syncpoint coordinator. The syncpoint coordinator is the broker's queue manager on distributed systems, and RRS (Resource Recovery Services) on z/OS. If you select this value, any messages that are received by the node are globally coordinated using an XA JMS session.
Delivery Mode	No	Yes	Non Persistent	This property controls the persistence mode that a JMS provider uses for a message. Valid values are: <ul style="list-style-type: none"> • Automatic: the mode from the input message is inherited • Persistent: the message survives if the JMS provider has a system failure • Non Persistent: the message is lost if the JMS provider has a system failure
Message Expiration (ms)	No	Yes	0	This property controls the length of time, in milliseconds, for which the JMS provider keeps the output JMS message. The default value, 0, is used to indicate that the message must not expire. <p>Select Inherit from header or enter an integer that represents a number of milliseconds. If you select Inherit from header, the property inherits the value of the JMSExpiry field in the JMS message, which is found at the following location:</p> <p><code>OutputRoot.JMSTransport.Transport_Folders.Header_Values.JMSExpiration</code></p>
Message Priority	No	Yes	4	This property assigns relative importance to the message and it can be used for message selection by a receiving JMS client application or a JMSOutput node. <p>Select a value between 0 (lowest priority) and 9 (highest priority) or select Inherit from header.</p> <p>The default value is 4, which indicates medium priority. Priorities in the range 0 to 4 relate to normal delivery. Priorities in the range 5 to 9 relate to graduations of expedited delivery. If you select Inherit from header, the property inherits the value of the JMSPriority field in the JMS message, which is found at the following location:</p> <p><code>OutputRoot.JMSTransport.Transport_Folders.Header_Values.JMSPriority</code></p>

The Validation properties of the JMSOutput node are described in the following table. For more information about Validation properties, see “Validating messages” on page 164 and “Validation properties” on page 1359.

Property	M	C	Default	Description
Validate	No	Yes	Inherit	This property controls whether validation takes place. Valid values are None, Content, Content And Value, and Inherit.
Failure Action	No	No	Exception	This property controls what happens if validation fails. You can set this property only if you set Validate to Content or Content and Value. Valid values are User Trace, Local Error Log, Exception, and Exception List.

JMSReply node

Use the JMSReply node to send messages to JMS destinations.

This topic contains the following sections:

- “Purpose”
- “Using the JMSReply node in a message flow”
- “Working with the JMS message ID”
- “Terminals and properties” on page 973

Purpose

The JMSReply node has a similar function to the JMSOutput node, but the JMSReply node sends JMS messages only to the reply destination that is supplied in the JMSReplyTo header field of the JMS message tree. Use the JMSReply node when you want to treat a JMS message that is output from a message flow as a reply to a JMS input message, and where you have no other routing requirements.

The JMSReply node is contained in the **JMS** drawer of the palette, and is represented in the workbench by the following icon:



Using the JMSReply node in a message flow

Consider a situation in which you create a message flow in which a JMSInput node message obtains point-to-point messages from a JMS destination called MyJMSInputQueue. The message flow updates a database using the contents of the message, then replies to a JMS destination called MyJMSReplyQueue, which is set by the generating application in the JMSReplyTo header of the input message.

In a similar scenario for the publish/subscribe message model, a JMSInput node subscribes to TopicA, and the JMSReply node publishes on the TopicB destination, which was retrieved from the JMSReplyTo header of the input message.

Working with the JMS message ID

The JMS message ID is generated by the JMS provider when a message is sent by the JMSReply node. You cannot set the message ID in the message flow, but you can use one of the following methods to obtain the generated ID after the message has been sent:

- Connect a Compute node to the Out terminal.

Connect a Compute node to the Out terminal of a JMSReply node and interrogate the WrittenDestination List. For more information, see “Viewing the logical message tree in trace output” on page 167.

An entry for a JMSReply node has the following format:

```
WrittenDestination = (  
  JMS = (  
    DestinationData = (  
      destinationName = 'queue://jmsQueue1'  
      initialContext = 'com.sun.jndi.fscontext.RefFSContextFactory'  
      JMSMessageID = ID:414d512054657374514d2020202020206ab98b4520017a02'  
      JMSCorrelationID = 'ABCDEFGHJKLMNOPQRSTUVWXYZ'  
    )  
  )  
)
```

- Configure a user exit to process an output message callback event. For more information, see “Exploiting user exits” on page 198.

Terminals and properties

When you have put an instance of the JMSReply node into a message flow, you can configure it; see “Configuring a message flow node” on page 235. The properties of the node are displayed in the Properties view. All mandatory properties that do not have a default value defined are marked with an asterisk.

The terminals of the JMSReply node are described in the following table.

Terminal	Description
Failure	The output terminal to which the message is routed if an error occurs. Even if the Validation property is set, messages that are propagated to this terminal are not validated.
Out	The output terminal to which the message is routed if it is successfully retrieved from the WebSphere MQ queue.

The following tables describe the node properties. The column headed M indicates whether the property is mandatory (marked with an asterisk if you must enter a value when no default is defined), the column headed C indicates whether the property is configurable (you can change the value when you add the message flow to the bar file to deploy it).

The Description properties of the JMSReply node are described in the following table.

Property	M	C	Default	Description
Node name	No	No	The node type	The name of the node.
Short Description	No	No		A brief description of the node.
Long Description	No	No		Text that describes the purpose of the node in the message flow.

The Basic properties of the JMSReply node are described in the following table.

Property	M	C	Default	Description
Send to destination list in local environment	No	Yes	Cleared	When you have built a list of JMS destinations in the LocalEnvironment, select this check box to use the destination list. If you do not select this check box, the node uses the configured JMS destination. If you select this check box but you have not built a list of JMS destinations in the LocalEnvironment, the node uses the configured JMS destination.

The JMS Connection properties of the JMSReply node are described in the following table.

Property	M	C	Default	Description
JMS provider name	Yes	No	WebSphere MQ	Select a JMS vendor name from the drop-down list, or enter a name of your choice. When you select a name from the list, the Initial Context Factory property is updated automatically with the relevant Java class. If you enter your own JMS provider name, you must also enter a value for the Initial Context Factory. The default value is WebSphere MQ.
Initial Context Factory	Yes	Yes	<code>com.sun.jndi.fscontext.ReffSContextFactory</code>	This property is the starting point for a JNDI name space. A JMS application uses the initial context to obtain and look up the connection factory and queue or topic objects for the JMS provider. If you select a JMS provider name from the list in JMS provider name, the Initial Context Factory property is updated automatically with the relevant Java class. If you enter your own JMS provider name, you must also enter a value for the Initial Context Factory. The default value is <code>com.sun.jndi.fscontext.ReffSContextFactory</code> , which defines the file-based initial context factory for the WebSphere MQ JMS provider.
Location JNDI Bindings	Yes	Yes		This property specifies either the file system path or the LDAP location for the bindings file. The bindings file contains definitions for the JNDI-administered objects that are used by the JMSReply node. When you enter a value for Location JNDI Bindings, ensure that it complies with the following instructions: <ul style="list-style-type: none"> • Construct the bindings file before you deploy a message flow that contains a JMSReply node. • Do not include the file name of the bindings file in this field. • If you have specified an LDAP location that requires authentication, configure both the LDAP principal (userid) and LDAP credentials (password) separately. These values are configured at broker level. For information about configuring these values, refer to the <code>mqsicreatebroker</code> and <code>mqsichangebroker</code> commands. • The string value must include the leading keyword, which is one of: <ul style="list-style-type: none"> - <code>file://</code> - <code>iio://</code> - <code>ldap://</code> For information about constructing the JNDI-administered objects bindings file, refer to the documentation that is supplied with the JMS provider.
Connection Factory Name	Yes	Yes		The name of the connection factory that is used by the JMSReply node to create a connection to the JMS provider. This name must already exist in the bindings file.

The Advanced properties of the JMSReply node are described in the following table.

Property	M	C	Default	Description
New Correlation ID	No	Yes	Cleared	If the JMSReply node is required to generate a new Correlation ID for the message, select the check box. The check box is cleared by default; if you leave the check box cleared, the Correlation ID of the output message is taken from the JMSCorrelationID field in the JMSTransport_Header_Values section of the message tree.
Transaction Mode	No	No	None	This property controls whether the incoming message is received under sync point. To define the transactional characteristics of how the message is handled, select one of the following values: <ul style="list-style-type: none"> • Select None if the outgoing message is to be treated as non-persistent. If you select this value, the message is sent using a non-transacted JMS session that is created using the <code>Session.AUTO_ACKNOWLEDGE</code> parameter. • Select Local if the input node that receives the message should coordinate the commit or roll-back of JMS messages that have been sent by the JMSReply node, along with any other resources, such as DB2 or WebSphere MQ, that perform work within the message flow. If you select this value, the node uses a transacted JMS session. • Select Global if the JMSReply node should participate in a global message flow transaction that is managed by the broker's external sync point coordinator. The sync point coordinator is the broker's queue manager on distributed systems, and RRS (Resource Recovery Services) on z/OS. If you select this value, any messages that are received by the node are globally coordinated using an XA JMS session.
Delivery Mode	No	Yes	Automatic	This property controls the persistence mode that a JMS provider uses for a message. Valid values are: <ul style="list-style-type: none"> • Automatic: the mode from the input message is inherited • Persistent: the message survives if the JMS provider has a system failure • Non-persistent: the message is lost if the JMS provider has a system failure
Message Expiration (ms)	Yes	Yes	0	This property controls the length of time, in milliseconds, for which the JMS provider keeps the output JMS message. The default value, 0, is used to indicate that the message must not expire. <p>Select Inherit from header or enter an integer that represents a number of milliseconds. If you select Inherit from header, the property inherits the value of the JMSExpiry field in the JMS message, which is found at the following location:</p> <p>OutputRoot.JMSTransport.Transport_Folders.Header_Values.JMSExpiration</p>
Message Priority	No	Yes	4	This property assigns relative importance to the message and it can be used for message selection by a receiving JMS client application or a JMSReply node. <p>Select a value between 0 (lowest priority) and 9 (highest priority) or select Inherit from header.</p> <p>The default value is 4, which indicates medium priority. Priorities in the range 0 to 4 relate to normal delivery. Priorities in the range 5 to 9 relate to graduations of expedited delivery. If you select Inherit from header, the property inherits the value of the JMSPriority field in the JMS message, which is found at the following location:</p> <p>OutputRoot.JMSTransport.Transport_Folders.Header_Values.JMSPriority</p>

Property	M	C	Default	Description
Message type	No	Yes	TextMessage	<p>This property controls the class of the JMS output message. The default value is TextMessage. Valid values are:</p> <ul style="list-style-type: none"> • TextMessage • BytesMessage • MapMessage • StreamMessage • ObjectMessage • Base JMS message with no payload <p>If you do not set this property, the node assumes the output type from the metadata PayLoadType field in the JMS message tree.</p>

The Validation properties of the JMSReply node are described in the following table. Refer to “Validation properties” on page 1359 for a full description of these properties.

Property	M	C	Default	Description
Validate	No	Yes	Inherit	<p>This property controls whether validation takes place. Valid values are:</p> <ul style="list-style-type: none"> • None • Content and Value • Content • Inherit <p>If a message is propagated to the Failure terminal of the node, it is not validated.</p>
Failure Action	No	No	Exception	<p>This property controls what happens if validation fails. You can set this property only if you set Validate to Content or Content and Value. Valid values are:</p> <ul style="list-style-type: none"> • User Trace • Local Error Log • Exception (default value) • Exception List

Label node

Use the Label node to process a message that is propagated by a RouteToLabel node to dynamically determine the route that the message takes through the message flow.

This topic contains the following sections:

- “Purpose”
- “Using this node in a message flow” on page 977
- “Terminals and properties” on page 977

Purpose

Use the Label node in combination with a RouteToLabel node to route a message through the message flow based on message content. The RouteToLabel node interrogates the LocalEnvironment of the message to determine the identifier of the Label node to which the message must be routed next. You can propagate the message by coding ESQL in a Compute node, or by coding Java in a JavaCompute or user-defined node.

Precede the RouteToLabel node in the message flow with a Compute node or JavaCompute node and populate the LocalEnvironment of the message with the identifiers of one or more Label nodes that introduce the next sequence of processing for the message.

Design your message flow so that a Label node logically follows a RouteToLabel node within a message flow, but do not connect it physically to the RouteToLabel node. The connection is made by the broker, when required, according to the contents of LocalEnvironment.

The Label node provides a target for a routing decision, and does not process the message that it handles in any way. Typically, a Label node connects to a subflow that processes each message in a specific way, and either ends in an output node or in another RouteToLabel node.

The Label node can also be used in conjunction with a SOAPExtract node or as the target of a PROPAGATE statement, which is specified in a Compute or Database node.

The Label node is contained in the **Routing** drawer of the palette, and is represented in the workbench by the following icon:



Using this node in a message flow

Look at the following sample to see how to use this node:

- Airline Reservations sample

You can view samples only when you use the information center that is integrated with the Message Broker Toolkit.

Terminals and properties

When you have put an instance of the Label node into a message flow, you can configure it; see “Configuring a message flow node” on page 235. The properties of the node are displayed in the Properties view. All mandatory properties for which you must enter a value (those that do not have a default value defined) are marked with an asterisk.

The Label node terminals are described in the following table.

Terminal	Description
Out	The output terminal to which the message is routed.

The following tables describe the node properties. The column headed M indicates whether the property is *mandatory* (marked with an asterisk if you must enter a value when no default is defined); the column headed C indicates whether the property is *configurable* (you can change the value when you add the message flow to the bar file to deploy it).

The Label node Description properties are described in the following table.

Property	M	C	Default	Description
Node name	No	No	The node type	The name of the node.
Short Description	No	No		A brief description of the node.
Long Description	No	No		Text that describes the purpose of the node in the message flow.

The Label node Basic properties are described in the following table.

Property	M	C	Default	Description
Label Name	Yes	No		An identifier for the node. It is used as a target for a message that is routed by a RouteToLabel node. Label Name must not be the same as the name of the instance of the node itself, and it must be unique within the message flow in which it appears. The name of the instance can be modified by the workbench if the subflow, of which this Label node is a part, is embedded into another message flow.

Mapping node

Use the Mapping node to construct one or more new messages and populate them with various types of information.

This topic contains the following sections:

- “Purpose”
- “Using this node in a message flow” on page 979
- “Terminals and properties” on page 979

Purpose

You can populate the new messages with the following types of information:

- New information
- Modified information from the input message
- Information taken from a database

You can modify elements of the message body data, its associated environment, and its exception list.

When you first open or create a message map for the node, if you select This map is called from a message flow node and maps properties and message body, the headers in the input message are always copied to the output message without modification. To modify the message headers in a Mapping node, select This map is called from a message flow node and maps properties, headers, and message body. When you select this property, the map that is created allows additional elements, including WebSphere MQ, HTTP, and JMS headers, to be mapped.

These components of the output message can be defined using mappings that are based on elements of both the input message and data from an external database. You create the mappings that are associated with this node, in the mapping file that is associated with this node, by mapping inputs (message or database) to outputs. You can modify the assignments made by these mappings using supplied or user-defined functions and procedures; for example, you can convert a string value to uppercase when you assign it to the message output field.

Use the Mapping node to:

- Build a new message
- Copy messages between parsers
- Transform a message from one format to another

The Mapping node is contained in the **Transformation** drawer of the palette, and is represented in the workbench by the following icon:



Using this node in a message flow

Look at the following sample to see how to use this node:

- Pager samples

You can view samples only when you use the information center that is integrated with the Message Broker Toolkit.

Terminals and properties

When you have put an instance of the Mapping node into a message flow, you can configure it; see “Configuring a message flow node” on page 235. The properties of the node are displayed in the Properties view. All mandatory properties for which you must enter a value (those that do not have a default value defined) are marked with an asterisk.

The Mapping node terminals are described in the following table.

Terminal	Description
In	The input terminal that accepts a message for processing by the node.
Failure	The output terminal to which the input message is propagated if a failure is detected during the computation. If you have selected Treat Warnings as Errors, the node propagates the message to this terminal if database warning messages are returned, even though the processing might have completed successfully.
Out	The output terminal that outputs the message following the execution of the mappings.

The following tables describe the node properties. The column headed M indicates whether the property is *mandatory* (marked with an asterisk if you must enter a value when no default is defined); the column headed C indicates whether the property is *configurable* (you can change the value when you add the message flow to the bar file to deploy it).

The Mapping node Description properties are described in the following table.

Property	M	C	Default	Description
Node name	No	No	The node type	The name of the node.
Short Description	No	No		A brief description of the node.
Long Description	No	No		Text that describes the purpose of the node in the message flow.

The Mapping node Basic properties are described in the following table.

Property	M	C	Default	Description
Data Source	No	Yes		<p>The ODBC data source name of the database that contains the tables to which you refer in the mappings that are associated with this node (identified by the Mapping Module property). This name identifies the appropriate database on the system on which this message flow is to execute. The broker connects to this database with user ID and password information that you have specified on the mqsicreatebroker, mqsicchangebroker, or mqsisetdbparms command.</p> <p>z/OS On z/OS systems, the broker uses the broker started task ID, or the user ID and password that are specified on the mqsisetdbparms command JCL, BIPSDBP in the customization data set <hlq>.SBIPPROC.</p>
Transaction	Yes	No	Automatic	<p>The transaction mode for the node. The values are:</p> <ul style="list-style-type: none"> • Automatic (the default). The message flow, of which the Mapping node is a part, is committed if it is successful; that is, the actions that you define in the mappings are performed and the message continues through the message flow. If the message flow fails, it is rolled back. If you choose Automatic, the ability to commit or rollback the action of the Mapping node on the database depends on the success or failure of the entire message flow. • Commit. To commit any uncommitted actions that are performed in this message flow on the database that is connected to this node, irrespective of the success or failure of the message flow as a whole, select Commit. The changes to the database are committed even if the message flow fails.
Mapping Routine	Yes	No	Mapping	<p>The name of the mapping routine that contains the statements to execute against the database or the message tree. By default, the name that is assigned to the mapping routine is identical to the name of the mapping file in which the routine is defined. The default name for the file is the name of the message flow concatenated with the name of the node when you include it in the message flow (for example, MFlow1_Mapping.msgmap for the first Mapping node in message flow MFlow1). You cannot specify a value that includes spaces.</p> <p>If you click Browse next to this entry field, a dialog box is displayed that lists all available mapping routines that this node can access. Select the routine that you want and click OK; the routine name is set in Mapping Module.</p> <p>To work with the mapping routine that is associated with this node, double-click the node, or right-click the node and click Open Mappings. If the mapping routine does not exist, it is created for you with the default name in the default file. If the file exists already, you can also open file <flow_name>_<node_name>.msgmap in the Broker Development view.</p> <p>A mapping routine is specific to the type of node with which it is associated; you cannot use a mapping routine that you have developed for a Mapping node with any other node that uses mappings (for example, a DataInsert node). If you create a mapping routine, you cannot call it from any other mapping routine, although you can call it from an ESQL routine.</p> <p>For more information about working with mapping files, and defining their content, see “Developing message mappings” on page 472.</p>

Property	M	C	Default	Description
Mapping Mode	Yes	No	Message	<p>The mode that is used to process information that is passed through the Mapping node. Valid values are:</p> <ul style="list-style-type: none"> • Message (the default): the message is generated or passed through by the Mapping node, as modified within the node. • LocalEnvironment: the LocalEnvironment tree structure is generated or passed through by the Mapping node, as modified within the node. • LocalEnvironment And Message: the LocalEnvironment tree structure and message are generated or passed through by the Mapping node, as modified by the node. • Exception: the ExceptionList is generated or passed through by the Mapping node, as modified by the node. • Exception And Message: the ExceptionList and message are generated or passed through by the Mapping node, as modified by the node. • Exception And LocalEnvironment: the ExceptionList and LocalEnvironment tree structures are generated or passed through by the Mapping node, as modified by the node. • All: the message, ExceptionList, and LocalEnvironment are generated or passed through by the Mapping node, as modified by the node. <p>You must set this property to reflect accurately the output message format that you need. If you select an option (or accept the default value) that does not include a particular component of the message, that component is not included in any output message that is constructed.</p> <p>You can choose any combination of Message, LocalEnvironment, and Exception components to be generated and modified by the Mapping node. To construct a map that propagates multiple target messages, set this property to LocalEnvironment And Message to ensure that the node executes correctly.</p> <p>LocalEnvironment was known as DestinationList in some previous versions; it is retained for compatibility.</p> <p>The Environment component of the message tree is not affected by the mode setting. Its contents, if any, are passed on from this node.</p>
Treat Warnings as Errors	Yes	No	Cleared	<p>For database warning messages to be treated as errors, and the node to propagate the output message to the Failure terminal, select Treat Warnings as Errors. The check box is cleared initially.</p> <p>When you select the check box, the node handles all positive return codes from the database as errors and generates exceptions in the same way as it does for the negative, or more serious, errors. If you do not select the check box, the node treats warnings as normal return codes, and does not raise any exceptions. The most significant warning raised is not found, which can be handled safely as a normal return code in most circumstances.</p>
Throw Exception on Database Error	Yes	No	Selected	<p>For the broker to generate an exception when a database error is detected, select Throw Exception on Database Error. The check box is selected initially. If you clear the check box, you must handle the error in the message flow to ensure the integrity of the broker and the database. The error is ignored if you do not handle it through your own processing, because you have chosen not to invoke the default error handling by the broker. For example, you could connect the Failure terminal to an error processing subroutine.</p>

The parser options for the Mapping node are described in the following table.

Property	M	C	Default	Description
Use XMLNS Compact Parser for XMLNS Domain	No	No	Cleared	If you select this check box, the outgoing MQRFH2 specifies the XMLNS instead of XMLNSC parser, allowing an external application to remain unchanged. If outgoing messages do not contain MQRFH2 headers, this property has no effect.

The Validation properties of Mapping node are described in the following table.

If a message is propagated to the Failure terminal of the node, it is not validated. These properties do not cause the input message to be validated. It is expected that, if such validation is required, the validation has already been performed by the input node or a preceding validation node. For more details about validating messages and validation properties, see “Validating messages” on page 164 and “Validation properties” on page 1359.

Property	M	C	Default	Description
Validate	No	Yes	None	This property controls whether validation takes place. Valid values are None, Content and Value, Content, and Inherit.
Failure Action	No	No	Exception	This property controls what happens if a validation failure occurs. You can set this property only if Validate is set to Content or Content and Value. Valid values are User Trace, Local Error Log, Exception, and Exception List.

MQeInput node

Use the MQeInput node to receive messages from clients that connect to the broker using the WebSphere MQ Mobile Transport protocol.

Attention: Using message flows that contain MQeInput and MQeOutput nodes in Version 6.1 is deprecated. The behavior that is described here is intended only for when you are deploying from Version 6.1 to a previous version, and to provide a route for migration. Redesign your flows to remove the MQe nodes and replace them with MQ nodes that are configured to your own specifications and coordinated with your MQe gateway configuration. For more details, see Migrating a message flow that contains WebSphere MQ Everyplace nodes.

This topic contains the following sections:

- “Purpose”
- “Using the MQeInput node in a message flow” on page 984
- “WebSphere MQ Everyplace documentation” on page 984
- “Configuring the MQeInput node” on page 984
- “Terminals and properties” on page 988

Purpose

The MQeInput node receives messages that are put to a message flow from a specified bridge queue on the broker’s WebSphere MQ Everyplace queue manager. The node also establishes the processing environment for the messages. You must create and configure the WebSphere MQ Everyplace queue manager before you deploy a message flow that contains this node.

Message flows that handle messages that are received across WebSphere MQ connections must always start with an MQeInput node. You can set the MQeInput

node's properties to control the way in which messages are received; for example, you can indicate that a message is to be processed under transaction control.

When you deploy message flows that contain WebSphere MQ Everyplace nodes to a broker, you must deploy them to a single execution group, regardless of the number of message flows. The WebSphere MQ Everyplace nodes in the message flows must all specify the same WebSphere MQ Everyplace queue manager name. If you do not meet this restriction, an error is raised when you deploy.

The MQeInput node handles messages in the following message domains:

- MRM
- XMLNSC
- XMLNS
- JMSMap
- JMSStream
- MIME
- BLOB
- XML (this domain is deprecated; use XMLNSC)
- IDOC (this domain is deprecated; use MRM)

If you include an output node in a message flow that starts with an MQeInput node, it can be any of the supported output nodes, including user-defined output nodes; you do not need to include an MQeOutput node. You can create a message flow that receives messages from WebSphere MQ Everyplace clients and generates messages for clients that use any of the supported transports to connect to the broker, because you can configure the message flow to request the broker to provide any conversion that is necessary.

WebSphere MQ Everyplace Version 1.2.6 is used by WebSphere Message Broker. This version is compatible with later versions of WebSphere MQ Everyplace. Clients that use later versions of WebSphere MQ Everyplace (for example, Version 2.0), work correctly when connected to this node, although additional functionality that is not supported in Version 1.2.6 (for example, JMS support) does not work.

Queue managers are *not* interchangeable between different versions of WebSphere MQ Everyplace. Nodes must use a queue manager that was created using Version 1.2.6. Similarly, the client must use its own level of the code when creating a queue manager.

z/OS You cannot use MQeInput nodes in message flows that you deploy to z/OS systems.

If you create a message flow to use as a subflow, you cannot use a standard input node; you must use an instance of the Input node as the first node to create an In terminal for the subflow.

If your message flow does not receive messages across WebSphere MQ connections, you can choose another supported input node.

The MQeInput node is contained in the **WebSphere MQ** drawer of the palette, and is represented in the workbench by the following icon:



Using the MQeInput node in a message flow

For an example of how this node can be used, consider a farmer who checks his fields to see how well they are irrigated. He is carrying a PDA device with WebSphere MQ Everyplace installed. He sees an area of field that requires water, and uses his PDA and a Global Satellite Navigation link to send a message to an MQeInput node. The data is manipulated using a Compute node, and a message is published by a Publication node so that a remote SCADA device can pick up the message and trigger the irrigation sprinklers. The farmer can see the water delivered to the field, minutes after sending his message.

WebSphere MQ Everyplace documentation

Find further information about WebSphere MQ Everyplace, and the properties of the node, in the WebSphere MQ Everyplace documentation on the WebSphere MQ Web page.

Configuring the MQeInput node

When you have put an instance of the MQeInput node into a message flow, you can configure it; see “Configuring a message flow node” on page 235. The properties of the node are displayed in the Properties view.

All mandatory properties for which you must enter a value (those that do not have a default value defined) are marked with an asterisk.

Configure the MQeInput node as follows:

1. Optional: On the **Description** tab, enter a Short description, a Long description, or both. You can also rename the node on this tab.
2. On the **Default** tab, set values for the properties that describe the message domain, message set, message type, and message format that the node uses to determine how to parse the incoming message, and the default topic that is associated with the message.

- If the incoming message has an MQRFH2 header, you do not need to set values for the Default properties because the values can be derived from the <mcd> folder in the MQRFH2 header; for example:

```
<mcd><Msd>MRM</Msd><Set>DHM4U0906S001</Set><Type>receiptmsg1</Type>  
<Fmt>XML</Fmt></mcd>
```

If you set values, and those values differ from those in the MQRFH2 header, the MQRFH2 header values take precedence.

- In Message domain, select the name of the parser that you are using from the list. Choose from the following options:
 - MRM
 - XMLNSC
 - XMLNS
 - JMSMap
 - JMSStream
 - MIME
 - BLOB
 - XML (this domain is deprecated; use XMLNSC)
 - IDOC (this domain is deprecated; use MRM)

You can also specify a user-defined parser, if appropriate.

- If you are using the MRM or IDOC parser, or the XMLNSC parser in validating mode, select the correct message set from the list in Message set. This list is populated with available message sets when you select MRM, XMLNSC, or IDOC as the domain.
 - If you are using the MRM parser, select the correct message from the list in Message type. This list is populated with messages that are defined in the message set that you have selected.
 - If you are using the MRM or IDOC parser, select the format of the message from the list in Message format. This list includes all the physical formats that you have defined for this message set.
 - Enter the message topic in Topic. You can enter any characters as the topic name. When messages pass through the MQeInput node, they assume whatever topic name you have entered. (If you are using publish/subscribe, you can subscribe to a topic and see any messages that passed through the MQeInput node under that topic name.)
3. On the **General** tab, set the following properties:
- a. Enter the Queue name of the WebSphere MQ Everyplace bridge queue from which this input node retrieves messages. If the queue does not exist, it is created for you when the message flow is deployed to the broker.
 - b. Set the level of Trace that you want for this node. If trace is active, the trace information is recorded in the file identified by Trace filename (described later in this section). Choose a level of trace:
 - None (the default). No trace output is produced, unless an unrecoverable error occurs.
 - Standard. Minimal trace output is generated to reflect the overall operations of the node.
 - Debug. Trace information is recorded at a level that helps you to debug WebSphere MQ Everyplace programs.
 - Full. All available debug information is recorded to provide a full record of the node activities.

If you set the trace level to Debug or Full, you will impact the performance of WebSphere MQ Everyplace, and significant trace files can be generated. Use these options for short periods only.
 - c. In Trace filename, specify the name of the file to which the trace information is written. The directory structure in which the file is specified must already exist; it cannot be created during operation.
 - d. Select the Transaction mode to define the transactional characteristics of how this message is handled:
 - If you select Automatic, the incoming message is received under sync point if it is marked persistent; otherwise it is not. The transactionality of any derived messages that are sent subsequently by an output node is determined by the incoming persistence property, unless the output node has overridden transactionality explicitly.
 - If you select Yes, the incoming message is received under sync point. Any derived messages that are sent subsequently by an output node in the same instance of the message flow are sent transactionally, unless the output node has overridden transactionality explicitly.
 - If you select No, the incoming message is not received under sync point. Any derived messages that are sent subsequently by an output node in the message flow are sent non-transactionally, unless the output node has specified that the message must be put under sync point.

- e. The Use config file check box is not selected by default; values for all properties for the MQeInput node are taken from the Properties view. If you select the check box, the definition of all properties is extracted from the file that is identified by Config filename (described later in this section) with the exception of the following properties:

- The Queue name and Config filename General properties
- All Default properties

Use a configuration file only to specify additional properties for the node. If the properties in the Properties view are sufficient for your needs, do not select the Use config file check box.

- f. If you have selected the Use config file check box, enter the full path and name of the configuration file for WebSphere MQ Everyplace in Config filename. This file must be installed on the system that supports every broker to which this message flow is deployed. If the file does not exist, an error is detected when you deploy the message flow. The default file name is MQeConfig.ini.
- g. In Queue manager name, specify the name of the WebSphere MQ Everyplace queue manager. This queue manager is not related to the queue manager of the broker to which you deploy the message flow that contains this node.

Only one WebSphere MQ Everyplace queue manager can be supported. Only one execution group can contain MQeInput or MQeOutput nodes. This property must therefore be set to the same value in every MQeInput node that is included in every message flow that you deploy to the same broker.

4. On the **Channel** tab, set the maximum number of channels that are supported by WebSphere MQ Everyplace in Max channels. The default value is zero, which means that there is no limit.
5. On the **Registry** tab, set the following properties:
- a. Select the type of registry from the Registry type list:
- FileRegistry. Registry and security information is provided in the Directory specified later in this section.
 - PrivateRegistry. You create the queue manager manually within WebSphere MQ Everyplace, specifying the security parameters that you need.
- b. In Directory, specify the directory in which the registry file is located. This property is valid only if you have selected a Registry type of FileRegistry.
- c. If you have selected a Registry type of PrivateRegistry, complete the following properties (for further details of these properties, see the WebSphere MQ Everyplace documentation):
- Specify a PIN for the associated queue manager.
 - Specify a Certificate request PIN for authentication requests.
 - Provide a Keyring password to be used as a seed for the generation of crypto keys.
 - In Certificate host, specify the name of the certificate server that WebSphere MQ Everyplace uses for authentication.
 - In Certificate port, specify the number of the port for the certificate server that WebSphere MQ Everyplace uses for authentication.
6. On the **Listener** tab, set the following properties that define the connection type for WebSphere MQ Everyplace:

- a. In Listener type, select the adapter type to use from the list. The default value is Http; you can also select Length or History. For further details, see the WebSphere MQ Everyplace documentation.
- b. In Hostname, specify the hostname of the server. Set this property to the special value localhost or to the TCP/IP address 127.0.0.1 (the default value), both of which resolve correctly to the hostname of the server to which the message flow is deployed. You can also use any valid hostname or TCP/IP address in your network, but you must use a different message flow for each broker to which you deploy it, or configure this property at deploy time.
- c. In Port, specify the port number on which WebSphere MQ Everyplace is listening. If more than one MQeInput node is included in a message flow that is deployed to a single broker, each MQeInput node must specify a different number for this property. You must also ensure that the number that you specify does not conflict with other listeners on the broker system; for example, with WebSphere MQ. The default value is 8081.
- d. In Time interval (sec), specify the timeout value, in seconds, before idle channels are timed out. The default value is 300 seconds.

Channels are persistent logical entities that last longer than a single queue manager request, and can survive network breakages, so it might be necessary to time out channels that have been inactive for a period of time.

Connecting the terminals:

The MQeInput node routes each message that it retrieves successfully to the Out terminal; if this fails, the message is retried. If the retry timeout expires (as defined by the BackoutThreshold attribute of the input queue), the message is routed to the Failure terminal; you can connect nodes to this terminal to handle this condition. If you have not connected the Failure terminal, the message is written to the backout queue.

If the message is caught by this node after an exception has been thrown further on in the message flow, the message is routed to the Catch terminal. If you have not connected the Catch terminal, the message loops continually through the node until the problem is resolved. You must define a backout queue or a dead-letter queue (DLQ) to prevent the message looping continuously through the node.

Configuring for coordinated transactions:

When you include an MQeInput node in a message flow, the value that you set for the Transaction mode property defines whether messages are received under sync point:

- If you set the property to Yes (the default), the message is received under sync point (that is, within a WebSphere MQ unit of work). Any messages that are sent subsequently by an output node in the same instance of the message flow are put under sync point, unless the output node has overridden this explicitly.
- If you set the property to Automatic, the message is received under sync point if the incoming message is marked persistent. Otherwise, it is not. Any message that is sent subsequently by an output node is put under sync point, as determined by the incoming persistence property, unless the output node has overridden this explicitly.

- If you set the property to No, the message is not received under sync point. Any messages that are sent subsequently by an output node in the flow are not put under sync point, unless an individual output node has specified that the message must be put under sync point.

The MQeOutput node is the only output node that you can configure to override this option.

Terminals and properties

The MQeInput node terminals are described in the following table.

Terminal	Description
Failure	The output terminal to which the message is routed if an error occurs.
Out	The output terminal to which the message is routed if it is successfully retrieved from the WebSphere MQ Everyplace queue.
Catch	The output terminal to which the message is routed if an exception is thrown downstream and caught by this node.

The following tables describe the node properties. The column headed M indicates whether the property is *mandatory* (marked with an asterisk if you must enter a value when no default is defined); the column headed C indicates whether the property is *configurable* (you can change the value when you add the message flow to the bar file to deploy it).

The MQeInput node Description properties are described in the following table.

Property	M	C	Default	Description
Node name	No	No	MQeInput	The name of the node.
Short description	No	No		A brief description of the node.
Long description	No	No		Text that describes the purpose of the node in the message flow.

The MQeInput node Default properties are described in the following table.

Property	M	C	Default	Description
Message domain	No	No		The domain that is used to parse the incoming message.
Message set	No	No		The name or identifier of the message set in which the incoming message is defined. If you set this property, then subsequently update the project dependencies to remove this message set reference, a warning is issued. Either update the Message set property, or restore the reference to this message set project.
Message type	No	No		The name of the incoming message.
Message format	No	No		The name of the physical format of the incoming message.
Topic	No	Yes		The default topic for the input message.

The MQeInput node General properties are described in the following table.

Property	M	C	Default	Description
Queue name	Yes	Yes		The name of the WebSphere MQ Everyplace bridge queue from which this node retrieves messages for processing by this message flow.
Trace	Yes	No	None	The level of trace required for this node. Valid values are None, Standard, Debug, and Full.
Trace filename	Yes	Yes	\MQeTraceFile.trc	The name of the file to which trace records are written.
Transaction mode	Yes	No	Yes	This property controls whether the incoming message is received under sync point. Valid values are Automatic, Yes, and No.
Use config file	Yes	No	Cleared	If you select the check box, a configuration file is used for this node.
Config filename	Yes	Yes	\MQeconfig.ini	The name of the configuration file to be used if the Use config file check box is selected.
Queue manager name	Yes	Yes	ServerQM1	The name of the WebSphere MQ Everyplace queue manager.

The MQeInput node Channel properties are described in the following table.

Property	M	C	Default	Description
Max channels	Yes	No	0	The maximum number of channels that are supported by the WebSphere MQ Everyplace queue manager.

The MQeInput node Registry properties are described in the following table.

Property	M	C	Default	Description
Registry type	Yes	Yes	FileRegistry	The type of registry information to be used. Valid values are FileRegistry and PrivateRegistry.
Directory	Yes	Yes	\ServerQM1\registry	The directory in which the registry file exists (valid only if FileRegistry is selected).
PIN	Yes	Yes		The PIN that is associated with the WebSphere MQ Everyplace queue manager (valid only if PrivateRegistry is selected).
Certificate request PIN	Yes	Yes		The PIN that is used to request authentication (valid only if PrivateRegistry is selected).
Keyring password	Yes	Yes		The password that is used to see crypto keys (valid only if PrivateRegistry is selected).
Certificate host	Yes	Yes		The name of the certificate server (valid only if PrivateRegistry is selected).
Certificate port	Yes	Yes		The port of the certificate server (valid only if PrivateRegistry is selected).

The MQeInput node Listener properties are described in the following table.

Property	M	C	Default	Description
Listener type	Yes	Yes	Http	The adapter type for the listener. Valid values are Http, Length, and History.

Property	M	C	Default	Description
Hostname	Yes	Yes	127.0.0.1	The hostname of the server.
Port	Yes	Yes	8081	The port on which WebSphere MQ Everyplace listens.
Time interval (sec)	Yes	Yes	300	The WebSphere MQ Everyplace polling interval, specified in seconds.

MQeOutput node

Use the MQeOutput node to send messages to clients that connect to the broker using the WebSphere MQ Mobile Transport protocol.

Attention: Using message flows that contain MQeInput and MQeOutput nodes in Version 6.1 is deprecated. The behavior that is described here is intended only for when you are deploying from Version 6.1 to a previous version, and to provide a route for migration. Redesign your flows to remove the MQe nodes and replace them with MQ nodes that are configured to your own specifications and coordinated with your MQe gateway configuration. For more details see *Migrating a message flow that contains WebSphere MQ Everyplace nodes*.

This topic contains the following sections:

- “Purpose”
- “Using this node in a message flow” on page 991
- “WebSphere MQ Everyplace documentation” on page 991
- “Connecting the terminals” on page 991
- “Terminals and properties” on page 991

Purpose

The MQeOutput node forwards messages to WebSphere MQ Everyplace queue managers. If you specify a non-local destination queue manager, ensure that there is either a route to the queue manager, or store-and-forward queue servicing for the queue manager, if it exists.

You cannot use the MQeOutput node to change the transactional characteristics of the message flow. The transactional characteristics that are set by the message flow’s input node determine the transactional behavior of the flow.

z/OS You cannot use MQeOutput nodes in message flows that you deploy to z/OS systems.

If you create a message flow to use as a subflow, you cannot use a standard output node; you must use an instance of the Output node to create an out terminal for the subflow through which to propagate the message.

If you do not want your message flow to send messages to a WebSphere MQ Everyplace queue, choose another supported output node.

The MQeOutput node is contained in the **WebSphere MQ** drawer of the palette, and is represented in the workbench by the following icon:



Using this node in a message flow

For an example of how this node can be used, consider a farmer who checks his fields to see how well they are irrigated. He is carrying a PDA device with WebSphere MQ Everyplace installed. He sees that his fields are not being irrigated, and uses his PDA and a Global Satellite Navigation link to check the water flow valve, and finds that it is faulty. This information is available because the remote SCADA device that is responsible for controlling the valve has published a diagnostic message, which was retrieved by the broker and forwarded to an MQeOutput node and on to the WebSphere MQ Everyplace client on his PDA.

WebSphere MQ Everyplace documentation

You can find further information about WebSphere MQ Everyplace, and the properties of the node, in the WebSphere MQ Everyplace documentation on the WebSphere MQ Web page.

Connecting the terminals

Connect the In terminal to the node from which outbound messages bound are routed.

Connect the Out or Failure terminal of this node to another node in this message flow if you want to process the message further, process errors, or send the message to an additional destination. If you propagate the message, the LocalEnvironment that is associated with the message is enhanced with the following information for each destination to which the message has been put by this node:

- Queue name
- Queue manager name
- Message reply identifier (this is set to the same value as message ID)
- Message ID (from the MQMD)
- Correlation ID (from the MQMD)

These values are written in WrittenDestination within the LocalEnvironment tree structure.

If you do not connect either terminal, the LocalEnvironment tree is unchanged.

If you use aggregation in your message flows, you must use these terminals.

Terminals and properties

When you have put an instance of the MQeOutput node into a message flow, you can configure it; see “Configuring a message flow node” on page 235. The properties of the node are displayed in the Properties view. All mandatory properties for which you must enter a value (those that do not have a default value defined) are marked with an asterisk.

The MQeOutput node terminals are described in the following table.

Terminal	Description
In	The input terminal that accepts a message for processing by the node.
Failure	The output terminal to which the message is routed if a failure is detected when the message is put to the output queue.

Terminal	Description
Out	The output terminal to which the message is routed if it has been successfully put to the output queue, and if further processing is required within this message flow.

The following tables describe the node properties. The column headed M indicates whether the property is *mandatory* (marked with an asterisk if you must enter a value when no default is defined); the column headed C indicates whether the property is *configurable* (you can change the value when you add the message flow to the bar file to deploy it).

The MQeOutput node Description properties are described in the following table.

Property	M	C	Default	Description
Node name	No	No	MQeOutput	The name of the node.
Short description	No	No		A brief description of the node.
Long description	No	No		Text that describes the purpose of the node in the message flow.

The MQeOutput node Basic properties are described in the following table.

Property	M	C	Default	Description
Queue manager name	No	Yes		The name of the WebSphere MQ Everyplace queue manager to which the output queue, which is specified in Queue name, is defined. Enter a value for this property if you select Queue Name in Destination mode (on the Advanced tab). If you select another option for Destination mode, you do not need to set this property.
Queue name	No	Yes		The name of the WebSphere MQ Everyplace output queue to which this node puts messages. Enter a value for this property if you select Queue Name in Destination mode (on the Advanced tab). If you select another option for Destination mode, you do not need to set these properties.

The MQeOutput node Advanced property is described in the following table.

Property	M	C	Default	Description
Destination mode	Yes	No	Destination List	The queues to which the output message is sent: <ul style="list-style-type: none"> Queue Name: the message is sent to the queue that is named in the Queue name property. The properties Queue manager name and Queue name (on the Basic tab) are mandatory if you select this option. Reply To Queue: the message is sent to the queue that is named in the ReplyToQ field in the MQMD. Destination List (the default): the message is sent to the list of queues that are named in the LocalEnvironment (also known as DestinationList) that is associated with the message.

The MQeOutput node Request properties are described in the following table.

Property	M	C	Default	Description
Request	Yes	No	Cleared	Select Request to indicate that each output message is marked in the MQMD as a request message (MQMD_REQUEST), and the message identifier field is cleared (set to MQML_NONE) to ensure that WebSphere MQ generates a new identifier. Clear the check box to indicate that each output message is not marked as a request message. You cannot select this check box if you have selected a Destination mode of Reply To Queue.
Reply-to queue manager	No	Yes		The name of the queue manager to which the output queue, which is specified in Reply-to queue, is defined. This name is inserted into the MQMD of each output message as the reply-to queue manager. This new value overrides the current value in the MQMD.
Reply-to queue	No	Yes		The name of the reply-to queue to which to put a reply to this request. This name is inserted into the MQMD of each output message as the reply-to queue. This new value overrides the current value in the MQMD.

MQGet node

Use the MQGet node to receive messages from clients that connect to the broker by using the WebSphere MQ Enterprise Transport, and the MQI and AMI application programming interfaces.

You can also use the MQGet node to retrieve messages that were previously placed in a WebSphere MQ message queue that is defined to the broker's queue manager.

This topic contains the following sections:

- "Purpose"
- "Using the MQGet node in a message flow" on page 994
- "Configuring the MQGet node" on page 994
- "Overriding node properties during message processing" on page 998
- "Configuring for coordinated transactions" on page 998
- "Connecting the terminals" on page 999
- "Terminals and properties" on page 999

The topic uses the following terms:

input message

A message that enters the In terminal of the MQGet node.

queue message

A message that the MQGet node reads from the queue.

Purpose

The MQGet node reads a message from a specified queue, and establishes the processing environment for the message. If appropriate, you can define the input queue as a WebSphere MQ clustered queue or shared queue.

You can use an MQGet node anywhere within a message flow, unlike an MQInput node, which you can use only as the first node in a message flow. The output message tree from an MQGet node is constructed by combining the input tree with the result tree from the MQGET call. You can set the properties of the MQGet node to control the way in which messages are received; for example, you can indicate that a message is to be processed under transaction control, or you can request that, when the result tree is being created, data conversion is performed on receipt of every input message.

The MQGet node handles messages in the following message domains:

- MRM
- XMLNSC
- DataObject
- XMLNS
- JMSMap
- JMSStream
- MIME
- BLOB
- XML (this domain is deprecated; use XMLNSC)
- IDOC (this domain is deprecated; use MRM)

The MQGet node is contained in the **WebSphere MQ** drawer of the palette, and is represented in the workbench by the following icon:



Using the MQGet node in a message flow

Look at the following topics to see how to use the MQGet node in a message flow:

- “A request-response scenario using an MQGet node” on page 189

Look at the following sample to see how to browse messages with the MQGet node:

- Browsing WebSphere MQ Queues sample

You can view samples only when you use the information center that is integrated with the Message Broker Toolkit.

Configuring the MQGet node

When you have put an instance of the MQGet node into a message flow, you can configure it; for more information, see “Configuring a message flow node” on page 235. The properties of the node are displayed in the Properties view.

All mandatory properties for which you must enter a value (those that do not have a default value defined) are marked with an asterisk.

Configure the MQGet node.

1. Optional: On the **Description** tab, enter a Short description, a Long description, or both. You can also rename the node on this tab.
2. On the **Basic** tab, enter in Queue name the name of the queue from which the message is to be obtained. You must predefine this WebSphere MQ queue to the queue manager that hosts the broker on which the message flow is deployed. If this queue is not a valid queue, the node generates an exception, and the input message is propagated to the Failure terminal.
3. On the **Input Message Parsing** tab, set values for the properties that describe the message domain, message set, message type, and message format that the node uses to determine how to parse the queue message.
 - If the queue message has an MQRFH2 header, you do not need to set values for the Input Message Parsing properties, because the values can be derived from the <mc> folder in the MQRFH2 header; for example:

```
<mcd><Msd>MRM</Msd><Set>DHM4U0906S001</Set><Type>receiptmsg1</Type>
<Fmt>XML</Fmt></mcd>
```

If you set values, and those values differ from those in the MQRFH2 header, the values in the MQRFH2 header take precedence.

- In Message domain, select the name of the parser that you want from the list. If the MQRFH2 header does not supply the Message domain value, you can select a value from the list. If you do not select a value then the default value is BLOB. You can choose from the following options:
 - MRM
 - XMLNSC
 - DataObject
 - XMLNS
 - JMSMap
 - JMSStream
 - MIME
 - BLOB
 - XML (this domain is deprecated; use XMLNSC)
 - IDOC (this domain is deprecated; use MRM)

You can also specify a user-defined parser, if appropriate.

- If you are using the MRM or IDOC parser, or the XMLNSC parser in validating mode, select the Message set that you want to use.
 - If you are using the MRM parser, select the correct message from the list in Message type. This list is populated with messages that are defined in the Message set that you have selected.
 - If you are using the MRM or IDOC parser, select the format of the message from the list in Message format. This list includes all of the physical formats that you have defined for this Message set.
4. On the **Parser Options** sub-tab:
 - a. Parse timing is, by default, set to On Demand, which causes parsing of the message to be delayed. To cause the message to be parsed immediately, see “Parsing on demand” on page 1363.
 - b. Select Use MQRFH2C compact parser for MQRFH2 header if you want the MQRFH2C parser to be used. By default, this check box is cleared, which means that the compact parser is not used.
 - c. If you are using the XMLNSC parser, set values for the properties that determine how the XMLNSC parser operates. For more information, see “Manipulating messages in the XMLNSC domain” on page 364.
 5. On the **Advanced** tab, set values for the advanced properties.
 - Select a value for Transaction mode from the list to define the transactional characteristics of how this message is handled:
 - If you select Automatic, the queue message is received under sync point if it is marked as persistent. If the message is not marked as persistent, it is not received under sync point. The persistence or non-persistence of the input message determines the transactionality of any derived messages that are subsequently propagated by an output node, unless the output node, or any other subsequent node in the message flow, overrides the transactionality explicitly.
 - If you select Yes, the queue message is received under sync point. Any derived messages that are subsequently propagated by an output node in the same instance of the message flow are sent transactionally, unless the output node, or any other subsequent node in the message flow, overrides the transactionality explicitly.

- If you select No, the queue message is not received under sync point. Any derived messages that are subsequently propagated by an output node in the same instance of the message flow are sent non-transactionally, unless the output node, or any other subsequent node in the message flow, has specified that the messages must be put under sync point.
- Select a value for Generate mode from the list to define which components of the output message are generated within the MQGet node, and which components are taken from the input message.
 - If you select None, all of the components of the message from the input tree are propagated unchanged.
 - If you select Message (the default), a new Message component is created by the node, but the LocalEnvironment, Environment, and ExceptionList components from the input tree are propagated unchanged.
 - If you select LocalEnvironment, a new LocalEnvironment component is created by the node, but the Message, Environment, and ExceptionList components from the input tree are propagated unchanged.
 - If you select Message and LocalEnvironment, new Message and LocalEnvironment components are created by the node, but the Environment and ExceptionList components from the input tree are propagated unchanged.
- If you have chosen Generate mode to be either Message or Message And LocalEnvironment, select a value for Copy message from the list to define which parts of the message are generated within the MQGet node, and which parts are taken from the input message.
 - If you select None (the default), no part of the input message from the input tree is propagated.
 - If you select Copy Headers, the headers from the input message in the input tree are copied to the output message.
 - If you select Copy Entire Message, the entire input message from the input tree is copied to the output message.
- If you have chosen Generate mode to be either LocalEnvironment or Message And LocalEnvironment, select a value for Copy Local Environment from the list to define which parts of the local environment are generated within the MQGet node, and which parts are taken from the input message.
 - If you select Copy Entire LocalEnvironment (the default), at each node in the message flow, a new copy of the local environment is created in the tree, and it is populated with the contents of the local environment from the preceding node. So if a node changes the local environment, the upstream nodes do not see those changes because they have their own copies. This behavior might be an issue if you are using a FlowOrder node, or if you use the propagate command on a Compute node. The entire local environment that is defined in the input message is copied to the output message.
 - If you select None, each node does not generate its own copy of the local environment, but it uses the local environment that is passed to it by the previous node. So if a node changes the local environment, those changes are seen by the upstream nodes.
- Provide a value for the Wait interval (ms) property to specify how many milliseconds to wait for a message to be received from the MQGET call. If you do not provide a value, the default value of 1000 milliseconds is used.
- Provide a value for the Minimum message buffer size (KB) property to specify the size, in KB, of the initial buffer for the MQGET call. The buffer

expands automatically to accept a message of any size, but if it is expected that messages will all be large, specify a suitable value to reduce the frequency of the buffer being re-sized. If you do not provide a value, the size of the buffer is 4 KB.

6. On the **Request** tab, set values for the properties that determine how the request parameters are constructed.
 - If the MQMD that is to be used for the MQGET call is not the default location `InputRoot.MQMD`, specify in `Input MQMD` location the location of the MQMD.
 - If the location of the parameters for the MQGET call (for example, `MQGMO` overrides), is not the default location `InputLocalEnvironment.MQ.GET`, specify the location in `Input MQ` parameters location.
 - If you select `Get by correlation ID`, the `CorrelId` field of the message to be retrieved must match the `CorrelId` field in the `Input MQMD` location. By default, this check box is cleared.
 - If you select `Get by message ID`, the `MsgId` field of the message to be retrieved must match the `MsgId` field in the `Input MQMD` location. By default, this check box is cleared.
 - If you select `Use all input MQMD fields`, all MQMD fields at the `Input MQMD` location are used to retrieve the message. If an MQMD bit stream is present at the `Input MQMD` location, all fields in the bit stream are used. Make sure that the MQMD of the message to be retrieved matches these fields. By default, this check box is cleared.
 - Select `Browse only` to specify that the message should be retained on the queue when it is read.

7. On the **Result** tab, set values for the properties that determine how the results of the MQGET call are handled.

- In `Output data` location, enter the start location within the output message tree at which the parsed elements from the bit string of the queue message are stored; the default value is `OutputRoot`. All elements at this location are deleted, and the default behavior is to replace the input tree message with the queue message.

You can enter any valid ESQL field reference (this reference can include expressions), including new field references to create a new node within the message tree for inserting the response into the message that is propagated from the input tree. For example, `OutputRoot.XMLNS.ABC.DEF` and `Environment.GotReply` are valid field references. For more detailed information, see “A request-response scenario using an MQGet node” on page 189.

When the queue message bit string is parsed to create the contents of the message tree, the message properties that you have specified as the `Input Message Parsing` properties of the node are used.

- Set a value in `Result data` location to control which subtree of the queue message is placed in the output message. The default value is `ResultRoot`, which means that the whole queue message is placed in the output message. If, for example, you want only the MQMD from the queue message, use `ResultRoot.MQMD`; this subtree is then placed at the location specified by `Output data` location.
- Set a value in `Output MQ parameters` location to control where the CC (completion code), the RC (reason code), the `Browsed` indicator, and any other WebSphere MQ parameters (for example, the MQMD that is used by the MQGET call) are placed in the output tree. The default value is `OutputLocalEnvironment.MQ.GET`.

- Set a value in Warning data location to control where the queue message is placed when the MQGET call returns a warning code. The default value is OutputRoot.

You can enter any valid ESQL field reference (see the description of the Output data location property). The data that is placed at this location is always the complete result tree, with the body as a BLOB element. Result data location is not used for warning data.

- Clear Include message contents in output message assembly to specify that no result or warning data is required for the output message assembly. This action gets or browses the message on the queue without reading or parsing its contents.

If you select Include message contents in output message assembly, it does not guarantee that the message contents are included in the output tree because this inclusion depends on other node properties, such as the Generate mode property.

8. On the **Validation** tab, set the validation properties if you want the parser to validate the body of each queue message against the Message set. (If a message is propagated to the Failure terminal of the node, it is not validated.)

For more details, see “Validating messages” on page 164 and “Validation properties” on page 1359.

Overriding node properties during message processing

When you include and configure an MQGet node in a message flow, you might want to override its properties under some conditions. For example, you might want to read from a queue that is identified in another part of the message, or that is retrieved from a database record.

To override the values that you set for the MQGet node properties to achieve a more dynamic way to process messages, include a Compute or JavaCompute node in your message flow before the MQGet node. Configure this node to create a new output message, and add fields to the LocalEnvironment tree to define new values for the properties that you want to change.

For example, add a Compute node into the flow and define a new queue name for the MQGet node to read for messages, by including the following ESQL statement:

```
SET LocalEnvironment.MQ.GET.QueueName = 'new_queue';
```

Use LocalEnvironment.MQ.GET. as the correlation name for all fields that relate to the MQGet node.

Configuring for coordinated transactions

When you include an MQGet node in a message flow, the value that you set for Transaction mode defines whether messages are received under sync point.

- If you set the property to Yes (the default), the queue message is received under sync point (that is, within a WebSphere MQ unit of work). Any messages that an output node in the same instance of the message flow sends subsequently are put under sync point, unless the output node, or any other subsequent node, overrides this setting explicitly.
- If you set the property to Automatic, the queue message is received under sync point if the incoming message is marked as persistent. Otherwise, it is not received under sync point. Any message that is sent subsequently by an output

node is put under sync point, as determined by the incoming persistence property, unless the output node, or any other subsequent node, overrides this setting explicitly.

- If you set the property to No, the queue message is not received under sync point. Any messages that are sent subsequently by an output node in the message flow are not put under sync point, unless an individual output node, or any other subsequent node, specifies that the message must be put under sync point.

If you set the Browse only property, the value that you set for the Transaction mode property is ignored because a message cannot be browsed under sync point. However, any derived messages that are propagated subsequently by an output node in the same instance of the message flow follow the behavior that is described previously in accordance with the specified Transaction mode value.

Connecting the terminals

Connect the Out, Warning, Failure, and No Message output terminals of this node to another node in the message flow to process the message further, process errors, or send the message to an additional destination.

The completion code (CC) that is generated by the MQGET call controls what is propagated to each of the output terminals.

- If the MQGET call is successful, the MQGet node routes each parsed output message to the Out terminal.
- If the MQGET call fails, but with a CC that indicates a warning, an unparsed output message is propagated to the Warning terminal.
- If the MQGET call fails with a CC more severe than a warning, the input message is propagated to the Failure terminal.
- If the MQGET call fails with a reason code of MQRC_NO_MSG_AVAILABLE, the output message is propagated (without a result body) to the No Message terminal. The output message that is propagated to the No Message terminal is constructed from the input message only, according to the values of the Generate mode, Copy message, and Copy local environment properties.
- If you do not connect the Out, Warning, or No Message terminals to another node in the message flow, any message that is propagated to those terminals is discarded.
- If you do not connect the Failure terminal to another node in the message flow, the broker generates an exception when a message is propagated to that terminal.

For more information, see “Connecting failure terminals” on page 206.

Terminals and properties

The terminals of the MQGet node are described in the following table.

Terminal	Description
In	The input terminal that accepts the message that is being processed by the message flow.

Terminal	Description
Warning	The output terminal to which the output tree is propagated if an error (with a CC that indicates a warning) occurs within the node while trying to get a message from the queue. The MQMD part of the message is parsed, but the rest of the message is an unparsed BLOB element. The warning is discarded if the terminal is not connected, and there is no output propagation from the node at all.
Failure	The output terminal to which the input message is routed if an error (with a CC that indicates an error that is more severe than a warning) occurs within the node while trying to get a message from the queue.
Out	The output terminal to which the message is routed if it is retrieved successfully from the WebSphere MQ queue.
No Message	The output terminal to which the input message is routed if no message is available on the queue. The output message that is propagated to the No Message terminal is constructed from the input message only, according to the values of the Generate mode, Copy message, and Copy local environment properties.

The following tables describe the node properties. The column headed M indicates whether the property is *mandatory* (marked with an asterisk if you must enter a value); the column headed C indicates whether the property is *configurable* (you can change the value when you add the message flow to the bar file to deploy it).

The Description properties of the MQGet node are described in the following table.

Property	M	C	Default	Description
Node name	No	No	The node type, MQGet	The name of the node.
Short description	No	No	Blank	A brief description of the node.
Long description	No	No	Blank	Text that describes the purpose of the node in the message flow.

The Basic properties of the MQGet node are described in the following table.

Property	M	C	Default	Description
Queue name	Yes	Yes	None	The name of the WebSphere MQ message queue from which this node retrieves messages.

The Input Message Parsing properties of the MQGet node are described in the following table.

Property	M	C	Default	Description
Message domain	No	No	BLOB	The domain that is used to parse the queue message. If the MQRFH2 header does not supply the Message domain value, then you can select a value from the list. If you do not select a value, the default value is BLOB.
Message set	No	No	None	The name or identifier of the message set in which the queue message is defined. If you set this property, then subsequently update the project dependencies to remove this message set reference, a warning is issued. Either update the Message set property, or restore the reference to this message set project.

Property	M	C	Default	Description
Message type	No	No	None	The name of the queue message.
Message format	No	No	None	The name of the physical format of the queue message.

The Parser Options properties of the MQGet node are described in the following table.

Property	M	C	Default	Description
Parse timing	No	No	On Demand	This property controls when the queue message is parsed. Valid values are On Demand, Immediate, and Complete. For a full description of this property, see "Parsing on demand" on page 1363.
Use MQRFH2C compact parser for MQRFH2 header	No	No	Cleared	This property controls whether the MQRFH2C compact parser, instead of the MQRFH2 parser, is used for MQRFH2 headers.
Build tree using XML schema data types	No	No	Cleared	This property controls whether the XMLNSC parser creates syntax elements in the message tree with data types taken from the XML Schema. You can select this property only if you set the Validate property on the Validation tab to Content or Content and Value.
Use XMLNSC compact parser for XMLNS domain	No	No	Cleared	This property controls whether the XMLNSC Compact Parser is used for messages in the XMLNS Domain. If you set this property, the message data appears under XMLNSC in nodes that are connected to the output terminal when the input MQRFH2 header or Input Message Parsing properties Message domain is XMLNS.
Retain mixed content	No	No	Cleared	This property controls whether the XMLNSC parser creates elements in the message tree when it encounters mixed text in the queue message message. If you select the check box, elements are created for mixed text. If you clear the check box, mixed text is ignored and no elements are created.
Retain comments	No	No	Cleared	This property controls whether the XMLNSC parser creates elements in the message tree when it encounters comments in the queue message message. If you select the check box, elements are created for comments. If you clear the check box, comments are ignored and no elements are created.
Retain processing instructions	No	No	Cleared	This property controls whether the XMLNSC parser creates elements in the message tree when it encounters processing instructions in the queue message. If you select the check box, elements are created for processing instructions. If you clear the check box, processing instructions are ignored and no elements are created.
Opaque elements	No	No	Blank	This property is used to specify a list of elements in the queue message that are to be opaquely parsed by the XMLNSC parser. Opaque parsing is performed only if validation is not enabled (that is, if Validate is None); entries that are specified in Opaque Elements are ignored if validation is enabled.

The Advanced properties of the MQGet node are described in the following table.

Property	M	C	Default	Description
Transaction mode	No	No	Yes	This property controls whether the incoming message is received under sync point. Valid values are Automatic, Yes, and No.
Generate mode	No	No	Message	This property controls which parts of the message from the input tree are copied. Valid values are Message, LocalEnvironment, Message And LocalEnvironment, and None.
Copy message	No	No	None	This property controls which parts of the message from the input tree are copied. Valid values are None, Copy Headers, and Copy Entire Message.
Copy local environment	No	No	Copy Entire LocalEnvironment	This property controls how the local environment is copied to the output message. If you set it to Copy Entire LocalEnvironment, at each node in the message flow, a new copy of the local environment is created in the tree, and it is populated with the contents of the local environment from the preceding node. So if a node changes the local environment, the upstream nodes do not see those changes because they have their own copies. This behavior might be an issue if you are using a FlowOrder node, or if you use the propagate command on a Compute node. If you set this property to None, each node does not generate its own copy of the local environment, but it uses the local environment that is passed to it by the previous node. So if a node changes the local environment, those changes are seen by the upstream nodes.
Wait interval (ms)	Yes	No	1000	The maximum time, in milliseconds, to wait for the queue message to be obtained from the message queue.
Minimum message buffer size (KB)	Yes	No	4	The minimum size, in KB, of the get buffer. The minimum value of this property is 1.

The Request properties of the MQGet node are described in the following table.

Property	M	C	Default	Description
Input MQMD location	No	No		The location in the input message assembly where the MQMD that is to be used for the MQGET can be found. The default location is InputRoot.MQMD.
Input MQ parameters location	No	No		The location in the input message assembly where the WebSphere MQ parameters (for example, the initial buffer size and the MQGMO overrides) can be found. The default location is InputLocalEnvironment.MQ.GET.
Get by correlation ID	No	No	Cleared	If you select this check box, only messages that have the specified correlation ID are retrieved.
Get by message ID	No	No	Cleared	If you select this check box, only messages that have the specified message ID are retrieved.
Use all input MQMD fields	No	No	Cleared	If you select this check box, all MQMD fields supplied are used; otherwise, only the message ID and correlation ID are used.

Property	M	C	Default	Description
Browse only	No	No	Cleared	This property controls whether a message is removed from the queue when it is read. If this check box is selected, the message is not removed from the queue when it is read.

The Result properties of the MQGet node are described in the following table.

Property	M	C	Default	Description
Output data location	No	No	OutputRoot	This property specifies where the output data is placed. If you leave the field blank, OutputRoot is used as a default.
Result data location	No	No	ResultRoot	This property specifies which subtree (of the queue message) to use. If you leave this field blank, ResultRoot is used as a default, and the whole queue message is used. If, for example, ResultRoot.MQMD.ReplyToQ is specified, only that subtree is used.
Output MQ parameters location	No	No		This property specifies where the output WebSphere MQ parameters are located. If you leave this field blank, OutputLocalEnvironment.MQ.GET is used as a default. Set Generate mode to include LocalEnvironment to ensure that the updated values are visible in downstream nodes. The default location is OutputLocalEnvironment.MQ.GET.
Warning data location	No	No	OutputRoot	This property specifies where the output data is placed if MQGET returns a warning code. If you leave this field blank, OutputRoot is used as a default.
Include message contents in output message assembly	No	No	Selected	This property specifies that no result or warning data is required for the output message assembly. If you select this check box, the node gets or browses the message on the queue without completely reading or parsing its contents. If you select Include message contents in output message assembly, it does not guarantee that the message contents are included in the output tree because this inclusion depends on other node properties, such as the Generate mode property.

The Validation properties of the MQGet node are described in the following table.

For a full description of these properties, see “Validation properties” on page 1359.

Property	M	C	Default	Description
Validate	No	Yes	None	This property controls whether validation takes place. Valid values are None, Content, Content and Value, and Inherit.
Failure action	No	No	Exception	This property controls what happens if validation fails. You can set this property only if you set Validate to Content or Content and Value. Valid values are User Trace, Local Error Log, Exception, and Exception List.

MQHeader node

Use the MQHeader node to add, modify, or delete MQ Message Descriptor (MQMD) and MQ Dead Letter Header (MQDLH) headers.

This topic contains the following sections:

- “Purpose”
- “Using this node in a message flow”
- “Terminals and properties”

Purpose

You can add or remove a whole header, or you can change only certain fields in a header. You can set these fields to a fixed value, or to a value specified by an XPath expression to access a value in one of the message trees. XPath is used to provide a valid location from which a value for a property can be copied. For example, the location can be the body of the message, the local environment tree, or an exception list.

The MQHeader node is contained in the **WebSphere MQ** drawer of the palette, and is represented in the workbench by the following icon:



Using this node in a message flow

Look at the following sample for more details about how to use the node:

- MQHeader node sample

You can view samples only when you use the information center that is integrated with the Message Broker Toolkit.

Terminals and properties

When you have put an instance of the node into a message flow, you can configure it; see “Configuring a message flow node” on page 235. The properties of the node are displayed in the Properties view. This node has no mandatory properties.

MQHeader node terminals are described in the following table.

Terminal	Description
In	The input terminal that accepts a message for processing by the node.
Failure	The output terminal to which the input message is routed if a failure is detected.
Out	The output terminal to which the transformed message is routed if the input message is processed successfully.

The following tables describes the node properties. The column headed M indicates whether the property is *mandatory* (marked with an asterisk if you must enter a value when no default is defined); the column headed C indicates whether the property is *configurable* (you can change the value when you add the message flow to the bar file to deploy it).

The MQHeader node Description properties are described in the following table.

Property	M	C	Default	Description
Node name	No	No	MQHeader	The name of the node.
Short description	No	No		A brief description of the node.
Long description	No	No		Text that describes the purpose of the node in the message flow.

The MQ Message Descriptor properties are described in the following table. Refer to *WebSphere MQ Application Programming Reference* and *WebSphere MQ Application Programming Guide* for full details of each of the MQ property and its supported values.

Property	M	C	Default	Description
MQMD header options	No	Yes	Carry forward header	<p>Options to control the MQMD as a whole.</p> <p>Select Carry forward header to carry forward any values that are present in an incoming message.</p> <p>Select Add header to add a new header using the specified property values. If a header already exists, the header is modified using the specified property values. If <i>Inherit from header</i> is specified as a property value and the header does not exist, the default value for the property is used.</p> <p>Select Modify header to change an existing header using the specified property values. If a header does not exist, a new header is added first. If <i>Inherit from header</i> is specified as a property value and the header does not exist, the default value for the property is used.</p> <p>Select Delete header to delete the header, if it exists. Note: The Add header and Modify header options both add a header if it does not exist, and change a header if it does exist. However, the default values offered by each option differ, so use the appropriate option.</p>
Coded Character Set Identifier	No	Yes	MQCCSI_Q_MGR	<p>The character set identifier of character data in the message. A sample set of custom literals for EBCDIC and other common Unicode values is given here:</p> <p>MQCCSI_INTL_EBCDIC : 500 MQCCSI_US_EBCDIC : 037 MQCCSI_UNICODE_1200 : 1200 MQCCSI_UNICODE_1208 : 1208 MQCCSI_UNICODE_13488 : 13488 MQCCSI_UNICODE_17584 : 17584</p> <p>Refer to the <i>WebSphere MQ Application Programming Reference</i> and <i>WebSphere MQ Application Programming Guide</i> for full details.</p>
Format	No	Yes	MQFMT_NONE	A name that the sender of the message can use to indicate to the receiver the nature of the data in the message.
Version Number	No	Yes	MQMD_VERSION_1	The version ID of the MQMD message.
Message Type	No	Yes	MQMT_DATAGRAM	The message type.
Message Expiry	No	Yes	MQEI_UNLIMITED	A period of time expressed in tenths of a second, set by the application that puts the message. The message becomes eligible to be discarded if it has not been removed from the destination queue before this period of time elapses.
Feedback or Reason Code	No	Yes	MQFB_NONE	Used with a message of type MQMT_REPORT to indicate the nature of the report, and meaningful only with that type of message.

Property	M	C	Default	Description
Message Priority	No	Yes	MQPRL_PRIORITY_AS_Q_DEF	Message priority. 0 is the lowest value, and 9 is the highest. Custom display literals are as follows: MQPRL_PRIORITY_HIGH : 9 MQPRL_PRIORITY_8 : 8 MQPRL_PRIORITY_7 : 7 MQPRL_PRIORITY_6 : 6 MQPRL_PRIORITY_5 : 5 MQPRL_PRIORITY_MEDIUM : 4 MQPRL_PRIORITY_3 : 3 MQPRL_PRIORITY_2 : 2 MQPRL_PRIORITY_1 : 1 MQPRL_PRIORITY_LOW : 0
Message Persistence	No	Yes	MQPER_PERSISTENCE_AS_Q_DEF	Indicates whether the message survives system failures and restarts of the queue manager.
Message Identifier	No	Yes	MQMI_NONE	A string that is used to distinguish one message from another.
Correlation Identifier	No	Yes	MQCI_NONE	A string that the application can use to relate one message to another, or to relate the message to other work that the application is performing.
Reply To Queue	No	Yes	<No default value>	The message queue to which the application that issued the get request for the message should send Reply and Report messages.
Reply To Queue Manager	No	Yes	<No default value>	The queue manager to which the reply message or report message should be sent.

The Report properties are described in the following table.

Property	M	C	Default	Description
Inherit from header	No	Yes	Selected	This property is enabled only when the Modify header option is selected. Select this field to inherit any MQMD report property value that is present in an incoming message.
Exception	No	Yes	No default value	A type of MQ report message. Exception report message is generated.
Expiration	No	Yes	No default value	A type of MQ report message. Expiration report message is generated.
Confirm on arrival	No	Yes	No default value	A type of MQ report message. Confirm on arrival report message is generated.
Confirm on delivery	No	Yes	No default value	A type of MQ report message. Confirm on delivery report message is generated.
Notification	No	Yes	No default value	A type of MQ report Message. Action notification report message is generated.

The MQDLH header properties are described in the following table.

Property	M	C	Default	Description
MQDLH header options	No	Yes	Carry forward the header	<p>Options to control the MQMD as a whole.</p> <p>Select Carry forward header to carry forward any values that are present in an incoming message.</p> <p>Select Add header to add a new header using the specified property values. If a header already exists, the header is modified using the specified property values. If <i>Inherit from header</i> is specified as a property value and the header does not exist, the default value for the property is used.</p> <p>Select Modify header to change an existing header using the specified property values. If a header does not exist, a new header is added first. If <i>Inherit from header</i> is specified as a property value and the header does not exist, the default value for the property is used.</p> <p>Select Delete header to delete the header, if it exists.</p> <p>Note: The Add header and Modify header options both add a header if it does not exist, and change a header if it does exist. However, the default values offered by each option differ, so use the appropriate option.</p>
Coded Character Set Identifier	No	Yes	MQCCSI_UNDEFINED	The character set identifier of character data in the message.
Format	No	Yes	MQFMT_NONE	A name that the sender of the message can use to indicate to the receiver the nature of the data in the message.
Reason	No	Yes	MQRC_NONE	A code that indicates why the message is sent to the dead letter queue (DLQ).
Destination Queue Name	No	Yes	No default value	The name of the destination queue.
Destination Queue Manager Name	No	Yes	No default value	The name of the destination queue manager.
Save dead letter queue	No	Yes	Selected	If selected, the dead letter queue name is stored in the local environment.
Save source queue	No	Yes	Selected	If selected, the original source queue name is stored in the local environment.

MQInput node

Use the MQInput node to receive messages from clients that connect to the broker using the WebSphere MQ Enterprise Transport, and that use the MQI and AMI application programming interfaces.

This topic contains the following sections:

- “Purpose” on page 1008

- “Using the MQInput node in a message flow” on page 1009
- “Configuring the MQInput node” on page 1009
- “Connecting the terminals” on page 1014
- “Configuring for coordinated transactions” on page 1014
- “Terminals and properties” on page 1015

Purpose

The MQInput node receives a message from a WebSphere MQ message queue that is defined on the broker’s queue manager. The node uses MQGET to read a message from a specified queue, and establishes the processing environment for the message. If appropriate, you can define the input queue as a WebSphere MQ clustered queue or shared queue.

Message flows that handle messages that are received across WebSphere MQ connections must always start with an MQInput node. You can set the properties of the MQInput node to control the way in which messages are received, by causing appropriate MQGET options to be set. For example, you can indicate that a message is to be processed under transaction control. You can also request that data conversion is performed on receipt of every input message.

The MQInput node handles messages in the following message domains:

- MRM
- XMLNSC
- DataObject
- XMLNS
- JMSMap
- JMSStream
- MIME
- BLOB
- XML (this domain is deprecated; use XMLNSC)
- IDOC (this domain is deprecated; use MRM)

If you include an output node in a message flow that starts with an MQInput node, it can be any of the supported output nodes, including user-defined output nodes; you do not need to include an MQOutput node. You can create a message flow that receives messages from WebSphere MQ clients and generates messages for clients that use any of the supported transports to connect to the broker, because you can configure the message flow to request that the broker provides any conversion that is necessary.

If you create a message flow to use as a subflow, you cannot use a standard input node; you must use an instance of the Input node as the first node to create an In terminal for the subflow.

If your message flow does not receive messages across WebSphere MQ connections, you can choose one of the supported input nodes.

The MQInput node is contained in the **WebSphere MQ** drawer of the palette, and is represented in the workbench by the following icon:



Using the MQInput node in a message flow

Look at the following samples to see how to use the MQInput node:

- Pager samples
- Airline Reservations sample
- Error Handler sample
- Aggregation sample
- JMS Nodes sample
- Large Messaging sample
- Message Routing sample
- Scribble sample
- Soccer Results sample
- Timeout Processing sample
- Video Rental sample
- XSL Transform sample
- Browsing WebSphere MQ Queues sample

You can view samples only when you use the information center that is integrated with the Message Broker Toolkit.

Configuring the MQInput node

When you have put an instance of the MQInput node into a message flow, you can configure it; see “Configuring a message flow node” on page 235. The properties of the node are displayed in the Properties view.

All mandatory properties that do not have a default value defined are marked with an asterisk.

Configure the MQInput node:

1. Optional: On the **Description** tab, enter a Short description, a Long description, or both. You can also rename the node on this tab.
2. On the **Basic** tab, enter the Queue name from which the message flow receives messages. You must predefine this WebSphere MQ queue to the queue manager that hosts the broker to which the message flow is deployed. This property is mandatory.
3. On the **Input Message Parsing** tab, set values for the properties that describe the message domain, message set, message type, and message format that the node uses to determine how to parse the incoming message.

If the incoming message has an MQRFH2 header, you do not need to set values for the Input Message Parsing properties because the values are derived from the <mcd> folder in the MQRFH2 header; for example:

```
<mcd><Msd>MRM</Msd><Set>DHM4U0906S001</Set><Type>receiptmsg1</Type>  
<Fmt>XML</Fmt></mcd>
```

If you set values, and those values differ from those in the MQRFH2 header, and the <Msd> element is a valid domain, the values in the MQRFH2 header take precedence.

- In Message domain, select the name of the parser that you want to use from the list. If no MQRFH2 header exists to supply the value for the Message domain, then you can select the property value from the list. You can either

select an option or leave the property blank, in which case the default that is used is BLOB. You can select from the following options:

- MRM
- XMLNSC
- DataObject
- XMLNS
- JMSMap
- JMSStream
- MIME
- BLOB
- XML (this domain is deprecated; use XMLNSC)
- IDOC (this domain is deprecated; use MRM)

You can also specify a user-defined parser, if appropriate.

- If you use the MRM or IDOC parser, or the XMLNSC parser in validating mode, select the Message set that you want to use. The list of message sets consists of those that are available when you select MRM, XMLNSC, or IDOC as the domain.
 - If you use the MRM parser, select the type of message from the list in Message type. This list is populated with messages that are defined in the Message set that you have selected.
 - If you are using the MRM or IDOC parser, select the format of the message from the list in Message format. This list includes all the physical formats that you have defined for this Message set.
4. On the **Parser Options** sub-tab:
 - a. Parse timing is, by default, set to On Demand, which causes parsing of the message to be delayed. To cause the message to be parsed immediately, see “Parsing on demand” on page 1363.
 - b. Select Use MQRFH2C compact parser for MQRFH2 header if you want the MQRFH2C parser to be used. By default, this check box is cleared, which means that the compact parser is not used.
 - c. If you are using the XMLNSC parser, set values for the properties that determine how the XMLNSC parser operates. For more information, see “Manipulating messages in the XMLNSC domain” on page 364.
 5. On the **Advanced** tab, set the properties that determine how the message is processed, such as its transactional characteristics. Many of these properties map to options on the MQGET call.
 - Select Transaction mode from the list to define the transactional characteristics of how this message is handled:
 - If you select Automatic, the incoming message is received under syncpoint if it is marked persistent, otherwise it is not received under syncpoint. The transactionality of any derived messages that are sent subsequently by an output node is determined by the incoming persistence property, unless the output node has overridden transactionality explicitly.
 - If you select Yes, the incoming message is received under syncpoint. Any derived messages that are sent subsequently by an output node in the same instance of the message flow are sent transactionally, unless the output node has overridden transactionality explicitly.
 - If you select No, the incoming message is not received under syncpoint. Any derived messages that are sent subsequently by an output node in the message flow are sent non-transactionally, unless the output node has specified that the messages must be put under syncpoint.

- Select Order mode from the list to determine the order in which messages are retrieved from the input queue. This property has an effect only if the message flow property Additional instances on the **Instances** tab, is set to greater than zero; that is, if multiple threads read the input queue. Valid values are:
 - Default. Messages are retrieved in the order that is defined by the queue attributes, but this order is not guaranteed because the messages are processed by the message flow.
 - By User ID. Messages that have the same UserIdentifier in the MQMD are retrieved and processed in the order that is defined by the queue attributes; this order is guaranteed to be preserved when the messages are processed. A message that is associated with a particular UserIdentifier that is being processed by one thread, is completely processed before the same thread, or another thread, can start to process another message with the same UserIdentifier. No other ordering is guaranteed to be preserved.
 - By Queue Order. Messages are retrieved and processed by this node in the order that is defined by the queue attributes; this order is guaranteed to be preserved when the messages are processed. This behavior is identical to the behavior that is exhibited if the message flow property Additional instances is set to zero.

For more details about using this option, see “Receiving messages in a WebSphere MQ message group” on page 610.

- Select Logical order to ensure that messages that are part of a message group are received in the order that has been assigned by the sending application. This option maps to the MQGMO_LOGICAL_ORDER option of the MQGMO of the MQI.

If you clear the check box, messages that are sent as part of a group are not received in a predetermined order. If a broker expects to receive messages in groups, and you have not selected this check box, either the order of the input messages is not significant, or you must design the message flow to process them appropriately.

You must also select Commit by message group if you want message processing to be committed only after the final message of a group has been received and processed.

More information about the options to which this property maps is available in the *Application Programming Reference* section of the WebSphere MQ Version 6 information center online.

For more details about using this option, see “Receiving messages in a WebSphere MQ message group” on page 610.

- Select All messages available if you want message retrieval and processing to be done only when all messages in a single group are available. This property maps to the MQGMO_ALL_MSGS_AVAILABLE option of the MQGMO of the MQI. Clear this check box if message retrieval does not depend on all messages in a group being available before processing starts.

More information about the options to which this property maps is available in the *Application Programming Reference* section of the WebSphere MQ Version 6 information center online.

- Enter a message identifier in Match message ID if you want the input node to receive only messages that contain a matching message identifier value in the MsgId field of the MQMD.

Enter an even number of hexadecimal digits (characters 0 to 9, A to F, and a to f are valid) up to a maximum of 48 digits. If the ID that you enter is

shorter than the size of the MsgId field, it is padded on the right with X'00' characters. This property maps to the MQMO_MATCH_MSG_ID option of the MQGMO of the MQI.

Leave this property blank if you do not want the input node to check that the message ID matches.

More information about the options to which this property maps is available in the *Application Programming Reference* section of the WebSphere MQ Version 6 information center online.

- Enter a message identifier in Match correlation ID if you want the input node to receive only messages that contain a matching correlation identifier value in the CorrelId field of the MQMD.

Enter an even number of hexadecimal digits (characters 0 to 9, A to F, and a to f are valid) up to a maximum of 48 digits. If the ID that you enter is shorter than the size of the CorrelId field, it is padded on the right with X'00' characters. This property maps to the MQMO_MATCH_CORREL_ID option of the MQGMO of the MQI.

Leave this property blank if you do not want the input node to check that the CorrelID matches.

More information about the options to which this property maps is available in the *Application Programming Reference* section of the WebSphere MQ Version 6 information center online.

- Select Convert if you want WebSphere MQ to perform data conversion on the message when it is retrieved from the queue. This option is useful if you are handling messages in the BLOB domain, or are using a user-defined parser. Do not select this option if you are parsing messages with the XML or MRM domains, because the parser does the conversion.





WebSphere MQ converts the incoming message to the encoding and coded character set that is specified in the MQMD that the input node supplies on the MQGET call to retrieve the message from the input queue. The broker uses the MQGMO_CONVERT option on the MQGET call; typical rules for WebSphere MQ conversion apply. The values that you specify in the Convert encoding and Convert coded character set ID options are used in the **MsgDesc Encoding** and **CCSID** fields in the MQGET call. WebSphere MQ can convert the incoming message only if the MQMD **Format** field is a built-in MQ value that identifies character data, or if a data conversion exit exists in WebSphere MQ.

This property maps to the MQGMO_CONVERT option of the MQGMO of the MQI.

Clear the check box if you do not want WebSphere MQ to convert the message.

If you select this check box, you can also specify:

- Convert encoding. Enter the number that represents the encoding to which you want to convert numeric data in the message body. Valid values include:

-  546 for DOS and all Windows systems
-   273 for all Linux and UNIX systems
-  785 for z/OS systems

The encoding is used only in the following circumstances:

- If a user-defined WebSphere MQ data conversion exit uses the encoding.

- If the built-in WebSphere MQ conversion exit uses the encoding to convert messages in any of the predefined WebSphere MQ formats.

If you specify an incorrect value, no conversion is done.

- Convert coded character set ID. Enter the value that represents the character set identifier to which you want to convert character data in the message body.

If you specify an incorrect value, no conversion is done.

For more information about WebSphere MQ data conversion, and why you might choose to use this option, see the *Application Programming Guide* section of the WebSphere MQ Version 6 information center online. For further information about the values that you can specify for Convert encoding and Convert coded character set ID, see the *Application Programming Reference* section of the WebSphere MQ Version 6 information center online.

- Select Commit by message group if you want message processing to be committed only after the final message of a group has been received and processed. If you leave this check box cleared, a commit is performed after each message has been propagated completely through the message flow.

This property is relevant only if you have selected Logical order.

Set the Order mode property to By Queue Order if the messages in a group must be retrieved and processed in the order in which they are displayed on the queue.

- **z/OS** On z/OS only: Enter a serialization token in z/OS serialization token if you want to use the serialized access to shared resources that is provided by WebSphere MQ.

The value that you provide for the serialization token must conform to the rules described in the *Application Programming Reference* section of the WebSphere MQ Version 6 information center online.

For more information about serialization and queue sharing on z/OS, see the *Concepts and Planning Guide* section of the WebSphere MQ Version 6 information center online.

- Optional: You can associate a message with a publish/subscribe topic using the Topic property. You can enter any characters as the topic name. When messages pass through the MQInput node, they take on whatever topic name you have entered. (If you are using publish/subscribe, you can subscribe to a topic and see any messages that passed through the MQInput node and were published under that topic name.) If the incoming message has an MQRFH2 header, you do not need to set a value for the Topic property because the value can be obtained from the <psc> folder in the MQRFH2 header; for example:

```
<psc><Topic>stockquote</Topic></psc>
```

If you set a Topic property value, and that value differs from the <Topic> value in the MQRFH2 header, the value in the MQRFH2 header takes precedence.

- Select Browse Only to specify that the message must be retained on the queue when it is read. If you select this option, OutputLocalEnvironment.MQ.GET.Browsed is set to true when a message is propagated to the output terminal of the MQInput node.
- Provide a value for Reset browse timeout (ms) to specify how many milliseconds to wait between the last eligible message being browsed on the

input queue and the browse being reset to the beginning of the queue. If you do not provide a value, the default value of -1 is used to indicate that the browse is not reset.

6. On the **Validation** tab, set the validation properties if you want the parser to validate the body of messages against the Message set. (If a message is propagated to the Failure terminal of the node, it is not validated.)
For more details, see “Validating messages” on page 164 and “Validation properties” on page 1359.
7. Optional: On the **Security** tab, set values for the properties that control the extraction of an identity from a message (when a security profile is associated with the node).
 - Optional: Select an option from the Identity token type list to specify the type of identity in the incoming message. If you leave this option to default, the identity is retrieved from the transport headers, and the type is set to Username.
 - Optional: In Identity token location, enter the location in the message where the identity is specified. If you leave this option blank, the identity is retrieved from the MQMD.UserIdIdentifier transport header.
 - Optional: In Identity password location, enter the location in the message where the password is specified. This option can be set only if the Identity token type is set to Username + Password. If you leave this option blank, the password is not set.
 - Optional: In Identity issuedBy location, specify the location in the message where information about the issuer of the identity is held. If you leave this blank, the MQMD.PutApplName value is used. If you leave the Identity issuedBy location field blank and the MQMD.PutApplName is also blank, the string MQ is used.
 - Optional: Select Treat security exceptions as normal exceptions if you want security exceptions, for example Access Denied, to be treated as normal exceptions and propagated down the failure terminal (if it is wired).

For more information, see Message flow security and Setting up message flow security.

8. Optional: On the **Instances** tab, set values for the properties that control the additional instances that are available for a node. For more details, see “Configurable message flow properties” on page 1372.

Connecting the terminals:

The MQInput node routes each message that it retrieves successfully to the Out terminal. If this action fails, the message is retried. If the backout count is exceeded (as defined by the BackoutThreshold attribute of the input queue), the message is routed to the Failure terminal; you can connect nodes to this terminal to handle this condition. If you have not connected the Failure terminal, the message is written to the backout queue.

If the message is caught by this node after an exception has been thrown further on in the message flow, the message is routed to the Catch terminal. If you have not connected the Catch terminal, the message loops continually through the node until the problem is resolved.

You must define a backout queue or a dead-letter queue (DLQ) to prevent the message from looping continually through the node.

Configuring for coordinated transactions:

When you include an MQInput node in a message flow, the value that you set for Transaction mode defines whether messages are received under syncpoint:

- If you set the property to Automatic, the message is received under syncpoint if the incoming message is marked as persistent; otherwise, it is not received under syncpoint. Any message that is sent subsequently by an output node is put under syncpoint, as determined by the incoming persistence property, unless the output node has overridden this explicitly.
- If you set the property to Yes (the default), the message is received under syncpoint; that is, within a WebSphere MQ unit of work. Any messages that are sent subsequently by an output node in the same instance of the message flow are put under syncpoint, unless the output node has overridden this explicitly.
- If you set the property to No, the message is not received under syncpoint. Any messages that are sent subsequently by an output node in the message flow are not put under syncpoint, unless an individual output node has specified that the message must be put under syncpoint.

The MQOutput node is the only output node that you can configure to override this option.

If you have set the Browse Only property, the value that is set for the Transaction mode property is ignored because a message cannot be browsed under syncpoint. However, any derived messages that are propagated subsequently by an output node in the same instance of the message flow follow the behavior that is described previously in accordance with the specified Transaction mode value.

MQGET buffer size

The MQGET buffer size is implemented internally by the broker and you cannot change it. The following description is provided for information only. You must not rely on it when you develop your message flows, because the internal implementation might change.

When the MQInput node initializes, it sets the size of the default buffer for the first MQGET to 4 KB. The MQInput node monitors the size of messages and increases or reduces the size of the buffer:

1. If an MQGET fails because the message is larger than the size of the buffer, the node immediately increases the size of the buffer to accommodate the message, issues the MQGET again, and zeros a message count.
2. When 10 messages have been counted since the increase in the size of the buffer, the node compares the size of the largest of the 10 messages with the size of the buffer. If the size of the largest message is less than 75% of the size of the buffer, the buffer is reduced to the size of the largest of the 10 messages. If an MQGET fails during the 10 messages because the message is larger than the size of the buffer, the node takes action 1.

For example, if the first message that the node receives is 20 MB, and the next 10 messages are each 14 MB, the size of the buffer is increased from 4 KB to 20 MB and remains at 20 MB for 10 messages. However, after the 10th message the size of the buffer is reduced to 14 MB.

Terminals and properties

The terminals of the MQInput node are described in the following table.

Terminal	Description
Failure	The output terminal to which the message is routed if an error occurs. Even if the Validation property is set, messages propagated to this terminal are not validated.
Out	The output terminal to which the message is routed if it is successfully retrieved from the WebSphere MQ queue.
Catch	The output terminal to which the message is routed if an exception is thrown downstream and caught by this node.

The following tables describe the node properties. The column headed M indicates whether the property is *mandatory* (marked with an asterisk if you must enter a value when no default is defined); the column headed C indicates whether the property is *configurable* (you can change the value when you add the message flow to the bar file to deploy it).

The Description properties of the MQInput node are described in the following table.

Property	M	C	Default	Description
Node name	No	No	The node type, MQInput	The name of the node.
Short description	No	No		A brief description of the node.
Long description	No	No		Text that describes the purpose of the node in the message flow.

The Basic properties of the MQInput node are described in the following table.

Property	M	C	Default	Description
Queue name	Yes	Yes		The name of the WebSphere MQ input queue from which this node retrieves messages (using MQGET) for processing by this message flow.

The Input Message Parsing properties of the MQInput node are described in the following table.

Property	M	C	Default	Description
Message domain	No	No	BLOB	The domain that is used to parse the incoming message. The default value, BLOB, applies only if no preset MQRFH2 header values exist and no option has been selected from the list.
Message set	No	No		The name or identifier of the message set in which the incoming message is defined. If you set this property, then subsequently update the project dependencies to remove this message set reference, a warning is issued. Either update the Message set property, or restore the reference to this message set project.
Message type	No	No		The name of the incoming message.
Message format	No	No		The name of the physical format of the incoming message.

The properties of the Parser Options for the MQInput node are described in the following table.

Property	M	C	Default	Description
Parse timing	No	No	On Demand	This property controls when an input message is parsed. Valid values are On Demand, Immediate, and Complete. For a full description of this property, see "Parsing on demand" on page 1363.
Use MQRFH2C compact parser for MQRFH2 header	No	No	Cleared	This property controls whether the MQRFH2C compact parser, instead of the MQRFH2 parser, is used for MQRFH2 headers.
Build tree using XML schema data types	No	No	Cleared	This property controls whether the XMLNSC parser creates syntax elements in the message tree with data types taken from the XML Schema. You can select this property only if you set the Validate property on the Validation tab to Content or Content and Value.
Use XMLNSC compact parser for XMLNS domain	No	No	Cleared	This property controls whether the XMLNSC compact parser is used for messages in the XMLNS domain. If you set this property, the message data appears under XMLNSC in nodes that are connected to the output terminal when the input MQRFH2 header or Input Message Parsing properties Message domain is XMLNS.
Retain mixed content	No	No	Cleared	This property controls whether the XMLNSC parser creates elements in the message tree when it encounters mixed text in an input message. If you select the check box, elements are created for mixed text. If you clear the check box, mixed text is ignored and no elements are created.
Retain comments	No	No	Cleared	This property controls whether the XMLNSC parser creates elements in the message tree when it encounters comments in an input message. If you select the check box, elements are created for comments. If you clear the check box, comments are ignored and no elements are created.
Retain processing instructions	No	No	Cleared	This property controls whether the XMLNSC parser creates elements in the message tree when it encounters processing instructions in an input message. If you select the check box, elements are created for processing instructions. If you clear the check box, processing instructions are ignored and no elements are created.
Opaque elements	No	No	Blank	This property is used to specify a list of elements in the input message that are to be opaquely parsed by the XMLNSC parser. Opaque parsing is performed only if validation is not enabled (that is, if Validate is None); entries that are specified in Opaque Elements are ignored if validation is enabled.

The Advanced properties of the MQInput node are described in the following table.

Property	M	C	Default	Description
Transaction mode	Yes	No	Yes	This property controls whether the incoming message is received under syncpoint. Valid values are Automatic, Yes, and No.
Order mode	Yes	No	Default	The order in which messages are retrieved from the input queue and processed. Valid values are Default, By User ID, and By Queue Order.
Logical order	Yes	No	Selected	If you select this check box, messages are received in logical order, as defined by WebSphere MQ.
All messages available	Yes	No	Cleared	If you select the check box, all of the messages in a group must be available before retrieval of a message is possible.
Match message ID	No	No		A message ID that must match the message ID in the MQMD of the incoming message.
Match correlation ID	No	No		A correlation ID that must match the correlation ID in the MQMD of the incoming message.
Convert	Yes	No	Cleared	If you select this check box, WebSphere MQ converts data in the message to be received, in conformance with the CodedCharSetId and Encoding values set in the MQMD.
Convert encoding	No	No		The representation used for numeric values in the message data, expressed as an integer value. This property is valid only if you have selected Convert.
Convert coded character set ID	No	No		The coded character set identifier of character data in the message data, expressed as an integer value. This property is valid only if you have selected Convert.
Commit by message group	Yes	No	Cleared	This property controls when a transaction is committed when processing messages that are part of a message group. If you select the check box, the transaction is committed when the message group has been processed.
z/OS serialization token	No	No		A user-defined token for serialized application support. The value that is specified must conform to the rules for a valid ConnTag in the WebSphere MQ MQCNO structure.
Topic	No	Yes		The default topic for the input message.
Browse Only	No	No	Cleared	This property controls whether a message is removed from the queue when it is read. If you select this check box, the message is not removed from the queue when it is read.
Reset browse timeout (ms)	Yes	Yes	-1	The time, in milliseconds, between the last eligible message being browsed on the input queue and the browse being reset to the beginning of the queue. The default value of -1 indicates that the browse is not reset.

The Validation properties of the MQInput node are described in the following table.

For a full description of these properties, see “Validation properties” on page 1359.

Property	M	C	Default	Description
Validate	No	Yes	None	This property controls whether validation takes place. Valid values are None, Content, and Content and Value.
Failure action	No	No	Exception	This property controls what happens if validation fails. You can set this property only if you set Validate to Content or Content and Value. Valid values are User Trace, Local Error Log, Exception, and Exception List.

The Security properties of the MQInput node are described in the following table. For more information about these properties, see Identity and Configuring identity extraction.

Property	M	C	Default	Description
Identity token type	No	No	None	This property specifies the type of identity token present in the incoming message. Valid values are: Transport Default, Username, Username + Password, and X.509 Certificate. If this property is not specified, the identity is retrieved from the transport headers and the type is set to Username.
Identity token location	No	No	None	This property specifies where, in the message, the identity can be found. The location is specified as an ESQL field reference or XPath. If this property is not specified, the identity is retrieved from the MQMD.UserIdIdentifier transport header.
Identity password location	No	No	None	This property specifies where, in the message, the password can be found. The location is specified as an ESQL field reference or XPath. If it is not specified, the password is not set. This property can be set only if the Identity type is set to Username + Password.
Identity IssuedBy location	No	No	None	This property specifies a string or path expression describing the issuer of the identity. The location is specified as an ESQL field reference or XPath. This is for use in an identity mapper. If this property is not specified, the MQMD.PutApplName value is used.
Treat security exceptions as normal exceptions	No	No	False	This property specifies whether to treat security exceptions (such as Access Denied) as normal exceptions, and propagate them down the failure terminal (if wired). This is turned off by default, which ensures that security exceptions cause the message to be backed out even if the failure terminal is wired.

The Instances properties of the MQInput node are described in the following table. For a full description of these properties, see “Configurable message flow properties” on page 1372.

Property	M	C	Default	Description
Additional instances pool	No	Yes	Use Pool Associated with Message Flow	The pool from which additional instances are obtained. <ul style="list-style-type: none"> • If you select Use Pool Associated with Message Flow, additional instances are obtained from the message flow value. • If you select Use Pool Associated with Node, additional instances are allocated from the node's additional instances based on the number specified in the Additional instances property.
Additional instances	No	Yes	0	The number of additional instances that the node can start if the Additional instances pool property is set to Use Pool Associated with Node. By default, no additional instances are given to the node.

MQJMSTransform node

Use the MQJMSTransform node to receive messages that have a WebSphere MQ JMS provider message tree format, and transform them into a format that is compatible with messages that are to be sent to JMS destinations.

This topic contains the following sections:

- "Purpose"
- "Using the MQJMSTransform node in a message flow"
- "Terminals and properties"

Purpose

Use the MQJMSTransform node to send messages to legacy message flows and to interoperate with WebSphere MQ JMS and WebSphere Message Broker publish/subscribe.

The JMSMQTransform node handles messages in all supported message domains.

The MQJMSTransform node is contained in the **JMS** drawer of the palette, and is represented in the workbench by the following icon:



Using the MQJMSTransform node in a message flow

The following sample contains a message flow in which the MQJMSTransform node is used. Refer to this sample for an example of how to use the MQJMSTransform node.

- JMS Nodes sample

You can view samples only when you use the information center that is integrated with the Message Broker Toolkit.

Terminals and properties

When you have put an instance of the MQJMSTransform node into a message flow, you can configure it; see "Configuring a message flow node" on page 235. The properties of the node are displayed in the Properties view.

The terminals of the MQJMSTransform node are described in the following table.

Terminal	Description
Failure	The output terminal to which the message is routed if an error occurs. Even if the Validation property is set, messages that are propagated to this terminal are not validated.
Out	The output terminal to which the message is routed if it is successfully retrieved from the WebSphere MQ queue.
In	The input terminal that accepts a message for processing by the node.

The following table describes the node properties. The column headed M indicates whether the property is *mandatory* (marked with an asterisk if you must enter a value when no default is defined); the column headed C indicates whether the property is *configurable* (you can change the value when you add the message flow to the bar file to deploy it).

The MQJMSTransform node Description properties are described in the following table.

Property	M	C	Default	Description
Node name	No	No	The node type, MQJMSTransform	The name of the node.
Short Description	No	No		A brief description of the node.
Long Description	No	No		Text that describes the purpose of the node in the message flow.

MQOptimizedFlow node

Use the MQOptimizedFlow node to provide a high-performance publish/subscribe message flow. The node supports publishers and subscribers that use Java Message Service (JMS) application programming interfaces and the WebSphere MQ Enterprise Transport.

Restriction:  You cannot use an MQOptimizedFlow node in message flows that you deploy to z/OS systems.

This topic contains the following sections:

- “Purpose”
- “Using this node in a message flow” on page 1022
- “Terminals and properties” on page 1022

Purpose

Use the MQOptimizedFlow node to replace a publish/subscribe message flow that consists of an MQInput node that is connected to a Publication node and that uses the Java Message Service (JMS) over WebSphere MQ transport.

Use the MQOptimizedFlow node to improve performance, particularly where a single publisher produces a persistent publication for a single subscriber.

The MQOptimizedFlow node is contained in the **WebSphere MQ** drawer of the palette, and is represented in the workbench by the following icon:



Using this node in a message flow

Use an MQOptimizedFlow node in a message flow to publish a persistent JMS message to a single subscriber.

The MQOptimizedFlow node has no terminals, so you cannot connect it to any other message flow node.

Terminals and properties

When you have put an instance of the MQOptimizedFlow node into a message flow, you can configure it; see “Configuring a message flow node” on page 235. The properties of the node are displayed in the Properties view. All mandatory properties for which you must enter a value (those that do not have a default value defined) are marked with an asterisk.

The MQOptimizedFlow node has no terminals. It is a complete message flow and you cannot connect it to other message flow nodes to extend the message processing.

The following tables describe the node properties. The column headed M indicates whether the property is mandatory; that is, whether you must enter a value if no default value is defined; an asterisk next to the name of the property denotes this. The column headed C indicates whether the property is configurable; that is, whether you can change the value in the bar file.

The MQOptimizedFlow node Description properties are described in the following table.

Property	M	C	Default	Description
Node name	No	No	MQOptimizedFlow	The name of the node.
Short description	No	No		A brief description of the node.
Long description	No	No		Text that describes the purpose of the node in the message flow.

The MQOptimizedFlow node Basic properties are described in the following table.

Property	M	C	Default	Description
Queue name	Yes	Yes	None	The name of the WebSphere MQ input queue from which this node retrieves messages for processing by this message flow.

The MQOptimizedFlow node Advanced properties are described in the following table.

Property	M	C	Default	Description
Transaction mode	Yes	No	Yes	This property controls whether the incoming message is received under syncpoint. Valid values are Automatic, Yes, and No.

MQOutput node

Use the MQOutput node to send messages to clients that connect to the broker using the WebSphere MQ Enterprise Transport and that use the MQI and AMI application programming interfaces.

This topic contains the following sections:

- “Purpose”
- “Using this node in a message flow” on page 1024
- “Configuring the MQOutput node” on page 1024
- “Terminals and properties” on page 1027

Purpose

The MQOutput node delivers an output message from a message flow to a WebSphere MQ queue. The node uses MQPUT to put the message to the destination queue or queues that you specify.

If appropriate, define the queue as a WebSphere MQ clustered queue or shared queue. When you use a WebSphere MQ clustered queue, leave the queue manager name empty.

You can configure the MQOutput node to put a message to a specific WebSphere MQ queue that is defined on any queue manager that is accessible by the broker’s queue manager, or to the destinations identified in the LocalEnvironment (also known as the DestinationList) that is associated with the message.

Set other properties to control the way in which messages are sent, by causing appropriate MQPUT options to be set; for example, you can request that a message is processed under transaction control. You can also specify that WebSphere MQ can, if appropriate, break the message into segments in the queue manager.

If you create a message flow to use as a subflow, you cannot use a standard output node; use an instance of the Output node to create an Out terminal for the subflow through which to propagate the message.

If you do not want your message flow to send messages to a WebSphere MQ queue, choose another supported output node.

The MQOutput node checks for the presence of an MQMD (WebSphere MQ message descriptor) header in the message tree. If no MQMD is present, the MQOutput node creates an MQMD header in the message tree, and populates it with MQMD default properties. If an MQMD header is found, the MQOutput node checks that it is an MQ type header; if it is not, the Message Context property is set to Default. The MQOutput node treats any other transport headers in the message tree as data.

The MQOutput node is contained in the **WebSphere MQ** drawer of the palette, and is represented in the workbench by the following icon:



Using this node in a message flow

Look at the following samples to see how to use this node:

- Pager samples
- Airline Reservations sample
- Error Handler sample
- Aggregation sample
- Large Messaging sample
- Message Routing sample
- Timeout Processing sample
- Video Rental sample
- XSL Transform sample

You can view samples only when you use the information center that is integrated with the Message Broker Toolkit.

For an example of how to use this node, assume that you have written a publishing application that publishes stock updates on a regular basis. The application sends the messages to the broker on an MQInput node, and the message flow makes the publications available to multiple subscribers through a Publication node. You configure a Compute node to create a new output message whenever one particular stock is changed, and connect this node to an MQOutput node to record each price change for this stock.

Working with WrittenDestination data

After the message has been put, the WrittenDestination folder in the LocalEnvironment is updated with the destination information. A WrittenDestination for an MQOutput node has the following format:

```
WrittenDestination = (  
  MQ = (  
    DestinationData = (  
      queueName      = 'OUT'  
      queueManagerName = 'MYQUEUEMANAGER'  
      replyIdentifier = X'4d...2e'  
      msgId          = X'3c...2c'  
      correlId       = X'2a...00'  
      GroupId        = X'3a...00'  
    )  
  )  
)
```

Configuring the MQOutput node

When you have put an instance of the MQOutput node into a message flow, you can configure it; see “Configuring a message flow node” on page 235. The properties of the node are displayed in the Properties view.

All mandatory properties for which you must enter a value (those that do not have a default value defined) are marked with an asterisk.

Configure the MQOutput node.

1. Optional: On the **Description** tab, enter a short description, a long description, or both. You can also rename the node on this page.
2. On the **Basic** tab:

- To send the output message to a single destination queue that is defined by this node, enter the name of the queue to which the message flow sends messages in Queue Name.
 - Enter the name of the queue manager to which this queue is defined in Queue Manager Name. You must set these properties if you set the Destination Mode property on the **Advanced** tab (described below) to Queue Name. If you set Destination Mode to another value, these properties are ignored.
3. The properties on the **Advanced** tab define the transactional control for the message and the way in which the message is put to the queue. Many of these properties map to options on the MQPUT call.
- Select the Destination Mode from the list. This property identifies the queues to which the output message is put:
 - Queue Name (the default). The message is sent to the queue that is named in the Queue Name property. The Queue Manager Name and Queue Name properties on the **Basic** tab are mandatory if you select this option.
 - Reply To Queue. The message is sent to the queue that is named in the ReplyToQ field in the MQMD.
 - Destination List. The message is sent to the list of queues that are named in the LocalEnvironment (also known as DestinationList) that is associated with the message.
 - Select the Transaction Mode from the list to determine how the message is put:
 - If you select Automatic (the default), the message transactionality is derived from the way that it was specified at the input node.
 - If you select Yes, the message is put transactionally.
 - If you select No, the message is put non-transactionally.

For more information, see “Configuring for coordinated transactions” on page 1027.

- Select the Persistence Mode from the list to determine whether the message is put persistently:
 - If you select Automatic (the default), the persistence is as specified in the incoming message.
 - If you select Yes, the message is put persistently.
 - If you select No, the message is put non-persistently.
 - If you select As Defined for Queue, the message persistence is set as defined for the WebSphere MQ queue.
- Select New Message ID to generate a new message ID for this message. This property maps to the MQPMO_NEW_MSG_ID option of the MQPMO of the MQI.

Clear the check box if you do not want to generate a new ID. A new message ID is still generated if you select Request on the **Request** tab.

More information about the options to which this property maps is available in the *Application Programming Reference* section of the WebSphere MQ Version 6 information center online.
- Select New Correlation ID to generate a new correlation ID for this message. This property maps to the MQPMO_NEW_CORREL_ID option of the MQPMO of the MQI. Clear the check box if you do not want to generate a new ID.

More information about the options to which this property maps is available in the *Application Programming Reference* section of the WebSphere MQ Version 6 information center online.

- Select Segmentation Allowed if you want WebSphere MQ to segment the message within the queue manager when appropriate. Clear the check box if you do not want segmentation to occur. See “Sending message segments in a WebSphere MQ message” on page 612 for more information about message segmentation.

More information about the options to which this property maps is available in the *Application Programming Reference* section of the WebSphere MQ Version 6 information center online.

- Select the Message Context to indicate how origin context is handled. Choose one of the following options:
 - Pass All maps to the MQPMO_PASS_ALL_CONTEXT option of the MQPMO of the MQI.
 - Pass Identity maps to the MQPMO_PASS_IDENTITY_CONTEXT option of the MQPMO of the MQI.
 - Set All maps to the MQPMO_SET_ALL_CONTEXT option of the MQPMO of the MQI.
 - Set Identity maps to the MQPMO_SET_IDENTITY_CONTEXT option of the MQPMO of the MQI.
 - Default maps to the MQPMO_DEFAULT_CONTEXT option of the MQPMO of the MQI.
 - None maps to the MQPMO_NO_CONTEXT option of the MQPMO of the MQI.

More information about the options to which these properties map is available in the *Application Programming Reference* section of the WebSphere MQ Version 6 information center online.

When a security profile is associated with the node and is configured to perform identity propagation, the chosen context can be overridden to ensure that the outgoing identity is set.

- Select Alternate User Authority if you want the MQOO_ALTERNATE_USER_AUTHORITY option to be set in the open options (MQOO) of the MQI. If you select this check box, this option is specified when the queue is opened for output. The alternate user information is retrieved from the context information in the message. Clear the check box if you do not want to specify alternate user authority. If you clear the check box, the broker service user ID is used when the message is put.
4. On the **Request** tab, set the properties to define the characteristics of each output message generated.
 - Select Request to mark each output message in the MQMD as a request message (MQMT_REQUEST), and clear the message identifier field (which is set to MQMI_NONE) to ensure that WebSphere MQ generates a new identifier. Clear the check box to indicate that each output message is not marked as a request message. You cannot select this check box if you have selected a Destination Mode of Reply To Queue.

A new message identifier is generated even if the New Message ID check box is not selected on the **Advanced** tab.
 - Enter a queue manager name in Reply-to Queue Manager. This name is inserted into the MQMD of each output message as the reply-to queue manager.

- Enter a queue name in Reply-to Queue. This name is inserted into the MQMD of each output message as the reply-to queue.
5. On the **Validation** tab, set the validation properties if you want the parser to validate the body of messages against the message set. (If a message is propagated to the Failure terminal of the node, it is not validated.)
- For more details, refer to “Validating messages” on page 164 and “Validation properties” on page 1359.

Connecting the terminals:

Connect the In terminal to the node from which outbound messages bound are routed.

Connect the Out or Failure terminal of this node to another node in this message flow to process the message further, process errors, or send the message to an additional destination.

If you use aggregation in your message flows, you must use the output terminals.

Configuring for coordinated transactions:

When you define an MQOutput node, the option that you select for the Transaction Mode property defines whether the message is written under sync point:

- If you select Yes, the message is written under sync point (that is, within a WebSphere MQ unit of work).
- If you select Automatic (the default), the message is written under sync point if the incoming input message is marked as persistent.
- If you select No, the message is not written under sync point.

Another property of the MQOutput node, Persistence Mode, defines whether the output message is marked as persistent when it is put to the output queue:

- If you select Yes, the message is marked as persistent.
- If you select Automatic (the default), the message persistence is determined from the properties of the incoming message, as set in the MQMD.
- If you select No, the message is not marked as persistent.
- If you select As Defined for Queue, the message persistence is set as defined in the WebSphere MQ queue by the MQOutput node specifying the MQPER_PERSISTENCE_AS_Q_DEF option in the MQMD.

Terminals and properties

The MQOutput node terminals are described in the following table.

Terminal	Description
In	The input terminal that accepts a message for processing by the node.
Failure	The output terminal to which the message is routed if a failure is detected when the message is put to the output queue.
Out	The output terminal to which the message is routed if it has been successfully put to the output queue, and if further processing is required within this message flow.

The following tables describe the node properties. The column headed M indicates whether the property is *mandatory* (marked with an asterisk if you must enter a

value when no default is defined); the column headed C indicates whether the property is *configurable* (you can change the value when you add the message flow to the bar file to deploy it).

The MQOutput node Description properties are described in the following table.

Property	M	C	Default	Description
Node name	No	No	The node type, MQOutput	The name of the node.
Short Description	No	No		A brief description of the node.
Long Description	No	No		Text that describes the purpose of the node in the message flow.

The MQOutput node Basic properties are described in the following table.

Property	M	C	Default	Description
Queue Manager Name	No	Yes		The name of the WebSphere MQ queue manager to which the output queue, which is specified in Queue Name, is defined.
Queue Name	No	Yes		The name of the WebSphere MQ output queue to which this node puts messages (using MQPUT). If you set the Destination Mode property to Queue Name, you must specify a value for the Queue Name property.

The MQOutput node Advanced properties are described in the following table.

Property	M	C	Default	Description
Destination Mode	Yes	No	Queue Name	The queues to which the output message is sent. Valid values are Destination List, Reply To Queue, and Queue Name. If you set the Destination Mode to Queue Name, you must specify a value for the Queue Name property.
Transaction Mode	Yes	No	Automatic	This property controls whether the message is put transactionally. Valid values are Automatic, Yes, and No.
Persistence Mode	Yes	No	Automatic	This property controls whether the message is put persistently. Valid values are Automatic, Yes, No, and As Defined for Queue.
New Message ID	Yes	No	Cleared	If you select this check box, WebSphere MQ generates a new message identifier to replace the contents of the MsgId field in the MQMD.
New Correlation ID	Yes	No	Cleared	If you select this check box, WebSphere MQ generates a new correlation identifier to replace the contents of the CorrelId field in the MQMD.
Segmentation Allowed	Yes	No	Cleared	If you select this check box, WebSphere MQ breaks the message into segments in the queue manager.
Message Context	Yes	No	Pass All	This property controls how origin context is handled. Valid values are Pass All, Pass Identity, Set All, Set Identity, and Default.

Property	M	C	Default	Description
Alternate User Authority	Yes	No	Cleared	If you select this check box, alternate authority is used when the output message is put.

The MQOutput node Request properties are described in the following table.

Property	M	C	Default	Description
Request	Yes	No	Cleared	If you select the check box, each output message is generated as a request message.
Reply-to Queue Manager	No	Yes		The name of the WebSphere MQ queue manager to which the output queue, which is specified in Reply-to Queue, is defined.
Reply-to Queue	No	Yes		The name of the WebSphere MQ queue to which to put a reply to this request.

The Validation properties of the MQOutput node are described in the following table.

For a full description of these properties, see “Validation properties” on page 1359.

Property	M	C	Default	Description
Validate	No	Yes	Inherit	This property controls whether validation takes place. Valid values are None, Content and Value, Content, and Inherit.
Failure Action	No	No	Exception	This property controls what happens if validation fails. You can set this property only if you set Validate to Content or Content and Value. Valid values are User Trace, Local Error Log, Exception, and Exception List.

MQReply node

Use the MQReply node to send a response to the originator of the input message.

This topic contains the following sections:

- “Purpose”
- “Using this node in a message flow” on page 1030
- “Configuring the MQReply node” on page 1030
- “Terminals and properties” on page 1032

Purpose

The MQReply node is a specialized form of the MQOutput node that puts the output message to the WebSphere MQ queue that is identified by the ReplyToQ field of the input message header. If appropriate, define the queue as a WebSphere MQ clustered queue or shared queue.

The MQReply node uses the options that are set in the Report field in the MQMD. By default (if no options are set), the MQReply node generates a new MsgId and CorrelId in the reply message. If the receiving application expects other values in these fields, ensure that the application that puts the message to the message flow input queue sets the required report options, or that you set the appropriate options within the MQMD during message processing in the message flow; for example, use a Compute node to set the Report options in the message.

You can find more information about the Report field in the *WebSphere MQ Application Programming Reference*.

The MQReply node is contained in the **WebSphere MQ** drawer of the palette, and is represented in the workbench by the following icon:



Using this node in a message flow

Look at the following sample to see how to use this node:

- Airline Reservations sample

You can view samples only when you use the information center that is integrated with the Message Broker Toolkit.

You can use this node when you receive an order from a customer. When the order message is processed, a response is sent to the customer acknowledging receipt of the order and providing a possible date for delivery.

Working with WrittenDestination data

After the message has been put, the WrittenDestination folder in the LocalEnvironment is updated with the destination information. A WrittenDestination for an MQOutput node has the following format:

```
WrittenDestination = (  
  MQ = (  
    DestinationData = (  
      queueName      = 'OUT'  
      queueManagerName = 'MYQUEUEMANAGER'  
      replyIdentifier = X'4d...2e'  
      msgId          = X'3c...2c'  
      correlId       = X'2a...00'  
      groupId        = X'3a...00'  
    )  
  )  
)
```

Configuring the MQReply node

When you have put an instance of the MQReply node into a message flow, you can configure it; see “Configuring a message flow node” on page 235. The properties of the node are displayed in the Properties view.

All mandatory properties for which you must enter a value (those that do not have a default value defined) are marked with an asterisk.

Configure the MQReply node as follows:

1. Optional: On the **Description** tab, enter a short description, a long description, or both. You can also rename the node on this tab.
2. On the **Advanced** tab:
 - a. Select Segmentation Allowed if you want WebSphere MQ to break the message into segments in the queue manager, when appropriate. You must also set MQMF_SEGMENTATION_ALLOWED in the MsgFlags field in the MQMD for segmentation to occur.

More information about the options to which this property maps is available in the *WebSphere MQ Application Programming Reference*.

- b. Select the Persistence Mode that you want for the output message.
 - If you select Automatic (the default), the persistence is as specified in the incoming message.
 - If you select Yes, the message is put persistently.
 - If you select No, the message is put non-persistently.
 - If you select As Defined for Queue, the message persistence is set as defined in the WebSphere MQ queue.
 - c. Select the Transaction Mode that you want for the output message.
 - If you select Automatic (the default), the message transactionality is derived from how it was specified at the MQInput node.
 - If you select Yes, the message is put transactionally.
 - If you select No, the message is put non-transactionally.
3. On the **Validation** tab, set the validation properties; see “Validation properties” on page 1359. If a message is propagated to the Failure terminal of the node, it is not validated.

For more details, see “Validating messages” on page 164.

The reply message is put (using MQPUT) to the queue named in the input message MQMD as the ReplyTo queue. You cannot change this destination.

Connecting the output terminals to another node:

Connect the Out or Failure terminal of this node to another node in this message flow to process the message further, process errors, or send the message to an additional destination.

If you use aggregation in your message flows, you must use these output terminals.

Configuring for coordinated transactions:

When you define an MQReply node, the option that you select for the Transaction Mode property defines whether the message is written under sync point:

- If you select Yes, the message is written under sync point (that is, within a WebSphere MQ unit of work).
- If you select Automatic (the default), the message is written under sync point if the incoming input message is marked as persistent.
- If you select No, the message is not written under sync point.

Another property of the MQReply node, Persistence Mode, defines whether the output message is marked as persistent when it is put to the output queue:

- If you select Yes, the message is marked as persistent.
- If you select Automatic (the default), the message persistence is determined by the properties of the incoming message, as set in the MQMD (the WebSphere MQ message descriptor).
- If you select No, the message is not marked as persistent.
- If you select As Defined for Queue, the message persistence is set as defined in the WebSphere MQ queue; the MQReply node specifies the MQPER_PERSISTENCE_AS_Q_DEF option in the MQMD.

Terminals and properties

The MQReply node terminals are described in the following table.

Terminal	Description
In	The input terminal that accepts a message for processing by the node.
Failure	The output terminal to which the message is routed if a failure is detected when the message is put to the output queue.
Out	The output terminal to which the message is routed if it has been successfully put to the output queue, and if further processing is required within this message flow.

The following tables describe the node properties. The column headed M indicates whether the property is *mandatory* (marked with an asterisk if you must enter a value when no default is defined); the column headed C indicates whether the property is *configurable* (you can change the value when you add the message flow to the bar file to deploy it).

The MQReply node Description properties are described in the following table.

Property	M	C	Default	Description
Node name	No	No	The node type.	The name of the node.
Short Description	No	No		A brief description of the node.
Long Description	No	No		Text that describes the purpose of the node in the message flow.

The MQReply node Advanced properties are described in the following table.

Property	M	C	Default	Description
Segmentation Allowed	Yes	No	Cleared	If you select this check box, WebSphere MQ breaks the message into segments in the queue manager.
Persistence Mode	Yes	No	Automatic	This property controls whether the message is put persistently. Valid values are Automatic, Yes, No, and As Defined for Queue.
Transaction Mode	Yes	No	Automatic	This property controls whether the message is put transactionally. Valid values are Automatic, Yes, and No.

The Validation properties of the MQReply node are described in the following table.

For a full description of these properties, see “Validation properties” on page 1359.

Property	M	C	Default	Description
Validate	No	Yes	Inherit	This property controls whether validation takes place. Valid values are None, Content and Value, Content, and Inherit.
Failure Action	No	No	Exception	This property controls what happens if validation fails. You can set this property only if you set Validate to Content or Content and Value. Valid values are User Trace, Local Error Log, Exception, and Exception List.

The MQReply node also has the following properties that you cannot access or modify through the workbench interface. However, these values are used by the broker when the message is processed in the message flow.

Property	Description
Queue Manager Name	The name of the WebSphere MQ queue manager to which the output queue, identified in Queue Name, is defined. This name is retrieved from the ReplyTo field of the MQMD of the input message.
Queue Name	The name of the WebSphere MQ queue to which the output message is put. This name is retrieved from the ReplyTo field of the MQMD of the input message.
Destination	This property always has the value reply.

Output node

Use the Output node as an out terminal for an embedded message flow (a subflow).

This topic contains the following sections:

- “Purpose”
- “Using this node in a message flow” on page 1034
- “Terminals and properties” on page 1034

Purpose

You can use a subflow for a common task that can be represented by a sequence of message flow nodes. For example, you can create a subflow to increment or decrement a loop counter, or to provide error processing that is common to a number of message flows.

You must use an Output node to provide the Out terminal to a subflow; you cannot use a standard output node (a built-in output node such as MQOutput, or a user-defined output node).

You can include one or more Output nodes in a subflow. Each one that you include provides a terminal through which you can propagate messages to subsequent nodes in the message flow in which you include the subflow.

The Output node is contained in the **Construction** drawer of the palette, and is represented in the workbench by the following icon:



When you select and include a subflow in a message flow, it is represented by the following icon:



When you include the subflow in a message flow, this icon exhibits a terminal for each Output node that you included in the subflow, and the name of the terminal (which you can see when you hover over it) matches the name of that instance of

the Output node. Give your Output nodes meaningful names, you can easily recognize them when you use their corresponding terminal on the subflow node in your message flow.

Using this node in a message flow

Look at the following sample to see how to use this node:

- Error Handler sample

You can view samples only when you use the information center that is integrated with the Message Broker Toolkit.

Terminals and properties

When you have put an instance of the Output node into a message flow, you can configure it; see “Configuring a message flow node” on page 235. The properties of the node are displayed in the Properties view.

The Output node terminals are described in the following table.

Terminal	Description
In	The output terminal that defines an out terminal for the subflow.

The following table describes the node properties. The column headed M indicates whether the property is *mandatory* (marked with an asterisk if you must enter a value when no default is defined); the column headed C indicates whether the property is *configurable* (you can change the value when you add the message flow to the bar file to deploy it).

The Output node Description properties are described in the following table.

Property	M	C	Default	Description
Node name	No	No	The node type, Output	The name of the node.
Short Description	No	No		A brief description of the node.
Long Description	No	No		Text that describes the purpose of the node in the message flow.

Passthrough node

Use the Passthrough node to enable version control of a subflow at run time.

This topic contains the following sections:

- “Purpose”
- “Using this node in a message flow” on page 1035
- “Terminals and properties” on page 1035

Purpose

Use the Passthrough node to add a label to your message flow or subflow. By combining this label with keyword replacement from your version control system, you can identify which version of a subflow is included in a deployed message flow. You can use this label for your own purposes. If you have included the correct version keywords in the label, you can see the value of the label:

- Stored in the broker archive (bar) file, using the mqsireadbar command
- As last deployed to a particular broker, on the properties of a deployed message flow in the workbench
- At run time, if you enable user trace for that message flow

The Passthrough node does not process the message in any way. The message that it propagates on its Out terminal is the same message that it received on its In terminal.

The Passthrough node is contained in the **Construction** drawer of the palette, and is represented in the workbench by the following icon:



Using this node in a message flow

Use this node to identify a subflow; for example, if you develop an error processing subflow to include in several message flows, you might want to modify that subflow. However, you might want to introduce the modified version initially to just a subset of the message flows in which it is included. Set a value for the instance of the Passthrough node that identifies which version of the subflow you have included.

Terminals and properties

When you have put an instance of the Passthrough node into a message flow, you can configure it. For more information, see “Configuring a message flow node” on page 235. The properties of the node are displayed in the Properties view. All mandatory properties for which you must enter a value (those that do not have a default value defined) are marked with an asterisk.

The Passthrough node terminals are described in the following table.

Terminal	Description
In	The input terminal that accepts a message for processing by the node.
Out	The input terminal that delivers a message to the subflow.

The following tables describe the node properties. The column headed M indicates whether the property is *mandatory* (marked with an asterisk if you must enter a value when no default is defined), the column headed C indicates whether the property is *configurable* (you can change the value when you add the message flow to the bar file to deploy it).

The Passthrough node Description properties are described in the following table.

Property	M	C	Default	Description
Node name	No	No	Passthrough	The name of the node.
Short description	No	No		A brief description of the node.
Long description	No	No		Text that describes the purpose of the node in the message flow.

The Passthrough node Basic properties are described in the following table.

Property	M	C	Default	Description
Label	No	No		The label (identifier) of the node. Enter a value that defines a unique characteristic; for example, the version of the subflow in which the node is included.

PeopleSoftInput node

Use the PeopleSoftInput node to interact with a PeopleSoft application.

This topic contains the following sections:

- “Purpose”
- “Using this node in a message flow”
- “Terminals and properties” on page 1037

Purpose

Use the PeopleSoftInput node to interact with PeopleSoft applications. For example, a PeopleSoftInput node monitors a PeopleSoft system for a specified event. When that event occurs, the PeopleSoftInput node generates a message tree that represents the business object with the new event details. The message tree is propagated to the Out terminal so that the rest of the message flow can use the data to update other systems, or audit the changes.

The PeopleSoftInput node is contained in the **WebSphere Adapters** drawer of the message flow node palette, and is represented in the workbench by the following icon:



Using this node in a message flow

To function correctly, the PeopleSoftInput node needs an adapter component, which you set using the Adapter component node property, and business object definitions, which are stored in the message set that you reference from the node. For this reason, you must provide a message set. By default, the message that is propagated from the PeopleSoftInput node is in the DataObject domain, so the Message domain property is set to DataObject. You cannot specify a different domain. The message type is detected automatically by the node.

The PeopleSoftInput node populates the route to label destination list with the name of the method binding. If you add a RouteToLabel node to the message flow after the PeopleSoftInput node, the RouteToLabel node can use the name of the method binding to route the message to the correct part of the message flow for processing.

You can deploy only one input node that uses a particular adapter component to an execution group, but you can deploy many input nodes that use different adapter components to an execution group.

You can use the mqsisetdbparms command in the following format to configure an account name with a user name and password for the Adapter for PeopleSoft Enterprise.

```
mqsisetdbparms broker name -n adapter name -u user name -p password
```

For example:

```
mqsisetdbparms BRK1 -n PeopleSoftCustomerInbound.inadapter -u peoplesoftuid -p *****
```

Terminals and properties

When you have put an instance of the PeopleSoftInput node into a message flow, you can configure it; see “Configuring a message flow node” on page 235. The properties of the node are displayed in the Properties view. If you double-click a PeopleSoftInput node, you open the Adapter Connection wizard. All mandatory properties for which you must enter a value (those that do not have a default value defined) are marked with an asterisk.

The PeopleSoftInput node terminals are described in the following table.

Terminal	Description
Out	Business object events from the adapter are sent to the Out terminal.
Failure	If an error happens in the PeopleSoftInput node, the message is propagated to the Failure terminal. Information about the error, and business object events can also be propagated to the Failure terminal.
Catch	Business object events are sent to the Catch terminal if they cause an uncaught exception in the message flow. If the Catch terminal is not connected, the retry process is activated to handle the business object.

The following table describes the node properties. The column headed M indicates whether the property is *mandatory* (marked with an asterisk if you must enter a value when no default is defined); the column headed C indicates whether the property is *configurable* (you can change the value when you add the message flow to the bar file to deploy it).

The PeopleSoftInput node Description properties are described in the following table.

Property	M	C	Default	Description
Node name	No	No	The node type, PeopleSoftInput.	The name of the node.
Short Description	No	No		A brief description of the node.
Long Description	No	No		Text that describes the purpose of the node in the message flow.

The PeopleSoftInput node Basic properties are described in the following table.

Property	M	C	Default	Description
Adapter component	Yes	Yes		The name of the adapter component that contains configuration properties for the adapter. Either enter a name of an adapter file or click Browse to select an adapter file from the list of files that are available in referenced message set projects.

The PeopleSoftInput node Routing properties are described in the following table.

Property	M	C	Default	Description
Set destination list	No	No	Selected	This property specifies whether to add the method binding name to the route to label destination list. If you select this check box, the method binding name is added so that you can use a RouteToLabel node in the message flow after the PeopleSoftInput node.
Label prefix	No	No		The prefix to add to the method name when routing to label. Add a label prefix to avoid a clash of corresponding label nodes when you include multiple WebSphere Adapters input nodes in the same message flow. By default, there is no label prefix, so the method name and label name are identical.

The PeopleSoftInput node Input Message Parsing properties are described in the following table.

Property	M	C	Default	Description
Message domain	No	No	DataObject	The domain that is used to parse the incoming message. By default, the message that is propagated from the PeopleSoftInput node is in the DataObject domain. You cannot specify a different domain.
Message set	Yes	No	Set automatically	The name of the message set in which the incoming message is defined. This field is set automatically from the Adapter component property. If you set this property, then subsequently update the project dependencies to remove this message set reference, a warning is issued. Either update the Message set property, or restore the reference to this message set project.
Message type	No	No		The name of the incoming message. The node detects the message type automatically. You cannot set this property.
Message format	No	No		The name of the physical format of the incoming message. You cannot set this property.

The PeopleSoftInput node Transactionality properties are described in the following table.

Property	M	C	Default	Description
Transaction mode	No		Yes	This property specifies how updates are handled. If you select Yes, updates are performed in a single transaction. If you select No, updates are performed independently.

The Instances properties of the PeopleSoftInput node are described in the following table. For a full description of these properties, refer to “Configurable message flow properties” on page 1372.

Property	M	C	Default	Description
Additional instances pool	No	Yes	Use Pool Associated with Message Flow	The pool from which additional instances are obtained. <ul style="list-style-type: none"> If you select Use Pool Associated with Message Flow, additional instances are obtained from the message flow value. If you select Use Pool Associated with Node, additional instances are allocated from the node’s additional instances based on the number specified in the Additional instances property.
Additional instances	No	Yes	0	The number of additional instances that the node can start if the Additional instances pool property is set to Use Pool Associated with Node. By default, no additional instances are given to the node.

The PeopleSoftInput node Retry properties are described in the following table.

Property	M	C	Default	Description
Retry mechanism	No	No	Failure	This property specifies how retry processing is handled when a failure is rolled back to the PeopleSoftInput node. <ul style="list-style-type: none"> • If you select Failure, retry processing is not performed so you cannot set the remaining properties. • If you select Short and long retry, retry processing is performed first at the interval that is specified by the Short retry interval property, and if that is unsuccessful, it is then performed at the interval that is specified by the Long retry interval property.
Retry threshold	No	Yes	0	The maximum number of times that retry processing is performed for short retry.
Short retry interval	No	Yes	0	The interval between short retry attempts.
Long retry interval	No	Yes	0	The interval between long retry attempts.

PeopleSoftRequest node

Use the PeopleSoftRequest node to interact with a PeopleSoft application.

This topic contains the following sections:

- “Purpose”
- “Using this node in a message flow”
- “Terminals and properties” on page 1040

Purpose

Use the PeopleSoftRequest node to interact with PeopleSoft applications. For example, a PeopleSoftRequest node requests information from a PeopleSoft Enterprise Information System (EIS). A customer business object is sent to PeopleSoft, causing PeopleSoft to retrieve information about a customer, such as an address and account details. The response information that is retrieved by the PeopleSoftRequest node can then be used by the rest of the message flow. The PeopleSoftRequest node can send and receive business data.

The PeopleSoftRequest node is contained in the **WebSphere Adapters** drawer of the message flow node palette, and is represented in the workbench by the following icon:



Using this node in a message flow

To function correctly, the PeopleSoftRequest node needs an adapter component, which you set using the Adapter component node property, and business object definitions, which are stored in the message set that you reference from the node. For this reason, you must provide a message set. By default, the message that is propagated from the PeopleSoftRequest node is in the DataObject domain, so the Message domain property is set to DataObject. You cannot specify a different domain. The message type is detected automatically by the node.

The PeopleSoftRequest node supports local transactions using the broker's Local Transaction Manager, and global transactions using the broker's external syncpoint coordinator.

You can deploy several WebSphere Adapters request nodes that use the same adapter component to an execution group.

You can use the mqsisetdbparms command in the following format to configure an account name with a user name and password for the Adapter for PeopleSoft Enterprise.

```
mqsisetdbparms broker name -n adapter name -u user name -p password
```

For example:

```
mqsisetdbparms BRK1 -n PeopleSoftCustomerOutbound.outadapter -u peoplesoftuid -p *****
```

Terminals and properties

When you have put an instance of the PeopleSoftRequest node into a message flow, you can configure it; see "Configuring a message flow node" on page 235. The properties of the node are displayed in the Properties view. If you double-click a PeopleSoftRequest node, you open the Adapter Connection wizard. All mandatory properties for which you must enter a value (those that do not have a default value defined) are marked with an asterisk.

The PeopleSoftRequest node terminals are described in the following table.

Terminal	Description
In	The input terminal that accepts the request business object.
Out	The output terminal to which the response business object is sent if it represents successful completion of the request, and if further processing is required within this message flow.
Failure	If an error happens in the PeopleSoftRequest node, the message is propagated to the Failure terminal. Information about the error, and business object events can also be propagated to the Failure terminal.

The following tables describe the node properties. The column headed M indicates whether the property is *mandatory* (marked with an asterisk on the panel if you must enter a value when no default is defined); the column headed C indicates whether the property is *configurable* (you can change the value when you add the message flow to the bar file to deploy it).

The PeopleSoftRequest node Description properties are described in the following table.

Property	M	C	Default	Description
Node name	No	No	The node type, e.g. PeopleSoftRequest	The name of the node.
Short Description	No	No		A brief description of the node.
Long Description	No	No		Text that describes the purpose of the node in the message flow.

The PeopleSoftRequest node Basic properties are described in the following table.

Property	M	C	Default	Description
Adapter component	Yes	No		The name of the adapter component that contains configuration properties for the adapter. Either enter a name of an adapter file, or click Browse to select an adapter file from the list of files that are available in referenced message set projects.
Default method	Yes	Yes		The default method binding to use.

The PeopleSoftRequest node Response Message Parsing properties are described in the following table.

Property	M	C	Default	Description
Message domain	No	No	DataObject	The domain that is used to parse the response message. By default, the response message that is propagated from the PeopleSoftRequest node is in the DataObject domain. You cannot specify a different domain.
Message set	Yes	No	Set automatically	The name of the message set in which the response message is defined. This field is set automatically from the Adapter component property. If you set this property, then subsequently update the project dependencies to remove this message set reference, a warning is issued. Either update the Message set property, or restore the reference to this message set project.
Message type	No	No		The name of the response message. The node detects the message type automatically. You cannot set this property.
Message format	No	No		The name of the physical format of the response message. You cannot set this property.

The PeopleSoftRequest node Transactionality properties are described in the following table.

Property	M	C	Default	Description
Transaction mode	No	No	No	This property specifies that updates are performed independently, not as part of a local transaction. You cannot change this property.

The PeopleSoftRequest node Request properties are described in the following table.

Property	M	C	Default	Description
Method Location	Yes	No	\$LocalEnvironment/Adapter/MethodName	The business method that is used to trigger the PeopleSoftRequest node to perform an action on the external system. For example: <ul style="list-style-type: none"> createPurchaseOrder causes the PeopleSoftRequest node to create a purchase order in the EIS. deletePurchaseOrder causes the PeopleSoftRequest node to delete a purchase order in the EIS.
Data Location	Yes	No	\$Body	The location in the incoming message tree from which data is retrieved to form the request that is sent from the PeopleSoftRequest node to the EIS.

The PeopleSoftRequest node Result properties are described in the following table.

Property	M	C	Default	Description
Output data location	No	No	\$OutputRoot	The message tree location to which the PeopleSoftRequest node sends output.
Copy local environment	No	No	Selected	<p>This property controls how the local environment is copied to the output message. If you select the check box, at each node in the message flow, a new copy of the local environment is created in the tree, and it is populated with the contents of the local environment from the preceding node. So if a node changes the local environment, the upstream nodes do not see those changes because they have their own copies. This behavior might be an issue if you are using a FlowOrder node, or if you use the propagate command on a Compute node.</p> <p>If you clear the check box, each node does not generate its own copy of the local environment, but it uses the local environment that is passed to it by the previous node. So if a node changes the local environment, those changes are seen by the upstream nodes.</p>

Publication node

Use the Publication node to filter output messages from a message flow and transmit them to subscribers who have registered an interest in a particular set of topics. The Publication node must always be an output node of a message flow and has no output terminals of its own.

This topic contains the following sections:

- “Purpose”
- “Using this node in a message flow” on page 1043
- “Terminals and properties” on page 1043

Purpose

Use the Publication node (or a user-defined node that provides a similar service) if your message flow supports publish/subscribe applications. Applications that expect to receive publications must register a subscription with a broker, and can optionally qualify the publications that they get by providing restrictive criteria (such as a specific publication topic).

If your subscriber applications use the WebSphere MQ Enterprise Transport to connect to the broker, you can define the queues to which messages are published as WebSphere MQ clustered queues or shared queues.

Publications can also be sent to subscribers within a WebSphere MQ cluster if a cluster queue is nominated as the subscriber queue. In this case, the subscriber should use the name of an “imaginary” queue manager that is associated with the cluster, and should ensure that a corresponding blank queue manager alias definition for this queue manager is made on the broker that satisfies the subscription.

The Publication node is contained in the **Routing** drawer of the palette, and is represented in the workbench by the following icon:



Using this node in a message flow

Look at the following samples to see how to use this node:

- Soccer Results sample
- Scribble sample
- JMS Nodes sample
- Pager samples

You can view samples only when you use the information center that is integrated with the Message Broker Toolkit.

For an example of how to use this node, assume that you have written a publishing application that publishes stock updates on a regular basis. The application sends the messages to the broker on an MQInput node, and the message flow provides a conversion from the input currency to a number of output currencies. Include a Publication node for each currency that is supported, and set the Subscription Point to a value that reflects the currency in which the stock price is published by the node; for example, Sterling, or USD.

Terminals and properties

When you have put an instance of the Publication node into a message flow, you can configure it; see “Configuring a message flow node” on page 235. The properties of the node are displayed in the Properties view. All mandatory properties for which you must enter a value (those that do not have a default value defined) are marked with an asterisk.

The Publication node terminals are described in the following table.

Terminal	Description
In	The input terminal that accepts a message for processing by the node.

The following tables describe the node properties. The column headed M indicates whether the property is *mandatory* (marked with an asterisk if you must enter a value when no default is defined); the column headed C indicates whether the property is *configurable* (you can change the value when you add the message flow to the bar file to deploy it).

The Publication node Description properties are described in the following table.

Property	M	C	Default	Description
Node name	No	No	The node type: Publication	The name of the node.
Short Description	No	No		A brief description of the node.
Long Description	No	No		Text that describes the purpose of the node in the message flow.

The Publication node Basic properties are described in the following table.

Property	M	C	Default	Description
Implicit Stream Naming	Yes	No	Cleared	Select Implicit Stream Naming to take the name of the WebSphere MQ queue on which the message was received by the message flow as the stream name. This property provides forward compatibility with WebSphere MQ Publish/Subscribe, and applies to messages with an MQRFH header when MQPStream is not specified. Clear the check box if you do not want this action to be taken.
Subscription Point	No	No		The subscription point value for the node. If you do not specify a value for this property, the default subscription point is assumed. This value uniquely identifies the node, and can be used by subscribers to get a specific publication (as described in the example scenario in "Using this node in a message flow" on page 1043). For more information, see Subscription points.

Real-timeInput node

Use the Real-timeInput node to receive messages from clients that connect to the broker using the WebSphere MQ Real-time Transport or the WebSphere MQ Multicast Transport, and that use JMS application programming interfaces.

This topic contains the following sections:

- "Purpose"
- "Using this node in a message flow" on page 1045
- "Terminals and properties" on page 1045

Purpose

The Real-timeInput node handles messages in the following message domains:

- JMSMap
- JMSStream

An output node in a message flow that starts with a Real-timeInput node can be any of the supported output nodes, including user-defined output nodes. You can create a message flow that receives messages from real-time clients and generates messages for clients that use all supported transports to connect to the broker, because you can configure the message flow to request the broker to provide any conversion that is required.

If you create a message flow to use as a subflow, you cannot use a standard input node; you must use an instance of the Input node as the first node to create an In terminal for the subflow.

If your message flow does not receive messages from JMS applications, choose one of the supported input nodes.

The Real-timeInput node is contained in the **Additional Protocols** drawer of the palette, and is represented in the workbench by the following icon:



Using this node in a message flow

Look at the following sample to see how you can use this node:

- Scribble sample

You can view samples only when you use the information center that is integrated with the Message Broker Toolkit.

Terminals and properties

When you have put an instance of the Real-timeInput node into a message flow, you can configure it; see “Configuring a message flow node” on page 235. The properties of the node are displayed in the Properties view. All mandatory properties for which you must enter a value (those that do not have a default value defined) are marked with an asterisk.

The Real-timeInput node terminals are described in the following table.

Terminal	Description
Out	The output terminal to which the message is routed if it is successfully retrieved from JMS. If this routing fails, the message is retried.

The following tables describe the node properties. The column headed M indicates whether the property is *mandatory* (marked with an asterisk if you must enter a value when no default is defined), the column headed C indicates whether the property is *configurable* (you can change the value when you add the message flow to the bar file to deploy it).

The Real-timeInput node Description properties are described in the following table.

Property	M	C	Default	Description
Node name	No	No	The node type: Real-timeInput	The name of the node.
Short Description	No	No		A brief description of the node.
Long Description	No	No		Text that describes the purpose of the node in the message flow.

The Real-timeInput node Basic properties are described in the following table.

Property	M	C	Default	Description
Port	Yes	Yes		The port number on which the input node listens for publish or subscribe requests from JMS applications. Ensure that the port number that you specify does not conflict with any other listener service. No default value is provided for this property; you must enter a value.
Authentication	Yes	No	Cleared	To authenticate users that send messages on receipt of their messages, select this check box. If you clear the check box (the default setting), users are not authenticated.

Property	M	C	Default	Description
Tunnel through HTTP	Yes	No	Cleared	Select the check box to indicate that users use HTTP tunneling. If you clear the check box (the default setting), messages do not use HTTP tunneling. If you select the check box, all client applications that connect must use this feature. If they do not use this feature, their connection is rejected. The client application cannot use this option in conjunction with the connect-via proxy setting, which is activated from the client side.
Read Threads	No	Yes	10	The number of threads that you want the broker to allocate to read messages. The broker starts as many instances of the message flow as are necessary to process current messages, up to this limit.
Write Threads	No	Yes	10	The number of threads that you want the broker to allocate to write messages. The broker starts as many instances of the message flow as are necessary to process current messages, up to this limit.
Authentication Threads	No	Yes	10	The number of threads that you want the broker to allocate to user authentication checks. The user authentication check is performed when a message is received. The broker starts as many instances of the message flow as are necessary to process current messages, up to this limit.

The properties of the General Message Options for the Real-timeInput node are described in the following table.

Property	M	C	Default	Description
Parse Timing	No	No	On Demand	This property controls when an input message is parsed. Valid values are On Demand, Immediate, and Complete. Parse timing is, by default, set to On Demand, which causes parsing of the message to be delayed. To cause the message to be parsed immediately, see "Parsing on demand" on page 1363.

Real-timeOptimizedFlow node

Use the Real-timeOptimizedFlow node to receive messages from clients that connect to the broker using the WebSphere MQ Real-time Transport or the WebSphere MQ Multicast Transport, and that use JMS application programming interfaces.

Purpose

The Real-timeOptimizedFlow node is a complete message flow that provides a high performance publish/subscribe message flow. The actions that are taken by this node are all internalized; you cannot influence the node's operation except by configuring its properties, and you cannot connect it to any other node.

This node also supports publication to, or subscription from, standard WebSphere MQ applications, but its performance for these applications is not as good as the performance achieved for JMS applications.

You cannot affect the message content in any way when you use the Real-timeOptimizedFlow node. To modify the input message, or to send messages or make publications available to applications that use other communications protocols, use the Real-timeInput node.

Include the Real-timeOptimizedFlow node in a message flow when you want to distribute messages through a broker to and from client applications that use JMS.

The Real-timeOptimizedFlow node is contained in the **Additional Protocols** drawer of the palette, and is represented in the workbench by the following icon:



Terminals and properties

When you have put an instance of the Real-timeOptimizedFlow node into a message flow, you can configure it. For more information, see “Configuring a message flow node” on page 235. The properties of the node are displayed in the Properties view. All mandatory properties for which you must enter a value (those that do not have a default value defined) are marked with an asterisk.

The Real-timeOptimizedFlow node has no terminals. It is a complete message flow and cannot be connected to other nodes to extend the message processing.

The following tables describe the node properties. The column headed M indicates whether the property is *mandatory* (marked with an asterisk if you must enter a value when no default is defined), the column headed C indicates whether the property is *configurable* (you can change the value when you add the message flow to the bar file to deploy it).

The Real-timeOptimizedFlow node Description properties are described in the following table.

Property	M	C	Default	Description
Node name	No	No	Real-timeOptimizedFlow	The name of the node.
Short description	No	No		A brief description of the node.
Long description	No	No		Text that describes the purpose of the node in the message flow.

The Real-timeOptimizedFlow node Basic properties are described in the following table.

Property	M	C	Default	Description
Port	Yes	Yes		The port number on which the node listens for publish or subscribe requests from JMS applications. Ensure that the port number that you specify does not conflict with any other listener service. No default value is provided for this property; you must enter a value.
Authentication	Yes	No	Cleared	For users to authenticate that send messages on receipt of their messages, select Authentication. If you clear the check box (the default setting), users are not authenticated.
Tunnel through HTTP	Yes	No	Cleared	For clients to use HTTP tunneling, select Tunnel through HTTP. If you clear the check box (the default setting), messages do not use HTTP tunneling. If you select the check box, all client applications that connect must use this feature. If they do not use this feature, their connection is rejected. The client application cannot use this option in conjunction with the connect-via-proxy setting, which is activated from the client side.

Property	M	C	Default	Description
Read threads	No	Yes	10	The number of threads that you want the broker to allocate to read messages. The broker starts as many instances of the message flow as are necessary to process current messages, up to this limit.
Write threads	No	Yes	10	The number of threads that you want the broker to allocate to write messages. The broker starts as many instances of the message flow as are necessary to process current messages, up to this limit.
Authentication threads	No	Yes	10	The number of threads that you want the broker to allocate to user authentication checks. The user authentication check is performed when a message is received. The broker starts as many instances of the message flow as are necessary to process current messages, up to this limit.

RegistryLookup node

Use the RegistryLookup node to access service metadata that resides in the WebSphere Service Registry and Repository. The RegistryLookup node does not perform additional filtering or selection other than that specified by the property matching.

This topic contains the following sections:

- “Purpose”
- “Terminals and properties” on page 1049

Important: WebSphere Message Broker V6.1.0.2 only supports WebSphere Service Registry and Repository V6.1. Previous versions of the product are not supported.

Purpose

You can use two nodes to access service metadata that resides in the WebSphere Service Registry and Repository, the EndpointLookup node and the RegistryLookup node. These nodes are designed to be included in message processing flows that mediate between service consumers and service providers in an SOA installation. These nodes are for generic WebSphere Service Registry and Repository access.

The RegistryLookup node is contained in the **Web services** drawer of the message flow node palette, and is represented in the workbench by the following icon:



RegistryLookup node processing

The RegistryLookup node processes messages in the following sequence.

1. The RegistryLookup node receives a message.
2. The RegistryLookup node retrieves the entity metadata information from the WebSphere Service Registry and Repository using the specified query string.

The RegistryLookup node can be used to define a query dynamically within the message. Both the RegistryLookup and the EndpointLookup nodes can accept a query specified within the LocalEnvironment. Accepting a query specified within the LocalEnvironment overrides any property values set on the node, and all values are strings. XPath and ESQL are not supported when

specifying the User Properties using the LocalEnvironment. Using the LocalEnvironment to set the properties, you can define the properties at runtime, or message processing time, rather than defining them at development time. You must use the format `LocalEnvironment.ServiceRegistryLookupProperties.Name` where *Name* is the property you want to define. It is still mandatory to set values on the properties of the nodes because the nodes cannot deploy without doing so.

3. If one or more matches are found:
 - If Match Policy is set to One, the RegistryLookup node adds the single matching metadata information to the message instance. If multiple possible matches exist the RegistryLookup node retrieves a random match.
 - If Match Policy is set to All, the RegistryLookup node adds all matching metadata to the message instance, leaving all other message content unchanged.

Metadata information is propagated to the Out terminal, where it is available for further processing either by ESQL or by a JavaCompute node.

4. If no matches are found, the RegistryLookup node propagates the input message to the NoMatch terminal.

Example usage. RegistryLookup node can be used to select the current endpoint address from multiple Version properties. When the destination is not a Web service you can use the RegistryLookup node to retrieve entity metadata, which can include the endpoint address. The Match Policy property value must be set to All. You can use a transformation node, such as the JavaCompute, Compute, XSLTransform, or Mapping node, to select the current version, to set endpoint address, and to add appropriate transport header. You must propagate the LocalEnvironment tree with the message.

Terminals and properties

When you have put an instance of the RegistryLookup node into a message flow, you can configure it; see “Configuring a message flow node” on page 235. The properties of the node are displayed in the Properties view. All mandatory properties for which you must enter a value (those that do not have a default value defined) are marked with an asterisk.

The RegistryLookup node terminals are described in the following table.

Terminal	Description
In	The input terminal that accepts a message for processing by the node.
Failure	The output terminal to which the message is routed if an error occurs.
Out	The output terminal to which matching registry information is sent.
NoMatch	The terminal to which the message is sent if no matching entity is found based on the specified values.

The following tables describe the node properties. The column headed M indicates whether the property is *mandatory* (marked with an asterisk if you must enter a value when no default is defined); the column headed C indicates whether the property is *configurable* (you can change the value when you add the message flow to the bar file to deploy it).

The RegistryLookup node Description properties are described in the following table:

Property	M	C	Default	Description
Node name	No	No	The node type: RegistryLookup	The name of the node.
Short description	No	No	None	A brief description of the node.
Long description	No	No	None	Text that describes the purpose of the node in the message flow.

The RegistryLookup node Basic properties are described in the following table:

Property	M	C	Default	Description
Name	No	Yes	None	Enter the string values for one or more of Name, Namespace, and Version for the entities or artifacts that you want to retrieve from the WebSphere Service Registry and Repository. At least one of the properties is required. If you leave all three property values blank, you will get an error message when you try to save.
Namespace	No	Yes	None	
Version	No	Yes	None	
Template	No	Yes	None	The template or artifact type that you want to return from WebSphere Service Registry and Repository.
User Properties	No	No	None	Allows a query to specify user-defined properties. Add User Properties by clicking Add . User Properties refer to the Custom Properties that are used to catalogue the entities in WebSphere Service Registry and Repository. Enter values for Property Name, Property Type, and Property Value. The Property Type can be a String (the default), XPATH expression, or ESQL Expression. The Property Type refers to the type of property provided within the Property Value.
Classification	No	No	None	The Web Ontology Language (OWL) classification system property. Each classifier is a class in OWL, and has a Uniform Resource Identifier (URI). Using classifications in the registry can help to make objects easier to find and can also add meaning to custom objects that are unique to a particular system. Add a Classification by clicking Add and typing the complete fully qualified OWL URI for the OWL classification.
Match Policy	Yes	No	One	The policies to be returned. Select One to match one policy, or All to match all policies to the search criteria.

ResetContentDescriptor node

Use the ResetContentDescriptor node to request that the message is re-parsed by a different parser.

This topic contains the following sections:

- "Purpose"
- "Using this node in a message flow" on page 1051
- "Configuring the ResetContentDescriptor node" on page 1052
- "Terminals and properties" on page 1053

Purpose

If you specify MRM as the new parser, you can also specify a different message template (message set, message type, and message format). This node does not re-parse the message, but the properties that you set for this node determine how the message is parsed when it is next re-parsed by the message flow.

The node associates the new parser information with the input message bit stream. If the message has been parsed already to create a message tree, and the contents of the tree have been modified (for example, by a Compute node), the ResetContentDescriptor node must re-create the bit stream from the message tree by calling the current parser.

If your message flow has updated the message before it is received by the ResetContentDescriptor node, ensure that the changed message contents are still valid for the current parser. If the contents are not valid, the parser generates an error when it attempts to re-create the bit stream from the message tree, and the ResetContentDescriptor node raises an exception. For example, if you have added a new field to a message in the MRM domain, and the field is not present in the model, the re-creation of the bit stream fails.

The ResetContentDescriptor node does not:

- Change the message content; it changes message properties to specify the way in which the bit stream is parsed next time that the parser is started.
- Convert the message from one format to another; for example, if the incoming message has a message format of XML and the outgoing message format is binary, the ResetContentDescriptor node does not do any reformatting. It starts the parser to re-create the bit stream of the incoming XML message, which retains the XML tags in the message. When the message is re-parsed by a subsequent node, the XML tags are not valid and the re-parse fails.

The ResetContentDescriptor node is contained in the **Construction** drawer of the palette, and is represented in the workbench by the following icon:



Using this node in a message flow

For an example of how to use this node, assume that you want to swap between the BLOB and the MRM domains. The format of an incoming message might be unknown when it enters a message flow, therefore the BLOB parser is started. Later on in the message flow, you might decide that the message is predefined as a message in the MRM domain, and you can use the ResetContentDescriptor node to set the correct values to use when the message is parsed by a subsequent node in the message flow.

The following table shows typical ResetContentDescriptor node properties.

Property	Value
Message domain	MRM
Reset message domain	Selected
Message set	MyMessageSet
Reset message set	Selected
Message type	m_MESSAGE1
Reset message type	Selected
Message format	Text1
Reset message format	Selected

The Message domain is set to MRM, and the MRM parser is started when the message is next parsed. The Message set, Message type, and Message format are the message template values that define the message model, and all of the reset check boxes are selected because all of the properties need to change.

The ResetContentDescriptor node causes the BLOB parser that is associated with the input message to construct the physical bit stream of the message (not the logical tree representation of it), which is later passed to the MRM parser. The MRM parser then parses the bit stream using the message template (Message set, Message type, and Message format) specified in this ResetContentDescriptor node.

In Version 6.1, you do not have to include a ResetContentDescriptor node after an XSLTransform node in your message flow to set Message domain, Message set, Message type, and Message format of the message generated by the XSLTransform node. The XSLTransform node performs this function.

Configuring the ResetContentDescriptor node

When you have put an instance of the ResetContentDescriptor node into a message flow, you can configure it. For more information, see “Configuring a message flow node” on page 235. The properties of the node are displayed in the Properties view.

All mandatory properties for which you must enter a value (those that do not have a default value defined) are marked with an asterisk.

1. Optional: On the **Description** tab, enter a Short description, a Long description, or both. You can also rename the node on this tab.
2. On the **Basic** tab:
 - a. To use a different parser associated with the message, specify the new domain in the Message domain property:
 - MRM
 - XMLNSC
 - DataObject
 - XMLNS
 - JMSMap
 - JMSStream
 - MIME
 - BLOB
 - XML (this domain is deprecated; use XMLNSC)
 - IDOC (this domain is deprecated; use MRM)

You can also specify a user-defined parser if appropriate.

Select Reset message domain.

If you leave the Message domain property blank and do not select Reset message domain, the domain is not reset. If you leave the Message domain property blank and select Reset message domain, the default value is BLOB.

- b. If the MRM, XMLNSC, or IDOC parser is to re-parse the message, specify the other properties of the model that are to be associated with the input message, and select the relevant reset check box beneath each field. If you select a reset check box for a property then, if you have not specified a value for that property, the value of that property is reset to blank. Alternatively, if you have specified a value for that property, the property is not blank. If you do not select the reset check box for a property, the value

for that property is inherited from the incoming message. If the parser is associated with the input message already, specify only the properties that are to change.

- 1) Define the Message set. Choose a value from the list of available message sets (the name and identifier of the message set are shown), and select Reset message set.
- 2) For MRM only, define the name of the message in Message type. Enter the name and select Reset message type.
- 3) For MRM and IDOC, define the Message format. This property specifies the physical format for the parser. You can select one of the formats from the list (which lists the names of those formats that you have defined on the Message set specified previously), and select Reset message format.

These properties set the message domain, message set, message type, and message format values in the message header of the message that you want to pass through the ResetContentDescriptor node. However, these actions are taken only if suitable headers already exist. If the message does not have an MQRFH2 header, the node does not create one.

3. On the **Parser Options** sub-tab:
 - a. Parse timing is, by default, set to On Demand, which causes parsing of the message to be delayed.
For more details, see “Parsing on demand” on page 1363.
 - b. Select Use MQRFH2C compact parser for MQRFH2 header if you want the MQRFH2C parser to be used. By default, this check box is cleared, which means that the compact parser is not used.
 - c. If you are using the XMLNSC parser, set values for the properties that determine how the XMLNSC parser operates. For more information, see “Manipulating messages in the XMLNSC domain” on page 364.
4. On the **Validation** tab, set the validation properties if you want the parser to validate the body of messages against the Message set. (If a message is propagated to the Failure terminal of the node, it is not validated.)
For more details, see “Validating messages” on page 164 and “Validation properties” on page 1359.

Terminals and properties

The ResetContentDescriptor node terminals are described in the following table.

Terminal	Description
In	The input terminal that accepts a message for processing by the node.
Failure	The output terminal to which the message is routed if an error is detected by the node.
Out	The output terminal to which the message is routed if a new parser is identified by the properties.

The following tables describe the node properties. The column headed M indicates whether the property is *mandatory* (marked with an asterisk if you must enter a value when no default is defined); the column headed C indicates whether the property is *configurable* (you can change the value when you add the message flow to the bar file to deploy it).

The Description properties of the ResetContentDescriptor node are described in the following table.

Property	M	C	Default	Description
Node name	No	No	The node type	The name of the node.
Short description	No	No		A brief description of the node.
Long description	No	No		Text that describes the purpose of the node in the message flow.

The Basic properties of the ResetContentDescriptor node are described in the following table.

Property	M	C	Default	Description
Message domain	No	No	BLOB	The message domain that is associated with the message that you want to re-parse.
Reset message domain	Yes	No	Cleared	If you select the reset check box, the Message domain property is reset. In this case, if you do not select a value for the Message domain property, the Message domain property value is BLOB.
Message set	No	No		The message set that is associated with the message that you want to re-parse. If you set this property, then subsequently update the project dependencies to remove this message set reference, a warning is issued. Either update the Message set property, or restore the reference to this message set project.
Reset message set	Yes	No	Cleared	If you select the reset check box, the Message set property is reset. In this case, if you do not select a value for the Message set property, the Message set property value is blank.
Message type	No	No		The message type that is associated with the message that you want to re-parse.
Reset message type	Yes	No	Cleared	If you select the reset check box, the Message type property is reset. In this case, if you do not select a value for the Message type property, the Message type property value is blank.
Message format	No	No		The message format that is associated with the message that you want to re-parse.
Reset message format	Yes	No	Cleared	If you select the reset check box, the Message format property is reset. In this case, if you do not select a value for the Message format property, the Message format property value is blank.

The Parser Options properties of the ResetContentDescriptor node are described in the following table.

Property	M	C	Default	Description
Parse timing	No	No	On Demand	This property controls when the re-parsed message is parsed. Valid values are On Demand, Immediate, and Complete. For a full description of this property, see "Parsing on demand" on page 1363.
Use MQRFH2C compact parser for MQRFH2 header	No	No	Cleared	This property controls whether the MQRFH2C compact parser, instead of the MQRFH2 parser, is used for MQRFH2 headers.
Build tree using XML schema data types	No	No	Cleared	This property controls whether the XMLNSC parser creates syntax elements in the message tree with data types taken from the XML Schema. You can select this property only if you set the Validate property on the Validation tab to Content or Content and Value.
Use XMLNSC compact parser for XMLNS domain	No	No	Cleared	This property controls whether the XMLNSC Compact Parser is used for messages in the XMLNS Domain. If you set this property, the message data appears under XMLNSC in nodes that are connected to the output terminal when the input MQRFH2 header or Domain is XMLNS.
Retain mixed content	No	No	Cleared	This property controls whether the XMLNSC parser creates elements in the message tree when it encounters mixed text in the re-parsed message. If you select the check box, elements are created for mixed text. If you clear the check box, mixed text is ignored and no elements are created.
Retain comments	No	No	Cleared	This property controls whether the XMLNSC parser creates elements in the message tree when it encounters comments in the re-parsed message. If you select the check box, elements are created for comments. If you clear the check box, comments are ignored and no elements are created.
Retain processing instructions	No	No	Cleared	This property controls whether the XMLNSC parser creates elements in the message tree when it encounters processing instructions in the re-parsed message. If you select the check box, elements are created for processing instructions. If you clear the check box, processing instructions are ignored and no elements are created.
Opaque elements	No	No	Blank	This property is used to specify a list of elements in the re-parsed message that are to be opaquely parsed by the XMLNSC parser. Opaque parsing is performed only if validation is not enabled (that is, if Validate is None); entries that are specified in Opaque Elements are ignored if validation is enabled.

The Validation properties of the ResetContentDescriptor node are described in the following table. For a full description of these properties, see "Validation properties" on page 1359.

Property	M	C	Default	Description
Validate	No	Yes	None	This property controls whether validation takes place. Valid values are None, Content, Content and Value, and Inherit.

Property	M	C	Default	Description
Failure action	No	No	Exception	This property controls what happens if validation fails. You can set this property only if you set Validate to Content and Value or Content. Valid values are User Trace, Local Error Log, Exception, and Exception List.

Route node

Use the Route node to direct messages that meet certain criteria down different paths of a message flow.

This topic contains the following sections:

- “Purpose”
- “Using this node in a message flow”
- “Terminals” on page 1057
- “Properties” on page 1058

Purpose

As an example, you can forward a message to different service providers, based on the request details. You can also use the Route node to bypass unnecessary steps. For example, you can check to see if certain data is in a message, and perform a database lookup operation only if the data is missing. If you set the Distribution Mode property to All, you can trigger multiple events that each require different conditions. For example, you could log requests that relate to a particular account identifier, and send requests that relate to a particular product to be audited.

You use XPath filter expressions to control processing. A filter expression’s result is cast as Boolean, so the result is guaranteed to be either true or false. For more information about XPath 1.0 query syntax, see XPath.

The Route node is contained in the **Routing** drawer of the message flow node palette, and is represented in the workbench by the following icon:



Using this node in a message flow

Look at the Simplified Database Routing sample to see how to use this node. You can view samples only when you use the information center that is integrated with the Message Broker Toolkit.

The Route node has one input terminal and a minimum of three output terminals: Match, Default, and Failure. The Default and Failure output terminals are static, so they are always present on the node. The dynamic Match terminal is created automatically each time a new Route node is selected and used in the Message Flow editor. This behavior means that you do not always need to create this node’s first dynamic output terminal, which is the minimum number of terminals needed for this node to operate. You can rename this dynamic terminal if “Match” is not an appropriate name.

A message is copied to the Default terminal if none of the filter expressions are true. If an exception occurs during filtering, the message is propagated to the Failure terminal. The Route node can define one or more dynamic output

terminals. For all terminals, the associated filter expression is applied to the input message and, if the result is true, a copy of the message is routed to the given terminal. The Route node determines the order in which the terminals are driven. The node always propagates messages to the terminals in the order in which they appear in the filter table.

Each filter expression is applied to the input message in the order that is given in the filter table. If the result is true, a copy of the message is routed to its associated dynamic output terminal. If you set the Distribution Mode property to First, application of all filter expressions might not occur.

Consider the following example input message:

```
<EmployeeRecord>
  <EmployeeNumber>00001</EmployeeNumber>
  <FamilyName>Smith</FamilyName>
  <Wage>20000</Wage>
</EmployeeRecord>
```

and the following XPath filter expressions:

```
$Body/EmployeeRecord/EmployeeNumber="00002" | Match
$Body/EmployeeRecord/EmployeeNumber="00001" | out_exp2
```

In this example, the Distribution Mode property is set to First. The Route node processes the XPath filter expressions, in the order in which they appear, against the input message. Because the Distribution Mode property is set to First, the unmodified input message is propagated only once to the dynamic output terminal that is mapped to the first filter expression that resolves to true. In the example above, the first filter expression, which is associated with the Match terminal, is false because the employee number in the input message is not "00002". So no message is propagated to the Match terminal. The second filter expression is true, so a copy of the input message is routed to the "out_exp2" dynamic terminal. If the employee number in the input message were "00003", and therefore did not match either filter expression, the message would be propagated to the static Default output terminal. If the Distribution Mode property were set to All for this example, the same outcome would be achieved because only one filter expression was true.

Terminals

The Route node terminals are described in the following table.

Terminal	Description
In	The static input terminal that accepts a message for processing by the node.
Match	A dynamic output terminal to which the original message can be routed when processing completes successfully. You can create additional dynamic terminals; see "Dynamic terminals."
Default	The static output terminal to which the message is routed if no filter expression resolves to true.
Failure	The static output terminal to which the message is routed if a failure is detected during processing.

Dynamic terminals

The Route node can have further dynamic output terminals. Not all dynamic output terminals that are created on a Route node need to be mapped to an

expression in the filter table. For unmapped dynamic output terminals, messages are never propagated to them. Several expressions can map to the same single dynamic output terminal. No static output terminal exists to which the message is passed straight through. For more information about using dynamic terminals, see “Using dynamic terminals” on page 237.

Properties

When you have put an instance of the Route node into a message flow, you can configure it. For more information, see “Configuring a message flow node” on page 235. The properties of the node are displayed in the Properties view. All mandatory properties for which you must enter a value (those that do not have a default value defined) are marked with an asterisk.

The following tables describe the node properties. The column headed M indicates whether the property is *mandatory* (marked with an asterisk if you must enter a value when no default is defined); the column headed C indicates whether the property is *configurable* (you can change the value when you add the message flow to the bar file to deploy it).

The Route node Description properties are described in the following table.

Property	M	C	Default	Description
Node name	No	No	The node type, Route	The name of the node.
Short Description	No	No		A brief description of the node.
Long Description	No	No		Text that describes the purpose of the node in the message flow.

The Route node Basic properties are described in the following table.

Property	M	C	Default	Description
Filter table	Yes	No		<p>A table where all rows are expressions and associated terminal names that define the switching that is performed by this node following evaluation of each filter expression. The full expression is in the format <i>XPath filter expression, terminal name</i></p> <p>All XPath expressions must start with \$Root, \$Body, \$Properties, \$LocalEnvironment, \$DestinationList, \$ExceptionList, or \$Environment. Expressions are evaluated in the order in which they appear in the table. To improve performance, specify the expressions that are satisfied most frequently at the top of the filter table. Typically, you specify a unique terminal name for each XPath expression.</p>

Property	M	C	Default	Description
Distribution Mode	No	Yes	All	This property determines the routing behavior of the node when an inbound message matches multiple filter expressions. If you set the Distribution Mode property to First, the message is propagated to the associated output terminal of the first expression in the table that resolves to true. If you set this property to All, the message is propagated to the associated output terminal for each expression in the table that resolves to true. If no output terminal matches, the message is propagated to the Default terminal.

RouteToLabel node

Use the RouteToLabel node in combination with one or more Label nodes to dynamically determine the route that a message takes through the message flow, based on its content.

This topic contains the following sections:

- “Purpose”
- “Using this node in a message flow” on page 1060
- “Terminals and properties” on page 1060

Purpose

The RouteToLabel node interrogates the LocalEnvironment of the message to determine the identifier of the Label node to which to route the message.

You must precede the RouteToLabel node in the message flow with a Compute node that populates the LocalEnvironment of the message with the identifiers of one or more Label nodes that introduce the next sequence of processing for the message. The destinations are set up as a list of label names in the LocalEnvironment tree in a specific location. This excerpt of ESQL from the Airline Reservations sample demonstrates how to set up the LocalEnvironment content in a Compute node:

```
IF InputRoot.XMLNSC.PassengerQuery.ReservationNumber<>' ' THEN
  SET OutputLocalEnvironment.Destination.RouterList.DestinationData[1].labelname = 'SinglePassenger';
ELSE
  SET OutputLocalEnvironment.Destination.RouterList.DestinationData[1].labelname = 'AllReservations';
END IF;
```

The label names can be any string value, and can be specified explicitly in the Compute node, taken or cast from any field in the message, or retrieved from a database. A label name in the LocalEnvironment must match the Label Name property of a corresponding Label node.

When you configure the Compute node, you must also select a value for the Compute Mode property from the list that includes LocalEnvironment.

Design your message flow so that a RouteToLabel node logically precedes one or more Label nodes within a message flow, but do not physically wire the RouteToLabel node with a Label node. The connection is made by the broker, when required, according to the contents of LocalEnvironment.

The RouteToLabel node is contained in the **Routing** drawer of the palette, and is represented in the workbench by the following icon:



Using this node in a message flow

Look at the following sample to see how to use this node:

- Airline Reservations sample

You can view samples only when you use the information center that is integrated with the Message Broker Toolkit.

Terminals and properties

When you have put an instance of the RouteToLabel node into a message flow, you can configure it; see “Configuring a message flow node” on page 235. The properties of the node are displayed in the Properties view. All mandatory properties for which you must enter a value are marked with an asterisk.

The RouteToLabel node terminals are described in the following table.

Terminal	Description
In	The input terminal that accepts a message for processing by the node.
Failure	The output terminal to which the message is routed if a failure is detected during processing.

The following tables describe the node properties. The column headed M indicates whether the property is *mandatory* (marked with an asterisk if you must enter a value when no default is defined); the column headed C indicates whether the property is *configurable* (you can change the value when you add the message flow to the bar file to deploy it).

The RouteToLabel node Description properties are described in the following table.

Property	M	C	Default	Description
Node name	No	No	The node type: RouteToLabel	The name of the node.
Short Description	No	No		A brief description of the node.
Long Description	No	No		Text that describes the purpose of the node in the message flow.

The RouteToLabel node Basic properties are described in the following table.

Property	M	C	Default	Description
Mode	Yes	No	Route To Last	This property controls how the RouteToLabel node processes the items within the LocalEnvironment that is associated with the current message . Valid values are: <ul style="list-style-type: none">• Route To First: removes the first item from LocalEnvironment. The current message is routed to the Label node that is identified by labelName in that list item.• Route To Last (the default): removes the last item from LocalEnvironment. The current message is routed to the Label node that is identified by labelName in that list item.

SAPInput node

Use the SAPInput node to accept input from an SAP application.

This topic contains the following sections:

- “Purpose”
- “Using this node in a message flow”
- “Terminals and properties” on page 1062

Purpose

Use the SAPInput node to accept input from SAP applications. For example, the SAPInput node might monitor an SAP system for new purchase orders. When a new purchase order is raised, the SAPInput node generates a message tree that represents the business object with the new purchase order details. The message tree is propagated to the Out terminal so that the rest of the message flow can use the data to update other systems, or to audit the changes.

The SAPInput node is contained in the **WebSphere Adapters** drawer of the message flow node palette, and is represented in the workbench by the following icon:



Using this node in a message flow

The SAPInput node needs an adapter component to function correctly. You set the component by using the Adapter component node property and business object definitions, which are stored in the message set that you reference from the node. For this reason, you must provide a message set. By default, the message that is propagated from the SAPInput node is in the DataObject domain, so the Message domain property is set to DataObject. You cannot specify a different domain. The message type is detected automatically by the node.

The SAPInput node populates the route-to-label destination list with the name of the method binding. If you add a RouteToLabel node to the message flow after the SAPInput node, the RouteToLabel node can use the name of the method binding to route the message to the correct part of the message flow for processing.

You can deploy only one input node that uses a particular adapter component to an execution group, but you can deploy many input nodes that use different adapter components to an execution group.

You can use the `mqsisetdbparms` command in the following format to configure an account name with a user name and password for the Adapter for SAP Software.

```
mqsisetdbparms broker name -n adapter name -u user name -p password
```

For example:

```
mqsisetdbparms BRK1 -n SAPCustomerInbound.inadapter -u sapuid -p *****
```

The SAP inbound adapter has a property called Number of listeners, which configures the adapter to have a particular number of threads listening to the SAP program ID. These threads are not used directly to process messages in a message flow. When a message listener has an event to deliver to the message flow, it requests one of the instances of the flow. In general, it is sensible to keep the

number of listeners equal to the number of instances (where instances equals 1 plus additional instances set on the flow or node). For example:

- If the number of listeners is 1, and additional instances is 0, you get a single-threaded message flow that processes one message at a time.
- If the number of listeners is 2, and additional instances is 1, you get two threads that process messages at the same time.
- If the number of listeners is 2, and additional instances is 0, you get two threads that receive data from the EIS, but only one message flow thread will ever run.

The listeners block processing until a message flow instance is available; the listeners do not queue multiple pieces of work. If you leave the number of listeners set to 1 (the default value), the broker ensures that the number of listeners is equal to the number of additional instances plus one.

Look at the SAP Connectivity sample to see how to use this node. You can view samples only when you use the information center that is integrated with the Message Broker Toolkit.

Terminals and properties

When you have put an instance of the SAPInput node into a message flow, you can configure it; see “Configuring a message flow node” on page 235. The properties of the node are displayed in the Properties view. If you double-click a SAPInput node, you open the Adapter Connection wizard. All mandatory properties for which you must enter a value (those that do not have a default value defined) are marked with an asterisk.

The SAPInput node terminals are described in the following table.

Terminal	Description
Out	Business object events from the adapter are sent to the Out terminal.
Failure	If an error occurs in the SAPInput node, the message is propagated to the Failure terminal. Information about the error, and business object events can also be propagated to the Failure terminal.
Catch	Business object events are sent to the Catch terminal if they cause an uncaught exception in the message flow. If the Catch terminal is not connected, the retry process is activated to handle the business object.

The following tables describe the node properties. The columns headed M indicate whether the property is *mandatory* (marked with an asterisk if you must enter a value when no default is defined); the columns headed C indicate whether the property is *configurable* (you can change the value when you add the message flow to the bar file to deploy it).

The SAPInput node Description properties are described in the following table.

Property	M	C	Default	Description
Node name	No	No	The node type, SAPInput	The name of the node.
Short Description	No	No		A brief description of the node.
Long Description	No	No		Text that describes the purpose of the node in the message flow.

The SAPInput node Basic properties are described in the following table.

Property	M	C	Default	Description
Adapter component	Yes	Yes		The name of the adapter component that contains configuration properties for the adapter. Either enter a name of an adapter file, or click Browse to select an adapter file from the list of files that are available in referenced message set projects.

The SAPInput node Routing properties are described in the following table.

Property	M	C	Default	Description
Set destination list	No	No	Selected	Specifies whether to add the method binding name to the route-to-label destination list. If you select this check box, the method binding name is added so that you can use a RouteToLabel node in the message flow after the SAPInput node.
Label prefix	No	No		The prefix to add to the method name when routing to a label. Add a label prefix to avoid a clash of corresponding label nodes when you include multiple WebSphere Adapters input nodes in the same message flow. By default, there is no label prefix, so the method name and label name are identical.

The SAPInput node Input Message Parsing properties are described in the following table.

Property	M	C	Default	Description
Message domain	No	No	DataObject	The domain that is used to parse the incoming message. By default, the message that is propagated from the SAPInput node is in the DataObject domain. You cannot specify a different domain.
Message set	Yes	No	Set automatically	The name of the message set in which the incoming message is defined. This field is set automatically from the Adapter component property. If you set this property, then subsequently update the project dependencies to remove this message set reference, a warning is issued. Either update the Message set property, or restore the reference to this message set project.
Message type	No	No		The name of the incoming message. The node detects the message type automatically. You cannot set this property.
Message format	No	No		The name of the physical format of the incoming message. You cannot set this property.

The SAPInput node Transactionality properties are described in the following table.

Property	M	C	Default	Description
Transaction mode	No	No	Yes	Specifies how updates are handled. If you select Yes, updates are performed in a single transaction. If you select No, updates are performed independently.

The Instances properties of the SAPInput node are described in the following table. For a full description of these properties, refer to “Configurable message flow properties” on page 1372.

Property	M	C	Default	Description
Additional instances pool	No	Yes	Use Pool Associated with Message Flow	The pool from which additional instances are obtained. <ul style="list-style-type: none"> If you select Use Pool Associated with Message Flow, additional instances are obtained from the message flow value. If you select Use Pool Associated with Node, additional instances are allocated from the node's additional instances based on the number specified in the Additional instances property.
Additional instances	No	Yes	0	The number of additional instances that the node can start if the Additional instances pool property is set to Use Pool Associated with Node. By default, no additional instances are given to the node.

The SAPInput node Retry properties are described in the following table.

Property	M	C	Default	Description
Retry mechanism	No	No	Failure	Specifies how retry processing is handled when a failure is rolled back to the SAPInput node. <ul style="list-style-type: none"> If you select Failure, retry processing is not performed so you cannot set the remaining properties. If you select Short and long retry, retry processing is performed first at the interval that is specified by the Short retry interval property, and if that is unsuccessful, it is then performed at the interval that is specified by the Long retry interval property.
Retry threshold	No	Yes	0	The maximum number of times that retry processing is performed for short retry.
Short retry interval	No	Yes	0	The interval between short retry attempts.
Long retry interval	No	Yes	0	The interval between long retry attempts.

SAPRequest node

Use the SAPRequest node to send requests to an SAP application.

This topic contains the following sections:

- "Purpose"
- "Using the SAPRequest node in a message flow" on page 1065
- "Terminals and properties" on page 1065

Purpose

Use the SAPRequest node to send requests to an SAP applications. For example, the SAPRequest node might request information from an SAP Enterprise Information System (EIS). A customer business object is sent to SAP, causing SAP to retrieve information about a customer, such as an address and account details. The response information that is retrieved by the SAPRequest node can then be used by the rest of the message flow. The SAPRequest node can send and receive business data.

The SAPRequest node is contained in the **WebSphere Adapters** drawer of the message flow node palette, and is represented in the workbench by the following icon:



Using the SAPRequest node in a message flow

The SAPRequest node needs an adapter component to function correctly. You set the component by using the Adapter component node property and business object definitions, which are stored in the message set that you reference from the node. For this reason, you must provide a message set. By default, the message that is propagated from the SAPRequest node is in the DataObject domain, so that the Message domain property is set to DataObject. You cannot specify a different domain. The node automatically detects the message type.

The SAPRequest node supports local transactions using the broker's Local Transaction Manager, and global transactions using the broker's external sync point coordinator.

You can deploy several WebSphere Adapters request nodes that use the same adapter component to an execution group.

You can use the `mqsisetdbparms` command in the following format to configure an account name with a user name and password for the Adapter for SAP Software. The `mqsisetdbparms` command stores the password in case-sensitive form. However, when the SAP GUI sets a password, it automatically converts the password to upper case. Therefore, specify an upper case password to connect to the SAP system.

```
mqsisetdbparms broker name -n adapter name -u user name -p PASSWORD
```

For example:

```
mqsisetdbparms BRK1 -n SAPCustomerOutbound.outadapter -u sapuid -p *****
```

Look at the SAP Connectivity sample to see how to use this node. You can view samples only when you use the information center that is integrated with the Message Broker Toolkit.

Terminals and properties

When you have put an instance of the SAPRequest node into a message flow, you can configure it; see "Configuring a message flow node" on page 235. The properties of the node are displayed in the Properties view. If you double-click a SAPRequest node, you open the Adapter Connection wizard. All mandatory properties for which you must enter a value (those that do not have a default value defined) are marked with an asterisk.

The SAPRequest node terminals are described in the following table.

Terminal	Description
In	The input terminal that accepts the request business object.
Out	The output terminal to which the response business object is sent if it represents successful completion of the request, and if further processing is required within this message flow.
Failure	If an error occurs in the SAPRequest node, the message is propagated to the Failure terminal. Information about the error, and business object events can also be propagated to the Failure terminal.

The following tables describe the node properties. The columns headed M indicate whether the property is *mandatory* (marked with an asterisk on the panel if you must enter a value when no default is defined); the columns headed C indicate whether the property is *configurable* (you can change the value when you add the message flow to the bar file to deploy it).

The SAPRequest node Description properties are described in the following table.

Property	M	C	Default	Description
Node name	No	No	The node type, e.g. SAPRequest	The name of the node.
Short description	No	No		A brief description of the node.
Long description	No	No		Text that describes the purpose of the node in the message flow.

The SAPRequest node Basic properties are described in the following table.

Property	M	C	Default	Description
Adapter component	Yes	No		The name of the adapter component that contains configuration properties for the adapter. Either enter a name of an adapter file, or click Browse to select an adapter file from the list of files that are available in referenced message set projects.
Default method	Yes	Yes		The default method binding to use.

The SAPRequest node Response Message Parsing properties are described in the following table.

Property	M	C	Default	Description
Message domain	No	No	DataObject	The domain that is used to parse the response message. By default, the message that is propagated from the SAPRequest node is in the DataObject domain. You cannot specify a different domain.
Message set	Yes	No	Set automatically	The name of the message set in which the incoming message is defined. This field is set automatically from the Adapter component property. If you set this property, then subsequently update the project dependencies to remove this message set reference, a warning is issued. Either update the Message set property, or restore the reference to this message set project.
Message type	No	No		The name of the response message. The node detects the message type automatically. You cannot set this property.
Message format	No	No		The name of the physical format of the response message. You cannot set this property.

The SAPRequest node Transactionality properties are described in the following table.

Property	M	C	Default	Description
Transaction mode	No	No	Automatic	Specifies how updates are handled. <ul style="list-style-type: none"> • If you select Yes, the SAPRequest node takes part in the local transaction that is started by the message flow's input node. • If you select No, the SAPRequest node does not take part in the local transaction that is started by the message flow's input node. • If you select Automatic, the SAPRequest node uses the value that is set on the input node that drives the message flow. For example, if the message flow is driven by a SAPInput node, the SAPRequest assumes the Transaction mode that is set on the SAPInput node.

The SAPRequest node Request properties are described in the following table.

Property	M	C	Default	Description
Method Location	Yes	No	\$LocalEnvironment/ Adapter/MethodName	The business method that is used to trigger the SAPRequest node to perform an action on the external system. For example: <ul style="list-style-type: none"> • createPurchaseOrder causes the SAPRequest node to create a purchase order in the EIS. • deletePurchaseOrder causes the SAPRequest node to delete a purchase order in the EIS.
Data Location	Yes	No	\$Body	The location in the incoming message tree from which data is retrieved to form the request that is sent from the SAPRequest node to the EIS.

The SAPRequest node Result properties are described in the following table.

Property	M	C	Default	Description
Output data location	No	No	\$OutputRoot	The message tree location to which the SAPRequest node sends output.
Copy local environment	No	No	Selected	This property controls how the local environment is copied to the output message. If you select this check box, a new copy of the local environment is created in the tree (at each node in the message flow), and it is populated with the contents of the local environment from the preceding node. Therefore, if a node changes the local environment, the previous nodes in the flow do not see those changes because they have their own copies. This behavior might be an issue if you are using a FlowOrder node, or if you use the propagate command on a Compute node. If you clear the check box, each node does not generate its own copy of the local environment, but it uses the local environment that is passed to it by the previous node. Therefore, if a node changes the local environment, those changes are seen by the upstream nodes.

SCADAInput node

Use the SCADAInput node to receive messages from clients that connect to the broker across the WebSphere MQ Telemetry Transport.

This topic contains the following sections:

- "Purpose" on page 1068
- "Using this node in a message flow" on page 1069
- "Configuring the SCADAInput node" on page 1069
- "Terminals and properties" on page 1071

Purpose

SCADA device clients use the MQIsdp protocol to send messages that are converted by the SCADAInput node into a format that is recognized by WebSphere Message Broker. The node also establishes the processing environment for these messages.

Message flows that handle messages received from SCADA devices must always start with a SCADAInput node. Set the SCADAInput node properties to control the way in which messages are received; for example, you can indicate that a message is to be processed under transaction control.

When you deploy message flows that contain SCADA nodes to a broker, deploy them to a single execution group, regardless of the number of message flows.

The execution group to which the SCADA flows are deployed must be the default execution group. The default execution group can be identified by inspecting the defaultExecutionGroup field in the BIP2201 message at the execution group startup. A value of true denotes the default execution group.

SCADA is primarily a publish/subscribe protocol; therefore, you typically include a Publication node to end the flow. In scenarios where you do not want to use a Publication node, include a SCADAOutput node. If you include a SCADAOutput node, you must also include a SCADAInput node, regardless of the source of the messages, because the SCADAInput node provides the connectivity information that is required by the SCADAOutput node.

If you include an output node in a message flow that starts with a SCADAInput node, it can be any of the supported output nodes, including user-defined output nodes. You can create a message flow that receives messages from SCADA devices, and generates messages for clients that use all supported transports to connect to the broker, because you can configure the message flow to request the broker to provide any necessary conversion.

You can request that the broker starts or stops a SCADA listener by publishing messages with a specific topic. This request can apply to all ports or to a single port that is identified in the message.

The SCADAInput node handles messages in the following message domains:

- MRM
- XMLNSC
- XMLNS
- JMSMap
- JMSStream
- MIME
- BLOB
- XML (this domain is deprecated; use XMLNSC)

You also specify that a user-defined parser is to be used, if appropriate.

z/OS You cannot use SCADAInput nodes in message flows that are to be deployed on z/OS systems.

To process the data in an incoming SCADA message, include a node such as the ResetContentDescriptor node, and set its properties to force the bit stream to be re-parsed by a subsequent node.

If you create a message flow to use as a subflow, you cannot use a standard input node; you must use an instance of the Input node as the first node to create an In terminal for the subflow.

If your message flow does not receive messages across SCADA connections, choose one of the supported input nodes.

The SCADAInput node is contained in the **Additional Protocols** drawer of the palette, and is represented in the workbench by the following icon:



Using this node in a message flow

For an example of how to use this node, assume that you create a message flow with a SCADAInput node that receives messages from a remote sensor when it detects a change in its operating environment (for example, a drop in outside temperature). You connect the node to an MQOutput node, which makes these messages available on a queue that is serviced by a WebSphere MQ application that analyses and responds to the information that is received.

In another example, you create a message flow with a SCADAInput node that receives messages every minute from a remote system. The messages contain details of the system's switch settings. The data that is received is fed into a ResetContentDescriptor node to cast the data from binary (BLOB) to MRM message format. The information about the system is stored in a database using the Database node, and enriched using a Compute node to create an XML message, which is published using a Publication node.

XML messages are expensive to send (because satellite transmission has a high cost for each byte); therefore, it is advantageous to use this method because data is enriched by the broker.

Configuring the SCADAInput node

When you have put an instance of the SCADAInput node into a message flow, you can configure it. For more information, see "Configuring a message flow node" on page 235. The properties of the node are displayed in the Properties view.

All mandatory properties for which you must enter a value (those that do not have a default value defined) are marked with an asterisk.

1. Optional: On the **Description** tab, enter a Short description, a Long description, or both. You can also rename the node on this tab.
2. On the **Basic** tab, set the following properties:
 - Update the status of the listener by publishing on the control topic `$/SYS/SCADA/MQIsdpListener/<port_number>` with the Payload part of the message set to ON or OFF. Enable listener on startup is initially selected, which means that the listener for MQIsdp clients is initialized when the message flow is deployed.
 - Specify the Port number on which the MQIsdp server listens. This value must be a unique port number, and must not conflict with other listeners (for example, those set up for WebSphere MQ or WebSphere MQ Everyplace). The default number is 1883.

- Set the Max threads value to indicate the maximum number of threads available to the MQIsdp server to support clients. The default value is 500. If you are using DB2 as your broker database, specify a value that is less than or equal to the value that you have set for the DB2 configuration parameters *maxappls* and *maxagents*. For further information, see Enabling ODBC connections to the databases.
- Select Use thread pooling if you want the node to use a pool of threads to service clients. If you select this option, the number of threads that are available to the MQIsdp server is limited by Max threads, which is most effective when set to a value between 20 and 40. If you do not select this option, a new thread is created for each client that connects. The check box is cleared initially.
Use this option only if you expect a large number of clients (greater than 200) to connect.

3. On the **Input Message Parsing** tab, set values for the properties that describe the message domain, message set, message type, and message format that the node uses to determine how to parse the incoming message.

- In Message domain, select the name of the parser that you are using from the list. The default value is BLOB. You can choose from the following options:
 - MRM
 - XMLNSC
 - XMLNS
 - JMSMap
 - JMSStream
 - MIME
 - BLOB
 - XML (this domain is deprecated; use XMLNSC)

You can also specify a user-defined parser, if appropriate.

- If you are using the MRM parser or XMLNSC parser in validating mode, select the Message set that you want to use. This list is populated with available message sets when you select MRM or XMLNSC as the domain.
- If you are using the MRM parser, select the correct message from the list in Message type. This list is populated with messages that are defined in the Message set that you have selected.
- If you are using the MRM parser, select the format of the message from the list in Message format. This list includes all the physical formats that you have defined for this Message set.

4. On the **Parser Options** sub-tab:

- Parse timing is, by default, set to On Demand, which causes parsing of the message to be delayed. To cause the message to be parsed immediately, see “Parsing on demand” on page 1363.
- If you are using the XMLNSC parser, set values for the properties that determine how the XMLNSC parser operates. For more information, see “Manipulating messages in the XMLNSC domain” on page 364.

5. On the **Advanced** tab, set the required value for Transaction mode to define the transactional characteristics of how this message is handled:

- If you select Automatic, the incoming message is received under sync point if it is marked as persistent; otherwise, it is not received under sync point. The transactionality of any derived messages that are sent subsequently by an output node is determined by the incoming persistence property, unless the output node has overridden transactionality explicitly.

- If you select Yes, the incoming message is received under sync point. Any derived messages that are sent subsequently by an output node in the same instance of the message flow are sent transactionally, unless the output node has overridden transactionality explicitly.
 - If you select No, the incoming message is not received under sync point. Any derived messages that are sent subsequently by an output node in the flow are sent non-transactionally, unless the output node has specified that the message must be put under sync point.
6. On the **Validation** tab, set the validation properties if you want the parser to validate the body of messages from the Message set. If a message is propagated to the Failure terminal of the node, it is not validated.
- For more details, see “Validating messages” on page 164 and “Validation properties” on page 1359.

Connecting the terminals:

The SCADAInput node routes each message that it retrieves successfully to the Out terminal. If this action fails, the message is propagated to the Failure terminal; you can connect nodes to this terminal to handle this condition. If you have not connected the Failure terminal, the message loops continually through the node until the problem is resolved.

If the message is caught by this node after an exception has been thrown further on in the message flow, the message is routed to the Catch terminal. If you have not connected the Catch terminal, the message loops continually through the node until the problem is resolved. Ensure that a node is always connected to this terminal if there is the possibility of the message rolling back within a message flow.

Configuring for coordinated transactions:

When you include a SCADAInput node in a message flow, the value that you set for Transaction mode defines whether messages are received under sync point:

- If you set this property to Yes (the default), the message is received under sync point; that is, within a WebSphere MQ unit of work. Any messages that are sent subsequently by an output node in the same instance of the message flow are put under sync point, unless the output node has overridden this explicitly.
- If you set this property to Automatic, the message is received under sync point if the incoming message is marked as persistent; otherwise, it is not received under sync point. Any message that is sent subsequently by an output node is put under sync point, as determined by the incoming persistence property, unless the output node has overridden this explicitly.
- If you set this property to No, the message is not received under sync point. Any messages that are sent subsequently by an output node in the message flow are not put under sync point, unless an individual output node has specified that the message must be put under sync point.

The MQOutput node is the only output node that you can configure to override this option.

Terminals and properties

The SCADAInput node terminals are described in the following table.

Terminal	Description
Failure	The output terminal to which the message is routed if an error occurs.
Out	The output terminal to which the message is routed if it is successfully retrieved from the queue.
Catch	The output terminal to which the message is routed if an exception is thrown downstream and caught by this node.

The following tables describe the node properties. The column headed M indicates whether the property is *mandatory* (marked with an asterisk if you must enter a value when no default is defined); the column headed C indicates whether the property is *configurable* (you can change the value when you add the message flow to the bar file to deploy it).

The SCADAInput node Description properties are described in the following table.

Property	M	C	Default	Description
Node name	No	No	The node type, SCADAInput	The name of the node.
Short description	No	No		A brief description of the node.
Long description	No	No		Text that describes the purpose of the node in the message flow.

The SCADAInput node Basic properties are described in the following table.

Property	M	C	Default	Description
Enable listener on startup	Yes	No	Selected	This property controls when the listener is started. If you select the check box, the listener starts when the message flow is started by the broker. If you clear the check box, the listener starts on the arrival of a message on the specified port.
Port	Yes	Yes	1883	The port on which the SCADA protocol is listening.
Max threads	Yes	Yes	500	The maximum number of threads to be started to support SCADA devices.
Use thread pooling	Yes	Yes	Cleared	If you select the check box, thread pooling is used.

The SCADAInput node Input Message Parsing properties are described in the following table.

Property	M	C	Default	Description
Message domain	No	No	BLOB	The domain that is used to parse the incoming message.
Message set	No	No		The name or identifier of the message set in which the incoming message is defined. If you set this property, then subsequently update the project dependencies to remove this message set reference, a warning is issued. Either update the Message set property, or restore the reference to this message set project.
Message type	No	No		The name of the incoming message.

Property	M	C	Default	Description
Message format	No	No		The name of the physical format of the incoming message.

The SCADAInput node Parser Options properties are described in the following table.

Property	M	C	Default	Description
Parse timing	No	No	On Demand	This property controls when an input message is parsed. Valid values are On Demand, Immediate, and Complete. For a full description of this property, see "Parsing on demand" on page 1363.
Build tree using XML schema data types	No	No	Cleared	This property controls whether the XMLNSC parser creates syntax elements in the message tree with data types taken from the XML Schema. You can select this property only if you set the Validate property on the Validation tab to Content or Content and Value.
Use XMLNSC compact parser for XMLNS domain	No	No	Cleared	This property controls whether the XMLNSC Compact Parser is used for messages in the XMLNS Domain. If you set this property, the message data appears under XMLNSC in nodes that are connected to the output terminal when the Input Message Parsing properties Message domain is XMLNS.
Retain mixed content	No	No	Cleared	This property controls whether the XMLNSC parser creates elements in the message tree when it encounters mixed text in an input message. If you select the check box, elements are created for mixed text. If you clear the check box, mixed text is ignored and no elements are created.
Retain comments	No	No	Cleared	This property controls whether the XMLNSC parser creates elements in the message tree when it encounters comments in an input message. If you select the check box, elements are created for comments. If you clear the check box, comments are ignored and no elements are created.
Retain processing instructions	No	No	Cleared	This property controls whether the XMLNSC parser creates elements in the message tree when it encounters processing instructions in an input message. If you select the check box, elements are created for processing instructions. If you clear the check box, processing instructions are ignored and no elements are created.
Opaque elements	No	No	Blank	This property is used to specify a list of elements in the input message that are to be opaquely parsed by the XMLNSC parser. Opaque parsing is performed only if validation is not enabled (that is, if Validate is None); entries that are specified in Opaque Elements are ignored if validation is enabled.

The SCADAInput node Advanced property is described in the following table.

Property	M	C	Default	Description
Transaction mode	Yes	No	Yes	This property controls whether the incoming message is received under sync point. Valid values are Automatic, Yes, and No.

The SCADAInput node Validation properties are described in the following table.

For a full description of these properties, see “Validation properties” on page 1359.

Property	M	C	Default	Description
Validate	No	Yes	None	This property controls whether validation takes place. Valid values are None, Content and Value, and Content.
Failure action	No	No	Exception	This property controls what happens if validation fails. You can set this property only if you set Validate to Content or Content and Value. Valid values are User Trace, Local Error Log, Exception, and Exception List.

SCADAOutput node

Use the SCADAOutput node to send a message to a client that connects to the broker using the MQIsdp protocol across the WebSphere MQ Telemetry Transport.

This topic contains the following sections:

- “Purpose”
- “Connecting the terminals” on page 1075
- “Terminals and properties” on page 1075

Purpose

You use the Publication node to send output to a SCADA client. The SCADAOutput node lets you write your own Publication node.

If you include a SCADAOutput node in a message flow, also include a SCADAInput node, regardless of the source of the messages, because the SCADAInput node provides the connectivity information that is required by the SCADAOutput node.

When you deploy message flows that contain SCADA nodes to a broker, deploy them to a single execution group, regardless of the number of message flows.

The execution group to which the SCADA flows are deployed must be the default execution group. The default execution group can be identified by inspecting the defaultExecutionGroup field in the BIP2201 message at the execution group startup. A value of true denotes the default execution group.

You cannot use the SCADAOutput node to change the transactional characteristics of the message flow. The transactional characteristics that are set by the message flow’s input node determine the transactional behavior of the flow.

z/OS You cannot use SCADAOutput nodes in message flows that you deploy to z/OS systems.

If you create a message flow to use as a subflow, you cannot use a standard output node; use an instance of the Output node to create an out terminal for the subflow through which the message can be propagated.

If you do not want your message flow to send messages to a SCADA device, choose another supported output node.

The SCADAOutput node is contained in the **Additional Protocols** drawer of the message flow node palette, and is represented in the workbench by the following icon:



Connecting the terminals

Connect the In terminal to the node from which messages that are bound for SCADA destinations are routed.

Connect the Out or Failure terminal of this node to another node in this message flow to process the message further, process errors, or send the message to an additional destination.

If you connect the Out or Failure terminal, the LocalEnvironment that is associated with the message is enhanced with the following information for each destination to which the message has been put by this node:

- Queue name
- Queue manager name
- Message reply identifier (this is set to the same value as message ID)
- Message ID (from the MQMD)
- Correlation ID (from the MQMD)

These values are written in WrittenDestination within the LocalEnvironment tree structure.

If you do not connect either terminal, the LocalEnvironment tree is unchanged.

Terminals and properties

When you have put an instance of the SCADAOutput node into a message flow, you can configure it. For more information, see “Configuring a message flow node” on page 235. The properties of the node are displayed in the Properties view. All mandatory properties for which you must enter a value (those that do not have a default value defined) are marked with an asterisk.

The SCADAOutput node terminals are described in the following table.

Terminal	Description
In	The input terminal that accepts a message for processing by the node.
Failure	The output terminal to which the message is routed if a failure is detected when the message is put to the output queue.
Out	The output terminal to which the message is routed if it has been successfully put to the output queue, and if further processing is required within this message flow.

The following table describes the node properties. The column headed M indicates whether the property is *mandatory* (marked with an asterisk if you must enter a value when no default is defined); the column headed C indicates whether the property is *configurable* (you can change the value when you add the message flow to the bar file to deploy it).

The SCADAOutput node Description properties are described in the following table.

Property	M	C	Default	Description
Node name	No	No	The node type, SCADAOutput	The name of the node.
Short description	No	No		A brief description of the node.
Long description	No	No		Text that describes the purpose of the node in the message flow.

The Validation properties of the SCADAOutput node are described in the following table.

If a message is propagated to the Failure terminal of the node, it is not validated. For more details, see “Validating messages” on page 164 and “Validation properties” on page 1359.

Property	M	C	Default	Description
Validate	No	Yes	Inherit	This property controls whether validation takes place. Valid values are None, Content and Value, Content, and Inherit.
Failure action	No	No	Exception	This property controls what happens if validation fails. You can set this property only if you set Validate to Content or Content and Value. Valid values are User Trace, Local Error Log, Exception, and Exception List.

SiebellInput node

Use the SiebellInput node to interact with a Siebel application.

This topic contains the following sections:

- “Purpose”
- “Using this node in a message flow” on page 1077
- “Terminals and properties” on page 1077

Purpose

Use the SiebellInput node to interact with Siebel applications. For example, a SiebellInput node monitors a Siebel system for a specified event. When that event occurs, the SiebellInput node generates a message tree that represents the business object with the new event details. The message tree is propagated to the Out terminal so that the rest of the message flow can use the data to update other systems, or audit the changes.

The SiebellInput node is contained in the **WebSphere Adapters** drawer of the message flow node palette, and is represented in the workbench by the following icon:



Using this node in a message flow

To use the SiebelInput node, you must first create the Siebel event table. For instructions, see “Creating the event store manually” on page 252.

To function correctly, the SiebelInput node needs an adapter component, which you set using the Adapter component node property, and business object definitions, which are stored in the message set that you reference from the node. For this reason, you must provide a message set. By default, the message that is propagated from the SiebelInput node is in the DataObject domain, so the Message domain property is set to DataObject. You cannot specify a different domain. The message type is detected automatically by the node.

The SiebelInput node populates the route to label destination list with the name of the method binding. If you add a RouteToLabel node to the message flow after the SiebelInput node, the RouteToLabel node can use the name of the method binding to route the message to the correct part of the message flow for processing.

You can deploy only one input node that uses a particular adapter component to an execution group, but you can deploy many input nodes that use different adapter components to an execution group.

You can use the mqsisetdbparms command in the following format to configure an account name with a user name and password for the Adapter for Siebel Business Applications.

```
mqsisetdbparms broker name -n adapter name -u user name -p password
```

For example:

```
mqsisetdbparms BRK1 -n SiebelCustomerInbound.inadapter -u siebeluid -p *****
```

Terminals and properties

When you have put an instance of the SiebelInput node into a message flow, you can configure it; see “Configuring a message flow node” on page 235. The properties of the node are displayed in the Properties view. If you double-click a SiebelInput node, you open the Adapter Connection wizard. All mandatory properties for which you must enter a value (those that do not have a default value defined) are marked with an asterisk.

The SiebelInput node terminals are described in the following table.

Terminal	Description
Out	Business object events from the adapter are sent to the Out terminal.
Failure	If an error happens in the SiebelInput node, the message is propagated to the Failure terminal. Information about the error, and business object events can also be propagated to the Failure terminal.
Catch	Business object events are sent to the Catch terminal if they cause an uncaught exception in the message flow. If the Catch terminal is not connected, the retry process is activated to handle the business object.

The following table describes the node properties. The column headed M indicates whether the property is *mandatory* (marked with an asterisk if you must enter a

value when no default is defined); the column headed C indicates whether the property is *configurable* (you can change the value when you add the message flow to the bar file to deploy it).

The SiebelInput node Description properties are described in the following table.

Property	M	C	Default	Description
Node name	No	No	The node type, SiebelInput.	The name of the node.
Short Description	No	No		A brief description of the node.
Long Description	No	No		Text that describes the purpose of the node in the message flow.

The SiebelInput node Basic properties are described in the following table.

Property	M	C	Default	Description
Adapter component	Yes	Yes		The name of the adapter component that contains configuration properties for the adapter. Either enter a name of an adapter file or click Browse to select an adapter file from the list of files that are available in referenced message set projects.

The SiebelInput node Routing properties are described in the following table.

Property	M	C	Default	Description
Set destination list	No	No	Selected	This property specifies whether to add the method binding name to the route to label destination list. If you select this check box, the method binding name is added so that you can use a RouteToLabel node in the message flow after the SiebelInput node.
Label prefix	No	No		The prefix to add to the method name when routing to label. Add a label prefix to avoid a clash of corresponding label nodes when you include multiple WebSphere Adapters input nodes in the same message flow. By default, there is no label prefix, so the method name and label name are identical.

The SiebelInput node Input Message Parsing properties are described in the following table.

Property	M	C	Default	Description
Message domain	No	No	DataObject	The domain that is used to parse the incoming message. By default, the message that is propagated from the SiebelInput node is in the DataObject domain. You cannot specify a different domain.
Message set	Yes	No	Set automatically	The name of the message set in which the incoming message is defined. This field is set automatically from the Adapter component property. If you set this property, then subsequently update the project dependencies to remove this message set reference, a warning is issued. Either update the Message set property, or restore the reference to this message set project.
Message type	No	No		The name of the incoming message. The node detects the message type automatically. You cannot set this property.
Message format	No	No		The name of the physical format of the incoming message. You cannot set this property.

The SiebelInput node Transactionality properties are described in the following table.

Property	M	C	Default	Description
Transaction mode	No	No	Yes	This property specifies how updates are handled. If you select Yes, updates are performed in a single transaction. If you select No, updates are performed independently.

The Instances properties of the SiebelInput node are described in the following table. For a full description of these properties, see “Configurable message flow properties” on page 1372.

Property	M	C	Default	Description
Additional instances pool	No	Yes	Use Pool Associated with Message Flow	The pool from which additional instances are obtained. <ul style="list-style-type: none"> If you select Use Pool Associated with Message Flow, additional instances are obtained from the message flow value. If you select Use Pool Associated with Node, additional instances are allocated from the node’s additional instances based on the number specified in the Additional instances property.
Additional instances	No	Yes	0	The number of additional instances that the node can start if the Additional instances pool property is set to Use Pool Associated with Node. By default, no additional instances are given to the node.

The SiebelInput node Retry properties are described in the following table.

Property	M	C	Default	Description
Retry mechanism	No	No	Failure	This property specifies how retry processing is handled when a failure is rolled back to the SiebelInput node. <ul style="list-style-type: none"> If you select Failure, retry processing is not performed so you cannot set the remaining properties. If you select Short and long retry, retry processing is performed first at the interval that is specified by the Short retry interval property, and if that is unsuccessful, it is then performed at the interval that is specified by the Long retry interval property.
Retry threshold	No	Yes	0	The maximum number of times that retry processing is performed for short retry.
Short retry interval	No	Yes	0	The interval between short retry attempts.
Long retry interval	No	Yes	0	The interval between long retry attempts.

SiebelRequest node

Use the SiebelRequest node to interact with a Siebel application.

This topic contains the following sections:

- “Purpose” on page 1080
- “Using this node in a message flow” on page 1080
- “Terminals and properties” on page 1080

Purpose

Use the SiebelRequest node to interact with Siebel applications. For example, a SiebelRequest node requests information from a Siebel Enterprise Information System (EIS). A customer business object is sent to Siebel, causing Siebel to retrieve information about a customer, such as an address and account details. The response information that is retrieved by the SiebelRequest node can then be used by the rest of the message flow. The SiebelRequest node can send and receive business data.

The SiebelRequest node is contained in the **WebSphere Adapters** drawer of the message flow node palette, and is represented in the workbench by the following icon:



Using this node in a message flow

To function correctly, the SiebelRequest node needs an adapter component, which you set using the Adapter component node property, and business object definitions, which are stored in the message set that you reference from the node. For this reason, you must provide a message set. By default, the message that is propagated from the SiebelRequest node is in the DataObject domain, so the Message domain property is set to DataObject. You cannot specify a different domain. The message type is detected automatically by the node.

The SiebelRequest node supports local transactions using the broker's Local Transaction Manager, and global transactions using the broker's external syncpoint coordinator.

You can deploy several WebSphere Adapters request nodes that use the same adapter component to an execution group.

You can use the `mqsisetdbparms` command in the following format to configure an account name with a user name and password for the Adapter for Siebel Business Applications.

```
mqsisetdbparms broker name -n adapter name -u user name -p password
```

For example:

```
mqsisetdbparms BRK1 -n SiebelCustomerOutbound.outadapter -u siebeluid -p *****
```

Terminals and properties

When you have put an instance of the SiebelRequest node into a message flow, you can configure it; see “Configuring a message flow node” on page 235. The properties of the node are displayed in the Properties view. If you double-click a SiebelRequest node, you open the Adapter Connection wizard. All mandatory properties for which you must enter a value (those that do not have a default value defined) are marked with an asterisk.

The SiebelRequest node terminals are described in the following table.

Terminal	Description
In	The input terminal that accepts the request business object.

Terminal	Description
Out	The output terminal to which the response business object is sent if it represents successful completion of the request, and if further processing is required within this message flow.
Failure	If an error happens in the SiebelRequest node, the message is propagated to the Failure terminal. Information about the error, and business object events can also be propagated to the Failure terminal.

The following tables describe the node properties. The column headed M indicates whether the property is *mandatory* (marked with an asterisk on the panel if you must enter a value when no default is defined); the column headed C indicates whether the property is *configurable* (you can change the value when you add the message flow to the bar file to deploy it).

The SiebelRequest node Description properties are described in the following table.

Property	M	C	Default	Description
Node name	No	No	The node type, for example, SiebelRequest	The name of the node.
Short description	No	No		A brief description of the node.
Long description	No	No		Text that describes the purpose of the node in the message flow.

The SiebelRequest node Basic properties are described in the following table.

Property	M	C	Default	Description
Adapter component	Yes	No		The name of the adapter component that contains configuration properties for the adapter. Either enter a name of an adapter file, or click Browse to select an adapter file from the list of files that are available in referenced message set projects.
Default method	Yes	Yes		The default method binding to use.

The SiebelRequest node Response Message Parsing properties are described in the following table.

Property	M	C	Default	Description
Message domain	No	No	DataObject	The domain that is used to parse the response message. By default, the response message that is propagated from the SiebelRequest node is in the DataObject domain. You cannot specify a different domain.
Message set	Yes	No	Set automatically	The name of the message set in which the incoming message is defined. This field is set automatically from the Adapter component property. If you set this property, then subsequently update the project dependencies to remove this message set reference, a warning is issued. Either update the Message set property, or restore the reference to this message set project.
Message type	No	No		The name of the response message. The node detects the message type automatically. You cannot set this property.
Message format	No	No		The name of the physical format of the response message. You cannot set this property.

The SiebelRequest node Transactionality properties are described in the following table.

Property	M	C	Default	Description
Transaction mode	No	No	No	This property specifies that updates are performed independently, not as part of a local transaction. You cannot change this property.

The SiebelRequest node Request properties are described in the following table.

Property	M	C	Default	Description
Method Location	Yes	No	\$LocalEnvironment/ Adapter/MethodName	The business method that is used to trigger the SiebelRequest node to perform an action on the external system. For example: <ul style="list-style-type: none"> createPurchaseOrder causes the SiebelRequest node to create a purchase order in the EIS. deletePurchaseOrder causes the SiebelRequest node to delete a purchase order in the EIS.
Data Location	Yes	No	\$Body	The location in the incoming message tree from which data is retrieved to form the request that is sent from the SiebelRequest node to the EIS.

The SiebelRequest node Result properties are described in the following table.

Property	M	C	Default	Description
Output data location	No	No	\$OutputRoot	The message tree location to which the SiebelRequest node sends output.
Copy local environment	No	No	Selected	This property controls how the local environment is copied to the output message. If you select the check box, at each node in the message flow, a new copy of the local environment is created in the tree, and it is populated with the contents of the local environment from the preceding node. So if a node changes the local environment, the upstream nodes do not see those changes because they have their own copies. This behavior might be an issue if you are using a FlowOrder node, or if you use the propagate command on a Compute node. If you clear the check box, each node does not generate its own copy of the local environment, but it uses the local environment that is passed to it by the previous node. So if a node changes the local environment, those changes are seen by the upstream nodes.

SOAPAsyncRequest node

Use the SOAPAsyncRequest node in conjunction with the SOAPAsyncResponse node to construct a pair of message flows that call a Web service asynchronously.

This topic contains the following sections:

- “Purpose” on page 1083
- “Using this node in a message flow” on page 1084
- “Configuring the SOAPAsyncRequest node” on page 1084
- “LocalEnvironment overrides” on page 1088
- “Working with WrittenDestination data” on page 1088
- “Terminals and properties” on page 1089

Purpose

The SOAPAsyncRequest node sends a Web service request, but the node does not wait for the associated Web service response to be received. However, the SOAPAsyncRequest node does wait for the HTTP 202 acknowledgement before continuing with the message flow, and the SOAPAsyncRequest node blocks if the acknowledgement is not received. The Web service response is received by the SOAPAsyncResponse node, which can be in a separate message flow. The nodes are used as a pair, and correlate responses against the original requests.

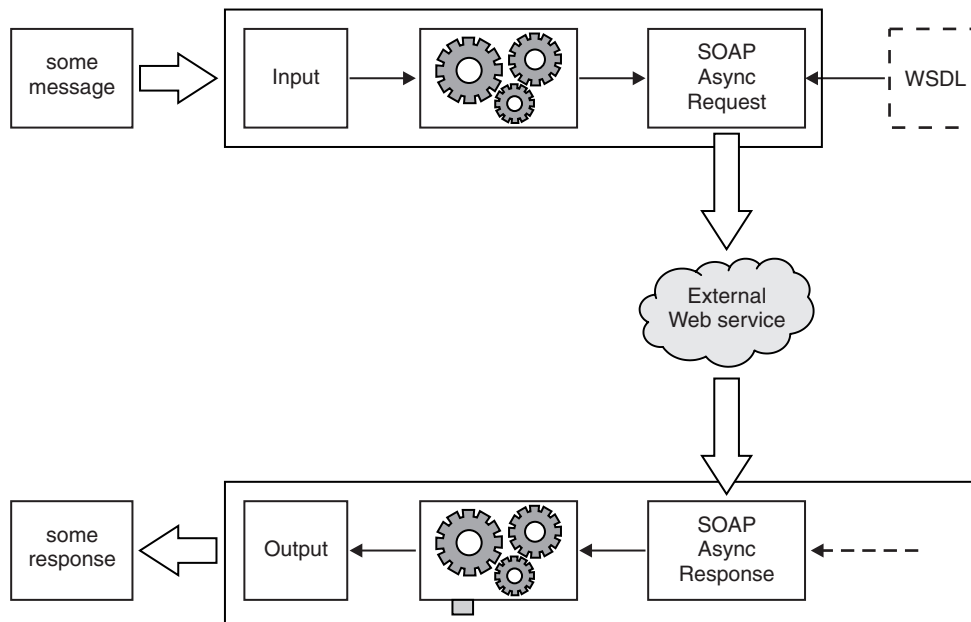

The SOAPAsyncRequest node is the first half of the asynchronous request and response node pair. The SOAPAsyncRequest node calls a remote SOAP-based Web service. The request is sent by the SOAPAsyncRequest node, but the SOAPAsyncRequest node does not receive the response. The response is received by a SOAPAsyncResponse node that is running on a different thread. The SOAPAsyncResponse node is typically at the beginning of a different message flow; however, it must be in the same execution group as the SOAPAsyncRequest node.

The SOAPAsyncRequest node is WSDL-driven, in a similar manner to the SOAPRequest node.

The SOAPAsyncRequest node is contained in the **Web Services** drawer of the palette, and is represented in the workbench by the following icon:



Using this node in a message flow

The following sample demonstrates how to use the asynchronous SOAP nodes when you call a Web service. The Web service simulates an order service, and the client shows how existing WebSphere MQ interfaces can be extended to make Web service requests.

- Asynchronous Consumer sample

You can view samples only when you use the information center that is integrated with the Message Broker Toolkit.

Configuring the SOAPAsyncRequest node

When you have put an instance of the SOAPAsyncRequest node into a message flow, you can configure it; see “Configuring a message flow node” on page 235. The properties of the node are displayed in the Properties view.

All mandatory properties for which you must enter a value (those that do not have a default value defined) are marked with an asterisk.

1. Optional: On the **Description** tab, enter a Short description, a Long description, or both. You can also rename the node on this tab.
2. On the **Basic** tab, you must set the following properties:
 - Unique identifier. You must specify the unique URL fragment that is common to your pair of SOAPAsyncRequest and SOAPAsyncResponse nodes. This property is mandatory.
 - You must associate a WSDL file with this node, and configure a number of WSDL-related properties. Before configuring the WSDL file on this node you must have a message set with a Deployable WSDL resource.
 - WSDL file name. This property is mandatory and is of type String. If the node was created by dropping a WSDL file from a message set onto the message flow editor, this property will be preset to the name of the WSDL file. If the name of the WSDL file is not preset, you can set this property in one of the following ways.
 - If you have Deployable WSDL, you can select from the Deployable WSDL files by clicking **Browse**.
 - If you have WSDL definitions, but no message set, then you can create a message set:
 - a. Click **Browse** to open the WSDL Selection window.
 - b. Click **Import/Create New** to open the Import WSDL file wizard.
 - c. Enter the message set name and message set project name. Click **Next**.
 - d. Choose the relevant option:
 - If your WSDL file already exists in your workspace, select **Use resources from the workspace**, and select the WSDL file.
 - If your WSDL file is in the file system, select **Use external resources**. Select the WSDL file. Click **Next**.
 - e. Select the WSDL bindings to import. Any warnings or errors are displayed in the wizard banner.
 - f. Click **Finish**. Result: Creates a new message set project and message set, with message definitions. The WSDL definitions are added to the Deployable WSDL folder.

g. You can now select the WSDL file from the WSDL Selection window. Click **OK**.

- If you have a message set but no WSDL definition, you must generate a WSDL definition. See *Generating a WSDL definition from a message set*.
- Drag a WSDL file from a message set onto the node.
- Type in a file name that is relative to the message set project in which the deployable WSDL file exists.

When you select a WSDL file for the WSDL file name field, the WSDL is validated to ensure that it is WS-I compliant. The other properties on the **Basic** tab are automatically completed with values based on the WSDL definition.

Only Deployable WSDL can be used to configure the SOAP nodes.

After a valid WSDL file is selected, the message set project to which WSDL file belongs is added as a referenced project to the corresponding flow project, if the reference does not already exist.

If the WSDL file is not valid, or an incorrect file name is entered, an error message is displayed in the Properties view and all WSDL properties are blank.

The following situations lead to error conditions on this property:

- The WSDL file does not come from a message set project, or the WSDL file was not imported correctly; see *Importing from WSDL and Importing WSDL definitions from the command line*.
- The WSDL file contains no HTTP bindings.
- The WSDL file contains no port type.
- The WSDL file entered in the text box does not exist.
- Port type. This property is mandatory and is of type String. This field lists all of the port types defined by the specified WSDL file. By default, the first port type found in the WSDL file that has an associated HTTP binding, is selected.

Error Conditions:

- Selected Port type does not contain at least one operation.
- Imported binding. This property is mandatory and is of type String. The Imported binding box lists all of the SOAP bindings associated with the selected port type. Only HTTP transport is supported. Bindings are listed in the order that they are displayed in the WSDL file. By default, the first binding that implements the operation and has an associated service port, is selected. This property is updated every time the Port type value changes.

Error Conditions:

- No SOAP bindings (with HTTP transport) in the WSDL file are associated with the Port type.
- Selected binding does not have any operations.
- Binding operation. This property is mandatory and is of type String. The Binding operation box lists all of the operations defined by the selected binding. The first operation in the list is selected by default. This property is updated every time the selected binding value changes.
- Service port. This property is mandatory and is of type String. The Service port box lists all of the service ports that point to the selected binding. The first service port for the binding is selected by default. This property is updated every time the selected binding value changes.

Error Conditions:

- No ports point to the selected binding.
- Target namespace. This property type is String. Target namespace displays the namespace of the selected WSDL file.

When you save the flow file, validation of some of the WSDL-related properties occur:

- It is validated that the WSDL file exists in the message set.
- It is validated that the selected Port type, Binding operation, and Service port are all valid within the content of the selected WSDL file.

If any of these conditions are not met, an error is generated, and you will not be able to add a flow that contains this SOAPAsyncRequest node to the broker archive (bar) file.

3. On the **HTTP Transport** tab, you can set the HTTP transport related properties:

- Web service URL. This property is mandatory and is of type String. This is automatically derived from the <soap:address> element of the selected Service port. Whenever the selected port is updated, the Web service URL is updated accordingly. However, if you override the value then your value persists and the URL is no longer updated from the service port.

If you choose to override this property you must specify it in the form

http://<hostname>[:<port>]/[<path>] where:

- http://<hostname> must be specified.
- <port> has a default of 80. If you specify a value, you must include the : before the port number.
- <path> has a default of /. If you specify a value, you must include the / before the path.

For more details of how to override this property, see Changing the default URL for a SOAPRequest node or a SOAPAsyncRequest node request.

- Request timeout (in seconds). This property type is Integer. This property has the value of the wait time for the remote server to respond with an acknowledgement that the message has been received. The time in seconds that the node waits for a response from the Web service. The valid range is 1 to $(2^{31})-1$. You cannot enter a value that represents an unlimited wait. The default is 120.
- HTTP(S) Proxy Location. This property type is String. In the HTTP(S) Proxy Location field, set the location of the proxy server to which requests are sent. This value must be in the form hostname:port.
- SSL Protocol (if using SSL). This property type is Enumerate. Specify the SSL Protocol that you want to use to make the request. The following options are available:

SSL The default. This option attempts to connect using the SSLv3 protocol first, but the handshake can fall back to the SSLv2 protocol where the SSLv2 protocol is supported by the underlying JSSE provider.

SSLv3 This option attempts to connect with the SSLv3 protocol only. The handshake cannot fallback to SSLv2.

TLS This option attempts to connect with the TLS protocol only. The handshake cannot fallback to SSLv3 or SSLv2.

Both ends of an SSL connection must use the same protocol. The protocol must be one that the remote server can accept.

- Allowed SSL Ciphers (if using SSL). This property type is String. This setting enables you to specify a single cipher (such as `SSL_RSA_FIPS_WITH_3DES_EDE_CBC_SHA`), or a list of ciphers that are the only ones used by the connection. This list of ciphers must include one or more that are accepted by the remote server. A comma (,) is used as a separator between the ciphers. The default value is an empty string, which allows the node to use any, or all, of the available ciphers during the SSL connection handshake. This method enables the greatest scope for making a successful SSL connection.
4. Use the **Advanced** tab to define your headers.

SOAP headers that are part of the must understand headers list are incorporated into the flow rather than causing a SOAP fault. Adding headers to the must understand headers list stops SOAP faults being generated by SOAP headers.

- The WSDL-defined SOAP headers table is read-only, and is populated based on the SOAP headers defined in the output part of the selected operations. By default, the check boxes, in the second column of the table, are cleared for all entries in the WSDL-defined SOAP headers table. You must select the relevant check box to add the header to the must understand headers list.
- You can add custom headers (headers that are not defined in the WSDL file) in the User-defined SOAP headers table. Use **Add**, **Edit**, and **Delete** for this table. You must select the check box, in the second column of the table, to ensure that the newly added custom header is added to the must understand headers list.

You do not need to add must understand headers for WS-Addressing and WS-Security as these are understood if you configure **WS Extensions**.

The must understand headers list that is configured on this node is applied to the corresponding SOAPAsyncResponse node when the SOAPAsyncResponse node receives the reply from the remote server.

5. Use the **WS Extensions** tab to configure WS extensions. The tab features two configurations:
- Use WS-Addressing. This property indicates that WS-Addressing is always engaged on the SOAPAsyncRequest node.
 - WS-Security. The WS-Security table features two columns:
 - Alias
 - XPath Expression

You can add XPath expressions with an associated Alias value to the WS-Security table. The Alias is resolved in a Policy Set that is created by the administrator. The Policy Set resolves the Alias to either encrypt or sign the part of the message referred to by the XPath Expression. You can **Add**, **Edit**, and **Delete** in this table.

For more details about WS-Addressing with the SOAPAsyncRequest node, see “WS-Addressing with the SOAPAsyncRequest and SOAPAsyncResponse nodes” on page 640.

6. Use the **Request Parser Options** tab to configure request parser options. The tab features a property that controls whether MTOM is enabled for the parser. Valid values are Yes, No, and Inherit. For more information about MTOM, see “SOAP MTOM” on page 682.

LocalEnvironment overrides

You can dynamically override set values in the LocalEnvironment in the same way as setting values in other elements of a message. You can be set the following properties under LocalEnvironment.Destination.SOAP.Request.Transport.HTTP.

Setting	Description
WebServiceURL	Overrides the Web service URL property on the node. For example: SET OutputLocalEnvironment.Destination.SOAP.Request.Transport.HTTP.WebServiceURL = 'http://ibm.com/abc/';
RequestURI	Overrides the RequestURI, which is the path after the URL and port. For example: SET OutputLocalEnvironment.Destination.SOAP.Request.Transport.HTTP.RequestURI = '/abc/def?x=y&g=h';
Timeout	Overrides the Request timeout (in seconds) property on the node. For example: SET OutputLocalEnvironment.Destination.SOAP.Request.Transport.HTTP.Timeout = 42;
ProxyURL	Overrides the HTTP(S) proxy location property on the node. For example: SET OutputLocalEnvironment.Destination.SOAP.Request.Transport.HTTP.ProxyURL = 'my.proxy';
SSLProtocol	Overrides the SSLProtocol property on the node. For example: SET OutputLocalEnvironment.Destination.SOAP.Request.Transport.HTTP.SSLProtocol = 'TLS'; Valid values are: SSL, SSLv3, and TLS.
SSLCiphers	Overrides the Allowed SSL Ciphers (if using SSL) property on the node. For example: SET OutputLocalEnvironment.Destination.SOAP.Request.Transport.HTTP.SSLCiphers = 'SSL_RSA_FIPS_WITH_3DES_EDE_CBC_SHA';
HTTPVersion	Overrides the HTTPVersion. For example: SET OutputLocalEnvironment.Destination.SOAP.Request.Transport.HTTP.HTTPVersion = 'HTTP/1.1';
Method	Overrides the Method. For example: SET OutputLocalEnvironment.Destination.SOAP.Request.Transport.HTTP.Method = 'GET';
ProxyConnectHeaders	Sets the ProxyConnectHeaders. Set this, when using a proxy server, to send extra SOAP headers when connecting to that server. For example, this allows you to send proxy authentication information to a proxy server. Multiple headers can be sent but each must be separated by a carriage return and a line feed (ASCII 0x0D 0x0A) in accordance with RFC2616. For example: <pre>DECLARE CRLF CHAR CAST('0D0A' AS CHAR CCSID 1208); SET OutputLocalEnvironment.Destination.SOAP.Request.Transport.HTTP. ProxyConnectHeaders = 'Proxy-Authorization: Basic Zm5lcmJsZTpwYXNzd29yZAo=' CRLF 'Proxy-Connection: Keep-Alive' CRLF;</pre>

Working with WrittenDestination data

After the request has been made, the WrittenDestination folder in LocalEnvironment is updated with the WS-Addressing (if in use) and transport details. A WrittenDestination for a SOAPAsyncRequest node has the following format, with WS-Addressing present only if it is used:

```
WrittenDestination = (
  SOAP = (
    Request = (
      WSA = (
        To = 'URI'
        MessageID = 'id'
```

Property	M	C	Default	Description
WSDL file name	Yes	No		This property type is String. When you select a WSDL file for the WSDL file name field, the WSDL is validated to ensure that it is WS-I compliant. Only Deployable WSDL can be used to configure the SOAP nodes. After a valid WSDL file is selected, the message set project to which WSDL file belongs is added as a referenced project to the corresponding flow project, if the reference does not already exist.
Port type	Yes	No	By default, the first Port type found in the WSDL file, that has an associated HTTP binding with it, is selected.	This property type is String. This field lists all of the port types defined by the specified WSDL file. By default, the first port type found in the WSDL file that has an associated HTTP binding, is selected. Error Conditions: <ul style="list-style-type: none"> Selected Port type does not contain at least one operation.
Imported binding	Yes	No		This property type is String. The Imported binding box lists all of the SOAP bindings associated with the selected port type. Only HTTP transport is supported. Bindings are listed in the order that they are displayed in the WSDL file. By default, the first binding that implements the operation and has an associated service port, is selected. This property is updated every time the Port type value changes. Error Conditions: <ul style="list-style-type: none"> No SOAP bindings (with HTTP transport) in the WSDL file are associated with the Port type. Selected binding does not have any operations.
Binding operation	Yes	No		This property type is String. The Binding operation box contains all of the operations defined by the selected binding. The first operation in the list is selected by default.
Service port	Yes	No		This property type is String. The Service port box lists all of the service ports that point to the selected binding. The first service port for the binding is selected by default. This property is updated every time the selected binding value changes. Error Conditions: <ul style="list-style-type: none"> No ports point to the selected binding.
Target namespace	No	No		This property type is String. Target namespace displays the namespace of the selected WSDL file.

The SOAPAsyncRequest node HTTP Transport properties are described in the following table.

Property	M	C	Default	Description
Web service URL	Yes	No		<p>This property type is String. This property is automatically derived from the <soap:address> element of the selected Service port. Whenever the selected port is updated, the Web service URL is updated accordingly. However, if you override the value then your value persists and the URL is no longer updated from the service port.</p> <p>If you choose to override this property you must specify it in the form http://<hostname>[:<port>]/ [<path>] where:</p> <ul style="list-style-type: none"> • http://<hostname> must be specified. • <port> has a default of 80. If you specify a value, you must include the : before the port number. • <path> has a default of /. If you specify a value, you must include the / before the path.
Request timeout (in seconds)	No	No	120	<p>This property type is Integer. This property has the value of the wait time for the remote server to respond with an acknowledgement that the message has been received.</p> <p>The time in seconds that the node waits for a response from the Web service. The valid range is 1 to $(2^{31})-1$. You cannot enter a value that represents an unlimited wait.</p>
HTTP(S) proxy location	No	No		This property type is String. The proxy server to which requests are sent. This value must be in the form hostname:port.
SSL Protocol (if using SSL)	No	No	SSL	<p>This property type is Enumerate. The SSL protocol to use when making an HTTPS request. Valid values are:</p> <ul style="list-style-type: none"> • SSL • SSLv3 • TLS
Allowed SSL ciphers (if using SSL)	No	No	Empty	This property type is String. A comma-separated list of ciphers to use when making an SSL request. The default value of an empty string means use all available ciphers.

The SOAPAsyncRequest node Advanced properties are described in the following table.

Property	M	C	Default	Description
WSDL-defined SOAP headers	No	No		The WSDL-defined SOAP headers table is read-only, and is populated based on the SOAP headers defined in the output part of the selected operations. By default, the check boxes, in the second column of the table, are cleared for all entries in the WSDL-defined SOAP headers table. You must select the relevant check box to add the header to the 'must understand headers' list.

Property	M	C	Default	Description
User-defined SOAP headers	No	No		You can add custom headers (headers that are not defined in the WSDL file) in the User-defined SOAP headers table. Use Add , Edit , and Delete for this table. You must select the relevant check box, in the second column of the table, to ensure that the newly added custom header is added to the 'must understand headers' list.

The SOAPAsyncRequest node WS Extensions properties are described in the following table.

Property	M	C	Default	Description
Use WS-Addressing	No	No	Selected	You cannot edit this property. This property indicates that WS-Addressing is always engaged on the SOAPAsyncRequest node.
WS-Security	No	No		This table and features two columns: <ul style="list-style-type: none"> • Alias • XPath Expression You can add XPath expressions with an associated Alias value to the WS-Security table. The Alias is resolved in a Policy Set that is created by the administrator. The Policy Set resolves the Alias to either encrypt or sign the part of the message referred to by the XPath Expression. You can Add , Edit and Delete in this table.

The SOAPAsyncRequest node Request Parser Options property is described in the following table.

Property	M	C	Default	Description
Allow MTOM	No	Yes	No	This property controls whether MTOM is enabled for the parser. Valid values are Yes, No, and Inherit. For more information about using SOAP MTOM with the SOAPReply, SOAPRequest, and SOAPAsyncRequest nodes, see "Using SOAP MTOM with the SOAPReply, SOAPRequest, and SOAPAsyncRequest nodes" on page 634.

SOAPAsyncResponse node

Use the SOAPAsyncResponse node in conjunction with the SOAPAsyncRequest node to construct a pair of message flows that call a Web service asynchronously.

This topic contains the following sections:

- "Purpose"
- "Using this node in a message flow" on page 1093
- "Terminals and properties" on page 1093

Purpose

The SOAPAsyncRequest node sends a Web service request, but the node does not wait for the associated Web service response to be received. However, the SOAPAsyncRequest node does wait for the HTTP 202 acknowledgement before continuing with the message flow, and the SOAPAsyncRequest node blocks if the acknowledgement is not received. The Web service response is received by the

SOAPAsyncResponse node, which can be in a separate message flow. The nodes are used as a pair, and correlate responses against the original requests.

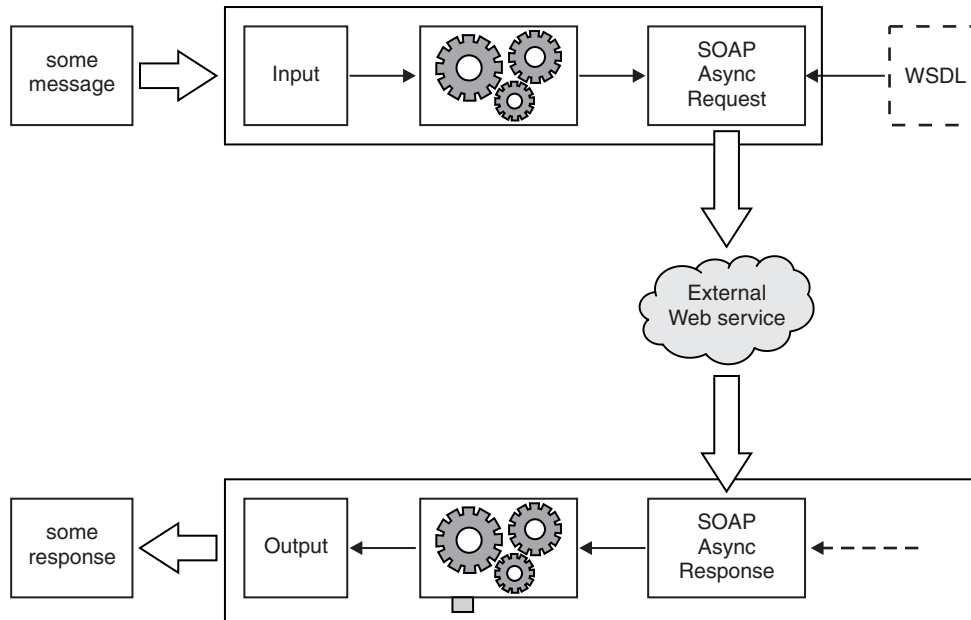

The SOAP parser invokes the XMLNSC parser to parse the XML content of the SOAP Web service, and to validate the XML body of the SOAP Web service. The SOAP parser options are passed through to the XMLNSC parser. For more information, see “Manipulating messages in the XMLNSC domain” on page 364.

The SOAPAsyncResponse node is contained in the **Web Services** drawer of the palette, and is represented in the workbench by the following icon:



Using this node in a message flow

Configuration of the SOAPAsyncResponse node is not WSDL-driven, although the ‘must understand headers’ list configured on the corresponding SOAPAsyncRequest node is applicable to the SOAPAsyncResponse node.

The following sample demonstrates how to use the asynchronous SOAP nodes when you call a Web service. The Web service simulates an order service, and the client shows how existing WebSphere MQ interfaces can be extended to make Web service requests.

- Asynchronous Consumer sample

You can view samples only when you use the information center that is integrated with the Message Broker Toolkit.

Terminals and properties

When you have put an instance of the SOAPAsyncResponse node into a message flow, you can configure it; see “Configuring a message flow node” on page 235.

The properties of the node are displayed in the Properties view. All mandatory properties for which you must enter a value (those that do not have a default value defined) are marked with an asterisk.

The SOAPAsyncResponse node terminals are described in the following table.

Terminal	Description
Failure	The output terminal to which the message is routed if a failure is detected when the message is propagated.
Out	The output terminal to which the message is routed if it has been propagated successfully, and if further processing is required within this message flow.
Fault	SOAP fault messages will be directed down the Fault terminal.
Catch	The output terminal to which the message is routed if an exception is thrown downstream and caught by this node.

The following tables describe the node properties. The column headed M indicates whether the property is *mandatory* (marked with an asterisk if you must enter a value when no default is defined); the column headed C indicates whether the property is *configurable* (you can change the value when you add the message flow to the bar file to deploy it).

The SOAPAsyncResponse node Description properties are described in the following table.

Property	M	C	Default	Description
Node name	No	No	The node type: SOAPAsyncResponse	The name of the node.
Short description	No	No	None	A brief description of the node.
Long description	No	No	None	Text that describes the purpose of the node in the message flow.

The SOAPAsyncResponse node Basic properties are described in the following table:

Property	M	C	Default	Description
Unique identifier	Yes	No		Specify the unique URL fragment that is common to your pair of SOAPAsyncRequest and SOAPAsyncResponse nodes.

The SOAPAsyncResponse node Advanced property is described in the following table.

Property	M	C	Default	Description
Set destination list	No	No	Selected	This property indicates whether to add the incoming SOAP operation to the route to label destination list.
Label prefix	No	No		Use this property to add a prefix to the SOAP Operation name in the destination list. You must add a Label prefix if you want to use multiple SOAPAsyncResponse nodes in the same message flow without causing their corresponding Label nodes to clash. By default, the prefix is an empty string so that the operation name and the label name are identical. This property is not available if the Set destination list property is cleared.

Property	M	C	Default	Description
Place WS-Addressing headers into LocalEnvironment	No	No	Cleared	This property specifies whether the node puts WS-Addressing headers from the response message into the LocalEnvironment tree. WS-Addressing headers are not accessible to the flow if this check box is cleared because by default, all headers are processed and removed.

The SOAPAsyncResponse node Instances properties are described in the following table.

Property	M	C	Default	Description
Additional instances pool	No	Yes	Use Pool Associated with Message Flow	The pool from which additional instances are obtained. <ul style="list-style-type: none"> If you select Use Pool Associated with Message Flow, additional instances are obtained from the message flow value. If you select Use Pool Associated with Node, additional instances are allocated from the node's additional instances based on the number specified in the Additional instances property.
Additional instances	No	Yes	0	The number of additional instances that the node can start if the Additional instances pool property is set to Use Pool Associated with Node. By default, no additional instances are given to the node.

The SOAPAsyncResponse node Response Message Parsing properties are described in the following table. The SOAPAsyncResponse node sets these properties automatically; you cannot set them yourself.

Property	M	C	Default	Description
Message domain	No	No	SOAP	The domain that is used to parse the response message. By default, the message that is propagated from the SOAPAsyncResponse node is in the SOAP domain. You cannot specify a different domain. For more information, see "SOAP parser and domain" on page 78.
Message set	Yes	No	Set automatically from the WSDL file name property that is provided by the SOAPAsyncRequest node.	The name of the message set in which the response message is defined. Message set is set automatically to the message set that contains the WSDL file that is configured on the corresponding SOAPAsyncRequest node. If you set this property, then subsequently update the project dependencies to remove this message set reference, a warning is issued. Either update the Message set property, or restore the reference to this message set project.
Message type	No	No		The name of the response message. The node detects the message type automatically. You cannot set this property.
Message format	No	No		The name of the physical format of the response message. You cannot set this property.

The SOAPAsyncResponse node Parser Options properties are described in the following table. The properties are passed through to the XMLNSC parser.

Property	M	C	Default	Description
Parse timing	No	No	On Demand	This property controls when a response message is parsed. Valid values are On Demand, Immediate, and Complete. By default, parse timing is set to On demand, which causes parsing of the input message to be delayed. For a full description of this property, see "Parsing on demand" on page 1363.
Build tree using XML schema data types	No	No	Selected	This property controls whether the XMLNSC parser creates syntax elements in the message tree with data types taken from the XML Schema.
Retain mixed content	No	No	Cleared	This property controls whether the XMLNSC parser creates elements in the message tree when it encounters mixed text in a response message. If you select the check box, elements are created for mixed text. If you clear the check box, mixed text is ignored and no elements are created.
Retain comments	No	No	Cleared	This property controls whether the XMLNSC parser creates elements in the message tree when it encounters comments in an response message. If you select the check box, elements are created for comments. If you clear the check box, comments are ignored and no elements are created.
Retain processing instructions	No	No	Cleared	This property controls whether the XMLNSC parser creates elements in the message tree when it encounters processing instructions in a response message. If you select the check box, elements are created for processing instructions. If you clear the check box, processing instructions are ignored and no elements are created.
Opaque elements	No	No	Blank	This property is used to specify a list of elements in the response message that are to be opaquely parsed by the XMLNSC parser. Opaque parsing is performed only if validation is not enabled (that is, if Validate is None); entries that are specified in Opaque Elements are ignored if validation is enabled.

The SOAPAsyncResponse node Validation properties are described in the following table. By default, validation is enabled.

If a message is propagated to the failure terminal of the node, it is not validated. For more details, see "Validating messages" on page 164 and "Validation properties" on page 1359.

Property	M	C	Default	Description
Validate	No	Yes	Content and value	This property controls whether validation takes place. Valid values are None, Content and value, and Content.
Failure action	No	Yes	Exception	This property controls what happens if validation fails. You can set this property only if you set Validate to Content or Content and value. Valid values are User trace, Exception list, Local error log, and Exception.

SOAPEnvelope node

Use the SOAPEnvelope node to add a SOAP envelope onto an existing message. This node is designed to be used with the SOAPExtract node.

This topic contains the following sections:

- "Purpose" on page 1097
- "Using the SOAPEnvelope node in a message flow" on page 1097
- "Configuring the SOAPEnvelope node" on page 1097

- Supported parsers
- “Terminals and properties” on page 1098
- “Example SOAP messages” on page 1099

Purpose

The default behavior of the SOAPEnvelope node is to attach the SOAP envelope from a standard location (\$LocalEnvironment/SOAP/Envelope) in the LocalEnvironment tree; you can specify an explicit location by using an XPath expression.

You can also use the node in a flow without a corresponding SOAPExtract node; the node has an option to create a default SOAP envelope.

The SOAPEnvelope node is contained in the **Web Services** drawer of the palette, and is represented in the workbench by the following icon:



Using the SOAPEnvelope node in a message flow

This node is designed to be used in conjunction with the SOAPExtract node; see “SOAPExtract node” on page 1099.

Configuring the SOAPEnvelope node

When you have put an instance of the SOAPEnvelope node into a message flow, you can configure it; see “Configuring a message flow node” on page 235. The properties of the node are displayed in the Properties view.

1. Optional: On the **Description** tab, enter a Short description, a Long description, or both. You can also rename the node on this tab.
2. On the **Basic** tab:
 - a. In Create new envelope, specify whether the node must create a SOAP envelope, or use an existing one. The default value is to use an existing one.
 - b. In Existing Envelope Location, specify an XPath expression that represents the location from which the node will copy the SOAP envelope. By default the node copies the envelope from the LocalEnvironment (\$LocalEnvironment/SOAP/Envelope).

Supported parsers

This node is designed to work with SOAP messages. Use one of the following parsers:

- SOAP
- XMLNSC
- MRM
- XMLNS

Other XML parsers are not supported because they do not support namespaces. An exception is thrown if a message is received which is not using the correct parser or does not conform to the basic structure of a SOAP message.

Full validation is not done on the SOAP message, which just needs to contain a body element.

Terminals and properties

The terminals of the SOAPEnvelope node are described in the following table:

Terminal	Description
In	The input terminal that accepts a SOAP message for processing by the node.
Out	The output terminal that outputs the SOAP message that was constructed from the SOAP message body and a SOAP envelope.
Failure	The output terminal to which the message is routed if a failure is detected during processing.

The following tables describe the node properties. The column headed M indicates whether the property is *mandatory* (marked with an asterisk if you must enter a value when no default is defined); the column headed C indicates whether the property is *configurable* (you can change the value when you add the message flow to the bar file to deploy it).

The Description properties of the SOAPEnvelope node are described in the following table.

Property	M	C	Default	Description
Node name	No	No	The node type	The name of the node.
Short description	No	No		A brief description of the node.
Long description	No	No		Text that describes the purpose of the node in the message flow.

The Basic properties of the SOAPEnvelope node are described in the following table.

Property	M	C	Default	Description
Create new envelope	No	No	Cleared	This property controls whether the node creates a SOAP envelope, or gets an existing one from the message tree. If you select the check box, the node creates a new envelope. If you clear the check box, the node copies the envelope from the value entered in the Existing Envelope Location property.
Existing Envelope Location	No	No	\$LocalEnvironment/ SOAP/Envelope	An XPath expression that represents the location from which the node will copy the SOAP envelope. The following correlation names are available: \$Root The root of the message tree. \$Body The last child of the root of the message tree (equivalent to /). \$LocalEnvironment The root of the LocalEnvironment tree. \$Environment The root of the Global Environment tree.

Example SOAP messages

Incoming SOAP envelope

```
<?xml version="1.0"?>
<soapenv:Envelope
xmlns:soapenv="http://schemas.xmlsoap.org/soap/envelope/"
xmlns:soapenc="http://schemas.xmlsoap.org/soap/encoding/"
xmlns:tns="http://ws3.st.mqsi.ibm.com/App/DocLiteral1"
xmlns:xsd="http://www.w3.org/2001/XMLSchema"
xmlns:xsi="http://www.w3.org/2001/XMLSchema-instance">
  <soapenv:Header>
    <tns:requestHeader>
      <tns:assessorUrl>header1</tns:assessorUrl>
    </tns:requestHeader>
  </soapenv:Header>
</soapenv:Envelope>
```

Incoming SOAP message body

```
<?xml version="1.0"?>
<tns:requestAvailability
xmlns:tns="http://ws3.st.mqsi.ibm.com/App/DocLiteral1"
xmlns:soapenc="http://schemas.xmlsoap.org/soap/encoding/"
xmlns:soapenv="http://schemas.xmlsoap.org/soap/envelope/"
xmlns:xsd="http://www.w3.org/2001/XMLSchema"
xmlns:xsi="http://www.w3.org/2001/XMLSchema-instance">
  <tns:carDetails>body1</tns:carDetails>
  <tns:claimID>body2</tns:claimID>
  <tns:location>body3</tns:location>
  <tns:reqDate>body4</tns:reqDate>
</tns:requestAvailability>
```

Outgoing SOAP message

```
<?xml version="1.0"?>
<soapenv:Envelope
xmlns:soapenv="http://schemas.xmlsoap.org/soap/envelope/"
xmlns:soapenc="http://schemas.xmlsoap.org/soap/encoding/"
xmlns:tns="http://ws3.st.mqsi.ibm.com/App/DocLiteral1"
xmlns:xsd="http://www.w3.org/2001/XMLSchema"
xmlns:xsi="http://www.w3.org/2001/XMLSchema-instance">
  <soapenv:Header>
    <tns:requestHeader>
      <tns:assessorUrl>header1</tns:assessorUrl>
    </tns:requestHeader>
  </soapenv:Header>
  <soapenv:Body>
    <tns:requestAvailability>
      <tns:carDetails>body1</tns:carDetails>
      <tns:claimID>body2</tns:claimID>
      <tns:location>body3</tns:location>
      <tns:reqDate>body4</tns:reqDate>
    </tns:requestAvailability>
  </soapenv:Body>
</soapenv:Envelope>
```

SOAPEXtract node

Use the SOAPEXtract node to remove SOAP envelopes, allowing just the body of a SOAP message to be processed. It can also route a SOAP message based on its operation name. Both functions are optional; they are contained within one node because they are often used together.

This topic contains the following sections:

- “Purpose”
- “Using the SOAPExtract node in a message flow”
- “Configuring the SOAPExtract node”
- “Supported parsers” on page 1101
- “Terminals and properties” on page 1101
- “Example SOAP messages” on page 1103

Purpose

The SOAPExtract node can perform two functions:

Extract function

The default behavior is to detach the SOAP envelope to a standard location (\$LocalEnvironment/SOAP/Envelope) in the LocalEnvironment tree. Alternatively, you can specify an explicit location using an XPath expression. Any existing SOAP envelope at the chosen location is replaced.

Routing function

The SOAP message is routed to a Label node within the message flow as identified by the SOAP operation within the message. The SOAP Operation is identified within the SOAP body tag.

Ensure that the message parser options in the properties folder of the outgoing message are correctly set up to parse the message, by copying the message set and message format from the incoming message. The message type is derived from the SOAP envelope message body first child.

Only a single child of the SOAP message body is supported.

The SOAPExtract node is contained in the **Web Services** drawer of the palette, and is represented in the workbench by the following icon:



Using the SOAPExtract node in a message flow

Look at the following sample to see how to use this node:

- SOAP Nodes sample

You can view samples only when you use the information center that is integrated with the Message Broker Toolkit.

Configuring the SOAPExtract node

When you have put an instance of the SOAPExtract node into a message flow, you can configure it; see “Configuring a message flow node” on page 235. The properties of the node are displayed in the Properties view.

1. Optional: On the **Description** tab, enter a Short description, a Long description, or both. You can also rename the node on this tab.
2. On the **Basic** tab:
 - a. Specify in Remove envelope whether the node must remove the soap envelope and place it in the location given in Envelope Destination, or leave it on the message. The default value is that the node removes the envelope.

- b. In Envelope Destination, enter an XPath expression that represents the destination to which the node will copy the envelope. By default, the node copies the envelope to the LocalEnvironment (\$LocalEnvironment/SOAP/Envelope).
- c. In Destination path mode, specify the behavior of the Envelope Destination property.
 - Create path: The node creates the tree if the path specifies a location that does not already exist. Only simple expressions of the form aaa/bbb/ccc in Envelope Destination are supported. The default.
 - XPath location of existing element: If you know that the destination element exists, you can use any valid XPath 1.0 expression in Envelope Destination.
- d. In Route to 'operation' label, specify whether the node must route the message to the SOAP operation given in the message. The default setting is for the node to send the message to the Out terminal.
- e. In Label Prefix, enter the value to prefix to the label used for routing by the node. Entering a prefix allows for name spacing between subflows. By default, no value is prefixed to the label name used for routing the message.

Supported parsers

This node is designed to work with SOAP messages. Use one of the following parsers:

- SOAP
- XMLNSC
- MRM
- XMLNS

Other XML parsers are not supported because they do not support namespaces. An exception is thrown if a message is received which is not using the correct parser or does not conform to the basic structure of a SOAP message.

Full validation is not done on the SOAP message, which just needs to contain a body element.

Terminals and properties

The terminals of the SOAPExtract node are described in the following table:

Terminal	Description
In	The input terminal that accepts a SOAP message for processing by the node.
Out	The output terminal that outputs the SOAP message body (without the envelope if the Remove envelope check box is selected on the node properties).
Failure	The output terminal to which the message is routed if a failure is detected during processing.

The following tables describe the node properties. The column headed M indicates whether the property is *mandatory* (marked with an asterisk if you must enter a value when no default is defined); the column headed C indicates whether the property is *configurable* (you can change the value when you add the message flow to the bar file to deploy it).

The Description properties of the SOAPExtract node are described in the following table.

Property	M	C	Default	Description
Node name	No	No	The node type	The name of the node.
Short description	No	No		A brief description of the node.
Long description	No	No		Text that describes the purpose of the node in the message flow.

The Basic properties of the SOAPExtract node are described in the following table.

Property	M	C	Default	Description
Remove envelope	No	No	Selected	<p>If you select the check box, the node removes the SOAP header from the message. For a SOAP tree, the node outputs to the Out terminal the first child of SOAP.body from the SOAP tree. It outputs to Envelope Destination the full SOAP tree minus the first child of SOAP.body.</p> <p>If you clear the check box, the node leaves the envelope on the message. In the case of a SOAP tree, the full tree is propagated to the Out terminal.</p>
Envelope Destination	No	No	\$LocalEnvironment/ SOAP/Envelope	<p>An XPath expression that represents the destination to which the node will copy the SOAP envelope. The following correlation names are available:</p> <p>\$Root The root of the message tree.</p> <p>\$Body The last child of the root of the message tree (equivalent to /).</p> <p>\$LocalEnvironment The root of the LocalEnvironment tree.</p> <p>\$Environment The root of the Global Environment tree.</p>
Destination path mode	No	No	Create path	<p>This determines the behavior of the Envelope Destination property. Set this property:</p> <p>Create path The default. The tree is created if the path specifies a location that does not exist. Only simple expressions of the form aaa/bbb/ccc are supported.</p> <p>XPath location of existing element If you know that the destination element exists, you can enter any valid XPath 1.0 expression.</p>

Property	M	C	Default	Description
Route to 'operation' label	No	No	Cleared	<p>This property determines whether the node must route the message to the SOAP operation given in the message.</p> <p>If you select the check box, the message is routed to a Label node that matches the SOAP operation. An exception is thrown if no Label node matches. The name of the first child element of the SOAP body is used to determine the RouteToLabel name. For the 'RPC literal' and 'wrapped doc literal' WSDL types, this is the 'operation' name. For a SOAP tree, the first child of SOAP.Body supplies the operation name.</p> <p>If you clear the check box, the node sends the message to the Out terminal.</p>
Label Prefix	No	No		The value to prefix to the label that the node uses for routing. Entering a prefix allows for name spacing between subflows.

Example SOAP messages

Incoming SOAP message

```
<?xml version="1.0"?>
<soapenv:Envelope
xmlns:soapenv="http://schemas.xmlsoap.org/soap/envelope/"
xmlns:soapenc="http://schemas.xmlsoap.org/soap/encoding/"
xmlns:tns="http://ws3.st.mqsi.ibm.com/App/DocLiteral1"
xmlns:xsd="http://www.w3.org/2001/XMLSchema"
xmlns:xsi="http://www.w3.org/2001/XMLSchema-instance">
  <soapenv:Header>
    <tns:requestHeader>
      <tns:assessorUrl>header1</tns:assessorUrl>
    </tns:requestHeader>
  </soapenv:Header>
  <soapenv:Body>
    <tns:requestAvailability>
      <tns:carDetails>body1</tns:carDetails>
      <tns:claimID>body2</tns:claimID>
      <tns:location>body3</tns:location>
      <tns:reqDate>body4</tns:reqDate>
    </tns:requestAvailability>
  </soapenv:Body>
</soapenv:Envelope>
```

De-enveloped message

The operation name is requestAvailability. Note that the namespacing is removed from the operation.

```
<?xml version="1.0"?>
<tns:requestAvailability
xmlns:tns="http://ws3.st.mqsi.ibm.com/App/DocLiteral1"
xmlns:soapenc="http://schemas.xmlsoap.org/soap/encoding/"
xmlns:soapenv="http://schemas.xmlsoap.org/soap/envelope/"
xmlns:xsd="http://www.w3.org/2001/XMLSchema"
xmlns:xsi="http://www.w3.org/2001/XMLSchema-instance">
  <tns:carDetails>body1</tns:carDetails>
  <tns:claimID>body2</tns:claimID>
  <tns:location>body3</tns:location>
  <tns:reqDate>body4</tns:reqDate>
</tns:requestAvailability>
```

Removed envelope

```
<?xml version="1.0"?>
<soapenv:Envelope
xmlns:soapenv="http://schemas.xmlsoap.org/soap/envelope/"
xmlns:soapenc="http://schemas.xmlsoap.org/soap/encoding/"
xmlns:tns="http://ws3.st.mqsi.ibm.com/App/DocLiteral"
xmlns:xsd="http://www.w3.org/2001/XMLSchema"
xmlns:xsi="http://www.w3.org/2001/XMLSchema-instance">
  <soapenv:Header>
    <tns:requestHeader>
      <tns:assessorUrl>header1</tns:assessorUrl>
    </tns:requestHeader>
  </soapenv:Header>
</soapenv:Envelope>
```

SOAPInput node

Use the SOAPInput node to process client SOAP messages, thus enabling the broker to be a SOAP Web services provider.

This topic contains the following sections:

- “Purpose”
- “Using this node in a message flow”
- “Configuring the SOAPInput node”
- “Terminals and properties” on page 1109

Purpose

The SOAPInput node is typically used in conjunction with the SOAPReply node.

The SOAPInput node is contained in the **Web Services** drawer of the message flow node palette, and is represented in the workbench by the following icon:



Using this node in a message flow

The SOAPInput node can be used in any message flow that needs to accept SOAP messages. Look at the following sample to see how to use this node:

- SOAP Nodes sample

You can view samples only when you use the information center that is integrated with the Message Broker Toolkit.

Configuring the SOAPInput node

When you have put an instance of the SOAPInput node into a message flow, you can configure it; see “Configuring a message flow node” on page 235. The properties of the node are displayed in the Properties view.

All mandatory properties for which you must enter a value (those that do not have a default value defined) are marked with an asterisk.

1. Optional: On the **Description** tab, enter a Short description, a Long description, or both. You can also rename the node on this tab.

2. On the **Basic** tab, you must configure the following WSDL Properties. Before configuring the WSDL file on this node you must have a message set with a Deployable WSDL resource.
 - WSDL file name. This property is mandatory and is of type String. If the node was created by dropping a WSDL file from a message set onto the message flow editor, this property will be preset to the name of the WSDL file. If the name of the WSDL file is not preset, you can set this property in one of the following ways.
 - If you have Deployable WSDL, you can select from the Deployable WSDL files by clicking **Browse**.
 - If you have WSDL definitions, but no message set, then you can create a message set:
 - a. Click **Browse** to open the WSDL Selection window.
 - b. Click **Import/Create New** to open the Import WSDL file wizard.
 - c. Enter the message set name and message set project name. Click **Next**.
 - d. Choose the relevant option:
 - If your WSDL file already exists in your workspace, select **Use resources from the workspace**, and select the WSDL file.
 - If your WSDL file is in the file system, select **Use external resources**. Select the WSDL file. Click **Next**.
 - e. Select the WSDL bindings to import. Any warnings or errors are displayed in the wizard banner.
 - f. Click **Finish**. Result: Creates a new message set project and message set, with message definitions. The WSDL definitions are added to the Deployable WSDL folder.
 - g. You can now select the WSDL file from the WSDL Selection window. Click **OK**.
 - If you have a message set but no WSDL definition, you must generate a WSDL definition. See *Generating a WSDL definition from a message set*.
 - Drag a WSDL file from a message set onto the node.
 - Type in a file name that is relative to the message set project in which the deployable WSDL file exists.

When you select a WSDL file for the WSDL file name field, the WSDL is validated to ensure that it is WS-I compliant. The other properties on the **Basic** tab are automatically completed with values based on the WSDL definition.

Only Deployable WSDL can be used to configure the SOAP nodes.

After a valid WSDL file is selected, the message set project to which WSDL file belongs is added as a referenced project to the corresponding flow project, if the reference does not already exist.

If the WSDL file is not valid, or an incorrect file name is entered, an error message is displayed in the Properties view and all WSDL properties are blank.

The following situations lead to error conditions on this property:

- The WSDL file does not come from a message set project, or the WSDL file was not imported correctly; see *Importing from WSDL and Importing WSDL definitions from the command line*.
- The WSDL file contains no HTTP bindings.
- The WSDL file contains no port type.

- The WSDL file entered in the text box does not exist.
- Port type. This property is mandatory and is of type String. This field lists all of the port types defined by the specified WSDL file. By default, the first port type found in the WSDL file that has an associated HTTP binding, is selected.

Error Conditions:

- Selected Port type does not contain at least one operation.
- Imported binding. This property is mandatory and is of type String. The Imported binding box lists all of the SOAP bindings associated with the selected port type. Only HTTP transport is supported. Bindings are listed in the order that they are displayed in the WSDL file. By default, the first binding that implements the operation and has an associated service port, is selected. This property is updated every time the Port type value changes.

Error Conditions:

- No SOAP bindings (with HTTP transport) in the WSDL file are associated with the Port type.
- Selected binding does not have any operations.
- Service port. This property is mandatory and is of type String. The Service port box lists all of the service ports that point to the selected binding. The first service port for the binding is selected by default. This property is updated every time the selected binding value changes.

Error Conditions:

- No ports point to the selected binding.
- Target namespace. This property type is String. Target namespace displays the namespace of the selected WSDL file.

When you save the flow file, validation of some of the WSDL-related properties occur:

- It is validated that the WSDL file exists in the message set.
- It is validated that the selected Port type, Binding operation, and Service port are all valid within the content of the selected WSDL file.

If any of these conditions are not met, an error is generated, and you will not be able to add a flow that contains this SOAPInput node to the broker archive (bar) file.

3. On the **HTTP Transport** tab, set the following HTTP transport related properties. You can use the `mqsichangeproperties` command to change port ranges and keyStores using the BrokerRegistry component; see `mqsichangeproperties` command.
 - URL Selector. This property type is String. This property is automatically set from the `<soap:address>` element of the selected Service port. Whenever the selected port is updated, URL Selector is updated accordingly. However, if you override the value then your value persists, and the URL is no longer updated from the service port.
If you choose to override this property, you must specify the [`<path>`].
 - Use HTTPS. This property type is Boolean. This property is also automatically configured from the `<soap:address>` element of the selected Service port.
If the address contains an https URL, the check box is selected, otherwise it is not.
However, if you manually override this property value it will no longer be updated from the corresponding service port.

- Maximum client wait time (sec). Enter the Maximum client wait time timeout interval in seconds. The SOAPInput node is typically used in conjunction with the SOAPReply node. This property specifies the length of time that the TCP/IP listener that received the input message from the Web service client waits for a response from the SOAPReply node in the message flow. If a response is received within this time, the listener propagates the response to the client. If a response is not received in this time, the listener sends a SOAP Fault message to the client indicating that its timeout has expired.
4. Use the **Advanced** tab to define your headers:
- SOAP 1.1 actor (SOAP 1.2 role). This property type is String. This property enables configuring of SOAP actor (SOAP 1.1 protocol) or SOAP role (SOAP 1.2 protocol) that the SOAPInput node acts as. The default value is Ultimate Destination (Ultimate Receiver). (Ultimate Destination relates to SOAP 1.1 and Ultimate Receiver relates to SOAP 1.2). You can enter any predefined or user-defined value.
 Predefined roles are specified in the respective SOAP 1.1 or SOAP 1.2 specifications, and are used to process SOAP Headers targeted at the specific role.
 Error Conditions:
 - If you select empty, there is an error on flow validation.
 - Set destination list. This property type is Boolean. This property indicates whether to add the incoming SOAP operation to the route to label in the destination list.
 - Label prefix. This property type is String. A prefix to add to the operation name in the destination list. You must add a Label prefix if you want to use multiple SOAPInput nodes in the same flow without their corresponding label nodes clashing.
 The default prefix is an empty string so that the operation name and the label name are identical, but the field displays the user instruction: <enter a prefix if required>. This property is not enabled if the setDestinationList property is not enabled.
 - SOAP headers that are part of the must understand headers list are incorporated into the flow rather than causing a SOAP fault. Adding headers to the must understand headers list stops SOAP faults being generated by SOAP headers.
 - The WSDL-defined headers table is read-only, and is populated, based on the SOAP headers defined in the input part of all operations of the selected binding. By default, the check boxes in the second column of the table, are cleared for all entries in the WSDL-defined table. You must select the check box for those headers that you want to add to the must understand headers list.
 - You can add custom headers, that is, headers not defined in the WSDL, in the User-defined SOAP headers table. You can **Add**, **Edit**, and **Delete** rows in this table. You must ensure that the check box for the newly added custom header, in the second column of the table, is selected in order for the header to be added to the must understand headers list.
 You do not need to add must understand headers for WS-Addressing and WS-Security as these are understood if you configure **WS Extensions**.
5. Use the **WS Extensions** tab to configure WS extensions.

- Use **WS-Addressing**. This property indicates whether to engage WS-Addressing on the SOAPInput node. This check box is selected by default.
- Place **WS-Addressing Headers into LocalEnvironment**. This property specifies whether the node puts WS-Addressing headers received in the message into the LocalEnvironment tree. WS-Addressing headers are not accessible to the flow if this check box is cleared because by default, all headers are processed and removed.
- The **WS-Security** table features two columns:
 - Alias
 - XPath Expression

You can add XPath expressions with an associated Alias value to the WS-Security table. The Alias is resolved in a Policy Set that is created by the administrator. The Policy Set resolves the Alias to either encrypt or sign the part of the message referred to by the XPath Expression. You can **Add**, **Edit**, and **Delete** in this table.

6. On the **Input Message Parsing** tab, the properties are automatically set when the WSDL file property is configured, you cannot set them yourself.
 - Message domain. This value is always set to SOAP. For more information, see “SOAP parser and domain” on page 78.
 - Message set. This property is automatically set to the message set that contains the WSDL file, when the WSDL is associated with the node.
 - Message type. This property is not used.
 - Message format. This property is not used.
7. On the **Parser Options** sub tab, set properties associated with the parser. The following properties are listed on this tab:
 - Parse timing is, by default, set to On Demand, which causes parsing of the message to be delayed. To cause the message to be parsed immediately, see “Parsing on demand” on page 1363.
 - Soap Parser Options. Set values for the properties that determine how the SOAP parser operates. The SOAP parser options are passed through to the XMLNSC parser. For more information, see “Manipulating messages in the XMLNSC domain” on page 364.
8. On the **Error Handling** tab, set the properties associated with fault processing:
 - Send failures during inbound SOAP processing to failure terminal. This property type is Boolean. If a situation arises during inbound SOAP processing that results in a SOAP Fault, instead of immediately sending the SOAP Fault back to the client, send it to the Failure terminal instead, to allow logging, and recovery processing.
 In this situation an exception list is sent down the Failure terminal with the inbound message as a BLOB. The default value of this property is Cleared.
9. On the **Validation** tab, set the validation properties if you want the SOAP parser to validate the body of each input message against XML Schema generated from the message set. By default, validation is enabled. The SOAP parser invokes the XMLNSC parser to validate the XML body of the SOAP Web service. If a message is propagated to the Failure terminal of the node, it is not validated.
 For more details, see “Validating messages” on page 164 and “Validation properties” on page 1359.
10. On the **Instances** tab, you can set the following properties:
 - Additional instances pool. This property has the following values:

- Use Pool Associated with Message Flow; this value is default value.
 - Use Pool Associated with Node.
 - Additional instances. This property has the default value 0.
11. Use the **Retry** tab to define how retry processing is carried out when a failure gets rolled back to the input node:
- Retry mechanism: This property type is Enumerate and defines the format of the mechanism. Enter one of the values Failure or Short and long retry.
 - Retry threshold: This property type is Integer and defines the number of retries to correct the failure.
 - Short retry interval: This property type is Integer and defines the time the client waits in seconds before attempting to correct the failure.
 - Long retry interval: This property type is Integer and defines the time the client waits in seconds before attempting to correct the failure.

Terminals and properties

The SOAPInput node terminals are described in the following table.

Terminal	Description
Failure	The output terminal to which a message is routed if a failure is detected when the message is propagated to the Out flow (such as a message validation failure). Failures routed to this terminal include those caused by the retry processing occurring before the retry propagates the message to the Out flow.
Out	The output terminal to which the message is routed if it has been successfully put to the output queue, and if further processing is required within this message flow. If no errors occur within the input node, a message received from an external resource is always sent to the Out terminal first.
Catch	The output terminal to which the message is routed if an exception is thrown downstream and caught by this node.

The following tables describe the node properties. The column headed M indicates whether the property is *mandatory* (marked with an asterisk if you must enter a value when no default is defined); the column headed C indicates whether the property is *configurable* (you can change the value when you add the message flow to the bar file to deploy it).

The SOAPInput node Description properties are described in the following table.

Property	M	C	Default	Description
Node name	No	No	The node type	The name of the node.
Short description	No	No	None	A brief description of the node.
Long description	No	No	None	Text that describes the purpose of the node in the message flow.

The SOAPInput node Basic properties are described in the following table.

Property	M	C	Default	Description
WSDL file name	Yes	No	<None>	This property type is String. When you select a WSDL file for the WSDL file name field, the WSDL is validated to ensure that it is WS-I compliant. Only Deployable WSDL can be used to configure the SOAP nodes. After a valid WSDL file is selected, the message set project to which WSDL file belongs is added as a referenced project to the corresponding flow project, if the reference does not already exist.
Port type	Yes	No	By default, the first Port type found in the WSDL file, that has an associated HTTP binding with it, is selected.	This property type is String. This field lists all of the port types defined by the specified WSDL file. By default, the first port type found in the WSDL file that has an associated HTTP binding, is selected. Error Conditions: <ul style="list-style-type: none"> Selected Port type does not contain at least one operation.
Imported binding	Yes	No		This property type is String. The Imported binding box lists all of the SOAP bindings associated with the selected port type. Only HTTP transport is supported. Bindings are listed in the order that they are displayed in the WSDL file. By default, the first binding that implements the operation and has an associated service port, is selected. This property is updated every time the Port type value changes. Error Conditions: <ul style="list-style-type: none"> No SOAP bindings (with HTTP transport) in the WSDL file are associated with the Port type. Selected binding does not have any operations.
Service port	Yes	No		This property type is String. The Service port box lists all of the service ports that point to the selected binding. The first service port for the binding is selected by default. This property is updated every time the selected binding value changes. Error Conditions: <ul style="list-style-type: none"> No ports point to the selected binding.
Target namespace	Yes	No		This property type is String. Target namespace displays the namespace of the selected WSDL file.

The SOAPInput node HTTP Transport properties are described in the following table.

Property	M	C	Default	Description
URL selector	Yes	Yes	None	This property is the HTTP path selector upon which the node accepts inbound messages
Use HTTPS	No	Yes	Cleared	If the address contains an HTTPS URL, the check box is selected, otherwise it is not.
Maximum client wait time (sec)	Yes	Yes	180	The time the client waits for a for a remote server to respond with a 'message received' acknowledgement.

The SOAPInput node Advanced properties are described in the following table.

Property	M	C	Default	Description
SOAP 1.1 actor (SOAP 1.2 role)	Yes	No	Ultimate Destination (Ultimate Receiver)	The SOAP role the receiver is acting in.
Set destination list	No	No	Selected	This property specifies whether to add the method binding name to the route to label destination list. If you select this check box, the method binding name is added so that you can use a RouteToLabel node in the message flow after the SOAPInput node.
Label prefix	No	No	None	The prefix to add to the method name when routing to label. Add a label prefix to avoid a clash of corresponding label nodes when you include multiple input nodes in the same message flow. By default, there is no label prefix, therefore the method name and label name are identical.
WSDL defined SOAP headers	No	No		This table is read-only, and is populated by the SOAP headers defined in the output part of the selected operations. The table is updated automatically when the selected operation is updated. This property is generated in the CMF file.
User defined SOAP headers	No	Yes	None	You can add custom headers in this table. You can Add , Edit and Delete rows in this table. This property is generated in the CMF file.

The SOAPInput node WS Extensions properties are described in the following table.

Property	M	C	Default	Description
Use WS-Addressing	No	No	Cleared	This property specifies whether to use WS-Addressing.
Place WS-Addressing headers into LocalEnvironment	No	No	Cleared	This property specifies whether the node puts WS-Addressing headers received in the message into the LocalEnvironment tree. WS-Addressing headers are not accessible to the flow if this check box is cleared.
WS-Security	No	Yes		<p>This complex property is in the form of a table and consists of two columns:</p> <ul style="list-style-type: none"> • Alias • XPath Expression <p>You can add XPath expressions with an associated Alias value to the WS-Security table. The Alias is resolved in a Policy Set that is created by the administrator. The Policy Set resolves the Alias to either encrypt or sign the part of the message referred to by the XPath Expression. You can Add, Edit and Delete in this table.</p>

The SOAPInput node Input Message Parsing properties are described in the following table.

Property	M	C	Default	Description
Message domain	No	No	SOAP	The domain that is used to parse the incoming message. By default, the message that is propagated from the SOAPInput node is in the SOAP domain. You cannot specify a different domain.
Message set	Yes	No	Set automatically from the WSDL file name property.	The name of the message set in which the incoming message is defined. If you set this property, then subsequently update the project dependencies to remove this message set reference, a warning is issued. Either update the Message set property, or restore the reference to this message set project.
Message type	No	No		The name of the incoming message. The node detects the message type automatically. You cannot set this property.
Message format	No	No		The name of the physical format of the incoming message. You cannot set this property.

The SOAPInput node Parser Options properties are described in the following table.

Property	M	C	Default	Description
Parse timing	No	No	On demand	This property controls when an input message is parsed. Valid values are On demand, Immediate, and Complete. For a full description of this property, see “Parsing on demand” on page 1363.
Build tree using XML Schema data types	No	No	Selected	This property controls whether the syntax elements in the message tree has data types taken from the XML Schema.
Retain mixed content	No	No	Cleared	This property controls whether the XMLNSC parser creates elements in the message tree when it encounters mixed text in an input message. If you select the check box, elements are created for mixed text. If you clear the check box, mixed text is ignored and no elements are created.
Retain comments	No	No	Cleared	This property controls whether the XMLNSC parser creates elements in the message tree when it encounters comments in an input message. If you select the check box, elements are created for comments. If you clear the check box, comments are ignored and no elements are created.
Retain processing instructions	No	No	Cleared	This property controls whether the XMLNSC parser creates elements in the message tree when it encounters processing instructions in an input message. If you select the check box, elements are created for processing instructions. If you clear the check box, processing instructions are ignored and no elements are created.

Property	M	C	Default	Description
Opaque elements	No	No	Blank	This property is used to specify a list of elements in the input message that are to be opaquely parsed. Opaque parsing is performed only if validation is not enabled (that is, if Validate is None); entries that are specified in Opaque Elements are ignored if validation is enabled.

The SOAPInput node Error Handling property is described in the following table.

Property	M	C	Default	Description
Send failures during inbound SOAP processing to failure terminal	No	Yes	Cleared	During inbound SOAP processing, send any fault to the Failure terminal

The SOAPInput node Validation properties are described in the following table. See “Validation properties” on page 1359.

Property	M	C	Default	Description
Validate	No	Yes	Content and value	This property controls whether validation takes place. Valid values are None, Content and value, and Content.
Failure action	No	No	Exception	This property controls what happens if validation fails. You can set this property only if you set Validate to Content or Content and value. Valid values are User Trace, Local Error Log, Exception, and Exception List.

The SOAPInput node Instances properties are described in the following table.

Property	M	C	Default	Description
Additional instances pool	No	Yes	Use Pool Associated with Message Flow	The pool from which additional instances are obtained. <ul style="list-style-type: none"> If you select Use Pool Associated with Message Flow, additional instances are obtained from the message flow value. If you select Use Pool Associated with Node, additional instances are allocated from the node’s additional instances based on the number specified in the Additional instances property.
Additional instances	No	Yes	0	The number of additional instances that the node can start if the Additional instances pool property is set to Use Pool Associated with Node. By default, no additional instances are given to the node.

The SOAPInput node Retry properties are described in the following table.

Property	M	C	Default	Description
Retry mechanism	No	No	Failure	This property specifies how retry processing is handled when a failure is rolled back to the SOAPInput node. <ul style="list-style-type: none"> • If you select Failure, retry processing is not performed so you cannot set the remaining properties. • If you select Short and long retry, retry processing is performed first at the interval that is specified by the Short retry interval property, and if that is unsuccessful, it is then performed at the interval that is specified by the Long retry interval property.
Retry threshold	No	Yes	0	The maximum number of times that retry processing is performed for short retry.
Short retry interval	No	Yes	0	The interval between short retry attempts.
Long retry interval	No	Yes	0	The interval between long retry attempts.

SOAPReply node

Use the SOAPReply node to send SOAP messages from the broker to the originating client in response to a message received by a SOAPInput node.

This topic contains the following sections:

- “Purpose”
- “Using this node in a message flow”
- “Working with WrittenDestination data”
- “Terminals and properties” on page 1115

Purpose

The SOAPReply node is contained in the **Web Services** drawer of the message flow node palette, and is represented in the workbench by the following icon:



Using this node in a message flow

The SOAPReply node can be used in any message flow that needs to send SOAP messages from the broker to the originating client in response to a message received by a SOAPInput node. Look at the following sample to see how to use this node:

- SOAP Nodes sample

You can view samples only when you use the information center that is integrated with the Message Broker Toolkit.

Working with WrittenDestination data

After the reply has been made, the WrittenDestination folder in the LocalEnvironment is updated if WS-Addressing is in use, and with transport details if WS-Addressing is in non-anonymous mode. A WrittenDestination for a SOAPReply node has the following format:

```

WrittenDestination = (
  SOAP = (
    Reply = (
      WSA = (
        To = 'URI'
        MessageID = 'id'
        Action = 'doAllTheStuff'
      )
    )
  )
)

```

Terminals and properties

When you have put an instance of the SOAPReply node into a message flow, you can configure it; see “Configuring a message flow node” on page 235. The properties of the node are displayed in the Properties view. All mandatory properties for which you must enter a value (those that do not have a default value defined) are marked with an asterisk.

The SOAPReply node terminals are described in the following table.

Terminal	Description
In	The input terminal that accepts a message for processing by the node.
Failure	The output terminal to which the message is routed if a failure is detected when the message is propagated.
Out	The output terminal to which the message is routed if it has been propagated successfully, and if further processing is required within this message flow.

The following tables describe the node properties. The column headed M indicates whether the property is *mandatory* (marked with an asterisk if you must enter a value when no default is defined); the column headed C indicates whether the property is *configurable* (you can change the value when you add the message flow to the bar file to deploy it).

The SOAPReply node Description properties are described in the following table.

Property	M	C	Default	Description
Node name	No	No	The node type: SOAPReply	The name of the node.
Short description	No	No	None	A brief description of the node.
Long description	No	No	None	Text that describes the purpose of the node in the message flow.

The SOAPReply node Validation properties are described in the following table. By default, validation is enabled.

If a message is propagated to the Failure terminal of the node, it is not validated. For more details, see “Validating messages” on page 164 and “Validation properties” on page 1359.

Property	M	C	Default	Description
Validate	No	Yes	Inherit	This property controls whether validation takes place. Valid values are None, Content and Value, Content, and Inherit.

Property	M	C	Default	Description
Failure action	No	No	User trace	This property controls what happens if validation fails. You can set this property only if you set Validate to Content or Content and Value. Valid values are User trace, Local error log, Exception, and Exception list.

The SOAPReply node Parser Options property is described in the following table.

Property	M	C	Default	Description
Allow MTOM	No	Yes	No	This property controls whether MTOM is enabled for the parser. Valid values are Yes, No, and Inherit. For more information about using SOAP MTOM with the SOAPReply, SOAPRequest, and SOAPAsyncRequest nodes, see “Using SOAP MTOM with the SOAPReply, SOAPRequest, and SOAPAsyncRequest nodes” on page 634.

SOAPRequest node

Use the SOAPRequest node to send a SOAP request to the remote Web service. The node is a synchronous request and response node and blocks after sending the request until the response is received.

This topic contains the following sections:

- “Purpose”
- “Using this node in a message flow”
- “Configuring the SOAPRequest node”
- “Working with WrittenDestination data” on page 1120
- “LocalEnvironment overrides” on page 1121
- “Terminals and properties” on page 1121

Purpose

The SOAPRequest node is contained in the **Web Services** drawer of the message flow node palette, and is represented in the workbench by the following icon:



Using this node in a message flow

The SOAPRequest node can be used in any message flow that needs to call a Web service. Look at the following sample to see how to use this node:

- SOAP Nodes sample

You can view samples only when you use the information center that is integrated with the Message Broker Toolkit.

Configuring the SOAPRequest node

When you have put an instance of the SOAPRequest node into a message flow, you can configure it; see “Configuring a message flow node” on page 235. The properties of the node are displayed in the Properties view.

All mandatory properties for which you must enter a value (those that do not have a default value defined) are marked with an asterisk.

1. Optional: On the **Description** tab, enter a Short description, a Long description, or both. You can also rename the node on this tab.
2. On the **Basic** tab, you must configure the following WSDL Properties. Before configuring the WSDL file on this node you must have a message set with a Deployable WSDL resource.
 - WSDL file name. This property is mandatory and is of type String. If the node was created by dropping a WSDL file from a message set onto the message flow editor, this property will be preset to the name of the WSDL file. If the name of the WSDL file is not preset, you can set this property in one of the following ways.
 - If you have Deployable WSDL, you can select from the Deployable WSDL files by clicking **Browse**.
 - If you have WSDL definitions, but no message set, then you can create a message set:
 - a. Click **Browse** to open the WSDL Selection window.
 - b. Click **Import/Create New** to open the Import WSDL file wizard.
 - c. Enter the message set name and message set project name. Click **Next**.
 - d. Choose the relevant option:
 - If your WSDL file already exists in your workspace, select **Use resources from the workspace**, and select the WSDL file.
 - If your WSDL file is in the file system, select **Use external resources**. Select the WSDL file. Click **Next**.
 - e. Select the WSDL bindings to import. Any warnings or errors are displayed in the wizard banner.
 - f. Click **Finish**. Result: Creates a new message set project and message set, with message definitions. The WSDL definitions are added to the Deployable WSDL folder.
 - g. You can now select the WSDL file from the WSDL Selection window. Click **OK**.
 - If you have a message set but no WSDL definition, you must generate a WSDL definition. See *Generating a WSDL definition from a message set*.
 - Drag a WSDL file from a message set onto the node.
 - Type in a file name that is relative to the message set project in which the deployable WSDL file exists.

When you select a WSDL file for the WSDL file name field, the WSDL is validated to ensure that it is WS-I compliant. The other properties on the **Basic** tab are automatically completed with values based on the WSDL definition.

Only Deployable WSDL can be used to configure the SOAP nodes.

After a valid WSDL file is selected, the message set project to which WSDL file belongs is added as a referenced project to the corresponding flow project, if the reference does not already exist.

If the WSDL file is not valid, or an incorrect file name is entered, an error message is displayed in the Properties view and all WSDL properties are blank.

The following situations lead to error conditions on this property:

- The WSDL file does not come from a message set project, or the WSDL file was not imported correctly; see *Importing from WSDL and Importing WSDL definitions from the command line*.
- The WSDL file contains no HTTP bindings.

- The WSDL file contains no port type.
- The WSDL file entered in the text box does not exist.
- Port type. This property is mandatory and is of type String. This field lists all of the port types defined by the specified WSDL file. By default, the first port type found in the WSDL file that has an associated HTTP binding, is selected.

Error Conditions:

- Selected Port type does not contain at least one operation.
- Imported binding. This property is mandatory and is of type String. The Imported binding box lists all of the SOAP bindings associated with the selected port type. Only HTTP transport is supported. Bindings are listed in the order that they are displayed in the WSDL file. By default, the first binding that implements the operation and has an associated service port, is selected. This property is updated every time the Port type value changes.

Error Conditions:

- No SOAP bindings (with HTTP transport) in the WSDL file are associated with the Port type.
- Selected binding does not have any operations.
- Binding operation. This property is mandatory and is of type String. The Binding operation box lists all of the operations defined by the selected binding. The first operation in the list is selected by default. This property is updated every time the selected binding value changes.
- Service port. This property is mandatory and is of type String. The Service port box lists all of the service ports that point to the selected binding. The first service port for the binding is selected by default. This property is updated every time the selected binding value changes.

Error Conditions:

- No ports point to the selected binding.
- Target namespace. This hidden property type is String. Target namespace is implemented as a read-only field. This property is updated with the Target namespace of the WSDL file when the WSDL file name is configured.

3. On the **HTTP Transport** tab, set the HTTP transport related properties:

- Web service URL. This property is mandatory and is of type String. This is automatically derived from the <soap:address> element of the selected Service port. Whenever the selected port is updated, the Web service URL is updated accordingly. However, if you override the value then your value persists and the URL is no longer updated from the service port.

If you choose to override this property you must specify it in the form `http://<hostname>[:<port>]/[<path>]` where:

- `http://<hostname>` must be specified.
- `<port>` has a default of 80. If you specify a value, you must include the colon `:` before the port number.
- `<path>` has a default of `/`. If you specify a value, you must include the `/` before the path.

For more details of how to override this property, see Changing the default URL for a SOAPRequest node or a SOAPAsyncRequest node request.

- Request timeout (in seconds). This property type is Integer. This is the wait time for a remote server to respond with a 'message received' acknowledgement.
- HTTP(S) proxy location. This property type is String. This is the location of the proxy server to which requests are sent.

- Protocol (if using SSL) This property type is Enumerate. The following options are available:

SSL (the default). This option tries to connect using the SSLv3 protocol first, but allows the handshake to fall back to the SSLv2 protocol where the SSLv2 protocol is supported by the underlying JSSE provider.

SSLv3 This option tries to connect with the SSLv3 protocol only. Fallback to SSLv2 is not allowed.

TLS This option tries to connect with the TLS protocol only. Fallback to SSLv3 or SSLv2 is not allowed.

Note that both ends of an SSL connection must agree on the protocol to use, so the chosen protocol must be one that the remote server can accept.

- Allowed SSL ciphers (if using SSL) This property type is String. This setting allows you to specify a single cipher (such as `SSL_RSA_FIPS_WITH_3DES_EDE_CBC_SHA`) or a list of ciphers that are the only ones used by the connection. This set of ciphers must include one or more that are accepted by the remote server.

A comma is used as a separator between the ciphers. The default value is an empty string, which allows the node to use any, or all, of the available ciphers during the SSL connection handshake. This method allows the greatest scope for making a successful SSL connection.

4. Use the **Advanced** tab to define your headers.

SOAP headers that are part of the must understand headers list are incorporated into the flow rather than causing a SOAP fault. Adding headers to the must understand headers list stops SOAP faults being generated by SOAP headers.

- The WSDL-defined SOAP headers table is read-only, and is populated based on the SOAP headers defined in the output part of the selected operations. By default, the check boxes, in the second column of the table, are cleared for all entries in the WSDL-defined SOAP headers table. You must select the relevant check box to add the header to the must understand headers list.
- You can add custom headers (headers that are not defined in the WSDL file) in the User-defined SOAP headers table. Use **Add**, **Edit**, and **Delete** for this table. You must select the check box, in the second column of the table, to ensure that the newly added custom header is added to the must understand headers list.

You do not need to add must understand headers for WS-Addressing and WS-Security as these are understood if you configure **WS Extensions**.

5. Use the **WS Extensions** tab to implement WS extensions.

- Use WS-Addressing. This property indicates whether to engage WS-Addressing on the SOAPRequest node.
- Place WS-Addressing Headers into LocalEnvironment. This property specifies whether the node puts WS-Addressing headers received in the response message into the LocalEnvironment tree. WS-Addressing headers are not accessible to the flow if this check box is cleared because by default, all headers are processed and removed.
- The WS-Security table features two columns:
 - Alias
 - XPath Expression

|
|
|
|
|

You can add XPath expressions with an associated Alias value to the WS-Security table. The Alias is resolved in a Policy Set that is created by the administrator. The Policy Set resolves the Alias to either encrypt or sign the part of the message referred to by the XPath expression. You can **Add**, **Edit**, and **Delete** in this table.

For more details about WS-Addressing with the SOAPRequest node, see “WS-Addressing with the SOAPRequest node” on page 639.

6. On the **Response Message Parsing** tab, the properties are automatically set when the WSDL file property is configured, you cannot set them yourself.
 - Message domain. This value is always set to SOAP. For more information, see “SOAP parser and domain” on page 78.
 - Message set. This property is automatically set to the message set that contains the WSDL file, when the WSDL is associated with the node.
 - Message type. This property is not used.
 - Message format. This property is not used.
7. On the **Parser Options** sub tab, set properties associated with the parser. The following properties are listed on this tab:
 - Parse timing is, by default, set to On Demand, which causes parsing of the message to be delayed. To cause the message to be parsed immediately, see “Parsing on demand” on page 1363.
 - Soap Parser Options. Set values for the properties that determine how the SOAP parser operates. The SOAP parser options are passed through to the XMLNSC parser. For more information, see “Manipulating messages in the XMLNSC domain” on page 364.
8. On the **Validation** tab, set the validation properties if you want the SOAP parser to validate the body of each input message against XML Schema generated from the message set. By default, validation is enabled. The SOAP parser invokes the XMLNSC parser to validate the XML body of the SOAP Web service. If a message is propagated to the Failure terminal of the node, it is not validated.

For more details, see “Validating messages” on page 164 and “Validation properties” on page 1359.

Working with WrittenDestination data

After the request has been made, the WrittenDestination folder in the LocalEnvironment is updated with the WS-Addressing (if in use) and transport details. A WrittenDestination for a SOAPRequest node has the following format, with WS-Addressing present only if it is used:

```
WrittenDestination = (  
  SOAP = (  
    Request = (  
      WSA = (  
        To = 'URI'  
        MessageID = 'id'  
        Action = 'doAllTheStuff'  
      )  
    )  
    Transport = (  
      HTTP = (  
        WebServiceURL = 'http://server:8080/thing'  
      )  
    )  
  )  
)
```

LocalEnvironment overrides

You can dynamically override set values in LocalEnvironment in the same way as setting values in other elements of a message. You can set the following properties under LocalEnvironment.Destination.SOAP.Request.Transport.HTTP.

Setting	Description
WebServiceURL	Overrides the Web service URL property on the node. For example: SET OutputLocalEnvironment.Destination.SOAP.Request.Transport.HTTP.WebServiceURL = 'http://ibm.com/abc/';
RequestURI	Overrides the RequestURI, which is the path after the URL and port. For example: SET OutputLocalEnvironment.Destination.SOAP.Request.Transport.HTTP.RequestURI = '/abc/def?x=y&g=h';
Timeout	Overrides the Request timeout (in seconds) property on the node. For example: SET OutputLocalEnvironment.Destination.SOAP.Request.Transport.HTTP.Timeout = 42;
ProxyURL	Overrides the HTTP(S) proxy location property on the node. For example: SET OutputLocalEnvironment.Destination.SOAP.Request.Transport.HTTP.ProxyURL = 'my.proxy';
SSLProtocol	Overrides the SSLProtocol property on the node. For example: SET OutputLocalEnvironment.Destination.SOAP.Request.Transport.HTTP.SSLProtocol = 'TLS'; Valid values are SSL, SSLv3, and TLS.
SSLCiphers	Overrides the Allowed SSL Ciphers (if using SSL) property on the node. For example: SET OutputLocalEnvironment.Destination.SOAP.Request.Transport.HTTP.SSLCiphers = 'SSL_RSA_FIPS_WITH_3DES_EDE_CBC_SHA';
HTTPVersion	Overrides the HTTPVersion. For example: SET OutputLocalEnvironment.Destination.SOAP.Request.Transport.HTTP.HTTPVersion = 'HTTP/1.1';
Method	Overrides the Method. For example: SET OutputLocalEnvironment.Destination.SOAP.Request.Transport.HTTP.Method = 'GET';
ProxyConnectHeaders	Sets the ProxyConnectHeaders. Set this, when using a proxy server, to send extra SOAP headers when connecting to that server. For example, this allows you to send proxy authentication information to a proxy server. Multiple headers can be sent but each must be separated by a carriage return and a line feed (ASCII 0x0D 0x0A) in accordance with RFC2616. For example: DECLARE CRLF CHAR CAST(X'0D0A' AS CHAR CCSID 1208); SET OutputLocalEnvironment.Destination.SOAP.Request.Transport.HTTP.ProxyConnectHeaders = 'Proxy-Authorization: Basic Zm5lcmJsZTpwYXNzd29yZAo=' CRLF 'Proxy-Connection: Keep-Alive' CRLF;

Terminals and properties

The SOAPRequest node terminals are described in the following table.

Terminal	Description
Failure	The output terminal to which a message is routed if a failure is detected when the message is propagated to the Out flow (such as a message validation failure). Failures routed to this terminal include those caused by the retry processing occurring before the retry propagates the message to the Out flow.

Terminal	Description
Out	The output terminal to which the message is routed if it has been successfully put to the output queue, and if further processing is required within this message flow. If no errors occur within the input node, a message received from an external resource is always sent to the Out terminal first.
Catch	The output terminal to which the message is routed if an exception is thrown downstream and caught by this node.

The following tables describe the node properties. The column headed M indicates whether the property is *mandatory* (marked with an asterisk if you must enter a value when no default is defined; the column headed C indicates whether the property is *configurable* (you can change the value when you add the message flow to the bar file to deploy it).

The SOAPRequest node Description properties are described in the following table.

Property	M	C	Default	Description
Node name	No	No	The node type	The name of the node.
Short description	No	No	None	A brief description of the node.
Long description	No	No	None	Text that describes the purpose of the node in the message flow.

The SOAPRequest node Basic properties are described in the following table.

Property	M	C	Default	Description
WSDL file name	Yes	No	<None>	This property type is String. When you select a WSDL file for the WSDL file name field, the WSDL is validated to ensure that it is WS-I compliant. Only Deployable WSDL can be used to configure the SOAP nodes. After a valid WSDL file is selected, the message set project to which WSDL file belongs is added as a referenced project to the corresponding flow project, if the reference does not already exist.
Port type	Yes	No	By default, the first Port type found in the WSDL file, that has an associated HTTP binding with it, is selected.	This property type is String. The field lists all of the Port types defined in WSDL file selected in the WSDL file name property. Error Conditions: <ul style="list-style-type: none"> Selected Port type does not contain at least one operation.

Property	M	C	Default	Description
Imported binding	Yes	No		<p>This property type is String.</p> <p>This property is updated every time that the Port type value changes. The field lists all of the SOAP bindings with HTTP transport (6.1) associated with the selected Port type. Bindings are listed in the same order in which they appear in the WSDL file. The selected binding is the one that has both ports and operations. If there is no such binding, then binding with ports is selected. If no bindings have ports then the first binding in the list is selected.</p> <p>Error Conditions:</p> <ul style="list-style-type: none"> • No SOAP bindings (with HTTP transport) in the WSDL file are associated with the Port type. • The selected binding does not have any operations.
Binding operation	Yes	No		<p>This property type is String.</p> <p>The Binding operation box contains all of the operations defined by the selected binding. The first operation in the list is selected by default.</p>
Service port	Yes	No		<p>This property type is String. This field is updated every time that the selected binding is updated. This field lists all of the WSDL ports that point to the selected binding. The first port for the binding is the selected port by default.</p> <p>Error Conditions:</p> <ul style="list-style-type: none"> • No ports point to the selected binding.
Target namespace	Yes	No		<p>Target namespace is implemented as a read-only field.</p> <p>This hidden property type is String. It is updated with the Target namespace of the WSDL file when the WSDL file name is configured.</p>

The SOAPRequest node HTTP Transport properties are described in the following table.

Property	M	C	Default	Description
Web service URL	Yes	Yes	SOAP address of the selected port	The URL of the SOAP address selected.
Request timeout (in seconds)	No	Yes	180	The time the client waits for a for a remote server to respond with a 'message received' acknowledgement.
HTTP(S) proxy location	No	Yes	Blank	The location of the proxy server.
Protocol (if using SSL)	No	Yes	SSL	The selected protocol if you use SSL
Allowed SSL ciphers (if using SSL)	No	Yes	None	The specific SSL cipher, or ciphers, you are using.

The SOAPRequest node Advanced properties are described in the following table.

Property	M	C	Default	Description
WSDL-defined SOAP headers	No	No		This table is read-only, and is populated by the SOAP headers defined in the output part of the selected operations. The table is updated automatically when the selected operation is updated. This property is generated in the CMF file.
User-defined SOAP headers	No	Yes	None	You can add custom headers in this table. You can Add , Edit and Delete in this table. This property is generated in the CMF file.

The SOAPRequest node WS Extensions properties are described in the following table.

Property	M	C	Default	Description
Use WS-Addressing	No	No		This property specifies whether to use WS-Addressing.
Place WS-Addressing headers into LocalEnvironment	No	No	Cleared	This property specifies whether the node puts WS-Addressing headers received in the response message into the LocalEnvironment tree. WS-Addressing headers are not accessible to the flow if this check box is cleared because by default, all headers are processed and removed.
WS-Security	No	Yes		This complex property is in the form of a table and consists of two columns: <ul style="list-style-type: none"> • Alias • XPath Expression You can add XPath expressions with an associated Alias value to the WS-Security table. The Alias is resolved in a Policy Set that is created by the administrator. The Policy Set resolves the Alias to either encrypt or sign the part of the message referred to by the XPath Expression. You can Add , Edit and Delete in this table.

The SOAPRequest node Response Message Parsing properties are described in the following table.

Property	M	C	Default	Description
Message domain	No	No	SOAP	The domain that is used to parse the response message. By default, the message that is propagated from the SOAPInput node is in the SOAP domain. You cannot specify a different domain.
Message set	Yes	No	Set automatically from the WSDL file name property.	The name of the message set in which the response message is defined. If you set this property, then subsequently update the project dependencies to remove this message set reference, a warning is issued. Either update the Message set property, or restore the reference to this message set project.
Message type	No	No		The name of the response message. The node detects the message type automatically. You cannot set this property.

Property	M	C	Default	Description
Message format	No	No		The name of the physical format of the response message. You cannot set this property.

The SOAPRequest node Parser Options properties are described in the following table.

Property	M	C	Default	Description
Parse timing	No	No	On demand	This property controls when a response message is parsed. Valid values are On demand, Immediate, and Complete. For a full description of this property, see "Parsing on demand" on page 1363.
Build tree using XML schema data types	No	No	Set	This property controls whether the syntax elements in the message tree has data types taken from the XML Schema.
Retain mixed content	No	No	Cleared	This property controls whether the XMLNSC parser creates elements in the message tree when it encounters mixed text in a response message. If you select the check box, elements are created for mixed text. If you clear the check box, mixed text is ignored and no elements are created.
Retain comments	No	No	Cleared	This property controls whether the XMLNSC parser creates elements in the message tree when it encounters comments in a response message. If you select the check box, elements are created for comments. If you clear the check box, comments are ignored and no elements are created.
Retain processing instructions	No	No	Cleared	This property controls whether the XMLNSC parser creates elements in the message tree when it encounters processing instructions in a response message. If you select the check box, elements are created for processing instructions. If you clear the check box, processing instructions are ignored and no elements are created.
Opaque elements	No	No	Blank	This property is used to specify a list of elements in the input message that are to be opaquely parsed. Opaque parsing is performed only if validation is not enabled (that is, if Validate is None); entries that are specified in Opaque Elements are ignored if validation is enabled.

The SOAPRequest node Validation properties are described in the following table.

Property	M	C	Default	Description
Validate	No	Yes	Content and value	This property controls whether validation takes place. Valid values are None, Content and value, and Content.
Failure action	No	Yes	Exception	This property controls what happens if validation fails. You can set this property only if you set Validate to Content or Content and value. Valid values are User trace, Local error log, Exception, and Exception list.

The SOAPRequest node Request Parser Options property is described in the following table.

Property	M	C	Default	Description
Allow MTOM	No	Yes	No	This property controls whether MTOM is enabled for the parser. Valid values are Yes, No, and Inherit. For more information about using SOAP MTOM with the SOAPReply, SOAPRequest, and SOAPAsyncRequest nodes, see “Using SOAP MTOM with the SOAPReply, SOAPRequest, and SOAPAsyncRequest nodes” on page 634.

TCPIPClientInput node

Use the TCPIPClientInput node to create a client connection to a raw TCP/IP socket, and to receive data over that connection.

This topic contains the following sections:

- “Purpose”
- “Using the TCPIPClientInput node in a message flow” on page 1128
- “Configuring the TCPIPClientInput node” on page 1128
- “Terminals and properties” on page 1132

Purpose

The TCPIPClientInput node opens connections to a remote server application that is listening on a TCP/IP port. The connections are not made directly by the node but are obtained from a connection pool managed by the message broker execution group. The execution group uses the default TCPIPClient configurable service to determine which attributes are used for the socket connection. However, if the configurable service is set on the node, the configurable service is used for all the properties, including the host and port number.

The node requests a client connection that contains data ready for reading. Until such a connection is available the node is paused waiting for data (in a similar way to the MQ input node). Therefore, two criteria must be met before the node becomes active:

- A client connection has been made
- There is at least 1 byte of data available to be processed.

By default (as set in the configurable service), no client connections are made by the input node. It relies on the creation of client connections by output or request nodes. In this mode of operation, an input node is never started until an output or request node starts an interaction.

The mode can be changed on the configurable service to create a pool of client connections ready for processing. To enable this function, minimumConnections must be set to a value larger than zero. The execution group then ensures that the specified number of connections are always available by creating them at start up and continuing to make them until the minimum value is reached.

This is different from the TCPIPServerInput node, which does not attempt to make a minimum number of connections. For more information, see “TCPIPServerInput node” on page 1158.

The client node also has a maximum value, which limits how many connections it can create. There can be more connections than the minimum value as a result of output nodes creating connections.

When connections are available, the second criterion is met when there is at least 1 byte of data to be processed; otherwise the connection closes. In either case the connection is given to the node and the event is processed.

The first record of data is detected in accordance with properties on the node and then sent to the Out terminal. If an error occurs, including a timeout waiting for data or the closure of a connection while waiting for the full record, the data is sent to the failure terminal. If the connection closes and there is no data, a message is sent to the Close terminal. Although the message has no data, the local environment does have details of the connection that closed.

For both data and close events, the following local environment is created:

Table 35. Location in local environment

Location in local environment	Description
\$LocalEnvironment/TCPIP/Input/ConnectionDetails/Type	Client
\$LocalEnvironment/TCPIP/Input/ConnectionDetails/Hostname	The hostname used to make a connection
\$LocalEnvironment/TCPIP/Input/ConnectionDetails/Port	The port number used to make a connection
\$LocalEnvironment/TCPIP/Input/ConnectionDetails/OpenTimestamp	The timestamp when the connection was first opened
\$LocalEnvironment/TCPIP/Input/ConnectionDetails/CloseTimestamp	The timestamp when the connection was closed (null if not yet closed)
\$LocalEnvironment/TCPIP/Input/ConnectionDetails/SequenceNumber/InputRecord	The sequence number of the message received on this connection. The first record has a sequencing number of 1. The second record has a sequencing number of 2, and so on.
\$LocalEnvironment/TCPIP/Input/ConnectionDetails/SequenceNumber/OutputRecord	The sequence number of the message sent on this connection. The first record has a sequencing number of 1. The second record has a sequencing number of 2, and so on.
\$LocalEnvironment/TCPIP/Input/ConnectionDetails/Id	The ID of the socket being used. This is an internal identifier used by the message broker to uniquely identify a connection.
\$LocalEnvironment/TCPIP/Input/ConnectionDetails/ReplyId	The Reply ID that has been stored on this connection. It can be any text string.

When the node has constructed the record from the connection stream it releases the connection back to the connection pool for use by other nodes. Properties on the Advanced panel of the node control how that connection can be used by other nodes in the future. By default, the Advanced options mark the input stream on the TCP/IP connection as being reserved, which means that no other input node can use it, until the message flow's current use is finished. Alternatively, you can choose to reserve the connection until it is unreserved by another node, or to not reserve it at all but allow any other node (or thread in this node) to use the connection straight away. Similar options are available on the output stream but it is kept unreserved by default.

A reserved stream can be accessed by another node only if the ID of the connection is known. This allows all the nodes in a message flow to access the same connection using the same ID while stopping any other flow acquiring the connection.

The TCPIPClientInput node is contained in the **TCPIP** drawer of the palette, and is represented in the workbench by the following icon:



Message structure

The TCPIPClientInput node handles messages in the following message domains:

- MRM
- XMLNSC
- DataObject
- XMLNS
- JMSMap
- JMSStream
- MIME
- BLOB
- XML (this domain is deprecated; use XMLNSC)
- IDOC (this domain is deprecated; use MRM)

Using the TCPIPClientInput node in a message flow

Look at the following samples to see how to use the TCPIPClientInput node:

- TCPIP Client Nodes sample
- TCPIP Handshake sample.

You can view samples only when you use the information center that is integrated with the Message Broker Toolkit.

Configuring the TCPIPClientInput node

When you have put an instance of the TCPIPClientInput node into a message flow, you can configure it; see “Configuring a message flow node” on page 235. The properties of the node are displayed in the Properties view.

All mandatory properties that do not have a default value defined are marked with an asterisk.

Configure the TCPIPClientInput node:

1. Optional: On the **Description** tab, enter a Short description, a Long description, or both. You can also rename the node on this tab.
2. On the **Basic** tab, set the properties that determine how the TCP/IP connection is controlled.
 - Use the Connection details property to specify either the hostname and port number to be used, or the name of a configurable service. This property is mandatory. The following formats are supported:
 - Configurable service name. This is used to look up the port and hostname in configurable services. For example, TCPIPProfile1.

- <Hostname>:<Port>. This is the hostname followed by the port number (separated by a colon). For example, tcpip.server.com:1111
 - <Port>. This is the port number. In this case the hostname is assumed to be localhost.
 - Use the Timeout waiting for a data record (seconds) property to specify how long the node will listen on a connection for more data after the first byte of data has arrived. You can specify any length of time in seconds. A value of -1 specifies that there is no time limit (wait forever). The default is 60 seconds. When the specified time has been exceeded, all available data is sent to the failure terminal.
3. On the **Advanced** tab, set the properties that determine how the data stream is controlled.
- Use the Close connection property to specify when and how to close the connection.
 - Select No to leave the connection open. This is the default.
 - Select After timeout to close the connection when a timeout occurs.
 - Select After data has been received to close the connection when the end of the record is found.
 - Select At end of flow to close the connection after the flow has been invoked.
 - Select Close input stream after a record has been received to close the input stream as soon as the data has been retrieved. When the connection input stream is reserved no other node can use it without specifying the ID. This property is not selected by default.
 - Use the Input Stream Modification property to specify whether to reserve the input stream for use only by input and receive nodes that specify the connection ID, and, if so, whether to release it at the end of the flow. These options are available only if you have not selected the Close input stream after a record has been received property.
 - Select Leave unchanged to leave the input stream as it was when it entered the node. This is selected by default.
 - Select Reserve input stream (for use by future TCP/IP input and receive nodes) to specify that this input stream can be used only by this node and by other receive nodes that request it by specifying the connection ID. When the connection input stream is reserved no other nodes can use it without specifying the correct connection ID.
 - Select Reserve input stream (for use by future TCP/IP input and receive nodes) then release at end of flow to specify that this input stream can be used only by this node and receive nodes that request it by specifying the correct connection ID. After the flow has been run, this input stream is returned to the pool and becomes available for use by any input or receive node.
 - Use the Output Stream Modification property to specify whether to release the output stream.
 - Select Leave unchanged to leave the output stream as it was when it entered the node. This is selected by default.
 - Select Release output stream and reset ReplyID to specify that this output stream is returned to the pool and is available for use by any output node. The ReplyID is passed in the LocalEnvironment when leaving this node, but is reset for the next record on this connection.
4. On the **Input Message Parsing** tab, set values for the properties that the node uses to determine how to parse the incoming message.

If the incoming message has an MQRFH2 header, you do not need to set values for the Input Message Parsing properties because the values are derived from the <mcd> folder in the MQRFH2 header; for example:

```
<mcd><Msgd>MRM</Msgd><Set>DHM4U0906S001</Set><Type>receiptmsg1</Type>  
<Fmt>XML</Fmt></mcd>
```

If you set values, and those values differ from those in the MQRFH2 header, the values in the MQRFH2 header take precedence.

- In Message domain, select the name of the parser that you are using from the list. The default is BLOB. You can choose from the following options:
 - MRM
 - XMLNSC
 - DataObject
 - XMLNS
 - JMSMap
 - JMSStream
 - MIME
 - BLOB
 - XML (this domain is deprecated; use XMLNSC)
 - IDOC (this domain is deprecated; use MRM)

You can also specify a user-defined parser, if appropriate.

- If you are using the MRM or IDOC parser, or the XMLNSC parser in validating mode, select the Message set that you want to use. The list contains the message sets that are available when you select MRM, XMLNSC, or IDOC as the domain.
 - If you are using the MRM parser, select the correct message type from the list in Message type. This list is populated with available message types when you select the MRM parser.
 - If you are using the MRM or IDOC parser, select the correct message format from the list in Message format. This list is populated with available message formats when you select the MRM or IDOC parser.
 - Specify the message coded character set ID in Message coded character set ID.
 - Select the message encoding from the list in Message encoding or specify a numeric encoding value. For more information about encoding, see “Converting data with message flows” on page 128.
5. On the **Parser Options** sub-tab:
 - Parse timing is, by default, set to On Demand, which causes parsing of the message to be delayed. To cause the message to be parsed immediately, see “Parsing on demand” on page 1363.
 - If you are using the XMLNSC parser, set values for the properties that determine how the XMLNSC parser operates. For more information, see “Manipulating messages in the XMLNSC domain” on page 364.
 6. Use the **Retry** tab to define how retry processing is performed when a flow fails. You can set the following:
 - Retry mechanism determines the action that occurs should the flow fail. Choose from the following:
 - Select Failure for the node to report a failure without any retry attempts.
 - Select Short retry for the node to retry before reporting a failure if the condition persists. The number of times that it retries is specified in Retry threshold.
 - Select Short retry and long retry for the node to retry, first using the value in Retry threshold as the number of attempts it should make. If the

condition persists after the Retry threshold has been reached, the node then uses the Long retry interval between attempts.

- Specify the Retry threshold. The number of times the node retries the flow transaction if the Retry mechanism property is set to either Short retry or Short retry and long retry.
- Specify the Short retry interval. The length of time, in seconds, to wait between short retry attempts.
- Specify the Long retry interval. The length of time to wait between long retry attempts until a message is successful, the message flow is stopped, or the message flow is redeployed. The broker property **MinLongRetryInterval** defines the minimum value that the Long retry interval can take. If the value is lower than the minimum then the broker value is used.

7. Use the **Records and Elements** tab to specify how the data is interpreted as records:

- Use the Record detection property to determine how the data is split into records, each of which generates a single message. Choose from the following options:
 - End of stream specifies that all of the data sent in the data stream is a single record.
 - Fixed Length specifies that each record is a fixed number of bytes in length. Each record should contain the number of bytes specified in the Length property, except possibly a shorter final record in the file.
 - Select Delimited, if the records you are processing are separated, or terminated, by a DOS or UNIX line end or by a sequence of user-defined delimiter bytes. Specify the delimiter and delimiter type in the Delimiter, and Delimiter type properties.
 - Select Parsed Record Sequence if the data contains a sequence of one or more records that are serially recognized by the parser that is specified in Message domain. The node propagates each recognized record as a separate message. If you select this Record detection option, the parser specified in Message domain must be either XMLNSC or MRM (either CWF or TDS physical format).
- If you specified Fixed Length in Record detection, use Length to specify the required length of the output record. This value must be between 1 byte and 100 MB. The default is 80 bytes.

If you specify Connection closed, Fixed Length, or Delimited in Record detection, a limit of 100 MB applies to the length of the records. If you specify Parsed Record Sequence in Record detection, the TCP/IP Client Input node does not determine or limit the length of a record. Nodes that are downstream in the message flow might try to determine the record length or process a very long record. If you intend to process large records in this way, ensure that your broker has sufficient memory. You might need to apply flow techniques described in the Large Messaging sample to best use the available memory.

- If you specified Delimited in Record detection, use Delimiter to specify the delimiter to be used. Choose from:
 - DOS or UNIX Line End, which, on UNIX systems, specifies the line feed character (<LF>, X'0A'), and, on Windows systems, specifies a carriage return character followed by a line feed character (<CR><LF>, X'0D0A'). The node treats both of these strings as delimiters, irrespective of the system on which the broker is running. If they both appear in the same record, the node recognizes both as delimiters. The node does not

recognize X'15' which, on z/OS systems, is the 'newline' byte; specify a value of Custom Delimiter in this property and a value of 15 in the Custom delimiter property if your input file is coded using EBCDIC new lines, such as EBCDIC files from a z/OS system.

- Custom Delimiter, which permits a sequence of bytes to be specified in Custom delimiter
 - In Custom delimiter, specify the delimiter byte or bytes to be used when Custom delimiter is set in the Delimiter property. Specify this value as an even-numbered string of hexadecimal digits. The default is X'0A' and the maximum length of the string is 16 bytes (represented by 32 hexadecimal digits).
 - If you specified Delimited in Record detection, use Delimiter type to specify the type of delimiter. Permitted values are:
 - Infix. If you select this value, each delimiter separates records. If the data ends with a delimiter the (zero length) data following the final delimiter is still propagated although it contains no data.
 - Postfix. If you specify this value, each delimiter terminates records. If the data ends with a delimiter, no empty record is propagated after the delimiter. If the data does not end with a delimiter, it is processed as if a delimiter follows the final bytes of the data. Postfix is the default value.
 - The TCPIPClientInput node considers each occurrence of the delimiter in the input as either separating (infix) or terminating (postfix) each record. If the data begins with a delimiter, the node treats the (zero length) contents preceding that delimiter as a record and propagates an empty record to the flow. The delimiter is never included in the propagated message.
8. Use the **Validation** tab to provide validation based on the message set for predefined messages. For more information about validation, see "Validating messages" on page 164. For information about how to complete this tab, see "Validation tab properties" on page 1360.
 9. On the **Transactions** tab, set the transaction mode. Although TCP/IP operations are non-transactional, the transaction mode on this input node determines whether the rest of the nodes in the flow are to be executed under sync point. Select Yes if you want the flow updates to be treated transactionally (if possible) or No if you do not. The default for this property is No.
 10. Optional: On the **Instances** tab, set values for the properties that control the additional instances (threads) that are available for a node. For more details, see "Configurable message flow properties" on page 1372.

Terminals and properties

The terminals of the TCPIPClientInput node are described in the following table.

Terminal	Description
Failure	The output terminal to which the message is routed if an error occurs. This includes failures caused by retry processing. Even if the Validation property is set, messages propagated to this terminal are not validated.
Out	The output terminal to which the message is routed if it is successfully retrieved from an external resource. If no errors occur within the input node, a message received from an external resource is always sent to the Out terminal first.
Close	The output terminal to which the message is routed if the connection closes.

Terminal	Description
Catch	The output terminal to which the message is routed if an exception is thrown downstream and caught by this node. Exceptions are caught only if this terminal is attached.

The following tables describe the node properties. The column headed M indicates whether the property is *mandatory* (marked with an asterisk if you must enter a value when no default is defined); the column headed C indicates whether the property is *configurable* (you can change the value when you add the message flow to the bar file to deploy it).

The Description properties of the TCPIPClientInput node are described in the following table.

Property	M	C	Default	Description
Node name	No	No	TCPIPClientInput	The name of the node.
Short description	No	No	None	A brief description of the node.
Long description	No	No	None	Text that describes the purpose of the node in the message flow.

The Basic properties of the TCPIPClientInput node are described in the following table.

Property	M	C	Default	Description
Connection details	Yes	Yes	Node properties	A string containing either the hostname and port number to be used, or the name of a configurable service.
Timeout waiting for a data record (seconds)	Yes	Yes	60	Specifies how long the node will listen on a connection for more data after the first byte of data has arrived. You can specify any length of time in seconds. A value of -1 specifies that there is no time limit (wait forever).

The Advanced properties of the TCPIPClientInput node are described in the following table.

Property	M	C	Default	Description
Close connection	Yes	No	No	Controls when the connection is closed, or if it remains open. Valid options are: <ul style="list-style-type: none"> • No • After timeout • After data has been received • At end of flow.
Close input stream after a record has been received	Yes	No	False	Specifies whether to close the input stream as soon as the data has been retrieved. When the connection input stream is reserved no other node can use it without knowing the ID. This property is not selected by default.

Property	M	C	Default	Description
Input stream modification	No	No	Leave unchanged	<p>Specifies whether to reserve the input stream for use only by input and receive nodes that specify the connection ID, and, if so, whether to release it at the end of the flow. Valid options are:</p> <ul style="list-style-type: none"> • Leave unchanged • Reserve input stream (for use by future TCP/IP input and receive nodes) • Reserve input stream (for use by future TCP/IP input and receive nodes) then release at end of flow. <p>When the connection input stream is reserved no other nodes can use it without specifying the correct connection ID. If the input stream is released at the end of the flow, it is returned to the pool and becomes available for use by any input or receive node.</p>
Output stream modification	No	No	Leave unchanged	<p>Specifies whether this output stream is released and returned to the pool for use by any output node. Valid options are:</p> <ul style="list-style-type: none"> • Leave unchanged • Release output stream and reset ReplyID. <p>If you select Release output stream and reset ReplyID, the ReplyID is passed in the LocalEnvironment when leaving this node, but is reset for the next record on this connection.</p>

The Input Message Parsing properties of the TCPIPClientInput node are described in the following table.

Property	M	C	Default	Description
Message Domain	No	No		The domain that is used to parse the incoming message.
Message Set	No	No		<p>The name or identifier of the message set in which the incoming message is defined.</p> <p>If you set this property, then subsequently update the project dependencies to remove this message set reference, a warning is issued. Either update the Message Set property, or restore the reference to this message set project.</p>
Message Type	No	No		The name of the incoming message.
Message Format	No	No		The name of the physical format of the incoming message.
Message coded character set ID	Yes	No	Broker System Default	The ID of the coded character set used to interpret the data being read.
Message encoding	Yes	No	Broker System Default	The encoding scheme for numbers and large characters used to interpret the data being read. Valid values are Broker System Determined or a numeric encoding value. For more information about encoding, see “Converting data with message flows” on page 128.

The Parser Options properties of the TCPIPClientInput node are described in the following table.

Property	M	C	Default	Description
Parse timing	No	No	On Demand	This property controls when an input message is parsed. Valid values are: <ul style="list-style-type: none"> • On Demand • Immediate • Complete. For a full description of this property, see “Parsing on demand” on page 1363.
Build tree using XML schema data types	No	No	Cleared	This property controls whether the syntax elements in the message tree have data types taken from the XML Schema.
Use XMLNSC compact parser for XMLNS domain	No	No	Cleared	This property controls whether the XMLNSC Compact Parser is used for messages in the XMLNS Domain. If you set this property, the message data appears under XMLNSC in nodes that are connected to the output terminal when the input MQRFH2 header or Input Message Parsing property, Message Domain, is XMLNS.
Retain mixed content	No	No	Cleared	This property controls whether the XMLNSC parser creates elements in the message tree when it encounters mixed text in an input message. If you select the check box, elements are created for mixed text. If you clear the check box, mixed text is ignored and no elements are created.
Retain comments	No	No	Cleared	This property controls whether the XMLNSC parser creates elements in the message tree when it encounters comments in an input message. If you select the check box, elements are created for comments. If you clear the check box, comments are ignored and no elements are created.
Retain processing instructions	No	No	Cleared	This property controls whether the XMLNSC parser creates elements in the message tree when it encounters processing instructions in an input message. If you select the check box, elements are created for processing instructions. If you clear the check box, processing instructions are ignored and no elements are created.
Opaque elements	No	No	Blank	This property is used to specify a list of elements in the input message that are to be opaquely parsed by the XMLNSC parser.

The Records and Elements properties of the TCPIPClientInput node are described in the following table:

Property	M	C	Default	Description
Record detection	Yes	No	End of stream	The mechanism used to identify records in the input data. Valid options are: <ul style="list-style-type: none"> • End of stream • Fixed Length • Delimited • Parsed Record Sequence.
Length	Yes	No	80	The length of each record, in bytes, when Fixed Length record detection is selected.
Delimiter	Yes	No	DOS or UNIX Line End	The type of delimiter bytes that separate, or terminate, each record when Delimited record detection is selected. Valid options are: <ul style="list-style-type: none"> • DOS or UNIX Line End • Custom Delimiter.
Custom delimiter	No	No		The delimiter bytes, expressed in hexadecimal, when Delimited record detection and Custom Delimiter are selected. This property is mandatory only if the Delimiter property is set to Custom Delimiter.
Delimiter type	Yes	No	Postfix	The position of the delimiter when Delimited record detection and Custom Delimiter are selected. Valid options are: <ul style="list-style-type: none"> • Postfix • Infix. <p>This property is ignored unless the Delimiter property is set to Custom Delimiter.</p>

The Retry properties of the TCPIPClientInput node are described in the following table:

Property	M	C	Default	Description
Retry mechanism	Yes	No	Failure	How the node handles a flow failure. Valid options are: <ul style="list-style-type: none"> • Failure • Short retry • Short and long retry.
Retry threshold	Yes	Yes	0	The number of times to retry the flow transaction when Retry mechanism is Short retry.
Short retry interval	No	Yes	0	The interval, in seconds, between each retry if Retry threshold is not zero.
Long retry interval	No	Yes	300	The interval between retries if Retry mechanism is Short and long retry and the retry threshold has been exhausted.

The Validation properties of the TCPIPClientInput node are described in the following table.

For a full description of these properties, see “Validation properties” on page 1359.

Property	M	C	Default	Description
Validate	No	Yes	None	This property controls whether validation takes place. Valid values are <ul style="list-style-type: none"> • None • Content and Value • Content.
Failure action	No	No	Exception	This property controls what happens if validation fails. Valid values are: <ul style="list-style-type: none"> • User Trace • Local Error Log • Exception • Exception List.

The Transactions properties of the TCPIPClientInput node are described in the following table:

Property	M	C	Default	Description
Transaction mode	No	Yes	No	The transaction mode on this input node determines whether the rest of the nodes in the flow are executed under sync point. Valid options are: <ul style="list-style-type: none"> • No • Yes.

The Instances properties of the TCPIPClientInput node are described in the following table. For a full description of these properties, see “Configurable message flow properties” on page 1372.

Property	M	C	Default	Description
Additional instances pool	No	Yes	Use Pool Associated with Message Flow	The pool from which additional instances are obtained. <ul style="list-style-type: none"> • If you select Use Pool Associated with Message Flow, additional instances are obtained from the message flow pool. • If you select Use Pool Associated with Node, additional instances are allocated from the node’s additional instances based on the number specified in the Additional instances property.
Additional instances	No	Yes	0	The number of additional instances that the node can start if the Additional instances pool property is set to Use Pool Associated with Node.

TCPIPClientOutput node

Use the TCPIPClientOutput node to create a client connection to raw a TCP/IP socket, and to send data over that connection to an external application.

This topic contains the following sections:

- “Purpose” on page 1138
- “Using the TCPIPClientOutput node in a message flow” on page 1139
- “Configuring the TCPIPClientOutput node” on page 1139
- “Terminals and properties” on page 1143

Purpose

The TCPIPClientOutput node opens connections to a remote server application that is listening on a TCP/IP port. The connections are not made directly by the node but are obtained from a connection pool managed by the message broker execution group. The execution group uses the default TCPIPClient configurable service to determine which attributes are used for the socket connection. However, if the configurable service is set on the node, the configurable service is used for all the properties, including the host and port number.

The TCPIPClient configurable service is used to create a pool of client connections ready for processing. To enable this function, the minimumConnections property must be set to a value larger than zero. The execution group then ensures that the specified number of connections are always available by creating them at start up and continuing to make them until the minimum value is reached.

The node requests a client connection, and, if there are no connections available for sending data, the output node requests that the pool creates a new connection. If the maximumConnections property has not been exceeded, a new connection is created.

When the connection has been established, the data is sent. If the data has not been sent successfully within the time limit specified by the node's Timeout sending a data record property, an exception is thrown.

Properties in the local environment can override the TCP/IP connection used by the node:

Table 36. Input local environment properties

Location in local environment	Description
\$LocalEnvironment/Destination/TCPIP/Output/Hostname	The hostname used to make a connection
\$LocalEnvironment/Destination/TCPIP/Output/Port	The port number used to make a connection
\$LocalEnvironment/Destination/TCPIP/Output/Id	The ID of the socket being used. This is an internal identifier used by message broker to uniquely identify a connection.
\$LocalEnvironment/Destination/TCPIP/Output/ReplyId	The Reply ID that has been stored on this connection. It can be any text string.

These properties allow the connection details (hostname and port number) and the connection used (ID) to be chosen dynamically. The Reply ID can also be set on the connection. This enables a string to be stored in the connection and to appear in the local environment. This can be used to store Reply IDs from other TCP/IP nodes or from other transports such as WebSphere MQ.

The output of the node contains the same information as the input, plus any fields that were missing from the input are updated with details from the connection used. For example, if the Id property is not provided as input (because you want to create a new connection or reuse a pool connection), the output local environment will contain the ID of the connection that is used.

Table 37. Output local environment properties

Location in local environment	Description
\$LocalEnvironment/WrittenDestination/TCPIP/Output/ConnectionDetails/Hostname	The hostname used to make a connection
\$LocalEnvironment/WrittenDestination/TCPIP/Output/ConnectionDetails/Port	The port number used to make a connection
\$LocalEnvironment/WrittenDestination/TCPIP/Output/ConnectionDetails/OpenTimestamp	The timestamp when the connection was first opened
\$LocalEnvironment/WrittenDestination/TCPIP/Output/ConnectionDetails/CloseTimestamp	The timestamp when the connection was closed (null if not yet closed)
\$LocalEnvironment/WrittenDestination/TCPIP/Output/ConnectionDetails/SequenceNumber	The sequence number of the message received on this connection. The first record has a sequencing number of 1. The second record has a sequencing number of 2, and so on.
\$LocalEnvironment/WrittenDestination/TCPIP/Output/ConnectionDetails/Id	The ID of the socket being used. This is an internal identifier used by message broker to uniquely identify a connection.
\$LocalEnvironment/WrittenDestination/TCPIP/Output/ConnectionDetails/ReplyId	The Reply ID that has been stored on this connection. It can be any text string.

If the connection closes (or any other type of exception occurs) while using the TCP/IP transport, an exception is thrown. This goes to the failure terminal if it is connected, otherwise the exception returns back down the flow.

The node also has a Close input terminal. If a message is sent to this terminal, the connection is closed using a combination of the details provided in the node and the local environment.

The TCPIPClientOutput node is contained in the **TCPIP** drawer of the palette and is represented in the workbench by the following icon:



Using the TCPIPClientOutput node in a message flow

The TCPIPClientOutput node can be used in any message flow that needs to send data to an external application. Look at the following samples to see how to use this node:

- TCPIP Client Nodes sample
- TCPIP Handshake sample.

You can view samples only when you use the information center that is integrated with the Message Broker Toolkit.

Configuring the TCPIPClientOutput node

When you have put an instance of the TCPIPClientOutput node into a message flow, you can configure it. The properties of the node are displayed in the

Properties view. All mandatory properties for which you must enter a value (those that do not have a default value defined) are marked with an asterisk in that view.

To configure the TCPIPClientOutput node:

1. Optional: On the **Description** tab, enter a short description, a long description, or both. You can also rename the node on this tab.
2. On the **Basic** tab, set the properties that determine how the TCP/IP connection is controlled.
 - Use the Connection details property to specify either the hostname and port number to be used, or the name of a configurable service. This property is mandatory. The following formats are supported:
 - Configurable service name. This is used to look up the port and hostname in configurable services. For example, TCPIPProfile1.
 - <Hostname>:<Port>. This is the hostname followed by the port number (separated by a colon). For example, tcpip.server.com:1111
 - <Port>. This is the port number. In this case the hostname is assumed to be localhost.
 - Use the Timeout sending a data record (seconds) property to specify how long the node will wait when trying to send data. You can specify any length of time in seconds. When the specified time has been exceeded, all available data is sent to the failure terminal. The default is 60 seconds.
3. On the **Advanced** tab, set the properties that determine how the data stream is controlled.
 - Use the Send to: property to specify whether the data is to be sent to one connection or to all available connections:
 - Select One connection to send the message to only one connection, as specified by the node properties and message overrides. This is the default.
 - Select All available connections to send the data to all available connections.
 - Use the Close connection property to specify when and how to close the connection.
 - Select No to leave the connection open. This is the default.
 - Select After timeout to close the connection when a timeout occurs.
 - Select After data has been sent to close the connection when the end of the record has been sent.
 - Select Close output stream after a record has been sent to close the output stream as soon as the data has been sent. This property is not selected by default.
 - Use the Output Stream Modification property to specify whether to reserve or release the output stream. These options are available only if you have not selected the Close output stream after a record has been sent property.
 - Select Leave unchanged to leave the output stream as it was when it entered the node. This is selected by default.
 - Select Release output stream to specify that this output stream is returned to the pool and is available for use by any output node.
 - Select Reserve output stream (for use by future TCP/IP output nodes) to specify that this output stream can be used only by this node and by other output nodes that request it by specifying the connection ID. When the connection input stream is reserved no other nodes can use it without specifying the correct connection ID.

- Select Reserve output stream (for use by future TCP/IP output nodes) then release after propagate to specify that this output stream can be used only by this node and output nodes that request it by specifying the correct connection ID. After the message has been propagated, this output stream is returned to the pool and becomes available for use by any output node.
 - Use the Input Stream Modification property to specify whether to reserve the input stream for use only by input and receive nodes that specify the connection ID, and, if so, whether to release it at the end of the flow.
 - Select Leave unchanged to leave the input stream as it was when it entered the node. This is selected by default.
 - Select Release input stream to specify that this input stream is returned to the pool and is available for use by any input or receive node.
 - Select Reserve input stream (for use by future TCP/IP input and receive nodes) to specify that this input stream can be used only by this node and by other input or receive nodes that request it by specifying the connection ID. When the connection input stream is reserved no other nodes can use it without specifying the correct connection ID.
 - Select Reserve input stream (for use by future TCP/IP input and receive nodes) then release after propagate to specify that this input stream can be used only by this node and receive nodes that request it by specifying the correct connection ID. After the message has been propagated, this input stream is returned to the pool and becomes available for use by any input or receive node.
4. On the **Request** tab, specify the location of the data to be written. You can specify the properties on this tab as XPath or ESQL expressions. Content-assist is available in the properties pane and also in the XPath Expression Builder, which you can invoke by using the **Edit...** button to the right of each property.
- a. In Data location, specify the input data location. This is the location in the input message tree that contains the record to be written. The default value is \$Body, which is the entire message body (\$InputRoot.Body).
- When you are specifying this property and the data in the message tree that it identifies is owned by a model-driven parser, such as the MRM parser or XMLNSC parser, be aware of the following considerations:
- If you are using MRM CWF format, ensure that the identified message tree exists as a message definition. If this is defined as a global element only, exceptions BIP5180 and BIP5167 are generated.
 - If you are using MRM TDS format, the serialization of the identified message is successful if the element is defined as a global element or message. However, if the identified field is not found as a global element or message, note that:
 - If this is a leaf field in the message tree, the field is written as self-defining. No validation occurs even if validation is enabled.
 - If this is a complex element, an internal exception is generated, BIP5522, indicating that the logical type cannot be converted to a string.
 - If you are using MRM XML, the events are similar as for the MRM TDS format except that, if the field is a complex element, it is written as self-defining.
 - If you use the XMLNSC parser, no validation occurs even if validation is enabled.

- b. In Hostname location, specify the location of the value to override the Hostname set in the Connection details property of the **Basic** tab. If you do not specify a location, the default value is `$LocalEnvironment/Destination/TCPIP/Output/Hostname`.
 - c. In Port location, specify the location of the value to override the Port set in the Connection details property of the **Basic** tab. If you do not specify a location, the default value is `$LocalEnvironment/Destination/TCPIP/Output/Port`.
 - d. In ID location, specify the location of the Id of the socket being used. This internal identifier is used by Message Broker to uniquely identify a connection. If you do not specify a location, the default value is `$LocalEnvironment/Destination/TCPIP/Output/Id`.
 - e. In Reply ID location, specify the location of the Reply ID that is stored on the connection being used. The Reply ID can be used when data is returned in an input node. If you do not specify a location, the default value is `$LocalEnvironment/Destination/TCPIP/Output/ReplyId`.
5. Use the **Records and Elements** tab to specify how the `TCPIPClientOutput` node writes the record derived from the message.
- In Record definition, choose from:
 - Record is Unmodified Data to specify that records are left unchanged. This is the default.
 - Record is Fixed Length Data to specify that records are padded to a given length if necessary. You specify this length in the Length property. If the record is longer than the value specified in Length, the node generates an exception. Use the Padding byte (hexadecimal) property to specify the byte to be used for padding the message to the required length.
 - Record is Delimited Data to specify that records are separated by a delimiter and accumulated by concatenation. The delimiter is specified by the Delimiter, Custom delimiter, and Delimiter type properties. The file is finished only when a message is received on the Finish File terminal.
 - In Length (bytes), specify the length (in bytes) of records when Record is Fixed Length Data is specified in Record definition. Records longer than this value cause an exception to be thrown. This must be a value between 1 byte and 100 MB. The default is 80 bytes.
 - When Record is Fixed Length Data is specified in Record definition, use Padding byte (hexadecimal) to specify the byte to be used when padding records to the specified length if they are shorter than this length. Specify this as 2 hexadecimal digits. The default value is `X'20'`.
 - In Delimiter, specify the delimiter to be used if you specify Record is Delimited Data in Record definition. Choose from:
 - Broker System Line End to specify that a line end sequence of bytes is used as the delimiter as appropriate for the file system on which the broker is to run. This is the default. For example, on Windows systems, this is a 'carriage-return, line-feed' pair (`X'0D0A'`); on UNIX systems, this is a single 'line-feed' byte (`X'0A'`); on z/OS systems, it is a 'newline' byte (`X'15'`).
 - Custom Delimiter (hexadecimal) to specify that the explicit delimiter sequence defined in the Custom delimiter property is to be used to delimit records.
 - In Custom delimiter (hexadecimal), specify the delimiter sequence of bytes to be used to be used to delimit records when Custom Delimiter is specified in

the Delimiter property. Specify this as an even-numbered string of hexadecimal digits. The default is X'0A' and the maximum length of the string is 16 bytes.

- If you specified Record is Delimited Data in Record definition, use Delimiter type to specify how the delimiter is to separate records. Choose from:
 - Postfix to specify that the delimiter is added after each record that is written. This is the default.
 - Infix to specify that the delimiter is only inserted between any two adjacent records.

6. On the **Validation** tab, specify the parser validation properties of the node. For more information about validation, see “Validating messages” on page 164. For information on how to fill in this tab, see “Validation tab properties” on page 1360.

Terminals and properties

The TCPIPClientOutput node terminals are described in the following table.

Terminal	Type	Description
In	Input data	The input terminal that accepts a message for processing by the node.
Close	Input control	The input terminal to which a message is routed when the connection given in the local environment is closed.
Out	Output data	The output terminal to which the message is routed if it is successfully sent to an external resource. The message received on the In terminal is propagated to the Out terminal and is left unchanged except for the addition of status information.
Close	Output control	The output terminal to which a message propagated from the Close input terminal is routed.
Failure	Output data	The output terminal to which the message is routed if a failure is detected in the node.

The following tables describe the node properties. The column headed M indicates whether the property is *mandatory* (marked with an asterisk if you must enter a value when no default is defined); the column headed C indicates whether the property is *configurable* (you can change the value when you add the message flow to the bar file to deploy it).

The Description properties of the TCPIPClientOutput node are described in the following table:

Property	M	C	Default	Description
Node name	No	No	TCPIPClientOutput	The name of the node.
Short Description	No	No		A brief description of the node.
Long Description	No	No		Text that describes the purpose of the node in the message flow.

The Basic properties of the TCPIPClientOutput node are described in the following table:

Property	M	C	Default	Description
Connection details	Yes	Yes	Node properties	A string containing either the hostname and port number to be used, or the name of a configurable service.
Timeout sending a data record (seconds)	Yes	Yes	60	Specifies how long the node will wait when trying to send data. You can specify any length of time in seconds.

The Advanced properties of the TCP/IPClientOutput node are described in the following table.

Property	M	C	Default	Description
Send to:	Yes	No	One connection	Valid options are: <ul style="list-style-type: none"> • One connection • All available connections.
Close connection	Yes	No	No	Controls when the connection is closed, or if it remains open. Valid options are: <ul style="list-style-type: none"> • No • After timeout • After data has been sent .
Close output stream after a record has been sent	Yes	No	False	Specifies whether to close the output stream as soon as the data has been sent. This property is not selected by default.
Output stream modification	No	No	Leave unchanged	Specifies whether to reserve this output stream or release it and return it to the pool for use by any output node. Valid options are: <ul style="list-style-type: none"> • Leave unchanged • Release output stream • Reserve output stream (for use by future TCP/IP output nodes) • Reserve output stream (for use by future TCP/IP output nodes) then release after propagate.
Input stream modification	No	No	Leave unchanged	Specifies whether to reserve the input stream for use only by input and receive nodes that specify the connection ID, and, if so, whether to release it at the end of the flow. Valid options are: <ul style="list-style-type: none"> • Leave unchanged • Release input stream • Reserve input stream (for use by future TCP/IP input and receive nodes) • Reserve input stream (for use by future TCP/IP input and receive nodes) then release after propagate. <p>When the connection input stream is reserved no other nodes can use it without specifying the correct connection ID. If the input stream is released after the message has been propagated, it is returned to the pool and becomes available for use by any input or receive node.</p>

The Request properties of the TCPIPClientOutput node are described in the following table:

Property	M	C	Default	Description
Data location	Yes	No	\$Body	The location in the input message tree containing the record to be written.
Hostname location	Yes	No	\$LocalEnvironment/Destination/TCPIP/Output/Hostname	The message element location containing the Hostname.
Port location	Yes	No	\$LocalEnvironment/Destination/TCPIP/Output/Port	The message element location containing the Port.
ID location	Yes	No	\$LocalEnvironment/Destination/TCPIP/Output/Id	The message element location containing the ID.
Reply ID location	Yes	No	\$LocalEnvironment/Destination/TCPIP/Output/ReplyId	The message element location containing the Reply ID.

The Records and Elements properties of the TCPIPClientOutput node are described in the following table:

Property	M	C	Default	Description
Record definition	Yes	No	Record is Unmodified data	This property controls how the records derived from the message are written. Valid options are: <ul style="list-style-type: none"> Record is Unmodified Data Record is Fixed Length Data Record is Delimited Data.
Length	Yes	No	80	The required length of the output record. This property applies only when Record is Fixed Length Data is specified in Record definition.
Padding byte	Yes	No	X'20'	The 2-digit hexadecimal byte to be used to pad short messages when Record is Fixed Length Data is specified in Record definition.
Delimiter	Yes	No	Broker System Line End	The delimiter to be used when Record is Delimited Data is specified in Record definition. Valid options are: <ul style="list-style-type: none"> Broker System Line End Custom Delimiter.
Custom delimiter	No	No	None	The delimiter byte sequence to be used when Record is Delimited Data is specified in the Record definition property and Custom Delimiter is specified in the Delimiter property.

Property	M	C	Default	Description
Delimiter type	Yes	No	Postfix	This property specifies the way in which the delimiters are to be inserted between records when Record is Delimited Data is specified in Record definition. Valid options are: <ul style="list-style-type: none"> • Postfix • Infix.

The Validation properties of the TCPIPClientOutput node are described in the following table.

For a full description of these properties, see “Validation properties” on page 1359.

Property	M	C	Default	Description
Validate	No	Yes	Inherit	This property controls whether validation takes place. Valid values are: <ul style="list-style-type: none"> • None • Content and Value • Content • Inherit.
Failure action	No	No	Exception	This property controls what happens if validation fails. You can set this property only if you set Validate to Content or Content and Value. Valid values are: <ul style="list-style-type: none"> • User Trace • Local Error Log • Exception • Exception List.

TCPIPClientReceive node

Use the TCPIPClientReceive node to receive data over a client TCP/IP connection.

This topic contains the following sections:

- “Purpose”
- “Using the TCPIPClientReceive node in a message flow” on page 1148
- “Configuring the TCPIPClientReceive node” on page 1148
- “Terminals and properties” on page 1153

Purpose

The TCPIPClientReceive node waits for data to be received on a TCP/IP connection, and retrieves the data. If the connection is closed, an exception is thrown.

When a connection is established, the data is sent to the TCPIPClientReceive node. If the TCPIPClientReceive node fails to receive all of the data within the time specified in the **Timeout waiting for a data record** property, the message is sent to the Timeout terminal; if no Timeout terminal is connected, an exception is thrown.

Properties in the local environment can override the TCP/IP connection used by the node:

Table 38. Input local environment properties

Location in local environment for input to node	Description
\$LocalEnvironment//TCPIP/Receive/Hostname	The hostname used to make a connection
\$LocalEnvironment//TCPIP/Receive/Port	The port number used to make a connection
\$LocalEnvironment/TCPIP/Receive/Id	The ID of the socket being used. This is an internal identifier used by message broker to uniquely identify a connection.
\$LocalEnvironment/TCPIP/Receive/ReplyId	The Reply ID to be stored on this connection. This can then be used when data is returned on an input node. The Reply ID can be any text string.

These properties allow the connection details (hostname and port number) and the connection used (ID) to be chosen dynamically. The Reply ID can also be set on the connection, which enables a string to be stored in the connection and to appear in the local environment of any data that is received back from this connection. This connection can be used to store Reply IDs from other TCP/IP nodes or from other transports such as WebSphere MQ.

When a record has been retrieved, the ConnectionDetails field in the LocalEnvironment is populated with the details of the connection that is being used.

Table 39. Output local environment properties

Location in local environment for output from node	Description
\$LocalEnvironment/TCPIP/Receive/ConnectionDetails/Type	Client
\$LocalEnvironment/TCPIP/Receive/ConnectionDetails/Hostname	The hostname used to make a connection
\$LocalEnvironment/TCPIP/Receive/ConnectionDetails/Port	The port number used to make a connection
\$LocalEnvironment/TCPIP/Receive/ConnectionDetails/OpenTimestamp	The timestamp when the connection was first opened
\$LocalEnvironment/TCPIP/Receive/ConnectionDetails/CloseTimestamp	The timestamp when the connection was closed (null if not yet closed)
\$LocalEnvironment/TCPIP/Receive/ConnectionDetails/SequenceNumber/InputRecord	The sequence number of the message received on this connection. The first record has a sequencing number of 1. The second record is 2, and so on.
\$LocalEnvironment/TCPIP/Receive/ConnectionDetails/SequenceNumber/OutputRecord	The sequence number of the message sent on this connection. The first record has a sequencing number of 1. The second record is 2, and so on.
\$LocalEnvironment/TCPIP/Receive/ConnectionDetails/Id	The ID of the socket being used. This is an internal identifier used by message broker to uniquely identify a connection.
\$LocalEnvironment/TCPIP/Receive/ConnectionDetails/ReplyId	The Reply ID that has been stored on this connection. It can be any text string.

The TCPIPClientReceive node is contained in the **TCPIP** drawer of the palette, and is represented in the workbench by the following icon:



Message structure

The TCPIPClientReceive node handles messages in the following message domains:

- MRM
- XMLNSC
- DataObject
- XMLNS
- JMSMap
- JMSStream
- MIME
- BLOB
- XML (this domain is deprecated; use XMLNSC)
- IDOC (this domain is deprecated; use MRM)

Using the TCPIPClientReceive node in a message flow

Look at the following samples to see how to use the TCPIPClientReceive node:

- TCPIP Client Nodes sample
- TCPIP Handshake sample.

You can view samples only when you use the information center that is integrated with the Message Broker Toolkit.

Configuring the TCPIPClientReceive node

When you have put an instance of the TCPIPClientReceive node into a message flow, you can configure it; see “Configuring a message flow node” on page 235. The properties of the node are displayed in the Properties view.

All mandatory properties that do not have a default value defined are marked with an asterisk.

Configure the TCPIPClientReceive node:

1. Optional: On the **Description** tab, enter a Short description, a Long description, or both. You can also rename the node on this tab.
2. On the **Basic** tab, set the properties that determine how the TCP/IP connection is controlled.
 - Use the Connection details property to specify either the hostname and port number to be used, or the name of a configurable service. This property is mandatory. The following formats are supported:
 - Configurable service name. This is used to look up the port and hostname in configurable services. For example, TCPIPProfile1.
 - <Hostname>:<Port>. This is the hostname followed by the port number (separated by a colon). For example, tcpip.server.com:1111

- <Port>. This is the port number. In this case the hostname is assumed to be localhost.
 - Use the Timeout waiting for a data record (seconds) property to specify how long the node will listen on a connection for more data after the first byte of data has arrived. You can specify any length of time in seconds. A value of -1 specifies that there is no time limit (wait forever). The default is 60 seconds. When the specified time has been exceeded, all available data is sent to the failure terminal.
3. On the **Advanced** tab, set the properties that determine how the data stream is controlled.
- Use the Close connection property to specify when and how to close the connection.
 - Select No to leave the connection open. This is the default.
 - Select After timeout to close the connection when a timeout occurs.
 - Select After data has been received to close the connection when the end of the record is found.
 - Select Close input stream after a record has been received to close the input stream as soon as the data has been retrieved. This property is not selected by default. When the connection input stream is reserved no other node can use it without knowing the ID.
 - Use the Input Stream Modification property to specify whether to reserve the input stream for use only by input and receive nodes that specify the connection ID, and, if so, whether to release it at the end of the flow.
 - Select Leave unchanged to leave the input stream as it was when it entered the node. This is selected by default.
 - Select Release input stream to specify that this input stream is returned to the pool and is available for use by any input or receive node.
 - Select Reserve input stream (for use by future TCP/IP input and receive nodes) to specify that this input stream can be used only by this node and by other input or receive nodes that request it by specifying the connection ID. When the connection input stream is reserved no other nodes can use it without specifying the correct connection ID.
 - Select Reserve input stream (for use by future TCP/IP input and receive nodes) then release after propagate to specify that this input stream can be used only by this node and receive nodes that request it by specifying the correct connection ID. After the message has been propagated, this input stream is returned to the pool and becomes available for use by any input or receive node.
 - Use the Output Stream Modification property to specify whether to reserve or release the output stream. These options are available only if you have not selected the Close output stream after a record has been sent property.
 - Select Leave unchanged to leave the output stream as it was when it entered the node. This is selected by default.
 - Select Release output stream to specify that this output stream is returned to the pool and is available for use by any output node.
 - Select Reserve output stream (for use by future TCP/IP output nodes) to specify that this output stream can be used only by this node and by other output nodes that request it by specifying the connection ID. When the connection input stream is reserved no other nodes can use it without specifying the correct connection ID.
 - Select Reserve output stream (for use by future TCP/IP output nodes) then release after propagate to specify that this output stream can be used

only by this node and output nodes that request it by specifying the correct connection ID. After the message has been propagated, this output stream is returned to the pool and becomes available for use by any output node.

4. On the **Request** tab, specify the location of the data to be written. You can specify the properties on this tab as XPath or ESQL expressions. Content-assist is available in the properties pane and also in the XPath Expression Builder, which you can run by clicking **Edit** to the right of each property.

- In Data location, specify the location of the message to be sent out as part of the request. This is the location in the input message tree that contains the record to be written. The default value is \$Body, which is the entire message body (\$InputRoot.Body).

When you are specifying this property and the data in the message tree that it identifies is owned by a model-driven parser, such as the MRM parser or XMLNSC parser, be aware of the following considerations:

- If you are using MRM CWF format, ensure that the identified message tree exists as a message definition. If this is defined as a global element only, exceptions BIP5180 and BIP5167 are generated.
 - If you are using MRM TDS format, the serialization of the identified message is successful if the element is defined as a global element or message. However, if the identified field is not found as a global element or message, note that:
 - If this is a leaf field in the message tree, the field is written as self-defining. No validation occurs even if validation is enabled.
 - If this is a complex element, an internal exception is generated, BIP5522, indicating that the logical type cannot be converted to a string.
 - If you are using MRM XML, the events are similar to those for the MRM TDS format except that, if the field is a complex element, it is written as self-defining.
 - If you use the XMLNSC parser, no validation occurs even if validation is enabled.
- In Hostname location, specify the location of the value to override the Hostname set in the Connection details property of the **Basic** tab. If you do not specify a location, the default value is \$LocalEnvironment/TCPIP/Receive/Hostname.
 - In Port location, specify the location of the value to override the Port set in the Connection details property of the **Basic** tab. If you do not specify a location, the default value is \$LocalEnvironment/TCPIP/Receive/Port.
 - In ID location, specify the location of the Id of the socket being used. This internal identifier is used by Message Broker to uniquely identify a connection. If you do not specify a location, the default value is \$LocalEnvironment/TCPIP/Receive/Id.
 - In Reply ID location, specify the location of the Reply ID that is stored on the connection being used. The Reply ID can be used when data is returned in an input node. If you do not specify a location, the default value is \$LocalEnvironment/TCPIP/Receive/ReplyId.
5. On the **Result** tab, set values for the properties that determine where the reply is to be stored.
 - Use the Output data location property to specify the start location within the output message tree where the parsed elements from the bit string of the message are stored. The default value is \$Root.

- Use the Copy local environment property to specify whether or not the LocalEnvironment is copied to the output message.
 - If Copy local environment is selected, a new copy of the LocalEnvironment is created in the tree, and it is populated with the contents of the LocalEnvironment from the preceding node. This means that if a node changes the LocalEnvironment, the upstream nodes are not affected by those changes because they have their own copies. This is the default.
 - If Copy local environment is not selected, the node does not generate its own copy of the LocalEnvironment, but uses the LocalEnvironment passed to it by the preceding node. This means that if a node changes the LocalEnvironment, the changes are reflected by the upstream nodes.

6. On the **Input Message Parsing** tab, set values for the properties that the node uses to determine how to parse the incoming message.

If the incoming message has an MQRFH2 header, you do not need to set values for the Input Message Parsing properties because the values are derived from the <mcd> folder in the MQRFH2 header; for example:

```
<mcd><Msd>MRM</Msd><Set>DHM4U0906S001</Set><Type>receiptmsg1</Type>
<Fmt>XML</Fmt><</mcd>
```

If you set values, and those values differ from those in the MQRFH2 header, the values in the MQRFH2 header take precedence.

- In Message domain, select the name of the parser that you are using from the list. The default is BLOB. You can choose from the following options:
 - MRM
 - XMLNSC
 - DataObject
 - XMLNS
 - JMSMap
 - JMSStream
 - MIME
 - BLOB
 - XML (this domain is deprecated; use XMLNSC)
 - IDOC (this domain is deprecated; use MRM)

You can also specify a user-defined parser, if appropriate.

- If you are using the MRM or IDOC parser, or the XMLNSC parser in validating mode, select the Message set that you want to use. The list contains the message sets that are available when you select MRM, XMLNSC, or IDOC as the domain.
- If you are using the MRM parser, select the correct message type from the list in Message type. This list is populated with available message types when you select the MRM parser.
- If you are using the MRM or IDOC parser, select the correct message format from the list in Message format. This list is populated with available message formats when you select the MRM or IDOC parser.
- Specify the message coded character set ID in Message coded character set ID.
- Select the message encoding from the list in Message encoding or specify a numeric encoding value. For more information about encoding, see “Converting data with message flows” on page 128.

7. On the **Parser Options** sub-tab:

- Parse timing is, by default, set to On Demand, which causes parsing of the message to be delayed. To cause the message to be parsed immediately, see “Parsing on demand” on page 1363.
 - If you are using the XMLNSC parser, set values for the properties that determine how the XMLNSC parser operates. For more information, see “Manipulating messages in the XMLNSC domain” on page 364.
8. Use the **Records and Elements** tab to specify how the data is interpreted as records:
- Use the Record detection property to determine how the data is split into records, each of which generates a single message. Choose from the following options:
 - Connection closed specifies that all of the data sent during a connection is a single record.
 - Fixed Length specifies that each record is a fixed number of bytes in length. Each record should contain the number of bytes specified in the Length property, except possibly a shorter final record in the file.
 - Select Delimited, if the records you are processing are separated, or terminated, by a DOS or UNIX line end or by a sequence of user-defined delimiter bytes. Specify the delimiter and delimiter type in the Delimiter, and Delimiter type properties.
 - Select Parsed Record Sequence if the data contains a sequence of one or more records that are serially recognized by the parser specified in Message domain. The node propagates each recognized record as a separate message. If you select this Record detection option, the parser specified in Message domain must be either XMLNSC or MRM (either CWF or TDS physical format).
 - If you specified Fixed Length in Record detection, use Length to specify the required length of the output record. This value must be between 1 byte and 100 MB. The default is 80 bytes.
 If you specify Connection closed, Fixed Length, or Delimited in Record detection, a limit of 100 MB applies to the length of the records. If you specify Parsed Record Sequence in Record detection, the TCP/IPClientReceive node does not determine or limit the length of a record. Nodes that are downstream in the message flow might try to determine the record length or process a very long record. If you intend to process large records in this way, ensure that your broker has sufficient memory. You might need to apply flow techniques described in the Large Messaging sample to best use the available memory.
 - If you specified Delimited in Record detection, use Delimiter to specify the delimiter to be used. Choose from:
 - DOS or UNIX Line End, which, on UNIX systems, specifies the line feed character (<LF>, X'0A'), and, on Windows systems, specifies a carriage return character followed by a line feed character (<CR><LF>, X'0D0A'). The node treats both of these strings as delimiters, irrespective of the system on which the broker is running. If they both appear in the same record, the node recognizes both as delimiters. The node does not recognize X'15' which, on z/OS systems, is the 'newline' byte; specify a value of Custom Delimiter in this property and a value of 15 in the Custom delimiter property if your input file is coded using EBCDIC new lines.
 - Custom Delimiter (hexadecimal), which permits a sequence of bytes to be specified in Custom delimiter (hexadecimal)

- In Custom delimiter (hexadecimal), specify the delimiter byte or bytes to be used when Custom delimiter (hexadecimal) is set in the Delimiter property. Specify this value as an even-numbered string of hexadecimal digits. The default is X'0A' and the maximum length of the string is 16 bytes (represented by 32 hexadecimal digits).
 - If you specified Delimited in Record detection, use Delimiter type to specify the type of delimiter. Permitted values are:
 - Infix. If you select this value, each delimiter separates records. If the data ends with a delimiter the (zero length) data following the final delimiter is still propagated although it contains no data.
 - Postfix. If you specify this value, each delimiter terminates records. If the data ends with a delimiter, no empty record is propagated after the delimiter. If the data does not end with a delimiter, it is processed as if a delimiter follows the final bytes of the data. Postfix is the default value.
 - The TCPIPClientReceive node considers each occurrence of the delimiter in the input as either separating (infix) or terminating (postfix) each record. If the data begins with a delimiter, the node treats the (zero length) contents preceding that delimiter as a record and propagates an empty record to the flow. The delimiter is never included in the propagated message.
9. Use the **Validation** tab to provide validation based on the message set for predefined messages. For more information about validation, see “Validating messages” on page 164. For information about how to complete this tab, see “Validation tab properties” on page 1360.

Terminals and properties

The terminals of the TCPIPClientReceive node are described in the following table.

Terminal	Description
In	The input terminal that accepts a message for processing by the node.
Out	The output terminal to which the message is routed if it is successfully retrieved from an external resource. If no errors occur within the input node, a message received from an external resource is always sent to the Out terminal first.
Timeout	The terminal to which a message is sent when the time specified in the Timeout waiting for a data record property has been exceeded. The message text is “Timeout value is exceeded”.
Failure	The output terminal to which the message is routed if an error occurs. This includes failures caused by retry processing. Even if the Validation property is set, messages propagated to this terminal are not validated.

The following tables describe the node properties. The column headed M indicates whether the property is *mandatory* (marked with an asterisk if you must enter a value when no default is defined); the column headed C indicates whether the property is *configurable* (you can change the value when you add the message flow to the bar file to deploy it).

The Description properties of the TCPIPClientReceive node are described in the following table.

Property	M	C	Default	Description
Node name	No	No	TCPIPClientReceive	The name of the node.
Short description	No	No	None	A brief description of the node.

Property	M	C	Default	Description
Long description	No	No	None	Text that describes the purpose of the node in the message flow.

The Basic properties of the TCPIPClientReceive node are described in the following table.

Property	M	C	Default	Description
Connection details	Yes	Yes	Node properties	A string containing either the hostname and port number to be used, or the name of a configurable service.
Timeout waiting for a data record (seconds)	Yes	Yes	60	Specifies how long the node will listen on a connection for more data after the first byte of data has arrived. You can specify any length of time in seconds. A value of -1 specifies that there is no time limit (wait forever).

The Advanced properties of the TCPIPClientReceive node are described in the following table.

Property	M	C	Default	Description
Close connection	Yes	No	No	Controls when the connection is closed, or if it remains open. Valid options are: <ul style="list-style-type: none"> • No • After data has been received • After timeout.
Close input stream after a record has been received	Yes	No	False	Specifies whether to close the input stream as soon as the data has been retrieved. When the connection input stream is reserved no other node can use it without knowing the ID. This property is not selected by default.
Input stream modification	No	No	Leave unchanged	Specifies whether to reserve the input stream for use only by input and receive nodes that specify the connection ID, and, if so, whether to release it at the end of the flow. Valid options are: <ul style="list-style-type: none"> • Leave unchanged • Release input stream • Reserve input stream (for use by future TCP/IP input and receive nodes) • Reserve input stream (for use by future TCP/IP input and receive nodes) then release after propagate. When the connection input stream is reserved no other nodes can use it without specifying the correct connection ID. If the input stream is released after the message has been propagated, it is returned to the pool and becomes available for use by any input or receive node.

Property	M	C	Default	Description
Output stream modification	No	No	Leave unchanged	Specifies whether to reserve this output stream or release it and return it to the pool for use by any output node. Valid options are: <ul style="list-style-type: none"> • Leave unchanged • Release output stream • Reserve output stream (for use by future TCP/IP output nodes) • Reserve output stream (for use by future TCP/IP output nodes) then release after propagate.

The Request properties of the TCPIPClientReceive node are described in the following table:

Property	M	C	Default	Description
Data location	Yes	No	\$Body	The location in the input message tree containing the record to be written.
Hostname location	Yes	No	\$LocalEnvironment/TCPIP/Receive/Hostname	The message element location containing the hostname.
Port location	Yes	No	\$LocalEnvironment/TCPIP/Receive/Port	The message element location containing the port.
ID location	Yes	No	\$LocalEnvironment//TCPIP/Receive/Id	The message element location containing the ID.
Reply ID location	Yes	No	\$LocalEnvironment/TCPIP/Receive/ReplyId	The message element location containing the Reply ID.

The Result properties of the TCPIPClientReceive node are described in the following table:

Property	M	C	Default	Description
Output data location	No	No	\$Root	The start location within the output message tree where the parsed elements from the bit string of the message are stored.
Copy local environment	No	No	True	Specifies whether or not the LocalEnvironment is copied to the output message.

The Input Message Parsing properties of the TCPIPClientReceive node are described in the following table.

Property	M	C	Default	Description
Message Domain	No	No		The domain that is used to parse the incoming message.
Message Set	No	No		The name or identifier of the message set in which the incoming message is defined. If you set this property, then subsequently update the project dependencies to remove this message set reference, a warning is issued. Either update the Message Set property, or restore the reference to this message set project.
Message Type	No	No		The name of the incoming message.
Message Format	No	No		The name of the physical format of the incoming message.
Message coded character set ID	Yes	No	Broker System Default	The ID of the coded character set used to interpret the data being read.
Message encoding	Yes	No	Broker System Default	The encoding scheme for numbers and large characters used to interpret the data being read. Valid values are Broker System Determined or a numeric encoding value. For more information about encoding, see “Converting data with message flows” on page 128.

The Parser Options properties of the TCPIPClientReceive node are described in the following table.

Property	M	C	Default	Description
Parse timing	No	No	On Demand	This property controls when an input message is parsed. Valid values are: <ul style="list-style-type: none"> • On Demand • Immediate • Complete. For a full description of this property, see “Parsing on demand” on page 1363.
Build tree using XML schema data types	No	No	Cleared	This property controls whether the syntax elements in the message tree have data types taken from the XML Schema.
Use XMLNSC compact parser for XMLNS domain	No	No	Cleared	This property controls whether the XMLNSC Compact Parser is used for messages in the XMLNS Domain. If you set this property, the message data appears under XMLNSC in nodes that are connected to the output terminal when the input MQRFH2 header or Input Message Parsing property, Message Domain, is XMLNS.
Retain mixed content	No	No	Cleared	This property controls whether the XMLNSC parser creates elements in the message tree when it encounters mixed text in an input message. If you select the check box, elements are created for mixed text. If you clear the check box, mixed text is ignored and no elements are created.

Property	M	C	Default	Description
Retain comments	No	No	Cleared	This property controls whether the XMLNSC parser creates elements in the message tree when it encounters comments in an input message. If you select the check box, elements are created for comments. If you clear the check box, comments are ignored and no elements are created.
Retain processing instructions	No	No	Cleared	This property controls whether the XMLNSC parser creates elements in the message tree when it encounters processing instructions in an input message. If you select the check box, elements are created for processing instructions. If you clear the check box, processing instructions are ignored and no elements are created.
Opaque elements	No	No	Blank	This property is used to specify a list of elements in the input message that are to be opaquely parsed by the XMLNSC parser.

The Records and Elements properties of the TCPIPClientReceive node are described in the following table:

Property	M	C	Default	Description
Record detection	Yes	No	Connection closed	The mechanism used to identify records in the input data. Valid options are: <ul style="list-style-type: none"> • Connection closed • Fixed Length • Delimited • Parsed Record Sequence.
Length	Yes	No	80	The length of each record, in bytes, when Fixed Length record detection is selected.
Delimiter	Yes	No	DOS or UNIX Line End	The type of delimiter bytes that separate, or terminate, each record when Delimited record detection is selected. Valid options are: <ul style="list-style-type: none"> • DOS or UNIX Line End • Custom Delimiter.
Custom delimiter	No	No		The delimiter bytes, expressed in hexadecimal, when Delimited record detection and Custom Delimiter are selected. This property is not mandatory if the Delimiter property is not set to Custom Delimiter.
Delimiter type	Yes	No	Postfix	The position of the delimiter when Delimited record detection and Custom Delimiter are selected. Valid options are: <ul style="list-style-type: none"> • Postfix • Infix. <p>This property is ignored unless the Delimiter property is set to Custom Delimiter.</p>

The Validation properties of the TCPIPClientReceive node are described in the following table.

For a full description of these properties, see “Validation properties” on page 1359.

Property	M	C	Default	Description
Validate	No	Yes	Inherit	This property controls whether validation takes place. Valid values are <ul style="list-style-type: none"> • None • Content and Value • Content • Inherit.
Failure action	No	No	Exception	This property controls what happens if validation fails. You can set this property only if you set Validate to Content or Content and Value. Valid values are: <ul style="list-style-type: none"> • User Trace • Local Error Log • Exception • Exception List.

TCPIPServerInput node

Use the TCPIPServerInput node to create a server connection to raw a TCP/IP socket, and to receive data over that connection.

This topic contains the following sections:

- “Purpose”
- “Using the TCPIPServerInput node in a message flow” on page 1159
- “Configuring the TCPIPServerInput node” on page 1160
- “Terminals and properties” on page 1164

Purpose

The TCPIPServerInput node listens on a port and, when a client socket connects to the port, the server socket creates a new connection for the client. Unlike the TCPIPClientInput node, the TCPIPServerInput node does not attempt to make a minimum number of connections, because the server end of the socket cannot initiate new connections, it can only accept them. The TCPIPServerInput node accepts connections up to a maximum value, which is specified in the MaximumConnections property of the TCPIPServer configurable service. By default the broker can accept up to 100 server connections. For more information see mqsicreateconfigurable service command and the mqsi report properties command.

The first record of data is detected in accordance with properties on the node and then sent to the Out terminal. If an error occurs, including a timeout waiting for data or the closure of a connection while waiting for the full record, the data is sent to the Failure terminal. If the connection closes and there is no data, a message is sent to the Close terminal. Although the message has no data, the local environment does have details of the connection that closed.

For both data and close events, the following local environment is created:

Table 40. Location in local environment

Location in local environment	Description
\$LocalEnvironment/TCPIP/Input/ConnectionDetails/Type	Server

Table 40. Location in local environment (continued)

Location in local environment	Description
\$LocalEnvironment/TCPIP/Input/ConnectionDetails/Hostname	The hostname used to make a connection
\$LocalEnvironment/TCPIP/Input/ConnectionDetails/Port	The port number used to make a connection
\$LocalEnvironment/TCPIP/Input/ConnectionDetails/OpenTimestamp	The timestamp when the connection was first opened
\$LocalEnvironment/TCPIP/Input/ConnectionDetails/CloseTimestamp	The timestamp when the connection was closed (null if not yet closed)
\$LocalEnvironment/TCPIP/Input/ConnectionDetails/SequenceNumber/InputRecord	The sequence number of the message received on this connection. The first record has a sequencing number of 1. The second record has a sequencing number of 2, and so on.
\$LocalEnvironment/TCPIP/Input/ConnectionDetails/SequenceNumber/OutputRecord	The sequence number of the message sent on this connection. The first record has a sequencing number of 1. The second record has a sequencing number of 2, and so on.
\$LocalEnvironment/TCPIP/Input/ConnectionDetails/Id	The ID of the socket being used. This is an internal identifier used by message broker to uniquely identify a connection.
\$LocalEnvironment/TCPIP/Input/ConnectionDetails/ReplyId	The Reply ID that has been stored on this connection. It can be any text string.

The TCPIPServerInput node is contained in the **TCPIP** drawer of the palette, and is represented in the workbench by the following icon:



Message structure

The TCPIPServerInput node handles messages in the following message domains:

- MRM
- XMLNSC
- DataObject
- XMLNS
- JMSMap
- JMStream
- MIME
- BLOB
- XML (this domain is deprecated; use XMLNSC)
- IDOC (this domain is deprecated; use MRM)

Using the TCPIPServerInput node in a message flow

Look at the following samples to see how to use the TCPIPServerInput node:

- TCPIP Client Nodes sample
- TCPIP Handshake sample.

You can view samples only when you use the information center that is integrated with the Message Broker Toolkit.

Configuring the TCPIPServerInput node

When you have put an instance of the TCPIPServerInput node into a message flow, you can configure it; see “Configuring a message flow node” on page 235. The properties of the node are displayed in the Properties view.

All mandatory properties that do not have a default value defined are marked with an asterisk.

Configure the TCPIPServerInput node:

1. Optional: On the **Description** tab, enter a Short description, a Long description, or both. You can also rename the node on this tab.
2. On the **Basic** tab, set the properties that determine how the TCP/IP connection is controlled.
 - Use the Connection details property to specify either the hostname and port number to be used, or the name of a configurable service. This property is mandatory. The following formats are supported:
 - Configurable service name. This is used to look up the port and hostname in configurable services. For example, TCPIPProfile1.
 - <Hostname>:<Port>. This is the hostname followed by the port number (separated by a colon). For example, tcpip.server.com:1111
 - <Port>. This is the port number. In this case the hostname is assumed to be localhost.
 - Use the Timeout waiting for a data record (seconds) property to specify how long the node will listen on a connection for more data after the first byte of data has arrived. You can specify any length of time in seconds. A value of -1 specifies that there is no time limit (wait forever). The default is 60 seconds. When the specified time has been exceeded, all available data is sent to the Failure terminal.
3. On the **Advanced** tab, set the properties that determine how the data stream is controlled.
 - Use the Close connection property to specify when and how to close the connection.
 - Select No to leave the connection open. This is the default.
 - Select After timeout to close the connection when a timeout occurs.
 - Select After data has been received to close the connection when the end of the record is found.
 - Select At end of flow to close the connection after the flow has been invoked.
 - Select Close input stream after a record has been received to close the input stream as soon as the data has been retrieved. When the connection input stream is reserved no other node can use it without specifying the ID. This property is not selected by default.
 - Use the Input Stream Modification property to specify whether to reserve the input stream for use only by input and receive nodes that specify the connection ID, and, if so, whether to release it at the end of the flow. These options are available only if you have not selected the Close input stream after a record has been received property.

- Select Leave unchanged to leave the input stream as it was when it entered the node. This is selected by default.
- Select Reserve input stream (for use by future TCP/IP input and receive nodes) to specify that this input stream can be used only by this node and by other receive nodes that request it by specifying the connection ID. When the connection input stream is reserved no other nodes can use it without specifying the correct connection ID.
- Select Reserve input stream (for use by future TCP/IP input and receive nodes) then release at end of flow to specify that this input stream can be used only by this node and receive nodes that request it by specifying the connection ID. After the flow has been run, this input stream is returned to the pool and becomes available for use by any input or receive node.
- Use the Output Stream Modification property to specify whether to release the output stream.
 - Select Leave unchanged to leave the output stream as it was when it entered the node. This is selected by default.
 - Select Release output stream and reset ReplyID to specify that this output stream is returned to the pool and is available for use by any output node. The ReplyID is passed in the LocalEnvironment when leaving this node, but is reset for the next record on this connection.

4. On the **Input Message Parsing** tab, set values for the properties that the node uses to determine how to parse the incoming message.

If the incoming message has an MQRFH2 header, you do not need to set values for the Input Message Parsing properties because the values are derived from the <mcd> folder in the MQRFH2 header; for example:

```
<mcd><Msd>MRM</Msd><Set>DHM4U0906S001</Set><Type>receiptmsg1</Type>
<Fmt>XML</Fmt></mcd>
```

If you set values, and those values differ from those in the MQRFH2 header, the values in the MQRFH2 header take precedence.

- In Message domain, select the name of the parser that you are using from the list. The default is BLOB. You can choose from the following options:
 - MRM
 - XMLNSC
 - DataObject
 - XMLNS
 - JMSMap
 - JMSStream
 - MIME
 - BLOB
 - XML (this domain is deprecated; use XMLNSC)
 - IDOC (this domain is deprecated; use MRM)

You can also specify a user-defined parser, if appropriate.

- If you are using the MRM or IDOC parser, or the XMLNSC parser in validating mode, select the Message set that you want to use. The list contains the message sets that are available when you select MRM, XMLNSC, or IDOC as the domain.
- If you are using the MRM parser, select the correct message type from the list in Message type. This list is populated with available message types when you select the MRM parser.

- If you are using the MRM or IDOC parser, select the correct message format from the list in Message format. This list is populated with available message formats when you select the MRM or IDOC parser.
 - Specify the message coded character set ID in Message coded character set ID.
 - Select the message encoding from the list in Message encoding or specify a numeric encoding value. For more information about encoding, see “Converting data with message flows” on page 128.
5. On the **Parser Options** sub-tab:
 - a. Parse timing is, by default, set to On Demand, which causes parsing of the message to be delayed. To cause the message to be parsed immediately, see “Parsing on demand” on page 1363.
 - b. If you are using the XMLNSC parser, set values for the properties that determine how the XMLNSC parser operates. For more information, see “Manipulating messages in the XMLNSC domain” on page 364.
 6. Use the **Retry** tab to define how retry processing is performed when a flow fails. You can set the following:
 - Retry mechanism determines the action that occurs should the flow fail. Choose from the following:
 - Select Failure for the node to report a failure without any retry attempts.
 - Select Short retry for the node to retry before reporting a failure if the condition persists. The number of times that it retries is specified in Retry threshold.
 - Select Short retry and long retry for the node to retry, first using the value in Retry threshold as the number of attempts it should make. If the condition persists after the Retry threshold has been reached, the node then uses the Long retry interval between attempts.
 - Specify the Retry threshold. The number of times the node retries the flow transaction if the Retry mechanism property is set to either Short retry or Short retry and long retry.
 - Specify the Short retry interval. The length of time, in seconds, to wait between short retry attempts.
 - Specify the Long retry interval. The length of time to wait between long retry attempts until a message is successful, the message flow is stopped, or the message flow is redeployed. The broker property **MinLongRetryInterval** defines the minimum value that the Long retry interval can take. If the value is lower than the minimum then the broker value is used.
 7. Use the **Records and Elements** tab to specify how the data is interpreted as records:
 - Use the Record detection property to determine how the data is split into records, each of which generates a single message. Choose from the following options:
 - End of stream specifies that all of the data sent in the data stream is a single record.
 - Fixed Length specifies that each record is a fixed number of bytes in length. Each record should contain the number of bytes specified in the Length property.

- Select Delimited, if the records you are processing are separated, or terminated, by a DOS or UNIX line end or by a sequence of user-defined delimiter bytes. Specify the delimiter and delimiter type in the Delimiter, and Delimiter type properties.
- Select Parsed Record Sequence if the data contains a sequence of one or more records that are serially recognized by the parser specified in Message domain. The node propagates each recognized record as a separate message. If you select this Record detection option, the parser specified in Message domain must be either XMLNSC or MRM (either CWF or TDS physical format).
- If you specified Fixed Length in Record detection, use Length to specify the required length of the output record. This value must be between 1 byte and 100 MB. The default is 80 bytes.

If you specify End of stream, Fixed Length, or Delimited in Record detection, a limit of 100 MB applies to the length of the records. If you specify Parsed Record Sequence in Record detection, the TCPIPServerInput node does not determine or limit the length of a record. Nodes that are downstream in the message flow might try to determine the record length or process a very long record. If you intend to process large records in this way, ensure that your broker has sufficient memory. You might need to apply flow techniques described in the Large Messaging sample to best use the available memory.

- If you specified Delimited in Record detection, use Delimiter to specify the delimiter to be used. Choose from:
 - DOS or UNIX Line End, which, on UNIX systems, specifies the line feed character (<LF>, X'0A'), and, on Windows systems, specifies a carriage return character followed by a line feed character (<CR><LF>, X'0D0A'). The node treats both of these strings as delimiters, irrespective of the system on which the broker is running. If they both appear in the same record, the node recognizes both as delimiters. The node does not recognize X'15' which, on z/OS systems, is the 'newline' byte; specify a value of Custom Delimiter in this property and a value of 15 in the Custom delimiter property if your input data is coded using EBCDIC new lines.
 - Custom Delimiter, which permits a sequence of bytes to be specified in Custom delimiter
- In Custom delimiter, specify the delimiter byte or bytes to be used when Custom delimiter is set in the Delimiter property. Specify this value as an even-numbered string of hexadecimal digits. The default is X'0A' and the maximum length of the string is 16 bytes (represented by 32 hexadecimal digits).
- If you specified Delimited in Record detection, use Delimiter type to specify the type of delimiter. Permitted values are:
 - Infix. If you select this value, each delimiter separates records. If the data ends with a delimiter the (zero length) data following the final delimiter is still propagated although it contains no data.
 - Postfix. If you specify this value, each delimiter terminates records. If the data ends with a delimiter, no empty record is propagated after the delimiter. If the data does not end with a delimiter, it is processed as if a delimiter follows the final bytes of the data. Postfix is the default value.
- The TCPIPServerInput node considers each occurrence of the delimiter in the input as either separating (infix) or terminating (postfix) each record. If the data begins with a delimiter, the node treats the (zero length) contents

preceding that delimiter as a record and propagates an empty record to the flow. The delimiter is never included in the propagated message.

8. Use the **Validation** tab to provide validation based on the message set for predefined messages. For more information about validation, see “Validating messages” on page 164. For information about how to complete this tab, see “Validation tab properties” on page 1360.
9. On the **Transactions** tab, set the transaction mode. Although TCP/IP operations are non-transactional, the transaction mode on this input node determines whether the rest of the nodes in the flow are to be executed under sync point or not. Select Yes if you want the flow updates to be treated transactionally (if possible) or No if you do not. The default for this property is No.
10. Optional: On the **Instances** tab, set values for the properties that control the additional instances (threads) that are available for a node. For more details, see “Configurable message flow properties” on page 1372.

Terminals and properties

The terminals of the TCPIPServerInput node are described in the following table.

Terminal	Description
Failure	The output terminal to which the message is routed if an error occurs. This includes failures caused by retry processing. Even if the Validation property is set, messages propagated to this terminal are not validated.
Out	The output terminal to which the message is routed if it is successfully retrieved from an external resource. If no errors occur within the input node, a message received from an external resource is always sent to the Out terminal first.
Close	The output terminal to which the message is routed if the connection closes.
Catch	The output terminal to which the message is routed if an exception is thrown downstream and caught by this node. Exceptions are caught only if this terminal is attached.

The following tables describe the node properties. The column headed M indicates whether the property is *mandatory* (marked with an asterisk if you must enter a value when no default is defined); the column headed C indicates whether the property is *configurable* (you can change the value when you add the message flow to the bar file to deploy it).

The Description properties of the TCPIPServerInput node are described in the following table.

Property	M	C	Default	Description
Node name	No	No	TCPIPServerInput	The name of the node.
Short description	No	No	None	A brief description of the node.
Long description	No	No	None	Text that describes the purpose of the node in the message flow.

The Basic properties of the TCPIPServerInput node are described in the following table.

Property	M	C	Default	Description
Connection details	Yes	Yes	Node properties	A string containing either the hostname and port number to be used, or the name of a configurable service.
Timeout waiting for a data record (seconds)	Yes	Yes	60	Specifies how long the node will listen on a connection for more data after the first byte of data has arrived. You can specify any length of time in seconds. A value of -1 specifies that there is no time limit (wait forever).

The Advanced properties of the TCPIPServerInput node are described in the following table.

Property	M	C	Default	Description
Close connection	Yes	No	No	Controls when the connection is closed, or if it remains open. Valid options are: <ul style="list-style-type: none"> • No • After timeout • After data has been received • At end of flow.
Close input stream after a record has been received	Yes	No	False	Specifies whether to close the input stream as soon as the data has been retrieved. When the connection input stream is reserved no other node can use it without knowing the ID. This property is not selected by default.
Input stream modification	No	No	Leave unchanged	Specifies whether to reserve the input stream for use only by input and receive nodes that specify the connection ID, and, if so, whether to release it at the end of the flow. Valid options are: <ul style="list-style-type: none"> • Leave unchanged • Reserve input stream (for use by future TCP/IP input and receive nodes) • Reserve input stream (for use by future TCP/IP input and receive nodes) then release at end of flow. When the connection input stream is reserved no other nodes can use it without specifying the correct connection ID. If the input stream is released at the end of the flow, it is returned to the pool and becomes available for use by any input or receive node.
Output stream modification	No	No	Leave unchanged	Specifies whether this output stream is released and returned to the pool for use by any output node. Valid options are: <ul style="list-style-type: none"> • Leave unchanged • Release output stream and reset ReplyID. If you select Release output stream and reset ReplyID, the ReplyID is passed in the LocalEnvironment when leaving this node, but is reset for the next record on this connection.

The Input Message Parsing properties of the TCPIPServerInput node are described in the following table.

Property	M	C	Default	Description
Message Domain	No	No		The domain that is used to parse the incoming message.
Message Set	No	No		The name or identifier of the message set in which the incoming message is defined. If you set this property, then subsequently update the project dependencies to remove this message set reference, a warning is issued. Either update the Message Set property, or restore the reference to this message set project.
Message Type	No	No		The name of the incoming message.
Message Format	No	No		The name of the physical format of the incoming message.
Message coded character set ID	Yes	No	Broker System Default	The ID of the coded character set used to interpret the data being read.
Message encoding	Yes	No	Broker System Default	The encoding scheme for numbers and large characters used to interpret the data being read. Valid values are Broker System Determined or a numeric encoding value. For more information about encoding, see “Converting data with message flows” on page 128.

The Parser Options properties of the TCPIPServerInput node are described in the following table.

Property	M	C	Default	Description
Parse timing	No	No	On Demand	This property controls when an input message is parsed. Valid values are: <ul style="list-style-type: none"> • On Demand • Immediate • Complete. For a full description of this property, see “Parsing on demand” on page 1363.
Build tree using XML schema data types	No	No	Cleared	This property controls whether the syntax elements in the message tree have data types taken from the XML Schema.
Use XMLNSC compact parser for XMLNS domain	No	No	Cleared	This property controls whether the XMLNSC Compact Parser is used for messages in the XMLNS Domain. If you set this property, the message data appears under XMLNSC in nodes that are connected to the output terminal when the input MQRFH2 header or Input Message Parsing property, Message Domain, is XMLNS.
Retain mixed content	No	No	Cleared	This property controls whether the XMLNSC parser creates elements in the message tree when it encounters mixed text in an input message. If you select the check box, elements are created for mixed text. If you clear the check box, mixed text is ignored and no elements are created.

Property	M	C	Default	Description
Retain comments	No	No	Cleared	This property controls whether the XMLNSC parser creates elements in the message tree when it encounters comments in an input message. If you select the check box, elements are created for comments. If you clear the check box, comments are ignored and no elements are created.
Retain processing instructions	No	No	Cleared	This property controls whether the XMLNSC parser creates elements in the message tree when it encounters processing instructions in an input message. If you select the check box, elements are created for processing instructions. If you clear the check box, processing instructions are ignored and no elements are created.
Opaque elements	No	No	Blank	This property is used to specify a list of elements in the input message that are to be opaquely parsed by the XMLNSC parser.

The Records and Elements properties of the TCPIPServerInput node are described in the following table:

Property	M	C	Default	Description
Record detection	Yes	No	End of stream	The mechanism used to identify records in the input data. Valid options are: <ul style="list-style-type: none"> • End of stream • Fixed Length • Delimited • Parsed Record Sequence.
Length	Yes	No	80	The length of each record, in bytes, when Fixed Length record detection is selected.
Delimiter	Yes	No	DOS or UNIX Line End	The type of delimiter bytes that separate, or terminate, each record when Delimited record detection is selected. Valid options are: <ul style="list-style-type: none"> • DOS or UNIX Line End • Custom Delimiter.
Custom delimiter	No	No		The delimiter bytes, expressed in hexadecimal, when Delimited record detection and Custom Delimiter are selected. This property mandatory only if the Delimiter property is set to Custom Delimiter.
Delimiter type	Yes	No	Postfix	The position of the delimiter when Delimited record detection and Custom Delimiter are selected. Valid options are: <ul style="list-style-type: none"> • Postfix • Infix. <p>This property is ignored unless the Delimiter property is set to Custom Delimiter.</p>

The Retry properties of the TCPIPServerInput node are described in the following table:

Property	M	C	Default	Description
Retry mechanism	Yes	No	Failure	How the node handles a flow failure. Valid options are: <ul style="list-style-type: none"> • Failure • Short retry • Short and long retry.
Retry threshold	Yes	Yes	0	The number of times to retry the flow transaction when Retry mechanism is Short retry.
Short retry interval	No	Yes	0	The interval, in seconds, between each retry if Retry threshold is not zero.
Long retry interval	No	Yes	300	The interval between retries if Retry mechanism is Short and long retry and the retry threshold has been exhausted.

The Validation properties of the TCPIPServerInput node are described in the following table.

For a full description of these properties, see “Validation properties” on page 1359.

Property	M	C	Default	Description
Validate	No	Yes	None	This property controls whether validation takes place. Valid values are <ul style="list-style-type: none"> • None • Content and Value • Content.
Failure action	No	No	Exception	This property controls what happens if validation fails. Valid values are: <ul style="list-style-type: none"> • User Trace • Local Error Log • Exception • Exception List.

The Transactions properties of the TCPIPServerInput node are described in the following table:

Property	M	C	Default	Description
Transaction mode	No	Yes	No	The transaction mode on this input node determines whether the rest of the nodes in the flow are executed under sync point. Valid options are: <ul style="list-style-type: none"> • No • Yes.

The Instances properties of the TCPIPServerInput node are described in the following table. For a full description of these properties, see “Configurable message flow properties” on page 1372.

Property	M	C	Default	Description
Additional instances pool	No	Yes	Use Pool Associated with Message Flow	The pool from which additional instances are obtained. <ul style="list-style-type: none"> • If you select Use Pool Associated with Message Flow, additional instances are obtained from the message flow pool. • If you select Use Pool Associated with Node, additional instances are allocated from the node's additional instances based on the number specified in the Additional instances property.
Additional instances	No	Yes	0	The number of additional instances that the node can start if the Additional instances pool property is set to Use Pool Associated with Node.

TCPIPServerOutput node

Use the TCPIPServerOutput node to create a server connection to a raw TCP/IP socket, and to send data over that connection to an external application.

This topic contains the following sections:

- "Purpose"
- "Using the TCPIPServerOutput node in a message flow" on page 1171
- "Configuring the TCPIPServerOutput node" on page 1171
- "Terminals and properties" on page 1174

Purpose

The TCPIPServerOutput listens on a TCP/IP port and waits for a client node to connect to the port. When the client node connects to the port, the server node creates a new connection for the client. The connections are not made directly by the node but are obtained from a connection pool managed by the message broker execution group.

The execution group uses the default TCPIPServer configurable service to determine which attributes are used for the socket connection. However, if the configurable service is set on the node, the configurable service is used for all the properties, including the host and port number.

When the connection has been established, the data is sent. If the data has not been sent successfully within the time limit specified by the node's Timeout sending a data record property, an exception is thrown.

Properties in the local environment can override the TCP/IP connection used by the node:

Table 41. Input local environment properties

Location in local environment	Description
\$LocalEnvironment/Destination/TCPIP/Output/Hostname	The hostname used to make a connection
\$LocalEnvironment/Destination/TCPIP/Output/Port	The port number used to make a connection
\$LocalEnvironment/Destination/TCPIP/Output/Id	The ID of the socket being used. This is an internal identifier used by message broker to uniquely identify a connection.

Table 41. Input local environment properties (continued)

Location in local environment	Description
\$LocalEnvironment/Destination/TCPIP/Output/ReplyId	The Reply ID that has been stored on this connection. It can be any text string.

These properties allow the connection details (hostname and port number) and the connection used (ID) to be chosen dynamically. The Reply ID can also be set on the connection. This enables a string to be stored in the connection and to appear in the local environment. This can be used to store Reply IDs from other TCP/IP nodes or from other transports such as WebSphere MQ.

The output of the node contains the same information as the input, plus any fields that were missing from the input are updated with details from the connection used. For example, if the Id property is not provided as input (because you want to create a new connection or reuse a pool connection), the output local environment will contain the ID of the connection that is used.

Table 42. Output local environment properties

Location in local environment	Description
\$LocalEnvironment/WrittenDestination/TCPIP/Output/ConnectionDetails/Hostname	The hostname used to make a connection
\$LocalEnvironment/WrittenDestination/TCPIP/Output/ConnectionDetails/Port	The port number used to make a connection
\$LocalEnvironment/WrittenDestination/TCPIP/Output/ConnectionDetails/OpenTimestamp	The timestamp when the connection was first opened
\$LocalEnvironment/WrittenDestination/TCPIP/Output/ConnectionDetails/CloseTimestamp	The timestamp when the connection was closed (null if not yet closed)
\$LocalEnvironment/WrittenDestination/TCPIP/Output/ConnectionDetails/SequenceNumber	The sequence number of the message received on this connection. The first record has a sequencing number 1. The second record 2, and so on.
\$LocalEnvironment/WrittenDestination/TCPIP/Output/ConnectionDetails/Id	The ID of the socket being used. This is an internal identifier used by message broker to uniquely identify a connection.
\$LocalEnvironment/WrittenDestination/TCPIP/Output/ConnectionDetails/ReplyId	The Reply ID that has been stored on this connection. It can be any text string.

If the connection closes (or any other type of exception occurs) while using the TCP/IP transport, an exception is thrown. This goes to the failure terminal if it is connected, otherwise the exception goes back down the flow.

The node also has a Close input terminal. If a message is sent to this terminal, the connection is closed using a combination of the details provided in the node and the local environment.

The TCPIPServerOutput node is contained in the **TCPIP** drawer of the palette and is represented in the workbench by the following icon:



Using the TCPIPServerOutput node in a message flow

The TCPIPServerOutput node can be used in any message flow that needs to send data to an external application. Look at the following samples to see how to use it:

- TCPIP Client Nodes sample
- TCPIP Handshake sample.

You can view samples only when you use the information center that is integrated with the Message Broker Toolkit.

Configuring the TCPIPServerOutput node

When you have put an instance of the TCPIPServerOutput node into a message flow, you can configure it. The properties of the node are displayed in the Properties view. All mandatory properties for which you must enter a value (those that do not have a default value defined) are marked with an asterisk in that view.

To configure the TCPIPServerOutput node:

1. Optional: On the **Description** tab, enter a short description, a long description, or both. You can also rename the node on this tab.
2. On the **Basic** tab, set the properties that determine how the TCP/IP connection is controlled.
 - Use the Connection details property to specify either the hostname and port number to be used, or the name of a configurable service. This property is mandatory. The following formats are supported:
 - Configurable service name. This is used to look up the port and hostname in configurable services. For example, `TCPIPProfile1`.
 - `<Hostname>:<Port>`. This is the hostname followed by the port number (separated by a colon). For example, `tcpip.server.com:1111`
 - `<Port>`. This is the port number. In this case the hostname is assumed to be localhost.
 - Use the Timeout sending a data record (seconds) property to specify how long the node will wait when trying to send data. You can specify any length of time in seconds. When the specified time has been exceeded, all available data is sent to the failure terminal. The default is 60 seconds.
3. On the **Advanced** tab, set the properties that determine how the data stream is controlled.
 - Use the Send to: property to specify whether the data is to be sent to one connection or to all available connections:
 - Select One connection to send the message to only one connection, as specified by the node properties and message overrides. This is the default.
 - Select All available connections to send the data to all available connections.
 - Use the Close connection property to specify when and how to close the connection.
 - Select No to leave the connection open. This is the default.
 - Select After timeout to close the connection when a timeout occurs.
 - Select After data has been sent to close the connection when the end of the record has been sent.

- Select Close output stream after a record has been sent to close the output stream as soon as the data has been sent. This property is not selected by default.
 - Use the Output Stream Modification property to specify whether to reserve or release the output stream. These options are available only if you have not selected the Close output stream after a record has been sent property.
 - Select Leave unchanged to leave the output stream as it was when it entered the node. This is selected by default.
 - Select Release output stream to specify that this output stream is returned to the pool and is available for use by any output node.
 - Select Reserve output stream (for use by future TCP/IP output nodes) to specify that this output stream can be used only by this node and by other output nodes that request it by specifying the connection ID. When the connection input stream is reserved no other nodes can use it without specifying the correct connection ID.
 - Select Reserve output stream (for use by future TCP/IP output nodes) then release after propagate to specify that this output stream can be used only by this node and output nodes that request it by specifying the correct connection ID. After the message has been propagated, this output stream is returned to the pool and becomes available for use by any output node.
 - Use the Input Stream Modification property to specify whether to reserve the input stream for use only by input and receive nodes that specify the connection ID, and, if so, whether to release it at the end of the flow.
 - Select Leave unchanged to leave the input stream as it was when it entered the node. This is selected by default.
 - Select Release input stream to specify that this input stream is returned to the pool and is available for use by any input or receive node.
 - Select Reserve input stream (for use by future TCP/IP input and receive nodes) to specify that this input stream can be used only by this node and by other input or receive nodes that request it by specifying the connection ID. When the connection input stream is reserved no other nodes can use it without specifying the correct connection ID.
 - Select Reserve input stream (for use by future TCP/IP input and receive nodes) then release after propagate to specify that this input stream can be used only by this node and receive nodes that request it by specifying the correct connection ID. After the message has been propagated, this input stream is returned to the pool and becomes available for use by any input or receive node.
4. On the **Request** tab, specify the location of the data to be written. You can specify the properties on this tab as XPath or ESQL expressions. Content-assist is available in the properties pane and also in the XPath Expression Builder, which you can invoke by using the **Edit...** button to the right of each property.
- a. In Data location, specify the input data location. This is the location in the input message tree that contains the record to be written. The default value is \$Body, which is the entire message body (\$InputRoot.Body).
- When you are specifying this property and the data in the message tree that it identifies is owned by a model-driven parser, such as the MRM parser or XMLNSC parser, be aware of the following considerations:
- If you are using MRM CWF format, ensure that the identified message tree exists as a message definition. If this is defined as a global element only, exceptions BIP5180 and BIP5167 are generated.

- If you are using MRM TDS format, the serialization of the identified message is successful if the element is defined as a global element or message. However, if the identified field is not found as a global element or message, note that:
 - If this is a leaf field in the message tree, the field is written as self-defining. No validation occurs even if validation is enabled.
 - If this is a complex element, an internal exception is generated, BIP5522, indicating that the logical type cannot be converted to a string.
 - If you are using MRM XML, the events are similar as for the MRM TDS format except that, if the field is a complex element, it is written as self-defining.
 - If you use the XMLNSC parser, no validation occurs even if validation is enabled.
- b. In Port location, specify the location of the value to override the Port set in the Connection details property of the **Basic** tab. If you do not specify a location, the default value is `$LocalEnvironment/Destination/TCPIP/Output/Port`.
 - c. In ID location, specify the location of the Id of the socket being used. This internal identifier is used by Message Broker to uniquely identify a connection. If you do not specify a location, the default value is `$LocalEnvironment/Destination/TCPIP/Output/Id`.
 - d. In Reply ID location, specify the location of the Reply ID that is stored on the connection being used. The Reply ID can be used when data is returned in an input node. If you do not specify a location, the default value is `$LocalEnvironment/Destination/TCPIP/Output/ReplyId`.
5. Use the **Records and Elements** tab to specify how the TCPIPServerOutput node writes the record derived from the message.
 - In Record definition, choose from:
 - Record is Unmodified Data to specify that records are left unchanged. This is the default.
 - Record is Fixed Length Data to specify that records are padded to a given length if necessary. You specify this length in the Length property. If the record is longer than the value specified in Length, the node generates an exception. Use the Padding byte property to specify the byte to be used for padding the message to the required length.
 - Record is Delimited Data to specify that records are separated by a delimiter and accumulated by concatenation. The delimiter is specified by the Delimiter, Custom delimiter, and Delimiter type properties. The file is finished only when a message is received on the Finish File terminal.
 - In Length, specify the length (in bytes) of records when Record is Fixed Length Data is specified in Record definition. Records longer than this value cause an exception to be thrown. This must be a value between 1 byte and 100 MB. The default is 80 bytes.
 - When Record is Fixed Length Data is specified in Record definition, use Padding byte to specify the byte to be used when padding records to the specified length if they are shorter than this length. Specify this as 2 hexadecimal digits. The default value is X'20'.
 - In Delimiter, specify the delimiter to be used if you specify Record is Delimited Data in Record definition. Choose from:
 - Broker System Line End to specify that a line end sequence of bytes is used as the delimiter as appropriate for the file system on which the

broker is to run. This is the default. For example, on Windows systems, this is a 'carriage-return, line-feed' pair (X'0D0A'); on UNIX systems, this is a single 'line-feed' byte (X'0A'); on z/OS systems, it is a 'newline' byte (X'15').

- Custom Delimiter to specify that the explicit delimiter sequence defined in the Custom delimiter property is to be used to delimit records.
 - In Custom delimiter, specify the delimiter sequence of bytes to be used to be used to delimit records when Custom Delimiter is specified in the Delimiter property. Specify this as an even-numbered string of hexadecimal digits. The default is X'0A' and the maximum length of the string is 16 bytes.
 - If you specified Record is Delimited Data in Record definition, use Delimiter type to specify how the delimiter is to separate records. Choose from:
 - Postfix to specify that the delimiter is added after each record that is written. This is the default.
 - Infix to specify that the delimiter is only inserted between any two adjacent records.
6. On the **Validation** tab, specify the parser validation properties of the node. For more information about validation, see "Validating messages" on page 164. For information on how to fill in this tab, see "Validation tab properties" on page 1360.

Terminals and properties

The TCPIPServerOutput node terminals are described in the following table.

Terminal	Type	Description
In	Input data	The input terminal that accepts a message for processing by the node.
Close	Input control	The input terminal to which a message is routed when the connection given in the local environment is closed.
Out	Output data	The output terminal to which the message is routed if it is successfully sent to an external resource. The message received on the In terminal is propagated to the Out terminal and is left unchanged except for the addition of status information.
Close	Output control	The output terminal to which a message propagated from the Close input terminal is routed.
Failure	Output data	The output terminal to which the message is routed if a failure is detected in the node.

The following tables describe the node properties. The column headed M indicates whether the property is *mandatory* (marked with an asterisk if you must enter a value when no default is defined); the column headed C indicates whether the property is *configurable* (you can change the value when you add the message flow to the bar file to deploy it).

The Description properties of the TCPIPServerOutput node are described in the following table:

Property	M	C	Default	Description
Node name	No	No	TCPIPServerOutput	The name of the node.
Short Description	No	No		A brief description of the node.

Property	M	C	Default	Description
Long Description	No	No		Text that describes the purpose of the node in the message flow.

The Basic properties of the TCPIPServerOutput node are described in the following table:

Property	M	C	Default	Description
Connection details	Yes	Yes	Node properties	A string containing either the hostname and port number to be used, or the name of a configurable service.
Timeout sending a data record (seconds)	Yes	Yes	60	Specifies how long the node will wait when trying to send data. You can specify any length of time in seconds.

The Advanced properties of the TCPIPServerOutput node are described in the following table.

Property	M	C	Default	Description
Send to:	Yes	No	One connection	Valid options are: <ul style="list-style-type: none"> • One connection • All available connections.
Close connection	Yes	No	No	Controls when the connection is closed, or if it remains open. Valid options are: <ul style="list-style-type: none"> • No • After data has been sent • After timeout.
Close output stream after a record has been sent	Yes	No	False	Specifies whether to close the output stream as soon as the data has been sent. This property is not selected by default.
Output stream modification	No	No	Leave unchanged	Specifies whether to reserve this output stream or release it and return it to the pool for use by any output node. Valid options are: <ul style="list-style-type: none"> • Leave unchanged • Release output stream • Reserve output stream (for use by future TCP/IP output nodes) • Reserve output stream (for use by future TCP/IP output nodes) then release after propagate.

Property	M	C	Default	Description
Input stream modification	No	No	Leave unchanged	<p>Specifies whether to reserve the input stream for use only by input and receive nodes that specify the connection ID, and, if so, whether to release it at the end of the flow. Valid options are:</p> <ul style="list-style-type: none"> • Leave unchanged • Release input stream • Reserve input stream (for use by future TCP/IP input and receive nodes) • Reserve input stream (for use by future TCP/IP input and receive nodes) then release after propagate. <p>When the connection input stream is reserved no other nodes can use it without specifying the correct connection ID. If the input stream is released after the message has been propagated, it is returned to the pool and becomes available for use by any input or receive node.</p>

The Request properties of the TCPIPServerOutput node are described in the following table:

Property	M	C	Default	Description
Data location	Yes	No	\$Body	The location in the input message tree containing the record to be written.
Port location	Yes	No	\$LocalEnvironment/Destination/TCPIP/Output/Port	The message element location containing the port.
Id	Yes	No	\$LocalEnvironment/Destination/TCPIP/Output/Id	The message element location containing the ID.
ReplyId	Yes	No	\$LocalEnvironment/Destination/TCPIP/Output/ReplyId	The message element location containing the Reply ID.

The Records and Elements properties of the TCPIPServerOutput node are described in the following table:

Property	M	C	Default	Description
Record definition	Yes	No	Record is Unmodified data	<p>This property controls how the records derived from the message are written. Valid options are:</p> <ul style="list-style-type: none"> • Record is Unmodified Data • Record is Fixed Length Data • Record is Delimited Data.
Length	Yes	No	80	The required length of the output record. This property applies only when Record is Fixed Length Data is specified in Record definition.

Property	M	C	Default	Description
Padding byte	Yes	No	X'20'	The 2-digit hexadecimal byte to be used to pad short messages when Record is Fixed Length Data is specified in Record definition.
Delimiter	Yes	No	Broker System Line End	The delimiter to be used when Record is Delimited Data is specified in Record definition. Valid options are: <ul style="list-style-type: none"> • Broker System Line End • Custom Delimiter.
Custom delimiter	No	No	None	The delimiter byte sequence to be used when Record is Delimited Data is specified in the Record definition property and Custom Delimiter is specified in the Delimiter property.
Delimiter type	Yes	No	Postfix	This property specifies the way in which the delimiters are to be inserted between records when Record is Delimited Data is specified in Record definition. Valid options are: <ul style="list-style-type: none"> • Postfix • Infix.

The Validation properties of the TCPIPServerOutput node are described in the following table.

For a full description of these properties, see “Validation properties” on page 1359.

Property	M	C	Default	Description
Validate	No	Yes	Inherit	This property controls whether validation takes place. Valid values are: <ul style="list-style-type: none"> • None • Content and Value • Content • Inherit.
Failure action	No	No	Exception	This property controls what happens if validation fails. You can set this property only if you set Validate to Content or Content and Value. Valid values are: <ul style="list-style-type: none"> • User Trace • Local Error Log • Exception • Exception List.

TCPIPServerReceive node

Use the TCPIPServerReceive node to receive data over a server TCP/IP connection.

This topic contains the following sections:

- “Purpose” on page 1178
- “Using the TCPIPServerReceive node in a message flow” on page 1179
- “Configuring the TCPIPServerReceive node” on page 1180
- “Terminals and properties” on page 1184

Purpose

The TCPIPServerReceive node waits for data to be received on a TCP/IP connection, and retrieves the data. If the connection is closed, an exception is thrown.

When a connection is established, the data is sent to the TCPIPServerReceive node. If the TCPIPServerReceive node fails to receive all of the data within the time specified in the Timeout waiting for a data record property, the message is sent to the Timeout terminal; if no Timeout terminal is connected, an exception is thrown.

Properties in the local environment can override the TCP/IP connection used by the node:

Table 43. Input local environment properties

Location in local environment for input to node	Description
\$LocalEnvironment//TCPIP/Receive/Hostname	The hostname used to make a connection
\$LocalEnvironment//TCPIP/Receive/Port	The port number used to make a connection
\$LocalEnvironment/TCPIP/Receive/Id	The ID of the socket being used. This is an internal identifier used by message broker to uniquely identify a connection.
\$LocalEnvironment/TCPIP/Receive/ReplyId	The Reply ID to be stored on this connection. This can then be used when data is returned on an input node. The Reply ID can be any text string.

These properties allow the connection details (hostname and port number) and the connection used (ID) to be chosen dynamically. The Reply ID can also be set on the connection, which enables a string to be stored in the connection and to appear in the local environment. In this way, you can store Reply IDs from other TCP/IP nodes or from other transports such as WebSphere MQ.

When a record has been retrieved, the ConnectionDetails field in the LocalEnvironment tree is populated with the details of the connection that is being used.

Table 44. Output local environment properties

Location in local environment for output from node	Description
\$LocalEnvironment/TCPIP/Receive/ConnectionDetails/Type	Server
\$LocalEnvironment/TCPIP/Receive/ConnectionDetails/Hostname	The hostname used to make a connection
\$LocalEnvironment/TCPIP/Receive/ConnectionDetails/Port	The port number used to make a connection
\$LocalEnvironment/TCPIP/Receive/ConnectionDetails/OpenTimestamp	The timestamp when the connection was first opened
\$LocalEnvironment/TCPIP/Receive/ConnectionDetails/CloseTimestamp	The timestamp when the connection was closed (null if not yet closed)

Table 44. Output local environment properties (continued)

Location in local environment for output from node	Description
\$LocalEnvironment/TCPIP/Receive/ConnectionDetails/SequenceNumber/InputRecord	The sequence number of the message received on this connection. The first record has a sequencing number of 1. The second record is 2, and so on.
\$LocalEnvironment/TCPIP/Receive/ConnectionDetails/SequenceNumber/OutputRecord	The sequence number of the message sent on this connection. The first record has a sequencing number of 1. The second record is 2, and so on.
\$LocalEnvironment/TCPIP/Receive/ConnectionDetails/Id	The ID of the socket being used. This is an internal identifier used by message broker to uniquely identify a connection.
\$LocalEnvironment/TCPIP/Receive/ConnectionDetails/ReplyId	The Reply ID that has been stored on this connection. It can be any text string.

The TCPIPServerReceive node is contained in the **TCPIP** drawer of the palette, and is represented in the workbench by the following icon:



Message structure

The TCPIPServerReceive node handles messages in the following message domains:

- MRM
- XMLNSC
- DataObject
- XMLNS
- JMSMap
- JMSStream
- MIME
- BLOB
- XML (this domain is deprecated; use XMLNSC)
- IDOC (this domain is deprecated; use MRM)

Using the TCPIPServerReceive node in a message flow

Look at the following samples to see how to use the TCPIPServerReceive node:

- TCPIP Client Nodes sample
- TCPIP Handshake sample.

You can view samples only when you use the information center that is integrated with the Message Broker Toolkit.

Configuring the TCPIPServerReceive node

When you have put an instance of the TCPIPServerReceive node into a message flow, you can configure it; see “Configuring a message flow node” on page 235. The properties of the node are displayed in the Properties view.

All mandatory properties that do not have a default value defined are marked with an asterisk.

Configure the TCPIPServerReceive node:

1. Optional: On the **Description** tab, enter a Short description, a Long description, or both. You can also rename the node on this tab.
2. On the **Basic** tab, set the properties that determine how the TCP/IP connection is controlled.
 - Use the Connection details property to specify either the hostname and port number to be used, or the name of a configurable service. This property is mandatory. The following formats are supported:
 - Configurable service name. This is used to look up the port and hostname in configurable services. For example, TCPIPProfile1.
 - <Hostname>:<Port>. This is the hostname followed by the port number (separated by a colon). For example, tcpip.server.com:1111
 - <Port>. This is the port number. In this case the hostname is assumed to be localhost.
 - Use the Timeout waiting for a data record (seconds) property to specify how long the node will listen on a connection for more data after the first byte of data has arrived. You can specify any length of time in seconds. A value of -1 specifies that there is no time limit (wait forever). The default is 60 seconds. When the specified time has been exceeded, all available data is sent to the failure terminal.
3. On the **Advanced** tab, set the properties that determine how the data stream is controlled.
 - Use the Close connection property to specify when and how to close the connection.
 - Select No to leave the connection open. This is the default.
 - Select After timeout to close the connection when a timeout occurs.
 - Select After data has been received to close the connection when the end of the record is found.
 - Select Close input stream after a record has been received to close the input stream as soon as the data has been retrieved. This property is not selected by default. When the connection input stream is reserved no other node can use it without knowing the ID.
 - Use the Input Stream Modification property to specify whether to reserve the input stream for use only by input and receive nodes that specify the connection ID, and, if so, whether to release it at the end of the flow.
 - Select Leave unchanged to leave the input stream as it was when it entered the node. This is selected by default.
 - Select Release input stream to specify that this input stream is returned to the pool and is available for use by any input or receive node.
 - Select Reserve input stream (for use by future TCP/IP input and receive nodes) to specify that this input stream can be used only by this node and by other input or receive nodes that request it by specifying the

connection ID. When the connection input stream is reserved no other nodes can use it without specifying the correct connection ID.

- Select Reserve input stream (for use by future TCP/IP input and receive nodes) then release after propagate to specify that this input stream can be used only by this node and receive nodes that request it by specifying the correct connection ID. After the message has been propagated, this input stream is returned to the pool and becomes available for use by any input or receive node.
 - Use the Output Stream Modification property to specify whether to reserve or release the output stream. These options are available only if you have not selected the Close output stream after a record has been sent property.
 - Select Leave unchanged to leave the output stream as it was when it entered the node. This is selected by default.
 - Select Release output stream to specify that this output stream is returned to the pool and is available for use by any output node.
 - Select Reserve output stream (for use by future TCP/IP output nodes) to specify that this output stream can be used only by this node and by other output nodes that request it by specifying the connection ID. When the connection input stream is reserved no other nodes can use it without specifying the correct connection ID.
 - Select Reserve output stream (for use by future TCP/IP output nodes) then release after propagate to specify that this output stream can be used only by this node and output nodes that request it by specifying the correct connection ID. After the message has been propagated, this output stream is returned to the pool and becomes available for use by any output node.
4. On the **Request** tab, specify the location of the data to be written. You can specify the properties on this tab as XPath or ESQL expressions. Content-assist is available in the properties pane and also in the XPath Expression Builder, which you can run by clicking **Edit** to the right of each property.
- In Data location, specify the input data location. This is the location in the input message tree that contains the record to be written. The default value is \$Body, which is the entire message body (\$InputRoot.Body).
- When you are specifying this property and the data in the message tree that it identifies is owned by a model-driven parser, such as the MRM parser or XMLNSC parser, be aware of the following considerations:
- If you are using MRM CWF format, ensure that the identified message tree exists as a message definition. If this is defined as a global element only, exceptions BIP5180 and BIP5167 are generated.
 - If you are using MRM TDS format, the serialization of the identified message is successful if the element is defined as a global element or message. However, if the identified field is not found as a global element or message, note that:
 - If this is a leaf field in the message tree, the field is written as self-defining. No validation occurs even if validation is enabled.
 - If this is a complex element, an internal exception is generated, BIP5522, indicating that the logical type cannot be converted to a string.
 - If you are using MRM XML, the events are similar to those for the MRM TDS format except that, if the field is a complex element, it is written as self-defining.
 - If you use the XMLNSC parser, no validation occurs even if validation is enabled.

- In Port location, specify the location of the value to override the Port set in the Connection details property of the **Basic** tab. If you do not specify a location, the default value is \$LocalEnvironment/TCPIP/Receive/Port.
 - In ID location, specify the location of the Id of the socket being used. This internal identifier is used by Message Broker to uniquely identify a connection. If you do not specify a location, the default value is \$LocalEnvironment/TCPIP/Receive/Id.
 - In Reply ID location, specify the location of the Reply ID that is stored on the connection being used. The Reply ID can be used when data is returned in an input node. If you do not specify a location, the default value is \$LocalEnvironment/TCPIP/Receive/ReplyId.
5. On the **Result** tab, set values for the properties that determine where the reply is to be stored.
- Use the Output data location property to specify the start location within the output message tree where the parsed elements from the bit string of the message are stored. The default value is \$Root.
 - Use the Copy local environment property to specify whether or not the LocalEnvironment is copied to the output message.
 - If Copy local environment is selected, a new copy of the LocalEnvironment is created in the tree, and it is populated with the contents of the LocalEnvironment from the preceding node. This means that if a node changes the LocalEnvironment, the upstream nodes are not affected by those changes because they have their own copies. This is the default.
 - If Copy local environment is not selected, the node does not generate its own copy of the LocalEnvironment, but uses the LocalEnvironment passed to it by the preceding node. This means that if a node changes the LocalEnvironment, the changes are reflected by the upstream nodes.
6. On the **Input Message Parsing** tab, set values for the properties that the node uses to determine how to parse the incoming message.

If the incoming message has an MQRFH2 header, you do not need to set values for the Input Message Parsing properties because the values are derived from the <mcd> folder in the MQRFH2 header; for example:

```
<mcd><Msd>MRM</Msd><Set>DHM4U0906S001</Set><Type>receiptmsg1</Type>
<Fmt>XML</Fmt></mcd>
```

If you set values, and those values differ from those in the MQRFH2 header, the values in the MQRFH2 header take precedence.

- In Message domain, select the name of the parser that you are using from the list. The default is BLOB. You can choose from the following options:
 - MRM
 - XMLNSC
 - DataObject
 - XMLNS
 - JMSMap
 - JMSStream
 - MIME
 - BLOB
 - XML (this domain is deprecated; use XMLNSC)
 - IDOC (this domain is deprecated; use MRM)

You can also specify a user-defined parser, if appropriate.

- If you are using the MRM or IDOC parser, or the XMLNSC parser in validating mode, select the Message set that you want to use. The list contains the message sets that are available when you select MRM, XMLNSC, or IDOC as the domain.
 - If you are using the MRM parser, select the correct message type from the list in Message type. This list is populated with available message types when you select the MRM parser.
 - If you are using the MRM or IDOC parser, select the correct message format from the list in Message format. This list is populated with available message formats when you select the MRM or IDOC parser.
 - Specify the message coded character set ID in Message coded character set ID.
 - Select the message encoding from the list in Message encoding or specify a numeric encoding value. For more information about encoding, see “Converting data with message flows” on page 128.
7. On the **Parser Options** sub-tab:
- Parse timing is, by default, set to On Demand, which causes parsing of the message to be delayed. To cause the message to be parsed immediately, see “Parsing on demand” on page 1363.
 - If you are using the XMLNSC parser, set values for the properties that determine how the XMLNSC parser operates. For more information, see “Manipulating messages in the XMLNSC domain” on page 364.
8. Use the **Records and Elements** tab to specify how the data is interpreted as records:
- Use the Record detection property to determine how the data is split into records, each of which generates a single message. Choose from the following options:
 - Connection closed specifies that all of the data sent during a connection is a single record.
 - Fixed Length specifies that each record is a fixed number of bytes in length. Each record should contain the number of bytes specified in the Length property, except possibly a shorter final record in the file.
 - Select Delimited, if the records you are processing are separated, or terminated, by a DOS or UNIX line end or by a sequence of user-defined delimiter bytes. Specify the delimiter and delimiter type in the Delimiter, and Delimiter type properties.
 - Select Parsed Record Sequence if the data contains a sequence of one or more records that are serially recognized by the parser specified in Message domain. The node propagates each recognized record as a separate message. If you select this Record detection option, the parser specified in Message domain must be either XMLNSC or MRM (either CWF or TDS physical format).
 - If you specified Fixed Length in Record detection, use Length to specify the required length of the output record. This value must be between 1 byte and 100 MB. The default is 80 bytes.
- If you specify Connection closed, Fixed Length, or Delimited in Record detection, a limit of 100 MB applies to the length of the records. If you specify Parsed Record Sequence in Record detection, the TCPIPServerReceive node does not determine or limit the length of a record. Nodes that are downstream in the message flow might try to determine the record length or process a very long record. If you intend to process large records in this way,

ensure that your broker has sufficient memory. You might need to apply flow techniques described in the Large Messaging sample to best use the available memory.

- If you specified Delimited in Record detection, use Delimiter to specify the delimiter to be used. Choose from:
 - DOS or UNIX Line End, which, on UNIX systems, specifies the line feed character (<LF>, X'0A'), and, on Windows systems, specifies a carriage return character followed by a line feed character (<CR><LF>, X'0D0A'). The node treats both of these strings as delimiters, irrespective of the system on which the broker is running. If they both appear in the same record, the node recognizes both as delimiters. The node does not recognize X'15' which, on z/OS systems, is the 'newline' byte; specify a value of Custom Delimiter in this property and a value of 15 in the Custom delimiter property if your input file is coded using EBCDIC new lines, such as EBCDIC files from a z/OS system.
 - Custom Delimiter (hexadecimal), which permits a sequence of bytes to be specified in Custom delimiter (hexadecimal)
 - In Custom delimiter (hexadecimal), specify the delimiter byte or bytes to be used when Custom delimiter (hexadecimal) is set in the Delimiter property. Specify this value as an even-numbered string of hexadecimal digits. The default is X'0A' and the maximum length of the string is 16 bytes (represented by 32 hexadecimal digits).
 - If you specified Delimited in Record detection, use Delimiter type to specify the type of delimiter. Permitted values are:
 - Infix. If you select this value, each delimiter separates records. If the data ends with a delimiter the (zero length) data following the final delimiter is still propagated although it contains no data.
 - Postfix. If you specify this value, each delimiter terminates records. If the data ends with a delimiter, no empty record is propagated after the delimiter. If the data does not end with a delimiter, it is processed as if a delimiter follows the final bytes of the data. Postfix is the default value.
 - The TCPIPServerReceive node considers each occurrence of the delimiter in the input as either separating (infix) or terminating (postfix) each record. If the data begins with a delimiter, the node treats the (zero length) contents preceding that delimiter as a record and propagates an empty record to the flow. The delimiter is never included in the propagated message.
9. Use the **Validation** tab to provide validation based on the message set for predefined messages. For more information about validation, see “Validating messages” on page 164. For information about how to complete this tab, see “Validation tab properties” on page 1360.

Terminals and properties

The terminals of the TCPIPServerReceive node are described in the following table.

Terminal	Description
In	The input terminal that accepts a message for processing by the node.
Out	The output terminal to which the message is routed if it is successfully retrieved from an external resource. If no errors occur within the input node, a message received from an external resource is always sent to the Out terminal first.
Timeout	The terminal to which a message is sent when the time specified in the Timeout waiting for a data record property has been exceeded. The message text is “Timeout value is exceeded”.

Terminal	Description
Failure	The output terminal to which the message is routed if an error occurs. This includes failures caused by retry processing. Even if the Validation property is set, messages propagated to this terminal are not validated.

The following tables describe the node properties. The column headed M indicates whether the property is *mandatory* (marked with an asterisk if you must enter a value when no default is defined); the column headed C indicates whether the property is *configurable* (you can change the value when you add the message flow to the bar file to deploy it).

The Description properties of the TCPIPServerReceive node are described in the following table.

Property	M	C	Default	Description
Node name	No	No	TCPIPServerReceive	The name of the node.
Short description	No	No	None	A brief description of the node.
Long description	No	No	None	Text that describes the purpose of the node in the message flow.

The Basic properties of the TCPIPServerReceive node are described in the following table.

Property	M	C	Default	Description
Connection details	Yes	Yes	Node properties	A string containing either the hostname and port number to be used, or the name of a configurable service.
Timeout waiting for a data record (seconds)	Yes	Yes	60	Specifies how long the node will listen on a connection for more data after the first byte of data has arrived. You can specify any length of time in seconds. A value of -1 specifies that there is no time limit (wait forever).

The Advanced properties of the TCPIPServerReceive node are described in the following table.

Property	M	C	Default	Description
Close connection	Yes	No	No	Controls when the connection is closed, or if it remains open. Valid options are: <ul style="list-style-type: none"> • No • After data has been received • After timeout.
Close input stream after a record has been received	Yes	No	False	Specifies whether to close the input stream as soon as the data has been retrieved. When the connection input stream is reserved no other node can use it without knowing the ID. This property is not selected by default.

Property	M	C	Default	Description
Input stream modification	No	No	Leave unchanged	<p>Specifies whether to reserve the input stream for use only by input and receive nodes that specify the connection ID, and, if so, whether to release it at the end of the flow. Valid options are:</p> <ul style="list-style-type: none"> • Leave unchanged • Release input stream • Reserve input stream (for use by future TCP/IP input and receive nodes) • Reserve input stream (for use by future TCP/IP input and receive nodes) then release after propagate. <p>When the connection input stream is reserved no other nodes can use it without specifying the correct connection ID. If the input stream is released after the message has been propagated, it is returned to the pool and becomes available for use by any input or receive node.</p>
Output stream modification	No	No	Leave unchanged	<p>Specifies whether to reserve this output stream or release it and return it to the pool for use by any output node. Valid options are:</p> <ul style="list-style-type: none"> • Leave unchanged • Release output stream • Reserve output stream (for use by future TCP/IP output nodes) • Reserve output stream (for use by future TCP/IP output nodes) then release after propagate.

The Request properties of the TCPIPServerReceive node are described in the following table:

Property	M	C	Default	Description
Data location	Yes	No	\$Body	The location in the input message tree containing the record to be written.
Port location	Yes	No	\$LocalEnvironment/TCPIP/Receive/Port	The message element location containing the Port.
ID location	Yes	No	\$LocalEnvironment/TCPIP/Receive/Id	The message element location containing the ID.
Reply ID location	Yes	No	\$LocalEnvironment/TCPIP/Receive/ReplyId	The message element location containing the Reply ID.

The Result properties of the TCPIPServerReceive node are described in the following table:

Property	M	C	Default	Description
Output data location	No	No	\$Root	The start location within the output message tree where the parsed elements from the bit string of the message are stored.
Copy local environment	No	No	True	Specifies whether or not the LocalEnvironment is copied to the output message.

The Input Message Parsing properties of the TCPIPServerReceive node are described in the following table.

Property	M	C	Default	Description
Message Domain	No	No		The domain that is used to parse the incoming message.
Message Set	No	No		The name or identifier of the message set in which the incoming message is defined. If you set this property, then subsequently update the project dependencies to remove this message set reference, a warning is issued. Either update the Message Set property, or restore the reference to this message set project.
Message Type	No	No		The name of the incoming message.
Message Format	No	No		The name of the physical format of the incoming message.
Message coded character set ID	Yes	No	Broker System Default	The ID of the coded character set used to interpret the data being read.
Message encoding	Yes	No	Broker System Default	The encoding scheme for numbers and large characters used to interpret the data being read. Valid values are Broker System Determined or a numeric encoding value. For more information about encoding, see “Converting data with message flows” on page 128.

The Parser Options properties of the TCPIPServerReceive node are described in the following table.

Property	M	C	Default	Description
Parse timing	No	No	On Demand	This property controls when an input message is parsed. Valid values are: <ul style="list-style-type: none"> • On Demand • Immediate • Complete. For a full description of this property, see “Parsing on demand” on page 1363.

Property	M	C	Default	Description
Build tree using XML schema data types	No	No	Cleared	This property controls whether the syntax elements in the message tree have data types taken from the XML Schema.
Use XMLNSC compact parser for XMLNS domain	No	No	Cleared	This property controls whether the XMLNSC Compact Parser is used for messages in the XMLNS Domain. If you set this property, the message data appears under XMLNSC in nodes that are connected to the output terminal when the input MQRFH2 header or Input Message Parsing property, Message Domain, is XMLNS.
Retain mixed content	No	No	Cleared	This property controls whether the XMLNSC parser creates elements in the message tree when it encounters mixed text in an input message. If you select the check box, elements are created for mixed text. If you clear the check box, mixed text is ignored and no elements are created.
Retain comments	No	No	Cleared	This property controls whether the XMLNSC parser creates elements in the message tree when it encounters comments in an input message. If you select the check box, elements are created for comments. If you clear the check box, comments are ignored and no elements are created.
Retain processing instructions	No	No	Cleared	This property controls whether the XMLNSC parser creates elements in the message tree when it encounters processing instructions in an input message. If you select the check box, elements are created for processing instructions. If you clear the check box, processing instructions are ignored and no elements are created.
Opaque elements	No	No	Blank	This property is used to specify a list of elements in the input message that are to be opaquely parsed by the XMLNSC parser.

The Records and Elements properties of the TCPIPServerReceive node are described in the following table:

Property	M	C	Default	Description
Record detection	Yes	No	Connection closed	The mechanism used to identify records in the input data. Valid options are: <ul style="list-style-type: none"> • Connection closed • Fixed Length • Delimited • Parsed Record Sequence.
Length	Yes	No	80	The length of each record, in bytes, when Fixed Length record detection is selected.
Delimiter	Yes	No	DOS or UNIX Line End	The type of delimiter bytes that separate, or terminate, each record when Delimited record detection is selected. Valid options are: <ul style="list-style-type: none"> • DOS or UNIX Line End • Custom Delimiter.

Property	M	C	Default	Description
Custom delimiter	No	No		The delimiter bytes, expressed in hexadecimal, when Delimited record detection and Custom Delimiter are selected. This property is mandatory only if the Delimiter property is set to Custom Delimiter.
Delimiter type	Yes	No	Postfix	The position of the delimiter when Delimited record detection and Custom Delimiter are selected. Valid options are: <ul style="list-style-type: none"> • Postfix • Infix. This property is ignored unless the Delimiter property is set to Custom Delimiter.

The Validation properties of the TCPIPServerReceive node are described in the following table.

For a full description of these properties, see “Validation properties” on page 1359.

Property	M	C	Default	Description
Validate	No	Yes	Inherit	This property controls whether validation takes place. Valid values are <ul style="list-style-type: none"> • None • Content and Value • Content • Inherit.
Failure action	No	No	Exception	This property controls what happens if validation fails. You can set this property only if you set Validate to Content or Content and Value. Valid values are: <ul style="list-style-type: none"> • User Trace • Local Error Log • Exception • Exception List.

Throw node

Use the Throw node to throw an exception within a message flow.

This topic contains the following sections:

- “Purpose”
- “Using this node in a message flow” on page 1190
- “Terminals and properties” on page 1190

Purpose

An exception can be caught and processed by:

- A preceding TryCatch node
- The message flow input node (the built-in nodes, for example HTTPInput and MQInput, have Catch terminals)
- A preceding AggregateReply node

Include a Throw node to force an error path through the message flow if the content of the message contains unexpected data. For example, to back out a message that does not contain a particular field, you can check (using a Filter node) that the field exists; if the field does not exist, the message can be passed to a Throw node that records details about the exception in the ExceptionList subtree within the message.

The Throw node is contained in the **Construction** drawer of the palette, and is represented in the workbench by the following icon:



Using this node in a message flow

Look at the following samples to see how to use this node:

- Airline Reservations sample
- Error Handler sample
- Large Messaging sample

You can view samples only when you use the information center that is integrated with the Message Broker Toolkit.

Include a Throw node with a TryCatch node in your message flow to alert the systems administrator of a potential error situation; for example, if you have a Compute node that calculates a number, test the result of this calculation and throw an exception if the result exceeds a certain amount. The TryCatch node catches this exception and propagates the message to a sequence of nodes that process the error.

Terminals and properties

When you have put an instance of the Throw node into a message flow, you can configure it; see “Configuring a message flow node” on page 235. The properties of the node are displayed in the Properties view. All mandatory properties for which you must enter a value (those that do not have a default value defined) are marked with an asterisk.

The Throw node terminal is described in the following table.

Terminal	Description
In	The input terminal that accepts a message for processing by the node.

The following tables describe the node properties. The column headed M indicates whether the property is *mandatory* (marked with an asterisk if you must enter a value when no default is defined); the column headed C indicates whether the property is *configurable* (you can change the value when you add the message flow to the bar file to deploy it).

The Throw node Description properties are described in the following table.

Property	M	C	Default	Description
Node name	No	No	The node type: Throw	The name of the node.

Property	M	C	Default	Description
Short Description	No	No		A brief description of the node.
Long Description	No	No		Text that describes the purpose of the node in the message flow.

The Throw node Basic properties are described in the following table.

Property	M	C	Default	Description
Message Catalog	No	No		The name of the message catalog from which the error text for the error number of the exception is extracted. Enter the fully-qualified path and file name of the message catalog that contains the message source. This file can be your own message catalog, or the default message catalog that is supplied with WebSphere Message Broker. To use the default supplied catalog, leave this property blank.
Message Number	No	No	3001	The error number of the exception that is being thrown. <ul style="list-style-type: none"> • If you have created your own message catalog, enter the number for the message in the catalog that you want to use when this exception is thrown. • If you are using the default message catalog, specify a number between 3001 (the default) and 3049. These numbers are reserved in the default catalog for your use. The text of each of these messages in the default message catalog is identical, but you can use a different number within this range for each situation in which you throw an exception; use the number to identify the exact cause of the error.
Message Text	No	No		Additional text that explains the cause of the error. Enter any additional free format text that contains information that you want to include with the message when it is written to the local error log; for example, if you have checked for the existence of a particular field in a message and thrown an exception when that field is not found, you might include the text: The message did not contain the required field: Branch number If you are using the default message catalog, this text is inserted as &1 in the message text.

TimeoutControl node

Use the TimeoutControl node to process an input message that contains a timeout request.

This topic contains the following sections:

- “Purpose”
- “Using this node in a message flow” on page 1192
- “Terminals and properties” on page 1192

Purpose

The TimeoutControl node validates the timeout request message, stores the message, and propagates the message (unchanged) to the next node in the message flow. For more information, see “Sending timeout request messages” on page 603.

The TimeoutControl node is contained in the **Timer** drawer of the palette, and is represented in the workbench by the following icon:



Using this node in a message flow

Use a TimeoutControl node and a TimeoutNotification node together in a message flow for an application that requires events to occur at particular times, or at regular intervals.

These examples show when you must use the timeout nodes in a message flow:

- You need to run a batch job every day at midnight.
- You want information about currency exchange rates to be sent to banks at hourly intervals.
- You want to confirm that important transactions are processed within a certain time period and perform some other specified actions to warn when a transaction has not been processed in that time period.

You can use more than one TimeoutControl node with a TimeoutNotification node. Timeout requests that are initiated by those TimeoutControl nodes are all processed by the same TimeoutNotification node if the same Unique identifier is used for the TimeoutNotification node and each of the TimeoutControl nodes.

Look at the following sample for more details about how to use the timeout processing nodes:

- Timeout Processing sample

You can view samples only when you use the information center that is integrated with the Message Broker Toolkit.

Terminals and properties

When you have put an instance of the TimeoutControl node into a message flow, you can configure it; see “Configuring a message flow node” on page 235. The properties of the node are displayed in the Properties view. All mandatory properties for which you must enter a value (those that do not have a default value defined) are marked with an asterisk.

The TimeoutControl node terminals are described in the following table.

Terminal	Description
In	The input terminal that accepts a message tree for processing (which includes validating the timeout request specified in the message tree at Request location) and adds it to the control queue.
Failure	The output terminal to which the input message is propagated if a failure is detected during processing in this node. If this terminal is not connected to another node, error information is passed back to the previous node in the message flow.
Out	The output terminal to which incoming messages are propagated, unchanged, after successful timeout request processing. If this terminal is not connected to another node, no propagation occurs. If propagation of the message fails, the message is propagated to the Failure terminal.

The following tables describe the node properties. The column headed M indicates whether the property is *mandatory* (marked with an asterisk if you must enter a value when no default is defined); the column headed C indicates whether the property is *configurable* (you can change the value when you add the message flow to the bar file to deploy it).

The Description properties of the TimeoutControl node are described in the following table.

Property	M	C	Default	Description
Node name	No	No	The node type, TimeoutControl	The name of the node.
Short description	No	No		A brief description of the node.
Long description	No	No		Text that describes the purpose of the node in the message flow.

The Basic properties of the TimeoutControl node are described in the following table.

Property	M	C	Default	Description
Unique identifier	Yes	Yes	None	This is the only mandatory property for the node. Its value must be unique within the broker. The equivalent property of the TimeoutNotification node with which it is paired must have the same value. The maximum length of this identifier is 12 characters.
Request location	No	No	None	This property describes where to find the timeout request information in the incoming message. This value can be any valid location in the input message tree and is validated at run time. If you do not specify a request location, InputLocalEnvironment.TimeoutRequest is assumed. For more information about the timeout request message, see “Sending timeout request messages” on page 603.
Request persistence	No	No	Automatic	This property controls whether an incoming timeout request survives a restart of either the broker or the message flow that contains the TimeoutNotification node that is paired with this TimeoutControl node. Select Yes if you want the incoming request to persist; select No if you do not. If you select Automatic (the default), the Persistence setting in the Properties folder of the incoming message is used.

The Message properties of the TimeoutControl node are described in the following table.

Property	M	C	Default	Description
Stored message location	No	No	None	This property identifies the location of the part of the request message that you want to store for propagation by the TimeoutNotification node with which this node is paired. If you do not specify a value, the entire message is stored. You can specify any valid location in the message tree. If you choose to store the entire message, you do not need to specify any values in Message domain, Message set, Message type, or Message format.

Property	M	C	Default	Description
Message domain	No	No	BLOB	<p>The domain that is used to parse the stored timeout request message by the TimeoutNotification node. If you do not specify a value and the message location is stored, the default value is BLOB.</p> <p>Select the name of the parser that you are using. This value, and the three corresponding values in Message set, Message type, and Message format, are used by the TimeoutNotification node with which it is paired when it rebuilds the stored message for propagation. If you have stored the entire request message (by leaving Stored message location blank), do not specify any values here. If you choose to store part of the request message, specify values here that reflect the stored request message fragment as if it were the entire message, which is the case when it is processed by the TimeoutNotification node. Choose from the following parsers:</p> <ul style="list-style-type: none"> • MRM • XMLNSC • XMLNS • BLOB • XML (this domain is deprecated; use XMLNSC) <p>You can also specify a user-defined parser, if appropriate.</p>
Message set	No	No	None	<p>The name or identifier of the message set in which the stored timeout request message is defined. If you are using the MRM parser, or the XMLNSC parser in validating mode, select the Message set that you want to use from the list.</p> <p>If you set this property, then subsequently update the project dependencies to remove this message set reference, a warning is issued. Either update the Message set property, or restore the reference to this message set project.</p>
Message type	No	No	None	<p>The name of the stored timeout request message. If you are using the MRM parser, select the correct message from the list in Message type. This list is populated with messages that are defined in the Message set that you have selected.</p>
Message format	No	No	None	<p>The name of the physical format of the stored timeout request message. If you are using the MRM parser, select the format of the message from the list in Message format. This list includes all the physical formats that you have defined for this Message set.</p>

TimeoutNotification node

Use the TimeoutNotification node to manage timeout-dependent message flows,

This topic contains the following sections:

- “Purpose”
- “Using this node in a message flow” on page 1195
- “Terminals and properties” on page 1195

Purpose

The TimeoutNotification node is an input node that you can use in two ways:

- A TimeoutNotification node can be paired with one or more TimeoutControl nodes.

The TimeoutNotification node processes timeout request messages that are sent by the TimeoutControl nodes with which it is paired, and propagates copies of the messages (or selected fragments of the messages) to the next node in the message flow.

- A TimeoutNotification node can be used as a stand-alone node.

Generated messages are propagated to the next node in the message flow at time intervals that are specified in the configuration of this node.

The TimeoutNotification node is contained in the **Timer** drawer of the palette, and is represented in the workbench by the following icon:



Using this node in a message flow

Use a TimeoutControl node and a TimeoutNotification node together in a message flow for an application that requires events to occur at a particular time, or at regular intervals; for example, when you want a batch job to run every day at midnight, or you want information about currency exchange rates to be sent to banks at hourly intervals.

You can use more than one TimeoutControl node with a TimeoutNotification node. Timeout requests that are initiated by those TimeoutControl nodes are all processed by the same TimeoutNotification node if the same Unique Identifier is used for the TimeoutNotification node and each of the TimeoutControl nodes. However, do not use the same Unique Identifier for more than one TimeoutNotification node.

When a TimeoutNotification node is started as a result of the broker starting, or by the message flow that contains the node starting, it scans its internal timeout store and purges any non-persistent timeout requests. Notifications are issued for any persistent timeout requests that are now past and that have the IgnoreMissed property set to False.

If you use a TimeoutNotification node to generate a WebSphere MQ message to an output node, such as theMQOutput node, provide a valid MQMD. You must also provide a valid MQMD if the TimeoutNotification node is running in automatic mode (as a stand-alone node). If the TimeoutNotification node is running in controlled mode (that is, it is paired with one or more TimeoutControl nodes), you must provide a valid MQMD only if the stored messages do not already have an MQMD. The following ESQL shows how to provide a valid MQMD:

```
CREATE NEXTSIBLING OF OutputRoot.Properties DOMAIN 'MQMD';  
SET OutputRoot.MQMD.Version = MQMD_CURRENT_VERSION;  
SET OutputRoot.MQMD.Format = 'XML';
```

Look at the following sample for more details about how to use the timeout processing nodes:

- Timeout Processing sample

You can view samples only when you use the information center that is integrated with the Message Broker Toolkit.

Terminals and properties

When you have put an instance of the TimeoutNotification node into a message flow, you can configure it; see “Configuring a message flow node” on page 235. The properties of the node are displayed in the Properties view. All mandatory properties for which you must enter a value (those that do not have a default value defined) are marked with an asterisk.

The terminals of the TimeoutNotification node are described in the following table.

Terminal	Description
Failure	The output terminal to which the message is propagated if a failure is detected during processing in this node. Nodes can be connected to this terminal to process these failures. If this terminal is not connected to another node, messages are not propagated and no logging or safe storage of data occurs.
Out	<p>The output terminal to which messages are propagated after timeouts expire.</p> <ul style="list-style-type: none"> • If the TimeoutNotification node is running in Automatic mode (that is, there are no TimeoutControl nodes paired with this node), the propagated messages contain only a Properties folder and a LocalEnvironment that is populated with the timeout information. • If the TimeoutNotification node is running in Controlled mode (that is, TimeoutControl nodes that are paired with this node store timeout requests), the propagated messages contain what was stored by the TimeoutControl nodes, which might be entire request messages or fragments of them. <p>If the TimeoutNotification node is used as the input node to a message flow that generates a WebSphere MQ message (for example, by using an MQOutput node), the message flow must create the necessary MQ headers and data (for example, MQMD).</p>
Catch	<p>The output terminal to which the message is propagated if an exception is thrown downstream. If this terminal is not connected to another node, the following events occur:</p> <ol style="list-style-type: none"> 1. The TimeoutNotification node writes the error to the local error log. 2. The TimeoutNotification node repeatedly tries to process the request until the problem that caused the exception is resolved.

The following tables describe the node properties. The column headed M indicates whether the property is *mandatory* (marked with an asterisk if you must enter a value when no default is defined); the column headed C indicates whether the property is *configurable* (you can change the value when you add the message flow to the bar file to deploy it).

The Description properties of the TimeoutNotification node are described in the following table.

Property	M	C	Default	Description
Node name	No	No	The node type: TimeoutNotification	The name of the node.
Short Description	No	No		A brief description of the node.
Long Description	No	No		Text that describes the purpose of the node in the message flow.

The Basic properties of the TimeoutNotification node are described in the following table.

Property	M	C	Default	Description
Unique Identifier	Yes	Yes	None	<p>This property specifies a value that is unique within the broker and that is the same as the identifier that is specified for the TimeoutControl nodes with which this node is paired (if there are any). The maximum length of this identifier is 12 characters.</p> <p>Do not use the same Unique Identifier for more than one TimeoutNotification node.</p>

Property	M	C	Default	Description
Transaction Mode	No	No	Yes	The transaction mode for the node. If the transaction mode is Automatic, a transaction is based on the persistence of the stored messages, which is controlled by the Request Persistence property of the TimeoutControl node with which it is paired. You can set this property to one of the following values: <ul style="list-style-type: none"> • Select Yes, if you want a transaction to be started. • Select No, if you do not want a transaction to be started. • Select Automatic, only if you have set Operation Mode to Controlled. Whether a transaction is started depends on the persistence of the stored timeout requests, which is controlled by the value of Request Persistence in the TimeoutControl node with which it is paired.
Operation Mode	No	No	Automatic	This property indicates whether this node is paired with any paired TimeoutControl nodes. Valid values are: <ul style="list-style-type: none"> • If you select Automatic, the node is not paired with any TimeoutControl nodes. The node generates timeout requests with an interval that is controlled by the setting of the Timeout Value property, which must be a positive integer. • If you select Controlled, the node processes all timeout requests that have been stored by the TimeoutControl nodes with which it is paired.
Timeout Interval	No	No	1	The interval (in seconds) between timeout requests. This property is relevant only if Operation Mode is set to Automatic. The value of this property must be a positive integer.

The properties of the Parser Options for the TimeoutNotification node are described in the following table.

Property	M	C	Default	Description
Parse Timing	No	No	On Demand	This property controls when the timeout message is parsed. Valid values are On Demand, Immediate, and Complete. By default, this property is set to On Demand, which causes parsing of the message to be delayed. To cause the message to be parsed immediately, see "Parsing on demand" on page 1363.
Build tree using XML schema data types	No	No	Cleared	This property controls whether the XMLNSC parser creates syntax elements in the message tree with data types taken from the XML Schema. You can select this property only if you set the Validate property on the Validation tab to Content or Content and Value.
Use MQRFH2C Compact Parser for MQRFH2 Domain	No	No	Cleared	This property controls whether the MQRFH2C Compact Parser, instead of the MQRFH2 parser, is used for MQRFH2 headers.
Use XMLNSC Compact Parser for XMLNS Domain	No	No	Cleared	This property controls whether the XMLNSC Compact Parser is used for messages in the XMLNS Domain. If you set this property, the message data appears under XMLNSC in nodes that are connected to the output terminal when the input RFH2 header or default properties Domain is XMLNS.
Retain Mixed Content	No	No	None	This property controls whether the XMLNSC parser creates elements in the message tree when it encounters mixed text in a timeout message. If you select the check box, elements are created for mixed text. If you clear the check box, mixed text is ignored and no elements are created.

Property	M	C	Default	Description
Retain Comments	No	No	None	This property controls whether the XMLNSC parser creates elements in the message tree when it encounters comments in a timeout message. If you select the check box, elements are created for comments. If you clear the check box, comments are ignored and no elements are created.
Retain Processing Instructions	No	No	None	This property controls whether the XMLNSC parser creates elements in the message tree when it encounters processing instructions in a timeout message. If you select the check box, elements are created for processing instructions. If you clear the check box, processing instructions are ignored and no elements are created.
Opaque elements	No	No	Blank	This property is used to specify a list of elements in the timeout message that are to be opaquely parsed by the XMLNSC parser. Opaque parsing is performed only if validation is not enabled (that is, if Validate is None); entries that are specified in Opaque Elements are ignored if validation is enabled.

The Validation properties of the TimeoutNotification node are described in the following table.

If a message is propagated to the Failure terminal of the node, it is not validated. For more information, see “Validating messages” on page 164 and “Validation properties” on page 1359.

Property	M	C	Default	Description
Validate	No	Yes	None	This property controls whether validation takes place. Valid values are None, Content, and Content And Value.
Failure Action	No	No	Exception	This property controls what happens if validation fails. You can set this property only if you set Validate to Content or Content and Value. Valid values are User Trace, Local Error Log, Exception, and Exception List.

Trace node

Use the Trace node to generate trace records that you can use to monitor the behavior of a message flow.

This topic contains the following sections:

- “Purpose”
- “Using this node in a message flow” on page 1199
- “Terminals and properties” on page 1199

Purpose

Trace records can incorporate text, message content, and date and time information, to help you to monitor the behavior of the message flow.

You can choose to write the records to the user trace file, another file, or the local error log (which contains error and information messages written by all other WebSphere Message Broker components). If you write traces to the local error log, you can issue a message from the default message catalog that is supplied with WebSphere Message Broker, or you can create your own message catalog.

The operation of the Trace node is independent of the setting of user tracing for the message flow that contains it. In particular, records that are written by the Trace node to the user trace log are written even if user trace is not currently active for the message flow.

The Trace node is contained in the **Construction** drawer of the palette, and is represented in the workbench by the following icon:



Using this node in a message flow

Look at the following samples to see how to use this node:

- Airline Reservations sample
- Aggregation sample
- Timeout Processing sample

You can view samples only when you use the information center that is integrated with the Message Broker Toolkit.

Include a Trace node to help diagnose errors in your message flow. By tracing the contents of the message at various points in the flow, you can determine the sequence of processing. You can configure the Trace node to record the content of a message, and to check the action of a specific node on the message. For example, you can include a Trace node immediately after a Compute node to check that the output message has the expected format.

You can also use the Trace node to provide information in error handling within your message flows. For example, you can use this node to record failures in processing due to errors in the content or format of a message.

When you have tested the message flow and proved that its operation is correct, remove Trace nodes from your message flow, or switch them off.

Terminals and properties

When you have put an instance of the Trace node into a message flow, you can configure it; see “Configuring a message flow node” on page 235. The properties of the node are displayed in the Properties view. All mandatory properties for which you must enter a value (those that do not have a default value defined) are marked with an asterisk.

The terminals of the Trace node are described in the following table.

Terminal	Description
In	The input terminal that accepts a message for processing by the node.
Out	The output terminal through which the message is propagated.

The following tables describe the node properties. The column headed M indicates whether the property is *mandatory* (marked with an asterisk if you must enter a value when no default is defined); the column headed C indicates whether the property is *configurable* (you can change the value when you add the message flow to the bar file to deploy it).

The Description properties of the Trace node are described in the following table.

Property	M	C	Default	Description
Node name	No	No	The node type: Trace	The name of the node.
Short Description	No	No		A brief description of the node.
Long Description	No	No		Text that describes the purpose of the node in the message flow.

The Basic properties of the Trace node are described in the following table.

Property	M	C	Default	Description
Destination	Yes	No	User Trace	<p>The destination of the trace record that is written by the node. The Destination refers to the computer that hosts the broker on which the Trace node is deployed:</p> <ul style="list-style-type: none"> To write the trace record to the local system error log, select Local Error Log. The information that you include in the trace record is written to one of the following locations: <ul style="list-style-type: none"> Windows On Windows, data is written to the Event log (Application View) Linux UNIX On Linux and UNIX, data is written to the syslog z/OS On z/OS, data is written to the operator console <p>If you select Local Error Log, indicate the number of the trace message that is to be written, and the message catalog in which the message is defined.</p> <ul style="list-style-type: none"> If you leave Message Catalog blank, the default message catalog is used as the source of the message that is to be written. <p>You must also enter the error number of the record in Message Number. Numbers 3051 to 3099 are reserved in the default catalog for this use. The text of each of these messages in the default message catalog is identical, but if you use a different number within this range for each situation that you trace, you can identify the exact cause of the error. The default message number is 3051.</p> <ul style="list-style-type: none"> If you create your own message catalog, enter the fully-qualified file name for your catalog in Message Catalog. <p>You must also enter the appropriate number for the message in the catalog that you want to write to the local error log in Message Number. On some systems, message numbers that end 00 are reserved for system use; do not include messages with numbers like 3100 in your message catalog.</p> <ul style="list-style-type: none"> To write the trace record to the system-generated user trace log, select User Trace. <p>These records are written regardless of the setting of the User Trace property for the deployed message flow.</p> <p>The user trace is written to the \log subdirectory of the root directory (for example, the default path on Windows is C:\Documents and Settings\All Users\Application Data\IBM\MQSI\common\log). The file name is made up of the broker name, the broker UUID, and a suffix of userTrace.bin (for example, broker.e51906cb-dd00-0000-0080-b10e69a5d551.userTrace.bin.0). Use the mqsireadlog and mqsiformatlog commands before you view the user trace log.</p> <ul style="list-style-type: none"> To write the trace record to a file of your choice, select File. <p>If you select this option, you must also set File Path to the fully-qualified path name for the trace. If you do not set the path, the location of the file depends on the system; for example, on z/OS, the file is created within the home directory of the broker service ID.</p> <p>You can use any name for the trace file; for example, c:\user\trace\trace.log</p> <p>If you specify a file that does not exist already, the file is created. However, directories are not created by this process, so the full path must already exist.</p> <p>The file is written as text, in the format specified by the Pattern property. You do not need to run the mqsireadlog or mqsiformatlog commands against the file.</p> <ul style="list-style-type: none"> If you do not want to write any trace records, select None. You can also switch Trace nodes off.
File Path	No	Yes		<p>The fully-qualified file name of the file to which to write records. This property is valid only if Destination is set to File.</p>

Property	M	C	Default	Description
Pattern	No	No		<p>The data that is to be included in the trace record. Create an ESQL pattern to specify what information to write. If you write the trace record to the local error log, the pattern governs the information that is written in the text of the message number that is selected. If you use the default message catalog, and a number between 3051 and 3099, the pattern information is inserted as &1 in the message text.</p> <ul style="list-style-type: none"> You can write plain text, which is copied into the trace record exactly as you have entered it. You can identify parts of the message to write to the trace record, specifying the full field identifiers enclosed within the characters <code>#{</code> and <code>}</code>. To record the entire message, specify <code>#{Root}</code>. Use the ESQL functions to provide additional information; for example, use the ESQL function <code>CURRENT_DATE</code> to record the date, time, or both, at which the trace record is written. <p>The pattern below illustrates some of the options that are available. The pattern writes an initial line of text, records two elements of the current message, and adds a simple timestamp:</p> <pre>Message passed through with the following fields: Store name is #{Body.storedetailselement.storename} Total sales are #{Body.totalselement.totalsales} Time is: #{EXTRACT(HOUR FROM CURRENT_TIMESTAMP)} :#{EXTRACT(MINUTE FROM CURRENT_TIMESTAMP)}</pre> <p>The resulting trace record is:</p> <pre>Message passed through with the following fields: Store name is 'SRUCorporation' Total sales are '34.98' Time is: 11:19</pre> <p>A pattern that contains syntax errors does not prevent a message flow that contains the Trace node from deploying, but the node writes no trace records.</p>
Message Catalog	No	No		<p>The name of the message catalog from which the error text for the error number of the exception is extracted. The default value (blank) indicates that the message is taken from the message catalog that is supplied with WebSphere Message Broker. See Creating message catalogs for more information.</p>
Message Number	No	No	3051	<p>The error number of the message that is written.</p>

TryCatch node

Use the TryCatch node to provide a special handler for exception processing.

This topic contains the following sections:

- “Purpose”
- “Using this node in a message flow” on page 1203
- “Connecting the terminals” on page 1203
- “Terminals and properties” on page 1203

Purpose

Initially, the input message is routed on the Try terminal, which you must connect to the remaining non-error processing nodes of the message flow. If a downstream node (which can be a Throw node) throws an exception, the TryCatch node catches it and routes the original message to its Catch terminal. Connect the Catch terminal to further nodes to provide error processing for the message after an

exception. If the Catch terminal is connected, the message is propagated to it. If the Catch terminal is not connected, the message is discarded.

The TryCatch node is contained in the **Construction** drawer of the palette, and is represented in the workbench by the following icon:



Using this node in a message flow

Look at the following sample to see how to use this node:

- Error Handler sample

You can view samples only when you use the information center that is integrated with the Message Broker Toolkit.

Use the Throw and TryCatch nodes when you use the Compute node to calculate a total. You can create a message that is sent to your system administrator when the total that is calculated exceeds the maximum value for the Total field.

Connecting the terminals

The TryCatch node has no configurable properties that affect its operation. You determine how it operates by connecting the output terminals to subsequent nodes in your message flow.

1. Connect the Try terminal to the first node in the sequence of nodes that provides the normal (non-error) phase of processing of this message. This sequence can contain one or more nodes that perform any valid processing. The sequence of nodes can optionally conclude with an output node.
2. Connect the Catch terminal to the first node in the sequence of nodes that provides the error processing for this message flow. This sequence can contain one or more nodes that perform any valid processing. The sequence of nodes can optionally conclude with an output node.

When an exception is thrown in the message flow, either by the explicit use of the Throw node or the ESQL THROW statement, or by the broker raising an implicit exception when it detects an error that the message flow is not programmed to handle, control returns to the TryCatch node.

The message is propagated through the Catch terminal and the error handling that you have designed is executed. The message that is propagated through this terminal has the content that it had at the point at which the exception was thrown, including the full description of the exception in the ExceptionList.

Terminals and properties

When you have put an instance of the TryCatch node into a message flow, you can configure it; see “Configuring a message flow node” on page 235. The properties of the node are displayed in the Properties view.

The TryCatch node terminals are described in the following table.

Terminal	Description
In	The input terminal that accepts a message for processing by the node.

Terminal	Description
Catch	The output terminal to which the message is propagated if an exception is thrown downstream and caught by this node.
Try	The output terminal to which the message is propagated if it is not caught.

The following table describes the node properties. The column headed M indicates whether the property is *mandatory* (marked with an asterisk if you must enter a value when no default is defined); the column headed C indicates whether the property is *configurable* (you can change the value when you add the message flow to the bar file to deploy it).

The TryCatch node Description properties are described in the following table.

Property	M	C	Default	Description
Node name	No	No	The node type: TryCatch	The name of the node.
Short Description	No	No		A brief description of the node.
Long Description	No	No		Text that describes the purpose of the node in the message flow.

TwineballInput node

Use the TwineballInput node to find out how the WebSphere Adapters nodes work.

This topic contains the following sections:

- “Purpose”
- “Terminals and properties” on page 1205

Purpose

The TwineballInput node is provided for educational purposes and helps you to see how the WebSphere Adapters nodes work. The TwineballInput node is a sample node with its own sample EIS. You cannot use the TwineBall nodes to connect to the external SAP, Siebel, and PeopleSoft EIS systems. Do not use this node in production.

The TwineballInput node is contained in the **WebSphere Adapters** drawer of the message flow node palette, and is represented in the workbench by the following icon:



You can use the `mqsisetdbparms` command in the following format to configure an account name with a user name and password for the Twineball adapter.

```
mqsisetdbparms broker name -n adapter name -u user name -p password
```

For example:

```
mqsisetdbparms BRK1 -n TwineballInbound.inadapter -u mqbroker -p *****
```

Look at the Twineball Example EIS Adapter sample to see how to use this node. You can view samples only when you use the information center that is integrated with the Message Broker Toolkit.

Terminals and properties

When you have put an instance of the TwineballInput node into a message flow, you can configure it; see “Configuring a message flow node” on page 235. The properties of the node are displayed in the Properties view. If you double-click a TwineballInput node, you open the Adapter Connection wizard. All mandatory properties for which you must enter a value (those that do not have a default value defined) are marked with an asterisk.

The TwineballInput node terminals are described in the following table.

Terminal	Description
Out	Business object events from the adapter are sent to the Out terminal.
Failure	If an error happens in the TwineballInput node, the message is propagated to the Failure terminal. Information about the error, and business object events can also be propagated to the Failure terminal.
Catch	Business object events are sent to the Catch terminal if they cause an uncaught exception in the message flow. If the Catch terminal is not connected, the retry process is activated to handle the business object.

The following table describes the node properties. The column headed M indicates whether the property is *mandatory* (marked with an asterisk if you must enter a value when no default is defined); the column headed C indicates whether the property is *configurable* (you can change the value when you add the message flow to the bar file to deploy it).

The TwineballInput node Description properties are described in the following table.

Property	M	C	Default	Description
Node name	No	No	The node type, TwineballInput.	The name of the node.
Short Description	No	No		A brief description of the node.
Long Description	No	No		Text that describes the purpose of the node in the message flow.

The TwineballInput node Basic properties are described in the following table.

Property	M	C	Default	Description
Adapter component	Yes	Yes		The name of the adapter component that contains configuration properties for the adapter. Either enter a name of an adapter file or click Browse to select an adapter file from the list of files that are available in referenced message set projects.

The TwineballInput node Routing properties are described in the following table.

Property	M	C	Default	Description
Set destination list	No	No	Selected	This property specifies whether to add the method binding name to the route to label destination list. If you select this check box, the method binding name is added so that you can use a RouteToLabel node in the message flow after the TwineballInput node.
Label prefix	No	No		The prefix to add to the method name when routing to label. Add a label prefix to avoid a clash of corresponding label nodes when you include multiple WebSphere Adapters input nodes in the same message flow. By default, there is no label prefix, so the method name and label name are identical.

The TwineballInput node Input Message Parsing properties are described in the following table.

Property	M	C	Default	Description
Message domain	No	No	DataObject	The domain that is used to parse the incoming message. By default, the message that is propagated from the TwineballInput node is in the DataObject domain. You cannot specify a different domain.
Message set	Yes	No	Set automatically	The name of the message set in which the incoming message is defined. This field is set automatically from the Adapter component property. If you set this property, then subsequently update the project dependencies to remove this message set reference, a warning is issued. Either update the Message set property, or restore the reference to this message set project.
Message type	No	No		The name of the incoming message. The node detects the message type automatically. You cannot set this property.
Message format	No	No		The name of the physical format of the incoming message. You cannot set this property.

The TwineballInput node Transactionality properties are described in the following table.

Property	M	C	Default	Description
Transaction mode	No	No	Yes	This property specifies how updates are handled. If you select Yes, updates are performed in a single transaction. If you select No, updates are performed independently.

The Instances properties of the TwineballInput node are described in the following table. For a full description of these properties, refer to “Configurable message flow properties” on page 1372.

Property	M	C	Default	Description
Additional instances pool	No	Yes	Use Pool Associated with Message Flow	The pool from which additional instances are obtained. <ul style="list-style-type: none"> If you select Use Pool Associated with Message Flow, additional instances are obtained from the message flow value. If you select Use Pool Associated with Node, additional instances are allocated from the node’s additional instances based on the number specified in the Additional instances property.
Additional instances	No	Yes	0	The number of additional instances that the node can start if the Additional instances pool property is set to Use Pool Associated with Node. By default, no additional instances are given to the node.

The TwineballInput node Retry properties are described in the following table.

Property	M	C	Default	Description
Retry mechanism	No	No	Failure	This property specifies how retry processing is handled when a failure is rolled back to the TwineballInput node. <ul style="list-style-type: none"> • If you select Failure, retry processing is not performed so you cannot set the remaining properties. • If you select Short and long retry, retry processing is performed first at the interval that is specified by the Short retry interval property, and if that is unsuccessful, it is then performed at the interval that is specified by the Long retry interval property.
Retry threshold	No	Yes	0	The maximum number of times that retry processing is performed for short retry.
Short retry interval	No	Yes	0	The interval between short retry attempts.
Long retry interval	No	Yes	0	The interval between long retry attempts.

TwineballRequest node

Use the TwineballRequest node to find out how WebSphere Adapters nodes work.

This topic contains the following sections:

- “Purpose”
- “Terminals and properties” on page 1208

Purpose

The TwineballRequest node is provided for educational purposes and helps you to see how the WebSphere Adapters nodes work. The TwineballRequest node is a sample node with its own sample EIS. You cannot use the TwineBall nodes to connect to the external SAP, Siebel, and PeopleSoft EIS systems. Do not use this node in production.

The TwineballRequest node is contained in the **WebSphere Adapters** drawer of the message flow node palette, and is represented in the workbench by the following icon:



You can use the `mqsisetdbparms` command in the following format to configure an account name with a user name and password for the Twineball adapter.

```
mqsisetdbparms broker name -n adapter name -u user name -p password
```

For example:

```
mqsisetdbparms BRK1 -n TwineballOutbound.outadapter -u mqbroker -p *****
```

Look at the Twineball Example EIS Adapter sample to see how to use this node. You can view samples only when you use the information center that is integrated with the Message Broker Toolkit.

Terminals and properties

When you have put an instance of the TwineballRequest node into a message flow, you can configure it; see “Configuring a message flow node” on page 235. The properties of the node are displayed in the Properties view. If you double-click a TwineballRequest node, you open the Adapter Connection wizard. All mandatory properties for which you must enter a value (those that do not have a default value defined) are marked with an asterisk.

The TwineballRequest node terminals are described in the following table.

Terminal	Description
In	The input terminal that accepts the request business object.
Out	The output terminal to which the response business object is sent if it represents successful completion of the request, and if further processing is required within this message flow.
Failure	If an error happens in the TwineballRequest node, the message is propagated to the Failure terminal. Information about the error, and business object events can also be propagated to the Failure terminal.

The following tables describe the node properties. The column headed M indicates whether the property is *mandatory* (marked with an asterisk on the panel if you must enter a value when no default is defined); the column headed C indicates whether the property is *configurable* (you can change the value when you add the message flow to the bar file to deploy it).

The TwineballRequest node Description properties are described in the following table.

Property	M	C	Default	Description
Node name	No	No	The node type, e.g. TwineballRequest	The name of the node.
Short Description	No	No		A brief description of the node.
Long Description	No	No		Text that describes the purpose of the node in the message flow.

The TwineballRequest node Basic properties are described in the following table.

Property	M	C	Default	Description
Adapter component	Yes	No		The name of the adapter component that contains configuration properties for the adapter. Either enter a name of an adapter file, or click Browse to select an adapter file from the list of files that are available in referenced message set projects.
Default method	Yes	Yes		The default method binding to use.

The TwineballRequest node Response Message Parsing properties are described in the following table.

Property	M	C	Default	Description
Message domain	No	No	DataObject	The domain that is used to parse the response message. By default, the response message that is propagated from the TwineballRequest node is in the DataObject domain. You cannot specify a different domain.

Property	M	C	Default	Description
Message set	Yes	No	Set automatically	The name of the message set in which the incoming message is defined. This field is set automatically from the Adapter component property. If you set this property, then subsequently update the project dependencies to remove this message set reference, a warning is issued. Either update the Message set property, or restore the reference to this message set project.
Message type	No	No		The name of the response message. The node detects the message type automatically. You cannot set this property.
Message format	No	No		The name of the physical format of the response message. You cannot set this property.

The TwineballRequest node Transactionality properties are described in the following table.

Property	M	C	Default	Description
Transaction mode	No	No	Automatic	This property specifies how updates are handled. If you select Yes, updates are performed in a single transaction. If you select No, updates are performed independently.

The TwineballRequest node Request properties are described in the following table.

Property	M	C	Default	Description
Method Location	Yes	No	\$LocalEnvironment/ Adapter/MethodName	The business method that is used to trigger the TwineballRequest node to perform an action on the external system. For example: <ul style="list-style-type: none"> createPurchaseOrder causes the TwineballRequest node to create a purchase order in the EIS. deletePurchaseOrder causes the TwineballRequest node to delete a purchase order in the EIS.
Data Location	Yes	No	\$Body	The location in the incoming message tree from which data is retrieved to form the request that is sent from the TwineballRequest node to the EIS.

The TwineballRequest node Result properties are described in the following table.

Property	M	C	Default	Description
Output data location	No	No	\$OutputRoot	The message tree location to which the TwineballRequest node sends output.
Copy local environment	No	No	Selected	This property controls how the local environment is copied to the output message. If you select the check box, at each node in the message flow, a new copy of the local environment is created in the tree, and it is populated with the contents of the local environment from the preceding node. So if a node changes the local environment, the upstream nodes do not see those changes because they have their own copies. This behavior might be an issue if you are using a FlowOrder node, or if you use the propagate command on a Compute node. If you clear the check box, each node does not generate its own copy of the local environment, but it uses the local environment that is passed to it by the previous node. So if a node changes the local environment, those changes are seen by the upstream nodes.

Validate node

Use the Validate node to check that the message that arrives on its input terminal is as expected. You can use this node to check that the message has the expected message template properties (the message domain, message set, and message type) and to check that the content of the message is correct by selecting message validation.

This topic contains the following sections:

- “Purpose”
- “Using this node in a message flow” on page 1211
- “Terminals and properties” on page 1211

Purpose

The checks that you can perform depend on the domain of the message.

Check	Domain
Check message domain	All domains
Check message set	XMLNSC, MRM, and IDOC only
Check message type	MRM only
Validate message body	XMLNSC, MRM and IDOC only

You can check the message against one or more of message domain, message set, or message type. The property is checked only if you select its corresponding check box, which means that a property that contains an empty string can be compared.

You can check the content of the message by giving a value to the Validate property. Validation takes place if the Validate property is set to a value other than None, which is the default value.

For validation failures to be returned to the Validate node from the parser, set the Failure Action property to either Exception or Exception List. Otherwise, validation failures are just logged.

If all the specified checks pass, the message is propagated to the Match terminal of the node.

If any of the checks fail, the message is propagated to the Failure terminal. If the Failure terminal is not connected to some failure handling processing, an exception is generated.

The Validate node replaces the Check node, which is deprecated in WebSphere Message Broker Version 6.0 and subsequent releases. The Validate node works in the same way as the Check node, but it has additional Validation properties to allow the validation of message content by parsers that support that capability.

The Validate node is contained in the **Validation** drawer of the palette, and is represented in the workbench by the following icon:



Using this node in a message flow

Use the Validate node to confirm that a message has the correct message template properties, and has valid content, before propagating the message to the rest of the flow. Subsequent nodes can then rely on the message being correct, without doing their own error checking.

You can also use the Validate node to ensure that the message is routed appropriately through the message flow. For example, configure the node to direct a message that requests stock purchases through a different route from that required for a message that requests stock sales.

Another routing example is the receipt of electronic messages from your staff at your head office. These messages are used for multiple purposes (for example, to request technical support or stationery, or to advise you about new customer leads). These messages can be processed automatically because your staff complete a standard form. If you want these messages to be processed separately from other messages that are received, use the Validate node to ensure that only staff messages that have a specific message type are processed by this message flow.

Terminals and properties

When you have put an instance of the Validate node into a message flow, you can configure it. For more information, see “Configuring a message flow node” on page 235. The properties of the node are displayed in the Properties view. All mandatory properties for which you must enter a value (those that do not have a default value defined) are marked with an asterisk.

The terminals of the Validate node are described in the following table.

Terminal	Description
In	The input terminal that accepts a message for processing by the node.
Failure	The output terminal to which the message is routed if the incoming message does not match the specified properties.
Match	The output terminal to which the message is routed if the incoming message matches the specified properties.

The following tables describe the properties of the node. The column headed M indicates whether the property is *mandatory* (marked with an asterisk if you must enter a value when no default is defined); the column headed C indicates whether the property is *configurable* (you can change the value when you add the message flow to the bar file to deploy it).

The Description properties of the Validate node are described in the following table.

Property	M	C	Default	Description
Node name	No	No	Validate	The name of the node.
Short description	No	No		A brief description of the node.
Long description	No	No		Text that describes the purpose of the node in the message flow.

The Validate node Basic properties are described in the following table.

Property	M	C	Default	Description
Domain	No	No		<p>The name of the domain. Select one of the following values from the list of the Domain property:</p> <ul style="list-style-type: none"> • MRM • SOAP • XMLNSC • DataObject • XMLNS • JMSMap • JMSSStream • MIME • BLOB • XML (deprecated - use XMLNSC) • IDOC (deprecated - use MRM) <p>You can also specify a user-defined parser, if appropriate.</p>
Check domain	Yes	No	Cleared	If you select this check box, the incoming message is checked against the Domain property.
Set	No	No		<p>The name or identifier of the message set to which the incoming message belongs. If you are using the XMLNSC, MRM, or IDOC parser and want to check that the incoming message belongs to a particular message set, select Check set and select one of the values from the list of the Set property. This list is populated when you select XMLNSC, MRM, or IDOC as the message domain.</p> <p>Leave Set clear for the other parsers.</p> <p>If you set this property, then subsequently update the project dependencies to remove this message set reference, a warning is issued. Either update the Set property, or restore the reference to this message set project.</p>
Check set	Yes	No	Cleared	If you select the check box, the incoming message is checked against the Set property. If you are using the XMLNSC, MRM, or IDOC parser and want to check that the incoming message belongs to a particular message set, select Check set and select one of the values from the list of the Set property.
Type	No	No		<p>The message name. If you are using the MRM parser and want to check that the incoming message is a particular message type, select Check type and enter the name of the message in the Type property.</p> <p>Leave Type clear for the other parsers.</p>
Check type	Yes	No	Cleared	If you select the check box, the incoming message is checked against the Type property. If you are using the MRM parser and want to check that the incoming message is a particular message type, select Check type and enter the name of the message in the Type property.

The Validation properties of the Validate node are described in the following table.

If you are using the XMLNSC, MRM, or IDOC parser and want to validate the body of messages against the message set, select the required validation properties on the **Validation** tab. For more details, see “Validating messages” on page 164 and “Validation properties” on page 1359.

Property	M	C	Default	Description
Validate	No	Yes	None	This property controls whether validation takes place. Valid values are None, Content and Value, Content, and Inherit.

Property	M	C	Default	Description
Failure Action	No	No	Exception	This property controls what happens if validation fails. You can set this property only if you set Validate to Content or Content and Value. Valid values are User Trace, Local Error Log, Exception, and Exception List.

Warehouse node

Use the Warehouse node to interact with a database in the specified ODBC data source.

This topic contains the following sections:

- “Purpose”
- “Using this node in a message flow”
- “Terminals and properties” on page 1214

Purpose

The Warehouse node is a specialized form of the Database node that stores the entire message, parts of the message, or both, in a table within the database. You define what is stored by creating mappings that use the data from the input message to identify the action that is required.

You can use the Warehouse node:

- To maintain an audit trail of messages that are passing through the broker
- For offline or batch processing of messages that have passed through the broker (data mining)
- As a source from which to reprocess selected messages in the broker

Use standard database query and mining techniques to retrieve messages that you have stored in the warehouse. (No explicit support is provided by WebSphere Message Broker.)

You must have created or identified the following items:

- Input data in the form of a message set and message
- An ODBC connection to the database
- A database and database table to store the message
- At least two columns in the table: one for the binary object (the message), and one for the timestamp

The Warehouse node is contained in the **Database** drawer of the palette, and is represented in the workbench by the following icon:



Using this node in a message flow

When you use the Warehouse node, you can choose to store the following elements in the database that is associated with the node:

- The entire message, optionally with an associated timestamp. The message is stored as a binary object, with the timestamp in a separate column. This option has two advantages:

- You do not need to decide beforehand how you will use the warehoused data; because you have stored it all, you can retrieve all the data and apply data mining tools to it later.
- You do not need to define a specific database schema for every type of message that might pass through the broker. In a complex system, many different message types might be processed, and the overhead of defining a unique schema for each message type can become prohibitive. You can precede each Warehouse node with a Compute node that converts each message into a canonical warehouse format with a common schema, or you can store the whole message as a binary object.
- Selected parts of the message, optionally with an associated timestamp, which requires a defined database schema for that message type. The message is mapped to true type so, for example, a character string in the message is stored as a character string in the database.

Terminals and properties

When you have put an instance of the Warehouse node into a message flow, you can configure it. For more information, see “Configuring a message flow node” on page 235. The properties of the node are displayed in the Properties view. (If you double-click a Warehouse node, you open the New Message Map dialog box.) All mandatory properties for which you must enter a value (those that do not have a default value defined) are marked with an asterisk.

The terminals of the Warehouse node are described in the following table.

Terminal	Description
In	The input terminal that accepts a message for processing by the node.
Failure	The output terminal to which the input message is propagated if a failure is detected during the computation. If you have selected Treat warnings as errors, the node propagates the message to this terminal even if the processing completes successfully.
Out	The output terminal that outputs the message following the execution of the database statement.

The following tables describe the node properties. The column headed M indicates whether the property is *mandatory* (marked with an asterisk if you must enter a value when no default is defined); the column headed C indicates whether the property is *configurable* (you can change the value when you add the message flow to the bar file to deploy it).

The Warehouse node Description properties are described in the following table.

Property	M	C	Default	Description
Node name	No	No	Warehouse	The name of the node.
Short description	No	No		A brief description of the node.
Long description	No	No		Text that describes the purpose of the node in the message flow.

The Warehouse node Basic properties are described in the following table.

Property	M	C	Default	Description
Data source	No	Yes		<p>The ODBC data source name of the database that contains the tables to which you refer in the mappings that are associated with this node (identified by the Field mapping property). The name identifies the appropriate database on the system on which this message flow is to run. The broker connects to this database with user ID and password information that you have specified on the mqsicreatebroker, mqsicchangebroker, or mqsisetdbparms command.</p> <p>z/OS On z/OS systems, the broker uses the broker started task ID, or the user ID and password that are specified on the mqsisetdbparms command JCL, BIPSDBP in the customization data set <hlq>SBIPPROC.</p>
Field mapping	Yes	No	Warehouse	<p>The name of the mapping routine that contains the statements that are to be executed against the database or the message tree.</p> <p>By default, the name that is assigned to the mapping routine is identical to the name of the mappings file in which the routine is defined, and the default name for the file is the name of the message flow concatenated with the name of the node when you include it in the message flow (for example, MFlow1_Warehouse.msgmap for the first Warehouse node in message flow MFlow1). You cannot specify a value that includes spaces.</p> <p>If you click Browse next to this entry field, a dialog box is displayed that lists all available mapping routines that can be accessed by this node. Select the routine that you want and click OK; the routine name is set in Field mapping.</p> <p>To work with the mapping routine that is associated with this node, double-click the node, or right-click the node and select Open Mappings. If the mapping routine does not exist, it is created for you with the default name in the default file. If the file exists already, you can also open file <i>flow_name_node_name.msgmap</i> in the Broker Development view.</p> <p>The content of the mapping routine determines what is stored in the database, and in what format. You can, for example, store all or just a part of each message. You can also store the data as binary data, or store each field in the same format as it is in the message (for example, a character field in the message is stored as character in the database).</p> <p>A mapping routine is specific to the type of node with which it is associated; you cannot use a mapping routine that you have developed for a Warehouse node with any other node that uses mappings (for example, a DataInsert node). If you create a mapping routine, you cannot call it from any other mapping routine, although you can call it from an ESQL routine.</p> <p>For more information about working with mapping files, and defining their content, see “Developing message mappings” on page 472.</p>
Transaction	Yes	No	Automatic	<p>The transaction mode for the node. Select the value that you require:</p> <ul style="list-style-type: none"> • If you select Automatic (the default), the message flow, of which the Warehouse node is a part, is committed if it is successful; that is, the actions that you define in the mappings are taken and the message continues through the message flow. If the message flow fails, it is rolled back. Therefore, selecting Automatic means that the ability to commit or roll back the action of the Warehouse node on the database depends on the success or failure of the entire message flow. • If you select Commit, any uncommitted actions that are taken in this message flow are committed on the database that is connected to this node, irrespective of the success or failure of the message flow as a whole. The changes to the database are committed even if the message flow itself fails.

Property	M	C	Default	Description
Treat warnings as errors	Yes	No	Cleared	<p>For database warning messages to be treated as errors, and the node to propagate the output message to the Failure terminal, select Treat warnings as errors. The check box is cleared by default.</p> <p>When you select the check box, the node handles all positive return codes from the database as errors and generates exceptions in the same way as it does for the negative, or more serious, errors.</p> <p>If you do not select the check box, the node treats warnings as typical return codes, and does not raise any exceptions. The most significant warning raised is not found, which can be handled as a typical return code safely in most circumstances.</p>
Throw exception on database error	Yes	No	Selected	<p>For the broker to generate an exception when a database error is detected, select Throw exception on database errors. The check box is selected by default.</p> <p>If you clear the check box, you must handle the error in the message flow to ensure the integrity of the broker and the database; the error is ignored if you do not handle it through your own processing, because you have chosen not to invoke the default error handling by the broker; for example, you can connect the Failure terminal to an error processing subroutine.</p>

XSLTransform node

Use the XSLTransform node to transform an XML message to another form of message, according to the rules provided by an XSL (Extensible Stylesheet Language) style sheet, and to set the Message domain, Message set, Message type, and Message format for the generated message.

This node was formerly known as the XMLTransformation node.

This topic contains the following sections:

- “Purpose”
- “Using this node in a message flow” on page 1217
- “Deployed and non-deployed style sheets” on page 1219
- “Configuring the XSLTransform node” on page 1220
- “Terminals and properties” on page 1223

Purpose

You can specify the location of the style sheet to apply to this transformation in three ways:

- Use the content of the XML data within the message itself to transform the message according to a style sheet that the message itself defines.
- Set a value within the LocalEnvironment folder. You must set this value in a node that precedes the XSLTransform node (for example, a Compute node). You can therefore use a variety of inputs to determine which style sheet to use for this message, such as the content of the message data, or a value in a database.
- Use node properties to ensure that the transformation that is defined by this single style sheet is applied to every message that is processed by this node.

An XSLT (Extensible Stylesheet Language for Transformations) compiler is used for the transformation if the style sheet is not embedded within the message, and the

node cache level (node property Stylesheet Cache Level) is greater than zero. If the XSLT is cached, the performance is improved because the XSLT is not parsed every time it is used.

If the prologue of the input message body contains an XML encoding declaration, the XSLTransform node ignores the encoding, and always uses the CodedCharSetId in the message property folder to decode the message.

The XSLTransform node is contained in the **Transformation** drawer of the palette, and is represented in the workbench by the following icon:



Using this node in a message flow

For an example of how to use this node, consider two news organizations that exchange information on a regular basis. One might be a television station, the other a newspaper. Although the information is similar, the vocabulary that is used by the two is different. This node can transform one format to the other by applying the rules of the specified style sheet. If you specify the style sheet in the message (either the XML data or the LocalEnvironment), the same node can perform both transformations.

You cannot use relative path external entities that are defined in the DTD of input messages (for example, `<!DOCTYPE note [<!ENTITY chap1 SYSTEM "chap1.xml">]>`). Use an absolute path definition.

Look at the following sample for more details about how to use the XSLTransform node:

- XSL Transform sample

You can view samples only when you use the information center that is integrated with the Message Broker Toolkit.

Using LocalEnvironment variables to set properties

This node supports a number of LocalEnvironment message tree variables, which you can use to dynamically alter the values that are set in the node's properties. The following table lists each LocalEnvironment variable against the name of the node property that it overrides:

Local environment variable name	Node property name
XSL.StyleSheetName	Stylesheet name
XSL.MessageDomain	Message domain
XSL.MessageSet	Message set
XSL.MessageType	Message type
XSL.MessageFormat	Message format
XSL.OutputCharSet	Character set

This node searches for the name of the style sheet to be used by interrogating, in the following order:

1. The input message. The node searches the message XML data for information about the location of the style sheet. For example, the XML data might contain:

```
<?xml-stylesheet type="text/xsl" href="foo.xsl"?>
```

and "foo.xsl" is then used as the name of the style sheet.

2. The LocalEnvironment. If no style sheet name is found in the input message, the node searches the LocalEnvironment that is associated with the current message for style sheet information stored in an element called XSL.StyleSheetName.

This node was available in Version 5.0 and Version 6.0, and element ComIbmXslXsltStylesheetname was used for the name of the style sheet, therefore the current node checks both elements. If both are present, the value in XSL.StyleSheetName takes precedence.

3. The node's properties. If no style sheet name is found in the input message or LocalEnvironment, the node uses the Stylesheet name and Stylesheet directory properties to determine the correct values.

The node searches for the message domain, message set, message type, and message format to use for the output message by interrogating, in the following order:

1. The LocalEnvironment. The node searches the LocalEnvironment that is associated with the current message for message domain, message set, message type, and message format information stored, respectively, in elements called XSL.MessageDomain, XSL.MessageSet, XSL.MessageType, and XSL.MessageFormat.
2. The node's properties. If no message domain, message set, message type, or message format information is found in these LocalEnvironment variables, the node uses, respectively, the Message domain, Message set, Message type, and Message format properties to determine the correct values.

If the node cannot determine the message domain from either XSL.MessageDomain or the Message domain property, the default value of BLOB is used. There are no default values for message set, message type, and message format.

The node searches for the character set to use for the output message by interrogating, in the following order:

1. The LocalEnvironment. The node searches the LocalEnvironment that is associated with the current message for character set information stored in an element called XSL.OutputCharSet; for example, to encode the output of the transformation as UTF-8, enter the value 1208 as a string in this element.
This node was available in Version 5.0 and Version 6.0, and element ComIbmXslXsltOutputcharset was used for the output character set, therefore the current node checks both elements. If both are present, the value in XSL.OutputCharSet takes precedence.
2. The node's properties. If no character set information is found in the LocalEnvironment, the node uses the Character set property to determine the correct value.

If you set a value for Character set, the value that you enter must be numeric; for example, to encode the output of the transformation as UTF-16, enter 1200.

If the node cannot determine the output character set from either of these two sources, because either no value is set or the selection priorities are set to zero, the default value of 1208 (UTF-8) is used.

You should be aware of certain considerations if the input to the XSLTransform node is generated from the XMLNSC parser or the MRM parser. The XMLNSC parser discards certain information in XML documents, such as processing instructions and comments, if you do not set properties to retain this information in a preceding node. To ensure that the XSLTransform node transforms the message correctly, set the Retain mixed content, Retain comments, and Retain processing instructions properties correctly on the preceding node (for example, an MQInput node). The MRM parser also discards this information, but you cannot retain information for this parser, therefore avoid using the MRM domain if such information is vital to your transformation.

Deployed and non-deployed style sheets

You can use style sheets in two different ways with the XSLTransform node:

Deployed style sheets

Deployed style sheets are style sheets that you import into a broker archive (bar) file and deploy to target systems. Deployed style sheets are managed by the broker. A *principal style sheet* is the root style sheet that is referenced in a message flow; for example, a reference to a principal style sheet in the Eclipse workspace, C:\project1\A\b.xml must be specified as a/b.xml (or ./a/b.xml). A principal style sheet can reference (include or import) its descendent style sheets.

Non-deployed style sheets

Non-deployed style sheets are style sheets that you store in a location where the XSLTransform node can access them. Non-deployed style sheets are not managed by the broker.

For more information, see Migrating style sheets and XML files from Version 5.0.

Deployment of deployed style sheets or XML files

Before you can configure the XSLTransform node, you must understand how to work with style sheets. A style sheet can refer to both another XML file and a style sheet. To use deployed style sheets or XML files:

1. Make sure that the files have the correct file name extensions.

Style sheets that are to be deployed must have either .xsl or .xslt as their file extension, and XML files to be deployed must have .xml as their file extension.

2. Import the files into the Eclipse workspace.

Import into an Eclipse workspace project all style sheets and XML files that are to be deployed. Put location-dependent descendant style sheets, or XML files that are to be deployed, in the correct directory structure relative to their parent style sheets. Do not put in the Eclipse workspace location-dependent descendants that you do not want to deploy.

3. Make sure that all references to the files are relative.

Typically, all references to a deployed style sheet must be made relative, no matter where they are displayed. A reference to a principal style sheet must be made relative to the root of the relevant Eclipse workspace project.

The only exception is when you specify a principal style sheet as the Stylesheet name property on an XSLTransform node; you can use an absolute path that points to the correct directory structure in the Eclipse workspace. If the principal style sheet is found, the system resets the node property automatically to the correct relative value.

The system also performs an automatic deployment of the principal style sheet, together with all of its location-dependent descendant style sheets that are available in the relevant Eclipse workspace project. All references to the location-dependent descendant style sheets (or XML files) of a principal style sheet must be made relative to the location of their parent style sheets. For example, if style sheet `//project1/a/b.xml` references style sheet `//project1/a/c/d.xml`, the reference must be changed to `c/d.xml` (or `./c/d.xml`).

4. Handle non-deployed child style sheets or XML files.

Style sheets can refer to other style sheets. If you have a relatively-referenced child style sheet (or XML file) that is not to be deployed, yet its parent is, make sure that the child style sheet is placed in the correct location under `workpath/XSL/external` (`workpath/XML/external`), where *workpath* is the full path to the working directory of the broker.

A broker automatically associates the execution group deployed storage tree, `workpath/XSL/external`, and `workpath/XML/external` tree, together. Therefore if, for example, the document `b/c.xml` is not found in the broker's deployed storage, the broker automatically searches for a reference to it in the `workpath/XML/external/a/b` directory in the deployed principal style sheet `a/style.xml`. Relative path references must also be used for files that have been deployed but which are not available in the workspace.

5. Deploy the files.

Deploy manually only those style sheets or XML files that are not picked up by the system (the Message Broker Toolkit provides warnings about these files). If you click **Browse** for the node, or provide the full path of the location of the style sheet in the Eclipse workspace, the style sheet is included automatically in the bar file.

To deploy manually, add the files to be deployed to a broker archive. For more information, see "Adding files to a broker archive" on page 759 and "Adding keywords to XSL style sheets" on page 1225.

For every execution group that uses the XSLTransform node, perform one of the following actions:

- Include the style sheet in the `workpath/XSL/external` directory on the broker; do not include the style sheet in the bar file.

If a style sheet in the `workpath/XSL/external` directory shares the same path and name with a deployed style sheet, the deployed style sheet is used.

- Include the style sheet in the bar file and deploy the bar file. If multiple bar files include the same style sheet name, the style sheet from the last bar file that was deployed is used.
- Deploy the style sheet in its own bar file. If the bar files use XSLTransform nodes, but do not include the style sheet, the Message Broker Toolkit issues warning messages.

Configuring the XSLTransform node

When you have put an instance of the XSLTransform node into a message flow, you can configure it; see "Configuring a message flow node" on page 235. The properties of the node are displayed in the Properties view.

All mandatory properties for which you must enter a value (those that do not have a default value defined) are marked with an asterisk.

Configure the XSLTransform node:

1. Optional: On the **Description** tab, enter a Short description, a Long description, or both. You can also rename the node on this tab.
2. On the **Stylesheet** tab, to specify a style sheet using node properties, enter the required value for Stylesheet name.

Specify a principal style sheet using one of the following methods:

- Click **Browse** next to Stylesheet name. The identified principal style sheet and all its relatively-referenced descendant style sheets are added automatically to the bar file when you add a message flow to a bar file (if both they and their parent style sheets are available).
- To identify an already deployed, or ready to be deployed, style sheet, use the Stylesheet name property, and leave the Stylesheet directory property blank.
- In the Message Flow editor, drag an .xslt file onto the XSLTransform node; the Stylesheet name is set automatically.

3. On the **Advanced** sub-tab:

- a. If the style sheet identification is fully qualified, Stylesheet directory is ignored; otherwise, the value that you set in this property is added to the beginning of the specification, regardless of where it is found.
- b. In Stylesheet cache level, specify the number of compiled or parsed style sheets that are stored in this instance of the node; the default value is 5. The style sheet cache is retained for the life of the node, and is cleared when the node is deleted from the flow, when the flow is deleted, or when the execution group is stopped.

If you change a cached style sheet (by redeploying or replacing the file in the file system), the XSLTransform node that is holding the cache replaces the cached version with the modified (latest) version before a new message is processed. However, if you are changing several style sheets, stop relevant message flows before you make any changes. If you do not stop the relevant message flows before you make the changes, the order of the changes cannot be guaranteed by running message flows, which might cause an incompatibility between the style sheets that are changed. Use the `mqswireload` command to reload a style sheet; however, this command does not prevent incompatibility.

4. On the **Output Message Parsing** tab:

- a. To associate a specific parser with the output message, specify the new domain in Message domain. The default value is BLOB. This domain is applied to the output message. Alternatively, use Inherit to associate the parser that owned the input message.
 - MRM
 - XMLNSC
 - XMLNS
 - JMSMap
 - JMSStream
 - MIME
 - BLOB
 - XML (deprecated - use XMLNSC)
 - Inherit

You can also specify a user-defined parser if appropriate.

- b. If you are using the MRM parser, or the XMLNSC parser in validating mode, select the Message set that you want to use. This list is populated with available message sets when you select MRM or XMLNSC as the domain.

- c. If you are using the MRM parser, select the correct message from the list in Message type. This list is populated with messages that are defined in the Message set that you have selected.
 - d. If you are using the MRM parser, select the XML physical format for the output message from the list in Message format. This list includes all the physical formats that you have defined for this Message set.
 - e. To specify a character set for the output message using node properties, specify the required value for Character set. The value that you specify must be numeric; for example, specify 1200 to encode the output message as UTF-16.
5. On the **Parser Options** sub-tab:
- a. Parse timing is, by default, set to On Demand, which causes parsing of the message to be delayed. To cause the message to be parsed immediately, see “Parsing on demand” on page 1363.
 - b. If you are using the XMLNSC parser, set values for the properties that determine how the XMLNSC parser operates. For more information, see “Manipulating messages in the XMLNSC domain” on page 364.
6. On the **Validation** tab, set the validation properties for the parser to validate the body of messages against the Message set. (If a message is propagated to the Failure terminal of the node, it is not validated.)
- For more details, see “Validating messages” on page 164 and “Validation properties” on page 1359.
7. On the **Detail Trace** tab, set the Trace setting property to trace the actions of the XSLTransform node. The default value is Off. To activate trace, set the property to On.

The trace information is written to a trace file XMLTTrace.log:

- **z/OS** On z/OS systems, the file is located in *install_dir/output*, where *install_dir* is the directory in which you have installed the broker.
- **Windows** On Windows systems, the file is located in *workpath\log* if you have specified the *-w* option of the *mqsicreatebroker* command. If you have not specified the broker workpath, data is written to *C:\Documents and Settings\All Users\Application Data\IBM\MQSI\common\log*.
- **Linux** **UNIX** On Linux and UNIX systems, the file is located in */var/mqsi/common/log*.

If you set Trace setting to On for one XSLTransform node, it is on for all of the nodes in the execution group.

This property is now deprecated. Any relevant trace now goes into the user trace, provided that user debug trace is enabled. The setting of Trace setting in the XSLTransform node does not affect any user trace.

If you have large XML messages and receive an out of memory error, use the *mqsireportproperties* command to see the current value of the Java Heap size for the XSLT engine:

```
mqsireportproperties brokerName -e executionGroupLabel
-o ComIbmJVMMManager -n jvmMaxHeapSize
```

Use the *mqsichangeproperties* command to increase the Java Heap size:

```
mqsichangeproperties brokerName -e executionGroupLabel
-o ComIbmJVMMManager -n jvmMaxHeapSize -v newSize
```

In the previous examples, replace *brokerName*, *executionGroupLabel*, and *newSize* with the appropriate values.

The value that you choose for *newSize* depends on the amount of physical memory that your computer has, and how much you are using Java. A value in the range 512 MB (536870912) to 1 GB (1073741824) is typically sufficient.

Terminals and properties

The XSLTransform node terminals are described in the following table.

Terminal	Description
In	The input terminal that accepts the message for processing by the node.
Failure	The output terminal to which the original message is routed if an error is detected during transformation.
Out	The output terminal to which the successfully transformed message is routed.

The following tables describe the node properties. The column headed M indicates whether the property is *mandatory* (marked with an asterisk if you must enter a value when no default is defined); the column headed C indicates whether the property is *configurable* (you can change the value when you add the message flow to the bar file to deploy it).

The XSLTransform node Description properties are described in the following table.

Property	M	C	Default	Description
Node name	No	No	The node type	The name of the node.
Short description	No	No		A brief description of the node.
Long description	No	No		Text that describes the purpose of the node in the message flow.

The XSLTransform node Stylesheet properties are described in the following table.

Property	M	C	Default	Description
Stylesheet name	No	Yes		The name of the style sheet, used if the style sheet specification is searched for in node properties.

The XSLTransform node Advanced properties are described in the following table.

Property	M	C	Default	Description
Stylesheet directory	No	Yes		The path where the style sheet is located. This path is used by all location methods.
Stylesheet cache level	No	No	5	The number of compiled or parsed style sheets that are stored in this instance of the node.

The XSLTransform node Output Message Parsing properties are described in the following table.

Property	M	C	Default	Description
Message domain	No	No	BLOB	The message domain that is associated with the output message.

Property	M	C	Default	Description
Message set	No	No		The message set that is associated with the output message. If you set this property, then subsequently update the project dependencies to remove this message set reference, a warning is issued. Either update the Message set property, or restore the reference to this message set project.
Message type	No	No		The message type that is associated with the output message.
Message format	No	No		The message format that is associated with the output message.
Character set	No	No		The numeric value of the character set for the output message.

The XSLTransform node Parser Options are described in the following table.

Property	M	C	Default	Description
Parse timing	No	No	On Demand	This property controls when an output message is parsed. Valid values are On Demand, Immediate, and Complete. For a full description of parsing on demand, see "Parsing on demand" on page 1363.
Build tree using XML schema data types	No	No	Cleared	This property controls whether the XMLNSC parser creates syntax elements in the message tree with data types taken from the XML Schema. You can select this property only if you set the Validate property to Content or Content and Value.
Use XMLNSC compact parser for XMLNS domain	No	No	No	This property controls whether the XMLNSC Compact Parser is used for output messages in the XMLNS Domain. If you set this property, the message data appears under XMLNSC in nodes that are connected to the output terminal when the input MQRFH2 header or Domain is XMLNS.

The XSLTransform node Validation properties are described in the following table. For a full description of Validation properties, see "Validation properties" on page 1359.

Property	M	C	Default	Description
Validate	No	Yes	None	This property controls whether validation takes place of the output message. Valid values are None, Content, Content and Value, and Inherit.
Failure action	No	No	Exception	This property controls what happens if validation of the output message fails. You can set this property only if you set Validate to Content and Value or Content. Valid values are User Trace, Local Error Log, Exception, and Exception List.

The XSLTransform node Detail Trace properties are described in the following table.

Property	M	C	Default	Description
Trace setting	Yes	No	Off	This property controls whether tracing is on or off. If tracing is on, low level tracing is recorded in a file.

Adding keywords to XSL style sheets

Keywords can be embedded at any place in an XSL style sheet. The keyword can be added as an XML comment.

XML comments must have the following format:

```
$MQSI keyword = value MQSI$
```

The example shows how to add the keyword of **author** with the value John to an XML style sheet:

```
<?xml version="1.0" encoding="UTF-8">
<!-- $MQSI author = John MQSI$>
<xsl:stylesheet version="1.0"
xmlns:xsl="http://www.w3.org/1999/XSL/Transform">
<xsl:output method="text" encoding="UTF-8"/>
<xsl:template match="/">
<xsl:value-of select="message"/>
</xsl:template>
</xsl:stylesheet>
```

The Configuration Manager does not extract version="1.0" from this example, because the value is not bounded by the \$MQSI and MQSI\$ keywords.

Restrictions within keywords

Do not use the following characters within keywords, because they might cause unpredictable behavior:

```
^$.|\<>?+=&[]
```

You can use these characters in the values that are associated with keywords, for example:

- \$MQSI RCSVER=\$id\$ MQSI\$ is acceptable
- \$MQSI \$name=Fred MQSI\$ is not acceptable

User-defined nodes

You can define your own nodes to use in WebSphere Message Broker message flows.

User-defined nodes add to the function that is provided by the WebSphere Message Broker supplied nodes. You can also use nodes that are created and supplied by independent software vendors and other companies.

Follow the instructions in Adding help to the node that describe how to provide help information for user-defined nodes, and how to include that help in this section of the information center.

WebSphere Adapters properties

Reference information about the properties that you set for WebSphere Adapters nodes.

See the properties for the Enterprise Information System (EIS) to which you want to connect:

- “WebSphere Adapter for SAP properties”
- “WebSphere Adapter for Siebel properties” on page 1287
- “WebSphere Adapter for PeopleSoft properties” on page 1309

WebSphere Adapter for SAP properties

Reference information to which to refer when you connect to an SAP application.

- “Business object information”
- “Supported data operations”
- “Naming conventions” on page 1230
- “Configuration properties for the WebSphere Adapter for SAP Software” on page 1234

Business object information

A business object contains application-specific information (metadata) about how the adapter processes the business object, and about the operation to be performed on the business object.

The name of the business object is generated by the Adapter Connection wizard in accordance with the naming convention for the adapter.

For more information, see the following topics:

- “Supported data operations”
- “Naming conventions” on page 1230

Supported data operations:

For outbound processing, an operation is the name of the action that is implemented by the adapter so that the client application component can perform the operation on the SAP server.

The adapter uses the application-specific information (ASI) inside the business object definition to implement the operation. The name of the operation typically indicates the type of action to be implemented, such as create or update. For inbound processing, adapters implement an operation by delivering events to their endpoints. For inbound processing, the action that is associated with the event varies depending on the interface (ALE or Advanced event processing). When the interface is ALE, the action is pushed to the adapter and the adapter delivers the event to an endpoint. When the interface is Advanced event processing, the event status is polled by the adapter and processed accordingly.

For more information, see the following topics:

- “Supported data operations on BAPI business objects”
- “Supported data operations on ALE business objects” on page 1227
- “Supported data operations of Query interface for SAP Software business objects” on page 1228
- “Supported data operations on Advanced event processing business objects” on page 1229

Supported data operations on BAPI business objects:

The operations that are supported by BAPI business objects are the same as those supported by BAPI work units. BAPI result sets support only the RetrieveAll operation.

For BAPI outbound processing, the operation of a BAPI business object is the name of the BAPI call that an adapter issues on the SAP server. The BAPI method determines the operation that is associated with it. The adapter uses the application-specific information (ASI) inside the business object definition to implement the operation. Operations of a business object are called by the component that makes calls to SAP through the adapter. The SAP JCo APIs are used to make the call to the SAP system.

BAPIs and BAPI unit of work

The following table defines operations that the adapter supports for BAPIs and BAPI work units. The definitions in the table are the expected uses for the operations. The action that is taken in the SAP application is based on the meaning of the BAPI itself.

Table 45. Supported operations: BAPI business objects

Operation	Definition
Create	The top-level business object and all contained children are created.
Update	The top-level business object is modified. This operation can include adding and deleting child objects.
Delete	The top-level business object and any contained children are deleted.
Retrieve	The top-level business object and any contained children are retrieved.

For an operation that is not supported, the adapter logs the appropriate error and produces a ResourceException.

Result sets

The following table defines the operation that the adapter supports for BAPI result sets.

Table 46. Supported operation: BAPI result sets

Operation	Definition
RetrieveAll	All the matching records for the BAPI result set are retrieved.

Supported data operations on ALE business objects:

The operations that are supported by ALE business objects vary, depending on whether the business object is an outbound or inbound object. The adapter uses the application-specific information (ASI) inside the business object definition to implement the operation.

Business objects that are generated with the ALE pass-through IDoc interface are not associated with an operation.

Outbound business objects

The operation of an ALE outbound business object is called by the application component that makes calls to SAP through the adapter. The adapter supports the following outbound operation:

Table 47. Supported operation: ALE outbound business objects

Operation	Definition
Execute	This operation posts the IDoc business object to the SAP application. This operation is one-way and asynchronous. For the CWYAP_SAPAdapter_TX.rar version of the adapter, the transaction ID is returned.

Inbound business objects

For ALE inbound business objects, the application-specific information of an operation contains the message type, message code, and message function for an IDoc type. The adapter supports the following inbound operations:

Table 48. Supported operations: ALE inbound business objects

Operation	Definition
Create	The top-level business object and all contained children are created.
Update	The top-level business object is modified. This operation can include adding and deleting child objects.
Delete	The top-level business object and any contained children are deleted.

The adapter uses the IDoc control record field data to determine the operation that is set on the business object before sending it to the endpoint. The following fields in the control record are used to determine the operation:

- Logical_message_type (MESTYP)
- Logical_message_code (MESCOD)
- Logical_message_function(MESFCT)

Supported data operations of Query interface for SAP Software business objects:

The SAP Query interface supports the RetrieveAll operation, with which you can have the results of an SAP table returned to you, and the Exists operation, which you use to determine whether data can be found in the SAP table. The adapter uses the application-specific information (ASI) inside the business object definition to implement the operation.

The supported operations for the Query interface for SAP Software are listed in the following table.

Table 49. Supported operations: Query interface for SAP Software business objects

Operation	Description
RetrieveAll	This operation returns a result set in the form of a container of SAP query business objects, which represent the data for each row that is retrieved from the table. If a table business object is sent to the SAP server (instead of a container business object), the rows are returned one at a time.
Exists	This operation provides a means to check for the existence of any records in SAP for a defined search criteria. The Exists operation does not return any data; it indicates whether the data exists in SAP. If no data is found, the adapter generates an exception.

Supported data operations on Advanced event processing business objects:

The operations that are supported by Advanced event processing business objects vary, depending on whether the business object is an outbound or inbound object. The adapter uses the application-specific information (ASI) inside the business object definition to implement the operation.

Outbound business objects

The operation of an Advanced event processing outbound business object is invoked by the client application that makes calls to SAP through the adapter. The adapter supports the following outbound operation.

Table 50. Supported operation: Advanced event processing outbound business objects

Operation	Definition
Create	The top-level business object and all contained children are created.
Update	The top-level business object is modified. This operation can include adding and deleting child objects.
Delete	The top-level business object and any contained children are deleted.
Retrieve	The top-level business object and any contained children are retrieved.

Inbound business objects

For Advanced event processing inbound business objects, the application-specific information of an operation contains the message type, message code, and message function for an IDoc type. The adapter supports the following inbound operations.

Table 51. Supported operations: Advanced event processing inbound business objects

Operation	Definition
Create	The top-level business object and all contained children are created.
Update	The top-level business object is modified. This operation can include adding and deleting child objects.
Delete	The top-level business object and any contained children are deleted.

Naming conventions:

When the Adapter Connection wizard generates a business object, it provides a name for the business object that is based on the name of the corresponding business function in the SAP server.

The convention that is applied by the SAP server when naming a business object varies depending on whether the name is for a BAPI business object, an ALE business object, an Advanced event processing business object, or a Query interface for SAP Software business object.

For more information, see the following topics:

- “Naming conventions for BAPI business objects”
- “Naming conventions for ALE business objects” on page 1231
- “Naming conventions for Query interface for SAP Software business objects” on page 1232
- “Naming conventions for Advanced event processing business objects” on page 1233

Naming conventions for BAPI business objects:

The Adapter Connection wizard provides names for the business objects for BAPIs, BAPI work units, and BAPI result sets. At its core, the business object name reflects the structure of the business function on the SAP server.

BAPIs

When it names business objects for BAPIs, the Adapter Connection wizard adds a prefix of Sap. The wizard also converts the name of the business function to mixed case, removing any separators such as spaces or underscores, capitalizes the first letter of each word, and it can add an element-specific suffix (for example, Wrapper for a top-level business object).

The following table describes the convention that is applied by the Adapter Connection wizard when it names BAPI business objects.

Table 52. Naming conventions for BAPI business objects

Element	Naming convention
Name of the top-level business object	Sap + <i>Name of the wrapper object that you specify in the Adapter Connection wizard</i> + Wrapper For example: SapSalesOrderWrapper
Name of the BAPI business object	Sap + <i>Name of the BAPI interface</i> For example: SapBapiSalesOrderCreateFromDat1 The top-level object can contain more than one BAPI object.
Name of the child object	Sap + <i>Name of the Structure/Table</i> For example: SapReturn

If structures with the same name exist in different BAPIs, or exist within a BAPI (for example, one at the export level and one at the table level), the Adapter Connection wizard adds a unique suffix to differentiate the structures. The first structure is assigned a name (for example, SapReturn) and the second structure is

assigned a name such as SapReturn619647890, where 619647890 is the unique identifier that is appended to the name by the wizard.

BAPI work units

The following table describes the convention that is applied by the Adapter Connection wizard when it names a BAPI work unit business object.

Table 53. Naming conventions for BAPI unit of work business objects

Element	Naming convention
Name of the top-level business object	Sap + <i>Name of the wrapper object that you specify in the Adapter Connection wizard</i> + Txn For example: SapCustomerTxn
Name of the BAPI business object	Sap + <i>Name of the BAPI interface</i> For example: SapCustomer
Name of the child object	Sap + <i>Name of the Structure/Table</i> For example: SapReturn

If structures with the same name exist in different BAPIs, or exist within a BAPI (for example, one at the export level and one at the table level), the Adapter Connection wizard adds a unique suffix to differentiate the structures. The first structure is assigned a name (for example, SapReturn) and the second structure is assigned a name such as SapReturn619647890, where 619647890 is the unique identifier that is appended to the name by the wizard.

BAPI result sets

The following table describes the convention that is applied by the Adapter Connection wizard when it names a BAPI result sets business object.

Table 54. Naming conventions for BAPI result sets

Element	Naming convention
Name of the result set BAPI business object	Sap + <i>Name of the BAPI interface</i> For example: SapBapiCustomerGetDetail
Name of the child object	Sap + <i>Name of the Structure/Table</i> For example: SapReturn
Name of the query business object	Sap + <i>Formatted name of the query BAPI interface</i> For example: SapBapiCustomerGetList

If structures with the same name exist in different BAPIs, or exist within a BAPI (for example, one at the export level and one at the table level), the Adapter Connection wizard adds a unique suffix to differentiate the structures. The first structure is assigned a name (for example, SapReturn) and the second structure is assigned a name such as SapReturn619647890, where 619647890 is the unique identifier that is appended to the name by the wizard.

Naming conventions for ALE business objects:

The Adapter Connection wizard provides names for the ALE business graph, top-level business object, and the business object itself. At its core, the business object name reflects the structure of the business function on the SAP server.

If you are using the ALE pass-through IDoc interface, the following naming conventions apply:

- When you select **Generic IDoc** from the Object Discovery and Selection window, the Adapter Connection wizard creates a business object named SapGenericIDocObject. The naming convention described in the following sections does not apply to generic IDocs.
- When you discover an IDoc from the system or from a file, the object is named according to the naming convention for top-level wrapper objects, as described in Table 55. No other objects are generated.

When it names business objects for ALE, the Adapter Connection wizard adds a prefix of Sap. The wizard also converts the name of the IDoc and extension to mixed case, removing any separators such as spaces or underscores, capitalizes the first letter of each word, and it can add an element-specific suffix (for example, BG for business graph).

The following table describes the conventions that are applied by the Adapter Connection wizard when it names ALE business objects. The *[Name of Extension type IDoc]* in the Naming convention column represents an optional entry. It is included in the name only if the selected IDoc is an Extension Type IDoc.

Table 55. Naming conventions for ALE business objects

Element	Naming convention
Name of the top-level wrapper object	Sap + <i>Name of IDoc</i> + <i>[Name of Extension type IDoc]</i> For example: SapAlereq01
Name of the IDoc business object for basic IDocs	Sap + <i>Name of IDoc</i> + <i>BO</i> For example, the business object for the IDoc MATMAS03 is: SapMatmas03B0
Name of the IDoc business object for extension type IDocs	Sap + <i>Name of IDoc</i> + <i>Name of Extension type IDoc</i> For example, the business object for the IDoc DELVRY03 and extension SD_DESADV_PDC is: SapDelvry03SdDesadvPdc

In the case of an IDoc duplicate name, the Adapter Connection wizard adds a unique suffix to differentiate the business object. If an IDoc packet has two segments with the same name (for example, segOrder), the first business object is assigned the name SapSegOrder and the second business object is assigned a name such as SapSegOrder619647890, where 619647890 is the unique identifier that the Adapter Connection wizard appends to the name.

Naming conventions for Query interface for SAP Software business objects:

The Adapter Connection wizard provides names for the Query interface for SAP Software container, business graph, top-level business object, table object, and query object. At its core, the business object name reflects the structure of the business function on the SAP server

When it names business objects for the Query interface for SAP Software, the Adapter Connection wizard adds a prefix of Sap. The wizard also converts the

name of the business function or SAP table to mixed case, removing any separators such as spaces or underscores, capitalizes the first letter of each word, and it can add an element-specific suffix (for example, Container for a container).

The following table describes the convention that is applied by the Adapter Connection wizard when it names a Query interface for SAP Software business object.

Table 56. Naming convention for a Query interface for SAP Software business object

Element	Naming convention
Name of the container	Sap + <i>Name of the object that you specify in the wizard</i> + Container For example: SapCustomerContainer
Name of the table object	Sap + <i>Name of the SAP table</i> For example: SapKna1
Name of the query object	Sap + <i>Name of the SAP table</i> + Querybo For example: SapKna1Querybo

Naming conventions for Advanced event processing business objects:

The Adapter Connection wizard provides names for the Advanced event processing business graph, top-level business object, and the business object itself. At its core, the business object name reflects the structure of the business function on the SAP server.

When it names business objects for the Advanced event processing interface, the Adapter Connection wizard adds a prefix of Sap. The wizard also converts the name of the IDoc and extension to mixed case, removing any separators such as spaces or underscores, capitalizes the first letter of each word, and it might add an element-specific suffix.

The following table describes the convention that is applied by the Adapter Connection wizard when it names Advanced event processing business objects. The [*Name of Extension type IDoc*] in the Naming convention column represents an optional entry; it is included in the name only if the selected IDoc is an Extension Type IDoc.

Table 57. Naming convention for advanced event processing business objects

Element	Naming convention
Name of the top-level wrapper object	Sap + <i>Name of IDoc</i> + [<i>Name of Extension type IDoc</i>] For example: SapAepreq01
Name of the IDoc business object for basic IDocs	Sap + <i>Name of IDoc</i> + <i>BO</i> For example, the business object for the IDoc MATMAS03 is: SapMatmas03B0
Name of the IDoc business object for extension type IDocs	Sap + <i>Name of IDoc</i> + <i>Name of Extension type IDoc</i> For example, the business object for the IDoc DELVRY03 and extension SD_DESADV_PDC is: SapDelvry03SdDesadvPdc

In the case of an IDoc duplicate name, the Adapter Connection wizard adds a unique suffix to differentiate the business object. If an IDoc packet has two

segments with the same name (for example, segOrder), the first business object is assigned the name SapSegOrder and the second business object is assigned a name such as SapSegOrder619647890, where 619647890 is the unique identifier that is appended to the name by the Adapter Connection wizard.

Configuration properties for the WebSphere Adapter for SAP Software

The WebSphere Adapter for SAP Software has several categories of configuration properties, which you set with the Adapter Connection wizard when you generate or create objects and services.

You can change the resource adapter, managed connection factory, and activation specification properties in WebSphere Message Broker.

For more information, see the following topics:

- “SAP connection properties for the Adapter Connection wizard”
- “Resource adapter properties” on page 1243
- “Managed connection factory properties” on page 1244
- “Activation specification properties for ALE inbound processing” on page 1253
- “Activation specification properties for Advanced event processing” on page 1271
- “Interaction specification properties” on page 1283

SAP connection properties for the Adapter Connection wizard:

Connection properties establish a connection between the Adapter Connection wizard, a tool that is used to create business objects, and the SAP server. The properties that you configure in the Adapter Connection wizard specify such things as connection configuration, and tracing and logging options.

After you have established a connection between the Adapter Connection wizard and the SAP server, the wizard can access the metadata that it needs from the SAP server to create business objects.

Some of the properties that you set in the Adapter Connection wizard are used as the initial values for resource adapter, managed connection factory, and activation specification properties that you can specify at a later time in the wizard.

The connection properties and their purpose are described in the following table. A complete description of each property is provided in the sections that follow the table. If you set any of these connection properties using bidirectional script, you must set values that identify the format of the bidirectional script that is entered for that property.

Table 58. Connection properties for the Adapter for SAP Software

Property name	Description
“Bidi direction ” on page 1235	The orientation component of the bidi format specification.
“Bidi ordering schema” on page 1236	The ordering schema of the bidi format specification.
“Bidi numeric shaping” on page 1236	The numeric shaping component of the bidi format specification.
“Bidi shaping” on page 1237	The shaping component of the bidi format specification.
“Bidi symmetric swapping” on page 1237	The symmetric swapping component of the bidi format specification.
“Client” on page 1237	The client number of the SAP system to which the adapter connects.

Table 58. Connection properties for the Adapter for SAP Software (continued)

Property name	Description
"Codepage number" on page 1238	The numeric identifier of the code page.
"Folder for RFC trace files" on page 1238	The fully qualified local path to the folder into which the RFC trace files are written.
"Host name" on page 1239	The IP address or the name of the application server host to which the adapter logs on.
"Language code" on page 1239	The language in which the adapter logs on.
"Log file output location property" on page 1239	The location of the log file for enterprise metadata discovery.
"Logging level property" on page 1240	The type error for which logging occurs during enterprise metadata discovery.
"Password" on page 1240	The password of the user account of the adapter on the SAP application server.
"RFC trace level" on page 1241	The global trace level.
"RFC trace on" on page 1241	Specifies whether to generate a text file that details the RFC activity for each event listener.
"SAP interface name" on page 1242	The SAP interface to be used.
"System number" on page 1243	The system number of the SAP application server.
"User name" on page 1243	The user account for the adapter on the SAP server.

The Adapter Connection wizard uses the bidirectional connection properties to apply the proper bidirectional transformation on the data that is passed to the SAP server.

The bidi properties specify the bidirectional format for data coming from an external application into the adapter in the form of any business object that is supported by this adapter.

Accept the default values for the bidirectional formatting properties on the Adapter Connection wizard that provides SAP server bidirectional format specification. When combined, these bidirectional properties define one single bidirectional format.

The default values for bidirectional formatting properties listed below are based on Windows bidirectional formatting. If the Enterprise Information System supports a bidirectional format other than the Windows standard bidirectional format, you must make appropriate changes to the bidi properties that are listed in the following sections.

Bidi direction

This property specifies the orientation component of the bidi format specification.

Table 59. Bidi direction details

Required	No
----------	----

Table 59. Bidi direction details (continued)

Possible values	<p>Possible values include:</p> <ul style="list-style-type: none"> • LTR The orientation is left-to-right. • RTL The orientation is right-to-left. • contextualLTR The orientation is left-to-right because of the context. A character that is not categorized as LTR, and that is located between two strong characters with a different writing direction, inherits the main context's writing direction (in a LTR document the character becomes LTR). • contextualRTL The orientation is right-to-left because of the context. A character that is not categorized as RTL, and is located between two strong characters with a different writing direction, inherits the main context's writing direction (in a RTL document the character becomes RTL).
Default	LTR
Property type	String
Usage	Specifies the orientation component of the bidi format specification.
Globalized	Yes
Bidi supported	No

Bidi ordering schema

This property specifies the ordering schema of the bidi format specification.

Table 60. Bidi ordering schema details

Required	No
Possible values	Implicit Visual
Default	Implicit
Property type	String
Usage	Specifies the ordering schema of the bidi format specification.
Globalized	Yes
Bidi supported	No

Bidi numeric shaping

This property specifies the numeric shaping component of the bidi format specification.

Table 61. Bidi numeric details

Required	No
Possible values	Nominal National Contextual
Default	Nominal
Property type	String
Usage	Specifies the numeric shaping component of the bidi format specification.

Table 61. Bidi numeric details (continued)

Globalized	Yes
Bidi supported	No

Bidi shaping

This property specifies the shaping component of the bidi format specification.

Table 62. Bidi shaping details

Required	No
Possible values	Nominal Shaped Initial Middle Final Isolated
Default	Nominal
Property type	String
Usage	Specifies the shaping component of the bidi format specification.
Globalized	Yes
Bidi supported	No

Bidi symmetric swapping

This property specifies the symmetric swapping component of the bidi format specification.

Table 63. Bidi symmetric swapping details

Required	No
Possible values	True False
Default	True
Property type	Boolean
Usage	This property specifies the symmetric swapping component of the bidi format specification.
Globalized	Yes
Bidi supported	No

Client

This property is the client number of the SAP system to which the adapter connects.

Table 64. Client details

Required	Yes
Possible values	You can enter a range of values from 000 to 999.
Default	100
Property type	Integer

Table 64. Client details (continued)

Usage	When an application attempts to log on to the SAP server, the application must have a Client number associated with it. The Client property value identifies the client (the adapter) that is attempting to log on to the SAP server
Globalized	No
Bidi supported	No

Codepage number

This property is the numeric identifier of the code page.

Table 65. Codepage number details

Required	No
Possible values	You can enter a range of values from 0000 to 9999. For a full listing of languages and associated code page numbers that are supported by SAP, see SAP Note 7360.
Default	The default value for this property is conditionally determined by the value that is set for the Language code property.
Property type	Integer
Usage	The value that is assigned to the Codepage number property defines the code page to be used, and has a one-to-one relationship with the value that is set for the Language code property. The code page number establishes a connection to the appropriate language. Each language code value has a code page number value associated with it. For example, the language code for English is EN. If you select EN (English) as your language code, the code page number is automatically set to the numeric value that is associated with EN (English). The SAP code page number for EN (English) is 1100.
Example	If Language code is set to JA (Japanese), Codepage number is set to 8000.
Globalized	No
Bidi supported	No

Folder for RFC trace files

This property sets the fully qualified local path to the folder in which to write RFC trace files.

Table 66. Folder for RFC trace files details

Required	No
Default	No default value
Property type	String
Usage	Identifies the fully qualified local path into which RFC trace files are written. If RFC trace on is set to False (not selected), you cannot set a value in the Folder for RFC trace files property.
Example	c:\temp\rfcTraceDir
Globalized	Yes
Bidi supported	No

Host name

The IP address or the name of the application server host to which the adapter logs on.

Table 67. Host name details

Required	Yes (when load balancing is not used).
Default	No default value
Property type	String
Usage	When the adapter is configured to run without load balancing, this property specifies the IP address or the name of the application server that the adapter logs on to.
Example	sapServer
Globalized	No
Bidi supported	No

Language code

This property specifies the SAP logon language code.

Table 68. Language code details

Required	Yes
Possible values	Each of the supported languages is preceded by a two-character language code. The language itself displays in parentheses. The language codes in the list represent the SAP default set of 41 languages for non Unicode systems plus Arabic. For a full listing of supported language codes and languages, see the SAP documentation.
Default	The default language code is your current locale. If your current locale is not listed as one of the supported language codes, a default language code of EN (English) is used.
Property type	String
Usage	If you enter a language code manually, you do not need to enter the language in parenthesis.
Example	If the system locale is English, the value for this property is EN (English)
Globalized	No
Bidi supported	No

Log file output location property

This property specifies the location of the log file for external metadata discovery.

Table 69. Log file output location details

Required	Yes
Default	The .metadata directory of the workspace
Property type	String
Usage	Use this directory to hold the log file that lists the errors that occur during the discovery process. The type of discovery errors for which logging occurs is controlled by the Logging level property
Example	C:\IBM\wmbt61\workspace\.metadata\SAPMetadataDiscovery.log

Table 69. Log file output location details (continued)

Globalized	Yes
Bidi supported	No

Logging level property

This property specifies the type error for which logging occurs during enterprise metadata discovery.

Table 70. Logging level details

Required	No
Possible values	FATAL SEVERE WARNING AUDIT INFO CONFIG DETAIL
Default	SEVERE
Property type	String
Usage	Use this property to tailor tracing capabilities. When you specify an error type, you indicate that trace operations occur only for errors of the specified type.
Example	<p>If you accept the default value of SEVERE, trace information is provided on errors that fall into the SEVERE category. Severe errors mean that an operation cannot continue, although the adapter can still function. Severe errors also include error conditions that indicate an impending fatal error, that is, reporting on situations that strongly suggest that resources are on the verge of being depleted.</p> <p>Other error descriptions are listed here:</p> <ul style="list-style-type: none"> • Fatal Adapter cannot continue. Adapter cannot function • Warning Potential error or impending error, including conditions that indicate a progressive failure (for example, the potential leaking of resources). • Audit Significant event affecting adapter state or resources • Info General information outlining overall operation progress. • Config Configuration change or status. • Detail General information detailing operation progress
Globalized	Yes
Bidi supported	No

Password

This property is the password of the user account of the adapter on the SAP server.

Table 71. Password details

Required	Yes
Default	No default value
Property type	String
Usage	The restrictions on the password depend on the version of SAP Web Application Server. <ul style="list-style-type: none"> • For SAP Web Application Server version 6.40 or earlier, the password: <ul style="list-style-type: none"> – Must be uppercase – Must be 8 characters in length • For versions of SAP Web Application Server later than 6.40, the password: <ul style="list-style-type: none"> – Is not case-sensitive – Can be up to 40 characters in length
Globalized	No
Bidi supported	Yes

RFC trace level

This property specifies the global trace level.

Table 72. RFC trace level details

Required	No
Possible values	1: SAP JCo Java API logging occurs (default) 3: SAP JCo JNI API logging occurs 5: Error diagnostic logging occurs
Default	1
Property type	Integer
Usage	If RFC trace on is set to False (not selected), you cannot set a value in the RFC trace level property.
Globalized	No
Bidi supported	No

RFC trace on

This property specifies whether to generate a text file that describes the RFC activity for each event listener.

Table 73. RFC trace on details

Required	No
Possible values	True False
Default	False
Property type	Boolean

Table 73. RFC trace on details (continued)

Usage	<p>A value of True activates tracing, which generates a text file.</p> <p>This file is created in the directory in which the adapter process was started. The file has a prefix of rfx and a file type of .trc (for example, rfc03912_02220.trc).</p> <p>Use this text file in a development environment only, because the files can grow rapidly.</p> <p>If RFC trace on is set to False (not selected), you cannot set values in the Folder for RFC trace files or RFC trace level properties.</p>
Example	<p>Examples of the information in the file are RfcCall FUNCTION BAPI_CUSTOMER_GETLIST, followed by the information for the parameters in the interface, or RFC Info rftable, followed by the data from one of the interface tables.</p> <p>The trace file is created in the directory where the adapter process has been started. The trace file has a .trc file extension and the file name starts with the letters rfc followed by a unique identifier. For example, <i>rfc03912_02220.trc</i>.</p>
Globalized	No
Bidi supported	No

SAP interface name

This property indicates whether you are creating business objects for the ALE, BAPI, Advanced event processing, or Query interface for SAP Software.

Table 74. SAP interface name details

Required	Yes
Possible values	<p>For outbound:</p> <ul style="list-style-type: none"> Advanced event processing (AEP) ALE ALE pass-through IDoc BAPI BAPI work unit BAPI result set Query interface for SAP Software (QSS) <p>For inbound:</p> <ul style="list-style-type: none"> Advanced event processing (AEP) ALE ALE pass-through IDoc
Default	<p>For outbound: BAPI</p> <p>For inbound: ALE</p>
Property type	String
Usage	<p>Specifies the interface used by the adapter.</p> <p>The adapter interacts with the interface to support outbound or inbound processing by enabling the exchange of data in the form of business objects.</p>
Globalized	No
Bidi supported	No

System number

This property is the system number of the application server.

Table 75. System number details

Required	Yes
Possible values	You can enter a range of values from 00 to 99
Default	00
Property type	Integer
Usage	The system number further identifies the Gateway service.
Globalized	No
Bidi supported	No

User name

This property is the user account for the adapter on the SAP server.

Table 76. User name details

Required	Yes
Default	No default value
Property type	String
Usage	This property has a maximum length of 12 characters. The user name is not case sensitive. Set up a CPIC user account in the SAP application and give this account the necessary privileges to manipulate the data that is required by the business objects that are supported by the adapter. For example, if the adapter must perform certain SAP business transactions, the adapter's account in the SAP application must have the correct permissions to perform these transactions.
Example	SapUser
Globalized	Yes
Bidi supported	Yes

Resource adapter properties:

The resource adapter properties control the general operation of the adapter. Use the Adapter Connection wizard to set the resource adapter properties when you configure the adapter.

Adapter ID to use for logging and tracing (AdapterID)

This property identifies a specific deployment, or instance, of the adapter.

Table 77. Adapter ID to use for logging and tracing details

Required	Yes
Default	CWYMY_Adapter Without local transaction support: CWYAP_SAPAdapter With local transaction support: CWYAP_SAPAdapter_Tx
Property type	String

Table 77. Adapter ID to use for logging and tracing details (continued)

Usage	Use this property to identify the adapter instance for PMI events. If you are deploying multiple instances of an adapter, set this property to a unique value for each adapter instance. For inbound processing, this property is retrieved from the resource adapter properties. For outbound processing, it is retrieved from the managed connection factory properties.
Globalized	Yes
Bidi supported	No

Managed connection factory properties:

The adapter uses the managed connection factory properties at run time to create an outbound connection instance with the SAP server.

Use the Adapter Connection wizard to set the managed connection factory properties.

The following table lists and describes the managed connection factory properties. A more detailed description of each property is provided in the sections that follow the table.

Table 78. Managed connection factory properties for Adapter for SAP Software

Property name	Description
ABAPDebug	ABAP debugger property.
Client	The client number of the SAP system to which the adapter connects.
Codepage	The numeric identifier of the code page.
SncMode	Indicates whether secure network connection mode is used.
RfcTracePath	The fully qualified local path to the folder into which the RFC trace files are written.
GatewayHost	The host name of the SAP gateway.
GatewayService	The identifier of the gateway on the gateway host that carries out the RFC services.
ApplicationServerHost	The IP address or the name of the application server host to which the adapter logs on.
Language code	The Language code in which the adapter logs on to SAP.
MessageServerHost	The name of the host on which the message server is running.
PartnerCharset	The PartnerCharset encoding.
Password	The password of the user account of the adapter on the SAP application server.
RfcTraceLevel	The global trace level.
RfcTraceOn	Specifies whether to generate a text file that details the RFC activity for each event listener.
SAPSystemID	The system ID of the SAP system for which logon load balancing is allowed.
SncLib	Specifies the path to the library that provides the secure network connection service.

Table 78. Managed connection factory properties for Adapter for SAP Software (continued)

Property name	Description
SncMyname	Specifies the name of the secure network connection.
SncPartnername	Specifies the name of the secure network connection partner.
SncQop	Specifies the level of security for the secure network connection.
SystemNumber	The system number of the SAP application server.
userName	The user account for the adapter on the SAP server.
X509cert	Specifies the X509 certificate to be used as the logon ticket.

ABAP debug

This property specifies whether the adapter invokes the ABAP Debugger for the appropriate function module when the adapter starts to process a business object.

Table 79. ABAP debug details

Required	No
Possible values	True False
Default	False
Property type	Boolean
Usage	<p>When the property is set to True, the adapter opens the SAP GUI in debug mode.</p> <p>You must have proper authorization to use the debugger. Create a dialog user ID because a CPI-C user ID cannot open an SAP GUI session. You need authorization to run in debug mode as well as any authorizations that are required by the ABAP code that is being debugged. For example, if a BAPL_CUSTOMER_CREATEFROMDATA1 is being debugged, you need authorization to create customers.</p> <p>You can add breakpoints only after the debugger opens.</p> <p>Always set this property to False in a production environment.</p> <p>This property is supported on Windows systems only.</p>
Globalized	No
Bidi supported	No

Client

This property is the client number of the SAP system to which the adapter connects.

Table 80. Client details

Required	Yes
Possible values	You can enter a range of values from 000 to 999.
Default	100
Property type	Integer

Table 80. Client details (continued)

Usage	When an application attempts to log on to the SAP server, the application must have a Client number associated with it. The Client property value identifies the client (the adapter) that is attempting to log on to the SAP server
Globalized	No
Bidi supported	No

Codepage number

This property is the numeric identifier of the code page.

Table 81. Codepage number details

Required	No
Possible values	You can enter a range of values from 0000 to 9999. For a full listing of languages and associated code page numbers that are supported by SAP, see SAP Note 7360.
Default	The default value for this property is conditionally determined by the value that is set for the Language code property.
Property type	Integer
Usage	The value that is assigned to the Codepage number property defines the code page to be used, and has a one-to-one relationship with the value that is set for the Language code property. The code page number establishes a connection to the appropriate language. Each language code value has a code page number value associated with it. For example, the language code for English is EN. If you select EN (English) as your language code, the code page number is automatically set to the numeric value that is associated with EN (English). The SAP code page number for EN (English) is 1100.
Example	If Language code is set to JA (Japanese), Codepage number is set to 8000.
Globalized	No
Bidi supported	No

Enable Secure Network Connection

This property indicates whether secure network connection mode is enabled.

Table 82. Enable Secure Network Connection details

Required	No
Possible values	0 (off) 1 (on)
Default	0
Property type	String
Usage	Set the value to 1 (on) if you want to use secure network connection. If you set this value to 1, you must also set following properties: <ul style="list-style-type: none"> • "Secure Network Connection library path" on page 1251 • "Secure Network Connection name" on page 1251 • "Secure Network Connection partner" on page 1251 • "Secure Network Connection security level" on page 1252
Globalized	No

Table 82. Enable Secure Network Connection details (continued)

Bidi supported	No
----------------	----

Folder for RFC trace files

This property sets the fully qualified local path to the folder in which to write RFC trace files.

Table 83. Folder for RFC trace files details

Required	No
Default	No default value
Property type	String
Usage	Identifies the fully qualified local path into which RFC trace files are written. If RFC trace on is set to False (not selected), you cannot set a value in the Folder for RFC trace files property.
Example	c:\temp\rfcTraceDir
Globalized	Yes
Bidi supported	No

Gateway host

This property is the Gateway host name. Enter either the IP address or the name of the Gateway host. Consult your SAP administrator for information on the Gateway host name.

Table 84. Gateway host details

Required	Yes
Default	No default value
Property type	String
Usage	This property is the host name of the SAP gateway. The gateway enables communication between work processes on the SAP system and external programs. The host that you identify is used as the gateway for the resource adapter. The name can have a maximum length of 20 characters. If the computer name is longer than 20 characters, define a symbolic name in the THOSTS table.
Globalized	No
Bidi supported	No

Gateway service

This property is the identifier of the gateway on the gateway host that carries out the RFC services.

Table 85. Gateway service details

Required	Yes
Default	sapgw00
Property type	String

Table 85. Gateway service details (continued)

Usage	These services enable communication between work processes on the SAP server and external programs. The service typically has the format of sapgw00, where 00 is the SAP system number. The name can have a maximum of 20 characters.
Globalized	No
Bidi supported	No

Host name

The IP address or the name of the application server host to which the adapter logs on.

Table 86. Host name details

Required	Yes (when load balancing is not used).
Default	No default value
Property type	String
Usage	When the adapter is configured to run without load balancing, this property specifies the IP address or the name of the application server that the adapter logs on to.
Example	sapServer
Globalized	No
Bidi supported	No

Language code

This property specifies the Language code in which the adapter logs on.

Table 87. Language code details

Required	Yes
Possible values	For a full listing of languages and associated code page numbers that are supported by SAP, access SAP Note 7360.
Default	The default value for the Language code property is based on the system locale.
Property type	String
Usage	Each of the supported languages is preceded by a two-character language code. The language itself displays in parentheses. If you enter a language code manually, you do not need to enter the language in parenthesis. The language codes in the list represent the SAP default set of 41 languages for non-Unicode systems plus Arabic. The value that you select determines the value of the Codepage number property.
Example	If the system locale is English, the value for this property is EN (English).
Globalized	No
Bidi supported	No

Message server host

This property specifies the name of the host on which the message server is running.

Table 88. Message server host details

Required	Yes (if load balancing is used)
Default	No default value
Property type	String
Usage	This property specifies the name of the host that informs all the servers (instances) that belong to this SAP system of the existence of the other servers to be used for load balancing. The message server host contains the information about load balancing for RFC clients so that an RFC client can be directed to an appropriate application server.
Example	SAPERP05
Globalized	No
Bidi supported	No

Partner character set

This property specifies the partner character set encoding.

Table 89. Partner character set details

Required	No
Default	UTF-8
Property type	String
Usage	When an encoding is specified, it is used; otherwise, the default encoding is used.
Globalized	No
Bidi supported	No

Password

This property is the password of the user account of the adapter on the SAP server.

Table 90. Password details

Required	Yes
Default	No default value
Property type	String
Usage	The restrictions on the password depend on the version of SAP Web Application Server. <ul style="list-style-type: none"> • For SAP Web Application Server version 6.40 or earlier, the password: <ul style="list-style-type: none"> – Must be uppercase – Must be 8 characters in length • For versions of SAP Web Application Server later than 6.40, the password: <ul style="list-style-type: none"> – Is not case-sensitive – Can be up to 40 characters in length
Globalized	No
Bidi supported	Yes

RFC trace level

This property specifies the global trace level.

Table 91. RFC trace level details

Required	No
Possible values	1: SAP JCo Java API logging occurs (default) 3: SAP JCo JNI API logging occurs 5: Error diagnostic logging occurs
Default	1
Property type	Integer
Usage	If RFC trace on is set to False (not selected), you cannot set a value in the RFC trace level property.
Globalized	No
Bidi supported	No

RFC trace on

This property specifies whether to generate a text file that describes the RFC activity for each event listener.

Table 92. RFC trace on details

Required	No
Possible values	True False
Default	False
Property type	Boolean
Usage	A value of True activates tracing, which generates a text file. This file is created in the directory in which the adapter process was started. The file has a prefix of rfx and a file type of .trc (for example, rfc03912_02220.trc). Use this text file in a development environment only, because the files can grow rapidly. If RFC trace on is set to False (not selected), you cannot set values in the Folder for RFC trace files or RFC trace level properties.
Example	Examples of the information in the file are RfcCall FUNCTION BAPI_CUSTOMER_GETLIST, followed by the information for the parameters in the interface, or RFC Info rfcTable, followed by the data from one of the interface tables. The trace file is created in the directory where the adapter process has been started. The trace file has a .trc file extension and the file name starts with the letters rfc followed by a unique identifier. For example, rfc03912_02220.trc.
Globalized	No
Bidi supported	No

SAP system ID

This property specifies the system ID of the SAP system for which logon load balancing is allowed.

Table 93. SAP system ID details

Required	Yes (when load balancing is used)
Default	No default value
Property type	String

Table 93. SAP system ID details (continued)

Usage	This value must be three characters
Example	DYL
Globalized	No
Bidi supported	No

Secure Network Connection library path

This property specifies the path to the library that provides the secure network connection service.

Table 94. Secure Network Connection library path details

Required	Yes, if SncMode is set to 1; otherwise, no.
Default	No default value
Property type	String
Usage	If the SncMode property is set to 1 (indicating that you are using a secure network connection), specify the path to the library that provides the service.
Example	/WINDOWS/system32/gssapi32.dll
Globalized	No
Bidi supported	No

Secure Network Connection name

This property specifies the name of the secure network connection.

Table 95. Secure Network Connection name details

Required	Yes, if SncMode is set to 1; otherwise, no.
Default	No default value
Property type	String
Usage	If the SncMode property is set to 1 (indicating that you are using a secure network connection), specify a name for the connection.
Example	DOMAINNAME/USERNAME
Globalized	No
Bidi supported	No

Secure Network Connection partner

This property specifies the name of the secure network connection partner.

Table 96. Secure Network Connection partner details

Required	Yes, if SncMode is set to 1; otherwise, no.
Default	No default value
Property type	String
Usage	If the SncMode property is set to 1 (indicating that you are using a secure network connection), specify a name for the connection partner.
Example	CN=sap00.saperpdev, OU=Adapter, O=IBM, C=US

Table 96. Secure Network Connection partner details (continued)

Globalized	No
Bidi supported	No

Secure Network Connection security level

This property specifies the level of security for the secure network connection.

Table 97. Secure Network Connection security level details

Required	Yes, if SncMode is set to 1; otherwise, no.
Possible values	<ul style="list-style-type: none"> 1 (Authentication only) 2 (Integrity protection) 3 (Privacy protection) 8 (Use the value from snc/data_protection/use on the application server) 9 (Use the value from snc/data_protection/max on the application server)
Default	3 (Privacy protection)
Property type	String
Usage	If the SncMode property is set to 1 (indicating that you are using a secure network connection), specify a value to indicate the level of security for the connection.
Globalized	No
Bidi supported	No

System number

This property is the system number of the application server.

Table 98. System number details

Required	Yes
Possible values	You can enter a range of values from 00 to 99
Default	00
Property type	Integer
Usage	The system number further identifies the Gateway service.
Globalized	No
Bidi supported	No

User name

This property is the user account for the adapter on the SAP server.

Table 99. User name details

Required	Yes
Default	No default value
Property type	String

Table 99. User name details (continued)

Usage	This property has a maximum length of 12 characters. The user name is not case sensitive. Set up a CPIC user account in the SAP application and give this account the necessary privileges to manipulate the data that is required by the business objects that are supported by the adapter. For example, if the adapter must perform certain SAP business transactions, the adapter's account in the SAP application must have the correct permissions to perform these transactions.
Example	SapUser
Globalized	Yes
Bidi supported	Yes

X509 certificate

This property specifies the X509 certificate to be used as the logon ticket.

Table 100. X509 certificate details

Required	No.
Default	No default value
Property type	String
Usage	If the SncMode property is set to 1 (indicating that you are using a secure network connection), you can provide a value for the X509 certificate.
Globalized	No
Bidi supported	No

Activation specification properties for ALE inbound processing:

Activation specification properties hold the inbound event processing configuration information for a message endpoint. Use the Adapter Connection wizard to set activation specification properties.

Activation specification properties are used during endpoint activation to notify the adapter of eligible event listeners. During inbound processing, the adapter uses these event listeners to receive events before it forwards them to the endpoint.

The following table describes the activation specification properties for ALE inbound processing. A more detailed description of each property is provided in the sections that follow the table.

Table 101. Activation specification properties for ALE inbound processing

Property name	Description
AleFailureCode	The status code for dispatch failure.
AleFailureText	The descriptive text for dispatch failure.
AleSelectiveUpdate	The IDoc Type and MessageType combinations that are to be updated when the adapter is configured to update a standard SAP status code.
AleStatusMsgCode	If required, the message code to use when the adapter posts the ALEAUD Message IDoc (ALEAUD01).
AleSuccessCode	The success status code for Application Document Posted.

Table 101. Activation specification properties for ALE inbound processing (continued)

Property name	Description
AleSuccessText	The descriptive text for successful Application Document Posted.
AleUpdateStatus	Specifies whether an audit trail is required for all message types.
AssuredOnceDelivery	Specifies whether to provide assured once-only delivery for inbound events.
EP_CreateTable	Specifies whether the adapter should create the event recovery table automatically if it does not already exist.
Client	The client number of the SAP system to which the adapter connects.
Codepage	The numeric identifier of the code page.
EP_SchemaName	The schema that is used for automatically creating the event recovery table.
SncMode	Indicates whether secure network connection mode is used.
EP_DataSource_JNDIName	The JNDI name of the data source that is configured for event recovery.
EP_TableName	The name of the event recovery table.
RfcTracePath	The fully qualified local path to the folder into which the RFC trace files are written.
GatewayHost	The host name of the SAP gateway.
GatewayService	The identifier of the gateway on the gateway host that carries out the RFC services.
ApplicationServerHost	The IP address or the name of the application server host to which the adapter logs on.
IgnoreIDocPacketErrors	Specifies what the adapter does when it encounters an error while processing the IDoc packet.
Language code	The Language code in which the adapter logs on to SAP.
Group	An identifier for the name of the group of application server instances that have been defined in transaction SMLG and linked together for logon load balancing.
retryLimit	The number of times that the adapter tries to restart the event listeners.
MessageServerHost	The name of the host on which the message server is running.
NumberOfListeners	The number of event listeners that are to be started
PartnerCharset	The PartnerCharset encoding.
Password	The password of the user account of the adapter on the SAP application server.
EP_Password	The user password for connecting to the database.
RfcProgramID	The remote function call identifier under which the adapter registers in the SAP gateway.
RfcTraceLevel	The global trace level.
RfcTraceOn	Specifies whether to generate a text file that details the RFC activity for each event listener.

Table 101. Activation specification properties for ALE inbound processing (continued)

Property name	Description
SAPSystemID	The system ID of the SAP system for which logon load balancing is allowed.
SncLib	Specifies the path to the library that provides the secure network connection service.
SncMyname	Specifies the name of the secure network connection.
SncPartnername	Specifies the name of the secure network connection partner.
SncQop	Specifies the level of security for the secure network connection.
SystemNumber	The system number of the SAP application server.
retryInterval	The time interval between attempts to restart the event listeners.
userName	The user account for the adapter on the SAP server.
EP_UserName	The user name for connecting to the database.
X509cert	Specifies the X509 certificate to be used as the logon ticket.

ALE failure code

This property determines how the adapter updates the SAP failure status code after the ALE module has retrieved an IDoc object for event processing.

Table 102. ALE failure code details

Required	Yes if AleUpdateStatus is set to True; otherwise, no.
Possible values	68 58
Default	No default value.
Property type	Integer
Usage	<p>Set a value for this property only if you set the value for AleUpdateStatus to True.</p> <p>Specify a value of 68 for this property to cause the adapter to update the SAP failure status code after the ALE module has retrieved an IDoc object for event processing. SAP converts this value to 40 (Application Document not created in receiving system).</p> <p>When you set the AleUpdateStatus property to True, the adapter updates a standard SAP status code after the adapter retrieves an IDoc object for event processing. An IDoc that is not sent successfully to the endpoint is considered to be a failure. Use the ALE failure code property to specify the code that is used to signify this failure.</p>
Globalized	No
Bidi supported	No

ALE failure text

The property specifies the text that appears in the event that an IDoc is not sent successfully to the endpoint.

Table 103. ALE failure text details

Required	Yes if AleUpdateStatus is set to True; otherwise, no.
----------	---

Table 103. ALE failure text details (continued)

Default	No default value.
Property type	String
Usage	Use this property only if you set the AleUpdateStatus property to True. The length of the text string cannot exceed 70 characters. When you set the AleUpdateStatus property to True, the adapter updates a standard SAP status code after the adapter retrieves an IDoc object for event processing. An IDoc that is not sent successfully to the endpoint is considered to be a failure. Use the ALE failure text property to specify the descriptive text that is used to signify this failure.
Example	ALE Dispatch Failed
Globalized	Yes
Bidi supported	No

ALE selective update

This property specifies which IDoc Type and MessageType combinations are to be updated.

Table 104. ALE selective update details

Required	No
Default	No default value
Property type	String
Usage	You can set values for this property only if AleUpdateStatus is set to True. When you set the AleUpdateStatus property to True, the adapter updates a standard SAP status code after the adapter retrieves an IDoc object for event processing. Use the ALE selective update property to specify which IDoc Type and MessageType combinations are to be updated. The syntax for this property is: IDocType: MessageType [;IDocType: MessageType [;...]] where a slash (/) delimiter separates each IDoc Type and MessageType, and a semicolon (;) delimiter separates entries in a set.
Example	The following example illustrates two sets. In the example, MATMAS03 and DEBMAS03 are the IDocs, and MATMAS and DEBMAS are the message types: MATMAS03/MATMAS;DEBMAS03/DEBMAS
Globalized	No
Bidi supported	No

ALE status message code

This property specifies the message code to use when the adapter posts the ALEAUD01 IDoc with message type ALEAUD.

Table 105. ALE status message code details

Required	No
Possible values	For a list of available codes, refer to the SAP table TEDS1.
Default	No default value.
Property type	String

Table 105. ALE status message code details (continued)

Usage	You can set a value for this property only if AleUpdateStatus has been set to True. You must configure this message code in the receiving partner profile on SAP.
Globalized	No
Bidi supported	No

ALE success code

This property specifies the ALE success code for the successful posting of an IDoc.

Table 106. ALE success code details

Required	Yes if AleUpdateStatus is set to True; otherwise, no.
Possible values	52 53
Default	No default value.
Property type	String
Usage	Use this property only if you set the AleUpdateStatus property to True. When you set the AleUpdateStatus property to True, the adapter updates a standard SAP status code after the adapter retrieves an IDoc object for event processing. Use the ALE success code property to specify the code for IDoc posted as 53. After the IDoc is sent to the endpoint, the IDoc status remains as 03 (IDoc posted to port) in SAP. After posting the IDoc, the adapter posts the audit IDoc with the current IDoc number and status as 53. SAP converts the current IDoc status to 41 (Application Document Created in Receiving System).
Globalized	No
Bidi supported	No

ALE success text

This property specifies the text that appears when an application document is posted successfully.

Table 107. ALE success text details

Required	Yes if AleUpdateStatus is set to True; otherwise, no.
Default	No default value.
Property type	String
Usage	Use this property only if you set the AleUpdateStatus property to True. When you set the AleUpdateStatus property to True, the adapter updates a standard SAP status code after the adapter retrieves an IDoc object for event processing. Use the ALE success text property to specify the descriptive text that is used to signify Application Document Posted.
Example	ALE Dispatch OK
Globalized	Yes
Bidi supported	No

ALE update status

This property specifies whether an audit trail is required for all message types.

Table 108. ALE update status details

Required	Yes
Possible values	True False
Default	False
Property type	Boolean
Usage	Set this property to True if you want the adapter to update a standard SAP status code after the ALE module has retrieved an IDoc object for event processing. If you set this value to True, you must also set following properties: <ul style="list-style-type: none">• AleFailureCode• AleSuccessCode• AleFailureText• AleSuccessText.
Globalized	No
Bidi supported	No

Assured once-only delivery (AssuredOnceDelivery)

This property specifies whether to provide assured once-only delivery for inbound events.

Table 109. Assured once-only delivery details

Required	Yes
Possible values	True False
Default	False
Property type	Boolean
Usage	When this property is set to True, the adapter provides assured once-only event delivery, so that each event is delivered only once. A value of False does not provide assured once-only event delivery, but provides better performance. When this property is set to True, the adapter attempts to store transaction (XID) information in the event store. If it is set to False, the adapter does not attempt to store the information. This property is used only if the export component is transactional. If the export component is not transactional, no transaction can be used, regardless of the value of this property.
Globalized	No
Bidi supported	No

Auto create event table

This property determines if the event table is created automatically.

Table 110. Auto create event table details

Required	Yes if Assured once-only event delivery is set to True; otherwise, no.
----------	---

Table 110. Auto create event table details (continued)

Possible values	True False
Default	True
Property type	Boolean
Usage	This property indicates whether the adapter should create the event recovery table automatically if it does not already exist. If you specify a value of True to automatically create the table, you must specify information about the event table (such as the event recovery table name). The value that is provided in Event recovery table name property is used to create the table.
Globalized	No
Bidi supported	No

Client

This property is the client number of the SAP system to which the adapter connects.

Table 111. Client details

Required	Yes
Possible values	You can enter a range of values from 000 to 999.
Default	100
Property type	Integer
Usage	When an application attempts to log on to the SAP server, the application must have a Client number associated with it. The Client property value identifies the client (the adapter) that is attempting to log on to the SAP server
Globalized	No
Bidi supported	No

Codepage number

This property is the numeric identifier of the code page.

Table 112. Codepage number details

Required	No
Possible values	You can enter a range of values from 0000 to 9999. For a full listing of languages and associated code page numbers that are supported by SAP, see SAP Note 7360.
Default	The default value for this property is conditionally determined by the value that is set for the Language code property.
Property type	Integer

Table 112. Codepage number details (continued)

Usage	The value that is assigned to the Codepage number property defines the code page to be used, and has a one-to-one relationship with the value that is set for the Language code property. The code page number establishes a connection to the appropriate language. Each language code value has a code page number value associated with it. For example, the language code for English is EN. If you select EN (English) as your language code, the code page number is automatically set to the numeric value that is associated with EN (English). The SAP code page number for EN (English) is 1100.
Example	If Language code is set to JA (Japanese), Codepage number is set to 8000.
Globalized	No
Bidi supported	No

Database schema name

This property is the schema that is used to create the event recovery table automatically.

Table 113. Database schema name details

Required	No
Default	No default value.
Property type	String
Usage	Specifies the schema name for the database used by the adapter's event persistence feature.
Example	ALE_SCHEMA
Globalized	Yes
Bidi supported	No

Enable Secure Network Connection

This property indicates whether secure network connection mode is enabled.

Table 114. Enable Secure Network Connection details

Required	No
Possible values	0 (off) 1 (on)
Default	0
Property type	String
Usage	Set the value to 1 (on) if you want to use secure network connection. If you set this value to 1, you must also set following properties: <ul style="list-style-type: none"> • "Secure Network Connection library path" on page 1268 • "Secure Network Connection name" on page 1268 • "Secure Network Connection partner" on page 1268 • "Secure Network Connection security level" on page 1269.
Globalized	No
Bidi supported	No

Event recovery data source (JNDI) name

This property is the JNDI name of the data source that is configured for event recovery.

Table 115. Event recovery data source (JNDI) name details

Required	Yes
Default	No default value.
Property type	String
Usage	Used in event recovery processing. The data source must be created in WebSphere Message Broker. The adapter uses the data source for persisting the event state.
Example	jdbc/DB2
Globalized	No
Bidi supported	No

Event recovery table name

This property is the name of the event recovery table.

Table 116. Event recovery table name details

Required	Yes
Default	No default value.
Property type	String
Usage	Used in event recovery processing. Consult database documentation for information on naming conventions. Configure a separate event recovery table for each endpoint. The same data source can be used to hold all of the event recovery tables.
Example	EVENT_TABLE
Globalized	No
Bidi supported	No

Folder for RFC trace files

This property sets the fully qualified local path to the folder in which to write RFC trace files.

Table 117. Folder for RFC trace files details

Required	No
Default	No default value
Property type	String
Usage	Identifies the fully qualified local path into which RFC trace files are written. If RFC trace on is set to False (not selected), you cannot set a value in the Folder for RFC trace files property.
Example	c:\temp\rfcTraceDir
Globalized	Yes
Bidi supported	No

Gateway host

This property is the Gateway host name. Enter either the IP address or the name of the Gateway host. Consult your SAP administrator for information on the Gateway host name.

Table 118. Gateway host details

Required	Yes
Default	No default value
Property type	String
Usage	This property is the host name of the SAP gateway. The gateway enables communication between work processes on the SAP system and external programs. The host that you identify is used as the gateway for the resource adapter. The name can have a maximum length of 20 characters. If the computer name is longer than 20 characters, define a symbolic name in the THOSTS table.
Globalized	No
Bidi supported	No

Gateway service

This property is the identifier of the gateway on the gateway host that carries out the RFC services.

Table 119. Gateway service details

Required	Yes
Default	sapgw00
Property type	String
Usage	These services enable communication between work processes on the SAP server and external programs. The service typically has the format of sapgw00, where 00 is the SAP system number. The name can have a maximum of 20 characters.
Globalized	No
Bidi supported	No

Host name

The IP address or the name of the application server host to which the adapter logs on.

Table 120. Host name details

Required	Yes (when load balancing is not used).
Default	No default value
Property type	String
Usage	When the adapter is configured to run without load balancing, this property specifies the IP address or the name of the application server that the adapter logs on to.
Example	sapServer
Globalized	No
Bidi supported	No

Ignore IDoc packet errors

This property determines whether or not IDoc packet errors are to be ignored.

Table 121. Ignore IDOC packet errors details

Required	No
Possible values	True False
Default	False
Property type	Boolean
Usage	<p>If the adapter encounters an error while processing the IDoc packet, it can behave in two different ways.</p> <ul style="list-style-type: none">• When this property is set to False, the adapter stops processing further IDocs in that packet and reports an error to the SAP system.• When this property is set to True, the adapter logs an error and continues to process the rest of the IDocs in that packet. <p>The status of the transaction is marked as INPROGRESS. The adapter log would display the IDoc numbers that failed and you need to resubmit those individual IDocs separately. You need to manually maintain these records in the event recovery table.</p> <p>This property is not used for single IDocs and for non-split IDoc packets.</p>
Globalized	No
Bidi supported	No

Language code

This property specifies the Language code in which the adapter logs on.

Table 122. Language code details

Required	Yes
Possible values	For a full listing of languages and associated code page numbers that are supported by SAP, access SAP Note 7360.
Default	The default value for the Language code property is based on the system locale.
Property type	String
Usage	<p>Each of the supported languages is preceded by a two-character language code. The language itself displays in parentheses.</p> <p>If you enter a language code manually, you do not need to enter the language in parenthesis.</p> <p>The language codes in the list represent the SAP default set of 41 languages for non-Unicode systems plus Arabic.</p> <p>The value that you select determines the value of the Codepage number property.</p>
Example	If the system locale is English, the value for this property is EN (English).
Globalized	No
Bidi supported	No

Logon group name

This property is an identifier for the name of the group of application server instances that have been defined in transaction SMLG and linked together for logon load balancing.

Table 123. Logon group details

Required	Yes (if load balancing is used)
Possible values	Consult SAP documentation for information on creating Logon groups and on calling transaction SMLG.
Default	No default value
Property type	String
Usage	<p>When the adapter is configured for load balancing, this property represents the name of the group of application server instances that have been defined in transaction SMLG and linked together for logon load balancing.</p> <p>Logon load balancing allows for the dynamic distribution of logon connections to application server instances.</p> <p>This identifier can have a maximum of 20 characters. On most SAP systems, the SPACE logon group is reserved by SAP.</p>
Globalized	No
Bidi supported	No

Maximum number of retries in case of system connection failure

This property specifies the number of times that the adapter tries to restart the event listeners.

Table 124. Maximum number of retries in case of system failure details

Required	Yes
Default	0
Property type	Integer
Usage	<p>When the adapter encounters an error that is related to the inbound connection, this property specifies the number of times that the adapter tries to restart the event listeners. A value of 0 indicates an infinite number of retries.</p> <p>Configure the Time between retries in case of system connection failure (milliseconds) appropriately when retrying infinitely.</p> <p>For each retry attempt, the adapter waits for the time interval that is specified in the Time between retries in case of system connection failure (milliseconds).</p> <p>If all the retry attempts fail, the adapter logs relevant messages and CEI events and stops attempting to recover the event listener. If you reach this point, you might have to restart the application manually.</p>
Globalized	No
Bidi supported	No

Message server host

This property specifies the name of the host on which the message server is running.

Table 125. Message server host details

Required	Yes (if load balancing is used)
Default	No default value
Property type	String

Table 125. Message server host details (continued)

Usage	This property specifies the name of the host that informs all the servers (instances) that belong to this SAP system of the existence of the other servers to be used for load balancing. The message server host contains the information about load balancing for RFC clients so that an RFC client can be directed to an appropriate application server.
Example	SAPERP05
Globalized	No
Bidi supported	No

Number of listeners

This property specifies the number of listeners that are started by an event.

Table 126. Number of listeners details

Required	No
Default	1
Property type	Integer
Usage	For event sequencing, set this property to 1. To improve adapter performance you can increase the number of listeners.
Globalized	No
Bidi supported	No

Partner character set

This property specifies the partner character set encoding.

Table 127. Partner character set details

Required	No
Default	UTF-8
Property type	String
Usage	When an encoding is specified, it is used; otherwise, the default encoding is used.
Globalized	No
Bidi supported	No

Password

This property is the password of the user account of the adapter on the SAP server.

Table 128. Password details

Required	Yes
Default	No default value
Property type	String

Table 128. Password details (continued)

Usage	The restrictions on the password depend on the version of SAP Web Application Server. <ul style="list-style-type: none"> • For SAP Web Application Server version 6.40 or earlier, the password: <ul style="list-style-type: none"> – Must be uppercase – Must be 8 characters in length • For versions of SAP Web Application Server later than 6.40, the password: <ul style="list-style-type: none"> – Is not case-sensitive – Can be up to 40 characters in length
Globalized	No
Bidi supported	Yes

Password used to connect to event data source

This property is the user password for connecting to the database.

Table 129. Password to connect to event data source details

Required	Yes
Default	No default value.
Property type	String
Usage	This property specifies the password used by event-persistence processing to obtain the database connection from the data source.
Globalized	Yes
Bidi supported	No

RFC program ID

This property is the program identifier under which the adapter registers in the SAP gateway.

Table 130. RFC program ID details

Required	Yes
Possible values	Use the SAP transaction SM59 (Display and Maintain RFC Destinations) to see a list of available RFC program IDs.
Default	No default value.
Property type	String
Usage	The adapter registers with the gateway so that listener threads can process events from RFC-enabled functions. This value must match the program ID that is registered in the SAP application. The maximum length is 64 characters.
Globalized	No
Bidi supported	No

RFC trace level

This property specifies the global trace level.

Table 131. RFC trace level details

Required	No
Possible values	1: SAP JCo Java API logging occurs (default) 3: SAP JCo JNI API logging occurs 5: Error diagnostic logging occurs
Default	1
Property type	Integer
Usage	If RFC trace on is set to False (not selected), you cannot set a value in the RFC trace level property.
Globalized	No
Bidi supported	No

RFC trace on

This property specifies whether to generate a text file that describes the RFC activity for each event listener.

Table 132. RFC trace on details

Required	No
Possible values	True False
Default	False
Property type	Boolean
Usage	A value of True activates tracing, which generates a text file. This file is created in the directory in which the adapter process was started. The file has a prefix of rfx and a file type of .trc (for example, rfc03912_02220.trc). Use this text file in a development environment only, because the files can grow rapidly. If RFC trace on is set to False (not selected), you cannot set values in the Folder for RFC trace files or RFC trace level properties.
Example	Examples of the information in the file are RfcCall FUNCTION BAPI_CUSTOMER_GETLIST, followed by the information for the parameters in the interface, or RFC Info rfctable, followed by the data from one of the interface tables. The trace file is created in the directory where the adapter process has been started. The trace file has a .trc file extension and the file name starts with the letters rfc followed by a unique identifier. For example, rfc03912_02220.trc.
Globalized	No
Bidi supported	No

SAP system ID

This property specifies the system ID of the SAP system for which logon load balancing is allowed.

Table 133. SAP system ID details

Required	Yes (when load balancing is used)
Default	No default value
Property type	String

Table 133. SAP system ID details (continued)

Usage	This value must be three characters
Example	DYL
Globalized	No
Bidi supported	No

Secure Network Connection library path

This property specifies the path to the library that provides the secure network connection service.

Table 134. Secure Network Connection library path details

Required	Yes, if SncMode is set to 1; otherwise, no.
Default	No default value
Property type	String
Usage	If the SncMode property is set to 1 (indicating that you are using a secure network connection), specify the path to the library that provides the service.
Example	/WINDOWS/system32/gssapi32.dll
Globalized	No
Bidi supported	No

Secure Network Connection name

This property specifies the name of the secure network connection.

Table 135. Secure Network Connection name details

Required	Yes, if SncMode is set to 1; otherwise, no.
Default	No default value
Property type	String
Usage	If the SncMode property is set to 1 (indicating that you are using a secure network connection), specify a name for the connection.
Example	DOMAINNAME/USERNAME
Globalized	No
Bidi supported	No

Secure Network Connection partner

This property specifies the name of the secure network connection partner.

Table 136. Secure Network Connection partner details

Required	Yes, if SncMode is set to 1; otherwise, no.
Default	No default value
Property type	String
Usage	If the SncMode property is set to 1 (indicating that you are using a secure network connection), specify a name for the connection partner.
Example	CN=sap00.saperpdev, OU=Adapter, O=IBM, C=US

Table 136. Secure Network Connection partner details (continued)

Globalized	No
Bidi supported	No

Secure Network Connection security level

This property specifies the level of security for the secure network connection.

Table 137. Secure Network Connection security level details

Required	Yes, if SncMode is set to 1; otherwise, no.
Possible values	<ul style="list-style-type: none"> 1 (Authentication only) 2 (Integrity protection) 3 (Privacy protection) 8 (Use the value from snc/data_protection/use on the application server) 9 (Use the value from snc/data_protection/max on the application server)
Default	3 (Privacy protection)
Property type	String
Usage	If the SncMode property is set to 1 (indicating that you are using a secure network connection), specify a value to indicate the level of security for the connection.
Globalized	No
Bidi supported	No

System number

This property is the system number of the application server.

Table 138. System number details

Required	Yes
Possible values	You can enter a range of values from 00 to 99
Default	00
Property type	Integer
Usage	The system number further identifies the Gateway service.
Globalized	No
Bidi supported	No

Time between retries in case of system connection failure (milliseconds)

This property specifies the time interval between attempts to restart the event listeners.

Table 139. Time between retries in case of system connection failure details

Required	Yes
Default	60000
Unit of measure	Milliseconds
Property type	Integer

Table 139. Time between retries in case of system connection failure details (continued)

Usage	When the adapter encounters an error that is related to the inbound connection, this property specifies the time interval that the adapter waits between attempts to restart the event listeners.
Globalized	No
Bidi supported	No

User name

This property is the user account for the adapter on the SAP server.

Table 140. User name details

Required	Yes
Default	No default value
Property type	String
Usage	This property has a maximum length of 12 characters. The user name is not case sensitive. Set up a CPIC user account in the SAP application and give this account the necessary privileges to manipulate the data that is required by the business objects that are supported by the adapter. For example, if the adapter must perform certain SAP business transactions, the adapter's account in the SAP application must have the correct permissions to perform these transactions.
Example	SapUser
Globalized	Yes
Bidi supported	Yes

User name used to connect to event data source

This property is the user name for connecting to the database.

Table 141. User name to connect to event data source details

Required	Yes
Default	No default value.
Property type	String
Usage	User name used by event persistence for getting the database connection from the data source. Consult database documentation for information on naming conventions.
Globalized	Yes
Bidi supported	No

X509 certificate

This property specifies the X509 certificate to be used as the logon ticket.

Table 142. X509 certificate details

Required	No.
Default	No default value
Property type	String
Usage	If the SncMode property is set to 1 (indicating that you are using a secure network connection), you can provide a value for the X509 certificate.

Table 142. X509 certificate details (continued)

Globalized	No
Bidi supported	No

Activation specification properties for Advanced event processing:

Activation specification properties are properties that hold the inbound event-processing configuration information for a message endpoint. Use the Adapter Connection wizard to set activation specification properties.

Activation specification properties are used during endpoint activation to notify the adapter of eligible event listeners. During inbound processing, the adapter uses these event listeners to receive events before it forwards them to the endpoint.

The following table lists the activation specification properties for Advanced event inbound processing. A complete description of each property is provided in the sections that follow the table.

Table 143. Activation specification properties for Advanced event processing

Property name	Description
AssuredOnceDelivery	Specifies whether to provide assured once-only delivery for inbound events.
Client	The client number of the SAP system to which the adapter connects.
Codepage	The numeric identifier of the code page.
SncMode	Indicates whether secure network connection mode is used.
DeliveryType	Determines the order in which events are delivered by the adapter to the export
“Event type filter” on page 1274	A delimited list of event types that the WebSphere Adapter for SAP Software should deliver.
RfcTracePath	The fully qualified local path to the folder into which the RFC trace files are written.
GatewayHost	The host name of the SAP gateway.
GatewayService	The identifier of the gateway on the gateway host that carries out the RFC services.
ApplicationServerHost	The IP address or the name of the application server host to which the adapter logs on.
Language code	The Language code in which the adapter logs on to SAP.
Group	An identifier for the name of the group of application server instances that have been defined in transaction SMLG and linked together for logon load balancing.
PollQuantity	The number of events that the adapter delivers to the export during each poll period.
RetryLimit	The number of times that the adapter tries to reestablish an inbound connection after an error.
MessageServerHost	The name of the host on which the message server is running.
PartnerCharset	The PartnerCharset encoding.

Table 143. Activation specification properties for Advanced event processing (continued)

Property name	Description
Password	The password of the user account of the adapter on the SAP application server.
RfcTraceLevel	The global trace level.
RfcTraceOn	Specifies whether to generate a text file that details the RFC activity for each event listener.
SAPSystemID	The system ID of the SAP system for which logon load balancing is allowed.
SncLib	Specifies the path to the library that provides the secure network connection service.
SncMyname	Specifies the name of the secure network connection.
SncPartnername	Specifies the name of the secure network connection partner.
SncQop	Specifies the level of security for the secure network connection.
StopPollingOnError	Specifies whether the adapter stops polling for events when it encounters an error during polling.
SystemNumber	The system number of the SAP application server.
PollPeriod	The length of time that the adapter waits between polling periods.
RetryInterval	The length of time that the adapter waits between attempts to establish a new connection after an error during inbound operations.
userName	The user account for the adapter on the SAP server.
X509cert	Specifies the X509 certificate to be used as the logon ticket.

Assured once-only delivery (AssuredOnceDelivery)

This property specifies whether to provide assured once-only delivery for inbound events.

Table 144. Assured once-only delivery details

Required	Yes
Possible values	True False
Default	False
Property type	Boolean
Usage	<p>When this property is set to True, the adapter provides assured once-only event delivery, so that each event is delivered only once. A value of False does not provide assured once-only event delivery, but provides better performance.</p> <p>When this property is set to True, the adapter attempts to store transaction (XID) information in the event store. If it is set to False, the adapter does not attempt to store the information.</p> <p>This property is used only if the export component is transactional. If the export component is not transactional, no transaction can be used, regardless of the value of this property.</p>
Globalized	No
Bidi supported	No

Client

This property is the client number of the SAP system to which the adapter connects.

Table 145. Client details

Required	Yes
Possible values	You can enter a range of values from 000 to 999.
Default	100
Property type	Integer
Usage	When an application attempts to log on to the SAP server, the application must have a Client number associated with it. The Client property value identifies the client (the adapter) that is attempting to log on to the SAP server
Globalized	No
Bidi supported	No

Codepage number

This property is the numeric identifier of the code page.

Table 146. Codepage number details

Required	No
Possible values	You can enter a range of values from 0000 to 9999. For a full listing of languages and associated code page numbers that are supported by SAP, see SAP Note 7360.
Default	The default value for this property is conditionally determined by the value that is set for the Language code property.
Property type	Integer
Usage	The value that is assigned to the Codepage number property defines the code page to be used, and has a one-to-one relationship with the value that is set for the Language code property. The code page number establishes a connection to the appropriate language. Each language code value has a code page number value associated with it. For example, the language code for English is EN. If you select EN (English) as your language code, the code page number is automatically set to the numeric value that is associated with EN (English). The SAP code page number for EN (English) is 1100.
Example	If Language code is set to JA (Japanese), Codepage number is set to 8000.
Globalized	No
Bidi supported	No

Delivery type (DeliveryType)

This property specifies the order in which events are delivered by the adapter to the export.

Table 147. Delivery type details

Required	No
----------	----

Table 147. Delivery type details (continued)

Possible values	ORDERED UNORDERED
Default	ORDERED
Property type	String
Usage	The following values are supported: <ul style="list-style-type: none"> • ORDERED: The adapter delivers events to the export one at a time. • UNORDERED: The adapter delivers all events to the export at once.
Globalized	No
Bidi supported	No

Enable Secure Network Connection

This property indicates whether secure network connection mode is enabled.

Table 148. Enable Secure Network Connection details

Required	No
Possible values	0 (off) 1 (on)
Default	0
Property type	String
Usage	Set the value to 1 (on) if you want to use secure network connection. If you set this value to 1, you must also set following properties: <ul style="list-style-type: none"> • “Secure Network Connection library path” on page 1280 • “Secure Network Connection name” on page 1280 • “Secure Network Connection partner” on page 1280 • “Secure Network Connection security level” on page 1281
Globalized	No
Bidi supported	No

Event type filter

This property provides a delimited list of business object types for which the adapter should deliver events.

Table 149. Event type filter details

Required	No
Default	Null
Property type	String
Usage	The adapter uses the delimited list as a filter, delivering events for only those business object types that are contained in the list. If the list is empty (null), the adapter does not apply filtering, and delivers events for all business object types.
Globalized	No
Bidi supported	No

Folder for RFC trace files

This property sets the fully qualified local path to the folder in which to write RFC trace files.

Table 150. Folder for RFC trace files details

Required	No
Default	No default value
Property type	String
Usage	Identifies the fully qualified local path into which RFC trace files are written. If RFC trace on is set to False (not selected), you cannot set a value in the Folder for RFC trace files property.
Example	c:\temp\rfcTraceDir
Globalized	Yes
Bidi supported	No

Gateway host

This property is the Gateway host name. Enter either the IP address or the name of the Gateway host. Consult your SAP administrator for information on the Gateway host name.

Table 151. Gateway host details

Required	Yes
Default	No default value
Property type	String
Usage	This property is the host name of the SAP gateway. The gateway enables communication between work processes on the SAP system and external programs. The host that you identify is used as the gateway for the resource adapter. The name can have a maximum length of 20 characters. If the computer name is longer than 20 characters, define a symbolic name in the THOSTS table.
Globalized	No
Bidi supported	No

Gateway service

This property is the identifier of the gateway on the gateway host that carries out the RFC services.

Table 152. Gateway service details

Required	Yes
Default	sapgw00
Property type	String
Usage	These services enable communication between work processes on the SAP server and external programs. The service typically has the format of sapgw00, where 00 is the SAP system number. The name can have a maximum of 20 characters.
Globalized	No

Table 152. Gateway service details (continued)

Bidi supported	No
----------------	----

Host name

The IP address or the name of the application server host to which the adapter logs on.

Table 153. Host name details

Required	Yes (when load balancing is not used).
Default	No default value
Property type	String
Usage	When the adapter is configured to run without load balancing, this property specifies the IP address or the name of the application server that the adapter logs on to.
Example	sapServer
Globalized	No
Bidi supported	No

Language code

This property specifies the Language code in which the adapter logs on.

Table 154. Language code details

Required	Yes
Possible values	For a full listing of languages and associated code page numbers that are supported by SAP, access SAP Note 7360.
Default	The default value for the Language code property is based on the system locale.
Property type	String
Usage	Each of the supported languages is preceded by a two-character language code. The language itself displays in parentheses. If you enter a language code manually, you do not need to enter the language in parenthesis. The language codes in the list represent the SAP default set of 41 languages for non-Unicode systems plus Arabic. The value that you select determines the value of the Codepage number property.
Example	If the system locale is English, the value for this property is EN (English).
Globalized	No
Bidi supported	No

Logon group name

This property is an identifier for the name of the group of application server instances that have been defined in transaction SMLG and linked together for logon load balancing.

Table 155. Logon group details

Required	Yes (if load balancing is used)
----------	---------------------------------

Table 155. Logon group details (continued)

Possible values	Consult SAP documentation for information on creating Logon groups and on calling transaction SMLG.
Default	No default value
Property type	String
Usage	<p>When the adapter is configured for load balancing, this property represents the name of the group of application server instances that have been defined in transaction SMLG and linked together for logon load balancing.</p> <p>Logon load balancing allows for the dynamic distribution of logon connections to application server instances.</p> <p>This identifier can have a maximum of 20 characters. On most SAP systems, the SPACE logon group is reserved by SAP.</p>
Globalized	No
Bidi supported	No

Maximum number of events collected during each poll

This property specifies the number of events that the adapter delivers to the export during each poll period.

Table 156. Maximum number of events collected during each poll details

Required	Yes
Default	10
Property type	Integer
Usage	This value must be greater than 0
Globalized	No
Bidi supported	No

Maximum number of retries in case of system connection failure

This property specifies the number of times that the adapter tries to reestablish an inbound connection.

Table 157. Maximum number of retries in case of system connection failure details

Required	No
Possible values	Positive integers
Default	0
Property type	Integer
Usage	<p>Only positive values are valid.</p> <p>When the adapter encounters an error that is related to the inbound connection, this property specifies the number of times that the adapter tries to restart the connection. A value of 0 indicates an infinite number of retries.</p>
Globalized	No
Bidi supported	No

Message server host

This property specifies the name of the host on which the message server is running.

Table 158. Message server host details

Required	Yes (if load balancing is used)
Default	No default value
Property type	String
Usage	This property specifies the name of the host that informs all the servers (instances) that belong to this SAP system of the existence of the other servers to be used for load balancing. The message server host contains the information about load balancing for RFC clients so that an RFC client can be directed to an appropriate application server.
Example	SAPERP05
Globalized	No
Bidi supported	No

Partner character set

This property specifies the partner character set encoding.

Table 159. Partner character set details

Required	No
Default	UTF-8
Property type	String
Usage	When an encoding is specified, it is used; otherwise, the default encoding is used.
Globalized	No
Bidi supported	No

Password

This property is the password of the user account of the adapter on the SAP server.

Table 160. Password details

Required	Yes
Default	No default value
Property type	String
Usage	The restrictions on the password depend on the version of SAP Web Application Server. <ul style="list-style-type: none">• For SAP Web Application Server version 6.40 or earlier, the password:<ul style="list-style-type: none">– Must be uppercase– Must be 8 characters in length• For versions of SAP Web Application Server later than 6.40, the password:<ul style="list-style-type: none">– Is not case-sensitive– Can be up to 40 characters in length
Globalized	No
Bidi supported	Yes

RFC trace level

This property specifies the global trace level.

Table 161. RFC trace level details

Required	No
Possible values	1: SAP JCo Java API logging occurs (default) 3: SAP JCo JNI API logging occurs 5: Error diagnostic logging occurs
Default	1
Property type	Integer
Usage	If RFC trace on is set to False (not selected), you cannot set a value in the RFC trace level property.
Globalized	No
Bidi supported	No

RFC trace on

This property specifies whether to generate a text file that describes the RFC activity for each event listener.

Table 162. RFC trace on details

Required	No
Possible values	True False
Default	False
Property type	Boolean
Usage	A value of True activates tracing, which generates a text file. This file is created in the directory in which the adapter process was started. The file has a prefix of rfx and a file type of .trc (for example, rfc03912_02220.trc). Use this text file in a development environment only, because the files can grow rapidly. If RFC trace on is set to False (not selected), you cannot set values in the Folder for RFC trace files or RFC trace level properties.
Example	Examples of the information in the file are RfcCall FUNCTION BAPI_CUSTOMER_GETLIST, followed by the information for the parameters in the interface, or RFC Info rfcTable, followed by the data from one of the interface tables. The trace file is created in the directory where the adapter process has been started. The trace file has a .trc file extension and the file name starts with the letters rfc followed by a unique identifier. For example, rfc03912_02220.trc.
Globalized	No
Bidi supported	No

SAP system ID

This property specifies the system ID of the SAP system for which logon load balancing is allowed.

Table 163. SAP system ID details

Required	Yes (when load balancing is used)
Default	No default value
Property type	String
Usage	This value must be three characters
Example	DYL
Globalized	No
Bidi supported	No

Secure Network Connection library path

This property specifies the path to the library that provides the secure network connection service.

Table 164. Secure Network Connection library path details

Required	Yes, if SncMode is set to 1; otherwise, no.
Default	No default value
Property type	String
Usage	If the SncMode property is set to 1 (indicating that you are using a secure network connection), specify the path to the library that provides the service.
Example	/WINDOWS/system32/gssapi32.dll
Globalized	No
Bidi supported	No

Secure Network Connection name

This property specifies the name of the secure network connection.

Table 165. Secure Network Connection name details

Required	Yes, if SncMode is set to 1; otherwise, no.
Default	No default value
Property type	String
Usage	If the SncMode property is set to 1 (indicating that you are using a secure network connection), specify a name for the connection.
Example	DOMAINNAME/USERNAME
Globalized	No
Bidi supported	No

Secure Network Connection partner

This property specifies the name of the secure network connection partner.

Table 166. Secure Network Connection partner details

Required	Yes, if SncMode is set to 1; otherwise, no.
Default	No default value
Property type	String

Table 166. Secure Network Connection partner details (continued)

Usage	If the SncMode property is set to 1 (indicating that you are using a secure network connection), specify a name for the connection partner.
Example	CN=sap00.saperpdev, OU=Adapter, O=IBM, C=US
Globalized	No
Bidi supported	No

Secure Network Connection security level

This property specifies the level of security for the secure network connection.

Table 167. Secure Network Connection security level details

Required	Yes, if SncMode is set to 1; otherwise, no.
Possible values	1 (Authentication only) 2 (Integrity protection) 3 (Privacy protection) 8 (Use the value from snc/data_protection/use on the application server) 9 (Use the value from snc/data_protection/max on the application server)
Default	3 (Privacy protection)
Property type	String
Usage	If the SncMode property is set to 1 (indicating that you are using a secure network connection), specify a value to indicate the level of security for the connection.
Globalized	No
Bidi supported	No

Stop the adapter when an error is encountered while polling (StopPollingOnError)

This property specifies whether the adapter stops polling for events when it encounters an error during polling.

Table 168. Stop the adapter when an error is encountered while polling details

Required	No
Possible values	True False
Default	False
Property type	Boolean
Usage	If this property is set to True, the adapter stops polling when it encounters an error. If this property is set to False, the adapter logs an exception when it encounters an error during polling and continues polling.
Globalized	No
Bidi supported	No

System number

This property is the system number of the application server.

Table 169. System number details

Required	Yes
Possible values	You can enter a range of values from 00 to 99
Default	00
Property type	Integer
Usage	The system number further identifies the Gateway service.
Globalized	No
Bidi supported	No

Time between polling for events (milliseconds)

This property specifies the length of time that the adapter waits between polling periods.

Table 170. Time between polling for events (milliseconds)

Required	Yes
Possible values	Integers greater than or equal to 0.
Default	2000
Unit of measure	Milliseconds
Property type	Integer
Usage	The time interval between polling events is established at a fixed rate, which means that if running the poll cycle is delayed for any reason (for example, if a prior poll cycle takes longer than expected to complete), the next poll cycle occurs immediately to make up for the time that is lost because of the delay.
Globalized	No
Bidi supported	No

Time between retries in case of system connection failure (milliseconds)

This property specifies the time interval between attempts to reestablish an inbound connection.

Table 171. Time between retries in case of system connection failure details

Required	Yes
Default	60000
Unit of measure	Milliseconds
Property type	Integer
Usage	When the adapter encounters an error that is related to the inbound connection, this property specifies the time interval that the adapter waits in between attempts to reestablish an inbound connection.
Globalized	No
Bidi supported	No

User name

This property is the user account for the adapter on the SAP server.

Table 172. User name details

Required	Yes
Default	No default value
Property type	String
Usage	This property has a maximum length of 12 characters. The user name is not case sensitive. Set up a CPIC user account in the SAP application and give this account the necessary privileges to manipulate the data that is required by the business objects that are supported by the adapter. For example, if the adapter must perform certain SAP business transactions, the adapter's account in the SAP application must have the correct permissions to perform these transactions.
Example	SapUser
Globalized	Yes
Bidi supported	Yes

X509 certificate

This property specifies the X509 certificate to be used as the logon ticket.

Table 173. X509 certificate details

Required	No.
Default	No default value
Property type	String
Usage	If the SncMode property is set to 1 (indicating that you are using a secure network connection), you can provide a value for the X509 certificate.
Globalized	No
Bidi supported	No

Interaction specification properties:

An interaction is an operation. Interaction specification properties control how the operation is run.

The Adapter Connection wizard sets the interaction specification properties when you configure the adapter. Typically, you do not need to change these properties. However, you can change some properties for outbound operations. For example, you can increase the value of the interaction specification property that specifies the maximum number of hits for the discovery to be returned by a RetrieveAll operation, if your RetrieveAll operations do not return complete information.

The following table lists the interaction specification properties that you can set.

Table 174. Interaction specification properties for Adapter for SAP Software

Property name	Description
"Custom retrieve function name" on page 1284	The name of a custom function to be used by the Query interface to SAP Software to retrieve data from an SAP table.
Function name	The function name for a specific SAP interface.
Ignore errors in BAPI return	Specifies if errors in BAPI return are ignored.

Table 174. Interaction specification properties for Adapter for SAP Software (continued)

Property name	Description
“Maximum number of hits for the discovery” on page 1286	The maximum number of result sets to return during a RetrieveAll operation.
“Select the queue name” on page 1286	The name of a customer-defined queue on the SAP server.

Custom retrieve function name

For the Query interface for SAP Software, this property specifies the name of a custom function that must be used to retrieve data from an SAP table.

Table 175. Custom retrieve function name details

Required	No
Default	No default value
Property type	String
Usage	<p>This property applies to Query interface for SAP Software only.</p> <p>On non-Unicode systems, the default function used to retrieve data from SAP tables (RFC_READ_TABLE) might produce an exception. To avoid the problem, you can create another function on the SAP server and indicate, during configuration, that the adapter must use this custom function to retrieve data. This property specifies the name of the custom function.</p> <p>You must create the function on the SAP server before you specify this property on the Adapter Connection wizard. Follow the steps listed in SAP note 758278 to make a copy of RFC_READ_TABLE and modify the copy in line with the note.</p>
Globalized	No
Bidi supported	No

Function name

The functionName interaction specification property controls the interaction by associating operations with the proper interface.

Table 176. Function name details

Required	Yes
Possible values	True False
Default	Null
Property type	String

Table 176. Function name details (continued)

Usage	<p>The BAPI/RFC supports the following values for the functionName interaction specification property:</p> <p>WBIInteractionSpec.CREATE WBIInteractionSpec.UPDATE WBIInteractionSpec.RETRIEVE WBIInteractionSpec.DELETE</p> <p>The BAPI result set supports the following value for the functionName interaction specification property:</p> <p>WBIInteractionSpec.RETRIEVEALL</p> <p>The ALE outbound interface supports the following value:</p> <p>WBIInteractionSpec.EXECUTE</p> <p>The ALE inbound interface supports the following values for the functionName interaction specification property:</p> <p>WBIInteractionSpec.CREATE WBIInteractionSpec.UPDATE WBIInteractionSpec.RETRIEVE WBIInteractionSpec.DELETE</p> <p>The Query interface for SAP software (QISS) interface supports the following values for the functionName interaction specification property:</p> <ul style="list-style-type: none"> • WBIInteractionSpec.EXISTS Throws the exceptions NotExistsException and QISSQueryFailedException • WBIInteractionSpec.RETRIEVEALL Throws the exceptions QISSQueryFailedException <p>The Advanced event processing interface for inbound processing supports the following values for the functionName interaction specification property:</p> <p>WBIInteractionSpec.CREATE WBIInteractionSpec.UPDATE WBIInteractionSpec.DELETE</p> <p>The Advanced event processing interface for outbound processing supports the following values for the functionName interaction specification property:</p> <p>WBIInteractionSpec.CREATE WBIInteractionSpec.UPDATE WBIInteractionSpec.RETRIEVE WBIInteractionSpec.DELETE</p>
Globalized	No
Bidi supported	No

Ignore errors in BAPI return

This property indicates whether to ignore errors that are specified in a BAPI return operation. The return structure can be data or a table.

Table 177. Ignore errors in BAPI return details

Required	No
----------	----

Table 177. Ignore errors in BAPI return details (continued)

Possible values	True False
Default	False
Property type	Boolean
Usage	This property applies to BAPI outbound synchronous RFC processing only. When you set this property to True, the Adapter for SAP Software ignores the checking of error codes in the BAPI RETURN structure after BAPI has run, and returns this structure to the user as it is. The RETURN structure is part of every BAPI and contains the status of the BAPI execution. If you accept the default value of False, the Adapter for SAP Software processes the RETURN structure and throws an exception if an error code is found.
Globalized	No
Bidi supported	No

Maximum number of hits for the discovery

For the Query interface for SAP Software, this property specifies the maximum number of result sets, which represents data for each row that is retrieved from a table through a RetrieveAll operation.

Table 178. Result set limit details

Required	Yes
Default	100
Property type	Integer
Usage	This property applies to Query interface for SAP Software only. If the number of hits in the table on the SAP server exceeds the value of the ResultSetLimit property, the adapter returns the error: MatchesExceededLimitException. The adapter uses this property to help avoid out-of-memory issues.
Globalized	No
Bidi supported	No

Select the queue name

For BAPI outbound processing, when Asynchronous queued RFC is selected, this property specifies the name of a queue on the SAP server to which BAPIs will be delivered.

Table 179. Select the queue name details

Required	No
Default	The first queue defined on the SAP server. If no queue is defined on the SAP server, no default value exists.
Property type	String
Usage	This property applies to BAPI outbound asynchronous queued RFC processing only. When you want to deliver BAPI calls to a queue on the SAP server, you must specify the name of the queue. During configuration, you select an existing queue from a drop-down list. If no queues exist on the SAP server, you can type the name of a queue.

Table 179. Select the queue name details (continued)

Globalized	No
Bidi supported	No

WebSphere Adapter for Siebel properties

Reference information to refer to when you connect to a Siebel application.

- “Business object information”
- “Supported data operations”
- “Naming conventions for business objects representing Siebel business services” on page 1288
- “Adding external software dependencies for Siebel” on page 250
- “Configuration properties for the WebSphere Adapter for Siebel Business Applications” on page 1291
- “Siebel connection properties for the Adapter Connection wizard” on page 1291
- “Resource adapter properties” on page 1298
- “Managed connection factory properties” on page 1299
- “Activation specification properties” on page 1302

Business object information

A business object is a structure that contains application-specific information (metadata) about how the adapter should process the business object as well as the operation to be performed on the business object.

The name of the business object is generated by the Adapter Connection wizard in accordance with the naming convention for the adapter.

The Siebel business objects are created with long names by default. To generate business objects with shorter names, select **Generate business objects with shorter names** on the Configure Objects screen of the Adapter Connection wizard.

For more information about business objects, see the following topics.

- “Naming conventions for business objects representing Siebel business services” on page 1288
- “Supported data operations”

Supported data operations:

An operation is the action that an adapter can perform on the Siebel server during outbound processing. The name of the operation typically indicates the type of action that the adapter takes, such as create or update.

Table 180. Supported operations of business objects

Operation	Definition
Create	Creates the business component
Delete	Deletes the business component and its children
Exists	Checks for the existence of incoming business objects
Retrieve	Retrieves the values of the business component
Retrieve all	Retrieves multiple instances of the same business component

Table 180. Supported operations of business objects (continued)

Operation	Definition
Update	Updates the Siebel application with the incoming object

Naming conventions for business objects representing Siebel business services:

When the Adapter Connection wizard generates a business object, it provides a name for the business object based on the name of the object in the Siebel application that it uses to build the business object.

Naming conventions for business objects that represent Siebel business services and integration components

The naming conventions for business objects that represent Siebel business services are the same for both inbound and outbound processing. The names comprise the concatenation of several words, including prefix, business service name, integration object, and method name.

The following table describes the naming conventions that the Adapter Connection wizard uses to name business objects that represent Siebel business services and integration components.

Table 181. Business object naming conventions for Siebel business services and integration components

Element	Naming convention
Name of the business graph	<Top Level business object Name> + "BG" A "Prefix" is used only for top-level business objects that are generated against business service methods.
Name of the top-level business object	<Prefix><Business Service Name><Method Name><Names of all the integration objects selected for the Input and InputOutput complex type arguments> <ul style="list-style-type: none"> • If no Input or InputOutput arguments exist, the names of all the output arguments are: <Prefix><Business Service Name><Method Name><Names of all the integration objects selected for the output complex type arguments> • If the method contains no complex arguments in the method, the naming convention is: <Prefix><Business Service Name><Method Name>
Name of the inbound object that is generated against integration components	'IO' + <Name of Integration Object> + 'IC' + <Name of integration component> + 'BG' The top-level business graph has the suffix BG added to the business object name, as shown in this example: IOAccountInterfaceICAccountBG
Name of the outbound object that is generated against integration components	'IO' + <Name of Integration Object> + 'IC' + <Name of integration component> The name of an account interface integration object with the integration component account looks like this: IOAccountInterfaceICAccount

Optional: Shorter naming conventions for business objects that are generated against Siebel business services and integration components

The naming conventions for business objects that are generated against Siebel business services and integration components are valid if the optional property, 'Generate business objects with shorter names' is specified on the configuration objects pane in the Adapter Connection wizard.

If this optional property is used, you should set the 'Folder' property with a unique value to avoid overwriting existing xsds that were previously generated. For example, if you select 'EAI Siebel Adapter', and click **Query** in two different Adapter Connection wizard runs for the integration objects, 'Account (PRM ANI)' and 'ATP Check Interface', the top-level object is named EAISiebelAdapter.xsd.

The name comprises the concatenation of several words, including prefix, business service name, and integration component name.

The following table describes the naming conventions that the Adapter Connection wizard uses to name business objects that are generated against Siebel business services and integration components.

Table 182. Shorter business object naming conventions for business objects that are generated against Siebel business services and integration components

Element	Naming convention
Name of the inbound and outbound child business objects that are generated against integration components	<p><Prefix>+<Name of the Siebel Integration Component></p> <p>The Siebel business object and integration component names are stripped of all non-alphanumeric characters before being added to the business object name. If the resulting names are not unique, a counter is added to the end of the names.</p>
Name of the inbound top-level business object that is generated against business services and integration components	<p><Prefix>+<Name of the Siebel Integration Component> +BG (with business graph specified) and <Prefix>+<Name of the Siebel Integration Component> (without business graph specified)</p> <p>The Siebel business object and integration component names are stripped of all non-alphanumeric characters before being added to the business object name. If the resulting names are not unique, a counter is added to the end of the names.</p>
Name of the outbound top-level business object that is generated against business services and integration components	<p><Prefix>+<Name of the Siebel Business Service> +BG (with business graph specified) and <Prefix>+<Name of the Siebel Business Service> (without business graph specified)</p> <p>The Siebel business object and integration component names are stripped of all non-alphanumeric characters before being added to the business object name. If the resulting names are not unique, a counter is added to the end of the names.</p>

Naming conventions for business objects that represent Siebel business objects

The naming conventions for business objects that represent Siebel business objects are the same for both inbound and outbound processing. The name comprises the concatenation of several words, including prefix, business object name, and business component name.

The following table describes the naming conventions that are used by the Adapter Connection wizard to name business objects that represent Siebel business objects.

Table 183. Business object naming conventions for Siebel business objects

Element	Naming convention
Name of the business object	<p><Prefix>+<BO>+<Business Object Name>+<BC>+<Business Component Name>.</p> <p>The Siebel business object and component names are stripped of all non-alphanumeric characters before being added to the business object name. If the resulting names are not unique, a counter is added to the end of the names. For example, if two business objects have the name, SiebelBOAccountBCBusinessAddress, a counter is added as a suffix to make them unique, as shown in this example: SiebelBOAccountBCAddress1 and SiebelBOAccountBCAddress2</p>
Name of the container business object that is generated for the Exists operation	<p><SiebelExistsResult></p> <p>A business graph is not generated for the "SiebelExistsResult" business object.</p>
Name of the container business object that is generated for the Retrieve All operation	<p><Prefix>+BO+<Business Object Name>+<BC>+<Business Component Name>+Container</p>
Name of the top-level business object	<p><Prefix>+<BO>+<Business Object Name>+<BC>+<Business Component Name>+BG</p> <p>The top-level business object does have a business graph generated.</p>

Optional: Shorter naming conventions for business objects that are generated against Siebel business components

The naming conventions for business objects that are generated against Siebel business components are valid if the optional property, 'Generate business objects with shorter names' is specified on the configuration objects pane of the Adapter Connection wizard.

If this optional property is used, set the 'Folder' property with a unique value to avoid overwriting existing xsds that were previously generated. For example, Siebel business object -> Siebel business component combination of Account-ESP -> Account and Account (as the top-level object) is named Account.xsd.

The name comprises the concatenation of several words, including prefix and business component name.

The following table describes the naming conventions that the Adapter Connection wizard uses to name business objects that are generated against Siebel business components.

Table 184. Shorter business object naming conventions for business objects that are generated against Siebel business components

Element	Naming convention
Name of the top-level business object that is generated against business components	<p data-bbox="829 285 1430 405"><Prefix>+<Name of the Siebel Business Component> +BG (with business graph specified) and <Prefix>+<Name of the Siebel Business Component> (without business graph specified)</p> <p data-bbox="829 428 1455 569">The Siebel business object and integration component names are stripped of all non-alphanumeric characters before being added to the business object name. If the resulting names are not unique, a counter is added to the end of the names.</p>

Configuration properties for the WebSphere Adapter for Siebel Business Applications

WebSphere Adapter for Siebel Business Applications has several categories of configuration properties, which you set with the Adapter Connection wizard when you generate or create objects and services.

You can change the resource adapter, managed connection factory, and activation specification properties in WebSphere Message Broker.

For more information, see the following topics.

- “Siebel connection properties for the Adapter Connection wizard”
- “Resource adapter properties” on page 1298
- “Managed connection factory properties” on page 1299
- “Activation specification properties” on page 1302

Siebel connection properties for the Adapter Connection wizard:

Set Adapter Connection wizard properties to establish a connection between the wizard, a tool that is used to create business objects, and the Siebel server. The properties that you configure in the Adapter Connection wizard specify such things as connection configuration, and logging and tracing options.

After you have established a connection between the Adapter Connection wizard and the Siebel server, the Adapter Connection wizard is able to access the metadata that it needs from the Siebel server to create business objects.

Some of the properties that you set in the Adapter Connection wizard are used as the initial value for resource adapter, managed connection factory, and activation specification properties that you can specify at a later time in the wizard.

The following table describes the Adapter Connection wizard properties and their purpose. A complete description of each property is provided in the sections that follow the table.

If you set any of these connection properties using bidirectional script, you must set values that identify the format of the bidirectional script that is entered for that property.

Table 185. Adapter Connection wizard properties

Property name in the wizard	Description
Adapter style	The service type that is associated with the adapter module
Connection URL	The connection URL that you need to connect to the Siebel application
Delimiter for keys in the event store	Specifies that the delimiter that is used between two name value pairs contains the object key name and value
Folder	The location of the generated business object
Generate business objects with shorter names	Ensures that the adapter generates shorter business object names, which are based on the Siebel integration components, business services, and business components rather than the concatenation of several words (which is the default)
Language code	The language code that is used to log on to the Siebel server
Method name	The name of the business service method to be implemented
Password	The password for the corresponding user name
Prefix for business object names	The prefix for the business object name
Siebel repository name	The name of the Siebel repository from which the objects are to be discovered
Siebel server view mode	Specifies the Siebel server mode and controls the kind of data to be retrieved and what actions can be performed
Type of Siebel objects to discover	The type of Siebel objects (business objects or business services) that need to be discovered and listed
Use resonate support for load balancing on Siebel server	Specifies that if resonate support is installed on the Siebel server, and the value is set to True, the adapter takes advantage of the load balancing feature to connect to the Siebel server more efficiently
User name	The user name that is used to log into the Siebel application

Adapter style (AdapterStyle)

This property specifies the service type that is associated with the adapter module.

Table 186. Service type details

Required	Yes
Default	Outbound
Property type	List of values
Possible values	Outbound Inbound
Usage	Specifies the service type associated with the adapter module
Globalized	No
Bidi supported	No

Business object namespace (BusinessObjectNameSpace)

This property specifies that the namespace value has been added as a prefix to the business object name to keep the business object schemas separated.

Table 187. Business object namespace details

Required	Yes
Default	http://www.ibm.com/xmlns/prod/wbi/j2ca/siebel
Property type	String
Usage	The namespace value is added as a prefix to the business object name to keep the business object schemas separated.
Example	http://www.ibm.com/xmlns/prod/wbi/j2ca/siebel/IBMSiebelAccountInsertAccount
Globalized	No
Bidi supported	No

Connection URL (ConnectionURL)

This property specifies the connection URL that is needed to connect to the Siebel application.

Table 188. Connection URL details

Required	Yes
Default	No default value
Property type	String
Usage	The connection URLs for all versions of Siebel follow this format: Protocol://machinename:port/enterprisename/object manager/server name. . The default port number is 2320. For Siebel version 7.5x and earlier versions, the port number (2320) and server name are specified. For Siebel version 7.8, the port and server name are not specified. If you do not select the default port, then you can specify another port number (for example, 2321).
Examples	The following sample connection URLs are for different versions of Siebel: <ul style="list-style-type: none">• For Siebel 7.5: siebel://<IP_address>:2320/siebel/SSEObjMgr_ENU/sebldevl.• For Siebel 7.8: siebel://<IP_address>/Sieb78/SSEObjMgr_enu.• For Siebel 8: siebel://<IP_address>:2321/SBA_80/SSEObjMgr_enu.
Globalized	Yes
Bidi supported	Yes

Delimiter for keys in the event store (DelimiterForKeysInTheEventStore)

Table 189. Delimiter for keys in the event store details

Required	Yes
Default	;
Property type	String
Usage	This is the delimiter that is used between two name value pairs that contain the object key name and value.
Examples	You can change the default value for this property. However, if you remove the default value and do not set it again, the default value (;) is used. If the event table key field has values, such as AccountId=1-314:Id=1-325, the event delimiter is the colon (:). The object key names are AccountId and Id. The values are 1-314 and 1-325.
Globalized	Yes

Table 189. Delimiter for keys in the event store details (continued)

Bidi supported	Yes
----------------	-----

Folder (Folder)

This property specifies the location of the generated business objects.

Table 190. Folder details

Required	No
Default	No default value
Property type	String
Usage	The generated business objects are copied into this folder.
Example	inboundartifacts and outboundartifacts
Globalized	No
Bidi supported	No

**Generate business objects with shorter names
(GenerateBusinessObjectsWithShorterNames)**

This property ensures that the adapter generates shorter business object names, which are based on the Siebel integration components, business services, and business components rather than the concatenation of several words (which is the default).

Table 191. Generate business objects with shorter names details

Required	No
Default	No default value
Property type	Boolean
Usage	This property ensures that the adapter generates shorter business object names. The shorter business object names are based on the Siebel integration components, business services, and business components. The prefix is also attached to the shorter names. The adapter removes special characters from the shorter business object names. Alphanumeric characters (a-z, A-Z, and 1-9) are supported, and a counter (1-9) is added to the end of business object names to avoid duplication of names.
Example	If 'Account' is the name of the Siebel business component, and 'Siebel' is the prefix, the shorter name is 'Siebel_Account'.
Globalized	No
Bidi supported	No

Language code (LanguageCode)

This property specifies the language code that is used to log on to the Siebel server.

Table 192. Language code details

Required	Yes
Default	ENU
Property type	String

Table 192. Language code details (continued)

Usage	If the system locale is English, the value for this property is ENU (English). This is used to log on to the Siebel server.
Globalized	No
Bidi supported	No

Method name (MethodName)

This property specifies the name of the business service method to be implemented.

Table 193. Method name details

Required	Yes
Default	Query
Property type	String
Usage	The default is Query.
Example	Query, QueryByExample, QueryById, and so on.
Globalized	Yes
Bidi supported	Yes

Password (Password)

This property specifies the password for the corresponding user name.

Table 194. Password details

Required	Yes
Default	No default value
Property type	String
Usage	If a J2C Authentication Alias is used, then a password is not required.
Example	1-XYZ
Globalized	Yes
Bidi supported	Yes

Prefix for business object names (PrefixForBusinessObjectNames)

This property specifies the prefix for the business object name.

Table 195. Prefix details

Required	No
Default	No default value
Property type	String
Usage	The prefix string is attached to the front of the business object name that was generated.

Table 195. Prefix details (continued)

Example	For example, you use the prefix, IBM, and generate a business object for the EAI Siebel Adapter and the Insert method. Then you choose the Account Interface and Business Address Interface integration object against an Input and InputOutput method argument. The corresponding business object that is generated is: IBMEAISiebelAdapterInsertAccountInterfacBusinessAddressInterface .
Globalized	Yes
Bidi supported	Yes

Siebel business object name for event store (SiebelBusinessObjectNameForEventStore)

This property specifies the name of the business object in the event store where events are stored for inbound processing.

Table 196. Siebel business object name for event store details

Required	Yes
Default	IBM_EVENT
Property type	String
Usage	After you click Advanced on the connection properties pane of the Adapter Connection wizard, this property displays on the Event configuration tab. The two values that are listed are IBM_EVENT and IBM2. If you create a custom event component name, you can specify the value for it in the list box.
Globalized	Yes
Bidi supported	No

Siebel repository name (SiebelRepositoryName)

This property specifies the name of the Siebel repository from which the objects are discovered.

Table 197. Siebel repository name details

Required	Yes
Default	Siebel repository
Property type	String
Usage	This default value is Siebel Repository. Although this is a required field, it is optional on the Adapter Connection wizard. You can edit this value to point to other repositories if needed.
Globalized	No
Bidi supported	No

Siebel server view mode (SiebelServerViewMode)

This property specifies the Siebel server view mode and controls the data that can be retrieved and what actions can be performed on it.

Table 198. Siebel server view mode details

Required	Yes
----------	-----

Table 198. Siebel server view mode details (continued)

Default	3
Property type	Integer
Usage	This property displays when you click Advanced on the connection properties pane of the Adapter Connection wizard. This mode, when set to "Type of Siebel objects to discover" applies only to Siebel business objects, not to Siebel business services. The values that are supported by Siebel are 1 to 9.
Globalized	No

Type of Siebel objects to discover (TypeOfSiebelObjectsToDiscover)

This property specifies the type of Siebel object that needs to be discovered and listed.

Table 199. Type of Siebel objects to discover details

Required	Yes
Possible values	Siebel business objects and Siebel business services
Default	Siebel business objects
Property type	String
Usage	Although the default is Siebel business objects, you can select Siebel business services. Based on your selection, the Adapter Connection wizard retrieves either the business objects or the business services.
Globalized	No
Bidi supported	No

Use resonate support for load balancing on Siebel server (UseResonateSupportForLoadBalancingOnSiebelServer)

This property indicates whether the Siebel server uses resonate support.

Table 200. Use resonate support for load balancing on Siebel server details

Required	No
Possible values	True False
Default	True
Property type	Boolean
Usage	This property displays after you click Advanced on the connection properties pane of the Adapter Connection wizard. If you select the check box, the property is set to True and the adapter takes advantage of the load balancing feature to connect to the Siebel server more efficiently. If you clear the check box, the property is set to False.
Globalized	No

User name (UserName)

This property specifies the user name that is used to log into the Siebel application.

Table 201. User name details

Required	Yes
Default	No default value

Table 201. User name details (continued)

Property type	String
Usage	If a J2C Authentication Alias is used, then a user name is not required.
Globalized	Yes
Bidi supported	Yes

Resource adapter properties:

The resource adapter properties control the general operation of the adapter. You set the resource adapter properties using the Adapter Connection wizard when you configure the adapter.

The following table lists and describes the resource adapter properties. A more detailed description of each property is provided in the sections that follow the table.

Table 202. Resource adapter properties

Property name	Description
Adapter ID property	The adapter instance for CEI and PMI events with respect to logging and tracing.
Event delimiter	Specifies whether the delimiter that is used between two name value pairs contains the object key name and value
Resonate support	Specifies that if resonate support is installed on the Siebel server, and the value is set to True, the adapter takes advantage of the load balancing feature to connect to the Siebel server more efficiently
Siebel server view mode	Specifies the Siebel view mode and controls the kind of data to be retrieved and what actions can be performed

Adapter ID to use for logging and tracing (AdapterID)

This property identifies a specific deployment, or instance, of the adapter.

Table 203. Adapter ID to use for logging and tracing details

Required	Yes
Default	CWYMY_Adapter Without local transaction support: CWYAP_SAPAdapter With local transaction support: CWYAP_SAPAdapter_Tx
Property type	String
Usage	Use this property to identify the adapter instance for PMI events. If you are deploying multiple instances of an adapter, set this property to a unique value for each adapter instance. For inbound processing, this property is retrieved from the resource adapter properties. For outbound processing, it is retrieved from the managed connection factory properties.
Globalized	Yes
Bidi supported	No

Event delimiter (EventDelimiter)

This property indicates that the delimiter that is used between two name value pairs contains the object key name and value.

Table 204. Event delimiter details

Required	Yes
Default	;
Property type	String
Usage	If multiple value pairs are set against the object key in the event component, they are used for the delimiter.
Globalized	No

Resonate support (ResonateSupport)

This property indicates whether the Siebel server uses resonate support.

Table 205. Resonate support details

Required	No
Possible values	True False
Default	True
Property type	Boolean
Usage	If you select the check box, the value for Resonate Support is set to True, and the adapter takes advantage of the load balancing feature to connect to the Siebel server more efficiently. If you clear the check box, the value for Resonate Support is set to False.
Globalized	No

Siebel server view mode (SiebelServerViewMode)

This property specifies the Siebel view mode and controls the data that can be retrieved and what actions can be performed on it.

Table 206. View mode details

Required	Yes
Default	3
Property type	Integer
Usage	The View mode property applies only to Siebel business objects and not to Siebel business services.
Globalized	No

Managed connection factory properties:

The adapter uses managed connection factory properties at run time to create an outbound connection instance with the Siebel application.

Use the Adapter Connection wizard to set the managed connection factory properties.

The following table lists the managed connection factory properties for inbound communication. A complete description of each property is provided in the sections that follow the table.

Table 207. Managed connection factory properties

Property name	Description
Connection URL	The connection URL that is needed to connect to the Siebel application
Language code	The language code that is used to log on to the Siebel server
Password	The password for the corresponding user name
Prefix	The prefix for the business object name
Resonate support	Specifies that if resonate support is installed on the Siebel server, and the value is set to True, the adapter takes advantage of the load balancing feature to connect to the Siebel server more efficiently
User name	The user name that is used to log into the Siebel application
View mode	Specifies the Siebel view mode and controls the data that can be retrieved and what actions can be performed on it

Connection URL (ConnectionURL)

This property specifies the connection URL that is needed to connect to the Siebel application.

Table 208. Connection URL details

Required	Yes
Default	No default value
Property type	String
Usage	Protocol://machinename:port/enterprisename/object manager/server name For Siebel 7.0.5 to 7.5x : siebel://<IP ADDRESS>/siebel/SSEObjMgr_ENU/sebldev1 For Siebel 7.8 : siebel://<IP ADDRESS>:2321/Sieb78/SSEObjMgr_enu For Siebel 8 : siebel://<IP ADDRESS>:2321/SBA_80/SSEObjMgr_enu The default port number is 2320. In the examples above (for Siebel versions 7.8 and 8) another port (2321) has been specified.
Globalized	Yes
Bidi supported	Yes

Language code (LanguageCode)

This property specifies the language code that is used to log on to the Siebel server.

Table 209. Language code details

Required	Yes
Possible values	None
Default	ENU

Table 209. Language code details (continued)

Property type	String
Usage	If the system locale is English, the value for this property is ENU (English). This value is used to log on to the Siebel server.
Globalized	No
Bidi supported	No

Password (Password)

This property specifies the password for the corresponding user name.

Table 210. Password details

Required	Yes
Default	No default value
Property type	String
Example	sadmin
Usage	This property displays after you click Advanced on the connection properties pane of the external service wizard. The password is saved in .import and .export files so that the adapter can connect to the Siebel application after it has been deployed. If a J2C Authentication Alias is used, a password is not required.
Globalized	Yes
Bidi supported	Yes

Prefix (Prefix)

This property specifies the prefix for the business object name.

Table 211. Prefix details

Required	No
Default	No default value
Property type	String
Usage	The prefix string is attached to the front of the business object name.
Example	If you use the prefix IBM, generate a business object for the EAI Siebel Adapter and the Insert method, and choose the integration object, Account (PRM ANI), the corresponding business object generated is: IBMEAISiebelAdapterInsertAccountU40PRMANIU41 where U40 and U41 are the unicode value replacements of (and).
Globalized	Yes
Bidi supported	Yes

Resonate support (ResonateSupport)

This property indicates whether the Siebel server uses resonate support.

Table 212. Resonate support details

Required	No
----------	----

Table 212. Resonate support details (continued)

Possible values	True False
Default	True
Property type	Boolean
Usage	If you select the check box, the property is set to True, and the adapter takes advantage of the load balancing feature to connect to the Siebel server more efficiently. If you clear the check box, the property is set to False.
Globalized	No

User name (UserName)

This property specifies the user name that is used to log into the Siebel application.

Table 213. User name details

Required	Yes
Possible values	None
Default	No default value
Property type	String
Usage	This property displays after you click Advanced on the connection properties pane of the Adapter Connection wizard. The user name is saved in .import and .export files so that the adapter can connect to the Siebel application after it has been deployed. If a J2C Authentication Alias is used, a password is not required.
Globalized	Yes
Bidi supported	Yes

View mode (ViewMode)

This property specifies the Siebel view mode and controls the data that can be retrieved and what actions can be performed on it.

Table 214. View mode details

Required	Yes
Default	Although the adapter supports values 1 to 9, the default value is 3.
Property type	Integer
Usage	The View mode property applies only to Siebel business objects and not to Siebel business services. When this property is used for Siebel business objects, the default value is 3.
Example	The adapter supports values 1 to 9. For example, 1 is Manager View, 2 is Personal View, and 3 is All View.
Globalized	No

Activation specification properties:

Activation specification properties hold the inbound event processing configuration information for a message endpoint. Use the Adapter Connection wizard to set activation specification properties.

Activation specification properties are used during endpoint activation to notify the adapter of eligible event listeners. During inbound processing, the adapter uses these event listeners to receive events before it forwards them to the endpoint.

The following table lists the activation specification properties for inbound processing that you set using the Adapter Connection wizard. A more detailed description of each property is provided in the sections that follow the table.

Table 215. Activation specification properties

Property name	Description
Connection URL	The connection URL that is needed to connect to the Siebel application
Delivery type	Determines the order in which events are delivered by the adapter to the export
Do not process events that have a timestamp in the future	Specifies whether the adapter filters out future events by comparing the timestamp on each event with the system time
Ensure once-only event delivery	Specifies whether the adapter provides assured once delivery of events
Event component name	The name of the Siebel component for the event table
Event types to process	A delimited list of event types that indicates to the adapter which events it should deliver
Interval between polling periods	The length of time that the adapter waits between polling periods
Language code	The language code that is used to log on to the Siebel server
Maximum connections	The maximum number of connections that the adapter can use for inbound event delivery
Maximum events in polling period	The number of events that the adapter delivers to the export during each poll period
Minimum connections	The minimum number of connections that the adapter can use for inbound event delivery
Number of times to retry the system connection	The number of times that the adapter tries to re-establish an inbound connection after an error occurs.
Password	The password for the corresponding user name
Retry interval	The length of time that the adapter waits between attempts to establish a new connection after an error occurs during inbound operations
Stop the adapter when an error is encountered while polling	Specifies whether the adapter stops polling for events when it encounters an error during polling.
User name	The user name that is used to log on to the Siebel application

Connection URL (ConnectionURL)

This property specifies the connection URL that is needed to connect to the Siebel application.

Table 216. Connection URL details

Required	Yes
Default	No default value

Table 216. Connection URL details (continued)

Property type	String
Usage	Protocol://machinename:port/enterprisename/object manager/server name For Siebel 7.0.5 to 7.5x : siebel://<IP ADDRESS>/siebel/SSEObjMgr_ENU/sebldev1 For Siebel 7.8 : siebel://<IP ADDRESS>:2321/Sieb78/SSEObjMgr_enu For Siebel 8 : siebel://<IP ADDRESS>:2321/SBA_80/SSEObjMgr_enu The default port number is 2320. In the examples above (for Siebel versions 7.8 and 8), another port (2321) has been specified.
Globalized	Yes
Bidi supported	Yes

Delivery type (DeliveryType)

This property specifies the order in which events are delivered by the adapter to the export.

Table 217. Delivery type details

Required	No
Possible values	ORDERED UNORDERED
Default	ORDERED
Property type	String
Usage	The following values are supported: <ul style="list-style-type: none"> • ORDERED: The adapter delivers events to the export one at a time. • UNORDERED: The adapter delivers all events to the export at once.
Globalized	No
Bidi supported	No

Do not process events that have a timestamp in the future (FilterFutureEvents)

This property specifies whether the adapter filters out future events by comparing the timestamp on each event with the system time.

Table 218. Do not process events that have a timestamp in the future details

Required	Yes
Possible values	True False
Default	False
Property type	Boolean
Usage	If set to True, the adapter compares the time of each event to the system time. If the event time is later than the system time, the event is not be delivered. If set to False, the adapter delivers all events.
Globalized	No
Bidi supported	No

Ensure once-only event delivery (AssuredOnceDelivery)

This property specifies whether to provide ensured once-only event delivery for inbound events.

Table 219. Ensure once-only event delivery details

Required	Yes
Possible values	True False
Default	True
Property type	Boolean
Usage	<p>When this property is set to True, the adapter provides assured once event delivery. This means that each event will be delivered once and only once. A value of False does not provide assured once event delivery, but provides better performance.</p> <p>When this property is set to True, the adapter attempts to store transaction (XID) information in the event store. If it is set to False, the adapter does not attempt to store the information.</p> <p>This property is used only if the export component is transactional. If it is not, no transaction can be used, regardless of the value of this property.</p>
Globalized	No
Bidi supported	No

Event component name (EventComponentName)

This property specifies the name of the event store where events are stored for inbound processing.

Table 220. Event component name details

Required	Yes
Default	IBM2 (for Siebel version 7.x) and IBM Event (for Siebel version 8)
Property type	String
Usage	<p>The default value is IBM2 for Siebel version 7.x, and IBM Event for Siebel version 8. If you select one of these default values to configure the event business component on the Siebel server, it is the name of the Siebel event business component that was created. You can also select a value from the list of values provided by the adapter. You can edit the list of values. If you create your own Siebel event business component, you can edit the list to include the name of that event business component.</p>
Globalized	Yes
Bidi supported	Yes

Event types to process (EventTypeFilter)

This property contains a delimited list of event types that indicates to the adapter which events it should deliver.

Table 221. Event types to process details

Required	No
Possible values	A comma-delimited (,) list of business object types
Default	null
Property type	String

Table 221. Event types to process details (continued)

Usage	Events are filtered by business object type. If the property is set, the adapter delivers only those events that are in the list. A value of null indicates that no filter will be applied and that all events will be delivered to the export.
Example	To receive only events that relate to the Customer and Order business objects, specify this value: Customer,Order
Globalized	No
Bidi supported	No

Interval between polling periods (PollPeriod)

This property specifies the length of time that the adapter waits between polling periods.

Table 222. Interval between polling periods details

Required	Yes
Possible values	Integers greater than or equal to 0.
Default	2000
Unit of measure	Milliseconds
Property type	Integer
Usage	The poll period is established at a fixed rate, which means that if running the poll cycle is delayed for any reason (for example, if a prior poll cycle takes longer than expected to complete) the next poll cycle occurs immediately to make up for the lost time that was caused by the delay.
Globalized	No
Bidi supported	No

Language code (LanguageCode)

This property specifies the language code that is used to log on to the Siebel server.

Table 223. Language code details

Required	Yes
Default	ENU
Property type	String
Usage	If the system locale is English, the value for this property is ENU (English), which is used to log on to the Siebel server.
Globalized	No
Bidi supported	No

Maximum connections (MaximumConnections)

This property specifies the maximum number of connections that the adapter can use for inbound event delivery.

Table 224. Maximum connections details

Required	No
Default	1
Property type	Integer
Usage	Only positive values are valid. The adapter considers any positive entry less than 1 to be equal to 1. Typing a negative value or 1 for this property may result in run time errors.
Globalized	No
Bidi supported	No

Maximum events in polling period (PollQuantity)

This property specifies the number of events that the adapter delivers to the export during each poll period.

Table 225. Maximum events in polling period details

Required	Yes
Default	10
Property type	Integer
Usage	The value must be greater than 0. If this value is increased, more events are processed per polling period, and the adapter might perform less efficiently. If this value is decreased, less events are processed per polling period, and the adapter's performance might improve slightly.
Globalized	No
Bidi supported	No

Minimum connections (MinimumConnections)

This property specifies the minimum number of connections that the adapter can use for inbound event delivery.

Table 226. Minimum connections details

Required	No
Default	1
Property type	Integer
Usage	Only positive values are valid. Any value less than 1 is treated as 1 by the adapter. Typing a negative value or 1 for this property may result in run time errors.
Globalized	No
Bidi supported	No

Number of times to retry the system connection (RetryLimit)

This property specifies the number of times that the adapter tries to re-establish an inbound connection.

Table 227. Number of times to retry the system connection details

Required	No
Possible values	Positive integers
Default	0

Table 227. Number of times to retry the system connection details (continued)

Property type	Integer
Usage	Only positive values are valid. When the adapter encounters an error that is related to the inbound connection, this property specifies the number of times that the adapter tries to restart the connection. A value of 0 indicates an infinite number of retries.
Globalized	Yes
Bidi supported	No

Password (Password)

This property specifies the password for the corresponding user name.

Table 228. Password details

Required	Yes
Default	No default value
Property type	String
Usage	This property displays after you click Advanced on the connection properties pane of the Adapter Connection wizard. The password is saved in .import and .export files so that the adapter can connect to the Siebel application after it has been deployed. If a J2C Authentication Alias is used, a password is not required.
Example	sadmin
Globalized	Yes
Bidi supported	Yes

Retry interval if connection fails (RetryInterval)

When the adapter encounters an error that is related to the inbound connection, this property specifies the length of time that the adapter waits before trying to establish a new connection.

Table 229. Retry interval details

Required	Yes
Default	2000
Unit of measure	Milliseconds
Property type	Integer
Usage	Only positive values are valid. When the adapter encounters an error that is related to the inbound connection, this property specifies the length of time that the adapter waits before trying to establish a new connection.
Globalized	Yes
Bidi supported	No

Stop the adapter when an error is encountered while polling (StopPollingOnError)

This property specifies whether the adapter stops polling for events when it encounters an error during polling.

Table 230. Stop the adapter when an error is encountered while polling details

Required	No
Possible values	True False
Default	False
Property type	Boolean
Usage	If this property is set to True, the adapter stops polling when it encounters an error. If this property is set to False, the adapter logs an exception when it encounters an error during polling and continues polling.
Globalized	No
Bidi supported	No

User name (UserName)

This property specifies the user name that is used to log into the Siebel application.

Table 231. User name details

Required	Yes
Default	No default value
Property type	String
Usage	This property displays after you click Advanced on the connection properties pane of the Adapter Connection wizard. The user name is saved in .import and .export files so that the adapter can connect to the Siebel application after it has been deployed. If a J2C Authentication Alias is used, a password is not required.
Globalized	Yes
Bidi supported	Yes

WebSphere Adapter for PeopleSoft properties

Reference information to refer to when you connect to a PeopleSoft application.

- “Business object information”
- “Supported operations” on page 1310
- “PeopleCode for a custom event project” on page 1311
- “Configuration properties for the WebSphere Adapter for PeopleSoft Enterprise” on page 1315
- “PeopleSoft connection properties for the Adapter Connection wizard” on page 1315
- “Resource adapter properties” on page 1318
- “Managed connection factory properties” on page 1320
- “Activation specification properties” on page 1323
- “Interaction specification properties” on page 1328

Business object information

Information about the content of a business object is located primarily inside the business object definition file, a file that is generated by the Adapter Connection wizard when it creates business objects.

The business object definition file contains application-specific information (ASI), which the adapter uses to perform operations, such as creating or updating. You can also find information about the content of a business object in the name of the business object. Although business object names have no semantic value, they often contain clues about what the business object contains and what operation it allows the adapter to perform on the PeopleSoft Enterprise server. For example, a business object named UpdateAddress is probably going to allow the adapter to update an address in the PeopleSoft Enterprise server.

For more information, see “Supported operations.”

Supported operations:

An operation is the action that an adapter can perform on the PeopleSoft Enterprise server during outbound processing. The name of the operation typically indicates the type of action that the adapter takes, such as create or update.

The following table defines the operations that the adapter supports.

Table 232. Supported operations of business objects

Operation	Definition
Create	The adapter accesses the PeopleSoft component and retrieves values from the attributes that have the primary key application-specific information set. The adapter then instantiates the corresponding component interface using the value that is provided for the ObjectName application-specific information. It sets the attribute values on the corresponding Create Keys in the component interface. An empty Component Interface is created, and the adapter maps all the business object data to the created component interface. When mapping the data, the adapter sends all data for simple attributes in the hierarchy, and it creates items that match each of the child objects in the hierarchy, including effective-dated and effective-sequenced child records.
Retrieve	The adapter accesses the PeopleSoft component and retrieves values from the attributes that have the primary key application-specific information set. The adapter then instantiates the corresponding component interface using the value that is provided for the ObjectName application-specific information. It sets the attribute values on the corresponding Get Keys in the component interface. The adapter then maps the component data onto the business object hierarchy. Child objects are included in the data mapping.
RetrieveAll	This operation performs in the same way as the Retrieve operation, except that it allows retrieval of multiple instances of the same PeopleSoft component.
Update	The adapter retrieves an object from PeopleSoft and compares it to the target business object. When the comparison reveals extra child objects in PeopleSoft, the adapter deletes children. When the comparison reveals missing children in PeopleSoft, the adapter creates children. When the comparison reveals child objects that have been updated in PeopleSoft, the adapter updates them.
Exists	The adapter processes an exist operation in the same way that it processes a retrieve operation, except that it does not populate the business object with retrieved data; it checks for the existence of an object in PeopleSoft.
Delete	Based on the values that are set for the application-specific metadata elements StatusColumnName and StatusValue, the adapter updates a business object to inactive. A delete operation can be performed only on a top level object. PeopleSoft does not allow an object to be physically deleted, so the inactive object remains in the PeopleSoft database.
Apply Changes	This operation updates the PeopleSoft component based on the operation that was performed on it. The supported operations are create, update, and delete.

PeopleCode for a custom event project

Two PeopleCode functions are required to support inbound processing. If you create a custom event project in PeopleTools for inbound support, add the PeopleCode functions to the project.

The following PeopleCode contains the IBMPublishEvent and IBMPublishFutureDatedEvent functions that are used to publish events to the event table. Calls to these functions are made from the SavePostChange PeopleCode function in the PeopleSoft component of interest.

```
/* IBM event notification */
Component string &KEYSTRING;
Component string &KEYNAME;
Component array of string &KEYARRAY;
Component string &KEYDELIM;
Component string &IBMVERB;
Local Record &IBMREC;

Function IBMPublishFutureDatedEvent(&BO, &KEYS, &EFFDATE)
; /* == create a new record object for cw_event_tbl == */
  &IBMREC = CreateRecord(Record.IBM_EVENT_TBL);
  /* ===== KEYS ===== */
  /* composing keys and values in name value format */
  &KEYSTRING = "";
  &KEYDELIM = ";";
  &KEYARRAY = Split(&KEYS, &KEYDELIM);
  &LEN = &KEYARRAY.Len;
  For &I = 1 To &LEN;
  /* get keys and values */
  /* get rid of record name */
    &POS1 = Find(".", &KEYARRAY [&I]);
    &L1 = Len(&KEYARRAY [&I]);
    &POS2 = &L1 - &POS1;
    &KEYNAME = Right(&KEYARRAY [&I], &POS2);
  /*****The code below will remove special characters and****/
  /*****adjust the characters' case to ensure it is same as the*****/
  /*****attribute name in the business object definition****/
  /*****Start****/
    &lLen = Len(&KEYNAME);
    &sOrigString = &KEYNAME;
    &sNewString = "";
    &lCtr2 = 1;
    &isSpecialChar = "true";
    For &lCtr = 1 To &lLen;
      &sChar = Substring(&sOrigString, &lCtr, 1);
      If (&sChar = "A" Or
          &sChar = "a" Or
          &sChar = "B" Or
          &sChar = "b" Or
          &sChar = "C" Or
          &sChar = "c" Or
          &sChar = "D" Or
          &sChar = "d" Or
          &sChar = "E" Or
          &sChar = "e" Or
          &sChar = "F" Or
          &sChar = "f" Or
          &sChar = "G" Or
          &sChar = "g" Or
          &sChar = "H" Or
          &sChar = "h" Or
          &sChar = "I" Or
          &sChar = "i" Or
          &sChar = "J" Or
          &sChar = "j" Or
          &sChar = "K" Or
          &sChar = "k" Or
          &sChar = "L" Or
          &sChar = "l" Or
          &sChar = "M" Or
          &sChar = "m" Or
          &sChar = "N" Or
          &sChar = "n" Or
          &sChar = "O" Or
          &sChar = "o" Or
          &sChar = "P" Or
          &sChar = "p" Or
          &sChar = "Q" Or
          &sChar = "q" Or
          &sChar = "R" Or
          &sChar = "r" Or
          &sChar = "S" Or
          &sChar = "s" Or
          &sChar = "T" Or
          &sChar = "t" Or
          &sChar = "U" Or
```

```

        &sChar = "u" Or
        &sChar = "v" Or
        &sChar = "y" Or
        &sChar = "w" Or
        &sChar = "w" Or
        &sChar = "x" Or
        &sChar = "x" Or
        &sChar = "y" Or
        &sChar = "y" Or
        &sChar = "z" Or
        &sChar = "z" Or
        &sChar = "1" Or
        &sChar = "2" Or
        &sChar = "3" Or
        &sChar = "4" Or
        &sChar = "5" Or
        &sChar = "6" Or
        &sChar = "7" Or
        &sChar = "8" Or
        &sChar = "9" Or
        &sChar = "0") Then
    If (&isSpecialChar = "true") Then
        &sNewString = &sNewString | Upper(&sChar);
        &isSpecialChar = "false";
    Else
        &sNewString = &sNewString | Lower(&sChar);
    End-If;
Else
    &isSpecialChar = "true";
End-If;
End-For;
&KEYNAME = &sNewString;
/*****End*****/
&KEYSTRING = &KEYSTRING | &KEYNAME | "=" | @&KEYARRAY [&I] | &KEYDELIM
End-For;
&KEYSTRING = RTrim(&KEYSTRING, ".");
&IBMREC.IBM_OBJECT_KEYS.Value = &KEYSTRING;
/***** VERB *****/
/* verb determination uses variable &IBMVERB */
Evaluate %Mode
When = "A"
    &IBMVERB = "Create";
    Break;
When = "U"
    &IBMVERB = "Update";
    Break;
When = "L"
    &IBMVERB = "Update";
    Break;
When = "C"
    &IBMVERB = "Update";
    Break;
When-Other
    &IBMVERB = "Retrieve";
End-Evaluate;
&IBMREC.IBM_OBJECT_VERB.Value = &IBMVERB;
/* ===== EVENT_ID GEN ===== */
/* create event_id */
&NEWNUM = GetNextNumber(IBM_FETCH_ID.IBM_NEXT_EVENT_ID, 99999);
/* only use newnum if no error generating next number */
If &NEWNUM > 0 Then
    &IBMREC.IBM_EVENT_ID.Value = &NEWNUM;
Else
    &IBMREC.IBM_EVENT_ID.Value = %Datetime;
End-If; /*Support for Future Effective Date - The adapter will poll such events when the date arrives*/
If &EFFDATE > %Datetime Then
    &IBMREC.IBM_EVENT_DTTM.Value = &EFFDATE;
    &IBMREC.IBM_EVENT_STATUS.Value = "99";
Else
    &IBMREC.IBM_EVENT_DTTM.Value = %Datetime;
    &IBMREC.IBM_EVENT_STATUS.Value = "0";
End-If; /*===== INSERT EVENT INTO IBM_EVENT_TBL =====*/
/* insert row into table using record object*/
&IBMREC.IBM_OBJECT_NAME.Value = &BO;
&IBMREC.Insert();
End-Function;
Function IBMPublishEvent(&BO, &KEYS);
    /* == create a new record object for cw_event_tbl == */
    &IBMREC = CreateRecord(Record.IBM_EVENT_TBL);

    /* ===== KEYS ===== */
    /* composing keys and values in name value format */
    &KEYSTRING = "";
    &KEYDELIM = ":";
    &KEYARRAY = Split(&KEYS, &KEYDELIM);

```



```

&LEN = &KEYARRAY.Len;

For &I = 1 To &LEN;
  /* get keys and values */
  /* get rid of record name */
  &POS1 = Find(".", &KEYARRAY [&I]);
  &L1 = Len(&KEYARRAY [&I]);
  &POS2 = &L1 - &POS1;
  &KEYNAME = Right(&KEYARRAY [&I], &POS2);

  /*****The code below will remove special characters and
  /*****adjust the characters' case to ensure it is same as the
  /*****attribute name in the business object definition****/
  /*****Start****/
  &lLen = Len(&KEYNAME);
  &sOrigString = &KEYNAME;
  &sNewString = "";
  &lCtr2 = 1;
  &isSpecialChar = "true";
  For &lCtr = 1 To &lLen;
    &sChar = Substring(&sOrigString, &lCtr, 1);
    If (&sChar = "A" Or
        &sChar = "a" Or
        &sChar = "B" Or
        &sChar = "b" Or
        &sChar = "C" Or
        &sChar = "c" Or
        &sChar = "D" Or
        &sChar = "d" Or
        &sChar = "E" Or
        &sChar = "e" Or
        &sChar = "F" Or
        &sChar = "f" Or
        &sChar = "G" Or
        &sChar = "g" Or
        &sChar = "H" Or
        &sChar = "h" Or
        &sChar = "I" Or
        &sChar = "i" Or
        &sChar = "J" Or
        &sChar = "j" Or
        &sChar = "K" Or
        &sChar = "k" Or
        &sChar = "L" Or
        &sChar = "l" Or
        &sChar = "M" Or
        &sChar = "m" Or
        &sChar = "N" Or
        &sChar = "n" Or
        &sChar = "O" Or
        &sChar = "o" Or
        &sChar = "P" Or
        &sChar = "p" Or
        &sChar = "Q" Or
        &sChar = "q" Or
        &sChar = "R" Or
        &sChar = "r" Or
        &sChar = "S" Or
        &sChar = "s" Or
        &sChar = "T" Or
        &sChar = "t" Or
        &sChar = "U" Or
        &sChar = "u" Or
        &sChar = "V" Or

```

```

        &sChar = "v" Or
        &sChar = "W" Or
        &sChar = "w" Or
        &sChar = "X" Or
        &sChar = "x" Or
        &sChar = "Y" Or
        &sChar = "y" Or
        &sChar = "Z" Or
        &sChar = "z" Or
        &sChar = "1" Or
        &sChar = "2" Or
        &sChar = "3" Or
        &sChar = "4" Or
        &sChar = "5" Or
        &sChar = "6" Or
        &sChar = "7" Or
        &sChar = "8" Or
        &sChar = "9" Or
        &sChar = "0") Then
    If (&isSpecialChar = "true") Then
        &sNewString = &sNewString | Upper(&sChar);
        &isSpecialChar = "false";
    Else
        &sNewString = &sNewString | Lower(&sChar);
    End-If;
Else
    &isSpecialChar = "true";
End-If;
End-For;
&KEYNAME = &sNewString;

    /*****End*****/
    &KEYSTRING = &KEYSTRING | &KEYNAME | "=" | @&KEYARRAY [&I] | &KEYDELIM
End-For;
&KEYSTRING = RTrim(&KEYSTRING, ":");

&IBMREC.IBM_OBJECT_KEYS.Value = &KEYSTRING;

/*===== VERB =====*/
/* verb determination uses variable &IBMVERB */
Evaluate %Mode
When = "A"
    &IBMVERB = "Create";
    Break;
When = "U"
    &IBMVERB = "Update";
    Break;
When = "L"
    &IBMVERB = "Update";
    Break;
When = "C"
    &IBMVERB = "Update";
    Break;
When-Other
    &IBMVERB = "Retrieve";
End-Evaluate;

&IBMREC.IBM_OBJECT_VERB.Value = &IBMVERB;

/* ===== EVENT_ID GEN ===== */
/* create event_id */

&NEWNUM = GetNextNumber(IBM_FETCH_ID.IBM_NEXT_EVENT_ID, 99999);

```

```

/* only use newnum if no error generating next number */

If &NEWNUM > 0 Then
    &IBMREC.IBM_EVENT_ID.Value = &NEWNUM;
Else
    &IBMREC.IBM_EVENT_ID.Value = %Datetime;
End-If;

&IBMREC.IBM_EVENT_DTTM.Value = %Datetime;

/* ===== EVENT_STATUS =====*/
/* Validate and set event status &IBMSTATUS - list values if date is ok*/
&IBMREC.IBM_EVENT_STATUS.Value = "0";

/*===== INSERT EVENT INTO IBM_EVENT_TBL =====*/
/* insert row into table using record object*/

&IBMREC.IBM_OBJECT_NAME.Value = &B0;

&IBMREC.Insert();

End-Function;

```

Configuration properties for the WebSphere Adapter for PeopleSoft Enterprise

WebSphere Adapter for PeopleSoft Enterprise has several categories of configuration properties, which you set with the Adapter Connection wizard when it generates or creates objects and services.

You can change the resource adapter, managed connection factory, and activation specification properties in WebSphere Message Broker.

For more information, see the following topics.

- “PeopleSoft connection properties for the Adapter Connection wizard”
- “Resource adapter properties” on page 1318
- “Managed connection factory properties” on page 1320
- “Activation specification properties” on page 1323
- “Interaction specification properties” on page 1328

PeopleSoft connection properties for the Adapter Connection wizard:

Connection properties for the Adapter Connection wizard are used to establish a connection between the Adapter Connection wizard and the application from which the wizard obtains metadata. These properties specify such things as connection configuration, and logging options.

If you set any of these connection properties using bidirectional script, you must set values that identify the format of the bidirectional script entered for that property.

The connection properties and their purpose are described in the following table. A complete description of each property is provided in the sections that follow the table.

Table 233. Connection properties

Property name	Description
"Component interface jar file"	The PeopleSoft Enterprise component interface that the adapter uses to establish a connection to the PeopleSoft components that are targets of integration transactions
"Host name "	The name or address of the server that hosts PeopleSoft Enterprise
"Password " on page 1317	The password of the user account of the adapter on the PeopleSoft Enterprise server
"Port number" on page 1317	The port number at which PeopleSoft Enterprise is configured to listen for client requests.
"Prefix for business object names" on page 1317	A prefix to be added to generated business objects
"User name" on page 1317	The name of the user account that the adapter uses on the PeopleSoft Enterprise server

Component interface jar file

This property specifies the PeopleSoft Enterprise component interface that the adapter uses to establish a connection to the PeopleSoft components that are targets of integration transactions.

Table 234. Component interface jar file details

Required	Yes
Default	No default
Property type	String
Usage	The name of the JAR file that the adapter uses to connect to the PeopleSoft Enterprise components of interest
Example	CWYES_PeopleSoft\connectorModule\WbiEvent.jar
Globalized	No
Bidi supported	No

Host name

This property specifies the name or address of the server that hosts PeopleSoft Enterprise.

Table 235. Host name details

Required	Yes
Default	No default value
Property type	String
Usage	Identifies the server, either by name or IP address, that hosts PeopleSoft Enterprise
Example	9.26.248.202
Globalized	No
Bidi supported	No

Password

This property specifies the password of the user account of the adapter on the PeopleSoft Enterprise server.

Table 236. Password details

Required	Yes
Default	No default value
Property type	String
Usage	The restrictions (case, length, and character) are determined by the PeopleSoft Enterprise version.
Globalized	Yes
Bidi supported	Yes

Port number

This property specifies the port number at which PeopleSoft Enterprise is configured to listen for client requests.

Table 237. Port number details

Required	Yes
Default	The port number that is entered when you run the Adapter Connection wizard
Property type	Integer
Example	9000
Globalized	No
Bidi supported	No

Prefix for business object names

This property specifies a prefix to be added to generated business objects.

Table 238. Prefix details

Required	No
Default	No default
Property type	String
Usage	Use this property to distinguish between different business objects that are generated against the same PeopleSoft component interface.
Example	If you use IB as a prefix, all business objects that are generated by this service are named using this prefix.
Globalized	Yes
Bidi supported	No

User name

This property specifies the name of the user account that the adapter uses on the PeopleSoft Enterprise server.

Table 239. User name details

Required	Yes
Default	No default value
Property type	String
Usage	The restrictions (case, length, and character) are determined by the PeopleSoft Enterprise version.
Example	DV1
Globalized	Yes
Bidi supported	Yes

Resource adapter properties:

The resource adapter properties control the general operation of the adapter, such as specifying the namespace for business objects. You set the resource adapter properties using the Adapter Connection wizard when you configure the adapter.

The following table lists the resource adapter properties and their purpose. A complete description of each property is provided in the sections that follow the table.

Table 240. Resource adapter properties for the Adapter for PeopleSoft Enterprise

Property	Description
Adapter ID to use for logging and tracing	The adapter instance for CEI and PMI events with respect to logging and tracing.
LogFileMaxSize	Supported for compatibility with earlier versions
LogFilename	Supported for compatibility with earlier versions
LogNumberOfFiles	Supported for compatibility with earlier versions
TraceFileMaxSize	Supported for compatibility with earlier versions
TraceFileName	Supported for compatibility with earlier versions
TraceNumberOfFiles	Supported for compatibility with earlier versions

Adapter ID to use for logging and tracing (AdapterID)

This property identifies a specific deployment, or instance, of the adapter.

Table 241. Adapter ID to use for logging and tracing details

Required	Yes
Default	CWYMY_Adapter Without local transaction support: CWYAP_SAPAdapter With local transaction support: CWYAP_SAPAdapter_Tx
Property type	String
Usage	Use this property to identify the adapter instance for PMI events. If you are deploying multiple instances of an adapter, set this property to a unique value for each adapter instance. For inbound processing, this property is retrieved from the resource adapter properties. For outbound processing, it is retrieved from the managed connection factory properties.
Globalized	Yes
Bidi supported	No

Log file maximum size (LogFileMaxSize)

This property specifies the size of the log files in kilobytes.

Table 242. Log file maximum size details

Required	No
Default	0
Property type	Integer
Usage	When the log file reaches its maximum size, the adapter starts to use a new log file. If the file size is specified as 0, or no maximum size is specified, the file does not have a maximum size.
Globalized	Yes
Bidi supported	No

Log file name (LogFilename)

This property specifies the full path name of the log file.

Table 243. Log file name details

Required	No
Default	No default value
Property type	String
Usage	This property is deprecated.
Globalized	Yes
Bidi supported	Yes

Log number of files (LogNumberOfFiles)

This property specifies the number of log files.

Table 244. Log number of files details

Required	No
Default	1
Property type	Integer
Usage	When a log file reaches its maximum size, the adapter starts to use another log file. If no value is specified, the adapter creates a single log file.
Globalized	Yes
Bidi supported	No

Trace file maximum size (TraceFileMaxSize)

This property specifies the size of the trace files in kilobytes.

Table 245. Trace file maximum size details

Required	No
Default	0
Property type	Integer
Usage	If no value is specified, the trace file has no maximum size.

Table 245. Trace file maximum size details (continued)

Globalized	Yes
Bidi supported	No

Trace file name (TraceFilename)

This property specifies the full path of the trace file.

Table 246. Trace file name details

Required	No
Default	No default value
Unit of measure	Kilobytes
Property type	String
Usage	This property is deprecated.
Globalized	Yes
Bidi supported	Yes

Trace number of files (TraceNumberOfFiles)

This property specifies the number of trace files to use. When a trace file reaches its maximum size, the adapter starts to use another trace file.

Table 247. Trace number of files details

Required	No
Default	1
Property type	Integer
Usage	If no value is specified, the adapter uses a single trace file.
Globalized	Yes
Bidi supported	No

Managed connection factory properties:

The adapter uses managed connection factory properties at run time to create an outbound connection instance with the PeopleSoft Enterprise server.

The following table lists and describes the managed connection factory properties for outbound communication. You set the managed connection factory properties using the Adapter Connection wizard.

A more detailed description of each property is provided in the sections that follow the table.

Table 248. Managed connection factory properties

Property	Description
Component interface for testing failed connection	The component interface that the adapter uses to validate a connection to the PeopleSoft Enterprise server
Host name	The name or address of the server that hosts PeopleSoft Enterprise

Table 248. Managed connection factory properties (continued)

Property	Description
“Language (Language)”	The language code that the adapter uses to log on to the PeopleSoft Enterprise server
“Password (Password)” on page 1322	The password of the user account of the adapter on the PeopleSoft Enterprise server
“Port number (Port)” on page 1322	The port number that the adapter uses to access the PeopleSoft Enterprise server
“User name (UserName)” on page 1322	The name of the user account that the adapter uses on the PeopleSoft Enterprise server

Component interface for testing failed connection (PingCompInterface)

This property specifies the name of the PeopleSoft Enterprise component interface that the adapter uses to validate a connection to the PeopleSoft Enterprise server.

Table 249. Component interface for testing failed connection details

Required	Yes
Default	The name of the first component interface in the list
Property type	String
Usage	Specify a component interface name that already exists within your PeopleSoft Enterprise applications.
Example	WBI_CUSTOMER_CI
Globalized	No
Bidi supported	No

Host name (HostName)

This property specifies the name or address of the server that hosts PeopleSoft Enterprise.

Table 250. Host name details

Required	Yes
Default	No default value
Property type	String
Usage	Identifies, either by name or IP address, the server that hosts PeopleSoft Enterprise
Example	9.26.248.202
Globalized	No
Bidi supported	No

Language (Language)

This property specifies the language code that the adapter uses to log on to the PeopleSoft Enterprise server.

Table 251. Language details

Required	Yes
Default	The default value for the Language property is based on the system locale.

Table 251. Language details (continued)

Property type	String
Usage	Each of the supported languages is preceded by a three-character language code. The language itself is presented in parentheses.
Example	If the system locale is English, the value for this property is ENG (English).
Globalized	No
Bidi supported	No

Password (Password)

This property specifies the password of the user account of the adapter on the PeopleSoft Enterprise server.

Table 252. Password details

Required	Yes
Default	No default value
Property type	String
Usage	The restrictions (case, length, and character) are determined by the PeopleSoft Enterprise version.
Globalized	No
Bidi supported	No

Port number (Port)

This property specifies the port number that the adapter uses to access the PeopleSoft Enterprise server.

Table 253. Port number details

Required	Yes
Default	The port number that is entered when you use the Adapter Connection wizard to discover objects and services
Property type	Integer
Example	9000
Globalized	No
Bidi supported	No

User name (UserName)

This property specifies the name of the user account that the adapter uses on the PeopleSoft Enterprise server.

Table 254. User name details

Required	Yes
Default	No default value
Property type	String
Usage	The restrictions (case, length, and character) are determined by the PeopleSoft Enterprise version.

Table 254. User name details (continued)

Example	DV1
Globalized	No
Bidi supported	No

Activation specification properties:

Activation specification properties hold the inbound event processing configuration information for an export. You set activation specification properties using the Adapter Connection wizard.

The following table lists the activation specification properties for inbound communication. A more detailed description of each property is provided in the sections that follow the table.

Table 255. Activation specification properties

Property name	Purpose
AssuredOnceDelivery	Specifies whether the adapter provides assured once delivery of events
PingCompIntfc	The component interface that the adapter uses to validate a connection to the PeopleSoft Enterprise server
EventCIName	The component interface that the adapter uses for event notification
DeliveryType	Determines the order in which events are delivered by the adapter to the export
EventKeyDelimiter	The name and value for an object key in the event table
EventTypeFilter	A delimited list of event types that indicates to the adapter which events it should deliver
DateFormat	The format that is used to create the event timestamp
MaximumConnections	The maximum number of connections that the adapter can use for inbound event delivery
MinimumConnections	The minimum number of connections that the adapter can use for inbound event delivery
PollPeriod	The length of time that the adapter waits between polling periods
PollQuantity	The number of events that the adapter delivers to the export during each poll period
RetryInterval	The length of time that the adapter waits between attempts to establish a new connection after an error occurs during inbound operations
RetryLimit	The number of times that the adapter tries to re-establish an inbound connection after an error occurs.
StopPollingOnError	Specifies whether the adapter stops polling for events when it encounters an error during polling.

Ensure once-only event delivery (AssuredOnceDelivery)

This property specifies whether to provide ensured once-only event delivery for inbound events.

Table 256. Ensure once-only event delivery details

Required	Yes
----------	-----

Table 256. Ensure once-only event delivery details (continued)

Possible values	True False
Default	True
Property type	Boolean
Usage	<p>When this property is set to True, the adapter provides assured once event delivery. This means that each event will be delivered once and only once. A value of False does not provide assured once event delivery, but provides better performance.</p> <p>When this property is set to True, the adapter attempts to store transaction (XID) information in the event store. If it is set to False, the adapter does not attempt to store the information.</p> <p>This property is used only if the export component is transactional. If it is not, no transaction can be used, regardless of the value of this property.</p>
Globalized	No
Bidi supported	No

Component interface for testing failed connection (PingCompInterface)

This property specifies the name of the PeopleSoft Enterprise component interface that the adapter uses to validate a connection to the PeopleSoft Enterprise server.

Table 257. Component interface for testing failed connection details

Row	Explanation
Required	Yes
Default	The name of the first component interface in the list
Property type	String
Usage	The name of the component interface that the adapter uses to test connectivity to the PeopleSoft Enterprise server. Specify a component interface name that already exists in your PeopleSoft Enterprise applications.
Globalized	No
Bidi supported	No

Component interface name for event notification (EventCIName)

This property specifies the name of the PeopleSoft Enterprise component interface that the adapter uses to for inbound processing.

Table 258. Component interface name for event notification details

Row	Explanation
Required	Yes
Default	IBM_EVENT_CI
Property type	String
Usage	The name of the component interface that the adapter uses for inbound processing. To use inbound processing, create a component interface specifically for event notification in PeopleSoft Enterprise.
Globalized	No
Bidi supported	No

Delivery type (DeliveryType)

This property specifies the order in which events are delivered by the adapter to the export.

Table 259. Delivery type details

Required	No
Possible values	ORDERED UNORDERED
Default	ORDERED
Property type	String
Usage	The following values are supported: <ul style="list-style-type: none">• ORDERED: The adapter delivers events to the export one at a time.• UNORDERED: The adapter delivers all events to the export at once.
Globalized	No
Bidi supported	No

Delimiter for keys in the event store (EventKeyDelimiter)

This property specifies the delimiter for the object key name-value pair in the event table.

Table 260. Delimiter for keys in the event store details

Row	Explanation
Required	No
Default	=:
Property type	String
Usage	Use this property to specify an object name and value to be used as an object key in the event store.
Example	CustomerID=2001
Globalized	No
Bidi supported	No

Event types to process (EventTypeFilter)

This property contains a delimited list of event types that indicates to the adapter which events it should deliver.

Table 261. Event types to process details

Required	No
Possible values	A comma-delimited (,) list of business object types
Default	null
Property type	String
Usage	Events are filtered by business object type. If the property is set, the adapter delivers only those events that are in the list. A value of null indicates that no filter will be applied and that all events will be delivered to the export.

Table 261. Event types to process details (continued)

Example	To receive only events that relate to the Customer and Order business objects, specify this value: Customer,Order
Globalized	No
Bidi supported	No

Java date format for event timestamp (DateFormat)

This property specifies the format that is used for the event timestamp.

Table 262. Java date format for event timestamp details

Row	Explanation
Required	Yes
Default	MM/dd/yy
Property type	String
Usage	This property is used to format the date values from the PeopleSoft Enterprise server.
Globalized	No
Bidi supported	No

Maximum connections (MaximumConnections)

This property specifies the maximum number of connections that the adapter can use for inbound event delivery.

Table 263. Maximum connections details

Required	No
Default	1
Property type	Integer
Usage	Only positive values are valid. The adapter considers any positive entry less than 1 to be equal to 1. Typing a negative value or 1 for this property may result in run time errors.
Globalized	No
Bidi supported	No

Minimum connections (MinimumConnections)

This property specifies the minimum number of connections that the adapter can use for inbound event delivery.

Table 264. Minimum connections details

Required	No
Default	1
Property type	Integer
Usage	Only positive values are valid. Any value less than 1 is treated as 1 by the adapter. Typing a negative value or 1 for this property may result in run time errors.
Globalized	No

Table 264. Minimum connections details (continued)

Bidi supported	No
----------------	----

Interval between polling periods (PollPeriod)

This property specifies the length of time that the adapter waits between polling periods.

Table 265. Interval between polling periods details

Required	Yes
Possible values	Integers greater than or equal to 0.
Default	2000
Unit of measure	Milliseconds
Property type	Integer
Usage	The poll period is established at a fixed rate, which means that if running the poll cycle is delayed for any reason (for example, if a prior poll cycle takes longer than expected to complete) the next poll cycle occurs immediately to make up for the lost time that was caused by the delay.
Globalized	No
Bidi supported	No

Maximum events in polling period (PollQuantity)

This property specifies the number of events that the adapter delivers to the export during each poll period.

Table 266. Maximum events in polling period details

Required	Yes
Default	10
Property type	Integer
Usage	The value must be greater than 0. If this value is increased, more events are processed per polling period, and the adapter might perform less efficiently. If this value is decreased, less events are processed per polling period, and the adapter's performance might improve slightly.
Globalized	No
Bidi supported	No

Retry interval if connection fails (RetryInterval)

When the adapter encounters an error that is related to the inbound connection, this property specifies the length of time that the adapter waits before trying to establish a new connection.

Table 267. Retry interval details

Required	Yes
Default	2000
Unit of measure	Milliseconds
Property type	Integer

Table 267. Retry interval details (continued)

Usage	Only positive values are valid. When the adapter encounters an error that is related to the inbound connection, this property specifies the length of time that the adapter waits before trying to establish a new connection.
Globalized	Yes
Bidi supported	No

Number of times to retry the system connection (RetryLimit)

This property specifies the number of times that the adapter tries to re-establish an inbound connection.

Table 268. Number of times to retry the system connection details

Required	No
Possible values	Positive integers
Default	0
Property type	Integer
Usage	Only positive values are valid. When the adapter encounters an error that is related to the inbound connection, this property specifies the number of times that the adapter tries to restart the connection. A value of 0 indicates an infinite number of retries.
Globalized	Yes
Bidi supported	No

Stop the adapter when an error is encountered while polling (StopPollingOnError)

This property specifies whether the adapter stops polling for events when it encounters an error during polling.

Table 269. Stop the adapter when an error is encountered while polling details

Required	No
Possible values	True False
Default	False
Property type	Boolean
Usage	If this property is set to True, the adapter stops polling when it encounters an error. If this property is set to False, the adapter logs an exception when it encounters an error during polling and continues polling.
Globalized	No
Bidi supported	No

Interaction specification properties:

Interaction specification properties control the interaction for an operation. The Adapter Connection wizard sets the interaction specification properties when you configure the adapter.

Typically, you do not need to change these properties. However, you can change some properties for outbound operations. For example, you might increase the value of the interaction specification property that specifies the maximum number of records to be returned by a RetrieveAll operation, if your RetrieveAll operations do not return complete information.

The following table lists and describes the interaction specification property that you set.

Table 270. Interaction specification property for the Adapter for PeopleSoft Enterprise

Property name	Description
Maximum number of records for RetrieveAll operation	The maximum number of records to return during a RetrieveAll operation

Maximum number of records for RetrieveAll operation (MaxRecords)

This property specifies the maximum number of records to return during a RetrieveAll operation.

Table 271. Maximum number of records for RetrieveAll operation details

Required	Yes
Default	100
Usage	If the number of hits in PeopleSoft Enterprise exceeds the value of the Maximum number of records for the RetrieveAll operation property, the adapter returns an error. The adapter uses this property to help avoid out-of-memory issues.
Property type	Integer
Globalized	No
Bidi supported	No

Supported code pages

Application messages must conform to supported code pages.

The message flows that you create, configure, and deploy to a broker can process and construct application messages in any code page that is listed in the table. You can also generate a new code page converter.

This behavior might be affected by the use of other products with WebSphere Message Broker. Check the documentation for other products, including any databases that you use, for further code page support information.

If you experience code page translation problems on HP-UX, check the WebSphere MQ queue manager attribute *CodedCharSetID* (CCSID). The default value for this attribute is 1051. Change this to 819 for queue managers that host WebSphere Message Broker components.

For detailed information about Chinese code page GB18030 support, see “Chinese code page GB18030” on page 1357.

By default, WebSphere Message Broker supports the code pages that are given in the following tables. To find a code page for a specific CCSID, search for an internal converter name in the form *ibm-ccsid*, where *ccsid* is the CCSID for which you are looking.

- Unicode converters
- European and American language converters
- Asian language converters
- Windows US and European converters
- MAC-related converters
- Hebrew, Cyrillic and ECMA language converters
- Indian language converters
- EBCDIC converters

Unicode converters

Internal converter name	Aliases
UTF-8	UTF-8 ibm-1208 ibm-1209 ibm-5304 ibm-5305 windows-65001 cp1208
UTF-16	UTF-16 ISO-10646-UCS-2 unicode csUnicode ucs-2
UTF-16BE	UTF-16BE x-utf-16be ibm-1200 ibm-1201 ibm-5297 ibm-13488 ibm-17584 windows-1201 cp1200 cp1201 UTF16_BigEndian
UTF-16LE	UTF-16LE x-utf-16le ibm-1202 ibm-13490 ibm-17586 UTF16_LittleEndian windows-1200
UTF-32	UTF-32 ISO-10646-UCS-4 csUCS4 ucs-4

Internal converter name	Aliases
UTF-32BE	UTF-32BE UTF32_BigEndian ibm-1232 ibm-1233
UTF-32LE	UTF-32LE UTF32_LittleEndian ibm-1234
UTF16_PlatformEndian	UTF16_PlatformEndian
UTF16_OppositeEndian	UTF16_OppositeEndian
UTF32_PlatformEndian	UTF32_PlatformEndian
UTF32_OppositeEndian	UTF32_OppositeEndian
UTF-7	UTF-7 windows-65000
IMAP-mailbox-name	IMAP-mailbox-name
SCSU	SCSU
BOCU-1	BOCU-1 csBOCU-1
CESU-8	CESU-8

European and American language converters

Internal converter name	Aliases
ISO-8859-1	ISO-8859-1 ibm-819 IBM819 cp819 latin1 8859_1 csISOLatin1 iso-ir-100 ISO_8859-1:1987 11 819

Internal converter name	Aliases
US-ASCII	US-ASCII ASCII ANSI_X3.4-1968 ANSI_X3.4-1986 ISO_646.irv:1991 iso_646.irv:1983 ISO646-US us csASCII iso-ir-6 cp367 ascii7 646 windows-20127
gb18030	gb18030 ibm-1392 windows-54936
ibm-367_P100-1995	ibm-367_P100-1995 ibm-367 IBM367
ibm-912_P100-1995	ibm-912_P100-1995 ibm-912 iso-8859-2 ISO_8859-2:1987 latin2 csISOLatin2 iso-ir-101 l2 8859_2 cp912 912 windows-28592
ibm-913_P100-2000	ibm-913_P100-2000 ibm-913 iso-8859-3 ISO_8859-3:1988 latin3 csISOLatin3 iso-ir-109 l3 8859_3 cp913 913 windows-28593

Internal converter name	Aliases
ibm-914_P100-1995	ibm-914_P100-1995 ibm-914 iso-8859-4 latin4 csISOLatin4 iso-ir-110 ISO_8859-4:1988 l4 8859_4 cp914 914 windows-28594
ibm-915_P100-1995	ibm-915_P100-1995 ibm-915 iso-8859-5 cyrillic csISOLatinCyrillic iso-ir-144 ISO_8859-5:1988 8859_5 cp915 915 windows-28595
ibm-1089_P100-1995	ibm-1089_P100-1995 ibm-1089 iso-8859-6 arabic csISOLatinArabic iso-ir-127 ISO_8859-6:1987 ECMA-114 ASMO-708 8859_6 cp1089 1089 windows-28596 ISO-8859-6-I ISO-8859-6-E

Internal converter name	Aliases
ibm-813_P100-1995	ibm-813_P100-1995 ibm-813 iso-8859-7 greek greek8 ELOT_928 ECMA-118 csISOLatinGreek iso-ir-126 ISO_8859-7:1987 8859_7 cp813 813 windows-28597
ibm-916_P100-1995	ibm-916_P100-1995 ibm-916 iso-8859-8 hebrew csISOLatinHebrew iso-ir-138 ISO_8859-8:1988 ISO-8859-8-I ISO-8859-8-E 8859_8 cp916 916 windows-28598
ibm-920_P100-1995	ibm-920_P100-1995 ibm-920 iso-8859-9 latin5 csISOLatin5 iso-ir-148 ISO_8859-9:1989 l5 8859_9 cp920 920 windows-28599 ECMA-128
ibm-921_P100-1995	ibm-921_P100-1995 ibm-921 iso-8859-13 8859_13 cp921 921

Internal converter name	Aliases
ibm-923_P100-1998	ibm-923_P100-1998 ibm-923 iso-8859-15 Latin-9 l9 8859_15 latin0 csisolatin0 csisolatin9 iso8859_15_fdis cp923 923 windows-28605

Asian language converters

Internal converter name	Aliases
ibm-942_P12A-1999	ibm-942_P12A-1999 ibm-942 ibm-932 cp932 shift_jis78 sjis78 ibm-942_VSUB_VPUA ibm-932_VSUB_VPUA
ibm-943_P15A-2003	ibm-943_P15A-2003 ibm-943 Shift_JIS MS_Kanji csShiftJIS windows-31j csWindows31J x-sjis x-ms-cp932 cp932 windows-932 cp943c IBM-943C ms932 pck sjis ibm-943_VSUB_VPUA

Internal converter name	Aliases
ibm-943_P130-1999	ibm-943_P130-1999 ibm-943 Shift_JIS cp943 943 ibm-943_VASCII_VSUB_VPUA
ibm-33722_P12A-1999	ibm-33722_P12A-1999 ibm-33722 ibm-5050 EUC-JP Extended_UNIX_Code_Packed_Format_for_Japanese csEUCPkdFmtJapanese X-EUC-JP eucjis windows-51932 ibm-33722_VPUA IBM-eucJP
ibm-33722_P120-1999	ibm-33722_P120-1999 ibm-33722 ibm-5050 cp33722 33722 ibm-33722_VASCII_VPUA
ibm-954_P101-2000	ibm-954_P101-2000 ibm-954 EUC-JP
ibm-1373_P100-2002	ibm-1373_P100-2002 ibm-1373 windows-950
windows-950-2000	windows-950-2000 Big5 csBig5 windows-950 x-big5
ibm-950_P110-1999	ibm-950_P110-1999 ibm-950 cp950 950
macos-2566-10.2	macos-2566-10.2 Big5-HKSCS big5hk HKSCS-BIG5

Internal converter name	Aliases
ibm-1375_P100-2003	ibm-1375_P100-2003 ibm-1375 Big5-HKSCS
ibm-1386_P100-2002	ibm-1386_P100-2002 ibm-1386 cp1386 windows-936 ibm-1386_VSUB_VPUA
windows-936-2000	windows-936-2000 GBK CP936 MS936 windows-936
ibm-1383_P110-1999	ibm-1383_P110-1999 ibm-1383 GB2312 csGB2312 EUC-CN ibm-eucCN hp15CN cp1383 1383 ibm-1383_VPUA
ibm-5478_P100-1995	ibm-5478_P100-1995 ibm-5478 GB_2312-80 chinese iso-ir-58 csISO58GB231280 gb2312-1980 GB2312.1980-0
ibm-964_P110-1999	ibm-964_P110-1999 ibm-964 EUC-TW ibm-eucTW cns11643 cp964 964 ibm-964_VPUA
ibm-949_P110-1999	ibm-949_P110-1999 ibm-949 cp949 949 ibm-949_VASCII_VSUB_VPUA

Internal converter name	Aliases
ibm-949_P11A-1999	ibm-949_P11A-1999 ibm-949 cp949c ibm-949_VSUB_VPUA
ibm-970_P110-1995	ibm-970_P110-1995 ibm-970 EUC-KR KS_C_5601-1987 windows-51949 csEUCKR ibm-eucKR KSC_5601 5601 ibm-970_VPUA
ibm-971_P100-1995	ibm-971_P100-1995 ibm-971 ibm-971_VPUA
ibm-1363_P11B-1998	ibm-1363_P11B-1998 ibm-1363 KS_C_5601-1987 KS_C_5601-1989 KSC_5601 csKSC56011987 korean iso-ir-149 5601 cp1363 ksc windows-949 ibm-1363_VSUB_VPUA
ibm-1363_P110-1997	ibm-1363_P110-1997 ibm-1363 ibm-1363_VASCII_VSUB_VPUA
windows-949-2000	windows-949-2000 windows-949 KS_C_5601-1987 KS_C_5601-1989 KSC_5601 csKSC56011987 korean iso-ir-149 ms949
ibm-1162_P100-1999	ibm-1162_P100-1999 ibm-1162

Internal converter name	Aliases
ibm-874_P100-1995	ibm-874_P100-1995 ibm-874 ibm-9066 cp874 TIS-620 tis620.2533 eucTH cp9066
windows-874-2000	windows-874-2000 TIS-620 windows-874 MS874

Windows US and European converters

Internal converter name	Aliases
ibm-437_P100-1995	ibm-437_P100-1995 ibm-437 IBM437 cp437 437 csPC8CodePage437 windows-437
ibm-850_P100-1995	ibm-850_P100-1995 ibm-850 IBM850 cp850 850 csPC850Multilingual windows-850
ibm-851_P100-1995	ibm-851_P100-1995 ibm-851 IBM851 cp851 851 csPC851
ibm-852_P100-1995	ibm-852_P100-1995 ibm-852 IBM852 cp852 852 csPCp852 windows-852

Internal converter name	Aliases
ibm-855_P100-1995	ibm-855_P100-1995 ibm-855 IBM855 cp855 855 csIBM855 csPCp855
ibm-856_P100-1995	ibm-856_P100-1995 ibm-856 cp856 856
ibm-857_P100-1995	ibm-857_P100-1995 ibm-857 IBM857 cp857 857 csIBM857 windows-857
ibm-858_P100-1997	ibm-858_P100-1997 ibm-858 IBM00858 CCSID00858 CP00858 PC-Multilingual-850+euro cp858
ibm-860_P100-1995	ibm-860_P100-1995 ibm-860 IBM860 cp860 860 csIBM860
ibm-861_P100-1995	ibm-861_P100-1995 ibm-861 IBM861 cp861 861 cp-is csIBM861 windows-861

Internal converter name	Aliases
ibm-862_P100-1995	ibm-862_P100-1995 ibm-862 IBM862 cp862 862 csPC862LatinHebrew DOS-862 windows-862
ibm-863_P100-1995	ibm-863_P100-1995 ibm-863 IBM863 cp863 863 csIBM863
ibm-864_X110-1999	ibm-864_X110-1999 ibm-864 IBM864 cp864 csIBM864
ibm-865_P100-1995	ibm-865_P100-1995 ibm-865 IBM865 cp865 865 csIBM865
ibm-866_P100-1995	ibm-866_P100-1995 ibm-866 IBM866 cp866 866 csIBM866 windows-866
ibm-867_P100-1998	ibm-867_P100-1998 ibm-867 cp867
ibm-868_P100-1995	ibm-868_P100-1995 ibm-868 IBM868 cp868 868 csIBM868 cp-ar

Internal converter name	Aliases
ibm-869_P100-1995	ibm-869_P100-1995 ibm-869 IBM869 cp869 869 cp-gr csIBM869 windows-869
ibm-878_P100-1996	ibm-878_P100-1996 ibm-878 KOI8-R koi8 csKOI8R cp878
ibm-901_P100-1999	ibm-901_P100-1999 ibm-901_P100-1999 ibm-901
ibm-902_P100-1999	ibm-902_P100-1999 ibm-902
ibm-922_P100-1999	ibm-922_P100-1999 ibm-922 cp922 922
ibm-4909_P100-1999	ibm-4909_P100-1999 ibm-4909
ibm-5346_P100-1998	ibm-5346_P100-1998 ibm-5346 windows-1250 cp1250
ibm-5347_P100-1998	ibm-5347_P100-1998 ibm-5347 windows-1251 cp1251
ibm-5348_P100-1997	ibm-5348_P100-1997 ibm-5348 windows-1252 cp1252
ibm-5349_P100-1998	ibm-5349_P100-1998 ibm-5349 windows-1253 cp1253

Internal converter name	Aliases
ibm-5350_P100-1998	ibm-5350_P100-1998 ibm-5350 windows-1254 cp1254
ibm-9447_P100-2002	ibm-9447_P100-2002 ibm-9447 windows-1255 cp1255
windows-1256-2000	windows-1256-2000 windows-1256 cp1256
ibm-9449_P100-2002	ibm-9449_P100-2002 ibm-9449 windows-1257 cp1257
ibm-5354_P100-1998	ibm-5354_P100-1998 ibm-5354 windows-1258 cp1258
ibm-1250_P100-1995	ibm-1250_P100-1995 ibm-1250 windows-1250
ibm-1251_P100-1995	ibm-1251_P100-1995 ibm-1251 windows-1251
ibm-1252_P100-2000	ibm-1252_P100-2000 ibm-1252 windows-1252
ibm-1253_P100-1995	ibm-1253_P100-1995 ibm-1253 windows-1253
ibm-1254_P100-1995	ibm-1254_P100-1995 ibm-1254 windows-1254
ibm-1255_P100-1995	ibm-1255_P100-1995 ibm-1255
ibm-5351_P100-1998	ibm-5351_P100-1998 ibm-5351 windows-1255
ibm-1256_P110-1997	ibm-1256_P110-1997 ibm-1256

Internal converter name	Aliases
ibm-5352_P100-1998	ibm-5352_P100-1998 ibm-5352 windows-1256
ibm-1257_P100-1995	ibm-1257_P100-1995 ibm-1257
ibm-5353_P100-1998	ibm-5353_P100-1998 ibm-5353 windows-1257
ibm-1258_P100-1997	ibm-1258_P100-1997 ibm-1258 windows-1258

MAC-related converters

Internal converter name	Aliases
macos-0_2-10.2	macos-0_2-10.2 macintosh mac csMacintosh windows-10000
macos-6-10.2	macos-6-10.2 x-mac-greek windows-10006 macgr
macos-7_3-10.2	macos-7_3-10.2 x-mac-cyrillic windows-10007 maccy
macos-29-10.2	macos-29-10.2 x-mac-centraleurroman windows-10029 x-mac-ce macce
macos-35-10.2	macos-35-10.2 x-mac-turkish windows-10081 mactr
ibm-1051_P100-1995	ibm-1051_P100-1995 ibm-1051 hp-roman8 roman8 r8 csHPRoman8

Internal converter name	Aliases
ibm-1276_P100-1995	ibm-1276_P100-1995 ibm-1276 Adobe-Standard-Encoding csAdobeStandardEncoding
ibm-1277_P100-1995	ibm-1277_P100-1995 ibm-1277 Adobe-Latin1-Encoding

Hebrew, Cyrillic, and ECMA language converters

Internal converter name	Aliases
ibm-1006_P100-1995	ibm-1006_P100-1995 ibm-1006 cp1006 1006
ibm-1098_P100-1995	ibm-1098_P100-1995 ibm-1098 cp1098 1098
ibm-1124_P100-1996	ibm-1124_P100-1996 ibm-1124 cp1124 1124
ibm-1125_P100-1997	ibm-1125_P100-1997 ibm-1125 cp1125
ibm-1129_P100-1997	ibm-1129_P100-1997 ibm-1129
ibm-1131_P100-1997	ibm-1131_P100-1997 ibm-1131 cp1131
ibm-1133_P100-1997	ibm-1133_P100-1997 ibm-1133
ibm-1381_P110-1999	ibm-1381_P110-1999 ibm-1381 cp1381 1381
ISO_2022,locale=ja,version=0	ISO_2022,locale=ja,version=0 ISO-2022-JP csISO2022JP

Internal converter name	Aliases
ISO_2022,locale=ja,version=1	ISO_2022,locale=ja,version=1 ISO-2022-JP-1 JIS JIS_Encoding
ISO_2022,locale=ja,version=2	ISO_2022,locale=ja,version=2 ISO-2022-JP-2 csISO2022JP2
ISO_2022,locale=ja,version=3	ISO_2022,locale=ja,version=3 JIS7 csJISEncoding
ISO_2022,locale=ja,version=4	ISO_2022,locale=ja,version=4 JIS8
ISO_2022,locale=ko,version=0	ISO_2022,locale=ko,version=0 ISO-2022-KR csISO2022KR
ISO_2022,locale=ko,version=1	ISO_2022,locale=ko,version=1 ibm-25546
ISO_2022,locale=zh,version=0	ISO_2022,locale=zh,version=0 ISO-2022-CN
ISO_2022,locale=zh,version=1	ISO_2022,locale=zh,version=1 ISO-2022-CN-EXT
HZ	HZ HZ-GB-2312
ibm-897_P100-1995	ibm-897_P100-1995 ibm-897 JIS_X0201 X0201 csHalfWidthKatakana

Indian language converters

Internal converter name	Aliases
ISCII,version=0 ISCII,version=0	x-iscii-de windows-57002 iscii-dev
ISCII,version=1 ISCII,version=1	x-iscii-be windows-57003 iscii-bng windows-57006 x-iscii-as

Internal converter name	Aliases
ISCII,version=2 ISCII,version=2	x-iscii-pa windows-57011 iscii-gur
ISCII,version=3 ISCII,version=3	x-iscii-gu windows-57010 iscii-guj
ISCII,version=4 ISCII,version=4	x-iscii-or windows-57007 iscii-ori
ISCII,version=5 ISCII,version=5	x-iscii-ta windows-57004 iscii-tml
ISCII,version=6 ISCII,version=6	x-iscii-te windows-57005 iscii-tlg
ISCII,version=7 ISCII,version=7	x-iscii-ka windows-57008 iscii-knd
ISCII,version=8 ISCII,version=8	x-iscii-ma windows-57009 iscii-mlm

EBCDIC converters

Internal converter name	Aliases
LMBCS-1	LMBCS-1 lmbcs
LMBCS-2	LMBCS-2
LMBCS-3	LMBCS-3
LMBCS-4	LMBCS-4
LMBCS-5	LMBCS-5
LMBCS-6	LMBCS-6
LMBCS-8	LMBCS-8
LMBCS-11	LMBCS-11
LMBCS-16	LMBCS-16
LMBCS-17	LMBCS-17
LMBCS-18	LMBCS-18
LMBCS-19	LMBCS-19

Internal converter name	Aliases
ibm-37_P100-1995	ibm-37_P100-1995 ibm-37 IBM037 ibm-037 ebcdic-cp-us ebcdic-cp-ca ebcdic-cp-wt ebcdic-cp-nl csIBM037 cp037 037 cpibm37 cp37
ibm-273_P100-1995	ibm-273_P100-1995 ibm-273 IBM273 CP273 csIBM273 ebcdic-de cpibm273 273
ibm-277_P100-1995	ibm-277_P100-1995 ibm-277 IBM277 cp277 EBCDIC-CP-DK EBCDIC-CP-NO csIBM277 ebcdic-dk cpibm277 277
ibm-278_P100-1995	ibm-278_P100-1995 ibm-278 IBM278 cp278 ebcdic-cp-fi ebcdic-cp-se csIBM278 ebcdic-sv cpibm278 278

Internal converter name	Aliases
ibm-280_P100-1995	ibm-280_P100-1995 ibm-280 IBM280 CP280 ebcdic-cp-it csIBM280 cpibm280 280
ibm-284_P100-1995	ibm-284_P100-1995 ibm-284 IBM284 CP284 ebcdic-cp-es csIBM284 cpibm284 284
ibm-285_P100-1995	ibm-285_P100-1995 ibm-285 IBM285 CP285 ebcdic-cp-gb csIBM285 ebcdic-gb cpibm285 285
ibm-290_P100-1995	ibm-290_P100-1995 ibm-290 IBM290 cp290 EBCDIC-JP-kana csIBM290
ibm-297_P100-1995	ibm-297_P100-1995 ibm-297 IBM297 cp297 ebcdic-cp-fr csIBM297 cpibm297 297
ibm-420_X120-1999	ibm-420_X120-1999 IBM420 cp420 ebcdic-cp-ar1 csIBM420 420

Internal converter name	Aliases
ibm-424_P100-1995	ibm-424_P100-1995 ibm-424 IBM424 cp424 ebcdic-cp-he csIBM424 424
ibm-500_P100-1995	ibm-500_P100-1995 ibm-500 IBM500 CP500 ebcdic-cp-be csIBM500 ebcdic-cp-ch cpibm500 500
ibm-803_P100-1999	ibm-803_P100-1999 ibm-803 cp803
ibm-838_P100-1995	ibm-838_P100-1995 ibm-838 IBM-Thai csIBMThai cp838 838 ibm-9030
ibm-870_P100-1995	ibm-870_P100-1995 ibm-870 IBM870 CP870 ebcdic-cp-roece ebcdic-cp-yu csIBM870
ibm-871_P100-1995	ibm-871_P100-1995 ibm-871 IBM871 ebcdic-cp-is csIBM871 CP871 ebcdic-is cpibm871 871

Internal converter name	Aliases
ibm-875_P100-1995	ibm-875_P100-1995 ibm-875 IBM875 cp875 875
ibm-918_P100-1995	ibm-918_P100-1995 ibm-918 IBM918 CP918 ebcdic-cp-ar2 csIBM918
ibm-930_P120-1999	ibm-930_P120-1999 ibm-930 ibm-5026 cp930 cpibm930 930
ibm-933_P110-1995	ibm-933_P110-1995 ibm-933 cp933 cpibm933 933
ibm-935_P110-1999	ibm-935_P110-1999 ibm-935 cp935 cpibm935 935
ibm-937_P110-1999	ibm-937_P110-1999 ibm-937 cp937 cpibm937 937
ibm-939_P120-1999	ibm-939_P120-1999 ibm-939 ibm-931 ibm-5035 cp939 939
ibm-1025_P100-1995	ibm-1025_P100-1995 ibm-1025 cp1025 1025

Internal converter name	Aliases
ibm-1026_P100-1995	ibm-1026_P100-1995 ibm-1026 IBM1026 CP1026 csIBM1026 1026
ibm-1047_P100-1995	ibm-1047_P100-1995 ibm-1047 IBM1047 cpibm1047
ibm-1097_P100-1995	ibm-1097_P100-1995 ibm-1097 cp1097 1097
ibm-1112_P100-1995	ibm-1112_P100-1995 ibm-1112 cp1112 1112
ibm-1122_P100-1999	ibm-1122_P100-1999 ibm-1122 cp1122 1122
ibm-1123_P100-1995	ibm-1123_P100-1995 ibm-1123 cp1123 1123 cpibm1123
ibm-1130_P100-1997	ibm-1130_P100-1997 ibm-1130
ibm-1132_P100-1998	ibm-1132_P100-1998 ibm-1132
ibm-1140_P100-1997	ibm-1140_P100-1997 ibm-1140 IBM01140 CCSID01140 CP01140 cp1140 cpibm1140 ebcdic-us-37+euro

Internal converter name	Aliases
ibm-1141_P100-1997	ibm-1141_P100-1997 ibm-1141 IBM01141 CCSID01141 CP01141 cp1141 cpibm1141 ebcdic-de-273+euro
ibm-1142_P100-1997	ibm-1142_P100-1997 ibm-1142 IBM01142 CCSID01142 CP01142 cp1142 cpibm1142 ebcdic-dk-277+euro ebcdic-no-277+euro
ibm-1143_P100-1997	ibm-1143_P100-1997 ibm-1143 IBM01143 CCSID01143 CP01143 cp1143 cpibm1143 ebcdic-fi-278+euro ebcdic-se-278+euro
ibm-1144_P100-1997	ibm-1144_P100-1997 ibm-1144 IBM01144 CCSID01144 CP01144 cp1144 cpibm1144 ebcdic-it-280+euro
ibm-1145_P100-1997	ibm-1145_P100-1997 ibm-1145 IBM01145 CCSID01145 CP01145 cp1145 cpibm1145 ebcdic-es-284+euro

Internal converter name	Aliases
ibm-1146_P100-1997	ibm-1146_P100-1997 ibm-1146 IBM01146 CCSID01146 CP01146 cp1146 cpibm1146 ebcdic-gb-285+euro
ibm-1147_P100-1997	ibm-1147_P100-1997 ibm-1147 IBM01147 CCSID01147 CP01147 cp1147 cpibm1147 ebcdic-fr-297+euro
ibm-1148_P100-1997	ibm-1148_P100-1997 ibm-1148 IBM01148 CCSID01148 CP01148 cp1148 cpibm1148 ebcdic-international-500+euro
ibm-1149_P100-1997	ibm-1149_P100-1997 ibm-1149 IBM01149 CCSID01149 CP01149 cp1149 cpibm1149 ebcdic-is-871+euro
ibm-1153_P100-1999	ibm-1153_P100-1999 ibm-1153 cpibm1153
ibm-1154_P100-1999	ibm-1154_P100-1999 ibm-1154 cpibm1154
ibm-1155_P100-1999	ibm-1155_P100-1999 ibm-1155 cpibm1155
ibm-1156_P100-1999	ibm-1156_P100-1999 ibm-1156 cpibm1156

Internal converter name	Aliases
ibm-1157_P100-1999	ibm-1157_P100-1999 ibm-1157 cpibm1157
ibm-1158_P100-1999	ibm-1158_P100-1999 ibm-1158 cpibm1158
ibm-1160_P100-1999	ibm-1160_P100-1999 ibm-1160 cpibm1160
ibm-1164_P100-1999	ibm-1164_P100-1999 ibm-1164 cpibm1164
ibm-1364_P110-1997	ibm-1364_P110-1997 ibm-1364 cp1364
ibm-1371_P100-1999	ibm-1371_P100-1999 ibm-1371 cpibm1371
ibm-1388_P103-2001	ibm-1388_P103-2001 ibm-1388 ibm-9580
ibm-1390_P110-2003	ibm-1390_P110-2003 ibm-1390 cpibm1390
ibm-1399_P110-2003	ibm-1399_P110-2003 ibm-1399
ibm-16684_P110-2003	ibm-16684_P110-2003 ibm-16684
ibm-4899_P100-1998	ibm-4899_P100-1998 ibm-4899 cpibm4899
ibm-4971_P100-1999	ibm-4971_P100-1999 ibm-4971 cpibm4971
ibm-12712_P100-1998	ibm-12712_P100-1998 ibm-12712 cpibm12712 ebcdic-he

Internal converter name	Aliases
ibm-16804_X110-1999	ibm-16804_X110-1999 ibm-16804 cpibm16804 ebcdic-ar
ibm-1137_P100-1999	ibm-1137_P100-1999 ibm-1137
ibm-5123_P100-1999	ibm-5123_P100-1999 ibm-5123
ibm-8482_P100-1999	ibm-8482_P100-1999 ibm-8482
ibm-37_P100-1995,swaplfnl	ibm-37_P100-1995,swaplfnl ibm-37-s390 ibm037-s390
ibm-1047_P100-1995,swaplfnl	ibm-1047_P100-1995,swaplfnl ibm-1047-s390
ibm-1140_P100-1997,swaplfnl	ibm-1140_P100-1997,swaplfnl ibm-1140-s390
ibm-1142_P100-1997,swaplfnl	ibm-1142_P100-1997,swaplfnl ibm-1142-s390
ibm-1143_P100-1997,swaplfnl	ibm-1143_P100-1997,swaplfnl ibm-1143-s390
ibm-1144_P100-1997,swaplfnl	ibm-1144_P100-1997,swaplfnl ibm-1144-s390
ibm-1145_P100-1997,swaplfnl	ibm-1145_P100-1997,swaplfnl ibm-1145-s390
ibm-1146_P100-1997,swaplfnl	ibm-1146_P100-1997,swaplfnl ibm-1146-s390
ibm-1147_P100-1997,swaplfnl	ibm-1147_P100-1997,swaplfnl ibm-1147-s390
ibm-1148_P100-1997,swaplfnl	ibm-1148_P100-1997,swaplfnl ibm-1148-s390
ibm-1149_P100-1997,swaplfnl	ibm-1149_P100-1997,swaplfnl ibm-1149-s390
ibm-1153_P100-1999,swaplfnl	ibm-1153_P100-1999,swaplfnl ibm-1153-s390
ibm-12712_P100-1998,swaplfnl	ibm-12712_P100-1998,swaplfnl ibm-12712-s390
ibm-16804_X110-1999,swaplfnl	ibm-16804_X110-1999,swaplfnl ibm-16804-s390
ebcdic-xml-us	ebcdic-xml-us

Chinese code page GB18030

If you are working with messages in Chinese code page GB18030,

There are some restrictions.

The broker can input, manipulate, and output application messages encoded in code page IBM-5488 (GB18030 support) with the following restrictions:

- If you configure a message flow to store GB18030 data in character form in a user database, ensure that the database manager that you are using supports GB18030.
- To enable support for GB18030 in the workbench and Configuration Manager:
 - If you run a workbench or Configuration Manager that requires GB18030 support on a Windows 2003 system, apply the GB18030 patch supplied by Microsoft®. This support is included in Windows XP.
 - Change the text font preference in the workbench to use GB18030:
 - Select **Preferences** in the **Window** menu.
 - Expand the **Workbench** item in the left pane of the Preferences dialog (click the plus sign) and select **Fonts**.
 - In the Fonts window, select Text Font. Click **Change**, and select the correct values in the Fonts selection dialog.
 - Click **OK** to confirm the selection and close the dialog.
 - Click **Apply** to apply the change, then **OK** to close the Preference dialog.

WebSphere MQ connections

The number of WebSphere MQ connections a broker requires to its queue manager depends on the actions of the message flows that access the MQ resource. For each broker flow that accesses a queue, one connection is required for every message flow thread. If a different node on the same thread uses the same queue manager, the same connection is used.

The number of queue handles required also depends on the behavior of the flow. For each flow that accesses queues, one queue handle is required for each unique queue name for every message flow thread. Nodes accessing the same queue name in the same flow use the same queue handle.

When you start a broker, and while it is running, it opens WebSphere MQ queue handles. The broker caches these queue handles. For example, when a message flow node initiates access to the first MQ resource it uses, it opens a connection for the queue manager and opens the queue. This is done the first time that a message is processed by that message flow node. For MQInput nodes this occurs when the flow is started. This queue handle remains open until:

The message flow becomes idle and has not been used for one minute

The execution group is stopped

The broker is stopped

The queue handle for the input node is not released when the flow is idle. The queue handle is released only when you stop the message flow.

A thread performing WebSphere MQ work becomes idle when it has not received any messages on its input queue for one minute. The allowed idle time starts from

when the input queue being read becomes empty. If a message flow gets a message from the input queue, the timer is reset.

When a message flow is idle, the execution group periodically releases WebSphere MQ queue handles. Therefore, connections held by the broker reflect the broker's current use of these resources.

Listing database connections that the broker holds

The broker does not have any functionality to list the connections it has to a database, instead use the facilities that your database supplies to list connections. Refer to the documentation for your database to find out about these.

Quiescing a database

This topic illustrates the behavior that WebSphere Message Broker expects when a database is quiesced. A database administrator issues the quiesce instruction on a database; it is not a function of the broker.

This topic assumes three things about the database being quiesced:

- The database can be quiesced
- New connections to the database are blocked by the database when it is quiescing
- Message flows using the database eventually become idle

The following list shows the behavior expected while a database is quiescing:

1. Tell the database to quiesce. As soon as you tell the database to quiesce, the connections that are in use remain in use, but no new connections to the database are allowed.
2. Processing messages. Messages that are using existing connections to the database continue to use their connections until the connections become idle. This can take a long time if messages continue to be processed. To ensure that messages are no longer processed, stop the message flow. Stopping the message flow stops messages being processed and releases the database connections that the flow was using. This ensures that the database connections that the flow holds become idle.
3. Database connections for the message flow become idle. This causes the broker to release the connections to the user databases that the message flow is using. When all connections to the database from the broker and from any other applications using the database are released, the database can complete its quiesce function.

Support for UNICODE and DBCS data in databases

The broker does not support DBCS-only columns within tables defined in databases. The broker does not, therefore, support certain data types, including the following types:

- DB2: GRAPHIC, VARGRAPHIC, LONGVARGRAPHIC, DBCLOB
- Oracle: NCHAR, NVARCHAR, NVARCHAR2, NCLOB
- Sybase: NCHAR, NVARCHAR, NTEXT, UNICHAR, UNIVARCHAR
- SQL Server: NCHAR, NVARCHAR, NTEXT
- Informix: NCHAR, NVARCHAR

It is possible to manipulate UNICODE data in suitably configured databases but there are restrictions associated with this function; refer to the readme.html file available on the product readmes Web page.

Data integrity within message flows

Code pages in which data is manipulated must be compatible between brokers and databases.

Subscription data retrieved from client applications (for example, topics from publishers and subscribers, and content filters from subscribers) and the character data entered through the workbench (for example, message flow names) are stored in the configuration repository. This data is translated from its originating code page to the code page of the process in which the broker or Configuration Manager is running, and then by the database manager to the code page in which the database or databases were created.

To preserve data consistency and integrity, ensure that all this subscription data and workbench character data is originated in a compatible code page to the two code pages to which it is translated. If you do not do so, you might get unpredictable results and lose data.

Data stored in the broker database is not affected in this way.

The restrictions described above do not apply to user data in messages. Ensure that any data in messages generated by your applications is compatible with the code page of any database you access from your message flows.

SQL statements generated as a result of explicit reference to databases within message processing nodes can contain character data that has a variety of sources. For example, the data might have been entered through the workbench, derived from message content, or read from another database. All this data is translated from its originating code page to the code page in which the broker was created, and then by the database manager to the code page in which the database was created. Ensure that these three code pages are compatible to avoid data conversion problems.

Validation properties

You can control validation by setting properties on the Validate and Parser Options tabs for the nodes that are listed in the following table.

Node type	Nodes with validation options
Input node	MQInput, SCADAInput, HTTPInput, JMSInput, TimeoutNotification, SOAPInput, FileInput
Output node	MQOutput, MQReply, SCADAOutput, HTTPReply, JMSOutput, JMSReply, FileOutput, SOAPReply
Other nodes	Compute, Mapping, JavaCompute, Validate, ResetContentDescriptor, MQGet, HTTPRequest, XSLTransform, DatabaseRetrieve, SOAPRequest, SOAPAsyncResponse

For an overview of message validation in the broker, refer to “Validating messages” on page 164.

You can set the properties that are shown in the following table.

Tab	Properties that affect validation
Validation	Validate, Failure Action
Parser Options	Parse Timing

Validation tab properties

Validate

Sets whether validation is required. All nodes provide the following options:

None The default value. No validation is performed.

Content

Indicates that you want to perform content checks, such as Content validation and Composition.

Content and Value

Indicates that you want to perform content checks, such as Content validation and Composition, and value checks, such as whether the value conforms to data type, length, range, and enumeration.

Note: Even if **Content** is selected, the SOAP and XMLNSC domains always perform **Content and Value** validation.

Some nodes also provide the following option:

Inherit

Instructs the node to use all the validation options that are provided with the input message tree in preference to any supplied on the node. Inherit therefore resolves to None, Content, or Content And Value. If Inherit is selected, the other validation properties on the tab are not available.

Failure Action

The action that you want to be taken when a validation failure occurs. You can set it to the following values:

Exception

The default value. An exception is thrown on the first validation failure encountered. The resulting exception list is shown below. The failure is also logged in the user trace if you have asked for user tracing of the message flow, and validation stops. Use this setting if you want processing of the message to halt as soon as a failure is encountered.

MRM and IDOC

Parse

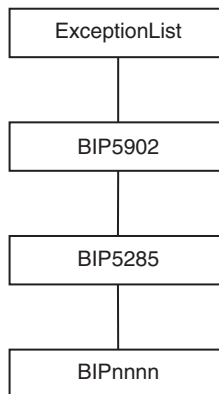

Write

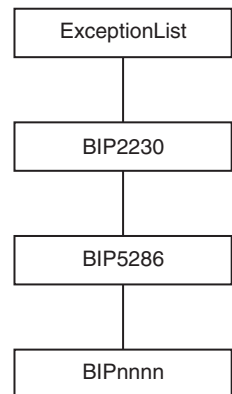

XMLNSC and SOAP

Parse

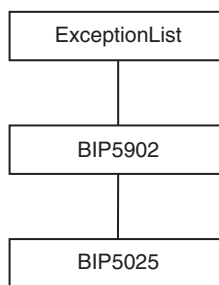

Write

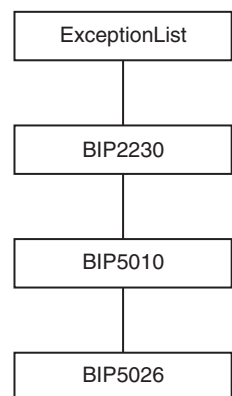

Exception List

Throws an exception if validation failures are encountered, but only when the current parsing or writing operation has completed. The resulting exception list is shown below. Each failure is also logged in the user trace if you have asked for user tracing of the message flow, and validation stops. Use this setting if you want processing of the message to halt if a validation failure occurs, but you want to see the full list of failures encountered. This property is affected by the Parse Timing property; when partial parsing is selected the current parsing operation parses only a portion of an input message, so only the validation failures in that portion of the message are reported.

MRM and IDOC

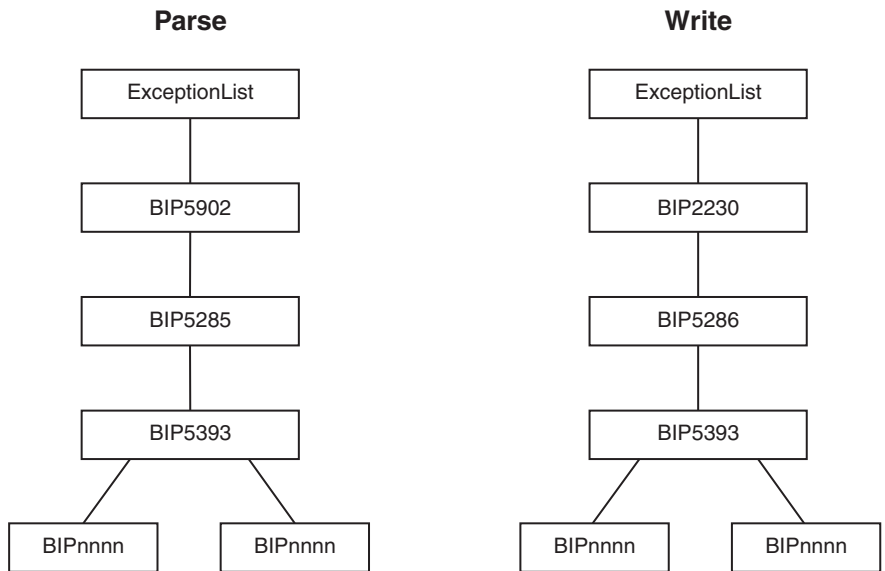

XMLNSC and SOAP

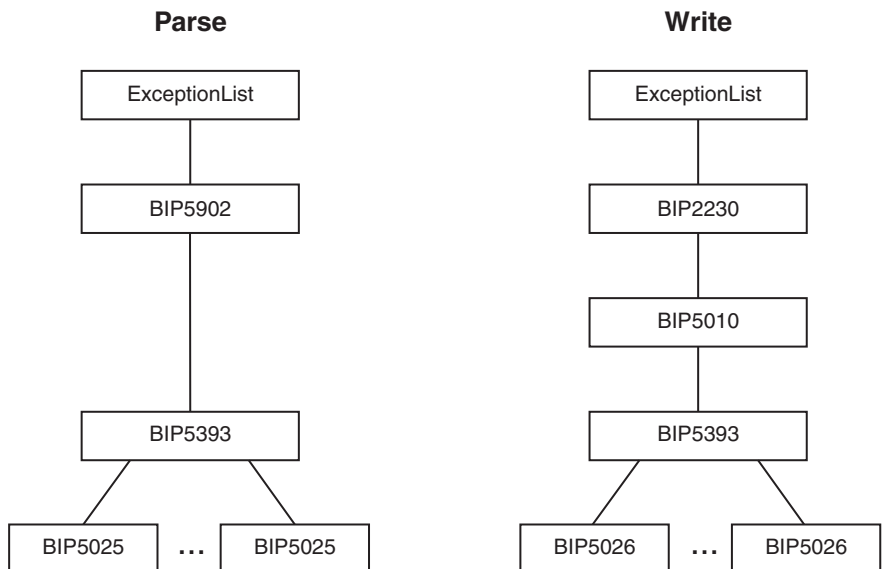

User Trace

Logs all validation failures to the user trace, even if you have not asked for user tracing of the message flow. Use this setting if you want processing of the message to continue regardless of validation failures.

Local Error Log

Logs all validation failures to the error log (for example, the Event Log on Windows). Use this setting if you want processing of the message to continue regardless of validation failures.

Parser Options tab properties

Parse Timing

The Parse Timing property determines whether on demand parsing is to be used when parsing a message. It also gives you control over the timing of input message validation:

- If you select a Parse Timing value of On Demand, validation of a field in the message is delayed until it is parsed by on demand parsing.
- If you select a Parse Timing value of Immediate, on demand parsing is overridden, and everything in the message is parsed and validated except, if the message domain is MRM, those complex types with a Composition of Choice or Message that can not be resolved at the time
- If you select a Parse Timing value of Complete, on demand parsing is overridden, and everything is parsed and validated. If the message domain is MRM, complex types with a Composition of Choice or Message that can not be resolved at the time cause a validation failure.

If you enable message validation, and you select On Demand or Immediate for Parse Timing, validation errors might not be detected until later in the processing of a message by a message flow, or might never be detected if a portion of the message is never parsed. To make sure that all fields in a message are validated, either select Complete or, if the message domain is MRM, select Immediate and make sure that you resolve all unresolved types with a Composition of Choice or Message at the start of your message flow.

The Parse Timing property has no effect on the validation of output messages.

Parsing on demand

On demand parsing, referred to as partial parsing, is used to parse an input message bit stream only as far as is necessary to satisfy the current reference. The parsers that are capable of performing partial parsing of input messages are the MRM, XML, XMLNS, and XMLNSC parsers.

An input message can be of any length. To improve performance of message flows, a message is parsed only when necessary to resolve the reference to a particular part of its content. If none of the message content is referenced within the message flow (for example, the entire message is stored in a database by the DataUpdate node, but no manipulation of the message content takes place), the message body is not parsed.

If a parser is capable of parsing an input bit stream on demand, instead of immediately parsing the entire bit stream, the Parse Timing property of a message flow node controls the on demand behavior of the parser.

You can set the Parse Timing property to On Demand (the default), Immediate, or Complete.

On Demand causes partial parsing to occur. When fields in the message are referenced, as much of the message is parsed as is necessary to completely resolve the reference. Therefore, fields might not be parsed until late in the message flow, or never. This restriction applies to both the message body and the message headers.

Immediate and Complete both override partial parsing and parse the entire message, including any message headers, except when the MRM parser encounters an element with a complex type with Composition set to Choice or Message that

cannot be resolved at the time; for example, the content needs to be resolved by the user in ESQL. If Composition is set to Choice, the data is added to the message tree as an unresolved item, and parsing continues with the next element. If Composition is set to Message, parsing terminates at that point. The only difference in behavior between Immediate and Complete occurs when MRM validation is enabled.

The Parse Timing property also gives you control over how MRM message validation interacts with partial parsing. Refer to “Validation properties” on page 1359 for a full description.

The Parse Timing property has no effect on the serialization of output messages.

Exception list structure

The following figure shows one way in which to construct an exception list.

```

ExceptionList {
  RecoverableException = {
    1
    File = 'f:/build/argo/src/DataFlowEngine/ImbDataFlowNode.cpp'
    Line = 538
    Function = 'ImbDataFlowNode::createExceptionList'
    Type = 'ComIbmComputeNode'
    Name = '0e416632-de00-0000-0080-bdb4d59524d5'
    Label = 'mf1.Compute1'
    Text = 'Node throwing exception'
    Catalog = 'WebSphere Message Broker2'
    Severity = 3
    Number = 2230
    RecoverableException = {
      2
      File = 'f:/build/argo/src/DataFlowEngine/ImbRdlBinaryExpression.cpp'
      Line = 231
      Function = 'ImbRdlBinaryExpression::scalarEvaluate'
      Type = 'ComIbmComputeNode'
      Name = '0e416632-de00-0000-0080-bdb4d59524d5'
      Label = 'mf1.Compute1'
      Text = 'error evaluating expression'
      Catalog = 'WebSphere Message Broker2'
      Severity = 2
      Number = 2439
      Insert = {
        Type = 2
        Text = '2'
      }
      Insert = {
        Type = 2
        Text = '30'
      }
    }
    RecoverableException = {
      3
      File = 'f:/build/argo/src/DataFlowEngine/ImbRdlValueOperations.cpp'
      Line = 257
      Function = 'intDivideInt'
      Type = 'ComIbmComputeNode'
      Name = '0e416632-de00-0000-0080-bdb4d59524d5'
      Label = 'mf1.Compute1'
      Text = 'Divide by zero calculating '%1 / %2''
      Catalog = 'WebSphere Message Broker2'
      Severity = 2
      Number = 2450
      Insert = {
        Type = 5
        Text = '100 / 0'
      }
    }
  }
}
}
}

```

Notes:

1. The first exception description 1 is a child of the root. This identifies error number 2230, indicating that an exception has been thrown. The node that has thrown the exception is also identified (*mf1.Compute1*).
2. Exception description 2 is a child of the first exception description 1. This identifies error number 2439.
3. Exception description 3 is a child of the second exception description 2. This identifies error number 2450, which indicates that the node has attempted to divide by zero.

The following topics provide examples of exception lists that have been written to the trace output destination (by the Trace node):

- “Database exception trace output”
- “Conversion exception trace output” on page 1368
- “Parser exception trace output” on page 1370
- “User exception trace output” on page 1370

Database exception trace output

The following figure shows an extract of the output that might be generated by a Trace node that has its property *Pattern* set to a value that represents a structure that includes the ExceptionList tree.

The exception shown occurred when a database exception was detected

Conversion exception trace output

The following figure shows an extract of the output that might be generated by a Trace node that has its property *Pattern* set to a value that represents a structure that includes the ExceptionList tree.

The exception shown occurred when a conversion (CAST) exception was detected.

Parser exception trace output

The following figure shows an extract of the output that might be generated by a Trace node that has its property *Pattern* set to a value that represents a structure that includes the ExceptionList tree.

The exception shown occurred when the message parser was invoked.

```
ExceptionList = (  
  (0x1000000)RecoverableException = (  
    (0x3000000)File = 'F:\build\S000_D\src\DataFlowEngine\ImbMqOutputNode.cpp'  
    (0x3000000)Line = 1444  
    (0x3000000)Function = 'ImbMqOutputNode::evaluate'  
    (0x3000000)Type = 'ComIbmMQOutputNode'  
    (0x3000000)Name = 'c76eb6cd-e600-0000-0080-b78796c5e70d'  
    (0x3000000)Label = 'esql_13485_check_defect.OUT'  
    (0x3000000)Text = 'Caught exception and rethrowing'  
    (0x3000000)Catalog = 'WMQIv210'  
    (0x3000000)Severity = 3  
    (0x3000000)Number = 2230  
    (0x1000000)ParserException = (  
      (0x3000000)File = 'F:\build\S000_D\src\MTI\MTIforBroker\GenXmlParser2\XmlImbParser.cpp'  
      (0x3000000)Line = 210  
      (0x3000000)Function = 'XmlImbParser::refreshBitStreamFromElements'  
      (0x3000000)Type = 'ComIbmMQInputNode'  
      (0x3000000)Name = 'ce64b6cd-e600-0000-0080-b78796c5e70d'  
      (0x3000000)Label = 'esql_13485_check_defect.IN'  
      (0x3000000)Text = 'XML Writing Errors have occurred'  
      (0x3000000)Catalog = 'WMQIv210'  
      (0x3000000)Severity = 3  
      (0x3000000)Number = 5010  
      (0x1000000)ParserException = (  
        (0x3000000)File = 'F:\build\S000_D\src\MTI\MTIforBroker\GenXmlParser2\XmlImbParser.cpp'  
        (0x3000000)Line = 551  
        (0x3000000)Function = 'XmlImbParser::checkForBodyElement'  
        (0x3000000)Type = ''  
        (0x3000000)Name = ''  
        (0x3000000)Label = ''  
        (0x3000000)Text = 'No valid body of the document could be found.'  
        (0x3000000)Catalog = 'WMQIv210'  
        (0x3000000)Severity = 3  
        (0x3000000)Number = 5005  
      )  
    )  
  )  
)
```

User exception trace output

The following figure shows an extract of the output that might be generated by a Trace node that has its property *Pattern* set to a value that represents a structure that includes the ExceptionList tree.

The exception shown occurred when a user exception was generated (with the ESQL THROW statement).

Configurable message flow properties

When you add a message flow to a broker archive (bar) file in preparation for deploying it to a broker, you can set additional properties that influence its runtime operation. These properties are available for review and update when you select the **Configure** tab for the broker archive file.

Additional Instances

Specifies the number of additional threads that the broker can use to service the message flow. These additional threads are created only if there are sufficient input messages. You can use up to 256 threads. The default value is 0. Additional threads can increase the throughput of a message flow but you should consider the potential impact on message order.

If the message flow processes WebSphere MQ messages, you can configure the message flow to control the message order. Set the Order Mode property on the MQInput node accordingly. You might also need to set the Commit by Message Group and Logical Order properties.

The broker opens the input queue as shared (using the MQOO_INPUT_SHARED option), therefore you must ensure that the input queue has been defined with the SHARE property to enable multiple broker threads to read from the same input queue.

If you have multiple input nodes in your message flow, the available additional threads might not be allocated evenly between the different input nodes. In an extreme case, all the threads might be allocated to a single input node, and only one aspect of the message flow's throughput is improved. To avoid this problem, you can use the Additional Instances Pool property, together with the Additional Instances property, to allocate a pool of additional instance threads for each input node.

Additional Instances Pool

Specifies whether additional instance threads for an input node are allocated from a thread pool for the whole message flow, or from a thread pool for use by that node only. The value of the Additional Instances property that is specified for the node controls the number of instances in the pool.

If your message flow contains multiple input nodes, use the Additional Instances Pool and Additional Instances properties to ensure that each of the input nodes is allocated the required number of additional instances. Setting these properties allows you to fine tune your message flow operation, therefore if you know that one input node will receive twice as much input as another node, you can give it twice the number of additional threads.

- To request additional instance allocation from the message flow thread pool, set Additional Instances Pool to Use pool associated with message flow.
- To request additional instance allocation from the node's own thread pool, set Additional Instances Pool to Use pool associated with node.

If the Additional Instances Pool property is not available for a node, the behavior is the same as if Additional Instances Pool is set to Use pool associated with message flow. You can set this property on the MQInput node, FileInput node, WebSphere Adapters input nodes, and Web Services input nodes.

Commit Count

For WebSphere MQ messages, specifies how many input messages are processed by a message flow before a syncpoint is taken (by issuing an MQCMIT).

The default value of 1 is also the minimum permitted value. Change this property to avoid frequent MQCMIT calls when messages are being processed quickly and the lack of an immediate commit can be tolerated by the receiving application.

Use the Commit Interval to ensure that a commit is performed periodically when not enough messages are received to fulfill the Commit Count.

This property has no effect if the message flow does not process WebSphere MQ messages.

Commit Interval

For WebSphere MQ messages, specifies a time interval at which a commit is taken when the Commit Count property is greater than 1 (that is, where the message flow is batching messages), but the number of messages processed has not reached the value of the Commit Count property. It ensures that a commit is performed periodically when not enough messages are received to fulfill the Commit Count.

The time interval is specified in seconds, as a decimal number with a maximum of 3 decimal places (millisecond granularity). The value must be in the range 0.000 through 60.000. The default value is 0.

This property has no effect if the message flow does not process WebSphere MQ messages.

Coordinated Transaction

Controls whether the message flow is processed as a global transaction, coordinated by WebSphere MQ. Such a message flow is said to be fully globally-coordinated. The default value is No.

Use coordinated transactions only where you need to process the message and any database updates that are performed by the message flow in a single unit-of-work, using a two-phase commit protocol. In this case, both the message is read and the database updates are performed, or neither is done.

If you change this value, ensure that the broker's queue manager is configured correctly. If you do not set up the queue manager correctly, the broker generates a message when the message flow receives a message to indicate that, although the message flow is to be globally coordinated, the queue manager configuration does not support this.

See Supported databases for information about which databases are supported as participants in a global transaction, and the *System Administration* section of the WebSphere MQ Version 6 information center online for how to configure WebSphere MQ and the database managers.

This property has no effect if the message flow does not process WebSphere MQ messages.

User-defined properties

The initial value of a user-defined property (UDP) can be modified at design time by the Message Flow editor, or overridden at deployment time by the Broker Archive editor. The advantage of UDPs is that their values can be changed by operational staff at deployment time. If, for example, you use UDPs to hold configuration data, you can configure a message

flow for a particular computer, task, or environment at deployment time, without having to change the code at the node level. You can also query and set the values of user-defined properties at run time by using the Configuration Manager Proxy (CMP) API. For example, a systems monitoring tool could use the CMP API to modify the value of a user-defined property at run time to change the behavior of the message flow.

For introductory information about UDPs and dynamic UDPs, see “User-defined properties in ESQL” on page 261 and “User-defined properties” on page 111.

For information about configuring UDPs at deployment time, see “Configuring a message flow at deployment time using UDPs” on page 410.

For information about configuring UDPs at run time, see Setting user-defined properties dynamically at run time.

You can view and update other configurable properties for the message flow. The properties that are displayed depend on the nodes within the message flow; some have no configurable properties to display. The node properties that are configurable are predominantly system-related properties that are likely to change for each broker to which the message flow is deployed. These properties include data source names and the names of WebSphere MQ queues and queue managers. For full details of configurable properties for a node, see the appropriate node description.

Message flow porting considerations

If you have configured a message flow that runs on a broker on a distributed system, and you now want to deploy it to a broker that runs on z/OS, you might have to take additional actions to port the flow successfully.

Consider the following resources and attributes:

WebSphere MQ queue manager and queue names

WebSphere MQ imposes some restrictions for resource names on z/OS:

- The queue manager name cannot be greater than four characters.
- All queue names must be in uppercase. Although using quotation marks preserves the case, certain WebSphere MQ activities on z/OS cannot find the queue names being referenced.

For more information about configuring on z/OS, refer to the *Concepts and Planning Guide* section of the WebSphere MQ Version 6 information center online

File system references

File system references must reflect a UNIX file path. If you deploy a message flow to z/OS that you have previously run on Windows, you might have to make changes. If you have previously deployed the message flow to a UNIX system (AIX®, Linux, Solaris, or HP-UX), you do not have to make any changes.

Databases

If the message flow accesses one or more databases, it might be subject to some restrictions based on the system on which the database is defined. These restrictions are described in Database locations.

Monitoring profile

You can create a monitoring profile to configure the monitoring options for your message flow.

Purpose

A monitoring profile has the following properties which can be set using an XML file:

Event identity XPath query

This property overrides the default value of `eventPointData/eventData/eventIdentity/@eventName`. If this query is not supplied, `@eventName` is set to `transactionStart transactionEnd transactionRollback`. You can specify a field in your message body that contains a more specific value. Example values for fields in the message:

```
$Properties/messageType  
$InputBody/soapenv:Header/
```

localTransactionId XPath query

This property overrides the default value of `eventPointData/eventData/eventCorrelation/@localTransactionId`. If this query is not supplied, `@localTransactionId` is set to a unique message identifier for the transport. You can specify a field in your message that contains a more specific value. Example values for fields in the message:

```
$InputBody/soapenv:Header/wsa:messageID
```

parentTransactionId XPath query

This property supplies a value for `eventPointData/eventData/eventCorrelation/@parentTransactionId`. If this query is not supplied, `@parentTransactionId` is omitted from the event. You can specify a field in your message that populates this field in your events.

globalTransactionId XPath query

This property supplies a value for `eventPointData/eventData/eventCorrelation/@globalTransactionId`. If this query is not supplied, `@globalTransactionId` is omitted from the event. You can specify a field in your message that populates this field in your events.

Sequence field XPath query

This property overrides the default value of `eventPointData/eventData/eventSequence/@value`. If this query is not supplied, `eventSequene/@value` is populated with the creation time of the event. You can use this to get proper sequencing of fields, but missed events cannot be detected. You can specify a field in your message that populates this field in your events.

sequence data type

Specifies the data type of the field identified by the sequence field query. Supplying the data type of the field is useful when constructing a monitoring model in WebSphere Business Monitor.

Valid values are `dateTime`, `integer` and `string`.

Sequence field name

Specifies the name of the sequence data field. Supplying a name for the field is helpful when constructing a monitoring model in WebSphere Business Monitor.

Simple content XPath queries

You can use these queries to extract simple fields from your message and put them into the `ApplicationData/simpleContent` section of the event. If no simple content queries are specified, the event does not contain any fields from the message, and the entire `ApplicationData/simpleContent` element is omitted from the event.

Simple content name

The name of the simple element that is selected by this query

Simple content namespace [optional]

The namespace of the simple element that is selected by this query

Simple content data type

The data type of the simple element being selected by this query. Valid values are:

- boolean
- date
- dateTime
- decimal
- duration
- integer
- string
- time

Default content of monitoring events

When monitoring is enabled for a message flow, the fields in the generated events are populated with default values. These default values are described in the following table. Some of these fields can be populated by a monitoring profile. Any field which is not explicitly overridden using a monitoring profile is given the default values as shown in the table.

Table 272. Default values for monitoring events

Field in event	Default Value	Example
<code>event/eventPointData/eventData/@eventSchemaVersion</code>	6.1.0.2	
<code>event/eventPointData/eventData/@productVersion</code>	6102	
<code>event/eventPointData/eventData/eventIdentity/@eventName</code>	One of the following event types: <ul style="list-style-type: none">• transactionStart• transactionEnd• transactionRollback	
<code>event/eventPointData/eventData/eventSequence/@creationTime</code>	The date and time when the event was created.	2007-12-31T23:59:59.999

Table 272. Default values for monitoring events (continued)

Field in event	Default Value	Example
event/eventPointData/eventData/ eventCorrelation/ @localTransactionId	A default value based on the transport used: <ul style="list-style-type: none"> • MQ • JMS • SOAP • HTTP 	InputRoot.MQMD.MsgId InputRoot.JMSTransport.Transport_Folders. Header_Values.JMSMessageId InputLocalEnvironment.Destination.SOAP.Reply. ReplyIdentifier InputLocalEnvironment.Destination.HTTP. RequestIdentifier
event/eventPointData/ messageFlowData/broker/@name	The name of the broker.	
event/eventPointData/ messageFlowData/broker/@UUID	The UUID of the broker.	
event/eventPointData/ messageFlowData/ executionGroup/@name	The name of the execution group.	
event/eventPointData/ messageFlowData/ executionGroup/@UUID	The UUID of the execution group.	
event/eventPointData/ messageFlowData/messageFlow/ @name	The name of the message flow.	
event/eventPointData/ messageFlowData/messageFlow/ @UUID	The UUID of the message flow.	
event/eventPointData/ messageFlowData/messageFlow/ @uniqueFlowName	A string composed of the names of the broker, execution group and flow in the form: [brokerName],[execution GroupName],[flowName]	myBroker.myEG.messageFlow1
event/eventPointData/ messageFlowData/messageFlow/ @threadId	The thread id of the message flow. The format is platform dependent.	
event/eventPointData/ messageFlowData/node/ @nodeLabel	The label of the node that emitted the event.	
event/eventPointData/ messageFlowData/node/ @nodeType	The type of the node that emitted the event.	
event/eventPointData/ messageFlowData/node/ @nodeDetail	Optional information about the node.	In an MQInput node, this field contains the name of the input queue.
event/bitstreamData/bitstream/ @encoding	base64Binary	
event/bitstreamData/bitstream	A base64 representation of the entire input bitstream.	

Monitoring profile examples

The following XML documents conform to the monitoring profile schema

Monitoring profile 1 : Supply an alternative localTransactionId

```
<?xml version="1.0" encoding="UTF-8"?>
<wmb:monitoringProfile
  xmlns:wmb="http://www.ibm.com/xmlns/prod/websphere/messagebroker/6.1.0/monitoring/profile"
  xmlns:xsi="http://www.w3.org/2001/XMLSchema-instance"
  xsi:schemaLocation="http://www.ibm.com/xmlns/prod/websphere/messagebroker
/6.1.0/monitoring/profile MonitoringProfile.xsd ">
  <wmb:eventPointDataQuery>
    <wmb:eventCorrelation>
      <wmb:localTransactionId wmb:queryText="$Body/soapenv:Header/wsa:messageID" >
        <wmb:prefixMapping wmb:prefix="soapenv" wmb:URI="http://www.w3.org/2003/05/soap-envelope" />
        <wmb:prefixMapping wmb:prefix="wsa" wmb:URI="http://www.w3.org/2005/08/addressing" />
      </wmb:localTransactionId>
    </wmb:eventCorrelation>
  </wmb:eventPointDataQuery>
</wmb:monitoringProfile>
```

Monitoring profile 2 : Supply an alternative sequence field

```
<?xml version="1.0" encoding="UTF-8"?>
<wmb:monitoringProfile
  xmlns:wmb="http://www.ibm.com/xmlns/prod/websphere/messagebroker/6.1.0/monitoring/profile"
  xmlns:xsi="http://www.w3.org/2001/XMLSchema-instance"
  xsi:schemaLocation="http://www.ibm.com/xmlns/prod/websphere/messagebroker
/6.1.0/monitoring/profile MonitoringProfile.xsd ">
  <wmb:eventPointDataQuery>
    <wmb:eventSequence wmb:dataType="integer" wmb:name="InvoiceNumber">
      <wmb:value wmb:queryText="$InputBody/invoice/InvoiceNo" />
    </wmb:eventSequence>
  </wmb:eventPointDataQuery>
</wmb:monitoringProfile>
```

Monitoring profile 3 : Add simple content

```
<?xml version="1.0" encoding="UTF-8"?>
<wmb:monitoringProfile
  xmlns:wmb="http://www.ibm.com/xmlns/prod/websphere/messagebroker/6.1.0/monitoring/profile"
  xmlns:xsi="http://www.w3.org/2001/XMLSchema-instance"
  xsi:schemaLocation="http://www.ibm.com/xmlns/prod/websphere/messagebroker
/6.1.0/monitoring/profile MonitoringProfile.xsd ">
  <wmb:applicationDataQuery>
    <wmb:simpleContent wmb:dataType="integer" wmb:name="InvoiceNumber">
      <wmb:valueQuery wmb:queryText="$InputBody/invoice/InvoiceNo" />
    </wmb:simpleContent>
    <wmb:simpleContent wmb:dataType="string" wmb:name="batchID">
      <wmb:valueQuery wmb:queryText="$InputBody/batch/batchNo" />
    </wmb:simpleContent>
  </wmb:applicationDataQuery>
</wmb:monitoringProfile>
```

Monitoring profile 4 : Change the bitstream encoding to CDATA

By default, bitstreams are encoded in base64Binary format. The following monitoring profile changes the encoding to CDATA. CDATA encoding is not suitable for all types of data. You must not use CDATA if your message bitstreams can contain characters that are illegal in XML (see <http://www.w3.org/TR/2006/REC-xml-20060816/#charsets>).

```
<?xml version="1.0" encoding="UTF-8"?>
<wmb:monitoringProfile
  xmlns:wmb="http://www.ibm.com/xmlns/prod/websphere/messagebroker/6.1.0/monitoring/profile"
```

```

|   xmlns:xsi="http://www.w3.org/2001/XMLSchema-instance"
|   xsi:schemaLocation="http://www.ibm.com/xmlns/prod/websphere/messagebroker
| /6.1.0/monitoring/profile MonitoringProfile.xsd ">
|   <wmb:bitstreamDataQuery wmb:encoding="CDATA" wmb:bitstreamContent="all"/>
| </wmb:monitoringProfile>

```

Monitoring profile 5 : The default monitoring profile

```

| <?xml version="1.0" encoding="UTF-8"?>
| <wmb:monitoringProfile
|   xmlns:wmb="http://www.ibm.com/xmlns/prod/websphere/messagebroker/6.1.0/monitoring/profile"
|   <wmb:bitstreamDataQuery wmb:encoding="base64Binary">
|     <wmb:bitstream queryText="$Root" />
|   </wmb:bitstreamDataQuery>
| </wmb:monitoringProfile>

```

Monitoring profile schema

You can create an XML file containing the properties to use for your monitoring profile. The XML files with the properties must conform to this monitoring profile schema.

The schema below defines the content of the monitoring profiles used to generate events in message flows.

```

| <xsd:schema xmlns="http://www.w3.org/2001/XMLSchema"
| targetNamespace="http://www.ibm.com/xmlns/prod/websphere/messagebroker
| /6.1.0/monitoring/profile" xmlns:wmb="http://www.ibm.com/xmlns/prod/websphere/messagebroker
| /6.1.0/monitoring/profile" elementFormDefault="qualified" attributeFormDefault="qualified"
| xmlns:xsd="http://www.w3.org/2001/XMLSchema">
|
|   <!-- A monitoring profile configures the event sources in a message flow -->
|   <xsd:element name="monitoringProfile" type="wmb:monitoringProfileType"/>
|
|   <xsd:complexType name="monitoringProfileType">
|     <xsd:sequence>
|       <xsd:element ref="wmb:eventPointDataQuery" minOccurs="0" maxOccurs="1"/>
|       <xsd:element ref="wmb:applicationDataQuery" minOccurs="0" maxOccurs="1"/>
|       <xsd:element ref="wmb:bitstreamDataQuery" minOccurs="0" maxOccurs="1"/>
|     </xsd:sequence>
|   </xsd:complexType>
|
|   <xsd:element name="eventPointDataQuery">
|     <xsd:complexType>
|       <xsd:sequence>
|         <!-- This query populates the eventPointData/eventData/eventIdentity/@eventName attribute -->
|         <xsd:element name="eventIdentity" minOccurs="0" maxOccurs="1">
|           <xsd:complexType>
|             <xsd:sequence>
|               <xsd:element name="eventName" type="wmb:queryType" minOccurs="1" maxOccurs="1">
|             </xsd:sequence>
|           </xsd:complexType>
|         </xsd:element>
|       </xsd:sequence>
|     </xsd:complexType>
|   </xsd:element>
|
|   <!-- Information for eventPointData/eventData/eventSequence/@* -->
|   <xsd:element name="eventSequence" minOccurs="0" maxOccurs="1">
|     <xsd:complexType>
|       <xsd:sequence>
|         <!-- Overrides the default value of eventPointData/eventData/eventSequence/@value -->
|         <xsd:element name="value" type="wmb:queryType"></xsd:element>
|       </xsd:sequence>
|       <!-- A user-supplied name for this query's result -->
|       <xsd:attribute name="name" type="xsd:string"/>
|       <xsd:attribute name="dataType" type="wmb:sequenceDataType"/>
|     </xsd:complexType>
|   </xsd:element>
|   <!-- These queries supply values for eventPointData/eventData/eventCorrelation/@*transactionId -->

```

```

|         <xsd:element name="eventCorrelation" minOccurs="0" maxOccurs="1">
|             <xsd:complexType>
|                 <xsd:sequence>
|                     <xsd:element name="localTransactionId" type="wmb:queryType" minOccurs="0" maxOccurs="1">
| </xsd:element>
|                     <xsd:element name="parentTransactionId" type="wmb:queryType" minOccurs="0" maxOccurs="1">
| </xsd:element>
|                     <xsd:element name="globalTransactionId" type="wmb:queryType" minOccurs="0" maxOccurs="1">
| </xsd:element>
|                 </xsd:sequence>
|             </xsd:complexType>
|         </xsd:element>
|
|         <!-- A query and associated metadata which populates applicationData/simpleContent or applicationData/complexContent -->
| <xsd:element name="applicationDataQuery">
|     <xsd:complexType>
|         <xsd:sequence>
|             <xsd:element name="simpleContent" minOccurs="0" maxOccurs="unbounded">
|                 <xsd:complexType>
|                     <xsd:sequence>
|                         <xsd:element name="valueQuery" type="wmb:queryType" minOccurs="1" maxOccurs="1"></xsd:element>
|                     </xsd:sequence>
|                     <xsd:attribute name="name" type="xsd:string" use="required"/>
|                     <xsd:attribute name="dataType" type="wmb:simpleContentDataType" use="required"/>
|                     <xsd:attribute name="targetNamespace" type="xsd:string" use="optional"/>
|                 </xsd:complexType>
|             </xsd:element>
|
|             <xsd:element name="complexContent" minOccurs="0" maxOccurs="unbounded">
|                 <xsd:complexType>
|                     <xsd:sequence>
|                         <xsd:element name="payloadQuery" type="wmb:queryType"></xsd:element>
|                     </xsd:sequence>
|                     <xsd:attribute name="name" type="xsd:string" use="required"/>
|                     <xsd:attribute name="targetNamespace" type="xsd:string" use="optional"/>
|                 </xsd:complexType>
|             </xsd:element>
|         </xsd:sequence>
|     </xsd:complexType>
| </xsd:element>
|
| <!-- This query populates the bitstreamData/bitstream element -->
| <xsd:element name="bitstreamDataQuery">
|     <xsd:complexType>
|         <!-- Overrides the default value of attribute bitstreamData/bitstream/@encoding -->
|         <xsd:attribute name="encoding" type="wmb:encodingType"/>
|         <xsd:attribute name="bitstreamContent" type="wmb:bitstreamContentType"/>
|     </xsd:complexType>
| </xsd:element>
|
| <xsd:complexType name="queryType">
|     <xsd:sequence>
|         <xsd:element name="prefixMapping" minOccurs="0" maxOccurs="unbounded">
|             <xsd:complexType>
|                 <xsd:attribute name="prefix" type="xsd:string" use="required"/>
|                 <xsd:attribute name="URI" type="xsd:string" use="required"/>
|             </xsd:complexType>
|         </xsd:element>
|     </xsd:sequence>
|     <xsd:attribute name="queryText" type="xsd:string"/>
| </xsd:complexType>

```

```

| <xsd:simpleType name="bitstreamContentType">
|   <xsd:restriction base="xsd:string">
|     <xsd:enumeration value="none"/>
|     <xsd:enumeration value="headers"/>
|     <xsd:enumeration value="body"/>
|     <xsd:enumeration value="all"/>
|   </xsd:restriction>
| </xsd:simpleType>
|
| <xsd:simpleType name="encodingType">
|   <xsd:restriction base="xsd:string">
|     <xsd:enumeration value="none"/>
|     <xsd:enumeration value="CDATA"/>
|     <xsd:enumeration value="hexBinary"/>
|     <xsd:enumeration value="base64Binary"/>
|   </xsd:restriction>
| </xsd:simpleType>
|
| <xsd:simpleType name="sequenceDataType">
|   <xsd:restriction base="xsd:string">
|     <xsd:enumeration value="dateTime"/>
|     <xsd:enumeration value="integer"/>
|     <xsd:enumeration value="string"/>
|   </xsd:restriction>
| </xsd:simpleType>
|
| <xsd:simpleType name="simpleContentDataType">
|   <xsd:restriction base="xsd:string">
|     <xsd:enumeration value="boolean"/>
|     <xsd:enumeration value="date"/>
|     <xsd:enumeration value="dateTime"/>
|     <xsd:enumeration value="decimal"/>
|     <xsd:enumeration value="duration"/>
|     <xsd:enumeration value="integer"/>
|     <xsd:enumeration value="string"/>
|     <xsd:enumeration value="time"/>
|   </xsd:restriction>
| </xsd:simpleType>
| </xsd:schema>

```

Message flow accounting and statistics data

This section provides information for message flow accounting and statistics data.

Details of the information that is collected, and the output formats in which it can be recorded, are provided:

- Statistics details
- Data formats
- Example output

You can also find information on how to use accounting and statistics data to improve the performance of a message flow in this developerWorks article on message flow performance.

Message flow accounting and statistics details

This topic identifies the statistics that are collected for message flows.

The details that are available are:

Message flow statistics

One record is created for each message flow in an execution group. Each record contains the following details:

- Message flow name and UUID
- Execution group name and UUID
- Broker name and UUID
- Start and end times for data collection
- Type of data collected (snapshot or archive)
- CPU and elapsed time spent processing messages
- CPU and elapsed time spent waiting for input
- Number of messages processed
- Minimum, maximum, and average message sizes
- Number of threads available and maximum assigned at any time
- Number of messages committed and backed out
- Accounting origin

Thread statistics

One record is created for each thread assigned to the message flow. Each record contains the following details:

- Thread number (this has no significance and is for identification only)
- CPU and elapsed time spent processing messages
- CPU and elapsed time spent waiting for input
- Number of messages processed
- Minimum, maximum, and average message sizes

Node statistics

One record is created for each node in the message flow. Each record contains the following details:

- Node name
- Node type (for example MQInput)
- CPU time spent processing messages
- Elapsed time spent processing messages
- Number of times that the node is invoked
- Number of messages processed
- Minimum, maximum, and average message sizes

Terminal statistics

One record is created for each terminal on a node. Each record contains the following details:

- Terminal name
- Terminal type (input or output)
- Number of times that a message is propagated through this terminal

For further details about specific output formats, see the following topics:

- “User trace entries for message flow accounting and statistics data” on page 1386
- “XML publication for message flow accounting and statistics data” on page 1383
- “z/OS SMF records for message flow accounting and statistics data” on page 1390

Message flow accounting and statistics output formats

The message flow accounting and statistics data is written in one of three formats:

- User trace entries
- XML publication
- z/OS SMF records

XML publication for message flow accounting and statistics data

This topic describe the information that is written to the XML publication for message flow accounting and statistics data. The data is created within the folder WMQIStatisticsAccounting, which contains subfolders that provide more detailed information. All folders are present within the publication even if you set current data collection parameters to specify that the relevant data is not collected.

Snapshot data is used for performance analysis, and is published as retained and non-persistent. Archive data is used for accounting where an audit trail might be required, and is published as retained and persistent. All publications are global and can be collected by a subscriber that has registered anywhere in the network. They can also be collected by more than one subscriber.

One XML publication is generated for each message flow that is producing data for the time period you have chosen. For example, if MessageFlowA and MessageFlowB, are both producing archive data over a period of 60 minutes, both MessageFlowA and MessageFlowB will produce an XML publication every 60 minutes.

If you are concerned about the safe delivery of these messages, for example for charging purposes, use a secure delivery mechanism such as WebSphere MQ.

The folders and subfolders in the XML publication have the following identifiers:

- WMQIStatisticsAccounting
- MessageFlow
- Threads
- ThreadStatistics
- Nodes
- NodesStatistics
- TerminalStatistics

The tables provided here describe the contents of each of these folders in the order listed above.

The table below describes the general accounting and statistics information, created in folder WMQIStatisticsAccounting.

Field	Data type	Details
RecordType	Character	Type of output, one of: <ul style="list-style-type: none">• Archive• Snapshot
RecordCode	Character	Reason for output, one of: <ul style="list-style-type: none">• MajorInterval• Snapshot• Shutdown• ReDeploy• StatsSettingsModified

The table below describes the message flow statistics information, created in folder MessageFlow.

Field	Data type	Details
BrokerLabel	Character (maximum 32)	Broker name

Field	Data type	Details
BrokerUUID	Character (maximum 32)	Broker universal unique identifier
ExecutionGroupName	Character (maximum 32)	Execution group name
ExecutionGroupUUID	Character (maximum 32)	Execution group universal unique identifier
MessageFlowName	Character (maximum 32)	Message flow name
StartDate	Character	Interval start date (YYYY-MM-DD)
StartTime	Character	Interval start time (HH:MM:SS:NNNNNN)
EndDate	Character	Interval end date (YYYY-MM-DD)
EndTime	Character	Interval end time (HH:MM:SS:NNNNNN)
TotalElapsedTime	Numeric	Total elapsed time spent processing input messages (microseconds)
MaximumElapsedTime	Numeric	Maximum elapsed time spent processing an input message (microseconds)
MinimumElapsedTime	Numeric	Minimum elapsed time spent processing an input message (microseconds)
TotalCPUTime	Numeric	Total CPU time spent processing input messages (microseconds)
MaximumCPUTime	Numeric	Maximum CPU time spent processing an input message (microseconds)
MinimumCPUTime	Numeric	Minimum CPU time spent processing an input message (microseconds)
CPUTimeWaitingForInputMessage	Numeric	Total CPU time spent waiting for input messages (microseconds)
ElapsedTimeWaitingForInputMessage	Numeric	Total elapsed time spent waiting for input messages (microseconds)
TotalInputMessages	Numeric	Total number of messages processed
TotalSizeOfInputMessages	Numeric	Total size of input messages (bytes)
MaximumSizeOfInputMessages	Numeric	Maximum input message size (bytes)
MinimumSizeOfInputMessages	Numeric	Minimum message input size (bytes)
NumberOfThreadsInPool	Numeric	Number of threads in pool

Field	Data type	Details
TimesMaximumNumberOfThreadsReached	Numeric	Number of times the maximum number of threads is reached
TotalNumberOfMQErrors ¹	Numeric	Number of MQGET errors (MQInput node) or Web services errors (HTTPInput node)
TotalNumberOfMessagesWithErrors ²	Numeric	Number of messages that contain errors
TotalNumberOfErrorsProcessingMessages	Numeric	Number of errors processing a message
TotalNumberOfTimeOutsWaitingForRepliesToAggregateMessages	Numeric	Number of timeouts processing a message (AggregateReply node only)
TotalNumberOfCommits	Numeric	Number of transaction commits
TotalNumberOfBackouts	Numeric	Number of transaction backouts
AccountingOrigin	Character (maximum 32)	Accounting origin
Notes:		
1. For example, a conversion error occurs when the message is got from the queue.		
2. These include exceptions that are thrown downstream of the input node, and errors detected by the input node after it has successfully retrieved the message from the queue but before it has propagated it to the out terminal (for example, a format error).		

The table below describes the thread statistics information, created in folder Threads.

Field	Data type	Details
Number	Numeric	Number of thread statistics subfolders within Threads folder

The table below describes the thread statistics information for each individual thread, created in folder ThreadStatistics, a subfolder of Threads.

Field	Data type	Details
Number	Numeric	Relative thread number in pool
TotalNumberOfInputMessages	Numeric	Total number of messages processed by thread
TotalElapsedTime	Numeric	Total elapsed time spent processing input messages (microseconds)
TotalCUPTime	Numeric	Total CPU time spent processing input messages (microseconds)
CPUTimeWaitingForInputMessage	Numeric	Total CPU time spent waiting for input messages (microseconds)
ElapsedTimeWaitingForInputMessage	Numeric	Total elapsed time spent waiting for input messages (microseconds)
TotalSizeOfInputMessages	Numeric	Total size of input messages (bytes)

Field	Data type	Details
MaximumSizeOfInputMessages	Numeric	Maximum size of input messages (bytes)
MinimumSizeOfInputMessages	Numeric	Minimum size of input messages (bytes)

The table below describes the node statistics information, created in folder Nodes.

Field	Data type	Details
Number	Numeric	Number of node statistics subfolders within Nodes folder

The table below describes the node statistics information for each individual node, created in folder NodesStatistics, a subfolder of Nodes.

Field	Data type	Details
Label	Character	Name of node (Label)
Type	Character	Type of node
TotalElapsedTime	Numeric	Total elapsed time spent processing input messages (microseconds)
MaximumElapsedTime	Numeric	Maximum elapsed time spent processing input messages (microseconds)
MinimumElapsedTime	Numeric	Minimum elapsed time spent processing input messages (microseconds)
TotalCPUTime	Numeric	Total CPU time spent processing input messages (microseconds)
MaximumCPUTime	Numeric	Maximum CPU time spent processing input messages (microseconds)
MinimumCPUTime	Numeric	Minimum CPU time spent processing input messages (microseconds)
CountOfInvocations	Numeric	Total number of messages processed by this node
NumberOfInputTerminals	Numeric	Number of input terminals
NumberOfOutputTerminals	Numeric	Number of output terminals

The table below describes the terminal statistics information, created in folder TerminalStatistics.

Field	Data type	Details
Label	Character	Name of terminal
Type	Character	Type of terminal, one of: <ul style="list-style-type: none"> • Input • Output
CountOfInvocations	Numeric	Total number of invocations

User trace entries for message flow accounting and statistics data

This topic describes the information that is written to the user trace log for message flow accounting and statistics data.

The data records are identified by the following message numbers:

- BIP2380I
- BIP2381I
- BIP2382I
- BIP2383I

The inserts for each message are described in the following tables, in the order shown above.

The following table describes the inserts in message BIP2380I. One message is written for the message flow.

Field	Data type	Details
ProcessID	Numeric	Process ID
Key	Numeric	Key used to associate related accounting and statistics BIP messages
Type	Character	Type of output, one of: <ul style="list-style-type: none"> • Archive • Snapshot
Reason	Character	Reason for output, one of: <ul style="list-style-type: none"> • MajorInterval • Snapshot • Shutdown • ReDeploy • StatsSettingsModified
BrokerLabel	Character (maximum 32)	Broker name
BrokerUUID	Character (maximum 32)	Broker universal unique identifier
ExecutionGroupName	Character (maximum 32)	Execution group name
ExecutionGroupUUID	Character (maximum 32)	Execution group universal unique identifier
MessageFlowName	Character (maximum 32)	Message flow name
StartDate	Character	Interval start date (YYYY-MM-DD)
StartTime	Character	Interval start time (HH:MM:SS.NNNNNN)
EndDate	Character	Interval end date (YYYY-MM-DD)
EndTime	Character	Interval end time (HH:MM:SS.NNNNNN)
TotalElapsedTime	Numeric	Total elapsed time spent processing input messages (microseconds)
MaximumElapsedTime	Numeric	Maximum elapsed time spent processing an input message (microseconds)

Field	Data type	Details
MinimumElapsedTime	Numeric	Minimum elapsed time spent processing an input message (microseconds)
TotalCPUTime	Numeric	Total CPU time spent processing input messages (microseconds)
MaximumCPUTime	Numeric	Maximum CPU time spent processing an input message (microseconds)
MinimumCPUTime	Numeric	Minimum CPU time spent processing an input message (microseconds)
CPUTimeWaitingForInputMessage	Numeric	Total CPU time spent waiting for input messages (microseconds)
ElapsedTimeWaitingForInputMessage	Numeric	Total elapsed time spent waiting for input messages (microseconds)
TotalInputMessages	Numeric	Total number of messages processed
TotalSizeOfInputMessages	Numeric	Total size of input messages (bytes)
MaximumSizeOfInputMessages	Numeric	Maximum input message size (bytes)
MinimumSizeOfInputMessages	Numeric	Minimum input message size (bytes)
NumberOfThreadsInPool	Numeric	Number of threads in pool
TimesMaximumNumberOfThreadsReached	Numeric	Number of times the maximum number of threads is reached
TotalNumberOfMQErrors ¹	Numeric	Number of MQGET errors (MQInput node) or Web services errors (HTTPInput node)
TotalNumberOfMessagesWithErrors ²	Numeric	Number of messages that contain errors
TotalNumberOfErrorsProcessingMessages	Numeric	Number of errors processing a message
TotalNumberOfTimeOutsWaitingForRepliesToAggregateMessages	Numeric	Number of timeouts processing a message (AggregateReply node only)
TotalNumberOfCommits	Numeric	Number of transaction commits
TotalNumberOfBackouts	Numeric	Number of transaction backouts
AccountingOrigin	Character (maximum 32)	Accounting origin

Field	Data type	Details
Notes:		
1. For example, a conversion error occurs when the message is got from the queue.		
2. These include exceptions that are thrown downstream of the input node, and errors detected by the input node after it has successfully retrieved the message from the queue (for example, a format error).		

The following table describes the inserts in message BIP2381I. One message is written for each thread.

Field	Data type	Details
ProcessID	Numeric	Process ID
Key	Numeric	Key used to associate related accounting and statistics BIP messages
Number	Numeric	Relative thread number in pool
TotalNumberOfInputMessages	Numeric	Total number of messages processed by thread
TotalElapsedTime	Numeric	Total elapsed time spent processing input messages (microseconds)
TotalCUPTime	Numeric	Total CPU time spent processing input messages (microseconds)
CPUTimeWaitingForInputMessage	Numeric	Total CPU time spent waiting for input messages (microseconds)
ElapsedTimeWaitingForInputMessage	Numeric	Total elapsed time spent waiting for input messages (microseconds)
TotalSizeOfInputMessages	Numeric	Total size of input messages (bytes)
MaximumSizeOfInputMessages	Numeric	Maximum size of input messages (bytes)
MinimumSizeOfInputMessages	Numeric	Minimum size of input messages (bytes)

The following table describes the inserts in message BIP2382I. One message is written for each node.

Field	Data type	Details
ProcessID	Numeric	Process ID
Key	Numeric	Key used to associate related accounting and statistics BIP messages
Label	Character	Name of node (Label)
Type	Character	Type of node
TotalElapsedTime	Numeric	Total elapsed time spent processing input messages (microseconds)
MaximumElapsedTime	Numeric	Maximum elapsed time spent processing input messages (microseconds)
MinimumElapsedTime	Numeric	Minimum elapsed time spent processing input messages (microseconds)
TotalCPUTime	Numeric	Total CPU time spent processing input messages (microseconds)
MaximumCPUTime	Numeric	Maximum CPU time spent processing input messages (microseconds)

Field	Data type	Details
MinimumCPUTime	Numeric	Minimum CPU time spent processing input messages (microseconds)
CountOfInvocations	Numeric	Total number of messages processed by this node
NumberOfInputTerminals	Numeric	Number of input terminals
NumberOfOutputTerminals	Numeric	Number of output terminals

The following table describes the inserts in message BIP2383I. One message is written for each terminal on each node.

Field	Data type	Details
ProcessID	Numeric	Process ID
Key	Numeric	Key used to associate related accounting and statistics BIP messages
Label	Character	Name of terminal
Type	Character	Type of terminal, one of: <ul style="list-style-type: none"> • Input • Output
CountOfInvocations	Numeric	Total number of invocations

z/OS SMF records for message flow accounting and statistics data

This topic describes the information that is written to z/OS SMF records for message flow accounting and statistics data.

The data records are type 117 records with the following identifiers:

- BipSMFDate
- BipSMFRecordHdr
- BipSMFTriplet
- BipSMFMessageFlow
- BipSMFThread
- BipSMFNode
- BipSMFTerminal

The following tables describe the contents of each of these records in the order listed above.

The following table describes the contents of the BipSMFDate record.

Field	Data type	Details
YYYY	signed short int	2 byte year
MM	char	1 byte month
DD	char	1 byte day

The following table describes the contents of the BipSMFRecordHdr record.

Field	Data type	Details
SM117LEN	unsigned short int	SMF record length

Field	Data type	Details
SM117SEG	unsigned short int	System reserved
SM117FLG	char	System indicator
SM117RTY	char	Record type 117 (x'75')
SM117TME	unsigned int	Time when SMF moved the record (time since midnight in hundredths of a second)
SM117DTE	unsigned int	Date when SMF moved the record in packed decimal form 0cyydddF where: c is 0 (19xx) or 1 (20xx) yy is the current year (0-99) ddd is the current day (1-366) F is the sign
SM117SID	unsigned int	System ID
SM117SSI	unsigned int	Subsystem ID
SM117STY	unsigned short int	Record subtype, one of : <ul style="list-style-type: none"> • 1 (only message flow or threads data is being collected) • 2 (node data is being collected)¹
SM117TCT	unsigned int	Count of triplets
SM117SRT	unsigned char	Record type, one of: <ul style="list-style-type: none"> • Archive • Snapshot
SM117SRC	unsigned char	Record code, one of: <ul style="list-style-type: none"> • 00 = None • 01 = Major Interval • 02 = Snapshot • 03 = Shutdown • 04 = Redeploy • 05 = Stats Settings Modified
SM117RSQ	unsigned short int	Sequence number of the record when multiple records are written for a collection interval.
SM117NOR	unsigned short int	Total number of related records in a collection interval.
Note:		
1. When only nodes data is being collected, a single subtype 2 record is written. If nodes and terminals data is being collected, multiple subtype 2 records are written.		

The following table describes the contents of the BipSMFTriplet record.

Field	Data type	Details
TRPLTOSE	signed int	Offset of record from start of SMF record
TRPLTDLE	signed short int	Length of data type
TRPLTNDR	signed short int	Number of data types in SMF record

The following table describes the contents of the BipSMFMessageFlow record.

Field	Data type	Details
IMFLID	short int	Control block hex ID (BipSMFMessageFlow_ID)
IMFLEN	short int	Length of control block

Field	Data type	Details
IMFLEYE	char[4]	Eyecatcher (IMFL)
IMFLVER	int	Version number (BipSMFRecordVersion)
IMFLBKNM	char[32]	Broker name
IMFLBKID	char[36]	Broker universal unique identifier
IMFLEXNM	char[32]	Execution group name
IMFLEXID	char[36]	Execution group universal unique identifier
IMFLMFNM	char[32]	Message flow name
IMFLSTDT	BipSMFDate	Interval start date
IMFLSTTM	unsigned int	Interval start time (format as for SM117TME)
IMFLENDT	BipSMFDate	Interval end date
IMFLENTM	unsigned int	Interval end time (format as for SM117TME)
IMFLTPTM	long long int	Total elapsed time spent processing input messages (8 bytes binary, microseconds)
IMFLMXTM	long long int	Maximum elapsed time spent processing an input message (8 bytes binary, microseconds)
IMFLMNTM	long long int	Minimum elapsed time spent processing an input message (8 bytes binary, microseconds)
IMFLTPCP	long long int	Total CPU time spent processing input messages (8 bytes binary, microseconds)
IMFLMXCP	long long int	Maximum CPU time spent processing an input message (8 bytes binary, microseconds)
IMFLMNCP	long long int	Minimum CPU time spent processing an input message (8 bytes binary, microseconds)
IMFLWTCP	long long int	Total CPU time spent waiting for input messages (8 bytes binary, microseconds)
IMFLWTIN	long long int	Total elapsed time spent waiting for input messages (8 bytes binary, microseconds)
IMFLTPMG	unsigned int	Total number of messages processed
IMFLTSMG	long long int	Total size of input messages (bytes)
IMFLMXMG	long long int	Maximum input message size (bytes)
IMFLMNMG	long long int	Minimum input message size (bytes)
IMFLTHDP	unsigned int	Number of threads in pool
IMFLTHDM	unsigned int	Number of times the maximum number of threads is reached
IMFLERMQ ¹	unsigned int	Number of MQGET errors (MQInput node) or Web services errors (HTTPInput node)
IMFLERMG ²	unsigned int	Number of messages that contain errors
IMFLERPR	unsigned int	Number of errors processing a message
IMFLTMOU	unsigned int	Number of timeouts processing a message (AggregateReply node only)
IMFLCMIT	unsigned int	Number of transaction commits
IMFLBKOU	unsigned int	Number of transaction backouts
IMFLACCT	char[32]	Accounting origin

Field	Data type	Details
Notes:		
1. For example, a conversion error occurs when the message is got from the queue.		
2. These include exceptions that are thrown downstream of the input node, and errors detected by the input node after it has successfully retrieved the message from the queue (for example, a format error).		

The following table describes the contents of the BipSMFThread record.

Field	Data type	Details
ITHDID	short int	Control block hex ID (BipSMFThread_ID)
ITHDLEN	short int	Length of control block
ITHDEYE	char[4]	Eyecatcher (ITHD)
ITHDVER	int	Version number (BipSMFRecordVersion)
ITHDNBR	unsigned int	Relative thread number in pool
ITHDTPMG	unsigned int	Total number of messages processed by thread
ITHDTPTM	long long int	Total elapsed time spent processing input messages (8 bytes binary, microseconds)
ITHDTPCP	long long int	Total CPU time spent processing input messages (8 bytes binary, microseconds)
ITHDWTCP	long long int	Total CPU time spent waiting for input messages (8 bytes binary, microseconds)
ITHDWTIN	long long int	Total elapsed time spent waiting for input messages (8 bytes binary, microseconds)
ITHDTSMG	long long int	Total size of input messages (bytes)
ITHDMXMG	long long int	Maximum size of input messages (bytes)
ITHDMNMG	long long int	Minimum size of input messages (bytes)

The following table describes the contents of the BipSMFNode record.

Field	Data type	Details
INODID	short int	Control block hex ID (BipSMFNode_ID)
INODLEN	short int	Length of control block
INODEYE	char[4]	Eyecatcher (INOD)
INODVER	int	Version number (BipSMFRecordVersion)
INODNDNM	char[32]	Name of node (Label)
INODTYPE	char[32]	Type of node
INODTPTM	long long int	Total elapsed time spent processing input messages (8 bytes binary, microseconds)
INODMXTM	long long int	Maximum elapsed time spent processing input messages (8 bytes binary, microseconds)
INODMNTM	long long int	Minimum elapsed time spent processing input messages (8 bytes binary, microseconds)
INODTPCP	long long int	Total CPU time spent processing input messages (8 bytes binary, microseconds)
INODMXCP	long long int	Maximum CPU time spent processing input messages (8 bytes binary, microseconds)

Field	Data type	Details
INODMNCP	long long int	Minimum CPU time spent processing input messages (8 bytes binary, microseconds)
INODTPMG	unsigned int	Total number of messages processed by this node
INODNITL	unsigned int	Number of input terminals
INODNOTL	unsigned int	Number of output terminals

The following table describes the contents of the BipSMFTerminal record.

Field	Data type	Details
ITRMID	short int	Control block hex ID (BipSMFTerminal_ID)
ITRMLN	short int	Length of control block
ITRMEYE	char[4]	Eyecatcher (ITRM)
ITRMVER	int	Version number (BipSMFRecordVersion)
ITRMTLNM	char[32]	Name of terminal
ITRMTYPE	char[8]	Type of terminal, one of: <ul style="list-style-type: none"> • Input • Output
ITRMTINV	unsigned int	Total number of invocations

Example message flow accounting and statistics data

The following topics give example output in two formats:

- XML publication
- User trace entries

An example is not provided for z/OS SMF records, because these contain hexadecimal data and are not easily viewed in that form. To view SMF records, use any available utility program that processes SMF records. For example, you can download WebSphere MQ SupportPac IS11, which generates formatted SMF records that are very similar to formatted user trace entries.

Example of an XML publication for message flow accounting and statistics

This example shows an XML publication that contains message flow accounting and statistics data.

The following example shows what is generated for a snapshot report. The content of this publication message shows that the message flow is called *XMLflow*, and that it is running in an execution group named *default* on broker *MQ02BRK*. The message flow contains the following nodes:

- An MQInput node called *INQueue3*
- An MQOutput node called *OUTQueue*
- An MQOutput node called *FAILQueue*

The MQInput node's Out terminal is connected to the OUTQueue node. The MQInput node's Failure terminal is connected to the FAILQueue node.

During the interval for which statistics have been collected, this message flow processed no messages.

A publication that is generated for this data always includes the appropriate folders, even if there is no current data.

The following command has been issued to achieve these results:

```
mqsiexchangeflowstats MQ02BRK -s -c active -e default -f XMLFlow -n advanced -t basic -b basic -o xml
```

Blank lines have been added between folders to improve readability.

The broker takes information about statistics and accounting from the operating system. On some operating systems, such as Windows, UNIX, and Linux, rounding can occur because the system calls that are used to determine the CPU times are not sufficiently granular. This rounding might affect the accuracy of the data.

The following example is the subscription message. The <psc> and <mcd> elements are part of the RFH header.

```
<psc>
  <Command>Publish</Command>
  <PubOpt>RetainPub</PubOpt>
  <Topic>$SYS/Broker/MQ02BRK/StatisticsAccounting/SnapShot/default/XMLflow
</Topic>
</psc>

<mcd>
  <Msd>xml</Msd>
</mcd>
```

The following example is the publication that the broker generates:

```
<WMQIStatisticsAccounting RecordType="SnapShot" RecordCode="Snapshot">

<MessageFlow BrokerLabel="MQ02BRK"
  BrokerUUID="7d951e31-f200-0000-0080-efe1b9d849dc"
  ExecutionGroupName="default"
  ExecutionGroupUUID="77cf1e31-f200-0000-0080-efe1b9d849dc"
  MessageFlowName="XMLflow" StartDate="2003-01-17"
  StartTime="14:44:34.581320" EndDate="2003-01-17" EndTime="14:44:44.582926"
  TotalElapsedTime="0"
  MaximumElapsedTime="0" MinimumElapsedTime="0" TotalCPUTime="0"
  MaximumCPUTime="0" MinimumCPUTime="0" CPUTimeWaitingForInputMessage="685"
  ElapsedTimeWaitingForInputMessage="10001425" TotalInputMessages="0"
  TotalSizeOfInputMessages="0" MaximumSizeOfInputMessages="0"
  MinimumSizeOfInputMessages="0" NumberOfThreadsInPool="1"
  TimesMaximumNumberOfThreadsReached="0" TotalNumberOfMQErrors="0"
  TotalNumberOfMessagesWithErrors="0" TotalNumberOfErrorsProcessingMessages="0"
  TotalNumberOfTimeOutsWaitingForRepliesToAggregateMessages="0"
  TotalNumberOfCommits="0" TotalNumberOfBackouts="0" AccountingOrigin="DEPT1"/>

<Threads Number="1">
<ThreadStatistics Number="5" TotalNumberOfInputMessages="0"
TotalElapsedTime="0" TotalCPUTime="0" CPUTimeWaitingForInputMessage="685"
ElapsedTimeWaitingForInputMessage="10001425" TotalSizeOfInputMessages="0"
MaximumSizeOfInputMessages="0" MinimumSizeOfInputMessages="0"/>
</Threads>

<Nodes Number="3">

<NodeStatistics Label="FAILQueue" Type="MQOutput" TotalElapsedTime="0"
  MaximumElapsedTime="0" MinimumElapsedTime="0" TotalCPUTime="0"
  MaximumCPUTime="0" MinimumCPUTime="0" CountOfInvocations="0"
  NumberOfInputTerminals="1" NumberOfOutputTerminals="2">
```

```

<TerminalStatistics Label="failure" Type="Output" CountOfInvocations="0"/>
<TerminalStatistics Label="in" Type="Input" CountOfInvocations="0"/>
<TerminalStatistics Label="out" Type="Output" CountOfInvocations="0"/>
</NodeStatistics>

<NodeStatistics Label="INQueue3" Type="MQInput" TotalElapsedTime="0"
  MaximumElapsedTime="0" MinimumElapsedTime="0" TotalCPUTime="0"
  MaximumCPUTime="0" MinimumCPUTime="0" CountOfInvocations="0"
  NumberOfInputTerminals="0" NumberOfOutputTerminals="3">
<TerminalStatistics Label="catch" Type="Output" CountOfInvocations="0"/>
<TerminalStatistics Label="failure" Type="Output" CountOfInvocations="0"/>
<TerminalStatistics Label="out" Type="Output" CountOfInvocations="0"/>
</NodeStatistics>

<NodeStatistics Label="OUTQueue" Type="MQOutput" TotalElapsedTime="0"
  MaximumElapsedTime="0" MinimumElapsedTime="0" TotalCPUTime="0"
  MaximumCPUTime="0" MinimumCPUTime="0" CountOfInvocations="0"
  NumberOfInputTerminals="1" NumberOfOutputTerminals="2">
<TerminalStatistics Label="failure" Type="Output" CountOfInvocations="0"/>
<TerminalStatistics Label="in" Type="Input" CountOfInvocations="0"/>
<TerminalStatistics Label="out" Type="Output" CountOfInvocations="0"/>
</NodeStatistics>

</Nodes>

</WMQIStatisticsAccounting>

```

Example of user trace entries for message flow accounting and statistics

This example shows a user trace that contains message flow accounting and statistics data.

The following example shows what is generated for a snapshot report. The messages that are written to the trace show that the message flow is called *myExampleFlow*, and that it is running in an execution group named *default* on broker *MQ01BRK*. The message flow contains the following nodes:

- An MQInput node called *inNode*
- A Compute node called *First1*
- An MQOutput node called *outNode*

The nodes are connected together (Out terminal to In terminal for each connection).

During the interval for which statistics have been collected, this message flow processed 150 input messages.

The records show that two threads are assigned to this message flow. One thread is assigned when the message flow is deployed (the default number); an additional thread (thread 0) listens on the input queue. The listening thread starts additional threads to process input messages that are dependent on the number of instances that you have configured for the message flow, and on the rate of arrival of the input messages on the input queue.

The following command has been issued to achieve these results:

```
mqsichange flowstats MQ01BRK -s -c active -e default -f myExampleFlow -n advanced -t basic -b basic
```

The trace entries have been retrieved with the `mqsireadlog` command and formatted using the `mqsiformatlog` command. The output from `mqsiformatlog` is shown below. Line breaks have been added to aid readability.

The broker takes information about statistics and accounting from the operating system. On some operating systems, such as Windows, UNIX, and Linux, rounding can occur because the system calls that are used to determine the CPU times are not sufficiently granular. This rounding might affect the accuracy of the data.

```
BIP2380I: WMQI message flow statistics. ProcessID='328467', Key='6', Type='Snapshot', Reason='Snapshot',
BrokerLabel='MQ01BRK', BrokerUUID='18792e66-e100-0000-0080-f197e5ed81bd',
ExecutionGroupName='default', ExecutionGroupUUID='15d4314a-3607-11d4-8000-09140f7b0000',
MessageFlowName='myExampleFlow',
StartDate='2003-05-20', StartTime='13:44:31.885862',
EndDate='2003-05-20', EndTime='13:44:51.310080',
TotalElapsedTime='9414843', MaximumElapsedTime='1143442', MinimumElapsedTime='35154',
TotalCPUTime='760147', MaximumCPUTime='70729', MinimumCPUTime='3124',
CPUTimeWaitingForInputMessage='45501', ElapsedTimeWaitingForInputMessage='11106438',
TotalInputMessages='150', TotalSizeOfInputMessages='437250',
MaximumSizeOfInputMessages='2915', MinimumSizeOfInputMessages='2915',
NumberOfThreadsInPool='1', TimesMaximumNumberOfThreadsReached='150',
TotalNumberOfMQErrors='0', TotalNumberOfMessagesWithErrors='0',
TotalNumberOfErrorsProcessingMessages='0', TotalNumberOfTimeOuts='0',
TotalNumberOfCommits='150', TotalNumberOfBackouts='0', AccountingOrigin="DEPT2".
Statistical information for message flow 'myExampleFlow' in broker 'MQ01BRK'.
This is an information message produced by WMQI statistics.
```

```
BIP2381I: WMQI thread statistics. ProcessID='328467', Key='6', Number='0',
TotalNumberOfInputMessages='0',
TotalElapsedTime='0', TotalCPUTime='0', CPUTimeWaitingForInputMessage='110',
ElapsedTimeWaitingForInputMessage='5000529', TotalSizeOfInputMessages='0',
MaximumSizeOfInputMessages='0', MinimumSizeOfInputMessages='0'.
Statistical information for thread '0'.
This is an information message produced by WMQI statistics.
```

```
BIP2382I: WMQI thread statistics. ProcessID='328467', Key='6', Number='18',
TotalNumberOfInputMessages='150',
TotalElapsedTime='9414843', TotalCPUTime='760147', CPUTimeWaitingForInputMessage='45391',
ElapsedTimeWaitingForInputMessage='6105909', TotalSizeOfInputMessages='437250',
MaximumSizeOfInputMessages='2915', MinimumSizeOfInputMessages='2915'.
Statistical information for thread '18'.
This is an information message produced by WMQI statistics.
```

```
BIP2382I: WMQI node statistics. ProcessID='328467', Key='6',
Label='First1', Type='ComputeNode',
TotalElapsedTime='6428815', MaximumElapsedTime='138261', MinimumElapsedTime='28367',
TotalCPUTime='604060', MaximumCPUTime='69645', MinimumCPUTime='2115',
CountOfInvocations='150', NumberOfInputTerminals='1', NumberOfOutputTerminals='2'.
Statistical information for node 'First1'.
This is an information message produced by WMQI statistics.
```

```
BIP2383I: WMQI terminal statistics. ProcessID='328467', Key='6',
Label='failure', Type='Output', CountOfInvocations='0',
Statistical information for terminal 'failure'.
This is an information message produced by WMQI statistics.
```

```
BIP2383I: WMQI terminal statistics. ProcessID='328467', Key='6',
Label='in', Type='Input', CountOfInvocations='150',
Statistical information for terminal 'in'.
This is an information message produced by WMQI statistics.
```

```
BIP2383I: WMQI terminal statistics. ProcessID='328467', Key='6',
Label='out', Type='Output', CountOfInvocations='150',
Statistical information for terminal 'out'.
This is an information message produced by WMQI statistics.
```

BIP2382I: WMQI node statistics. ProcessID='328467', Key='6', Label='inNode', Type='MQInputNode', TotalElapsedTime='1813446', MaximumElapsedTime='1040209', MinimumElapsedTime='1767', TotalCPUTime='70565', MaximumCPUTime='686', MinimumCPUTime='451', CountOfInvocations='150', NumberOfInputTerminals='0', NumberOfOutputTerminals='3'. Statistical information for node 'inNode'.
This is an information message produced by WMQI statistics.

BIP2383I: WMQI terminal statistics. ProcessID='328467', Key='6', Label='catch', Type='Output', CountOfInvocations='0', Statistical information for terminal 'catch'.
This is an information message produced by WMQI statistics.

BIP2383I: WMQI terminal statistics. ProcessID='328467', Key='6', Label='failure', Type='Output', CountOfInvocations='0', Statistical information for terminal 'failure'.
This is an information message produced by WMQI statistics.

BIP2383I: WMQI terminal statistics. ProcessID='328467', Key='6', Label='out', Type='Output', CountOfInvocations='150', Statistical information for terminal 'out'.
This is an information message produced by WMQI statistics.

BIP2382I: WMQI node statistics. ProcessID='328467', Key='6', Label='outNode', Type='MQOutputNode', TotalElapsedTime='1172582', MaximumElapsedTime='177516', MinimumElapsedTime='3339', TotalCPUTime='85522', MaximumCPUTime='762', MinimumCPUTime='536', CountOfInvocations='150', NumberOfInputTerminals='1', NumberOfOutputTerminals='2'. Statistical information for node 'outNode'.
This is an information message produced by WMQI statistics.

BIP2383I: WMQI terminal statistics. ProcessID='328467', Key='6', Label='failure', Type='Output', CountOfInvocations='0', Statistical information for terminal 'failure'.
This is an information message produced by WMQI statistics.

BIP2383I: WMQI terminal statistics. ProcessID='328467', Key='6', Label='in', Type='Input', CountOfInvocations='150', Statistical information for terminal 'in'.
This is an information message produced by WMQI statistics.

BIP2383I: WMQI terminal statistics. ProcessID='328467', Key='6', Label='out', Type='Output', CountOfInvocations='0', Statistical information for terminal 'out'.
This is an information message produced by WMQI statistics.

Coordinated message flows

The following topics provide reference information for database use in coordinated message flows:

- “Database connections for coordinated message flows”
- “Database support for coordinated message flows” on page 1399

Database connections for coordinated message flows

When you configure a message flow to access a database, the broker establishes a connection to that database based on the ODBC DSN. To coordinate the database updates with other updates (determined by the configuration you have set for each node that accesses a database), the broker makes a connection for each transaction mode for each DSN accessed on each message flow thread.

Therefore if you set the *Transaction Mode* property for one node in the message flow to *Automatic* and for another node to *Commit*, the broker establishes two separate connections to this DSN from the same thread. Take this into account when you calculate the number of connections required between a broker and a specific DSN.

For further information about connections made by the broker to user databases, see *User database connections*.

Connections to user databases are in addition to the runtime connections that are required by the broker (to the DB2, Oracle, Sybase, or SQL Server database that is defined to hold its internal information). For details of these connections, refer to *Enabling ODBC connections to the databases*.

Database support for coordinated message flows

If the message flow processing includes interaction with an external database, the transaction can be coordinated using XA technology.

This ensures that all participants update or return to a consistent state. This external coordination support is provided by the underlying WebSphere MQ facilities on distributed systems, and by Resource Recovery Services (RRS) on z/OS.

The following databases provide the correct level of XA support for coordinating message flows on distributed systems:

- DB2
Globally coordinated message flows that involve a DB2 resource manager are supported on DB2 Universal Database V8.
- Oracle
- Sybase

On z/OS, database support for coordinated message flows is provided by DB2 only.

Element definitions for message parsers

The topics in this section discuss data types for the WebSphere MQ headers, and define the element names, types, and attributes for each of the supported headers:

- “Data types of fields and elements” on page 1400
- “The MQCFH parser” on page 1403
- “The MQCIH parser” on page 1403
- “The MQDLH parser” on page 1404
- “The MQIIH parser” on page 1405
- “The MQMD parser” on page 1405
- “The MQMDE parser” on page 1406
- “The MQRFH parser” on page 1407
- “The MQRFH2 and MQRFH2C parsers” on page 1407
- “The MQRMH parser” on page 1408
- “The MQSAPH parser” on page 1408
- “The MQWIH parser” on page 1409
- “The SMQ_BMH parser” on page 1409

For each parser, the following terms are defined:

- Root element name: the name of the syntax element created by the parser at the root of its own part of the tree.
- Class name: the name by which the parser defines itself to WebSphere Message Broker.

Data types of fields and elements

The fields within WebSphere MQ headers and other subtrees built from the message are of a particular data type. When you manipulate the messages and their headers using ESQL in the message flow nodes, be aware of type information in field references:

- “Data types of the fields in the WebSphere MQ headers”
- “Data types for elements in the Properties subtree”
- “Data types for elements in the DestinationData subtree” on page 1401
- Data types for elements in an MRM message
- “Data types for an unstructured (BLOB) message” on page 1403
- Field names of the IDOC parser structures

Data types of the fields in the WebSphere MQ headers

The fields in the WebSphere MQ headers have specific data types. Parsers are supplied for the WebSphere MQ headers listed below. The parsers determine the data type of each field in the header:

- “The MQCFH parser” on page 1403
- “The MQCIH parser” on page 1403
- “The MQDLH parser” on page 1404
- “The MQIIH parser” on page 1405
- “The MQMD parser” on page 1405
- “The MQMDE parser” on page 1406
- “The MQRFH parser” on page 1407
- “The MQRFH2 and MQRFH2C parsers” on page 1407
- “The MQRMH parser” on page 1408
- “The MQSAPH parser” on page 1408
- “The MQWIH parser” on page 1409
- “The SMQ_BMH parser” on page 1409

The mapping of the WebSphere MQ data types to the data types used in the broker is shown in the table below:

Data type of the field	Represented as
MLONG	INTEGER
MQCHAR, MQCHAR4	CHARACTER
MQBYTE, MQBYTE _n	BLOB

Data types for elements in the Properties subtree

A parser is supplied for the Properties subtree; it associates each field with a specific data type.

The fields and data type of each field are shown in the table below:

Data type of the element	Represented as
CodedCharSetId	INTEGER

Data type of the element	Represented as
CreationTime	TIMESTAMP
ContentType	CHARACTER
Encoding	INTEGER
ExpirationTime	TIMESTAMP
MessageFormat	CHARACTER
IdentityMappedIssuedBy	CHARACTER
IdentityMappedPassword	CHARACTER
IdentityMappedToken	CHARACTER
IdentityMappedType	CHARACTER
IdentitySourceIssuedBy	CHARACTER
IdentitySourcePassword	CHARACTER
IdentitySourceToken	CHARACTER
IdentitySourceType	CHARACTER
MessageSet	CHARACTER
MessageType	CHARACTER
Persistence	BOOLEAN
Priority	INTEGER
ReplyIdentifier	CHARACTER
ReplyProtocol	CHARACTER
Topic (this field contains a list)	CHARACTER
Transactional	BOOLEAN

Data types for elements in the DestinationData subtree

The DestinationData subtree is part of the Destination subtree in the LocalEnvironment. LocalEnvironment trees are created by input nodes when they receive a message and, optionally, by compute nodes. When created, they are empty but you can create data in them by using ESQL statements coded in any of the SQL nodes.

The Destination subtree consists of subtrees for zero or more protocols, for example WebSphere MQ and WebSphere MQ Everyplace, or a subtree for routing destinations (RouterList), or both.

The protocol tree has two children:

- Defaults is the first element. There can be only one.
- DestinationData is the following element, and can be repeated any number of times, to represent each destination to which a message is sent.

“Local environment tree structure” on page 64 includes a picture of a typical tree, showing a Destination tree that has both protocol and RouterList subtrees.

The structure of data within the DestinationData folder is the same as that in Defaults for the same protocol, and can be used to override the default values in Defaults. You can therefore set up Defaults to contain values that are common to all destinations, and set only the unique values in each DestinationData subtree. If

a value is set neither in DestinationData, nor in Defaults, the value that you have set for the corresponding node property is used.

The fields, data type, and valid values for each element of Defaults and DestinationData subtrees for WebSphere MQ are shown in the following table. “MQOutput node” on page 1023 describes the corresponding node properties.

Refer to “Accessing the LocalEnvironment tree” on page 308 for information about using DestinationData.

Data type of the element	Represented as	Corresponding node property	Valid values
queueManagerName	CHARACTER	Queue Manager Name	
queueName	CHARACTER	Queue Name	
transactionMode	CHARACTER	Transaction Mode	no, yes, automatic
persistenceMode	CHARACTER	Persistence Mode	no, yes, automatic, asQdef
newMsgId	CHARACTER	New Message ID	no, yes
newCorrelId	CHARACTER	New Correlation ID	no, yes
segmentationAllowed	CHARACTER	Segmentation Allowed	no, yes
alternateUserAuthority	CHARACTER	Alternate User Authority	no, yes
replyToQMgr	CHARACTER	Reply-to queue manager	
replyToQ	CHARACTER	Reply-to queue	

Case-sensitivity for data types and values

When you create these fields in the DestinationData folder, you need to enter the data type and value exactly as shown in the table. If any variations in spelling or case are used then these fields or values are ignored in the DestinationData records and the next available value is used.

For example, the following ESQL samples could result in unexpected output:

```
SET OutputLocalEnvironment.Destination.MQ.DestinationData[1].persistenceMode = 'YES';
SET OutputLocalEnvironment.Destination.MQ.DestinationData[2].PersistenceMode = 'yes';
```

In each case the DestinationData folder might not write a persistent message for these destinations. In the first example the persistenceMode field has been given a value of 'YES', which is not one of the valid values listed in the table above and this value is ignored. In the second example, the field named 'PersistenceMode' is specified incorrectly and is ignored. Either the persistenceMode value of the Defaults folder, or the value of the associated attribute on the MQOutput node will be used. If this causes a value of 'no' or 'automatic' to be used, a persistent message will not be written.

If a DestinationData folder is producing unexpected output, you should check that you have used the correct case and spelling in the fields and values used.

Data types for an unstructured (BLOB) message

A parser is supplied for the body of a message in the BLOB domain; it associates each field with a specific data type.

An unstructured (BLOB) message has the data types shown in the following table.

Data type of the element	Represented as
BLOB	BLOB
UnknownParserName	CHARACTER

If the broker cannot find a parser that corresponds to the domain that is requested by the user, the message is assigned to the BLOB parser, and the requested domain is preserved in the *UnknownParserName* field.

This information is used by the header integrity routine (described in “Parsers” on page 74) to ensure that the semantic meaning of the message is preserved.

The MQCFH parser

The root name for this parser is MQPCF. The class name is MQPCF.

The table below lists the elements native to the MQCFH header:

Element Name	Element Data Type	Element Attributes
Type	INTEGER	Name Value
StrucLength	INTEGER	Name Value
Version	INTEGER	Name Value
Command	INTEGER	Name Value
MsgSeqNumber	INTEGER	Name Value
Control	INTEGER	Name Value
CompCode	INTEGER	Name Value
Reason	INTEGER	Name Value
ParameterCount	INTEGER	Name Value

For further information about this header and its contents, see the *WebSphere MQ Programmable Command Formats and Administration Interface* book.

The MQCIH parser

The root name for this parser is MQCIH. The class name is MQCICS.

The table below lists the elements native to the MQCIH header:

Element Name	Element Data Type	Element Attributes
Format	CHARACTER	Name Value
Version	INTEGER	Name Value
Encoding	INTEGER	Name Value
CodedCharSetId	INTEGER	Name Value

Element Name	Element Data Type	Element Attributes
Flags	INTEGER	Name Value
ReturnCode	INTEGER	Name Value
CompCode	INTEGER	Name Value
Reason	INTEGER	Name Value
UOWControl	INTEGER	Name Value
GetWaitInterval	INTEGER	Name Value
LinkType	INTEGER	Name Value
OutputDataLength	INTEGER	Name Value
FacilityKeepTime	INTEGER	Name Value
ADSDescriptor	INTEGER	Name Value
ConversationalTask	INTEGER	Name Value
TaskEndStatus	INTEGER	Name Value
Facility	BLOB	Name Value
Function	CHARACTER	Name Value
AbendCode	CHARACTER	Name Value
Authenticator	CHARACTER	Name Value
Reserved1	CHARACTER	Name Value
ReplyToFormat	CHARACTER	Name Value
RemoteSysId	CHARACTER	Name Value
RemoteTransId	CHARACTER	Name Value
TransactionId	CHARACTER	Name Value
FacilityLike	CHARACTER	Name Value
AttentionId	CHARACTER	Name Value
StartCode	CHARACTER	Name Value
CancelCode	CHARACTER	Name Value
NextTransactionId	CHARACTER	Name Value
Reserved2	CHARACTER	Name Value
Reserved3	CHARACTER	Name Value
CursorPosition	INTEGER	Name Value
ErrorOffset	INTEGER	Name Value
InputItem	INTEGER	Name Value
Reserved4	INTEGER	Name Value

The MQDLH parser

The root name for this parser is MQDLH. The class name is MQDEAD.

The table below lists the elements native to the MQDLH header:

Element Name	Element Data Type	Element Attributes
Format	CHARACTER	Name Value
Version	INTEGER	Name Value

Element Name	Element Data Type	Element Attributes
Encoding	INTEGER	Name Value
CodedCharSetId	INTEGER	Name Value
Reason	INTEGER	Name Value
DestQName	CHARACTER	Name Value
DestQMgrName	CHARACTER	Name Value
PutApplType	INTEGER	Name Value
PutApplName	CHARACTER	Name Value
PutDate	TIMESTAMP/CHARACTER	Name Value
PutTime	TIMESTAMP/CHARACTER	Name Value

The MQIIH parser

The root name for this parser is MQIIH. The class name is MQIMS.

The table below lists the elements native to the MQIIH header:

Element Name	Element Data Type	Element Attributes
Format	CHARACTER	Name Value
Version	INTEGER	Name Value
Encoding	INTEGER	Name Value
CodedCharSetId	INTEGER	Name Value
Flags	INTEGER	Name Value
LTermOverride	CHARACTER	Name Value
MFSMapName	CHARACTER	Name Value
ReplyToFormat	CHARACTER	Name Value
Authenticator	CHARACTER	Name Value
TranInstanceId	BLOB	Name Value
TranState	CHARACTER	Name Value
CommitMode	CHARACTER	Name Value
SecurityScope	CHARACTER	Name Value
Reserved	CHARACTER	Name Value

The MQMD parser

The root name for this parser is MQMD. The class name is MQHMD.

The table below lists the orphan elements adopted by the MQMD header:

Element Name	Element Data Type	Element Attributes
SourceQueue	CHARACTER	Name Value
Transactional	BOOLEAN	Name Value

The table below lists the elements native to the MQMD header:

Element Name	Element Data Type	Element Attributes
Format	CHARACTER	Name Value
Version	INTEGER	Name Value
Report	INTEGER	Name Value
MsgType	INTEGER	Name Value
Expiry ¹	INTEGER/GMTTIMESTAMP	Name Value
Feedback	INTEGER	Name Value
Encoding	INTEGER	Name Value
CodedCharSetId	INTEGER	Name Value
Priority	INTEGER	Name Value
Persistence	INTEGER	Name Value
MsgId	BLOB	Name Value
CorrelId	BLOB	Name Value
BackoutCount	INTEGER	Name Value
ReplyToQ	CHARACTER	Name Value
ReplyToQMgr	CHARACTER	Name Value
UserIdentifier	CHARACTER	Name Value
AccountingToken	BLOB	Name Value
ApplIdentityData	CHARACTER	Name Value
PutAppIType	INTEGER	Name Value
PutAppIName	CHARACTER	Name Value
PutDate	TIMESTAMP/CHARACTER	Name Value
PutTime	TIMESTAMP/CHARACTER	Name Value
ApplOriginData	CHARACTER	Name Value
GroupId	BLOB	Name Value
MsgSeqNumber	INTEGER	Name Value
Offset	INTEGER	Name Value
MsgFlags	INTEGER	Name Value
OriginalLength	INTEGER	Name Value

Note:

1. The Expiry field in the MQMD is a special case:

- An INTEGER value represents an expiry interval in tenths of a second. If the Expiry field is set to -1, it represents an unlimited expiry interval (that is, the message never expires) If the Expiry field is a positive INTEGER, it represents an expiry interval of that number of tenths of a second (for example, if it is set to 4, it represents 4 tenths of a second, if it is set to 15, it represents one and a half seconds).
- A GMTTIMESTAMP value represents a specific expiration time.

If Expiry contains a GMTTIMESTAMP in the past, or an INTEGER of less than 1 (excluding -1), it is set to the value 1 (one tenth of a second, the minimum value).

The MQMDE parser

The root name for this parser is MQMDE. The class name is MQHMDE.

The table below lists the elements native to the MQMDE header:

Element Name	Element Data Type	Element Attributes
Format	CHARACTER	Name Value
Version	INTEGER	Name Value
Encoding	INTEGER	Name Value
CodedCharSetId	INTEGER	Name Value
Flags	INTEGER	Name Value
GroupId	BLOB	Name Value
MsgSeqNumber	INTEGER	Name Value
Offset	INTEGER	Name Value
MsgFlags	INTEGER	Name Value
OriginalLength	INTEGER	Name Value

The MQRFH parser

The root name for this parser is MQRFH. The class name is MQHRE.

The table below lists the elements native to the MQRFH header:

Element Name	Element Data Type	Element Attributes
Format	CHARACTER	Name Value
Version	INTEGER	Name Value
Encoding	INTEGER	Name Value
CodedCharSetId	INTEGER	Name Value
Flags	INTEGER	Name Value

Other name value elements might be present that contain information as parsed from or destined for the option buffer. The *MQSeries Publish/Subscribe User's Guide* provides further information about the MQRFH header.

The MQRFH2 and MQRFH2C parsers

The MQRFH2 header can be parsed using either the MQRFH2 parser or the MQRFH2C compact parser.

The root names for these parsers are MQRFH2 and MQRFH2C. The class names are MQHRE2 and MQHRE2C.

The following table lists the elements that are required for the MQRFH2 header:

Element Name	Element Data Type	Element Attributes
Format	CHARACTER	Name Value
Version	INTEGER	Name Value
Encoding	INTEGER	Name Value
CodedCharSetId	INTEGER	Name Value
Flags	INTEGER	Name Value
NameValueCCSID	INTEGER	Name Value

Other name and child name value elements might be present that contain information that is parsed from, or destined for, the option buffer. See MQRFH2 header for further information about this header.

The MQRMH parser

The root name for this parser is MQRMH. The class name is MQHREF.

The table below lists the elements native to the MQRMH header:

Element Name	Element Data Type	Element Attributes
Format	CHARACTER	Name Value
Version	INTEGER	Name Value
Encoding	INTEGER	Name Value
CodedCharSetId	INTEGER	Name Value
Flags	INTEGER	Name Value
ObjectType	CHARACTER	Name Value
ObjectInstanceId	BLOB	Name Value
SrcEnv	CHARACTER ¹	Name Value
SrcName	CHARACTER ²	Name Value
DestEnv	CHARACTER ³	Name Value
DestName	CHARACTER ⁴	Name Value
DataLogicalLength	INTEGER	Name Value
DataLogicalOffset	INTEGER	Name Value
DataLogicalOffset2	INTEGER	Name Value
Notes:		
1. This field represents both SrcEnvLength and Offset		
2. This field represents both SrcNameLength and Offset		
3. This field represents both DestEnvLength and Offset		
4. This field represents both DestNameLength and Offset		

The MQSAPH parser

The root name for this parser is MQSAPH. The class name is MQHSAP.

The table below lists the elements native to the MQSAPH header:

Element Name	Element Data Type	Element Attributes
Format	CHARACTER	Name Value
Version	INTEGER	Name Value
Encoding	INTEGER	Name Value
CodedCharSetId	INTEGER	Name Value
Flags	INTEGER	Name Value
Client	CHARACTER	Name Value
Language	CHARACTER	Name Value

Element Name	Element Data Type	Element Attributes
HostName	CHARACTER	Name Value
UserId	CHARACTER	Name Value
Password	CHARACTER	Name Value
SystemNumber	CHARACTER	Name Value
Reserved	BLOB	Name Value

The MQWIH parser

The root name for this parser is MQWIH. The class name is MQHWIH.

The table below lists the elements native to the MQWIH header:

Element Name	Element Data Type	Element Attributes
Format	CHARACTER	Name Value
Version	INTEGER	Name Value
Encoding	INTEGER	Name Value
CodedCharSetId	INTEGER	Name Value
Flags	INTEGER	Name Value
ServiceName	CHARACTER	Name Value
ServiceStep	CHARACTER	Name Value
MsgToken	BLOB	Name Value
Reserved	CHARACTER	Name Value

The SMQ_BMH parser

The root name for this parser is SMQ_BMH. The class name is SMQBAD.

The table below lists the elements native to the SMQ_BMH header:

Element Name	Element Data Type	Element Attributes
Format	CHARACTER	Name Value
Version	INTEGER	Name Value
Encoding	INTEGER	Name Value
CodedCharSetId	INTEGER	Name Value
ErrorType	INTEGER	Name Value
Reason	INTEGER	Name Value
PutApplType	INTEGER	Name Value
PutApplName	CHARACTER	Name Value
PutDate	TIMESTAMP/CHARACTER	Name Value
PutTime	TIMESTAMP/CHARACTER	Name Value

Message mappings

This section contains topics that provide reference information about message mapping:

- “Message Mapping editor”
 - Source pane
 - Target pane
 - Edit pane
 - Spreadsheet pane
- “Mapping node” on page 1420
 - Syntax
 - Functions
 - Casts
- “Migrating message mappings from Version 5.0” on page 1428
 - Migration restrictions

Message Mapping editor

You configure a message mapping using the Message Mapping editor, which you use to set values for:

- the message destination
- message headers
- message content

Here is an example of the Message Mapping editor. There are separate panes for working with sources, targets and expressions, as well as a spreadsheet view.

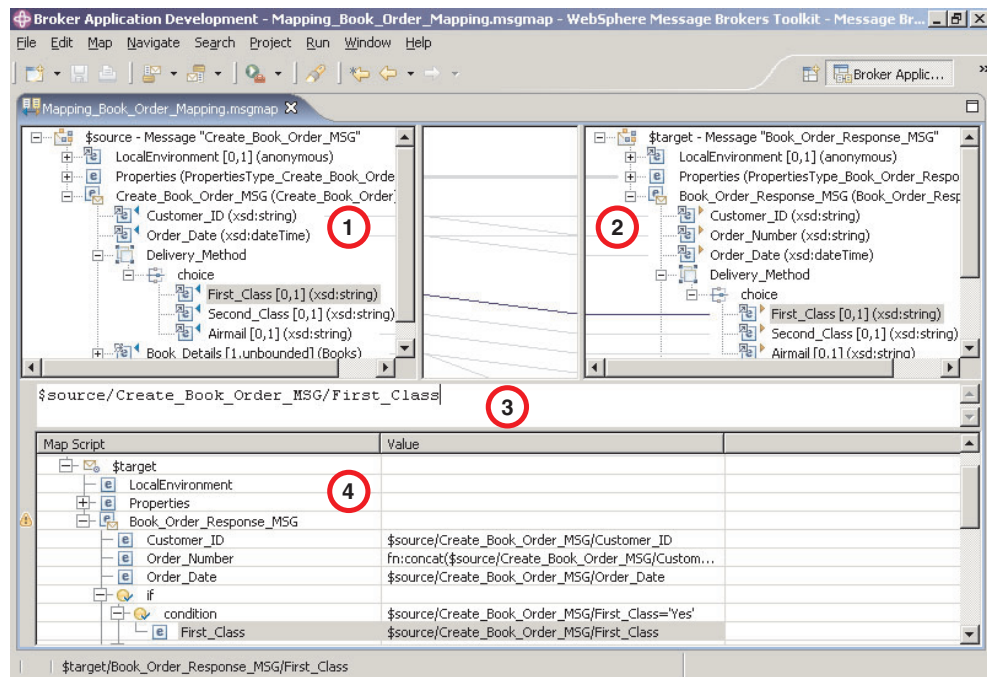

1. **Source pane:** displays a source message or database table
2. **Target pane:** displays a target message

3. **Edit pane:** displays the expression to be used to derive the target element value
4. **Spreadsheet pane:** displays a summary of the mappings in spreadsheet columns (each target field and its value)

Use the Message Mapping editor to perform various mapping tasks.

Wizards and dialog boxes are provided for tasks such as adding mappable elements, working with ESQL, and working with submaps. Mappings that are created with the Message Mapping editor are automatically validated and compiled, ready for adding to a broker archive (bar) file, and subsequent deployment to WebSphere Message Broker.

Message Mapping editor Source pane

The following example shows the “Message Mapping editor” on page 1410. The pane that is labelled as 1 in the example is the Source pane:

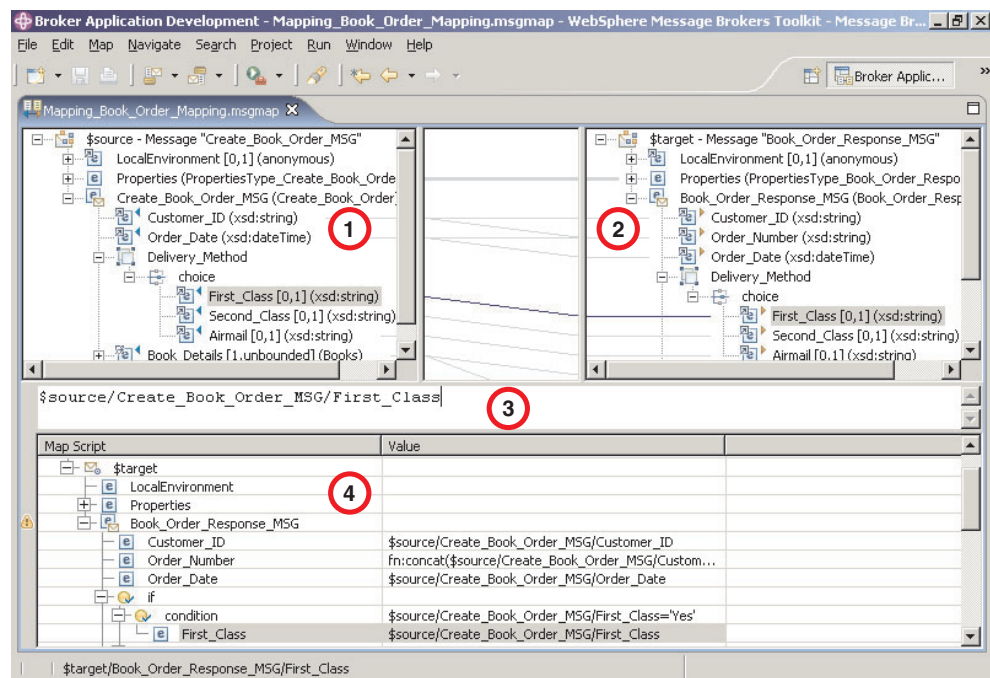

The following list describes the elements that are present in the Source pane:

- A source message is identified by \$source.
- A source database is identified by \$db:select.
- A mapped entry is indicated by a blue triangle alongside the element. In this example, Customer_ID and Order_Date are mapped.
- Square brackets contain minimum and maximum occurrences of an element.
- An optional field is indicated by [0,1]. In this example, First_Class is optional.
- A repeating field is indicated by [minoccurs, maxoccurs].
- A choice field is indicated by a choice line; under the choice line are the possible choices. In this example, First_Class, Second_Class, and Airmail are choices of Delivery_Method.
- The type of each element is indicated in round brackets after the element name.

- If the message schema uses namespaces, the namespace prefix is shown before the element name, separated by a colon.

Use the Source pane to invoke a number of actions, a list of which is displayed when you right-click within the Source pane. The following table describes the available actions.

Action	Description	Related tasks
Undo	Undo previous action	
Redo	Redo previous action	
Revert	Discard	
Open Declaration (message)	Display the element definition from the message set. For this action to be available, select any source message element except LocalEnvironment or Headers.	
Open Declaration (database)	Display the database, schema, or table definition from the database. For this action to be available, select any source database object.	
Show Derived Types	Hide or display derived types for an element in the source or target pane. For this action to be available, select a target element displayed as a specialization folder in the source pane.	
Show Substituting elements	Hide or display the substituting elements of the head element in the source or target pane. For this action to be available, select a target element displayed as a substitutions folder in the source pane.	
Add Sources and Targets	Add a message definition or a database table to a source. For this action to be available, select any source object.	“Adding messages or message components to the source or target” on page 492, “Adding a database as a source or target” on page 492
Go To	For this action to be available, select any source object.	

Action	Description	Related tasks
Delete (message)	<p>Remove a message and any existing maps from the source.</p> <p>For this action to be available, select the source message root (\$source).</p>	
Delete (database)	<p>Remove a database and any existing maps from the source.</p> <p>For this action to be available, select the source database root (\$db:select).</p>	
Map from Source	<p>Create a map between the focus source element and the focus target element.</p> <p>For this action to be available, select compatible source and target elements.</p>	<p>“Mapping a target element from source message elements” on page 481, “Mapping from source: by selection” on page 480</p>
Map by Name	<p>Create a map between the focus source element and the focus target element.</p> <p>For this action to be available, select compatible source and target elements.</p>	<p>“Mapping a target element from source message elements” on page 481, “Mapping from source: by name” on page 480</p>
Accumulate	<p>If the source and target fields contain numeric data types, this action maps all occurrences of a repeating source field to a non-repeating target, resulting in the sum of all the source elements.</p> <p>For this action to be available, select the source and target element.</p>	<p>“Configuring a repeating source and a non-repeating target” on page 488</p>
Create New Submap	<p>For this action to be available, select source and target elements that are either elements of complex types or wildcard elements.</p>	<p>“Creating and calling submaps and subroutines” on page 502, “Creating a new submap” on page 503, “Creating a new submap for a wildcard source” on page 504</p>
Call Existing Submap	<p>Call an existing submap</p>	<p>“Creating and calling submaps and subroutines” on page 502, “Calling a submap” on page 506</p>
Call ESQL Routine	<p>Call an ESQL routine</p>	<p>“Creating and calling submaps and subroutines” on page 502, “Calling an ESQL routine” on page 508</p>
Save	<p>Save the .msgmap file</p>	

Message Mapping editor Target pane

The following example shows the “Message Mapping editor” on page 1410. The pane that is labelled as 2 in the example is the Target pane:

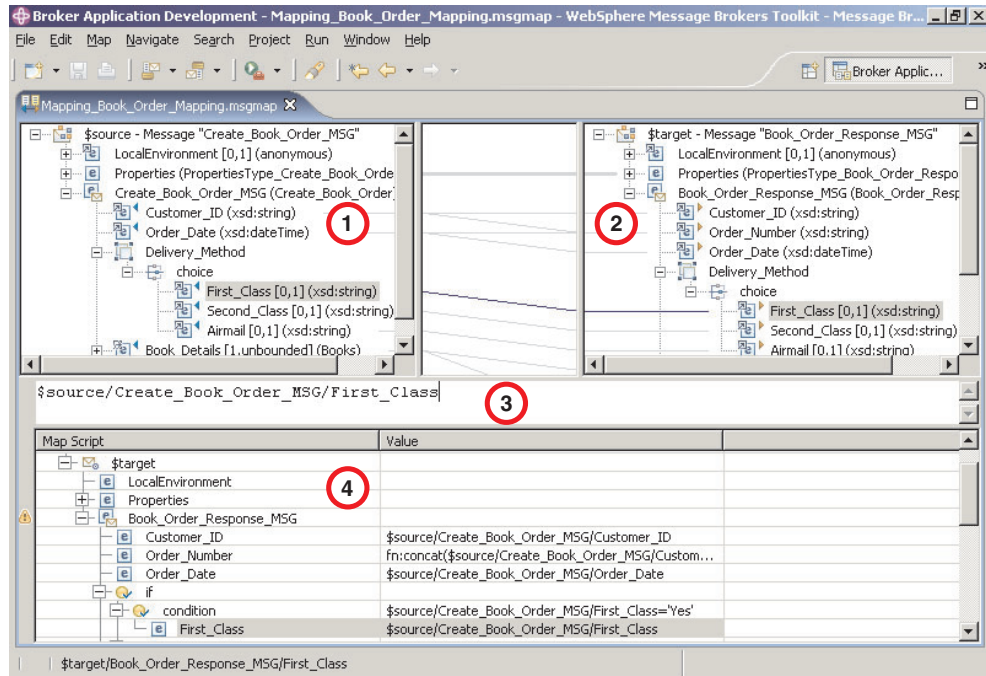

The following list describes the elements that are present in the Target pane:

- A target message is identified by \$target.
- A mapped entry is indicated by a yellow triangle alongside the element. In this example, Customer_ID, Order_Number, and Order_Date are mapped.
- Square brackets contain minimum and maximum occurrences of an element.
- An optional field is indicated by [0,1]. In this example, First_Class is optional.
- A repeating field is indicated by [minoccurs, maxoccurs].
- A choice field is indicated by a choice line; under the choice line are the possible choices. In this example, First_Class, Second_Class, and Airmail are choices of Delivery_Method.
- The type of each element is indicated in round brackets after the element name.
- If the message schema uses namespaces, the namespace prefix is shown before the element name, separated by a colon.

Use the Target pane to invoke a number of actions, a list of which is displayed when you right-click within the Target pane. The following table describes the available actions.

Action	Description	Related tasks
Undo	Undo previous action	
Redo	Redo previous action	
Revert	Discard	

Action	Description	Related tasks
Open Declaration (message)	<p>Display the element definition from the message set.</p> <p>For this action to be available, select any target message element except LocalEnvironment or Headers.</p>	
Open Declaration (database)	<p>Display the database, schema, or table definition from the database.</p> <p>For this action to be available, select any target database object.</p>	
Show Derived Types	<p>Hide or display derived types for an element in the source or target pane.</p> <p>For this action to be available, select a target element displayed as a specialization folder in the target pane.</p>	
Show Substituting elements	<p>Hide or display the substituting elements of the head element in the source or target pane.</p> <p>For this action to be available, select a target element displayed as a substitutions folder in the target pane.</p>	
Add Sources and Targets	<p>Add a message definition or a database table to a source.</p> <p>For this action to be available, select any target object.</p>	<p>“Adding messages or message components to the source or target” on page 492, “Adding a database as a source or target” on page 492</p>
Go To	<p>For this action to be available, select any target object.</p>	
Delete (message)	<p>Remove a message and any existing maps from the source.</p> <p>For this action to be available, select the target message root (\$target).</p>	

Action	Description	Related tasks
Map from Source	Create a map between the focus source element and the focus target element. For this action to be available, select compatible source and target elements.	"Mapping a target element from source message elements" on page 481, "Mapping from source: by selection" on page 480
Map by Name	Create a map between the focus source element and the focus target element. For this action to be available, select compatible source and target elements.	"Mapping a target element from source message elements" on page 481, "Mapping from source: by name" on page 480
Enter Expression	For this action to be available, select any target object except \$target	"Setting the value of a target element to a constant" on page 483, "Setting the value of a target element using an expression or function" on page 485
Accumulate	If the source and target fields contain numeric data types, this action maps all occurrences of a repeating source field to a non-repeating target, resulting in the sum of all the source elements. For this action to be available, select the source and target element.	"Configuring a repeating source and a non-repeating target" on page 488
Create New Submap	For this action to be available, select source and target elements that are either elements of complex types or wildcard elements.	"Creating and calling submaps and subroutines" on page 502, "Creating a new submap" on page 503, "Creating a new submap for a wildcard source" on page 504
Call Existing Submap	Call an existing submap	"Creating and calling submaps and subroutines" on page 502, "Calling a submap" on page 506
Call ESQL Routine	Call an existing ESQL routine	"Creating and calling submaps and subroutines" on page 502, "Calling an ESQL routine" on page 508
Save	Save the .msgmap file	

Message Mapping editor Edit pane

The following example shows the "Message Mapping editor" on page 1410. The pane that is labelled as 3 in the example is the Edit pane:

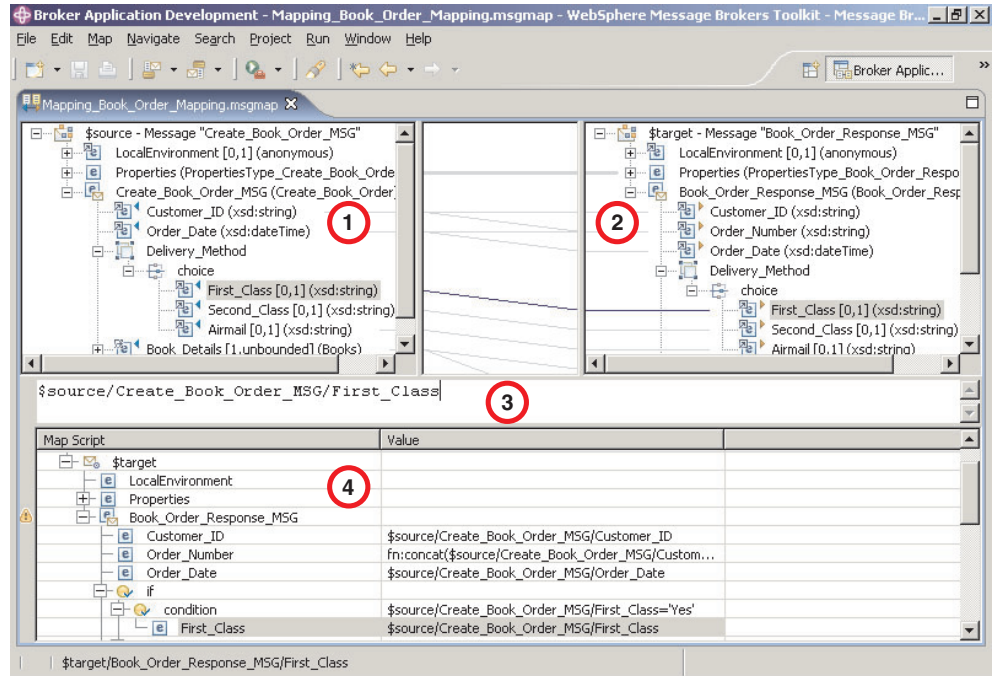

When you have selected a source or target element, use the Edit pane to enter an expression. Right-click inside the Edit pane to invoke a list of available actions, most of which are standard Windows functions, such as cut, copy, and paste. Click **Edit** → **Content Assist** (or press Ctrl+Space) to access ESQL Content Assist, which provides a drop-down list of functions that are available in a Mapping node.

To display the definition associated with a selected element or database object, right-click in the Edit pane, and click **Open Declaration**. The appropriate editor opens to display the definition associated with the element or database definition.

Message Mapping editor Spreadsheet pane

The following example shows the “Message Mapping editor” on page 1410. The pane that is labelled as 4 in the example is the Spreadsheet pane:

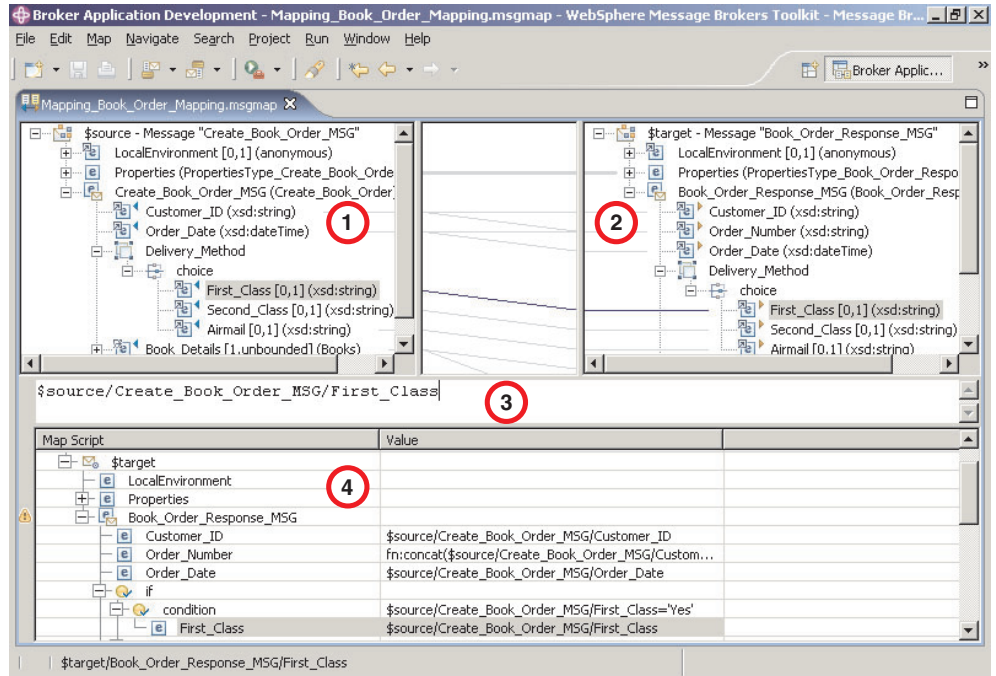

Use the Spreadsheet pane to invoke a number of actions, a list of which is displayed when you right-click within the Spreadsheet pane. The following table describes the available actions.

Action	Description	Related tasks
Undo	Undo previous action	
Redo	Redo previous action	
Revert	Discard	
Open Declaration (message)	Display the element definition from the message set. For this action to be available, select any message element except LocalEnvironment or Headers.	
Open Declaration (database)	Display the database, schema, or table definition from the database. For this action to be available, select any database object.	
Add Sources and Targets	Add a message definition to a target.	“Adding messages or message components to the source or target” on page 492, “Adding a database as a source or target” on page 492
Copy	Copy the selected item to the clipboard.	

Action	Description	Related tasks
Paste	Paste the item from the clipboard.	
Delete	Remove a row from the Spreadsheet.	
For	Define a repeating condition.	“Configuring a repeating source and a non-repeating target” on page 488, “Configuring a repeating source and a repeating target” on page 489
If	Placeholder for a new Condition block, to contain one or more Conditions.	“Configuring a repeating source and a non-repeating target” on page 488, “Configuring conditional mappings” on page 487
Condition	Define what must evaluate to ‘true’ to execute subsequent mappings.	“Configuring a repeating source and a non-repeating target” on page 488, “Configuring conditional mappings” on page 487
Else	Placeholder to execute subsequent mappings if previous Condition does not evaluate to ‘true’.	“Configuring conditional mappings” on page 487
Select Data Source	Define a database to be used in the mapping.	
Populate	Expand a structure so that each of its children have a row in the spreadsheet.	
Insert After	Create a number of new rows in the spreadsheet to set the values of specific instances of a repeating field. Can also be used to insert any non-repeating element, attribute or database column if valid at the selected location.	“Configuring a non-repeating source and a repeating target” on page 489
Insert Before	Create a number of new rows in the spreadsheet to set the values of specific instances of a repeating field. Can also be used to insert any non-repeating element, attribute or database column if valid at the selected location.	“Configuring a non-repeating source and a repeating target” on page 489
Replace	Substitute an element, attribute or database column in the spreadsheet with a similar item, retaining the mapping expression and any child mapping statements.	
Save	Save the .msgmap file.	

Mapping node

The Mapping node has one or more mappings that are stored in message map files (with a `.msgmap` file extension). These files are configured using the “Message Mapping editor” on page 1410.

A Mapping node must contain the following inputs and outputs:

- Zero or one source (input) messages
- Zero or more source (input) databases
- One or more target (output) messages

You must define, in message definition files in a message set, the source and target messages that are to be mapped. You can specify the parser of the source message at run time (for example, in an MQRFH2 header), but the target message is built using the runtime parser that is specified by the *Message Domain* property of the message set.

If a message mapping is between elements of different types, you might need to include casts in your mapping definitions, depending on which runtime parser is specified by the *Message Domain* property of your message set.

The Mapping node uses a language to manipulate messages that are based on XPath.

To develop message mappings for a Mapping node, use the Message Mapping editor, which provides separate panes for working with sources, targets and expressions.

Mapping node syntax

In a Mapping node, the source message, if present, is identified in the “Message Mapping editor” on page 1410 by `$source`.

The message tree is represented in XPath format. For example, if you have an element called `Body` within a source message called `Envelope`, this is represented in the Mapping node as:

```
$source/soap11:Envelope/soap11:Body
```

Where *soap11* is a namespace prefix.

The first target message is identified by `$target`; additional target messages are identified by `$target_1`, `$target_2`, etc.

The first source database is identified by `$db:select`; additional source databases are identified by `$db:select_1`, `$db:select_2`, etc.

The database element is represented in the following format:

```
$db:select.DB.SCH.TAB.COL1
```

where:

DB is the database name

SCH is the database schema name

TAB is the table name

COL1 is the column name

You can also use the Mapping node to:

- make comparisons
- perform arithmetic
- create complex conditions

The comparison operators are:

- = equals
- != not equals
- > greater than
- >= greater than or equals
- < less than
- <= less than or equals

The arithmetic operators are:

- + plus
- minus
- * multiply
- div divide

Conditional operators 'or' and 'and' are supported (these are case-sensitive).

The following objects can be mapped:

- Local Environment
 - Destination
 - WrittenDestination
 - File
 - SOAP
 - TCPIP
 - ServiceRegistry
 - Adapter
 - Wildcard
 - Variables
- Message headers (optional)
 - MQ Headers
 - HTTP Headers
 - JMSTransport
 - Email Headers
- Message elements
- Database columns

Naming restrictions for database objects

The names of objects in Oracle databases can contain certain characters, such as the dollar sign (\$) and number sign (#), which the Mapping node cannot process correctly. Database table names, table column names, stored procedure parameter names, and column names in stored procedure result sets, must not contain any of the following characters:

~ ! @ # \$ % ^ & * () + = - ` { } | \] [" : ' ; ? > < , . /

Mapping node functions

You can configure your message mappings using a variety of predefined and user-defined functions.

The following predefined functions are available to use in your message maps:

- ESQL - prefixed esql:
- XPath - prefixed fn:
- Mapping - prefixed msgmap:
- Schema casts - prefixed xs:

Not all ESQL functions can be used in a Mapping node. For information about which functions are supported, and for a description of how to achieve equivalent processing for ESQL functions that are not supported, see the ESQL topics. For information about the predefined ESQL functions, see “Predefined ESQL mapping functions.”

The fn:true() function (that always returns true) and the fn:false() function (that always returns false) are examples of XPath functions. You can get more information about the other XPath functions and XPath syntax from the online W3C XML Path Language document. For information about the predefined XPath functions, see “Predefined XPath mapping functions” on page 1425.

For information about the predefined mapping functions, see “Predefined mapping functions” on page 1426. See “Mapping node casts” on page 1427 for a list of the schema casts.

The mapping node can also:

- Set the value of a target to a WebSphere MQ constant. The expression to set the value looks similar to a function with \$mq: used as the prefix.
- Call a Java method directly. The expression to set the value looks similar to a function with java: used as a prefix.

Predefined ESQL mapping functions:

A table of predefined ESQL functions for use with message maps.

This table details the predefined ESQL mapping functions that are available to use with message maps:

Name	ESQL equivalent	Notes
Numeric functions: abs absval acos asin atan atan2 bitand bitnot bitor bitxor ceil ceiling cos cosh cot degrees exp floor in log log10 mod power radians rand sign sin sinh sqrt tan tanh truncate	ESQL function of the name same name such as ABS and ABSVAL.	The same parameters apply as for ESQL.
String functions: left length lower lcase ltrim replace replicate right rtrim space translate upper ucase	ESQL function of the same name such as LEFT and LENGTH.	The same parameters apply as for ESQL.
Field functions: bitstream fieldname fieldnamespace fieldtype fieldvalue lastmove samefield	ESQL function of the same name such as BITSTREAM and FIELDNAME.	The same parameters apply as for ESQL.

Name	ESQL equivalent	Notes
asbitstream	<p>These signatures are supported:</p> <p>ASBITSTREAM(FieldRef)</p> <p>ASBITSTREAM(FieldRef, typeExp, setExp, formatExp)</p> <p>ASBITSTREAM(FieldRef, typeExp, setExp, formatExp, encodingExp, ccsidExp)</p> <p>ASBITSTREAM(FieldRef, typeExp, setExp, formatExp, encodingExp, ccsidExp, options)</p>	<p>FieldRef is a source field reference such as \$source/po:PurchaseOrder</p> <p>typeExp is a string literal of the name of the message body, such as purchaseOrder, optionally qualified with a namespace URI, such as {http://www.ibm.com};purchaseOrder</p> <p>setExp is a string literal of the name of the message set, such as PurchaseOrder</p> <p>formatExp is a string literal of the wire format of the message, such as XML1</p> <p>encodingExp and ccsidExp evaluate to integers with values corresponding to ESQL ENCODING and CCSID constants.</p> <p>options is an ESQL constant or bit-or of ESQL constant that evaluates to an integer.</p>
cardinality	CARDINALITY	The same parameters apply as for ESQL.
coalesce	COALESCE	The same parameters apply as for ESQL.
current-date	CURRENT_DATE	No parameters apply.
current-gmtdate	CURRENT_GMTDATE	No parameters apply.
current-gmttime	CURRENT_GMTTIME	No parameters apply.
current-gmttimestamp	CURRENT_GMTTIMESTAMP	No parameters apply.
current-time	CURRENT_TIME	No parameters apply.
current-timestamp	CURRENT_TIMESTAMP	No parameters apply.
date	DATE	
for	FOR (expression)	Optional parameters are not supported.
gmttime	GMTTIME	
gmttimestamp	GMTTIMESTAMP	
interval-year	INTERVAL YEAR	<p>The same parameters apply as for ESQL. Some examples:</p> <p>esql:interval-minute('90')</p> <p>esql:interval-year-to-month('1-06')</p>
interval-year-to-month	INTERVAL YEAR TO MONTH	
interval-month	INTERVAL MONTH	
interval-day	INTERVAL DAY	
interval-day-to-hour	INTERVAL DAY TO HOUR	
interval-day-to-minute	INTERVAL DAY TO MINUTE	
interval-day-to-second	INTERVAL DAY TO SECOND	
interval-hour	INTERVAL HOUR	
interval-hour-to-minute	INTERVAL HOUR TO MINUTE	
interval-hour-to-second	INTERVAL HOUR TO SECOND	
interval-minute	INTERVAL MINUTE	
interval-minute-to-second	INTERVAL MINUTE TO SECOND	
interval-second	INTERVAL SECOND	
is-null	Operand IS NULL	<p>Some examples:</p> <p>esql:is-null(\$source/po:purchaseOrder/po:comment)</p> <p>esql:is-null(\$db:select.ACME.PARTS.INVENTORY.LAST_TRANSACTION)</p>
like	source LIKE pattern	<p>For example:</p> <p>esql:like(\$source/po:purchaseOrder/shipTo/first_name,'Fred')</p>
	source LIKE pattern ESCAPE EscapeChar	<p>For example:</p> <p>esql:like(\$source/po:purchaseOrder/shipTo/zip,'L6F\$1C7','\$')</p>
local-timezone	LOCAL_TIMEZONE	

Name	ESQL equivalent	Notes
nullif	NULLIF	The same parameters apply as for ESQL.
overlay	OVERLAY Str1 PLACING Str2 FROM Start	For example: esql:overlay (\$source/po:purchaseOrder/shipTo/city,'abc',2)
	OVERLAY Str1 PLACING Str2 FROM Start For Length	For example: esql:overlay (\$source/po:purchaseOrder/shipTo/city,'abcde',2,3)
position	POSITION searchExp IN SourceExp	For example: esql:position ('aet',\$source/po:purchaseOrder/shipTo/first_name)
	POSITION searchExp IN SourceExp FROM FromExp	For example: esql:position ('do',\$source/po:purchaseOrder/shipTo/last_name,1)
	POSITION searchExp IN SourceExp FROM FromExp REPEAT RepeatExp	For example: esql:position ('a',\$source/po:purchaseOrder/billTo/first_name,1,2)
round	ROUND	Optional parameters are not supported.
sqlcode	SQLCODE	No parameters apply.
sqlerrortext	SQLERRORTEXT	
sqlnativeerror	SQLNATIVEERROR	
sqlstate	SQLSTATE	
time	TIME	
timestamp	TIMESTAMP	The same parameters apply as for ESQL. For example: esql:gmttimestamp ('1999-12-31 23:59:59.999999')
trim-leading	TRIM LEADING FROM Source	For example: esql:trim-leading (\$source/po:purchaseOrder/shipTo/state)
	TRIM LEADING Singleton FROM Source	For example: esql:trim-leading ('G',\$source/po:purchaseOrder/shipTo/zip)
trim-trailing	TRIM TRAILING FROM Source	For example: esql:trim-trailing (\$source/po:purchaseOrder/billTo/last_name)
	TRIM TRAILING Singleton FROM Source	For example: esql:trim-trailing ('e',\$source/po:purchaseOrder/billTo/street)
trim-both	TRIM BOTH FROM Source	For example: esql:trim-both (\$source/po:purchaseOrder/shipTo/city)
	TRIM BOTH Singleton FROM Source	For example: esql:trim-both (", \$source/po:purchaseOrder/shipTo/city)

Name	ESQL equivalent	Notes
trim	TRIM Source	For example: esql:trim (\$source/po:purchaseOrder/shipTo/city)
	TRIM Singleton FROM Source	For example: esql:trim (",\$source/po:purchaseOrder/shipTo/city)
uuidasblob	UUIDASBLOB	Takes zero or more parameters as in ESQL.
uuidaschar	UUIDASCHAR	

Predefined XPath mapping functions:

A table of predefined XPath functions for use with message maps.

This table details the predefined XPath functions that are available to use with message maps. You can get more information about XPath functions and XPath syntax from the online W3C XML Path Language document.

Name	Parameters	Notes
true		
false		
sum	Source field from the message or database.	Source has to be a numeric type and repeats.
avg		
max		
min		
count	Source field from the message or database.	
concat	Two, or more, strings.	You cannot use <code>fn:concat(\$source/myElem)</code> to concatenate instances of 'myElem'.
not	1- Expression resolved to a Boolean value.	
exists	Source field from the message or database.	
empty		
substring	1- String 2- Zero-bases starting index 3- Length	For example: fn:substring (\$source/po:purchaseOrder/billTo/street, 3, 5)
year-from-dateTime	1- xs:dateTime	For example: fn:month-from-dateTime (xs:dateTime(\$source/po:purchaseOrder/shipTo/datetime)) where \$source/po:purchaseOrder/shipTo/datetime is xs:string.
month-from-dateTime		
day-from-dateTime		
hours-from-dateTime		
minutes-from-dateTime		
seconds-from-dateTime		

Name	Parameters	Notes
year-from-date	1-xs:date	For example: fn:year-from-date(xs:date (\$source/po:purchaseOrder/billTo/date)) where \$source/po:purchaseOrder/billTo/date is xs:string.
month-from-date		
day-from-date		
hours-from-time	1- xs:time	Some examples: fn:hours-from-time(xs:time("13:20:10:5")) fn:hours-from-time(xs:time (\$source/po:purchaseOrder/shipTo/time))
minutes-from-time		
seconds-from-time		
years-from-duration	1- xdt:dayTimeDuration	For example: fn:minutes-from-duration (xdt:dayTimeDuration(PT47H30M))
months-from-duration		
days-from-duration		
hours-from-duration		
minutes-from-duration		
seconds-from-duration		

Predefined mapping functions:

A table of predefined mapping functions for use with message maps.

This table details the predefined mapping functions that are available to use with message maps:

Name	Parameters	Return	Notes
cdata-element	One string	Nothing	Create an XML element with CDATA content in the following target message domains: <ul style="list-style-type: none"> • XMLNSC • SOAP • XMLNS • XML • JMSMap • JMSStream For example: msgmap:cdata-element ('<date><month>05</month><day>11</day><year>2008</year></date>')
occurrence	Source field from the message or database	Source field as selected from a group of repeating fields.	Often used in a condition statement when source repeats to execute specific statements for a specific occurrence. For example: msgmap:occurrence (\$source/po:purchaseOrder/items)=2 means the second field, po:purchaseOrder
exact-type	1- Source field from the message or database 2- Namespace prefix 3- Name of the type	True if the source is of the specified type in the specified namespace.	Often used in a condition to execute specific statements for a specific source type. For example: msgmap:exact-type (\$source/tn1:msg2, 'tn1', 'extendedMsgType')

Name	Parameters	Return	Notes
empty-element()	None	Nothing	Creates an XML element with an empty tag. For example, if an element is named MyElement and the mapping expression for MyElement is set to msgmap:empty-element(), the output message will contain an element with no content: <MyElement/> Call this function only for an XML element.
element-from-bitstream	These signatures are supported: msgmap:element-from-bitstream(<i>StreamRef</i>) msgmap:element-from-bitstream(<i>StreamRef</i> , <i>typeExp</i> , <i>setExp</i> , <i>formatExp</i>) msgmap:element-from-bitstream(<i>StreamRef</i> , <i>typeExp</i> , <i>setExp</i> , <i>formatExp</i> , <i>encodingExp</i> , <i>ccsidExp</i>) msgmap:element-from-bitstream(<i>StreamRef</i> , <i>typeExp</i> , <i>setExp</i> , <i>formatExp</i> , <i>encodingExp</i> , <i>ccsidExp</i> , <i>options</i>)	Nothing	Used to parse a bitstream. This function can be called only for a message element target. The parsed bit stream is placed in the target message tree as the target element. <i>StreamRef</i> is a reference to a BLOB of stream, such as '\$source/BLOB' or '\$db:select.dsn.schema.table.column' <i>typeExp</i> is a string literal of the name of the message body, such as 'purchaseOrder', optionally qualified with a namespace URI, such as '{http://www.ibm.com};purchaseOrder' <i>setExp</i> is a string literal of the name of the message set, such as 'PurchaseOrder' <i>formatExp</i> is a string literal of the wire format of the message, such as 'XML1' <i>encodingExp</i> and <i>ccsidExp</i> evaluate to integers with values corresponding to ESQL ENCODING and CCSID constants <i>options</i> is an ESQL constant or bit-or of ESQL constants that evaluate to an integer.

Mapping node casts

Source and target elements can be of different types in a Mapping node,

Depending on which runtime parsers are used, automatic casting cannot be done. In these cases, use one of the following cast functions:

- xs:boolean
- xs:date
- xs:dateTime
- xs:dayTimeDuration
- xs:decimal
- xs:duration
- xs:double
- xs:hexBinary
- xs:int
- xs:integer
- xs:string
- xs:long
- xs:time
- xs:yearMonthDuration

Headers and Mapping node

This topic lists the headers that can be manipulated by the Mapping node.

You can map these headers:

- | • MQ Headers
 - | MQMD
 - | MQCFH header with root element MQPCF
 - | MQCIH
 - | MQDLH
 - | MQIIH
 - | MQMDE
 - | MQRFH
 - | MQRFH header with MQRFH2 or MQRFH2C parser
 - | MQRMH
 - | MQSAPH
 - | MQWIH
 - | SMQ_BMH
- | • Email Headers
 - | EmailOutputHeader
- | • HTTP Headers
 - | HTTPInputHeader
 - | HTTPReplyHeader
 - | HTTPRequestHeader
 - | HTTPResponseHeader
- | • JMSTransport

Migrating message mappings from Version 5.0

Use the `mqsimigratemfmaps` command to migrate message mappings to the Version 6.1 format.

The `mqsimigratemfmaps` command creates Version 6.1 mapping files (.msgmap) from your Version 5.0 mapping files (.mfmap).

When you migrate message mappings from Version 5.0, read the restrictions that apply.

The following table lists the mapping functions that are supported in Version 5.0 but not supported in Version 6.1, and shows the error messages that you might see. Mappings that contain these Version 5.0 functions cannot be migrated to Version 6.1; you must re-create and redeploy these mappings using another node, such as a JavaCompute node. Alternatively, migrate as much of the mapping as possible using the migration command, view the error report to see details of the functions that could not be migrated, and create a new node that can execute those functions that were not migrated.

Supported in Version 5.0	Migration utility error message
Expressions that involve multiple instances of a repeating source element, for example: <code>src_msg.e[1] + src_msg.e[2] -> tgt_msg.e</code>	Error:102: Unexpected index '2' encountered for target mappable 'e'. The expected index is '1'. Migration currently provides no support for expressions involving more than one instance of the same repeating-element.

Supported in Version 5.0	Migration utility error message
ESQL field references that contain the asterisk wildcard character <code>"*"</code> . For example: <code>src_msg.e.*</code> or <code>src_msg.e.*[]</code>	Error:130: ESQL field-reference <code>'src_msg.e.*'</code> cannot be migrated. Migration currently provides no support for field-references containing <code>'*'</code> .
Dynamic ESQL field references. For example: <code>src_msg.e.{'a' 'b'}</code>	Error:131: ESQL field-reference <code>'src_msg.e.{'a' 'b'}</code> cannot be migrated. Migration currently provides no support for dynamic field-references.
ESQL expressions that contain a reference to the temporary index-variable <code>"#I"</code> . For example: <code>src_msg_e "#I" -> tgt_msg.e</code>	Error:128: ESQL expressions containing the variable <code>'#I'</code> anywhere other than the index of a repeating-element cannot be handled by the migration.
Expressions within an index of a repeating element. For example: <code>src_msg.e[src_msg.a]</code> or <code>src_msg.e["#I"+5]</code> or <code>src_msg.e[< 3]</code>	Error:116: ESQL field-reference <code>'src_msg.e[< 3]'</code> cannot be migrated. Migration currently provides no support for indexes other than the variable <code>'#I'</code> and plain integer indexes.
Aggregation functions MIN, MAX, and COUNT, used with the ESQL SELECT expression. For example: <code>SELECT MAX("#T".FIRSTNAME) FROM Database.CUSTOMER AS "#T" WHERE "#T".CUSTOMERID = 7</code>	Error:135: The ESQL expression <code>'SELECT MAX("#T".FIRSTNAME) FROM Database.CUSTOMER AS "#T" WHERE "#T".CUSTOMERID = 7'</code> could not be migrated. The expression contains syntax which has no direct equivalent in the new map-script language.
ESQL IN operator. For example: <code>src_msg.e IN (1, 2, 3)</code>	Error:135: The ESQL expression <code>'SELECT MAX("#T".FIRSTNAME) FROM Database.CUSTOMER AS "#T" WHERE "#T".CUSTOMERID = 7'</code> could not be migrated.

Restrictions on migrating message mappings

In certain scenarios, restrictions apply to the migration of `.mfmap` files from Version 5.0.

This topic explains why migration is not automatic in these situations, and provides instructions for how to complete a successful migration. This topic also provides information about restrictions that apply when you migrate submaps.

The programming model for message maps is different between Version 5.0 (where the file format is `.mfmap`) and Version 6.1 (where the format is `.msgmap`). Version 5.0 message maps have a procedural programming model, which is essentially an alternative ESQL, where you describe all the steps that are required to perform a transformation. Version 6.1 uses a declarative programming model, where you describe the result of the transformation, and the tools determine how to achieve that result.

Most migration failures result from message maps that contain too much information about the steps that perform the transformation, and not enough information about the desired result. For these message maps, migration is enabled by changing the `.mfmap` file so that specific "how to" sections are separated into an ESQL function or procedure that can be called by the message map. The `.mfmap` file calls the ESQL function instead of containing it as an expression. The `mqsimigratemfmaps` command then migrates the `.mfmap` file, but calls the ESQL function instead of logging a migration error.

A limitation is that ESQL (the run time for .mfmap and .msgmap files) cannot define functions that return complex element (or REFERENCE) values. The following procedure explains how to work around this complex element target limitation; in many cases, you must rewrite the map as an ESQL function. For more examples and information about calling ESQL from maps, refer to the following sample:

- Message Map sample

You can view samples only when you use the information center that is integrated with the Message Broker Toolkit.

1. Determine whether you can define an ESQL function for the .mfmap file.
 - a. When the target value is a complex element, or in ESQL terms a REFERENCE, the individual mapping must be rewritten in the .msgmap file. Delete the mapping from the .mfmap file, and proceed to Step 4.
 - b. Use a function for all other cases: CHAR string, numbers, date, and time. Proceed to Step 2.
2. Determine the source parameters and returns type for your function.
 - a. For each source path in the mapping, there must be one parameter in the function or procedure. For a function, all parameters are unchangeable. The type of the parameter must match the source data type.
 - b. The function return type is the ESQL data type identified above.
3. Update the .mfmap file to enable migration. Change the .mfmap file to invoke the function in the mapping, passing the source parameters to the function in the order in which they were listed in step 2a.
4. Re-run the mqsimigratemfmaps command to migrate the modified .mfmap file.
5. Repeat Steps 1 to 4 until no errors are reported in the migration log.
6. Start the Version 6.1 Message Broker Toolkit and open the migrated .msgmap file.
 - a. For ESQL that is migrated as functions, there should be no errors.
 - b. For complex element targets, rewrite the mapping using the Version 6.1 features.

The following examples illustrate migration of .mfmap files to .msgmap files.

- To migrate a multiple reference to a repeating source expression:

```
src_msg.e[1] + src_msg.e[2]
```

compute the result in an ESQL function like:

```
CREATE FUNCTION addOneAndTwo(IN src_msg)
BEGIN
  RETURN src_msg.e[1] + src_msg.e[2];
END;
```

In the .msgmap file, call the ESQL function addOneAndTwo using the parent element src_msg as a parameter.

- An expression that does not use element names:

```
src_msg.*
```

or

```
src_msg.*[]
```

can be processed using a function that takes the parent of the repeating field:

```

CREATE FUNCTION processAny(IN src_msg)
BEGIN
  DECLARE nodeRef REFERENCE TO src_msg.e.*;
  DECLARE result <dataType> <initialValue>;
  WHILE LASTMOVE nodeRef DO
    --expression goes here
    SET result = result;
  END WHILE;
  RETURN RESULT;
END;

```

In the .msgmap file, call the ESQL function processAny using the parent element src_msg as a parameter.

- Expressions that dynamically compute element names:

```
src_msg.{'a' || 'b'}
```

can be processed by ESQL functions that process the parent of the repeating field:

```

CREATE FUNCTION processDynamicName(IN src_msg)
BEGIN
  RETURN src_msg.{'a' || 'b'};
END;

```

In the .msgmap file, call the ESQL function processDynamicName using the parent element src_msg as a parameter.

- Expressions that use the select MIN, MAX, and COUNT functions:

```

SELECT MAX("#T".FIRSTNAME)
  FROM Database.CUSTOMER AS "#T"
 WHERE "#T".CUSTOMERID = custId

```

can be processed by ESQL functions that process the parent of the repeating field:

```

CREATE FUNCTION processMAX(IN custId)
BEGIN
  RETURN
  SELECT MAX("#T".FIRSTNAME)
    FROM Database.CUSTOMER AS "#T"
   WHERE "#T".CUSTOMERID = custId
END;

```

In the .msgmap file, call the ESQL function processMAX using the element custId as a parameter.

- .mfmap files that use mfmap index variables in expressions:

```
e || "#I"
```

must be rewritten entirely in ESQL. By definition, there must be a complex repeating parent element, and this is not supported by ESQL functions.

- Expressions that use source expressions to compute values:

```
src_msg.e[src_msg.a]
```

must be rewritten using if rows, msgmap:occurrence() functions, and ESQL functions:

```

for src_msg.e
  if
    condition msgmap:occurrence(src_msg/e) = src_msg/a

```

- For expressions that use index expressions to compute values:

```
src_msg.e["#1" +5]
src_msg.e[< 3]
```

the entire .msgmap file must be rewritten in ESQL, because the .msgmap files do not support indexed access to repeating fields.

- .mfmap files that use ROW expressions to compute values:

```
src_msg.e IN (1, 2, 3)
```

must be rewritten in ESQL, because .msgmap files do not support ESQL ROW expressions.

Restrictions on migrating maps that call ESQL

If there is a mismatch between the case that has been in the ESQL call in the message map, and the name of the routine defined in the ESQL file, an error is produced during migration of the message map. To prevent an error occurring during migration, ensure that the ESQL call in the message map uses the same case as the ESQL defined in the routines in the ESQL file. Alternatively you can manually edit the message map after migration to call the ESQL routine with matching case.

Restrictions on migrating submaps

In Version 5.0 message maps, any complex element type can be a root of a submap. However, in Version 6.1, only a global element or a global attribute can be the root of a submap. When a Version 5.0 message map with a call to a submap with a non-global element as the map root is migrated, the submap is not migrated as a standalone submap. Instead, the call to the submap in the main message map is replaced by the migrated content of the submap. Alternatively, if the submap has a global element as the map root, the submap is migrated to a standalone Version 6.1 submap instead.

For Version 6.1, you must define reusable schema structures as global elements and types. If you have Version 5.0 submaps that use local elements, you must change the schema to add definitions of global elements for the local elements, and then use the new schema after migration. If the new global elements have the same name and type as the local elements, the Version 5.0 submaps do not need to be changed.

You must qualify a local element in a Version 5.0 submap with a namespace to ensure its successful migration to Version 6.1, because the global element that replaces it after migration must be qualified by the namespace. If your submap contains local elements, you must re-create the submap and re-create the call to the submap from the main message map.

The following table shows differences between the features that are supported in a submap for Version 5.0 and Version 6.1.

Version	Supported feature
Version 5.0	global elements and global attributes as map source
	global elements and global attributes as map target
	local elements and local attributes as map source
	local elements and local attributes as map target
Version 6.1	global elements, global attributes, and global types as map source
	global elements and global attributes as map target

XML constructs

A self-defining XML message carries the information about its content and structure within the message in the form of a document that adheres to the XML specification. Its definition is not held anywhere else.

When the broker receives an XML message, it interprets the message using the generic XML parser, and created an internal message tree structure according to the XML definitions contained within that message.

A self-defining message is also known as a generic XML message. It does not have a recorded format.

The information provided with WebSphere Message Broker does not provide a full definition or description of XML terminology, concepts, and message constructs: it is a summary that highlights aspects that are important when you use XML messages with brokers and message flows.

For further information about XML, see the developerWorks Web site.

Example XML message

The name elements used in this description (for example, XmlDecl) are provided by WebSphere Message Broker, and are referred to as field type constants. They are available for symbolic use within the ESQL that defines the processing of message content performed by the nodes, such as a Filter node, within a message flow. They are not part of the XML specification.

A simple XML message might take the form:

```
<?xml version="1.0" encoding="UTF-8" standalone="no"?>
<!DOCTYPE s1 PUBLIC "http://www.ibm.com/example.dtd" "example.dtd">
<s1>.....</s1>
```

The corresponding syntax element tree (top level elements only) is shown below.



The WhiteSpace elements within the tree are there because of the line breaks in the original XML document, and have no business meaning. White space is used in XML for readability; if you process XML messages that contain line breaks (as shown above), blanks lines, or spaces between tags, these all appear as elements in the message tree.

WhiteSpace within an XML element (between start and end tags) has business meaning and is represented using the Content syntax element. See “XML WhiteSpace and DocTypeWhiteSpace” on page 1445 for more information.

The field type constants for XML name elements (for example, Element and XmlDecl) equate to a constant value of the form 0x01000000. You can see these constants in the output created by the Trace node when a message, or a portion of the message, is traced.

The XML declaration

The beginning of an XML message can contain an XML declaration.

An example of a declaration is shown below.

```
<?xml version="1.0" encoding="UTF-8" standalone="no"?>
<!DOCTYPE s1 PUBLIC "http://www.ibm.com/example.dtd" "example.dtd">
<s1>.....</s1>
```

The XML declaration includes the following field type constants:

- “XML encoding”
- “XML standalone”
- “XML version” on page 1435
- “XMLDecl” on page 1435

“XML declaration example” on page 1435 includes another example of an XML declaration and the tree structure it forms.

XML encoding

The encoding element is a value element and is always a child of the XmlDecl element.

The value of the encoding element is a string that corresponds to the value of the encoding string in the declaration. In the example shown below, the encoding element has a value of UTF-8.

```
<?xml version="1.0" encoding="UTF-8" standalone="no"?>
<!DOCTYPE s1 PUBLIC "http://www.ibm.com/example.dtd" "example.dtd">
<s1>.....</s1>
```

You cannot specify WebSphere MQ encodings in this element.

XML standalone

The XML standalone element defines the existence of an externally-defined DTD.

It is a value element and stores the data corresponding to the value of the standalone string in the declaration. It is always a child of the XmlDecl element. Valid values for the standalone element are yes and no. An example is shown below:

```
<?xml version="1.0" encoding="UTF-8" standalone="no"?>
<!DOCTYPE s1 PUBLIC "http://www.ibm.com/example.dtd" "example.dtd">
<s1>.....</s1>
```

A value of no indicates that this XML document is not standalone and depends on an externally-defined DTD. A value of yes indicates that the XML document is self-contained. However, the current release of WebSphere Message Broker does not resolve externally-defined DTDs, so the setting of standalone is irrelevant and is ignored.

XML version

The XML version element is a value element and stores the data corresponding to the version string in the declaration.

It is always a child of the XmlDecl element. In the example below, the version element contains the string value 1.0:

```
<?xml version="1.0" encoding="UTF-8" standalone="no"?>  
<!DOCTYPE s1 PUBLIC "http://www.ibm.com/example.dtd" "example.dtd">  
<s1>.....</s1>
```

XMLDecl

XMLDecl is a name element that corresponds to the XML declaration itself.

The XmlDecl element is a child of the XML parser and is written first to a bit stream. Although the XMLDecl element is a named element, its name has no relevance. An example is shown below:

```
<?xml version="1.0" encoding="UTF-8" standalone="no"?>  
<!DOCTYPE s1 PUBLIC "http://www.ibm.com/example.dtd" "example.dtd">  
<s1>.....</s1>
```

XML declaration example

The following example shows an XML declaration in an XML document.

```
<?xml version="1.0" encoding="UTF-8" standalone="yes"?>
```

The following figure shows the tree structure that is created from the declaration:

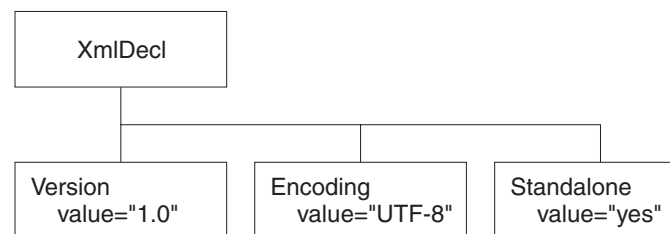

The XML message body

Every XML message must have a body. The body comprises a top-level XML element that contains all the message data.

The body contains complex XML markup, which translates to many syntax element types in the parsed tree. Each syntax element type is introduced here, with a series of example XML fragments.

The following common element types are discussed:

- “XML element” on page 1438
- “XML attribute” on page 1436
- “XML content” on page 1438

“XML message body example: elements, attributes, and content” on page 1439 provides an example of an XML message body and the tree structure that is created from it using the syntax elements types listed above.

More complex XML messages might use some of the following syntax element types:

- “XML CDataSection” on page 1437
- “XML EntityReferenceStart and EntityReferenceEnd” on page 1438
- “XML comment” on page 1437
- “XML ProcessingInstruction” on page 1439
- “XML AsIsElementContent”
- “XML BitStream” on page 1437

XML AsIsElementContent

The AsIsElementContent syntax element is a special value element. It is used to precisely control the XML generated in an output message without the safeguards of the Element, Attribute, and Content syntax elements. If you use AsIsElementContent, you must ensure that the output message is well-formed XML.

You might choose to use this syntax element if, for example, you want to suppress the normal behavior in which occurrences of ampersand (&), less than (<), greater than (>), quotation mark ("), and apostrophe (') are replaced by the predefined XML entities &, <, >, ", and '.

The following example illustrates the use of AsIsElementContent. The statement:

```
Set OutputRoot.XMLNS.(XML.Element)Message.(XML.Content) = '<rawMarkup>';
```

generates the following XML in an output message:

```
<Message>&lt;rawMarkup&gt;</Message>
```

However, the statement

```
Set OutputRoot.XMLNS.(XML.Element)Message.(XML.AsIsElementContent) = '<rawMarkup>';
```

generates the following output message:

```
<Message><rawMarkup></Message>
```

This shows that the value of an AsIsElementContent syntax element is not modified before it is written to the output message.

XML attribute

This syntax element is the default name-value element supported by the XML parser. Use it to represent the attributes that are associated with its parent element. The name and value of the syntax element correspond to the name and value of the attribute that is being represented. Attribute elements have no children, and must always be children of an element.

When attributes are written to a message, occurrences of ampersand (&), less than (<), greater than (>), double quotation mark ("), and apostrophe (') within the attribute value are replaced by the predefined XML entities &, <, >, ", and '.

The attr element is also supported for compatibility with earlier versions of the product.

XML BitStream

This syntax element is a name-value element. When writing an XML message, the value of the BitStream element is written directly into the message, and the name is not important. The BitStream element might be the only element in the message tree.

The value of the element must be of type BLOB; any other data type generates an error while writing the element. Ensure that the content of the element is appropriate for use in the output message.

Use of the BitStream element is similar to the AsisElementContent element, except that the AsisElementContent type converts its value into a string, whereas the BitStream element uses its BLOB value directly. This is a specialized element designed to aid processing of very large messages.

The following ESQL excerpts demonstrate a typical use for this element. First, declare the element:

```
DECLARE StatementBitStream BLOB
```

Initialize the contents of StatementBitStream from an appropriate source, such as an input message. If the source field is not of type BLOB, use the CAST statement to convert the contents to BLOB. Then create the new field in the output message, for example:

```
CREATE LASTCHILD OF resultCursor  
  Type XML.BitStream  
  NAME 'StatementBitStream'  
  VALUE StatementBitstream;
```

XML CDataSection

CData sections in the XML message are represented by the CDataSection value element. The content of the CDataSection element is the value of the CDataSection element without the `<![CDATA[` that marks its beginning and the `]]>` that marks its end.

For example, the following Cdata section:

```
<![CDATA[<greeting>Hello, world!</greeting>]]>
```

is represented by a CDataSection element with a string value of:

```
"<greeting>Hello, world!</greeting>"
```

Unlike Content, occurrences of `<`, `>`, `&`, `"`, and `'` are not translated to their escape sequences when the CDataSection is written out to a serialized message (bit stream).

XML comment

An XML comment encountered outside the document type declaration is represented by the Comment value syntax element. The value of the element is the comment text from the XML message.

If the value of the element contains the character sequence `-->`, the sequence is replaced with the text `-->`. This ensures that the contents of the comment cannot prematurely terminate the comment. Occurrences of `<`, `>`, `&`, `"`, and `'` are not translated to their escape sequences.

Examples of the XML comment in an XML document and in tree structure form are shown below:

```
<example><!-- This is a comment --></example>
```

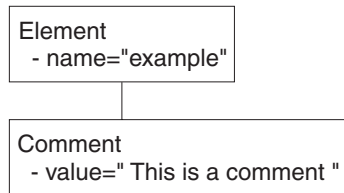

XML content

This syntax element is the default value element supported by the XML parser. Use content to represent character data (including white space characters) that is part of the element content. There might be many content elements as children of a single element, in which case they are separated by other syntax element types such as nested elements or attributes.

When content is written to a message, occurrences of ampersand (&), less than (<), greater than (>), double quotation mark ("), and apostrophe (') are replaced by the predefined XML entities &, <, >, ", and '.

The pCDATA element is also supported for compatibility with earlier versions of the product.

XML element

This syntax element is the default name element supported by the XML parser, and is one of the most common elements. The name of the syntax element corresponds to the name of the XML element in the message. This element can have many children, including attributes, elements, and content.

The tag element is also supported for backward compatibility.

XML EntityReferenceStart and EntityReferenceEnd

When an entity reference is encountered in the XML message, both the expanded form and the original entity name are stored in the syntax element tree. The name of the entity is stored as the value of the EntityReferenceStart and EntityReferenceEnd syntax elements, and any syntax elements between contain the entity expansion.

Examples of the XML entity references in an XML document and in tree structure form are shown below:

```
<?xml version="1.0" encoding="UTF-8" standalone="yes"?>
<!DOCTYPE example [ <!ENTITY entityName "eValue"> ]>
<example>Test: &entityName;</example>
```

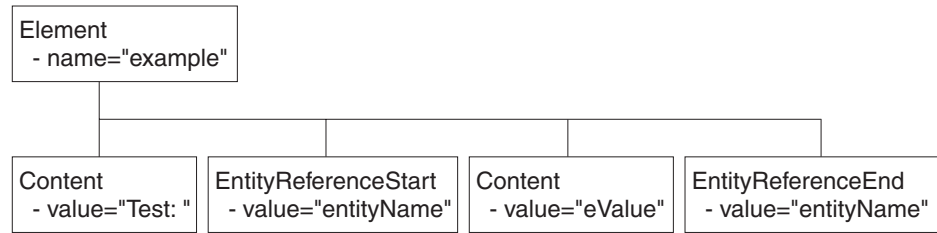

The XML declaration and the document type declaration are not shown here. Refer to “The XML declaration” on page 1434 and “XML document type declaration” on page 1440 for details of those sections of the syntax element tree.

XML message body example: elements, attributes, and content

Examples of an XML message body in an XML document and in tree structure form are shown below. The XML document contains elements, attributes, and content, and these items are shown in the tree structure.

```

<Person age="32" height="172cm">
  <Name>Cormac Keogh</Name>
</Person>
  
```

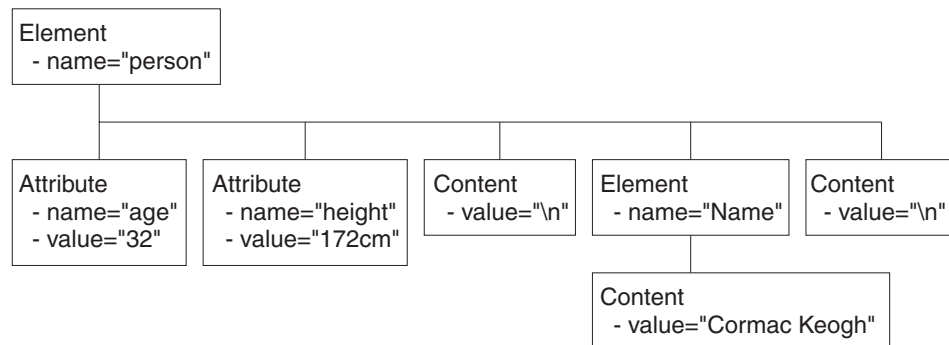

XML ProcessingInstruction

An XML processing instruction encountered outside the document type declaration is represented by the ProcessingInstruction syntax element. This is a name-value element; the name of the syntax element is the processing instruction target name, and the value of the syntax element is the character data of the processing instruction. The value of the syntax element must not be empty. The name cannot be XML in either uppercase or lowercase.

If the value of the element contains the character sequence `>`, the sequence is replaced with the text `>`. This ensures that the content of the processing instruction cannot prematurely terminate the processing instruction. Occurrences of `<`, `>`, `&`, `"`, and `'` are not translated to their escape sequences.

Examples of the XML ProcessingInstruction in an XML document and in tree structure form are shown below:

```

<example><?target This is a PI.?></example>
  
```

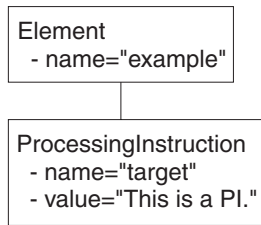

XML document type declaration

The document type declaration (DTD) of an XML message is represented by a syntax element of type DocTypeDecl and its children and descendants. These comprise the DOCTYPE construct.

Only internal (inline) DTD subsets are represented in the syntax element tree. An inline DTD is a DTD that is declared within the XML document itself. It can be a complete DTD definition, or can extend the definition in an external DTD.

External DTD subsets (identified by the SystemID or PublicId elements described below) can be referenced in the message, but those referenced are not resolved by the broker.

Field type constants are defined by WebSphere Message Broker:

- DocTypeDecl
- NotationDecl
- Entities
- ElementDef
- AttributeList
- AttributeDef
- DocTypePI
- WhiteSpace and DocTypeWhiteSpace
- DocTypeComment

DTD example is an example of an XML DTD.

XML DocTypeDecl

DocTypeDecl is a named element and is a child of the XML parser. DocTypeDecl is written to the bit stream before the element that represents the body of the document during serialization. The following attributes can be specified within this element:

- IntSubset
- PublicId
- SystemId

The example below is included in DTD example:

```

<!DOCTYPE test PUBLIC "-//this/is/a/URI/test" "test.dtd" [
...
...
]>
  
```

XML IntSubset:

IntSubset is a named element that groups all those elements that represent the DTD constructs contained in the internal subset of the message. Although the IntSubset element is a named element, its name is not relevant.

XML PublicId:

PublicId is an element that represents a public identifier in an XML message. It can be part of a DocTypeDecl, NotationDecl, or UnparsedEntityDecl element. The value of the PublicId element is typically a URL. A public identifier of the form PUBLIC "-//this/is/a/URI/test" has a string value of //this/is/a/URI/test.

XML SystemId:

SystemId is a value element that represents a system identifier in an XML message. It can be part of a DocTypeDecl, NotationDecl, or UnparsedEntityDecl element. The value of the SystemId is a URI, and is typically a URL or the name of a file on the current system. A system identifier of the form SYSTEM "Note.dtd" has a string value of Note.dtd.

XML NotationDecl

The NotationDecl element represents a notation declaration in an XML message. NotationDecl is a name element whose name corresponds to the name given with the notation declaration. It must have a SystemId as a child and it can optionally have a child element of type PublicId. For example:

```
<!NOTATION gif SYSTEM "image.gif">
```

The name of the NotationDecl is gif.

XML entities

Entities in the DTD are represented by one of six named element types described below:

- EntityDecl
- EntityDeclValue
- ExternalParameterEntityDecl
- ExternalEntityDecl
- ParameterEntityDecl
- UnparsedEntityDecl

XML EntityDecl:

The EntityDecl element represents a general entity and is declared in the internal subset of the DTD. It is a named element and has a single child element, which is of type EntityDeclValue.

An entity declaration of the form:

```
<!ENTITY bookTitle "User Guide">
```

has an EntityDecl element of name bookTitle and a child element of type EntityDeclValue with a string value of User Guide.

XML EntityDeclValue:

The EntityDeclValue element represents the value of an EntityDecl or ParameterEntityDecl defined internally in the DOCTYPE construct. It is always a child of an element of one of those types, and is a value element. For the following entity:

```
<!ENTITY bookTitle "User Guide">
```

the EntityDeclValue element has the string value User Guide.

XML ExternalParameterEntityDecl:

The ExternalParameterEntityDecl element represents a parameter entity definition where the entity definition is contained externally to the current message. It is a named element and has a child of type SystemId. It can also have a child of type PublicId. The name of the entity does not include the percent sign %. In XML an external parameter entity declaration takes the form:

```
<!ENTITY % bookDef SYSTEM "BOOKDEF.DTD">
```

This represents an ExternalParameterEntityDecl element of name bookDef with a single child of type SystemId with a string value of BOOKDEF.DTD.

XML ExternalEntityDecl:

The ExternalEntityDecl element represents a general entity where the entity definition is contained externally to the current message. It is a named element and has a child of type SystemId. It can also have a child of type PublicId.

An external entity declaration of the form:

```
<!ENTITY bookAppendix SYSTEM "appendix.txt">
```

has an EntityDecl element of name bookAppendix and a child element of type SystemId with a string value of appendix.txt.

XML ParameterEntityDecl:

The ParameterEntityDecl represents a parameter entity definition in the internal subset of the DTD. It is a named element and has a single child element that is of type EntityDeclValue. For parameter entities, the name of the entity does not include the percent sign %. In XML a parameter entity declaration takes the form:

```
<!ENTITY % inline "#PCDATA | emphasis | link">
```

XML UnparsedEntityDecl:

An unparsed entity is an external entity whose external reference is not parsed by an XML processor. This means that you can include data in an XML document that is not well-formed XML, such as a graphic file. The UnparsedEntityDecl is named element and a child of type SystemId that identifies the URI for the entity (a URL or a local file location). UnparsedEntityDecl can optionally have a child of type PublicId.

UnparsedEntityDecl can also have a child of type NotationReference, a value element that represents a reference to a notation declaration elsewhere in the XML document. It defines the type of data of the unparsed entity.

An unparsed entity declaration takes the form:

```
<!ENTITY pic SYSTEM "scheme.gif" NDATA gif>
```

In this example, the SystemId has a string value of `scheme.gif`. The value of NotationReference is `gif`. It refers to a NOTATION defined within the XML document:

```
<!NOTATION gif SYSTEM "image/gif">
```

The next entity is included in the DTD example:

```
<!ENTITY unpsd PUBLIC "-//this/is/a/URI/me.gif" "me.gif" NDATA TeX>
```

This shows the optional PublicId element, which has the string value of `//this/is/a/URI/me.gif`.

XML ElementDef

The ElementDef element represents the `<!ELEMENT` construct in a DTD. It is a child of the DOCTYPE element. The name of the element that is defined corresponds to the name of the syntax element. The value corresponds to the element definition.

This example is included in the DTD example:

```
<!ELEMENT sube12 (#PCDATA)>
```

The name of the element is `sube12` and the value is `(#PCDATA)`.

XML AttributeList

The AttributeList name element represents the `<!ATTLIST` construct in a DTD. The name of the AttributeList element corresponds to the name of the element for which the list of attributes is being defined. Its content represents one or more AttributeDef elements.

This example is included in the DTD example:

```
<!ATTLIST e15 e15satt CDATA #IMPLIED>
```

This example shows an AttributeList that defines one AttributeDef, and its content is explained in AttributeDef.

XML AttributeDef

The AttributeDef name element describes the definition of an attribute within an `<!ATTLIST` construct. It is always a child of the AttributeList element. The name of the syntax element is the name of the attribute being defined. It can have three children:

- AttributeDefValue
- AttributeDefType
- AttributeDefDefaultType

This example is included in the DTD example:

```
<!ATTLIST e15 e15satt CDATA #IMPLIED>
```

The name of the AttributeDef is `e15satt` and it is a child of AttributeList `e15`. The name of the AttributeDefType is `CDATA`, and the value of the AttributeDefDefaultType is `IMPLIED`.

XML AttributeDefValue:

For attributes of type CDATA (see “XML AttributeDefType”), or defined by an enumerated list, the AttributeDefValue gives the default value of the attribute.

For an example of AttributeDefValue, see DTD example.

XML AttributeDefType:

The AttributeDefType syntax element is a name-value element whose name corresponds to the attribute type found in the attribute definition. Possible values for the name are:

- CDATA
- ID
- IDREF
- IDREFS
- ENTITY
- ENTITIES
- NMTOKEN
- NMTOKENS
- NOTATION

If there is an enumeration present for the attribute definition, the entire enumeration string is held as a string in the value member of the name-value syntax element. In this case, the name member of the name-value syntax element is empty. The value string starts with an open parenthesis (and ends with a close parenthesis). Each entry in the enumeration string is separated by a vertical bar | character. If the Attribute value is not defined by an enumerated list, the value member of the syntax element is empty.

An example is included in AttributeDef.

XML AttributeDefDefaultType:

The AttributeDefDefaultType syntax element is a value element that represents the attribute default as defined under the attribute definition. The value can be one of the following strings:

- #REQUIRED
- #IMPLIED
- #FIXED

An example is included in AttributeDef.

XML DocTypeComment

Comments in the XML DTD are represented by the DocTypeComment element. It is a value element for which the value string contains the comment text. This element follows the same processing rules as the Comment element. See “XML comment” on page 1437.

XML DocTypePI

The DocTypePI element represents a processing instruction found within the DTD. The ProcessingInstruction element represents a processing instruction found in the XML message body.

This element is a name-value element. The name of the element is used to store the processing instruction target name, and the value contains the character data of the

processing instruction. The value of the element can be empty. The name cannot be the string XML in either uppercase or lowercase form. This element follows the same processing rules as the ProcessingInstruction element. See “XML ProcessingInstruction” on page 1439.

XML WhiteSpace and DocTypeWhiteSpace

The WhiteSpace element represents any white space characters outside the message body and DTD that are not represented by any other element. For example, white space within the body of the message (within elements) is reported as element content using the Content element type, but white space characters between the XML declaration and the beginning of the message body are represented by the WhiteSpace element.

```
<?xml version="1.0"?>      <BODY>...</BODY>
```

The characters between "1.0"?> and <BODY> are represented by the WhiteSpace element.

White space is used in XML for readability and has no business meaning. Input XML messages can include line breaks, blanks lines, and spaces between tags (all shown below). If you process XML messages that contain any of these spaces, they are represented as elements in the message tree. Therefore they appear when you view the message in the debugger, and in any trace output.

```
<?xml version="1.0" encoding="UTF-8" standalone="no"?>
<!DOCTYPE s1 PUBLIC "http://www.ibm.com/example.dtd" "example.dtd">
<s1>.....
<s2>abc</s2>  <s2>def</s2>

<s3>123</s3>
</s1>
```

If you do not want white space elements in your message trees, you must present the input message as a single line, or use the XMLNSC compact parser in its default mode

The DocTypeWhiteSpace element represents white space that is found inside the DTD that is not represented by any other element. White space characters found within a DocType between two definitions are represented by the DocTypeWhiteSpace element.

```
<!ENTITY % bookDef SYSTEM "BOOKDEF.DTD">  <!ENTITY bookTitle "User Guide">
```

The characters between DTD"> and <!ENTITY are represented by the DocTypeWhiteSpace element.

XML DTD example

This example shows an XML DTD in an XML document and the tree structure form of that document:

```
<!DOCTYPE test PUBLIC "-//this/is/a/URI/test" "test.dtd" [
<!NOTATION TeX PUBLIC "-//this/is/a/URI/TeXID" "//TeXID">
<!ENTITY ent1 "this is an entity">
<!ENTITY % ent2 "#PCDATA | sube12">
<!ENTITY % extent1 PUBLIC "-//this/is/a/URI/extent1" "more.txt">
<!ENTITY extent2 PUBLIC "-//this/is/a/URI/extent2" "more.txt">
<!ENTITY unpsd PUBLIC "-//this/is/a/URI/me.gif" "me.gif" NDATA TeX>
<?test Do this?>
<!--this is a comment-->
<!ELEMENT sube12 (#PCDATA)>
```

```

<!ELEMENT sube11 (sube12 | e14)+>
<!ELEMENT e11 (#PCDATA)>
<!ELEMENT e12 (#PCDATA | sube12)*>
<!ELEMENT e13 (#PCDATA | sube12)*>
<!ELEMENT e14 (#PCDATA)>
<!ELEMENT e15 (#PCDATA | sube11)*>
<!ELEMENT e16 (#PCDATA)>
<!ATTLIST sube11
  size (big | small) "big"
  shape (round | square) #REQUIRED>
<!ATTLIST e15
  e15satt CDATA #IMPLIED>
]>

```

When a message is parsed by the generic XML parser, the relevant part of the message tree looks like this (assuming that there are no carriage returns or white space between tags):

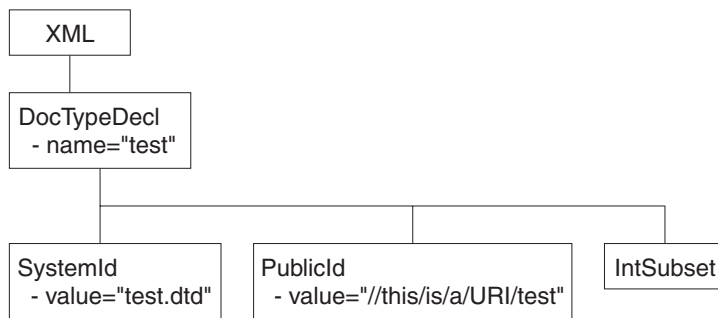

The IntSubset structure contains the following structures at the next level of nesting: the tree structure for each of these is shown in the tree structures below.

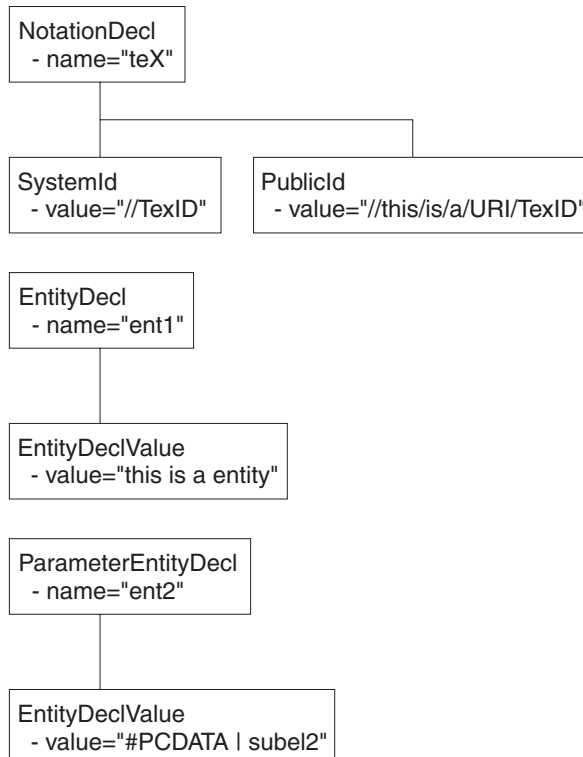

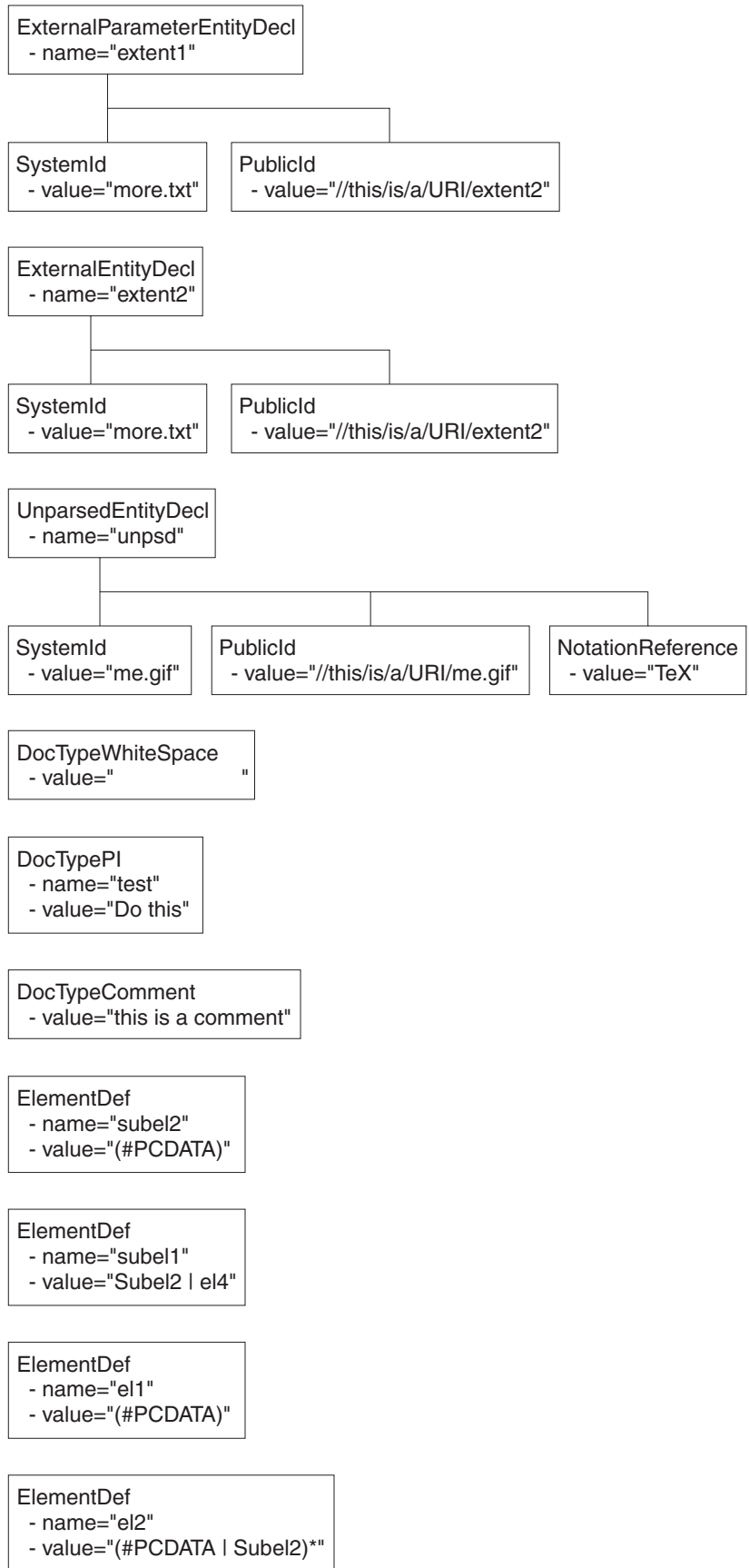

ElementDef
- name="el3"
- value="(#PCDATA | Subel2)*"

ElementDef
- name="el4"
- value="(#PCDATA)"

ElementDef
- name="el5"
- value="(#PCDATA | Subel1)*"

ElementDef
- name="el6"
- value="(#PCDATA)"

AttributeList
- name="Subel1"

AttributeDef
- name="size"

AttributeDef
- name="shape"

AttributeDefType
- value="(big | small)"

AttributeDefValue
- value="big"

AttributeDefDefaultType
- value="REQUIRED"

AttributeDefType
- value="(round | square)"

AttributeList
- name="el5"

AttributeDef
- name="el5satt"

AttributeDefType
- name="CDATA"

AttributeDefDefaultType
- value="IMPLIED"

Data sources on z/OS

The Data Source name in the Compute and Database nodes identifies the location of the table referred to in the respective node's ESQL. Data sources on z/OS correspond to DB2 subsystems rather than DB2 databases. The DB2 owning region for a particular database table is identified using a combination of the DSNAOINI file and DB2 subsystem configuration.

The MVSDEFAULTSSID parameter in the DSNAOINI file identifies the local DB2 subsystem to which the broker is connected. This subsystem is used to locate the data source which is either a local or remote DB2. The mapping between a particular data source and DB2 subsystem is shown in the DSNTIPR installation panel of the default DB2 subsystem and SYSIBM.LOCATIONS table.

When you access remote DB2 subsystems, ensure that the DBRMs for ODBC are bound at the remote subsystem. For more information, refer to the 'Programming for ODBC' topics in the DB2 Information Management Software Information Center for z/OS Solutions .

If you need to access databases that are not on DB2 on z/OS, you can use DB2's Distributed Data Facility (DDF) and Distributed Relational Architecture (DRDA) to incorporate a remote unit of work within a message flow.

ESQL reference

SQL is the industry standard language for accessing and updating database data and ESQL is a language derived from SQL Version 3, particularly suited to manipulating both database and message data.

This section covers the following topics:

“Syntax diagrams: available types” on page 1452

This describes the formats that are available for viewing ESQL syntax diagrams.

“ESQL data types in message flows” on page 1452

This describes the valid data types for ESQL.

“ESQL field references” on page 1465

This topic describes the syntax of field references.

“Special characters, case sensitivity, and comments in ESQL” on page 1666

This describes the special characters you use when writing ESQL statements.

“ESQL operators” on page 1472

This describes the operators that are available.

“ESQL reserved keywords” on page 1668

This lists the reserved keywords which you cannot use for variable names.

“ESQL non-reserved keywords” on page 1668

This lists the keywords that are not reserved, as well as those reserved for future releases, which you can use if you choose.

“ESQL functions: reference material, organized by function type” on page 1564

This topic lists the functions available in ESQL, and what they do.

“ESQL constants” on page 1662

This topic lists the constants available in ESQL, and what they do.

“ESQL statements” on page 1478

This topic lists the different statement types available in ESQL, and what they do.

“Calling ESQL functions” on page 1567

This topic describes all the ESQL functions in detail.

“ESQL variables” on page 1465

This topic describes the types of ESQL variable and their lifetimes.

“Broker properties that are accessible from ESQL and Java” on page 1663

This topic lists the broker attributes that can be accessed from ESQL code.

An XML format message that is used in many of the ESQL examples in these topics is shown in “Example message” on page 1671.

For information about how you can use ESQL statements and functions to configure Compute, Database, and Filter nodes, see “Writing ESQL” on page 280.

Syntax diagrams: available types

The syntax for commands and ESQL statements and functions is presented in the form of a diagram. The diagram tells you what you can do with the command, statement, or function and indicates relationships between different options and, sometimes, different values of an option. There are two types of syntax diagrams: railroad diagrams and dotted decimal diagrams. Railroad diagrams are a visual format suitable for sighted users. Dotted decimal diagrams are text-based diagrams that are more helpful for blind or partially-sighted users.

To select which type of syntax diagram you use, click the appropriate button above the syntax diagram in the topic that you are viewing.

The following topics describe how to interpret each type of diagram:

- How to read railroad diagrams
- How to read dotted decimal diagrams

ESQL data types in message flows

All data that is referred to in message flows must be one of the defined types:

- “ESQL BOOLEAN data type”
- “ESQL datetime data types”
- “ESQL NULL data type” on page 1457
- “ESQL numeric data types” on page 1458
- “ESQL REFERENCE data type” on page 1460
- “ESQL ROW data type” on page 1460
- “ESQL string data types” on page 1461

ESQL BOOLEAN data type

The BOOLEAN data type holds a Boolean value which can have the values:

- TRUE
- FALSE
- UNKNOWN

Boolean literals consist of the keywords TRUE, FALSE, and UNKNOWN. The literals can appear in uppercase or lowercase. For further information about UNKNOWN, see the “IF statement” on page 1537.

ESQL datetime data types

ESQL supports several data types that handle datetime values. The following data types are collectively known as **datetime** data types:

- “ESQL DATE data type” on page 1453
- “ESQL TIME data type” on page 1453
- “ESQL GMTTIME data type” on page 1453
- “ESQL TIMESTAMP data type” on page 1453
- “ESQL GMTTIMESTAMP data type” on page 1454
- “ESQL INTERVAL data type” on page 1454

For information about datetime functions see “ESQL datetime functions” on page 1572.

ESQL DATE data type

The DATE data type holds a Gregorian calendar date (year, month, and day). The format of a DATE literal is the word DATE followed by a space, followed by a date in single quotation marks in the form 'yyyy-mm-dd'. For example:

```
DECLARE MyDate DATE;  
SET MyDate = DATE '2000-02-29';
```

Do not omit leading zeroes from the year, month, and day.

ESQL TIME data type

The TIME data type holds a time of day in hours, minutes, seconds, and fractions of a second. The format of a TIME literal is the word TIME followed by a space, followed by a time in single quotation marks in the form 'hh:mm:ss.ffffff'. For example:

```
DECLARE MyTime TIME;  
SET MyTime = TIME '11:49:23.656';
```

Each of the hour, minute, and second fields in a TIME literal must always be two digits; the optional fractional seconds field can be up to 6 digits in length.

The PutTime reported by WebSphere MQ on z/OS and other times or timestamps can be inconsistent if the CVT field is not set correctly. For details about when this problem can occur, and how to solve it, see The PutTime that is reported by WebSphere MQ on z/OS, and other times or timestamps are inconsistent.

ESQL GMTTIME data type

The GMTTIME data type is similar to the TIME data type, except that its values are interpreted as values in Greenwich Mean Time. GMTTIME literals are defined in a similar way to TIME values. For example:

```
DECLARE MyGetGmtime GMTTIME;  
SET MyGetGmtime = GMTTIME '12:00:00';
```

The PutTime reported by WebSphere MQ on z/OS and other times or timestamps can be inconsistent if the CVT field is not set correctly. For details about when this problem can occur, and how to solve it, see The PutTime that is reported by WebSphere MQ on z/OS, and other times or timestamps are inconsistent.

ESQL TIMESTAMP data type

The TIMESTAMP data type holds a DATE and a TIME in years, months, days, hours, minutes, seconds, and fractions of a second. The format of a TIMESTAMP literal is the word TIMESTAMP followed by a space, followed by a time stamp in single quotation marks in the form 'yyyy-MM-dd HH:mm:ss.SSSSSS'. For example:

```
DECLARE MyTimeStamp TIMESTAMP;  
SET MyTimeStamp = TIMESTAMP '1999-12-31 23:59:59';
```

The year field must always be four digits in length. The month, day, hour, and minute fields must always be two digits. (Do not omit leading zeros.) The optional fractional seconds field can be 0 - 6 digits long.

For a description of the characters used when formatting a time stamp in the ESQL CAST function, see "Formatting and parsing dateTimes as strings" on page 1626

The PutTime reported by WebSphere MQ on z/OS and other times or time stamps can be inconsistent if the CVT field is not set correctly. For details about when this problem can occur, and how to solve it, see The PutTime that is reported by WebSphere MQ on z/OS, and other times or timestamps are inconsistent.

ESQL GMTTIMESTAMP data type

The GMTTIMESTAMP data type is similar to the TIMESTAMP data type, except that the values are interpreted as values in Greenwich Mean Time. GMTTIMESTAMP values are defined in a similar way to TIMESTAMP values, for example:

```
DECLARE MyGetGMTTimeStamp GMTTIMESTAMP;
SET MyGetGMTTimeStamp = GMTTIMESTAMP '1999-12-31 23:59:59.999999';
```

The PutTime reported by WebSphere MQ on z/OS and other times or timestamps can be inconsistent if the CVT field is not set correctly. For details about when this problem can occur, and how to solve it, see The PutTime that is reported by WebSphere MQ on z/OS, and other times or timestamps are inconsistent.

ESQL INTERVAL data type

The INTERVAL data type holds an interval of time. It has a number of subtypes:

- YEAR
- YEAR TO MONTH
- MONTH
- DAY
- DAY TO HOUR
- DAY TO MINUTE
- DAY TO SECOND
- HOUR
- HOUR TO MINUTE
- HOUR TO SECOND
- MINUTE
- MINUTE TO SECOND
- SECOND

All these subtypes describe intervals of time and all can take part in the full range of operations of the INTERVAL type; for example, addition and subtraction operations with values of type DATE, TIME, or TIMESTAMP.

Use the CAST function to convert from one subtype to another, except for intervals described in years and months, or months, which cannot be converted to those described in days, hours, minutes, and seconds.

The split between months and days arises because the number of days in each month varies. An interval of one month and a day is not meaningful, and cannot be sensibly converted into an equivalent interval in numbers of days only.

An interval literal is defined by the syntax:

```
INTERVAL <interval string> <interval qualifier>
```

The format of interval string and interval qualifier are defined by the table below.

Interval qualifier	Interval string format	Example
YEAR	'<year>' or '<sign> <year>'	'10' or '-10'
YEAR TO MONTH	'<year>-<month>' or '<sign> <year>-<month>'	'2-06' or '- 2-06'

Interval qualifier	Interval string format	Example
MONTH	'<month>' or '<sign> <month>'	'18' or '-18'
DAY	'<day>' or '<sign> <day>'	'30' or '-30'
DAY TO HOUR	'<day> <hour>' or '<sign> <day> <hour>'	'1 02' or '-1 02'
DAY TO MINUTE	'<day> <hour>:<minute>' or '<sign> <day> <hour>:<minute>'	'1 02:30' or '-1 02:30'
DAY TO SECOND	'<day> <hour>:<minute>:<second>' or '<sign> <day> <hour>:<minute>:<second>'	'1 02:30:15' or '-1 02:30:15.333'
HOUR	'<hour>' or '<sign> <hour>'	'24' or '-24'
HOUR TO MINUTE	'<hour>:<minute>' or '<sign> <hour>:<minute>'	'1:30' or '-1:30'
HOUR TO SECOND	'<hour>:<minute>:<second>' or '<sign> <hour>:<minute>:<second>'	'1:29:59' or '-1:29:59.333'
MINUTE	'<minute>' or '<sign> <minute>'	'90' or '-90'
MINUTE TO SECOND	'<minute>:<second>' or '<sign> <minute>:<second>'	'89:59' or '-89:59'
SECOND	'<second>' or '<sign> <second>'	'15' or '-15.7'

Where an interval contains both a year and a month value, a hyphen is used between the two values. In this instance, the month value must be within the range [0, 11]. If an interval contains a month value and no year value, the month value is unconstrained.

A space is used to separate days from the rest of the interval.

If an interval contains more than one of HOUR, MINUTE, and SECOND, a colon is needed to separate the values and all except the leftmost are constrained as follows:

HOUR

0-23

MINUTE

0-59

SECOND

0-59.999...

The largest value of the left-most value in an interval is +/- 2147483647.

Some examples of valid interval values are:

- 72 hours
- 3 days: 23 hours
- 3600 seconds
- 90 minutes: 5 seconds

Some examples of invalid interval values are:

- 3 days: 36 hours
A day field is specified, so the hours field is constrained to [0,23].
- 1 hour: 90 minutes
An hour field is specified, so minutes are constrained to [0,59].

Here are some examples of interval literals:

INTERVAL '1' HOUR
 INTERVAL '90' MINUTE
 INTERVAL '1-06' YEAR TO MONTH

Representation of ESQL datetime data types

When your application sends a message to a broker, the way in which the message data is interpreted depends on the content of the message itself and the configuration of the message flow. If your application sends a message to be interpreted either by the generic XML parser, or the MRM parser, that is tailored by an XML physical format, the application can include date or time data that is represented by any of the XML Schema primitive datetime data types.

The XML Schema data type of each piece of data is converted to an ESQL data type, and the element that is created in the logical message tree is of the converted type. If the datetime data in an input message does not match the rules of the chosen schema data type, the values that the parser writes to the logical message tree are modified even if the message is in the MRM domain and you have configured the message flow to validate the input message. (Validation is not available for generic XML messages.)

This has the following effect on the subfields of the input datetime data:

- If any of the subfields of the input message are missing, a default value is written to the logical message tree. This default is substituted from the full timestamp that refers to the beginning of the current epoch: 1970-01-01 00:00:00.
- If the input message contains information for subfields that are not present in the schema, the additional data is discarded. If this occurs, no exception is raised, even if a message in the MRM domain is validated.
- After the data is parsed, it is cast to one of three ESQL datetime data types. These are DATE, TIME, and TIMESTAMP.
 - If a datetime value contains only date subfields, it is cast to an ESQL DATE.
 - If a datetime value contains only time subfields, it is cast to an ESQL TIME.
 - If a datetime value contains both date and time subfields, it is cast to an ESQL TIMESTAMP.

The following examples illustrate these points.

Input data XML Schema data type	Schema rules	Input value in the bit stream	Value written to the logical tree (ESQL data type in brackets)
xsd:dateTime	CCYY-MM-DDThh:mm:ss	2002-12-31T23:59:59	2002-12-31 23:59:59 (TIMESTAMP)
		--24	1970-01-24 (DATE)
		23:59:59	23:59:59 (TIME)
xsd:date	CCYY-MM-DD	2002-12-31	2002-12-31 (DATE)
		2002-12-31T23:59:59	2002-12-31 (DATE)
		-06-24	1970-06-24 (DATE)
xsd:time	hh:mm:ss	14:15:16	14:15:16 (TIME)
xsd:gDay	---DD	---24	1970-01-24 (DATE)
xsd:gMonth	--MM	--12	1970-12-01 (DATE)
xsd:gMonthDay	--MM-DD	--12-31	1970-12-31 (DATE)
xsd:gYear	CCYY	2002	2002-01-01 (DATE)

Input data XML Schema data type	Schema rules	Input value in the bit stream	Value written to the logical tree (ESQL data type in brackets)
xsd:gYearMonth	CCYY-MM	2002-12	2002-12-01 (DATE)

Validation with missing subfields: When you consider which schema datetime data type to use, bear in mind that, if the message is in the MRM domain, and you configure the message flow to validate messages, missing subfields can cause validation exceptions.

The schema data types Gday, gMonth, gMonthDay, gYear, and gYearMonth are used to record particular recurring periods of time. There is potential confusion when validation is turned on, because the recurring periods of time that are used in these schema data types are stored by ESQL as specific points in time.

For example, when the 24th of the month, which is a gDay (a monthly day) type, is written to the logical tree, the missing month and year subfields are supplied from the epoch (January 1970) to provide the specific date 1970-01-24. If you code ESQL to manipulate this date, for example by adding an interval of 10 days, and then generate an output message that is validated, an exception is raised. This is because the result of the calculation is 1970-02-03 which is invalid because the month subfield of the date no longer matches the epoch date.

ESQL NULL data type

All ESQL data types (except REFERENCE) support the concept of the null value. A value of null means that the value is unknown, undefined, or uninitialized. Null values can arise when you refer to message fields that do not exist, access database columns for which no data has been supplied, or use the keyword NULL, which supplies a null literal value.

Null is a distinct state and is not the same as any other value. In particular, for integers it is not the same thing as the value 0 and for character variables it is not the same thing as a string of zero characters. The rules of ESQL arithmetic take null values into account, and you are typically unaware of their existence. Generally, but not always, these rules mean that, if any operand is null, the result is null.

If an expression returns a null value its data type is not, in general, known. All null values, whatever their origin, are therefore treated equally.

This can be regarded as their belonging to the data type NULL, which is a data type that can have just one value, null.

An expression always returns NULL if any of its elements are NULL.

Testing for null values

To test whether a field contains a null value, use the IS operator described in **Operator=**.

The effect of setting a field to NULL

Take care when assigning a null value to a field. For example, the following command *deletes* the Name field:

```
SET OutputRoot.XMLNS.Msg.Data.Name = NULL; -- this deletes the field
```

The correct way to assign a null value to a field is as follows:

```
SET OutputRoot.XMLNS.Msg.Data.Name VALUE = NULL;  
-- this assigns a NULL value to a field without deleting it
```

ESQL numeric data types

ESQL supports several data types that handle numeric values.

The following data types are collectively known as **numeric** data types:

- “ESQL DECIMAL data type”
- “ESQL FLOAT data type” on page 1459
- “ESQL INTEGER data type” on page 1460

Notes:

1. INTEGER and DECIMAL types are represented exactly inside the broker; FLOAT types are inherently subject to rounding error without warning. Do not use FLOAT if you need absolute accuracy, for example, to represent money.
2. Various casts are possible between different numeric types. These can result in loss of precision, if exact types are cast into FLOAT.

For information about numeric functions see “ESQL numeric functions” on page 1577.

ESQL DECIMAL data type

The **DECIMAL** data type holds an exact representation of a decimal number. Decimals have precision, scale, and rounding. Precision is the total number of digits of a number:

- The minimum precision is 1
- The maximum precision is 34

Scale is the number of digits to the right of the decimal point:

- The minimum scale (-exponent) is -999,999,999
- The maximum scale (-exponent) is +999,999,999

You cannot define precision and scale when declaring a DECIMAL, because they are assigned automatically. It is only possible to specify precision and scale when casting to a DECIMAL.

Scale, precision, and rounding:

The following scale, precision, and rounding rules apply:

- Unless rounding is required to keep within the maximum precision, the scale of the result of an addition or subtraction is the greater of the scales of the two operands.
- Unless rounding is required to keep within the maximum precision, the scale of the result of a multiplication is the sum of the scales of the two operands.
- The precision of the result of a division is the smaller of the number of digits needed to represent the result exactly and the maximum precision.
- All addition, subtraction, multiplication, and division calculations round the least significant digits, as necessary, to stay within the maximum precision

- All automatic rounding is *banker's* or *half even symmetric* rounding. The rules of this are:
 - When the first dropped digit is 4 or less, the first retained digit is unchanged
 - When the first dropped digit is 6 or more, the first retained digit is incremented
 - When the first dropped digit is 5, the first retained digit is incremented if it is odd, and unchanged if it is even. Therefore, both 1.5 and 2.5 round to 2 while 3.5 and 4.5 both round to 4
 - Negative numbers are rounded according to the same rule

Decimal literals:

Decimal literals that consist of an unquoted string of digits only, that is, that contain neither a decimal point nor an exponent (for example 12345) are of type INTEGER if they are small enough to be represented as integers. Otherwise they are of type DECIMAL.

Decimal literals that consist of an unquoted string of digits, optionally a decimal point, and an exponent (for example 123e1), are of type FLOAT if they are small enough to be represented as floats. Otherwise they are of type DECIMAL.

Decimal literals that consist of the keyword DECIMAL and a quoted string of digits, with or without a decimal point and with or without an exponent, are of type DECIMAL, for example, DECIMAL '42', DECIMAL '1.2346789e+203'.

The strings in this type of literal can also have the values:

- 'NAN', not a number
- 'INF', 'INFINITY'
- '+INF', '+INFINITY'
- '-INF', '-INFINITY'
- 'MAX'
- 'MIN'

(in any mixture of case) to denote the corresponding values.

Note, if you do not specify sufficient precision digits, that INF is returned, as shown in the following example:

```
SET VAL [equals char] CAST('123456' AS DECIMAL(3,0))
```

ESQL FLOAT data type

The FLOAT data type holds a 64-bit, base 2, fraction and exponent approximation to a real number. This gives a range of values between $+1.7E-308$ and $+1.7E+308$.

Float literals consist of an unquoted string of digits and either a decimal point (for example 123.4) or an exponent (for example 123e4) or both (for example 123.4e5) . They are of type FLOAT if they are small enough to be represented as floats. Otherwise they are of type DECIMAL

Rounding:

When you CAST a FLOAT to an INTEGER, either implicitly or explicitly, the FLOAT is truncated; that is, the numbers after the decimal point are removed and no rounding occurs.

ESQL INTEGER data type

The INTEGER data type holds an integer number in 64-bit two's complement form. This gives a range of values between -9223372036854775808 and +9223372036854775807.

Integer literals consist of an unquoted string of digits only; that is, they contain neither a decimal point nor an exponent; for example, 12345. They are of type INTEGER if they are small enough to be represented as integers. Otherwise they are of type DECIMAL.

In addition to this format, you can write integer literals in hexadecimal notation; for example, 0x1234abcd. You can write the hexadecimal letters A to F, and the "x" after the initial zero, in uppercase or lowercase. If you use hexadecimal format, the number must be small enough to fit into an integer. (That is, it cannot be a decimal.)

ESQL REFERENCE data type

The REFERENCE data type holds the location of a field in a message. It cannot hold the location of a constant, a database table, a database column, or another reference.

Note: For compatibility with earlier versions, reference variables can also point at scalar variables

A reference literal is a hierarchic path name, consisting of a list of path elements separated by periods. The first element in the list is known as the correlation name, and identifies a reference, row, or scalar variable. Any subsequent elements apply to references to message trees only, and identify field types, names, and indexes within the message tree relative to the field pointed to by the correlation name.

For example:

```
InputRoot.MQMD.Priority
```

is a field reference literal that refers to the Priority field contained within an MQMD structure within an input message.

ESQL ROW data type

The ROW data type holds a **tree structure**. A row in a database is a particular type of tree structure, but the ROW data type is not restricted to holding data from database rows.

In a database, a row is a fixed, ordered, set of scalar values.

Note: A *scalar* is a single entity value or a string.

A database table is an unordered set of rows and is thus a two dimensional "array" of scalar values, in which one dimension is fixed and the other is variable. In ESQL, a row is an open-ended, ordered, set of named values in which each value can be scalar or another row. That is, a row is an open-ended tree structure with no restrictions on dimensions or regularity. Consider the following diagram:

```

Root
  Row
    PartNumber = 1
    Description = 'Chocolate bar'
    Price      = 0.30
  Row
    PartNumber = 2
    Description = 'Biscuit'
    Price      = 0.35
  Row
    PartNumber = 3
    Description = 'Fruit'
    Price      = 0.42

```

In the example, *Root* contains three elements all named “*Row*”. Each of these in turn contains three elements with different names and values. This diagram equally describes an instance of an ESQL row data type (that is, a tree structure) or the contents of a database table.

ROW and LIST

The ROW data type is a normal data type. You can use the DECLARE statement to create ROW variables in the same way as you create INTEGER or CHARACTER variables. There is also a more general concept of a ROW data type. In the previous example, *Root* is the root element of a ROW variable. Each of the elements called “*Row*”, while not the root element of ROW variables, are the root elements of sub-structures. Many ESQL operations (and particularly the SELECT function) work with the general concept of ROW and will operate equally on whole trees or parts of them.

There is also a general concept of a LIST data type. The set of elements called “*Row*” can be regarded as a list. Some ESQL operations (particularly SELECT) work with the general concept of list.

InputRoot, *OutputRoot* (and so on) are examples of ROW variables that are automatically declared and connected into the broker’s structure, ready for use.

ESQL string data types

ESQL supports several data types that handle string values. The following data types are collectively known as **string** data types:

- “ESQL BIT data type”
- “ESQL BLOB data type” on page 1462
- “ESQL CHARACTER data type” on page 1462

For information about string functions, see “ESQL string manipulation functions” on page 1592.

ESQL BIT data type

The BIT data type holds a variable length string of binary digits. It is commonly used to represent arbitrary binary data that does not contain an exact number of bytes. A bit string literal consists of the letter B, followed by a string of binary digits enclosed in single quotation marks, as in the following example:

```
B'0100101001'
```

Any number of digits, which must be either 0 or 1, can be specified. The initial B can be specified in uppercase or lowercase.

ESQL BLOB data type

The BLOB data type holds a variable length string of 8-bit bytes. It is commonly used to represent arbitrary binary data. A BLOB literal consists of the letter X, followed by a string of hexadecimal digits enclosed in single quotation marks, as in the following example:

```
X'0123456789ABCDEF'
```

There must be an even number of digits in the string, because two digits are required to define each byte. Each digit can be one of the hexadecimal digits 0-9 and A-F. Both the initial X and the hexadecimal letters can be specified in uppercase or lowercase.

ESQL CHARACTER data type

The character data type holds a variable length string of Unicode characters. A character string literal consists of any number of characters in single quotation marks. If you want to include a single quotation mark within a character string literal, use another single quotation mark as an escape character.

For example, the assignment SET X='he''was'' puts the value he'was' into X.

ESQL-to-Java data-type mapping table

Table summarizing the mappings from ESQL to Java.

The following table summarizes the mappings from ESQL to Java.

Notes:

- Only the Java scalar wrappers are passed to Java.
- The ESQL scalar types are mapped to Java data types as object wrappers, or object wrapper arrays, depending upon the direction of the procedure parameter. Each wrapper array contains exactly one element.
- Scalar object wrappers are used to allow NULL values to be passed to and from Java methods.

ESQL data types ¹	Java IN data types	Java INOUT and OUT data types
INTEGER, INT	java.lang.Long	java.lang.Long []
FLOAT	java.lang.Double	java.lang.Double[]
DECIMAL	java.math.BigDecimal	java.math.BigDecimal[]
CHARACTER, CHAR	java.lang.String	java.lang.String[]
BLOB	byte[]	byte[][]
BIT	java.util.BitSet	java.util.BitSet[]
DATE	com.ibm.broker.plugin.MbDate	com.ibm.broker.plugin.MbDate[]
TIME ²	com.ibm.broker.plugin.MbTime	com.ibm.broker.plugin.MbTime[]
GMTTIME ²	com.ibm.broker.plugin.MbTime	com.ibm.broker.plugin.MbTime[]
TIMESTAMP ²	com.ibm.broker.plugin.MbTimestamp	com.ibm.broker.plugin.MbTimestamp[]
GMTTIMESTAMP ²	com.ibm.broker.plugin.MbTimestamp	com.ibm.broker.plugin.MbTimestamp[]
INTERVAL	Not supported	Not supported
BOOLEAN	java.lang.Boolean	java.lang.Boolean[]

REFERENCE (to a message tree) ^{3 4} _{5 6}	com.ibm.broker.plugin.MbElement	com.ibm.broker.plugin.MbElement[] (Supported for INOUT. Not supported for OUT)
ROW	Not supported	Not supported
LIST	Not supported	Not supported

- Variables that are declared to be CONSTANT (or references to variables that are declared to be CONSTANT) are not allowed to have the direction INOUT or OUT.
- The time zone set in the Java variable is not important; you obtain the required time zone in the output ESQL.
- The reference parameter cannot be NULL when passed into a Java method.
- The reference cannot have the direction OUT when passed into a Java method.
- If an *MbElement* is passed back from Java to ESQL as an INOUT parameter, it must point to a location in the same message tree as that pointed to by the *MbElement* that was passed into the called Java method.
For example, if an ESQL reference to `OutputRoot.XML.Test` is passed into a Java method as an INOUT *MbElement*, but a different *MbElement* is passed back to ESQL when the call returns, the different element must also point to somewhere in the `OutputRoot` tree.
- An *MbElement* cannot be returned from a Java method with the RETURNS clause, because no ESQL routine can return a reference. However, an *MbElement* can be returned as an INOUT direction parameter, subject to the conditions described in point 5.

A REFERENCE to a scalar variable can be used in the CALL of a Java method, provided that the data type of the variable to which the reference refers matches the corresponding data type in the Java program signature.

ESQL-to-XPath mapping table

The following table summarizes the mappings from ESQL to XPath.

ESQL	XPath 1.0	XPath 1.0 usage notes
BOOLEAN data types True False Unknown	True() False() No equivalent	Equivalent to Boolean "1" or "True" Equivalent to Boolean "0" or "False"
Date Time data types	No equivalent	
NULL data type	No equivalent	
Numeric data types DECIMAL FLOAT INTEGER	12678967.543233 with or without quotation marks 1.7976931348623158 with or without quotation marks 9223372036854775807 with or without quotation marks	Cannot express an exponent or a leading plus sign. Cannot express an exponent or a leading plus sign. Cannot express an exponent or a leading plus sign.
REFERENCE data type	FilterExpression '/' RelativeLocationPath	For example, <code>\$InputRoot/MQMD/ Priority</code>

String data types BIT BLOB CHARACTER	No equivalent No equivalent Literal	For example 'a "b"' or "a 'b'"
NAME	\$NAME	Can assign such a variable any valid value, of type Boolean, number, or string.
Simple comparison operators > < >= '=' <>	> < >= '=' !=	
Complex comparison operators	No equivalent	
Logical operators AND OR NOT	and or not (operand)	The not function returns true if its argument is false, and false otherwise.
Numeric operators Unary - + - * /	- Unary expression + - * div	Multiplication operator
String operator	No equivalent	
Date time functions	No equivalent	
Numeric functions FLOOR CEIL and CEILING ROUND	floor (number) ceiling (number) No equivalent	
String manipulation functions SUBSTRING TRANSLATE	substring(string, number, number) translate(string, string, string)	

XPath property editors

The XPath files are supplied in three property editors located in the `com.ibm.etools.mft.ibmnodes` plugin. The property editors are:

Read only

Located in
`com.ibm.etools.mft.ibmnodes.editors.xpath.XPathReadOnlyPropertyEditor`

Read write

Located in
`com.ibm.etools.mft.ibmnodes.editors.xpath.XPathReadWritePropertyEditor`

Expression

Located in
`com.ibm.etools.mft.ibmnodes.editors.xpath.XPathPropertyEditor`

For information on adding a property editor to your workspace, see [Adding a property editor or compiler](#).

ESQL variables

ESQL variables can be described as external, normal, or shared; their use is defined in the DECLARE statement.

Types of variable

External

External variables (defined with the EXTERNAL keyword) are also known as *user-defined properties* (see “User-defined properties in ESQL” on page 261). They exist for the entire lifetime of a message flow and are visible to all messages that pass through the flow. You can define external variables only at the module and schema level. You can modify their initial values (optionally set by the DECLARE statement) by using the Message Flow editor, or at deployment time, by using the BAR editor. You can query and set the values of user-defined properties at run time by using the Configuration Manager Proxy (CMP) API. For more information, see *Setting user-defined properties dynamically at run time*.

Normal

“Normal” variables have a lifetime of just one message passing through a node. They are visible to that message only. To define a “normal” variable, omit both the EXTERNAL and SHARED keywords.

Shared

Shared variables (defined with the SHARED keyword) can be used to implement an in-memory cache in the message flow (see “Optimizing message flow response times” on page 158). Shared variables have a long lifetime and are visible to multiple messages that pass through the flow (see “Long-lived variables” on page 261). They exist for the lifetime of the execution group process, the lifetime of the flow or node, or the lifetime of the node’s SQL that declares the variable (whichever is the shortest). They are initialized when the first message passes through the flow or node after each broker startup.

See also the ATOMIC option of the “BEGIN ... END statement” on page 1482. The BEGIN ATOMIC construct is useful when a number of changes need to be made to a shared variable and when it is important to prevent other instances seeing the intermediate states of the data.

ESQL field references

This topic describes how to use ESQL field references to form paths to message body elements.

The full syntax for field references is as shown below:

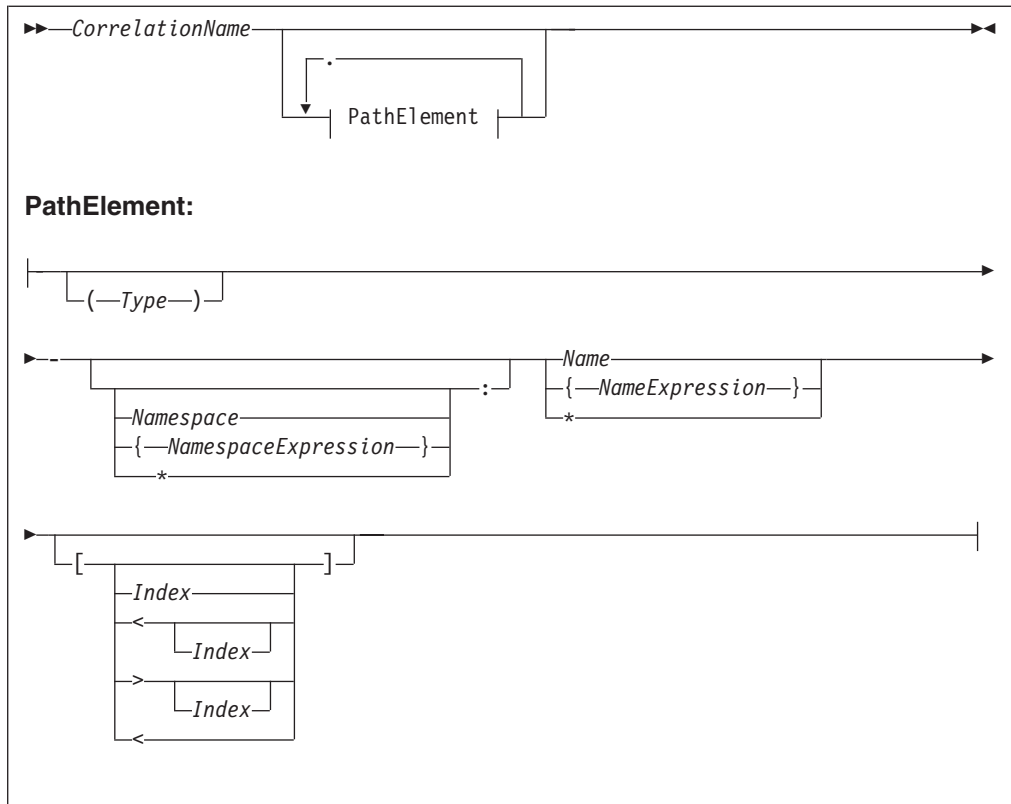

A field reference consists of a correlation name, followed by zero or more Path Elements separated by periods (.). The correlation name identifies a well-known starting point and must be the name of a constant, a declared variable (scalar, row or reference), or one of the predefined start points; for example, InputRoot. The path Fields define a path from the start point to the desired field.

See:

- “Namespace” on page 1467 for the meaning of the different combinations of namespace and name
- “Target field references” on page 1470 for the meaning of the different combinations of field references
- “Index” on page 1468 for the meaning of the different combinations of index clauses
- “Type” on page 1468 for the meaning of the different combinations of types

For example:

InputRoot.XMLNS.Data.Invoice

starts the broker at the location InputRoot (that is, the root of the input message to a Compute node) and then performs a sequence of navigations. First, it navigates from root to the first child field called XMLNS, then to the first child field of the XMLNS field called Data. Finally, the broker navigates to the first child field of the Data field called Invoice. Whenever this field reference occurs in an ESQL program, the invoice field is accessed.

This form of field reference is simple, convenient, and is the most commonly used. However, it does have two limitations:

- Because the names used must be valid ESQL identifiers, you can use only names that conform to the rules of ESQL. That is, the names can contain only alphanumeric characters including underscore, the first character cannot be numeric, and names must be at least one character long. You can avoid these limitations by enclosing names not conforming to these rules in double quotation marks. For example:

```
InputRoot.XMLNS."Customer Data".Invoice
```

If you need to refer to fields that contain quotation marks, use two pairs of quotation marks around the reference. For example:

```
Body.Message."""hello"""
```

Some identifiers are reserved as keywords but, with the exception of the correlation name, you can use them in field references without the use of double quotation marks

- Because the names of the fields appear in the ESQL program, they must be known when the program is written. This limitation can be avoided by using the alternative syntax that uses braces ({ ... }). This syntax allows you to use any expression that returns a non-null value of type character.

For example:

```
InputRoot.XMLNS."Customer Data".{'Customer-' ||
CurrentCustomer}.Invoice
```

in which the invoices are contained in a folder with a name is formed by concatenating the character literal Customer- with the value in CurrentCustomer (which in this example must be a declared variable of type character).

You can use the asterisk (*) wildcard character in a path element to match any name. You can also use ""*"" to specify a partial name. For example, Prefix* matches any name that begins with "Prefix".

Note that enclosing anything in double quotation marks in ESQL makes it an identifier; enclosing anything in single quotation marks makes it a character literal. You must enclose all character strings in single quotation marks.

Namespace

Field names can belong to namespaces. Field references provide support for namespaces as follows:

- Each field of each field reference that contains a name clause can also contain a namespace clause defining the namespace to which the specified name belongs.
- Each namespace name can be defined by either a simple identifier or by an expression (enclosed in curly braces). If an identifier is the name of a declared namespace constant, the value of the constant is used. If an expression is used, it must return a non-null value of type character.
- A namespace clause of * explicitly states that namespace information is to be ignored when locating Fields in a tree.
- A namespace clause consisting of only : explicitly targets the notarget namespace. The clause has no identifier, expression or wildcard (*).

For example:

```
DECLARE sp1 NAMESPACE 'http://www.ibm.com/spacel1';
```

```
/* Namespace declaration to associate prefix 'spacel1' with the namespace */
```

```
SET OutputRoot.XMLNS.TestCase.(XML.NamespaceDecl)xmlns:space1 = 'http://www.ibm.com/space1';
SET OutputRoot.XMLNS.TestCase.{sp1}:data1 = 'Hello!';
```

generates:

```
<TestCase xmlns:space1="http://www.ibm.com/space1">
<space1:data1>Hello!</space1:data1>
</TestCase>
```

Index

Each field of a field reference can contain an index clause. This clause is denoted by brackets ([...]) and accepts any expression that returns a non-null value of type integer. This clause identifies which of several fields with the same name is to be selected. Fields are numbered from the first, starting at one. If this clause is not present, it is assumed that the first field is required. Thus, the two examples below have exactly the same meaning:

```
InputRoot.XMLNS.Data[1].Invoice
InputRoot.XMLNS.Data.Invoice[1]
```

This construct is most commonly used with an index variable, so that a loop steps through all such fields in sequence. For example:

```
WHILE count < 32 DO
    SET TOTAL = TOTAL + InputRoot.XMLNS.Data.Invoice[count].Amount;
    SET COUNT = COUNT + 1
END WHILE;
```

Use this kind of construct with care, because it implies that the broker must count the fields from the beginning each time round the loop. If the repeat count is large, performance will be poor. In such cases, a better alternative is to use a field reference variable.

Index expressions can optionally be preceded by a less-than sign (<), indicating that the required field is to be indexed from the last field, not the first. In this case, the index 1 refers to the last field and the index 2 refers to the penultimate field. For completeness, you can use a greater-than sign to indicate counting from the first field. The example below shows ESQL code that handles indexes where there are four fields called Invoice.

```
InputRoot.XMLNS.Data.Invoice      -- Selects the first
InputRoot.XMLNS.Data.Invoice[1]   -- Selects the first
InputRoot.XMLNS.Data.Invoice[>]  -- Selects the first
InputRoot.XMLNS.Data.Invoice[>1] -- Selects the first
InputRoot.XMLNS.Data.Invoice[>2] -- Selects the second
InputRoot.XMLNS.Data.Invoice[<]   -- Selects the fourth
InputRoot.XMLNS.Data.Invoice[<1]  -- Selects the fourth
InputRoot.XMLNS.Data.Invoice[<2]  -- Selects the third
InputRoot.XMLNS.Data.Invoice[<3]  -- Selects the second
```

An index clause can also consist of an empty pair of brackets ([]). This selects all fields with matching names. Use this construct with functions and statements that expect lists (for example, the SELECT, CARDINALITY, SINGULAR, and EXISTS functions, or the SET statement) .

Type

Each field of a field reference can contain a type clause. These are denoted by parentheses (()), and accept any expression that returns a non-null value of type

integer. The presence of a type expression restricts the fields that are selected to those of the matching type. This construct is most commonly used with generic XML, where there are many field types and it is possible for one XML field to contain both attributes and further XML Fields with the same name.

For example:

```
<Item Value = '1234'>
  <Value>5678</Value>
</Item>
```

Here, the XML field Item has two child Fields, both called “Value”. The child Fields can be distinguished by using type clauses:

Item.(<Domain>.Attribute)Value to select the attribute, and

Item.(XML.Element)Value to select the field, where <Domain> is one of XML, XMLNS, or XMLNSC, as determined by the message domain of the source.

Type constraints

A type constraint checks the data type returned by a field reference.

(1)

►►—(—FieldReference—)—ScalarDataTypeName—►►

Notes:

1 *ScalarDataTypeName* can be any one of BOOLEAN, INTEGER, INT, FLOAT, DECIMAL, DEC, DATE, TIME, TIMESTAMP, GMTTIME, GMTTIMESTAMP, INTERVAL, CHARACTER, CHAR, BLOB, BIT.

Typically, a type constraint causes the scalar value of the reference to be extracted (in a similar way to the FIELDVALUE function) and an exception to be thrown if the reference is not of the correct type. By definition, an exception will be thrown for all nonexistent fields, because these evaluate to NULL. This provides a convenient and fast way of causing exceptions if essential fields are missing from messages.

However, when type constraints occur in expressions that are candidates for being passed to a database (for example, they are in a WHERE clause), the information is used to determine whether the expression can be given to the database. This can be important if a WHERE clause contains a CAST operating on a database table column. In the absence of a type constraint, such expressions cannot be given to the database because the broker cannot tell whether the database is capable of performing the required conversion. Note, however, that you should always exercise caution when using casts operating on column values, because some databases have exceedingly limited data conversion capabilities.

Field references summary

***, **[..]*, *(..)**, *(..)*[..]*

None of these forms specifies a name or namespace. The target field can have any name, in any namespace or in no namespace. It is located solely by its type, its index, or its type and index, as appropriate.

Name, Name[.], (.)Name, (.)Name[.]

All these forms specify a name but no namespace. The target field is located by namespace and name, and also by type and index where appropriate.

The namespace is taken to be the only namespace in the namespace path containing this name. The only namespace that can be in the path is the notarget namespace.

These forms all existed before namespaces were introduced. Although their behavior has changed in that they now compare both name and namespace, existing transforms should see no change in their behavior because all existing transforms create their Fields in the notarget namespace.

:* , :*[.], (.:)* , (.:)*[.]

All these forms specify the notarget namespace but no name. The target field is located by its namespace and also by type and index where appropriate.

:Name, :Name[.], (.:)Name, (.:)Name[.]

All these forms specify a name and the notarget namespace. The target field is located by namespace and name and also by type and index where appropriate.

***.* , *.*[.], (.)*.* , (.)*.*[.]**

None of these forms specifies a name or a namespace. Note that “*.*” is equivalent to “*”, and matches no namespace as well as any namespace. The target field can have any name, in any namespace or in no namespace. It is located solely by its type, its index, or its type and index, as appropriate.

***:Name, *:Name[.], (.)*:Name, (.)*:Name[.]**

All these forms specify a name but no namespace. The target field is located by name and also by type and index where appropriate.

Namespace:* , Namespace:*[.], (.)Namespace:* , (.)Namespace:*[.]

All these forms specify a namespace but no name. The target field is located by namespace and also by type and index where appropriate.

Namespace:Name, Namespace:Name[.], (.)Namespace:Name, (.)Namespace:Name[.]

All these forms specify a namespace and name. The target field is located by namespace and name and also by type and index where appropriate.

In all the preceding cases a name, or namespace, provided by an expression contained in braces ({}) is equivalent to a name provided as an identifier.

By definition, the name of the notarget namespace is the empty string. The empty string can be selected by expressions which evaluate to the empty string, the empty identifier "", or by reference to a namespace constant defined as the empty string.

Target field references

The use of field references usually implies searching for an existing field. However, if the required field does not exist, as is usually the case for field references that are the targets of SET statements and those in the AS clauses of SELECT functions, it is created.

In these situations, there are a variety of circumstances in which the broker cannot tell what the required name or namespace is, and in these situations the following general principles apply :

- If the name clause is absent or does not specify a name, and the namespace clause is absent or does not specify or imply a namespace (that is, there is no name or namespace available), one of the following conditions applies:
 - If the assignment algorithm does **not** copy the name from some existing field, the new field has both its name and namespace set to the empty string and its name flag is **not** set automatically.
In the absence of a type specification, the field's type is not *Name* or *NameValue*, which effectively indicates that the new field is nameless.
 - Otherwise, if the assignment algorithm chooses to copy the name from some existing field, the new field has both its name and namespace copied from the existing field and its *Name* flag is set automatically
- If the name clause is present and specifies a name, but the namespace clause is absent or does not specify or imply a namespace (that is, a name is available but a namespace is not), the new field has its:
 - *Name* set to the given value
 - *Namespace* set to the empty string
 - *Name* flag set automatically
- If the name clause is absent or does not specify a name, but the namespace clause is present and specifies or implies a namespace (that is, a namespace is available but a name is not), the new field has its:
 - *Namespace* set to the given value
 - *Name* set to the empty string
 - *Name* flag set automatically
- If the name clause is present and specifies a name, and the namespace clause is present and specifies or implies a namespace, the new field has its:
 - *Name* set to the given value
 - *Namespace* set to the given value
 - *Name* flag set automatically

There are also cases where the broker creates Fields in addition to those referenced by field references:

- Tree copy: new Fields are created by an algorithm that uses a source tree as a template. If the algorithm copies the name of a source field to a new field, its namespace is copied as well.
- Anonymous select expressions: SELECT clauses are not obliged to have AS clauses; those that do not have them, set the names of the newly created Fields to default values (see "SELECT function" on page 1632).

These defaults can be derived from field names, column names or can simply be manufactured sequence names. If the name is an field name, this is effectively a tree copy, and the namespace name is copied as above.

Otherwise, the namespace of the newly-created field is derived by searching the path, that is, the name is be treated as the *NameId* syntax of a field reference.

The effect of setting a field to NULL

Take care when assigning a null value to a field. For example, the following command *deletes* the Name field:

```
SET OutputRoot.XMLNS.Msg.Data.Name = NULL; -- this deletes the field
```

The correct way to assign a null value to a field is as follows:

```
SET OutputRoot.XMLNS.Msg.Data.Name VALUE = NULL;  
-- this assigns a NULL value to a field without deleting it
```

Note: to users on compatibility with earlier versions

For compatibility with earlier versions, the LAST keyword is still supported, but its use is deprecated. LAST cannot be used as part of an index expression: [LAST] is valid, and is equivalent to [<], but [LAST3] is not valid.

The LAST keyword has been replaced by the following arrow syntax, which allows both a direction of search and index to be specified:

```
Field [> ]                -- The first field, equivalent to [ 1 ]  
Field [> (a + b) * 2 ]  
Field [ < ]                -- The last field, equivalent to [ LAST ]  
Field [ < 1 ]              -- The last field, equivalent to [ LAST ]  
Field [ < 2 ]              -- The last but one field  
Field [ < (a + b) / 3 ]
```

ESQL operators

This section provides reference information for the following groups of operators, and for the rules for precedence:

- Simple comparison operators
- Complex comparison operators
- Logical operators
- Numeric operators
- String operator
- Rules for operator precedence

ESQL simple comparison operators

This topic describes ESQL's simple comparison operators. For information about ESQL's complex comparison operators, see "ESQL complex comparison operators" on page 1473.

ESQL provides a full set of comparison operators (predicates). Each compares two scalar values and returns a Boolean. If either operand is null the result is null. Otherwise the result is true if the condition is satisfied and false if it is not.

Comparison operators can be applied to all scalar data types. However, if the two operands are of different types, special rules apply. These are described in "Implicit casts" on page 1652.

Some comparison operators also support the comparison of rows and lists. These are noted below.

Operator >

The first operand is greater than the second.

Operator <

The first operand is less than the second.

Operator >=

The first operand is greater than or equal to the second.

Operator <=

The first operand is less than or equal to the second.

Operator =

The first operand is equal to that of the second.

This operator can also compare rows and lists. See “ROW and LIST comparisons” on page 1642 for a description of list and row comparison.

Operator <>

The first operand is not equal to the second.

This operator can also compare rows and lists. See “ROW and LIST comparisons” on page 1642 for a description of list and row comparison.

The meanings of “equal”, “less”, and “greater” in this context are as follows:

- For the numeric types (INTEGER, FLOAT, DECIMAL) the numeric values are compared. Thus 4.2 is greater than 2.4 and -2.4 is greater than -4.2.
- For the date/time types (DATE, TIME, TIMESTAMP, GMTTIME, GMTTIMESTAMP but not INTERVAL) a later point in time is regarded as being greater than an earlier point in time. Thus the date 2004-03-31 is greater than the date 1947-10-24.
- For the INTERVAL type, a larger interval of time is regarded as being greater than a smaller interval of time.

For the string types (CHARACTER, BLOB, BIT) the comparison is lexicographic. Starting from the left, the individual elements (each character, byte or bit) are compared. If no difference is found, the strings are equal. If a difference is found, the values are greater if the first different element in the first operand is greater than the corresponding element in the second and less if they are less. In the special case where two strings are of unequal length but equal as far as they go, the longer string is regarded as being greater than the shorter. Thus:

'ABD' is greater than 'ABC'
'ABC' is greater than 'AB'

Trailing blanks are regarded as insignificant in character comparisons. Thus if you want to ensure that two strings are truly equal you need to compare both the strings themselves and their lengths. For example:

'ABC ' is equal to 'ABC'

Note that comparing strings with a length of one is equivalent to comparing individual characters, bytes, or bits. Because ESQL has no single character, byte, or bit data types, it is standard practice to use strings of length one to compare single characters, bytes, or bits.

ESQL complex comparison operators

This topic describes ESQL’s complex comparison operators (predicates). For information about ESQL’s simple comparison operators, see “ESQL simple comparison operators” on page 1472.

Operator BETWEEN

The operator BETWEEN allows you to test whether a value lies between two boundary values.

BETWEEN operator

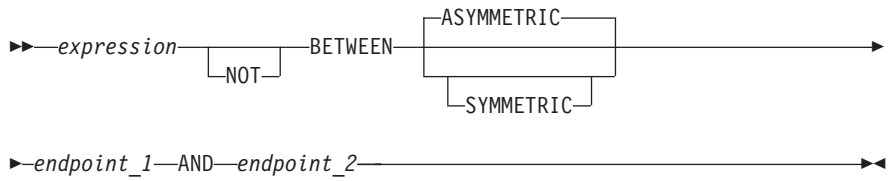

This operator exists in two forms, SYMMETRIC and ASYMMETRIC (which is the default if neither is specified). The SYMMETRIC form is equivalent to:

```
(source >= boundary1 AND source <= boundary2) OR  
(source >= boundary2 AND source <= boundary1)
```

The ASYMMETRIC form is equivalent to:

```
source >= boundary1 AND source <= boundary2
```

The ASYMMETRIC form is simpler but returns only the result that you expect when the first boundary value has a smaller value than the second boundary. It is only useful when the boundary condition expressions are literals.

If the operands are of different types, special rules apply. These are described in “Implicit casts” on page 1652.

Operator EXISTS

EXISTS operator



The operator EXISTS returns a Boolean value indicating whether a SELECT function returned one or more values (TRUE) or none (FALSE).

```
EXISTS(SELECT * FROM something WHERE predicate)
```

Operator IN

The operator IN allows you to test whether a value is equal to one of a list of values.

IN operator

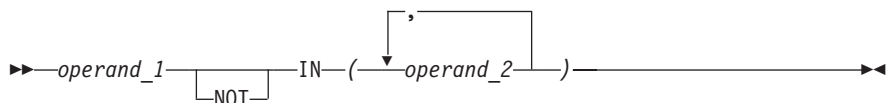

The result is TRUE if the left operand is not NULL and is equal to one of the right operands. The result is FALSE if the left operand is not NULL and is not equal to any of the right operands, none of which have NULL values. Otherwise the result is UNKNOWN. If the operands are of different types, special rules apply. These are described in “Implicit casts” on page 1652.

Operator IS

The operator IS allows you to test whether an expression has returned a special value.

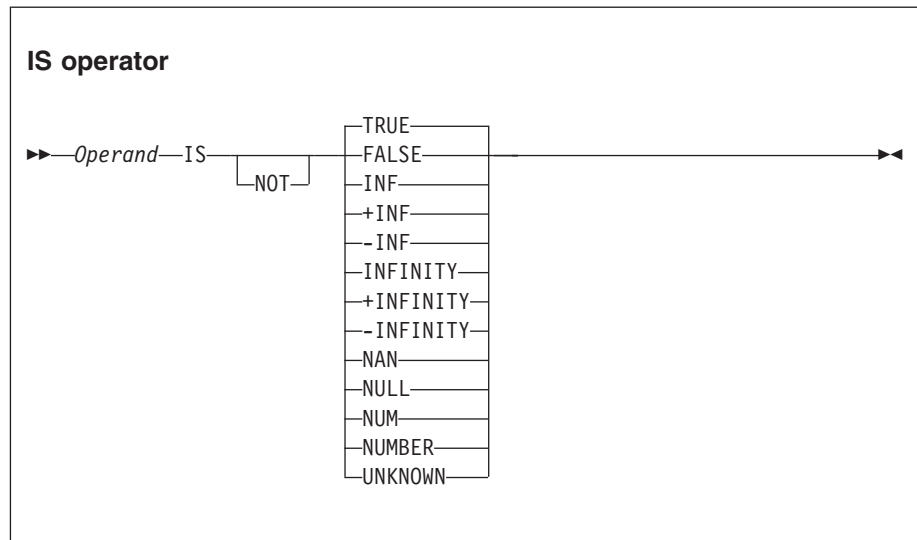

The primary purpose of the operator IS is to test whether a value is NULL. The comparison operator (=) does not allow this because the result of comparing anything with NULL is NULL.

IS also allows you to test for the Boolean values TRUE and FALSE, and the testing of decimal values for special values. These are denoted by INF, +INF, -INF, NAN (not a number), and NUM (a valid number) in any mixture of case. The alternative forms +INFINITY, -INFINITY, and NUMBER are also accepted.

If applied to non-numeric types, the result is FALSE.

Operator LIKE

The operator LIKE searches for strings that match a certain pattern.

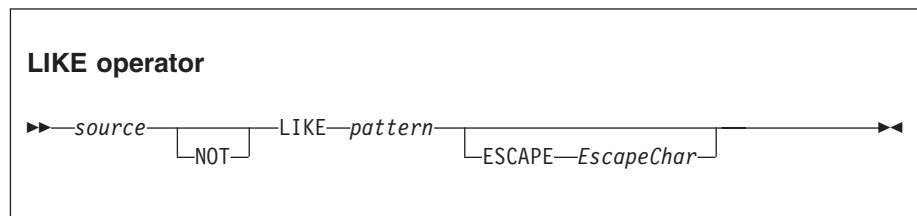

The result is TRUE if none of the operands is NULL and the *source* operand matches the *pattern* operand. The result is FALSE if none of the operands is NULL and the *source* operand does not match the *pattern* operand. Otherwise the result is UNKNOWN.

The pattern is specified by a string in which the percent (%) and underscore (_) characters have a special meaning:

- The underscore character _ matches any single character.

For example, the following finds matches for IBM and for IGI, but not for International Business Machines or IBM Corp:

```
Body.Trade.Company LIKE 'I_'
```

- The percent character % matches a string of zero or more characters.

For example, the following finds matches for IBM, IGI, International Business Machines, and IBM Corp:

```
Body.Trade.Company LIKE 'I%'
```

To use the percent and underscore characters within the expressions that are to be matched, precede the characters with an ESCAPE character, which defaults to the backslash (\) character.

For example, the following predicate finds a match for IBM_Corp.

```
Body.Trade.Company LIKE 'IBM\_Corp'
```

You can specify a different escape character by using the ESCAPE clause. For example, you could also specify the previous example like this:

```
Body.Trade.Company LIKE 'IBM$_Corp' ESCAPE '$'
```

Operator SINGULAR

SINGULAR operator

▶—Operand—(—ListExpression—)————▶

The operator SINGULAR returns a Boolean value of TRUE if the list has exactly one element, otherwise it returns FALSE.

ESQL logical operators

ESQL provides the following logical operators:

Operator AND

The result is the logical AND of the two operands. Both operands must be Boolean values.

Operator OR

The result is the logical OR of the two operands. Both operands must be Boolean values.

Operator NOT

The result is the logical NOT of the operand, which must be a Boolean value.

NULL and UNKNOWN values are treated as special values by these operators. The principles are:

- NULL and UNKNOWN are treated the same.
- If an operand is NULL the result is NULL unless the operation result is already dictated by the other parameter.

The result of AND and OR operations is defined by the following table.

Value of P	Value of Q	Result of P AND Q	Result of P OR Q
TRUE	TRUE	TRUE	TRUE
TRUE	FALSE	FALSE	TRUE
TRUE	UNKNOWN	UNKNOWN	TRUE
FALSE	TRUE	FALSE	TRUE
FALSE	FALSE	FALSE	FALSE
FALSE	UNKNOWN	FALSE	UNKNOWN
UNKNOWN	TRUE	UNKNOWN	TRUE
UNKNOWN	FALSE	FALSE	UNKNOWN
UNKNOWN	UNKNOWN	UNKNOWN	UNKNOWN

The result of NOT operations is defined by the following table.

Operand	Result of NOT
TRUE	FALSE
FALSE	TRUE
UNKNOWN	UNKNOWN

ESQL numeric operators

ESQL provides the following numeric operators:

Unary Operator -

The result is the negation of the operand (that is, it has the same magnitude as the operand but the opposite sign). You can negate numeric values (INTEGER, DECIMAL and FLOAT) and intervals (INTERVAL).

Operator +

The result is the sum of the two operands. You can add two numeric values, two intervals, and an interval to a datetime value (DATE, TIME, TIMESTAMP, GMTTIME, and GMTTIMESTAMP).

Operator -

The result is the difference between the two operands. It is possible to:

- Subtract one numeric value from another.
- Subtract one date-time from another. The result is an interval.
- Subtract one interval from another. The result is an interval.
- Subtract an interval from a datetime value. The result is a date-time.

When subtracting one date-time from another, you must indicate the type of interval required. You do this by using a qualifier consisting of parentheses enclosing the expression, followed by an interval qualifier. For example:

```
SET OutputRoot.XMLNS.Data.Age =
    (DATE '2005-03-31' - DATE '1947-10-24') YEAR TO MONTH;
```

Operator *

The result is the product of the two operands. You can multiply numeric values and multiply an interval by a numeric value.

Operator /

The result is the dividend of the two operands. You can divide numeric values and divide an interval by a numeric value.

Operator ||

The result is the concatenation of the two operands. You can concatenate string values (CHARACTER, BIT, and BLOB).

In all cases, if either operand is NULL, the result is NULL. If the operands are of different types, special rules apply. These are described in “Implicit casts” on page 1652.

For examples of how you can use these operators to manipulate datetime values, see “Using numeric operators with datetime values” on page 295.

ESQL string operator

ESQL provides the following string operator:

Operator ||

The result is the concatenation of the two operands. You can concatenate string values (CHARACTER, BIT, and BLOB).

If either operand is NULL, the result is NULL.

Rules for ESQL operator precedence

When an expression involves more than one operator, the order in which the expression is evaluated might affect the result. Consider the following example:

```
SET a = b + c * d;
```

Under ESQL’s precedence rules, c is multiplied by d and the result is added to b. This rule states that multiplication takes precedence over addition, so reordering the expression as follows:

```
SET a = c * d + b;
```

makes no difference. ESQL’s precedence rules are set out below but it is generally considered good practice to use parentheses to make the meaning clear. The order of precedence is:

1. Parentheses
2. Unary operators including unary - and NOT
3. Multiplication and division
4. Concatenation
5. Addition and subtraction

Operations at the same level are evaluated from left to right.

ESQL statements

The following table summarizes the ESQL statements and what they do.

Statement type	Description
Basic statements:	

Statement type	Description
"BEGIN ... END statement" on page 1482	Gives the statements defined within the BEGIN and END keywords the status of a single statement.
"CALL statement" on page 1487	Invokes a user-written routine that has been defined using a CREATE FUNCTION or CREATE PROCEDURE statement.
"CASE statement" on page 1490	Uses rules defined in WHEN clauses to select a block of statements to execute.
"CREATE FUNCTION statement" on page 1500	Like CREATE PROCEDURE, CREATE FUNCTION defines a user-written routine. (The few differences between CREATE FUNCTION and CREATE ROUTINE are described in the reference material.)
"CREATE MODULE statement" on page 1509	Creates a module (a named container associated with a node).
"CREATE PROCEDURE statement" on page 1511	Like CREATE FUNCTION, CREATE PROCEDURE defines a user-written routine. (The few differences between CREATE FUNCTION and CREATE ROUTINE are described in the reference material.)
"DECLARE statement" on page 1525	Declares one or more variables that can be used to store temporary values.
"IF statement" on page 1537	Processes a set of statements based on the result of evaluating condition expressions.
"ITERATE statement" on page 1541	Abandons processing the current iteration of the containing WHILE, REPEAT, LOOP, or BEGIN statement, and might start the next iteration.
"LEAVE statement" on page 1542	Abandons processing the current iteration of the containing WHILE, REPEAT, LOOP or BEGIN statement, and stops looping.
"LOOP statement" on page 1544	Processes a sequence of statements repeatedly and unconditionally.
"REPEAT statement" on page 1553	Processes a sequence of statements and then evaluates a condition expression. If the expression evaluates to TRUE, executes the statements again.
"RETURN statement" on page 1554	Stops processing the current function or procedure and passes control back to the caller.
"SET statement" on page 1557	Evaluates a source expression, and assigns the result to the target entity.
"THROW statement" on page 1559	Generates a user exception.
"WHILE statement" on page 1563	Evaluates a condition expression, and if it is TRUE executes a sequence of statements.
Message tree manipulation statements:	
"ATTACH statement" on page 1480	Attaches a portion of a message tree into a new position in the message hierarchy.
"CREATE statement" on page 1492	Creates a new message field.

Statement type	Description
"DELETE statement" on page 1534	Detaches and destroys a portion of a message tree, allowing its memory to be reused.
"DETACH statement" on page 1534	Detaches a portion of a message tree without deleting it.
"FOR statement" on page 1536	Iterates through a list (for example, a message array).
"MOVE statement" on page 1545	Changes the field pointed to by a target reference variable.
Database update statements:	
"DELETE FROM statement" on page 1531	Deletes rows from a table in an external database based on a search condition.
"INSERT statement" on page 1538	Adds a new row to an external database.
"PASSTHRU statement" on page 1547	Takes a character value and passes it as an SQL statement to an external database.
"UPDATE statement" on page 1560	Updates the values of specified rows and columns in a table in an external database.
Node interaction statements:	
"PROPAGATE statement" on page 1550	Propagates a message to the downstream nodes within the message flow.
Other statements:	
"BROKER SCHEMA statement" on page 1484	This statement is optional and is used in an ESQL file to explicitly identify the schema that contains the file.
"DECLARE HANDLER statement" on page 1530	Declares an error handler.
"EVAL statement" on page 1535	Takes a character value, interprets it as an SQL statement, and executes it.
"LOG statement" on page 1543	Writes a record to the event or user trace log.
"RESIGNAL statement" on page 1554	Re-throws the current exception (if any). This is used by an error handler, when it cannot handle an exception, to give an error handler in higher scope the opportunity of handling the exception.

ATTACH statement

The ATTACH statement attaches a portion of a message tree into a new position in the message hierarchy.

Syntax

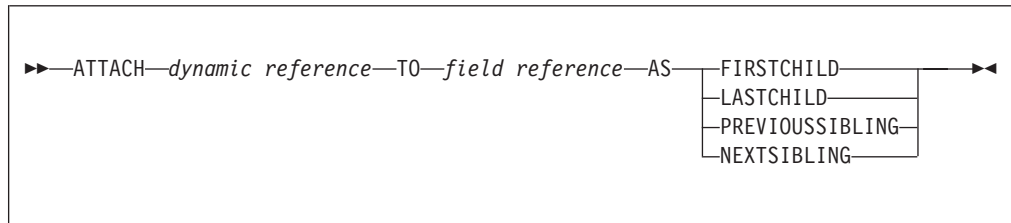

The following example illustrates how to use the ATTACH statement, together with the DETACH statement described in “DETACH statement” on page 1534, to modify a message structure. The dynamic reference supplied to the DETACH statement must point to a modifiable message tree such as Environment, LocalEnvironment, OutputRoot, OutputExceptionList, or InputLocalEnvironment.

There are some limitations on the use of ATTACH. In general, elements detached from the output trees of a Compute node are not attached to the environment or to input trees.

For example, if you take the following message:

```
<Data>
  <Order>
    <Item>cheese
      <Type>stilton</Type>
    </Item>
    <Item>bread</Item>
  </Order>
  <Order>
    <Item>garlic</Item>
    <Item>wine</Item>
  </Order>
</Data>
```

the following ESQL statements:

```
SET OutputRoot = InputRoot;
DECLARE ref1 REFERENCE TO OutputRoot.XMLNSC.Data.Order[1].Item[1];
DETACH ref1;
ATTACH ref1 TO OutputRoot.XMLNSC.Data.Order[2] AS LASTCHILD;
```

result in the following new message structure:

```
<Data>
  <Order>
    <Item>bread</Item>
  </Order>
  <Order>
    <Item>garlic</Item>
    <Item>wine</Item>
    <Item>cheese
      <Type>stilton</Type>
    </Item>
  </Order>
</Data>
```

For information about dynamic references see “Creating dynamic field references” on page 291.

The BEGIN ATOMIC construct is useful when a number of changes need to be made to a shared variable and it is important to prevent other instances seeing the intermediate states of the data. Consider the following code example:

```
CREATE PROCEDURE WriteSharedVariable1(IN NewValue CHARACTER)
SharedVariableMutex1 : BEGIN ATOMIC
  -- Set new value into shared variable
END;

CREATE FUNCTION ReadSharedVariable1() RETURNS CHARACTER
SharedVariableMutex1 : BEGIN ATOMIC
  DECLARE Value CHARACTER;
  -- Get value from shared variable
  RETURN Value;
END;
```

The last example assumes that the procedure WriteSharedVariable1 and the function ReadSharedVariable1 are in the same schema and are used by nodes within the same flow. However, it does not matter whether or not the procedure and function are contained within modules, or whether they are used within the same or different nodes. The broker ensures that, at any particular time, only one thread is executing any of the statements within the atomic sections. This ensures that, for example, two simultaneous writes or a simultaneous read and write are executed serially. Note that:

- The serialization is limited to the flow. Two flows which use BEGIN ATOMIC... END statements with the same schema and label can be executed simultaneously. In this respect, multiple instances within a flow and multiple copies of a flow are not equivalent.
- The serialization is limited by the schema and label. Atomic BEGIN ... END statements specified in different schemas or with different labels do not interact with each other.

Note: You can look at this in a different way, if you prefer. For each combination of message flow, schema, and label, the broker has a mutex that prevents simultaneous access to the statements associated with that mutex.

Do not nest BEGIN ATOMIC... END statements, either directly or indirectly, because this could lead to “deadly embraces”. For this reason, do not use a PROPAGATE statement from within an atomic block.

It is not necessary to use the BEGIN ATOMIC construct in flows that will never be deployed with more than one instance (but it might be unwise to leave this to chance). It is also unnecessary to use the BEGIN ATOMIC construct on reads and writes to shared variables. The broker always safely writes a new value to, and safely reads the latest value from, a shared variable. ATOMIC is only required when the application is sensitive to seeing intermediate results.

Consider the following example:

```
DECLARE LastOrderDate SHARED DATE;
...
SET LastOrderDate = CURRENT_DATE;
...
SET OutputRoot.XMLNSC.Data.Orders.Order[1].Date = LastOrderDate;
```

Here we assume that one thread is periodically updating LastOrderDate and another is periodically reading it. There is no need to use ATOMIC, because the second SET statement always reads a valid value. If the updating and reading

occur very closely in time, whether the old or new value is read is indeterminate, but it is always one or the other. The result will never be garbage.

But now consider the following example:

```
DECLARE Count SHARED INT;  
...  
SET Count = Count + 1;
```

Here we assume that several threads are periodically executing the SET statement. In this case you do need to use ATOMIC, because two threads might read Count in almost the same instant, and get the same value. Both threads perform the addition and both store the same value back. The end result is thus N+1 and not N+2.

The broker does not automatically provide higher-level locking than this (for example, locking covering the whole SET statement), because such locking is liable to cause “deadly embraces”.

Hint

You can consider the BEGIN ... END statement to be a looping construct, which always loops just once. The effect of an ITERATE or LEAVE statement nested within a BEGIN ... END statement is then as you would expect: control is transferred to the statement following the END. Using ITERATE or LEAVE within a BEGIN ... END statement is useful in cases where there is a long series of computations that needs to be abandoned, either because a definite result has been achieved or because an error has occurred.

BROKER SCHEMA statement

The BROKER SCHEMA statement is optional; use it in an ESQL file to explicitly identify the schema that contains the file.

Syntax

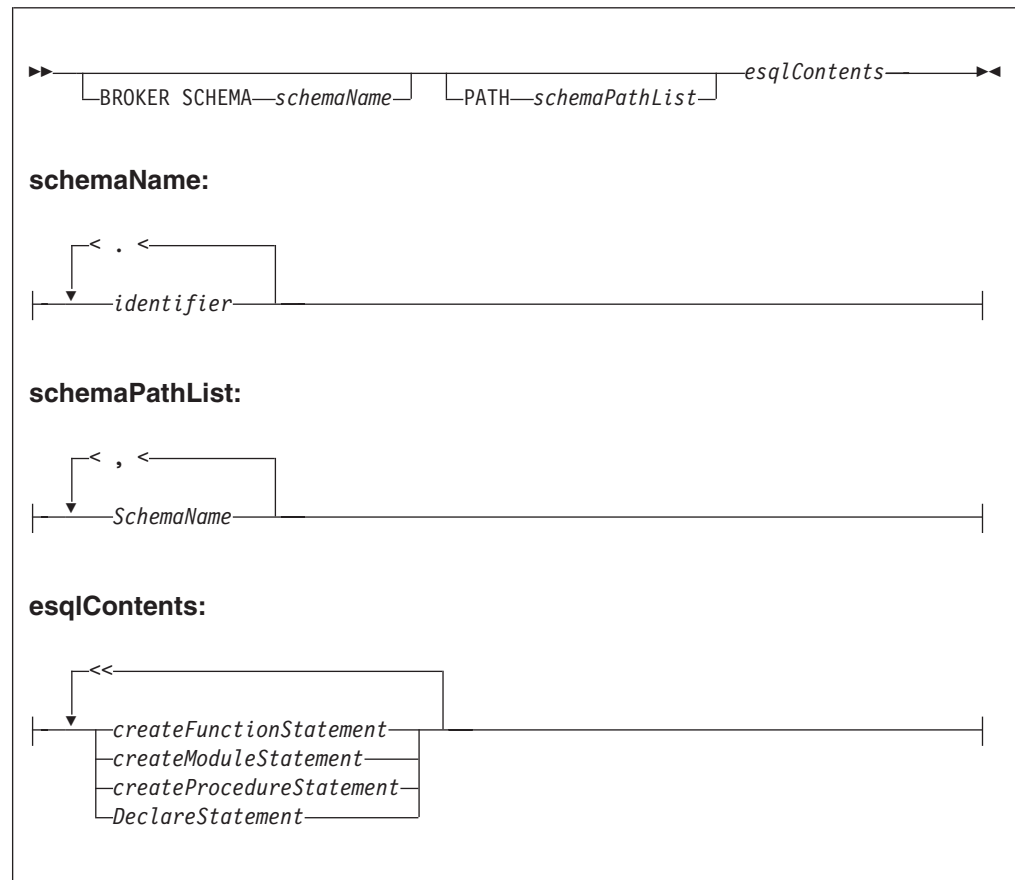

An ESQL schema is a named container for functions, procedures, modules, and variables. ESQL schema is similar to the namespace concept of C++ and XML, and to the package concept of Java.

In the absence of a BROKER SCHEMA statement, all functions, procedures, modules, and constants belong to the default schema. The default schema is similar to the default namespace in C++, the no-target namespace in XML Schema, and the default package in Java.

Note: The concept of BROKER SCHEMA in ESQL language is equivalent to package in Java. The BROKER SCHEMA is not in the broker ESQL.

PATH clause

The PATH clause specifies a list of additional schemas to be searched when matching function and procedure calls to their implementations. The schema in which the call lies is implicitly included in the PATH clause.

The PATH clause is used to resolve unqualified function and procedure names in the tools according to the following algorithm.

A single function or procedure must match the unqualified name, or the tools report an error. You can correct the error by qualifying the function or procedure name with a *schemaId*:

1. The current MODULE (if any) is searched for a matching function or procedure. MODULE-scope functions or procedures are visible only within

their containing MODULE. If functions or procedures with the same name are found in the current MODULE and schema, then MODULE-scope functions or procedures take precedence over schema scoped functions or procedures.

2. The <node schema> (but none of its contained MODULEs) and the <SQL-broker schema> or schemas identified by the PATH clause are searched for a matching function or procedure.

Note: The *schemaId* must be a fully qualified schema name.

When you start a function or procedure, the name you use must be qualified by the schema name. The behavior depends on the circumstances:

For a module routine:

- If the schema is specified, the named schema routine is started. The scalar built-in functions, excluding CAST, EXTRACT, and the special registers, are considered to be defined within an implicitly declared schema called SQL.
- If the schema is not specified, and the calling statement is in a module routine, and a routine of the given name exists in the local module, then that local routine is started.
- If the schema is not specified, and the calling statement is in a module routine, and a routine of the given name does not exist in the local module, all of the schemas in the schema path are searched for a routine of the same name.
If a matching function exists in one schema, it is used. If a matching function exists in more than one schema then a compile time error occurs. If there is no matching function, then the schema SQL is searched.

Note: This rule and the preceding rule imply that a local module routine takes priority over a built-in routine of the same name.

For a schema routine:

- If the schema is specified, the named schema routine is started. The scalar built-in functions, excluding CAST, EXTRACT, and the special registers, are considered to be defined within an implicitly declared schema called SQL.
- If the schema is not specified, and the caller is a schema routine, and a routine of the given name exists in the local schema, then that local routine is started.
- If the schema is not specified, and the calling statement is in a schema routine, and a routine of the given name does not exist in the local schema, then all of the schemas in the schema path are searched for a routine of the same name.
If a matching function exists in one schema, it is used. If a matching function exists in more than one schema then a compile time error occurs. If there is no matching function, the schema SQL is searched.

Note: This rule and the preceding rule imply that a local schema routine takes priority over a built-in routine of the same name.

The <node schema> is defined as the schema containing the node's message flow.

The <node schema> is specified in this manner to provide compatibility with earlier versions of WebSphere Message Broker.

When the <node schema> is the only schema referenced, the broker XML message does not include the extra features contained in WebSphere Message Broker V6.1.

Brokers in previous versions of WebSphere Message Broker do not support multiple schemas, for example, subroutine libraries for reuse. To deploy to a broker in a previous version of the product, put all of the ESQL subroutines into the same schema as the message flow and node that start the ESQL subroutines.

Eclipse tooling uses WebSphere Message Broker V6.1 ESQL syntax in content assist and source code validation.

The broker schema of the message flow must contain, at the schema level, any of the following in its ESQL files:

- A schema level function
- A schema level procedure
- A schema level constant
- A module level constant
- A module level variable

Without the presence of any of the preceding items, the Eclipse tooling generates broker ESQL without MODULE and FUNCTION Main wrappers.

Function and procedure names must be unique within their SCHEMA or MODULE.

Examples

The following example adds a path to a schema called CommonUtils:

```
BROKER SCHEMA CommonUtils
PATH SpecialUtils;

MODULE ....
```

The next example adds a path to the default schema:

```
PATH CommonUtils, SpecialUtils;

MODULE ....
```

CALL statement

The CALL statement calls (invokes) a routine.

Syntax

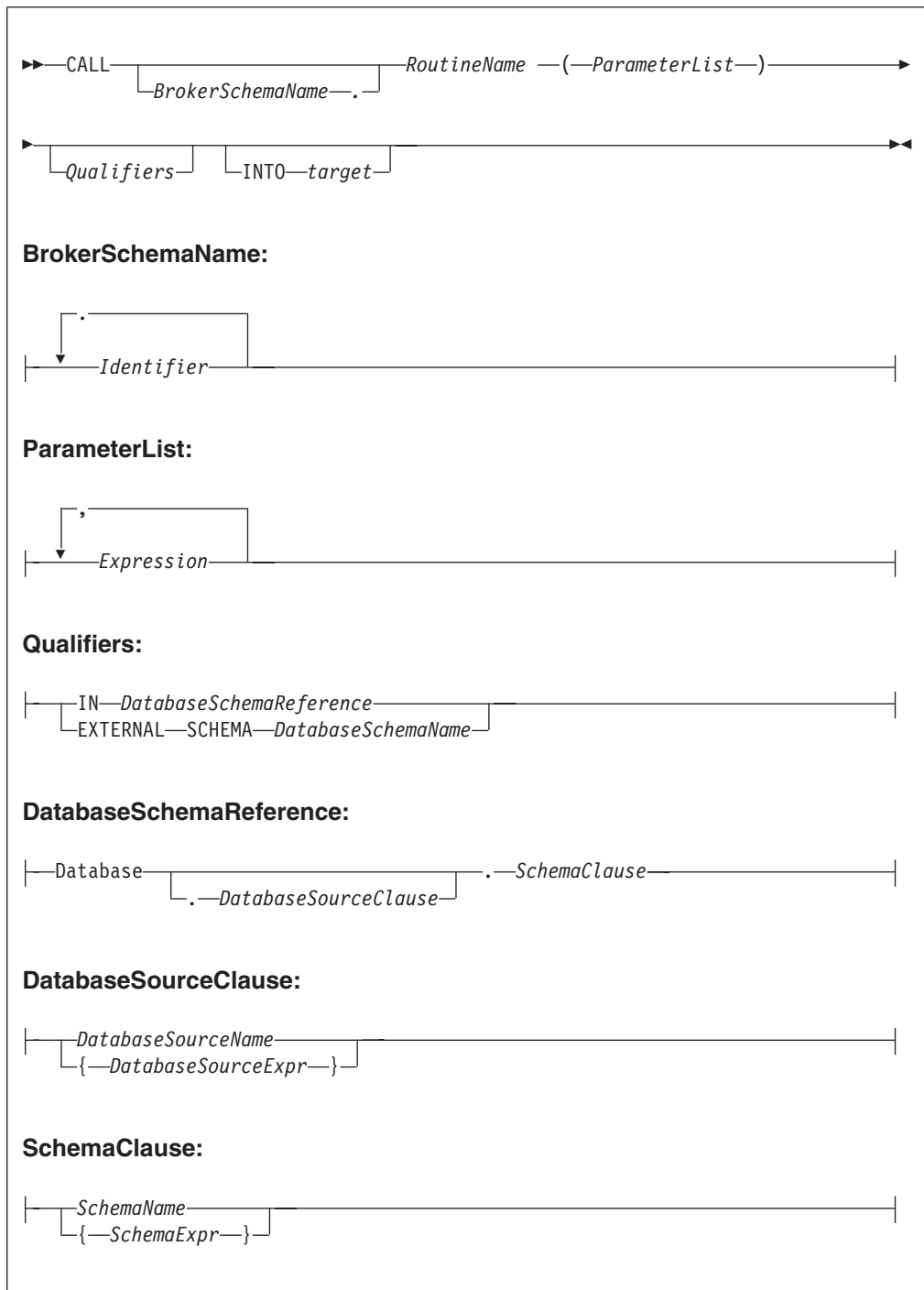

Using the CALL statement

The CALL statement invokes a routine. A routine is a user-defined function or procedure that has been defined by one of the following:

- A CREATE FUNCTION statement
- A CREATE PROCEDURE statement

Note: As well as standard user-defined functions and procedures, you can also use CALL to invoke built-in (broker-provided) functions and user-defined SQL functions. However, the usual way of invoking these types of function is simply to include their names in expressions.

The called routine must be invoked in a way that matches its definition. For example, if a routine has been defined with three parameters, the first two of type integer and the third of type character, the CALL statement must pass three variables to the routine, each of a data-type that matches the definition. This is called *exact signature matching*, which means that the signature provided by the CALL statement must match the signature provided by the routine's definition.

Exact signature matching applies to a routine's return value as well. If the RETURNS clause is specified on the CREATE FUNCTION statement, or the routine is a built-in function, the INTO clause must be specified on the CALL statement. A return value from a routine cannot be ignored. Conversely, if the RETURNS clause is not specified on the CREATE FUNCTION statement, the INTO clause must not be specified, because there is no return value from the routine.

You can use the CALL statement to invoke a routine that has been implemented in any of the following ways:

- ESQL.
- Java.
- As a stored procedure in a database.
- As a built-in (broker-provided) function. (But see the note above about calling built-in functions.)

This variety of implementation means that some of the clauses in the CALL syntax diagram are not applicable (or allowed) for all types of routine. It also allows the CALL statement to invoke any type of routine, irrespective of how the routine has been defined.

When the optional *BrokerSchemaName* parameter is not specified, the broker SQL parser searches for the named procedure using the algorithm described in the PATH statement (see the "PATH clause" on page 1485 of the BROKER SCHEMA statement).

When the *BrokerSchemaName* parameter is specified, the broker SQL parser invokes the named procedure in the specified schema without first searching the path. However, if a procedure reference is ambiguous (that is, there are two procedures with the same name in different broker schemas) and the reference is not qualified by the optional *BrokerSchemaName*, the Eclipse toolset generates a "Tasks view error" that you must correct to deploy the ambiguous code.

The broker-provided built-in functions are automatically placed in a predefined broker schema called SQL. The SQL schema is always searched last for a routine that has not been matched to a user-defined routine. Therefore, a user-defined module takes precedence over a built-in routine of the same name.

Each broker schema provides a unique symbol or namespace for a routine, so a routine name is unique when it is qualified by the name of the schema to which it belongs.

The INTO clause is used to store the return value from a routine that has been defined with a RETURNS clause, or from a built-in function. The *target* can be an

ESQL variable of a data type that matches the data type on the RETURNS clause, or a dot-separated message reference. For example, both of the following ESQL statements are valid:

```
CALL myProc1() INTO cursor;  
CALL myProc1() INTO OutputRoot.XMLNS.TestValue1;
```

The CALL statement passes the parameters into the procedure in the order given to it. Parameters that have been defined as IN or INOUT on the routine's definition are evaluated before the CALL is made, but parameters defined as OUT are always passed in as NULL parameters of the correct type. When the procedure has completed, any parameters declared as OUT or INOUT are updated to reflect any changes made to them during the procedure's execution. Parameters defined as IN are never changed during the course of a procedure's execution.

Routine overloading is not supported. This means that you cannot create two routines of the same name in the same broker schema. If the broker detects that a routine has been overloaded, it raises an exception. Similarly, you cannot invoke a database stored procedure that has been overloaded. A database stored procedure is overloaded if another procedure of the same name exists in the same database schema. However, you can invoke an overloaded Java method, as long as you create a separate ESQL definition for each overloaded method you want to call, and give each ESQL definition a unique routine name.

CASE statement

The CASE statement uses rules defined in WHEN clauses to select a block of statements to process.

There are two forms of the CASE statement: the simple form and the searched form.

Syntax

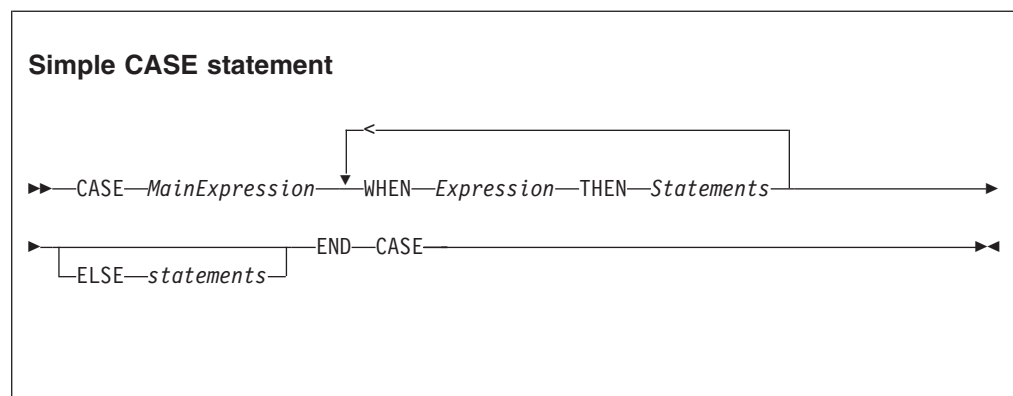

Searched CASE statement

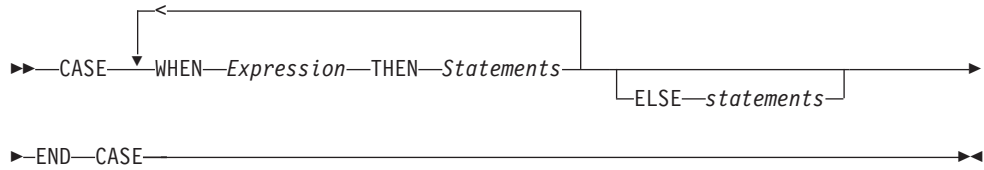

In the simple form, the main expression is evaluated first. Each WHEN clause expression is evaluated in turn until the result is equal to the main expression's result. That WHEN clause's statements are then processed. If no match is found and the optional ELSE clause is present, the ELSE clause's statements are executed instead. The test values do not have to be literals. The only requirement is that the main expression and the WHEN clause expressions evaluate to types that can be compared.

In the searched form, each WHEN clause expression is evaluated in turn until one evaluates to TRUE. That WHEN clause's statements are then executed. If none of the expressions evaluates to TRUE and the optional ELSE clause is present, the ELSE clause's statements are executed. There does not have to be any similarity between the expressions in each CASE clause. The only requirement is that they all evaluate to a Boolean value.

The ESQL language has both a CASE statement and a CASE function (see "CASE function" on page 1616 for details of the CASE function). The CASE statement chooses one of a set of statements to execute. The CASE function chooses one of a set of expressions to evaluate and returns as its value the return value of the chosen expression.

Examples

Simple CASE statement:

```
CASE size
  WHEN minimum + 0 THEN
    SET description = 'small';
  WHEN minimum + 1 THEN
    SET description = 'medium';
  WHEN minimum + 2 THEN
    SET description = 'large';
    CALL handleLargeObject();
  ELSE
    SET description = 'unknown';
    CALL handleError();
END CASE;
```

Searched CASE statement:

```
CASE
  WHEN i <> 0 THEN
    CALL handleI(i);
  WHEN j > 1 THEN
```

```
        CALL handleIZeroAndPositiveJ(j);  
    ELSE  
        CALL handleAllOtherCases(j);  
END CASE;
```

CREATE statement

The CREATE statement creates a new message field.

Syntax

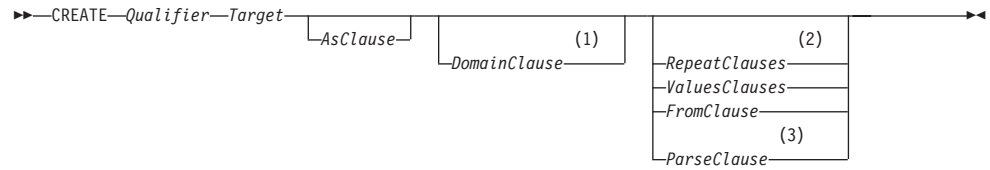

Qualifier:

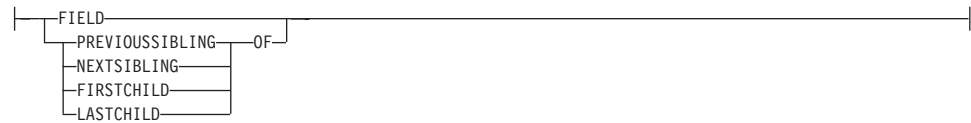

AsClause:



DomainClause:



RepeatClauses:

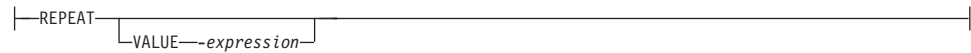

Values clauses:



NamesClauses:

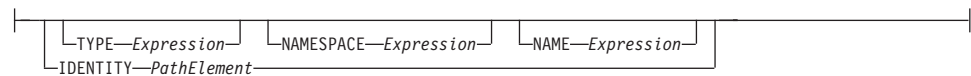

FromClause:



Parse clause:

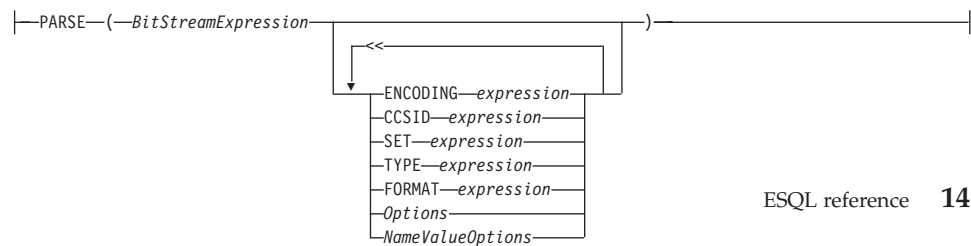

Options:**NameValueOptions:****Notes:**

- 1 Do not use the *DomainClause* and *ParseClause* with the **FIELD** qualifier.
- 2 Use the *RepeatClause* only with the **PREVIOUSIBLING** and **NEXTSIBLING** qualifiers
- 3 Each subclass within the *ParseClause* can occur once only.

The new message field is positioned either at a given location (CREATE FIELD) or relative to a currently-existing location (CREATE ... OF...). New fields can be created only when the target field reference points to a modifiable message, for example Environment, InputLocalEnvironment, OutputLocalEnvironment, OutputRoot, or OutputExceptionList.

If you include a FIELD clause, the field specified by target is navigated to (creating the fields if necessary) and any values clause or from clause is executed. This form of CREATE statement does not necessarily create any fields at all; it ensures only that the given fields do exist.

If you use array indices in the target field reference, only one instance of a particular field can be created. Thus, if you write a SET statement starting:

```
SET OutputRoot.XMLNS.Message.Structure[2].Field = ...
```

at least one instance of Structure must already exist in the message. That is, the only fields in the tree that are created are ones on a direct path from the root to the field identified by the field reference.

If you include a PREVIOUSIBLING, NEXTSIBLING, FIRSTCHILD, or LASTCHILD clause, the field specified by target is navigated to (creating the fields if necessary) in exactly the same way as for the FIELD clause. A new field is then created and attached in the specified position (for example as PREVIOUSIBLING or FIRSTCHILD). This form of CREATE statement always creates a new field and places it in the specified position.

If you use two CREATE FIRSTCHILD OF target statements that specify the same target, the second statement creates a new field as the first child of the target, and displaces the previously-created first child to the right in the message tree (so it is no longer the first child). Similarly, CREATE LASTCHILD OF target navigates to the target field and adds a new field as its rightmost child, displacing the previous last child to the left.

CREATE PREVIOUSIBLING OF target creates a field to the immediate left of the field specified by target (so the depth of the tree is not changed); similarly, CREATE NEXTSIBLING OF target creates a field to the immediate right of the field specified by target. When creating PREVIOUSIBLING or NEXTSIBLING, you can use the REPEAT keyword to copy the type and name of the new field from the current field.

AS clause:

If present, the AS clause moves the named reference variable to point at the newly-created field. This is useful because you probably want to involve the new field in some further processing.

DOMAIN clause:

If present, the DOMAIN clause associates the new field with a new parser of the specified type. This clause expects a root field name (for example, XMLNS or MQRFH2). If the DOMAIN clause is present, but the value supplied is a zero-length character string, a new parser of the same type as the parser that owns the field specified by target is created. An exception is thrown if the supplied domain name is not CHARACTER data type or its value is NULL. Do not specify the DOMAIN clause with the FIELD clause; it is not certain that a new field is created.

REPEAT clause:

Use the REPEAT clause to copy the new field’s type and name from the target field. Alternatively, the new field’s type, name, and value can be:

- Copied from any existing field (using the FROM clause)
- Specified explicitly (using the VALUES clause)
- Defined by parsing a bit stream (using the PARSE clause)

In the case of the FROM and PARSE clauses, you can also create children of the new field.

VALUES clause:

For the VALUES clause, the type, name, and value (or any subset of these) can be specified by any expression that returns a suitable data type (INTEGER for type, CHARACTER for name, and any scalar type for value). An exception is thrown if the value supplied for a type or name is NULL.

NAMES clause:

The NAMES clause takes any expression that returns a non-null value of type character. The meaning depends on the presence of NAME and NAMESPACE clauses as follows:

NAMESPACE	NAME	Element named as follows
No	No	The element is nameless (name flag not automatically set)
No	Yes	The element is given the name in the default namespace
Yes	No	The element is given the empty name in the given namespace

NAMESPACE	NAME	Element named as follows
Yes	Yes	The element is given the given name in the given namespace

The IDENTITY operand takes a single path element in place of the TYPE and NAME clauses, where a path element contains (at most) a type, a namespace, a name, and an index. These specify the type, namespace, name, and index of the element to be created and follow all the rules described in the topic for field references (see “ESQL field references” on page 1465). For example:

```
IDENTITY (XMLNS.attribute)Space1:Name1[42]
```

See the Examples section below for how to use the IDENTITY operand.

FROM clause:

For the FROM clause, the new field’s type, name, and value are taken from the field pointed to by *SourceFieldReference*. Any existing child fields of the target are detached (the field could already exist in the case of a FIELD clause), and the new field is given copies of the source field’s children, grandchildren, and so on.

PARSE clause:

If a PARSE clause is present, a subtree is built under the newly-created field from the supplied bit stream. The algorithm for doing this varies from parser to parser and according to the options specified. All parsers support the mode RootBitStream, in which the tree creation algorithm is the same as that used by an input node.

Some parsers also support a second mode, FolderBitStream, which generates a sub-tree from a bit stream created by the ASBITSTREAM function (see “ASBITSTREAM function” on page 1603) using that mode.

When you use the PARSE clause, specify a scalar value containing the bitstream to be parsed for *BitStreamExpression*. If you use a message tree field reference you must ensure it contains a scalar value that contains the bitstream. An existing message body folder such as InputRoot.XMLNSC does not contain a bitstream and therefore you cannot use this to serialize the XMLNS folder. If you pass a value other than a scalar containing the bitstream to the PARSE clause for *BitStreamExpression*, then the message flow produces a BIP2906 error message. Instead, you must first call the ASBITSTREAM function to serialize the existing message tree folder. The result of the ASBITSTREAM function can then be passed as the *BitStreamExpression* to the PARSE clause.

The following example shows how to serialize the XMLNSC folder and then use the result of the ASBITSTREAM in the PARSE clause.

```
DECLARE inCCSID INT InputProperties.CodedCharSetId;
DECLARE inEncoding INT InputProperties.Encoding;
DECLARE inBitstream BLOB ASBITSTREAM(InputRoot.XMLNSC, inEncoding, inCCSID);
CREATE LASTCHILD OF OutputRoot DOMAIN('MRM')
    PARSE(inBitstream, inEncoding, inCCSID, 'DP3UK14002001',
        'TestCase', 'XML1', options);
```

When the PARSE statement is processed, any PARSE clause expressions are evaluated. An exception is thrown if any of the following expressions do not result in a non-null value of the appropriate type:

Clause	Type	Default value
ENCODING	Integer	0
CCSID	Integer	0
SET	Character	Zero length string
TYPE	Character	Zero length string
FORMAT	Character	Zero length string

The ENCODING clause accepts any expression that returns a value of type integer. However, it is only meaningful to generate option values from the list of supplied constants:

```
MQENC_INTEGER_NORMAL
MQENC_INTEGER_REVERSED
MQENC_DECIMAL_NORMAL
MQENC_DECIMAL_REVERSED
MQENC_FLOAT_IEEE_NORMAL
MQENC_FLOAT_IEEE_REVERSED
MQENC_FLOAT_S390
```

The values used for the CCSID clause follow the normal numbering system. For example, 1200 = UCS-2, 1208 = UTF-8.

For absent clauses, the given default values are used. Use the CCSID and encoding default values because these take their values from the queue manager's encoding and CCSID settings.

Similarly, using the default values for each of the message set, type, and format options is useful, because many parsers do not require message set, type, or format information, and so any valid value is sufficient.

When any expressions have been evaluated, a bit stream is parsed using the results of the expressions.

Note: Because this function has a large number of clauses, an alternative syntax is supported, in which the parameters are supplied as a comma-separated list rather than by named clauses. In this case the expressions must be in the order:

```
ENCODING -> CCSID -> SET -> TYPE -> FORMAT -> OPTIONS
```

The list can be truncated at any point and an entirely empty expression can be used in any clauses where you do not supply a value.

For details of the syntax of the TYPE clause, refer to Specifying namespaces in the Message Type property.

OPTIONS subclause:

The value of the OPTIONS subclause can be either a single integer expression or a list of comma-separated integer expressions. When a list of integer expressions is supplied, the values of all the integer expressions are combined into a single integer using the logical OR operator.

NAMEVALUEOPTIONS subclause:

The NAMEVALUEOPTIONS subclause specifies a comma-separated list of named options and their values. Each item in the list must be a string expression of the form 'optionName=value'. There are two valid option names: XMLNSC.OpaqueElement and XMLNSC.OpaqueElementLiteral.

Note:

Examples of how to use the CREATE statement

1. The following example creates the specified field:

```
CREATE FIELD OutputRoot.XMLNS.Data;
```

2. The following example creates a field with no name, type, or value as the first child of ref1:

```
CREATE FIRSTCHILD OF ref1;
```

3. The following example creates a field using the specified type, name, and value:

```
CREATE NEXTSIBLING OF ref1 TYPE NameValue NAME 'Price' VALUE 92.3;
```

4. The following example creates a field with a type and name, but no value; the field is added before the sibling indicated by the dynamic reference (ref1):

```
CREATE PREVIOUSIBLING OF ref1 TYPE Name NAME 'Quantity';
```

5. The following example creates a field named Component, and moves the reference variable targetCursor to point at it:

```
CREATE FIRSTCHILD OF targetCursor AS targetCursor NAME 'Component';
```

6. The following example creates a new field as the right sibling of the field pointed to by the reference variable targetCursor having the same type and name as that field. The statement then moves targetCursor to point at the new field:

```
CREATE NEXTSIBLING OF targetCursor AS targetCursor REPEAT;
```

7. The following example shows how to use the PARSE clause:

```
DECLARE bodyBlob BLOB ASBITSTREAM(InputRoot.XMLNS, InputProperties.Encoding,
    InputProperties.CodedCharSetId);
DECLARE creationPtr REFERENCE TO OutputRoot;
CREATE LASTCHILD OF creationPtr DOMAIN('XMLNS') PARSE(bodyBlob,
    InputProperties.Encoding,
    InputProperties.CodedCharSetId);
```

This example can be extended to show the serializing and parsing of a field or folder:

```
DECLARE bodyBlob BLOB ASBITSTREAM(InputRoot.XMLNS.TestCase.myFolder,
    InputProperties.Encoding,
    InputProperties.CodedCharSetId, ",", " ", FolderBitStream);
DECLARE creationPtr REFERENCE TO OutputRoot;
CREATE LASTCHILD OF creationPtr DOMAIN('XMLNS') PARSE(bodyBlob,
    InputProperties.Encoding,
    InputProperties.CodedCharSetId, ",", " ", FolderBitStream);
```

8. The following example shows how to use the IDENTITY operand:

```
CREATE FIELD OutputRoot.XMLNS.TestCase.Root IDENTITY (XML.ParserRoot)Root;
CREATE FIELD OutputRoot.XMLNS.TestCase.Root.Attribute
    IDENTITY (XML.Attribute)NSpace1:Attribute VALUE 'Attrib Value';
CREATE LASTCHILD OF OutputRoot.XMLNS.TestCase.Root
    IDENTITY (XML.Element)NSpace1:Element1[1] VALUE 'Element 1 Value';
CREATE LASTCHILD OF OutputRoot.XMLNS.TestCase.Root
    IDENTITY (XML.Element)NSpace1:Element1[2] VALUE 'Element 2 Value';
```

This sequence of statements produces the following output message:

```

<TestCase>
  <Root xmlns:NS1="NSpace1" NS1:Attribute="Attrib Value">
    <NS1:Element1>Element 1 Value</NS1:Element1>
    <NS1:Element1>Element 2 Value</NS1:Element1>
  </Root>
</TestCase>

```

9. The following example shows how you can use the DOMAIN clause to avoid losing information unique to the XMLNS parser when an unlike parser copy occurs:

```

DECLARE bodyBlob BLOB ASBITSTREAM(InputRoot.XMLNS, InputProperties.Encoding,
InputProperties.CodedCharSetId);
CREATE FIELD Environment.Variables.myXMLTree;
DECLARE creationPtr REFERENCE TO Environment.Variables.myXMLTree;
CREATE FIRSTCHILD OF creationPtr DOMAIN('XMLNS') PARSE(bodyBlob,
InputProperties.Encoding,
InputProperties.CodedCharSetId);

```

An example of a CREATE statement

This example provides sample ESQL and an input message, which together produce the output message at the end of the example.

```

CREATE COMPUTE MODULE CreateStatement_Compute
CREATE FUNCTION Main() RETURNS BOOLEAN
BEGIN
  CALL CopyMessageHeaders();

  CREATE FIELD OutputRoot.XMLNS.TestCase.description TYPE NameValue VALUE 'This is my TestCase' ;
  DECLARE cursor REFERENCE TO OutputRoot.XMLNS.TestCase;
  CREATE FIRSTCHILD OF cursor Domain('XMLNS')
    NAME 'Identifier' VALUE InputRoot.XMLNS.TestCase.Identifier;
  CREATE LASTCHILD OF cursor Domain('XMLNS') NAME 'Sport' VALUE InputRoot.XMLNS.TestCase.Sport;
  CREATE LASTCHILD OF cursor Domain('XMLNS') NAME 'Date' VALUE InputRoot.XMLNS.TestCase.Date;
  CREATE LASTCHILD OF cursor Domain('XMLNS') NAME 'Type' VALUE InputRoot.XMLNS.TestCase.Type;
  CREATE FIELD
    cursor.Division[1].Number TYPE NameValue VALUE 'Premiership';
  CREATE FIELD
    cursor.Division[1].Result[1].Number TYPE NameValue VALUE '1' ;
  CREATE FIELD
    cursor.Division[1].Result[1].Home TYPE Name;
  CREATE LASTCHILD OF cursor.Division[1].Result[1].Home NAME 'Team' VALUE 'Liverpool' ;
  CREATE LASTCHILD OF cursor.Division[1].Result[1].Home NAME 'Score' VALUE '4';
  CREATE FIELD
    cursor.Division[1].Result[1].Away TYPE Name;
  CREATE LASTCHILD OF cursor.Division[1].Result[1].Away NAME 'Team' VALUE 'Everton';
  CREATE LASTCHILD OF cursor.Division[1].Result[1].Away NAME 'Score' VALUE '0';
  CREATE FIELD
    cursor.Division[1].Result[2].Number TYPE NameValue VALUE '2';
  CREATE FIELD
    cursor.Division[1].Result[2].Home TYPE Name;
  CREATE LASTCHILD OF cursor.Division[1].Result[2].Home NAME 'Team' VALUE 'Manchester United';
  CREATE LASTCHILD OF cursor.Division[1].Result[2].Home NAME 'Score' VALUE '2';
  CREATE FIELD
    cursor.Division[1].Result[2].Away TYPE Name;
  CREATE LASTCHILD OF cursor.Division[1].Result[2].Away NAME 'Team' VALUE 'Arsenal';
  CREATE LASTCHILD OF cursor.Division[1].Result[2].Away NAME 'Score' VALUE '3';
  CREATE FIELD
    cursor.Division[2].Number TYPE NameValue VALUE '2';
  CREATE FIELD
    cursor.Division[2].Result[1].Number TYPE NameValue VALUE '1';
  CREATE FIELD
    cursor.Division[2].Result[1].Home TYPE Name;
  CREATE LASTCHILD OF cursor.Division[2].Result[1].Home NAME 'Team' VALUE 'Port Vale';
  CREATE LASTCHILD OF cursor.Division[2].Result[1].Home NAME 'Score' VALUE '9' ;
  CREATE FIELD
    cursor.Division[2].Result[1].Away TYPE Name;
  CREATE LASTCHILD OF cursor.Division[2].Result[1].Away NAME 'Team' VALUE 'Brentford';
  CREATE LASTCHILD OF cursor.Division[2].Result[1].Away NAME 'Score' VALUE '5';

END;

CREATE PROCEDURE CopyMessageHeaders() BEGIN
  DECLARE I INTEGER 1;
  DECLARE J INTEGER CARDINALITY(InputRoot.*[]);
  WHILE I < J DO
    SET OutputRoot.*[I] = InputRoot.*[I];
  
```

```
    SET I = I + 1;  
  END WHILE;  
END;  
  
END MODULE;
```

CREATE FUNCTION statement

The CREATE FUNCTION statement defines a callable function or procedure.

You can also use the CREATE PROCEDURE statement to define a callable function or procedure, also known as a routine.

Syntax

►► CREATE RoutineType RoutineName (ParameterList)
↳ ReturnType Language ResultSet RoutineBody ◀◀

RoutineType:

FUNCTION
PROCEDURE

ParameterList:

Parameter

Parameter:

(1)
IN
OUT
INOUT
ParameterName
CONSTANT
NAMESPACE
NAME
DataType
(2)

ReturnType:

RETURNS DataType

Language:

LANGUAGE
ESQL
DATABASE
JAVA
(3)

ResultSet:

DYNAMIC RESULT SETS integer

RoutineBody:

Statement
EXTERNAL NAME ExternalRoutineName

Notes:

- 1 If the routine type is FUNCTION, the direction indicator (IN, OUT, or

INOUT) is optional for each parameter. However, for documentation purposes, it is good programming practice to specify a direction indicator for all new routines; if you do not specify the direction, a default value of IN is used.

- 2 When the NAMESPACE or NAME clause is used, its value is implicitly CONSTANT and of type CHARACTER. For information about the use of CONSTANT variables, see the “DECLARE statement” on page 1525.
- 3 If the routine type is FUNCTION, you cannot specify a LANGUAGE of DATABASE.

Overview

The CREATE FUNCTION and CREATE PROCEDURE statements define a callable function or procedure, also known as a routine.

In previous versions of this product, CREATE FUNCTION and CREATE PROCEDURE had different uses and different capabilities. Subsequent enhancements have resulted in the differences listed previously in notes 1 and 3.

Routines are useful for creating reusable blocks of code that can be run independently many times. You can implement them as a series of ESQL statements, a Java method, or a database stored procedure. This flexibility means that some of the clauses in the syntax diagram are not applicable (or allowed) for all types of routine.

Each routine has a name, which must be unique within the schema to which it belongs. Routine names therefore cannot be overloaded; if the broker detects that a routine name has been overloaded, it raises an exception.

The LANGUAGE clause specifies the language in which the routine’s body is written. The options are:

DATABASE

The procedure is called as a database stored procedure.

ESQL

The procedure is called as an ESQL routine.

JAVA

The procedure is called as a static method in a Java class.

Unspecified

If you do not specify the LANGUAGE clause, the default language is ESQL unless you specify the EXTERNAL NAME clause (in which case, the default language is DATABASE).

Restrictions on the use of the LANGUAGE clause exist. You cannot use:

- The ESQL option with an EXTERNAL NAME clause
- The DATABASE or JAVA options without an EXTERNAL NAME clause
- The DATABASE option with a routine type of FUNCTION

Specify the routine’s name using the *RoutineName* clause, and the routine’s parameters using the *ParameterList* clause. If the LANGUAGE clause specifies ESQL, implement the routine using a single ESQL statement. This statement is

most useful if it is a compound statement (BEGIN ... END), because it can then contain as many ESQL statements as necessary to fulfil its function.

Alternatively, instead of providing an ESQL body for the routine, you can specify a LANGUAGE clause other than ESQL. You can then use the EXTERNAL NAME clause to provide a reference to the actual body of the routine, wherever it is located externally to the broker. For more information about using the EXTERNAL NAME clause, see “Invoking stored procedures” on page 332 and Calling a Java routine.

Routines of any LANGUAGE type can have IN, OUT, and INOUT parameters. The caller can pass several values into the routine, and receive back several updated values. These returned parameters are in addition to any RETURNS clause that you have defined for the routine. The RETURNS clause defines the value that the routine returns to the caller.

Routines that are implemented in different languages have their own restrictions on which data types can be passed in or returned; these restrictions are documented later in this section. The data type of the returned value must match the data type of the value that is defined to be returned from the routine. Also, if a routine is defined to have a return value, the caller of the routine cannot ignore it. For more information see “CALL statement” on page 1487.

Routines can be defined in either a module or a schema. Routines that are defined in a module are local in scope to the current node, which means that only code belonging to that same module (or node) can invoke them. Routines that are defined in a schema, however, can be invoked by using either of the following options:

- Code in the same schema
- Code in any other schema, if either of the following conditions applies:
 - The other schema’s PATH clause contains the path to the called routine
 - The called routine is invoked using its fully qualified name (which is its name, prefixed by its schema name, separated by a period)

Thus, if you need to invoke the same routine in more than one node, define it in a schema.

For any language or routine type, the method of invocation of the routine must match the manner of declaration of the routine. If the routine has a RETURNS clause, use either the FUNCTION invocation syntax or a CALL statement with an INTO clause. Conversely, if a routine has no RETURNS clause, you must use a CALL statement without an INTO clause.

Parameter directions

Parameters that are passed to routines always have a direction associated with them, which is one of the following types:

IN The value of the parameter cannot be changed by the routine. A NULL value for the parameter is allowed, and can be passed to the routine.

OUT

When it is received by the called routine, the parameter that is passed into the routine always has a NULL value of the correct data type. This value is set irrespective of its value before the routine is called. The routine is allowed to change the value of the parameter.

INOUT

INOUT is both an IN and an OUT parameter. It passes a value into the routine, and the value that is passed in can be changed by the routine. A NULL value for the parameter is allowed, and can be passed both into and out of the routine.

If the routine type is FUNCTION, the direction indicator (IN, OUT, INOUT) is optional for each parameter. However, it is good programming practice to specify a direction indicator for all new routines of any type for documentation purposes.

ESQL variables that are declared to be CONSTANT (or references to variables declared to be CONSTANT) are not allowed to have the direction OUT or INOUT.

ESQL routines

ESQL routines are written in ESQL, and have a LANGUAGE clause of ESQL. The body of an ESQL routine is typically a compound statement of the form BEGIN ... END, that contains multiple statements for processing the parameters that are passed to the routine.

ESQL example 1

The following example shows the same procedure as in “Database routine example 1” on page 1522, but is implemented as an ESQL routine and not as a stored procedure. The CALL syntax and results of this routine are the same as those in “Restrictions on Java routines” on page 1508.

```
CREATE PROCEDURE swapParms (  
  IN parm1 CHARACTER,  
  OUT parm2 CHARACTER,  
  INOUT parm3 CHARACTER )  
BEGIN  
  SET parm2 = parm3;  
  SET parm3 = parm1;  
END;
```

ESQL example 2

This example procedure shows the recursive use of an ESQL routine. It parses a tree, visiting all places at and below the specified starting point, and reports what it has found:

```
SET OutputRoot.MQMD = InputRoot.MQMD;  
  
DECLARE answer CHARACTER;  
SET answer = '';  
  
CALL navigate(InputRoot.XMLNS, answer);  
SET OutputRoot.XMLNS.Data.FieldNames = answer;  
  
CREATE PROCEDURE navigate (IN root REFERENCE, INOUT answer CHARACTER)  
BEGIN  
  SET answer = answer || 'Reached Field... Type:'  
  || CAST(FIELDTYPE(root) AS CHAR)||  
  ': Name:' || FIELDNAME(root) || ': Value : ' || root || ': '  
  
  DECLARE cursor REFERENCE TO root;  
  MOVE cursor FIRSTCHILD;  
  IF LASTMOVE(cursor) THEN  
    SET answer = answer || 'Field has children... drilling down '  
  ELSE
```



```

    SET answer = answer || 'Listing siblings... ';
END IF;

WHILE LASTMOVE(cursor) DO
    CALL navigate(cursor, answer);
    MOVE cursor NEXTSIBLING;
END WHILE;

SET answer = answer || 'Finished siblings... Popping up ';
END;

```

When given the following input message:

```

<Person>
  <Name>John Smith</Name>
  <Salary period='monthly' taxable='yes'>-1200</Salary>
</Person>

```

the procedure produces the following output, which has been manually formatted:

```

Reached Field... Type:16777232: Name:XML: Value :: Field has children...
drilling down
Reached Field... Type:16777216: Name:Person: Value :: Field has children...
drilling down
Reached Field... Type:16777216: Name:Name:
Value :John Smith: Field has children... drilling down
Reached Field... Type:33554432: Name::
Value :John Smith: Listing siblings... Finished siblings... Popping up
Finished siblings... Popping up
Reached Field... Type:16777216: Name:Salary:
Value :-1200: Field has children... drilling down
Reached Field... Type:50331648: Name:period:
Value :monthly: Listing siblings... Finished siblings... Popping up
Reached Field... Type:50331648: Name:taxable:
Value :yes: Listing siblings... Finished siblings... Popping up
Reached Field... Type:33554432: Name::
Value :-1200: Listing siblings... Finished siblings... Popping up
Finished siblings... Popping up
Finished siblings... Popping up
Finished siblings... Popping up

```

Java routines

A Java routine is implemented as a Java method, and has a LANGUAGE clause of JAVA. For Java routines, the *ExternalRoutineName* must contain the class name and method name of the Java method to be called. Specify the *ExternalRoutineName* like this:

```
>>--"-- className---.--methodName--"-----<<
```

where *className* identifies the class that contains the method and *methodName* identifies the method to invoke. If the class is part of a package, the class identifier part must include the complete package prefix; for example, "com.ibm.broker.test.MyClass.myMethod".

To find the Java class, the broker uses the search method that is described in "Deploying Java classes" on page 1508.

Any Java method that you want to invoke must have the following basic signature:
public static <return-type> <method-name> (< 0 - N parameters>)

where <return-type> must be in the list of Java IN data types in the table in "ESQL to Java data type mapping" on page 1507 (excluding the REFERENCE type, which is not permitted as a return value), or the Java void data type. The

parameter data types must also be in the “ESQL to Java data type mapping” on page 1507 table. In addition, the Java method is not allowed to have an exception throws clause in its signature.

The Java method’s signature must match the ESQL routine’s declaration of the method. You must also observe the following rules:

- Ensure that the Java method name, including the class name and any package qualifiers, matches the procedure’s EXTERNAL NAME.
- If the Java return type is void, do not put a RETURNS clause on the ESQL routine’s definition. Conversely, if the Java return type is not void, you must put a RETURNS clause on the ESQL routine’s definition.
- Ensure that every parameter’s type and direction matches the ESQL declaration, according to the rules listed in the table in “ESQL to Java data type mapping” on page 1507.
- Ensure that the method’s return type matches the data type of the RETURNS clause.
- Enclose EXTERNAL NAME in quotation marks because it must contain at least “class.method”.
- If you want to invoke an overloaded Java method, you must create a separate ESQL definition for each overloaded method and give each ESQL definition a unique routine name.

You can use the Java user-defined node API in your Java method, provided that you observe the restrictions documented in “Restrictions on Java routines” on page 1508. For more information about using the Java API, see Compiling a Java user-defined node.

Java routine example 1

This routine contains three parameters of varying directions, and returns an integer, which maps to a Java return type of `java.lang.Long`.

```
CREATE FUNCTION myProc1( IN P1 INTEGER, OUT P2 INTEGER, INOUT P3 INTEGER )
  RETURNS INTEGER
  LANGUAGE JAVA
  EXTERNAL NAME "com.ibm.broker.test.MyClass.myMethod1";
```

You can use the following ESQL to invoke `myProc1`:

```
CALL myProc1( intVar1, intVar2, intVar3) INTO intReturnVar3;
-- or
SET intReturnVar3 = myProc1( intVar1, intVar2, intVar3);
```

Java routine example 2

This routine contains three parameters of varying directions and has a Java return type of `void`.

```
CREATE PROCEDURE myProc2( IN P1 INTEGER, OUT P2 INTEGER, INOUT P3 INTEGER )
  LANGUAGE JAVA
  EXTERNAL NAME "com.ibm.broker.test.MyClass.myMethod2";
```

You must use the following ESQL to invoke `myProc2`:

```
CALL myProc2(intVar1, intVar2, intVar3);
```

The following Java class provides a method for each of the preceding Java examples:

```

package com.ibm.broker.test;

class MyClass {
public static Long myMethod1( Long P1, Long[] P2 Long[] P3) { ... }
public static void myMethod2( Long P2, Long[] P2 Long[] P3) { ... }

/* When either of these methods is called:
   P1 may or may not be NULL (depending on the value of intVar1).
   P2[0] is always NULL (whatever the value of intVar2).
   P3[0] may or may not be NULL (depending on the value of intVar3).
   This is the same as with LANGUAGE ESQL routines.
   When these methods return:
       intVar1 is unchanged
       intVar2 may still be NULL or may have been changed
       intVar3 may contain the same value or may have been changed.
   This is the same as with LANGUAGE ESQL routines.

   When myMethod1 returns: intReturnVar3 is either NULL (if the
   method returns NULL) or it contains the value returned by the
   method.
*/
}

```

ESQL to Java data type mapping

The following table summarizes the mappings from ESQL to Java.

Notes:

- Only the Java scalar wrappers are passed to Java.
- The ESQL scalar types are mapped to Java data types as object wrappers, or object wrapper arrays, depending upon the direction of the procedure parameter. Each wrapper array contains exactly one element.
- Scalar object wrappers are used to allow NULL values to be passed to and from Java methods.

ESQL data types ¹	Java IN data types	Java INOUT and OUT data types
INTEGER, INT	java.lang.Long	java.lang.Long []
FLOAT	java.lang.Double	java.lang.Double[]
DECIMAL	java.math.BigDecimal	java.math.BigDecimal[]
CHARACTER, CHAR	java.lang.String	java.lang.String[]
BLOB	byte[]	byte[][]
BIT	java.util.BitSet	java.util.BitSet[]
DATE	com.ibm.broker.plugin.MbDate	com.ibm.broker.plugin.MbDate[]
TIME ²	com.ibm.broker.plugin.MbTime	com.ibm.broker.plugin.MbTime[]
GMTTIME ²	com.ibm.broker.plugin.MbTime	com.ibm.broker.plugin.MbTime[]
TIMESTAMP ²	com.ibm.broker.plugin.MbTimestamp	com.ibm.broker.plugin.MbTimestamp[]
GMTTIMESTAMP ²	com.ibm.broker.plugin.MbTimestamp	com.ibm.broker.plugin.MbTimestamp[]
INTERVAL	Not supported	Not supported
BOOLEAN	java.lang.Boolean	java.lang.Boolean[]
REFERENCE (to a message tree) ^{3 4} _{5 6}	com.ibm.broker.plugin.MbElement	com.ibm.broker.plugin.MbElement[] (Supported for INOUT. Not supported for OUT)
ROW	Not supported	Not supported

LIST	Not supported	Not supported
------	---------------	---------------

1. Variables that are declared to be CONSTANT (or references to variables that are declared to be CONSTANT) are not allowed to have the direction INOUT or OUT.
2. The time zone set in the Java variable is not important; you obtain the required time zone in the output ESQL.
3. The reference parameter cannot be NULL when passed into a Java method.
4. The reference cannot have the direction OUT when passed into a Java method.
5. If an *MbElement* is passed back from Java to ESQL as an INOUT parameter, it must point to a location in the same message tree as that pointed to by the *MbElement* that was passed into the called Java method.
For example, if an ESQL reference to `OutputRoot.XML.Test` is passed into a Java method as an INOUT *MbElement*, but a different *MbElement* is passed back to ESQL when the call returns, the different element must also point to somewhere in the `OutputRoot` tree.
6. An *MbElement* cannot be returned from a Java method with the RETURNS clause, because no ESQL routine can return a reference. However, an *MbElement* can be returned as an INOUT direction parameter, subject to the conditions described in point 5.

A REFERENCE to a scalar variable can be used in the CALL of a Java method, provided that the data type of the variable to which the reference refers matches the corresponding data type in the Java program signature.

Restrictions on Java routines

The following restrictions apply to Java routines that are called from ESQL:

- The Java method must be threadsafe (reentrant).
- Database connections must be JDBC type 2 or type 4. Furthermore, database operations are not part of a broker transaction and therefore cannot be controlled by an external resource coordinator (as is the case in an XA environment).
- The Java user-defined node API must be used only by the same thread that invoked the Java method.

You can create threads inside your method. However, created threads must not use the Java APIs, and you must return control back to the broker.

All restrictions that apply to the usage of the Java API also apply to Java methods that are called from ESQL.

- Java methods that are called from ESQL must not use the `MbNode` class. Therefore, they cannot create objects of type `MbNode`, or call any of the methods on an existing `MbNode` object.
- WebSphere MQ or JMS work done inside a Java method that is called from ESQL must be done in accordance with the guidelines for performing WebSphere MQ and JMS work in a user-defined node. See Planning user-defined input nodes.

Deploying Java classes

You can deploy your Java classes to a broker within a Java Archive (JAR) file, using one of the following two methods:

1. **Add the JAR file to the broker archive (bar) file**

The most efficient and flexible method of deploying to the broker is to add your JAR file to the bar file. You can do this manually or automatically using the workbench.

If the workbench finds the correct Java class inside a referenced Java project open in the workspace, it automatically compiles the Java class into a JAR file and adds it to the bar file. This procedure is the same procedure that you follow to deploy a JavaCompute node inside a JAR, as described in *User-defined node classloading*.

When you deploy a JAR file from the workbench, the flow that has been redeployed reloads the JAR file contained in the bar file.

The files are also reloaded if the message flow that references a Java class is stopped and restarted. Ensure that you stop and restart (or redeploy) all flows that reference the JAR file that you want to update. This action avoids the problem of some flows running with the old version of the JAR file and other flows running with the new version.

The workbench deploys only JAR files; it does not deploy standalone Java class files.

2. Store the JAR file in either of the following locations:

- a. The *workpath/shared-classes/* folder on the machine running the broker
- b. The CLASSPATH environment variable on the computer running the broker

You must complete this action manually; you cannot use the workbench.

In this method, redeploying the message flow does not reload the referenced Java classes; neither does stopping and restarting the message flow. The only way to reload the classes in this case is to stop and restart the broker itself.

To enable the broker to find a Java class, ensure that it is in one of the preceding locations. If the broker cannot find the specified class, it generates an exception.

Although you have the choices shown previously when you deploy the JAR file, using the workbench to deploy the bar file provides the greatest flexibility when redeploying the JAR file.

Database routines

CREATE FUNCTION does not support database routines. Use CREATE PROCEDURE to define a database routine.

CREATE MODULE statement

The CREATE MODULE statement creates a module, which is a named container associated with a node.

Correlation name	Compute module	Filter module	Database module
InputDestinationList	Deprecated synonym for InputLocalEnvironment		
OutputDestinationList	Deprecated synonym for OutputLocalEnvironment		

CREATE PROCEDURE statement

The CREATE PROCEDURE statement defines a callable function or procedure.

You can also use the CREATE FUNCTION statement to define a callable function or procedure, also known as a routine.

Syntax

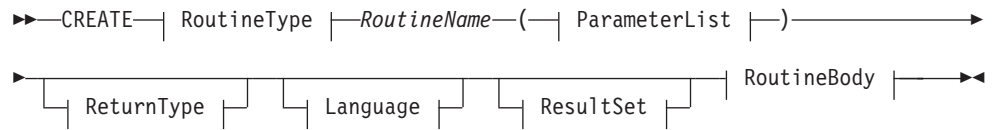

RoutineType:



ParameterList:



Parameter:

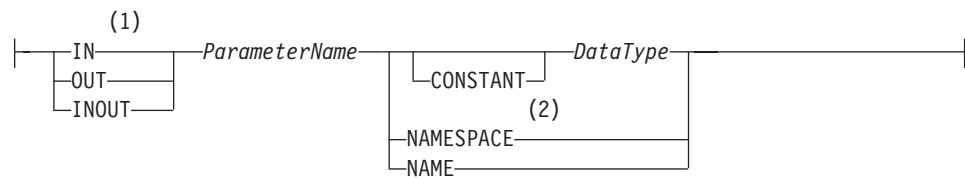

ReturnType:



Language:

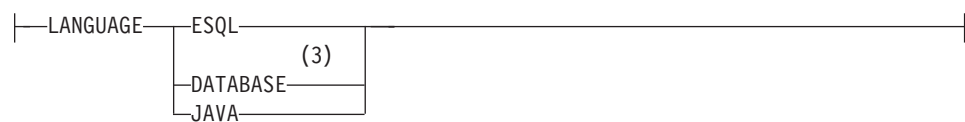

ResultSet:

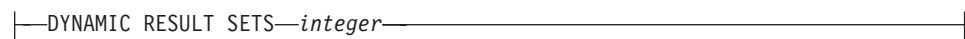

RoutineBody:



Notes:

- 1 If the routine type is FUNCTION, the direction indicator (IN, OUT, or

INOUT) is optional for each parameter. However, for documentation purposes, it is good programming practice to specify a direction indicator for all new routines; if you do not specify the direction, a default value of IN is used.

- 2 When the NAMESPACE or NAME clause is used, its value is implicitly CONSTANT and of type CHARACTER. For information about the use of CONSTANT variables, see the “DECLARE statement” on page 1525.
- 3 If the routine type is FUNCTION, you cannot specify a LANGUAGE of DATABASE.

Overview

The CREATE FUNCTION and CREATE PROCEDURE statements define a callable function or procedure, also known as a routine.

In previous versions of this product, CREATE FUNCTION and CREATE PROCEDURE had different uses and different capabilities. Subsequent enhancements have resulted in the differences listed previously in notes 1 and 3.

Routines are useful for creating reusable blocks of code that can be run independently many times. You can implement them as a series of ESQL statements, a Java method, or a database stored procedure. This flexibility means that some of the clauses in the syntax diagram are not applicable (or allowed) for all types of routine.

Each routine has a name, which must be unique within the schema to which it belongs. Routine names therefore cannot be overloaded; if the broker detects that a routine name has been overloaded, it raises an exception.

The LANGUAGE clause specifies the language in which the routine’s body is written. The options are:

DATABASE

The procedure is called as a database stored procedure.

ESQL

The procedure is called as an ESQL routine.

JAVA

The procedure is called as a static method in a Java class.

Unspecified

If you do not specify the LANGUAGE clause, the default language is ESQL unless you specify the EXTERNAL NAME clause (in which case, the default language is DATABASE).

Restrictions on the use of the LANGUAGE clause exist. You cannot use:

- The ESQL option with an EXTERNAL NAME clause
- The DATABASE or JAVA options without an EXTERNAL NAME clause
- The DATABASE option with a routine type of FUNCTION

Specify the routine’s name using the *RoutineName* clause, and the routine’s parameters using the *ParameterList* clause. If the LANGUAGE clause specifies ESQL, implement the routine using a single ESQL statement. This statement is

most useful if it is a compound statement (BEGIN ... END), because it can then contain as many ESQL statements as necessary to fulfil its function.

Alternatively, instead of providing an ESQL body for the routine, you can specify a LANGUAGE clause other than ESQL. You can then use the EXTERNAL NAME clause to provide a reference to the actual body of the routine, wherever it is located externally to the broker. For more information about using the EXTERNAL NAME clause, see “Invoking stored procedures” on page 332 and Calling a Java routine.

Routines of any LANGUAGE type can have IN, OUT, and INOUT parameters. The caller can pass several values into the routine, and receive back several updated values. These returned parameters are in addition to any RETURNS clause that you have defined for the routine. The RETURNS clause defines the value that the routine returns to the caller.

Routines that are implemented in different languages have their own restrictions on which data types can be passed in or returned; these restrictions are documented later in this section. The data type of the returned value must match the data type of the value that is defined to be returned from the routine. Also, if a routine is defined to have a return value, the caller of the routine cannot ignore it. For more information see “CALL statement” on page 1487.

Routines can be defined in either a module or a schema. Routines that are defined in a module are local in scope to the current node, which means that only code belonging to that same module (or node) can invoke them. Routines that are defined in a schema, however, can be invoked by using either of the following options:

- Code in the same schema
- Code in any other schema, if either of the following conditions applies:
 - The other schema’s PATH clause contains the path to the called routine
 - The called routine is invoked using its fully qualified name (which is its name, prefixed by its schema name, separated by a period)

Thus, if you need to invoke the same routine in more than one node, define it in a schema.

For any language or routine type, the method of invocation of the routine must match the manner of declaration of the routine. If the routine has a RETURNS clause, use either the FUNCTION invocation syntax or a CALL statement with an INTO clause. Conversely, if a routine has no RETURNS clause, you must use a CALL statement without an INTO clause.

Parameter directions

Parameters that are passed to routines always have a direction associated with them, which is one of the following types:

IN The value of the parameter cannot be changed by the routine. A NULL value for the parameter is allowed, and can be passed to the routine.

OUT

When it is received by the called routine, the parameter that is passed into the routine always has a NULL value of the correct data type. This value is set irrespective of its value before the routine is called. The routine is allowed to change the value of the parameter.

INOUT

INOUT is both an IN and an OUT parameter. It passes a value into the routine, and the value that is passed in can be changed by the routine. A NULL value for the parameter is allowed, and can be passed both into and out of the routine.

If the routine type is FUNCTION, the direction indicator (IN, OUT, INOUT) is optional for each parameter. However, it is good programming practice to specify a direction indicator for all new routines of any type for documentation purposes.

ESQL variables that are declared to be CONSTANT (or references to variables declared to be CONSTANT) are not allowed to have the direction OUT or INOUT.

ESQL routines

ESQL routines are written in ESQL, and have a LANGUAGE clause of ESQL. The body of an ESQL routine is typically a compound statement of the form BEGIN ... END, that contains multiple statements for processing the parameters that are passed to the routine.

ESQL example 1

The following example shows the same procedure as in “Database routine example 1” on page 1522, but is implemented as an ESQL routine and not as a stored procedure. The CALL syntax and results of this routine are the same as those in “Restrictions on Java routines” on page 1508.

```
CREATE PROCEDURE swapParms (  
  IN parm1 CHARACTER,  
  OUT parm2 CHARACTER,  
  INOUT parm3 CHARACTER )  
BEGIN  
  SET parm2 = parm3;  
  SET parm3 = parm1;  
END;
```

ESQL example 2

This example procedure shows the recursive use of an ESQL routine. It parses a tree, visiting all places at and below the specified starting point, and reports what it has found:

```
SET OutputRoot.MQMD = InputRoot.MQMD;  
  
DECLARE answer CHARACTER;  
SET answer = '';  
  
CALL navigate(InputRoot.XMLNS, answer);  
SET OutputRoot.XMLNS.Data.FieldNames = answer;  
  
CREATE PROCEDURE navigate (IN root REFERENCE, INOUT answer CHARACTER)  
BEGIN  
  SET answer = answer || 'Reached Field... Type:'  
  || CAST(FIELDTYPE(root) AS CHAR)||  
  ': Name:' || FIELDNAME(root) || ': Value : ' || root || ': '  
  
  DECLARE cursor REFERENCE TO root;  
  MOVE cursor FIRSTCHILD;  
  IF LASTMOVE(cursor) THEN  
    SET answer = answer || 'Field has children... drilling down '  
  ELSE
```

```

    SET answer = answer || 'Listing siblings... ';
END IF;

WHILE LASTMOVE(cursor) DO
    CALL navigate(cursor, answer);
    MOVE cursor NEXTSIBLING;
END WHILE;

SET answer = answer || 'Finished siblings... Popping up ';
END;

```

When given the following input message:

```

<Person>
  <Name>John Smith</Name>
  <Salary period='monthly' taxable='yes'>-1200</Salary>
</Person>

```

the procedure produces the following output, which has been manually formatted:

```

Reached Field... Type:16777232: Name:XML: Value :: Field has children...
drilling down
Reached Field... Type:16777216: Name:Person: Value :: Field has children...
drilling down
Reached Field... Type:16777216: Name:Name:
Value :John Smith: Field has children... drilling down
Reached Field... Type:33554432: Name::
Value :John Smith: Listing siblings... Finished siblings... Popping up
Finished siblings... Popping up
Reached Field... Type:16777216: Name:Salary:
Value :-1200: Field has children... drilling down
Reached Field... Type:50331648: Name:period:
Value :monthly: Listing siblings... Finished siblings... Popping up
Reached Field... Type:50331648: Name:taxable:
Value :yes: Listing siblings... Finished siblings... Popping up
Reached Field... Type:33554432: Name::
Value :-1200: Listing siblings... Finished siblings... Popping up
Finished siblings... Popping up
Finished siblings... Popping up
Finished siblings... Popping up

```

Java routines

A Java routine is implemented as a Java method, and has a LANGUAGE clause of JAVA. For Java routines, the *ExternalRoutineName* must contain the class name and method name of the Java method to be called. Specify the *ExternalRoutineName* like this:

```
>>--"-- className---.---methodName--"-----<<
```

where *className* identifies the class that contains the method and *methodName* identifies the method to invoke. If the class is part of a package, the class identifier part must include the complete package prefix; for example, "com.ibm.broker.test.MyClass.myMethod".

To find the Java class, the broker uses the search method that is described in "Deploying Java classes" on page 1508.

Any Java method that you want to invoke must have the following basic signature:
public static <return-type> <method-name> (< 0 - N parameters>)

where <return-type> must be in the list of Java IN data types in the table in "ESQL to Java data type mapping" on page 1507 (excluding the REFERENCE type, which is not permitted as a return value), or the Java void data type. The

parameter data types must also be in the “ESQL to Java data type mapping” on page 1507 table. In addition, the Java method is not allowed to have an exception throws clause in its signature.

The Java method’s signature must match the ESQL routine’s declaration of the method. You must also observe the following rules:

- Ensure that the Java method name, including the class name and any package qualifiers, matches the procedure’s EXTERNAL NAME.
- If the Java return type is void, do not put a RETURNS clause on the ESQL routine’s definition. Conversely, if the Java return type is not void, you must put a RETURNS clause on the ESQL routine’s definition.
- Ensure that every parameter’s type and direction matches the ESQL declaration, according to the rules listed in the table in “ESQL to Java data type mapping” on page 1507.
- Ensure that the method’s return type matches the data type of the RETURNS clause.
- Enclose EXTERNAL NAME in quotation marks because it must contain at least “class.method”.
- If you want to invoke an overloaded Java method, you must create a separate ESQL definition for each overloaded method and give each ESQL definition a unique routine name.

You can use the Java user-defined node API in your Java method, provided that you observe the restrictions documented in “Restrictions on Java routines” on page 1508. For more information about using the Java API, see Compiling a Java user-defined node.

Java routine example 1

This routine contains three parameters of varying directions, and returns an integer, which maps to a Java return type of `java.lang.Long`.

```
CREATE FUNCTION myProc1( IN P1 INTEGER, OUT P2 INTEGER, INOUT P3 INTEGER )
  RETURNS INTEGER
  LANGUAGE JAVA
  EXTERNAL NAME "com.ibm.broker.test.MyClass.myMethod1";
```

You can use the following ESQL to invoke `myProc1`:

```
CALL myProc1( intVar1, intVar2, intVar3) INTO intReturnVar3;
-- or
SET intReturnVar3 = myProc1( intVar1, intVar2, intVar3);
```

Java routine example 2

This routine contains three parameters of varying directions and has a Java return type of `void`.

```
CREATE PROCEDURE myProc2( IN P1 INTEGER, OUT P2 INTEGER, INOUT P3 INTEGER )
  LANGUAGE JAVA
  EXTERNAL NAME "com.ibm.broker.test.MyClass.myMethod2";
```

You must use the following ESQL to invoke `myProc2`:

```
CALL myProc2(intVar1, intVar2, intVar3);
```

The following Java class provides a method for each of the preceding Java examples:

```

package com.ibm.broker.test;

class MyClass {
public static Long myMethod1( Long P1, Long[] P2 Long[] P3) { ... }
public static void myMethod2( Long P2, Long[] P2 Long[] P3) { ... }

/* When either of these methods is called:
   P1 may or may not be NULL (depending on the value of intVar1).
   P2[0] is always NULL (whatever the value of intVar2).
   P3[0] may or may not be NULL (depending on the value of intVar3).
   This is the same as with LANGUAGE ESQL routines.
   When these methods return:
       intVar1 is unchanged
       intVar2 may still be NULL or may have been changed
       intVar3 may contain the same value or may have been changed.
   This is the same as with LANGUAGE ESQL routines.

   When myMethod1 returns: intReturnVar3 is either NULL (if the
   method returns NULL) or it contains the value returned by the
   method.
*/
}

```

ESQL to Java data type mapping

The following table summarizes the mappings from ESQL to Java.

Notes:

- Only the Java scalar wrappers are passed to Java.
- The ESQL scalar types are mapped to Java data types as object wrappers, or object wrapper arrays, depending upon the direction of the procedure parameter. Each wrapper array contains exactly one element.
- Scalar object wrappers are used to allow NULL values to be passed to and from Java methods.

ESQL data types ¹	Java IN data types	Java INOUT and OUT data types
INTEGER, INT	java.lang.Long	java.lang.Long []
FLOAT	java.lang.Double	java.lang.Double[]
DECIMAL	java.math.BigDecimal	java.math.BigDecimal[]
CHARACTER, CHAR	java.lang.String	java.lang.String[]
BLOB	byte[]	byte[][]
BIT	java.util.BitSet	java.util.BitSet[]
DATE	com.ibm.broker.plugin.MbDate	com.ibm.broker.plugin.MbDate[]
TIME ²	com.ibm.broker.plugin.MbTime	com.ibm.broker.plugin.MbTime[]
GMTTIME ²	com.ibm.broker.plugin.MbTime	com.ibm.broker.plugin.MbTime[]
TIMESTAMP ²	com.ibm.broker.plugin.MbTimestamp	com.ibm.broker.plugin.MbTimestamp[]
GMTTIMESTAMP ²	com.ibm.broker.plugin.MbTimestamp	com.ibm.broker.plugin.MbTimestamp[]
INTERVAL	Not supported	Not supported
BOOLEAN	java.lang.Boolean	java.lang.Boolean[]
REFERENCE (to a message tree) ^{3 4} _{5 6}	com.ibm.broker.plugin.MbElement	com.ibm.broker.plugin.MbElement[] (Supported for INOUT. Not supported for OUT)
ROW	Not supported	Not supported

LIST	Not supported	Not supported
------	---------------	---------------

1. Variables that are declared to be CONSTANT (or references to variables that are declared to be CONSTANT) are not allowed to have the direction INOUT or OUT.
2. The time zone set in the Java variable is not important; you obtain the required time zone in the output ESQL.
3. The reference parameter cannot be NULL when passed into a Java method.
4. The reference cannot have the direction OUT when passed into a Java method.
5. If an *MbElement* is passed back from Java to ESQL as an INOUT parameter, it must point to a location in the same message tree as that pointed to by the *MbElement* that was passed into the called Java method.
For example, if an ESQL reference to `OutputRoot.XML.Test` is passed into a Java method as an INOUT *MbElement*, but a different *MbElement* is passed back to ESQL when the call returns, the different element must also point to somewhere in the `OutputRoot` tree.
6. An *MbElement* cannot be returned from a Java method with the RETURNS clause, because no ESQL routine can return a reference. However, an *MbElement* can be returned as an INOUT direction parameter, subject to the conditions described in point 5.

A REFERENCE to a scalar variable can be used in the CALL of a Java method, provided that the data type of the variable to which the reference refers matches the corresponding data type in the Java program signature.

Restrictions on Java routines

The following restrictions apply to Java routines that are called from ESQL:

- The Java method must be threadsafe (reentrant).
- Database connections must be JDBC type 2 or type 4. Furthermore, database operations are not part of a broker transaction and therefore cannot be controlled by an external resource coordinator (as is the case in an XA environment).
- The Java user-defined node API must be used only by the same thread that invoked the Java method.

You can create threads inside your method. However, created threads must not use the Java APIs, and you must return control back to the broker.

All restrictions that apply to the usage of the Java API also apply to Java methods that are called from ESQL.

- Java methods that are called from ESQL must not use the `MbNode` class. Therefore, they cannot create objects of type `MbNode`, or call any of the methods on an existing `MbNode` object.
- WebSphere MQ or JMS work done inside a Java method that is called from ESQL must be done in accordance with the guidelines for performing WebSphere MQ and JMS work in a user-defined node. See Planning user-defined input nodes.

Deploying Java classes

You can deploy your Java classes to a broker within a Java Archive (JAR) file, using one of the following two methods:

1. **Add the JAR file to the broker archive (bar) file**

The most efficient and flexible method of deploying to the broker is to add your JAR file to the bar file. You can do this manually or automatically using the workbench.

If the workbench finds the correct Java class inside a referenced Java project open in the workspace, it automatically compiles the Java class into a JAR file and adds it to the bar file. This procedure is the same procedure that you follow to deploy a JavaCompute node inside a JAR, as described in User-defined node classloading.

When you deploy a JAR file from the workbench, the flow that has been redeployed reloads the JAR file contained in the bar file.

The files are also reloaded if the message flow that references a Java class is stopped and restarted. Ensure that you stop and restart (or redeploy) all flows that reference the JAR file that you want to update. This action avoids the problem of some flows running with the old version of the JAR file and other flows running with the new version.

The workbench deploys only JAR files; it does not deploy standalone Java class files.

2. Store the JAR file in either of the following locations:

- a. The *workpath/shared-classes/* folder on the machine running the broker
- b. The CLASSPATH environment variable on the computer running the broker

You must complete this action manually; you cannot use the workbench.

In this method, redeploying the message flow does not reload the referenced Java classes; neither does stopping and restarting the message flow. The only way to reload the classes in this case is to stop and restart the broker itself.

To enable the broker to find a Java class, ensure that it is in one of the preceding locations. If the broker cannot find the specified class, it generates an exception.

Although you have the choices shown previously when you deploy the JAR file, using the workbench to deploy the bar file provides the greatest flexibility when redeploying the JAR file.

Database routines

Database routines are implemented as database stored procedures. Database routines have a LANGUAGE clause of DATABASE, and must have a routine type of PROCEDURE.

When writing stored procedures in languages like C, you must use NULL indicators to ensure that your procedure can process the data correctly.

Although the database definitions of a stored procedure vary between the databases, the ESQL used to invoke them does not. The names given to parameters in the ESQL do not have to match the names they are given on the database side. However, the external name of the routine, including any package or container specifications, must match its defined name in the database.

The DYNAMIC RESULT SETS clause is allowed only for database routines. It is required only if a stored procedure returns one or more result sets. The integer parameter to this clause must be 0 (zero) or more, and specifies the number of result sets to be returned.

The optional RETURNS clause is required if a stored procedure returns a single scalar value.

The EXTERNAL NAME clause specifies the name by which the database knows the routine. This can be either a qualified or an unqualified name, where the qualifier is the name of the database schema in which the procedure is defined. If you do not provide a schema name, the database connection user name is used as the schema in which to locate the procedure. If the required procedure does not exist in this schema, you must provide an explicit schema name, either on the routine definition or on the CALL to the routine at runtime. For more information about dynamically choosing the schema that contains the routine, see the “CALL statement” on page 1487. When a qualified name is used, the name must be in quotation marks.

A fully qualified routine typically takes the form:

```
EXTERNAL NAME "mySchema.myProc";
```

However, if the procedure belongs to an Oracle package, the package is treated as part of the procedure’s name. Therefore you must provide a schema name and the package name, in the form:

```
EXTERNAL NAME "mySchema.myPackage.myProc";
```

This form allows the schema, but not the package name, to be chosen dynamically in the CALL statement.

If the name of the procedure contains SQL wildcards (which are the percent (%) character and the underscore (_) character), the procedure name is modified by the broker to include the database escape character immediately before each wildcard character. This technique ensures that the database receives the wildcards as literal characters. For example, assuming that the database escape character is a backslash, the following clause is modified by the broker so that “mySchema.Proc_” is passed to the database.

```
EXTERNAL NAME "mySchema.Proc\_";
```

All external procedures have the following restrictions:

- A stored procedure cannot be overloaded on the database side. A stored procedure is considered overloaded if there is more than one procedure of the same name in the same database schema. If the broker detects that a procedure has been overloaded, it raises an exception.
- Parameters cannot be of the ESQL REFERENCE, ROW, LIST, or INTERVAL data types.
- User-defined types cannot be used as parameters or as return values.

For LANGUAGE routines, the *ExternalRoutineName* is optional and contains the schema name, package name and procedure name of the routine to be called. Specify the *ExternalRoutineName* like this:

```
>>--"schemaName---.---packageName---,---procedureName--"-----><
```

where:

- *schemaName* is optional.
- *packageName* is optional and applies only to Oracle data sources. If you supply a *packageName* you must supply a *schemaName*.
- *procedureName* is optional.

Database routine example 1

The following example shows an ESQL definition of a stored procedure that returns a single scalar value and an OUT parameter:

```
CREATE PROCEDURE myProc1(IN P1 INT, OUT P2 INT)
  LANGUAGE DATABASE
  RETURNS INTEGER
  EXTERNAL NAME "myschema.myproc";
```

Use this ESQL to invoke the myProc1 routine:

```
/*using CALL statement invocation syntax*/
CALL myProc1(intVar1, intVar2) INTO intReturnVar3;

/*or using function invocation syntax*/
SET intReturnVar3 = myProc1(intVar1, intVar2);
```

Database routine example 2

The following ESQL code demonstrates how to define and call DB2 stored procedures:

```
ESQL Definition:
DECLARE inputParm CHARACTER;
DECLARE outputParm CHARACTER;
DECLARE inputOutputParm CHARACTER;

SET inputParm = 'Hello';
SET inputOutputParm = 'World';
CALL swapParms( inputParm, outputParm, inputOutputParm );

CREATE PROCEDURE swapParms (
  IN parm1 CHARACTER,
  OUT parm2 CHARACTER,
  INOUT parm3 CHARACTER
) EXTERNAL NAME dbSwapParms;
```

To register this stored procedure with DB2, copy the following script to a file (for example, test1.sql)

```
-- DB2 Example Stored Procedure
DROP PROCEDURE dbSwapParms @
CREATE PROCEDURE dbSwapParms
( IN in_param CHAR(32),
  OUT out_param CHAR(32),
  INOUT inout_param CHAR(32))
LANGUAGE SQL
BEGIN
SET out_param = inout_param;
  SET inout_param = in_param;
END @
```

Now run it from the DB2 command prompt:

```
db2 -td@ -vf test1.sql
```

Expect the following results from running this code:

- The value of the IN parameter does not (and cannot, by definition) change.
- The value of the OUT parameter becomes "World".
- The value of the INOUT parameter changes to "Hello".

Database routine example 3

The following ESQL code demonstrates how to define and call Oracle stored procedures:

ESQL Definition:

```
DECLARE inputParm CHARACTER;
DECLARE outputParm CHARACTER;
DECLARE inputOutputParm CHARACTER;

SET inputParm = 'Hello';
SET inputOutputParm = 'World';
CALL swapParms( inputParm, outputParm, inputOutputParm );

CREATE PROCEDURE swapParms (
  IN parm1 CHARACTER,
  OUT parm2 CHARACTER,
  INOUT parm3 CHARACTER
) EXTERNAL NAME dbSwapParms;
```

To register this stored procedure with Oracle, copy the following script to a file (for example, test1.sql)

```
CREATE OR REPLACE PROCEDURE dbSwapParms
( in_param IN VARCHAR2,
  out_param OUT VARCHAR2,
  inout_param IN OUT VARCHAR2 )
AS
BEGIN
  out_param := inout_param;
  inout_param := in_param;
END;
/
```

Now run it:

```
sqlplus userID/password @test1.sql
```

Expect the following results from running this code:

- The value of the IN parameter does not (and cannot, by definition) change.
- The value of the OUT parameter becomes “World”.
- The value of the INOUT parameter changes to “Hello”.

Database routine example 4

The following ESQL code demonstrates how to define and call SQL Server stored procedures:

ESQL Definition:

```
DECLARE inputParm CHARACTER;
DECLARE outputParm CHARACTER;
DECLARE inputOutputParm CHARACTER;

SET inputParm = 'Hello';
SET inputOutputParm = 'World';
CALL swapParms( inputParm, outputParm, inputOutputParm );

CREATE PROCEDURE swapParms (
  IN parm1 CHARACTER,
  INOUT parm2 CHARACTER,
  INOUT parm3 CHARACTER
) EXTERNAL NAME dbSwapParms;
```

To register this stored procedure with SQL Server, copy the following script to a file (for example, test1.sql)

```

-- SQLServer Example Stored Procedure
DROP PROCEDURE dbSwapParms
go
CREATE PROCEDURE dbSwapParms
    @in_param    CHAR(32),
    @out_param   CHAR(32) OUT,
    @inout_param CHAR(32) OUT
AS
    SET NOCOUNT ON
    SET @out_param = @inout_param
    SET @inout_param = @in_param
go

```

Now run it:

```
isql -UserID -Ppassword -Sserver -ddatasource -itest1.sql
```

SQL Server considers OUTPUT parameters from stored procedures as INPUT/OUTPUT parameters. If you declare these as OUT parameters in your ESQL you encounter a type mismatch error at run time. To avoid that mismatch you must declare SQL Server OUTPUT parameters as INOUT in your ESQL.

Use the SET NOCOUNT ON option, as shown in the preceding example, with SQL stored procedures for the following reasons:

1. To limit the amount of data returned from SQL Server to the broker.
2. To allow result sets to be returned correctly.

Expect the following results from running this code:

- The value of the IN parameter does not (and cannot, by definition) change.
- The value of the OUT parameter becomes "World".
- The value of the INOUT parameter changes to "Hello".

Database routine example 5

The following ESQL code demonstrates how to define and call Sybase stored procedures:

ESQL Definition:

```

DECLARE inputParm CHARACTER;
DECLARE outputParm CHARACTER;
DECLARE inputOutputParm CHARACTER;

SET inputParm = 'Hello';
SET inputOutputParm = 'World';
CALL swapParms( inputParm, outputParm, inputOutputParm );

CREATE PROCEDURE swapParms (
    IN parm1 CHARACTER,
    INOUT parm2 CHARACTER,
    INOUT parm3 CHARACTER
) EXTERNAL NAME dbSwapParms;

```

To register this stored procedure with Sybase, copy the following script to a file (for example, test1.sql)

```

-- SYBASE Example Stored Procedure
DROP PROCEDURE dbSwapParms
go
CREATE PROCEDURE dbSwapParms
    @in_param    CHAR(32),
    @out_param   CHAR(32) OUT,
    @inout_param CHAR(32) OUT

```

```

AS
  SET @out_param = @inout_param
  SET @inout_param = @in_param
go

```

Now run it:

```
isql -U<userID> -P<password> -S<server> -D<datasource> -itest1.sql
```

Sybase considers OUTPUT parameters from stored procedures as INPUT/OUTPUT parameters. If you declare these as OUT parameters in your ESQL, you encounter a type mismatch error at run time. To avoid that mismatch, declare Sybase OUTPUT parameters as INOUT in your ESQL.

Expect the following results from running this code:

- The value of the IN parameter does not (and cannot, by definition) change.
- The value of the OUT parameter becomes "World".
- The value of the INOUT parameter changes to "Hello".

Database routine example 6

This example shows how to call a stored procedure that returns two result sets, in addition to an out parameter:

```

CREATE PROCEDURE myProc1 (IN P1 INT, OUT P2 INT)
  LANGUAGE DATABASE
  DYNAMIC RESULT SETS 2
  EXTERNAL NAME "myschema.myproc";

```

Use the following ESQL to invoke myProc1:

```

/* using a field reference */
CALL myProc1(intVar1, intVar2, Environment.RetVal[], OutputRoot.XMLNS.A[])
/* using a reference variable*/
CALL myProc1(intVar1, intVar2, myReferenceVariable.RetVal[], myRef2.B[])

```

DECLARE statement

The DECLARE statement defines a variable, the data type of the variable and, optionally, its initial value.

The three types of variable you can define with the DECLARE statement are:

- External
- Normal
- Shared

See "ESQL variables" on page 1465 for further information.

Syntax

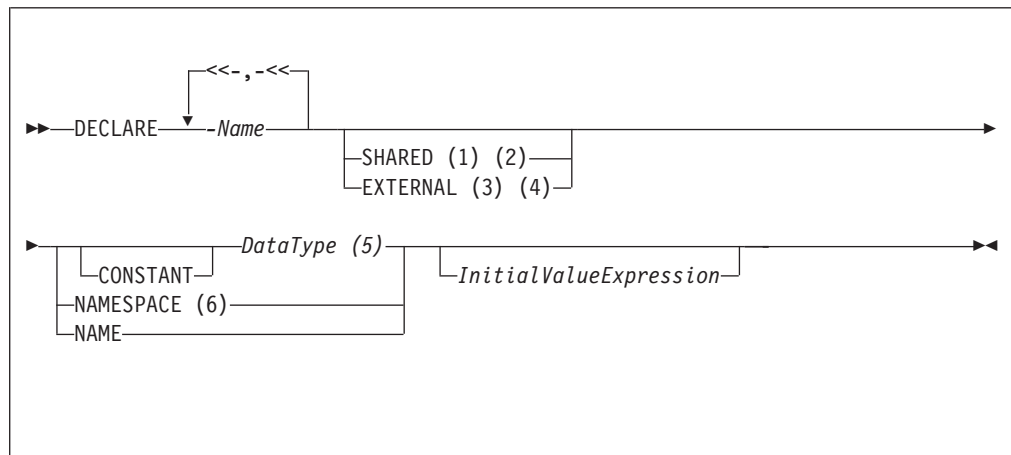

Notes:

1. The SHARED keyword is not valid within a function or procedure.
2. You cannot specify SHARED with a *Data Type* of REFERENCE TO. (To store a message tree in a shared variable, use the ROW data type.)
3. EXTERNAL variables are implicitly constant.
4. It is good programming practice to give an EXTERNAL variable an initial value.
5. If you specify a *Data Type* of REFERENCE TO, you must specify an initial value (of either a variable or a tree) in *Initial Value Expression*.
6. When you use the NAMESPACE and NAME clauses, their values are implicitly constant and of type CHARACTER.

CONSTANT

Use CONSTANT to define a constant. You can declare constants within schemas, modules, routines, or compound statements (both implicit and explicit). The behavior of these cases is shown in the following list:

- Within a compound statement, constants and variables occupy the same namespace.
- Within expressions, a constant or variable that is declared within a compound statement overlays all constants and variables of the same name that are declared in containing compound statements, modules and schemas.
- Within field reference namespace fields, a namespace constant that is declared within a compound statement overlays all namespace constants of the same name that are declared in containing compound statements.

A constant or variable that is declared within a routine overlays any parameters of the same name, and all constants and variables of the same name that are declared in a containing module or schema.

Data Type

The possible values that you can specify for *Data Type* are:

- BOOL
- BOOLEAN
- INT

- INTEGER
- FLOAT
- DEC
- DECIMAL
- DATE
- TIME
- TIMESTAMP
- GMTTIME
- GMTTIMESTAMP
- INTERVAL. This does not apply to external variables (EXTERNAL option specified)
- CHAR
- CHARACTER
- BLOB
- BIT
- ROW. This does not apply to external variables (EXTERNAL option specified)
- REF. This does not apply to external or shared variables (EXTERNAL or SHARED option specified)
- REFERENCE TO. This does not apply to external or shared variables (EXTERNAL or SHARED option specified)

EXTERNAL

Use EXTERNAL to denote a user-defined property (UDP). A UDP is a user-defined constant whose initial value (optionally set by the DECLARE statement) can be modified, at design time, by the Message Flow editor, see Message Flow editor, or overridden, at deployment time, by the Broker Archive editor, see Broker Archive editor. Its value cannot be modified by ESQL.

When a UDP is given an initial value on the DECLARE statement, this becomes its default. However, any value that you specify in the Message Flow editor at design time, or in the BAR editor at deployment time (even a zero length string) overrides any initial value coded on the DECLARE statement.

For example, if you code:

```
DECLARE deployEnvironment EXTERNAL CHARACTER 'Dev';
```

you have defined a UDP variable of deployEnvironment with an initial value Dev.

Add the UDP to the message flow by using the UDP tab in the message flow editor. When you add the flow to the bar file, the UDP is there as an attribute of the flow; you must name the attribute to be the same as the ESQL variable in the DECLARE statement (in this case deployEnvironment) to ensure that the initial value you set is unchanged.

All UDPs in a message flow must have a value, given either on the DECLARE statement or by the Message Flow or BAR editor; otherwise a deployment-time error occurs. At run time, after the UDP has been declared its value can be queried by subsequent ESQL statements, but cannot be modified.

The advantage of UDPs is that their values can be changed at deployment time. If, for example, you use the UDPs to hold configuration data, it means that you can configure a message flow for a particular computer, task, or environment at deployment time, without having to change the code at the node level.

You can declare UDPs only in modules or schemas, this means that you can use the DECLARE statement with the EXTERNAL keyword only at the MODULE or SCHEMA level. If you use a DECLARE statement with the EXTERNAL keyword within a PROCEDURE or FUNCTION, a BIP2402E exception is produced when you deploy the message flow.

The following types of broker node are capable of accessing UDPs:

- Compute node
- Database node
- Filter node
- Nodes derived from these node-types

Take care when specifying the data type of a UDP, because a CAST is used to change the value to the requested *DataType*.

For an overview of UDPs, see “User-defined properties in ESQL” on page 261.

Example 1

```
DECLARE mycolour EXTERNAL CHARACTER 'blue';
```

Example 2

```
DECLARE TODAYSCOLOR EXTERNAL CHARACTER;  
SET COLOR = TODAYSCOLOR;
```

where TODAYSCOLOR is a user-defined property that has a TYPE of CHARACTER and a VALUE set by the Message Flow Editor.

NAME

Use NAME to define an alias (an alternative name) by which a variable can be known.

Example 1

```
-- The following statement gives Schema1 an alias of 'Joe'.  
DECLARE Schema1 NAME 'Joe';  
-- The following statement produces a field called 'Joe'.  
SET OutputRoot.XMLNS.Data.Schema1 = 42;  
  
-- The following statement inserts a value into a table called Table1  
-- in the schema called 'Joe'.  
INSERT INTO Database.Schema1.Table1 (Answer) VALUES 42;
```

Example 2

```
DECLARE Schema1 EXTERNAL NAME;  
  
CREATE FIRSTCHILD OF OutputRoot.XMLNS.TestCase.Schema1 Domain('XMLNS')  
    NAME 'Node1' VALUE '1';  
  
-- If Schema1 has been given the value 'red', the result would be:  
<xml version="1.0"?>  
<TestCase>  
  <red>  
    <Node1>1</Node1>  
  </red>
```

NAMESPACE

Use NAMESPACE to define an alias (an alternative name) by which a namespace can be known.

Example

This example illustrates a namespace declaration, its use as a *SpaceId* in a path, and its use as a character constant in a namespace expression:

```
DECLARE prefixOne NAMESPACE 'http://www.example.com/P01';

-- On the right hand side of the assignment a namespace constant
-- is being used as such while, on the left hand side, one is
-- being used as an ordinary constant (that is, in an expression).

SET OutputRoot.XMLNS.{prefixOne}:{'PurchaseOrder'} =
    InputRoot.XMLNS.prefixOne:PurchaseOrder;
```

SHARED

Use SHARED to define a shared variable. Shared variables are private to the flow (if declared within a schema) or node (if declared within a module), but are shared between instances of the flow (threads). No type of variable is visible beyond the flow level; for example you cannot share variables across execution groups.

You can use shared variables to implement an in-memory cache in the message flow, see “Optimizing message flow response times” on page 158. Shared variables have a long lifetime and are visible to multiple messages passing through a flow, see “Long-lived variables” on page 261. They exist for the lifetime of the execution group process, the lifetime of the flow or node, or the lifetime of the node’s SQL that declares the variable (whichever is the shortest). They are initialized when the first message passes through the flow or node after each broker startup.

You cannot define a shared variable within a function or procedure.

The advantages of shared variables, relative to databases, are that:

- Write access is very much faster.
- Read access to small data structures is faster.
- Access is direct; that is, there is no need to use a special function (SELECT) to get data, or special statements (INSERT, UPDATE, or DELETE) to modify data. You can refer to the data directly in expressions.

The advantages of databases, relative to shared variables, are that:

- The data is persistent.
- The data is changed transactionally.

These read-write variables are ideal for users prepared to sacrifice the persistence and transactional advantages of databases in order to obtain better performance, because they have a longer life than only one message and perform better than a database.

Because flow-shared variables can be updated by multiple instances and multiple flows, ensure that your flows or instances do not make changes to shared variables that might cause unexpected results in other flows and instances, for example if

the variable is being used as a counter. You can prevent other instances seeing the intermediate stages of the data by using a BEGIN ATOMIC construct, see "BEGIN ... END statement" on page 1482.

Your user program can make an efficient read, or write, copy of an input node's message using shared-row variables. This is generally useful and, in particular, simplifies the technique for handling large messages.

There is a restriction that subtrees cannot be copied directly from one shared row variable to another shared row variable. Subtrees can be copied *indirectly* by using a non-shared row variable. Scalar values extracted from one shared row variable (using the FIELDVALUE function) can be copied to another shared row variable.

Example

The following sample shows how to use both shared and external variables:

- Message Routing sample

You can view samples only when you use the information center that is integrated with the Message Broker Toolkit.

DECLARE HANDLER statement

The DECLARE HANDLER statement creates an error handler for handling exceptions.

Syntax

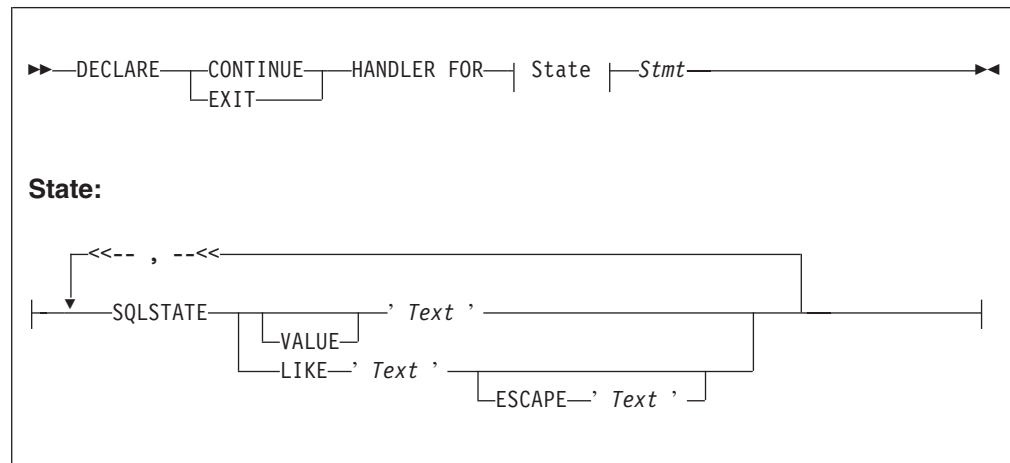

You can declare handlers in both explicitly declared (BEGIN...END) scopes and implicitly declared scopes (for example, the ELSE clause of an IF statement). However, all handler declarations must be together at the top of the scope, before any other statements.

If there are no exceptions, the presence of handlers has no effect on the behavior or performance of an SQL program. If an exception occurs, WebSphere Message Broker compares the SQL state of the exception with the SQL states associated with any relevant handlers, until either the exception leaves the node (just as it would if there were no handlers) or a matching handler is found. Within any one scope, handlers are searched in the order they are declared; that is, first to last. Scopes are searched from the innermost to outermost.

The SQL state values provided in DECLARE... HANDLER... statements can be compared directly with the SQL state of the exception or can be compared using wild card characters. To compare the state values directly, specify either VALUE or no condition operator. To make a wild card comparison, use the underscore and percent characters to represent single and multiple character wild cards, respectively, and specify the LIKE operator. The wild card method allows all exceptions of a general type to be handled without having to list them exhaustively.

If a matching handler is found, the SQLSTATE and other special registers are updated (according to the rules described below) and the handler's statement is processed.

As the handler's statement must be a single statement, it is typically a compound statement (such as BEGIN...END) that contains multiple other statements. There is no special behavior associated with these inner statements and there are no special restrictions. They can, for example, include RETURN, ITERATE, or LEAVE; these affect their containing routines and looping constructs in the same way as if they were contained in the scope itself.

Handlers can contain handlers for exceptions occurring within the handler itself

If processing of the handler's code completes without throwing further unhandled exceptions, execution of the normal code is resumed as follows:

- For EXIT handlers, the next statement processed is the first statement after the handler's scope.
- For CONTINUE handlers, it is the first directly-contained statement after the one that produced the exception.

Each handler has its own SQLCODE, SQLSTATE, SQLNATIVEERROR, and SQLERRORTXT special registers. These come into scope and their values are set just before the handler's first statement is executed. They remain valid until the handler's last statement has been executed. Because there is no carry over of SQLSTATE values from one handler to another, handlers can be written independently.

Handlers absorb exceptions, preventing their reaching the input node and thus causing the transaction to be committed rather than rolled back. A handler can use a RESIGNAL or THROW statement to prevent this.

Example

```
-- Drop the tables so that they can be recreated with the latest definition.
-- If the program has never been run before, errors will occur because you
-- can't drop tables that don't exist. We ignore these.
BEGIN
  DECLARE CONTINUE HANDLER FOR SQLSTATE LIKE'%' BEGIN END;

  PASSTHRU 'DROP TABLE Shop.Customers' TO Database.DSN1;
  PASSTHRU 'DROP TABLE Shop.Invoices' TO Database.DSN1;
  PASSTHRU 'DROP TABLE Shop.Sales' TO Database.DSN1;
  PASSTHRU 'DROP TABLE Shop.Parts' TO Database.DSN1;
END;
```

DELETE FROM statement

The DELETE FROM statement deletes rows from a table in an external database, based on a search condition.

Syntax

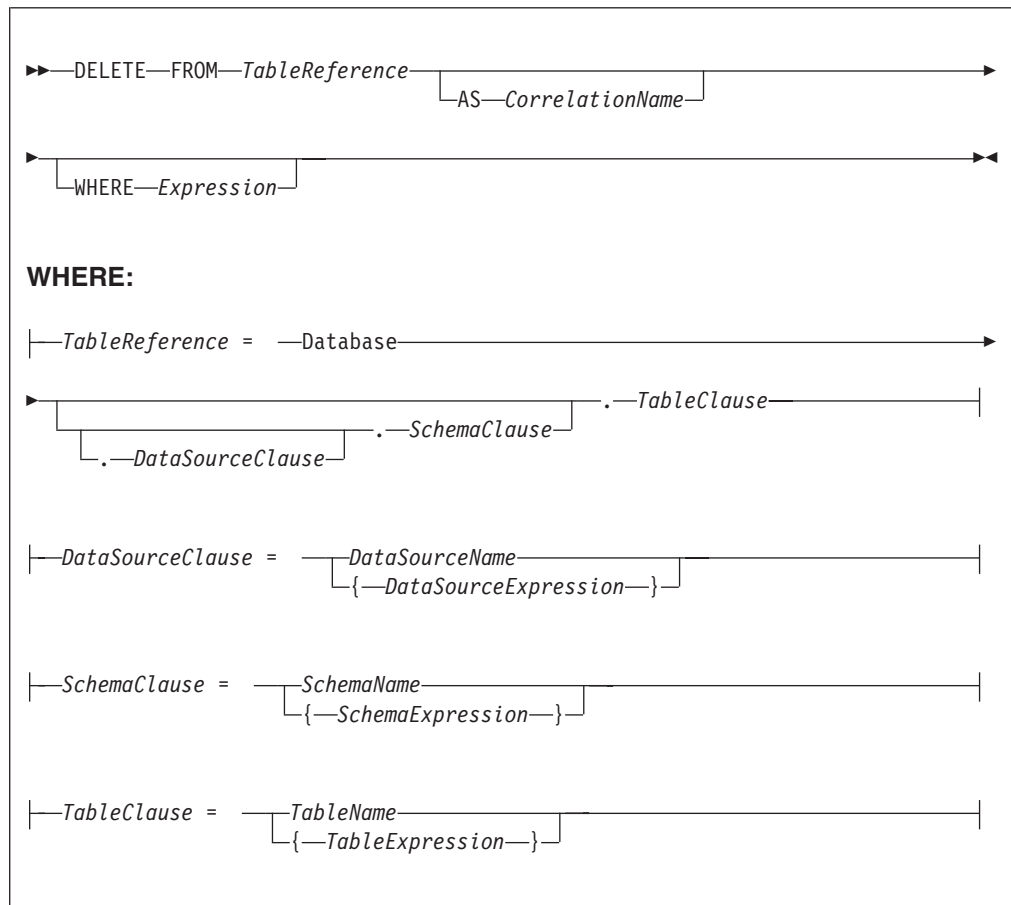

All rows for which the WHERE clause expression evaluates to TRUE are deleted from the table identified by *TableReference*.

Each row is examined in turn and a variable is set to point to the current row. Typically, the WHERE clause expression uses this variable to access column values and thus cause rows to be retained or deleted according to their contents. The variable is referred to by *CorrelationName* or, in the absence of an AS clause, by *TableName*.

Table reference

A table reference is a special case of the field references that are used to refer to message trees. It always starts with the word “Database” and may contain any of the following:

- A table name only
- A schema name and a table name
- A data source name (that is, the name of a database instance), a schema name, and a table name

In each case, the name may be specified directly or by an expression enclosed in braces (`{...}`). A directly-specified data source, schema, or table name is subject to name substitution. That is, if the name used has been declared to be a known name, the value of the declared name is used rather than the name itself (see “DECLARE statement” on page 1525).

If a schema name is not specified, the default schema for the broker's database user is used.

If a data source name is not specified, the database pointed to by the node's data source attribute is used.

The WHERE clause

The WHERE clause expression can use any of the broker's operators and functions in any combination. It can refer to table columns, message fields, and any declared variables or constants.

However, be aware that the broker treats the WHERE clause expression by examining the expression and deciding whether the whole expression can be evaluated by the database. If it can, it is given to the database. In order to be evaluated by the database, it must use only those functions and operators supported by the database.

The WHERE clause can, however, refer to message fields, correlation names declared by containing SELECT functions, and to any other declared variables or constants within scope.

If the whole expression cannot be evaluated by the database, the broker looks for top-level AND operators and examines each sub-expression separately. It then attempts to give the database those sub-expressions that it can evaluate, leaving the broker to evaluate the rest. You need to be aware of this situation for two reasons:

1. Apparently trivial changes to WHERE clause expressions can have large effects on performance. You can determine how much of the expression was given to the database by examining a user trace.
2. Some databases' functions exhibit subtle differences of behavior from those of the broker.

Handling errors

It is possible for errors to occur during delete operations. For example, the database may not be operational. In these cases, an exception is thrown (unless the node has its `throw exception on database error` property set to `FALSE`). These exceptions set appropriate SQL code, state, native error, and error text values and can be dealt with by error handlers (see the `DECLARE HANDLER` statement).

For further information about handling database errors, see "Capturing database state" on page 339.

Examples

The following example assumes that the `dataSource` property has been configured and that the database it identifies has a table called `SHAREHOLDINGS`, with a column called `ACCOUNTNO`.

```
DELETE FROM Database.SHAREHOLDINGS AS S
      WHERE S.ACCOUNTNO = InputBody.AccountNumber;
```

This removes all the rows from the `SHAREHOLDINGS` table where the value in the `ACCOUNTNO` column (in the table) is equal to that in the `AccountNumber` field in the message. This may delete zero, one, or more rows from the table.

The next example shows the use of calculated data source, schema, and table names:

```
-- Declare variables to hold the data source, schema, and table names and
-- set their default values
DECLARE Source CHARACTER 'Production';
DECLARE Schema CHARACTER 'db2admin';
DECLARE Table CHARACTER 'DynamicTable1';

-- Code which calculates their actual values comes here

-- Delete rows from the table
DELETE FROM Database.{Source}.{Schema}.{Table} As R WHERE R.Name = 'Joe';
```

DELETE statement

The DELETE statement detaches and destroys a portion of a message tree, allowing its memory to be reused. This statement is particularly useful when handling very large messages.

Syntax

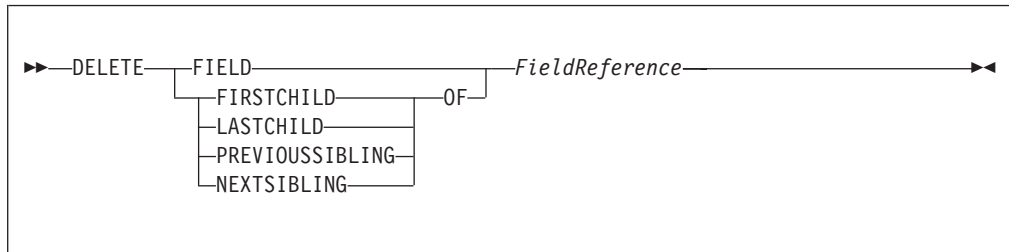

If the target field does not exist, the statement does nothing and normal processing continues. If any reference variables point into the deleted portion, they are disconnected from the tree so that no action involving them has any effect, and the LASTMOVE function returns FALSE. Disconnected reference variables can be reconnected by using a MOVE... TO... statement.

Example

```
DELETE FIELD OutputRoot.XMLNS.Data.Folder1.Folder12;
DELETE LASTCHILD OF Cursor;
```

DETACH statement

The DETACH statement detaches a portion of a message tree without deleting it. This portion can be reattached using the ATTACH statement.

Syntax

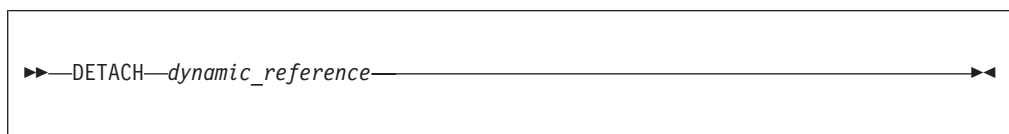

For information about dynamic references, see “Creating dynamic field references” on page 291.

For an example of DETACH, see the example in “ATTACH statement” on page 1480.

EVAL statement

The EVAL statement takes a character value, interprets it as an SQL statement, and processes it.

The EVAL function (also described here) takes a character value, but interprets it as an ESQL expression that returns a value.

Note: User defined functions and procedures cannot be defined within an EVAL statement or EVAL function.

Syntax

```
▶▶—EVAL—( SQL_character_value )————▶▶
```

EVAL takes one parameter in the form of an expression, evaluates this expression, and casts the resulting value to a character string if it is not one already. The expression that is passed to EVAL must therefore be able to be represented as a character string.

After this first stage evaluation is complete, the behavior of EVAL depends on whether it is being used as a complete ESQL statement, or in place of an expression that forms part of an ESQL statement:

- If it is a complete ESQL statement, the character string derived from the first stage evaluation is executed as if it were an ESQL statement.
- If it is an expression that forms part of an ESQL statement, the character string is evaluated as if it were an ESQL expression and EVAL returns the result.

In the following examples, A and B are integer scalar variables, and scalarVar1 and OperatorAsString are character string scalar variables.

The following examples are valid uses of EVAL:

- SET OutputRoot.XMLNS.Data.Result = EVAL(A+B);

The expression A+B is acceptable because, although it returns an integer value, integer values are representable as character strings, and the necessary cast is performed before EVAL continues with its second stage of evaluation.

- SET OutputRoot.XMLNS.Data.Result = EVAL('A' || operatorAsString || 'B');

- EVAL('SET ' || scalarVar1 || ' = 2;');

The semicolon included at the end of the final string literal is necessary, because if EVAL is being used in place of an ESQL statement, its first stage evaluation must return a string that represents a valid ESQL statement, including the terminating semicolon.

Variables declared within an EVAL statement do not exist outside that EVAL statement. In this way EVAL is similar to a function, in which locally-declared variables are local only, and go out of scope when the function is exited.

The real power of EVAL is that it allows you to dynamically construct ESQL statements or expressions. In the second and third examples above, the value of scalarVar1 or operatorAsString can be set according to the value of an incoming message field, or other dynamic value, allowing you to effectively control what ESQL is executed without requiring a potentially lengthy IF THEN ladder.

However, consider the performance implications in using EVAL. Dynamic construction and execution of statements or expressions is necessarily more time-consuming than simply executing pre-constructed ones. If performance is vital, you might prefer to write more specific, but faster, ESQL.

The following are not valid uses of EVAL:

- SET EVAL(scalarVar1) = 2;
In this example, EVAL is being used to replace a field reference, not an expression.
- SET OutputRoot.XMLNS.Data.Result[] = EVAL((SELECT T.x FROM Database.y AS T));
In this example, the (SELECT T.x FROM Database.y) passed to EVAL returns a list, which is not representable as a character string.

The following example is acceptable because (SELECT T.x FROM Database.y AS T) is a character string literal, not an expression in itself, and therefore is representable as a character string.

```
SET OutputRoot.XMLNS.Data.Result[]
= EVAL('(SELECT T.x FROM Database.y AS T)');
```

FOR statement

The FOR statement iterates through a list (for example, a message array).

Syntax

```
►►—FOR—correlation_name—AS—field_reference—DO—statements—END—FOR—◄◄
```

For each iteration, the FOR statement makes the correlation variable (*correlation_name* in the syntax diagram) equal to the current member of the list (*field_reference*) and then executes the block of statements. The advantage of the FOR statement is that it iterates through a list without your having to write any sort of loop construct (and eliminates the possibility of infinite loops).

For example the following ESQL:

```
SET OutputRoot.MQMD=InputRoot.MQMD;

SET Environment.SourceData.Folder[1].Field1 = 'Field11Value';
SET Environment.SourceData.Folder[1].Field2 = 'Field12Value';
SET Environment.SourceData.Folder[2].Field1 = 'Field21Value';
SET Environment.SourceData.Folder[2].Field2 = 'Field22Value';

DECLARE i INTEGER 1;
FOR source AS Environment.SourceData.Folder[] DO
    CREATE LASTCHILD OF OutputRoot.XMLNSC.Data.ResultData.MessageArrayTest.Folder[i]
        NAME 'FieldA' VALUE '\' || source.Field1 || '\' || CAST(i AS CHAR);
```



```

CREATE LASTCHILD OF OutputRoot.XMLNSC.Data.ResultData.MessageArrayTest.Folder[i]
  NAME 'FieldB' VALUE '\' || source.Field2 || '\' || CAST(i AS CHAR);
SET i = i + 1;
END FOR;

```

generates the output message:

```

<Data>
  <ResultData>
    <MessageArrayTest>
      <Folder>
        <FieldA>Field11Value\1</FieldA>
        <FieldB>Field12Value\1</FieldB>
      </Folder>
      <Folder>
        <FieldA>Field21Value\2</FieldA>
        <FieldB>Field22Value\2</FieldB>
      </Folder>
    </MessageArrayTest>
  </ResultData>
</Data>

```

IF statement

The IF statement executes one set of statements based on the result of evaluating condition expressions.

Syntax

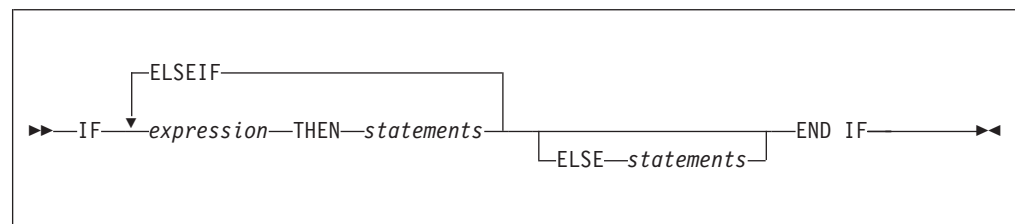

Each expression is evaluated in turn until one results in TRUE; the corresponding set of statements is then executed. If none of the expressions returns TRUE, and the optional ELSE clause is present, the ELSE clause's statements are executed.

UNKNOWN and FALSE are treated the same: the next condition expression is evaluated. ELSEIF is one word with no space between the ELSE and the IF. However, you can nest an IF statement within an ELSE clause: if you do, you can terminate both statements with END IF.

Example

```

IF i = 0 THEN
  SET size = 'small';
ELSEIF i = 1 THEN
  SET size = 'medium';
ELSEIF j = 4 THEN
  SET size = 'large';
ELSE
  SET size = 'unknown';
END IF;

```

```

IF J > MAX THEN
  SET J = MAX;
  SET Limit = TRUE;
END IF;

```

INSERT statement

The INSERT statement inserts a row into a database table.

Syntax

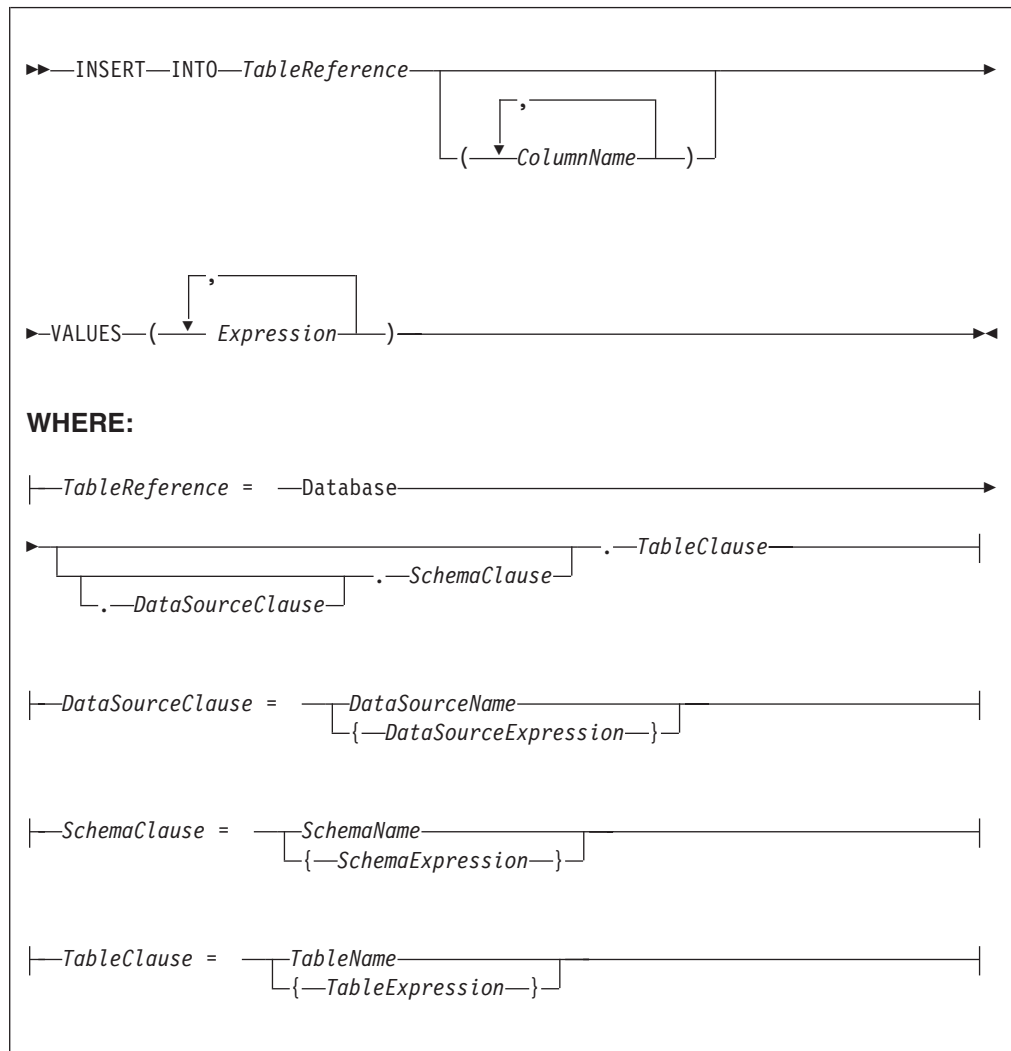

A single row is inserted into the table identified by *TableReference*. The *ColumnName* list identifies those columns in the target table that are to be given specific values. These values are determined by the expressions within the VALUES clause (the first expression gives the value of the first named column, and so on). The number of expressions in the VALUES clause must be the same as the number of named columns. Any columns present in the table but not mentioned in the list are given their default values.

Table reference

A table reference is a special case of the field references that are used to refer to message trees. It always starts with the word “Database” and may contain any of the following:

- A table name only
- A schema name and a table name
- A data source name (that is, the name of a database instance), a schema name, and a table name

In each case, the name may be specified directly or by an expression enclosed in braces ({...}). A directly-specified data source, schema, or table name is subject to name substitution. That is, if the name used has been declared to be a known name, the value of the declared name is used rather than the name itself (see “DECLARE statement” on page 1525).

If a schema name is not specified, the default schema for the broker’s database user is used.

If a data source name is not specified, the database pointed to by the node’s data source attribute is used.

Handling errors

It is possible for errors to occur during insert operations. For example, the database may not be operational, or the table may have constraints defined that the new row would violate. In these cases, an exception is thrown (unless the node has its **throw exception on database error** property set to FALSE). These exceptions set appropriate values for:

- SQL code
- state
- native error
- error text

and can be dealt with by error handlers (see the DECLARE HANDLER statement).

For further information about handling database errors, see “Capturing database state” on page 339.

Examples

The following example assumes that the **data source** property of the Database node has been configured, and that the database it identifies has a table called TABLE1 with columns A, B, and C.

Given a message with the following generic XML body:

```
<A>
  <B>1</B>
  <C>2</C>
  <D>3</D>
</A>
```

The following INSERT statement inserts a new row into the table with the values 1, 2, and 3 for the columns A, B, and C:

```
INSERT INTO Database.TABLE1(A, B, C) VALUES (Body.A.B, Body.A.C, Body.A.D);
```

The next example shows the use of calculated data source, schema, and table names:

```
-- Declare variables to hold the data source, schema, and table names
-- and set their default values
DECLARE Source CHARACTER 'Production';
DECLARE Schema CHARACTER 'db2admin';
DECLARE Table CHARACTER 'DynamicTable1';

-- Code which calculates their actual values comes here

-- Insert the data into the table
INSERT INTO Database.{Source}.{Schema}.{Table} (Name, Value) values ('Joe', 12.34);
```

Inserting a bitstream into a database

If the database column into which you want to insert data is set to a binary data type such as BLOB, the input message must be represented in bitstream form. If the input message is in the BLOB domain, use the following ESQL code:

```
DECLARE msgBitStream BLOB InputRoot.BLOB.BLOB;
INSERT INTO Database.TABLE1(MSGDATA) VALUES (msgBitStream);
```

Alternatively, if the input message is in an XML domain such as XMLNS, then the message tree must be serialized before the INSERT statement. To serialize the message tree and insert the contents into the database, use the following ESQL code:

```
DECLARE propRef REFERENCE TO InputRoot.Properties;
DECLARE msgBitStream BLOB ASBITSTREAM(InputRoot.XMLNS, propRef.Encoding, propRef.CodedCharSetId);
INSERT INTO Database.TABLE1(MSGDATA) VALUES (msgBitStream);
```

If the input messages received by your message flow come from different code pages, the CodedCharSetID and Encoding information is lost if you use the previous example. To capture CodedCharSetID and Encoding information, you can extend the table with two numeric columns to store the CodedCharSetID and Encoding data. To do this modify the ESQL from the previous example to insert the CodedCharSetID and Encoding data into separate database columns:

```
DECLARE propRef REFERENCE TO InputRoot.Properties;
DECLARE inCCSID INT propRef.CodedCharSetId;
DECLARE inEncoding INT propRef.Encoding;
DECLARE msgBitStream BLOB ASBITSTREAM(InputRoot.XMLNS, inEncoding, inCCSID);
INSERT INTO Database.TABLE1(MSGDATA, MSGENCODING, MSGCCSID) VALUES
(msgBitStream, inEncoding, inCCSID);
```

As an extension to the above example, if you require the entire message to be stored along with its MQMD header, and use it later for reconstructing the entire message in another message flow on a different platform using a different codepage and encoding, the database table can be extended to hold all the numeric fields of MQMD header.

For example, a message flow running on AIX inserts a message bitstream into the database table and another message flow running on Windows retrieves it and attempts to reconstruct the message along with the stored MQMD header.

The set of numeric fields in the MQMD header is listed below:

```
BackoutCount (MQLONG)
CodedCharSetId (MQLONG)
Encoding (MQLONG)
Expiry (MQLONG)
Feedback (MQLONG)
MsgFlags (MQLONG)
```

```

MsgSeqNumber (MQLONG)
MsgType (MQLONG)
Offset (MQLONG)
OriginalLength (MQLONG)
Persistence (MQLONG)
Priority (MQLONG)
PutApplType (MQLONG)
Report (MQLONG)
Version (MQLONG)

```

The following example uses CodedCharSetID, Encoding, Priority, and MsgSeqNumber.:

```

DECLARE propRef REFERENCE TO InputRoot.Properties;
DECLARE mqmdRef REFERENCE TO InputRoot.MQMD;
DECLARE inCCSID INT propRef.CodedCharSetId;
DECLARE inEncoding INT propRef.Encoding;

DECLARE inPriority INT mqmdRef.Priority;
DECLARE inMsgSeqNumber INT mqmdRef.MsgSeqNumber;

DECLARE msgBitStream BLOB ASBITSTREAM(InputRoot, inEncoding, inCCSID);

INSERT INTO Database.TABLE1(MSGDATA, MSGENCODING, MSGCCSID, MSGPRIORITY,MSGSEQNUMBER)
VALUES (msgBitStream, inEncoding, inCCSID, inPriority, inMsgSeqNumber);

```

If you want to insert an XML message into a database column that has a CHAR or VARCHAR data type, the ESQL must be modified to convert the input message to the CHAR data type before the INSERT statement. In the following example a CAST is used to transform the serialized message to the CHAR data type. The CodedCharSetID and Encoding data are inserted into separate database columns.

```

DECLARE propRef REFERENCE TO InputRoot.Properties;
DECLARE inCCSID INT propRef.CodedCharSetId;
DECLARE inEncoding INT propRef.Encoding;
DECLARE msgBitStream BLOB ASBITSTREAM(InputRoot.XMLNS, inEncoding, inCCSID);
DECLARE msgChar CHAR CAST(msgBitStream AS CHAR CCSID inCCSID);
INSERT INTO Database.TABLE1(MSGDATA, MSGENCODING, MSGCCSID) VALUES (msgChar, inEncoding, inCCSID);

```

For examples of how to extract a message bitstream from a database, based on the two previous examples, see “Selecting bitstream data from a database” on page 327.

ITERATE statement

The ITERATE statement stops the current iteration of the containing WHILE, REPEAT, LOOP, or BEGIN statement identified by Label.

The containing statement evaluates its loop condition (if any), and either starts the next iteration or stops looping, as the condition dictates.

Syntax

```

▶▶—ITERATE—Label—▶▶

```

Example

In the following example, the loop iterates four times; that is the line identified by the comment Some statements 1 is passed through four times. However, the line identified by the comment Some statements 2 is passed through twice only because of the action of the IF and ITERATE statements. The ITERATE statement does **not** bypass testing the loop condition. Take particular care that the action of the ITERATE does not bypass the logic that makes the loop advance and eventually terminate. The loop count is incremented at the start of the loop in this example:

```
DECLARE i INTEGER;
SET i = 0;
X : REPEAT
  SET i = i + 1;

  -- Some statements 1

  IF i IN(2, 3) THEN
    ITERATE X;
  END IF;

  -- Some statements 2

UNTIL
  i >= 4
END REPEAT X;
```

ITERATE statements do not have to be directly contained by their labelled statement, making ITERATE statements particularly powerful.

LEAVE statement

The LEAVE statement stops the current iteration of the containing WHILE, REPEAT, LOOP, or BEGIN statement identified by Label.

The containing statement's evaluation of its loop condition (if any) is bypassed and looping stops.

Syntax

```
▶▶—LEAVE—Label—▶▶
```

Examples

In the following example, the loop iterates four times:

```
DECLARE i INTEGER;
SET i = 1;
X : REPEAT
  ...
  IF i >= 4 THEN
    LEAVE X;
  END IF;

  SET i = i + 1;
UNTIL
  FALSE
END REPEAT;
```

LEAVE statements do not have to be directly contained by their labelled statement, making LEAVE statements particularly powerful.

```

DECLARE i INTEGER;
SET i = 0;
X : REPEAT                                -- Outer loop
...
  DECLARE j INTEGER;
  SET j = 0;
  REPEAT                                  -- Inner loop
  ...
    IF i>= 2 AND j = 1 THEN
      LEAVE X;                            -- Outer loop left from within inner loop
    END IF;
  ...
  SET j = j + 1;
UNTIL
  j>= 3
END REPEAT;

SET i = i + 1;
UNTIL
  i>= 3
END REPEAT X;

-- Execution resumes here after the leave

```

LOG statement

Use the LOG statement to write a record to the event log or to the user trace.

Syntax

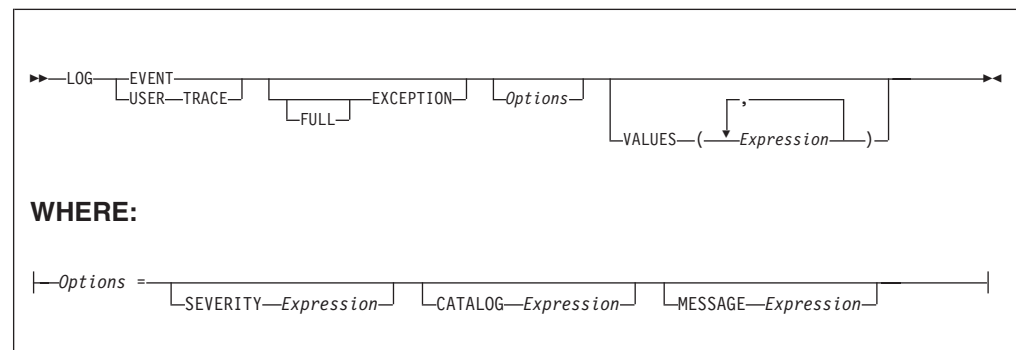

CATALOG

CATALOG is an optional clause; if you omit it, CATALOG defaults to the WebSphere Message Broker current version catalog. To use the current version message catalog explicitly, use BIPv610 on all operating systems.

EVENT

A record is written to the event log, and also to the user trace, if user tracing is enabled.

EXCEPTION

The current exception, if any, is logged.

For more information on exceptions, see Errors and exception handling.

FULL

The complete nested exception report is logged, just as if the exception had reached the input node. If FULL is not specified, any wrapping exceptions are ignored, and only the original exception is logged. Therefore, you can have either a full report or simply the actual error report without the extra

information regarding what was going on at the time. A current exception only exists within handler blocks (see "Handling errors in message flows" on page 203).

MESSAGE

The number of the message to be used. If specified, the MESSAGE clause can contain any expression that returns a non-NULL, integer, value.

If you omit MESSAGE, its value defaults to the first message number (2951) in a block of messages that is provided for use by the LOG and THROW statements in the WebSphere Message Broker catalog. If you specify a message number, you can use message numbers 2951 through 2999. Alternatively, you can generate your own catalog.

SEVERITY

The severity associated with the message. If specified, the SEVERITY clause can contain any expression that returns a non-NULL, integer, value. If you omit the clause, its value defaults to 1.

USER TRACE

A record is written to the user trace, whether user trace is enabled or not.

VALUES

Use the optional VALUES clause to provide values for the data inserts in your message. You can insert any number of pieces of information, but the messages supplied (2951 - 2999) cater for a maximum of ten data inserts.

Note the general similarity of the LOG statement to the THROW statement.

```
-- Write a message to the event log specifying the severity, catalog and message
-- number. Four inserts are provided
LOG EVENT SEVERITY 1 CATALOG 'BIPv610' MESSAGE 2951 VALUES(1,2,3,4);

-- Write to the trace log whenever a divide by zero occurs
BEGIN
  DECLARE a INT 42;
  DECLARE b INT 0;
  DECLARE r INT;

  BEGIN
    DECLARE EXIT HANDLER FOR SQLSTATE LIKE 'S22012' BEGIN
      LOG USER TRACE EXCEPTION VALUES(SQLSTATE, 'DivideByZero');

      SET r = 0x7FFFFFFFFFFFFFFF;
    END;

    SET r = a / b;
  END;

  SET OutputRoot.XMLNS.Data.Result = r;
END;
```

LOOP statement

The LOOP statement executes the sequence of statements repeatedly and unconditionally.

Ensure that the logic of the program provides some means of terminating the loop. You can use either LEAVE or RETURN statements.

Syntax

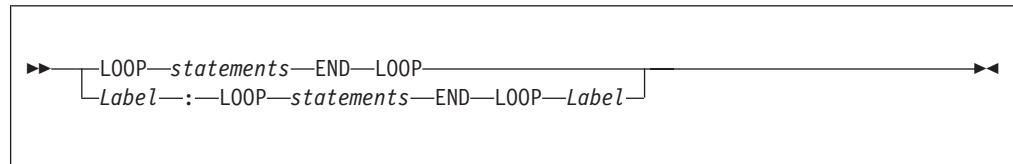

If present, *Label* gives the statement a name. This has no effect on the behavior of the LOOP statement, but allows *statements* to include ITERATE and LEAVE statements or other labelled statements, which in turn include ITERATE and LEAVE. The second *Label* can be present only if the first *Label* is present and, if it is, the labels must be identical.

Two or more labelled statements at the same level can have the same *Label* but this partly negates the advantage of the second *Label*. The advantage is that it unambiguously and accurately matches each END with its LOOP. However, a labelled statement within *statements* cannot have the same label, because this makes the behavior of the ITERATE and LEAVE statements ambiguous.

The LOOP statement is useful in cases where the required logic dictates that a loop is always exited part way through. This is because, in these cases, the testing of a loop condition that occurs in REPEAT or WHILE statements is both unnecessary and wasteful.

Example

```
DECLARE i INTEGER;
SET i = 1;
X : LOOP
  ...
  IF i >= 4 THEN
    LEAVE X;
  END IF;
  SET i = i + 1;
END LOOP X;
```

MOVE statement

The MOVE statement changes the field to which the *Target* reference variable points.

Syntax

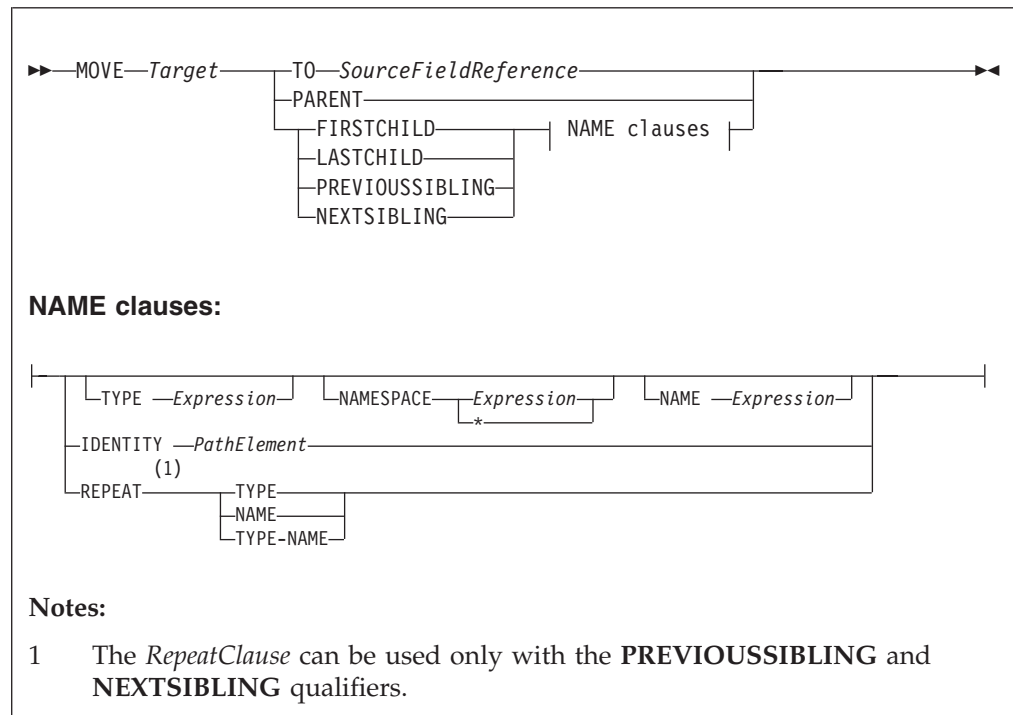

If you include a TO clause, this clause changes the target reference to point to the same entity as that pointed to by source; this can either be a message field or a declared variable.

If you include a PARENT, PREVIOUSIBLING, NEXTSIBLING, FIRSTCHILD, or LASTCHILD clause, the MOVE statement attempts to move the target reference variable in the direction specified relative to its current position. If any field exists in the given direction, the move succeeds. If there is no such field, the move fails; that is the reference variable continues to point to the same field or variable as before, and the LASTMOVE function returns false. You can use the LASTMOVE function to determine the success or failure of a move.

If a TYPE clause, NAME clause, or both are present, the target is again moved in the direction specified (PREVIOUSIBLING or NEXTSIBLING, or FIRSTCHILD or LASTCHILD) but to a field with the given type, name, or both. This is particularly useful when the name or type (or both) of the target field is known, because this reduces the number of MOVE statements required to navigate to a field. This is because fields that do not match the criteria are skipped over; this can also include unexpected message tree fields, for example, those representing whitespace.

If the specified move cannot be made (that is, a field with the given type or name does not exist), the target remains unchanged and the LASTMOVE function returns false. The TYPE clause, NAME clause, or both clauses can contain any expression that returns a value of a suitable data type (INTEGER for type and CHARACTER for name). An exception is thrown if the value supplied is NULL.

Two further clauses, NAMESPACE and IDENTITY enhance the functionality of the NAME clause.

The NAMESPACE clause takes any expression that returns a non-null value of type character. It also takes an * indicating any namespace. Note that this cannot be confused with an expression because * is not a unary operator in ESQL.

The meaning depends on the presence of NAME and NAMESPACE clauses as follows:

NAMESPACE	NAME	Element located by...
No	No	Type, index, or both
No	Yes	Name in the default namespace
*	Yes	Name
Yes	No	Namespace
Yes	Yes	Name and namespace

The IDENTITY clause takes a single path element in place of the TYPE, NAMESPACE, and NAME clauses and follows all the rules described in the topic for field references (see “ESQL field references” on page 1465).

When using MOVE with PREVIOUSIBLING or NEXTSIBLING, you can specify REPEAT, TYPE, and NAME keywords that move the target to the previous or next field with the same type and name as the current field. The REPEAT keyword is particularly useful when moving to a sibling of the same kind, because you do not have to write expressions to define the type and name.

Example

```
MOVE cursor FIRSTCHILD TYPE XML.Name 'Field1';
```

This example moves the reference variable cursor to the first child field of the field to which the cursor is currently pointing, that has the type XML.Name and the name *Field1*.

See “FIELDTYPE function” on page 1608 for a list of the types you can use.

The MOVE statement never creates new fields.

A common usage of the MOVE statement is to step from one instance of a repeating structure to the next. The fields within the structure can then be accessed by using a relative field reference. For example:

```
WHILE LASTMOVE(sourceCursor) DO
  SET targetCursor.ItemNumber = sourceCursor.item;
  SET targetCursor.Description = sourceCursor.name;
  SET targetCursor.Price      = sourceCursor.prc;
  SET targetCursor.Tax        = sourceCursor.prc * 0.175;
  SET targetCursor.quantity   = 1;
  CREATE NEXTSIBLING OF targetCursor AS targetCursor REPEAT;
  MOVE sourceCursor NEXTSIBLING REPEAT TYPE NAME;
END WHILE;
```

For more information about reference variables, and an example of moving a reference variable, see “Creating dynamic field references” on page 291.

PASSTHRU statement

The PASSTHRU statement evaluates an expression and runs the resulting character string as a database statement.

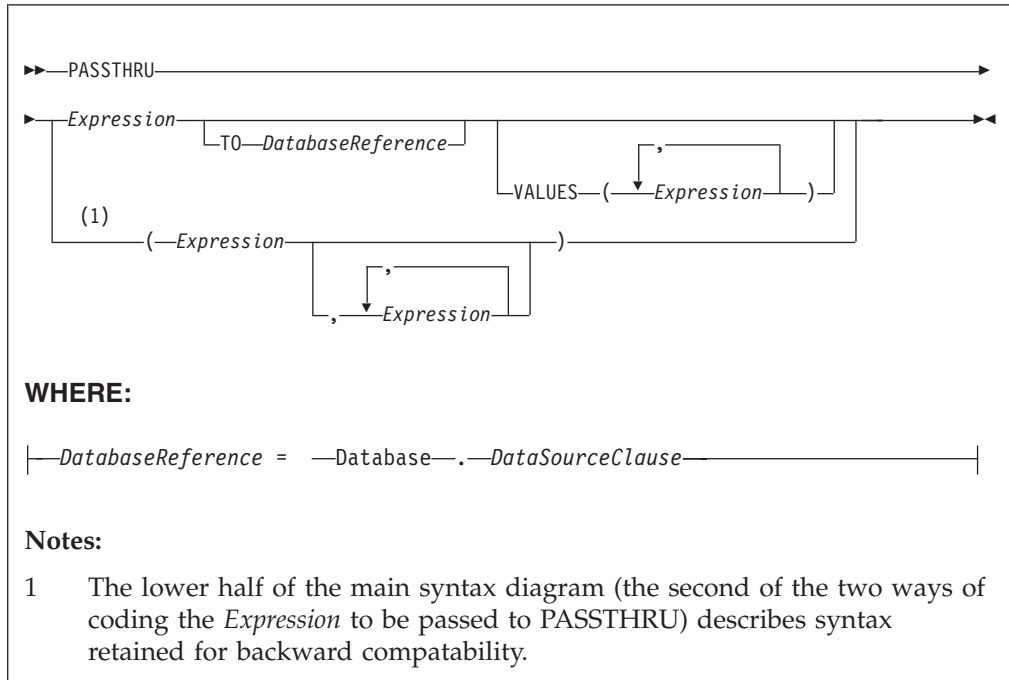

Usage

The main use of the PASSTHRU statement is to issue administrative commands to databases (for example, to create a table).

Note: Do not use PASSTHRU to call stored procedures; instead, use the CALL statement because PASSTHRU imposes limitations (you cannot use output parameters, for example).

The first expression is evaluated and the resulting character string is passed to the database pointed to by *DatabaseReference* (in the TO clause) for execution. If the TO clause is not specified, the database pointed to by the node's data source attribute is used.

Use question marks (?) in the database string to denote parameters. The parameter values are supplied by the VALUES clause.

If the VALUES clause is specified, its expressions are evaluated and passed to the database as parameters; (that is, the expressions' values are substituted for the question marks in the database statement).

If only one VALUE expression exists, the result might or might not be a list. If it is a list, the list's scalar values are substituted sequentially for the question marks. If it is not a list, the single scalar value is substituted for the (single) question mark in the database statement. If more than one VALUE expression exists, none of the expressions evaluate to a list; their scalar values are substituted sequentially for the question marks instead.

Because the database statement is constructed by the user program, it is not essential to use parameter markers (that is, the question marks) or the VALUES clause, because the whole of the database statement could be supplied, as a literal string, by the program. However, use parameter markers whenever possible

because this reduces the number of different statements that need to be prepared and stored in the database and the broker.

Database reference

A database reference is a special instance of the field references that is used to refer to message trees. It consists of the word **Database** followed by the name of a data source (that is, the name of a database instance).

You can specify the data source name directly or by an expression enclosed in braces ({...}). A directly-specified data source name is subject to name substitution. That is, if the name used has been declared to be a known name, the value of the declared name is used rather than the name itself (see “DECLARE statement” on page 1525).

If you have created a message flow that contains one of the following nodes, and the ESQL that is associated with this node includes a PASSTHRU statement and a database reference, you must specify a value for the Data source property of the relevant node:

- Compute
- Database
- Filter

Handling errors

It is possible for errors to occur during PASSTHRU operations. For example, the database might not be operational or the statement might be invalid. In these cases, an exception is thrown (unless the node has its Throw exception on database error property cleared). These exceptions set appropriate SQL code, state, native error, and error text values and can be dealt with by error handlers (see the DECLARE HANDLER statement).

For further information about handling database errors, see “Capturing database state” on page 339.

Examples

The following example creates the table Customers in schema Shop in database DSN1:

```
PASSTHRU 'CREATE TABLE Shop.Customers (  
  CustomerNumber INTEGER,  
  FirstName      VARCHAR(256),  
  LastName      VARCHAR(256),  
  Street        VARCHAR(256),  
  City          VARCHAR(256),  
  Country       VARCHAR(256)  
)' TO Database.DSN1;
```

If, as in the last example, the ESQL statement is specified as a string literal, you must put single quotes around it. If, however, it is specified as a variable, omit the quotation marks. For example:

```
SET myVar = 'SELECT * FROM user1.stocktable';  
SET OutputRoot.XMLNS.Data[] = PASSTHRU(myVar);
```

The following example “drops” (that is, deletes) the table Customers from schema Shop in database DSN1:

```
PASSTHRU 'DROP TABLE Shop.Customers' TO Database.DSN1;
```

PROPAGATE statement

The PROPAGATE statement propagates a message to the downstream nodes.

Syntax

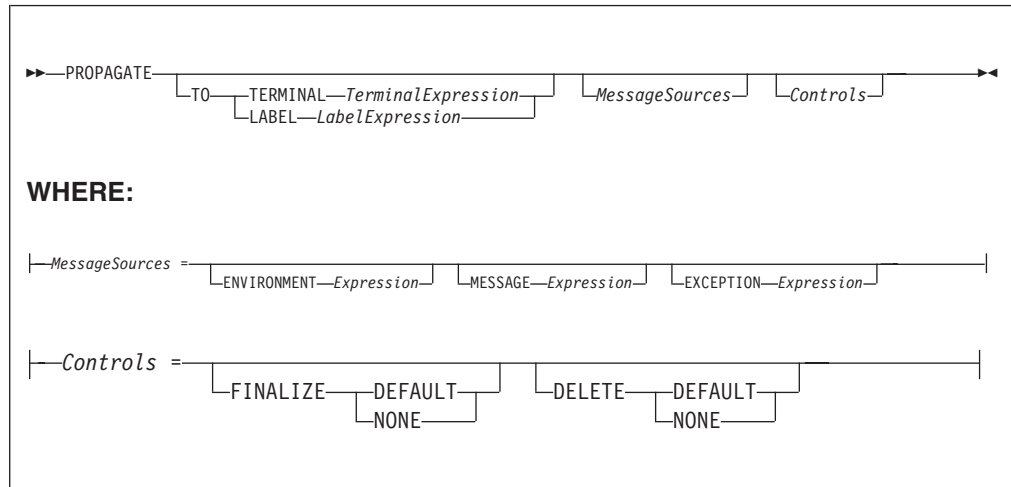

You can use the PROPAGATE statement in Compute and Database nodes, but not in Filter nodes. The additions to this statement assist in error handling - see “Coding ESQL to handle errors” on page 334.

TO TERMINAL clause

If the TO TERMINAL clause is present, *TerminalExpression* is evaluated. If the result is of type CHARACTER, a message is propagated to a terminal according to the rule:

```
'nowhere' : no propagation
'failure'  : Failure
'out'      : Out
'out1'     : Out1
'out2'     : Out2
'out3'     : Out3
'out4'     : Out4
```

Tip: Terminal names are case sensitive so, for example, Out1 does not match any terminal.

If the result of *TerminalExpression* is of type INTEGER, a message is propagated to a terminal according to the rule:

```
-2 : no propagation
-1 : Failure
0  : Out
1  : Out1
2  : Out2
3  : Out3
4  : Out4
```

If the result of *TerminalExpression* is neither a CHARACTER nor an INTEGER, the broker throws an exception.

If there is neither a TO TERMINAL nor a TO LABEL clause, the broker propagates a message to the Out terminal.

Tip: Using character values in terminal expressions leads to the most natural and readable code. Integer values, however, are easier to manipulate in loops and marginally faster.

TO LABEL clause

If the TO LABEL clause is present, *LabelExpression* is evaluated. If the result is of type CHARACTER **and** there is a Label node with a Label property that matches *LabelExpression*, in the same flow, the broker propagates a message to that node.

Tip: Labels, like terminals, are case sensitive. Also, note that, as with route to Label nodes, it is the Label Name property of the Label node that defines the target, not the node's label itself.

If the result of *LabelExpression* is NULL or not of type CHARACTER, or there is no matching Label node in the flow, the broker throws an exception.

If there is neither a TO TERMINAL nor a TO LABEL clause, the broker propagates a message to the out terminal.

MessageSources clauses

The MessageSources clauses select the message trees to be propagated. This clause is only applicable to the Compute node (it has no effect in the Database node).

The values that you can specify in MessageSources clauses are:

ENVIRONMENT :
 InputLocalEnvironment
 OutputLocalEnvironment

Message :
 InputRoot
 OutputRoot

ExceptionList :
 InputExceptionList
 OutputExceptionList

If there is no MessageSources clause, the node's Compute mode property is used to determine which messages are propagated.

FINALIZE clause

Finalization is a process that fixes header chains and makes the Properties folder match the headers. If present, the FINALIZE clause allows finalization to be controlled.

This clause is only applicable to the Compute node (it has no effect in a Database node).

The Compute node allows its output message to be changed by other nodes (by the other nodes changing their input message). However, a message created by a Compute node cannot be changed by another node after:

- It has been finalized
- It has reached any output or other node which generates a bit-stream

If FINALIZE is set to DEFAULT, or the FINALIZE clause is absent, the output message (but not the Environment, Local Environment or Exception List) is finalized before propagation.

If FINALIZE is set to NONE, no finalization takes place. This option is required if you want to preserve and allow updates of the entire output

message tree by the nodes downstream in the message flow and is used with DELETE NONE as described in the next section.

DELETE clause

The DELETE clause allows the clearing of the output local environment, message, and exception list to be controlled.

The DELETE clause is only applicable to the Compute node (it has no effect in a Database node).

If DELETE is set to DEFAULT, or the DELETE clause is absent, the output local environment, message, and exception list are all cleared and their memory recovered immediately after propagation.

If DELETE is set to NONE, nothing is cleared. Use DELETE NONE if you want the downstream nodes to be able to see a single instance of output local environment message, and exception list trees. Each propagate starts with the content of these trees as created by the previous propagate rather than starting with empty trees. If you also want these nodes to update the output tree, DELETE NONE must be used with the FINALIZE NONE option described in the previous section.

Note that the output trees that are finalized are cleared, regardless of which ones are propagated.

Propagation is a synchronous process. That is, the next statement is not executed until all the processing of the message in downstream nodes has completed. Be aware that this processing might throw exceptions and that, if these exceptions are not caught, they will prevent the statement following the PROPAGATE call being reached. This may be what the logic of your flow requires but, if it is not, you can use a handler to catch the exception and perform the necessary actions. Note that exceptions thrown downstream of a propagate, if not caught, will also prevent the final automatic actions of a Compute or Database node (for example, issuing a COMMIT Transaction set to Commit) from taking place.

```
DECLARE i INTEGER 1;
DECLARE count INTEGER;
SET count = CARDINALITY(InputRoot.XMLNS.Invoice.Purchases."Item"[])

WHILE i <= count DO
  --use the default tooling-generated procedure for copying message headers
  CALL CopyMessageHeaders();
  SET OutputRoot.XMLNS.BookSold.Item = InputRoot.XMLNS.Invoice.Purchases.Item[i];
  PROPAGATE;
  SET i = i+1;
END WHILE;
RETURN FALSE;
```

The following messages are produced on the Out terminal by the PROPAGATE statement:

```
<BookSold>
  <Item>
    <Title Category="Computer" Form="Paperback" Edition="2">The XML Companion </Title>
    <ISBN>0201674866</ISBN>
    <Author>Neil Bradley</Author>
    <Publisher>Addison-Wesley</Publisher>
    <PublishDate>October 1999</PublishDate>
    <UnitPrice>27.95</UnitPrice>
    <Quantity>2</Quantity>
  </Item>
</BookSold>
```



```

<BookSold>
  <Item>
    <Title Category="Computer" Form="Paperback" Edition="2">A Complete Guide to
      DB2 Universal Database</Title>
    <ISBN>1558604820</ISBN>
    <Author>Don Chamberlin</Author>
    <Publisher>Morgan Kaufmann Publishers</Publisher>
    <PublishDate>April 1998</PublishDate>
    <UnitPrice>42.95</UnitPrice>
    <Quantity>1</Quantity>
  </Item>
</BookSold>
<BookSold>
  <Item>
    <Title Category="Computer" Form="Hardcover" Edition="0">JAVA 2 Developers
      Handbook</Title>
    <ISBN>0782121799</ISBN>
    <Author>Phillip Heller, Simon Roberts </Author>
    <Publisher>Sybex, Inc.</Publisher>
    <PublishDate>September 1998</PublishDate> <UnitPrice>59.99</UnitPrice>
    <Quantity>1</Quantity>
  </Item>
</BookSold>

```

REPEAT statement

The REPEAT statement processes a sequence of statements and then evaluates the condition expression.

Syntax

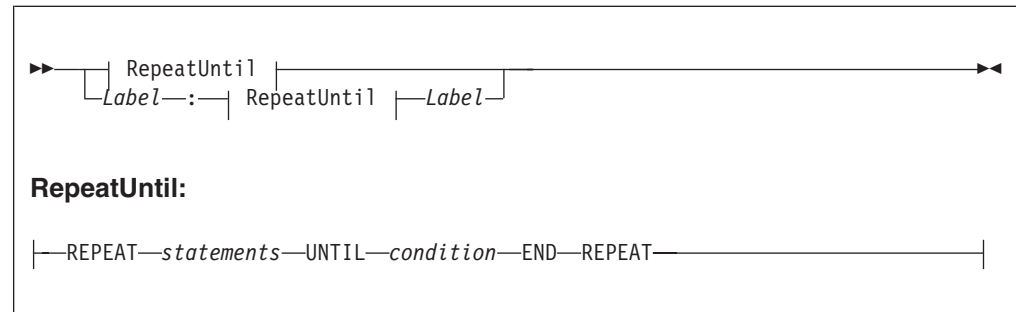

The REPEAT statement repeats the steps until condition is TRUE. Ensure that the logic of the program is such that the loop terminates. If the condition evaluates to UNKNOWN, the loop does **not** terminate.

If present, the *Label* gives the statement a name. This has no effect on the behavior of the REPEAT statement, but allows statements to include ITERATE and LEAVE statements or other labelled statements, which in turn include ITERATE and LEAVE. The second *Label* can be present only if the first *Label* is present and, if it is, the labels must be identical. Two or more labelled statements at the same level can have the same label, but this partly negates the advantage of the second *Label*. The advantage is that it unambiguously and accurately matches each END with its REPEAT. However, a labelled statement within statements cannot have the same label because this makes the behavior of the ITERATE and LEAVE statements ambiguous.

Example

```
DECLARE i INTEGER;  
SET i = 1;  
X : REPEAT  
  ...  
  SET i = i + 1;  
UNTIL  
  i >= 3  
END REPEAT X;
```

RESIGNAL statement

The RESIGNAL statement re-throws the current exception (if there is one).

Syntax



RESIGNAL re-throws the current exception (if there is one). You can use it only in error handlers..

Typically, RESIGNAL is used when an error handler catches an exception that it can't handle. The handler uses RESIGNAL to re-throw the original exception so that a handler in higher-level scope has the opportunity to handle it.

Because the handler throws the original exception, rather than a new (and therefore different) one:

1. The higher-level handler is not affected by the presence of the lower-level handler.
2. If there is no higher-level handler, you get a full error report in the event log.

Example

```
RESIGNAL;
```

RETURN statement

The RETURN statement ends processing. What happens next depends on the programming context in which the RETURN statement is issued.

Syntax

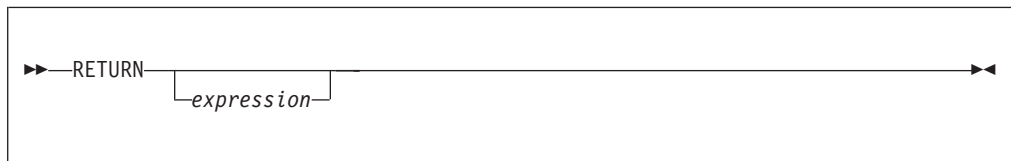

Main Function

When used in the Main function, the RETURN statement stops processing of the module and returns control to the next node in a message flow. In the Main

function the return statement must contain an *expression* of BOOLEAN type. The behavior of the RETURN statement in the Main function is dependant on the node. In the Compute node for example, if *expression* is anything other than TRUE, propagation of the message is stopped. In the Filter node, however, the message is propagated to the terminal matching the value of *expression*: TRUE, FALSE and UNKNOWN. The following table describes the differences between the RETURN statement when used in the Main function of the Compute, Filter, and Database nodes.

Node	RETURN TRUE;	RETURN FALSE;	RETURN UNKNOWN (if BOOLEAN type) or RETURN NULL;	RETURN;
Compute	Propagate message to Out terminal.	Stop propagation	Stop propagation	Deploy failure (BIP2912E: Type mismatch on RETURN)
Database	Propagate message to Out terminal.	Stop propagation	Stop propagation	Deploy failure (BIP2912E: Type mismatch on RETURN)
Filter	Propagate message to True terminal	Propagate message to False terminal	Propagate message to Unknown terminal	Deploy failure (BIP2912E: Type mismatch on RETURN)

User defined functions and procedures

When used in a function or a procedure, the RETURN statement stops processing of that function and returns control to the calling expression. The *expression*, which must be present if the function or procedure has been declared with a RETURNS clause, is evaluated and acts as the return value of the function. The data type of the returned value must be the same as that in the function's declaration. The following table describes the differences between the RETURN statement when used in user defined functions and procedures.

	RETURN <i>expression</i> ;	RETURN NULL; (or return <i>expression</i> that evaluates to NULL)	RETURN;	No RETURN statement
User defined function or procedure with a RETURNS clause	Returns control to the calling expression with the value of <i>expression</i>	Returns control to the calling expression with NULL	Deploy failure (BIP2912E: Type mismatch on RETURN)	Returns control to the calling expression with NULL after all the statements in the function or procedure have been run

User defined function or procedure without a RETURNS clause	Deploy failure (BIP2401E: Syntax error: expected ; but found <i>expression</i>)	Deploy failure (BIP2401E: Syntax error: expected ; but found NULL)	Returns control to the calling expression	Returns control to the calling expression after all the statements in the function or procedure have been run
--	--	--	---	---

The RETURN statement must be used within the body of a function or procedure that has the RETURNS statement in its declaration. This function can be invoked using the CALL ... INTO statement. The RETURNS statement provides the datatype that the function or procedure returns to the “CALL statement” on page 1487. The CALL ... INTO statement specifies the variable to which the return value is assigned. The example in this topic shows an example of how a RETURNS and CALL ... INTO statement are used together to assign the return statement. If you use the CALL ... INTO statement to call a function or procedure that does not have a RETURNS statement declared, a BIP2912E error message is generated.

Example

The following example, which is based on “Example message” on page 1671, illustrates how the RETURN, RETURNS and CALL...INTO statements can be used:

```
CREATE FILTER MODULE ProcessOrder
  CREATE FUNCTION Main() RETURNS BOOLEAN
  BEGIN

    DECLARE SpecialOrder BOOLEAN;
    SET OutputRoot.MQMD = InputRoot.MQMD;
    CALL IsBulkOrder(InputRoot.XMLNS.Invoice.Purchases) INTO SpecialOrder;

    --
    -- more processing could be inserted here
    -- before routing the order to the appropriate terminal
    --
    RETURN SpecialOrder;

  END;

CREATE FUNCTION IsBulkOrder (P1 REFERENCE)
  RETURNS BOOLEAN
  BEGIN
    -- Declare and initialize variables--
    DECLARE a INT 1;
    DECLARE PriceTotal FLOAT 0.0;
    DECLARE NumItems INT 0;
    DECLARE iroot REFERENCE TO P1;

    -- Calculate value of order, however if this is a bulk purchase, the --
    -- order will need to be handled differently (discount given) so return TRUE --
    -- or FALSE depending on the size of the order --
    WHILE a <= CARDINALITY(iroot.Item[]) DO
      SET NumItems = NumItems + iroot.Item[a].Quantity;
      SET PriceTotal = PriceTotal + iroot.Item[a].UnitPrice;
      SET a = a + 1;
    END WHILE;
    RETURN (PriceTotal/NumItems > 42);

  END;

END MODULE;
```

In the example, if the average price of items is greater than 42, TRUE is returned; otherwise FALSE is returned. Thus, a Filter node could route messages describing expensive items down a different path from messages describing inexpensive items. From the example, the CALL `IsBulkOrder(InputRoot.XMLNS.Invoice.Purchases) INTO SpecialOrder;` statement can also be written as `SpecialOrder = IsBulkOrder(InputRoot.XMLNS.Invoice.Purchases);`

If you are using the PROPAGATE statement in your node it is important that you use a RETURN FALSE; to prevent automatic propagation of the message to the next node in the message flow. See “PROPAGATE statement” on page 1550 for an example of preventing the implicit propagate at the end of processing in a Compute node.

SET statement

The SET statement assigns a value to a variable.

Syntax

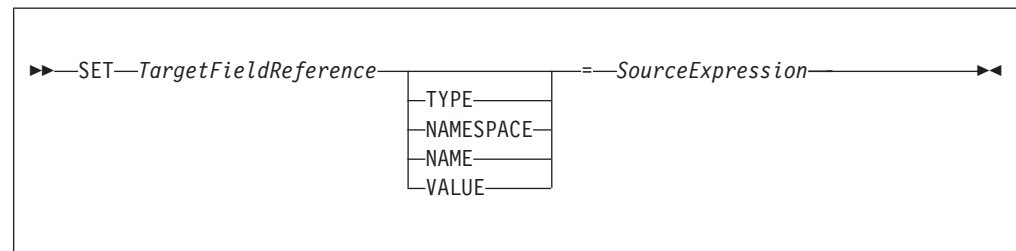

Introduction

TargetFieldReference identifies the target of the assignment. The target can be any of the following:

- A declared scalar variable
- A declared row variable
- One of the predefined row variables (for example, *InputRoot*)
- A field within any kind of row variable (that is, a sub tree or conceptual row)
- A list of fields within any kind of row variable (that is, a conceptual list)
- A declared reference variable that points to any of the above

The target cannot be any kind of database entity.

SourceExpression is an expression which supplies the value to be assigned. It may be any kind of expression and may return a scalar, row or list value.

Assignment to scalar variables

If the target is a declared scalar variable, *SourceExpression* is evaluated and assigned to the variable. If need be, its value is converted to the data type of the variable. If this conversion is not possible, there will be either an error at deploy time or an exception at run time.

Null values are handled in exactly the same way as any other value. That is, if the expression evaluates to null, the value “null” is assigned to the variable.

For scalar variables the TYPE, NAME, NAMESPACE, and VALUE clauses are meaningless and are not allowed.

Assignment to rows, lists, and fields

If the target is a declared row variable, one of the predefined row variables, a field within any kind of row variable, a list of fields within any kind of row variable, or a declared reference variable that points to any of these things, the ultimate target is a field. In these cases, the target field is navigated to (creating the fields if necessary).

If array indices are used in *TargetFieldReference*, the navigation to the target field can only create fields on the direct path from the root to the target field. For example, the following SET statement requires that at least one instance of Structure already exists in the message:

```
SET OutputRoot.XMLNS.Message.Structure[2].Field = ...
```

The target field's value is set according to a set of rules, based on:

1. The presence or absence of the TYPE, NAME, NAMESPACE, or VALUE clauses
2. The data type returned by the source expression

1. If no TYPE, NAME, NAMESPACE, or VALUE clause is present (which is the most common case) the outcome depends on whether *SourceExpression* evaluates to a scalar, a row, or a list:
 - If *SourceExpression* evaluates to a scalar, the value of the target field is set to the value returned by *SourceExpression*, except that, if the result is null, the target field is discarded. Note that the new value of the field may not be of the same data type as its previous value.
 - If *SourceExpression* evaluates to a row:
 - a. The target field is identified.
 - b. The target field's value is set.
 - c. The target field's child fields are replaced by a new set, dictated by the structure and content of the list.
 - If *SourceExpression* evaluates to a list:
 - a. The set of target fields in the target tree are identified.
 - b. If there are too few target fields, more are created; if there are too many, the extra ones are removed.
 - c. The target fields' values are set.
 - d. The target fields' child fields are replaced by a new set, dictated by the structure and content of the list.

For further information on working with elements of type list see "Working with elements of type list" on page 300

2. If a TYPE clause is present, the type of the target field is set to the value returned by *SourceExpression*. An exception is thrown if the returned value is not scalar, is not of type INTEGER, or is NULL.
3. If a NAMESPACE clause is present, the namespace of the target field is set to the value returned by *SourceExpression*. An exception is thrown if the returned value is not scalar, is not of type CHARACTER, or is NULL.
4. If a NAME clause is present, the name of the target field is set to the value returned by *SourceExpression*. An exception is thrown if the returned value is not scalar, is not of type CHARACTER, or is NULL.
5. If a VALUE clause is present, the value of the target field is changed to that returned by *SourceExpression*. An exception is thrown if the returned value is not scalar.

Notes

SET statements are particularly useful in Compute nodes that modify a message, either changing a field or adding a new field to the original message. SET statements are also useful in Filter and Database nodes, to set declared variables or the fields in the Environment tree or Local Environment trees. You can use statements such as the following in a Compute node that modifies a message:

```
SET OutputRoot = InputRoot;  
SET OutputRoot.XMLNS.Order.Name = UPPER(InputRoot.XMLNS.Order.Name);
```

This example puts one field in the message into uppercase. The first statement constructs an output message that is a complete copy of the input message. The second statement sets the value of the `Order.Name` field to a new value, as defined by the expression on the right.

If the `Order.Name` field does not exist in the original input message, it does not exist in the output message generated by the first statement. The expression on the right of the second statement returns NULL (because the field referenced inside the UPPER function call does not exist). Assigning the NULL value to a field has the effect of deleting it if it already exists, and so the effect is that the second statement has no effect.

If you want to assign a NULL value to a field without deleting the field, use a statement like this:

```
SET OutputRoot.XMLNS.Order.Name VALUE = NULL;
```

THROW statement

Use the THROW statement to generate a user exception.

Syntax

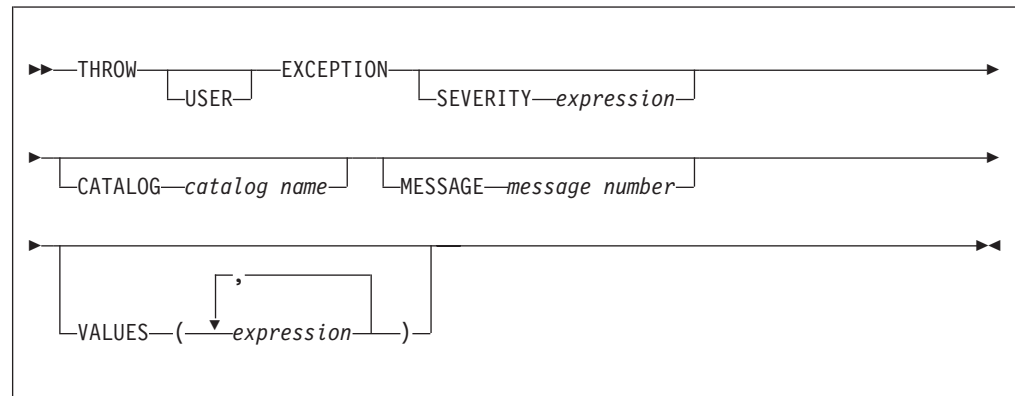

The `USER` keyword indicates the type of exception being thrown. (Currently, only `USER` exceptions are supported, and if you omit the `USER` keyword the exception defaults to a `USER` exception anyway.) Specify the `USER` keyword, even though it currently has no effect, for the following reasons:

- If future broker releases support other types of exception, and the default type changes, your code will not need to be changed.
- It makes it clear that this is a user exception.

SEVERITY is an optional clause that determines the severity associated with the exception. The clause can contain any expression that returns a non-NULL, integer value. If you omit the clause, it defaults to 1.

CATALOG is an optional clause; if you omit it, it defaults to the WebSphere Message Broker current version catalog. To use the current version message catalog explicitly, use BIPv610 on all operating systems.

MESSAGE is an optional clause; if you omit it, it defaults to the first message number of the block of messages provided for using THROW statements in the default catalog (2951). If you enter a message number in the THROW statement, you can use message numbers 2951 to 2999 from the default catalog. Alternatively, you can generate your own catalog by following the instructions in Creating message catalogs.

Use the optional VALUES field to insert data into your message. You can insert any number of pieces of information, but the messages supplied (2951 - 2999) cater for eight inserts only.

Examples

Here are some examples of how you might use a THROW statement:

- ```
THROW USER EXCEPTION;
```
- ```
THROW USER EXCEPTION CATALOG 'BIPv610' MESSAGE  
2951 VALUES(1,2,3,4,5,6,7,8) ;
```
- ```
THROW USER EXCEPTION CATALOG 'BIPv610' MESSAGE
2951 VALUES('The SQL State: ',
SQLSTATE, 'The SQL Code: ', SQLCODE, 'The SQLNATIVEERROR: ', SQLNATIVEERROR,
'The SQL Error Text: ', SQLERRORTXT) ;
```
- ```
THROW USER EXCEPTION CATALOG 'BIPv610' MESSAGE  
2951 ;
```
- ```
THROW USER EXCEPTION CATALOG 'MyCatalog' MESSAGE
2951 VALUES('Hello World') ;
```
- ```
THROW USER EXCEPTION MESSAGE  
2951 VALUES('Insert text 1', 'Insert text 2') ;
```

For more information about how to throw an exception, and details of SQLSTATE, SQLCODE, SQLNATIVEERROR, and SQLERRORTXT, see “ESQL database state functions” on page 1567.

UPDATE statement

The UPDATE statement changes the values of specified columns, in selected rows, in a table in an external database.

Syntax

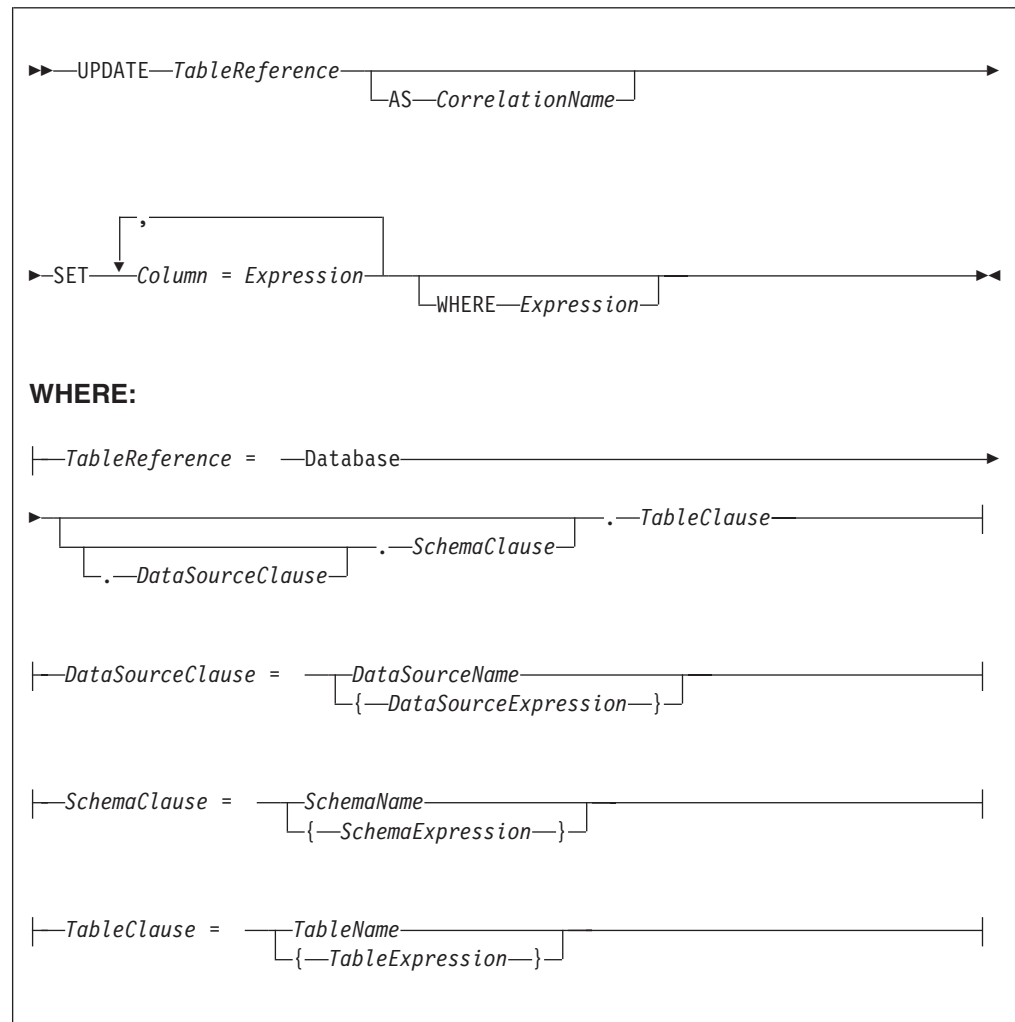

All rows for which the WHERE clause expression evaluates to TRUE are updated in the table identified by *TableReference*. Each row is examined in turn and a variable is set to point to the current row. Typically, the WHERE clause expression uses this variable to access column values and thus cause rows to be updated, or retained unchanged, according to their contents. The variable is referred to by *CorrelationName* or, in the absence of an AS clause, by *TableName*. When a row has been selected for updating, each column named in the SET clause is given a new value as determined by the corresponding expression. These expressions can, if you wish, refer to the current row variable.

Table reference

A table reference is a special case of the field references that are used to refer to message trees. It always starts with the word "Database" and may contain any of the following:

- A table name only
- A schema name and a table name
- A data source name (that is, the name of a database instance), a schema name, and a table name

In each case, the name may be specified directly or by an expression enclosed in braces ({...}). A directly-specified data source, schema, or table name is subject to name substitution. That is, if the name used has been declared to be a known name, the value of the declared name is used rather than the name itself (see “DECLARE statement” on page 1525).

If a schema name is not specified, the default schema for the broker’s database user is used.

If a data source name is not specified, the database pointed to by the node’s data source attribute is used.

The WHERE clause

The WHERE clause expression can use any of the broker’s operators and functions in any combination. It can refer to table columns, message fields, and any declared variables or constants.

However, be aware that the broker treats the WHERE clause expression by examining the expression and deciding whether the whole expression can be evaluated by the database. If it can, it is given to the database. In order to be evaluated by the database, it must use only those functions and operators supported by the database.

The WHERE clause can, however, refer to message fields, correlation names declared by containing SELECT functions, and to any other declared variables or constants within scope.

If the whole expression cannot be evaluated by the database, the broker looks for top-level AND operators and examines each sub-expression separately. It then attempts to give the database those sub-expressions that it can evaluate, leaving the broker to evaluate the rest. You need to be aware of this situation for two reasons:

1. Apparently trivial changes to WHERE clause expressions can have large effects on performance. You can determine how much of the expression was given to the database by examining a user trace.
2. Some databases’ functions exhibit subtle differences of behavior from those of the broker.

Handling errors

It is possible for errors to occur during update operations. For example, the database may not be operational, or the table may have constraints defined that the new values would violate. In these cases, an exception is thrown (unless the node has its `throw exception on database error` property set to `FALSE`). These exceptions set appropriate SQL code, state, native error, and error text values and can be dealt with by error handlers (see the `DECLARE HANDLER` statement).

For further information about handling database errors, see “Capturing database state” on page 339.

Examples

The following example assumes that the `dataSource` property of the Database node has been configured, and that the database it identifies has a table called

STOCKPRICES, with columns called COMPANY and PRICES. It updates the PRICE column of the rows in the STOCKPRICES table whose COMPANY column matches the value given in the Company field in the message.

```
UPDATE Database.StockPrices AS SP
  SET PRICE = InputBody.Message.StockPrice
  WHERE SP.COMPANY = InputBody.Message.Company
```

In the following example (which make similar assumptions), the SET clause expression refers to the existing value of a column and thus decrements the value by an amount in the message:

```
UPDATE Database.INVENTORY AS INV
  SET QUANTITY = INV.QUANTITY - InputBody.Message.QuantitySold
  WHERE INV.ITEMNUMBER = InputBody.Message.ItemNumber
```

The following example updates multiple columns:

```
UPDATE Database.table AS T
  SET column1 = T.column1+1,
      column2 = T.column2+2;
```

Note that the column names (on the left of the "=") are single identifiers. They must not be qualified with a table name or correlation name. In contrast, the references to database columns in the expressions (to the right of the "=") must be qualified with the correlation name.

The next example shows the use of calculated data source, schema, and table names:

```
-- Declare variables to hold the data source, schema and table names
-- and set their default values
DECLARE Source CHARACTER 'Production';
DECLARE Schema CHARACTER 'db2admin';
DECLARE Table CHARACTER 'DynamicTable1';
-- Code which calculates their actual values comes here

-- Update rows in the table
UPDATE Database.{Source}.{Schema}.{Table} AS R SET Value = 0;
```

WHILE statement

The WHILE statement evaluates a condition expression, and if it is TRUE executes a sequence of statements.

Syntax

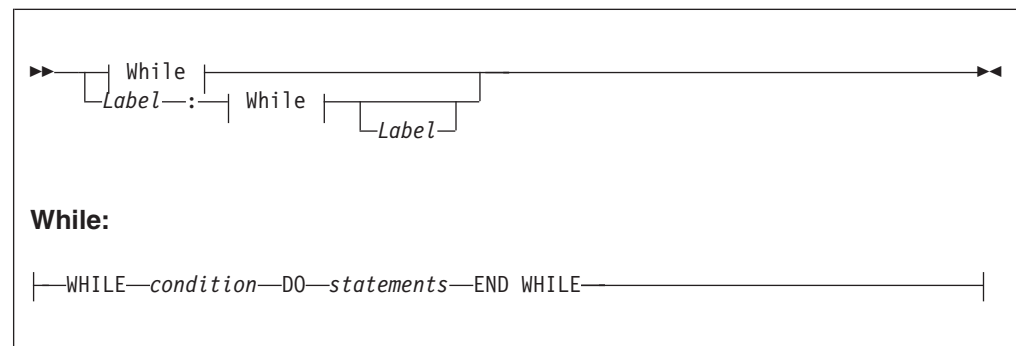

The WHILE statement repeats the steps specified in DO as long as *condition* is TRUE. It is your responsibility to ensure that the logic of the program is such that the loop terminates. If *condition* evaluates to UNKNOWN, the loop terminates immediately.

If present, *Label* gives the statement a name. This has no effect on the behavior of the WHILE statement itself, but allows statements to include ITERATE and LEAVE statements or other labelled statements, which in turn include them. The second *Label* can be present only if the first *Label* is present and if it is, the labels must be identical. It is not an error for two or more labelled statements at the same level to have the same *Label*, but this partly negates the advantage of the second *Label*. The advantage is that it unambiguously and accurately matches each END with its WHILE. However, it is an error for a labelled statement within statements to have the same label, because this makes the behavior of the ITERATE and LEAVE statements ambiguous.

Example

For example:

```
DECLARE i INTEGER;
SET i = 1;
X : WHILE i <= 3 DO
  ...
  SET i = i + 1;
END WHILE X;
```

ESQL functions: reference material, organized by function type

The following table summarizes the functions available in ESQL, and what they do.

CATEGORY	FUNCTIONS	RELATED KEYWORDS
Variable manipulation		
Manipulation of all sources of variables		
Basic manipulation of all types of variable	<ul style="list-style-type: none"> • “CAST function” on page 1618 	<ul style="list-style-type: none"> • ENCODING, CCSID, AS
Selective assignment to any variable	<ul style="list-style-type: none"> • “CASE function” on page 1616 • “COALESCE function” on page 1658 	<ul style="list-style-type: none"> • ELSE, WHEN, THEN, END
Creation of values	<ul style="list-style-type: none"> • “UIDASBLOB function” on page 1662 • “UIDASCHAR function” on page 1662 	-
Manipulation of message trees		
Assignment to and deletion from a message tree	<ul style="list-style-type: none"> • “SELECT function” on page 1632 (used with SET statement) • “ROW constructor function” on page 1639 • “LIST constructor function” on page 1640 	<ul style="list-style-type: none"> • FROM, AS, ITEM, THE, SUM, COUNT, MAX, MIN
Information relating to message trees or subtrees	<ul style="list-style-type: none"> • “ASBITSTREAM function” on page 1603 • “BITSTREAM function (deprecated)” on page 1606 • “FIELDNAME function” on page 1607 • “FIELDNAMESPACE function” on page 1608 • “FIELDTYPE function” on page 1608 	-

Processing Lists	<ul style="list-style-type: none"> • CARDINALITY, see “CARDINALITY function” on page 1613 for details. • EXISTS, see “EXISTS function” on page 1614 for details. • SINGULAR, see “SINGULAR function” on page 1615 for details. • THE, see “THE function” on page 1615 for details. 	
Processing repeating fields	<ul style="list-style-type: none"> • FOR • “SELECT function” on page 1632 	<ul style="list-style-type: none"> • ALL, ANY, SOME • FROM, AS, ITEM, THE, SUM, COUNT, MAX, MIN
Processing based on data type		
String processing		
Numeric information about strings	<ul style="list-style-type: none"> • “LENGTH function” on page 1593 • “POSITION function” on page 1596 	IN
String conversion	<ul style="list-style-type: none"> • “UPPER and UCASE functions” on page 1601 • “LOWER and LCASE functions” on page 1594 	-
String manipulation	<ul style="list-style-type: none"> • “LEFT function” on page 1593 • “LTRIM function” on page 1594 • “OVERLAY function” on page 1595 • “REPLACE function” on page 1597 • “REPLICATE function” on page 1597 • “RIGHT function” on page 1598 • “RTRIM function” on page 1598 • “SPACE function” on page 1599 • “SUBSTRING function” on page 1599 • “TRANSLATE function” on page 1600 • “TRIM function” on page 1600 	<ul style="list-style-type: none"> • LEADING, TRAILING, BOTH, FROM • PLACING, FROM, FOR • FROM FOR
Numeric processing		
Bitwise operations	<ul style="list-style-type: none"> • “BITAND function” on page 1580 • “BITNOT function” on page 1580 • “BITOR function” on page 1581 • “BITXOR function” on page 1581 	-

General	<ul style="list-style-type: none"> • “ABS and ABSVAL functions” on page 1578 • “ACOS function” on page 1579 • “ASIN function” on page 1579 • “ATAN function” on page 1579 • “ATAN2 function” on page 1579 • “COS function” on page 1582 • “COSH function” on page 1583 • “COT function” on page 1583 • “DEGREES function” on page 1583 • “EXP function” on page 1583 • “FLOOR function” on page 1584 • “LN and LOG functions” on page 1584 • “LOG10 function” on page 1585 • “MOD function” on page 1585 • “POWER function” on page 1585 • “RADIANS function” on page 1586 • “RAND function” on page 1586 • “ROUND function” on page 1586 • “SIGN function” on page 1590 • “SIN function” on page 1590 • “SINH function” on page 1590 • “SQRT function” on page 1590 • “TAN function” on page 1591 • “TANH function” on page 1591 • “TRUNCATE function” on page 1592 	-
Date time processing		
	<ul style="list-style-type: none"> • “CURRENT_DATE function” on page 1575 • “CURRENT_GMTDATE function” on page 1576 • “CURRENT_GMTTIME function” on page 1576 • “CURRENT_TIME function” on page 1575 • “CURRENT_TIMESTAMP function” on page 1575 • “CURRENT_GMTTIMESTAMP function” on page 1576 • “LOCAL_TIMEZONE function” on page 1577 • “EXTRACT function” on page 1573 	YEAR, MONTH, DAY, HOUR, MINUTE, SECOND
Boolean evaluation for conditional statements		

Functions that return a Boolean value	<ul style="list-style-type: none"> • BETWEEN, see “ESQL simple comparison operators” on page 1472 for details. • EXISTS, see “EXISTS function” on page 1614 for details. • IN, see “ESQL simple comparison operators” on page 1472 for details. • LIKE, see “ESQL simple comparison operators” on page 1472 for details. • “NULLIF function” on page 1659 • “LASTMOVE function” on page 1612 • “SAMEFIELD function” on page 1613 • SINGULAR, see “SINGULAR function” on page 1615 for details. 	SYMMETRIC, ASYMMETRIC, AND
Broker database interaction		
Actions on tables	<ul style="list-style-type: none"> • “PASSTHRU function” on page 1659 • “SELECT function” on page 1632 	<ul style="list-style-type: none"> • FROM, AS, ITEM, THE, SUM, COUNT, MAX, MIN
Results of actions	<ul style="list-style-type: none"> • “SQLCODE function” on page 1568 • “SQLERRORTTEXT function” on page 1568 • “SQLNATIVEERROR function” on page 1569 • “SQLSTATE function” on page 1569 	-

Calling ESQL functions

Most ESQL functions belong to a schema called SQL and this is particularly useful if you have functions with the same name. For example, if you have created a function called SQRT, you can code:

```
/* call my SQRT function */
SET Variable1=SQRT (4);

/* call the SQL supplied function */
SET Variable2=SQL.SQRT (144);
```

Most of the functions described in this section impose restrictions on the data types of the arguments that can be passed to the function. If the values passed to the functions do not match the required data types, errors are generated at node configuration time whenever possible. Otherwise runtime errors are generated when the function is evaluated.

ESQL database state functions

ESQL provides four functions to return database state. These are:

- “SQLCODE function” on page 1568
- “SQLERRORTTEXT function” on page 1568
- “SQLNATIVEERROR function” on page 1569
- “SQLSTATE function” on page 1569

SQLCODE function

SQLCODE is a database state function that returns an INTEGER data type with a default value of 0 (zero).

Syntax

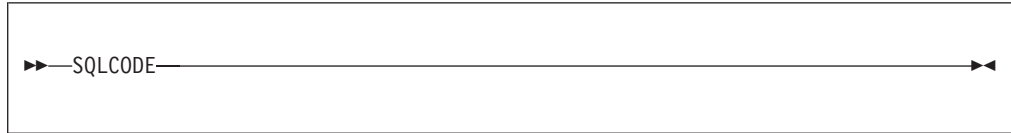

Within a message flow, you can access and update an external database resource using the available ESQL database functions in the Filter, Database, and Compute nodes. When making calls to an external database, you might get errors, such as a table does not exist, a database is not available, or an insert for a key that already exists.

When these errors occur, the default action of the broker is to generate an exception. This behavior is determined by how you have set the property *Throw exception on database error*. If this check box is selected, the broker stops processing the node, propagates the message to the node's failure terminal, and writes the details of the error to the ExceptionList. If you want to override the default behavior and handle a database error in the ESQL in the node, clear the *Throw exception on database error* check box. The broker does not throw an exception and you must include the THROW statement to throw an exception if a certain SQL state code is not expected. See "THROW statement" on page 1559 for a description of THROW.

If you choose to handle database errors in a node, you can use the database state function SQLCODE to receive information about the status of the DBMS call made in ESQL. You can include it in conditional statements in current node's ESQL to recognize and handle possible errors.

SQLERRORTXT function

SQLERRORTXT is a database state function that returns a CHARACTER data type with a default value of "" (empty string).

Syntax

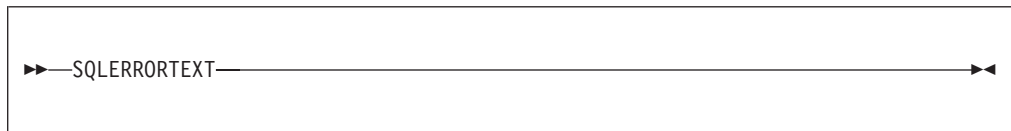

Within a message flow, you can access and update an external database resource using the available ESQL database functions in the Filter, Database, and Compute nodes. When making calls to an external database, you might get errors, such as a table does not exist, a database is not available, or an insert for a key that already exists.

When these errors occur, the default action of the broker is to generate an exception. This behavior is determined by how you have set the property *Throw exception on database error*. If you have selected this check box, the broker stops processing the node, propagates the message to the node's failure terminal, and

writes the details of the error to the ExceptionList. If you want to override the default behavior and handle a database error in the ESQL in the node, clear the *Throw exception on database error* check box. The broker does not throw an exception and you must include the THROW statement to throw an exception if a certain SQL state code is not expected. See “THROW statement” on page 1559 for a description of THROW.

If you choose to handle database errors in a node, you can use the database state function SQLERRORTXT to receive information about the status of the DBMS call made in ESQL. You can include it in conditional statements in current node’s ESQL to recognize and handle possible errors.

SQLNATIVEERROR function

SQLNATIVEERROR is a database state function that returns an INTEGER data type with a default value of 0 (zero).

Syntax

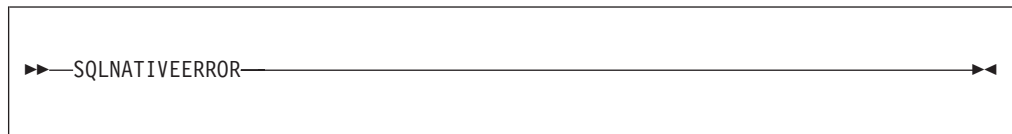

Within a message flow, you can access and update an external database resource using the available ESQL database functions in the Filter, Database, and Compute nodes. When making calls to an external database, you might get errors, such as a table does not exist, a database is not available, or an insert for a key that already exists.

When these errors occur, the default action of the broker is to generate an exception. This behavior is determined by how you have set the property *Throw exception on database error*. If you have selected this check box, the broker stops processing the node, propagates the message to the node’s failure terminal, and writes the details of the error to the ExceptionList. If you want to override the default behavior and handle a database error in the ESQL in the node, clear the *Throw exception on database error* check box. The broker does not throw an exception and you must include the THROW statement to throw an exception if a certain SQL state code is not expected. See “THROW statement” on page 1559 for a description of THROW.

If you choose to handle database errors in a node, you can use the database state function SQLNATIVEERROR to receive information about the status of the DBMS call made in ESQL. You can include it in conditional statements in current node’s ESQL to recognize and handle possible errors.

SQLSTATE function

SQLSTATE is a database state function that returns a 5 character data type of CHARACTER with a default value of ‘00000’ (five zeros as a string).

Syntax



Within a message flow, you can access and update an external database resource using the available ESQL database functions in the Compute, Database, and Filter nodes. When making calls to an external database, you might get errors, such as a table does not exist, a database is not available, or an insert for a key that already exists.

When these errors occur, the default action of the broker is to generate an exception. This behavior is determined by how you have set the property Throw exception on database error. If you select this property, the broker stops processing the node, propagates the message to the node's failure terminal, and writes the details of the error to the ExceptionList. If you want to override the default behavior and handle a database error in the ESQL in the node, clear Throw exception on database error. The broker does not throw an exception and you must include the THROW statement to throw an exception if a certain SQL state code is not expected. See "THROW statement" on page 1559 for a description of THROW.

If you choose to handle database errors in a node, you can use the database state function SQLSTATE to receive information about the status of the DBMS call made in ESQL. You can include it in conditional statements in current node's ESQL to recognize and handle possible errors.

SQL states

In ESQL, SQL states are variable length character strings. By convention, they are six characters long and contain only the characters 0-9, A-Z. The significance of the six characters is:

Char 1

The origin of the exception

Chars 2 - 3

The class of the exception

Chars 4 - 6

The subclass of the exception

The SQL state of an exception is determined by a two stage process. In the **first stage**, the exception information is examined and any wrapping exceptions (that is, information that says what the broker was doing at the time the exception occurred) is stepped over until the exception that describes the original error is located.

The **second stage** is as follows:

1. If the selected exception is a database exception, the SQL state is that supplied by the database, but prefixed by the letter "D" to avoid any confusion with exceptions arising in the broker. The SQL code, native error, and error text are those supplied by the database.
2. If the selected exception is a user exception (that is, it originated in a THROW statement), the SQL code, state, native error, and error text are taken from the first four inserts of the exception, in order. The resulting state value is taken as is (not prefixed by a letter such as "U"). The letter "U" is not used by the

broker as an origin indicator. If you want to define a unique SQL state rather than to imitate an existing one, use SQL states starting with the letter "U". If you use SQL states that start with the letter "U", you can write an error handler to match all user-defined and thrown exceptions with a LIKE 'U%' operator.

3. If the selected exception originated in the message transport or in the ESQL implementation itself, the SQL code, state, native error, and error text are as described in the list below.
4. For all other exceptions, the SQL state is "", indicating no origin, no class, and no subclass.

Some exceptions that currently give an empty SQL state might give individual states in future releases. If you want to catch unclassified exceptions, use the "all" wildcard ("%") for the SQL state on the last handler of a scope. This wildcard will continue to catch the same set of exceptions if previously unclassified exceptions are given new unique SQL states.

The following SQL states are defined:

Ddddd

dddd is the state returned by the database.

SqlState = 'S22003'

Arithmetic overflow. An operation whose result is a numeric type resulted in a value beyond the range supported.

SqlState = 'S22004'

Null value not allowed. A null value was present in a place where null values are not allowed.

SqlState = 'S22007'

Invalid date time format. A character string used in a cast from character to a datetime type had either the wrong basic format (for example, '01947-10-24') or had values outside the ranges allowed by the Gregorian calendar (for example, '1947-21-24').

SqlState = 'S22008'

Date time field overflow. An operation whose result is a datetime type resulted in a value beyond the range supported.

SqlState = 'S22011'

SUBSTRING error. The FROM and FOR parameters, in conjunction with the length of the first operand, violate the rules of the SUBSTRING function.

SqlState = 'S22012'

Divide by zero. A divide operation whose result data type has no concept of infinity had a zero right operand.

SqlState = 'S22015'

Interval field overflow. An operation whose result is of type INTERVAL resulted in a value beyond the range supported by the INTERVAL data type.

SqlState = 'S22018'

Invalid character value for cast.

SqlState = 'SPS001'

Invalid target terminal. A PROPAGATE to terminal statement attempted to use an invalid terminal name.

SqlState = 'SPS002'

Invalid target label. A PROPAGATE to label statement attempted to use an invalid label.

SqlState = 'MQW001', SqlNativeError = 0

The bit stream does not meet the requirements for WebSphere MQ messages. No attempt was made to put it to a queue. Retrying and queue administration does not resolve this problem.

SqlState = 'MQW002', SqlNativeError = 0

The target queue or queue manager names were not valid (that is, they could not be converted from Unicode to the queue manager's code page). Retrying and queue emptying does not resolve this problem.

SqlState = 'MQW003', SqlNativeError = 0

Request mode was specified but the "reply to" queue or queue manager names were not valid (that is, could not be converted from Unicode to the message's code page). Retrying and queue emptying does not resolve this problem.

SqlState = 'MQW004', SqlNativeError = 0

Reply mode was specified but the queue or queue manager names taken from the message were not valid (that is, they could not be converted from the given code page to Unicode). Retrying and queue emptying does not resolve this problem.

SqlState = 'MQW005', SqlNativeError = 0

Destination list mode was specified but the destination list supplied does not meet the basic requirements for destination lists. No attempt was made to put any message to a queue. Retrying and queue administration does not resolve this problem.

SqlState = 'MQW101', SqlNativeError = returned by WebSphere MQ

The target queue manager or queue could not be opened. Queue administration might resolve this problem but retrying does not.

SqlState = 'MQW102', SqlNativeError = returned by WebSphere MQ

The target queue manager or queue could not be written to. Retrying and queue administration might resolve this problem.

SqlState = 'MQW201', SqlNativeError = number of destinations with an error

More than one error occurred while processing a destination list. The message might have been put to zero or more queues. Retrying and queue administration might resolve this problem.

Anything that the user has used in a THROW statement

Use Uuuuuuu for user exceptions, unless imitating one of the exceptions defined above.

Empty string

All other errors.

ESQL datetime functions

This topic lists the ESQL datetime functions.

In addition to the functions described here, you can use arithmetic operators to perform various calculations on datetime values. For example, you can use the - (minus) operator to calculate the difference between two dates as an interval, or you can add an interval to a timestamp.

This section covers the following topics:

“EXTRACT function”

“CURRENT_DATE function” on page 1575

“CURRENT_TIME function” on page 1575

“CURRENT_TIMESTAMP function” on page 1575

“CURRENT_GMTDATE function” on page 1576

“CURRENT_GMTTIME function” on page 1576

“CURRENT_GMTTIMESTAMP function” on page 1576

“LOCAL_TIMEZONE function” on page 1577

EXTRACT function

The EXTRACT function extracts fields (or calculates values) from datetime values and intervals.

The result is INTEGER for YEAR, MONTH, DAY, HOUR, MINUTE, DAYS, DAYOFYEAR, DAYOFWEEK, MONTHS, QUARTEROFYEAR, QUARTERS, WEEKS, WEEKOFYEAR, and WEEKOFMONTH extracts, but FLOAT for SECOND extracts, and BOOLEAN for ISLEAPYEAR extracts. If the *SourceDate* is NULL, the result is NULL regardless of the type of extract.

Syntax

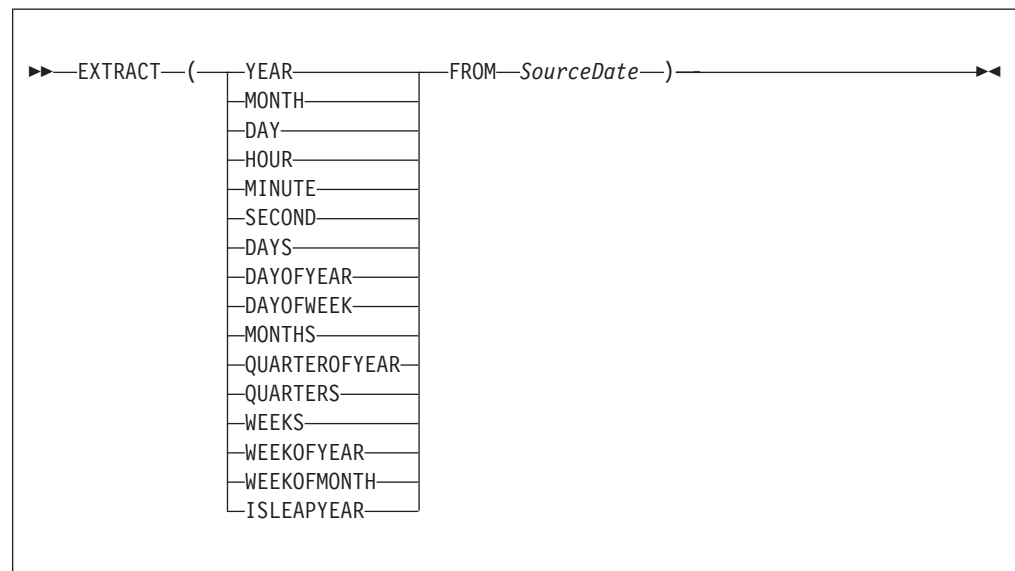

EXTRACT extracts individual fields from datetime values and intervals. You can extract a field only if it is present in the datetime value specified in the second parameter. Either a parse-time or a runtime error is generated if the requested field does not exist within the data type.

The following table describes the extracts that are supported:

Note: All new integer values start from 1.

Table 273.

Extract	Description
YEAR	Year
MONTH	Month
DAY	Day
HOUR	Hour
MINUTE	Minute
SECOND	Second
DAYS	Days encountered between 1st January 0001 and the <i>SourceDate</i> .
DAYOFYEAR	Day of year
DAYOFWEEK	Day of the week: Sunday = 1, Monday = 2, Tuesday = 3, Wednesday = 4, Thursday = 5, Friday = 6, Saturday = 7.
MONTHS	Months encountered between 1st January 0001 and the <i>SourceDate</i> .
QUARTEROFYEAR	Quarter of year: January to March = 1, April to June = 2, July to September = 3, October to December = 4.
QUARTERS	Quarters encountered between 1st January 0001 and the <i>SourceDate</i> .
WEEKS	Weeks encountered between 1st January 0001 and the <i>SourceDate</i> .
WEEKOFYEAR	Week of year
WEEKOFMONTH	Week of month
ISLEAPYEAR	Whether this is a leap year

Notes:

1. A week is defined as Sunday to Saturday, not any seven consecutive days. You must convert to an alternative representation scheme if required.
2. The source date time epoch is 1 January 0001. Dates before the epoch are not valid for this function.
3. The Gregorian calendar is assumed for calculation.

Example

```
EXTRACT(YEAR FROM CURRENT_DATE)
```

and

```
EXTRACT(HOUR FROM LOCAL_TIMEZONE)
```

both work without error, but

```
EXTRACT(DAY FROM CURRENT_TIME)
```

fails.

```
EXTRACT (DAYS FROM DATE '2000-02-29')
```

calculates the number of days encountered since year 1 to '2000-02-29' and
EXTRACT (DAYOFYEAR FROM CURRENT_DATE)

calculates the number of days encountered since the beginning of the current year
but

EXTRACT (DAYOFYEAR FROM CURRENT_TIME)

fails because CURRENT_TIME does not contain date information.

CURRENT_DATE function

The CURRENT_DATE datetime function returns the current date.

Syntax

```
▶▶—CURRENT_DATE—————▶▶
```

CURRENT_DATE returns a DATE value representing the current date in local time. As with all SQL functions that take no parameters, no parentheses are required or accepted. All calls to CURRENT_DATE within the processing of one node are guaranteed to return the same value.

CURRENT_TIME function

The CURRENT_TIME datetime function returns the current local time.

Syntax

```
▶▶—CURRENT_TIME—————▶▶
```

CURRENT_TIME returns a TIME value representing the current local time. As with all SQL functions that take no parameters, no parentheses are required or accepted. All calls to CURRENT_TIME within the processing of one node are guaranteed to return the same value.

CURRENT_TIMESTAMP function

The CURRENT_TIMESTAMP datetime function returns the current date and local time.

Syntax

```
▶▶—CURRENT_TIMESTAMP—————▶▶
```

CURRENT_TIMESTAMP returns a TIMESTAMP value representing the current date and local time. As with all SQL functions that take no parameters, no parentheses are required or accepted. All calls to CURRENT_TIMESTAMP within the processing of one node are guaranteed to return the same value.

Example

To obtain the following XML output message:

```
<Body>
<Message>Hello World</Message>
<DateStamp>2006-02-01 13:13:56.444730</DateStamp>
</Body>
```

use the following ESQL:

```
SET OutputRoot.XMLNS.Body.Message = 'Hello World';
SET OutputRoot.XMLNS.Body.DateStamp = CURRENT_TIMESTAMP;
```

CURRENT_GMTDATE function

The CURRENT_GMTDATE datetime function returns the current date in the GMT time zone.

Syntax

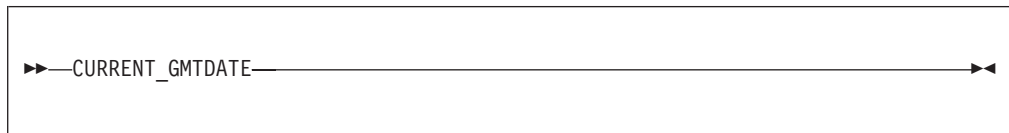

CURRENT_GMTDATE returns a DATE value representing the current date in the GMT time zone. As with all SQL functions that take no parameters, no parentheses are required or accepted. All calls to CURRENT_GMTDATE within the processing of one node are guaranteed to return the same value.

CURRENT_GMTTIME function

The CURRENT_GMTTIME datetime function returns the current time in the GMT time zone.

Syntax

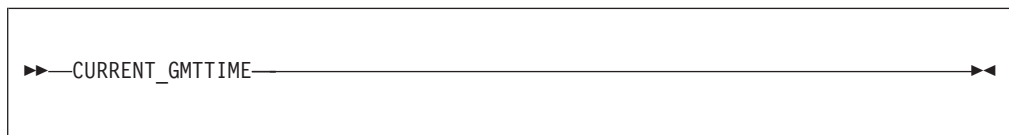

It returns a GMTTIME value representing the current time in the GMT time zone. As with all SQL functions that take no parameters, no parentheses are required or accepted. All calls to CURRENT_GMTTIME within the processing of one node are guaranteed to return the same value.

CURRENT_GMTTIMESTAMP function

The CURRENT_GMTTIMESTAMP datetime function returns the current date and time in the GMT time zone.

Syntax



►►—CURRENT_GMTTIMESTAMP—◄◄

CURRENT_GMTTIMESTAMP returns a GMTTIMESTAMP value representing the current date and time in the GMT time zone. As with all SQL functions that take no parameters, no parentheses are required or accepted. All calls to CURRENT_GMTTIMESTAMP within the processing of one node are guaranteed to return the same value.

LOCAL_TIMEZONE function

The LOCAL_TIMEZONE datetime function returns the displacement of the local time zone from GMT.

Syntax



►►—LOCAL_TIMEZONE—◄◄

LOCAL_TIMEZONE returns an interval value representing the local time zone displacement from GMT. As with all SQL functions that take no parameters, no parentheses are required or accepted. The value returned is an interval in hours and minutes representing the displacement of the current time zone from Greenwich Mean Time. The sign of the interval is such that a local time can be converted to a time in GMT by subtracting the result of the LOCAL_TIMEZONE function.

ESQL numeric functions

This topic lists the ESQL numeric functions and covers the following:

“ABS and ABSVAL functions” on page 1578

“ACOS function” on page 1579

“ASIN function” on page 1579

“ATAN function” on page 1579

“ATAN2 function” on page 1579

“BITAND function” on page 1580

“BITNOT function” on page 1580

“BITOR function” on page 1581

“BITXOR function” on page 1581

“CEIL and CEILING functions” on page 1582

“COS function” on page 1582

“COSH function” on page 1583

- "COT function" on page 1583
- "DEGREES function" on page 1583
- "EXP function" on page 1583
- "FLOOR function" on page 1584
- "LN and LOG functions" on page 1584
- "LOG10 function" on page 1585
- "MOD function" on page 1585
- "POWER function" on page 1585
- "RADIANS function" on page 1586
- "RAND function" on page 1586
- "ROUND function" on page 1586
- "SIGN function" on page 1590
- "SIN function" on page 1590
- "SINH function" on page 1590
- "SQRT function" on page 1590
- "TAN function" on page 1591
- "TANH function" on page 1591
- "TRUNCATE function" on page 1592

ABS and ABSVAL functions

The ABS and ABSVAL numeric functions return the absolute value of a supplied number.

Syntax

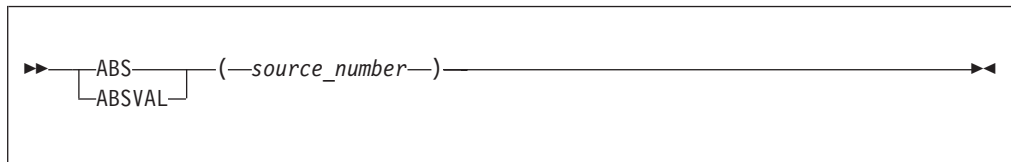

The absolute value of the source number is a number with the same magnitude as the source but without a sign. The parameter must be a numeric value. The result is of the same type as the parameter unless it is NULL, in which case the result is NULL.

For example:

```
ABS( -3.7 )
```

returns 3.7

```
ABS( 3.7 )
```

returns 3.7

```
ABS( 1024 )
```

returns 1024

ACOS function

The ACOS numeric function returns the angle of a given cosine.

Syntax



```
>> ACOS (NumericExpression) <<<
```

The ACOS function returns the angle, in radians, whose cosine is the given *NumericExpression*. The parameter can be any built-in numeric data type. The result is FLOAT unless the parameter is NULL, in which case the result is NULL.

ASIN function

The ASIN numeric function returns the angle of the given sine.

Syntax



```
>> ASIN (NumericExpression) <<<
```

The ASIN function returns the angle, in radians, whose sine is the given *NumericExpression*. The parameter can be any built-in numeric data type. The result is FLOAT unless the parameter is NULL, in which case the result is NULL.

ATAN function

The ATAN numeric function returns the angle of the given tangent.

Syntax



```
>> ATAN (NumericExpression) <<<
```

The ATAN function returns the angle, in radians, whose tangent is the given *NumericExpression*. The parameter can be any built-in numeric data type. The result is FLOAT unless the parameter is NULL, in which case the result is NULL.

ATAN2 function

The ATAN2 numeric function returns the angle subtended in a right angled triangle between an opposite and the base.

Syntax

▶▶ ATAN2 (*OppositeNumericExpression* , *BaseNumericExpression*) ▶▶

The ATAN2 function returns the angle, in radians, subtended (in a right angled triangle) by an opposite given by *OppositeNumericExpression* and the base given by *BaseNumericExpression*. The parameters can be any built-in numeric data type. The result is FLOAT unless either parameter is NULL, in which case the result is NULL

BITAND function

The BITAND numeric function performs a bitwise AND on the binary representation of two or more numbers.

Syntax

▶▶ BITAND (*source_integer* , *source_integer*) ▶▶

BITAND takes two or more integer values and returns the result of performing the bitwise AND on the binary representation of the numbers. The result is INTEGER unless either parameter is NULL, in which case the result is NULL.

For example:

BITAND(12, 7)

returns 4 as shown by this worked example:

	Binary	Decimal
	1100	12
AND	0111	7

	0100	4

BITNOT function

The BITNOT numeric function performs a bitwise complement on the binary representation of a number.

Syntax

▶▶ BITNOT (*source_integer*) ▶▶

BITNOT takes an integer value and returns the result of performing the bitwise complement on the binary representation of the number. The result is INTEGER unless either parameter is NULL, in which case the result is NULL.

For example:

```
BITNOT(7)
```

returns -8, as shown by this worked example:

	Binary	Decimal
	00...0111	7
NOT		
	<u>11...1000</u>	-8

BITOR function

The BITOR numeric function performs a bitwise OR on the binary representation of two or more numbers.

Syntax

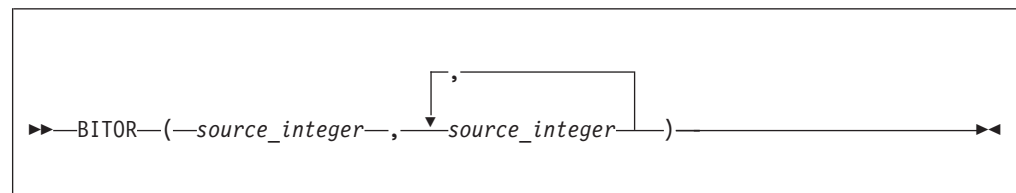

BITOR takes two or more integer values and returns the result of performing the bitwise OR on the binary representation of the numbers. The result is INTEGER unless either parameter is NULL, in which case the result is NULL.

For example:

```
BITOR(12, 7)
```

returns 15, as shown by this worked example:

	Binary	Decimal
	1100	12
OR	0111	7
	<u>1111</u>	15

BITXOR function

The BITXOR numeric function performs a bitwise XOR on the binary representation of two or more numbers.

Syntax

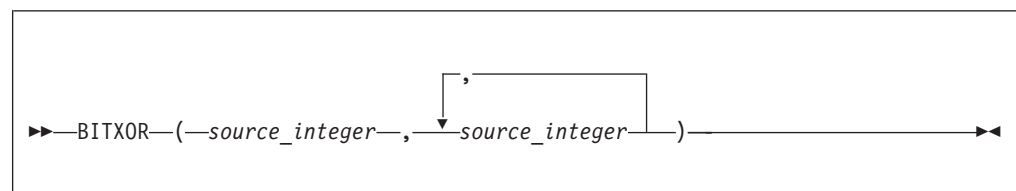

BITXOR takes two or more integer values and returns the result of performing the bitwise XOR on the binary representation of the numbers. The result is INTEGER unless either parameter is NULL, in which case the result is NULL.

For example:

```
BITXOR(12, 7)
```

returns 11, as shown by this worked example:

	Binary	Decimal
	1100	12
XOR	0111	7
<hr/>		
	1011	11

CEIL and CEILING functions

The CEIL and CEILING numeric functions return the smallest integer equivalent of a decimal number.

Syntax

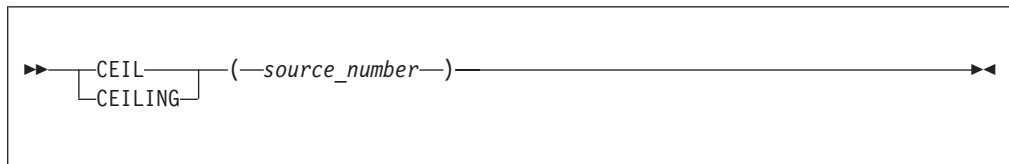

CEIL and CEILING return the smallest integer value greater than or equal to source_number. The parameter can be any numeric data type. The result is of the same type as the parameter unless it is NULL, in which case the result is NULL.

For example:

```
CEIL(1)
```

returns 1

```
CEIL(1.2)
```

returns 2.0

```
CEIL(-1.2)
```

returns -1.0

If possible, the scale is changed to zero. If the result cannot be represented at that scale, it is made sufficiently large to represent the number.

COS function

The COS numeric function returns the cosine of a given angle.

Syntax

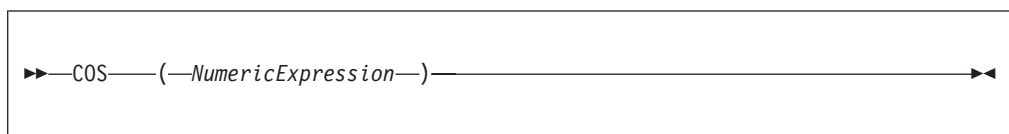

The COS function returns the cosine of the angle, in radians, given by *NumericExpression*. The parameter can be any built-in numeric data type. The result is FLOAT unless the parameter is NULL, in which case the result is NULL.

COSH function

The COSH numeric function returns the hyperbolic cosine of a given angle.

Syntax

```
►► COSH ( NumericExpression ) ◀◀
```

The COSH function returns the hyperbolic cosine of the angle, in radians, given by *NumericExpression*. The parameter can be any built-in numeric data type. The result is FLOAT unless the parameter is NULL, in which case the result is NULL.

COT function

The COT numeric function returns the cotangent of a given angle.

Syntax

```
►► COT ( NumericExpression ) ◀◀
```

The COT function returns the cotangent of the angle, in radians, given by *NumericExpression*. The parameter can be any built-in numeric data type. The result is FLOAT unless the parameter is NULL, in which case the result is NULL.

DEGREES function

The DEGREES numeric function returns the angle of the radians supplied.

Syntax

```
►► DEGREES ( NumericExpression ) ◀◀
```

The DEGREES function returns the angle, in degrees, specified by *NumericExpression* in radians. The parameter can be any built-in numeric data type. The result is FLOAT unless the parameter is NULL, in which case the result is NULL.

EXP function

The EXP numeric function returns the exponential value of a given number.

Syntax



The EXP function returns the exponential of the value specified by *NumericExpression*. The parameter can be any built-in numeric data type. The result is FLOAT unless the parameter is NULL, in which case the result is NULL.

FLOOR function

The FLOOR numeric function returns the largest integer equivalent to a given decimal number.

Syntax

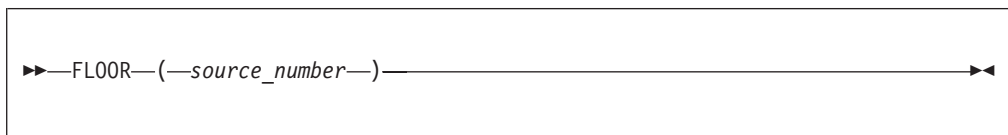

FLOOR returns the largest integer value less than or equal to *source_number*. The parameter can be any numeric data type. The result is of the same type as the parameter unless it is NULL, in which case the result is NULL.

For example:

FLOOR(1)

returns 1

FLOOR(1.2)

returns 1.0

FLOOR(-1.2)

returns -2.0

If possible, the scale is changed to zero. If the result cannot be represented at that scale, it is made sufficiently large to represent the number.

LN and LOG functions

The LN and LOG equivalent numeric functions return the natural logarithm of a given value.

Syntax

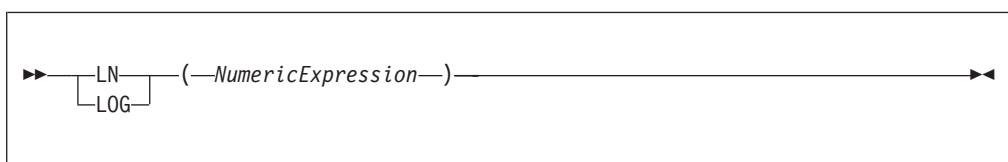

The LN and LOG functions return the natural logarithm of the value specified by *NumericExpression*. The parameter can be any built-in numeric data type. The result is FLOAT unless the parameter is NULL, in which case the result is NULL.

LOG10 function

The LOG10 numeric function returns the logarithm to base 10 of a given value.

Syntax

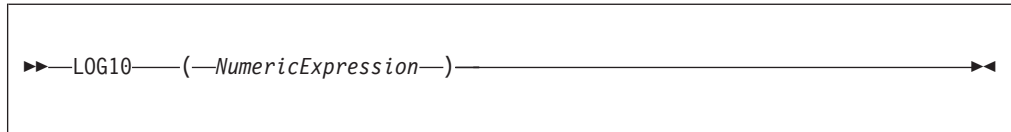

The LOG10 function returns the logarithm to base 10 of the value specified by *NumericExpression*. The parameter can be any built-in numeric data type. The result is FLOAT unless the parameter is NULL, in which case the result is NULL.

MOD function

The MOD numeric function returns the remainder when dividing two numbers.

Syntax

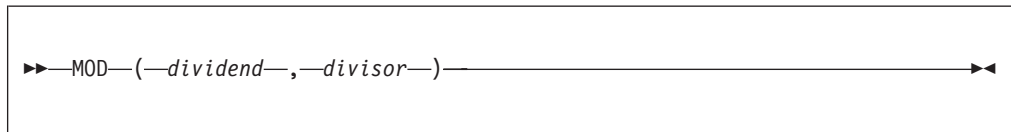

MOD returns the remainder when the first parameter is divided by the second parameter. The result is negative only if the first parameter is negative. Parameters must be integers. The function returns an integer. If any parameter is NULL, the result is NULL.

For example:

```
MOD(7, 3)
```

returns 1

```
MOD(-7, 3)
```

returns -1

```
MOD(7, -3)
```

returns 1

```
MOD(6, 3)
```

returns 0

POWER function

The POWER numeric function raises a value to the power supplied.

Syntax

```
▶▶ POWER ( ValueNumericExpression , PowerNumericExpression ) ▶▶
```

POWER returns the given value raised to the given power. The parameters can be any built-in numeric data type. The result is FLOAT unless any parameter is NULL, in which case the result is NULL

An exception occurs, if the value is either:

- Zero and the power is negative, or
- Negative and the power is not an integer

RADIANS function

The RADIANS numeric function returns a given radians angle in degrees.

Syntax

```
▶▶ RADIANS ( NumericExpression ) ▶▶
```

The RADIANS function returns the angle, in radians, specified by *NumericExpression* in degrees. The parameter can be any built-in numeric data type. The result is FLOAT unless the parameter is NULL, in which case the result is NULL.

RAND function

The RAND numeric function returns a pseudo random number.

Syntax

```
▶▶ RAND ( IntegerExpression ) ▶▶
```

The RAND function returns a pseudo random number in the range 0.0 to 1.0. If supplied, the parameter initializes the pseudo random sequence.

The parameter can be of any numeric data type, but any fractional part is ignored. The result is FLOAT unless the parameter is NULL, in which case the result is NULL.

ROUND function

The ROUND numeric function rounds a supplied value to a given number of places.

Syntax

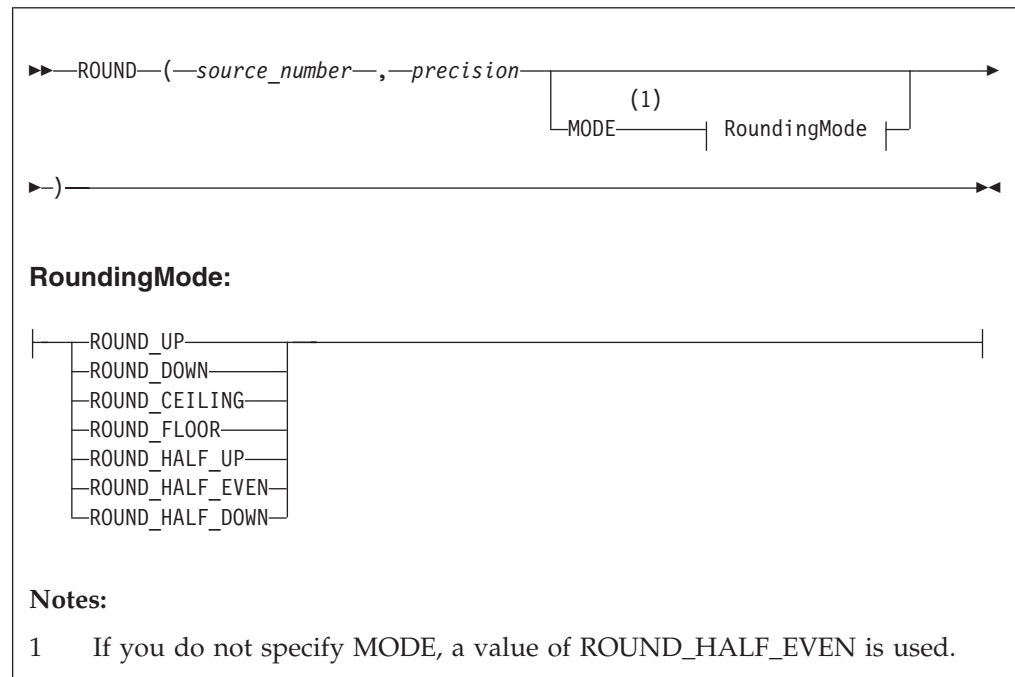

If *precision* is a positive number, *source_number* is rounded to *precision* places right of the decimal point. If *precision* is negative, the result is *source_number* rounded to the absolute value of *precision* places to the left of the decimal point.

source_number can be any built-in numeric data type; *precision* must be an integer. The result is of the same data type as the *source_number* parameter unless *source_number* is NULL, in which case the result is NULL.

This means that the result of the function is:

- INTEGER if *source_number* is INTEGER
- FLOAT if *source_number* is FLOAT
- DECIMAL if *source_number* is DECIMAL

When rounding, the *banker's* or *half-even symmetric* rounding rules are used by default, unless a *RoundingMode* is specified.

RoundingMode

RoundingMode can take one of the following values:

ROUND_UP

Round away from zero. Always increments the digit prior to a nonzero discarded fraction. This rounding mode never decreases the magnitude of the calculated value.

ROUND_DOWN

Round towards zero. Never increments the digit prior to a discarded fraction, that is, truncates. This rounding mode never increases the magnitude of the calculated value.

ROUND_CEILING

Round towards positive infinity. If the decimal is positive, behaves as for

ROUND_UP; if negative, behaves as for ROUND_DOWN. This rounding mode never decreases the calculated value.

ROUND_FLOOR

Round towards negative infinity. If the decimal is positive, behaves as for ROUND_DOWN; if negative, behaves as for ROUND_UP. This rounding mode never increases the calculated value.

ROUND_HALF_UP

Round towards "nearest neighbor" unless both neighbors are equidistant, in which case round up. Behaves as for ROUND_UP if the discarded fraction is greater than, or equal to, 0.5; otherwise, behaves as for ROUND_DOWN. This is the rounding mode that is typically taught in schools.

ROUND_HALF_DOWN

Round towards "nearest neighbor" unless both neighbors are equidistant, in which case round down. Behaves as for ROUND_UP if the discarded fraction is greater than 0.5; otherwise, behaves as for ROUND_DOWN.

ROUND_HALF_EVEN

Round towards the "nearest neighbor" unless both neighbors are equidistant, in which case, round towards the even neighbor. Behaves as for ROUND_HALF_UP if the digit to the left of the discarded fraction is odd; behaves as for ROUND_HALF_DOWN if it is even. This is the rounding mode that minimizes cumulative error when applied repeatedly over a sequence of calculations, and is sometimes referred to as Banker's rounding.

The following table gives a summary of rounding operations, with a precision of zero, under different rounding modes.

Input number	ROUND UP	ROUND DOWN	ROUND CEILING	ROUND FLOOR	ROUND HALF UP	ROUND HALF DOWN	ROUND HALF EVEN
5.5	6	5	6	5	6	5	6
2.5	3	2	3	2	3	2	2
1.6	2	1	2	1	2	2	2
1.1	2	1	2	1	1	1	1
1.0	1	1	1	1	1	1	1
-1.0	-1	-1	-1	-1	-1	-1	-1
-1.1	-2	-1	-1	-2	-1	-1	-1
-1.6	-2	-1	-1	-2	-2	-2	-2
-2.5	-3	-2	-2	-3	-3	-2	-2
-5.5	-6	-5	-5	-6	-6	-5	-6

Examples using the default rounding mode (ROUND_HALF_EVEN):

ROUND(27.75, 2)

returns 27.75

ROUND(27.75, 1)

returns 27.8

ROUND(27.75, 0)

returns 28
ROUND(27.75, -1)

returns 30

Examples using a rounding mode with a precision of zero:

ROUND(5.5, 0 MODE ROUND_UP);

returns 6

ROUND(5.5, 0 MODE ROUND_DOWN);

returns 5

ROUND(5.5, 0 MODE ROUND_CEILING);

returns 6

ROUND(5.5, 0 MODE ROUND_FLOOR);

returns 5

ROUND(5.5, 0 MODE ROUND_HALF_UP);

returns 6

ROUND(5.5, 0 MODE ROUND_HALF_DOWN);

returns 5

ROUND(5.5, 0 MODE ROUND_HALF_EVEN);

returns 6

ROUND(2.5, 0 MODE ROUND_UP);

returns 3

ROUND(2.5, 0 MODE ROUND_DOWN);

returns 2

ROUND(2.5, 0 MODE ROUND_CEILING);

returns 3

ROUND(2.5, 0 MODE ROUND_FLOOR);

returns 2

ROUND(2.5, 0 MODE ROUND_HALF_UP);

returns 3

ROUND(2.5, 0 MODE ROUND_HALF_DOWN);

returns 2

ROUND(2.5, 0 MODE ROUND_HALF_EVEN);

returns 3

If possible, the scale is changed to the given value. If the result cannot be represented within the given scale, it is INFINITY.

SIGN function

The SIGN numeric function tells you whether a given number is positive, negative, or zero.

Syntax

```
►►SIGN(—NumericExpression—)◄◄
```

The SIGN function returns -1, 0, or +1 when the *NumericExpression* value is negative, zero, or positive respectively. The parameter can be any built-in numeric data type and the result is of the same type as the parameter. If the parameter is NULL, the result is NULL.

SIN function

The SIN numeric function returns the sine of a given angle.

Syntax

```
►►SIN(—NumericExpression—)◄◄
```

The SIN function returns the sine of the angle, in radians, given by *NumericExpression*. The parameter can be any built-in numeric data type. The result is FLOAT unless the parameter is NULL, in which case the result is NULL.

SINH function

The SINH numeric function returns the hyperbolic sine of a given angle.

Syntax

```
►►SINH(—NumericExpression—)◄◄
```

The SINH function returns the hyperbolic sine of the angle, in radians, given by *NumericExpression*. The parameter can be any built-in numeric data type. The result is FLOAT unless the parameter is NULL, in which case the result is NULL.

SQRT function

The SQRT numeric function returns the square root of a given number.

Syntax

```
▶▶ Sqrt (—source_number—) ◀◀
```

Sqrt returns the square root of *source_number*. The parameter can be any built-in numeric data type. The result is a FLOAT. If the parameter is NULL, the result is NULL.

For example:

```
Sqrt(4)
```

returns 2E+1

```
Sqrt(2)
```

returns 1.414213562373095E+0

```
Sqrt(-1)
```

throws an exception.

TAN function

The TAN numeric function returns the tangent of a given angle.

Syntax

```
▶▶ Tan (—NumericExpression—) ◀◀
```

The TAN function returns the tangent of the angle, in radians, given by *NumericExpression*. The parameter can be any built-in numeric data type. The result is FLOAT unless the parameter is NULL, in which case the result is NULL.

TANH function

The TANH numeric function returns the hyperbolic tangent of an angle.

Syntax

```
▶▶ Tanh (—NumericExpression—) ◀◀
```

The TANH function returns the hyperbolic tangent of the angle, in radians, given by *NumericExpression*. The parameter can be any built-in numeric data type. The result is FLOAT unless the parameter is NULL, in which case the result is NULL.

TRUNCATE function

The TRUNCATE numeric function truncates a supplied decimal number a specified number of places.

Syntax

```
▶▶—TRUNCATE—(—source_number—,—precision—)————▶▶
```

If *precision* is positive, the result of the TRUNCATE function is *source_number* truncated to *precision* places right of the decimal point. If *precision* is negative, the result is *source_number* truncated to the absolute value of *precision* places to the left of the decimal point.

source_number can be any built-in numeric data type. *precision* must evaluate to an INTEGER. The result is of the same data type as *source_number*. If any parameter is NULL, the result is NULL.

For example:

```
TRUNCATE(27.75, 2)
```

returns 27.75

```
TRUNCATE(27.75, 1)
```

returns 27.7

```
TRUNCATE(27.75, 0)
```

returns 27.0

```
TRUNCATE(27.75, -1)
```

returns 20.0

If possible, the scale is changed to the given value. If the result cannot be represented within the given scale, it is INF.

ESQL string manipulation functions

This topic lists the ESQL string manipulation functions.

Most of the following functions manipulate all string data types (BIT, BLOB, and CHARACTER). Exceptions to this are UPPER, LOWER, LCASE, UCASE, and SPACE, which operate only on character strings.

In these descriptions, the term *singleton* refers to a single part (BIT, BLOB, or CHARACTER) within a string of that type.

In addition to the functions described here, you can use the logical OR operator to perform various calculations on ESQL string manipulation values.

To concatenate two strings, use the “ESQL string operator” on page 1478.

This section covers the following topics:

“LEFT function”

“LENGTH function”

“LOWER and LCASE functions” on page 1594

“LTRIM function” on page 1594

“OVERLAY function” on page 1595

“POSITION function” on page 1596

“REPLACE function” on page 1597

“REPLICATE function” on page 1597

“RIGHT function” on page 1598

“RTRIM function” on page 1598

“SPACE function” on page 1599

“SUBSTRING function” on page 1599

“TRANSLATE function” on page 1600

“TRIM function” on page 1600

“UPPER and UCASE functions” on page 1601

LEFT function

LEFT is a string manipulation function that returns a string consisting of the source string truncated to the length given by the length expression.

Syntax

```
▶▶—LEFT—(—source_string—,—LengthIntegerExpression—)————▶▶
```

The source string can be of the CHARACTER, BLOB or BIT data type and the length must be of type INTEGER. The truncation discards the final characters of the *source_string*.

The result is of the same type as the source string. If the length is negative or zero, a zero length string is returned. If either parameter is NULL, the result is NULL.

LENGTH function

The LENGTH function is used for string manipulation on all string data types (BIT, BLOB, and CHARACTER) and returns an integer value giving the number of singletons in *source_string*.

Syntax



If the *source_string* is NULL, the result is the NULL value. The term *singleton* refers to a single part (BIT, BYTE, or CHARACTER) within a string of that type.

For example:

```
LENGTH('Hello World!');
```

returns 12.

```
LENGTH('');
```

returns 0.

LOWER and LCASE functions

The LOWER and LCASE functions are equivalent, and manipulate CHARACTER string data; they both return a new character string, which is identical to *source_string*, except that all uppercase letters are replaced with the corresponding lowercase letters.

Syntax



For example:

```
LOWER('Mr Smith')
```

returns 'mr smith'.

```
LOWER('22 Railway Cuttings')
```

returns '22 railway cuttings'.

```
LCASE('ABCD')
```

returns 'abcd'.

LTRIM function

LTRIM is a string manipulation function, used for manipulating all data types (BIT, BLOB, and CHARACTER), that returns a character string value of the same data type and content as *source_string*, but with any leading default singletons removed.

Syntax

```
▶▶LTRIM(—source_string—)▶▶
```

The term *singleton* is used to refer to a single part (BIT, BLOB, or CHARACTER) within a string of that type.

The LTRIM function is equivalent to TRIM(LEADING FROM *source_string*).

If the parameter is NULL, the result is NULL.

The default singleton depends on the data type of *source_string*:

Table 274.

Character	' ' (space)
BLOB	X'00'
Bit	B'0'

OVERLAY function

OVERLAY is a string manipulation function that manipulates all string data types (BIT, BLOB, and CHARACTER) and replaces part of a string with a substring.

Syntax

```
▶▶OVERLAY(—source_string— PLACING —source_string2—  
▶ FROM —start_position—  
    └ FOR —string_length— ┘ )▶▶
```

OVERLAY returns a new string of the same type as the source and is identical to *source_string*, except that a given substring in the string, starting from the specified numeric position and of the given length, has been replaced by *source_string2*. When the length of the substring is zero, nothing is replaced.

For example:

```
OVERLAY ('ABCDEFGHJIJ' PLACING '1234' FROM 4 FOR 3)
```

returns the string 'ABC1234GHIJ'

If any parameter is NULL, the result is NULL. If *string_length* is not specified, it is assumed to be equal to LENGTH(*source_string2*).

The result of the OVERLAY function is equivalent to:

```
SUBSTRING(source_string FROM 1 FOR start_position -1 )  
|| source_string2 ||  
SUBSTRING(source_string FROM start_position + string_length)
```

where || is the concatenation operator.

POSITION function

POSITION is a string manipulation function that manipulates all data types (BIT, BLOB, and CHARACTER), and returns the position of one string within another.

Syntax

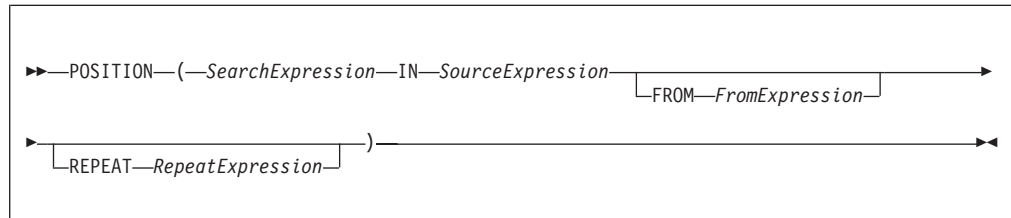

POSITION returns an integer giving the position of one string (*SearchExpression*) in a second string (*SourceExpression*). A position of one corresponds to the first character of the source string.

If present, the FROM clause gives a position within the search string at which the search commences. In the absence of a FROM clause, the source string is searched from the beginning.

If present, the REPEAT clause gives a repeat count, returning the position returned to be that of the nth occurrence of the search string within the source string. If the repeat count is negative, the source string is searched from the end.

In the absence of a REPEAT clause, a repeat count of +1 is assumed; that is, the position of the first occurrence, searching from the beginning is returned. If the search string has a length of zero, the result is one.

If the search string cannot be found, the result is zero: if the FROM clause is present, this applies only to the section of the source string being searched; if the REPEAT clause is present this applies only if there are insufficient occurrences of the string.

If any parameter is NULL, the result is NULL.

The search and source strings can be of the CHARACTER, BLOB, or BIT data types but they must be of the same type.

For example:

```
POSITION('Village' IN 'Hursley Village'); returns 9
POSITION('Town' IN 'Hursley Village'); returns 0

POSITION ('B' IN 'ABCABCABCABCABC'); -> returns 2
POSITION ('D' IN 'ABCABCABCABCABC'); -> returns 0

POSITION ('A' IN 'ABCABCABCABCABC' FROM 4); -> returns 4
POSITION ('C' IN 'ABCABCABCABCABC' FROM 2); -> returns 3

POSITION ('B' IN 'ABCABCABCABCABC' REPEAT 2); -> returns 5
POSITION ('C' IN 'ABCABCABCABCABC' REPEAT 4); -> returns 12

POSITION ('A' IN 'ABCABCABCABCABC' FROM 4 REPEAT 2); -> returns 7
POSITION ('AB' IN 'ABCABCABCABCABC' FROM 2 REPEAT 3); -> returns 10
```

```
POSITION ('A' IN 'ABCABCABCABC' REPEAT -2); -> returns 10
POSITION ('BC' IN 'ABCABCABCABC' FROM 2 REPEAT -3); -> returns 5
```

REPLACE function

REPLACE is a string manipulation function that manipulates all string data types (BIT, BLOB, and CHARACTER), and replaces parts of a string with supplied substrings.

Syntax

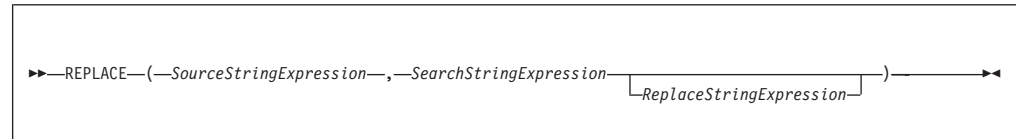

REPLACE returns a string consisting of the source string, with each occurrence of the search string replaced by the replace string. The parameter strings can be of the CHARACTER, BLOB, or BIT data types, but all three must be of the same type.

If any parameter is NULL, the result is NULL.

The search process is single pass from the left and disregards characters that have already been matched.

If you do not specify the replace string expression, the replace string uses the default value of an empty string, and the behavior of the function is to delete all occurrences of the search string from the result.

The following examples give the results shown:

```
REPLACE('ABCDABCDABCD', 'A', 'AA')  
-- RESULT = AABCDAAABCDAA
```

The above example shows that replacement is single pass. Each occurrence of A is replaced by AA but these are not then expanded further.

```
REPLACE('AAAABCDEFHAAAABCDEFH', 'AA', 'A')  
-- RESULT = AABCDEFHABCDEFH
```

This example shows that after characters are matched, they are not considered further. Each occurrence of AA is replaced by A. The resulting AA pairs are not matched.

```
REPLACE('AAAAABCDEFHAAAABCDEFH', 'AA', 'XYZ')  
-- RESULT = XYZXYZABCDEFHXYZXYZBCDEFH
```

This last example shows that matching is from the left. The first four As are matched as two pairs and replaced. The fifth A is not matched.

REPLICATE function

REPLICATE is a string manipulation function that manipulates all data types (BIT, BLOB, and CHARACTER) and returns a string made up of multiple copies of a supplied string.

Syntax

```
►►—REPLICATE—(—PatternStringExpression—,—CountNumericExpression—)—◄◄
```

REPLICATE returns a string consisting of the pattern string given by *PatternStringExpression* repeated the number of times given by *CountNumericExpression*.

The pattern string can be of the CHARACTER, BLOB, or BIT datatype and the count must be of type INTEGER. The result is of the same data type as the pattern string.

If the count is negative or zero, a zero length string is returned. If either parameter is NULL, the result is NULL.

The count is limited to 32*1024*1024 to protect the broker from erroneous programs. If this limit is exceeded, an exception condition is issued.

RIGHT function

RIGHT is a string manipulation function that manipulates all data types (BIT, BLOB, and CHARACTER), and truncates a string.

Syntax

```
►►—RIGHT—(—SourceStringExpression—,—LengthIntegerExpression—)—◄◄
```

RIGHT returns a string consisting of the source string truncated to the length given by the length expression. The truncation discards the initial characters of the source string.

The source string can be of the CHARACTER, BLOB, or BIT data type and the length must be of type INTEGER.

If the length is negative or zero, a zero length string is returned. If either parameter is NULL, the result is NULL

RTRIM function

RTRIM is a string manipulation function that manipulates all data types (BIT, BLOB, and CHARACTER), and removes trailing singletons from a string.

Syntax

```
►►—RTRIM—(—source_string—)—◄◄
```

RTRIM returns a string value of the same data type and content as *source_string* but with any trailing default singletons removed. The term *singleton* refers to a single part (BIT, BLOB, or CHARACTER) within a string of that type.

The RTRIM function is equivalent to TRIM(TRAILING FROM *source_string*).

If the parameter is NULL, the result is NULL.

The default singleton depends on the data type of *source_string*:

Character	' ' (space)
BLOB	X'00'
Bit	B'0'

SPACE function

SPACE is a string manipulation function that manipulates all data types (BIT, BLOB, and CHARACTER), and creates a string consisting of a defined number of blank spaces.

Syntax

```
▶▶ SPACE (NumericExpression) ▶▶
```

SPACE returns a character string consisting of the number of blank spaces given by *NumericExpression*. The parameter must be of type INTEGER; the result is of type CHARACTER.

If the parameter is negative or zero, a zero length character string is returned. If the parameter is NULL, the result is NULL.

The string is limited to 32*1024*1024 to protect the broker from erroneous programs. If this limit is exceeded, an exception condition is issued.

SUBSTRING function

SUBSTRING is a string manipulation function that manipulates all data types (BIT, BLOB, and CHARACTER), and extracts characters from a string to create another string.

Syntax

```
▶▶ SUBSTRING (source_string FROM start_position
FOR string_length) ▶▶
```

SUBSTRING returns a new string of the same type as *source_string*, containing one contiguous run of characters extracted from *source_string* as specified by *start_position* and *string_length*.

The start position can be negative. The start position and length define a range. The result is the overlap between this range and the input string.

If any parameter is NULL, the result is NULL. This is not a zero length string.

For example:

```
SUBSTRING('Hello World!' FROM 7 FOR 4)
```

returns 'Worl'.

TRANSLATE function

TRANSLATE is a string manipulation function that manipulates all string data types (BIT, BLOB, and CHARACTER), and replaces specified characters in a string.

Syntax

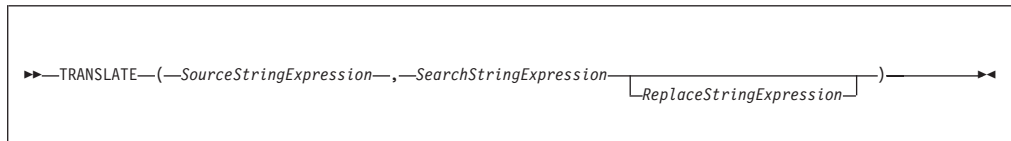

TRANSLATE returns a string consisting of the source string, with each occurrence of any character that occurs in the search string being replaced by the corresponding character from the replace string.

The parameter strings can be of the CHARACTER, BLOB, or BIT data type but all three must be of the same type. If any parameter is NULL, the result is NULL.

If the replace string is shorter than the search string, there are characters in the search string for which there is no corresponding character in the replace string. This is treated as an instruction to delete these characters and any occurrences of these characters in the source string are absent from the returned string.

If the replace string expression is not specified, the replace string is assumed to be an empty string, and the function deletes all occurrences of any characters in the search string from the result.

TRIM function

TRIM is a string manipulation function that manipulates all string data types (BIT, BLOB, and CHARACTER), and removes trailing and leading singletons from a string.

Syntax

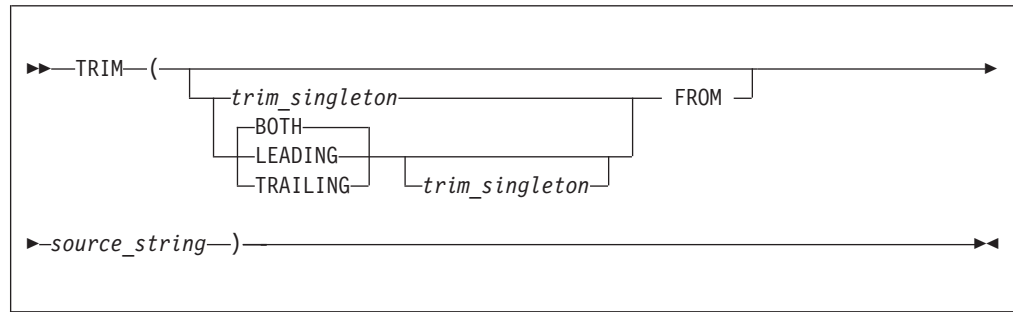

TRIM returns a new string of the same type as *source_string*, in which the leading, trailing, or both leading and trailing singletons have been removed. The term *singleton* refers to a single part (BIT, BYTE, or CHARACTER) within a string of that type.

If *trim_singleton* is not specified, a default singleton is assumed. The default singleton depends on the data type of *source_string*:

Character	' ' (space)
BLOB	X'00'
Bit	B'0'

If any parameter is NULL, the result is NULL.

It is often unnecessary to strip trailing blanks from character strings before comparison, because the rules of character string comparison mean that trailing blanks are not significant.

The following examples illustrate the behavior of the TRIM function:

```
TRIM(TRAILING 'b' FROM 'aaabB')
```

returns 'aaabB'.

```
TRIM(' a ')
```

returns 'a'.

```
TRIM(LEADING FROM ' a ')
```

returns 'a '.

```
TRIM('b' FROM 'bbbaaabb')
```

returns 'aaa'.

UPPER and UCASE functions

UPPER and UCASE are equivalent string manipulation functions that manipulate CHARACTER string data and convert lowercase characters in a string to uppercase.

Syntax

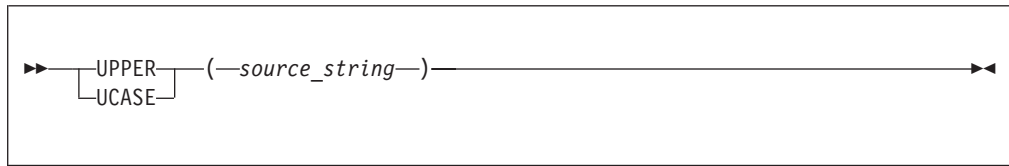

UPPER and UCASE both return a new character string, which is identical to *source_string*, except that all lowercase letters are replaced with the corresponding uppercase letters.

For example:

```
UPPER('ABCD')
```

returns 'ABCD'.

```
UCASE('abc123')
```

returns 'ABC123'.

Converting characters from different code pages to uppercase

If you are using certain code pages, characters with no uppercase equivalent in your code page might be converted when you use the UPPER or UCASE function. This conversion happens because the bitstream is converted to a Unicode message tree by the message parser. Even though characters might have no uppercase equivalent in the source code page, they can still have an uppercase equivalent in the Unicode code page, and are converted by the UPPER or UCASE function. When the bitstream is converted back to the original code page, these characters cannot be converted back, and a substitution character is inserted into the output message for each character. The substitution character inserted depends on the original code page. For example, conversion to an EBCDIC code page inserts an X'3F' byte and conversion to a Japanese code page inserts an X'7F' byte.

A solution to this problem is to use the TRANSLATE function to convert selected characters to uppercase, instead of using the UPPER or UCASE function. Any characters that have no uppercase equivalent in the code page are excluded from the conversion.

In the following example, the input message is in code page 284, and the InputRoot.XML.MSG.APPDATA element contains characters that do not have an upper case equivalent in code page 284, but do have upper case equivalents in the Unicode code page. The TRANSLATE function is used to convert only the lowercase characters 'a' to 'z' to their equivalent uppercase characters. Any other characters in InputRoot.XML.MSG.APPDATA are excluded from the conversion.

```
DECLARE char1 CHAR;  
SET char1 = TRANSLATE(InputRoot.XML.MSG.APPDATA, 'abcdefghijklmnopqrstuvwxyz', 'ABCDEFGHIJKLMNOPQRSTUVWXYZ');  
SET OutputRoot.MQMD.CodedCharSetId = 284;  
SET OutputRoot.XML.TEST.translated = char1;
```

ESQL field functions

This topic lists the ESQL field functions and covers the following:

“ASBITSTREAM function” on page 1603

“BITSTREAM function (deprecated)” on page 1606

“FIELDNAME function” on page 1607

“FIELDNAMESPACE function” on page 1608

“FIELDTYPE function” on page 1608

“FIELDVALUE function” on page 1610

“FOR function” on page 1611

“LASTMOVE function” on page 1612

“SAMEFIELD function” on page 1613

ASBITSTREAM function

The ASBITSTREAM field function generates a bit stream for the subtree of a given field according to the rules of the parser that owns the field.

The ASBITSTREAM field function uses parameters supplied by the caller for:

- Encoding
- CCSID
- Message set
- Message type
- Message format
- Options

The ASBITSTREAM function removes the limitation of the existing BITSTREAM function, which can be used only on a tree produced by a parser that belongs to an input node.

The BITSTREAM function is retained only for compatibility with earlier versions.

Syntax

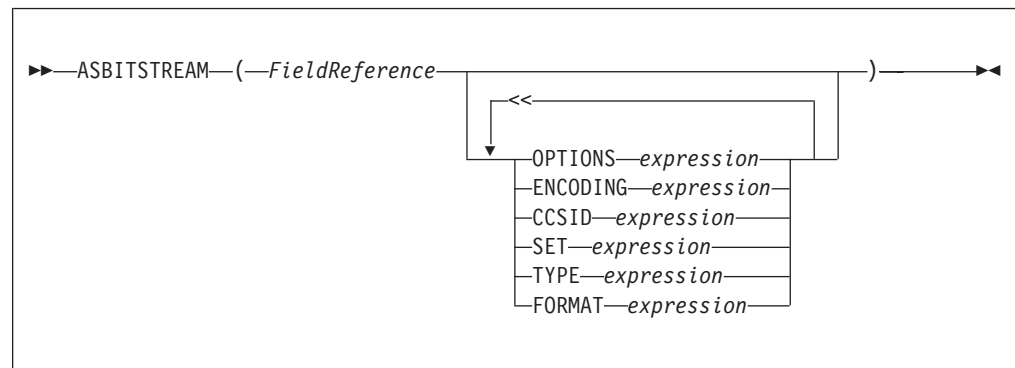

Note that each clause can occur once only.

ASBITSTREAM returns a value of type BLOB that contains a bitstream representation of the field that is pointed to by *FieldReference* and its children.

The algorithm for doing this varies from parser to parser, and according to the options specified. All parsers support the following modes:

- **RootBitStream**, in which the algorithm that generates the bit stream is the same as the algorithm that is used by an output node. In this mode, a meaningful result is obtained only if the field pointed to is at the head of a subtree with an appropriate structure.
- **EmbeddedBitStream**, in which not only is the algorithm that generates the bit stream is the same as the algorithm that is used by an output node, but also the
 - Encoding
 - CCSID
 - Message set
 - Message type
 - Message format

are determined, if not explicitly specified, in the same way as the output node. That is, they are determined by searching the previous siblings of *FieldReference* on the assumption that they represent headers.

In this way, the algorithm for determining these properties is essentially the same as that used for the BITSTREAM function.

Some parsers also support another mode, **FolderBitStream**, which generates a meaningful bit stream for any subtree, provided that the field that is pointed to represents a folder.

In all cases, the bit stream obtained can be given to a CREATE statement with a PARSE clause, using the same DOMAIN and OPTIONS to reproduce the original subtree.

When the function is called, any clause expressions are evaluated. An exception is thrown if any of the expressions do not result in a value of the appropriate type.

If any parameter is NULL the result is NULL.

Clause	Type	Default value
OPTIONS	Integer	RootBitStream & ValidateNone
ENCODING	Integer	0
CCSID	Integer	0
SET	Character	Zero length string
TYPE	Character	Zero length string
FORMAT	Character	Zero length string

For details of the syntax of the TYPE clause, refer to Specifying namespaces in the Message Type property.

Although the OPTIONS clause accepts any expression that returns a value of type integer, it is only meaningful to generate option values from the list of supplied constants, using the BITOR function if more than one option is required.

The generated value becomes an integer and can be saved in a variable, passed as a parameter to a function, or used directly in an ASBITSTREAM call. The list of globally-defined constants is:

```
Validate master options...
ValidateContentAndValue
ValidateValue    -- Can be used with ValidateContent
```

ValidateContent -- Can be used with ValidateValue

ValidateNone

Validate failure action options...

ValidateException

ValidateExceptionList

ValidateLocalError

ValidateUserTrace

Validate value constraints options...

ValidateFullConstraints

ValidateBasicConstraints

Validate fix up options...

ValidateFullFixUp

ValidateNoFixUp

Notes:

1. The validateFullFixUp option is reserved for future use. Selecting validateFullFixUp gives identical behaviour to validateNoFixUp.
2. The validateFullConstraints option is reserved for future use. Selecting validateFullConstraints gives identical behaviour to validateBasicConstraints.
3. For full details of the validation options, refer to “Validation properties” on page 1359.

C and Java equivalent APIs

Note that equivalent options are not available on:

- The Java plugin node API MBElement methods createElementAsLastChildFromBitstream() and toBitstream()
- The C plugin node API methods cniCreateElementAsLastChildFromBitstream() and cniElementAsBitstream.

Only one option from each group can be specified, with the exception of ValidateValue and ValidateContent, which can be used together to obtain the content and value validation. If you do not specify an option within a group, the option in bold is used.

The ENCODING clause accepts any expression that returns a value of type integer. However, it is only meaningful to generate encoding values from the list of supplied constants:

```
0
MQENC_INTEGER_NORMAL
MQENC_INTEGER_REVERSED
MQENC_DECIMAL_NORMAL
MQENC_DECIMAL_REVERSED
MQENC_FLOAT_IEEE_NORMAL
MQENC_FLOAT_IEEE_REVERSED
MQENC_FLOAT_S390
```

0 uses the queue manager’s encoding.

The values that are used for the CCSID clause follow the normal numbering system. For example, 1200 = UCS-2, 1208 = UTF-8.

In addition the special values 0 and -1 are supported:

- 0 uses the queue manager’s CCSID

- -1 uses the CCSID's as determined by the parser itself. This value is reserved.

For absent clauses, the given default values are used. Use the CCSID and encoding default values, because they take their values from the queue manager's encoding and CCSID settings.

Similarly, use the default values for each of the message set, type, and format options, because many parsers do not require message set, type, or format information; any valid value is sufficient.

When any expressions have been evaluated, the appropriate bit stream is generated.

Note: Because this function has a large number of clauses, an alternative syntax is supported in which the parameters are supplied as a comma-separated list rather than by named clauses. In this case, the expressions must be in the following order:

```
ENCODING -> CCSID -> SET -> TYPE -> FORMAT -> OPTIONS
```

The list can be truncated at any point and you can use an empty expression for any clauses for which you do not supply a value.

Examples

```
DECLARE options INTEGER BITOR(FolderBitStream, ValidateContent,
                               ValidateValue);
SET result = ASBITSTREAM(cursor OPTIONS options CCSID 1208);
SET Result = ASBITSTREAM(Environment.Variables.MQRFH2.Data,,1208
                          ,,,options);
```

BITSTREAM function (deprecated)

The BITSTREAM field function returns a value that represents the bit stream that is described by the given field and its children. Its use is deprecated; use the newer ASBITSTREAM function instead.

The BITSTREAM function can be used only on a tree produced by a parser belonging to an input node. The ASBITSTREAM function does not suffer from this limitation.

Syntax

►►—BITSTREAM—(—*field_reference*—)————►►

The BITSTREAM function returns a value of type BLOB that represents the bit stream that is described by the given field and its children. For incoming messages, the appropriate portion of the incoming bit stream is used. For messages that are constructed by Compute nodes, the following algorithm is used to establish the ENCODING, CCSID, message set, message type, and message format:

- If the addressed field has a previous sibling, and this sibling is the root of a subtree that belongs to a parser capable of providing an ENCODING and

CCSID, these values are obtained and used to generate the requested bit stream. Otherwise, the broker's default ENCODING and CCSID (that is, those of its queue manager) are used.

- Similarly, if the addressed field has a previous sibling, and this sibling is the root of a subtree that belongs to a parser capable of providing a message set, message type, and message format, these values are obtained and used to generate the requested bit stream. Otherwise, zero length strings are used.

This function is typically used for message warehouse scenarios, where the bit stream of a message needs to be stored in a database. The function returns the bit stream of the physical portion of the incoming message, identified by the parameter. In some cases, it does not return the bit stream that represents the actual field identified. For example, the following two calls return the same value:

```
BITSTREAM(Root.MQMD);  
BITSTREAM(Root.MQMD.UserIdentifier);
```

because they lie in the same portion of the message.

FIELDNAME function

The FIELDNAME field function returns the name of a given field.

Syntax

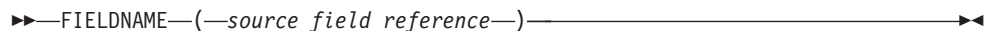

```
►►—FIELDNAME—(—source_field_reference—)—————►►
```

FIELDNAME returns the name of the field identified by *source_field_reference* as a character value. If the parameter identifies a nonexistent field, NULL is returned.

For example:

- FIELDNAME(InputRoot.XMLNS) returns XMLNS.
- FIELDNAME(InputBody) returns the name of the last child of InputRoot, which could be XMLNS.
- FIELDNAME(InputRoot.*[<]) returns the name of the last child of InputRoot, which could be XMLNS.

This function does not show any namespace information; this must be obtained by a separate call to the "FIELDNAMESPACE function" on page 1608.

Whereas the following ESQL sets X to "F1":

```
SET X=FIELDNAME(InputBody.*[<]);
```

The following ESQL sets Y to null:

```
SET Y=FIELDNAME(InputBody.F1.*[<]);
```

However, the following ESQL sets Z to the (expected) child of F1:

```
SET Z=FIELDNAME(InputBody.*[<].*[<]);
```

This is because F1 belongs to a namespace and needs to be explicitly referenced by, for example:

```
DECLARE ns NAMESPACE 'urn:nid:xxxxxx';  
SET Y=FIELDNAME(InputBody.ns:F1.*[<]);
```

FIELDNAMESPACE function

The FIELDNAMESPACE field function returns the namespace of a given field.

Syntax

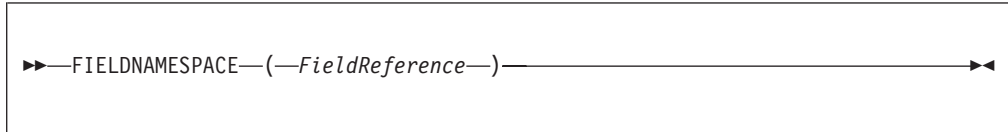

FIELDNAMESPACE takes a field reference as a parameter and returns a value of type CHARACTER containing the namespace of the addressed field. If the parameter identifies a nonexistent field, NULL is returned.

FIELDTYPE function

The FIELDTYPE field function returns the type of a given field.

Syntax

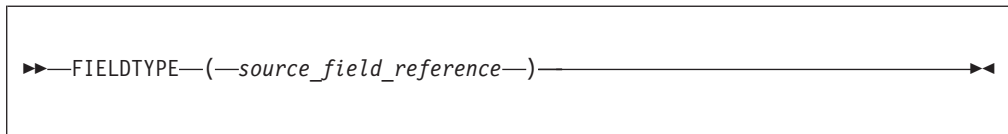

FIELDTYPE returns an integer representing the type of the field identified by *source_field_reference*; this is the type of the field, not the data type of the field that the parameter identifies. If the parameter identifies a nonexistent entity, NULL is returned.

The mapping of integer values to field types is not published, and might change from release to release. Compare the results of the FIELDTYPE function with named field types.

For example:

```
IF FIELDTYPE(source_field_reference) = NameValue  
THEN ...
```

The named field types that you can use in this context are listed below.

Note the following:

- *Name*, *Value*, *NameValue* and *MQRFH2.BitStream* are domain independent.
- The *XML.** types are applicable to the XML, XMLNS, JMSMap, and JMSStream domains, except for *XML.Namespace* which is specific to the XMLNS domain.
- The *XMLNSC.** types are applicable to the XMLNSC domain.

You must use these types with the capitalization shown:

- *Name*
- *Value*

- *NameValue*
- *MQRFH2.BitStream*
- *XML.AsisElementContent*
- *XML.Attribute*
- *XML.AttributeDef*
- *XML.AttributeDefDefaultType*
- *XML.AttributeDefType*
- *XML.AttributeDefValue*
- *XML.AttributeList*
- *XML.BitStream*
- *XML.CDataSection*
- *XML.Comment*
- *XML.Content*
- *XML.DocTypeComment*
- *XML.DocTypeDecl*
- *XML.DocTypePI*
- *XML.DocTypeWhiteSpace*
- *XML.Element*
- *XML.ElementDef*
- *XML.Encoding*
- *XML.EntityDecl*
- *XML.EntityDeclValue*
- *XML.EntityReferenceStart*
- *XML.EntityReferenceEnd*
- *XML.ExternalEntityDecl*
- *XML.ExternalParameterEntityDecl*
- *XML.ExtSubset*
- *XML.IntSubset*
- *XML.NamespaceDecl*
- *XML.NotationDecl*
- *XML.NotationReference*
- *XML.ParameterEntityDecl*
- *XML.ParserRoot*
- *XML.ProcessingInstruction*
- *XML.PublicId*
- *XML.RequestedDomain*
- *XML.Standalone*
- *XML.SystemId*
- *XML.UnparsedEntityDecl*
- *XML.Version*
- *XML.WhiteSpace*
- *XML.XmlDecl*
- *XMLNSC.Attribute*
- *XMLNSC.BitStream*
- *XMLNSC.CDataField*

- *XMLNSC.CDataValue*
- *XMLNSC.Comment*
- *XMLNSC.DocumentType*
- *XMLNSC.DoubleAttribute*
- *XMLNSC.DoubleEntityDefinition*
- *XMLNSC.EntityDefinition*
- *XMLNSC.EntityReference*
- *XMLNSC.Field*
- *XMLNSC.Folder*
- *XMLNSC.HybridField*
- *XMLNSC.HybridValue*
- *XMLNSC.PCDataField*
- *XMLNSC.PCDataValue*
- *XMLNSC.ProcessingInstruction*
- *XMLNSC.SingleAttribute*
- *XMLNSC.SingleEntityDefinition*
- *XMLNSC.Value*
- *XMLNSC.XmlDeclaration*

You can also use this function to determine whether a field in a message exists. To do this, use the form:

```
FIELDTYPE(SomeFieldReference) IS NULL
```

If the field exists, an integer value is returned to the function that indicates the field type (for example, string). When this is compared to NULL, the result is FALSE. If the field does not exist, NULL is returned and therefore the result is TRUE. For example:

```
IF FIELDTYPE(InputRoot.XMLNS.Message1.Name)
  IS NULL THEN
  // Name field does not exist, take error
  action....
  ... more ESQL ...
ELSE
  // Name field does exist, continue....
  ... more ESQL ...
END IF
```

FIELDVALUE function

The FIELDVALUE field function returns the scalar value of a given field.

Syntax

```
►►—FIELDVALUE—(—source_field_reference—)—————►►
```

FIELDVALUE returns the scalar value of the field identified by *source_field_reference*. If it identifies a non-existent field, NULL is returned.

For example, consider the following XML input message:

```
<Data>
  <Qty Unit="Gallons">1234</Qty>
</Data>
```

The ESQL statement

```
SET OutputRoot.XML.Data.Quantity =
  FIELDVALUE(InputRoot.XML.Data.Qty);
```

gives the result:

```
<Data><Quantity>1234</Quantity></Data>
```

whereas this ESQL statement (without the FIELDVALUE function):

```
SET OutputRoot.XML.Data.Quantity =
  InputRoot.XML.Data.Qty;
```

causes a tree copy, with the result:

```
<Data><Quantity Unit="Gallons">1234</Quantity></Data>
```

because the field Qty is not a leaf field.

FOR function

The FOR field function evaluates an expression and assigns a resulting value of TRUE, FALSE, or UNKNOWN

Syntax

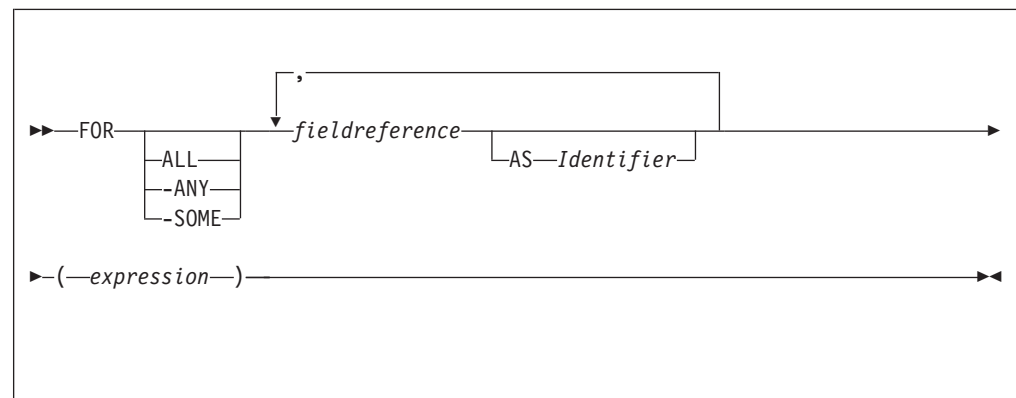

FOR enables you to write an expression that iterates over all instances of a repeating field. For each instance it processes a boolean expression and collates the results.

For example:

```
FOR ALL Body.Invoice.Purchases."Item"[] AS I (I.Quantity <= 50)
```

Note:

1. With the quantified predicate , the first thing to note is the [] on the end of the field reference after the FOR ALL. The square brackets define iteration over all instances of the Item field.

In some cases, this syntax appears unnecessary, because you can get that information from the context, but it is done for consistency with other pieces of syntax.

2.

The AS clause associates the name I in the field reference with the current instance of the repeating field. This is similar to the concept of iterator classes used in some object oriented languages such as C++. The expression in parentheses is a predicate that is evaluated for each instance of the Item field.

If you specify the **ALL** keyword, the function iterates over all instances of the field Item inside Body.Invoice.Purchases and evaluates the predicate I.Quantity <= 50. If the predicate evaluates to:

- TRUE (if the field is empty, or for all instances of Item) return TRUE.
- FALSE (for any instance of Item) return FALSE.
- Anything else, return UNKNOWN.

The **ANY** and **SOME** keywords are equivalent. If you use either, the function iterates over all instances of the field Item inside Body.Invoice.Purchases and evaluates the predicate I.Quantity <= 50. If the predicate evaluates to:

- FALSE (if the field is empty, or for all instances of Item) return FALSE.
- TRUE (for any instance of Item) return TRUE.
- Anything else, return UNKNOWN.

To further illustrate this, the following examples are based on the message described in "Example message" on page 1671. In the following filter expression:
FOR ANY Body.Invoice.Purchases."Item"[] AS I (I.Title = 'The XML Companion')

the sub-predicate evaluates to TRUE. However, this next expression returns FALSE:
FOR ANY Body.Invoice.Purchases."Item"[] AS I (I.Title = 'C Primer')

because the C Primer is not included on this invoice. If in this instance some of the items in the invoice do not include a book title field, the sub-predicate returns UNKNOWN, and the quantified predicate returns the value UNKNOWN.

Take great care to deal with the possibility of null values appearing. Write this filter with an explicit check on the existence of the field, as follows:

```
FOR ANY Body.Invoice.Purchases."Item"[] AS I (I.Book IS NOT NULL AND I.Book.Title = 'C Primer')
```

The IS NOT NULL predicate ensures that, if an Item field does not contain a Book, a FALSE value is returned from the sub-predicate.

LASTMOVE function

The LASTMOVE field function tells you whether the last MOVE function succeeded.

Syntax

```
►►—LASTMOVE—(—source_dynamic_reference—)—————►◄
```

LASTMOVE returns a Boolean value indicating whether the last MOVE function applied to *source_dynamic_reference* was successful (TRUE) or not (FALSE).

See “MOVE statement” on page 1545 for an example of using the MOVE statement, and the LASTMOVE function to check its success.

See “Creating dynamic field references” on page 291 for information about dynamic references.

SAMEFIELD function

The SAMEFIELD field function tells you whether two field references point to the same target.

Syntax

```
►►—SAMEFIELD—(—source_field_reference1—,—source_field_reference2—)—◄◄
```

SAMEFIELD returns a BOOLEAN value indicating whether two field references point to the same target. If they do, SAMEFIELD returns TRUE; otherwise SAMEFIELD returns FALSE.

For example:

```
DECLARE ref1 REFERENCE TO OutputRoot.XMLNS.Invoice.Purchases.Item[1];  
MOVE ref1 NEXTSIBLING;  
SET Result = SAMEFIELD(ref1,OutputRoot.XMLNS.Invoice.Purchases.Item[2]);
```

Result is TRUE.

See “Creating dynamic field references” on page 291 for information about dynamic references.

ESQL list functions

This topic lists the ESQL list functions and covers the following:

“CARDINALITY function”

“EXISTS function” on page 1614

“SINGULAR function” on page 1615

“THE function” on page 1615

CARDINALITY function

The CARDINALITY function returns the number of elements in a list.

Syntax

```
►►—CARDINALITY—(—ListExpression—)—◄◄
```

CARDINALITY returns an integer value giving the number of elements in the list specified by *ListExpression*.

ListExpression is any expression that returns a list. All the following, for example, return a list:

- A LIST constructor
- A field reference with the [] array indicator
- Some SELECT expressions (not all return a list)

A common use of this function is to determine the number of fields in a list before iterating over them.

Examples

```
-- Determine the number of F1 fields in the message.
-- Note that the [ ] are required
DECLARE CountF1 INT CARDINALITY(OutputRoot.XMLNS.Data.Source.F1[]);
-- Determine the number of fields called F1 with the value 'F12' in the message.
-- Again note that the [ ] are required
DECLARE CountF1F12 INT
  CARDINALITY(SELECT F.* FROM OutputRoot.XMLNS.Data.Source.F1[] AS F
              where F = 'F12');
-- Use the value returned by CARDINALITY to refer to a specific element
-- in a list or array:
-- Array indices start at 1, so this example refers to the third-from-last
-- instance of the Item field
Body.Invoice.Item[CARDINALITY(Body.Invoice.Item[]) - 2].Quantity
```

EXISTS function

The EXISTS function returns a BOOLEAN value indicating whether a list contains at least one element (that is, whether the list exists).

Syntax

►►—EXISTS—(—*ListExpression*—)—————◄◄

If the list specified by *ListExpression* contains one or more elements, EXISTS returns TRUE. If the list contains no elements, EXISTS returns FALSE.

ListExpression is any expression that returns a list. All the following, for example, return a list:

- A LIST constructor
- A field reference with the [] array indicator
- Some SELECT expressions (not all return a list)

If you only want to know whether a list contains any elements or none, EXISTS executes more quickly than an expression involving the CARDINALITY function (for example, CARDINALITY(*ListExpression*) <> 0).

A common use of this function is to determine whether a field exists.

Examples

```
-- Determine whether the F1 array exists in the message. Note that the [ ]
-- are required
DECLARE Field1Exists BOOLEAN EXISTS(OutputRoot.XMLNS.Data.Source.F1[]);
-- Determine whether the F1 array contains an element with the value 'F12'.
-- Again note that the [ ] are required
DECLARE Field1F12Exists BOOLEAN
  EXISTS(SELECT F.* FROM OutputRoot.XMLNS.Data.Source.F1[] AS F where F = 'F12');
```

SINGULAR function

The SINGULAR function returns a BOOLEAN value indicating whether a list contains exactly one element.

Syntax



► SINGULAR (ListExpression) ◄

If the list specified by *ListExpression* contains exactly one element, SINGULAR returns TRUE. If the list contains more or fewer elements, SINGULAR returns FALSE.

ListExpression is any expression that returns a list. All the following, for example, return a list:

- A LIST constructor
- A field reference with the [] array indicator
- Some SELECT expressions (not all return a list)

If you only want to know whether a list contains just one element or some other number, SINGULAR executes more quickly than an expression involving the CARDINALITY function (for example, CARDINALITY(ListExpression) = 1).

A common use of this function is to determine whether a field is unique.

Examples

```
-- Determine whether there is just one F1 field in the message.
-- Note that the [ ] are required
DECLARE Field1Unique BOOLEAN SINGULAR(OutputRoot.XMLNS.Data.Source.F1[]);
-- Determine whether there is just one field called F1 with the value 'F12'
-- in the message. Again note that the [ ] are required
DECLARE Field1F12Unique BOOLEAN
  SINGULAR(SELECT F.* FROM OutputRoot.XMLNS.Data.Source.F1[] AS F where F = 'F12');
```

THE function

The THE function returns the first element of a list.

Syntax



► THE (ListExpression) ◄

If *ListExpression* contains one or more elements; THE returns the first element of the list. Otherwise it returns an empty list.

Restrictions

Currently, *ListExpression* must be a SELECT expression.

Complex ESQL functions

This topic lists the complex ESQL functions and covers the following:

“CASE function”

“CAST function” on page 1618

“SELECT function” on page 1632

“ROW constructor function” on page 1639

“LIST constructor function” on page 1640

“ROW and LIST combined” on page 1641

“ROW and LIST comparisons” on page 1642

“Supported casts” on page 1644

“Implicit casts” on page 1652

“Implicit CASTs for comparisons” on page 1652

“Implicit CASTs for arithmetic operations” on page 1654

“Implicit CASTs for assignment” on page 1656

“Data types of values from external sources” on page 1657

CASE function

CASE is a complex function which has two forms; the simple-when form and the searched-when form. In either form CASE returns a value , the result of which controls the path of subsequent processing.

Syntax

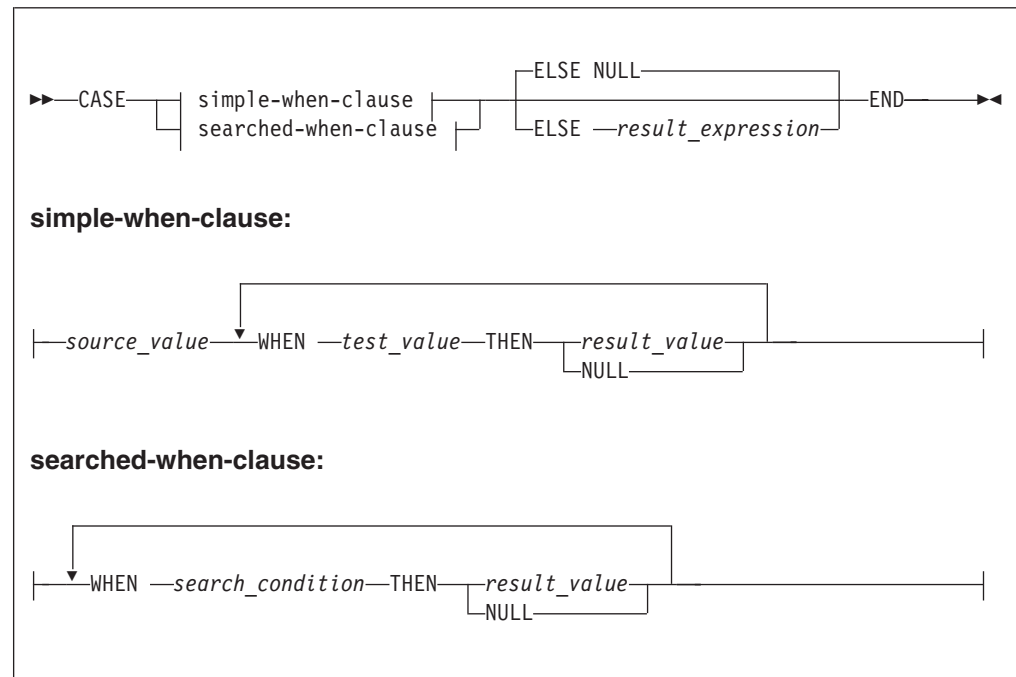

Both forms of CASE return a value depending on a set of rules defined in WHEN clauses.

In the simple-when form, *source_value* is compared with each *test_value* until a match is found. The result of the CASE function is the value of the corresponding *result_value*. The data type of *source_value* must therefore be comparable to the data type of each *test_value*.

The CASE function must have at least one WHEN. The ELSE is optional. The default ELSE expression is NULL. A CASE expression is delimited by END. The test values do not have to be literal values.

The searched-when clause version is similar, but has the additional flexibility of allowing a number of different values to be tested.

The following example shows a CASE function with a simple WHEN clause. In this example, the CASE can be determined only by one variable that is specified next to the CASE keyword.

```
DECLARE CurrentMonth CHAR;
DECLARE MonthText CHAR;
SET CurrentMonth = SUBSTRING(InputBody.Invoice.InvoiceDate FROM 6 FOR 2);

SET MonthText =
CASE CurrentMonth
  WHEN '01' THEN 'January'
  WHEN '02' THEN 'February'
  WHEN '03' THEN 'March'
  WHEN '04' THEN 'April'
  WHEN '05' THEN 'May'
  WHEN '06' THEN 'June'
  ELSE 'Second half of year'
END
```

The following example shows a CASE function with a searched-when-clause. This example is still determined by one variable CurrentMonth:

```

DECLARE CurrentMonth CHAR;
DECLARE MonthText CHAR;
SET CurrentMonth = SUBSTRING(InputBody.Invoice.InvoiceDate FROM 6 FOR 2);

SET MonthText =
CASE
  WHEN Month = '01' THEN 'January'
  WHEN Month = '02' THEN 'February'
  WHEN Month = '03' THEN 'March'
  WHEN Month = '04' THEN 'April'
  WHEN Month = '05' THEN 'May'
  WHEN Month = '06' THEN 'June'
  ELSE 'Second half of year'
END

```

In a searched-when-clause, different variables can be used in the WHEN clauses to determine the result. This is demonstrated in the following example of the searched-when-clause:

```

DECLARE CurrentMonth CHAR;
DECLARE CurrentYear CHAR;
DECLARE MonthText CHAR;
SET CurrentMonth = SUBSTRING(InputBody.Invoice.InvoiceDate FROM 6 FOR 2);
SET CurrentYear = SUBSTRING(InputBody.Invoice.InvoiceDate FROM 1 FOR 4);

SET MonthText =
CASE
  WHEN CurrentMonth = '01' THEN 'January'
  WHEN CurrentMonth = '02' THEN 'February'
  WHEN CurrentMonth = '03' THEN 'March'
  WHEN CurrentYear = '2000' THEN 'A month in the Year 2000'
  WHEN CurrentYear = '2001' THEN 'A month in the Year 2001'
  ELSE 'Not first three months of any year or a month in the Year 2000 or 2001'
END;

```

CAST function

CAST is a complex function that transforms one or more values from one data type into another.

Syntax

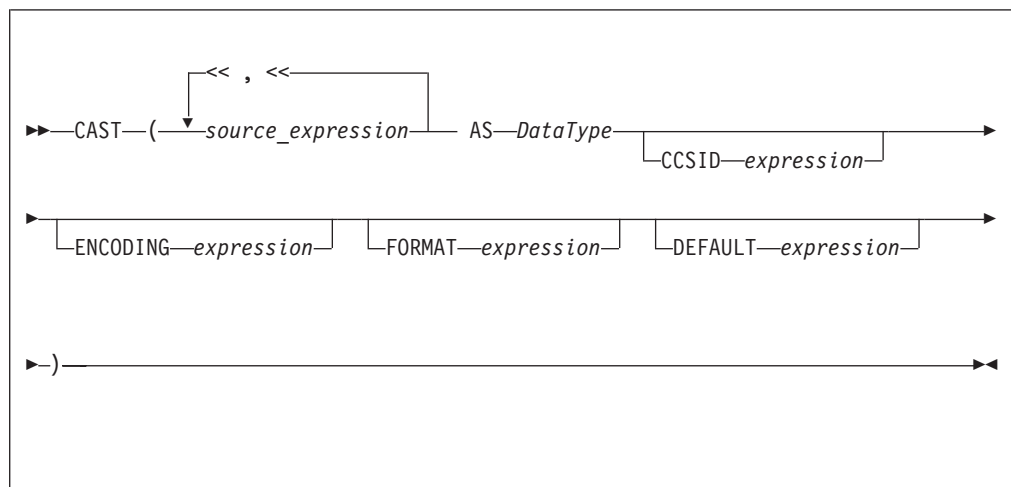

In practice, you cannot specify all of the above parameters at the same time. For example, **CCSID** and **ENCODING** parameters take effect only on string-to-string conversions, while **FORMAT** applies only to string-numeric and string-datetime conversions (in either direction).

The **CAST** function transforms one or more values from one data type into another data type. For example, you can use **CAST** to process generic XML messages. All fields in an XML message have character values, so to perform an arithmetic calculation or a date/time comparison on a field, for example, use **CAST** to convert the string value of the field into a value of the appropriate type.

Not all conversions are supported; see “Supported casts” on page 1644 for a list of supported conversions.

Parameters:

Source expression

CAST returns its first parameter (**source_expression**), which can contain more than one value, as the data type that is specified by its second parameter (**DataType**). In all cases, if the source expression is **NULL**, the result is **NULL**. If the evaluated source expression is not compatible with the target data type, or if the source expression is of the wrong format, a runtime error is generated.

CCSID

The **CCSID** parameter is used only for conversions to or from one of the string data types. Use the **CCSID** parameter to specify the code page of the source or target string.

The **CCSID** parameter can be any expression that evaluates to a value of type **INT**. The expression is interpreted according to normal WebSphere Message Broker rules for **CCSIDs**. See “Supported code pages” on page 1329 for a list of valid values.

DataType

The **DataType** parameter is the data type into which the source value is transformed. The possible values are:

- String types:
 - **BIT**
 - **BLOB**
 - **CHARACTER**
- Numeric types:
 - **DECIMAL**
 - **FLOAT**
 - **INTEGER**
- Date/Time types:
 - **DATE**
 - **GMTTIME**
 - **GMTTIMESTAMP**
 - **INTERVAL**
 - **TIME**
 - **TIMESTAMP**
- Boolean:
 - **BOOLEAN**

Ensure that you specify a valid ESQL interval subtype after a Date/Time type of INTERVAL. For valid ESQL interval subtypes, see “ESQL INTERVAL data type” on page 1454. For example commands that show how to specify a valid ESQL interval subtype, see examples 12, 13, and 14 below.

DEFAULT

The **DEFAULT** parameter provides a method of avoiding exceptions being thrown from CAST statements by providing a last-resort value to return.

The **DEFAULT** parameter must be a valid ESQL expression that returns the same data type as that specified on the **DataType** parameter, otherwise an exception is thrown.

The **CCSID**, **ENCODING**, and **FORMAT** parameters are not applied to the result of the **DEFAULT** parameter; the expression must, therefore, be of the correct **CCSID**, **ENCODING**, and **FORMAT**.

ENCODING

Use the **ENCODING** parameter to specify the encoding for certain conversions. The **ENCODING** value can be any expression that evaluates to a value of type INT, and is interpreted according to normal WebSphere Message Broker rules for encoding. Valid values are:

- MQENC_NATIVE (0x00000222L)
- MQENC_INTEGER_NORMAL (0x00000001L)
- MQENC_INTEGER_REVERSED (0x00000002L)
- MQENC_DECIMAL_NORMAL (0x00000010L)
- MQENC_DECIMAL_REVERSED (0x00000020L)
- MQENC_FLOAT_IEEE_NORMAL (0x00000100L)
- MQENC_FLOAT_IEEE_REVERSED (0x00000200L)
- MQENC_FLOAT_S390 (0x00000300L)

FORMAT

Use the **FORMAT** parameter for conversions between string data types and numerical or date/time data types. For conversions *from* string types, **FORMAT** defines how the source string should be parsed to fill the target data type. For conversions *to* string types, it defines how the data in the source expression is formatted in the target string.

FORMAT takes different types of expression for date/time and numerical conversions. However, the same **FORMAT** expression can be used irrespective of whether the conversion is to a string or from a string.

You can specify a **FORMAT** parameter when casting:

- From any of the string data types (BIT, BLOB, or CHARACTER) to:
 - DECIMAL
 - FLOAT
 - INTEGER
 - DATE
 - GMTTIMESTAMP
 - TIMESTAMP
 - GMTTIME

- TIME
- To any of the string data types (BIT, BLOB, or CHARACTER) from any of the numerical and date/time data types in the previous list.

Specifying **FORMAT** for an unsupported combination of source and target data types causes error message BIP3205 to be issued.

For more information about conversion to and from numerical data types, see “Formatting and parsing numbers as strings” on page 1623. For more information about conversion to and from date/time data types, see “Formatting and parsing dateTimes as strings” on page 1626.

The **FORMAT** parameter is equivalent to those used in many other products, such as ICU and Microsoft Excel.

Examples:

Example 1. Formatted CAST from DECIMAL to CHARACTER

```
DECLARE source DECIMAL 31415.92653589;
DECLARE target CHARACTER;
DECLARE pattern CHARACTER '#,##0.00';
SET target = CAST(source AS CHARACTER FORMAT pattern);
-- target is now '31,415.93'
```

Example 2. Formatted CAST from DATE to CHARACTER

```
DECLARE now CHARACTER = CAST(CURRENT_TIMESTAMP AS CHARACTER
                             FORMAT 'yyyyMMdd-HHmss');
-- target is now '20041007-111656' (in this instance at least)
```

Example 3. Formatted CAST from CHARACTER to DATE

```
DECLARE source CHARACTER '01-02-03';
DECLARE target DATE;
DECLARE pattern CHARACTER 'dd-MM-yy';
SET target = CAST(source AS DATE FORMAT pattern);
-- target now contains Year=2003, Month=02, Day=01
```

Example 4. Formatted CAST from CHARACTER to TIMESTAMP

```
DECLARE source CHARACTER '12 Jan 03, 3:45pm';
DECLARE target TIMESTAMP;
DECLARE pattern CHARACTER 'dd MMM yy, h:mma';
SET target = CAST(source AS TIMESTAMP FORMAT pattern);
-- target now contains Year=2003, Month=01, Day=03, Hour=15, Minute=45,
                          Seconds=58
-- (seconds taken from CURRENT_TIME since not present in input)
```

Example 5. Formatted CAST from DECIMAL to CHARACTER, with negative pattern

```
DECLARE source DECIMAL -54231.122;
DECLARE target CHARACTER;
DECLARE pattern CHARACTER '#,##0.00;(#,##0.00)';
SET target = CAST(source AS CHARACTER FORMAT pattern);
-- target is now '£(54,231.12)'
```

Example 6. Formatted CAST from CHARACTER to TIME

```
DECLARE source CHARACTER '16:18:30';
DECLARE target TIME;
DECLARE pattern CHARACTER 'hh:mm:ss';
SET target = CAST(source AS TIME FORMAT pattern);
-- target now contains Hour=16, Minute=18, Seconds=30
```

Example 7. CASTs from the numeric types to DATE

```
CAST(7, 6, 5 AS DATE);  
CAST(7.4e0, 6.5e0, 5.6e0 AS DATE);  
CAST(7.6, 6.51, 5.4 AS DATE);
```

Example 8. CASTs from the numeric types to TIME

```
CAST(9, 8, 7 AS TIME);  
CAST(9.4e0, 8.6e0, 7.1234567e0 AS TIME);  
CAST(9.6, 8.4, 7.7654321 AS TIME);
```

Example 9. CASTs from the numeric types to GMTTIME

```
CAST(DATE '0001-02-03', TIME '04:05:06' AS TIMESTAMP);  
CAST(2, 3, 4, 5, 6, 7.8 AS TIMESTAMP);
```

Example 10. CASTs to TIMESTAMP

```
CAST(DATE '0001-02-03', TIME '04:05:06' AS TIMESTAMP);  
CAST(2, 3, 4, 5, 6, 7.8 AS TIMESTAMP);
```

Example 11. CASTs to GMTTIMESTAMP

```
CAST(DATE '0002-03-04', GMTTIME '05:06:07' AS GMTTIMESTAMP);  
CAST(3, 4, 5, 6, 7, 8 AS GMTTIMESTAMP);  
CAST(3.1e0, 4.2e0, 5.3e0, 6.4e0, 7.5e0, 8.6789012e0 AS GMTTIMESTAMP);  
CAST(3.2, 4.3, 5.4, 6.5, 7.6, 8.7890135 AS GMTTIMESTAMP);
```

Example 12. CASTs to INTERVAL from INTEGER

```
CAST(1234 AS INTERVAL YEAR);  
CAST(32, 10 AS INTERVAL YEAR TO MONTH);  
CAST(33, 11 AS INTERVAL DAY TO HOUR);  
CAST(34, 12 AS INTERVAL HOUR TO MINUTE);  
CAST(35, 13 AS INTERVAL MINUTE TO SECOND);  
CAST(36, 14, 10 AS INTERVAL DAY TO MINUTE);  
CAST(37, 15, 11 AS INTERVAL HOUR TO SECOND);  
CAST(38, 16, 12, 10 AS INTERVAL DAY TO SECOND);
```

Example 13. CASTs to INTERVAL from FLOAT

```
CAST(2345.67e0 AS INTERVAL YEAR);  
CAST(3456.78e1 AS INTERVAL MONTH);  
CAST(4567.89e2 AS INTERVAL DAY);  
CAST(5678.90e3 AS INTERVAL HOUR);  
CAST(6789.01e4 AS INTERVAL MINUTE);  
CAST(7890.12e5 AS INTERVAL SECOND);  
CAST(7890.1234e0 AS INTERVAL SECOND);
```

Example 14. CASTs to INTERVAL from DECIMAL

```
CAST(2345.67 AS INTERVAL YEAR);  
CAST(34567.8 AS INTERVAL MONTH);  
CAST(456789 AS INTERVAL DAY);  
CAST(5678900 AS INTERVAL HOUR);  
CAST(67890100 AS INTERVAL MINUTE);  
CAST(789012000 AS INTERVAL SECOND);  
CAST(7890.1234 AS INTERVAL SECOND);
```

Example 15. CASTs to FLOAT from INTERVAL

```
CAST(INTERVAL '1234' YEAR AS FLOAT);  
CAST(INTERVAL '2345' MONTH AS FLOAT);  
CAST(INTERVAL '3456' DAY AS FLOAT);  
CAST(INTERVAL '4567' HOUR AS FLOAT);  
CAST(INTERVAL '5678' MINUTE AS FLOAT);  
CAST(INTERVAL '6789.01' SECOND AS FLOAT);
```

Example 16. CASTs DECIMAL from INTERVAL

```
CAST(INTERVAL '1234' YEAR AS DECIMAL);
CAST(INTERVAL '2345' MONTH AS DECIMAL);
CAST(INTERVAL '3456' DAY AS DECIMAL);
CAST(INTERVAL '4567' HOUR AS DECIMAL);
CAST(INTERVAL '5678' MINUTE AS DECIMAL);
CAST(INTERVAL '6789.01' SECOND AS DECIMAL);
```

Example 17. A ternary cast that fails and results in the substitution of a default value

```
CAST(7, 6, 32 AS DATE DEFAULT DATE '1947-10-24');
```

Example 18. A sexternary cast that fails and results in the substitution of a default value

```
CAST(2, 3, 4, 24, 6, 7.8 AS TIMESTAMP DEFAULT TIMESTAMP '1947-10-24 07:08:09');
```

Example 19. A ternary cast that fails and throws an exception

```
BEGIN
  DECLARE EXIT HANDLER FOR SQLSTATE LIKE '%' BEGIN
    SET OutputRoot.XMLNS.Data.Date.FromIntegersInvalidCast = 'Exception thrown';
  END;

  DECLARE Dummy CHARACTER CAST(7, 6, 32 AS DATE);
END;
```

Example 20. A sexternary cast that fails and throws an exception

```
BEGIN
  DECLARE EXIT HANDLER FOR SQLSTATE LIKE '%' BEGIN
    SET OutputRoot.XMLNS.Data.Timestamp.FromIntegersInvalidCast = 'Exception thrown';
  END;

  DECLARE Dummy CHARACTER CAST(2, 3, 4, 24, 6, 7.8 AS TIMESTAMP);
END;
```

Formatting and parsing numbers as strings:

For conversions between string data types and numeric data types, you can supply, on the `FORMAT` parameter of the `CAST` function, an optional formatting expression.

For conversions *from* string types, the formatting expression defines how the source string should be parsed to fill the target data type.

For conversions *to* string types, the formatting expression defines how the data in the source expression is to be formatted in the target string.

You can specify a `FORMAT` expression for the following numeric conversions (Specifying a `FORMAT` expression for date/time conversions is described in “Formatting and parsing dateTimes as strings” on page 1626).

- From any of the string data types (BIT, BLOB, or CHARACTER) to:
 - DECIMAL
 - FLOAT
 - INTEGER
- To any of the string data types (BIT, BLOB, or CHARACTER) from any of the numeric data types that are in the previous list.

The formatting expression consists of three parts:

1. A subpattern that defines positive numbers.

2. An optional subpattern that defines negative numbers. (If only one subpattern is defined, negative numbers use the positive pattern, prefixed with a minus sign.)
3. The optional parameters `groupsep` and `decsep`.

Syntax

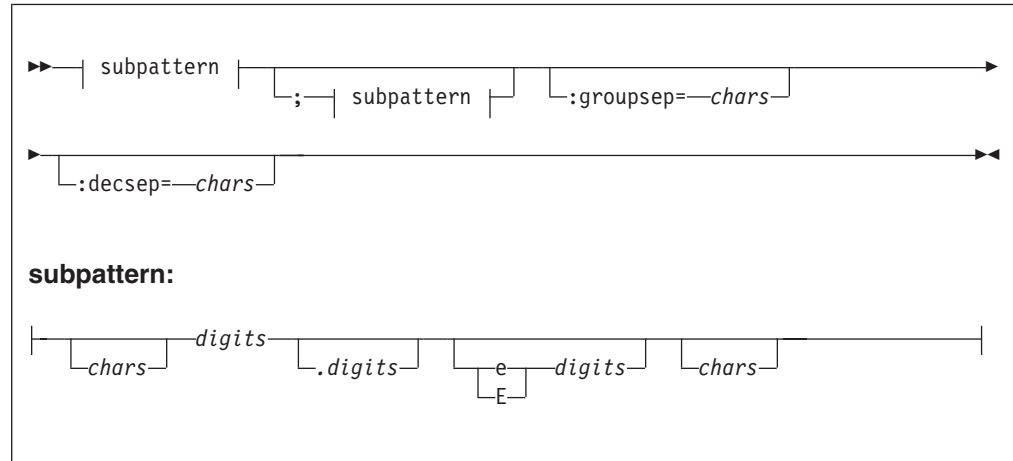

Parameters:

chars

A sequence of zero or more characters. All characters can be used, *except* the special characters that are listed under “subpattern” on page 1625.

decsep

One or more characters to be used as the separator between the whole and decimal parts of a number (the decimal separator). The default decimal separator is a period (.).

digits

A sequence of one or more of the numeric tokens (0 # - + , .) that are listed under “subpattern” on page 1625.

groupsep

One or more characters to be used as the separator between clusters of integers, to make large numbers more readable (the grouping separator). The default grouping separator is nothing (that is, there is no grouping of digits or separation of groups).

Grouping is commonly done in thousands, but it can be redefined by either the pattern or the locale. There are two grouping sizes:

The primary grouping size

Used for the least significant integer digits.

The secondary grouping size

Used for all other integer digits.

In most cases, the primary and secondary grouping sizes are the same, but they can be different. For example, if the pattern used is `#,##,##0`, the primary grouping size is 3 and the secondary is 2. The number 123456789 would become the string "12,34,56,789".

If multiple grouping separators are used (as in the previous example), the rightmost separator defines the primary size, and the penultimate rightmost separator defines the secondary size.

subpattern

The subpattern consists of:

1. An optional prefix (*chars*)
2. A mandatory pattern representing a whole number
3. An optional pattern representing decimal places
4. An optional pattern representing an exponent (the power by which the preceding number is raised)
5. An optional suffix (*chars*)

Parts 2, 3, and 4 of the subpattern are defined by the tokens in the following table.

Token	Represents
0	Any digit, including a leading zero.
#	Any digit, excluding a leading zero. (See the explanation of the difference between 0 and # that follows this table.)
.	Decimal separator.
+	Prefix of positive numbers.
-	Prefix of negative numbers.
,	Grouping separator.
E/e	Separates the number from the exponent.
;	Subpattern boundary.
'	Quotation mark, applied to special characters. If a quotation mark is needed in output, it must be doubled (").
*	Padding specifier. The character following the asterisk is used to pad the number to fit the length of the format pattern.

The # and 0 characters are used for digit substitution, the difference between them being that a # character is removed if there is no number to replace it with. For example, 10 formatted by the pattern `#,##0.00` gives "10.00", but formatted by `0,000.00` gives "0,010.00".

To specify padding characters, use an asterisk. When an asterisk is placed in either of the two *chars* regions (the prefix and suffix), the character immediately following it is used to pad the output. Padding can be specified only once. For example, a pattern of `*x#,###,##0.00` applied to 1234 gives "xxx1,234.00". But applied to 1234567, it gives "1,234,567.00".

Examples of formatting patterns:

The following table shows formatting patterns and the strings that are generated from sample numeric input.

Pattern	Input number	Output string
+###,##0.00;- ###,###,##0.00:groupsep='':decsep=,	123456789.123	"+123'456'789,12"
##0.00	1000000	"1000000.00"
##0.00	3.14159265	"3.14"

Formatting and parsing dateTimes as strings:

This section gives information on how you can specify the dateTime format using a string of pattern letters.

When you convert a date or time into a string, a format pattern must be applied that directs the conversion. Apply the format pattern to convert a date or time into a string, or to parse a string into a date or time.

During the conversion (for example, of a dateTime into a string), a pattern or a set of tokens is replaced with the equivalent source. The following diagram shows how a pattern is used to format a dateTime source to produce a character string output.

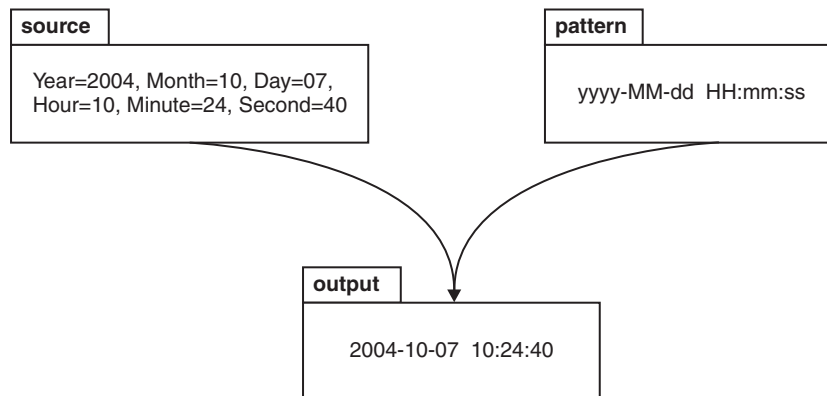

When a string is parsed (for example, when converting the string to a dateTime), the pattern or set of tokens is used to determine which part of the target dateTime is represented by which part of the string. The following diagram shows how this is done.

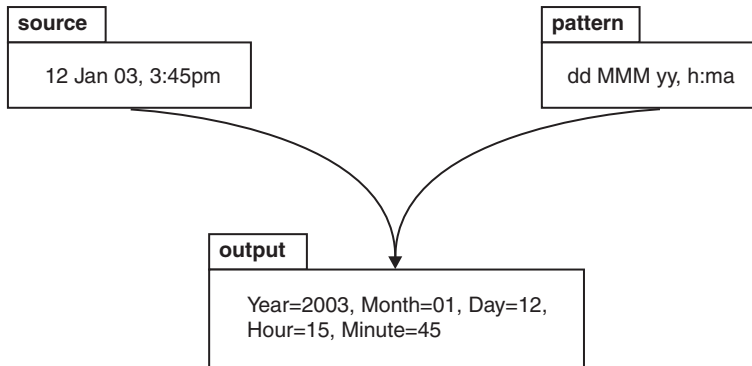

Syntax

The expression pattern is defined by:

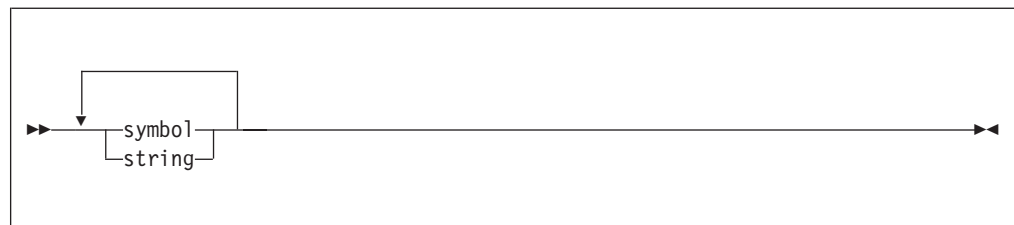

Where:

symbol

is a character in the set **adDeEFGhHIkKmMsSTUwWyYzZ**.

string is a sequence of characters enclosed in single quotation marks. If a single quotation mark is required within the string, use two single quotation marks ("").

Characters for formatting a dateTime as a string

The following table lists the characters that you can use in a pattern for formatting or parsing strings in relation to a dateTime. The table is followed by some notes that explain more about some of the examples in the table.

Symbol	Meaning	Presentation	Examples
a	am or pm marker	Text	Input am, AM, pm, PM. Output AM or PM
d	day in month (1-31)	Number	1, 20
dd	day in month (01-31)	Number	01, 31
D	day in year (1-366)	Number	3, 80, 100
DD	day in year (01-366)	Number	03, 80, 366
DDD	day in year (001-366)	Number	003
e	day in week (1-7) ¹	Number	2
EEE	day in week ¹	Text	Tue
EEEE	day in week ¹	Text	Tuesday

Symbol	Meaning	Presentation	Examples
F	day of week in month (1-5) ²	Number	2
G	Era	Text	BC or AD
h	hour in am or pm (1-12)	Number	6
hh	hour in am or pm (01-12)	Number	06
H	hour of day in 24 hour form (0-23) ³	Number	7
HH	hour of day in 24 hour form (00-23) ³	Number	07
I	ISO8601 Date/Time (up to yyyy-MM-dd'T'HH:mm:ss.SSSZZZ) ⁴	Text	2006-10-07T12:06:56.568+01:00
IU	ISO8601 Date/Time (similar to I, but ZZZ with output "Z" if the time zone is +00:00) ⁴	Text	2006-10-07T12:06:56.568+01:00, 2003-12-15T15:42:12.000Z
k	hour of day in 24 hour form (1-24) ³	Number	8
k	hour of day in 24 hour form (01-24) ³	Number	08
K	hour in am or pm (0-11)	Number	9
KK	hour in am or pm (00-11)	Number	09
m	minute	Number	4
mm	minute	Number	04
M	numeric month	Number	5, 12
MM	numeric month	Number	05, 12
MMM	named month	Text	Jan, Feb
MMMM	named month	Text	January, February
s	seconds	Number	5
ss	seconds	Number	05
S	decisecond ⁵	Number	7
SS	centisecond ⁵	Number	70
SSS	millisecond ⁵	Number	700
SSSS	0.0001 second ⁵	Number	7000
SSSSS	0.00001 second ⁵	Number	70000
SSSSSS	0.000001 second ⁵	Number	700000
T	ISO8601 Time (up to HH:mm:ss.SSSZZZ) ⁴	Text	12:06:56.568+01:00
TU	ISO8601 Time (similar to T, but a time zone of +00:00 is replaced with 'Z') ⁴	Text	12:06:56.568+01:00, 15:42:12.000Z
w	week in year ⁶	Number	7, 53
ww	week in year ⁶	Number	07, 53
W	week in month ⁷	Number	2
yy	year ⁸	Number	06

Symbol	Meaning	Presentation	Examples
yyyy	year ⁸	Number	2006
YY	year: use with week in year only ⁶	Number	06
YYYY	year: use with week in year only ⁶	Number	2006
zzz	time zone (abbreviated name)	Text	GMT
zzzz	time zone (full name)	Text	Greenwich Mean Time
Z	time zone (+/-n)	Text	+3
ZZ	time zone (+/-nn)	Text	+03
ZZZ	time zone (+/-nn:nn)	Text	+03:00
ZZZU	time zone (as ZZZ, "+00:00" is replaced by "Z")	Text	+03:00, Z
ZZZZ	time zone (GMT+/-nn:nn)	Text	GMT+03:00
ZZZZZ	time zone (as ZZZ, but no colon) (+/-nnnn)	Text	+0300
'	escape for text		'User text'
"	(two single quotation marks) single quotation mark within escaped text		'o'clock'

The presentation of the date`Time` object depends on what symbols you specify.

- **Text.** If you specify four or more of the symbols, the full form is presented. If you specify less than four symbols, the short or abbreviated form, if it exists, is presented. For example, EEEE produces Monday, EEE produces Mon.
- **Number.** The number of characters for a numeric date`Time` component must be within the bounds of the corresponding formatting symbols. Repeat the symbol to specify the minimum number of digits that are required. The maximum number of digits allowed is the upper bound for a particular symbol. For example, day in month has an upper bound of 31; therefore, a format string of d allows the values 2 or 21 to be parsed but disallows the values 32 and 210. On output, numbers are padded with zeros to the specified length. A year is a special case; see note 8 in the list below. Fractional seconds are also special case; see note 5 below.
- Any characters in the pattern that are not in the ranges of [`'a'..'z'`] and [`'A'..'Z'`] are treated as quoted text. For example, characters like colon (:), comma (,), period (.), the number sign (hash or pound, #), the at sign (@), and space appear in the resulting time text even if they are not enclosed within single quotes.
- You can create formatting strings that produce unpredictable results; therefore, you must use these symbols with care. For example, if you specify dMyyyy, you cannot distinguish between day, month, and year. dMyyyy tells the broker that a minimum of one character represents the day, a minimum of one character represents the month, and four characters represent the year. Therefore, 3111999 can be interpreted as either 3/11/1999 or 31/1/1999.

Notes: The following notes apply to the table above.

1. You can specify the following values in the day in week field:
 - 1 - Sunday

- 2 - Monday
 - 3 - Tuesday
 - 4 - Wednesday
 - 5 - Thursday
 - 6 - Friday
 - 7 - Saturday
2. 12th July 2006 is the second Wednesday in July and can be expressed as 2006 July Wednesday 2 using the format string yyyy MMMM EEEE F. Note that this format does not represent the Wednesday in week 2 of July 2006, which is 5th July 2006; the format string for this is yyyy MMMM EEEE W.
 3. 24-hour fields might result in an ambiguous time, if specified with a conflicting am/pm field.
 4. See "ISO8601, I and T DateTime tokens."
 5. Fractional seconds are represented by uppercase S. The length must implicitly match the number of format symbols on input. The format string ss SSS or ss.SSS, for example, represents seconds and milliseconds. However, the format string ss.sss represents a repeated field (of seconds); the value after the period (.) is taken as a seconds field, not as fractional seconds. The output is truncated to the specified length.
 6. In ESQL, the first day of the year is assumed to be in the first week; therefore, January 1 is always in week 1. As a result, dates that are specified relative to one year might actually be in a different year. For example, "Monday week 1 2005" parsed using "EEEE' week 'w' 'YYYY" gives a date of 2004-12-27, because the Monday of the first week in 2005 is actually a date in 2004.
If you use the y symbol, the adjustment is not done and unpredictable results might occur for dates around the end of the year. For example, if the string "2005 01 Monday" is formatted:
 - Monday of week 1 in 2005 using format string "YYYY ww EEEE" is correctly interpreted as 27th December 2004
 - Monday of week 1 in 2005 using format string "yyyy ww EEEE" is incorrectly interpreted as 27th December 2005
 7. The first and last week in a month might include days from neighboring months. For example, Monday 31st July 2006 can be expressed as *Monday in week one of August 2006*, which is 2006 08 1 Monday using format string yyyy MM W EEEE.
 8. Year is handled as a special case.
 - On output, if the count of y is 2, the year is truncated to 2 digits. For example, if yyyy produces 1997, yy produces 97.
 - On input, for 2 digit years the century window is fixed to 53. For example, an input date of 52 results in a year value of 2052, whereas an input date of 53 gives an output year of 1953, and 97 gives 1997.

ISO8601, I and T DateTime tokens

If your dateTime values comply with the ISO8601:2000 'Representation of dates and times' standard, consider using the formatting symbols I and T, which match the following subset of the ISO8601 standard.

- The restricted profile as proposed by the W3C at <http://www.w3.org/TR/NOTE-datetime>
- Truncated representations of calendar dates, as specified in section 5.2.1.3 of ISO8601:2000
 - Basic format (subsections c, e, and f)
 - Extended format (subsections a, b, and d)

Use the formatting symbols I and T only on their own:

- The I formatting symbol matches any dateTime string that conforms to the supported subset.
- The T formatting symbol matches any dateTime string that conforms to the supported subset that consists of a time portion only.

The following table shows how the output form relates to the logical data type.

Logical model data type	ESQL data type	Output form
xsd:dateTime	TIMESTAMP or GMTTIMESTAMP	yyyy-MM-dd'T'HH:mm:ss.SSSZZZ
xsd:date	DATE	yyyy-MM-dd
xsd:gYear	INTERVAL	yyyy
xsd:gYearMonth	INTERVAL	yyyy-MM
xsd:gMonth	INTERVAL	--MM
xsd:gmonthDay	INTERVAL	--MM-dd
xsd:gDay	INTERVAL	---dd
xsd:time	TIME / GMTTIME	'T'HH:mm:ss.SSSZZZ

Note:

- On input, both I and T accept both '+00:00' and 'Z' to indicate a zero time difference from Coordinated Universal Time (UTC), but on output they always generate '+00:00'. If you want 'Z' to always be generated on output, use the IU or TU formatting symbols instead.
- ZZZ always outputs '+00:00' to indicate a zero time difference from Coordinated Universal Time (UTC). If you want 'Z' to always be generated on output, use ZZZU instead.

Using the input UTC format on output

An element or attribute of logical type xsd:dateTime or xsd:time that contains a dateTime as a string can specify Coordinated Universal Time (UTC) by using either the Z symbol or time zone +00:00. On input, the MRM parser remembers the UTC format of such elements and attributes. On output, you can specify whether Z or +00:00 is displayed by using the Default DateTime Format property of the element or attribute. Alternatively, you can preserve the input UTC format by selecting the message set property Use input UTC format on output. If this property is selected, the UTC format is preserved in the output message and overrides the format that is implied by the dateTime format property.

Understanding daylight saving time and the CAST function

When the broker is running in a time zone other than GMT, it calculates the daylight saving time (DST) offset on times that are supplied to it by the CAST function. For CAST to calculate the offset correctly, the time passed into CAST

must have a time zone associated with it, as a Z parameter. If no time zone is associated with the value passed, the time is converted into GMT time; it is not treated as a local time stamp.

Also, when you use CAST to cast a string to a time value, the DST offset is calculated using the current system date. To cast a string to a time variable and calculate DST for a specific date, you must also specify the date.

For example, if timeValue='10:00:00', the following code, run on a broker that is in the Central Daylight Time zone, converts the time to GMT, because no time zone identifier is specified:

```
DECLARE castTime TIME;  
SET castTime = CAST (timeValue AS TIME FORMAT timePattern)
```

The time is not converted into GMT again if the castTime variable is used in any subsequent code, for example

```
CAST(castDate, castTime AS GMTTIMESTAMP);
```

Examples

The following table shows a few examples of dateTime formats.

Format pattern	Result
"yyyy.MM.dd 'at' HH:mm:ss ZZZ"	2006.07.10 at 15:08:56 -05:00
"EEE, MMM d, 'yy"	Wed, July 10, '06
"h:mm a"	8:08 PM
"hh o'clock a, ZZZZ"	09 o'clock AM, GMT+09:00
"K:mm a, ZZZ"	9:34 AM, -05:00
"yyyy.MMMMMM.dd hh:mm aaa"	1996.July.10 12:08 PM

SELECT function

The SELECT function combines, filters, and transforms complex message and database data.

Syntax

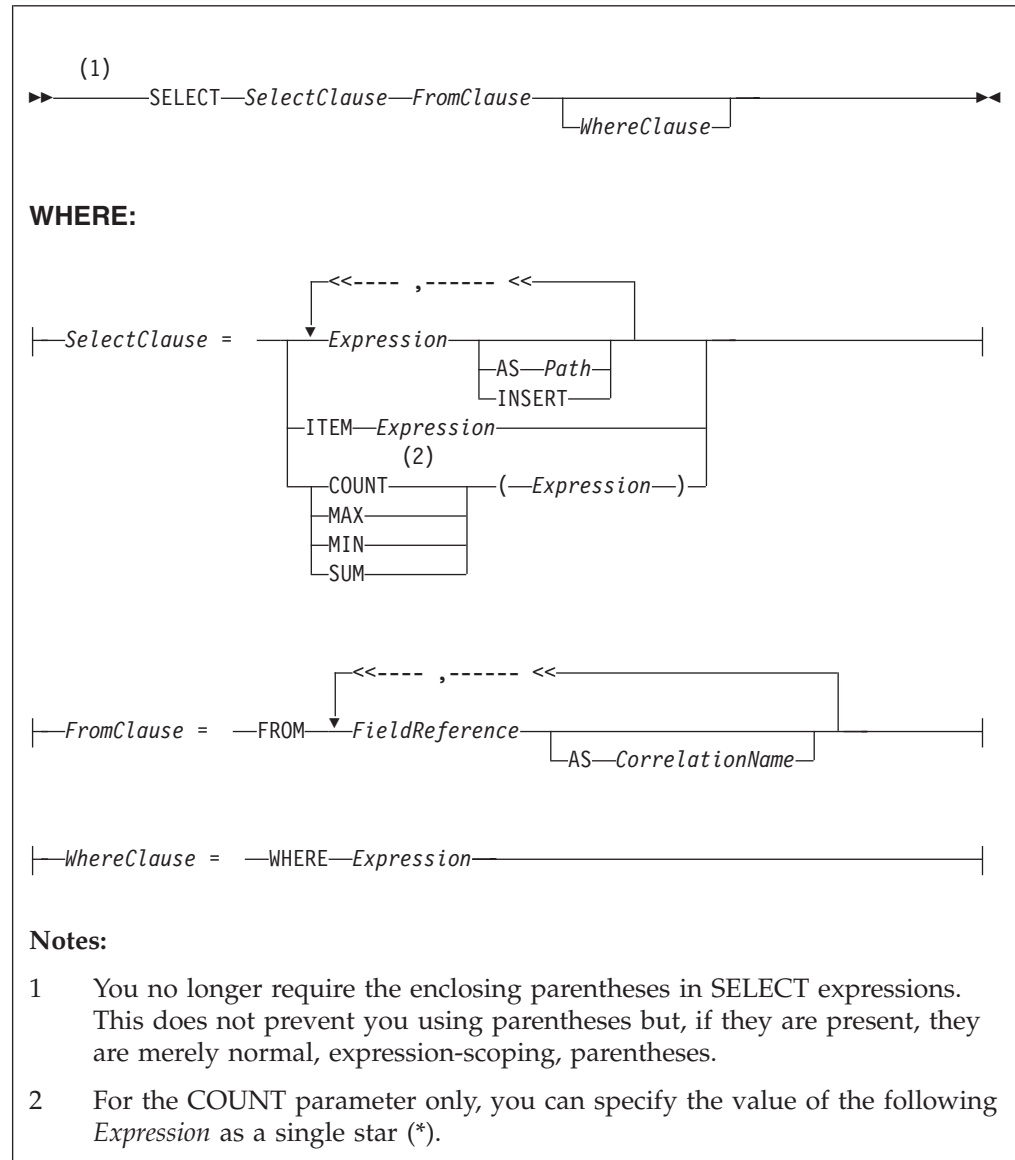

Usage

The SELECT function is the usual and most efficient way of transforming messages. You can use SELECT to:

- Comprehensively reformat messages
- Access database tables
- Make an output array that is a subset of an input array
- Make an output array that contains only the values of an input array
- Count the number of entries in an array
- Select the minimum or maximum value from a number of entries in an array
- Sum the values in an array

Introduction to SELECT

The SELECT function considers a message tree (or sub-tree) to consist of a number of rows and columns, rather like a database table. A *FieldReference* in a FROM clause identifies a field in a message tree. The identified field is regarded in the following ways:

- The identified field is regarded as a row in a table.
- The field's siblings are regarded as other rows of the same table.
- The field's children are regarded as the table's columns.

Note: The *FieldReference* in a FROM clause can also be a table reference that refers directly to a real database table.

The return value of the SELECT function is typically another message tree that contains rows whose structure and content is determined by the *SelectClause*. The number of rows in the result is the sum of all the rows pointed to by all the field references and table references in the FROM clause, filtered by the WHERE clause; only those fields for which the WHERE clause evaluates to TRUE are included.

The return value of the SELECT function can also be scalar (see "ITEM selections" on page 1636).

You can specify the *SelectClause* in several ways; see:

- "Simple selections"
- "INSERT selections" on page 1636
- "ITEM selections" on page 1636
- "Column function selections" on page 1636

If you have created a message flow that contains one of the following nodes, and the ESQL that is associated with this node includes a SELECT function and a database reference, you must specify a value for the Data source property of the relevant node:

- Compute
- Database
- Filter

Simple selections

To understand the SELECT function in more detail, first consider the following simple case:

- The *SelectClause* consists of a number of expressions, each with an AS *Path* clause.
- The FROM clause contains a single *FieldReference* and an AS *CorrelationName* clause.

The SELECT function creates a local, reference, correlation variable, whose name is given by the AS *CorrelationName* clause, and then steps, in turn, through each row of the list of rows derived from the FROM clause. For each row:

1. The correlation variable is set to point to the current row.
2. The WHERE clause (if present) is evaluated. If it evaluates to FALSE or unknown (null), nothing is added to the result tree and processing proceeds to the next row of the input. Otherwise processing proceeds to the next step.
3. A new member is added to the result list.

4. The SELECT clause expressions are evaluated and assigned to fields named as dictated by the AS *Path* clause. These fields are child fields of the new member of the result list.

Typically, both the *SelectClause* and the WHERE clause expressions use the correlation variable to access column values (that is, fields in the input message tree) and thus to build a new message tree containing data from the input message. The correlation variable is referred to by the name specified in the AS *CorrelationName* clause or, if an AS clause is not specified, by the final name in the FROM *FieldReference* (that is, the name after the last dot).

Note that:

- Despite the analogy with a table, you are not restricted to accessing or creating messages with a flat, table-like, structure; you can access and build trees with arbitrarily deep folder structures.
- You are not restricted to a column being a single value; a column can be a repeating list value or a structure.

These concepts are best understood by reference to the examples.

If the field reference is actually a *TableReference*, the operation is very similar. In this case, the input is a real database table and is thus restricted to the flat structures supported by databases. The result tree is still not so restricted, however.

If the FROM clause contains more than one field reference, the rightmost reference steps through each of its rows for each row in the next-to-rightmost reference, and so on. The total number of rows in the result is thus the product of the number of rows in each table. Such selects are known as *joins* and commonly use a WHERE clause that excludes most of these rows from the result. Joins are commonly used to add database data to messages.

The AS *Path* clause is optional. If it is unspecified, the broker generates a default name according to the following rules:

1. If the *SelectClause* expression is a reference to a field or a cast of a reference to a field, the name of the field is used.
2. Otherwise the broker uses the default names Column1, Column2, and so on.

Examples

The following example performs a SELECT on the table Parts in the schema Shop in the database DSN1. Because no WHERE clause exists, all rows are selected. Because the select clause expressions (for example, P.PartNumber) contain no AS clauses, the fields in the result adopt the same names:

```
SET PartsTable.Part[] = SELECT
  P.PartNumber,
  P.Description,
  P.Price
FROM Database.DSN1.Shop.Parts AS P;
```

If the target of the SET statement (PartsTable) is a variable of type ROW, after the statement is executed PartsTable will have, as children of its root element, a field called Part for each row in the table. Each of the Part fields will have child fields called PartNumber, Description, and Price. The child fields will have values dictated by the contents of the table. (PartsTable could also be a reference into a message tree).

The next example performs a similar SELECT. This case differs from the last in that the SELECT is performed on the message tree produced by the first example (rather than on a real database table). The result is assigned into a subfolder of OutputRoot:

```
SET OutputRoot.XMLNS.Data.TableData.Part[] = SELECT
    P.PartNumber,
    P.Description,
    P.Price
FROM PartsTable.Part[] AS P;
```

INSERT selections

The INSERT clause is an alternative to the AS clause. It assigns the result of the *SelectClause* expression (which must be a row) to the current new row itself, rather than to a child of it. The effect of this is to merge the row result of the expression into the row being generated by the SELECT. This differs from the AS clause, in that the AS clause always generates at least one child element before adding a result, whereas INSERT generates none. INSERT is useful when inserting data from other SELECT operations, because it allows the data to be merged without extra folders.

ITEM selections

The *SelectClause* can consist of the keyword ITEM and a single expression. The effect of this is to make the results nameless. That is, the result is a list of values of the type returned by the expression, rather than a row. This option has several uses:

- In conjunction with a scalar expression and the THE function, it can be used to create a SELECT query that returns a single scalar value (for example, the price of a particular item from a table).
- In conjunction with a CASE expression and ROW constructors, it can be used to create a SELECT query that creates or handles messages in which the structure of some rows (that is, repeats in the message) is different to others. This is useful for handling messages that have a repeating structure but in which the repeats do not all have the same structure.
- In conjunction with a ROW constructor, it can be used to create a SELECT query that collapses levels of repetition in the input message.

Column function selections

The *SelectClause* can consist of one of the functions COUNT, MAX, MIN, and SUM operating on an expression. These functions are known as column functions. They return a single scalar value (not a list) giving the count, maximum, minimum, or sum of the values that *Expression* evaluated to in stepping through the rows of the FROM clause. If *Expression* evaluates to NULL for a particular row, the value is ignored, so that the function returns the count, maximum, minimum, or sum of the remaining rows.

For the COUNT function only, *Expression* can consist of a single star (*). This form counts the rows regardless of null values.

To make the result a useful reflection of the input message, *Expression* typically includes the correlation variable.

Typically, *Expression* evaluates to the same data type for each row. In these cases, the result of the MAX, MIN, and SUM functions are of the same data type as the

operands. The returned values are not required to be all of the same type however, and if they are not, the normal rules of arithmetic apply. For example, if a field in a repeated message structure contains integer values for some rows and float values for others, the sum follows the normal rules for addition. The sum is of type float because the operation is equivalent to adding a number of integer and float values.

The result of the COUNT function is always an integer.

Differences between message and database selections

FROM expressions in which a correlation variable represents a row in a message behave slightly differently from those in which the correlation variable represents a row in a real database table.

In the message case, a path involving a star (*) has the normal meaning; it ignores the field's name and finds the first field that matches the other criteria (if any).

In the database case a star (*) has, for historical reasons, the special meaning of all fields. This special meaning requires advance knowledge of the definition of the database table and is supported only when querying the default database (that is, the database pointed to by the node's data source attribute). For example, the following queries return column name and value pairs only when querying the default database:

```
SELECT * FROM Database.Datasource.SchemaName.Table As A
SELECT A.* FROM Database.Datasource.SchemaName.Table As A
SELECT A FROM Database.Datasource.SchemaName.Table AS A
```

Specifying the SELECT expressions

SelectClause

SelectClause expressions can use any of the broker's operators and functions in any combination. They can refer to the tables' columns, message fields, correlation names declared by containing SELECTs, and to any other declared variables or constants that are in scope.

AS Path

An *AS Path* expression is a relative path (that is, there is no correlation name) but is otherwise unrestricted in any way. For example, it can contain:

- Indexes (for example, A.B.C[i])
- Field-type specifiers (for example, A.B.(XML.Attribute)C)
- Multipart paths (for example, A.B.C)
- Name expressions (for example, A.B.{var})

Any expressions in these paths can also use any of the broker's operators and functions in any combination. The expressions can refer to the tables' columns, message fields, correlation names declared by containing SELECTs, and any declared variables or constants.

FROM clause

FROM clause expressions can contain multiple database references, multiple message references, or a mixture of the two. You can join tables with tables, messages with messages, or tables with messages.

FROM clause *FieldReferences* can contain expressions of any kind (for example, Database.{DataSource}.{Schema}.Table1).

You can calculate a field, data source, schema, or table name at run time.

WHERE clause

The WHERE clause expression can use any of the broker's operators and functions in any combination. It can refer to table columns, message fields, and any declared variables or constants.

However, be aware that the broker treats the WHERE clause expression by examining the expression and deciding whether the whole expression can be evaluated by the database. If it can, it is given to the database. In order to be evaluated by the database, it must use only those functions and operators supported by the database.

The WHERE clause can, however, refer to message fields, correlation names declared by containing SELECT functions, and to any other declared variables or constants within scope.

If the whole expression cannot be evaluated by the database, the broker looks for top-level AND operators and examines each sub-expression separately. It then attempts to give the database those sub-expressions that it can evaluate, leaving the broker to evaluate the rest. You need to be aware of this situation for two reasons:

1. Apparently trivial changes to WHERE clause expressions can have large effects on performance. You can determine how much of the expression was given to the database by examining a user trace.
2. Some databases' functions exhibit subtle differences of behavior from those of the broker.

Relation to the THE function

You can use the function THE (which returns the first element of a list) in conjunction with SELECT to produce a non-list result. This is useful, for example, when a SELECT query is required to return no more than one item. It is particularly useful in conjunction with ITEM (see "ITEM selections" on page 1636).

Differences from the SQL standard

ESQL SELECT differs from database SQL SELECT in the following ways:

- ESQL can produce tree-structured result data
- ESQL can accept arrays in SELECT clauses
- ESQL has the THE function and the ITEM and INSERT parameters
- ESQL has no SELECT ALL function in this release
- ESQL has no ORDER BY function in this release
- ESQL has no SELECT DISTINCT function in this release
- ESQL has no GROUP BY or HAVING parameters in this release
- ESQL has no AVG column function in this release

Restrictions

The following restrictions apply to the current release:

- When a SELECT command operates on more than one database table, all the tables must be in the same database instance. (That is, the *TableReferences* must not specify different data source names.)
- If the FROM clause refers to both messages and tables, the tables must precede the messages in the list.

- Using dynamic DSN, SCHEMA and TABLE names with 'SELECT *' statements is not supported. If you use a schema, table or datasource name as a variable (dynamic variables) in 'SELECT *' queries, the variables are not resolved to the correct set of schema or table names.

ROW constructor function

ROW constructor is a complex function used to explicitly generate rows of values that can be assigned to fields in an output message.

Syntax

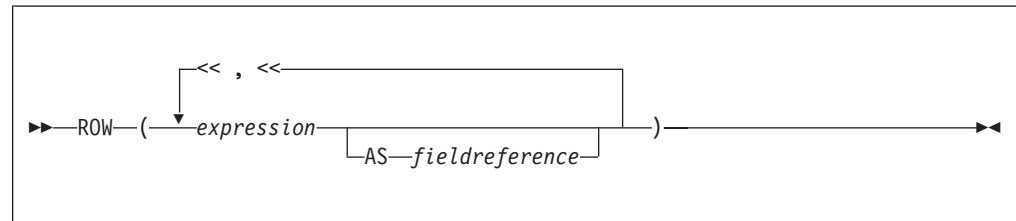

A ROW consists of a sequence of named values. When assigned to a field reference it creates that sequence of named values as child fields of the referenced field. A ROW cannot be assigned to an array field reference.

Examples:

Example 1

```
SET OutputRoot.XMLNS.Data = ROW('granary' AS bread,
                                'riesling' AS wine,
                                'stilton' AS cheese);
```

produces:

```
<Data>
  <bread>granary</bread>
  <wine>riesling</wine>
  <cheese>stilton</cheese>
</Data>
```

Example 2

Given the following XML input message body:

```
<Proof>
  <beer>5</beer>
  <wine>12</wine>
  <gin>40</gin>
</Proof>
```

the following ESQL:

```
SET OutputRoot.XMLNS.Data = ROW(InputBody.Proof.beer,
                                InputBody.Proof.wine AS vin,
                                (InputBody.Proof.gin * 2) AS special);
```

produces the following result:

```

<Data>
  <beer>5</beer>
  <vin>12</vin>
  <special>80</special>
</Data>

```

Because the values in this case are derived from field references that already have names, it is not necessary to explicitly provide a name for each element of the row, but you might choose to do so.

LIST constructor function

The LIST constructor complex function is used to explicitly generate lists of values that can be assigned to fields in an output message.

Syntax

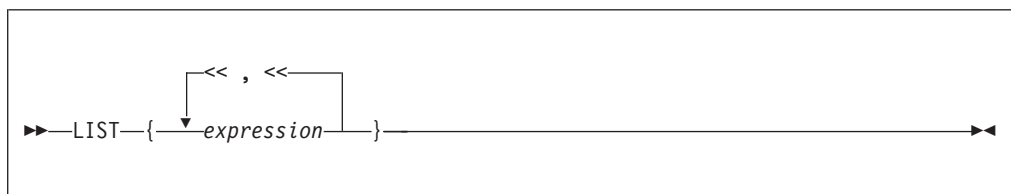

A LIST consists of a sequence of unnamed values. When assigned to an array field reference (indicated by `[]` suffixed to the last element of the reference), each value is assigned in sequence to an element of the array. A LIST cannot be assigned to a non-array field reference.

Examples:

Example 1

Given the following XML message input body:

```

<Car>
  <size>big</size>
  <color>red</color>
</Car>

```

The following ESQL:

```

SET OutputRoot.XMLNS.Data.Result[] = LIST{InputBody.Car.colour,
                                           'green',
                                           'blue'};

```

produces the following results:

```

<Data>
  <Result>red</Result>
  <Result>green</Result>
  <Result>blue</Result>
</Data>

```

In the case of a LIST, there is no explicit name associated with each value. The values are assigned in sequence to elements of the message field array specified as the target of the assignment. Curly braces rather than parentheses are used to surround the LIST items.

Example 2

Given the following XML input message body:

```
<Data>
  <Field>Keats</Field>
  <Field>Shelley</Field>
  <Field>Wordsworth</Field>
  <Field>Tennyson</Field>
  <Field>Byron</Field>
</Data>
```

the following ESQL:

```
-- Copy the entire input message to the output message,
-- including the XML message field array as above
SET OutputRoot = InputRoot;
SET OutputRoot.XMLNS.Data.Field[] = LIST{'Henri','McGough','Patten'};
```

Produces the following output:

```
<Data>
  <Field>Henri</Field>
  <Field>McGough</Field>
  <Field>Patten</Field>
</Data>
```

The previous members of the `Data.Field[]` array have been discarded. Assigning a new list of values to an already existing message field array removes all the elements in the existing array before the new ones are assigned.

ROW and LIST combined

ROW and LIST combined form a complex function.

A ROW might validly be an element in a LIST. For example:

```
SET OutputRoot.XMLNS.Data.Country[] =
  LIST{ROW('UK' AS name, 'pound' AS currency),
       ROW('US' AS name, 'dollar' AS currency),
       'default'};
```

produces the following result:

```
<Data>
  <Country>
    <name>UK</name>
    <currency>pound</currency>
  </Country>
  <Country>
    <name>US</name>
    <currency>dollar</currency>
  </Country>
  <Country>default</Country>
</Data>
```

ROW and non-ROW values can be freely mixed within a LIST.

A LIST cannot be a member of a ROW. Only named scalar values can be members of a ROW.

ROW and LIST comparisons

You can compare ROWs and LISTs against other ROWs and LISTs.

Examples:

Example 1

```
IF ROW(InputBody.Data.*[1],InputBody.Data.*[2]) =  
    ROW('Raf' AS Name,'25' AS Age) THEN ...  
IF LIST{InputBody.Data.Name, InputBody.Data.Age} = LIST{'Raf','25'} THEN ...
```

With the following XML input message body both the IF expressions in both the above statements evaluate to TRUE:

```
<Data>  
  <Name>Raf</Name>  
  <Age>25</Age>  
</Data>
```

In the comparison between ROWs, both the name and the value of each element are compared; in the comparison between LISTs only the value of each element is compared. In both cases, the cardinality and sequential order of the LIST or ROW operands being compared must be equal in order for the two operands to be equal. In other words, all the following are false because either the sequential order or the cardinality of the operands being compared do not match:

```
ROW('alpha' AS A, 'beta' AS B) =  
    ROW('alpha' AS A, 'beta' AS B, 'delta' AS D)  
ROW('alpha' AS A, 'beta' AS B) =  
    ROW('beta' AS B, 'alpha' AS A)  
LIST{1,2,3} = LIST{1,2,3,4}  
LIST{3,2,1} = LIST{1,2,3}
```

Example 2

Consider the following ESQL:

```
IF InputBody.Places =  
    ROW('Ken' AS first, 'Bob' AS second, 'Kate' AS third) THEN ...
```

With the following XML input message body, the above IF expression evaluates to TRUE:

```
<Places>  
  <first>Ken</first>  
  <second>Bob</second>  
  <third>Kate</third>  
</Places>
```

The presence of an explicitly-constructed ROW as one of the operands to the comparison operator results in the other operand also being treated as a ROW.

Contrast this with a comparison such as:

```
IF InputBody.Lottery.FirstDraw = InputBody.Lottery.SecondDraw THEN ...
```

which compares the value of the FirstDraw and SecondDraw fields, not the names and values of each of FirstDraw and SecondDraw's child fields constructed as a ROW. Thus an XML input message body such as:

```
<Lottery>  
  <FirstDraw>wednesday  
    <ball1>32</ball1>  
    <ball2>12</ball2>  
  </FirstDraw>
```

```

    <SecondDraw>saturday
      <ball1>32</ball1>
      <ball2>12</ball2>
    </SecondDraw>
  </Lottery>

```

would not result in the above IF expression being evaluated as TRUE, because the values wednesday and saturday are being compared, not the names and values of the ball fields.

Example 3

Consider the following ESQL:

```
IF InputBody.Cities.City[] = LIST{'Athens','Sparta','Thebes'} THEN ...
```

With the following XML input message body, the IF expression evaluates to TRUE:

```

<Cities>
  <City>Athens</City>
  <City>Sparta</City>
  <City>Thebes</City>
</Cities>

```

Two message field arrays can be compared together in this way, for example:

```
IF InputBody.Cities.Mediaeval.City[] =
    InputBody.Cities.Modern.City[] THEN ...
```

```
IF InputBody.Cities.Mediaeval.*[] = InputBody.Cities.Modern.*[] THEN ...
```

```
IF InputBody.Cities.Mediaeval.(XML.Element)[] =
    InputBody.Cities.Modern.(XML.Element)[] THEN ...
```

With the following XML input message body, the IF expression of the first and third of the statements above evaluates to TRUE:

```

<Cities>
  <Mediaeval>1350
    <City>London</City>
    <City>Paris</City>
  </Mediaeval>
  <Modern>1990
    <City>London</City>
    <City>Paris</City>
  </Modern>
</Cities>

```

However the IF expression of the second statement evaluates to FALSE, because the *[] indicates that all the children of Mediaeval and Modern are to be compared, not just the (XML.Element)s. In this case the values 1350 and 1990, which form nameless children of Mediaeval and Modern, are compared as well as the values of the City tags.

The IF expression of the third statement above evaluates to TRUE with an XML input message body such as:

```

<Cities>
  <Mediaeval>1350
    <Location>London</Location>
    <Location>Paris</Location>
  </Mediaeval>
  <Modern>1990

```

```

    <City>London</City>
    <City>Paris</City>
  </Modern>
</Cities>

```

LISTs are composed of unnamed values. It is the values of the child fields of Mediaeval and Modern that are compared, not their names.

Supported casts

This topic lists the CASTs that are supported between combinations of data-types.

A CAST is not supported between every combination of data-types. Those that are supported are listed below, along with the effect of the CAST.

When casting, there can be a one-to-one or a many-to-one mapping between the source data-type and the target data-type. An example of a one-to-one mapping is where the source data-type is a single integer and the target data-type a single float. An example of a many-to-one mapping is where the source data consists of three integers that are converted to a single date. Table 275 lists the supported one-to-one casts. Table 276 on page 1651 lists the supported many-to-one casts.

See “ESQL data types” on page 259 for information about precision, scale, and interval qualifier.

Table 275. Supported casts: one-to-one mappings of source to target data-type

Source data-type	Target data-type	Effect
BIT	BIT	The result is the same as the input.
BIT	BLOB	The bit array is converted to a byte array with a maximum of 2^{63} elements. An error is reported if the source is not of a suitable length to produce a BLOB (that is a multiple of 8).
BIT	CHARACTER	<p>The result is a string conforming to the definition of a bit string literal whose interpreted value is the same as the source value. The resulting string has the form B'bbbbbb' (where b is either 0 or 1).</p> <p>If you specify either a CCSID or ENCODING clause, the bit array is assumed to be characters in the specified CCSID and encoding, and is code-page converted into the character return value.</p> <p>If you specify only a CCSID, big endian encoding is assumed.</p> <p>If you specify only an encoding, a CCSID of 1208 is assumed.</p> <p>This function reports conversion errors if the code page or encoding are unknown, the data supplied is not an integral number of characters of the code page, or the data contains characters that are not valid in the given code page.</p>
BIT	INTEGER	The bit array has a maximum of 2^{63} elements and is converted to an integer. An error is reported if the source is not of the correct length to match an integer.
BLOB	BIT	The given byte array is converted to a bit array with a maximum of 2^{63} elements.
BLOB	BLOB	The result is the same as the input.

Table 275. Supported casts: one-to-one mappings of source to target data-type (continued)

Source data-type	Target data-type	Effect
BLOB	CHARACTER	<p>The result is a string conforming to the definition of a binary string literal whose interpreted value is the same as the source value. The resulting string has the form X'hhhh' (where h is any hexadecimal character).</p> <p>If you specify either a CCSID or ENCODING clause, the byte array is assumed to be characters in the specified CCSID and encoding, and is code-page converted into the character return value.</p> <p>If you specify only a CCSID, big endian encoding is assumed.</p> <p>If you specify only an encoding, a CCSID of 1208 is assumed.</p> <p>This function reports conversion errors if the code page or encoding are unknown, the data supplied is not an integral number of characters of the code page, or the data contains characters that are not valid in the given code page.</p>
BLOB	INTEGER	<p>The byte array has a maximum of 2⁶³ elements and is converted to an integer. An error is reported if the source is not of the correct length to match an integer.</p>
BOOLEAN	BOOLEAN	<p>The result is the same as the input.</p>
BOOLEAN	CHARACTER	<p>If the source value is TRUE, the result is the character string TRUE. If the source value is FALSE, the result is the character string FALSE. Because the UNKNOWN Boolean value is the same as the NULL value for Booleans, the result is NULL if the source value is UNKNOWN.</p>
CHARACTER	BIT	<p>The character string must conform to the rules for a bit string literal or for the contents of the bit string literal. That is, the character string can be of the form B'bbbbbb' or bbbbb (where b' can be either 0 or 1).</p> <p>If you specify either a CCSID or ENCODING clause, the character string is converted into the specified CCSID and encoding and placed without further conversion into the bit array return value.</p> <p>If you specify only a CCSID, big endian encoding is assumed.</p> <p>If you specify only an encoding, a CCSID of 1208 is assumed.</p> <p>This function reports conversion errors if the code page or encoding are unknown or the data contains Unicode characters that cannot be converted to the given code page.</p>

Table 275. Supported casts: one-to-one mappings of source to target data-type (continued)

Source data-type	Target data-type	Effect
CHARACTER	BLOB	<p>This cast can work in two ways:</p> <ol style="list-style-type: none"> 1. If you specify either a CCSID or ENCODING clause, the whole string is written out in the code page or encoding that you requested. For example, the string "Cat" in CCSID 850 becomes the three-byte array in hexadecimal, 43,61,74. 2. If you specify neither the CCSID nor ENCODING clause, the string must itself contain two-character hexadecimal digits of the form X'hhhhhh' or hhhhhh (where h can be any hexadecimal characters). In this case, the input string "436174" becomes the same three-byte binary array (43,61,74). <p>Note that an error is generated if the input string is not of the correct format.</p> <p>If you specify only a CCSID, big endian encoding is assumed.</p> <p>If you specify only an encoding, a CCSID of 1208 is assumed.</p> <p>This function reports conversion errors if the code page or encoding are unknown or the data contains Unicode characters that cannot be converted to the given code page.</p>
CHARACTER	BOOLEAN	<p>The character string is interpreted in the same way as a Boolean literal. That is, the character string must be one of the strings TRUE, FALSE, or UNKNOWN (in any case combination).</p>
CHARACTER	CHARACTER	<p>The result is the same as the input.</p>
CHARACTER	DATE	<p>If a FORMAT clause is not specified, the character string must conform to the rules for a date literal or the date string. That is, the character string can be either DATE '2002-10-05' or 2002-10-05.</p> <p>See also "Formatting and parsing dateTimes as strings" on page 1626.</p>
CHARACTER	DECIMAL	<p>The character string is interpreted in the same way as an exact numeric literal to form a temporary decimal result with a scale and precision defined by the format of the string. This is converted into a decimal of the specified precision and scale, with a runtime error being generated if the conversion results in loss of significant digits.</p> <p>If you do not specify the precision and scale, the precision and scale of the result are the minimum necessary to hold the given value.</p> <p>The behavior changes if the FORMAT clause is specified. See also "Formatting and parsing numbers as strings" on page 1623.</p>
CHARACTER	FLOAT	<p>The character string is interpreted in the same way as a floating point literal.</p> <p>The behavior changes if the FORMAT clause is specified. See also "Formatting and parsing numbers as strings" on page 1623.</p>
CHARACTER	GMTTIME	<p>The character string must conform to the rules for a GMT time literal or the time string. That is, the character string can be either GMTTIME '09:24:15' or 09:24:15.</p> <p>The behavior changes if the FORMAT clause is specified. See also "Formatting and parsing dateTimes as strings" on page 1626.</p>

Table 275. Supported casts: one-to-one mappings of source to target data-type (continued)

Source data-type	Target data-type	Effect
CHARACTER	GMTTIMESTAMP	The character string must conform to the rules for a GMT timestamp literal or the timestamp string. That is, the character string can be either GMTTIMESTAMP '2002-10-05 09:24:15' or 2002-10-05 09:24:15. The behavior changes if the FORMAT clause is specified. See also "Formatting and parsing dateTimes as strings" on page 1626.
CHARACTER	INTEGER	The character string is interpreted in the same way as an integer literal. The behavior changes if the FORMAT clause is specified. See also "Formatting and parsing numbers as strings" on page 1623.
CHARACTER	INTERVAL	The character string must conform to the rules for an interval literal with the same interval qualifier as specified in the CAST function, or it must conform to the rules for an interval string that apply for the specified interval qualifier.
CHARACTER	TIME	The character string must conform to the rules for a time literal or for the time string. That is, the character string can be either TIME '09:24:15' or 09:24:15. The behavior changes if the FORMAT clause is specified. See also "Formatting and parsing dateTimes as strings" on page 1626.
CHARACTER	TIMESTAMP	The character string must conform to the rules for a timestamp literal or for the timestamp string. That is, the character string can be either TIMESTAMP '2002-10-05 09:24:15' or 2002-10-05 09:24:15. The behavior changes if the FORMAT clause is specified. See also "Formatting and parsing dateTimes as strings" on page 1626.
DATE	CHARACTER	The result is a string conforming to the definition of a date literal, whose interpreted value is the same as the source date value. For example: CAST (DATE '2002-10-05' AS CHARACTER) returns DATE '2002-10-05' The behavior changes if the FORMAT clause is specified. See also "Formatting and parsing dateTimes as strings" on page 1626.
DATE	DATE	The result is the same as the input.
DATE	GMTTIMESTAMP	The result is a value whose date fields are taken from the source date value, and whose time fields are taken from the current GMT time.
DATE	TIMESTAMP	The result is a value whose date fields are taken from the source date value, and whose time fields are taken from the current time.
DECIMAL	CHARACTER	The result is the shortest character string that conforms to the definition of an exact numeric literal and whose interpreted value is the value of the decimal. The behavior changes if the FORMAT clause is specified. See also "Formatting and parsing numbers as strings" on page 1623.
DECIMAL	DECIMAL	The value is converted to the specified precision and scale, with a runtime error being generated if the conversion results in loss of significant digits. If you do not specify the precision and scale, the value, precision and scale are preserved; it is a NOOP (no operation).

Table 275. Supported casts: one-to-one mappings of source to target data-type (continued)

Source data-type	Target data-type	Effect
DECIMAL	FLOAT	The number is converted, with rounding if necessary.
DECIMAL	INTEGER	The value is rounded and converted into an integer, with a runtime error being generated if the conversion results in loss of significant digits.
DECIMAL	INTERVAL	If the interval qualifier specified has only one field, the result is an interval with that qualifier with the field equal to the value of the exact numeric. Otherwise a runtime error is generated.
FLOAT	CHARACTER	The result is the shortest character string that conforms to the definition of an approximate numeric literal and whose mantissa consists of a single digit that is not 0, followed by a period and an unsigned integer, and whose interpreted value is the value of the float. The behavior changes if the FORMAT clause is specified. See also "Formatting and parsing numbers as strings" on page 1623.
FLOAT	FLOAT	The result is the same as the input.
FLOAT	DECIMAL	The value is rounded and converted into a decimal of the specified precision and scale, with a runtime error being generated if the conversion results in loss of significant digits. If you do not specify the precision and scale, the precision and scale of the result are the minimum necessary to hold the given value.
FLOAT	INTEGER	The value is rounded and converted into an integer, with a runtime error being generated if the conversion results in loss of significant digits.
FLOAT	INTERVAL	If the specified interval qualifier has only one field, the result is an interval with that qualifier with the field equal to the value of the numeric. Otherwise a runtime error is generated.
GMTTIME	CHARACTER	The result is a string conforming to the definition of a GMTTIME literal whose interpreted value is the same as the source value. The resulting string has the form GMTTIME 'hh:mm:ss'. The behavior changes if the FORMAT clause is specified. See also "Formatting and parsing dateTimes as strings" on page 1626.
GMTTIME	GMTTIME	The result is the same as the input.
GMTTIME	TIME	The resulting value is the source value plus the local time zone displacement (as returned by LOCAL_TIMEZONE). The hours field is calculated modulo 24.
GMTTIME	GMTTIMESTAMP	The result is a value whose date fields are taken from the current date, and whose time fields are taken from the source GMT time.
GMTTIME	TIMESTAMP	The result is a value whose date fields are taken from the current date, and whose time fields are taken from the source GMT time, plus the local time zone displacement (as returned by LOCAL_TIMEZONE).
GMTTIMESTAMP	CHARACTER	The result is a string conforming to the definition of a GMTTIMESTAMP literal whose interpreted value is the same as the source value. The resulting string has the form GMTTIMESTAMP 'yyyy-mm-dd hh:mm:ss'. The behavior changes if the FORMAT clause is specified. See also "Formatting and parsing dateTimes as strings" on page 1626.
GMTTIMESTAMP	DATE	The result is a value whose fields consist of the date fields of the source GMTTIMESTAMP value.

Table 275. Supported casts: one-to-one mappings of source to target data-type (continued)

Source data-type	Target data-type	Effect
GMTTIMESTAMP	GMTTIME	The result is a value whose fields consist of the time fields of the source GMTTIMESTAMP value.
GMTTIMESTAMP	TIME	The result is a value whose time fields are taken from the source GMTTIMESTAMP value, plus the local time zone displacement (as returned by LOCAL_TIMEZONE). The hours field is calculated modulo 24.
GMTTIMESTAMP	GMTTIMESTAMP	The result is the same as the input.
GMTTIMESTAMP	TIMESTAMP	The resulting value is source value plus the local time zone displacement (as returned by LOCAL_TIMEZONE).
INTEGER	BIT	The given integer is converted to a bit array with a maximum of 2 ⁶³ elements.
INTEGER	BLOB	The given integer is converted to a byte array with a maximum of 2 ⁶³ elements.
INTEGER	CHARACTER	The result is the shortest character string that conforms to the definition of an exact numeric literal and whose interpreted value is the value of the integer. The behavior changes if the FORMAT clause is specified. See also "Formatting and parsing numbers as strings" on page 1623.
INTEGER	FLOAT	The number is converted, with rounding if necessary.
INTEGER	INTEGER	The result is the same as the input.
INTEGER	DECIMAL	The value is converted into a decimal of the specified precision and scale, with a runtime error being generated if the conversion results in loss of significant digits. If you do not specify the precision and scale, the precision and scale of the result are the minimum necessary to hold the given value.
INTEGER	INTERVAL	If the interval qualifier specified has only one field, the result is an interval with that qualifier with the field equal to the value of the exact numeric. Otherwise a runtime error is generated.
INTERVAL	CHARACTER	The result is a string conforming to the definition of an INTERVAL literal, whose interpreted value is the same as the source interval value. For example: CAST(INTERVAL '4' YEARS AS CHARACTER) returns INTERVAL '4' YEARS
INTERVAL	DECIMAL	If the interval value has a qualifier that has only one field, the result is a decimal of the specified precision and scale with that value, with a runtime error being generated if the conversion results in loss of significant digits. If the interval has a qualifier with more than one field, such as YEAR TO MONTH, a runtime error is generated. If you do not specify the precision and scale, the precision and scale of the result are the minimum necessary to hold the given value.
INTERVAL	FLOAT	If the interval value has a qualifier that has only one field, the result is a float with that value. If the interval has a qualifier with more than one field, such as YEAR TO MONTH, a runtime error is generated.
INTERVAL	INTEGER	If the interval value has a qualifier that has only one field, the result is an integer with that value. If the interval has a qualifier with more than one field, such as YEAR TO MONTH, a runtime error is generated.

Table 275. Supported casts: one-to-one mappings of source to target data-type (continued)

Source data-type	Target data-type	Effect
INTERVAL	INTERVAL	<p>The result is the same as the input.</p> <p>Year-month intervals can be converted only to year-month intervals, and day-second intervals only to day-second intervals. The source interval is converted into a scalar in units of the least significant field of the target interval qualifier. This value is normalized into an interval with the target interval qualifier. For example, to convert an interval that has the qualifier MINUTE TO SECOND into an interval with the qualifier DAY TO HOUR, the source value is converted into a scalar in units of hours, and this value is normalized into an interval with qualifier DAY TO HOUR.</p>
TIME	CHARACTER	<p>The result is a string conforming to the definition of a TIME literal, whose interpreted value is the same as the source time value.</p> <p>For example: <code>CAST(TIME '09:24:15' AS CHARACTER)</code></p> <p>returns <code>TIME '09:24:15'</code></p> <p>The behavior changes if the FORMAT clause is specified. See also “Formatting and parsing dateTimes as strings” on page 1626.</p>
TIME	GMTTIME	<p>The result value is the source value minus the local time zone displacement (as returned by LOCAL_TIMEZONE). The hours field is calculated modulo 24.</p>
TIME	GMTTIMESTAMP	<p>The result is a value whose date fields are taken from the current date, and whose time fields are taken from the source GMT time, minus the local time zone displacement (as returned by LOCAL_TIMEZONE).</p>
TIME	TIME	<p>The result is the same as the input.</p>
TIME	TIMESTAMP	<p>The result is a value whose date fields are taken from the current date, and whose time fields are taken from the source time value.</p>
TIMESTAMP	CHARACTER	<p>The result is a string conforming to the definition of a TIMESTAMP literal, whose interpreted value is the same as the source timestamp value.</p> <p>For example: <code>CAST(TIMESTAMP '2002-10-05 09:24:15' AS CHARACTER)</code></p> <p>returns <code>TIMESTAMP '2002-10-05 09:24:15'</code></p> <p>The behavior changes if the FORMAT clause is specified. See also “Formatting and parsing dateTimes as strings” on page 1626.</p>
TIMESTAMP	DATE	<p>The result is a value whose fields consist of the date fields of the source timestamp value.</p>
TIMESTAMP	GMTTIME	<p>The result is a value whose time fields are taken from the source TIMESTAMP value, minus the local time zone displacement (as returned by LOCAL_TIMEZONE). The hours field is calculated modulo 24.</p>
TIMESTAMP	GMTTIMESTAMP	<p>The resulting value is the source value minus the local time zone displacement (as returned by LOCAL_TIMEZONE).</p>
TIMESTAMP	TIME	<p>The result is a value whose fields consist of the time fields of the source timestamp value.</p>

Table 275. Supported casts: one-to-one mappings of source to target data-type (continued)

Source data-type	Target data-type	Effect
TIMESTAMP	TIMESTAMP	The result is the same as the input.

Table 276. Supported casts: many-to-one mappings of source to target data-type

Source data-type	Target data-type	Effect
Numeric, Numeric, Numeric	DATE	Creates a DATE value from the numerics in the order year, month, and day. Non-integer values are rounded.
Numeric, Numeric, Numeric	TIME	Creates a TIME value from the numerics in the order hours, minutes, and seconds. Non-integer values for hours and minutes are rounded.
Numeric, Numeric, Numeric	GMTIME	Creates a GMTIME value from the numerics in the order of hours, minutes, and seconds. Non-integer values for hours and minutes are rounded.
Numeric, Numeric, Numeric, Numeric, Numeric, Numeric	TIMESTAMP	Creates a TIMESTAMP value from the numerics in the order years, months, days, hours, minutes, and seconds. Non-integer values for years, months, days, hours, and minutes are rounded.
Numeric, Numeric, Numeric, Numeric, Numeric, Numeric	GMTTIMESTAMP	Creates a GMTTIMESTAMP value from the numerics in the order years, months, days, hours, minutes, and seconds. Non-integer values for years, months, days, hours, and minutes are rounded.
DATE, TIME	TIMESTAMP	The result is a TIMESTAMP value with the given DATE and TIME.
DATE, GMTIME	GMTTIMESTAMP	The result is a GMTTIMESTAMP value with the given DATE and GMTIME.
Numeric, Numeric	INTERVAL YEAR TO MONTH	The result is an INTERVAL with the first source as years and the second as months. Non-integer values are rounded.
Numeric, Numeric	INTERVAL HOUR TO MINUTE	The result is an INTERVAL with the first source as hours and the second as minutes. Non-integer values are rounded.
Numeric, Numeric, Numeric	INTERVAL HOUR TO SECOND	The result is an INTERVAL with the sources as hours, minutes, and seconds, respectively. Non-integer values for hours and minutes are rounded.
Numeric, Numeric	INTERVAL MINUTE TO SECOND	The result is an INTERVAL with the sources as minutes and seconds, respectively. Non-integer values for minutes are rounded.
Numeric, Numeric	INTERVAL DAY TO HOUR	The result is an INTERVAL with the sources as days and hours, respectively. Non-integer values are rounded.
Numeric, Numeric, Numeric	INTERVAL DAY TO MINUTE	The result is an INTERVAL with the sources as days, hours, and minutes, respectively. Non-integer values are rounded.
Numeric, Numeric, Numeric, Numeric	INTERVAL DAY TO SECOND	The result is an INTERVAL with the sources as days, hours, minutes, and seconds, respectively. Non-integer values for days, hours, and minutes are rounded.
Numeric	INTERVAL YEAR	The result is an INTERVAL with the source as years, rounded if necessary.
Numeric	INTERVAL MONTH	The result is an INTERVAL with the source as months, rounded if necessary.
Numeric	INTERVAL DAY	The result is an INTERVAL with the source as days, rounded if necessary.
Numeric	INTERVAL HOUR	The result is an INTERVAL with the source as hours, rounded if necessary.
Numeric	INTERVAL MINUTE	The result is an INTERVAL with the source as minutes, rounded if necessary.

Table 276. Supported casts: many-to-one mappings of source to target data-type (continued)

Source data-type	Target data-type	Effect
Numeric	INTERVAL SECOND	The result is an INTERVAL with the source as seconds.

Implicit casts

This topic discusses implicit casts.

It is not always necessary to cast values between types. Some casts are done implicitly. For example, numbers are implicitly cast between the three numeric types for the purposes of comparison and arithmetic. Character strings are also implicitly cast to other data types for the purposes of comparison.

There are three situations in which a data value of one type is cast to another type implicitly. The behavior and restrictions of the implicit cast are the same as described for the explicit cast function, except where noted in the topics listed below.

Implicit CASTs for comparisons

The standard SQL comparison operators $>$, $<$, $>=$, $<=$, $=$, $<>$ are supported for comparing two values in ESQL.

When the data types of the two values are not the same, one of them can be implicitly cast to the type of the other to allow the comparison to proceed. In the table below, the vertical axis represents the left hand operand, the horizontal axis represents the right hand operand.

L means that the right hand operand is cast to the type of the left hand operand before comparison; R means the opposite; X means that no implicit casting takes place; a blank means that comparison between the values of the two data types is not supported.

	ukn	bln	int	float	dec	char	time	gtm	date	ts	gts	ivl	blob	bit
ukn														
bln		X				L								
int			X	R	R	L								
float			L	X	L	L								
dec			L	R	X	L								
chr		R	R	R	R	X	R	R	R	R	R	R ¹	R	R
tm						L	X	L						
gtm						L	R	X						
dt						L			X	R ²	R ²			
ts						L			L ²	X	L			
gts						L			L ²	R	X			
ivl						L ¹						X		
blb						L							X	
bit						L								X

	ukn	bln	int	float	dec	char	time	gtm	date	ts	gts	ivl	blob	bit
Notes:														
1. When casting from a character string to an interval, the character string must be of the format INTERVAL ' <code><values></code> ' <code><qualifier></code> . The format <code><values></code> , which is allowed for an explicit CAST, is not allowed here because no qualifier external to the string is supplied.														
2. When casting from a DATE to a TIMESTAMP or GMTTIMESTAMP, the time portion of the TIMESTAMP is set to all zero values (00:00:00). This is different from the behavior of the explicit cast, which sets the time portion to the current time.														

Numeric types:

The comparison operators operate on all three numeric types.

Character strings:

You cannot define an alternative collation order that, for example, collates upper and lowercase characters equally.

When comparing character strings, trailing blanks are not significant, so the comparison `'hello' = 'hello '` returns true.

Datetime values:

Datetime values are compared in accordance with the natural rules of the Gregorian calendar and clock.

You can compare the time zone you are working in with the GMT time zone. The GMT time zone is converted into a local time zone based on the difference between your local time zone and the GMT time specified. When you compare your local time with the GMT time, the comparison is based on the difference at a given time on a given date.

Conversion is always based on the value of LOCAL_TIMEZONE. This is because GMT timestamps are converted to local timestamps only if it can be done unambiguously. Converting a local timestamp to a GMT timestamp has difficulties around the daylight saving cut-over time, and converting between times and GMT times (without date information) has to be done based on the LOCAL_TIMEZONE value, because you cannot specify which time zone difference to use otherwise.

Booleans:

Boolean values can be compared using all the normal comparison operators. The TRUE value is defined to be greater than the FALSE value. Comparing either value to the UNKNOWN Boolean value (which is equivalent to NULL) returns an UNKNOWN result.

Intervals:

Intervals are compared by converting the two interval values into intermediate representations, so that both intervals have the same interval qualifier. Year-month intervals can be compared only with other year-month intervals, and day-second intervals can be compared only with other day-second intervals.

For example, if an interval in minutes, such as INTERVAL '120' MINUTE is compared with an interval in days to seconds, such as INTERVAL '0 02:01:00', the two

intervals are first converted into values that have consistent interval qualifiers, which can be compared. So, in this example, the first value is converted into an interval in days to seconds, which gives `INTERVAL '0 02:00:00'`, which can be compared with the second value.

Comparing character strings with other types:

If a character string is compared with a value of another type, WebSphere Message Broker attempts to cast the character string into a value of the same data type as the other value.

For example, you can write an expression:

```
'1234' > 4567
```

The character string on the left is converted into an integer before the comparison takes place. This behavior reduces some of the need for explicit `CAST` operators when comparing values derived from a generic XML message with literal values. (For details of explicit casts that are supported, see “Supported casts” on page 1644.) It is this facility that allows you to write the following expression:

```
Body.Trade.Quantity > 5000
```

In this example, the field reference on the left evaluates to the character string '1000' and, because this is being compared to an integer, that character string is converted into an integer before the comparison takes place.

You must still check whether the price field that you want interpreted as a decimal is greater than a given threshold. Make sure that the literal you compare it to is a decimal value and not an integer.

For example:

```
Body.Trade.Price > 100
```

does not have the desired effect, because the `Price` field is converted into an integer, and that conversion fails because the character string contains a decimal point. However, the following expression succeeds:

```
Body.Trade.Price > 100.00
```

Implicit CASTs for arithmetic operations

This topic lists the implicit `CASTs` available for arithmetic operations.

Normally the arithmetic operators (+, -, *, and /) operate on operands of the same data type, and return a value of the same data type as the operands. Cases where it is acceptable for the operands to be of different data types, or where the data type of the resulting value is different from the type of the operands, are shown in the following table.

The following table lists the implicit `CASTs` for arithmetic operation.

Left operand data type	Right operand data type	Supported operators	Result data type
INTEGER	FLOAT	+, -, *, /	FLOAT ¹
INTEGER	DECIMAL	+, -, *, /	DECIMAL ¹
INTEGER	INTERVAL	*	INTERVAL ⁴

Left operand data type	Right operand data type	Supported operators	Result data type
FLOAT	INTEGER	+, -, *, /	FLOAT ¹
FLOAT	DECIMAL	+, -, *, /	FLOAT ¹
FLOAT	INTERVAL	*	INTERVAL ⁴
DECIMAL	INTEGER	+, -, *, /	DECIMAL ¹
DECIMAL	FLOAT	+, -, *, /	FLOAT ¹
DECIMAL	INTERVAL	*	INTERVAL ⁴
TIME	TIME	-	INTERVAL ²
TIME	GMTTIME	-	INTERVAL ²
TIME	INTERVAL	+, -	TIME ³
GMTTIME	TIME	-	INTERVAL ²
GMTTIME	GMTTIME	-	INTERVAL ²
GMTTIME	INTERVAL	+, -	GMTTIME ³
DATE	DATE	-	INTERVAL ²
DATE	INTERVAL	+, -	DATE ³
TIMESTAMP	TIMESTAMP	-	INTERVAL ²
TIMESTAMP	GMTTIMESTAMP	-	INTERVAL ²
TIMESTAMP	INTERVAL	+, -	TIMESTAMP ³
GMTTIMESTAMP	TIMESTAMP	-	INTERVAL ²
GMTTIMESTAMP	GMTTIMESTAMP	-	INTERVAL ²
GMTTIMESTAMP	INTERVAL	+, -	GMTTIMESTAMP ³
INTERVAL	INTEGER	*, /	INTERVAL ⁴
INTERVAL	FLOAT	*, /	INTERVAL ⁴
INTERVAL	DECIMAL	*, /	INTERVAL ⁴
INTERVAL	TIME	+	TIME ³
INTERVAL	GMTTIME	+	GMTTIME ³
INTERVAL	DATE	+	DATE ³
INTERVAL	TIMESTAMP	+	TIMESTAMP ³
INTERVAL	GMTTIMESTAMP	+	GMTTIMESTAMP ³

Left operand data type	Right operand data type	Supported operators	Result data type
Notes:			
1. The operand that does not match the data type of the result is cast to the data type of the result before the operation proceeds. For example, if the left operand to an addition operator is an INTEGER, and the right operand is a FLOAT, the left operand is cast to a FLOAT before the addition operation is performed.			
2. Subtracting a (GMT)TIME value from a (GMT)TIME value, a DATE value from a DATE value, or a (GMT)TIMESTAMP value from a (GMT)TIMESTAMP value, results in an INTERVAL value representing the time interval between the two operands.			
3. Adding or subtracting an INTERVAL from a (GMT)TIME, DATE or (GMT)TIMESTAMP value results in a new value of the data type of the non-INTERVAL operand, representing the point in time represented by the original non-INTERVAL, plus or minus the length of time represented by the INTERVAL.			
4. Multiplying or dividing an INTERVAL by an INTEGER, FLOAT, or DECIMAL value results in a new INTERVAL representing the length of time represented by the original, multiplied or divided by the factor represented by the non-INTERVAL operand. For example, an INTERVAL value of 2 hours 16 minutes multiplied by a FLOAT value of 2.5 results in a new INTERVAL value of 5 hours 40 minutes. The intermediate calculations involved in multiplying or dividing the original INTERVAL are carried out in the data type of the non-INTERVAL, but the individual fields of the INTERVAL (such as HOUR, YEAR, and so on) are always integral, so some rounding errors might occur.			

Implicit CASTs for assignment

Values can be assigned to one of three entities.

A message field (or equivalent in an exception or destination list)

Support for implicit conversion between the WebSphere Message Broker data types and the message (in its bitstream form) depends on the appropriate parser. For example, the XML parser casts everything as character strings before inserting them into the WebSphere MQ message.

A field in a database table

WebSphere Message Broker converts each of its data types into a suitable standard SQL C data type, as detailed in the following table. Conversion between this standard SQL C data type, and the data types supported by each DBMS, depends on the DBMS. Consult your DBMS documentation for more details.

The following table lists the available conversions from WebSphere Message Broker to SQL data types

WebSphere Message Broker data type	SQL data type
NULL, or unknown or invalid value	SQL_NULL_DATA
BOOLEAN	SQL_C_BIT
INTEGER	SQL_C_LONG
FLOAT	SQL_C_DOUBLE
DECIMAL	SQL_C_CHAR ¹
CHARACTER	SQL_C_CHAR
TIME	SQL_C_TIME
GMTTIME	SQL_C_TIME
DATE	SQL_C_DATE
TIMESTAMP	SQL_C_TIMESTAMP
GMTTIMESTAMP	SQL_C_DATE

WebSphere Message Broker data type	SQL data type
INTERVAL	Not supported ²
BLOB	SQL_C_BINARY
BIT	Not supported ²
Notes: <ol style="list-style-type: none"> For convenience, DECIMAL values are passed to the DBMS in character form. There is no suitable standard SQL C data type for INTERVAL or BIT. Cast these to another data type, such as CHARACTER, if you need to assign them to a database field. 	

A scalar variable

When assigning to a scalar variable, if the data type of the value being assigned and that of the target variable data type are different, an implicit cast is attempted with the same restrictions and behavior as specified for the explicit CAST function. The only exception is when the data type of the variable is INTERVAL or DECIMAL.

In both these cases, the value being assigned is first cast to a CHARACTER value, and an attempt is made to cast the CHARACTER value to an INTERVAL or DECIMAL. This is because INTERVAL requires a qualifier and DECIMAL requires a precision and scale. These must be specified in the explicit cast, but must be obtained from the character string when implicitly casting. Therefore, a further restriction is that when implicitly casting to an INTERVAL variable, the character string must be of the form INTERVAL '<values>' <qualifier>. The shortened <values> form that is acceptable for the explicit cast is not acceptable here.

Data types of values from external sources

ESQL can extract data from two external sources: message fields and database columns.

The ESQL data type of message fields depends on the type of the message (for example, XML), and the parser that is used to parse it. The ESQL data type of the value returned by a database column reference depends on the data type of the column in the database.

The following table shows which ESQL data types the various built-in database data types are cast to, when they are accessed by message flows that are running in a broker.

The versions that are supported for the database products shown in this table are listed in Supported databases.

Data type	DB2	SQL Server and Sybase	Oracle	Informix [®]
BOOLEAN		BIT		
INTEGER	SMALLINT, INTEGER, BIGINT	INT, SMALLINT, TINYINT		INT, SMALLINT
FLOAT	REAL, DOUBLE	FLOAT, REAL	NUMBER() ¹	FLOAT, SMALLFLOAT, DOUBLE
DECIMAL	DECIMAL	DECIMAL, NUMERIC, MONEY, SMALLMONEY	NUMBER(P) ¹ , NUMBER(P,S) ¹	DECIMAL, MONEY

Data type	DB2	SQL Server and Sybase	Oracle	Informix®
CHARACTER	CHAR, VARCHAR, CLOB	CHAR, VARCHAR, TEXT	CHAR, VARCHAR2, ROWID, UROWID, LONG, CLOB	CHAR, VARCHAR, CHAR VARYING
TIME	TIME			
GMPTIME				
DATE	DATE			DATE
TIMESTAMP	TIMESTAMP	DATETIME, SMALLDATETIME, TIMESTAMP	DATE	DATETIME
GMTTIMESTAMP				
INTERVAL				INTERVAL
BLOB	BLOB	BINARY, VARBINARY, IMAGE, UNIQUEIDENTIFIER	RAW LONG, RAW BLOB	
BIT				

Note:

1. If an Oracle database column with NUMBER data type is defined with an explicit precision (P) and scale (S), it is cast to an ESQL DECIMAL value; otherwise it is cast to a FLOAT.

For example, an ESQL statement like this:

```
SET OutputRoot.xxx[]
= (SELECT T.department FROM Database.personnel AS T);
```

where Database.personnel resolves to a TINYINT column in an SQL Server database table, results in a list of ESQL INTEGER values being assigned to OutputRoot.xxx.

By contrast, an identical query, where Database.personnel resolves to a NUMBER() column in an Oracle database, results in a list of ESQL FLOAT values being assigned to OutputRoot.xxx.

Miscellaneous ESQL functions

This topic lists the miscellaneous ESQL functions and covers the following:

“COALESCE function”

“NULLIF function” on page 1659

“PASSTHRU function” on page 1659

“UIDASBLOB function” on page 1662

“UIDASCHAR function” on page 1662

COALESCE function

COALESCE is a miscellaneous function that lets you provide default values for fields.

Syntax

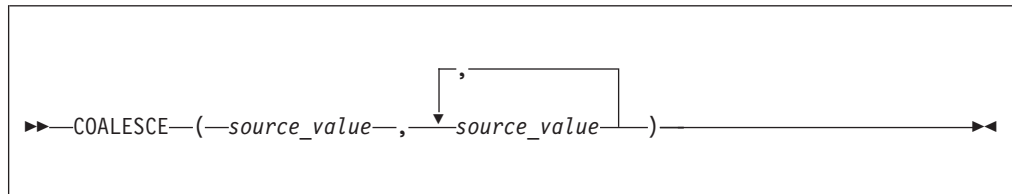

The COALESCE function evaluates its parameters in order and returns the first one that is not NULL. The result is NULL if, and only if, all the arguments are NULL. The parameters can be of any scalar type, but they need not all be of the same type.

Use the COALESCE function to provide a default value for a field, which might not exist in a message. For example, the expression:

```
COALESCE(Body.Salary, 0)
```

returns the value of the Salary field in the message if it exists, or 0 (zero) if that field does not exist.

NULLIF function

NULLIF is a miscellaneous function that returns a NULL value if the arguments are equal.

Syntax

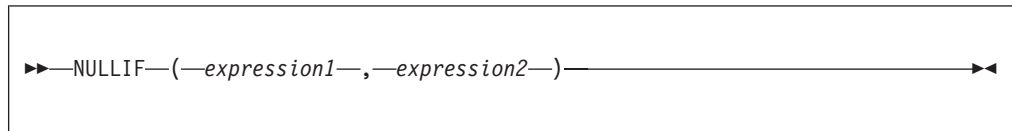

The NULLIF function returns a NULL value if the arguments are equal; otherwise, it returns the value of the first argument. The arguments must be comparable. The result of using NULLIF(e1,e2) is the same as using the expression:

```
CASE WHEN e1=e2 THEN NULL ELSE e1 END
```

When e1=e2 evaluates to unknown (because one or both of the arguments is NULL), NULLIF returns the value of the first argument.

PASSTHRU function

The PASSTHRU function evaluates an expression and executes the resulting character string as a database statement, returning a result set.

The PASSTHRU function is similar to the PASSTHRU statement, which is described in “PASSTHRU statement” on page 1547.

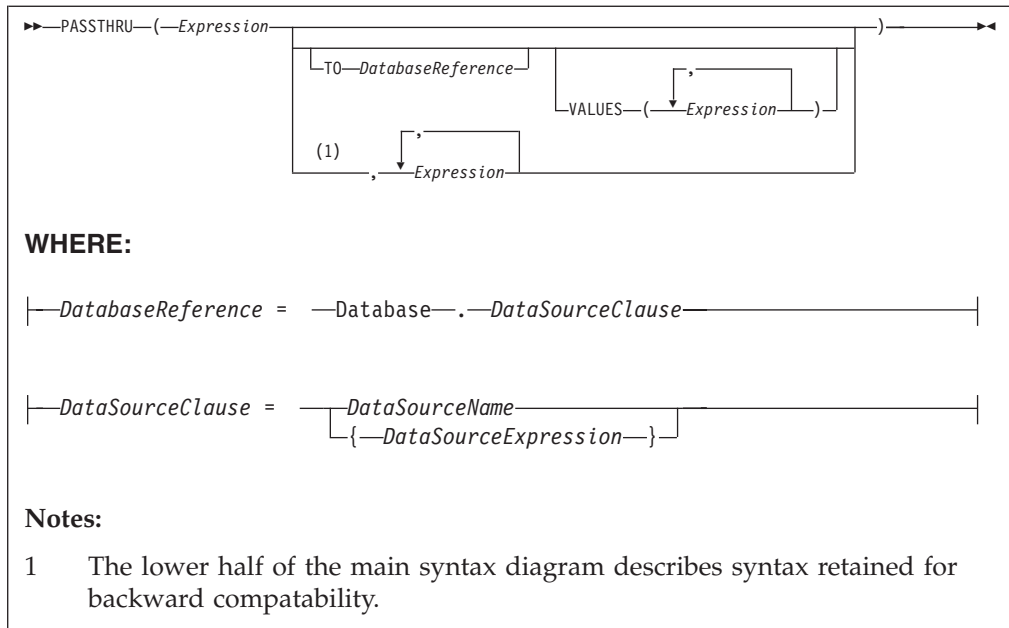

Usage

The main use of the PASSTHRU function is to issue complex SELECTs, not currently supported by the broker, to databases. (Examples of complex SELECTs not currently supported by the broker are those containing GROUP BY or HAVING clauses.)

The first expression is evaluated and the resulting character string is passed to the database pointed to by *DatabaseReference* (in the TO clause) for execution. If the TO clause is not specified, the database pointed to by the node's data source attribute is used.

Use question marks (?) in the database string to denote parameters. The parameter values are supplied by the VALUES clause.

If the VALUES clause is specified, its expressions are evaluated and passed to the database as parameters; (that is, the expressions' values are substituted for the question marks in the database statement).

If only one VALUE expression exists, the result might or might not be a list. If it is a list, the list's scalar values are substituted sequentially for the question marks. If it is not a list, the single scalar value is substituted for the (single) question mark in the database statement. If more than one VALUE expression exists, none of the expressions evaluate to a list; their scalar values are substituted sequentially for the question marks instead.

Because the database statement is constructed by the user program, it is not essential to use parameter markers (that is, the question marks) or the VALUES clause, because the whole of the database statement could be supplied, as a literal string, by the program. However, use parameter markers whenever possible because this reduces the number of different statements that need to be prepared and stored in the database and the broker.

Database reference

A database reference is a special instance of the field references that is used to refer to message trees. It consists of the word **Database** followed by the name of a data source (that is, the name of a database instance).

You can specify the data source name directly or by an expression enclosed in braces ({...}). A directly-specified data source name is subject to name substitution. That is, if the name used has been declared to be a known name, the value of the declared name is used rather than the name itself (see “DECLARE statement” on page 1525).

If you have created a message flow that contains one of the following nodes, and the ESQL that is associated with this node includes a PASSTHRU statement and a database reference, you must specify a value for the Data source property of the relevant node:

- Compute
- Database
- Filter

Handling errors

It is possible for errors to occur during PASSTHRU operations. For example, the database might not be operational or the statement might be invalid. In these cases, an exception is thrown (unless the node has its Throw exception on database error property cleared). These exceptions set appropriate SQL code, state, native error, and error text values and can be dealt with by error handlers (see the DECLARE HANDLER statement).

For further information about handling database errors, see “Capturing database state” on page 339.

Example

The following example performs a SELECT on table Table1 in schema Schema1 in database DSN1, passing two parameters to the WHERE clause and asking for the result set to be ordered in ascending name order. The result set is assigned to the SelectResult folder:

```
SET OutputRoot.XML.Data.SelectResult.Row[] =
  PASSTHRU('SELECT R.* FROM Schema1.Table1 AS R WHERE R.Name = ? OR R.Name =
    ? ORDER BY Name'
  TO Database.DSN1
  VALUES ('Name1', 'Name4'));
```

The above example assigns the result set to the OutputRoot message body tree that is owned by the Generic XML parser, which allows self-defining messages.

If assigning the result set into a message tree owned by one of the MRM parsers, and the result set structure exactly matches the MRM message definition, then the result set can be assigned directly into the OutputRoot message body tree.

If the result set structure does not exactly match the MRM message definition, then you must first assign the result set into a ROW data type, or an Environment tree that does not have any parsers associated with it. The required data can then be assigned to OutputRoot to build a message tree that conforms to the message definition.

ESQL constants in the Mapping node	Corresponding ESQL constants
\$esql:ValidateNone	ValidateNone
\$esql:ValidateException	ValidateException
\$esql:ValidateExceptionList	ValidateExceptionList
\$esql:ValidateLocalError	ValidateLocalError
\$esql:ValidateUserTrace	ValidateUserTrace
\$esql:ParseComplete	ParseComplete
\$esql:ParseImmediate	ParseImmediate
\$esql:ParseOnDemand	ParseOnDemand

Broker properties that are accessible from ESQL and Java

You can access broker, message flow, and node properties from ESQL and Java.

The following table shows the properties that are available to ESQL and Java code. The fourth column indicates whether the properties are also accessible from Java nodes. If a property is listed as being accessible from Java nodes, it is accessible from Java nodes *only*, *not* from Java routines that are called as ESQL functions or procedures.

For a complete overview of broker properties, see “Broker properties” on page 109.

Property type	Property name	Return type	From Java nodes?	What is it?
General broker properties ¹	BrokerDataSourceUserId	Character	Yes ²	The data source user ID used by the broker.
	BrokerDataSource	Character	No	The ODBC Data Source Name (DSN) of the database that contains the broker's tables.
	BrokerName	Character	Yes ³	The name of the broker.
	BrokerUserId	Character	No	The user ID that the broker uses to access its database tables.
	BrokerVersion	Character	No	The 4-character version number of the broker (see "BrokerVersion" on page 1666).
	ExecutionGroupLabel	Character	Yes ⁴	The label of the Execution Group (a human-readable name).
	ExecutionGroupName	Character	No	The name of the Execution Group (often a UUID identifier).
	Family	Character	No	The generic name of the software platform that the broker is running on ('WINDOWS', 'UNIX', or 'ZOS').
	ProcessId	Integer	No	The process identifier (PID) of the DataFlowEngine.
	QueueManagerName	Character	Yes ⁵	The name of the WebSphere MQ queue manager to which the broker is connected.
WorkPath	Character	No	(Optional) The directory in which working files for this broker are stored.	
Flow properties	AdditionalInstances	Integer	No	The number of additional threads that the broker can use to service the message flow.
	CommitCount	Integer	No	How many input messages are processed by the message flow before a syncpoint is taken.
	CommitInterval	Integer	No	The time interval at which a commit is taken when the CommitCount property is greater than 1 (that is, where the message flow is batching messages), but the number of messages processed has not reached the value of the CommitCount property.
	CoordinatedTransaction	Boolean	Yes ⁶	Whether or not the message flow is processed as a global transaction, coordinated by WebSphere MQ.
MessageFlowLabel	Character	Yes ⁷	The name of the flow.	

Property type	Property name	Return type	From Java nodes?	What is it?
Node properties	DataSource	Character	No	The ODBC Data Source Name (DSN) of the database in which the user tables are created.
	DataSourceUserId	Character	No	The user ID that the broker uses to access the database user tables.
	MessageOptions	Integer (64-bit)	No	The bitstream and validation options in force.
	NodeLabel	Character	Yes ⁸	The name of the node.
	NodeType	Character	No	The type of node (Compute, Filter, or Database).
	ThrowExceptionOnDatabaseError	Boolean	Yes ⁹	Whether the broker generates an exception when a database error is detected.
	TransactionType	Character	Yes ¹⁰	The type of transaction (Automatic or commit) used to access a database from this node.
	TreatWarningsAsErrors	Boolean	Yes ¹¹	Whether database warning messages are treated as errors and cause the output message to be propagated to the failure terminal.

Notes:

1. The only broker-defined properties that can be used in a Trace node are those in the “General broker properties” group. For example, you could specify the Pattern setting of a Trace node as:

```
#### Start Trace Input Message
Time: ${CURRENT_TIMESTAMP}
Broker: ${BrokerName} Version: ${BrokerVersion} Platform: ${Family}
ProcessID: ${ProcessId} BrokerUserId: ${BrokerUserId}
ExecutionGroupLabel: ${ExecutionGroupLabel}
Transaction: ${Transaction}
Root Tree: ${Root}
#### End Trace Input Message
```

2. Accessible through:
 - a. `MbNode.getBroker()`
 - b. `MbBroker.getDataSourceUserId()`
3. Accessible through:
 - a. `MbNode.getBroker()`
 - b. `MbBroker.getName()`
4. Accessible through:
 - a. `MbNode.getExecutionGroup()`
 - b. `MbExecutionGroup.getName()`
5. Accessible through:
 - a. `MbNode.getBroker()`
 - b. `MbBroker.getQueueManagerName()`
6. Accessible through:
 - a. `MbNode.getMessageFlow()`
 - b. `MbMessageFlow.isCoordinatedTransaction()`
7. Accessible through:
 - a. `MbNode.getMessageFlow()`

- b. `MbMessageFlow.getName()`
- 8. Accessible through `MbNode.getName()`
- 9. Accessible through `MbSQL.getThrowExceptionOnDatabaseError()`
- 10. Accessible through `MbSQL.getTransactionType()`
- 11. Accessible through `MbSQL.getTreatWarningsAsErrors()`

BrokerVersion

The `BrokerVersion` property contains a 4-character code that indicates the version of the broker. The code is based on the IBM Version/Release/Modification/Fix pack (VRMF) product-numbering system. The VRMF code works like this:

- V** The Version number. A Version is a separate IBM licensed program that usually has significant new code or new function. Each version has its own license, terms, and conditions.
- R** The Release number. A Release is a distribution of new function and authorized program analysis report (APAR) fixes for an existing product.
- M** The Modification number. A Modification is new function added to an existing product, and is delivered separately from an announced Version or Release.
- F** The Fix pack number. Fix packs contain defect and APAR fixes. They do not contain new function.

A fix pack is cumulative: that is, it contains all the fixes shipped in previous maintenance to the release, including previous fix packs. It can be applied on top of any previously-shipped maintenance to bring the system up to the current fix pack level.

Special characters, case sensitivity, and comments in ESQL

This topic describes the special characters used in ESQL, case sensitivity, and how comments are handled in the following sections:

- “Special characters”
- “Case sensitivity of ESQL syntax” on page 1667
- “Comments” on page 1667

Special characters

Symbol	Name	Usage
;	semicolon	End of ESQL statement
.	period	Field reference separator or decimal point
=	equals	Comparison or assignment
>	greater than	Comparison
<	less than	Comparison
[]	square brackets	Array subscript

Symbol	Name	Usage
'	single quotation mark	Delimit string, date-time, and decimal literals Note, that to escape a single quotation mark inside a string literal, you must use two single quotation marks.
	double vertical bar	Concatenation
()	parentheses	Expression delimiter
"	quotation mark	Identifier delimiter
*	asterisk	Any name or multiply
+	plus	Arithmetic add
-	minus	Arithmetic subtract, date separator, or negation
/	forward slash	Arithmetic divide
_	underscore	LIKE single wild card
%	percent	LIKE multiple wild card
\	backslash	LIKE escape character
:	colon	Name space and Time literal separator
,	comma	List separator
<>	less than greater than	Not equals
--	double minus	ESQL single line comment
/* */	slash asterisk asterisk slash	ESQL multiline comment
?	question mark	Substitution variable in PASSTHRU
<=	less than or equal	Comparison
>=	greater than or equal	Comparison
/*!{ }!*/	executable comment	Bypass tools check

Case sensitivity of ESQL syntax

The case of ESQL statements is:

- Case sensitive in field reference literals
- Not case sensitive in ESQL language words

Comments

ESQL has two types of comment: single line and multiple line. A single line comment starts with the characters -- and ends at the end of the line.

In arithmetic expressions you must take care not to initiate a line comment accidentally. For example, consider the expression:

```
1 - -2
```

Removing all white space from the expression results in:

```
1--2
```

which is interpreted as the number 1, followed by a line comment.

A multiple line comment starts with `/*` anywhere in ESQL and ends with `*/`.

ESQL reserved keywords

The following keywords are reserved in uppercase, lowercase, or mixed case. You cannot use these keywords for variable names. However, you *can* use reserved keywords as names in a field reference.

ALL	ASYMMETRIC	BOTH
CASE	DISTINCT	FROM
ITEM	LEADING	NOT
SYMMETRIC	TRAILING	WHEN

ESQL non-reserved keywords

The following keywords are used in the ESQL language but are not reserved. Do not use them for variable, function, or procedure names (in any combination of upper and lower case) because your code can become difficult to understand.

- AND
- ANY
- AS
- ATOMIC
- ATTACH
- BEGIN
- BETWEEN
- BIT
- BLOB
- BOOLEAN
- BY
- CALL
- CATALOG
- CCSID
- CHAR
- CHARACTER
- COMPUTE
- CONDITION
- CONSTANT
- CONTINUE
- COORDINATED
- COUNT
- CREATE
- CURRENT_DATE
- CURRENT_GMTDATE
- CURRENT_GMTTIME
- CURRENT_GMTTIMESTAMP
- CURRENT_TIME
- CURRENT_TIMESTAMP
- DATA
- DATABASE
- DATE
- DAY

- DAYOFWEEK
- DAYOFYEAR
- DAYS
- DECIMAL
- DECLARE
- DEFAULT
- DELETE
- DETACH
- DO
- DOMAIN
- DYNAMIC
- ELSE
- ELSEIF
- ENCODING
- END
- ENVIRONMENT
- ESCAPE
- ESQL
- EVAL
- EVENT
- EXCEPTION
- EXISTS
- EXIT
- EXTERNAL
- FALSE
- FIELD
- FILTER
- FINALIZE
- FIRSTCHILD
- FLOAT
- FOR
- FORMAT
- FOUND
- FULL
- FUNCTION
- GMTTIME
- GMTTIMESTAMP
- GROUP
- HANDLER
- HAVING
- HOUR
- IDENTITY
- IF
- IN
- INF
- INFINITY
- INOUT
- INSERT
- INT
- INTEGER
- INTERVAL
- INTO
- IS
- ISLEAPYEAR
- ITERATE
- JAVA

- LABEL
- LANGUAGE
- LAST
- LASTCHILD
- LEAVE
- LIKE
- LIST
- LOCALTIMEZONE
- LOG
- LOOP
- MAX
- MESSAGE
- MIN
- MINUTE
- MODIFIES
- MODULE
- MONTH
- MONTHS
- MOVE
- NAME
- NAMESPACE
- NAN
- NEXTSIBLING
- NONE
- NULL
- NUM
- NUMBER
- OF
- OPTIONS
- OR
- ORDER
- OUT
- PARSE
- PASSTHRU
- PATH
- PLACING
- PREVIOUSIBLING
- PROCEDURE
- PROPAGATE
- QUARTEROFYEAR
- QUARTERS
- READS
- REFERENCE
- REPEAT
- RESIGNAL
- RESULT
- RETURN
- RETURNS
- ROW
- SAMEFIELD
- SCHEMA
- SECOND
- SELECT
- SET
- SETS
- SEVERITY

- SHARED
- SHORT
- SOME
- SQL
- SQLCODE
- SQLERRORTXT
- SQLEXCEPTION
- SQLNATIVEERROR
- SQLSTATE
- SQLWARNING
- SUM
- TERMINAL
- THE
- THEN
- THROW
- TIME
- TIMESTAMP
- TO
- TRACE
- TRUE
- TYPE
- UNCOORDINATED
- UNKNOWN
- UNTIL
- UPDATE
- USER
- UUIDASBLOB
- UUIDASCHAR
- VALUE
- VALUES
- WEEKOFMONTH
- WEEKOFYEAR
- WEEKS
- WHERE
- WHILE
- YEAR

Example message

This topic defines the example message that is used in many of the examples throughout the information center.

The example message is:

```

<Invoice>
<InvoiceNo>300524</InvoiceNo>
<InvoiceDate>2000-12-07</InvoiceDate>
<InvoiceTime>12:40:00</InvoiceTime>
<TillNumber>3</TillNumber>
<Cashier StaffNo="089">Mary</Cashier>
<Customer>
  <FirstName>Andrew</FirstName>
  <LastName>Smith</LastName>
  <Title>Mr</Title>
  <DOB>20-01-70</DOB>
  <PhoneHome>01962818000</PhoneHome>
  <PhoneWork/>
  <Billing>

```

```

        <Address>14 High Street</Address>
        <Address>Hursley Village</Address>
        <Address>Hampshire</Address>
        <PostCode>SO213JR</PostCode>
    </Billing>
</Customer>
<Payment>
    <CardType>Visa</CardType>
    <CardNo>4921682832258418</CardNo>
    <CardName>Mr Andrew J. Smith</CardName>
    <Valid>1200</Valid>
    <Expires>1101</Expires>
</Payment>
<Purchases>
    <Item>
        <Title Category="Computer" Form="Paperback" Edition="2">The XML Companion
    </Title>
        <ISBN>0201674866</ISBN>
        <Author>Neil Bradley</Author>
        <Publisher>Addison-Wesley</Publisher>
        <PublishDate>October 1999</PublishDate>
        <UnitPrice>27.95</UnitPrice>
        <Quantity>2</Quantity>
    </Item>
    <Item>
        <Title Category="Computer" Form="Paperback" Edition="2">A Complete Guide
to DB2 Universal Database</Title>
        <ISBN>1558604820</ISBN>
        <Author>Don Chamberlin</Author>
        <Publisher>Morgan Kaufmann Publishers</Publisher>
        <PublishDate>April 1998</PublishDate>
        <UnitPrice>42.95</UnitPrice>
        <Quantity>1</Quantity>
    </Item>
    <Item>
        <Title Category="Computer" Form="Hardcover" Edition="0">JAVA 2 Developers
Handbook</Title>
        <ISBN>0782121799</ISBN>
        <Author>Philip Heller, Simon Roberts </Author>
        <Publisher>Sybex, Inc.</Publisher>
        <PublishDate>September 1998</PublishDate>
        <UnitPrice>59.99</UnitPrice>
        <Quantity>1</Quantity>
    </Item>
</Purchases>
<StoreRecords/>
<DirectMail/>
<Error/>
</Invoice>

```

For a diagrammatic representation of this message, and for examples of how this message can be manipulated with ESQL statements and functions, refer to “Writing ESQL” on page 280.

Message mappings

This section contains topics that provide reference information about message mapping:

- “Message Mapping editor”
 - Source pane
 - Target pane
 - Edit pane
 - Spreadsheet pane
- “Mapping node” on page 1683
 - Syntax
 - Functions
 - Casts
- “Migrating message mappings from Version 5.0” on page 1691
 - Migration restrictions

Message Mapping editor

You configure a message mapping using the Message Mapping editor, which you use to set values for:

- the message destination
- message headers
- message content

Here is an example of the Message Mapping editor. There are separate panes for working with sources, targets and expressions, as well as a spreadsheet view.

The screenshot displays the Message Mapping editor interface. It features four main panes:

- Source Pane (1):** Shows the source message structure, including `LocalEnvironment`, `Properties`, `Create_Book_Order_MSG`, `Customer_ID`, `Order_Date`, `Delivery_Method`, and `Book_Details`.
- Target Pane (2):** Shows the target message structure, including `LocalEnvironment`, `Properties`, `Book_Order_Response_MSG`, `Customer_ID`, `Order_Number`, `Order_Date`, `Delivery_Method`, and `Book_Details`.
- Map Script (3):** Shows the mapping script for the `First_Class` element, with the value `$source/Create_Book_Order_MSG/First_Class`.
- Spreadsheet View (4):** Shows a table with columns for `Map Script` and `Value`. The table contains the following entries:

Map Script	Value
<code>\$target</code>	
<code>LocalEnvironment</code>	
<code>Properties</code>	
<code>Book_Order_Response_MSG</code>	
<code>Customer_ID</code>	<code>\$source/Create_Book_Order_MSG/Customer_ID</code>
<code>Order_Number</code>	<code>fn:concat(\$source/Create_Book_Order_MSG/Custom...</code>
<code>Order_Date</code>	<code>\$source/Create_Book_Order_MSG/Order_Date</code>
<code>if</code>	
<code>condition</code>	<code>\$source/Create_Book_Order_MSG/First_Class='Yes'</code>
<code>First_Class</code>	<code>\$source/Create_Book_Order_MSG/First_Class</code>

1. **Source pane:** displays a source message or database table
2. **Target pane:** displays a target message
3. **Edit pane:** displays the expression to be used to derive the target element value
4. **Spreadsheet pane:** displays a summary of the mappings in spreadsheet columns (each target field and its value)

Use the Message Mapping editor to perform various mapping tasks.

Wizards and dialog boxes are provided for tasks such as adding mappable elements, working with ESQL, and working with submaps. Mappings that are created with the Message Mapping editor are automatically validated and compiled, ready for adding to a broker archive (bar) file, and subsequent deployment to WebSphere Message Broker.

Message Mapping editor Source pane

The following example shows the “Message Mapping editor” on page 1673. The pane that is labelled as 1 in the example is the Source pane:

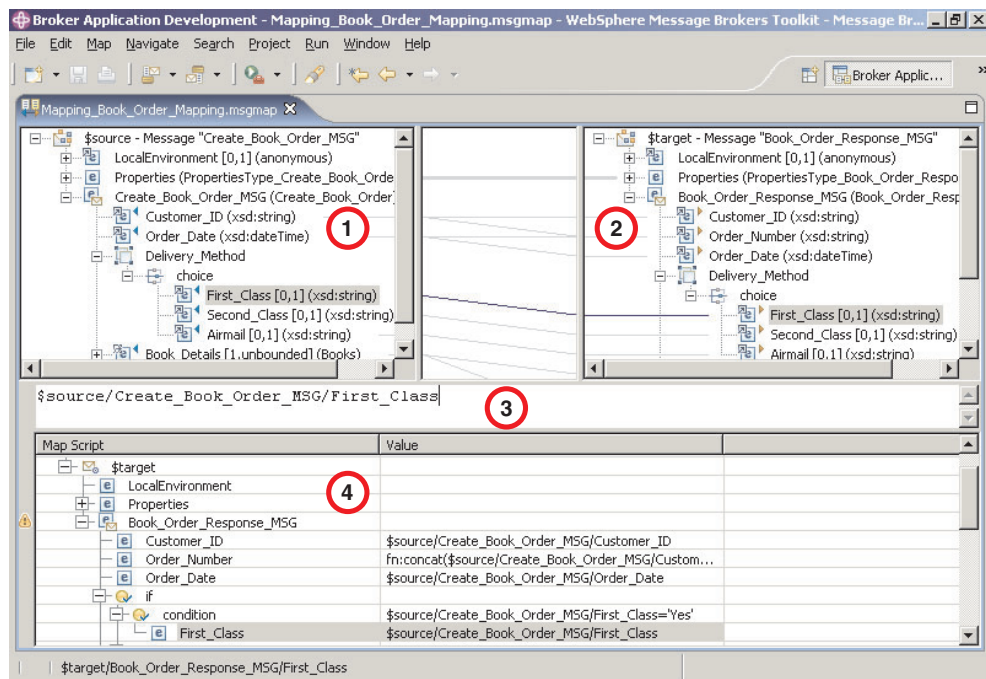

The following list describes the elements that are present in the Source pane:

- A source message is identified by \$source.
- A source database is identified by \$db:select.
- A mapped entry is indicated by a blue triangle alongside the element. In this example, Customer_ID and Order_Date are mapped.
- Square brackets contain minimum and maximum occurrences of an element.
- An optional field is indicated by [0,1]. In this example, First_Class is optional.
- A repeating field is indicated by [minoccurs, maxoccurs].
- A choice field is indicated by a choice line; under the choice line are the possible choices. In this example, First_Class, Second_Class, and Airmail are choices of Delivery_Method.

- The type of each element is indicated in round brackets after the element name.
- If the message schema uses namespaces, the namespace prefix is shown before the element name, separated by a colon.

Use the Source pane to invoke a number of actions, a list of which is displayed when you right-click within the Source pane. The following table describes the available actions.

Action	Description	Related tasks
Undo	Undo previous action	
Redo	Redo previous action	
Revert	Discard	
Open Declaration (message)	Display the element definition from the message set. For this action to be available, select any source message element except LocalEnvironment or Headers.	
Open Declaration (database)	Display the database, schema, or table definition from the database. For this action to be available, select any source database object.	
Show Derived Types	Hide or display derived types for an element in the source or target pane. For this action to be available, select a target element displayed as a specialization folder in the source pane.	
Show Substituting elements	Hide or display the substituting elements of the head element in the source or target pane. For this action to be available, select a target element displayed as a substitutions folder in the source pane.	
Add Sources and Targets	Add a message definition or a database table to a source. For this action to be available, select any source object.	“Adding messages or message components to the source or target” on page 492, “Adding a database as a source or target” on page 492
Go To	For this action to be available, select any source object.	

|
|
|
|
|
|
|
|
|

Action	Description	Related tasks
Delete (message)	Remove a message and any existing maps from the source. For this action to be available, select the source message root (\$source).	
Delete (database)	Remove a database and any existing maps from the source. For this action to be available, select the source database root (\$db:select).	
Map from Source	Create a map between the focus source element and the focus target element. For this action to be available, select compatible source and target elements.	"Mapping a target element from source message elements" on page 481, "Mapping from source: by selection" on page 480
Map by Name	Create a map between the focus source element and the focus target element. For this action to be available, select compatible source and target elements.	"Mapping a target element from source message elements" on page 481, "Mapping from source: by name" on page 480
Accumulate	If the source and target fields contain numeric data types, this action maps all occurrences of a repeating source field to a non-repeating target, resulting in the sum of all the source elements. For this action to be available, select the source and target element.	"Configuring a repeating source and a non-repeating target" on page 488
Create New Submap	For this action to be available, select source and target elements that are either elements of complex types or wildcard elements.	"Creating and calling submaps and subroutines" on page 502, "Creating a new submap" on page 503, "Creating a new submap for a wildcard source" on page 504
Call Existing Submap	Call an existing submap	"Creating and calling submaps and subroutines" on page 502, "Calling a submap" on page 506
Call ESQL Routine	Call an ESQL routine	"Creating and calling submaps and subroutines" on page 502, "Calling an ESQL routine" on page 508
Save	Save the .msgmap file	

Message Mapping editor Target pane

The following example shows the “Message Mapping editor” on page 1673. The pane that is labelled as 2 in the example is the Target pane:

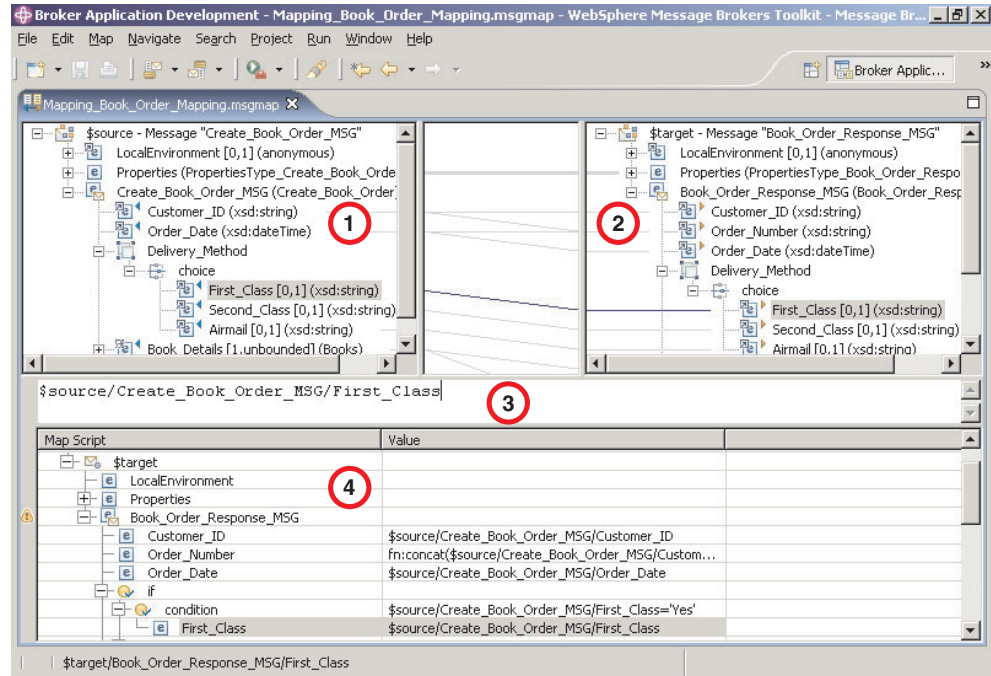

The following list describes the elements that are present in the Target pane:

- A target message is identified by \$target.
- A mapped entry is indicated by a yellow triangle alongside the element. In this example, Customer_ID, Order_Number, and Order_Date are mapped.
- Square brackets contain minimum and maximum occurrences of an element.
- An optional field is indicated by [0,1]. In this example, First_Class is optional.
- A repeating field is indicated by [minoccurs, maxoccurs].
- A choice field is indicated by a choice line; under the choice line are the possible choices. In this example, First_Class, Second_Class, and Airmail are choices of Delivery_Method.
- The type of each element is indicated in round brackets after the element name.
- If the message schema uses namespaces, the namespace prefix is shown before the element name, separated by a colon.

Use the Target pane to invoke a number of actions, a list of which is displayed when you right-click within the Target pane. The following table describes the available actions.

Action	Description	Related tasks
Undo	Undo previous action	
Redo	Redo previous action	
Revert	Discard	

Action	Description	Related tasks
Open Declaration (message)	<p>Display the element definition from the message set.</p> <p>For this action to be available, select any target message element except LocalEnvironment or Headers.</p>	
Open Declaration (database)	<p>Display the database, schema, or table definition from the database.</p> <p>For this action to be available, select any target database object.</p>	
Show Derived Types	<p>Hide or display derived types for an element in the source or target pane.</p> <p>For this action to be available, select a target element displayed as a specialization folder in the target pane.</p>	
Show Substituting elements	<p>Hide or display the substituting elements of the head element in the source or target pane.</p> <p>For this action to be available, select a target element displayed as a substitutions folder in the target pane.</p>	
Add Sources and Targets	<p>Add a message definition or a database table to a source.</p> <p>For this action to be available, select any target object.</p>	<p>“Adding messages or message components to the source or target” on page 492, “Adding a database as a source or target” on page 492</p>
Go To	<p>For this action to be available, select any target object.</p>	
Delete (message)	<p>Remove a message and any existing maps from the source.</p> <p>For this action to be available, select the target message root (\$target).</p>	

Action	Description	Related tasks
Map from Source	Create a map between the focus source element and the focus target element. For this action to be available, select compatible source and target elements.	"Mapping a target element from source message elements" on page 481, "Mapping from source: by selection" on page 480
Map by Name	Create a map between the focus source element and the focus target element. For this action to be available, select compatible source and target elements.	"Mapping a target element from source message elements" on page 481, "Mapping from source: by name" on page 480
Enter Expression	For this action to be available, select any target object except \$target	"Setting the value of a target element to a constant" on page 483, "Setting the value of a target element using an expression or function" on page 485
Accumulate	If the source and target fields contain numeric data types, this action maps all occurrences of a repeating source field to a non-repeating target, resulting in the sum of all the source elements. For this action to be available, select the source and target element.	"Configuring a repeating source and a non-repeating target" on page 488
Create New Submap	For this action to be available, select source and target elements that are either elements of complex types or wildcard elements.	"Creating and calling submaps and subroutines" on page 502, "Creating a new submap" on page 503, "Creating a new submap for a wildcard source" on page 504
Call Existing Submap	Call an existing submap	"Creating and calling submaps and subroutines" on page 502, "Calling a submap" on page 506
Call ESQL Routine	Call an existing ESQL routine	"Creating and calling submaps and subroutines" on page 502, "Calling an ESQL routine" on page 508
Save	Save the .msgmap file	

Message Mapping editor Edit pane

The following example shows the "Message Mapping editor" on page 1673. The pane that is labelled as 3 in the example is the Edit pane:

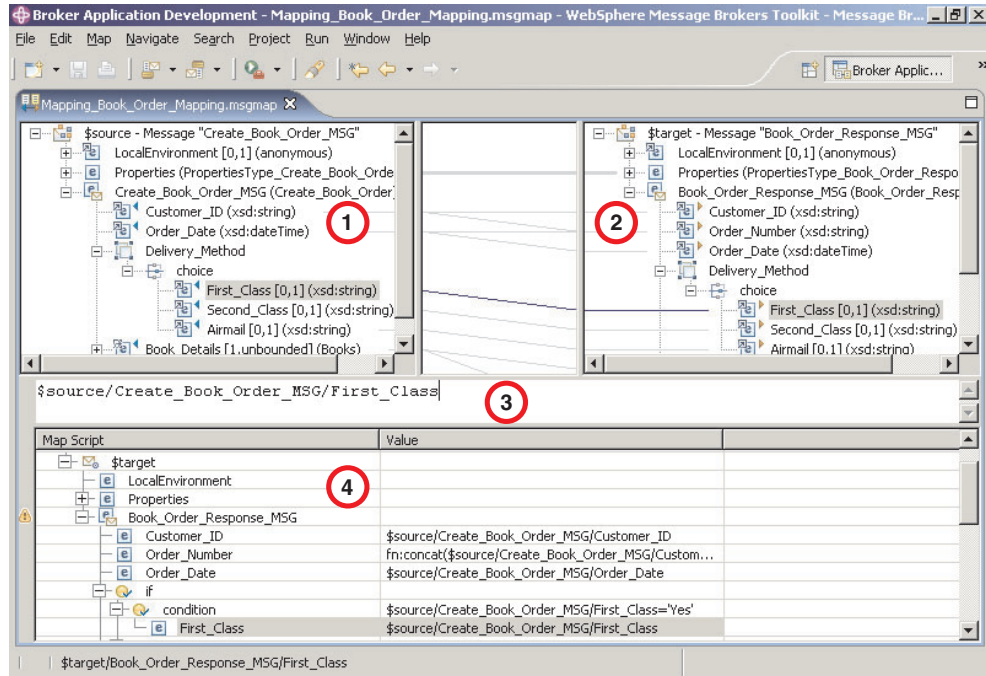

When you have selected a source or target element, use the Edit pane to enter an expression. Right-click inside the Edit pane to invoke a list of available actions, most of which are standard Windows functions, such as cut, copy, and paste. Click **Edit** → **Content Assist** (or press Ctrl+Space) to access ESQL Content Assist, which provides a drop-down list of functions that are available in a Mapping node.

To display the definition associated with a selected element or database object, right-click in the Edit pane, and click **Open Declaration**. The appropriate editor opens to display the definition associated with the element or database definition.

Message Mapping editor Spreadsheet pane

The following example shows the “Message Mapping editor” on page 1673. The pane that is labelled as 4 in the example is the Spreadsheet pane:

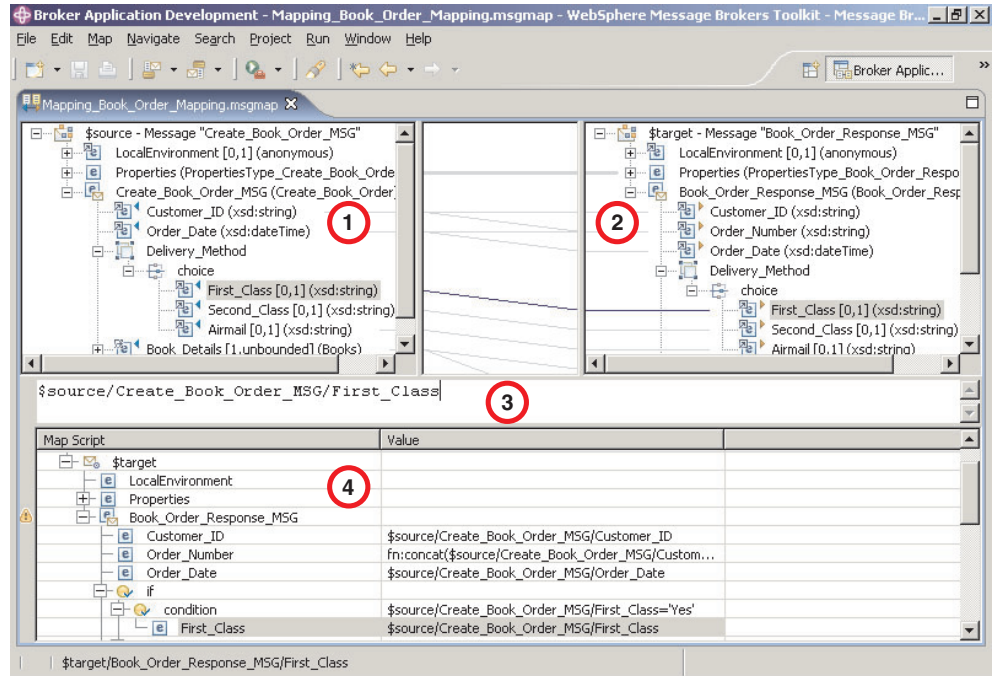

Use the Spreadsheet pane to invoke a number of actions, a list of which is displayed when you right-click within the Spreadsheet pane. The following table describes the available actions.

Action	Description	Related tasks
Undo	Undo previous action	
Redo	Redo previous action	
Revert	Discard	
Open Declaration (message)	Display the element definition from the message set. For this action to be available, select any message element except LocalEnvironment or Headers.	
Open Declaration (database)	Display the database, schema, or table definition from the database. For this action to be available, select any database object.	
Add Sources and Targets	Add a message definition to a target.	“Adding messages or message components to the source or target” on page 492, “Adding a database as a source or target” on page 492
Copy	Copy the selected item to the clipboard.	

Action	Description	Related tasks
Paste	Paste the item from the clipboard.	
Delete	Remove a row from the Spreadsheet.	
For	Define a repeating condition.	“Configuring a repeating source and a non-repeating target” on page 488, “Configuring a repeating source and a repeating target” on page 489
If	Placeholder for a new Condition block, to contain one or more Conditions.	“Configuring a repeating source and a non-repeating target” on page 488, “Configuring conditional mappings” on page 487
Condition	Define what must evaluate to ‘true’ to execute subsequent mappings.	“Configuring a repeating source and a non-repeating target” on page 488, “Configuring conditional mappings” on page 487
Else	Placeholder to execute subsequent mappings if previous Condition does not evaluate to ‘true’.	“Configuring conditional mappings” on page 487
Select Data Source	Define a database to be used in the mapping.	
Populate	Expand a structure so that each of its children have a row in the spreadsheet.	
Insert After	Create a number of new rows in the spreadsheet to set the values of specific instances of a repeating field. Can also be used to insert any non-repeating element, attribute or database column if valid at the selected location.	“Configuring a non-repeating source and a repeating target” on page 489
Insert Before	Create a number of new rows in the spreadsheet to set the values of specific instances of a repeating field. Can also be used to insert any non-repeating element, attribute or database column if valid at the selected location.	“Configuring a non-repeating source and a repeating target” on page 489
Replace	Substitute an element, attribute or database column in the spreadsheet with a similar item, retaining the mapping expression and any child mapping statements.	
Save	Save the .msgmap file.	

Mapping node

The Mapping node has one or more mappings that are stored in message map files (with a `.msgmap` file extension). These files are configured using the “Message Mapping editor” on page 1673.

A Mapping node must contain the following inputs and outputs:

- Zero or one source (input) messages
- Zero or more source (input) databases
- One or more target (output) messages

You must define, in message definition files in a message set, the source and target messages that are to be mapped. You can specify the parser of the source message at run time (for example, in an MQRFH2 header), but the target message is built using the runtime parser that is specified by the *Message Domain* property of the message set.

If a message mapping is between elements of different types, you might need to include casts in your mapping definitions, depending on which runtime parser is specified by the *Message Domain* property of your message set.

The Mapping node uses a language to manipulate messages that are based on XPath.

To develop message mappings for a Mapping node, use the Message Mapping editor, which provides separate panes for working with sources, targets and expressions.

Mapping node syntax

In a Mapping node, the source message, if present, is identified in the “Message Mapping editor” on page 1673 by `$source`.

The message tree is represented in XPath format. For example, if you have an element called `Body` within a source message called `Envelope`, this is represented in the Mapping node as:

```
$source/soap11:Envelope/soap11:Body
```

Where *soap11* is a namespace prefix.

The first target message is identified by `$target`; additional target messages are identified by `$target_1`, `$target_2`, etc.

The first source database is identified by `$db:select`; additional source databases are identified by `$db:select_1`, `$db:select_2`, etc.

The database element is represented in the following format:

```
$db:select.DB.SCH.TAB.COL1
```

where:

DB is the database name

SCH is the database schema name

TAB is the table name

COL1 is the column name

You can also use the Mapping node to:

- make comparisons
- perform arithmetic
- create complex conditions

The comparison operators are:

= equals
!= not equals
> greater than
>= greater than or equals
< less than
<= less than or equals

The arithmetic operators are:

+ plus
- minus
* multiply
div divide

Conditional operators 'or' and 'and' are supported (these are case-sensitive).

The following objects can be mapped:

- Local Environment
 - Destination
 - WrittenDestination
 - File
 - SOAP
 - TCPIP
 - ServiceRegistry
 - Adapter
 - Wildcard
 - Variables
- Message headers (optional)
 - MQ Headers
 - HTTP Headers
 - JMSTransport
 - Email Headers
- Message elements
- Database columns

Naming restrictions for database objects

The names of objects in Oracle databases can contain certain characters, such as the dollar sign (\$) and number sign (#), which the Mapping node cannot process correctly. Database table names, table column names, stored procedure parameter names, and column names in stored procedure result sets, must not contain any of the following characters:

~ ! @ # \$ % ^ & * () + = - ` { } | \] [" : ' ; ? > < , . /

Mapping node functions

You can configure your message mappings using a variety of predefined and user-defined functions.

The following predefined functions are available to use in your message maps:

- ESQL - prefixed esql:
- XPath - prefixed fn:
- Mapping - prefixed msgmap:
- Schema casts - prefixed xs:

Not all ESQL functions can be used in a Mapping node. For information about which functions are supported, and for a description of how to achieve equivalent processing for ESQL functions that are not supported, see the ESQL topics. For information about the predefined ESQL functions, see “Predefined ESQL mapping functions.”

The fn:true() function (that always returns true) and the fn:false() function (that always returns false) are examples of XPath functions. You can get more information about the other XPath functions and XPath syntax from the online W3C XML Path Language document. For information about the predefined XPath functions, see “Predefined XPath mapping functions” on page 1688.

For information about the predefined mapping functions, see “Predefined mapping functions” on page 1689. See “Mapping node casts” on page 1690 for a list of the schema casts.

The mapping node can also:

- Set the value of a target to a WebSphere MQ constant. The expression to set the value looks similar to a function with \$mq; used as the prefix.
- Call a Java method directly. The expression to set the value looks similar to a function with java: used as a prefix.

Predefined ESQL mapping functions

A table of predefined ESQL functions for use with message maps.

This table details the predefined ESQL mapping functions that are available to use with message maps:

Name	ESQL equivalent	Notes
Numeric functions: abs absval acos asin atan atan2 bitand bitnot bitor bitxor ceil ceiling cos cosh cot degrees exp floor in log log10 mod power radians rand sign sin sinh sqrt tan tanh truncate	ESQL function of the name same name such as ABS and ABSVAL.	The same parameters apply as for ESQL.
String functions: left length lower lcase ltrim replace replicate right rtrim space translate upper ucase	ESQL function of the same name such as LEFT and LENGTH.	The same parameters apply as for ESQL.
Field functions: bitstream fieldname fieldnamespace fieldtype fieldvalue lastmove samefield	ESQL function of the same name such as BITSTREAM and FIELDNAME.	The same parameters apply as for ESQL.

Name	ESQL equivalent	Notes
asbitstream	<p>These signatures are supported:</p> <p>ASBITSTREAM(FieldRef)</p> <p>ASBITSTREAM(FieldRef, typeExp, setExp, formatExp)</p> <p>ASBITSTREAM(FieldRef, typeExp, setExp, formatExp, encodingExp, ccsidExp)</p> <p>ASBITSTREAM(FieldRef, typeExp, setExp, formatExp, encodingExp, ccsidExp, options)</p>	<p>FieldRef is a source field reference such as \$source/po:PurchaseOrder</p> <p>typeExp is a string literal of the name of the message body, such as purchaseOrder, optionally qualified with a namespace URI, such as {http://www.ibm.com}:purchaseOrder</p> <p>setExp is a string literal of the name of the message set, such as PurchaseOrder</p> <p>formatExp is a string literal of the wire format of the message, such as XML1</p> <p>encodingExp and ccsidExp evaluate to integers with values corresponding to ESQL ENCODING and CCSID constants.</p> <p>options is an ESQL constant or bit-or of ESQL constant that evaluates to an integer.</p>
cardinality	CARDINALITY	The same parameters apply as for ESQL.
coalesce	COALESCE	The same parameters apply as for ESQL.
current-date	CURRENT_DATE	No parameters apply.
current-gmtdate	CURRENT_GMTDATE	No parameters apply.
current-gmttime	CURRENT_GMTTIME	No parameters apply.
current-gmttimestamp	CURRENT_GMTTIMESTAMP	No parameters apply.
current-time	CURRENT_TIME	No parameters apply.
current-timestamp	CURRENT_TIMESTAMP	No parameters apply.
date	DATE	
for	FOR (expression)	Optional parameters are not supported.
gmttime	GMTTIME	
gmttimestamp	GMTTIMESTAMP	
interval-year	INTERVAL YEAR	<p>The same parameters apply as for ESQL. Some examples:</p> <p>esql:interval-minute('90')</p> <p>esql:interval-year-to-month('1-06')</p>
interval-year-to-month	INTERVAL YEAR TO MONTH	
interval-month	INTERVAL MONTH	
interval-day	INTERVAL DAY	
interval-day-to-hour	INTERVAL DAY TO HOUR	
interval-day-to-minute	INTERVAL DAY TO MINUTE	
interval-day-to-second	INTERVAL DAY TO SECOND	
interval-hour	INTERVAL HOUR	
interval-hour-to-minute	INTERVAL HOUR TO MINUTE	
interval-hour-to-second	INTERVAL HOUR TO SECOND	
interval-minute	INTERVAL MINUTE	
interval-minute-to-second	INTERVAL MINUTE TO SECOND	
interval-second	INTERVAL SECOND	
is-null	Operand IS NULL	<p>Some examples:</p> <p>esql:is-null(\$source/po:purchaseOrder/po:comment)</p> <p>esql:is-null(\$db:select.ACME.PARTS.INVENTORY.LAST_TRANSACTION)</p>
like	source LIKE pattern	<p>For example:</p> <p>esql:like(\$source/po:purchaseOrder/shipTo/first_name,'Fred')</p>
	source LIKE pattern ESCAPE EscapeChar	<p>For example:</p> <p>esql:like(\$source/po:purchaseOrder/shipTo/zip,'L6F\$1C7','\$')</p>
local-timezone	LOCAL_TIMEZONE	

Name	ESQL equivalent	Notes
nullif	NULLIF	The same parameters apply as for ESQL.
overlay	OVERLAY Str1 PLACING Str2 FROM Start	For example: esql:overlay (\$source/po:purchaseOrder/shipTo/city,'abc',2)
	OVERLAY Str1 PLACING Str2 FROM Start For Length	For example: esql:overlay (\$source/po:purchaseOrder/shipTo/city,'abcde',2,3)
position	POSITION searchExp IN SourceExp	For example: esql:position ('aet',\$source/po:purchaseOrder/shipTo/first_name)
	POSITION searchExp IN SourceExp FROM FromExp	For example: esql:position ('do',\$source/po:purchaseOrder/shipTo/last_name,1)
	POSITION searchExp IN SourceExp FROM FromExp REPEAT RepeatExp	For example: esql:position ('a',\$source/po:purchaseOrder/billTo/first_name,1,2)
round	ROUND	Optional parameters are not supported.
sqlcode	SQLCODE	No parameters apply.
sqlerrortext	SQLERRORTEXT	
sqlnativeerror	SQLNATIVEERROR	
sqlstate	SQLSTATE	
time	TIME	
timestamp	TIMESTAMP	The same parameters apply as for ESQL. For example: esql:gmttimestamp ('1999-12-31 23:59:59.999999')
trim-leading	TRIM LEADING FROM Source	For example: esql:trim-leading (\$source/po:purchaseOrder/shipTo/state)
	TRIM LEADING Singleton FROM Source	For example: esql:trim-leading ('G',\$source/po:purchaseOrder/shipTo/zip)
trim-trailing	TRIM TRAILING FROM Source	For example: esql:trim-trailing (\$source/po:purchaseOrder/billTo/last_name)
	TRIM TRAILING Singleton FROM Source	For example: esql:trim-trailing ('e',\$source/po:purchaseOrder/billTo/street)
trim-both	TRIM BOTH FROM Source	For example: esql:trim-both (\$source/po:purchaseOrder/shipTo/city)
	TRIM BOTH Singleton FROM Source	For example: esql:trim-both (", \$source/po:purchaseOrder/shipTo/city)

Name	ESQL equivalent	Notes
trim	TRIM Source	For example: esql:trim (\$source/po:purchaseOrder/shipTo/city)
	TRIM Singleton FROM Source	For example: esql:trim (",\$source/po:purchaseOrder/shipTo/city)
uuidasblob	UUIDASBLOB	Takes zero or more parameters as in ESQL.
uuidaschar	UUIDASCHAR	

Predefined XPath mapping functions

A table of predefined XPath functions for use with message maps.

This table details the predefined XPath functions that are available to use with message maps. You can get more information about XPath functions and XPath syntax from the online W3C XML Path Language document.

Name	Parameters	Notes
true		
false		
sum	Source field from the message or database.	Source has to be a numeric type and repeats.
avg		
max		
min		
count	Source field from the message or database.	
concat	Two, or more, strings.	You cannot use <code>fn:concat(\$source/myElem)</code> to concatenate instances of 'myElem'.
not	1- Expression resolved to a Boolean value.	
exists	Source field from the message or database.	
empty		
substring	1- String 2- Zero-bases starting index 3- Length	For example: fn:substring (\$source/po:purchaseOrder/billTo/street, 3, 5)
year-from-dateTime	1- xs:dateTime	For example: fn:month-from-dateTime (xs:dateTime(\$source/po:purchaseOrder/shipTo/datetime)) where \$source/po:purchaseOrder/shipTo/datetime is xs:string.
month-from-dateTime		
day-from-dateTime		
hours-from-dateTime		
minutes-from-dateTime		
seconds-from-dateTime		

Name	Parameters	Notes
year-from-date	1-xs:date	For example: fn:year-from-date(xs:date (\$source/po:purchaseOrder/billTo/date)) where \$source/po:purchaseOrder/billTo/date is xs:string.
month-from-date		
day-from-date		
hours-from-time	1- xs:time	Some examples: fn:hours-from-time(xs:time("13:20:10:5")) fn:hours-from-time(xs:time (\$source/po:purchaseOrder/shipTo/time))
minutes-from-time		
seconds-from-time		
years-from-duration	1- xdt:dayTimeDuration	For example: fn:minutes-from-duration (xdt:dayTimeDuration(PT47H30M))
months-from-duration		
days-from-duration		
hours-from-duration		
minutes-from-duration		
seconds-from-duration		

Predefined mapping functions

A table of predefined mapping functions for use with message maps.

This table details the predefined mapping functions that are available to use with message maps:

Name	Parameters	Return	Notes
cdata-element	One string	Nothing	Create an XML element with CDATA content in the following target message domains: <ul style="list-style-type: none"> • XMLNSC • SOAP • XMLNS • XML • JMSMap • JMSStream For example: msgmap:cdata-element ('<date><month>05</month><day>11</day><year>2008</year></date>')
occurrence	Source field from the message or database	Source field as selected from a group of repeating fields.	Often used in a condition statement when source repeats to execute specific statements for a specific occurrence. For example: msgmap:occurrence (\$source/po:purchaseOrder/items)=2 means the second field, po:purchaseOrder
exact-type	1- Source field from the message or database 2- Namespace prefix 3- Name of the type	True if the source is of the specified type in the specified namespace.	Often used in a condition to execute specific statements for a specific source type. For example: msgmap:exact-type (\$source/tn1:msg2, 'tn1', 'extendedMsgType')

Name	Parameters	Return	Notes
empty-element()	None	Nothing	Creates an XML element with an empty tag. For example, if an element is named MyElement and the mapping expression for MyElement is set to msgmap:empty-element(), the output message will contain an element with no content: <MyElement/> Call this function only for an XML element.
element-from-bitstream	These signatures are supported: msgmap:element-from-bitstream(<i>StreamRef</i>) msgmap:element-from-bitstream(<i>StreamRef</i> , <i>typeExp</i> , <i>setExp</i> , <i>formatExp</i>) msgmap:element-from-bitstream(<i>StreamRef</i> , <i>typeExp</i> , <i>setExp</i> , <i>formatExp</i> , <i>encodingExp</i> , <i>ccsidExp</i>) msgmap:element-from-bitstream(<i>StreamRef</i> , <i>typeExp</i> , <i>setExp</i> , <i>formatExp</i> , <i>encodingExp</i> , <i>ccsidExp</i> , <i>options</i>)	Nothing	Used to parse a bitstream. This function can be called only for a message element target. The parsed bit stream is placed in the target message tree as the target element. <i>StreamRef</i> is a reference to a BLOB of stream, such as '\$source/BLOB' or '\$db:select.dsn.schema.table.column' <i>typeExp</i> is a string literal of the name of the message body, such as 'purchaseOrder', optionally qualified with a namespace URI, such as '{http://www.ibm.com}:purchaseOrder' <i>setExp</i> is a string literal of the name of the message set, such as 'PurchaseOrder' <i>formatExp</i> is a string literal of the wire format of the message, such as 'XML1' <i>encodingExp</i> and <i>ccsidExp</i> evaluate to integers with values corresponding to ESQL ENCODING and CCSID constants <i>options</i> is an ESQL constant or bit-or of ESQL constants that evaluate to an integer.

Mapping node casts

Source and target elements can be of different types in a Mapping node,

Depending on which runtime parsers are used, automatic casting cannot be done. In these cases, use one of the following cast functions:

- xs:boolean
- xs:date
- xs:dateTime
- xs:dayTimeDuration
- xs:decimal
- xs:duration
- xs:double
- xs:hexBinary
- xs:int
- xs:integer
- xs:string
- xs:long
- xs:time
- xs:yearMonthDuration

Headers and Mapping node

This topic lists the headers that can be manipulated by the Mapping node.

You can map these headers:

- MQ Headers
 - MQMD
 - MQCFH header with root element MQPCF
 - MQCIH
 - MQDLH
 - MQIIH
 - MQMDE
 - MQRFH
 - MQRFH header with MQRFH2 or MQRFH2C parser
 - MQRMH
 - MQSAPH
 - MQWIH
 - SMQ_BMH
- Email Headers
 - EmailOutputHeader
- HTTP Headers
 - HTTPInputHeader
 - HTTPReplyHeader
 - HTTPRequestHeader
 - HTTPResponseHeader
- JMSTransport

Migrating message mappings from Version 5.0

Use the `mqsimigratemfmaps` command to migrate message mappings to the Version 6.1 format.

The `mqsimigratemfmaps` command creates Version 6.1 mapping files (.msgmap) from your Version 5.0 mapping files (.mfmap).

When you migrate message mappings from Version 5.0, read the restrictions that apply.

The following table lists the mapping functions that are supported in Version 5.0 but not supported in Version 6.1, and shows the error messages that you might see. Mappings that contain these Version 5.0 functions cannot be migrated to Version 6.1; you must re-create and redeploy these mappings using another node, such as a JavaCompute node. Alternatively, migrate as much of the mapping as possible using the migration command, view the error report to see details of the functions that could not be migrated, and create a new node that can execute those functions that were not migrated.

Supported in Version 5.0	Migration utility error message
Expressions that involve multiple instances of a repeating source element, for example: src_msg.e[1] + src_msg.e[2] -> tgt_msg.e	Error:102: Unexpected index '2' encountered for target mappable 'e'. The expected index is '1'. Migration currently provides no support for expressions involving more than one instance of the same repeating-element.
ESQL field references that contain the asterisk wildcard character "*". For example: src_msg.e.* or src_msg.e.*[]	Error:130: ESQL field-reference 'src_msg.e.*' cannot be migrated. Migration currently provides no support for field-references containing '*'.
Dynamic ESQL field references. For example: src_msg.e.{'a' 'b'}	Error:131: ESQL field-reference 'src_msg.e.{'a' 'b'}' cannot be migrated. Migration currently provides no support for dynamic field-references.
ESQL expressions that contain a reference to the temporary index-variable "#I". For example: src_msg_e "#I" -> tgt_msg.e	Error:128: ESQL expressions containing the variable '#I' anywhere other than the index of a repeating-element cannot be handled by the migration.
Expressions within an index of a repeating element. For example: src_msg.e[src_msg.a] or src_msg.e["#I"+5] or src_msg.e[< 3]	Error:116: ESQL field-reference 'src_msg.e[< 3]' cannot be migrated. Migration currently provides no support for indexes other than the variable '#I' and plain integer indexes.
Aggregation functions MIN, MAX, and COUNT, used with the ESQL SELECT expression. For example: SELECT MAX("#T".FIRSTNAME) FROM Database.CUSTOMER AS "#T" WHERE "#T".CUSTOMERID = 7	Error:135: The ESQL expression 'SELECT MAX("#T".FIRSTNAME) FROM Database.CUSTOMER AS "#T" WHERE "#T".CUSTOMERID = 7' could not be migrated. The expression contains syntax which has no direct equivalent in the new map-script language.
ESQL IN operator. For example: src_msg.e IN (1, 2, 3)	Error:135: The ESQL expression 'SELECT MAX("#T".FIRSTNAME) FROM Database.CUSTOMER AS "#T" WHERE "#T".CUSTOMERID = 7' could not be migrated.

Restrictions on migrating message mappings

In certain scenarios, restrictions apply to the migration of .mfmap files from Version 5.0.

This topic explains why migration is not automatic in these situations, and provides instructions for how to complete a successful migration. This topic also provides information about restrictions that apply when you migrate submaps.

The programming model for message maps is different between Version 5.0 (where the file format is .mfmap) and Version 6.1 (where the format is .msgmap). Version 5.0 message maps have a procedural programming model, which is essentially an alternative ESQL, where you describe all the steps that are required to perform a transformation. Version 6.1 uses a declarative programming model, where you describe the result of the transformation, and the tools determine how to achieve that result.

Most migration failures result from message maps that contain too much information about the steps that perform the transformation, and not enough information about the desired result. For these message maps, migration is enabled

by changing the .mfmap file so that specific "how to" sections are separated into an ESQL function or procedure that can be called by the message map. The .mfmap file calls the ESQL function instead of containing it as an expression. The mqsimigratemfmaps command then migrates the .mfmap file, but calls the ESQL function instead of logging a migration error.

A limitation is that ESQL (the run time for .mfmap and .msgmap files) cannot define functions that return complex element (or REFERENCE) values. The following procedure explains how to work around this complex element target limitation; in many cases, you must rewrite the map as an ESQL function. For more examples and information about calling ESQL from maps, refer to the following sample:

- Message Map sample

You can view samples only when you use the information center that is integrated with the Message Broker Toolkit.

1. Determine whether you can define an ESQL function for the .mfmap file.
 - a. When the target value is a complex element, or in ESQL terms a REFERENCE, the individual mapping must be rewritten in the .msgmap file. Delete the mapping from the .mfmap file, and proceed to Step 4.
 - b. Use a function for all other cases: CHAR string, numbers, date, and time. Proceed to Step 2.
2. Determine the source parameters and returns type for your function.
 - a. For each source path in the mapping, there must be one parameter in the function or procedure. For a function, all parameters are unchangeable. The type of the parameter must match the source data type.
 - b. The function return type is the ESQL data type identified above.
3. Update the .mfmap file to enable migration. Change the .mfmap file to invoke the function in the mapping, passing the source parameters to the function in the order in which they were listed in step 2a.
4. Re-run the mqsimigratemfmaps command to migrate the modified .mfmap file.
5. Repeat Steps 1 to 4 until no errors are reported in the migration log.
6. Start the Version 6.1 Message Broker Toolkit and open the migrated .msgmap file.
 - a. For ESQL that is migrated as functions, there should be no errors.
 - b. For complex element targets, rewrite the mapping using the Version 6.1 features.

The following examples illustrate migration of .mfmap files to .msgmap files.

- To migrate a multiple reference to a repeating source expression:

```
src_msg.e[1] + src_msg.e[2]
```

compute the result in an ESQL function like:

```
CREATE FUNCTION addOneAndTwo(IN src_msg)
BEGIN
  RETURN src_msg.e[1] + src_msg.e[2];
END;
```

In the .msgmap file, call the ESQL function addOneAndTwo using the parent element src_msg as a parameter.

- An expression that does not use element names:

```
src_msg.*
```

```
or
src_msg.*[]
```

can be processed using a function that takes the parent of the repeating field:

```
CREATE FUNCTION processAny(IN src_msg)
BEGIN
  DECLARE nodeRef REFERENCE TO src_msg.e.*;
  DECLARE result <dataType> <initialValue>;
  WHILE LASTMOVE nodeRef DO
    --expression goes here
    SET result = result;
  END WHILE;
  RETURN RESULT;
END;
```

In the .msgmap file, call the ESQL function processAny using the parent element src_msg as a parameter.

- Expressions that dynamically compute element names:

```
src_msg.{'a' || 'b'}
```

can be processed by ESQL functions that process the parent of the repeating field:

```
CREATE FUNCTION processDynamicName(IN src_msg)
BEGIN
  RETURN src_msg.{'a' || 'b'};
END;
```

In the .msgmap file, call the ESQL function processDynamicName using the parent element src_msg as a parameter.

- Expressions that use the select MIN, MAX, and COUNT functions:

```
SELECT MAX("#T".FIRSTNAME)
FROM Database.CUSTOMER AS "#T"
WHERE "#T".CUSTOMERID = custId
```

can be processed by ESQL functions that process the parent of the repeating field:

```
CREATE FUNCTION processMAX(IN custId)
BEGIN
  RETURN
  SELECT MAX("#T".FIRSTNAME)
  FROM Database.CUSTOMER AS "#T"
  WHERE "#T".CUSTOMERID = custId
END;
```

In the .msgmap file, call the ESQL function processMAX using the element custId as a parameter.

- .mmap files that use mmap index variables in expressions:

```
e || "#I"
```

must be rewritten entirely in ESQL. By definition, there must be a complex repeating parent element, and this is not supported by ESQL functions.

- Expressions that use source expressions to compute values:

```
src_msg.e[src_msg.a]
```

must be rewritten using if rows, msgmap:occurrence() functions, and ESQL functions:

```

for src_msg.e
  if
    condition msgmap:occurrence(src_msg/e) = src_msg/a

```

- For expressions that use index expressions to compute values:

```

src_msg.e["#I" +5]
src_msg.e[< 3]

```

the entire .msgmap file must be rewritten in ESQL, because the .msgmap files do not support indexed access to repeating fields.

- .mfmap files that use ROW expressions to compute values:

```

src_msg.e IN (1, 2, 3)

```

must be rewritten in ESQL, because .msgmap files do not support ESQL ROW expressions.

Restrictions on migrating maps that call ESQL

If there is a mismatch between the case that has been in the ESQL call in the message map, and the name of the routine defined in the ESQL file, an error is produced during migration of the message map. To prevent an error occurring during migration, ensure that the ESQL call in the message map uses the same case as the ESQL defined in the routines in the ESQL file. Alternatively you can manually edit the message map after migration to call the ESQL routine with matching case.

Restrictions on migrating submaps

In Version 5.0 message maps, any complex element type can be a root of a submap. However, in Version 6.1, only a global element or a global attribute can be the root of a submap. When a Version 5.0 message map with a call to a submap with a non-global element as the map root is migrated, the submap is not migrated as a standalone submap. Instead, the call to the submap in the main message map is replaced by the migrated content of the submap. Alternatively, if the submap has a global element as the map root, the submap is migrated to a standalone Version 6.1 submap instead.

For Version 6.1, you must define reusable schema structures as global elements and types. If you have Version 5.0 submaps that use local elements, you must change the schema to add definitions of global elements for the local elements, and then use the new schema after migration. If the new global elements have the same name and type as the local elements, the Version 5.0 submaps do not need to be changed.

You must qualify a local element in a Version 5.0 submap with a namespace to ensure its successful migration to Version 6.1, because the global element that replaces it after migration must be qualified by the namespace. If your submap contains local elements, you must re-create the submap and re-create the call to the submap from the main message map.

The following table shows differences between the features that are supported in a submap for Version 5.0 and Version 6.1.

Version	Supported feature
Version 5.0	global elements and global attributes as map source
	global elements and global attributes as map target
	local elements and local attributes as map source
	local elements and local attributes as map target
Version 6.1	global elements, global attributes, and global types as map source
	global elements and global attributes as map target

Flow application debugger

The flow debugger is a visual interface that supports the debugging of message flow applications in the workbench. The following topics provide reference information to help you use the debugger effectively:

- “Flow debugger shortcuts”
- “Flow debugger icons and symbols” on page 1698

You can also use the “Java Debugger” on page 1700 provided by the Java Development tools to debug Java code within the workbench.

Flow debugger shortcuts

You can use function keys and shortcut keys to complete actions in the flow debugger views and windows.

Shortcut keys are shown as a pair that you press together, followed by a subsequent key, for example `Shift-F10, C` means hold the Shift key down and press F10, then release both and press key C.

The tables below describe the main shortcuts that are available in the debug session:

- “Debug view”
- “Breakpoints view” on page 1698
- “Flow Breakpoint Properties dialog” on page 1698
- “Variables view” on page 1698

To see a complete list of all the shortcuts that are available, press `Shift-F10` and release; the contextual menu is displayed.

Debug view

Key combination	Function
<code>Shift-F10, C</code>	Run to completion
<code>Shift-F10, E</code>	Disconnect
<code>F5</code> or <code>Shift-F10, I</code>	Step into
<code>F8</code> or <code>Shift-F10, M</code>	Resume
<code>Shift-F10, N</code>	Terminate All
<code>F6</code> or <code>Shift-F10, O</code>	Step over
<code>Shift-F10, T</code>	Terminate
<code>F7</code> or <code>Shift-F10, U</code>	Step return
<code>Shift-F10, V</code>	Terminate and Remove

Breakpoints view

Key combination	Function
Shift-F10, A	Select All
Shift-F10, B	Add breakpoint
Shift-F10, D	Disable the selected breakpoints
Shift-F10, E	Enable the selected breakpoints
Shift-F10, L	Remove all breakpoints
Shift-F10, O	Remove the selected breakpoints

Flow Breakpoint Properties dialog

Key combination	Function
E	Enable the breakpoint
Alt-R, <space>	Restrict the breakpoint to the selected flow instances

Variables view

Key combination	Function
Shift-F10, A	Select All
Shift-F10, C	Change the value of the selected flow variable
Shift-F10, V	Copy variables



Flow debugger icons and symbols

This topic describes the icons and symbols used in the Debug perspective and its views:















- “Debug perspective”
- “Debug view” on page 1699
- “Message Flow editor” on page 1699
- “Breakpoints view” on page 1700
- “Variables view” on page 1700

Debug perspective

These icons and symbols are used in the Debug perspective *outside* any individual view.





Icon or Symbol	Description
	Debug perspective (symbol)
	Attach to Flow runtime (icon)

Debug view





Icon or Symbol	Description
	Debug view (symbol)
	Flow engine (symbol)
	Flow (symbol)
	Flow instance paused (symbol)
	Flow instance running (symbol)
	Flow instance terminated (symbol)
	Stack frame (symbol)
	Detach from the selected flow engine (icon)
	Resume flow execution (icon)
	Run the flow to completion (icon)
	Step into subflow (icon)
	Step over node (icon)
	Step out of subflow (icon)
	Step into source code (icon)

Message Flow editor

These icons and symbols in the message flow editor are specific to the flow debugger.









Icon or Symbol	Description
	Enabled breakpoint (symbol)
	Disabled breakpoint (symbol)
	Paused at breakpoint (symbol)
	Source code available (symbol)
	Error or exception (symbol)

Breakpoints view

Icon or Symbol	Description
	Breakpoints view (symbol)
	Enabled breakpoint (symbol)
	Disabled breakpoint (symbol)
	Remove selected breakpoints (icon)
	Remove all breakpoints (icon)

Variables view

These icons and symbols in the Variables view are specific to ESQL.

Icon or Symbol	Description
	Variable view (symbol)
	Tree reference variable (symbol)
	Message (symbol)
	ESQL reference variable (symbol)
	ESQL constant (symbol)
	ESQL scalar variable (symbol)
	ESQL schema variable (symbol)
	ESQL module variable (symbol)

Java Debugger

The Java Development Tools include a debugger that enables you to detect and diagnose errors in your programs running on local or remote systems. You can control the execution of your program by setting breakpoints, suspending launched programs, stepping through your code, and examining the contents of variables.

For further information about the Java debugger, refer to the Java Development User Guide plug-in - Debugger.

Part 7. Appendixes

Appendix. Notices for WebSphere Message Broker

This information was developed for products and services offered in the U.S.A.

IBM may not offer the products, services, or features discussed in this information in other countries. Consult your local IBM representative for information on the products and services currently available in your area. Any reference to an IBM product, program, or service is not intended to state or imply that only that IBM product, program, or service may be used. Any functionally equivalent product, program, or service that does not infringe any IBM intellectual property right may be used instead. However, it is the user's responsibility to evaluate and verify the operation of any non-IBM product, program, or service.

IBM may have patents or pending patent applications covering subject matter described in this information. The furnishing of this information does not give you any license to these patents. You can send license inquiries, in writing, to:

*IBM Director of Licensing
IBM Corporation
North Castle Drive
Armonk, NY 10504-1785
U.S.A.*

For license inquiries regarding double-byte (DBCS) information, contact the IBM Intellectual Property Department in your country or send inquiries, in writing, to:

*IBM World Trade Asia Corporation
Licensing
2-31 Roppongi 3-chome, Minato-ku
Tokyo 106-0032,
Japan*

The following paragraph does not apply to the United Kingdom or any other country where such provisions are inconsistent with local law:

INTERNATIONAL BUSINESS MACHINES CORPORATION PROVIDES THIS PUBLICATION "AS IS" WITHOUT WARRANTY OF ANY KIND, EITHER EXPRESS OR IMPLIED, INCLUDING, BUT NOT LIMITED TO, THE IMPLIED WARRANTIES OF NON-INFRINGEMENT, MERCHANTABILITY OR FITNESS FOR A PARTICULAR PURPOSE. Some states do not allow disclaimer of express or implied warranties in certain transactions, therefore, this statement may not apply to you.

This information could include technical inaccuracies or typographical errors. Changes are periodically made to the information herein; these changes will be incorporated in new editions of the information. IBM may make improvements and/or changes in the product(s) and/or the program(s) described in this information at any time without notice.

Any references in this information to non-IBM Web sites are provided for convenience only and do not in any manner serve as an endorsement of those Web sites. The materials at those Web sites are not part of the materials for this IBM product and use of those Web sites is at your own risk.

IBM may use or distribute any of the information you supply in any way it believes appropriate without incurring any obligation to you.

Licensees of this program who wish to have information about it for the purpose of enabling: (i) the exchange of information between independently created programs and other programs (including this one) and (ii) the mutual use of the information which has been exchanged, should contact:

*IBM United Kingdom Laboratories,
Mail Point 151,
Hursley Park,
Winchester,
Hampshire,
England
SO21 2JN*

Such information may be available, subject to appropriate terms and conditions, including in some cases, payment of a fee.

The licensed program described in this information and all licensed material available for it are provided by IBM under terms of the IBM Customer Agreement, IBM International Programming License Agreement, or any equivalent agreement between us.

Any performance data contained herein was determined in a controlled environment. Therefore, the results obtained in other operating environments may vary significantly. Some measurements may have been made on development-level systems and there is no guarantee that these measurements will be the same on generally available systems. Furthermore, some measurements may have been estimated through extrapolation. Actual results may vary. Users of this document should verify the applicable data for their specific environment.

Information concerning non-IBM products was obtained from the suppliers of those products, their published announcements or other publicly available sources. IBM has not tested those products and cannot confirm the accuracy of performance, compatibility or any other claims related to non-IBM products. Questions on the capabilities of non-IBM products should be addressed to the suppliers of those products.

All statements regarding IBM's future direction or intent are subject to change or withdrawal without notice, and represent goals and objectives only.

This information includes examples of data and reports used in daily business operations. To illustrate them as completely as possible, the examples include the names of individuals, companies, brands, and products. All of these names are fictitious and any similarity to the names and addresses used by an actual business enterprise is entirely coincidental.

COPYRIGHT LICENSE:

This information contains sample application programs in source language, which illustrate programming techniques on various operating platforms. You may copy, modify, and distribute these sample programs in any form without payment to IBM, for the purposes of developing, using, marketing or distributing application programs conforming to the application programming interface for the operating platform for which the sample programs are written. These examples have not

been thoroughly tested under all conditions. IBM, therefore, cannot guarantee or imply reliability, serviceability, or function of these programs.

Each copy or any portion of these sample programs or any derivative work, must include a copyright notice as follows:

(C) *(your company name)* (year). Portions of this code are derived from IBM Corp. Sample Programs. © Copyright IBM Corp. *_enter the year or years_*. All rights reserved.

Trademarks in the WebSphere Message Broker information center

The following terms are trademarks of International Business Machines Corporation in the United States, other countries, or both:

AIX	CICS	DB2
DB2 Connect	DB2 Universal Database	developerWorks
Domino		Everyplace
FFST	First Failure Support Technology	IBM
IBMLink	IMS	IMS/ESA
Informix	iSeries	i5/OS
Language Environment	Lotus	MQSeries
MVS	NetView	OS/400
OS/390	Passport Advantage	POWER
pSeries	RACF	Rational
Redbooks	RETAIN	RS/6000
SupportPac	System i	S/390
Tivoli	VisualAge	WebSphere
xSeries	z/OS	zSeries

Adobe, the Adobe logo, PostScript, and the PostScript logo are either registered trademarks or trademarks of Adobe Systems Incorporated in the United States, and/or other countries.

Intel and Pentium are trademarks or registered trademark of Intel Corporation or its subsidiaries in the United States and other countries.

Java and all Java-based trademarks and logos are trademarks of Sun Microsystems, Inc. in the United States, other countries, or both.

Microsoft, Windows, Windows NT, and the Windows logo are trademarks of Microsoft Corporation in the United States, other countries, or both.

UNIX is a registered trademark of The Open Group in the United States and other countries.

Linux is a trademark of Linus Torvalds in the United States, other countries, or both.

Other company, product, or service names may be trademarks or service marks of others.

Index

A

- accounting and statistics data 119
 - accounting origin 121
 - collecting 564
 - collection options 120
 - details 1381
 - example output 1394
 - output data formats 1382
 - output formats 122
 - parameters, modifying 569
 - parameters, viewing 568
 - resetting archive data 569
 - setting accounting origin 566
 - starting 564
 - stopping 567
- accounting origin 121
 - setting 566
- Adapter Connection wizard 256
- Adapters (WebSphere)
 - connecting 256
 - developing applications 245
- additional instances, file processing 720
- AggregateControl node 824
- AggregateReply node 826
- AggregateRequest node 829
- aggregation 124
 - database deadlocks, resolving 588
 - exceptions, handling 588
 - fan-in flows, creating 577
 - fan-out flows, creating 573
 - multiple AggregateControl nodes 584
 - requests and responses,
 - correlating 585
 - timeouts, setting 583
 - WebSphere MQ to store state 590
- alignment, nodes 244
- application clients
 - MQGet node message processing 185
 - request-response, MQGet node 189
 - Web services
 - call existing 701
 - HTTP flows 697
 - implement existing interface 709
 - implement existing interface to new 713
 - implement new 705
 - scenarios 700
 - SOAP applications 623
 - SOAP domain message flows 689
 - WSDL applications 629
 - XML domain message flows 696
- archive data 120
 - resetting 569

B

- bar files 751
 - creating 758
 - deploying 763

- bar files (*continued*)
 - editing
 - manually 760
 - properties 761
 - message flows
 - adding 759
 - adding multiple instances 761
 - message sets, adding 759
 - redeploying 763
 - bend points 52
 - adding 242
 - removing 243
 - BLOB
 - parser 107
 - breakpoints 790
 - adding 790
 - disabling 792
 - enabling 792
 - removing 793
 - restricting 791
 - broker archive 751
 - configurable properties 752
 - deployment 749
 - broker archive files
 - creating 758
 - deploying 763
 - editing
 - manually 760
 - properties 761
 - message flows
 - adding 759
 - adding multiple instances 761
 - message sets, adding 759
 - redeploying 763
 - broker configuration deployment 753
 - broker configuration, deploying 767
 - broker properties, message flow 110, 263
 - broker schema 114
 - creating 217
 - brokers
 - cancel deployment 755
 - deployed flows, querying 803
 - business objects
 - PeopleSoft 47

C

- cancel deployment 755
- Check node 831
- cluster queues 162
- code dependencies, Java 452
- code pages
 - conversion 128
 - converting with ESQL 315
- collector node
 - collection expiry, setting 599
 - collection name, setting 599
 - control messages, using 602
 - event coordination, setting 600
 - event handler properties, setting 596
 - input terminals, adding 596

- collector node (*continued*)
 - persistence mode, setting 601
- Collector node 833
- collector node, configuring 595
- collector node, using 593
- comment and path, message flows 50
- complete broker archive
 - deployment 749
- complete topics deployment 754
- complete topology deployment 753
- complex types
 - broker properties 110, 263
- Compute node 838
- conditional mappings, configuring 487
- conditional mappings, creating 511
- configurable properties, broker
 - archive 752
- configurable properties, message flow 1372
- configurable services 50
- connections 52
 - creating with the mouse 240
 - creating with the Terminal Selection dialog box 241
 - listing 1358
 - removing 242
 - WebSphere MQ 1357
- coordinated message flows,
 - configuring 173
- coordination
 - database connections 1398
 - database support 1399
- correlation names
 - logical message tree 71
 - XML constructs 1433

D

- data conversion 128
 - configuring message flows 183
- data source
 - z/OS
 - Compute node 1448
 - Database node 1448
- data types
 - BLOB message 1403
 - DestinationData subtree 1401
 - elements 1400
 - fields 1400
 - Properties subtree 1400
 - support for 1657
 - WebSphere MQ header fields 1400
 - XMLNSC parser 92
- database connections
 - listing 1358
 - quiescing 1358
- database definitions, adding 494
- Database node 846
- DatabaseRetrieve node 850
- DatabaseRoute node 859

- databases
 - adding 494
 - code page support 1359
 - data type support 1657
 - DBCS restrictions 1358
 - definitions, creating 494
 - Java 467
 - listing connections 1358
 - quiescing 1358
 - stored procedures in ESQL 332
- DataDelete node 866
- datagram message, sending 961
- DataInsert node 869
- DataUpdate node 872
- DBCS, database restrictions 1358
- debugging 781
 - data 799
 - ESQL 800
 - Java 801
 - mappings 802
 - messages 799
 - dequeuing 789
 - enqueueing 786
 - icons and symbols 1698
 - keyboard shortcuts 1697
 - message flows 783
 - starting 784
 - stepping through message flows 794
- delta topics deployment 754
- delta topology deployment 753
- deployment 745
 - broker archive (bar) files 763
 - broker configuration 767
 - canceling 774
 - checking results 772
 - complete 745
 - delta 745
 - message flow application 757
 - message flows 745
 - message sets 745
 - overview 746
 - broker archive (bar) files 751
 - broker configuration 753
 - cancel 755
 - configurable properties 752
 - message flow applications 749
 - methods 746
 - topics 754
 - topology 753
 - types 748
 - publish/subscribe topics
 - hierarchy 770
 - publish/subscribe topology 768
 - Version 5 or Version 6 authored ESQL
 - to a Version 2.1 broker 271
- dequeuing, using in debugging 789
- Destination (LocalEnvironment),
 - populating 311
- destination lists
 - creating 162
 - using 156
- domains
 - cancel deployment 755
- DTD support
 - XMLNS parser 96
 - XMLNSC parser 93
- dynamic terminals, adding 237

E

- editors
 - Message Mapping 1410, 1673
 - palette
 - customizing 229
 - layout, changing 228
 - settings, changing 229
- EIS, connecting 256
- EJB, calling 470
- element definitions for message
 - parsers 1399
- EmailOutput node 875
- empty elements
 - XMLNSC parser 87
- Empty elements
 - XMLNS parser 94
- encoding 128
- EndpointLookup node 881
- enqueueing, using in debugging 786
- Enterprise Information System,
 - connecting 256
- Environment tree 63
 - accessing with ESQL 312
- errors
 - connecting failure terminals 206
 - handling 203
 - input node 206
 - MQInput node 208
 - TimeoutNotification node 211
 - TryCatch node 212
- errors, from saving 227
- ESQL
 - accessible from Java 110, 263
 - accessing databases 172
 - adding keywords 322
 - BLOB messages 407
 - Broker attributes 110, 263
 - constants 1662
 - converting EBCDIC NL to ASCII
 - CRLF 318
 - data
 - casting 314
 - converting 315
 - transforming 314
 - data types 259
 - database columns
 - referencing 324
 - selecting data from 325
 - database content, changing 330
 - database state 339
 - database updates, committing 332
 - databases, interacting with 322
 - datetime representation 1456
 - debugging 800
 - deploying Version 5 or Version 6 to a
 - Version 2.1 broker 271
 - Destination, populating 311
 - developing 257
 - elements
 - accessing 284
 - setting or querying null 284
 - elements, multiple occurrences
 - accessing known 288
 - accessing unknown 289
 - Environment tree, accessing 312
 - errors 334
 - example message 1671

ESQL (continued)

- ExceptionList tree, accessing 313
- exceptions 338
- explicit null handling 284
- field references 264
 - anonymous 290
 - creating 291
 - syntax 1465
- field types, referencing 283
- fields
 - copying those that repeat 298
 - creating new 292
 - manipulating those that repeat in a
 - message tree 302
- files
 - copying 275
 - creating 269
 - deleting 279
 - moving 277
 - opening 270
 - renaming 276
 - saving 274
- functions 266
- headers, accessing 303
- IDoc messages 404
- implicit null handling 284
- JMS messages 404
- keywords
 - non-reserved 1668
 - reserved 1668
- like-parser-copy 320
- list type elements, working with 300
- LocalEnvironment tree, accessing 308
- mapping between a list and a
 - repeating element 301
- mapping functions 1422, 1685
- message body data,
 - manipulating 283
- message format, changing 320
- message tree parts, manipulating 303
- MIME messages 405
- modules 267
- MQCFH header, accessing 305
- MQMD header, accessing 304
- MQPCF header, accessing 305
- MQRFH2 header, accessing 304
- MRM domain messages
 - handling large 401
 - working with 398
- MRM domain messages, accessing
 - attributes 390
 - elements 389
 - elements in groups 392
 - embedded messages 395
 - mixed content 393
 - multiple occurrences 389
 - namespace-enabled messages 396
- MRM domain messages, null values
 - querying 396
 - setting 397
- multiple database tables,
 - accessing 329
- nested statements 265
- node
 - creating 271
 - deleting 279
 - modifying 273

- ESQL (*continued*)
 - numeric operators with datetime 295
 - operators 264
 - complex comparison 1473
 - logical 1476
 - numeric 1477
 - rules for operator precedence 1478
 - simple comparison 1472
 - string 1478
 - output messages, generating 294
 - overview of 1451
 - preferences, changing 277
 - procedures 266
 - Properties tree, accessing 307
 - returns to SELECT, checking 331
 - SELECT function 340
 - settings
 - editor 277
 - validation 278
 - special characters 1666
 - statements 265
 - stored procedures, invoking 332
 - subfield, selecting 297
 - syntax preference 1452
 - tailoring for different nodes 282
 - time interval, calculating 296
 - unlike-parser-copy 320
 - variables 259
 - XML domain, manipulating messages in the 387
 - XML messages
 - complex message, transforming 344
 - data, translating 350
 - message and table data, joining 351
 - message data, joining 348
 - scalar value, returning 346
 - simple message, transforming 341
 - XMLNS domain, manipulating messages in the 378
 - XMLNSC domain, manipulating messages in the 364
- ESQL data types
 - BOOLEAN 1452
 - database, ROW 1460
 - Datetime 1452
 - DATE 1453
 - GMTTIME 1453
 - GMTTIMESTAMP 1454
 - INTERVAL 1454
 - TIME 1453
 - TIMESTAMP 1453
 - ESQL to Java, mapping of 1462
 - ESQL to XPath, mapping of 1463
 - list of 1452
 - NULL 1457
 - numeric 1458
 - DECIMAL 1458
 - FLOAT 1459
 - INTEGER 1460
 - REFERENCE 1460
 - string 1461
 - BIT 1461
 - BLOB 1462
 - CHARACTER 1462
- ESQL functions 1564
 - CAST
 - formatting and parsing dates as strings 1626
 - formatting and parsing numbers as strings 1623
 - formatting and parsing times as strings 1626
 - complex 1616
 - CASE 1616
 - CAST 1618
 - data types from external sources 1657
 - LIST constructor 1640
 - ROW and LIST combined 1641
 - ROW and LIST comparisons 1642
 - ROW constructor 1639
 - SELECT 1633
 - Supported casts 1644
 - database state 1567
 - SQLCODE 1568
 - SQLERRORTXT 1568
 - SQLNATIVEERROR 1569
 - SQLSTATE 1570
 - datetime 1572
 - CURRENT_DATE 1575
 - CURRENT_GMTDATE 1576
 - CURRENT_GMTTIME 1576
 - CURRENT_GMTTIMESTAMP 1576
 - CURRENT_TIME 1575
 - CURRENT_TIMESTAMP 1575
 - EXTRACT 1573
 - LOCAL_TIMEZONE 1577
 - field 1602
 - ASBITSTREAM 1603
 - BITSTREAM 1606
 - FIELDNAME 1607
 - FIELDNAMESPACE 1608
 - FIELDTYPE 1608
 - FIELDVALUE 1610
 - FOR 1611
 - LASTMOVE 1612
 - SAMEFIELD 1613
 - implicit casts 1652
 - arithmetic operations 1654
 - assignment 1656
 - comparisons 1652
 - list 1613
 - CARDINALITY 1613
 - EXISTS 1614
 - SINGULAR 1615
 - THE 1615
 - miscellaneous 1658
 - COALESCE 1658
 - NULLIF 1659
 - PASSTHRU 1659
 - UIDASBLOB 1662
 - UIDASCHAR 1662
 - numeric 1577
 - ABS and ABSVAL 1578
 - ACOS 1579
 - ASIN 1579
 - ATAN 1579
 - ATAN2 1579
 - BITAND 1580
 - BITNOT 1580
 - BITOR 1581
- ESQL functions (*continued*)
 - numeric (*continued*)
 - BITXOR 1581
 - CEIL and CEILING 1582
 - COS 1582
 - COSH 1583
 - COT 1583
 - DEGREES 1583
 - EXP 1583
 - FLOOR 1584
 - LN and LOG 1584
 - LOG10 1585
 - MOD 1585
 - POWER 1585
 - RADIANS 1586
 - RAND 1586
 - ROUND 1586
 - SIGN 1590
 - SIN 1590
 - SINH 1590
 - SQRT 1590
 - TAN 1591
 - TANH 1591
 - TRUNCATE 1592
 - string manipulation 1592
 - LEFT 1593
 - LENGTH 1593
 - LOWER and LCASE 1594
 - LTRIM 1594
 - OVERLAY 1595
 - POSITION 1596
 - REPLACE 1597
 - REPLICATE 1597
 - RIGHT 1598
 - RTRIM 1598
 - SPACE 1599
 - SUBSTRING 1599
 - TRANSLATE 1600
 - TRIM 1600
 - UPPER and UCASE 1601
 - ESQL statements 1478
 - ATTACH 1480
 - BEGIN ... END 1482
 - BROKER SCHEMA 1485
 - PATH clause 1485
 - CALL 1487
 - CASE 1490
 - CREATE 1493
 - CREATE FUNCTION 1500
 - CREATE MODULE 1509
 - CREATE PROCEDURE 1511
 - DECLARE 1525
 - DECLARE HANDLER 1530
 - DELETE 1534
 - DELETE FROM 1531
 - DETACH 1534
 - EVAL 1535
 - FOR 1536
 - IF 1537
 - INSERT 1538
 - ITERATE 1541
 - LEAVE 1542
 - list of available 1478
 - Local error handler 1530
 - LOG 1543
 - LOOP 1544
 - MOVE 1546

ESQL statements (*continued*)

- PASSTHRU 1548
- PROPAGATE 1550
- REPEAT 1553
- RESIGNAL 1554
- RETURN 1554
- SET 1557
- THROW 1559
- UPDATE 1560
- WHILE 1563

event store

- PeopleSoft adapter 45

exception handling, Java 471

ExceptionList tree 68

- accessing with ESQL 313

exceptions, message tree content 58

execution groups

- message flows, removing 776

Extract node 884

F

failure terminals, connecting 206

fan-in flows, creating 577

fan-out flows, creating 573

Favorites category (palette) 230

FileInput node 886

- mqsiarchive subdirectory 726

- parsing file records 719

- reading a file 727

FileOutput node 899

- mqsiarchive subdirectory 726

- writing a file 735

files

file processing 717

- additional instances 720

- file name patterns 724

- LocalEnvironment variables 721

- mqsiarchive subdirectory 726

- parsing file records 719

- reading a file 727

- shared access 720

- writing a file 735

- parsing file records 719

- reading 727

- writing 735

Filter node 910

flow debugger 781

- ESQL nodes 782

- icons and symbols 1698

- Java nodes 782

- keyboard shortcuts 1697

- mapping nodes 782

flow engine

- attaching to 784

- detaching from 805

flow instances

- managing 803

- stepping through 794

- resuming execution 794

- running to completion 795

- stepping into source code 797

- stepping into subflows 796

- stepping out of source code 798

- stepping out of subflows 796

- stepping over nodes 795

- stepping over source code 798

flow instances (*continued*)

- terminating 804

FlowOrder node 914

G

global environment, Java 465

H

headers 511

Java

- accessing 463

- copying 463

- mapping 1427, 1691

HTTPHeader node 916

HTTPInput node 920

HTTPReply node 927

HTTPRequest node 929

I

IBM Tivoli License Manager

- activating for WebSphere

- Adapters 246

icons

- flow debugger 1698

IDOC parser 107

incremental broker archive

- deployment 749

Input node 942

J

Java

- accessing attributes 465

- accessing elements 455

- accessing the global environment 465

- calling an EJB 470

- classloading 453

- code dependencies 452

- copying a message 457

- copying headers 463

- creating a filter 459

- creating a new message 457

- creating code 450

- creating elements 458

- debugging 801

- deploying code 453

- developing 449

- exception handling 471

- headers, accessing 463

- interacting with databases 467

- keywords 466

- logging errors 471

- managing files 449

- manipulating messages 454

- MQMD 463

- MQRFH2 464

- opening files 451

- propagating a message 460

- saving files 451

- setting elements 458

- transforming messages 457

- updating the Local Environment 464

Java (*continued*)

- user-defined properties 466

- writing 454

- XPath 460

Java, broker attributes accessible

- from 110, 263

JavaCompute node 943

- accessing databases 467

- using `mbSQLStatement` 467

- using SQLJ 467

- using types 2 and 4 JDBC 467

- calling an EJB 470

JDBC, types 2 and 4

- used by JavaCompute node 467

JDT Java debugger 1700

JMSHeader node 946

JMSInput node 949

JMSMQTransform node 960

JMSOutput node 961

JMSReply node 972

K

keyboard shortcuts

- flow debugger 1697

keywords 820

- description properties 819

- displaying 224

- ESQL 322

- Java 466

- subflows 157

- XSL style sheet 1225

L

Label node 976

list of available 1564

local environment, Java 464

LocalEnvironment tree 64

- accessing with ESQL 308

- file processing 721

- LocalEnvironment.File structure 721

- LocalEnvironment.Wildcard.WildcardMatch

- structure 721

- LocalEnvironment.WrittenDestination.File

- structure 721

- populating Destination 311

- using as scratchpad 310

LocalEnvironment.File structure 721

LocalEnvironment.Wildcard.WildcardMatch

- structure 721

LocalEnvironment.WrittenDestination.File

- structure 721

logical message tree

- contents after exception 58

- correlation names 71

- Environment tree 63

- ExceptionList tree 68

- LocalEnvironment tree 64

- message body 61

- Properties folder 61

- structure 60

logical message tree, viewing 167

lost messages, avoiding 200

M

- map file, creating 476
- map file, creating from DataDelete node 497
- map file, creating from DataInsert node 495
- map file, creating from DataUpdate node 496
- map file, creating from node 477
- Mapping node 978
 - casts 1427, 1690
 - functions 1422, 1685
 - ESQL mapping functions 1422, 1685
 - predefined mapping functions 1426, 1689
 - Xpath mapping functions 1425, 1688
 - syntax 1420, 1683
- mappings 511
 - adding
 - headers and folders 491
 - conditional
 - configuring 487
 - creating 511
 - configuring 478
 - creating 476
 - database
 - adding 492
 - BLOB message to database 501
 - change operation 497
 - database to database 501
 - database to message 502
 - source 498
 - databases 494
 - debugging 802
 - deleting data 500
 - deleting source and target 486
 - derived types 475
 - hiding 479
 - showing 479
 - developing 472
 - ESQL routines, calling 508
 - examples 515
 - from database tables 498
 - from source
 - by name 480
 - by selection 480
 - from source messages 481
 - headers and folders 491
 - headers, configuring 490
 - Java methods, calling 509
 - list types 475
 - LocalEnvironment, configuring 490
 - map file, creating 476
 - map file, creating from DataDelete node 497
 - map file, creating from DataInsert node 495
 - map file, creating from DataUpdate node 496
 - map file, creating from mapping node 477
 - mappable headers 1427, 1691
 - Mapping node casts 1427, 1690
 - Mapping node functions 1422, 1685

- mappings (*continued*)
 - ESQL mapping functions 1422, 1685
 - predefined mapping functions 1426, 1689
 - XPath mapping functions 1425, 1688
- Mapping node syntax 1420, 1683
- Message Mapping editor 1410, 1673
 - Edit pane 1416, 1679
 - Source pane 1411, 1674
 - Spreadsheet pane 1417, 1680
 - Target pane 1414, 1677
- message, adding 492
- migrating 1428, 1691
 - restrictions 1429, 1692
- overview 473
- populate 489
- removing
 - headers and folders 491
- repeating elements, configuring 488
- restrictions 512
- scenarios 515
- schema structure 475
- SOAP 510
- statements, order 511
- submaps 502
 - calling 506
 - converting a message map 505
 - converting an inline mapping 506
 - creating 503
 - modify database 504
 - wildcard source 504
- subroutines 502
 - calling from ESQL 507
 - user-defined, calling 508
- substituting elements
 - hiding 479
 - showing 479
- substitution groups 475
- target, setting the value
 - to a constant 483
 - to a WebSphere MQ constant 483
 - to an ESQL constant 484
 - using a function 485
 - using an expression 485
- union types 475
- wildcards 475

- mbSQLStatement
 - used by JavaCompute node 467
- message
 - assembly 60
- message body 61
- message, accessing with 283
- message collection 126
 - collector node, configuring 595
 - collector node, using 593
- message definitions
 - importing from WSDL
 - WSDL validation 630
- message destination mode 961
- message flow application, deploying 757
- message flow nodes 822
 - AggregateControl 824
 - AggregateReply 826
 - AggregateRequest 829
 - Check 831

- message flow nodes (*continued*)
 - Collector 833
 - Compute 838
 - Database 846
 - DatabaseRetrieve 850
 - DatabaseRoute 859
 - DataDelete 866
 - DataInsert 869
 - DataUpdate 872
 - dynamic terminals, adding 237
 - EmailOutput 875
 - EndpointLookup 881
 - Extract 884
 - FileInput 886
 - FileOutput 899
 - Filter 910
 - FlowOrder 914
 - HTTPHeader 916
 - HTTPInput 920
 - HTTPReply 927
 - HTTPRequest 929
 - Input 942
 - JavaCompute 943
 - JMSHeader 946
 - JMSInput 949
 - JMSMQTransform 960
 - JMSOutput 961
 - JMSReply 972
 - Label 976
 - Mapping 978
 - MQeInput 982
 - MQeOutput 990
 - MQGet 993
 - MQHeader 1004
 - MQInput 1007
 - MQJMSTransform 1020
 - MQOptimizedFlow 1021
 - MQOutput 1023
 - MQReply 1029
 - Output 1033
 - Passthrough 1034
 - PeopleSoftInput 1036
 - PeopleSoftRequest 1039
 - Publication 1042
 - Real-timeInput 1044
 - Real-timeOptimizedFlow 1046
 - RegistryLookup 1048
 - ResetContentDescriptor 1050
 - Route 1056
 - RouteToLabel 1059
 - SAPInput 1061
 - SAPRequest 1064
 - SCADAInput 1067
 - SCADAOutput 1074
 - SiebelInput 1076
 - SiebelRequest 1079
 - SOAPAsyncRequest 1082
 - SOAPAsyncResponse 1092
 - SOAPEnvelope 1096
 - SOAPExtract 1099
 - SOAPInput 1104
 - SOAPReply 1114
 - SOAPRequest 1116
 - TCPIPClientInput 1126
 - TCPIPClientOutput 1137
 - TCPIPClientReceive 1146
 - TCPIPServerInput 1158

- message flow nodes (*continued*)
 - TCPIPServerOutput 1169
 - TCPIPServerReceive 1177
 - Throw 1189
 - TimeoutControl 1191
 - TimeoutNotification 1194
 - Trace 1198
 - TryCatch 1202
 - TwineballInput 1204
 - TwineballRequest 1207
 - Validate 1210
 - Warehouse 1213
 - WebSphere Adapters 7
 - PeopleSoftInput 1036
 - PeopleSoftRequest 1039
 - SAPInput 1061
 - SAPRequest 1064
 - SiebelInput 1076
 - SiebelRequest 1079
 - TwineballInput 1204
 - TwineballRequest 1207
 - XSLTransform 1216
- message flows 4
 - accessing databases 170
 - from ESQL 172
 - accounting and statistics data 119
 - accounting origin 121
 - collecting 564
 - collection options 120
 - details 1381
 - example output 1394
 - output data formats 1382
 - output formats 122
 - parameters, modifying 569
 - parameters, viewing 568
 - resetting archive data 569
 - setting accounting origin 566
 - starting 564
 - stopping 567
 - aggregation 124
 - database deadlocks, resolving 588
 - exceptions, handling 588
 - fan-in flow, creating 577
 - fan-out and fan-in flows, associating 581
 - fan-out flow, creating 573
 - multiple AggregateControl nodes 584
 - requests and responses, correlating 585
 - timeouts, setting 583
 - unknown and timeout message exceptions 589
 - WebSphere MQ to store state 590
 - bend points 52
 - adding 242
 - removing 243
 - broker archive (bar) file, adding to 759
 - broker properties 110, 263
 - broker schemas
 - creating 217
 - deleting 224
 - built-in nodes 822
 - Chinese code page GB18030 1357
 - cluster queues 162
 - code page support 1329
- message flows (*continued*)
 - collector node
 - control messages, using 602
 - comment and path 50
 - configurable properties 1372
 - Additional Instances 1372
 - Commit Count 1372
 - Commit Interval 1372
 - Coordinated Transaction 1372
 - configuration for globally coordinated transactions 173
 - connections 52
 - adding with the mouse 240
 - adding with the Terminal Selection dialog 241
 - removing 242
 - conversion exception trace output 1368
 - coordination 113
 - database connections 1398
 - database support 1399
 - copying 220
 - correcting save errors 227
 - creating 218
 - creating ESQL code 271
 - creating using a Quick Start wizard 131
 - customizing nodes with ESQL 280
 - data conversion 183
 - data integrity 1359
 - data types 1400
 - BLOB message 1403
 - DestinationData subtree 1401
 - headers 1400
 - Properties subtree 1400
 - database
 - listing connections 1358
 - database exception trace output 1366
 - debugging 783
 - default version 819
 - defining content 228
 - deleting 223
 - deploying 745
 - description properties 819
 - keywords 819
 - designing 139
 - destination lists
 - creating 162
 - using to route messages 156
 - errors 203
 - catching in TryCatch 212
 - connecting failure terminals 206
 - input node 206
 - MQInput node 208
 - TimeoutNotification node 211
 - ESQL 258
 - events
 - configuring 562
 - exception list structure 1364
 - exceptions, catching in TryCatch 212
 - execution model 53
 - generating events 116
 - globally coordinated transaction 113
 - input nodes
 - configuring JMS nodes 176
 - defining characteristics 153
 - using more than one 152
- message flows (*continued*)
 - JVM heap size 161
 - keywords
 - description properties 819
 - guidance 820
 - logical message tree, viewing 167
 - lost messages, avoiding 200
 - managing 803
 - managing ESQL files 268
 - message collection 126
 - collection expiry, setting 599
 - collection name, setting 599
 - collector node, configuring 595
 - collector node, using 593
 - event coordination, setting 600
 - event handler properties, setting 596
 - input terminals, adding 596
 - persistence mode, setting 601
 - message content, testing 155
 - message parser element definitions 1399
 - message structure, testing 154
 - MIME
 - message details 103
 - tree details 105
 - monitoring 116
 - basics 118
 - configuring 562
 - profile 1375
 - profile schema 1379
 - moving 222
 - nodes 5
 - adding with the GUI 231
 - adding with the keyboard 232
 - aligning 244
 - arranging 244
 - configuring 235
 - connecting with the mouse 240
 - connecting with the Terminal Selection dialog 241
 - deciding which to use 141
 - decision making 154
 - dragging resources from the Navigator 233
 - dynamic terminals, adding 237
 - removing 238
 - renaming 234
 - opening 219
 - order, imposing 155
 - palette 47
 - Favorites category 230
 - Parse Timing property 1363
 - parser exception trace output 1370
 - parsers 74
 - BLOB 107
 - DataObject 100
 - IDOC 107
 - JMS 101
 - MIME 101
 - MQCFH 1403
 - MQCIH 1403
 - MQDLH 1404
 - MQIIH 1405
 - MQMD 1405
 - MQMDE 1406
 - MQRFH 1407

- message flows (*continued*)
 - parsers (*continued*)
 - MQRFH2 1407
 - MQRFH2C 1407
 - MQRMH 1408
 - MQSAPH 1408
 - MQWIH 1409
 - MRM 98
 - SMQ_BMH 1409
 - SOAP 78
 - XML 98
 - XMLNS 94
 - XMLNSC 85
 - porting considerations 1374
 - preferences 819
 - projects 5
 - creating 215
 - creating using a Quick Start wizard 131
 - deleting 216
 - managing 214
 - promoted properties 110
 - converging 559
 - promoting 554
 - removing 558
 - renaming 557
 - properties 109
 - redeploying 804
 - relationship with ESQL and mappings 49, 474
 - removing from an execution group 776
 - renaming 221
 - response time, optimizing 158
 - restrictions for code page
 - GB18030 1357
 - save errors, correcting 227
 - saving 225
 - saving as 226
 - shared queues 164
 - stack size, determining 160
 - style sheet keywords 1225
 - subflows 5
 - adding 234
 - configuring 235
 - keywords 157
 - removing 238
 - renaming 234
 - using 156
 - supported code sets 1329
 - system considerations 160
 - terminals 52
 - dynamic terminals, adding 237
 - threading 53
 - timeout control
 - automatic messages 608
 - multiple messages 606
 - performance considerations 609
 - sending a message 605
 - sending messages at a specified time 606
 - transaction support 113
 - TryCatch
 - catching exceptions 212
 - user database
 - DBCS restrictions 1358
 - quiescing 1358

- message flows (*continued*)
 - user exception trace output 1370
 - user exits 129
 - deploying 571
 - developing 570
 - exploiting 198
 - user-defined nodes 1225
 - user-defined properties 111
 - validating messages 164
 - validation properties 1359
 - version and keywords 50
 - version and keywords, displaying 224
 - WebSphere Adapters 245
 - WebSphere MQ connections 1357
 - WebSphere MQ message groups
 - receiving messages 610
 - sending messages 611
 - WebSphere MQ message segments
 - sending segments 612
 - which XML parser 77
 - XML parsers 81
 - z/OS data sources
 - Compute node 1448
 - Database node 1448
- message groups
 - receiving 610
 - sending 611
- Message Mapping editor 1410, 1673
 - Edit pane 1416, 1679
 - Source pane 1411, 1674
 - Spreadsheet pane 1417, 1680
 - Target pane 1414, 1677
- message segments
 - sending 612
- message set files
 - creating using a Quick Start wizard 131
- message set projects
 - creating using a Quick Start wizard 131
- message sets
 - broker archive (bar) file, adding to 759
 - creating using a Quick Start wizard 131
 - deploying 745
 - using existing message set in a Quick Start wizard 134
- message tree options
 - XMLNSC parser 91
- messages
 - debugging 799
 - Java, manipulating 454
 - parsing on demand 1363
 - partial parsing 1363
 - self-defining and predefined 72
 - test message, getting 789
 - test message, putting 786
 - validating
 - Fix property 1359
 - in message flows 164
 - Include All Value Constraints property 1359
 - Validate property 1359
- migration
 - mappings 1428, 1691

- migration (*continued*)
 - restrictions 1429, 1692
- MIME
 - message details 103
 - tree details 105
- monitoring 116
 - basics 118
 - configuring 562
 - profile 1375
 - profile schema 1379
- MQCFH header
 - accessing with ESQL 305
- MQeInput node 982
- MQeOutput node 990
- MQGet node 993
 - request-response scenario 189
 - example message trees 194
- MQHeader node 1004
- MQInput node 1007
- MQJMSTransform node 1020
- MQMD (message descriptor)
 - accessing with ESQL 304
- MQOptimizedFlow node 1021
- MQOutput node 1023
 - using in debugging 789
- MQPCF header
 - accessing with ESQL 305
- MQReply node 1029
- MQRFH2 header
 - accessing with ESQL 304
- mqsarchive subdirectory 726

N

- namespace support
 - XML parsers 97
- nodes, stepping over using the flow debugger 795
- null values
 - XMLNSC parser 87
- NULL values
 - XMLNS parser 94
- numeric order in data conversion 128

O

- object keyword 752
- object version 752
- opaque parsing
 - XMLNSC parser 88
- Opaque parsing
 - XMLNS parser 95
- Oracle
 - naming restrictions for database objects 1420, 1683
- order
 - imposing within a message flow 155
- Output node 1033

P

- palette 47
 - customizing 229
 - Favorites category 230
 - layout, changing 228
 - settings, changing 229

- parsers 74
 - BLOB 107
 - choosing 76
 - DataObject 100
 - IDOC 107
 - JMS 101
 - MIME 101
 - MQCFH 1403
 - MQCIH 1403
 - MQDLH 1404
 - MQIIH 1405
 - MQMD 1405
 - MQMDE 1406
 - MQRFH 1407
 - MQRFH2 1407
 - MQRFH2C 1407
 - MQRMH 1408
 - MQSAPH 1408
 - MQWIH 1409
 - MRM 98
 - null handling 108
 - partial parsing 1363
 - SMQ_BMH 1409
 - SOAP 78
 - message details 79
 - tree details 80
 - XML 98
 - XMLNS 94
 - XMLNSC 85
- parsing messages 74
- Passthrough node 1034
- PeopleCode 1311
- PeopleSoft
 - dependencies 253
- PeopleSoftInput node 1036
- PeopleSoftRequest node 1039
- PeopleTools custom event project 255
- performance
 - message flow response time 158
- policy sets
 - associating with message flows and nodes 657
 - implementing web services
 - security 655
 - overview 648
- populate 489
- predefined messages 72
- preferences
 - flow debugger 784
- projects
 - message flows 5
- promoted properties 110
 - converging 559
 - promoting 554
 - removing 558
 - renaming 557
- properties
 - complex 110, 263
 - message flow 109
 - PeopleSoft adapter 1309
 - SAP adapter 1226
 - Siebel adapter 1287
 - WebSphere Adapters nodes 1226
- Properties folder 61
- Properties tree, accessing with ESQL 307
- Publication node 1042

Q

- queues
 - cluster 162
 - shared 164
- Quick Start wizards
 - Create New Web Service Usage wizard 135
 - introduction 130
 - overview 131
 - Start from adapter connection 135
 - Start from existing message set wizard 134
 - Start from scratch wizard 131
 - Start from WSDL and/or XSD files wizard 132
- quiescing databases 1358

R

- Real-timeInput node 1044
- Real-timeOptimizedFlow node 1046
- redeploying bar files 763
- RegistryLookup node 1048
- renaming deployed objects 776
- repeating elements, configuring
 - mappings 488
- reply message, sending 961
- request message, sending 961
- ResetContentDescriptor node 1050
- Route node 1056
- RouteToLabel node 1059

S

- SAP
 - dependencies 247
 - server, configuring 248
- SAPInput node 1061
- SAPRequest node 1064
- SCADAInput node 1067
- SCADAOutput node 1074
- schemas, broker 114
- self-defining messages 72
- server project, creating 757
- setting accounting origin 566
- shared access, file processing 720
- shared queues 164
- Siebel
 - application, configuring 251
 - dependencies 250
- SiebelInput node 1076
- SiebelRequest node 1079
- snapshot data 120
- SnCMode property 1246, 1260
- SOAP parser
 - example usage of 624
 - main message flow 624
 - testing
 - using HTTP 629
 - using integrated client 628
- SOAPAsyncRequest node 1082
- SOAPAsyncResponse node 1092
- SOAPEnvelope node 1096
- SOAPExtract node 1099
- SOAPInput node 1104
- SOAPReply node 1114

- SOAPRequest node 1116
- source code
 - stepping into 797
 - stepping out of 798
 - stepping over 798
- specifying opaque elements
 - XMLNSC parser 89
- SQLJ
 - used by JavaCompute node 467
- stack size
 - size, determining 160
- stack storage
 - increasing stack size 160
- statistics and accounting data 119
 - accounting origin 121
 - collecting 564
 - collection options 120
 - output formats 122
 - parameters, modifying 569
 - parameters, viewing 568
 - resetting archive data 569
 - setting accounting origin 566
 - starting 564
 - stopping 567
- subflows 5
 - adding 234
 - configuring 235
 - keywords 157
 - removing 238
 - renaming 234
 - stepping into 796
 - stepping out of 796
 - using 156
- symbols for flow debugger 1698

T

- TCP/IP 422
 - connection management 428
 - nodes 425
 - overview 422
 - Scenarios
 - Message Broker using TCP/IP 433
 - TCP/IP only 430
 - Working with 434
- TCPIPClientInput node 1126
- TCPIPClientOutput node 1137
- TCPIPClientReceive node 1146
- TCPIPServerInput node 1158
- TCPIPServerOutput node 1169
- TCPIPServerReceive node 1177
- terminals
 - dynamic 52
 - dynamic terminals, adding 237
 - message flows 52
- test messages
 - getting 789
 - putting 786
- Throw node 1189
- timeout control
 - automatic messages 608
 - multiple messages 606
 - performance considerations 609
 - sending a message 605
 - sending messages at a specified time 606

- timeout request messages, example
 - XML 605
- timeout request messages, predefined
 - schema definition 604
- timeout request messages, sending 603
- TimeoutControl node 1191
- TimeoutNotification node 1194
 - error handling 211
- timeouts
 - aggregation 583
- topics
 - deployment 754
- topics hierarchy, deploying 770
- topology
 - deploying 768
 - deployment 753
- Trace node 1198
- trademarks 1705
- TryCatch node 1202
 - catching exceptions 212
- TwineballInput node 1204
- TwineballRequest node 1207

U

- user databases
 - accessing 170
 - from ESQ 172
- user exits 129
 - deploying 571
 - developing 570
 - exploiting 198
- user-defined nodes 1225
- user-defined properties
 - message flow 111

V

- Validate node 1210
- validation
 - XMLNSC parser 89
- validation, message 164
- version
 - default value 819
 - displaying 224
- version and keywords, message
 - flows 50

W

- Warehouse node 1213
- Web services 615
 - using MTOM 634
- web services addressing
 - example usage
 - building the logger message
 - flow 693
 - building the main message
 - flow 691
 - deploying the message flows 694
 - testing the message flows 695
 - example use 644
 - how to use 637
 - information in
 - LocalEnvironment 642
 - overview 635

- web services addressing (*continued*)
 - SOAPAsync nodes, using with 640
 - SOAPInput node, using with 638
 - SOAPReply node, using with 639
 - SOAPRequest node, using with 639
- WebSphere Adapters nodes 7
 - EIS, connecting 256
 - Enterprise Information System,
 - connecting 256
 - IBM Tivoli License Manager,
 - activating 246
 - message flows, developing 245
 - monitoring 805
 - PeopleCode 1311
 - PeopleSoft
 - dependencies 253
 - PeopleSoftInput 1036
 - PeopleSoftRequest 1039
 - PeopleTools custom event project 255
 - properties 1226
 - PeopleSoft 1309
 - SAP 1226
 - Siebel 1287
 - SAP
 - dependencies 247
 - server, configuring 248
 - SAPInput 1061
 - SAPRequest 1064
 - Siebel
 - application, configuring 251
 - dependencies 250
 - SiebelInput 1076
 - SiebelRequest 1079
 - TwineballInput 1204
 - TwineballRequest 1207
- WebSphere MQ
 - connections 1357
 - message groups
 - receiving messages 610
 - sending messages 611
 - message segments
 - sending segments 612
- WebSphere Service Registry and
 - Repository 666
 - Cache 672
 - configuring loading options 673
 - loading strategy 673
 - setting up Cache Notification 675
 - LocalEnvironment 677
 - defining search criteria 677
 - EndpointLookup node output 678
 - RegistryLookup node output 680
 - nodes
 - changing configuration
 - parameters 669
 - configuration parameters 667
 - displaying configuration
 - parameters 668
 - secure 670
 - wildcards
 - in file name patterns 724
 - writing messages 74
 - WS-Security
 - capabilities 659
 - implementing 655
 - mechanisms 647
 - security 645

WSDL

- applications 629
- configuring message flows 632
- use in a Quick Start wizard 132
- validation 630

X

- XML parsers
 - namespace support 97
- XML self-defining message
 - AttributeDef 1443
 - AttributeList 1443
 - DocTypeComment 1444
 - DocTypeDecl 1440
 - DocTypePI 1444
 - DocTypeWhiteSpace 1445
 - document type declaration 1440
 - DTD 1440
 - example 1445
 - ElementDef 1443
 - example message 1433
 - external DTD 1440
 - inline DTD 1440
 - message body 1435
 - AsIsElementContent 1436
 - Attribute 1436
 - BitStream 1437
 - CDataSection 1437
 - Comment 1437
 - Content 1438
 - Element 1438
 - EntityReferenceEnd 1438
 - EntityReferenceStart 1438
 - example 1439
 - ProcessingInstruction 1439
 - NotationDecl 1441
 - WhiteSpace 1445
 - XML declaration 1434
 - example 1435
 - XML entities 1441
- XMLNS parser
 - DTD support 96
 - Empty elements 94
 - NULL values 94
- XMLNS parsers
 - Opaque parsing 95
- XMLNSC parser
 - data types 92
 - DTD support 93
 - empty elements 87
 - message tree options 91
 - null values 87
 - opaque parsing 88
 - specifying opaque elements 89
 - validation 89
- XPath 460
 - mapping functions 1425, 1688
- XPath property editors 1464
- XSD
 - use in a Quick Start wizard 132
- XSL style sheet, keywords 1225
- XSLTransform node 1216

Z

z/OS

data sources

Compute node 1448

Database node 1448



Printed in USA