



## **Managing your enterprise CICS systems now and in the future.**

---

**Contents**

---

- 2 Executive summary**
- 2 Evolution of CICS systems management in an enterprise**
- 3 Today's CICS system-management challenges**
- 6 New enterprise-management capabilities introduced by CICS Transaction Server for z/OS, Version 3.2**
- 21 Removed function**
- 21 Considerations for TCP/IP connectivity**
- 22 End-to-end system management**
- 25 Technical summary**
- 26 Conclusion**
- 27 For more information**

**Executive summary**

This white paper is designed to address the concerns of IBM CICS® systems managers, system programmers, developers and testers. It provides a high-level overview of CICS enterprise management, the related challenges and how the new capabilities of IBM CICS Transaction Server for z/OS, Version 3.2 help address these challenges. Essentially, it helps answer the question “What do I need to consider when managing my systems for CICS Transaction Server for z/OS, Version 3.2?”

**Evolution of CICS systems management in an enterprise**

When CICS was originally introduced, transaction-processing needs were very different from today's requirements. At that time, the business needs were served by a single CICS address space running on a single IBM MVS™ logical partition (LPAR), itself running on a single MVS task control block (TCB). This system was started each day and ran back-office applications throughout the business day. The system then had to be shut down so that batch workloads could be processed overnight. In this environment, applications resided solely inside the CICS system, and work arrived in the region across a relatively small terminal network.

The system-management tools at that time consisted of remote data objects (RDOs) through the CEDA transaction and batch utility DFHCSDUP, the master terminal transaction CEMT, and CICS monitoring and statistics written to standard message format (SMF).

Today, CICS applications run in highly available IBM CICSplex® environments that can span multiple IBM z/OS® sysplexes. CICSplex environments can consist of hundreds of interconnected CICS regions, each providing specific types of service. Listener regions capture incoming requests that arrive over various protocols such as traditional 3270 traffic, Web requests arriving over TCP/IP, Web services requests, and requests from IBM WebSphere® Application Server arriving through IBM CICS Transaction Gateway over Java™ 2 Platform, Enterprise Edition (J2EE) Connector Architecture (JCA). Regions that own applications process work requests, and data is accessed through shared IBM DB2® databases, Virtual Storage Access Memory (VSAM) record-level sharing (RLS), IBM IMS™ or shared temporary storage (TS) queue servers.

Nowadays, Web-based applications run by customers of the business are critical to the very existence of the business itself. In addition, applications now no longer just consist purely of CICS components. Instead, applications span multiple subsystems, and run in environments where the workload can be dynamically managed to help ensure high availability and to achieve application response-time objectives. Running in this type of multiaddress space environment enables organizations to efficiently use modern multiprocessor systems. These applications can also benefit from using multiple TCBs within a CICS region by taking advantage of the threadsafe nature of applications.

In this type of large, around-the-clock, highly dynamic environment, traditional single-address-space, system-management tools such as CEDA and CEMT can no longer cope with the demands of the modern enterprise environment. Today's enterprise management systems consist of IBM CICSplex System Manager (part of CICS Transaction Server), the tools in the CICS portfolio, IBM Tivoli® Service Management products and tools from other vendors. These products make up the modern enterprise-management toolset with which companies can manage their enterprise systems.

#### **Today's CICS system-management challenges**

A number of challenges require different skills when managing today's enterprise systems. Different skills are needed for maintaining agreed levels of service and enhancing the applications that provide core business function and competitive advantage in today's marketplace.

Some of the key challenges facing today's CICS system managers are:

- *Configuration management*
- *Application development*
- *Change and release management*
- *Service-level agreement*
- *Operations and help desk*
- *Incident management and problem determination*
- *Performance and capacity planning*
- *Batch control*

#### *Configuration management*

Configuration management typically consists of server configuration, resource provisioning and application deployment in various environments such as unit test, quality assurance and production. When configuring the servers, it is necessary to configure the server address spaces, the connectivity between them and other address spaces, and the functional capability of the servers within a specific environment. Resource provisioning provides access to resources needed for the correct functioning of applications, and application deployment involves deploying assets specific to running the application.

#### *Application development*

Business applications are designed, coded and tested using development suites, such as the IBM Rational<sup>®</sup> toolset and IBM WebSphere Developer for System z<sup>™</sup>. Application assets and associated resources can then be deployed into a test environment using the same tools. To learn more about how Rational tools and WebSphere Developer for System z can help you design and develop your applications, visit [ibm.com/software/awdtools/devzseries/](http://ibm.com/software/awdtools/devzseries/).

#### *Change and release management*

When testing is complete, assets are typically moved through different functional testing environments on their way to the production environment, where they are finally used as part of the business. To maintain effective change control, these changes are usually packaged together and moved to the next environment under strict approval and audit control conditions. A release is a set of changes distributed as a whole.

#### *Service-level agreement*

Deployed applications have an acceptable service-level agreement that determines system availability, response time, performance and expected transaction-volume throughput.

#### *Operations and help desk*

When applications are deployed, operations personnel must monitor the health of the various CICS regions and applications. These personnel must also perform routine data backup, and they must coordinate batch work with online systems. Also, help desk personnel must be available to respond to requests for help with problems that are related to application availability. The help desk is responsible for resolving or reporting incidents with the application suite.

#### *Incident management and problem determination*

Incident-management tools enable reported incidents to be tracked to a successful conclusion. You can use online and offline problem-management tools to determine and resolve problems occurring within the environment. You can use automation to detect and resolve simple situations within the various subsystems without manual intervention. This helps speed problem resolution and reduce outages.

#### *Performance and capacity planning*

Performance and capacity tools provide the ability to identify (online or offline) possible impacts on performance. These tools help identify possible future constraints in operational capacity.

#### *Batch control*

Database backup and batch scheduling are managed by the controlled sharing of data across the offline and online environments.

#### *Additional challenges*

The complexities of CICS system management that have already been outlined are compounded by the requirement to work across multiple subsystems. This challenge makes an integrated system-management solution critically important. As a reduction in the available skill base occurs, the need for simplification also becomes apparent.

You also have to take into account the wide diversity of system-management tools and user interfaces, each possibly having a different look and feel, a different implementation technology and a different set of management application programming interfaces (APIs). And when you add in new legislative requirements (for example, the U.S. Sarbanes-Oxley Act [SOX]), effective enterprise management can seem daunting.

The new capabilities provided by CICS Transaction Server for z/OS, Version 3.1, CICSplex System Manager and CICS tools are designed to address these issues. To learn more about how CICS tools and IBM service-management solutions can help you manage the enterprise, visit the CICS tools page at [ibm.com/software/http/cics/](http://ibm.com/software/http/cics/).

### **New enterprise-management capabilities introduced by CICS Transaction Server for z/OS, Version 3.2**

Many new enterprise-management capabilities are introduced in CICS Transaction Server for z/OS, Version 3.2, including:

- *Internet Protocol (IP) connections and dynamic program library (DPL) over TCP/IP*
- *Enhanced TCP/IP management and control*
- *IBM Enterprise Workload Manager (EWLM) correlator support*
- *Dynamic program library management*
- *Integrated CICS MQ Adapter*
- *Monitoring and statistics enhancements*
- *System programming interface (SPI) enhancements*
- *Integrated and enhanced CICSplex System Manager*

These functional enhancements are accompanied by related enhancements to CICS monitoring and statistics and CICS SPI. For continuity, most support is also provided through the CEDA and CEMT transactions. To manage your environment more comprehensively, use the facilities provided by CICSplex System Manager.

*IP connections and dynamic DPL over TCP/IP*

CICS Transaction Server for z/OS, Version 3.2 enables you to connect CICS regions over TCP/IP. Connections are defined through a new RDO that is installed using EXEC CICS CREATE (or CEDA). New connection-management commands (INQUIRE, SET and DISCARD) and new monitoring and statistics capabilities are also provided. It is possible for static or dynamic DPL requests to flow over the new connection type, with CICSplex System Manager EWLM balancing dynamic requests.

*Enhanced TCP/IP management and control*

CICS Transaction Server for z/OS, Version 3.2 uses new TCP/IP facilities to identify the work flowing through regions over a TCP/IP connection. Work arriving at the CICSplex boundary now has information about the point of entry associated with it. You can customize and extend point-of-entry information, enabling you to identify individual work requests for tracking purposes. CICSplex System Manager and equivalent tools can display this information online or offline. This new capability is made possible through enhancements to CICS monitoring data.

*EWLM correlator support*

EWLM is part of the IBM autonomic computing initiative. It provides end-to-end correlation of workloads across IBM eServer™ family products. In particular, it enables you to track end-to-end goals, and it also integrates with z/OS workload management. CICS and other z/OS subsystems provide the support that enables EWLM correlators to be passed at the cross-system boundaries.

EWLM implements the application response-time management (ARM) standard of The Open Group. This standard enables you to manage applications, track transactions, monitor resources and analyze problems.

CICS supports EWLm by enabling correlators to be:

- *Passed between z/OS workload manager and CICS regions*
- *Flowed across several CICS transports (such as multiregion operation [MRO] or IP connections)*
- *Received from work coming into CICS Transaction Server*
- *Passed on flows leaving CICS Transaction Server (such as DB2)*

You can learn more about this capability in the EWLm control center available at [publib.boulder.ibm.com/infocenter/eserver/v1r2/index.jsp?topic=/ewlminfo/eicaaewlmui.htm](http://publib.boulder.ibm.com/infocenter/eserver/v1r2/index.jsp?topic=/ewlminfo/eicaaewlmui.htm).

#### *DPL management*

With this release, CICS Transaction Server includes a facility that enables the data sets from which program artifacts are loaded to be defined dynamically without requiring the CICS region to be restarted. This capability is in addition to the existing means of defining the data sets statically in the DFHRPL concatenation.

#### *Integrated CICS MQ Adapter*

CICS MQ Adapter enables CICS systems programs to call the IBM WebSphere MQ API. This adapter has now been integrated into CICS Transaction Server, and can be managed through the CICS system-management facilities.

#### *Monitoring and statistics enhancements*

Monitoring and statistics enhancements in CICS Transaction Server for z/OS, Version 3.2 include:

- *Higher-precision timing data*
- *Improvements to the MVS Workload Manager address-space goal information to MONITOR type records*
- *SMF 110 record compression*



#### *SPI enhancements*

Extensions to the SPI INQUIRE MVSTCB command include storage key, and the amount in use for each storage element.

#### *Integrated and enhanced CICSplex System Manager*

CICSplex System Manager is now an integrated component within CICS Transaction Server for z/OS, Version 3.2, and has been enhanced in the following areas:

- *Integrated installation*

In CICS Transaction Server for z/OS, Version 3.2, the installation and configuration of the CICSplex System Manager components have been simplified by integrating them with the installation of server.

- *EYU9XDBT batch utility*

The new utility EYU9XDBT helps simplify the setup and use of the CICSplex System Manager environment, making it easier and quicker to use the capabilities of CICSplex System Manager.

- *Natural language support (NLS)-enabled messages*

Many CICSplex System Manager messages have been moved to the CICS message domain, as part of national-language enablement for translation.

- *BAS, operations and RTA*

Operations and systems staff can immediately use CICSplex System Manager to manage the new CICS capabilities and resources using its business application services (BAS), operations and real-time analysis (RTA) functions.

- *Dynamic workload management*

EWLM extends the capabilities of z/OS Workload Manager services to all members of the eServer family, making end-to-end workload monitoring possible in heterogeneous environments containing multiple, interacting servers.

- *System-management API*

BAS, operations, and RTA functions are accessible through the CICSplex System Manager Web user interface (WUI) and system-management API.

- *CICSplex System Manager WUI*

The WUI is further enhanced to provide an intuitive system-management interface that makes for more-efficient enterprise management.

CICSplex System Manager implements the unique single system image (SSI) concept, which enables you to manage CICS systems and resources independent of their physical location and from a single point of control. Because all interactions are at this logical level, the movement of resources has little to no effect on interactions with the management system, which can make routine management tasks simpler to perform.

It is possible to define different environments as CICSplex environments (for example, test plex or production plex) to which CICS regions belong. It is also possible to define subsets of CICSplex environments, known as *scopes*. Scoping enables the logical grouping of CICS regions for management purposes (for example, application-owning region [AOR] set). You can also define business applications through the BAS component. When you do this, you can restrict operational interaction to a given business application (such as close files associated with payroll). This capability provides a highly flexible way of identifying the regions and resources that require managing at any time.

Interactions with CICSplex System Manager are supported with a WUI, a system-management API and batch commands. In addition, the following system management tasks are supported:

- *Resource definition and installation through BAS*
- *Monitoring of statistical data and operational control through operations*
- *Situation detection and resolution through RTA*
- *Dynamic workload management*

CICSplex System Manager supports CICS Transaction Server for z/OS, Version 1.3, 2.2, 2.3, 3.1 and 3.2. Figure 1 shows the architecture of CICS Transaction Server for z/OS, Version 3.2.

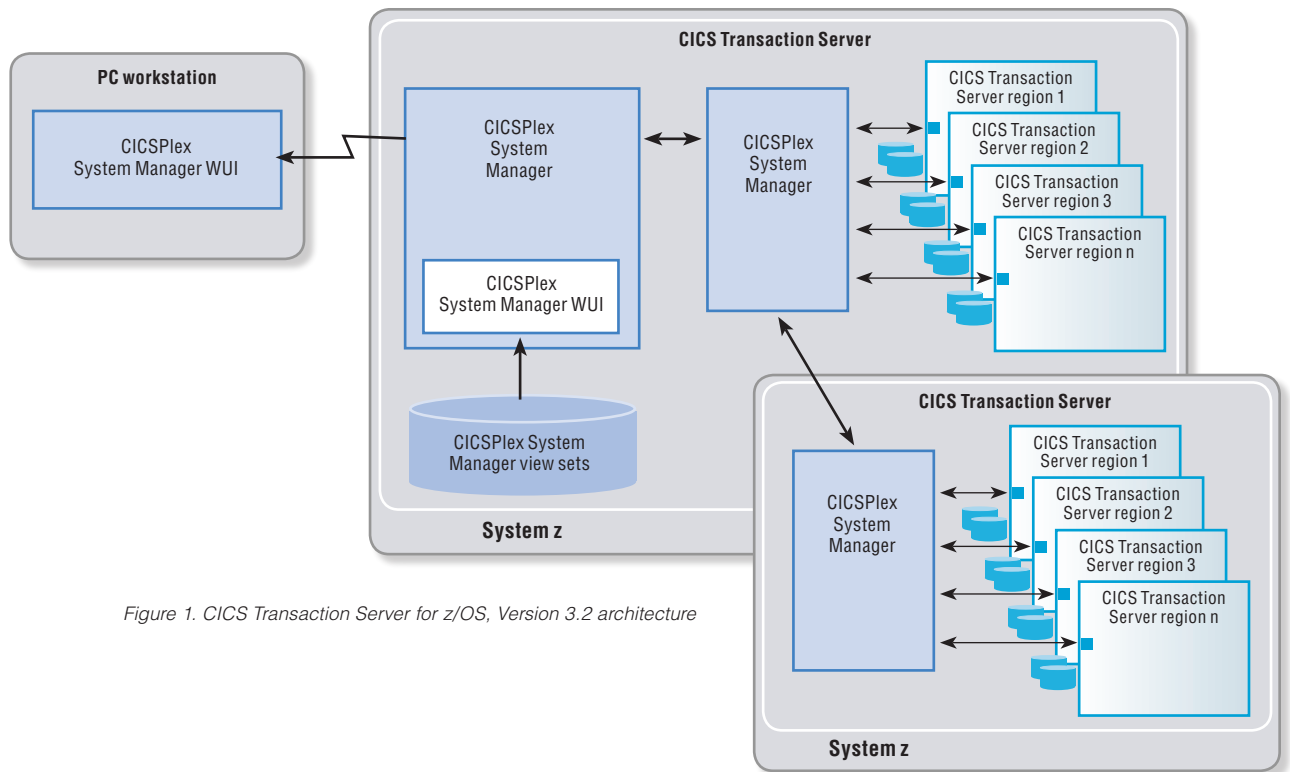

Figure 1. CICS Transaction Server for z/OS, Version 3.2 architecture

In this figure, CICS regions on two LPARs are being managed by another CICS address space configured as a system-management server (one per LPAR). These system-management servers communicate using CICS communications to provide SSI management. The CICSplex System Manager repository maintains administrative data, and access through a Web browser is provided by another CICS region configured as a WUI server. The WUI uses CICS Web facilities directly, so it does not require a separate Web server. You can configure the address spaces so that no single point of failure occurs.

#### *CICSplex System Manager WUI*

The CICSplex System Manager WUI provides a Web-browser environment for managing CICS systems. It includes menus and views for selecting and viewing information, a navigation frame and contextual hyperlinks. The WUI menus provide choices that can hyperlink to other menus or views, enabling interactions to be structured into appropriate subtasks. One example of this is the administration of CICS resources and operations. The menus and views are available in Chinese and Japanese, and the WUI is also fully accessible in these languages.

The WUI views are related to specific CICS resources and can contain multiple visual representations of resources. In particular, they can provide table views of information across CICS regions, and detailed and matrix views of data. An expandable navigation bar enables you to rapidly navigate to specific data. In fact, the WUI has been designed so that data is never more than two mouse clicks away. It is also possible to specify data-selection criteria, and to save and access commonly used views as favorites.

All new resource types introduced in CICS Transaction Server for z/OS, Version 3.2 are supported with updated views, menus and an updated navigation pane. Figure 2 shows the WUI main menu with menu items presented as hyperlinks. The navigation frame and editor launch buttons are on the left.



Figure 2. WUI main menu

Figure 3 shows the WUI active-tasks view, which displays a table view of currently active tasks.

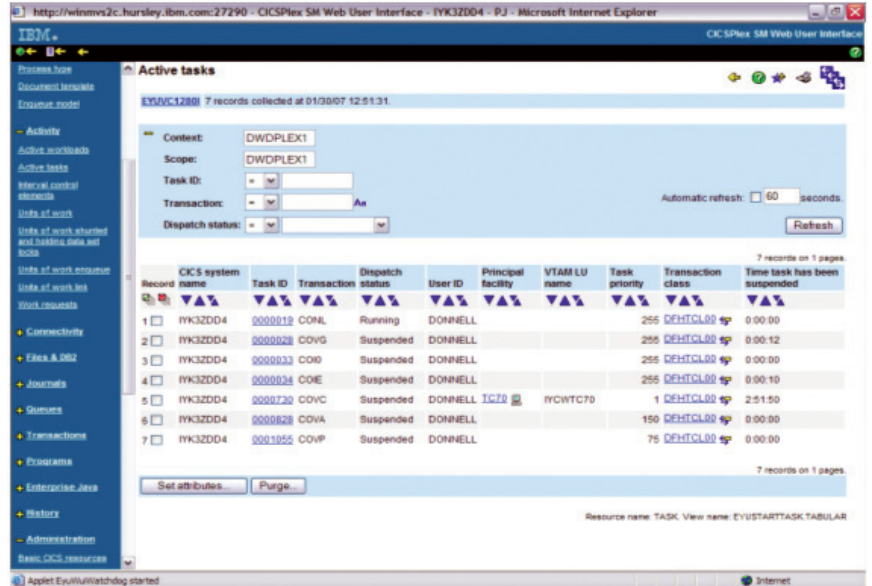

Figure 3. WUI active-tasks view

Figure 4 shows the WUI programs view containing details of a specific CICS program.



Figure 4. WUI programs view

The WUI provides not only a complete set of views and menus, but also an editor for creating menus and views. These can be created either from the set provided by IBM or as completely new menus and views based on the available CICS resources. The WUI editors provided by IBM are Web-based and involve a “pick and choose” approach. No knowledge of HTML syntax is required. You can potentially create new views and integrate them into the online environment in a few minutes. The view editor also enables you to create task-based menus and views.

Task-based menus and views represent tasks that the WUI user can perform. You can customize the terminology used in the WUI editors, and include references to local procedures. You can also restrict data contained within the views to the information required for completing the current task. These capabilities provide a reassuringly familiar display for users and also help ensure that users get just the data they need. The WUI also provides editors for managing user defaults and favorites.

Figure 5 shows the WUI table-contents view, which is a typical screen from the WUI editor where a table view is under construction. The editor shows the “pick and choose” design philosophy and a preview of the layout being designed.



Figure 5. WUI table-contents view

The WUI supports HTTP and security for HTTP data streams with Secure Sockets Layer (SSL). Protection against unauthorized access is also provided with a sign-on to the WUI backed by Security Access Facility (SAF)-compliant products such as IBM Resource Access Control Facility (IBM RACF®).

CICS Transaction Server for z/OS, Version 3.2 includes various extensions to the WUI capabilities. Along with the extensions to the existing menus and view sets, there are also functional and usability enhancements, including:

- *Comprehensive help for all views*
- *The ability to map administrative-definition relationships*
- *Contextual expansion of summarized table views*
- *Sorting by CICS region in tabular views*
- *More-consistent CICS terminology*
- *Easier setting of CICSplex System Manager trace settings*
- *More resource views, such as historical task data and task Remote Method Invocation (RMI) data (first introduced by IBM CICS Performance Monitor)*

WUI server capabilities have also been enhanced so that it is easier to export menus and view sets without affecting the results of a previous export (the COVC ALL option). Changes have also been made to the management of WUI views and menus in the WUI repository. Figure 6 shows the WUI help facility.

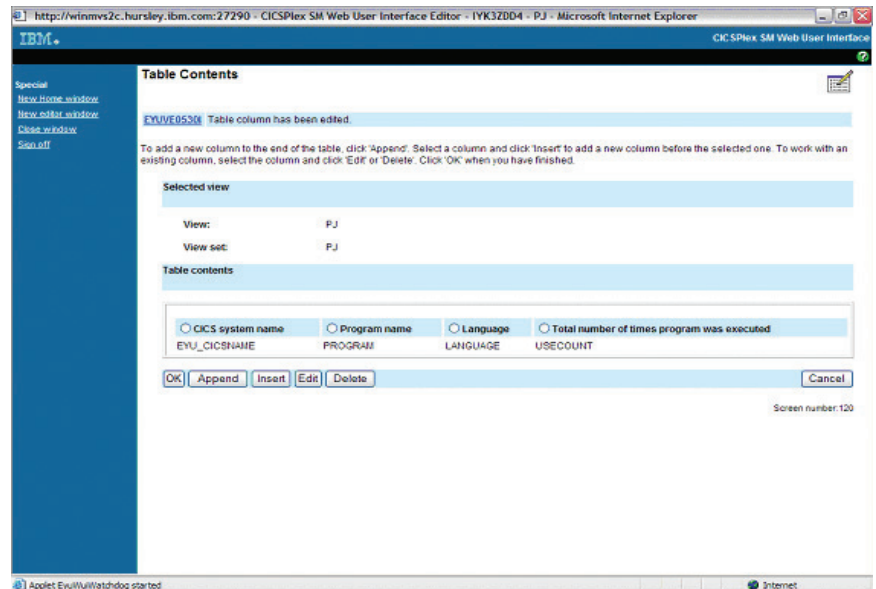

Figure 6. WUI help facility

Figure 7 shows the WUI event view.

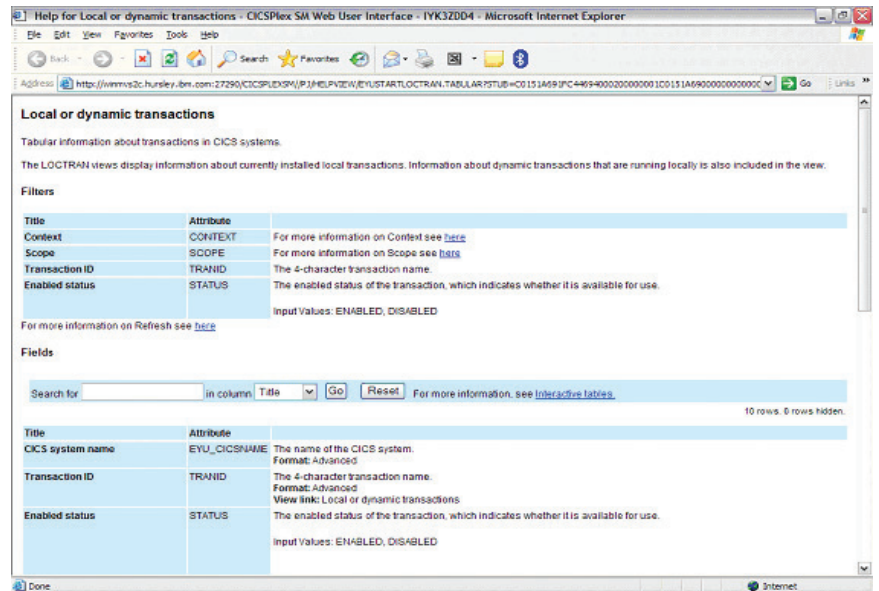

Figure 7. WUI event view

Figure 8 shows the WUI transaction view, summarized.

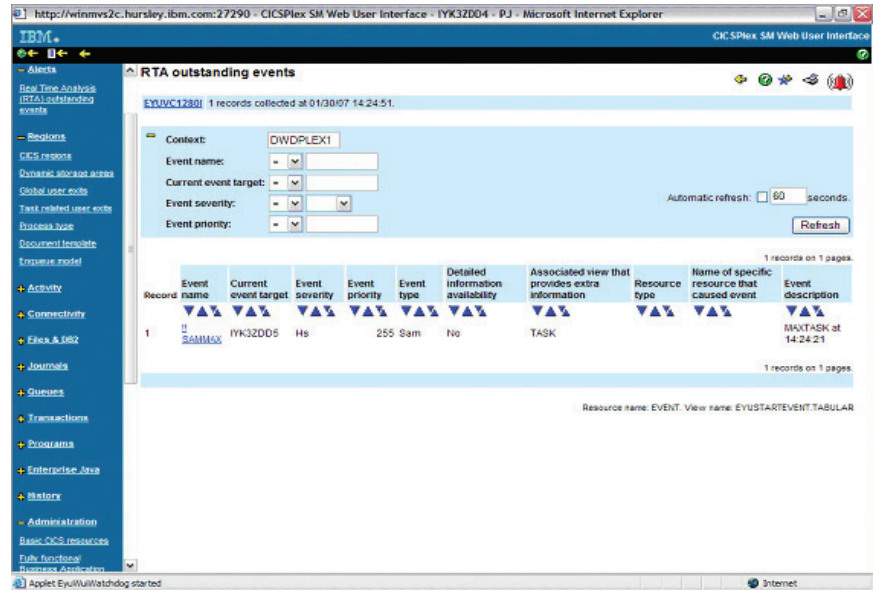

Figure 8. WUI transaction view (summarized)



*Integrated installation*

CICSplex System Manager is now integrated with CICS Transaction Server for z/OS, Version 3.2. This integration enables quicker use of the new product features. Installation is incorporated under the DFHISTAR process. Also, installation of RDO definitions is now automated within the code, which helps remove the need to keep these definitions on the CICS system definition data set (CSD).

*EYU9XDBT batch utility*

Another batch application is provided for populating CICSplex System Manager. This application populates CICSplex System Manager with sufficient definitions for operational management, through the WUI.

*NLS-enabled messages*

CICSplex System Manager messages are now routed through the CICS message domain, enabling messages to be intercepted and suppressed through XMEOUT.

*BAS*

BAS provide similar capabilities to CICS RDO, but are not restricted to a single CICS region. Resource definitions are shared across the enterprise, and installations into multiple regions are possible with a single command.

BAS also enable operational business applications to be defined. Definitions can be more widely shared, and migration utilities for moving from RDO-maintained resources are also provided. Also, the new resource types introduced in CICS Transaction Server for z/OS, Version 3.2 are now supported through the BAS component.

Figure 9 shows the WUI expanded summary view. The annotations in this figure provide additional guidance to the user when entering information. Guidance includes case information (Aa), pick lists (pencil), required fields (checks) and enumerated values (drop-down lists).

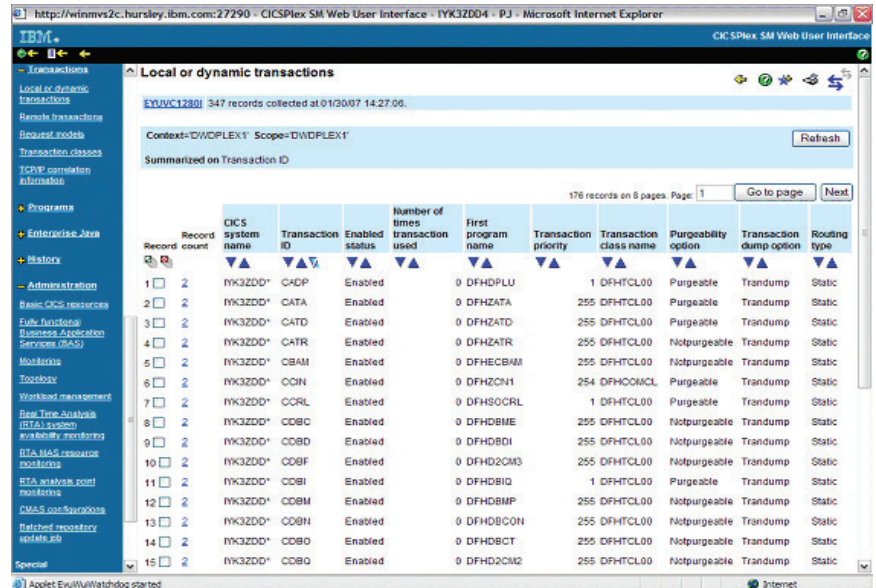

Figure 9. WUI expanded summary view

### Operations

Operations provide access to runtime information on CICS resources across the CICSplex environment. You can use scoping or business-application names to restrict the data being accessed. The data are a superset of data accessed through CEMT and CICS monitoring and statistics. You can also take actions (perform tasks) against these resources. The enhancement with this release enables all new resource types introduced in CICS Transaction Server for z/OS, Version 3.2 to be supported through the operations component.

In this view, you can set filter criteria to select the appropriate data. Hyperlinks to detailed information are provided, and tasks are performed by selecting resources and clicking the appropriate button. You can sort and summarize views with up and down arrows. Filters are collapsible by clicking the – (dash) symbol, enabling more screen space for displaying data.

*Real-time analysis*

When detecting events in CICS regions, the RTA component within CICSplex System Manager provides the ability to define thresholds against any attribute of any CICS resource. You can also combine thresholds against multiple attributes. You can use various aggregation schemes to gain a composite view of the state of CICS regions. This type of detection scheme is far more comprehensive than detection through external messages.

When situations are detected, events are raised for action (alerts and resolutions are both identified). Events can be raised manually (for resolution by an operator), automatically (through action services within CICSplex System Manager) and through messages detected by external automation products.

All new resources introduced in CICS Transaction Server for z/OS, Version 3.2 are supported through the RTA component. Figure 11 shows the WUI RTA outstanding-events view. This window displays a CICS region that has reached capacity (maxtask).

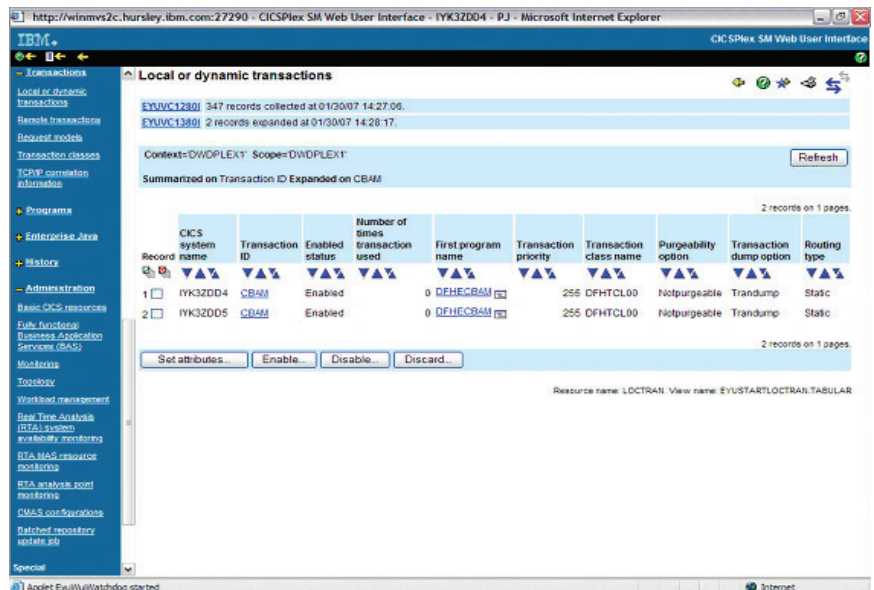

Figure 11. WUI RTA outstanding-events view

#### *Dynamic workload management*

Dynamic workload management provides the ability to dynamically balance workload requests for all major types of CICS workloads. It enables you to:

- *Separate workloads based on user ID and application.*
- *Identify candidate AORs to process such requests.*
- *Balance requests across AORs with a queue-based or a z/OS goal-based balancing algorithm.*

All these tasks are performed while maintaining the affinities that exist in the application and that were specified to CICSplex System Manager. To learn more about detecting affinities, visit the IBM CICS Interdependency Analyzer product page at [ibm.com/software/http/cics/ianaly/](http://ibm.com/software/http/cics/ianaly/). In addition, dynamic workload management now supports the balancing of DPL across TCP/IP connections between CICS regions.

#### *System-management API*

CICSplex System Manager provides a comprehensive system-management API. Programs using the API can be written in C, COBOL, assembler, PL/I or REXX. These programs can run in the CICS environment, in the z/OS batch address space, under Time Sharing Option (TSO) or in the IBM Tivoli NetView® environment.

The REXX interface is especially useful for constructing one-off management scripts, or for providing automated responses to events detected in the Tivoli NetView environment. This interface is also critically important when integrating system management across multiple environments and into customer-developed tools.

The WUI server uses the system-management API to provide the browser interface to CICSplex System Manager. All new resource types introduced in CICS Transaction Server for z/OS, Version 3.2 are supported through the system-management API.

### **Removed function**

The TSO user interface that was provided with CICSplex System Manager has been removed in CICS Transaction Server for z/OS, Version 3.2. This removal was documented in the CICS Transaction Server for z/OS, Version 3.1 announcement.

### **Considerations for TCP/IP connectivity**

The whole IT industry is rapidly moving to TCP/IP for connectivity needs. The announcements related to Systems Network Architecture (SNA) network controllers have hastened this movement, and have increased the urgency of placing CICS connectivity on a firm TCP/IP base. As previously mentioned, connectivity between CICS systems over TCP/IP (through IP connection resources) has been introduced in this release. Today, 90 percent of those using the z/OS platform have adopted TCP/IP for connectivity, compared with 64 percent using connections over SNA, with the SNA portion rapidly decreasing.

In parallel with this trend, many businesses conduct trade through ubiquitous Web-browser access over HTTP Secure (HTTPS). Access to customer-facing applications through TCP/IP networks is commonplace.

From an enterprise-management perspective, many new products only have browser-based clients entering the enterprise over TCP/IP. The z/OS operating system has already delivered IBM Tivoli Enterprise Portal as part of the integrated system-console interface for z/OS, and IBM has announced plans to centralize management under this infrastructure. Various Tivoli products are exclusively TCP/IP-based solutions, as are management products from many other vendors.

This rapid move to TCP/IP-based networks might necessitate minor changes in business practices while TCP/IP permeates every corner of the IT business. Businesses are going to need to put various well-known practices into place (SSL, HTTPS and firewalls, for example) to provide appropriate security for using existing and future technology for competitive advantage. The WUI, with its use of SSL and secure sign-on to RACF, is well placed to provide appropriate levels of security in this modern environment.

### End-to-end system management

The ability to manage CICS applications end to end is provided by:

- EWLM
- IBM Tivoli OMEGAMON® for CICS, Version 3.1 and 4.1
- CICS Performance Analyzer, Version 2.1
- IBM Tivoli Composite Application Manager
- IBM Tivoli Business System Manager
- IBM CICS Configuration Manager

### EWLM

EWLM enables observation of workload requests as they transition across address-space boundaries that support the EWLM correlator. Figure 12 shows the EWLM architecture.

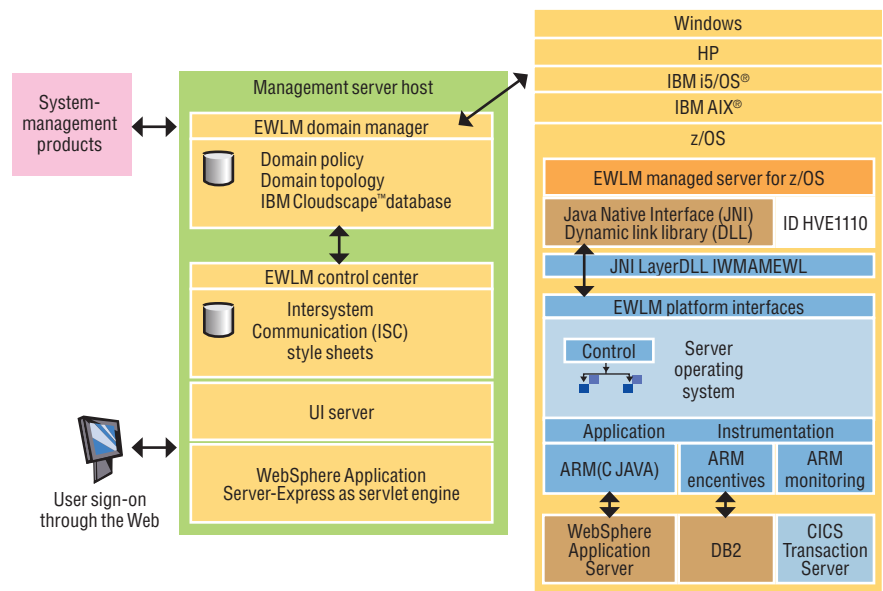

Figure 12. EWLM architecture

You can use the control center in the EWLM to view workload data configuration. Using the control center, you can view the currently active service classes in the enterprise. You can also display detailed information about the hop count during the transition from terminal-owning region (TOR) to application-owning region (AOR) to file-owning region (FOR).

Figure 13 shows the EWLM service-classes view.

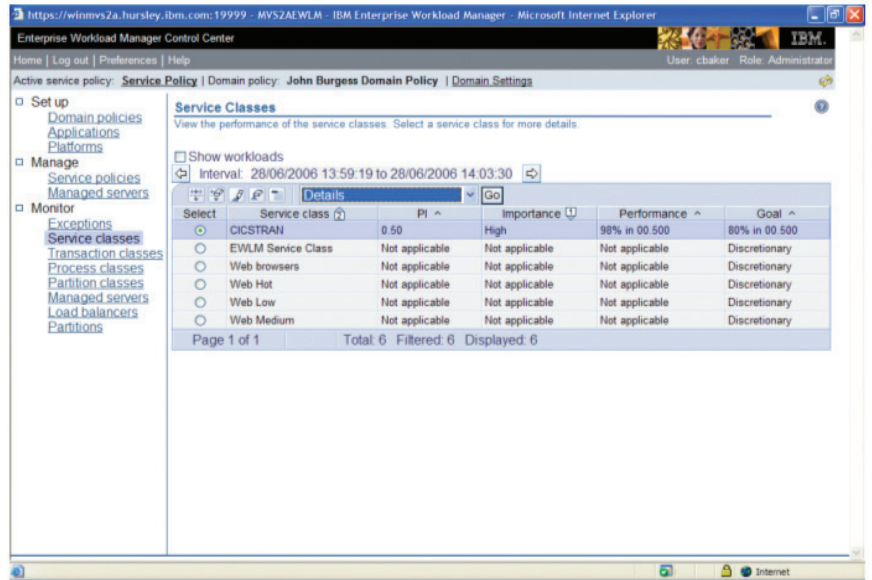

Figure 13. EWLM service-classes view

Detailed information about hops, specific instances, performance indexes, goal achievement and transaction rate is also available.

#### *Support for Tivoli OMEGAMON for CICS*

CICS Transaction Server for z/OS, Version 3.2 supports Tivoli OMEGAMON for CICS, Version 4.1. This product enables performance monitoring for new CICS resources. When combined with Tivoli OMEGAMON products for z/OS, IMS, DB2, WebSphere MQ, and CICS Transaction Gateway, Tivoli OMEGAMON for CICS provides end-to-end performance management for CICS applications.

#### *Support for CICS Performance Analyzer, Version 2.1*

CICS Transaction Server for z/OS, Version 3.2 also supports CICS Performance Analyzer, Version 2.1. This product enables comprehensive offline analysis of SMF data for CICS, WebSphere MQ and DB2. It also supports the new SMF formats introduced in CICS Transaction Server for z/OS, Version 3.2.

*Support for Tivoli Composite Application Manager*

CICS Transaction Server for z/OS, Version 3.2 supports the Tivoli Composite Application Manager family of products. These products help ensure the performance and availability of modern IT environments by predicting problems or highlighting, diagnosing and resolving them when they do occur. Tivoli Composite Application Manager products manage the services, applications, middleware and other resources that service oriented architecture (SOA)-based systems are built upon. Tivoli Composite Application Manager for SOA can monitor, manage and control the Web services layer of IT architectures while drilling down to the application or resource layer to identify the source of bottlenecks or failures and to pinpoint services that take the most time or use the most resources. Tivoli Composite Application Manager for CICS enables requests to be tracked from WebSphere Application Server to CICS Transaction Server, and then to DB2 using Tivoli Composite Application Manager for WebSphere and Tivoli Composite Application Manager for Response Time Tracking.

*Support for Tivoli Business Systems Manager*

CICS Transaction Server for z/OS, Version 3.2 supports Tivoli Business Systems Manager to enable real-time service management. This capability makes it possible to map CICS components to business services.

*CICS Configuration Manager, Version 1.2*

CICS Configuration Manager, Version 1.2 is enhanced through a program temporary fix (PTF) to support the new resources in CICS Transaction Server for z/OS, Version 3.2. It enables controlled management of resource definitions in multiple CICS systems. Accurate and up-to-date CICS resource definitions are essential to maintain the high availability expected of your CICS environment. Resource definition can be a daunting task, especially if the topology of the CICS regions of your systems is large and complex. CICS Configuration Manager helps simplify CICS administration; helps improve the productivity of your IT staff, including managers, system programmers, and application developers; helps improve availability; and helps reduce administrative errors and maintenance costs.



### Technical summary

CICS Transaction Server for z/OS, Version 3.2 delivers the following functions:

- *Support for Web Services Description Language (WSDL), Version 2.0*
- *Web services support for Message Transmission Optimization Mechanism (MTOM) and XML-binary Optimized Programs (XOP)*
- *Support for Web Services Interoperability (WS-I) Basic Profile, Version 1.1 and Simple SOAP Binding Profile, Version 1.0*
- *Support for the Web Services Trust Language (WS-Trust) specification in Web Services Security (WS-Security)*
- *IP interconnectivity for DPL*
- *Enhanced TCP/IP management and control*
- *Updates for CICS Web support*
- *Enhancements to data mapping and to WSDL in Web services*
- *Java API for Web services assistant*
- *64-bit support for channels and containers*
- *Optimized support for coded character set identifier (CCSID) data conversion*
- *C/C++ integrated translator*
- *Further codepage support in CICS translator for the C programming language*
- *Online management of program libraries*
- *Support for EWLM*
- *Thread safety for the file-control API, the definition for system auto-installed global user exits, CICS journaling commands and the WebSphere MQ API*
- *Enhancements to configuration and management for Java, Version 1.4.2*
- *Support for Java, Version 5*
- *Integrated installation of CICSplex System Manager*
- *Enhancements to CICSplex System Manager*
- *Enhancements to the WUI*
- *Map capability in the CICSplex System Manager WUI*
- *ALL option for COVC EXPORT*
- *Improvements to WUI terminology*
- *Functions transferred from WebSphere MQ*
- *CICSplex System Manager support for new functions*
- *Information center enhancements*

- *Revised WUI view and menu packaging*
- *Larger capacity for shared data tables*
- *Support for larger capacity VSAM entry-sequenced data set (ESDS) files*
- *Improved timing-data precision in monitoring and statistics records*
- *Compression for monitoring data records*
- *Enhancement to CICS statistics*
- *Increase in default size of the trace table*
- *The ability of DFHTRxxx trace programs to run RMODE(31)*
- *Enhancements to INQUIRE MVSTCB*
- *Experimental Computing Facility (XCF) group-limit avoidance*

### **Conclusion**

CICSplex System Manager is an integrated component within CICS Transaction Server for z/OS, Version 3.2. Its role is to reduce the complexity of CICS system management across a whole range of management tasks. CICSplex System Manager also integrates with other CICS tools and with Tivoli management products to provide a complete enterprise systems-management solution. CICS Transaction Server for z/OS, Version 3.2 continues the enterprise-management themes of integration, simplification and monitoring, and the autonomic behavior of CICS systems.

The other benefits provided by CICS Transaction Server for z/OS, Version 3.2 include:

- *The ability to dynamically balance DPL requests across TCP/IP-connected CICS regions now that enterprises are moving away from SNA to TCP/IP networks*
- *More-efficient tracking of TCP/IP flows across the enterprise*
- *Quicker identification of where problems are occurring in end-to-end application flows across the enterprise, using the EWLM control center*
- *The ability to manage application change without having to restart CICS Transaction Server, through the provision of application-based dynamic library support.*

- *More-efficient management of the CICS WebSphere MQ interface*
- *Reduced consumption of direct access storage devices (DASD) through SMF data compression*
- *Faster use of CICSplex System Manager through integrated installation and a new startup utility*
- *Comprehensive management of all new CICS resources right from the start*
- *Higher productivity and lower skill requirements through an improved system-management WUI, which is now more usable, has better help facilities, has increased consistency with familiar CICS terminology, and also provides improved mapping support*
- *Simpler export and import of WUI menus and views through simplified WUI server-management capabilities.*

The new capabilities introduced by CICS Transaction Server for z/OS, Version 3.2 enable you to make the most of CICSplex System Manager. The combination of increased functionality that is now available makes a powerful argument for moving to CICS Transaction Server for z/OS, Version 3.2.

**For more information**

To learn more about the IBM CICS family of products, contact your IBM representative or IBM Business Partner, or visit:

[ibm.com/cics/](http://ibm.com/cics/)

To learn more about the IBM CICS Transaction Server, contact your IBM representative or IBM Business Partner, or visit:

[ibm.com/cics/tserver](http://ibm.com/cics/tserver)



© Copyright IBM Corporation 2007

BM United Kingdom Limited  
Hursley Park  
Winchester  
Hampshire  
SO21 2JN  
United Kingdom

Produced in the United States of America  
04-07  
All Rights Reserved

CICS, CICSplex, Cloudscape, DB2, eServer, i5/OS, IBM, the IBM logo, IMS, MVS, NetView, OMEGAMON, RACF, Rational, System z, Tivoli, WebSphere and z/OS are trademarks of International Business Machines Corporation in the United States, other countries or both.

Java and all Java-based trademarks are trademarks of Sun Microsystems, Inc. in the United States, other countries or both.

Other company, product and service names may be trademarks or service marks of others.

All statements regarding IBM future direction or intent are subject to change without notice and represent goals and objectives only.