

Soluciones de almacenamiento en disco IBM TotalStorage

Con la era de la información bajo demanda, las empresas deben responder con flexibilidad y velocidad a cualquier requerimiento de cliente, oportunidad de mercado ó amenaza externa

Llegar a On Demand implica trabajar en tres áreas:

1.

Simplificación de la capa de Infraestructura de IT y su gestión

2.

Asegurar Continuidad de Negocio, seguridad y durabilidad del dato

3.

Gestionar eficientemente la información durante su Ciclo de Vida

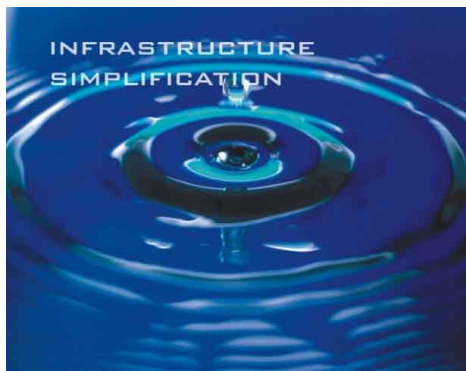

La familia IBM System Storage DS



Common management platform

Common suite of copy services

Virtualization

Compelling price points

Industry leading service and support

Enterprise-class Storage Continuum

IBM System Storage DS Family innovations help you:

- **Simplify** the underlying IT infrastructure of storage and its management to lower cost and complexity while increasing the ability to respond to changing needs.
- Assure **business continuity**, security and data durability.
- Efficiently manage information **throughout its lifecycle**, relative to its business value.

DS4000 tamaño intermedio con prestaciones completas

•eServer p5



DS4000

- ▶ Serie DS4000
 - Crecimiento flexible y posibilidades de consolidación que maximizan el rendimiento y la disponibilidad a la vez que reducen el coste
 - Monitorización avanzada de rendimiento e incidentes para contribuir a la alta disponibilidad
 - Opción de discos SATA de bajo coste
 - Soporte de múltiples plataformas Unix/ Wintel
- ▶ Incorpora mejoras de resiliencia y de gestión que antes sólo se encontraban en productos de gama alta
- ▶ Diseñado para empresas medianas, implantaciones departamentales o disco de segundo nivel para grandes empresas

DS4000 Series Beneficios

- **Actualizaciones flexibles**
- **Capacidades dinámicas únicas en la industria**
- **Orientados a proporcionar fiabilidad y rendimiento**
- **Características de alta disponibilidad diseñadas para rechazar los puntos únicos de fallo**
- **Consolidan almacenamiento**
 - ▶ Hasta 64 host
 - ▶ Servidores Homogeneos o Heterogeneos
- **Ayudan a la protección de los datos**
 - ▶ Múltiples niveles RAID
 - ▶ Particiones de almacenamiento (LUN masking)
 - ▶ Componentes redundantes, hot-swap
 - ▶ Diseñados para proporcionar acceso rápido a los datos
- **Ayudan a reducir el TCO**
 - ▶ La consolidación de almacenamiento reduce los costes de almacenamiento
 - ▶ 3 años de garantía dependiendo del modelo

Posicionamiento de la familia DS4000

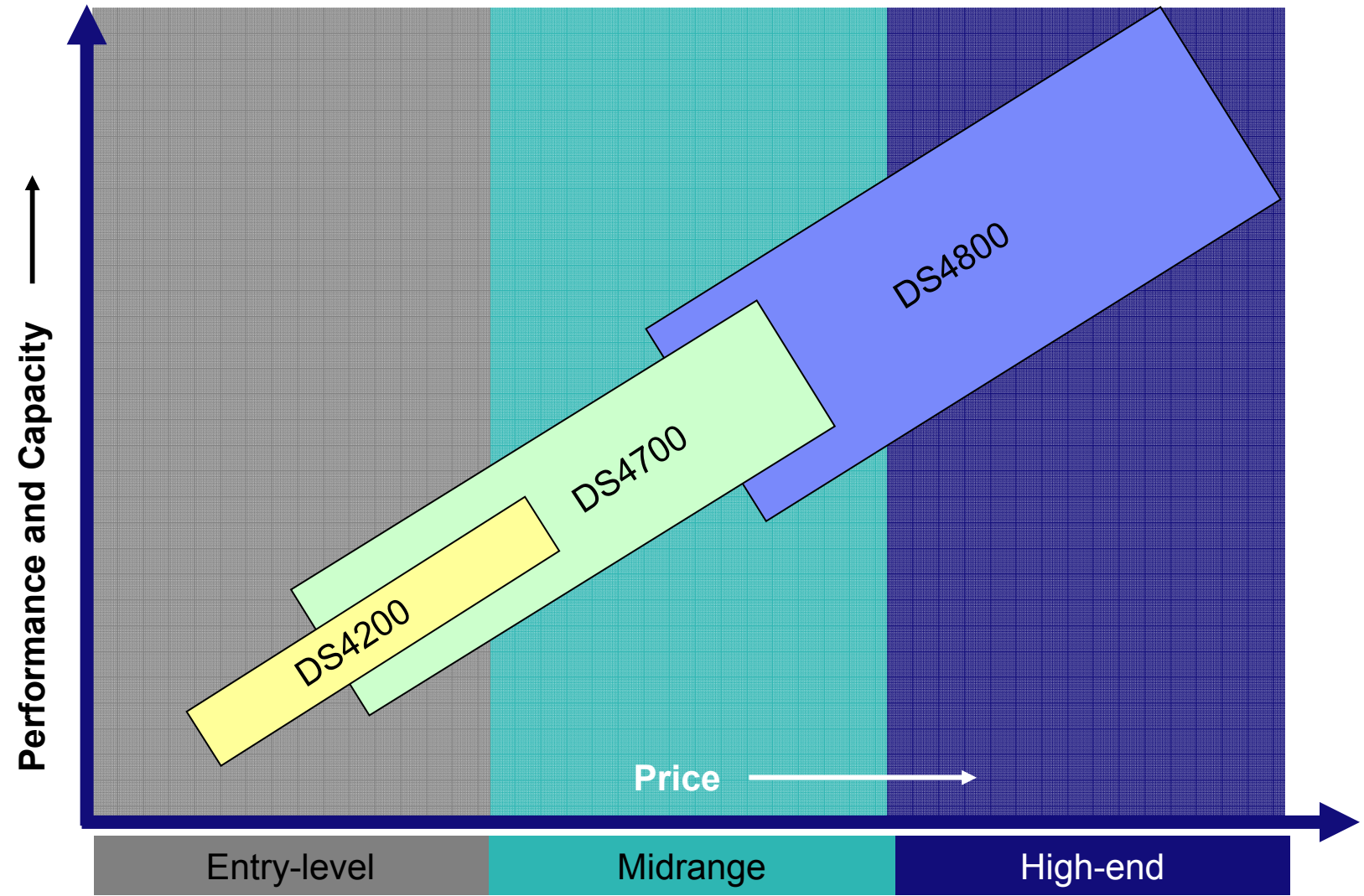

DS4000 Series 4Gb/s and 2Gb/s Products

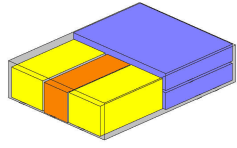
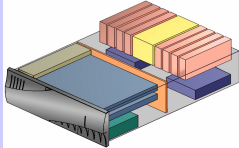
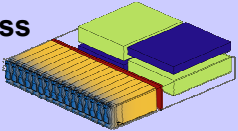
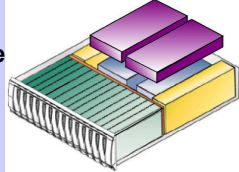
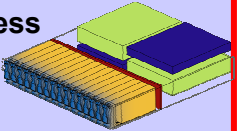
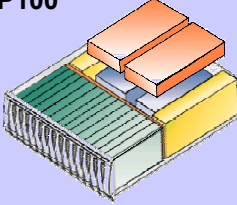
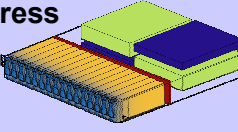
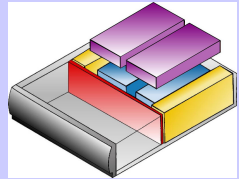
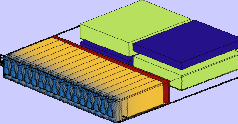
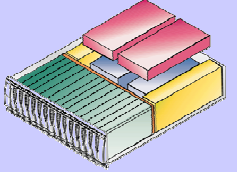
	4Gb/s	2Gb/s
Mayo 2005	<p>DS4800</p> 	<p>DS4500</p> 
Mayo 2006	<p>DS4700 Express</p> 	<p>DS4300 Dual/Turbo/Single DS4100 Dual/Single with SATA</p> 
Agosto 2006	<p>DS4200 Express</p> 	<p>EXP100</p> 
Agosto 2006	<p>EXP420 Express</p> 	<p>DS4300 when attaching EXP100 SATA</p> 
Feb 2006	<p>EXP810</p> 	<p>EXP710</p> 

- **DS4800 Lider de mercado - Industry First 4Gb/s Disk Array Controller**
- **DS4700, DS4200 Express, EXP810/EXP420 – Expands 4Gbps capable products**

Rendimiento de la familia DS4000

- **Exceptional performance value for entry-level / secondary storage**
 - ▶ **SATA is not a good fit for applications requiring higher IOPS**
 - ▶ **SATA is a good fit for most applications requiring throughput**

Maximum performance	DS4800	DS4500	DS4700	DS4300	DS4200	DS4100
Maximum burst I/O rate on cache reads	575,000 IOPS	148,000 IOPS	120,000 IOPS	77,500 IOPS	120,000 IOPS	70,000 IOPS
Maximum sustained I/O rate on disk reads	86,000 IOPS	53,200 IOPS	44,000 IOPS	25,000 IOPS	11,200 IOPS	10,000 IOPS
Maximum sustained I/O rate on disk writes	22,000 IOPS	10,900 IOPS	9,000 IOPS	5,200 IOPS	1,800 IOPS	2,000 IOPS
Maximum burst throughput on cache reads	1,700 MB/s	800 MB/s	1,600 MB/s	400 MB/s	1,600 MB/s	800 MB/s
Maximum sustained throughput on disk reads	1,600 MB/s	795 MB/s	990 MB/s	400 MB/s	990 MB/s	485 MB/s
Maximum sustained throughput on disk writes	1,300 MB/s	630 MB/s	850 MB/s	315 MB/s	690 MB/s	415 MB/s

DS4800, DS4700, DS4500 and DS4300 Turbo performance numbers are with FC drives. DS4200 and DS4100 performance numbers are with SATA drives.
 Note: Source of information from Engenio and not confirmed by IBM. Performance results achieved under ideal circumstances in a benchmark test environment.
 Actual customer results will vary based on configuration and infrastructure components.

Componentes Hardware DS4000

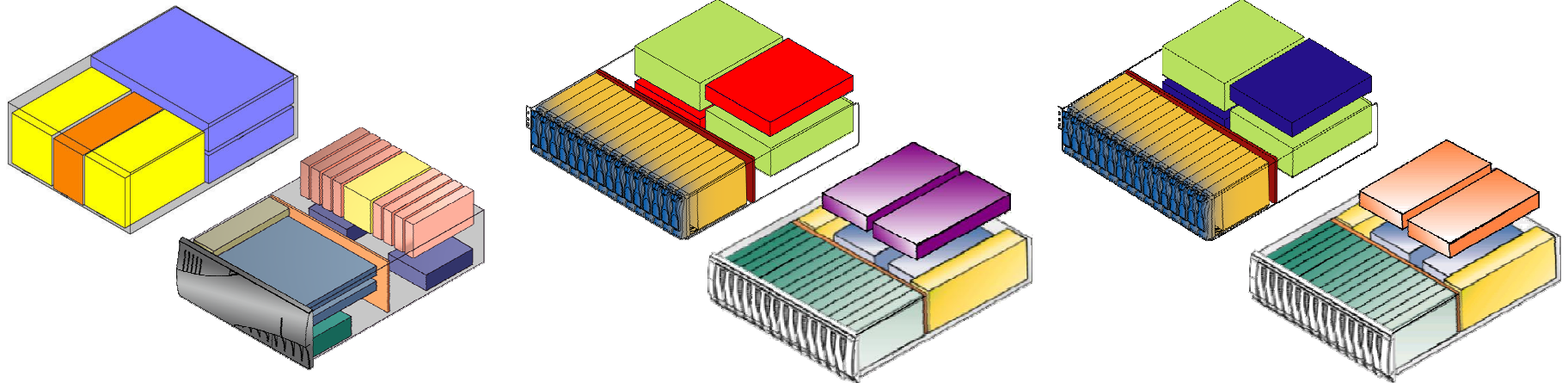

4U Controller Module	3U Controller Module	3U EXP Expansion units
<ul style="list-style-type: none"> ▪ Dual-active controllers ▪ Host/SAN connections ▪ Redundant drive loops ▪ Ethernet connections ▪ Hot-swappable FRUs 	<ul style="list-style-type: none"> ▪ Dual-active controllers ▪ Host/SAN connections ▪ Redundant drive loops ▪ FC or SATA Drives ▪ Ethernet connections ▪ Hot-swappable FRUs 	<ul style="list-style-type: none"> ▪ FC (EXP810, EXP710) ▪ SATA drives (EXP810, EXP420, EXP100) ▪ Redundant pathing features ▪ Hot-swappable FRUs ▪ Switched architecture
DS4800, DS4500	DS4700 (FC), DS4300 (FC), DS4200, (SATA), DS4100 (SATA)	EXP810, EXP420, EXP710, EXP100

Introducción del DS4800

- **4 Gbps** technology is here with the latest member of the DS4000 Series of products, the IBM TotalStorage DS4800!
- Targeted at **enterprises with compute-intensive** applications and replication requirements
- **Eight 4 Gbps host and SAN interfaces** support existing infrastructures – helping provide investment protection
- Outstanding **performance** designed for open systems
- Support for **224** Fibre Channel or Serial ATA disk drives
- DS4000 Storage Manager delivers robust functionality through an intuitive GUI - help maximize ROI



Five Components

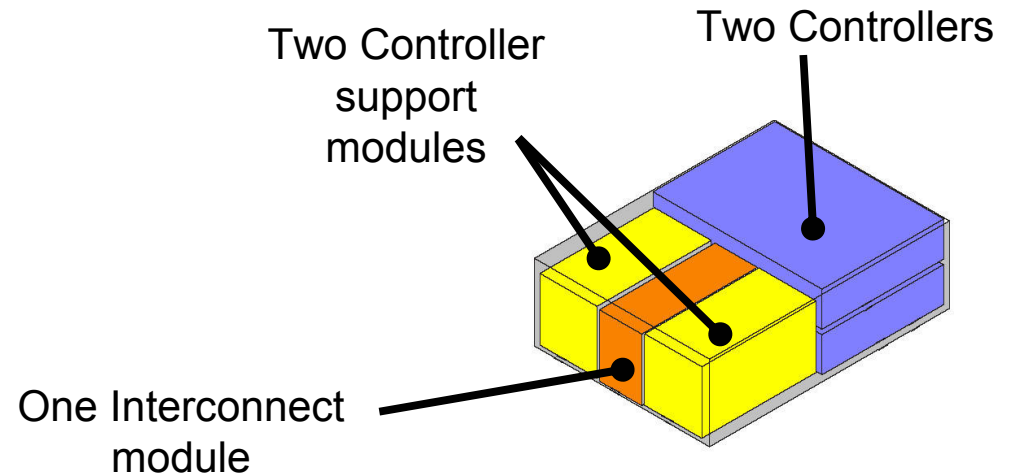

DS4700 Express especificaciones

Dos Modelos

Model 72

- **Eight** 4 Gb/s FC host ports
- Four 4 Gb/s FC drive ports
- Max of 112 drives with six EXP810 Expansion Units
 - ▶ 16 disk drives inside controller
 - 4 – 6 trays requires and expansion license
 - ▶ FC or SATA
- **4 GB** of cache memory
- Integrated XOR engine
- Storage Manager software
 - ▶ Partitions
 - ▶ FlashCopy®
 - ▶ VolumeCopy
 - ▶ Enhanced Remote Mirroring

Model 70

- Four 4 Gb/s FC host ports
- Four 4 Gb/s FC drive ports
- Max of 112 drives with six EXP810 Expansion units
 - ▶ 16 disk drives inside controller
 - 1 – 3 trays requires an expansion license, 4 – 6 trays requires and expansion license
 - ▶ FC or SATA
- 2 GB of cache memory
- Integrated XOR engine
- Storage Manager software
 - ▶ Partitions
 - ▶ FlashCopy®
 - ▶ VolumeCopy
 - ▶ Enhanced Remote Mirroring

DS4200 Express especificaciones

Modelo 7V

DS4200 Express Model 7V

- **Four** 4 Gb/s FC host ports
- **Four** 4 Gb/s FC drive ports
- Max of **112** drives with six EXP420 Expansion units
 - ▶ 16 disk drives inside controller
 - 1 – 3 trays requires an expansion license, 4 – 6 trays requires and expansion license
 - ▶ SATA only (DS4200 Express 500 GB EV-DDM)
- **2 GB** of cache memory
- Integrated XOR engine
- Storage Manager software options
 - ▶ Partitions
 - ▶ FlashCopy®
 - ▶ VolumeCopy
 - ▶ Enhanced Remote Mirroring

Comparación de especificaciones

<i>Dual-controller system (unless noted)</i>	DS4800 Model 88, 84, 82	DS4800 Model 80	DS4700 Model 72	DS4700 Model 70
Host channels	8	8	8	4
Native host interface link speed	4 Gb/s	4 Gb/s	4 Gb/s	4 Gb/s
Supported host interface link speeds	4, 2, 1 Gb/s	4, 2, 1 Gb/s	4, 2, 1 Gb/s	4, 2, 1 Gb/s
Total host channel bandwidth	3,200 MB/s	3,200 MB/s	3,200 MB/s	1,600 MB/s
Redundant drive channels	Eight 4 Gb/s	Eight 4 Gb/s	Four 4 Gb/s	Four 4 Gb/s
Total drive channel bandwidth	3,200 MB/s	3,200 MB/s	1,600 MB/s	1,600 MB/s
Max drives	224	224	112	112
Drives supported	FC and SATA	FC and SATA	FC and SATA	FC and SATA
Processor	Intel Xeon 2.4 GHz	Intel Xeon 2.4 GHz	Intel xScale 667 MHz	Intel xScale 667 MHz
Processor memory (single controller)	512 MB	512 MB	128 MB	128 MB
Data bus bandwidth	1 GB/s 64 bit / 133 MHz	800 MB/s 64 bit / 100 MHz	800 MB/s 64 bit / 100 MHz	800 MB/s 64 bit / 100 MHz
XOR engine	Dedicated	Dedicated	Integrated	Integrated
Dedicated data cache per dual-controller system (min/max)	16, 8, 4 GB	4 GB	4 GB	2 GB

Switched Disk Expansion Unit

- Significant reduction in number of nodes on the drive loop
 - ▶ Point - Point technology designed eliminate the arbitrated loop within the expansion unit

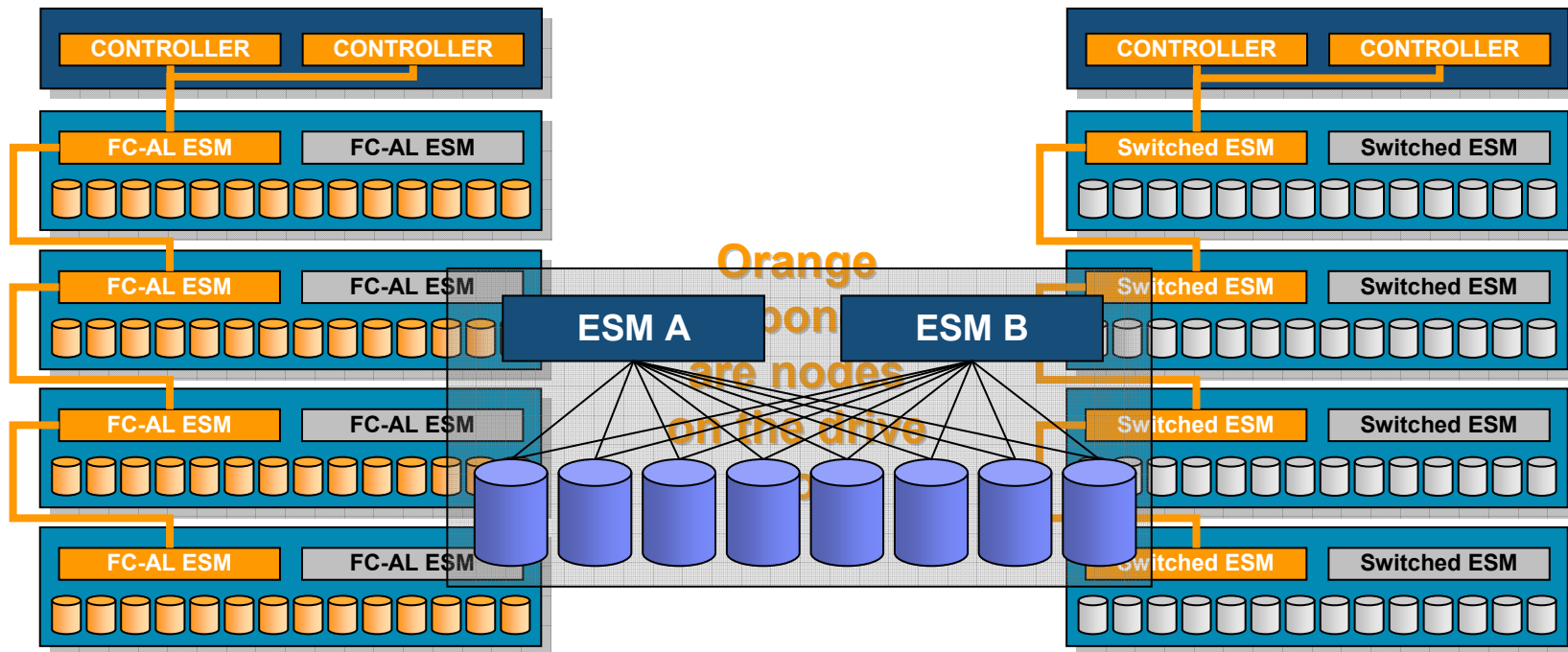

DS4000 Storage Manager

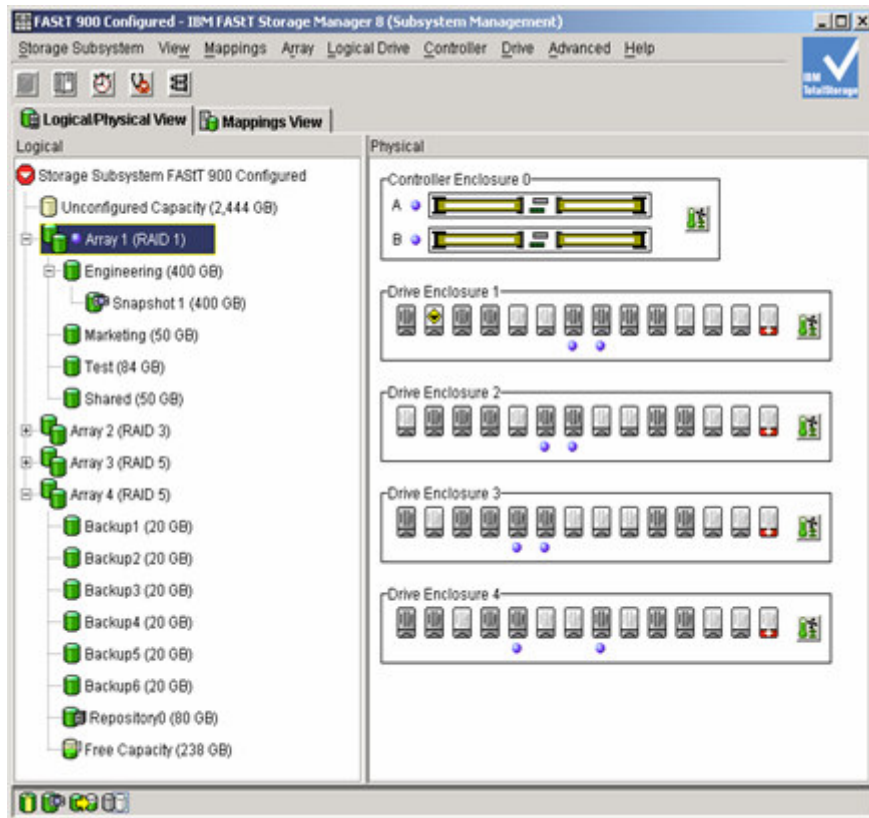

- **Powerful functionality included at **NO ADDITIONAL CHARGE****
 - ▶ **Lower storage management costs**
 - Centralized administration of all FC and SATA systems
 - Common interface across all products / platforms
 - Robust functionality with intuitive GUI and configuration wizards
 - Fully-integrated premium features
 - ▶ **Effective use of raw capacity**
 - Configuration flexibility creates superior storage utilization
 - Tune any attribute to meet any server / application need
 - Incremental capacity / performance scaling
 - ▶ **Investment protection**
 - Common components lowers training / support costs

DS4000 Storage Manager :Anytime Administration – Anytime Data

- EXP HotAdd Technology
 - ▶ **Online capacity expansion, configuration and LUN access**

- Dynamic Array Expansion (DAE)
 - ▶ **Add drives to existing array**

- Dynamic Volume Expansion (DVE)
 - ▶ **Add available capacity to existing logical drives (OS dependent)**

- Dynamic RAID Level Migration (DRM)
 - ▶ **Change the RAID configuration of an array**

- Dynamic Segment Size Migration (DSS)
 - ▶ **Change the data stripe size**

- Dynamic mode switching
 - ▶ **Change between remote mirroring modes**

Multiple Data Replication Offerings - Optional

- **FlashCopy**

- ▶ Designed to create a point-in-time image
- ▶ Ideal uses: backup source, restoration point, checkpoint

- **VolumeCopy**

- ▶ Designed to create a complete physical copy (clone)
- ▶ Ideal uses: data mining / analysis, PiT archive

- **Remote Mirroring**

- ▶ Designed to create a continuously updated copy at a remote location
- ▶ Ideal use: disaster recovery

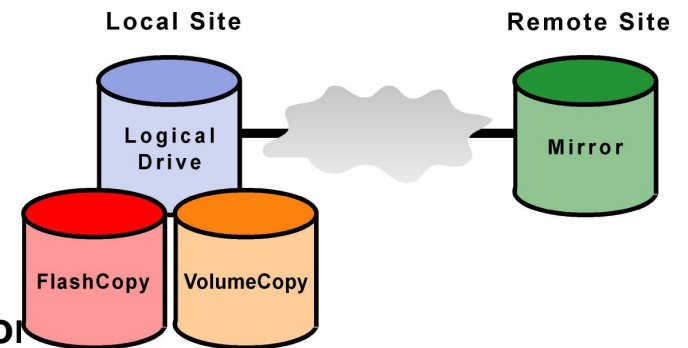

DS4000 FlashCopy

- A point-in-time (PiT) image of a volume
 - ▶ Logical equivalent of a physical copy
- Features:
 - ▶ Near instantaneous copy
 - ▶ Requires less disk space than a full copy
 - ▶ Mappable to host
 - ▶ Can be read from, or written to
- Primary uses:
 - ▶ PiT backup image
 - ▶ File / volume restoration
 - ▶ Data mining / analysis

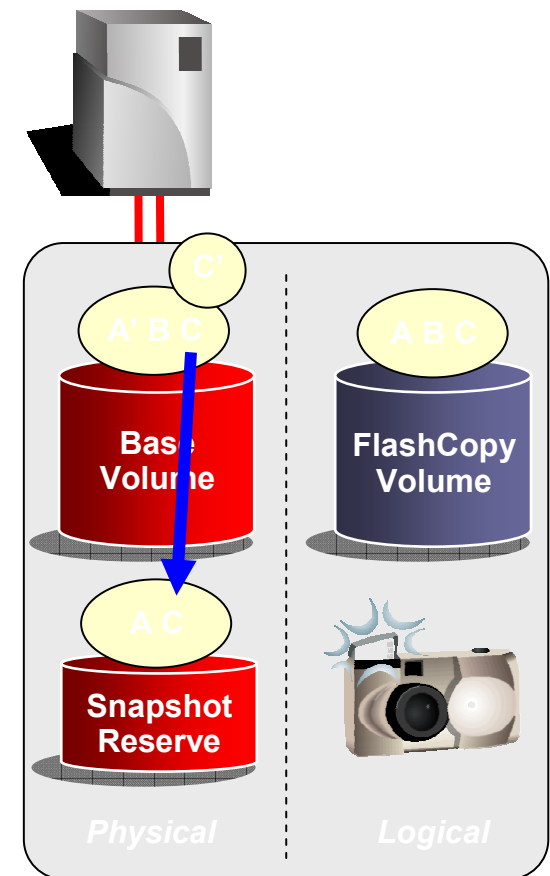

DS4000 Volume Copy

- **Complete (byte-by-byte) PiT replication of one logical drive (source) to another (target) within a storage system**
 - ▶ Target logical drive also referred to as a clone
- **Primary uses:**
 - ▶ Full PiT data set for analysis, mining, testing, backup
 - Designed to help reduce I/O contention on the primary logical drive

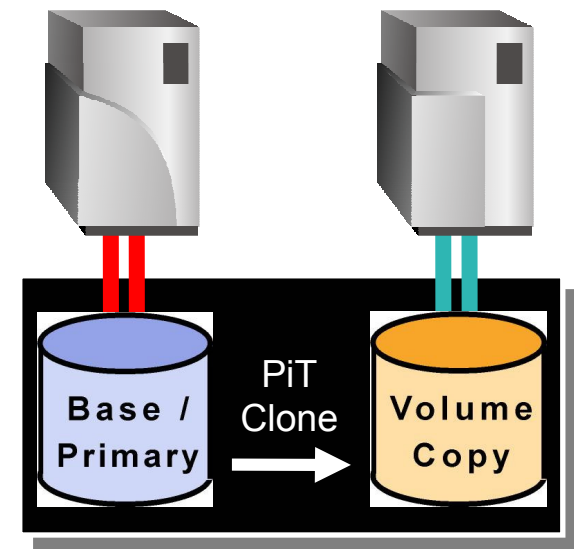

VolumeCopy Integration with FlashCopy

- Copying the FlashCopy creates a full PiT clone copy while I/O continues to base logical drive

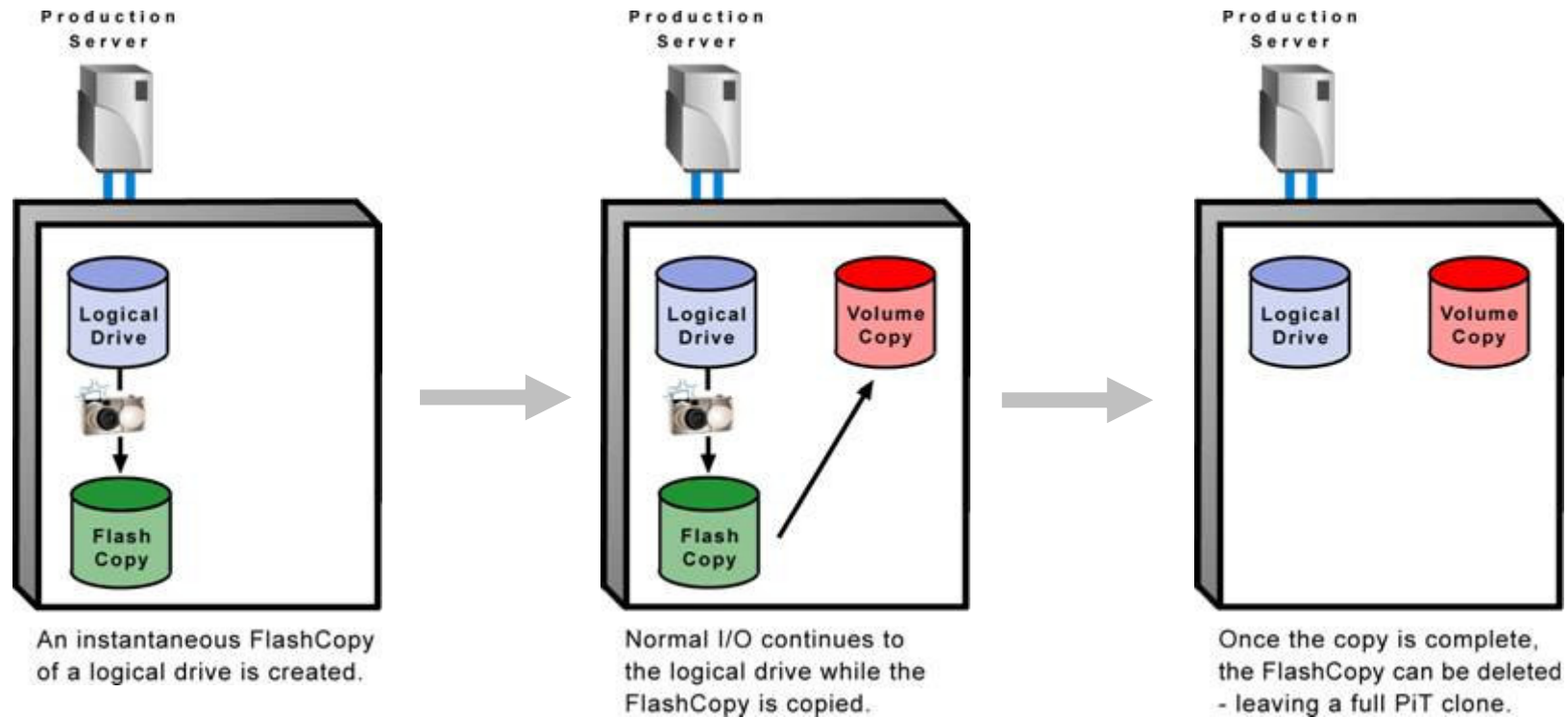

DS4000 Enhanced Remote Mirroring

- **Storage-based data replication**
 - ▶ **Designed to provide ongoing, real-time replication of a logical drive from one DS4000 storage subsystem to another**
- **Three mirroring modes**
 - ▶ **Metro Mirror**
 - ▶ **Global Copy**
 - ▶ **Global Mirror**
- **Primary uses:**
 - ▶ **Disaster recovery**
 - ▶ **Centralize backup data**
 - ▶ **Centralize data mining / analysis**

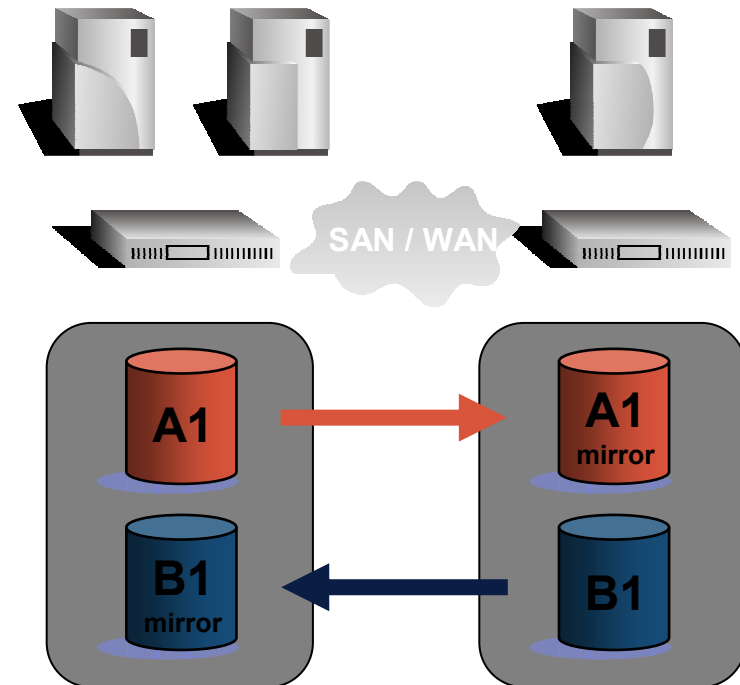

Metro Mirror

¿Que es Metro Mirror?



- ▶ Proporciona una copia Sincrona y continua de un conjunto de datos a una ubicación remota.
- ▶ Realizada a nivel de Volumen.

¿Para que se usa Metro Mirror típicamente?

- ▶ Para aplicaciones que no pueden sufrir ninguna pérdida en el caso de un fallo. Metro Mirror proporciona el Recovery Point Objective mas ajustado.

Metro Mirror - Technology

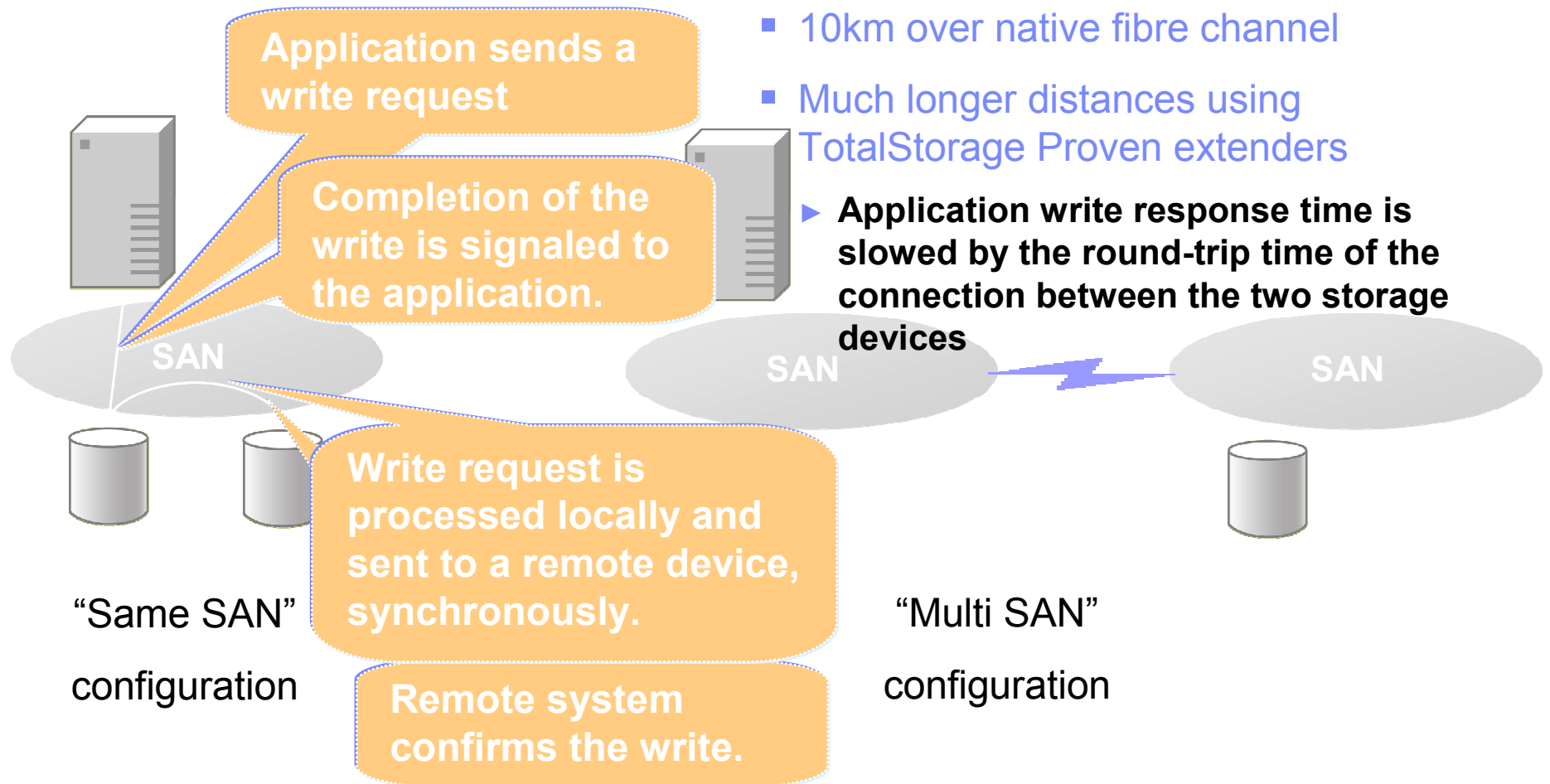

Global Mirror

¿Que es Global Mirror?



- ▶ Diseñado para proporcionar una copia Asincrona y continua de un conjunto de datos a una ubicacion remota.
- ▶ Realizada a nivel de Volumen.

¿Para que se usa Global Mirror tipicamente?

- ▶ Para Centros de recuperacion a muy largas distancias, Global Mirror proporciona Integridad de los datos a un Recovery Point Objective ajustado.

Global Copy

¿Que es Global Copy?



- ▶ Diseñado para proporcionar una copia de alto rendimiento de un conjunto de datos a una ubicación remota.
- ▶ Sus objetivos son Rendimiento *durante* la copia e Integridad *al acabar* la copia.
- ▶ Realizada a nivel de Volumen.

¿Para que se usa Global Copy típicamente?

- ▶ Migración de datos durante un movimiento de Datacenter o Aplicación.
- ▶ Usada a veces en configuraciones de servicios de copia complejas junto a Metro Mirror y Point-in-time Copy.

Gestion Centralizada

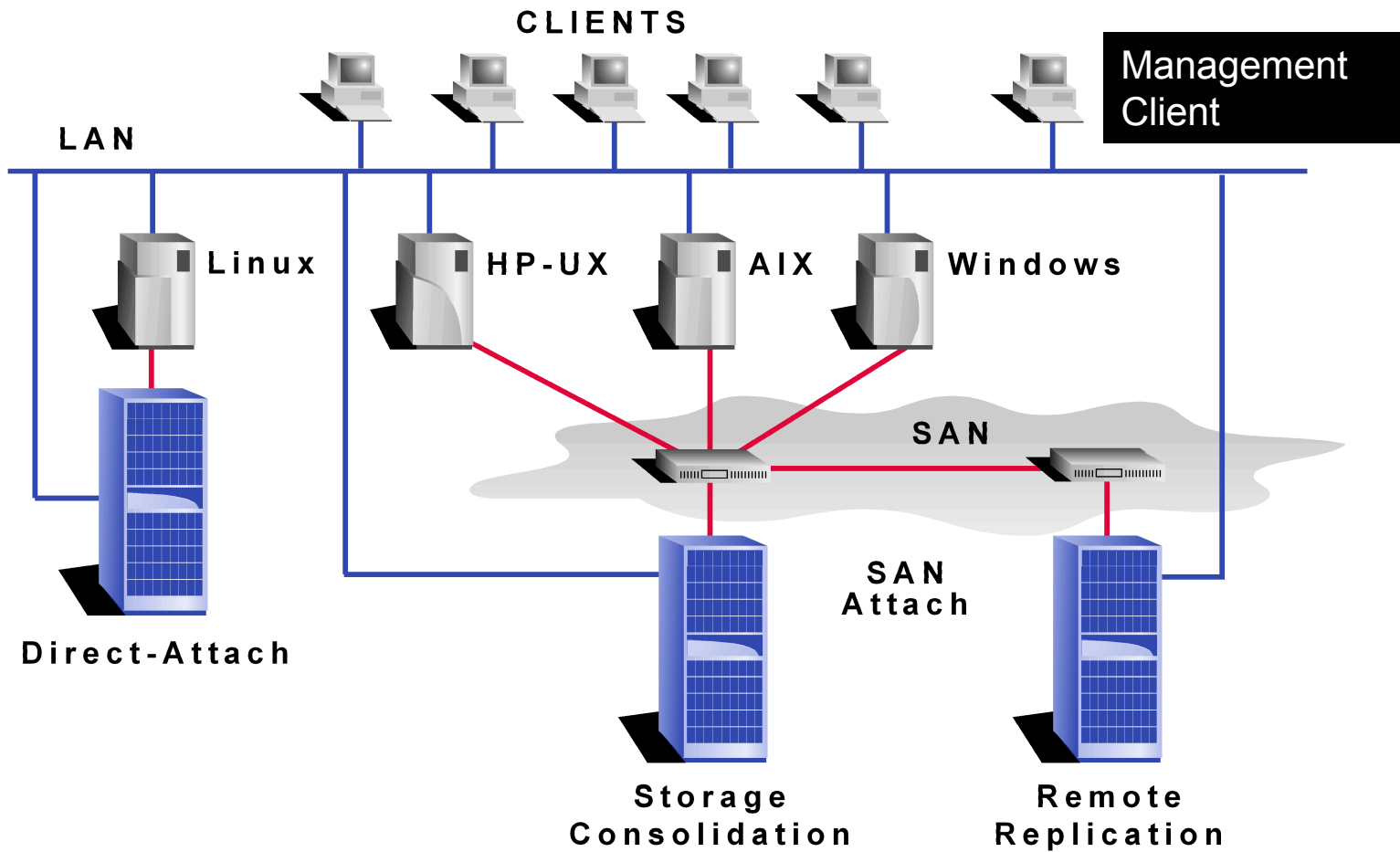

El siguiente paso

- ▶ **IBM TotalStorage DS6000**— precio excepcional y rendimiento extraordinario en un formato modular que redefine el almacenamiento de gama alta – “enterprise”
- ▶ **IBM TotalStorage DS8000**— una nueva referencia que proporciona escalabilidad masiva y particionado revolucionario con los procesadores IBM POWER5™—ayudando a reducir costes



**Control Total sobre la infraestructura de almacenamiento:
La escalabilidad. El rendimiento. El valor.**

DS6000—máximo de información, mínimo tamaño

Mainframe and Open



DS6000

- ▶ **TotalStorage DS6000**— prestaciones “enterprise-class “ en un tamaño increíblemente reducido y a un precio extremadamente atractivo
- ▶ Las empresas medianas pueden tener ahora almacenamiento con rendimiento y valor propios de soluciones de gama alta
- ▶ Las empresas tienen ahora más posibilidades de elección de almacenamiento flexible
- ▶ Características:
 - Soporte de mainframes y sistemas abiertos— implantación flexible
 - Escalabilidad—expansión incremental
 - Servicios de Copia y de Gestión comunes con otros discos de la familia DS

DS6800 características

- **Highly available, resilient and robust storage solution for medium and large enterprises**
- **High performance**
 - ▶ Over 1600 MB/sec throughput
 - ▶ Over 330,000 IOPS
- **Supports tiered storage strategies**
 - ▶ Fibre Channel disk drives for mission critical workloads
 - ▶ Fibre Channel ATA (FATA) disks for near-line or tier 2 storage
- **High storage density footprint – 8TB's in 3U**
 - ▶ 16 drives per 3U package, including controller
 - ▶ Up to 64TB's of storage
- **Differentiators**
 - ▶ Enterprise-class functionality with open systems and mainframe host attachment
 - ▶ Enterprise-class warranty
 - ▶ Advanced functions interoperable with DS8000 and Enterprise Storage Server



Enterprise-class storage in a small, modular package at an affordable prices

DS6800 especificaciones

Controllers	Dual Active
Max Cache	4 GB
Max Host Ports	8-Ports; 2Gb FC/FICON
Max Hosts	1024
Max Storage / Disks	Up to 64TB / 128 drives
Disk Drives	FC 10K rpm: 146 GB, 300 GB FC 15K rpm: 73, 146 GB FATA 7.2K rpm: 500 GB
Max Expansion Mod	7
Max Disk Loops	4 (2 dual redundant)
Max LUNs	8192
RAID Levels	5, 10
RAID Array Sizes	4 or 8 drives
Operating Systems	z/OS, z/VM, i5/OS, OS/400, AIX, SUN Solaris, HP UX, VMWare, UNIX, Microsoft Windows, Linux
Packaging	3U – Controller & Expansion Drawers <i>Height: 5¼ inches, Width: 18.8 inches, Depth: 24 inches</i>
Power consumption	Controller: 0.69 kVA Expansion drawer: 0.48 kVA

DS6800 Diseñado para ahorrar espacio y dinero

IBM TotalStorage®
Enterprise Storage Server 800

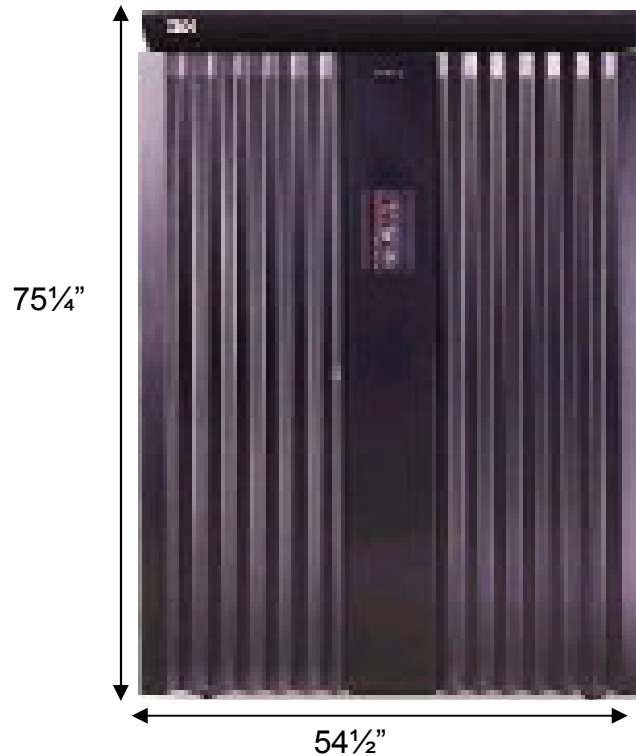

IBM System Storage
DS6000 series

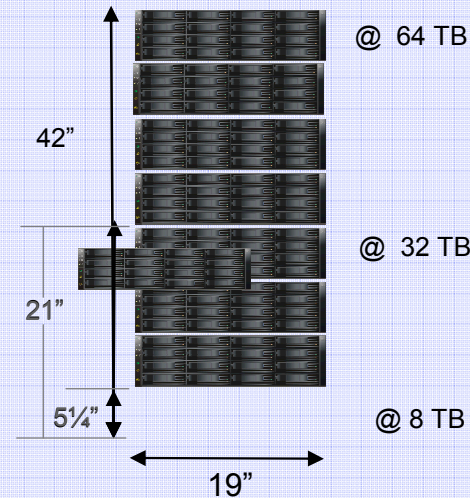

EMC
DMX800

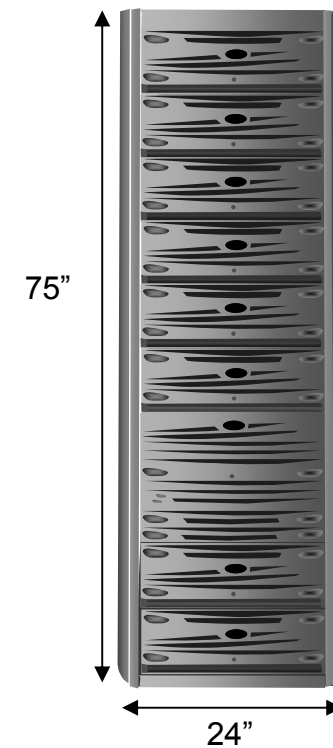

Maximum Configuration Up to 55.9 TBs

Weight @ 8 TB 2,322 lbs

Maximum Power Consumption 6.4 kVA

Up to 64 TBs

125 lbs per enclosure
0.69 kVA controller
0.48 kVA expansion unit

Up to 60 TB's HDDs

1,596 lbs (full config)
4.64kVA

Escalabilidad Modular

- **Flexible design to accommodate on Demand business environments**
- **Designed for dynamic configuration changes**
 - ▶ Add disk drives in increments of 4
 - ▶ Add storage expansion units
- **Scale capacity to 64 TB**

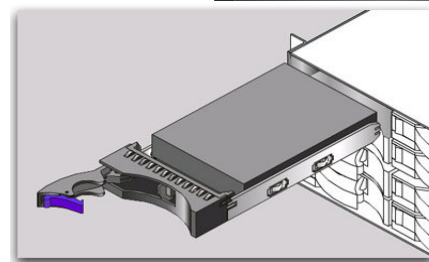
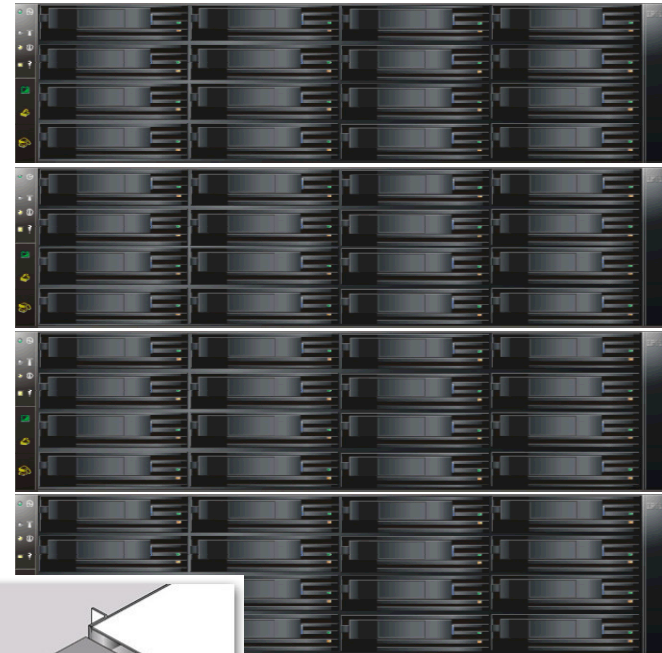

Beneficios de la escalabilidad modular

- **Lower acquisition costs**
 - ▶ Avoid having to buy for the future
- **“Pay as you grow” design**
 - ▶ Grow capacity with storage needs
 - ▶ Add capacity and function as needed
- **Flexible storage capacity**
 - ▶ Add capacity without disrupting data availability
 - ▶ Optimize storage to information needs by using appropriate drive sizes and speeds
- **Tiered storage within a single system**
 - ▶ Mission critical data on Fibre Channel disks
 - ▶ Tier 2 or near-line data on FATA drives

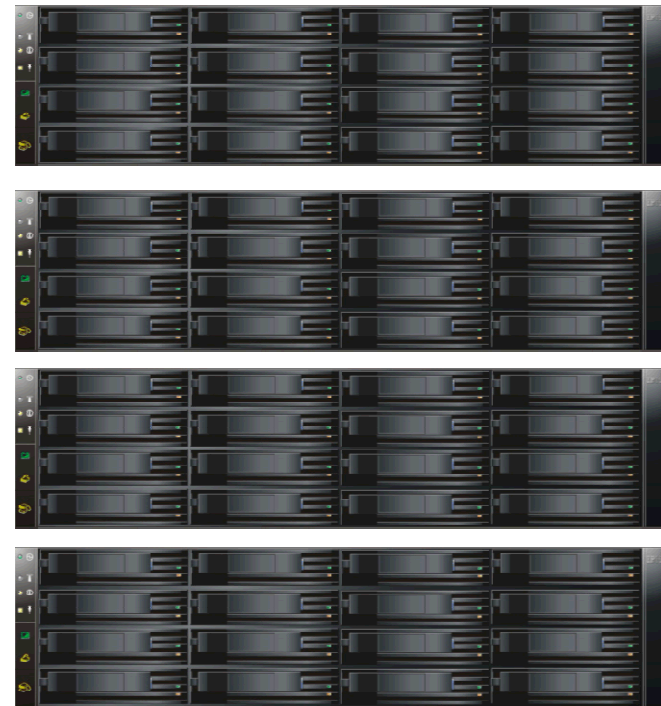

NEW Fibre Channel ATA (FATA) Disk Drives

Potential benefits of using FATA drives for near-line storage

- Integrates easily into current IT environment
- Provides fast, random access to infrequently requested information
- Reduce data recovery times
 - ▶ FATA disk drives can provide near-line volumes as an intermediate storage tier between primary disk and tape
- Offers a low total cost of ownership
 - ▶ Lower cost per gigabyte than Fibre channel disks offer an economical storage solution for:
 - Data that is infrequently accessed or low random I/O requirements; or
 - For applications with sequential I/O requirements
- Enables a cost-effective alternative for disaster recovery
 - ▶ Low-cost FATA disk drives can dramatically reduce the price point for setting up a secondary disaster recovery site

Soporte para los discos Fibre Channel ATA (FATA)

- **Fibre Channel ATA (FATA) disk drives**
 - ▶ 500GB 7,200 RPM
- **4-pack ordering of FATA disk drives**
 - ▶ One feature code (3006) for a package of 4 FATA disk drives
- **Intermix of FATA and FC disks**
 - ▶ Within in a system
 - ▶ Enclosures can be either FC or FATA
 - 1750-522 – all FC or FATA
 - 1750-EX2 – all FC or FATA
- **Full host support**
 - ▶ System x, p, i, and z servers can use FATA volumes
- **Copy services**
 - ▶ FlashCopy and Mirroring can be done from Fibre Channel volumes to FATA volumes

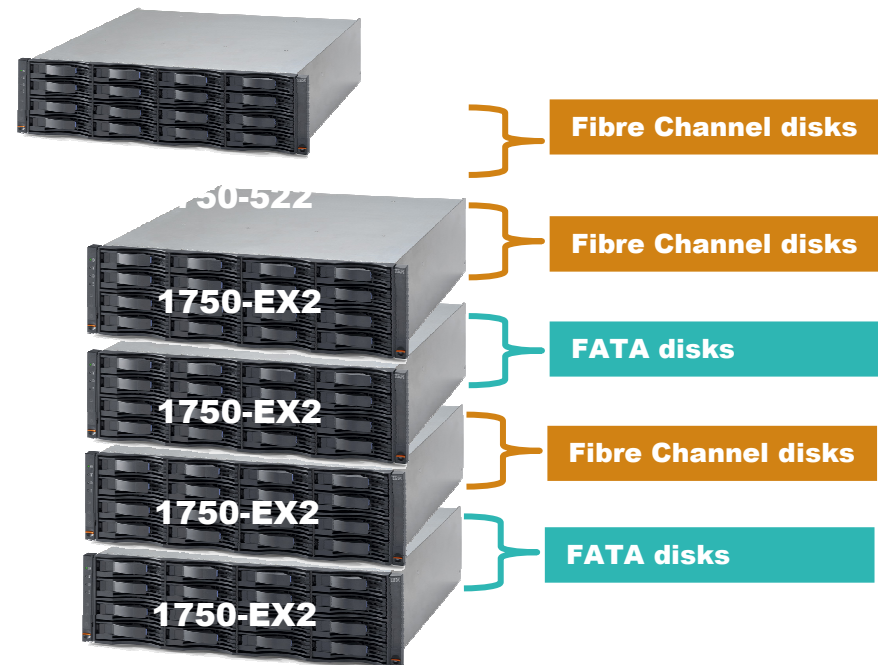

Example – for illustration purposes only

Donde implementar los discos FATA

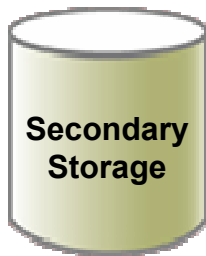

- **Disk-based near-line storage**
 - ▶ Storage in hierarchy between disk and tape
- **Virtual tape or tape cache**
 - ▶ Spinning archive prior to tape enables faster restores
- **Disaster recovery**
 - ▶ Target for remote replication
 - ▶ Ideally suited for source of restoration, not a “hot site”
- **Fixed content / Managed Retention data**
 - ▶ Medical imaging, object folders, historical reports
- **Temp work space for short-term processing**
 - ▶ Minimal IOPS performance requirements

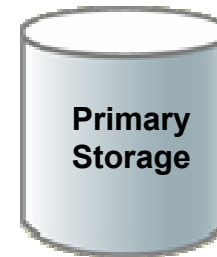

- **Bandwidth / streaming applications**
 - ▶ Rich media – audio/video streaming
 - ▶ Surveillance data
- **Business critical applications with low or limited IOPS performance requirements**
 - ▶ Lower cost solution that benefits from robust controllers, enclosures and management software

High Availability/Resiliency Features

- **Redundant and hot-swappable components**
- **Designed to reduce/avoid single points of failure**
- **Support for non-disruptive upgrades and configuration changes**
- **Switch fabric in disk expansion units**
- **4 data paths to each drive**
- **Preferred path I/O**
- **End to end data checking**
- **Predictive failure analysis for HDDs**

Advantages of FC Switched Storage Enclosures

- **Supports high levels of data availability**
 - ▶ Avoids loop/disk failure, data access losses
 - ▶ RAID Controller failure does not affect server
 - ▶ Four 'active/active' data paths per disk group
 - Some competitors provide only two data paths
- **Improves performance over loops**
 - ▶ Provides maximum disk data transfer
 - ▶ Improves effective bandwidth over loops

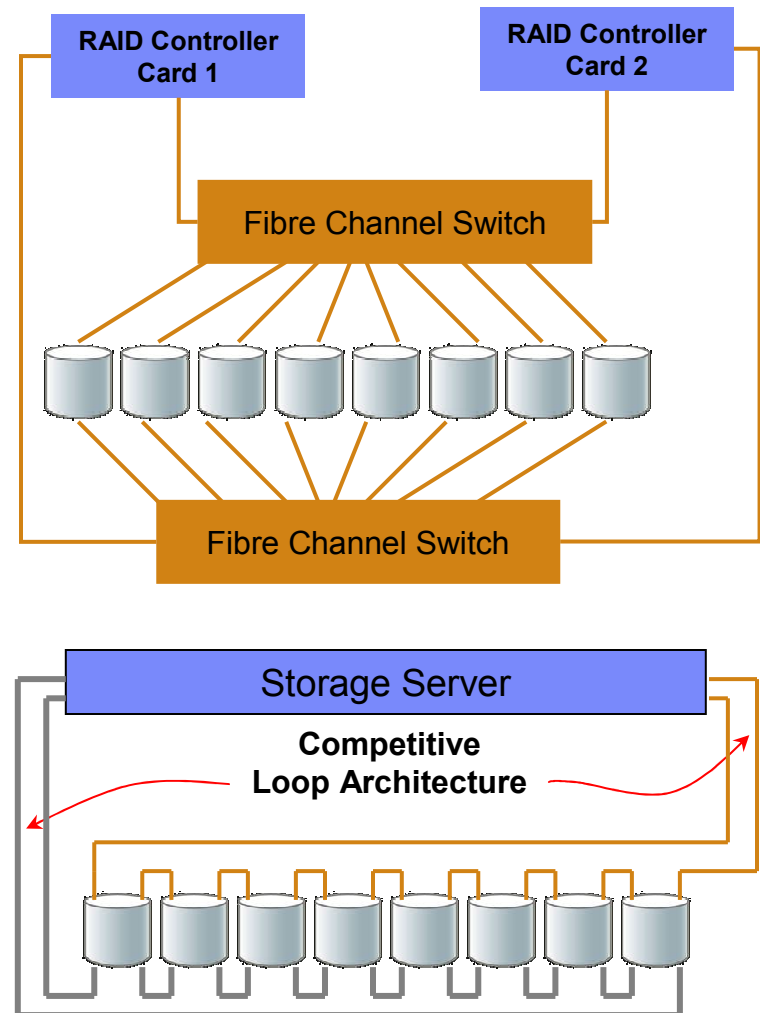

Four Data Paths To Every Disk

- **Multiple Storage Ports Connections**
 - ▶ RAID Controller Card has connections to each Fibre Channel switch
- **Fibre Channel Switches**
 - ▶ FC Switch 1
 - Connects RAID Controller 1 and 2 to Disk Port 1
 - ▶ FC switch 2
 - Connects RAID Controller 1 and 2 to Disk Port 2
- **Protects against single or multiple failures**
 - Cable
 - RAID Controller Card
 - Fibre Channel switch
 - Port
 - Or, combination of failures

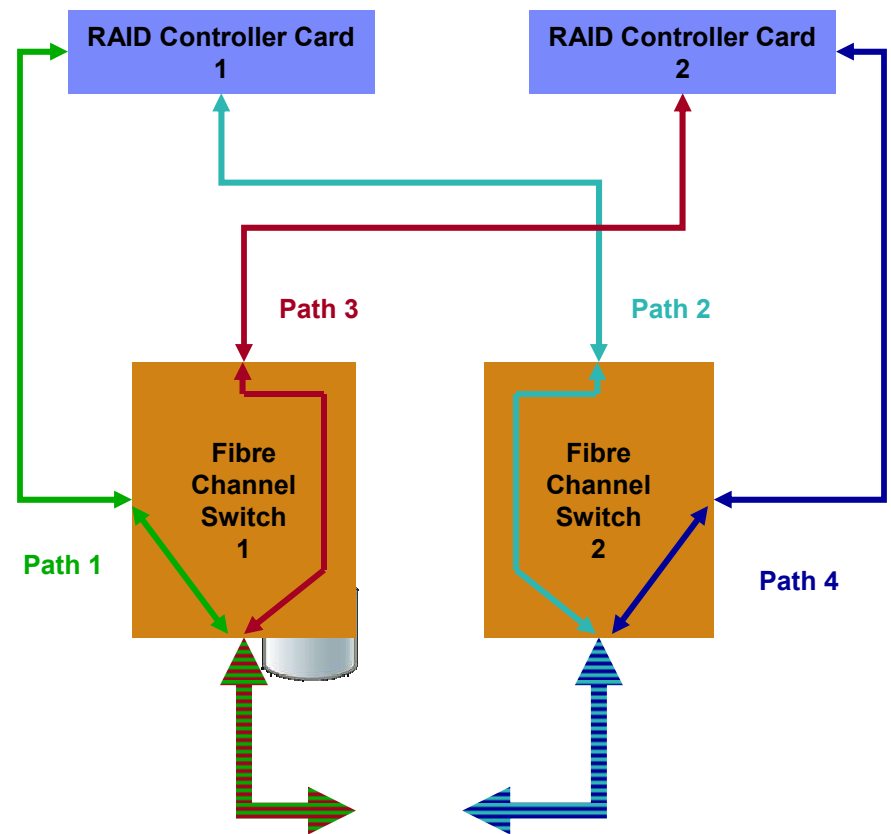

Preferred Path Data Operations

- **Chooses the most efficient and optimum path to store and retrieve data from the storage systems**
 - ▶ Beyond load balancing
 - ▶ Our system selects the best path at each stage of the request
- **Competitors – can do preferred path, but path is selected at time of initial request**
- **Preferred Path**
 - ▶ Dynamically selects the most efficient and optimum path to use at each data interchange during read and write operations
 - A level above load balancing used by competition

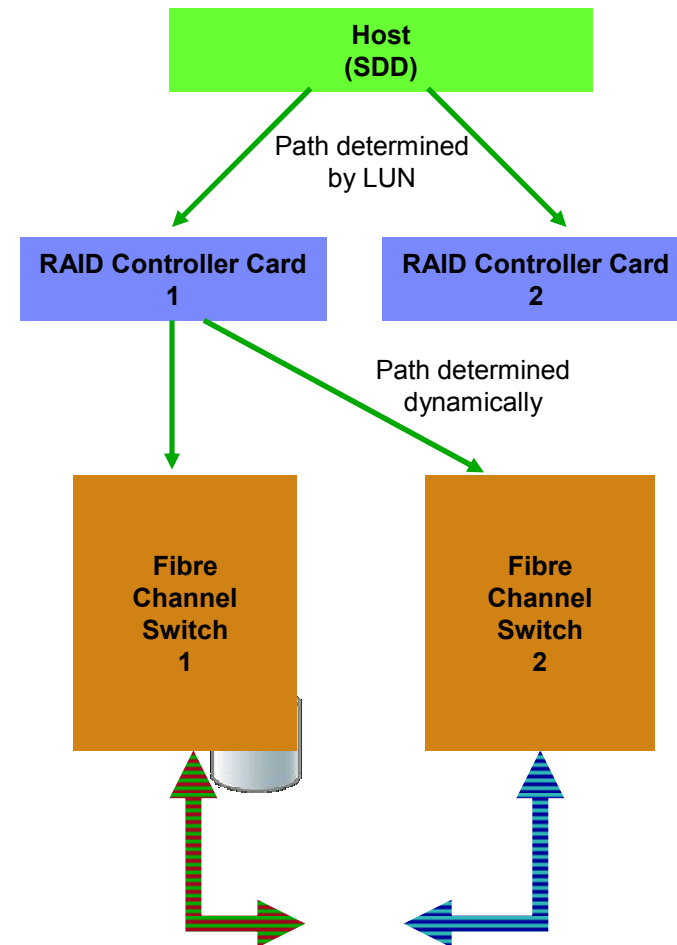

IBM Predictive Failure Analysis®

- **Monitors operations of system**
- **Takes pre-emptive and automatic actions before critical failures occur**
- **Disk responsiveness scenario**
 - ▶ **Disk is slow to respond**
 - **Policy based threshold is exceeded**
 - ▶ **Storage Server takes disk drive offline**
 - ▶ **Service alerts are invoked**
 - **Disk identified with Light Path indicators**
 - **Alert Message Popup on Management Server**
 - ▶ **Adopts global spare disk drive**
 - ▶ **RAID Array's data is reconstructed**

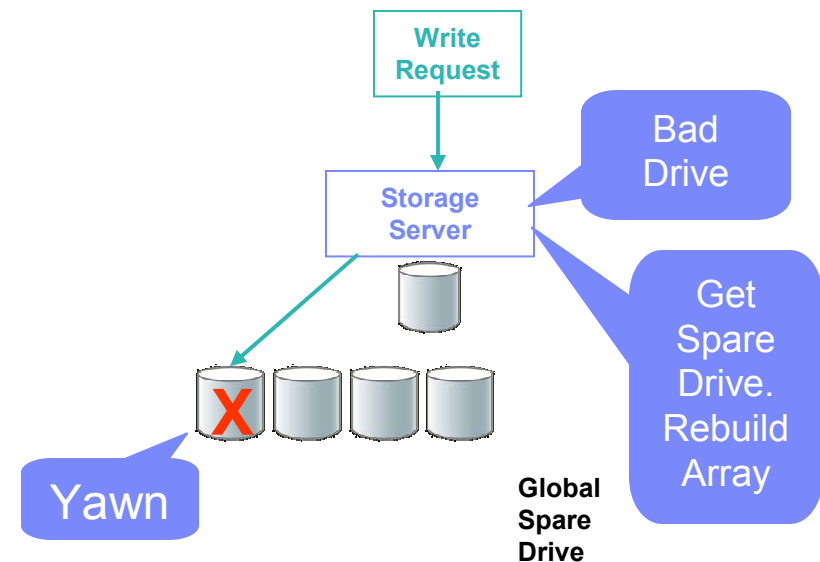

DS6800 Caching Algorithms

- **Over 20 years experience**
- **Simplified Adaptive Replacement Cache (SARC)**
 - ▶ **Self-Learning algorithms**
 - Adaptively and dynamically learn what data should be stored in Cache based upon the recent access and frequency needs of the Hosts
 - ▶ **Adaptive Replacement Cache**
 - Most advanced and sophisticated algorithms to determine what data in Cache is removed to accommodate newer data
 - ▶ **Pre-fetching**
 - Predictive algorithm to anticipate data prior to a host request and loads it into Cache
- **Benefits**
 - ▶ **Leading performance**
 - Improves cache hits by up to 100% over previous IBM caching algorithms and improve I/O response time by 25%
 - ▶ **More efficient use of Cache**
 - Intelligent caching algorithm profiles Host access patterns to determine what data is stored

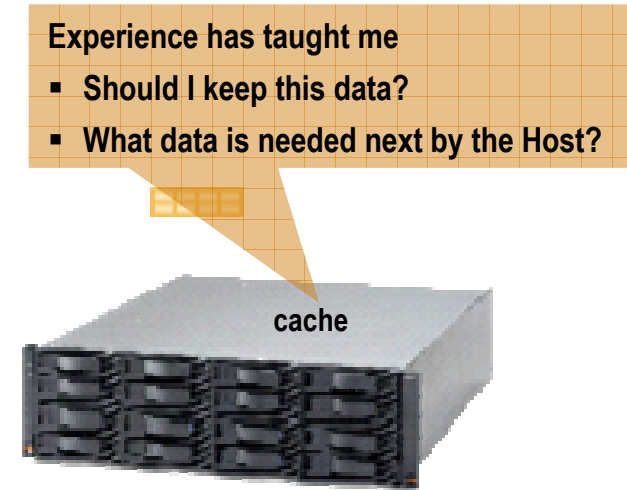

DS6800 Enterprise Interoperability

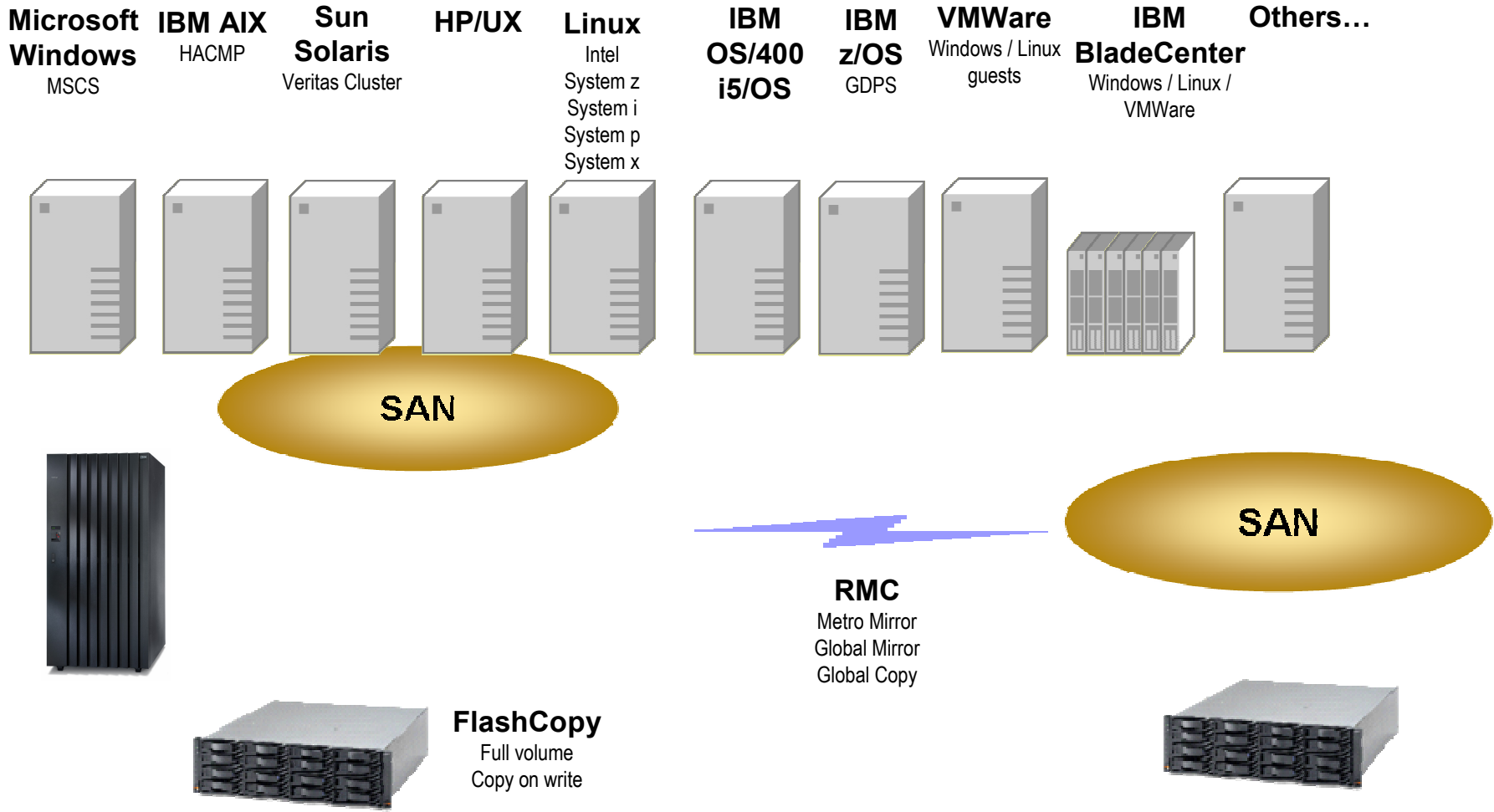



Enterprise-Class Warranty with Enterprise Choice

- **Enterprise-class warranty**
 - ▶ IBM installation included
 - ▶ 24x7, IBM on-site repair, same day response
 - ▶ Covers both hardware and software; parts and labor
 - ▶ Warranty terms and conditions as the like other IBM enterprise-class storage
 - IBM System Storage DS8000 and IBM TotalStorage Enterprise Storage Server
- **Enterprise Choice for length of service and support that's right for you**
 - ▶ 1 year, 2 years, 3 years, or 4 years
 - Extended warranty service options are available as a Machine Type Model on initial order
 - Normal maintenance contracts available at hardware purchase or at a later date

DS Storage Manager Interface



Physical summary: Real-time

Select a storage complex and storage unit to view the physical summary for the selected storage unit. You must select a component to view the log for that component. Click on the hyperlinked component name to view the general properties of the component. You can also print a report or download a formatted spreadsheet file of the summary table.

Storage complex: Storage unit:

Last refresh: Thursday, November 10, 2005 3:50:02 PM MST

Select ^	Component v	Battery backup unit ^	Disk drive module ^	Front display panel ^	Power Supply/Fan ^	Processor controller card ^	Rear display panel ^
<input type="radio"/>	Enclosure 11	<input checked="" type="checkbox"/> Normal	<input checked="" type="checkbox"/> Normal	<input checked="" type="checkbox"/> Normal	<input checked="" type="checkbox"/> Normal	<input checked="" type="checkbox"/> Normal	<input checked="" type="checkbox"/> Normal
<input type="radio"/>	Enclosure 10	<input checked="" type="checkbox"/> Normal	<input checked="" type="checkbox"/> Normal	<input checked="" type="checkbox"/> Normal	<input checked="" type="checkbox"/> Normal	<input checked="" type="checkbox"/> Normal	<input checked="" type="checkbox"/> Normal
<input type="radio"/>	Enclosure 0	<input checked="" type="checkbox"/> Normal	<input checked="" type="checkbox"/> Normal	<input checked="" type="checkbox"/> Normal	<input checked="" type="checkbox"/> Normal	<input checked="" type="checkbox"/> Normal	<input checked="" type="checkbox"/> Normal

Page 1 of 1 Total: 3 Filtered: 3 Displayed: 3 Selected: 0

- **Web Based Storage Management interface**
 - ▶ Common architecture with the DS8000 hardware management console
 - ▶ Common look and feel across multiple IBM System Storage management interfaces
- Monitor multiple systems, configure storage, view problems in in real time

DS6800 Advanced Copy Services

- **IBM FlashCopy®**
 - ▶ Point-in-time copying

- **Mirroring**
 - ▶ Metro Mirror (Synchronous PPRC)
 - ▶ Global Mirror (Asynchronous PPRC)
 - ▶ Global Copy (PPRC Extended Distance)
 - ▶ Global Mirror for System z (XRC)
 - DS6800 can be configured as and XRC target only

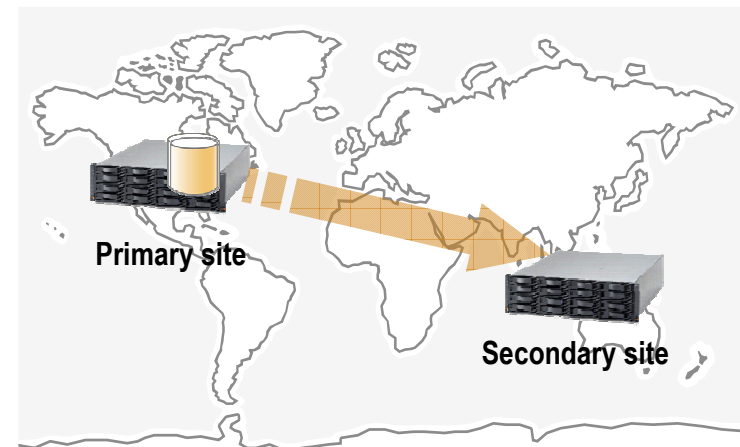
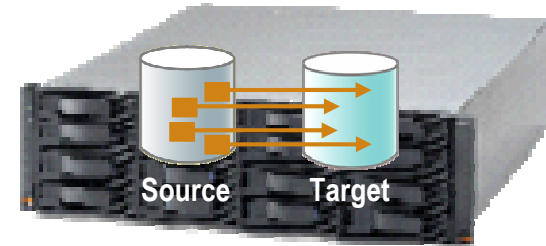

Potencia aprovechable



- ▶ Tecnología de servidor POWER 5+
 - Hasta 256GB de cache y nuevo algoritmo optimizado de cache ARC—Adaptive Replacement Cache
 - Posibilidad de crecimiento modelo a modelo
- ▶ Storage System LPARs
 - Pueden crearse subsistemas de almacenamiento virtuales para mejorar TCO y aprovechar la escalabilidad
 - Soporte de sistemas heterogéneos
- ▶ Administración eficiente, flexible y abierta
 - API abierta, compatible con SNIA SMI/S
 - GUI mejorada, más eficiente y basada en Web
- ▶ Funcionalidades de copia y mirroring
 - Servicios de copia interoperable entre DS8000, DS6000 y ESS Modelos 750/800

Introducing: IBM System Storage DS8000 Turbo Models

Faster, more scalable, lower cost



- **Faster than a speeding disk system for quick access to data**
 - ▶ **New Power5+ processor yields up to 15% performance improvement for transaction processing workloads over previous models**
 - ▶ **AIX/DB2 synergy items can enable greater efficiency and higher performance for high priority applications**
 - ▶ **4Gbps Fibre Channel/FICON® adapters support high-bandwidth host attachments**
- **More scalable to support massive amounts of information, greater consolidation and simplification**
 - ▶ **Up to 320 TB physical capacity with 500GB disk drives**
- **Able to leap to new levels of cost effectiveness**
 - ▶ **Lower base price on new Turbo base models**
 - ▶ **500GB FATA disk drives enable lower cost per GB for less frequently accessed near-line application needs**
 - ▶ **Use fewer host ports and network infrastructure with 4Gbps Fibre Channel/FICON® adapters**



IBM DS8000 Turbo 4Gb/s FC/FICON high-speed connectivity

New!!



Enables potential reduction in DS8000 host ports needed, helping to lower costs

Can help enable host adapter/channel and link consolidation to help simplify management and reduce the cost of the SAN infrastructure

Designed to offer up 50% improvement in single port MB/second throughput

Flexibility with both 2Gb/s and 4Gb/s FC/FICON® adapters – shortwave and longwave

IBM has a full range of Disk, SAN, Tape, Software, & Services ready to support 4Gb FC Connectivity

IBM is first vendor to offer 4Gbps FICON disk system connectivity

DS8000 Turbo Flexible Range of Disk Options

- Full range of FATA and Fibre Channel disk drive options
 - ▶ 500GB 7,200 RPM FATA drives – Near-line class
 - ▶ 73GB 15k RPM, 146GB 10k or 15k RPM, 300GB 10k or 15k RPM FC drives – Enterprise class
- 16-disk drive pack ordering of all drives, FATA and FC
 - ▶ All DS8000 disk drives are installed in disk drive sets that contains 16 identical disk drives (of the same capacity and rpm)
 - ▶ FC and FATA drives are both available in Capacity on Demand features
- Intermix enabled for FATA and FC disk sets
 - ▶ Intermix of different rpm/capacity FC and/or FATA disk sets
 - ▶ Supports intermix within a system and within a rack
 - ▶ Homogeneous FATA or FC systems are also supported – there is no need to configure FC drives if all FATA is desired
 - ▶ Intermix of FATA and FC drives in FlashCopy and mirroring relationships is supported

New!!

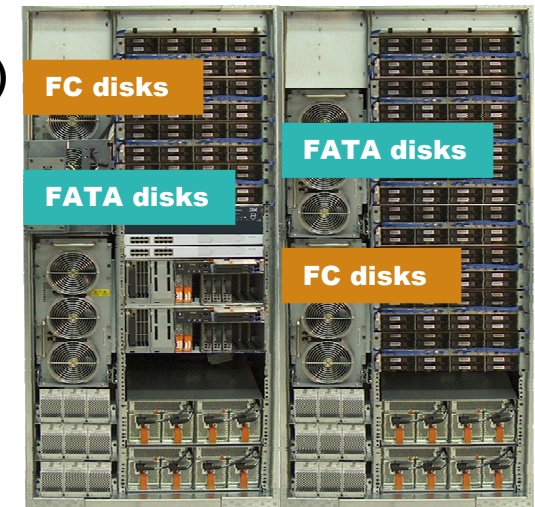

Leveraging and Extending IBM's Server-based Architecture

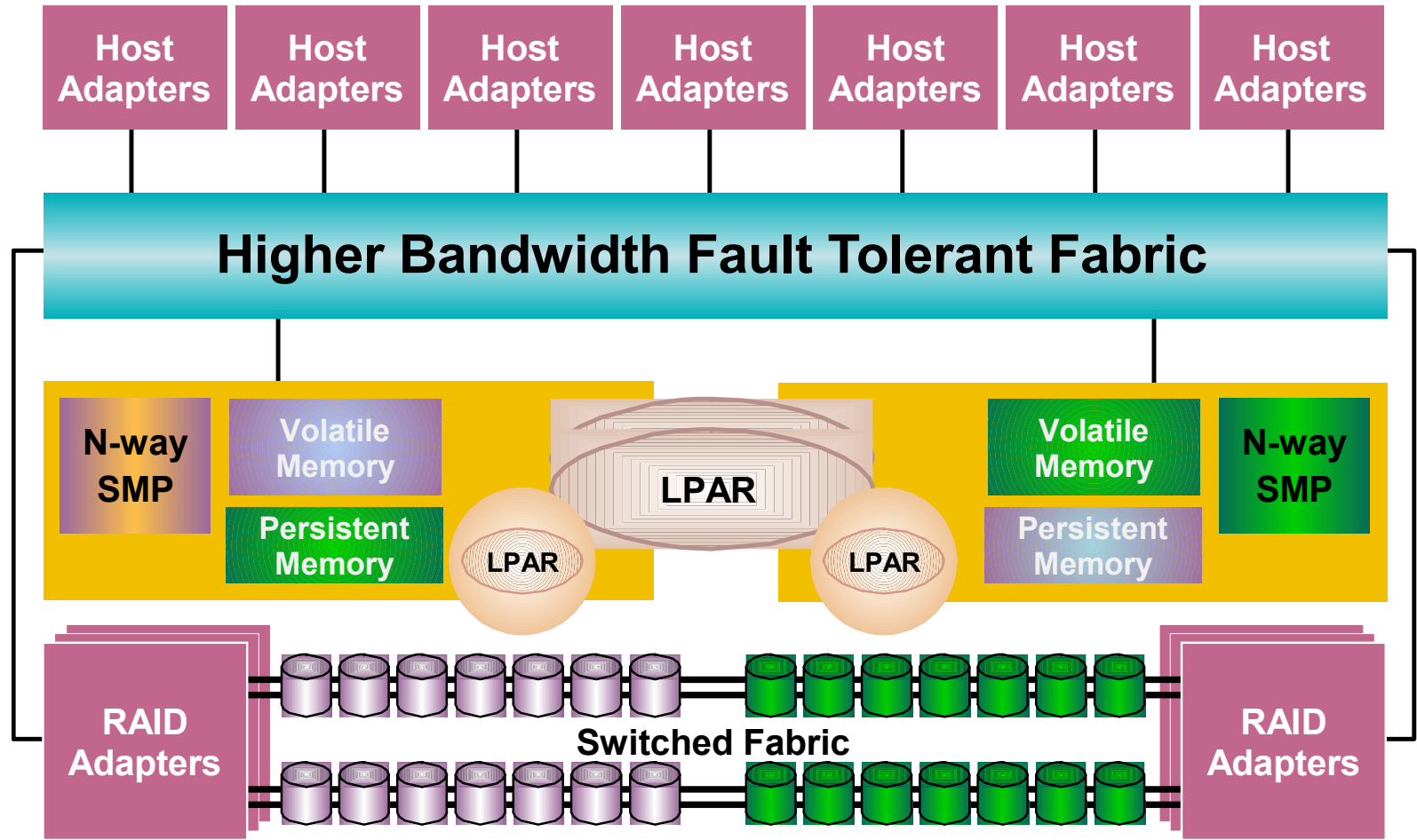

IBM System Storage DS8100 Turbo (2-Way)

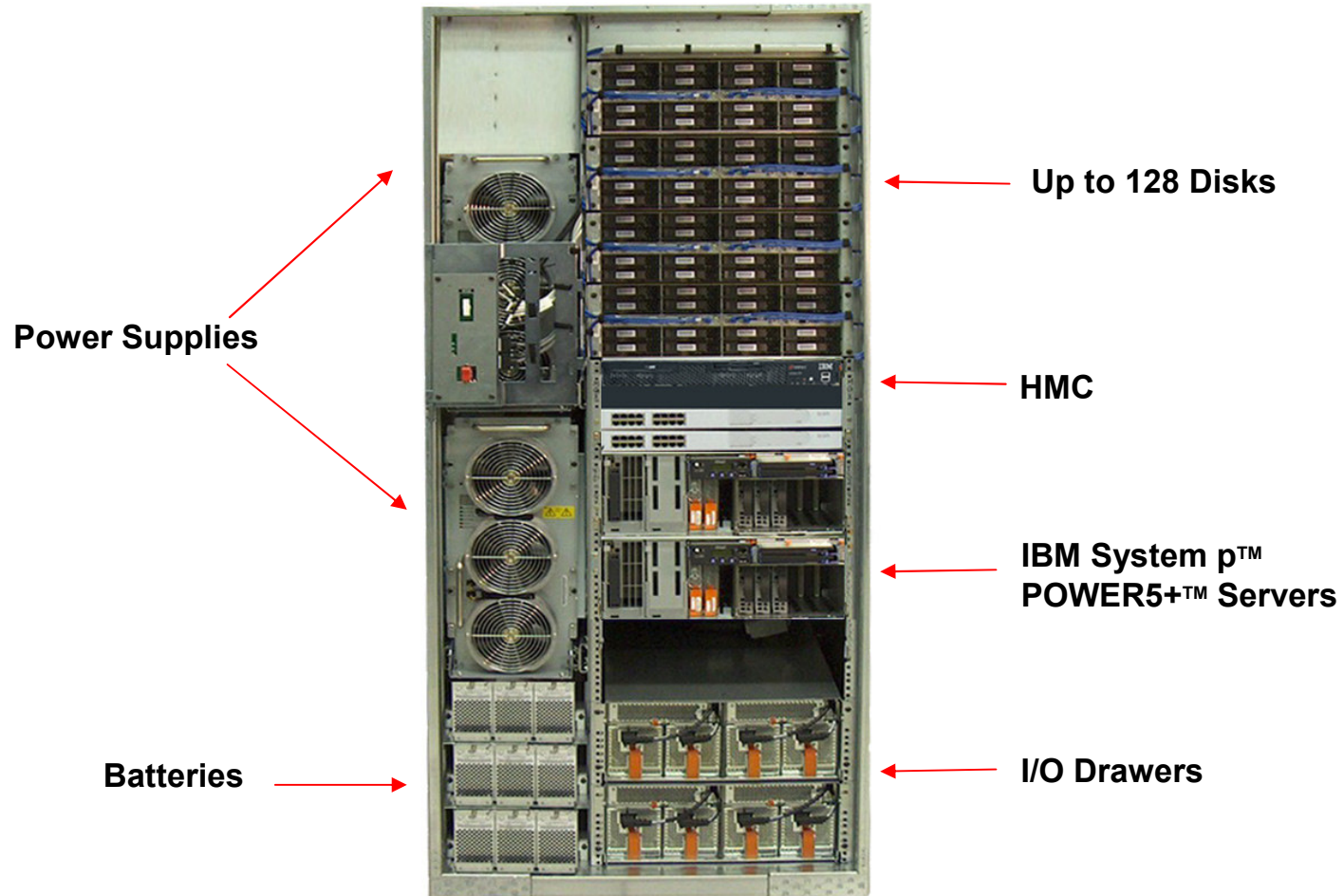

DS8300 Turbo (4-Way with two expansion frames)

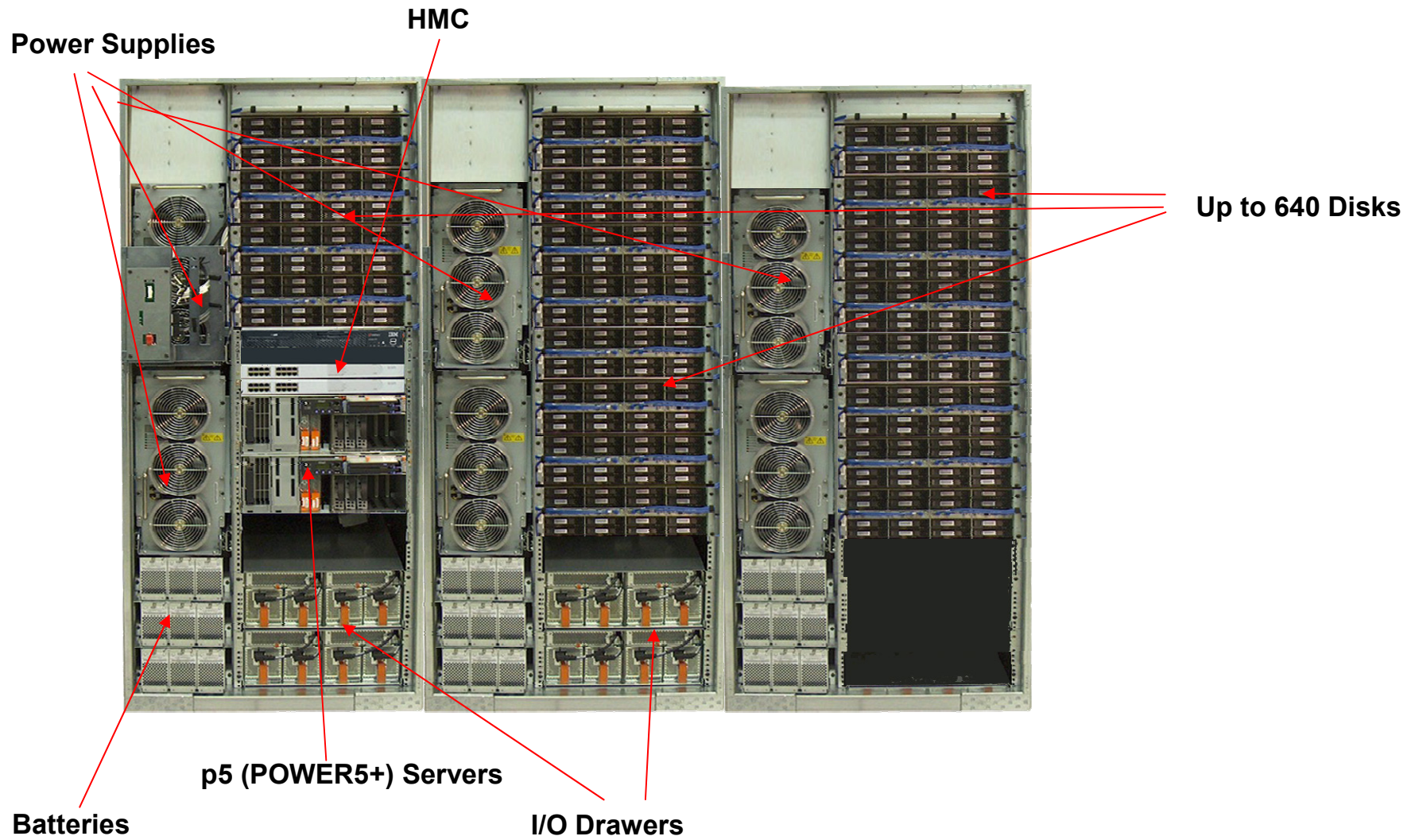

DS8000 Turbo Hardware Overview

	DS8100	DS8300	DS8300 with Two Expansions
Processor - pSeries POWER5	2-way	4-way	4-way
Cache	16 to 128 GB	32 to 256 GB	32 to 256 GB
Expansion Rack	Yes (1)	Yes (2)	-
Host Adapters - 4-port Fibre Channel / FICON (2 Gb) - 2-port ESCON	2 to 16	2 to 16	2 to 32
Device Adapters - Arrowhead	2 to 12	2 to 12	2 to 12
Drives - 73 GB or 145GB (15,000 rpm FC) - 146 GB or 300GB (10,000 rpm FC) - 500 GB (7200 rpm FATA)	16 to 128* (Increments of 16)	16 to 128 (Increments of 16)	16 to 640 (Increments of 16)
Physical Capacity	1.1 to 64 TB	1.1 to 64 TB	1.1 TB to 320 TB
Power	Three-Phase	Three-Phase	Three-Phase
Dimensions - Height x Width x Depth - Footprint	76 x 33.25 x 43 in 9.93 sq. ft.	76 x 33.25 x 43 in 9.93 sq. ft.	76 x 66.5 x 43 19.86 sq. ft.



DS8000 Hardware Overview

- **2-Way (DS8100 Models)**
 - ▶ **Two dual processor servers**
 - Up to 128GB Cache
 - ▶ **8 to 64 2Gb FC/FICON – 4 to 32 ESCON Ports**
 - ▶ **16 to 384 HDD**
 - Intermixable 73GB 15Krpm, 146/300GB 10Krpm
 - ▶ **Physical capacity from 1.1TB up to 115TB**

- **4-Way (DS8300 Models)**
 - ▶ **Two four processor servers**
 - Up to 256GB Cache
 - ▶ **8 to 128 2Gb FC/FICON – 4 to 64 ESCON Ports**
 - ▶ **16 to 640 HDD**
 - Intermixable 73GB 15Krpm, 146/300GB 10Krpm
 - ▶ **Physical capacity from 1.1TB up to 192TB**



IBM System Storage Resiliency Family

Core Data Replication Technologies for DS8000 Turbo

- FlashCopy – internal replication

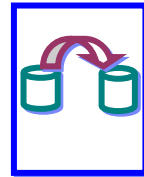

- Remote Mirroring – external replication

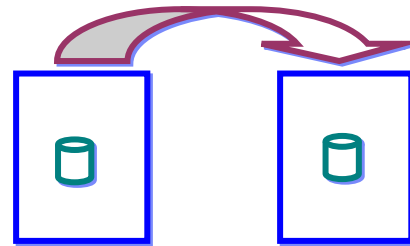

- ▶ *Metro Mirror (Synchronous protocol, remote site data currency, metro distance, consistency groups)*
- ▶ *Global Mirror (Asynchronous protocol, remote site near-data currency, unlimited distance, consistency groups)*
- ▶ *Global Copy (Asynchronous protocol, period point-in-time currency, unlimited distance)*
- ▶ *Metro/Global Mirror (3-site with A-to-B synchronous + B-to-C asynchronous)*
 - *Two site: AB-----C - periodic copy from A to B, unlimited distance*
 - *Three site: A---B-----C - current data at B is forwarded to C*
- ▶ *z/OS Global Mirror (optimized for z/OS, asynchronous protocol, remote site near-data currency, unlimited distance - XRC)*
- ▶ *z/OS Metro/Global Mirror (three site solution using Metro Mirror + zSeries Global Mirror)*

Modular Packaging

Up to 640 HDDs

Up to 576 HDDs

Up to 384 HDDs



76"

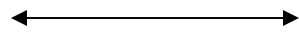

33"

DS8000 Turbo

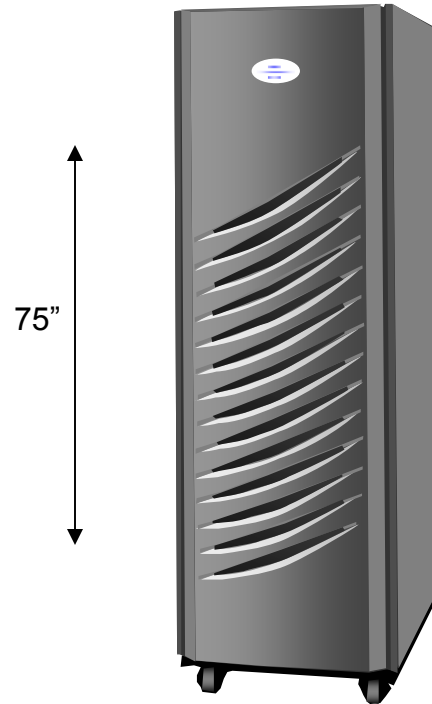

75"

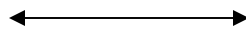

24.1"

DMX



75.25"

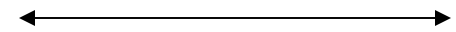

54.5"

ESS 800

DS8000 Turbo Enterprise Interoperability – Enabling Consolidation

