



# z/OS Network update

Comm Server 1.9

Large Systems Update 2007



[olle.zetterlund@se.ibm.com](mailto:olle.zetterlund@se.ibm.com)

# AGENDA

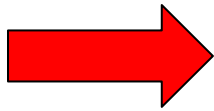

- OSA express enhancements
  - ***Virtual MAC Address***
  - ***Dynamic LAN timer***
  - ***Network traffic analyzer***
- Policy Enhancements
- Security enhancements
- Sysplex Enhancements
- Application enhancements
- Management
- EE/SNA enhancements

## Background Information Sharing of OSA-Express Features

- Allows many stacks, in different LPARs, to share bandwidth
- Even more important with high bandwidth adapters (10 gig, etc)
- Accomplished by registering IP addresses, sharing "burned in" MAC
- One stack may be PRIROUTER for unknown packets

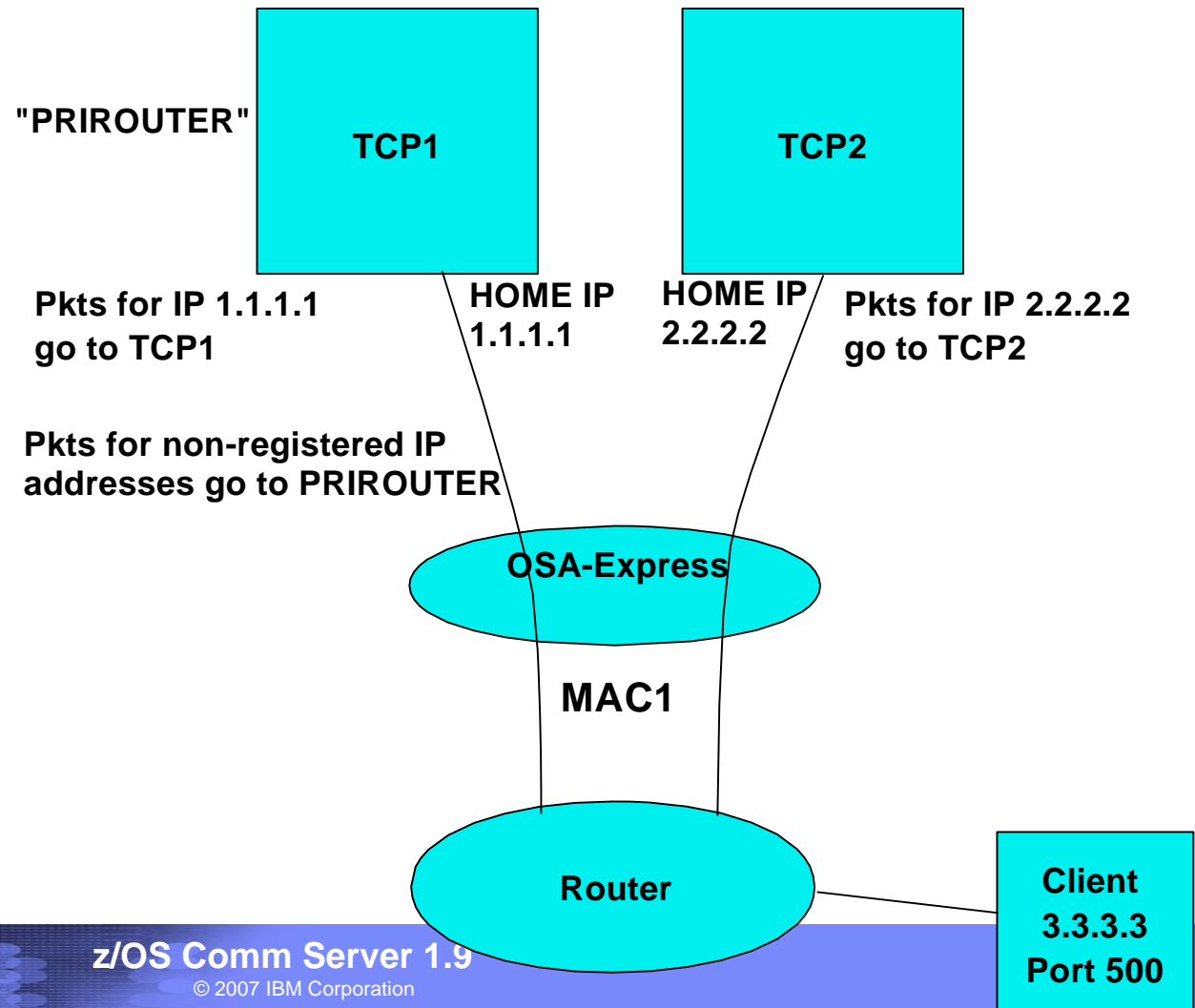

## Sharing Problems

---

- **Sharing can fail in Load Balancing solutions**
  - **Cisco MNLB**
  - **z/OS Load Balancing Advisor**
  - **Workaround is to use GRE or NAT**
    - **negative effect on performance**
    - **IPV6 not supported**
- **Only one routing stack possible**

## Solution: OSA-Express **virtual MAC address**

---

- **Problems are solved if each stack has its own MAC**
  - "virtual" MAC
  - To the network, each stack appears to have a dedicated OSA
- **All IP addresses for a stack advertised with virtual MAC**
  - by OSA using ARP for IPv4
  - by the stack using Neighbor Discovery (ND) for IPv6
- **All external routers now forward packets to virtual MAC**
  - OSA will route by virtual MAC instead of IP address
  - All stacks can be "routing" stacks instead of 1 PRIROUTER stack
- **Simplifies configuration greatly**
  - No PRIROUTER/SECROUTER!

## OSA-Express **virtual MAC** rules

---

- Each stack may define one VMAC per protocol (IPv4 or IPv6) for each OSA
  - One VMAC for the LINK statement
  - One VMAC for the INTERFACE statement
- VMAC routing is mutually exclusive with PRIROUTER/SECROUTER routing
  - If a VMAC is defined
    - This stack will not receive any packets destined to the physical MAC
  - If VMAC is not defined
    - This stack will not receive any packets destined for a VMAC
    - Even if this stack is PRIROUTER!
- VLAN ids apply to VMACs like physical MACs

## Dynamic LAN Timer Background Information

---

- OSA supports an inbound “blocking” function over the QDIO interface.
  - Affects how long OSA will hold packets before “presenting” those packets to the host.
  - Indirectly affects how frequent the host will be interrupted, and the payload per interrupt.
- For an OSA Express in QDIO mode device the TCP/IP profile INBPERF parameter can be specified with one of the following options:
  - **MINCPU** - a static interrupt-timing value, selected to minimize host interrupts without regard to throughput
  - **MINLATENCY** - a static interrupt-timing value, selected to minimize latency
  - **BALANCED** (default) - a static interrupt-timing value, selected to achieve reasonably high throughput and reasonably low CPU

## LAN idle timer Problem/solution

- **Problem:** LAN idle timer settings contributes to nw latency on zSeries
  - Even when the INBPERF parameter is specified with a value of MINLATENCY the permitted *inter-packet gap is set to 20 microseconds*
  - LAN idle timer settings are *static* and can not be changed unless the connection to OSA connection is terminated and reestablished.
- **Solution**
  - Dynamically tune the LAN Idle timer values to reflect current workload characteristics
  - Allow for the minimum latency when a light interactive workload is determined
  - The inter-packet gap time can now be reduced as small as a microsecond



## Dynamic LAN Timer configuration

- New **DYNAMIC** option for the existing **INBPERF** parameter.
  - INBPERF parameter can be specified on the OSA-Express QDIO LINK or INTERFACE statement.
  - New option is valid for OSA-Express2 on an IBM System z9 EC or z9 BC with the corresponding Dynamic LAN Idle functional support
  - When specified for an OSA-Express device that does not support this new function then the option of **BALANCED** will be used for INBPERF parameter.

# QDIO problem Diagnosis traces in different places

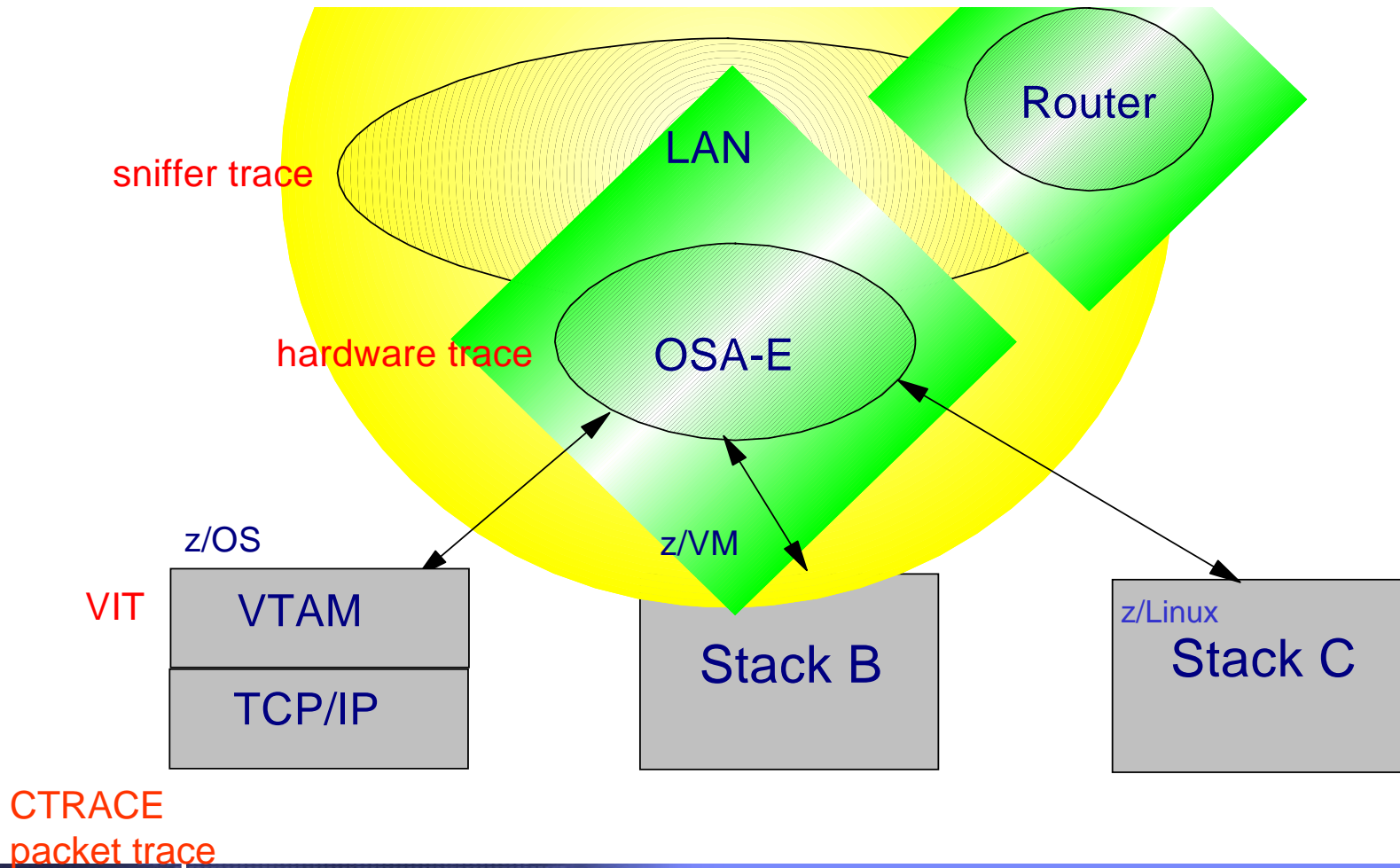

CTRACE  
packet trace

## **Solution: Network Traffic Analyzer**

---

- **Supported on OSA-Express2 GA3 (in QDIO mode) on z9-109.**
  - **Refer to the 2094DEVICE Preventive Service Planning (PSP) and the 2096DEVICE Preventive Service Planning (PSP) buckets for the level of the OSA-Express2 LIC.**
- **Allows z/OS Comm Server to collect Ethernet data frames from OSA**
  - **Not a sniffer trace (but similar in some aspects)**
  - **No promiscuous mode**
- **Minimizes the need to collect and coordinate multiple traces for diagnosis**
- **Minimizes the need for traces from the OSA Hardware Management Console (HMC)**

## Network Traffic Analyzer

---

- **Controlled by z/OS Comm Server**
  - **New OSAENTA command**
    - **Define trace filters and parameters**
    - **OSA sends trace records to the z/OS stack**
  - **Save and format the data using existing Ctrace facilities**
- **Collected by OSA**
  - **Ability to see:**
    - **ARP packets**
    - **MAC headers (including VLAN tags)**
    - **Packets to/from other stacks shared by the OSA (which could be z/VM or z/Linux)**
    - **SNA packets**

# Network Traffic Analyzer

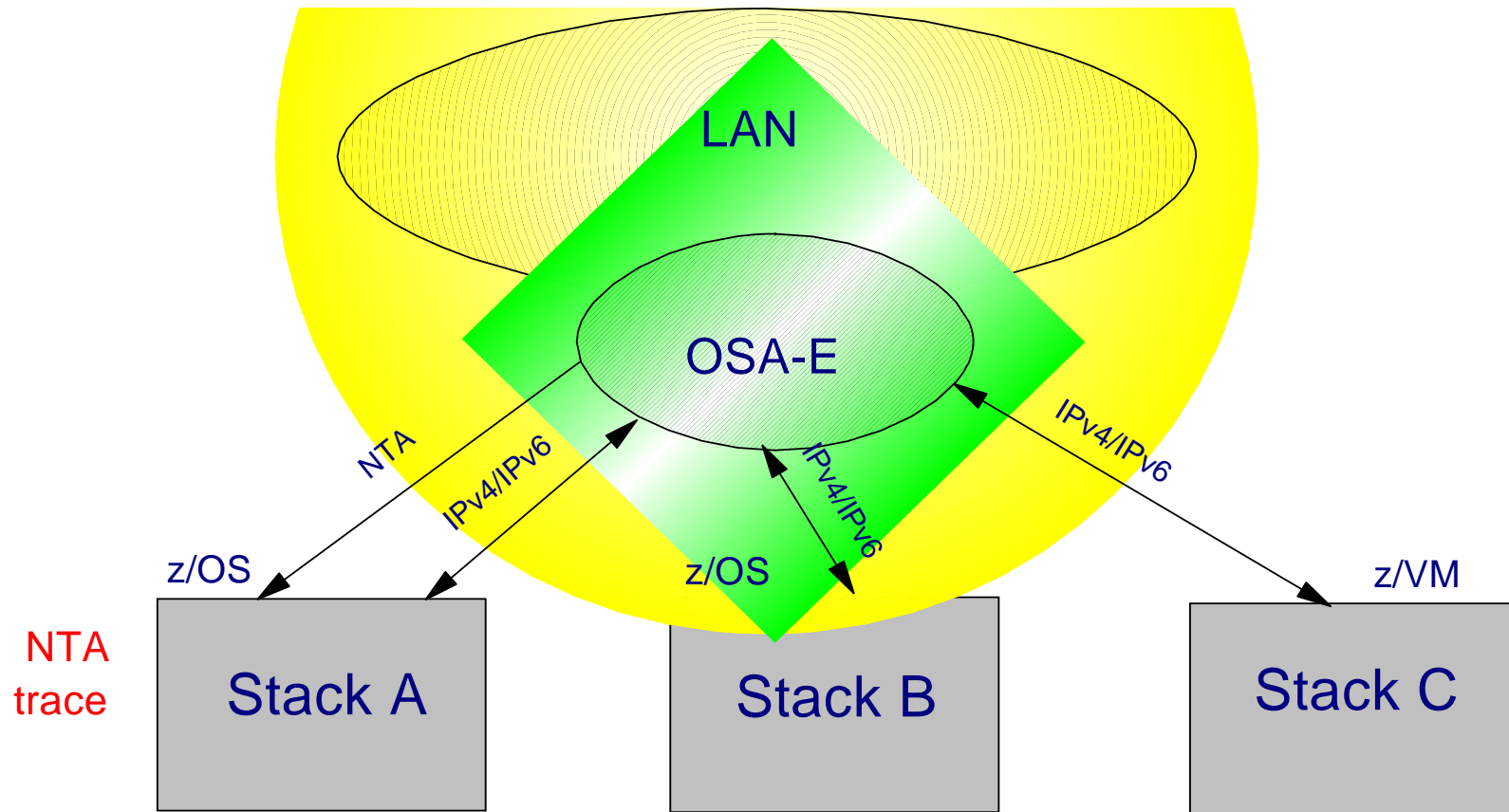

# AGENDA

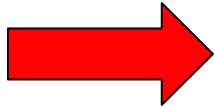

- OSA express enhancements
- Policy Enhancements
  - **Policy Based Routing**
  - **Central Policy Server**
  - **New Config Assistant**
- Security enhancements
- Sysplex Enhancements
- Application enhancements
- Management
- EE/SNA enhancements

## Policy-based routing

### □ What is Policy Based Routing (PBR)?

- Choose first hop router and outbound network interface
- Choice can be based on more than the usual destination IP address/subnet

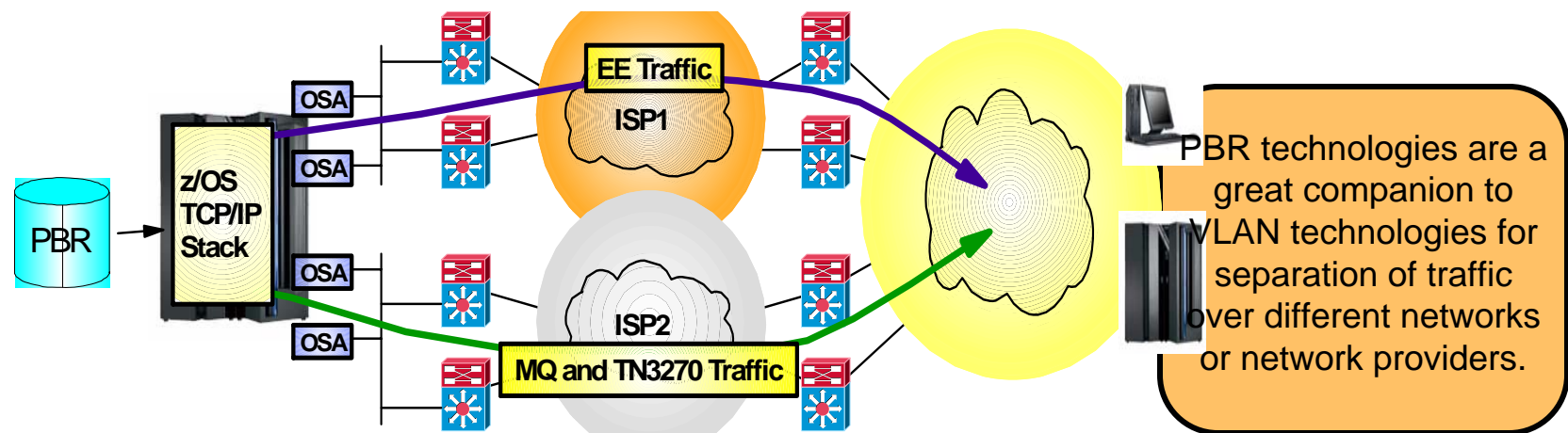

## Overview

# Policy-based routing

### ❑ Problem Statement / Need Addressed:

- Routing decision, within the TCP/IP stack, does not take into consideration the type of application, source IP address and other criteria
- A single metric is used to decide which route to use when sending packets
  - ✓ The shortest path (or a static route) for a destination IP address

### ❑ Solution:

- Policy-based routing (PBR) which enables routing decision that takes into account other criteria in addition to destination IP address.
  - ✓ Source and destination ports
  - ✓ Protocol (TCP or UDP)
  - ✓ Source and destination IP addresses
  - ✓ Job name
  - ✓ Security zones and security labels

### ❑ Benefit:

- Policy can be used to select networks with different capabilities for different applications
- Policy can be used to ensure that secure traffic is routed to a secured network via an appropriate outbound interface.



## Usage & Invocation

# Policy-based routing

- ❑ Policy-based routing (PBR) is configured in a policy agent flat-file
  - No LDAP file support for PBR
  - Centralized policy support for PBR
  
- ❑ IBM Configuration Assistant for z/OS Communications Server (Configuration Assistant)
  - Can be used to generate PBR policy statements

## Overview

# Centralized Policy Services

### ❑ Problem Statement / Need Addressed:

- The scope of Policy Agent policies continues to widen, with new policy types added over the last several releases
- Local management of policies is therefore becoming a larger administrative burden

### ❑ Solution:

- Use the Policy Agent as a centralized policy repository

### ❑ Benefit:

- Centralized administration and management of policy definitions
- The IBM Configuration Assistant only needs connectivity to the policy server, if no local policies are defined on the policy clients.

# Centralized Policy Services

➤ There is one Policy Agent per LPAR.

▶ This one Policy Agent supports all stacks that run in that LPAR.

**/etc/pagent.conf**

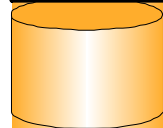

```
.....
CommonIPSecConfig /etc/policies/common/IPSec
CommonTTLSSConfig /etc/policies/common/TTLs
CommonIDSConfig /etc/policies/common/IDS
CommonPBRConfig /etc/policies/common/PBR
.....
TcpImage TCPCS /etc/tcps.image
TcpImage TCPCS2 /etc/tcps2.image
.....
```

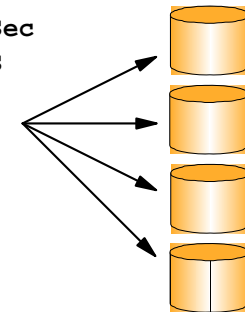

Policies that are shared by all the stacks in the LPAR

**/etc/tcps.image**

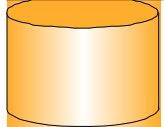

```
.....
IpSecConfig /etc/image/tcps/IPSec
TTLSSConfig /etc/image/tcps/TTLs
QoSConfig /etc/image/tcps/QoS
IDSConfig /etc/image/tcps/IDS
PBRConfig /etc/image/tcps/PBR
.....
```

**/etc/tcps2.image**

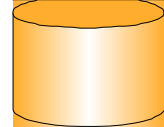

```
.....
IpSecConfig /etc/image/tcps2/IPSec
TTLSSConfig /etc/image/tcps2/TTLs
QoSConfig /etc/image/tcps2/QoS
IDSConfig /etc/image/tcps2/IDS
PBRConfig /etc/image/tcps2/PBR
.....
```

**/etc/image/tcps/TTLs**

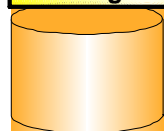

```
.....
TTLRule ..
.....
```

**/etc/image/tcps/IPSec**

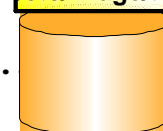

```
.....
IpFilterRule..
.....
```

**/etc/image/tcps/QoS**



```
.....
PolicyRule .
.....
```

**/etc/image/tcps/IDS**

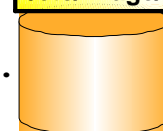

```
.....
IDSRule ...
.....
```

**/etc/image/tcps/PBR**

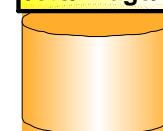

# Centralized Policy Services

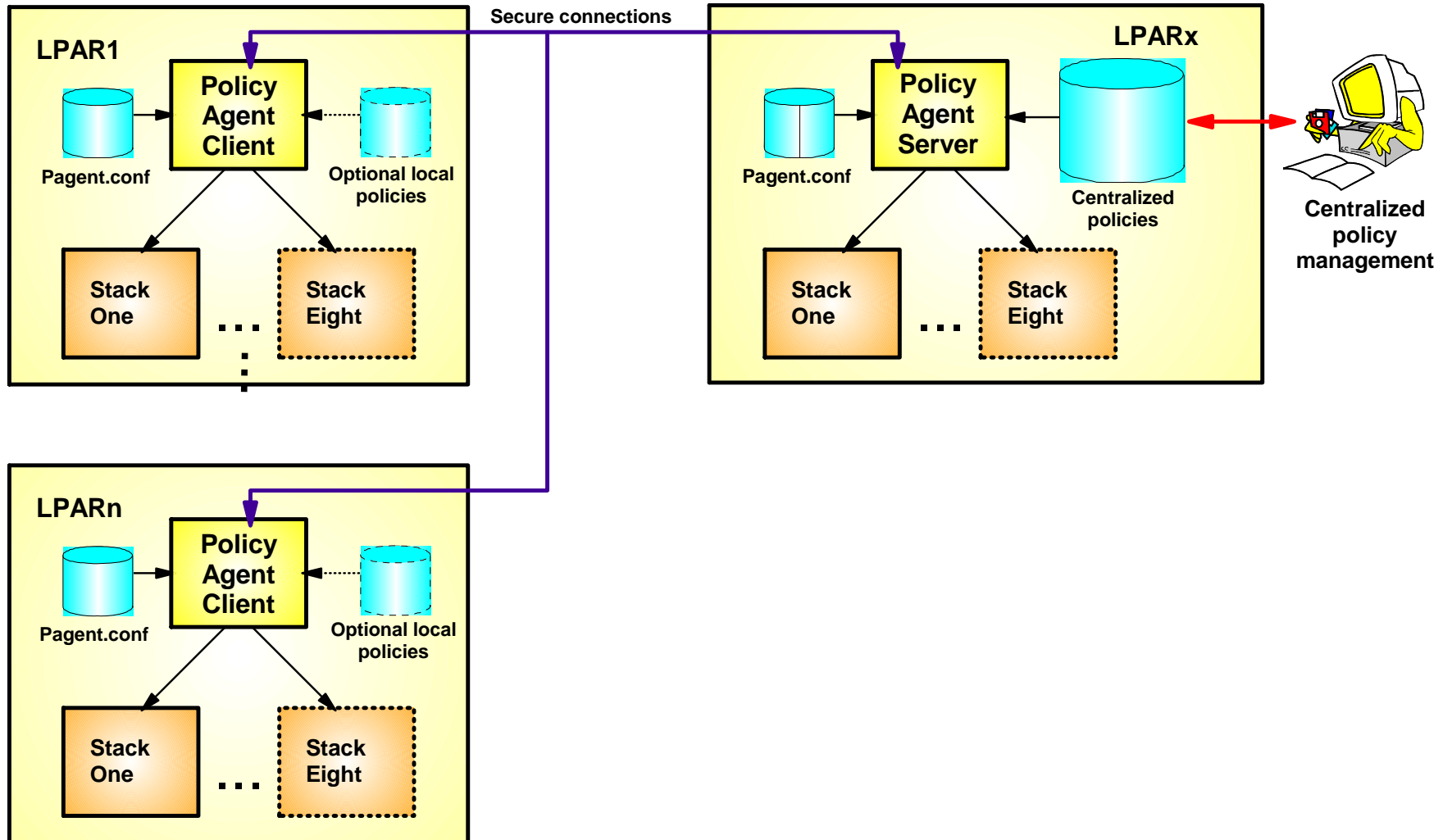

# IBM Configuration Assistant for z/OS Communications Server

- The new look is centered around the images and stacks to be configured

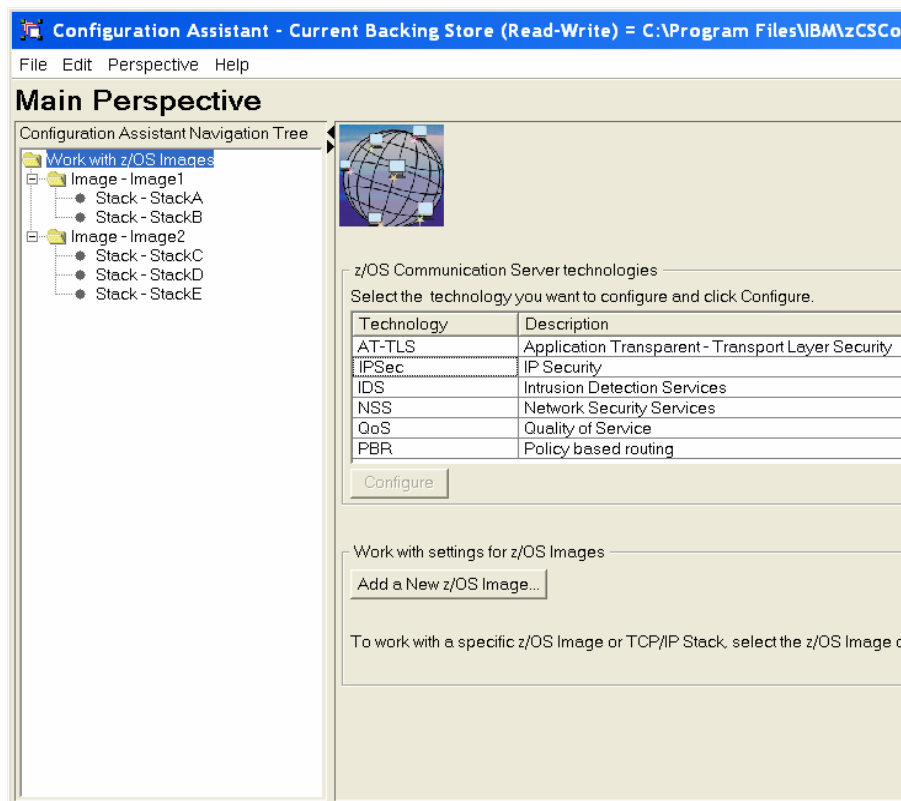

## V1R9 Configuration Assistant Enhancements

- Policy Based Routing (PBR)
- Network Security Services (NSS)
- Change to IPSec Perfect Forward Secrecy specification
- Image/Stack orientation across multiple technologies
- Protect multi-user edits of the same backing store
- Import and combine V1R7/R8/R9 backing store data
- Maintain configuration history for audit / tracking
- Maintain delivery (FTP) history for audit / tracking
- Support Active and Passive mode FTP
- Sort table data
- Enable/Disable of connectivity rules
- Continue extensive tutorials
- Improved diagnostics including log levels and a detailed FTP log

# AGENDA

- OSA express enhancements
- Policy Enhancements
- Security enhancements
  - ***AT-TLS enhancements***
  - ***enable TN3270/FTP to AT-TLS***
  - ***IPSec NMI***
  - ***IPSec NSS***
- Sysplex Enhancements
- Application enhancements
- Management
- EE/SNA enhancements



# AT-TLS Application Enhancements

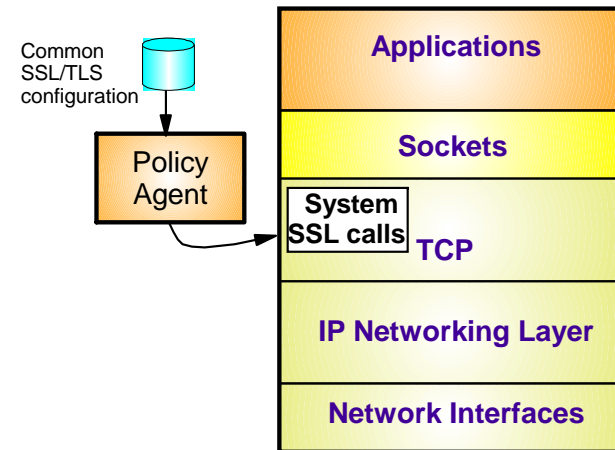
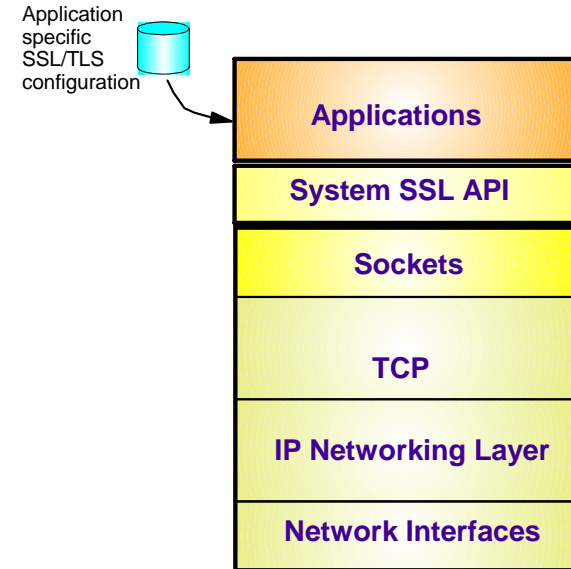

## Enable AT-TLS for FTP and TN3270

### ❑ Problem Statement / Need Addressed:

- FTP's and TN3270's SSL implementation do not exploit all the functions of System SSL

### ❑ Solution:

- The FTP client and server and TN3270 server can now be configured to use AT-TLS to support SSL/TLS connections.
  - ✓ FTP: **TLSMECHANISM ATTLS**
  - ✓ TN3270: **TTLSPORT nnnnn**

### ❑ Benefit:

- More System SSL functions available to the FTP and TN3270



# AT-TLS enabling the TN3270E Telnet server and the FTP client and server

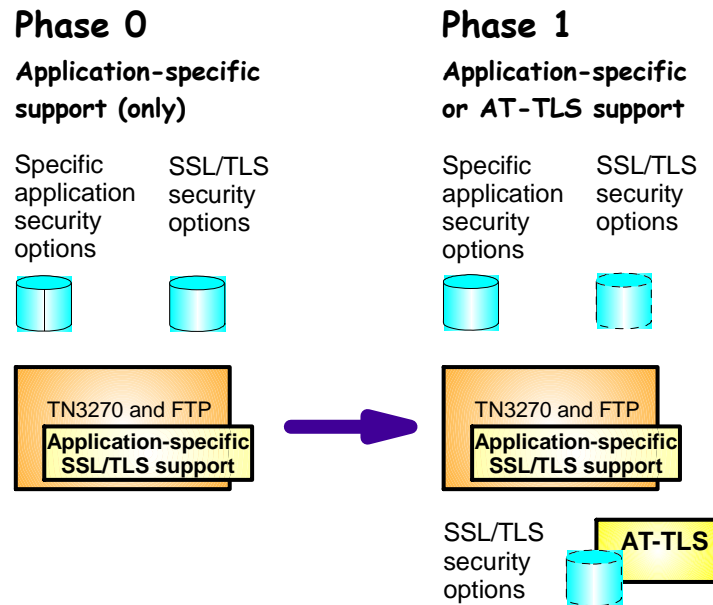

# IPSec Network Management Interface support

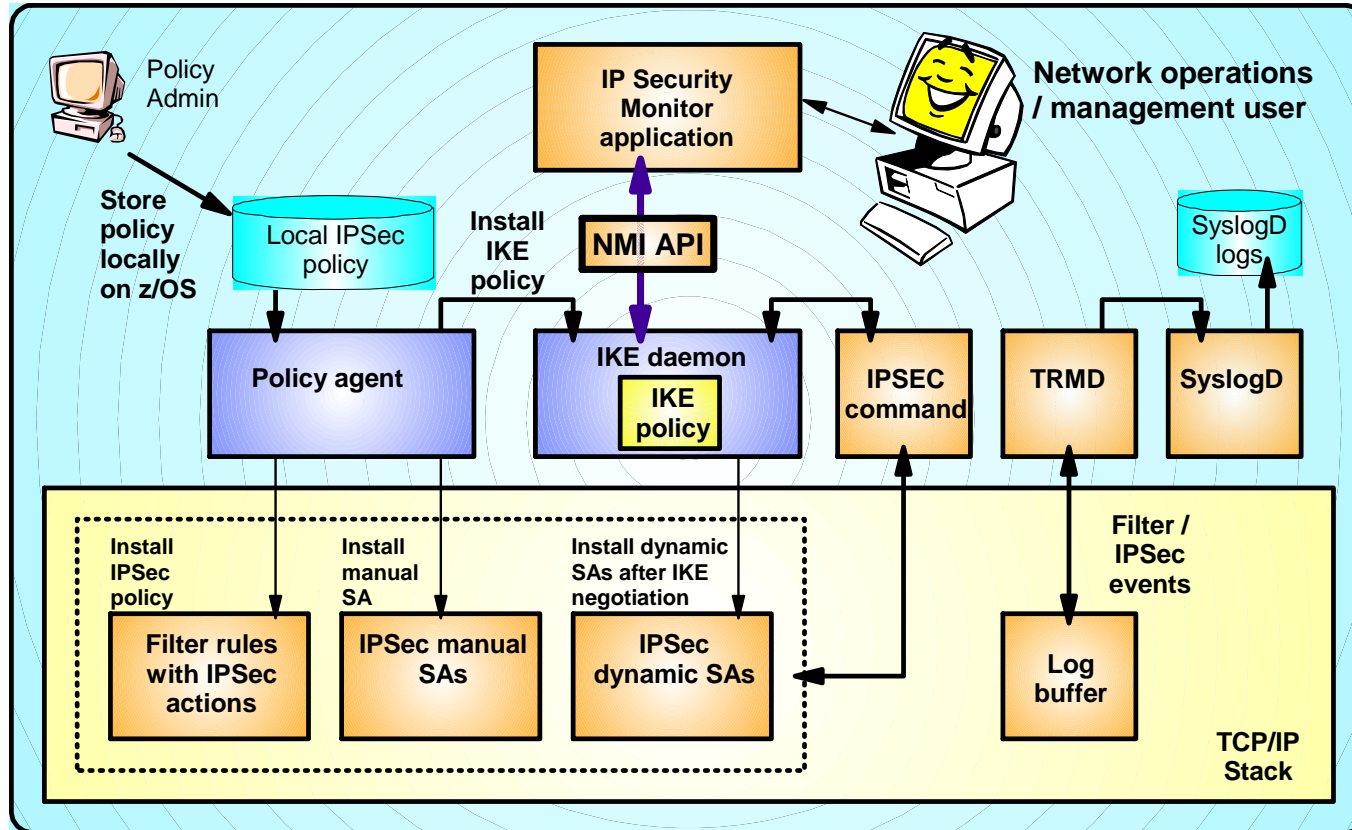

## Overview

# IPSec Network Security Services

### ❑ Problem Statement / Need Addressed:

- Storing sensitive data like private keys in less trusted zones can create security vulnerabilities
- Administration of certificates across many security endpoints can be cumbersome and error-prone

### ❑ Solution:

- Provide centralized certificate services, monitoring and management for IPSec

### ❑ Benefit:

- Centralize and reduce configuration and deployment complexity
- Enables monitoring and management of remote IPSec endpoints

# IPsec Network Security Services (NSS)

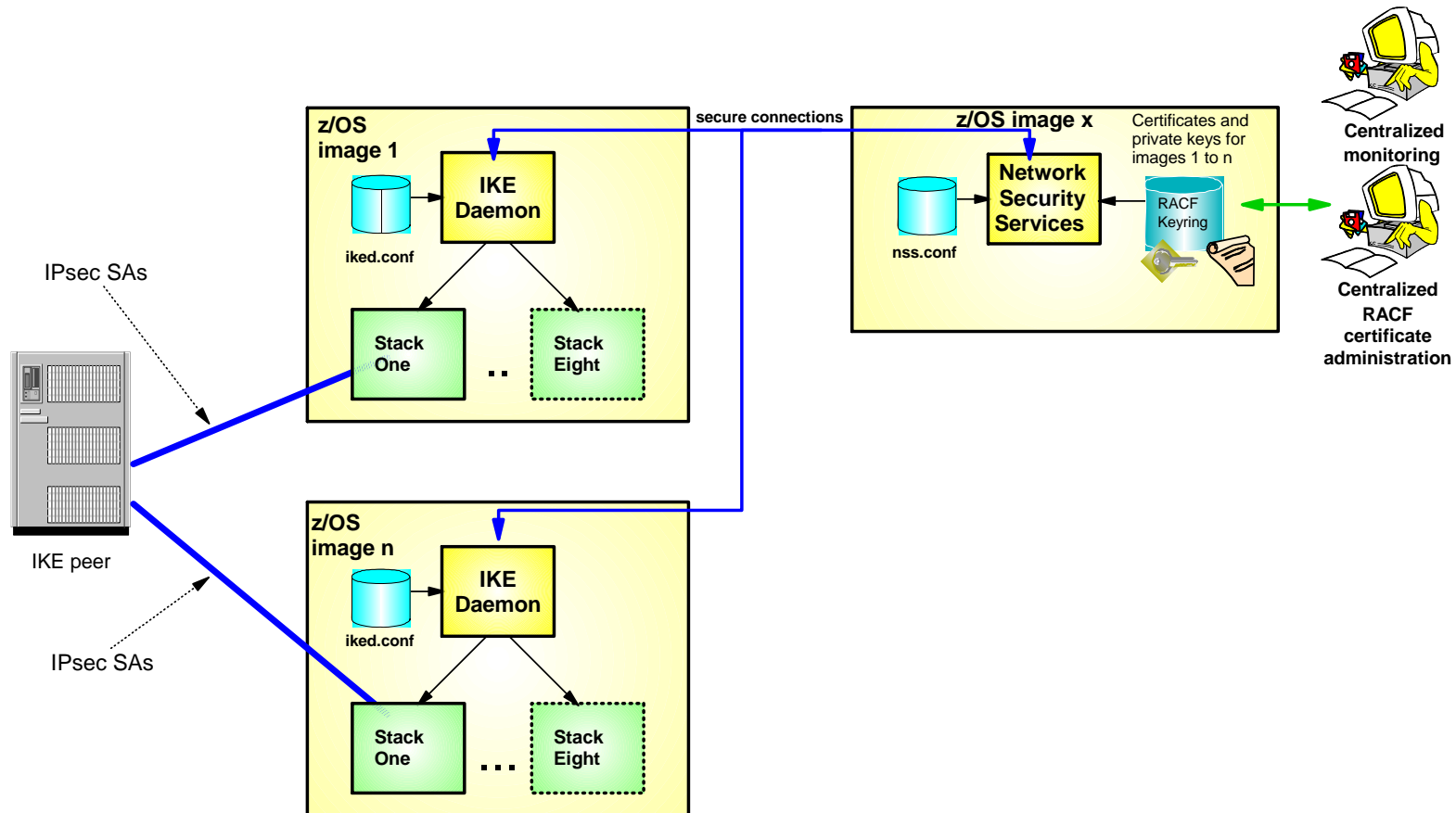

# AGENDA

- OSA express enhancements
- Policy Enhancements
- Security enhancements
- Sysplex Enhancements
  - **Source IP enhancements**
  - **DVIPA usability enhancements**
  - **V TCPIP,,SYSPLEX**
- Application enhancements
- Management
- EE/SNA enhancements

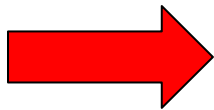

# Source IP (SRCIP) Enhancements

SRCIP			
Jobname	CUSTAJOB	9.85.112.1	
Jobname	CUSTBJOB	9.85.113.1	
Jobname	User1*	888:555::222	
DESTIP		10.1.1.0/24	9.85.114.1
DESTIP		10.1.2.0/24	9.85.115.1
ENDSRCIP			

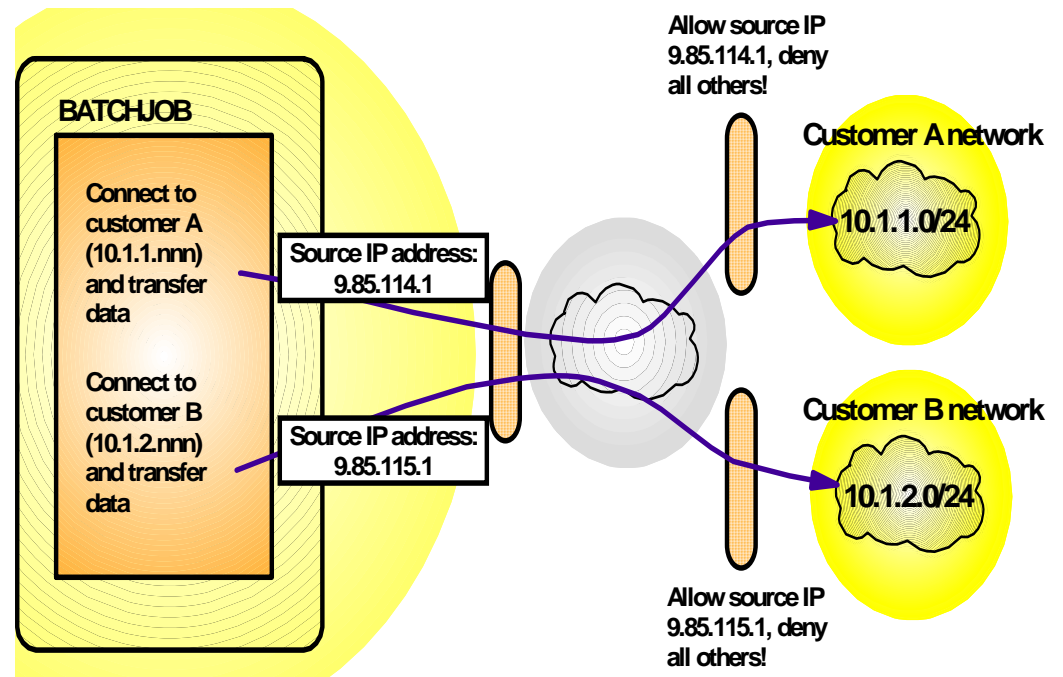

## Source IP (SRCIP) Enhancements

### ❑ Problem Statement / Need Addressed:

- Source IP address on DESTINATION rule in SRCIP block cannot be a distributed DVIPA
  - ✓ Source ports allocated for connections are not guaranteed to be unique across the sysplex

### ❑ Solution:

- Allow a distributed DVIPA as the source IP address
  - ✓ Establish a pool of sysplex-wide unique ports

### ❑ Benefit:

- SRCIP support based on destination IP address is more functional

## Overview

# Dynamic VIPA usability enhancements

### ❑ Problem Statement / Need Addressed:

- Servers started from AUTOLOG, binding to a DVIPA fail initialization when DELAYJOIN is coded
- Port range not allowed for VIPADISTRIBUTE ports
  - ✓ Ports have to be listed one at a time

### ❑ Solution:

- Delay the starting of procedures that bind to a dynamic VIPA
  - ✓ Started after TCP/IP has joined the sysplex and created DVIPAs
- Allow a range of ports to be configured on VIPADISTRIBUTE statement

### ❑ Benefit:

- Customers can configure GLOBALCONFIG DELAYJOIN and specify servers that are to be automatically started in the AUTOLOG block
- Customers can configure a range of port numbers on the VIPADISTRIBUTE PORT statement



## Usage & Invocation

# Dynamic VIPA usability enhancements

- ❑ The AUTOLOG support is enabled by:
  - Coding a new optional parameter, DELAYSTART on the AUTOLOG statement.
  
- ❑ The VIPADISTRIBUTE port range support is enabled by coding a range of ports on the statement
  - `VIPADISTRIBUTE 203.1.1.94 PORT 3006 3008-3010 DESTIP ALL`

## Overview

# VARY TCP/IP,,SYSPLEX enhancements

### ❑ Problem Statement / Need Addressed:

- Users can not quiesce or resume more than one unique application instance, listening on different ports, with one command
  - ✓ A command must be issued for each port bound by that application
- Only Quiesce or Resume TARGET can be used for an application with multiple listeners on the same port
  - ✓ The Quiesce or Resume Port command is rejected if more than one instance of a listening application matches the values provided

### ❑ Solution:

- Quiesce or resume all matching listeners regardless of port
  - ✓ New Quiesce/Resume JOBNAME command
- Enhance Quiesce/Resume Port to quiesce or resume all matching listeners
- All matching listeners **must** have the same jobname and asid

### ❑ Benefit:

- More flexibility is available with the VARY TCP/IP,,SYSPLEX command

# AGENDA

- OSA express enhancements
- Policy Enhancements
- Security enhancements
- Sysplex Enhancements
- Application enhancements
  - ***FTP RFC compliance***
  - ***FTP Kerberos SSO***
  - ***FTP Unicode support***
  - ***FTP select source addr***
  - ***TN3270 only in separate addr space***
- Management
- EE/SNA enhancements

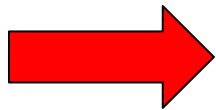

## Overview

# FTP TLS/SSL Compliance

### ❑ Problem Statement / Need Addressed:

- FTP's TLS/SSL support is not at the RFC 4217 level
- Non-compliance may cause interoperability problems with other platforms

### ❑ Solution:

- Implement RFC 4217
  - ✓ New TLSRFCLEVEL statement supported

### ❑ Benefit:

- Full RFC 4217 functionality is available to z/OS FTP users
- Customers don't have to be concerned with interoperability problems

## FTP TLS/SSL Compliance

- Bring FTP up to latest IETF standards level for SSL/TLS support for improved interoperability with other platforms

```
      +---DRAFT-----+
      |                 |
>---TLSRFCLEVEL-----+-----><
      |                 |
      +---RFC4217----+
```

## Overview

# FTP Kerberos single sign-on support

### ❑ Problem Statement / Need Addressed:

- The z/OS FTP server is not enabled for single sign-on when using Kerberos

### ❑ Solution:

- Allow users to login to the z/OS FTP server without having to re-enter the password
  - ✓ Userid is still required
  - ✓ New FTP server statement `SECURE_PASSWORD_KERBEROS`

### ❑ Benefit:

- Enables easier use of z/OS FTP server in Kerberos-based single sign-on environment.

# FTP Kerberos single sign-on support

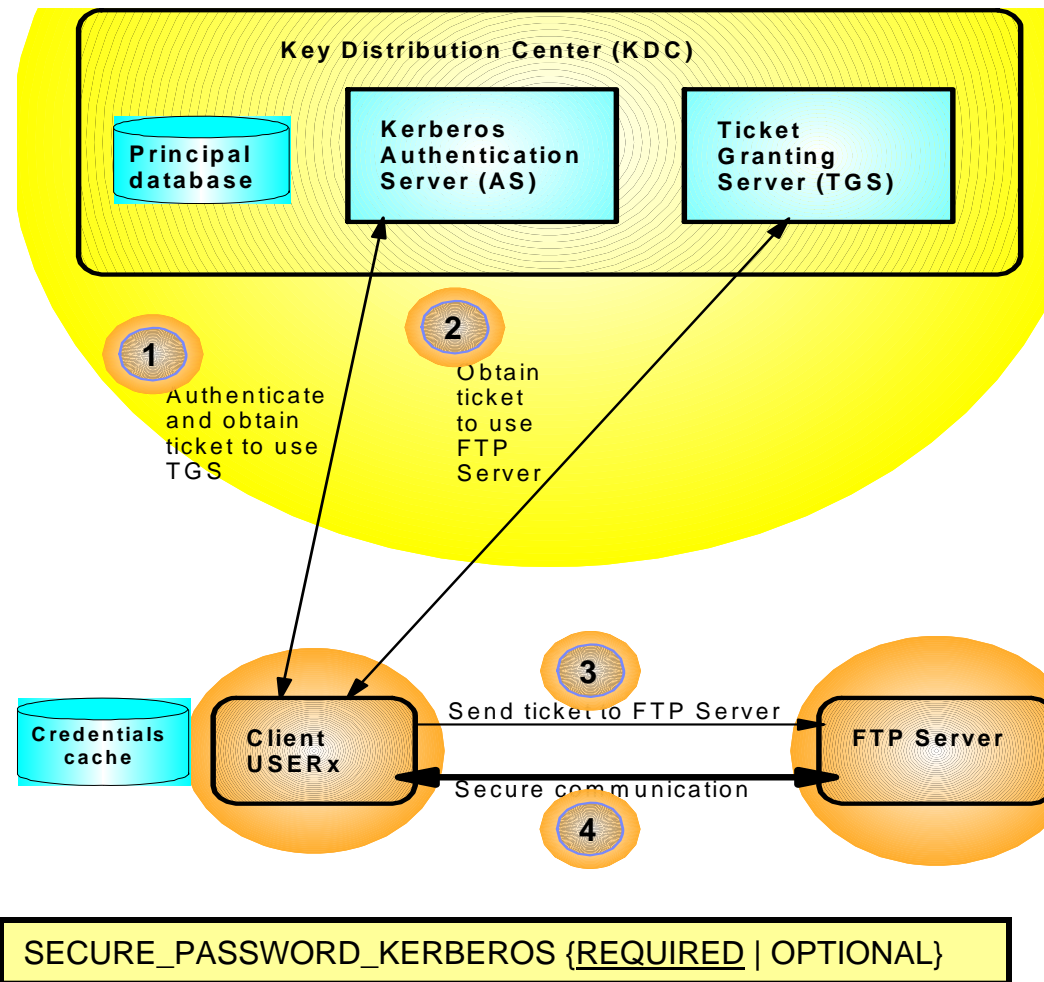

## Usage & Invocation

# FTP Kerberos single sign-on support

- ❑ The support is enabled by a new FTP server statement
  - `SECURE_PASSWORD_KERBEROS REQUIRED | OPTIONAL`
    - ✓ If `OPTIONAL` is specified then the user ID used to logon must be the same as the user ID used to authenticate to the Kerberos KDC
      - ❖ If not, z/OS FTP server prompts for the password



## FTP Unicode Support

### ❑ Problem Statement / Need Addressed:

- FTP supports Unicode file transfer and storage for UTF-8 only

### ❑ Solution:

- Support UTF-16 for file transfer and storage

### ❑ Benefit:

- z/OS FTP can be used when exchanging data of different encodings between government and public agencies

# Allow FTP client to select source IP address

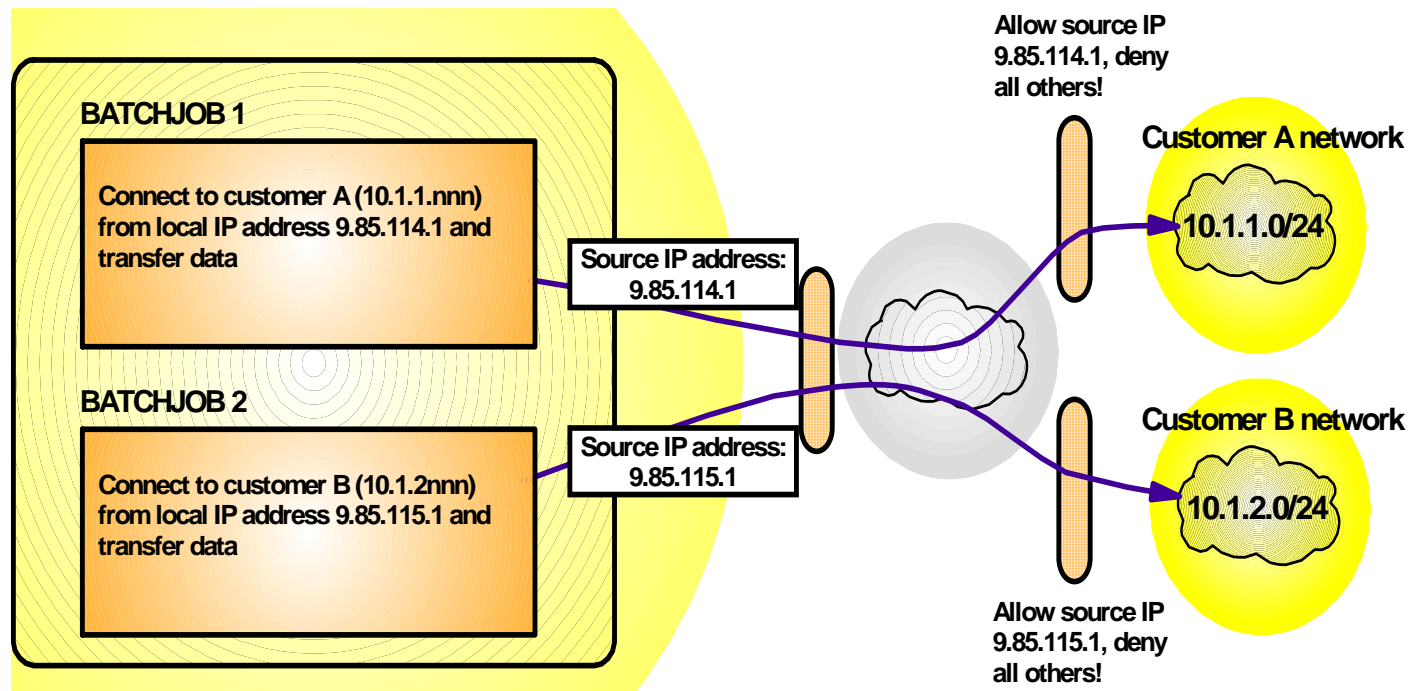

## Usage & Invocation

# Allow FTP client to select source IP address

- ❑ The support is invoked by the new command line parameter
  - `ftp -s srcip`
    - ✓ *srcip* must be a unicast IPv4 or IPv6 address.
    - ✓ Multicast, INADDR\_ANY, IN6ADDR\_ANY and IPv4-mapped IPv6 addresses are not supported.

## Allow the TN3270E Telnet server only in a separate address space

- ❑ Prior to z/OS V1R6, the TN3270 server runs as a subtask of the IBM TCP/IP stack address space
- ❑ In z/OS V1R6, provide customers with a choice:
  - Run the TN3270 server as a separately started address space from TCP/IP (TSASO)
  - Continue to run TN3270 server as a subtask of the TCP/IP address space

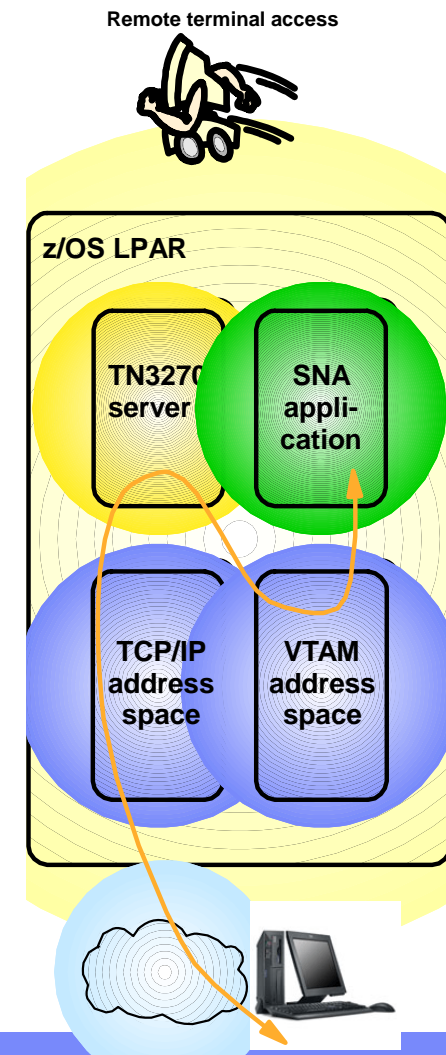

## Allow the TN3270E Telnet server only in a separate address space

### ❑ Problem Statement / Need Addressed:

- Dual support creates confusion
- Duplicate development, test, and support effort

### ❑ Solution:

- Stop supporting Telnet in the TCP/IP address space

### ❑ Benefit:

- Allows for prioritization of TCP/IP address space vs. TN3270 server
- Much less likely for TN3270 server failure to cause a total TCP/IP failure
- Allow for easier problem diagnosis for both TCP/IP and TN3270
- Easier controls for starting and stopping the server

# AGENDA

- OSA express enhancements
- Policy Enhancements
- Security enhancements
- Sysplex Enhancements
- Application enhancements
- Management
  - ***SNMP manager API***
  - ***Ping MTU discovery***
- EE/SNA enhancements

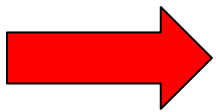

# Provide a programming interface for SNMP manager

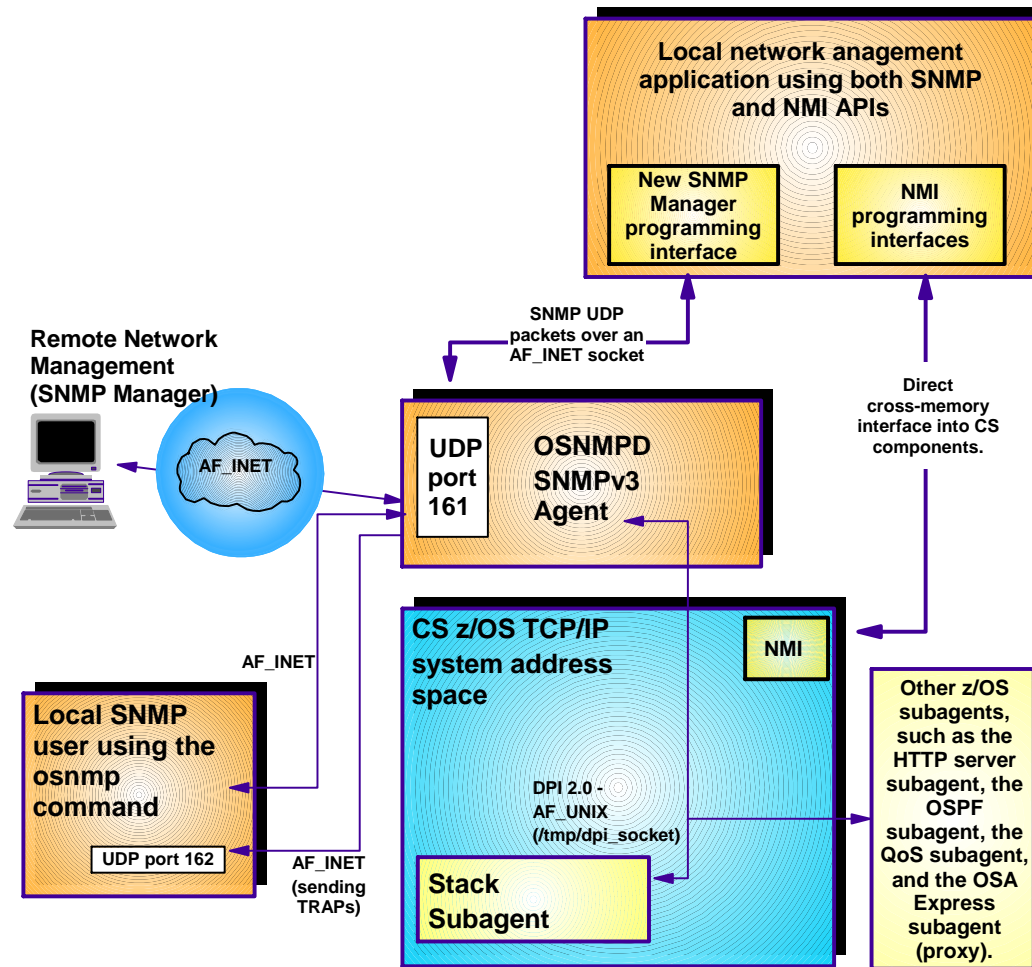

## Usage & Invocation

### Provide a programming interface for SNMP manager

- ❑ The function is enabled via the new API
  - Header file **snmpmgr.h** located in /usr/include/
  - Header file **snmpntfy.h** located in /usr/include/
  - A SNMP Manager sample, **snmpSMgr.c**, is provided
    - ✓ Located in /usr/lpp/TCP/IP/samples



## Ping command detection of network MTU

- ❑ IPv4 Ping from Host A to Host V, with a length of 1400, will be fragmented by Host U
- ❑ IPv6 Ping from Host A to Host V will time out

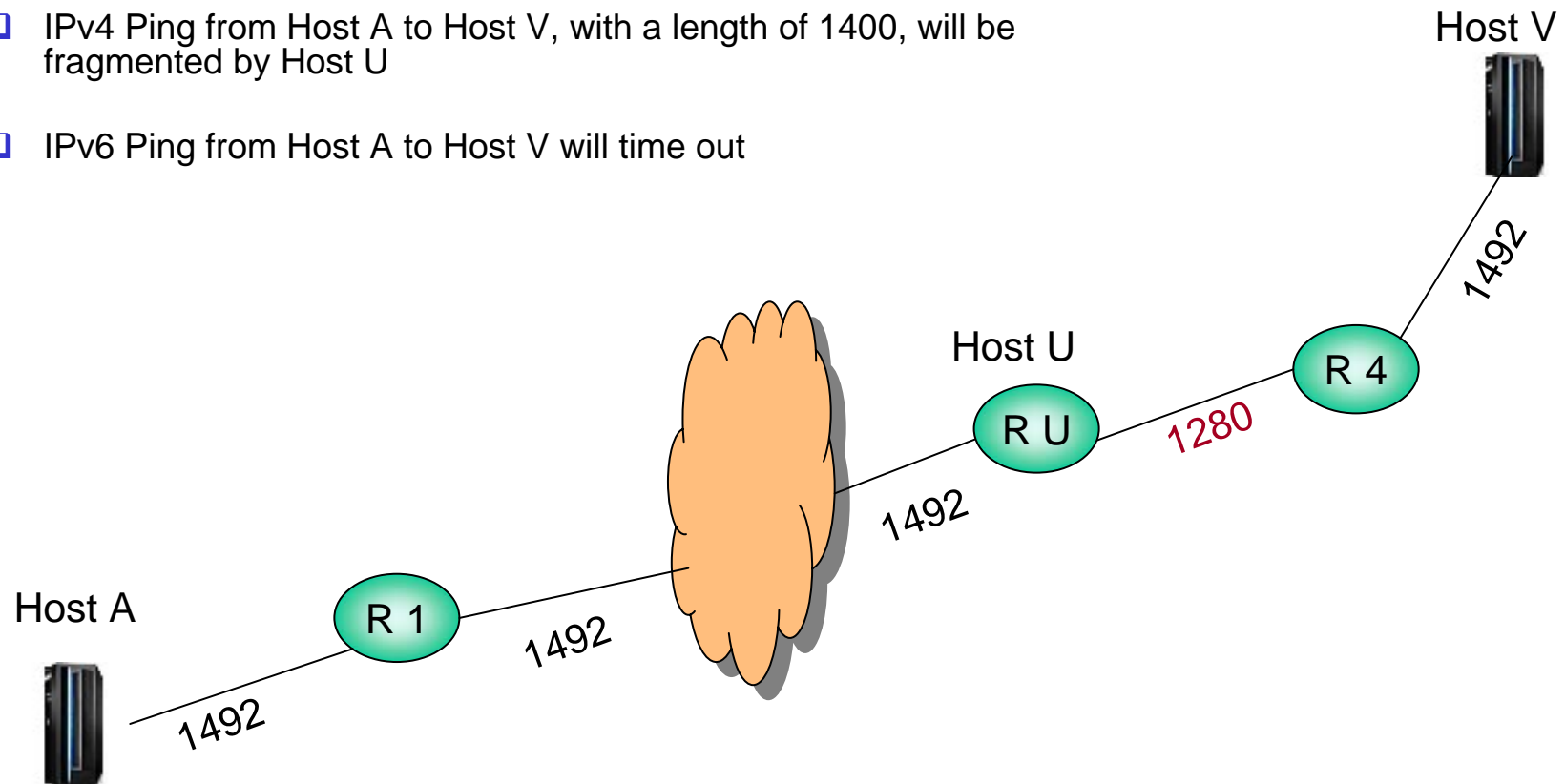

## Ping command detection of network MTU

### ❑ Problem Statement / Need Addressed:

- Difficult to determine where MTU problems exist in a network

### ❑ Solution:

- Enhance the Ping command to detect MTU and fragmentation problems in a network
  - ✓ The host name, IP address of the host, and next-hop MTU value displayed

### ❑ Benefit:

- MTU problems in the network are now easily detected

## Usage & Invocation

# Ping command detection of network MTU

- ❑ This support is enabled by specifying PMTU on TSO PING command
  - **PMTU YES | IGNORE**
  
- ❑ This support is also enabled by specifying -P on the z/OS Unix ping command
  - **-P yes | ignore**
  
- ❑ The current path MTU discovery value is used if **yes** is specified
  
- ❑ The current path MTU discovery value is ignored if **ignore** is specified
  - Allows a determination of where the MTU problem exist in the network

# AGENDA

- OSA express enhancements
- Policy Enhancements
- Security enhancements
- Sysplex Enhancements
- Application enhancements
- Management
- EE/SNA enhancements
  - ***EE MTU discovery***
  - ***GRPREFS***
  - .....

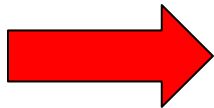

## Local MTU Discovery for Enterprise Extender

### ❑ Problem Statement / Need Addressed:

- The MTU size being utilized for an Enterprise Extender (EE) connection may not represent the current value.
- An EE connection may not be utilizing an optimal route between the two endpoints.

### ❑ Solution:

- EE dynamically learns when routing information, that pertains to EE connections, is changed and dynamically modify the MTU size that is used for that EE connection
  - ✓ The MTU size for the 1<sup>st</sup> hop is discovered
- Utilize more optimal routes for an EE connection when they become available

### ❑ Benefit:

- Avoid packet fragmentation
- Avoid locking into a small MTU size for the life of the EE connection

## Usage & Invocation

# MTU Discovery for Enterprise Extender

- ❑ This function is automatically enabled when Enterprise Extender is being used.

# Generic resources sample

## Duplicate Load Balancing DDVIPAA and GRCICS

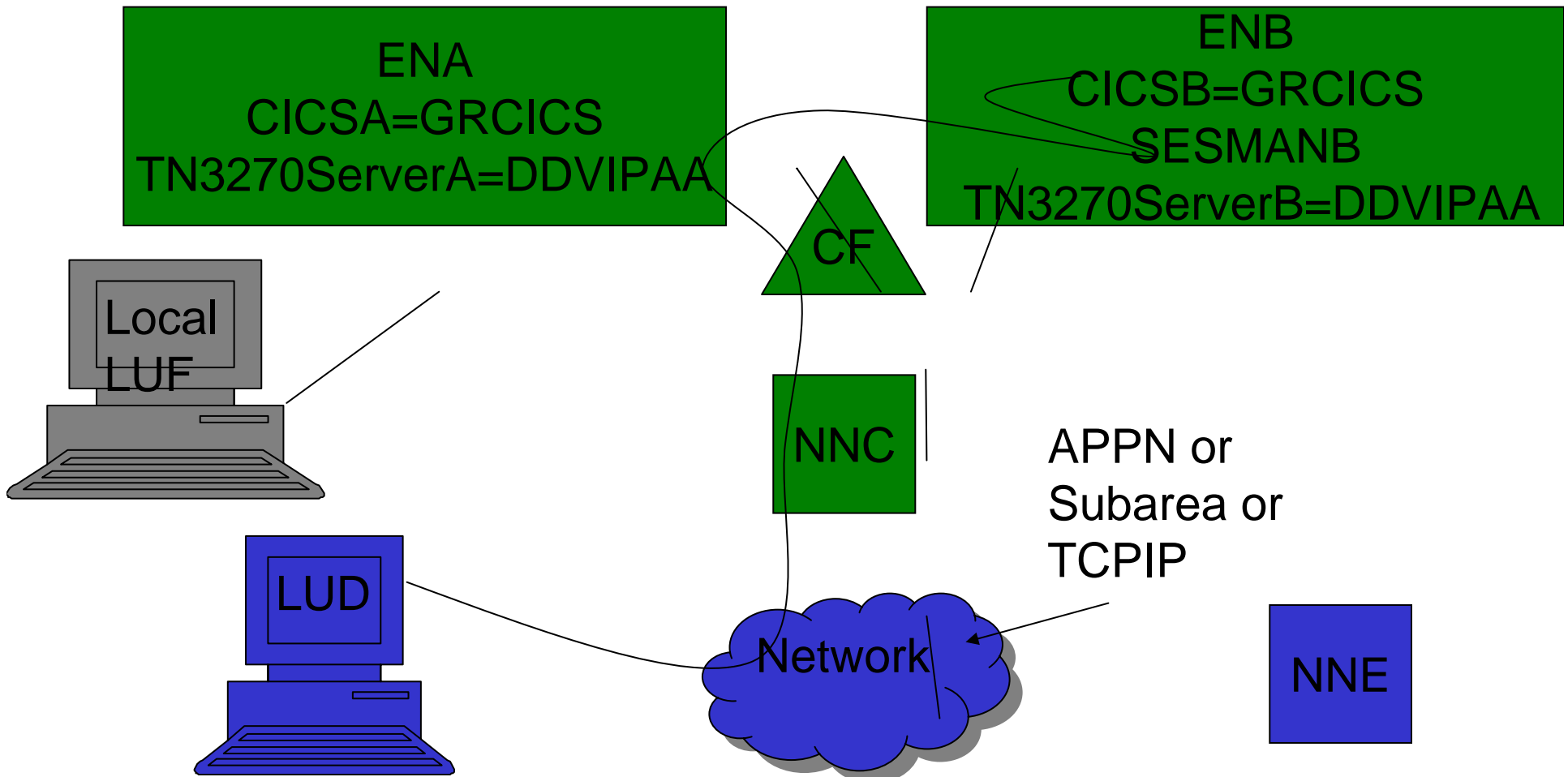

## GRPREFS (1.9) Definition example

- Example of defining a GRPREFS Table named GRHOST01 with default GR preferences and GR preferences for generic resources GRCICS and GRTSO.

```
GRHOST01  VBUILD  TYPE=GRPREFS

          GRPREF  GREXIT=NO ,WLM=YES ,LOCAPPL=YES ,LOCLU=YES ,PASSOLU=NO
GRCICS    GRPREF  GREXIT=NO ,WLM=NO ,LOCAPPL=YES ,LOCLU=YES ,PASSOLU=YES
GRTSO     GRPREF  GREXIT=YES ,WLM=YES ,LOCAPPL=YES ,LOCLU=YES ,PASSOLU=NO
```



For more information....

URL	Content
<a href="http://www.ibm.com/servers/eserver/zseries">http://www.ibm.com/servers/eserver/zseries</a>	IBM eServer zSeries Mainframe Server
<a href="http://www.ibm.com/servers/eserver/zseries/networking">http://www.ibm.com/servers/eserver/zseries/networking</a>	Networking: IBM zSeries Servers
<a href="http://www.ibm.com/servers/eserver/zseries/networking/technology.html">http://www.ibm.com/servers/eserver/zseries/networking/technology.html</a>	IBM Enterprise Servers: Networking Technologies
<a href="http://www.ibm.com/software/network/commserver">http://www.ibm.com/software/network/commserver</a>	Communications Server product overview
<a href="http://www.ibm.com/software/network/commserver/zos/">http://www.ibm.com/software/network/commserver/zos/</a>	z/OS Communications Server
<a href="http://www.ibm.com/software/network/commserver/z_lin/">http://www.ibm.com/software/network/commserver/z_lin/</a>	Communications Server for Linux on zSeries
<a href="http://www.ibm.com/software/network/ccl">http://www.ibm.com/software/network/ccl</a>	Communication Controller for Linux on zSeries
<a href="http://www.ibm.com/software/network/commserver/library">http://www.ibm.com/software/network/commserver/library</a>	Communications Server products - white papers, product documentation, etc.
<a href="http://www.redbooks.ibm.com">http://www.redbooks.ibm.com</a>	ITSO Redbooks
<a href="http://www.ibm.com/software/network/commserver/support">http://www.ibm.com/software/network/commserver/support</a>	Communications Server technical Support
<a href="http://www.ibm.com/support/techdocs/">http://www.ibm.com/support/techdocs/</a>	Technical support documentation (techdocs, flashes, presentations, white papers, etc.)
<a href="http://www.rfc-editor.org/rfcsearch.html">http://www.rfc-editor.org/rfcsearch.html</a>	Request For Comments (RFC)

