

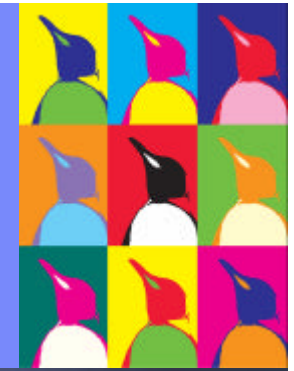

IBM System z



The W5 about Linux on System z – What, Why, When, Who, and Where

Per Fremstad
Senior I/T Specialist and zChampion
IBM Norway
(Material by Jim Elliott)



IBM Systems
Simplify your IT.

© 2006 IBM Corporation



9202 – The W5 about Linux on System z – What, Why, When, Who, and Where

- **Datacenters planning to adopt Linux have a key architectural choice to make in designing large-scale implementations.**
- **Is the best approach to running Linux scale-out with rack-optimized servers, to scale-up with large SMP servers using virtualization facilities to run many images on a single server?**
- **For many users, Linux on IBM System z may be the optimal choice.**
- **Jim will describe how Linux on System z, in combination with z/VM, will provide a robust Linux environment which integrates well with z/OS, z/TPF and z/VSE.**



Agenda

- **What Linux on System z is**
- **Why Linux on System z**
- **When should Linux on System z be used**
- **Who is using Linux on System z**
- **Where you can find additional information about Linux on System z**





First, a few words about naming ...

Long Form				Short Form
IBM	eServer	zSeries	990 / 890	z990 / z890
IBM	System	z9	EC / BC	z9 EC / z9 BC

- **System z = System z9 + eServer zSeries**
- **Linux “naming”**
 - Linux on System z (or zSeries) refers to Linux on the mainframe
 - Linux for System z (or zSeries) refers to a 64-bit distro
 - Linux for S/390 refers to a 31-bit distro
- **To slash or not to slash**
 - Hardware **does not** have a slash
 - Software **does** have a slash
 - z/OS, z/VM, z/VSE, z/TPF
 - z/Architecture (“considered” software)



IBM System z

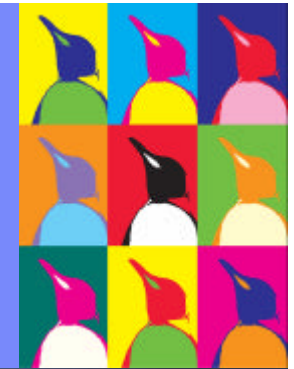

What Linux on System z is



IBM Systems
Simplify your IT.

© 2006 IBM Corporation



What is Linux on System z?

- **A native mainframe operating environment**
 - Exploits IBM System z hardware
 - Not a unique version of Linux
- **Application sourcing strategy**
 - The IBM commitment to z/OS, z/TPF and z/VSE is not affected by this Linux strategy
 - Customers are offered additional opportunities to leverage their investments through Linux
 - New doors are opening for customers to bring Linux-centric workloads to the platform

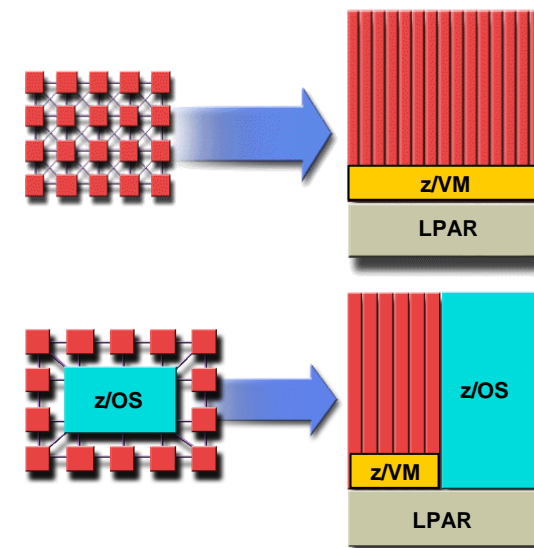



What System z brings to Linux

- **The most reliable hardware platform available**
 - Redundant processors and memory
 - Error detection and correction
 - Remote Support Facility (RSF)
- **Centralized Linux systems are easier to manage**
- **Designed to support mixed work loads**
 - Consolidation while maintaining one server per application
 - Complete work load isolation
 - High speed inter-server connectivity
- **Scalability**
 - System z9 EC scales to 54 application processors
 - **System z9 BC scales to 7 application processors**
 - eServer zSeries 990 scales to 32 application processors
 - eServer zSeries 890 scales to 4 application processors
 - Up to 8 dedicated I/O processors
 - 100s of Linux virtual servers



System z – A closer look at the ultimate virtualization resource

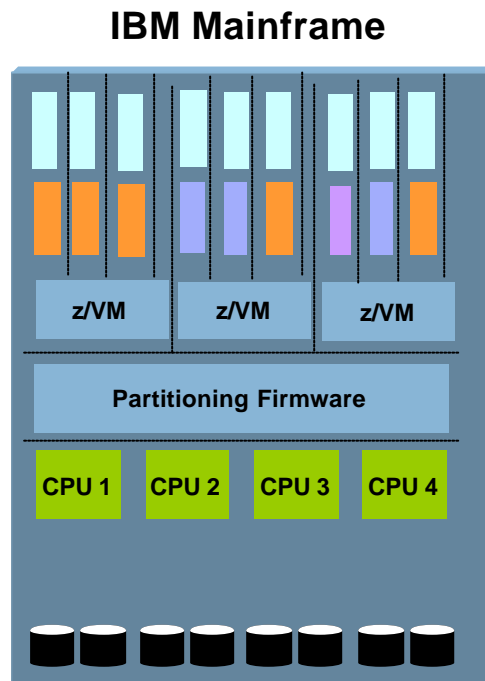

- **Utilization often exceeds 80%**
 - Handles peak workload utilization of 100% without service level degradation
- **Massive consolidation platform**
 - 60 logical partitions, 100s to 1000s of virtual servers under z/VM
 - Virtualization is built-in, not added-on
 - HiperSockets for memory-speed communication
 - Most sophisticated and complete hypervisor function available
- **Intelligent and autonomic management of diverse workloads and system resources based on business policies and workload performance objectives**



z/VM – unlimited virtualization

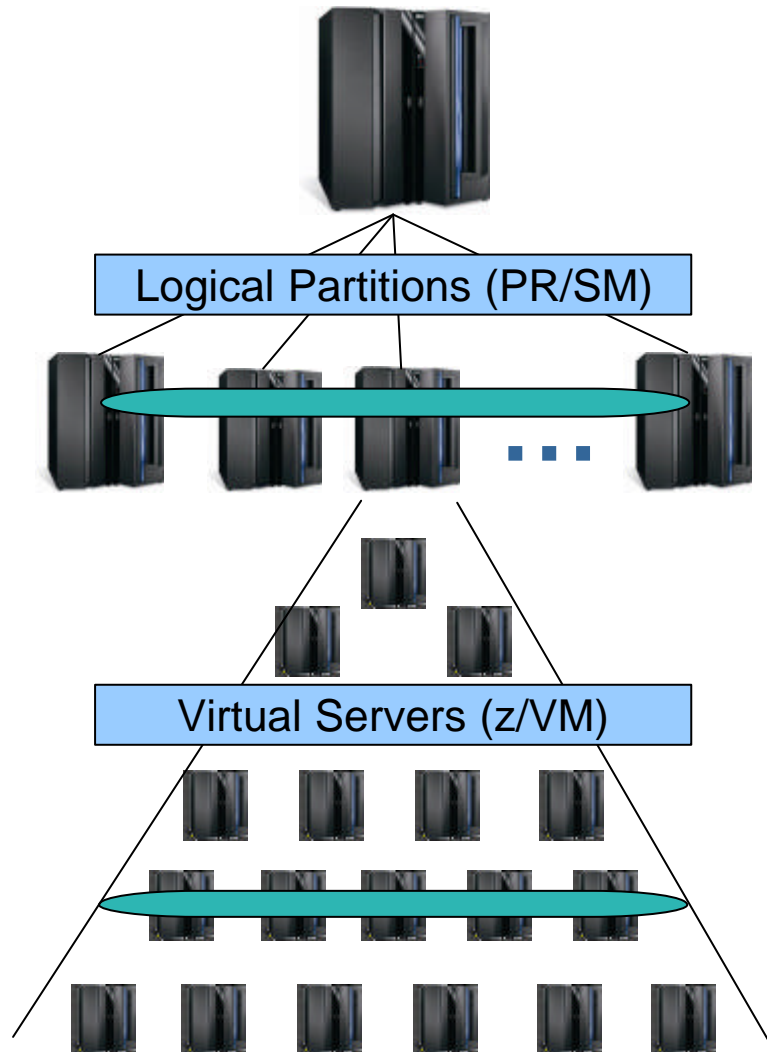

- **Mature technology – z/VM introduced in 1967**
- **Software Hypervisor integrated in hardware**
 - Sharing of CPU, memory and I/O resources
 - Virtual network – virtual switches/routers
 - Virtual I/O (mini-disks, virtual cache, ...)
 - Virtual appliances (SNA/NCP, etc.)
- **Easy management**
 - Rapid install of new servers – cloning or IBM Director task z/VM Center
 - Self-optimizing workload management
 - Excellent automation and system management facilities
 - Flexible solution for test and development systems



The value of z/VM for Linux

- **Enhanced performance, growth and scalability**
 - Server consolidation enables horizontal growth
 - N-tier architecture on two tiers of hardware
 - Extensive support for sharing resources
 - Virtual networking
 - Effective isolation of Linux images, if required
- **Increased productivity**
 - Development and testing
 - Production support
- **Improved operations**
 - Backup and recovery
 - Command and control

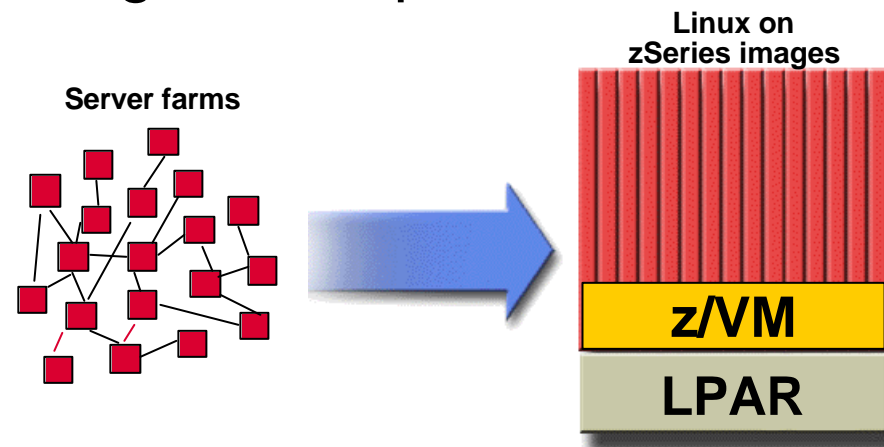



Integrated Facility for Linux

- **Additional engines dedicated to Linux workloads**
 - Supports z/VM and Linux on System z
 - IFLs on “sub-uni” systems run at “full speed”
 - z800, z890, **z9 EC**, **z9 BC**
- **Traditional mainframe software charges unaffected**
 - IBM mainframe software
 - Independent Software Vendor products
- **Linux and z/VM charged only against the IFLs**

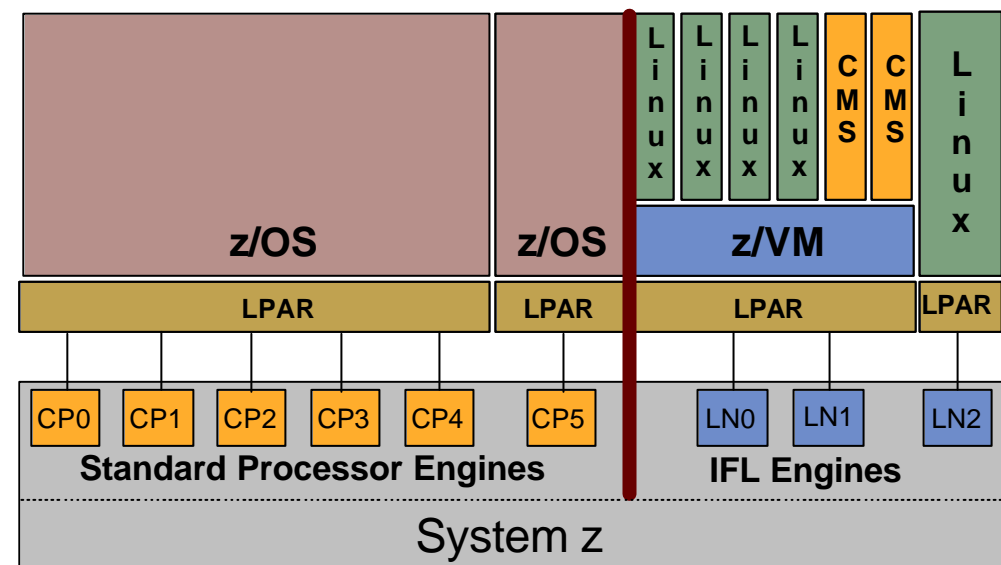



What is different about Linux on System z?

- **Access to zSeries specific hardware**
 - Crypto support – CPA, Crypto2
 - Traditional and Open I/O subsystems
 - Disk (ECKD or SCSI) and tape
 - SAN Volume Controller
 - OSA-Express and OSA-Express2 for very high speed communication between z/OS, z/VSE, z/TPF, and Linux
 - HiperSockets for ultra-high speed communication between z/OS, z/VSE, and Linux on the same machine
- **z/VM aware**
 - Enhanced performance
 - System management tools



Application serving with Linux on System z

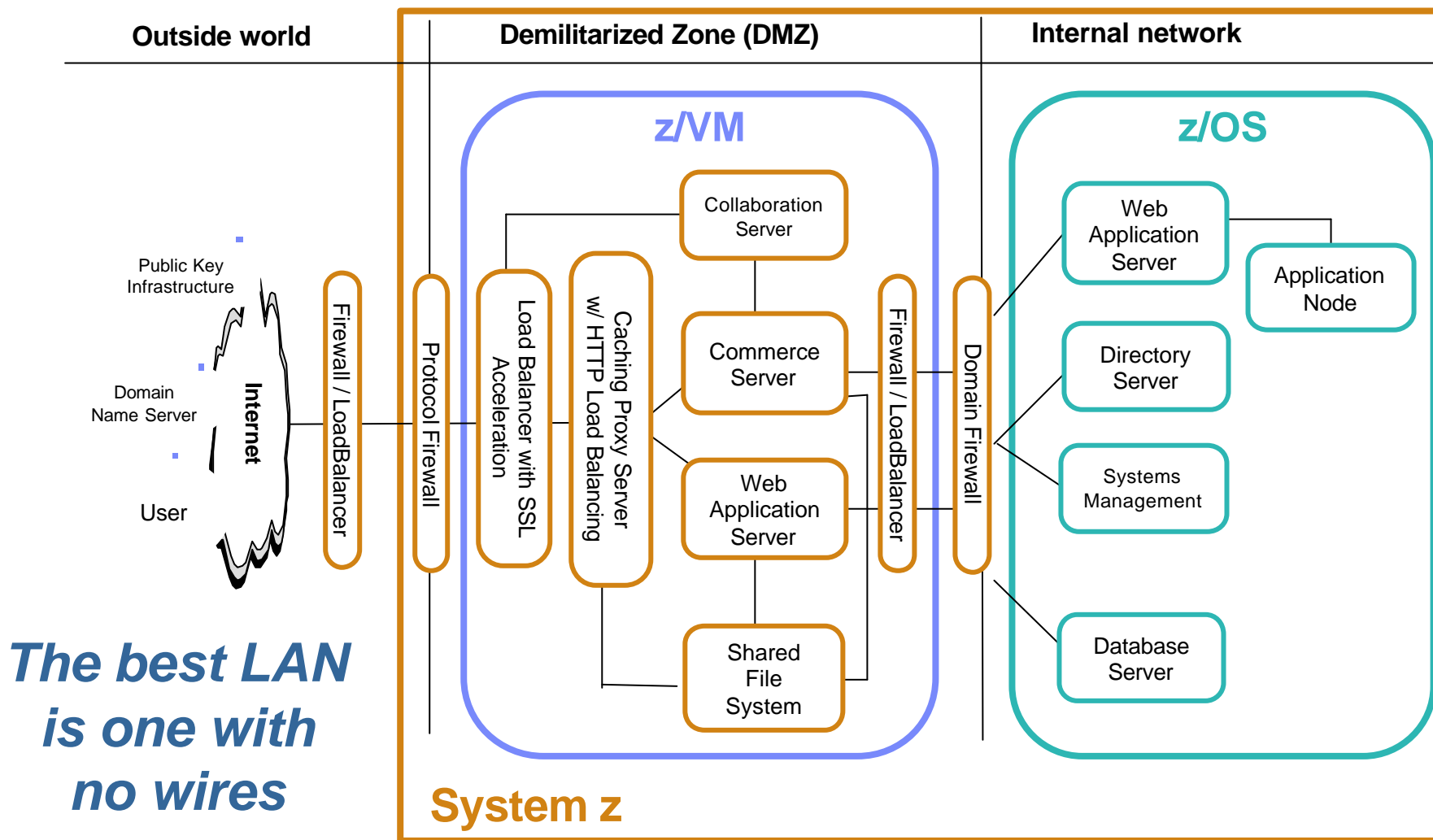

*The best LAN
is one with
no wires*



Linux Utilities for IBM System z

Leverage the potential Linux brings to the mainframe

- **Linux Utilities provide specific infrastructure functions; they are existing products**
- **Tightly integration of ‘commodity’ workloads – utilities – with z/OS workloads can provide an ideal combination of computing strength and open source nimbleness**
- **Technical documentation, covering details on installation and configuration, to help an easy and fast start for production usage**
- **Benefit from the control and management that System z offers**





Linux Utilities for System z

- **End-to-end security for z/OS transactions**
 - System z "network in a box" protection with the StoneGate™ firewall
 - z/OS Web application business logic protection with webApp.secure™
 - End-to-end, centralized authentication and single sign on for z/OS transactions with IBM Tivoli® Access Manager WebSEAL
- **Systems Management addresses 'indirect' costs of computing**
 - Manage critical online business applications by proactively monitoring essential system resources on z/OS by running the essential components of OMEGAMON® z/OS Management Console on System z
- **Preserve current system network architecture (SNA) assets**
 - IBM Communication Controller for Linux on System z allows you to run NCP software that has been critical, stable network component for many years

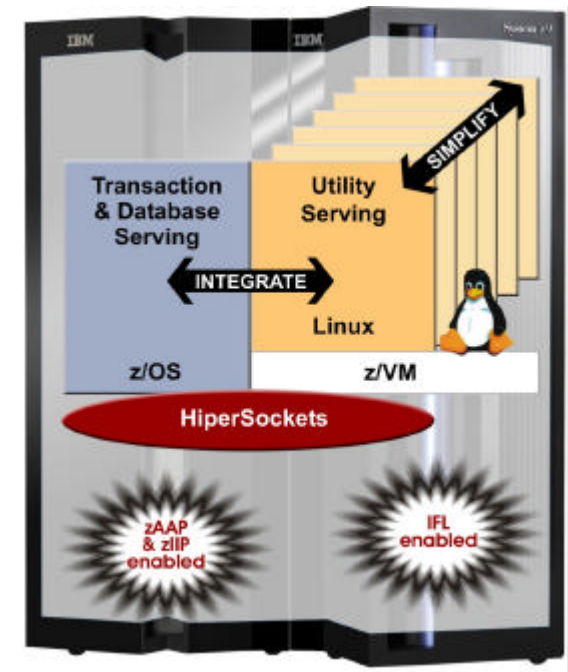

- **Lunch and Learn**
 - August 16
 - 12:15 to 1:15
 - Ballroom 3



IBM System z

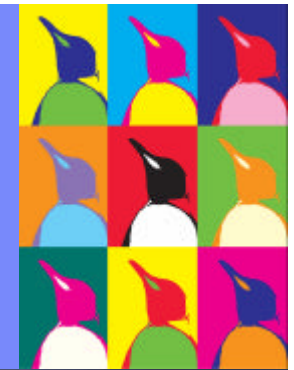

Why Linux on System z



IBM Systems
Simplify your IT.

© 2006 IBM Corporation



Business Case for Linux on System z

- 1. Increased solutions through Linux application portfolio**
- 2. Large number of highly skilled programmers familiar with Linux**
- 3. Integrated business solutions**
 - Data richness from System z
 - Wide range of Linux applications
- 4. Industrial strength environment**
 - Flexibility and openness of Linux
 - Qualities of service of System z
- 5. Unique ability to easily consolidate large number of servers**





Value of Linux on System z

- **Reduced Total Cost of Ownership (TCO)**
 - Environmental savings – single footprint vs. hundreds of servers
 - Consolidation savings – less storage, less servers, less software licenses, less server management/support
- **Improved service level**
 - Systems management (single point of control)
 - Reliability, availability, security of zSeries hardware and z/VM software
 - High performance integration with z/OS
- **Speed to market**
 - Capacity-on-demand capability on zSeries
 - Dynamic allocation of on-line users, less than 10 seconds to add a new Linux server image using z/VM and IBM DS8000



Customers Are Installing More Capacity

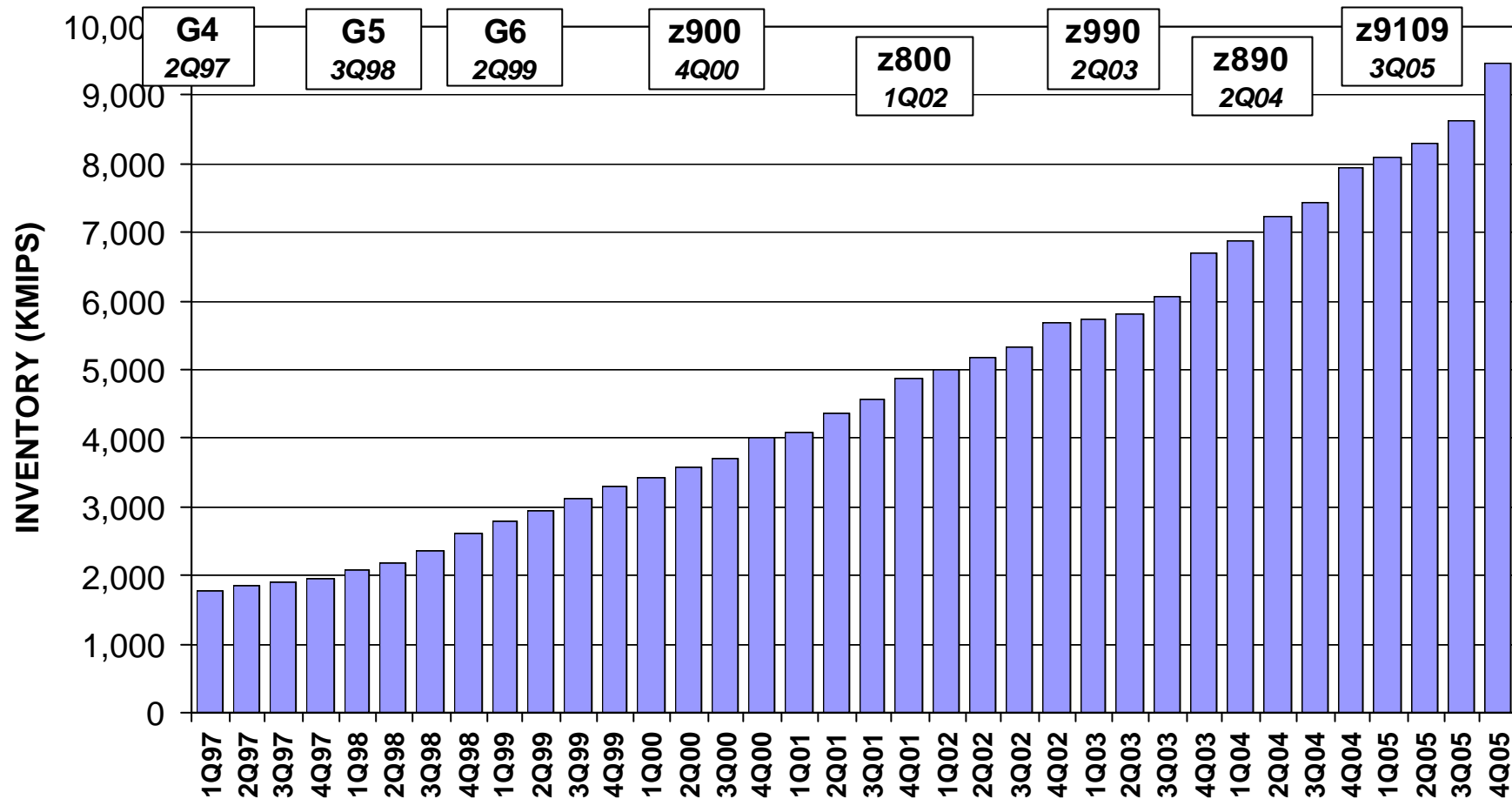

CAGR 1997-2000 = 26%

CAGR 2000-2005 = 19%

Source: IBM STG Finance



System z Advantage: Platform growth supporting core business and new workload

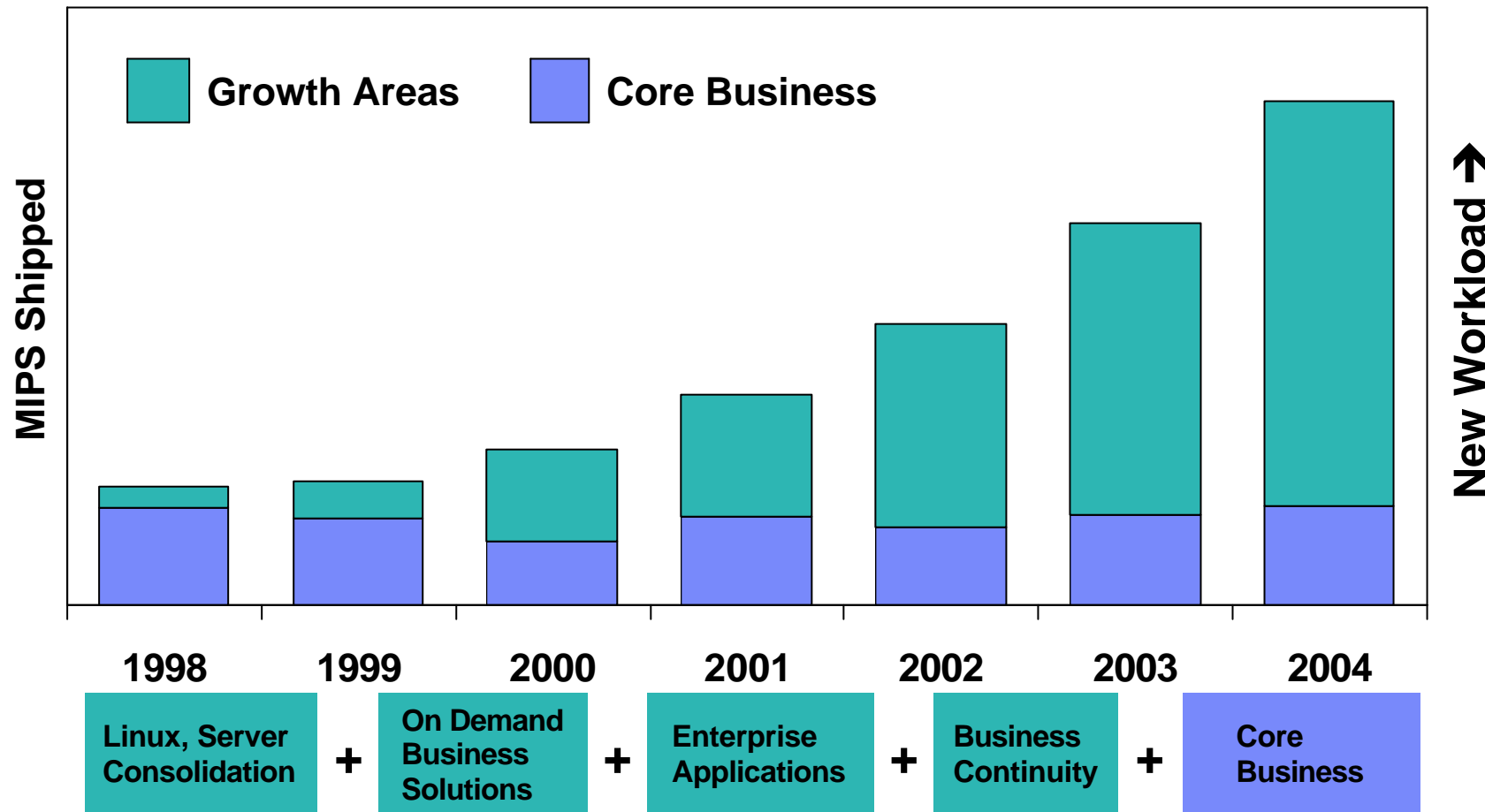

Source: IBM Market Research



Customers perceive a distinct gap between mainframe capabilities and other platforms

Server Platform Perceptions – Ratings on a Scale of 1-5

Attribute	Rating by Platform		
	Mainframe	UNIX	“Wintel”
Availability	4.81	3.59	2.64
System Integrity / Security Controls	4.65	3.30	2.27
Backup and Recovery (Including Disaster Recovery)	4.54	3.35	2.70
Workload Management	4.49	3.07	2.23
Average Response Time	4.15	3.60	2.96
Data and Transaction Processing	4.49	3.61	2.75
Integration of data, applications across business processes	3.59	3.47	3.09
Average	4.39	3.43	2.66

Respondents consistently view the mainframe as differentiated in its capabilities

Compared to market research in 2000, mainframe lead over Wintel has increased, gap over UNIX maintained

Survey of over 700 existing zSeries customers. Question: For each attribute shown below, please rate each platform based on your experience / perceptions. (Note that you may rate different platforms as having equivalent levels). 0 = Not sure; 1 = Poor, 2, 3 = Average, 4, 5 = Best-in-class



Customers viewed the mainframe as best suited to deliver enterprise wide capabilities

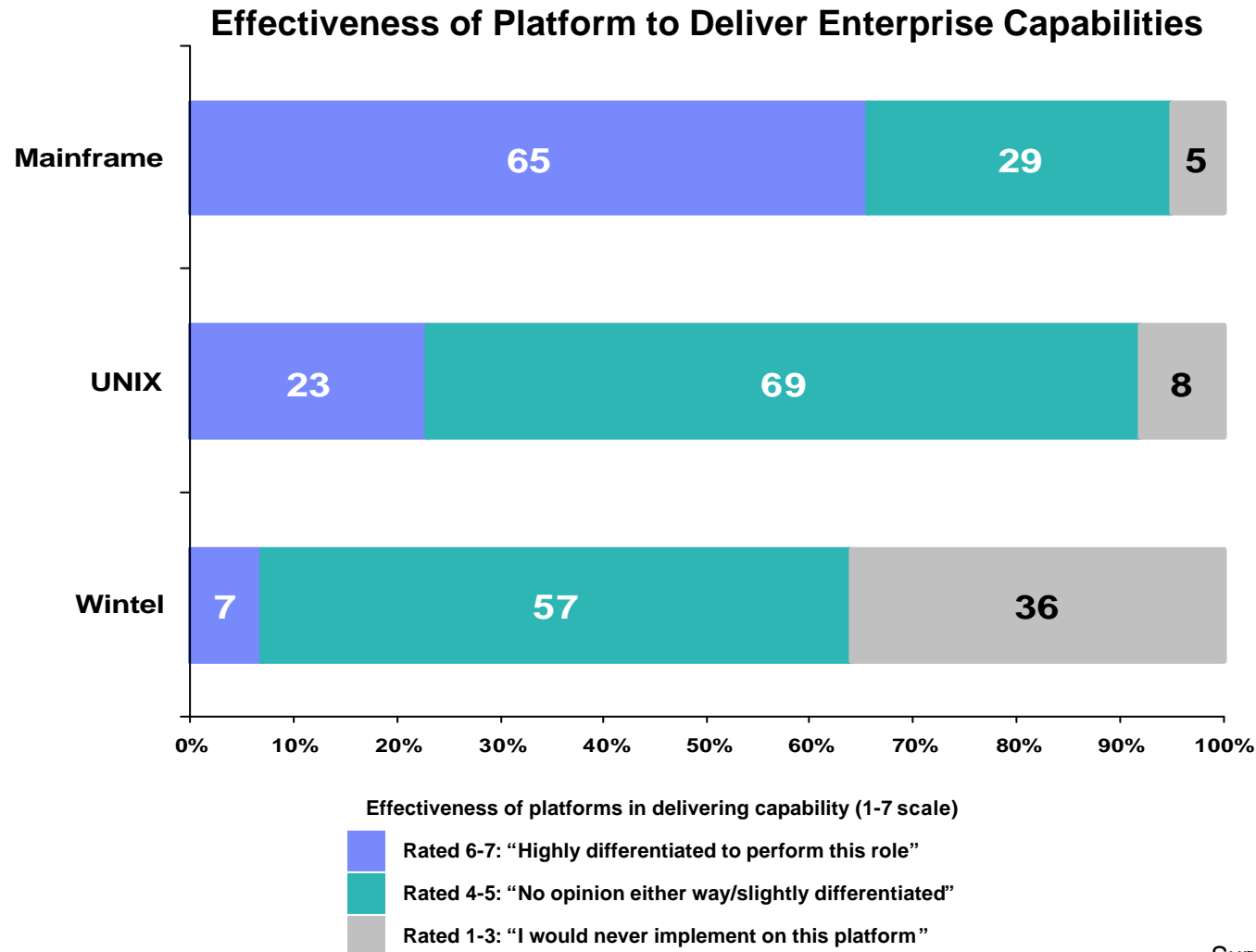

The mainframe is seen as substantially better suited to perform all Enterprise Roles, compared to other platforms

It is seen as most differentiated in its ability to deliver enterprise workload management

CIOs/CTOs believe in the mainframe's ability to deliver Enterprise Roles equivalent to that of other decision makers

Survey of over 700 existing zSeries customers.



IBM System z

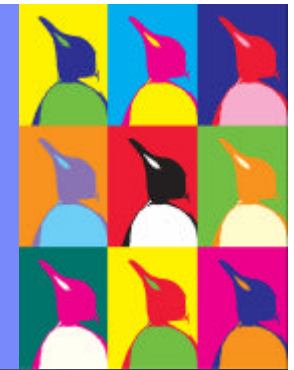

When should Linux on System z be used



IBM Systems
Simplify your IT.

© 2006 IBM Corporation



Infrastructure simplification

- Customers leveraging scale up and scale out technologies to simplify and integrate their on demand operating environment
- As one solution option:
 - Large SMP and Rack Optimized servers integrated with Linux, Java and Grid technologies can enable this transformation

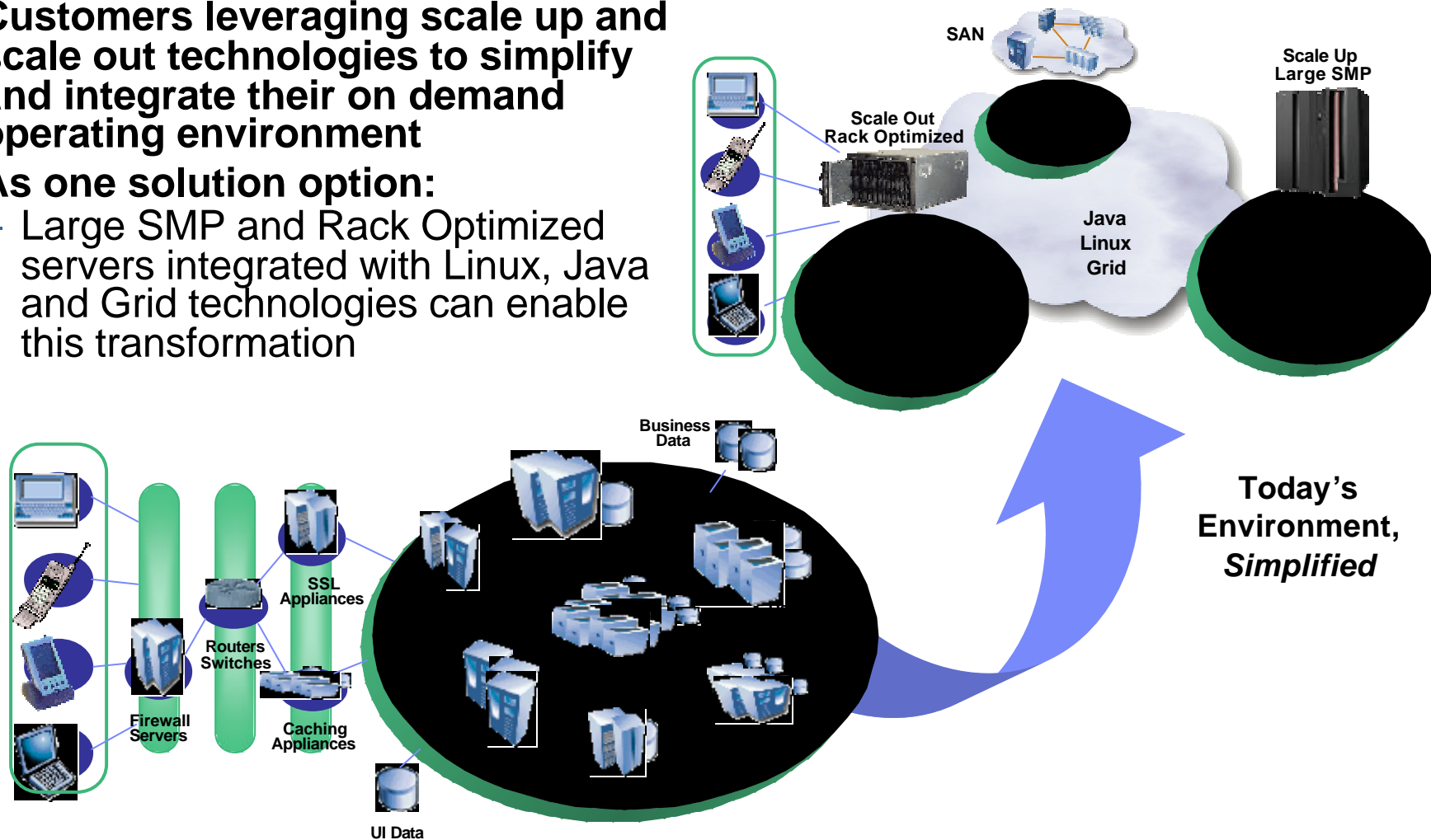



Ideal blade implementations

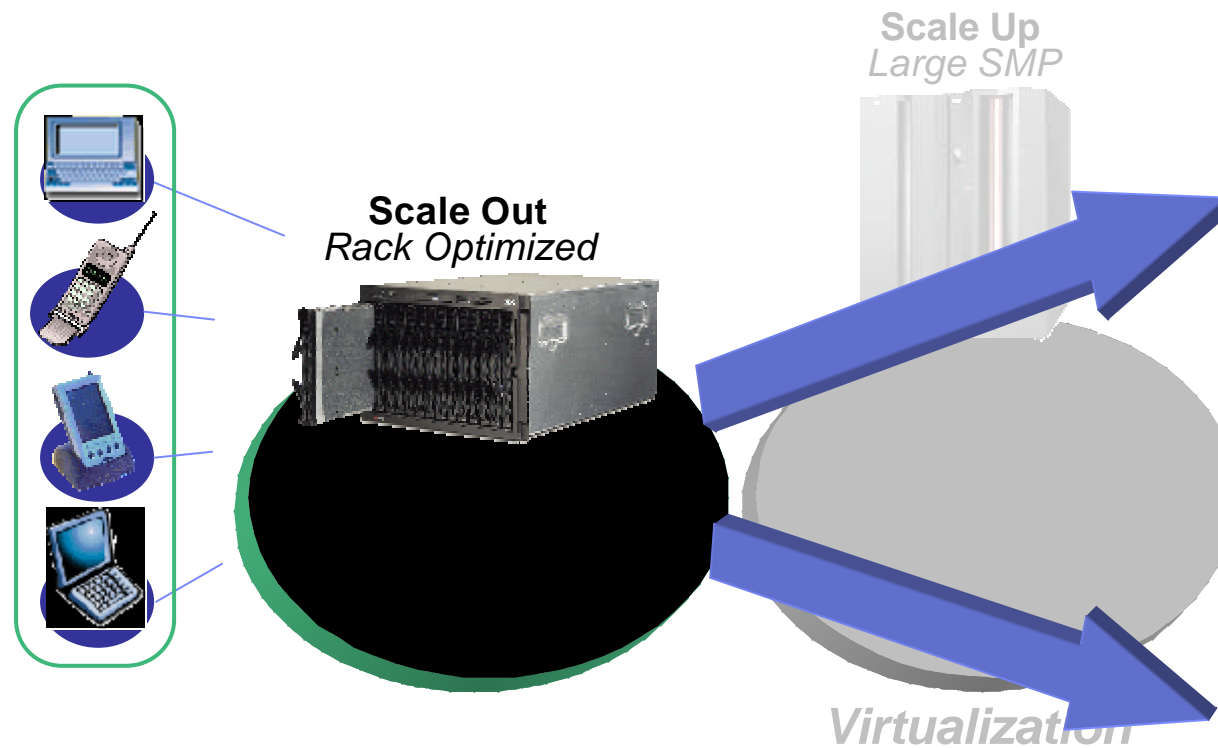

- **Clustered workloads**
- **Distributed computing applications**
- **Infrastructure applications**
- **Small database**
- **Processor and memory intensive workloads**
- **Centralized storage solutions**



Ideal mainframe implementations

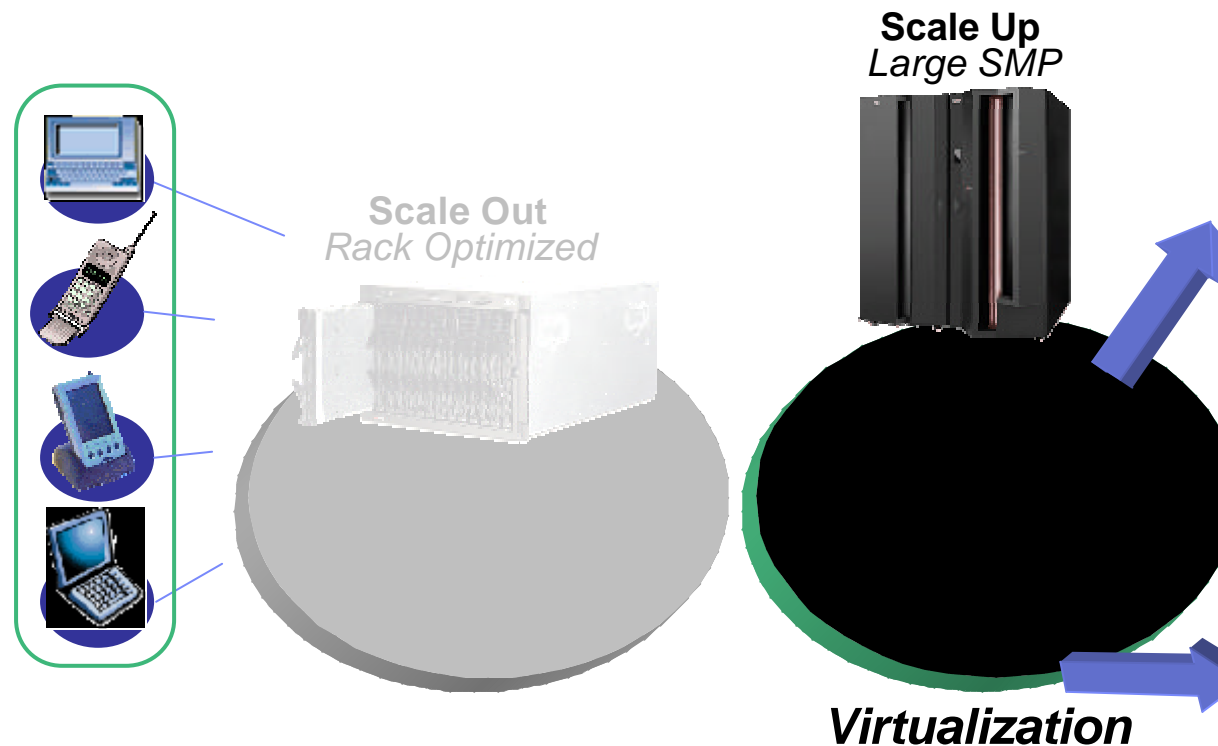

- High performance transaction processing
- I/O Intensive workloads
- Large database serving
- High resiliency and security
- Unpredictable and highly variable workload spikes
- Low utilization infrastructure applications
- Rapid provisioning and re-provisioning



Where to deploy on System z – z/OS or Linux?

Technical Considerations

Linux → z/OS

Quality of Service

Linux ← z/OS

Speed of deployment

Linux ← z/OS

Degree of portability

Other Considerations

- Application availability
- Workload Management function and granularity
- File sharing across a Sysplex
- Manageability and scaling characteristics
- Availability of skill



Where to deploy – System z or “distributed”

Technical Considerations

System z ← “distributed”
Quality of Service

System z ← “distributed”
Speed of deployment
Instances 2 - n

System z ← “distributed”
Data Intensity

System z → “distributed”
Compute Intensity

Other Considerations

- **Application availability**
 - Certification of solution on hardware/software platform
- **Workload Management**
- **Manageability and scaling characteristics**
 - Especially DB2 on z/OS
 - Proximity of data to application
 - The best network is an internal network!



Linux on System z ISV status

ibm.com/systems/z/solutions/isv/linuxproduct.html

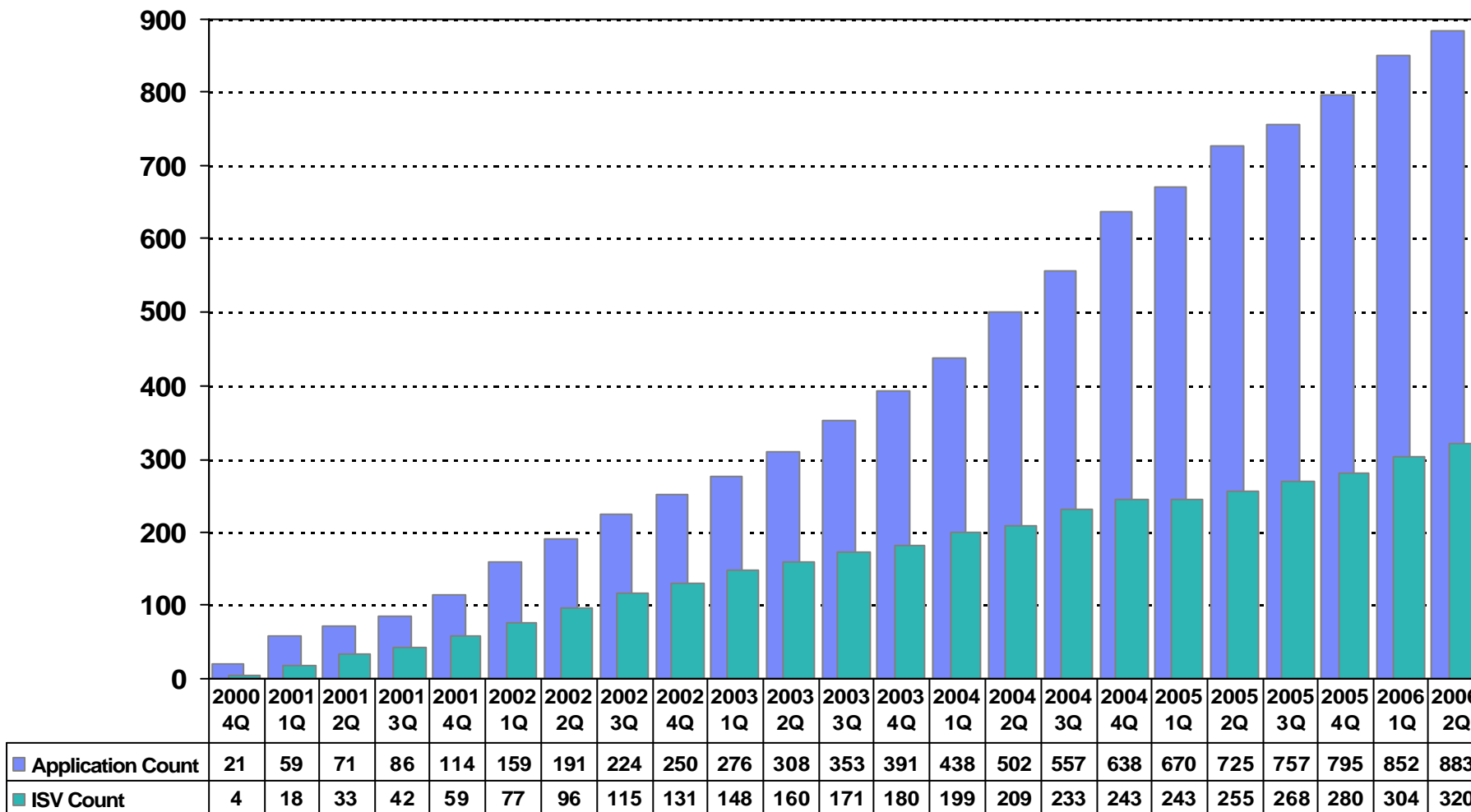



IBM System z

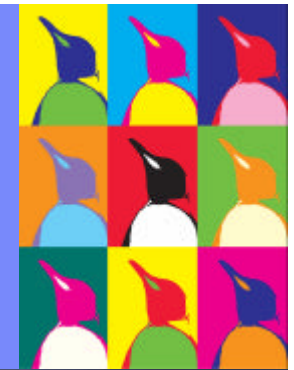

Who is using Linux on System z



IBM Systems
Simplify your IT.

© 2006 IBM Corporation



Current workload share on utilized IFLs

End 1Q2006 – primary applications

60%	Application serving for z/OS e.g. WebSphere, SAP, CICS TG, DB2 Connect
30%	Data serving e.g. Oracle DB, DB2 UDB
5%	Workplace serving e.g. Domino, other e-mail
5%	Infrastructure serving e.g. Apache, Samba
<1%	Linux application development/deployment

Notes: extrapolation based on analyzing 1/3 of inventory, excludes all IBM



University of Toronto



■ Business need

- U of T needed to reduce mainframe processing costs and increase computing capacity to support greater demand during the university's student registration periods

■ Solution implementation

- IBM z9 BC IFL running z/VM and Novell SLES
- IBM DB2 UDB off-loaded from z/OS

■ Benefit of the solution

- The migration was easy to implement and didn't affect any of the university's 50,000 users
- U of T expects to save \$30,000 per month in software costs, which adds up to more than \$1 million in savings over three years



US Office of Personnel Management

■ Current environment

- z900 IFL with 3 LPARs running z/VM and 45 Novell SLES images
 - Production, User Acceptance Test, Development, and SysProg Test
- Apache, WebSphere Application Server, DB2 UDB

■ Costs

- Linux on z solution → \$240K
- Linux on Intel solution → \$840K (lowest cost estimate)

- ***“... with an upgrade to a z9 BC my one IFL goes from 238 MIPS to 480 MIPS and my software charges stay exactly the same as they are today. ... Once I get a processor license for a piece of software I can bring up many of them virtually with no additional charges. Oh yes, the z900 IFL is not even breathing hard yet.”***

- Jim Marshall, US Office of Personnel Management, June 26, 2006



Office of Personnel Management

The Federal Government's Human Resources Agency





Nationwide Insurance

Why Server Virtualization? Why Linux on System z?

- **Issues – facing us from Infrastructure perspective**
 - 78% of our distributed servers have peak utilization of < 50%
 - Server provisioning time is measured in weeks
 - Dynamically allocating processing power is difficult, for example:
 - Some applications may need more processing power on Fridays
 - Development may want a performance test environment for only 8 weeks
 - Opportunity exists to dramatically reduce the TCO of Server / Web Hosting
 - Data center power and floor space scarcity – 10s of millions of dollar investment
- **Enablers – assist us in changing the way we do business**
 - Virtualization Capabilities:
 - Ability to share resources across multiple applications / workloads
 - 40 year old concept from Mainframe
 - These capabilities are now available for ‘distributed’ applications thru Linux on System z
 - Standardization: New Custom Applications to be based on J2EE/Linux
 - Linux pricing on System z is significantly different from traditional z/OS MIPS
 - Middleware pricing (WebSphere, Oracle, UDB) on System z is rather attractive
 - Tools to automate provisioning are widely becoming available



Nationwide Insurance

Completely new set of technology and fully operational environment was introduced over 4 months

- **A dedicated team**
 - Finalized the design and the business case,
 - Implemented the infrastructure,
 - Developed the rate structure and
 - Created operation processes and procedures within four months.
- **Applications are already in production today**
 - Nationwide.com runs on Linux on System z
 - 5 other mission critical applications are already in production
 - 10 more mission critical applications are in test mode
- **A total of 250+ virtual servers are in production today**
 - 200+ development and test servers are being supported by 3 IFLs!!
 - 50+ production servers are being supported by 3 IFLs!!
 - Tested scaling two applications 22x and 5x production levels simultaneously



Nationwide Insurance

What are the overall benefits?

- **Significantly Better TCO – \$16 million savings over 3 years**
 - More than 50% reduction in web hosting monthly cost
 - Significant savings on middleware costs (WebSphere, UDB, Oracle, etc.)
 - Significant Data center floor space (80% reduction) and power conservation.
 - Higher CPU utilization
 - 50% less FTEs are needed to support hardware & OS due to shared read only libraries (Standalone Unix environment 1FTE:30 Servers; System z Virtualized environment 1FTE:80 Virtual Servers)
- **Significantly Faster Provisioning Speed**
 - Reduce web hosting environment provisioning from months to days
- **Dynamic Allocation of Compute Power**
 - Allocate more compute power to applications when they need it
 - Ability to dynamically upgrades compute power – On Demand Model
- **Leverage tried and true technology over 40 year for virtualization**



DGTIC – environment and pains

- **IT environment**
 - Over 150 UNIX servers (Sun, IBM pSeries)
 - Approximately 375 Oracle DB processor licenses
- **Several Intel servers**
 - 5 x zSeries 890 for a total of 2000 MIPS
 - System z9 EC as a Linux only server (5 IFLs)
 - Several departments with all similar pains
 - Security, networking, infrastructure, architecture / support / development, etc.
- **Customer pains that z9 EC addresses**
 - Demand for Web environment increasing and unpredictable
 - Available resources decreasing to deploy and support these servers
 - Need for improvement in cost for deploying the solutions and time-to-market
 - Disaster recovery



DGTIC – business case

- **Divided the customer environment into functional layers suitable for Linux on System z with high/low probability**
 - DB, WAS, Web, LDAP, Edge, Firewalls, Portal, etc.
- **Sizing on a sample of each layer**
 - Done by IBM Techline with available data
- **Built scenarios with customer data**
 - Divided the business case in 2
 - Tangible benefits (hardware, software, maintenance, disaster recovery) – overall 20+% savings
 - Intangible benefits (management, resources, speed of deployment)
- **Find the one application driving the most benefits**
 - Criteria:
 - Quick payback
 - Portability
 - Speed of migration
 - Stable system
 - The winner: Oracle DB – 40+% savings (\$1.2M per year just in software costs for Oracle)



DGTIC – intangible benefits

Category	Importance	z/VM Description	Level	Distributed platform Description		
Disciplin-ability (production mentality)	50		50		20	30
Change management	5	Formal & part of the culture	5	Formal	2	
Start-up disk	5	Unique IPL pack (like z/OS)	5	Starting a project for a cloning engine	2	
Performance hardware	65		56		26	30
Partitions	3	Partitions take only what they need (determine by the weight)	5	Partitions take everything available (determine by the weight)	3	
Processor(s) I/O	3	Dedicated processors	5	Same processors (CPU & I/O)	1	
Flexibility (ad-hoc demand)	3	A partition can use unused cycles from other partitions	4	Partition will always use all cycles available (determine by the weight)	2	
On demand	2	Annual cost for the service	3	Must purchase additional processors	2	
Experience (virtualization)	2	Close to 20 years	4	2 years +	2	
Performance software	75		61		26	35
Virtual machines	4	Virtual machines only use what they need	5	See Partition	3	
Control	4	Weight & priority	4	Weight only	2	
Flexibility (ad-hoc demand)	4	A virtual machine can use unused cycles from other virtual machines	4	N/A		
Utilisation reporting	3	Performance ToolKit	3	In-house tool	2	
Deployment (speed)	50		44		21	23
New environment creation	4	Define a new virtual machine & use the cloner	5	Define a partition & install the operating system	3	
Network	3	New definitions VLAN (VM) & firewalls	4	Network cards, cables, ports in router if new server and firewall	1	
I/O	3	Shared FICON/ESCON ports	4	HBA + ports in director, cables if new server	2	
Easiness to manage software keys	10		8		4	4
	2	Calculated with the number of IFLs per partition	4	Add all processors on which the software is running, must consider virtual vs physical	2	
Disaster recovery	130		117		35	82
Exercises	4	Remote installation	5	Staff on site (New Jersey)	2	
Operating system recovery	5	Disk recovery (from backup)	5	Installation of the operating system	1	
Testing results	4	Complete & successful (the process is identical as z/OS)	4	Not enough time to complete the tests	1	
Hardware isolation	4	z/VM is independent of the hardware	4	Must have compatible hardware (might need the same identical hardware)	1	
Backups	5	Well known & integrated process (from mainframe expertise)	4	Limited trust in the process	2	
Inventory	4	One unique inventory	5	Multiple inventories	1	
Security	25		23		16	7
Certification	3	LPAR EAL5A	5	Partition EAL 4+	4	
Cryptography	2	CPACF + Crypto cards	4	Software	2	
RAS	55		48		22	26
Redundancy	4	Backup processors always available	5	Backup processors only available if on demand package available (\$)	2	
Operating system	4	100% of planned time	4	AIX, Windows, SAN	2	
Disks	3	Partitions 9980 & FICON	4	HDS 9585 & FCP and disk towers	2	
Total	460		407		170	237
			88.48%		36.96%	



DGTIC – next steps

- **Where we stand**
 - Installed z9 EC December 2005
 - Virtual architecture (z/VM V5.2) ready to receive Oracle DB
 - Cloning mechanism
 - VLANs
 - All 6 security zones
 - Data recovery test successful
 - Never was successful with distributed platform
 - Intrusion tests by security complete
 - Hurdles anticipated – they are not technical
 - Internal politics
 - Education
 - Should have around 150 instances of Oracle running by end of year
 - Currently 70 instances with z9 EC running 10% busy
- **What's next**
 - IBM WebSphere Application Server, IBM WebSphere Portal, IBM Lotus Domino, firewalls



IBM System z



**Where you can find
additional information
about Linux on System z**



IBM Systems
Simplify your IT.

© 2006 IBM Corporation



Linux on System z Web site

ibm.com/zseries/linux

Country/region [select] | Terms of use

IBM

Home | Products | Services & industry solutions | Support & downloads | My account

Servers > Mainframe servers >

Linux on IBM System z™

An ideal foundation for on demand operating environments
 What do you get when you combine the scalability and reliability of IBM mainframe servers with the flexibility and open standards of Linux? Measurable business value.
 → [Get started with Linux on IBM System z](#)

Featured topics

- **LGT teams with IBM to consolidate Oracle instances on zSeries**
 Rolf Künzler, CTO at LGT Financial Service AG, and his team are looking at additional Oracle databases for consolidation on zSeries. A driving force behind their analysis is use of their IBM mainframes as centralized "data centers", which offer optimized I/O processing for databases.
- **IBM Japan builds new accounting system for NYK Line**
 To implement a system that improved responsiveness to rapidly changing market conditions, scaled according to throughput increases required a minimal implementation period, NYK Line selected IBM's open mainframe IBM System z990, Linux and SAP's ERP package.
- **New software vendor products**
 Check out the over 20 new software vendor products that have been added to the "Software Developer Products for Linux on IBM System z" web page in the last three months? They are marked with a red indicators.

Request a quote
 Tell us what you need, and we will contact you with a custom quote.
 → [Request a quote](#)

Take back control

 IBM Systems z9 and zSeries Expo
 9-13 Oct 2006
 → [Learn more](#)

IBM Director Extensions



z/VM Web site

ibm.com/vm

The screenshot shows the IBM z/VM website. At the top, there is a navigation bar with the IBM logo, a search box, and links for 'Country/region [select]' and 'Terms of use'. Below this is a secondary navigation bar with links for 'Home', 'Products', 'Services & solutions', 'Support & downloads', and 'My account'. The main content area is titled 'z/VM' and includes a breadcrumb trail: 'Servers > Mainframe servers > z/VM >'. The central heading is 'z/VM® the newest VM operating system based on 64-bit z/Architecture.' Below this, there is a section for 'Currently supported releases of z/VM' which lists 'Now available: z/VM V5.2, z/VM V5.1' and 'Also supported: z/VM V4.4'. To the right of this section is a 'Mainframe history' graphic showing a timeline from 1964 to 2004, with the text '40 years and counting' and 'Explore IBM mainframe innovation'. Below the history is a section 'Is your VM current?' with the text 'Thinking about migration?'. At the bottom right, there is a 'Technical Conference' section titled 'ENROLL TODAY' for the 'IBM System z™ Expo' on 'Oct. 9-13, 2006 Orlando, Florida'. On the left side of the page, there is a vertical navigation menu with links for 'z/VM', 'News', 'About z/VM', 'Events calendar', 'Products and features', 'Downloads', 'Technical resources', 'Library', 'How to buy', 'Service', 'Education', 'Site map', 'Site search', 'Printer-friendly', 'Notify me', and 'Contact z/VM'. The bottom of the page features a 'Summary of News and Updates' section with a link to 'View 01 Aug. 2006 updates.' and a list of 'Worldwide announcement letters' with dates and titles.



Internet list server discussions

■ IBMVM discusses z/VM

- To subscribe, send a note to listserv@listserv.uark.edu. In the body of the note, write only the following line:
 - **SUBSCRIBE IBMVM** *firstname lastname*
- View and search the current list and archives:
 - <http://listserv.uark.edu/archives/ibmvm.html>

■ LINUX-390 discusses Linux on System z

- To subscribe, send a note to listserv@vm.marist.edu. In the body of the note, write only the following line:
 - **SUBSCRIBE LINUX-390** *firstname lastname*
- View and search the current list and archives:
 - <http://www.marist.edu/htbin/wlvindex?linux-390>



Mark Post's Linux for Big Iron site

linuxvm.org



Last updated on:
Tuesday May 23, 2006

Software

- [Linux/390 Distributions](#)
- [Linux/390 Patches](#)
- [Hercules](#) - An S/390 Hardware Emulator

Linux for S/390

Linux for Big Iron

Linux for S/390 and zSeries, also known as Linux/390, is the native port of Linux to the S/390 and zSeries hardware platforms. It runs on the bare hardware, in an LPAR and as a VM, or z/VM guest.

LinuxVM.org is the official home of the Linux/390 project. The purpose of the project is to provide a central source of Linux/390 information and software, and to explore the possibilities of Linux and CP integration or interoperation.

The list of Linux/390 Redbooks was getting a little too unweildy to remain on the front page, so it has been moved to its [own page](#).

05/11/2006 - Mark Post announced that he was now now able to provide Linux/390 DVDs for people that want them:

Thanks to the vast generosity of John McKown, I now have a DVD burner on one of my Intel Slackware systems. As I said in a previous post, I am now willing to provide DVDs of any freely available Linux/390 distribution that you can find .iso files for. (If



Linux LIVE Workshop

Poughkeepsie, NY – September 19-21, 2006

- **The Linux Live workshop is intended to help customers gain an understanding of the value of Linux on System z and z/VM, and to assist in their decisions regarding deploying applications with Linux on System z by providing the basic skills necessary to launch a Linux on System z and z/VM trial evaluation.**
- **The workshop is designed in modular fashion which permits attendees to choose what they want to see and learn, with minimal lecture and maximum hands-on, practicing a learning by doing.**
- **Expenses:**
 - There will be NO charge for the Workshop
 - Travel arrangements, room and board are the responsibility of the individuals attending the Workshop
- **Note: IBM will provide laptops for use during the workshop**
- **Duration: 8:30 - 5:00 (day 1,2, - day 3 ends at 1PM)**
- **How to register:**
 - Contact Danielle Nowak at danielln@us.ibm.com or call (845) 433-3519 note, Danielle can provide attendees with name of local hotels. Hotel reservations are the responsibility of individuals attending workshop.
 - Class size will be limited to 16 participants per session.
 - Registration will be done on a first come first served basis, but please be sure you have authorization to travel before you register.



Additional web sites

- **z/VM resources for Linux on IBM System z**
 - ibm.com/vm/linux
- **Answers.com**
 - www.answers.com/topic/linux-on-zseries
- **Wikipedia**
 - wikipedia.org/wiki/Linux_on_zSeries
- **Linux distributions for System z**
 - Novell SUSE Linux Enterprise at www.novell.com/linux
 - Red Hat Enterprise Linux at www.redhat.com/rhel
 - Centos at www.centos.org (no-charge)



IBM System z

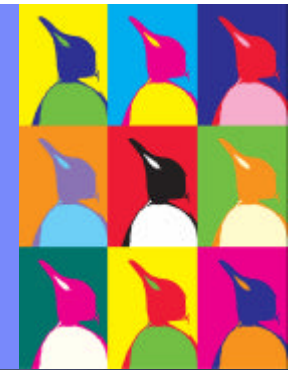

Summary



IBM Systems

Simplify your IT.

© 2006 IBM Corporation



What next?

- **Familiarize yourself with Linux and IBM System z**
- **View Linux as a valid alternative for IT systems**
- **Incorporate open source software development into IT strategies**
- **Look at Linux on System z to see how it can lower costs, increase reliability and security, and improve service**

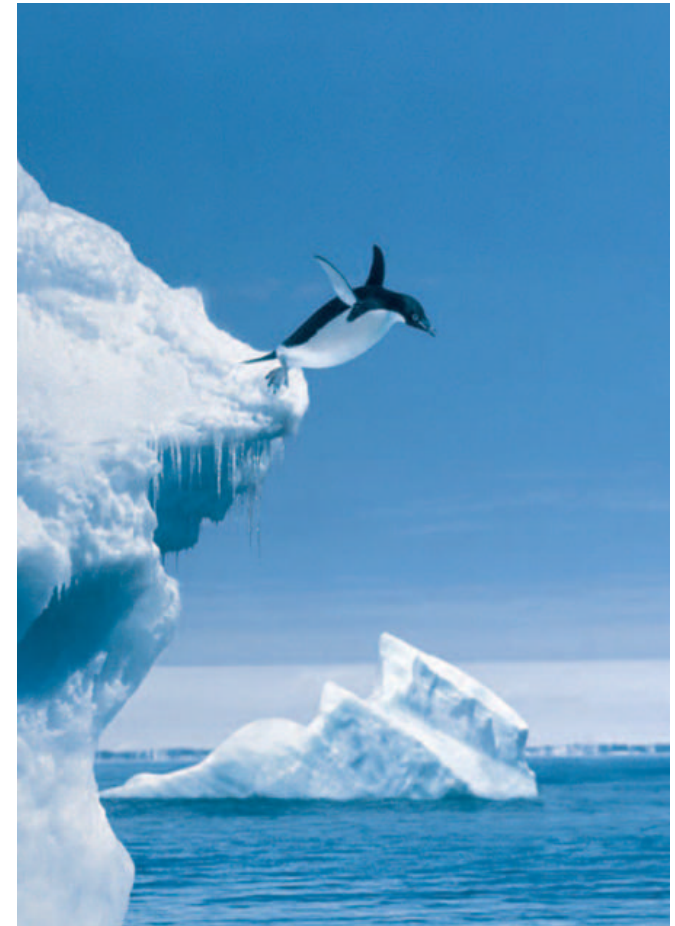

Thank you

Jim Elliott

Advocate – Linux, Open Source, and Virtualization
Manager – System z Operating Systems

IBM Canada Ltd.

jim_elliott@ca.ibm.com

905-316-5813

ibm.com/linux

ibm.com/systems/z

ibm.com/vm/devpages/jelliott

linux.ca/drupal/blog/58



Notices

- **© Copyright IBM Corporation 2000, 2006. All rights reserved.**
- **This document contains words and/or phrases that are trademarks or registered trademarks of the International Business Machines Corporation in the United States and/or other countries. For information on IBM trademarks go to <http://www.ibm.com/legal/copytrade.shtml>.**
- **The following are trademarks or registered trademarks of other companies.**
 - Java and all Java-related trademarks and logos are trademarks of Sun Microsystems, Inc., in the United States and other countries.
 - UNIX is a registered trademark of The Open Group in the United States and other countries.
 - Microsoft, Windows and Windows NT are registered trademarks of Microsoft Corporation.
 - Red Hat, the Red Hat "Shadow Man" logo, and all Red Hat-based trademarks and logos are trademarks or registered trademarks of Red Hat, Inc., in the United States and other countries.
 - Linux is a trademark of Linus Torvalds in the United States, other countries, or both.
 - All other products may be trademarks or registered trademarks of their respective companies.
- **Notes:**
 - This publication was produced in Canada. IBM may not offer the products, services or features discussed in this document in other countries, and the information may be subject to change without notice. Consult your local IBM business contact for information on the product or services available in your area.
 - All statements regarding IBM's future direction and intent are subject to change or withdrawal without notice, and represent goals and objectives only.
 - Information about non-IBM products is obtained from the manufacturers of those products or their published announcements. IBM has not tested those products and cannot confirm the performance, compatibility, or any other claims related to non-IBM products. Questions on the capabilities of non-IBM products should be addressed to the suppliers of those products.
 - Prices subject to change without notice. Contact your IBM representative or Business Partner for the most current pricing in your geography.
- **Permission is hereby granted to SHARE to publish an exact copy of this paper in the SHARE proceedings. IBM retains the title to the copyright in this paper as well as title to the copyright in all underlying works. IBM retains the right to make derivative works and to republish and distribute this paper to whomever it chooses in any way it chooses.**