

IBM Software Group

# Day In the Life Scenario - Developer sequence Using RTC, RAA and EGL integrated with RDz

**Mark Boyd**

Rational IT Specialist

**Wilbert Kho**

Rational IT Specialist

**Rational.** software



Feb, 15 2011

© 2011 IBM Corporation

## Scenario

JK Enterprises has a business need to provide their partners an interface into back end processing.

Doing so will drive top line growth and extend their business.

IT has the high level request, but there are inhibitors:

- What code executes these processes now?
- How will they extend it to the web?
- If they change the code what is the impact to other logic or applications?
- How will they track schedules and report changes?

Chief architect has set a strategy for services oriented architecture (SOA) and enterprise integration.

Although the processing is run on the mainframe, that team needs to demonstrate their value and contribute to the go forward strategy.



## But with Rational Team Concert for System z, you get...

*A unified client*

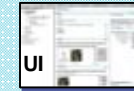

Unified Work Items, Planning,  
SCM, Build Mgmt, Reporting

Single UI, storage and process

Reduces Cost of Ownership

Administrative costs

Training/Adoption

Customizations

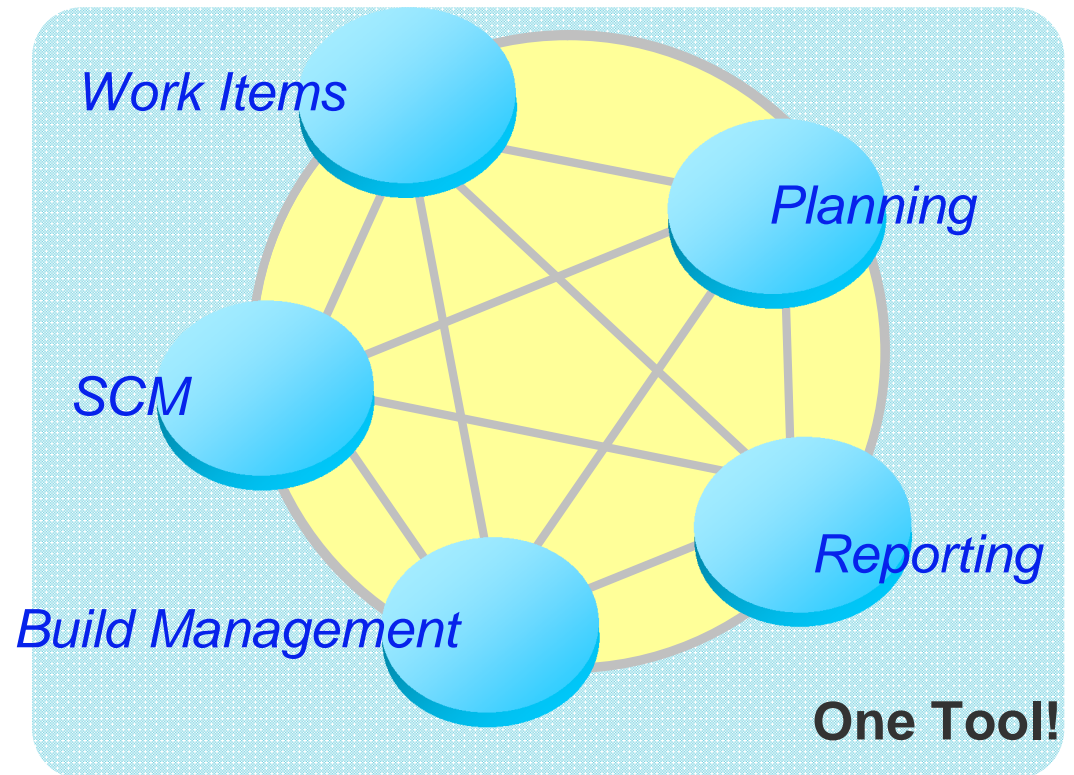

*With unified storage*



# Rational Team Concert for System z: An open, extensible architecture

*Supporting a broad range of desktop clients, IDE's and languages*

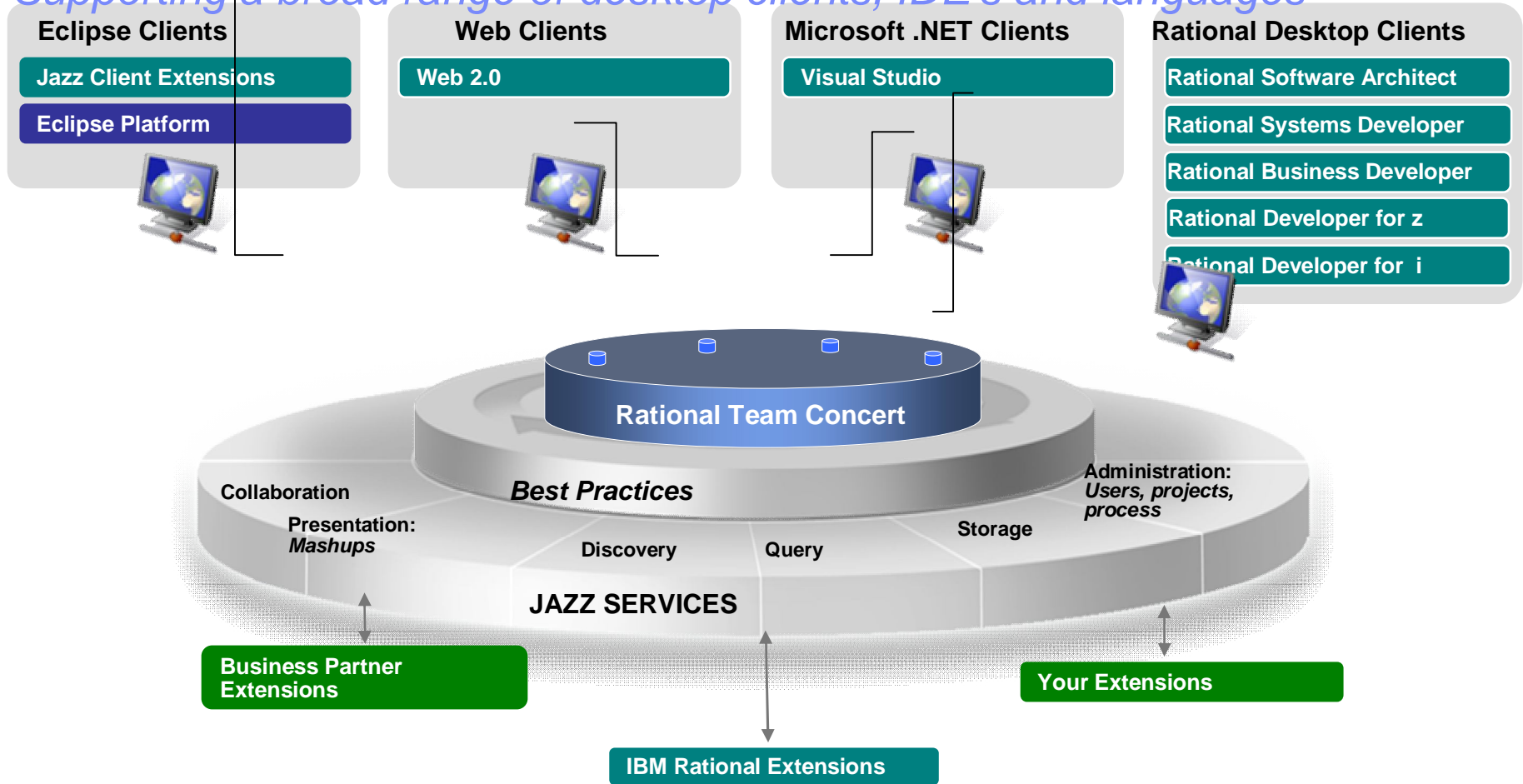

# Announcing the RDz Unit Test Feature

*The ultimate in modern application development for System z*

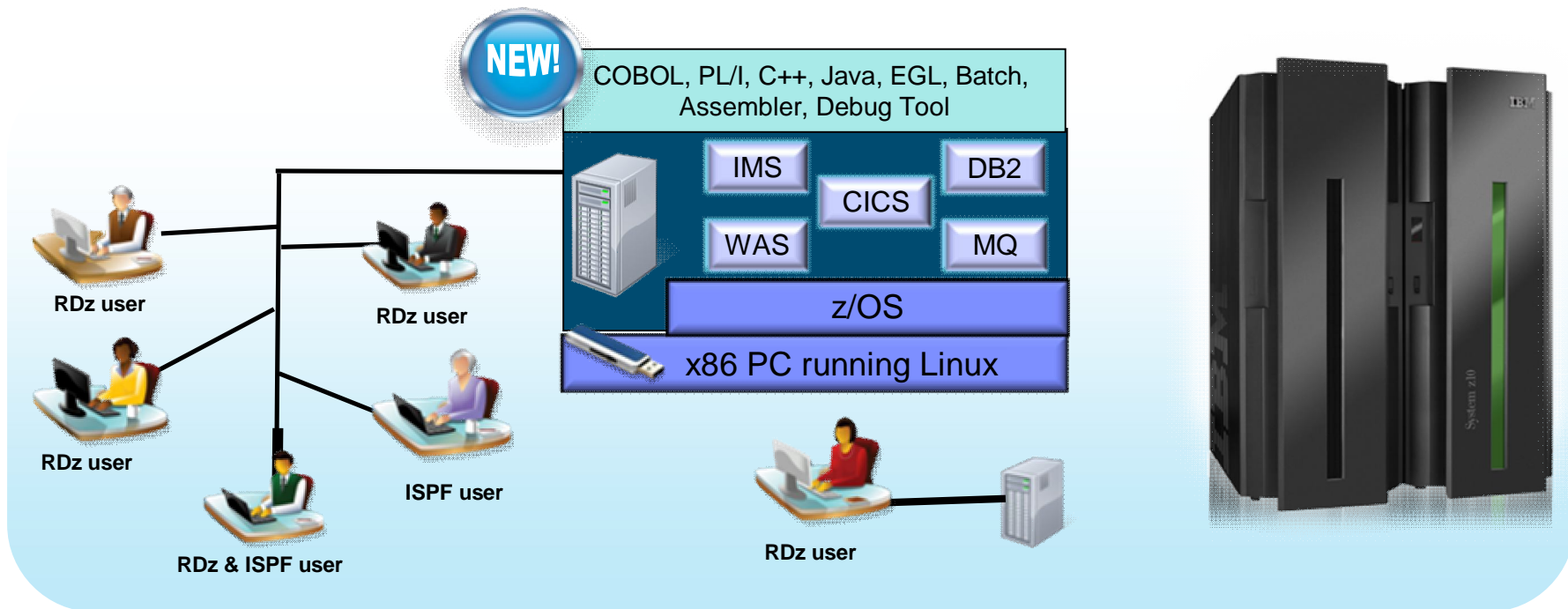

- Liberate developers to rapidly prototype new applications
- Develop and test System z applications anywhere, anytime!
- Free up mainframe development MIPS for production capacity
- Eliminate costly delays by reducing dependencies on operations staff

Note: This Program is licensed only for development and test of applications that run on IBM z/OS. The Program may not be used to run production workloads of any kind, nor more robust development workloads including without limitation production module builds, pre-production testing, stress testing, or performance testing.



# Rational Asset Analyzer Architectural View

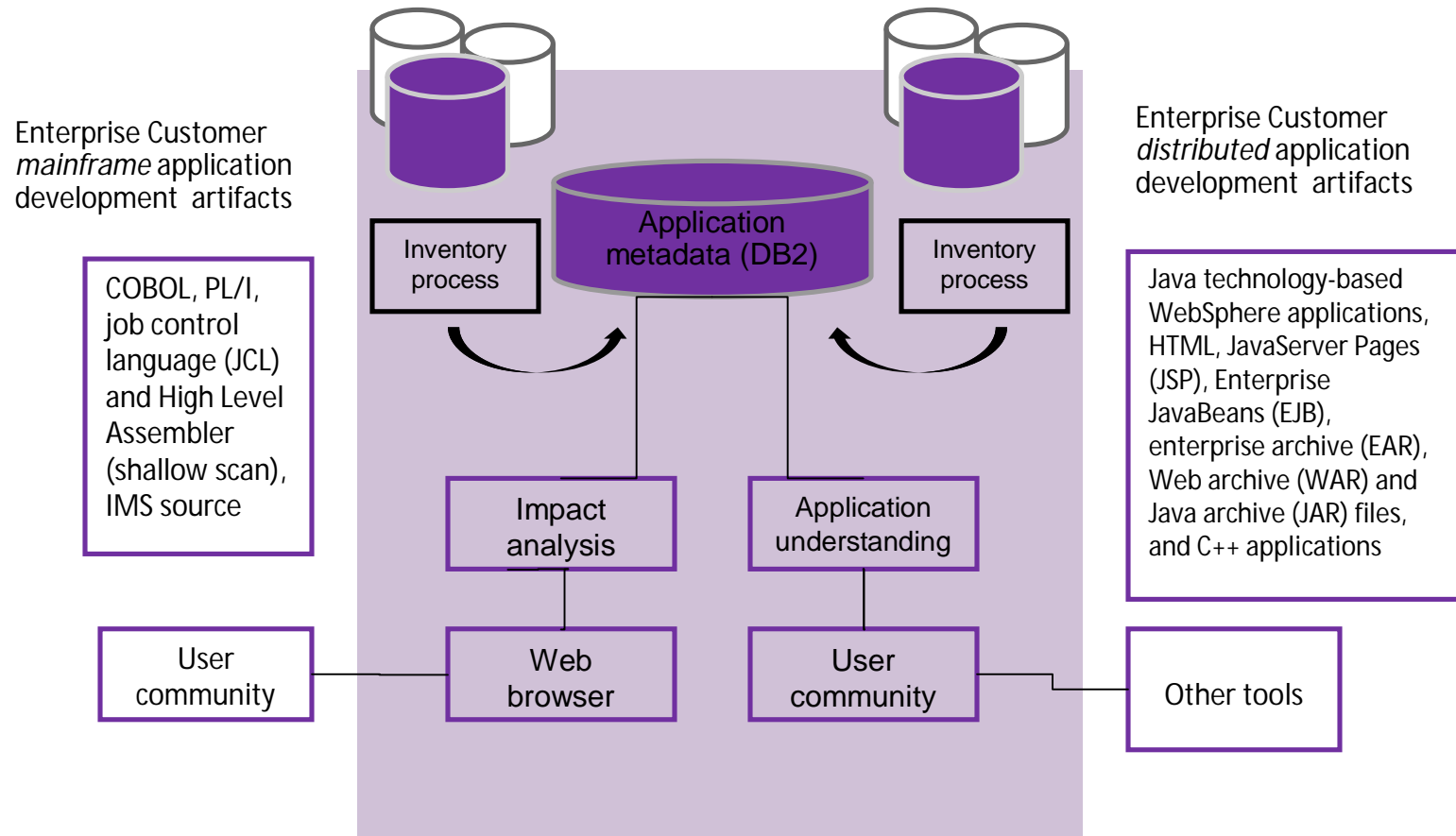

Understand code relationships  
Understand code complexity  
Perform impact analysis



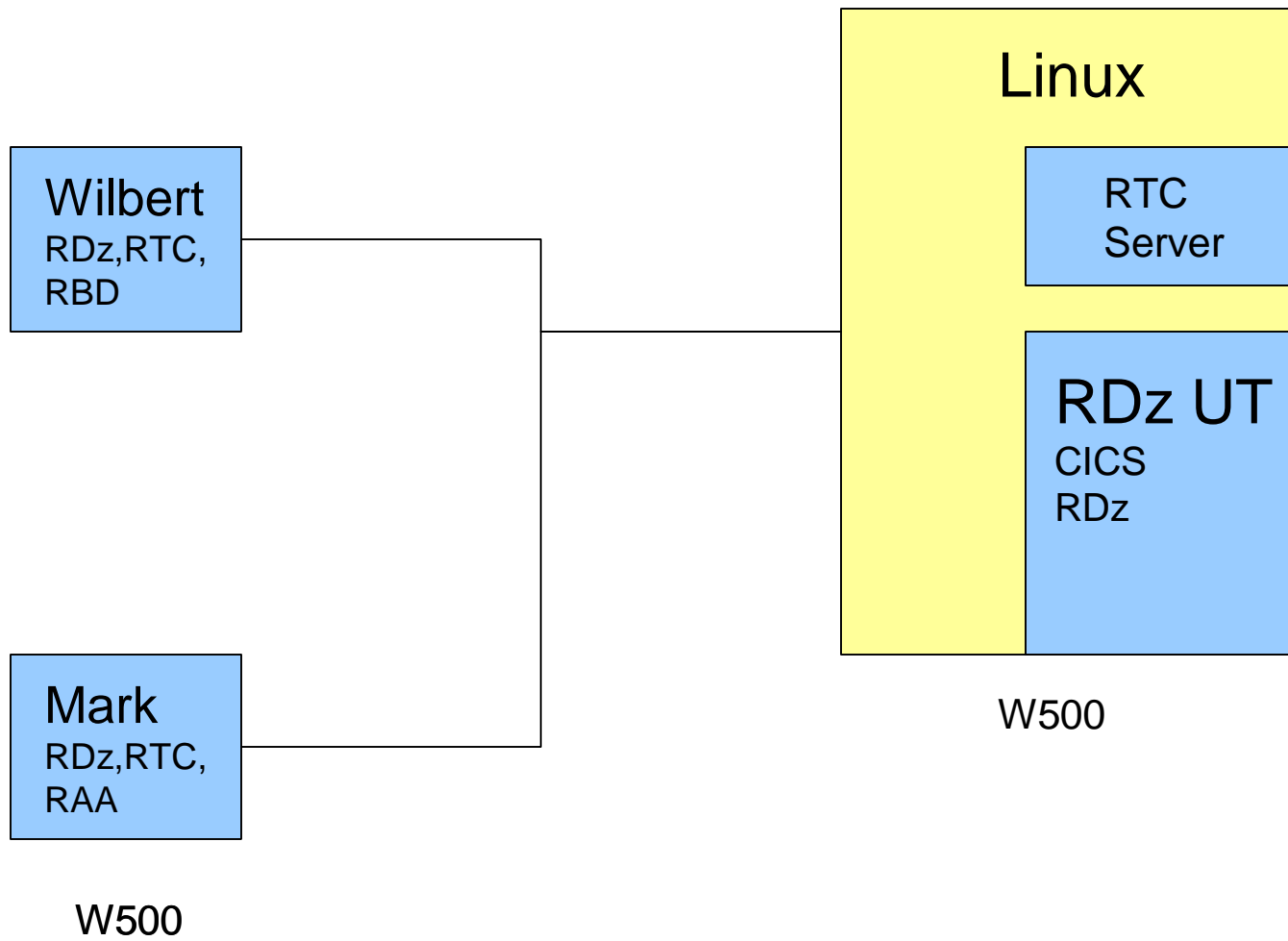



[One\\_day\\_developer\\_demo\\_27Min\One\\_day\\_developer\\_demo\\_27Min.html](#)





**Objective: Create a Web 2.0 Client from existing COBOL/CICS application**

**Analyst/Architect:**

**Analysis to understand the necessary transformations and impact**

1. Requirement to move the existing CICS transaction (BKXX) to the Web and creates the requirement (work item) using **Rational Team Concert (RTC)**.
2. Analyst or architect receives the request.  
Uses **Rational Asset Analyzer (RAA)** to understand application framework.  
Also need to determine which assets to transform along with impact analysis of any changes.
3. Using **Rational Team Concert (RTC)** creates additional requirements (work item) for development team to proceed with the transformations.



## RDz UT host machine specifications

- Underlying Linux host
  - ▶ Red Hat Enterprise Linux 5.3 (RHEL 5.3)
  - ▶ OpenSUSE 10.3, 11.0, and 11.1
  - ▶ Note: IBM does not support installation on other distributions.
- Base machine must have:
  - ▶ at least 3 GB of real memory:
    - 1 GB is required for the 64-bit Red Hat or openSUSE Linux
    - 1-2 GB is required for the System z operating system, depending on the size of the development system
  - ▶ at least 80 GB free disk space available after Linux
  - ▶ Note: RDz UT has been tested on:
    - Lenovo ThinkPad W Series
    - IBM System x 3500 M1, 3500 M2, 3650 M1, and 3650 M2



# Software Stack for as-is usage

## z/OS MLC Products

- IMS V10.1 Database Manager
- IMS V10.1 Transaction Manager
- DB2 for z/OS V9.1
- WS MQ Base for z/OS V7.0
- Enterprise COBOL V4.2
- Enterprise PL/I z/OS V3.9
- CICS TS for z/OS V4.1
- CICS TS for z/OS V3.2
- z/OS V1.11 Base
  - ▶ z/OS V1.11 C/C++ without Debug
  - ▶ z/OS V1.11 DFSMS dss
  - ▶ z/OS V1.11 DFSMS rmm
  - ▶ z/OS V1.11 DFSORT
  - ▶ z/OS V1.11 RMF
  - ▶ z/OS V1.11 SDSF
  - ▶ z/OS V1.11 Security Server
  - ▶ z/OS V1.11 ISPF
  - ▶ ... (all sub features)
- z/OS V1.10 Base
  - ▶ ... (all sub features)
- Other utilities...

## z/OS OTC Products

- WebSphere for z/OS 7.0
- DB2 Utilities Suite V9
- WebSphere Portal Enable z/OS
- IBM Debug Tool

## Other Tools pre-installed

- RTCz file/build agents
- RDz RSE and Job Monitor



**Objective: Create a Web 2.0 Client from existing COBOL/CICS application**

**Developer: Perform the transformations**

1. Uses **Rational Team Concert (RTC)** integrated with **Rational Developer for System z (RDz)** plug-in to verify the requirement (work item)
1. Uses **Rational Asset Analyzer** integration with RDz (**RAAi**) to better understand the program to be modified
2. Uses **RDz** to create, deploy and test the CICS Web Services
3. Developer uses CICS Explorer component of RDz to debug the COBOL/CICS program using the **z/OS Debug Tool** (running on z/OS – **RDz UT**)
4. Developer Create and test the Web 2.0 interface using **RDz with EGL**



Have iPhone or iPad ? Try below (all lower case)

<http://zserveros.demos.ibm.com:9080/bank/egl.html>

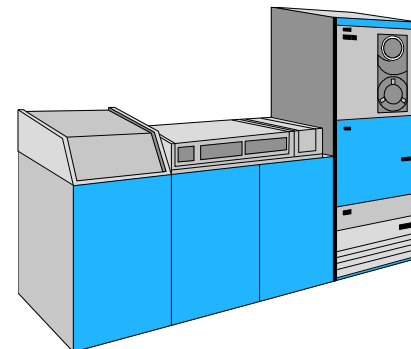
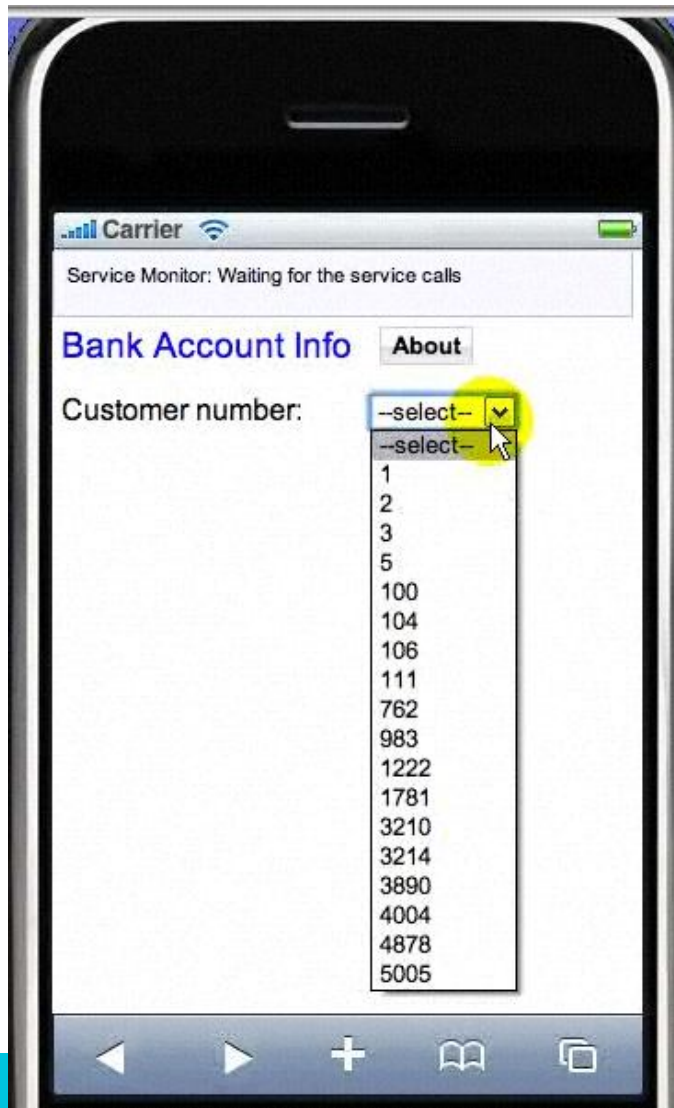

z/OS running in Texas

# IBM Enterprise Modernization Sandbox

*PLAY at your own pace with our mainframe...*

- ✓ Learn how to revitalize applications, empower people, unify teams and exploit infrastructure based on your knowledge and experiences
- ✓ New extended trials offering for customers and partners who need more time to explore product features in a controlled environment
- ✓ Get fast start with scripted scenarios and best practice education materials at no cost available 24x7
- ✓ A low risk way to try out several new offerings and integrated solutions without disturbing your existing environment



<http://www.ibm.com/developerworks/downloads/emsandbox/>

*Since the System z and Power Sandboxes are deployed in IBM's own data centers and available through a browser with a minimal footprint (i.e., a Citrix plug-in install) you can now realize the value proposition of IBM's Software Products firsthand within minutes.*



## Discovering the value of IBM Rational Developer for System z

**FREE**

Attendees will complete structured walk through labs that demonstrate the major features and new functionality of RDz. The labs also provide an introductory hands-on experience to using RDz on building a zSeries-based Service Oriented Architecture (SOA).

The main points to be covered are:

- How to code test and debug a simple COBOL or PL/I program that access DB2 without connection to the mainframe using RDz
- How to code compile and debug using a remote connection to z/OS eliminating the need for /ISPF.
- How to create a Java client from existing z/OS CICS or IMS COBOL programs using J2C connectors and then test it.
- How to transform and test existing COBOL programs to understand XML enabling service-oriented architecture (SOA) access to CICS Transaction Server and IMS.
- How to create test and debug z/OS DB2 Stored Procedures using COBOL or PL/I
- How to use the BMS Editor for CICS or MFS Editor for IMS with RDz.
- How to use the Enterprise Service Tools Service Flow modeling capability of RDz to create a business service that may be deployed to CICS and invoked as a Web service
- How to generate COBOL/CICS/DB2 COBOL program from existing z/OS DB2 tables using RDz wizard
- How to generate a Web application that access databases and Web 2.0 examples using EGL wizards.

**Duration : 2 days**

<http://techworks.dfw.ibm.com/americas/RWBA-7P8LKX>

