

IBM System z Technology Summit

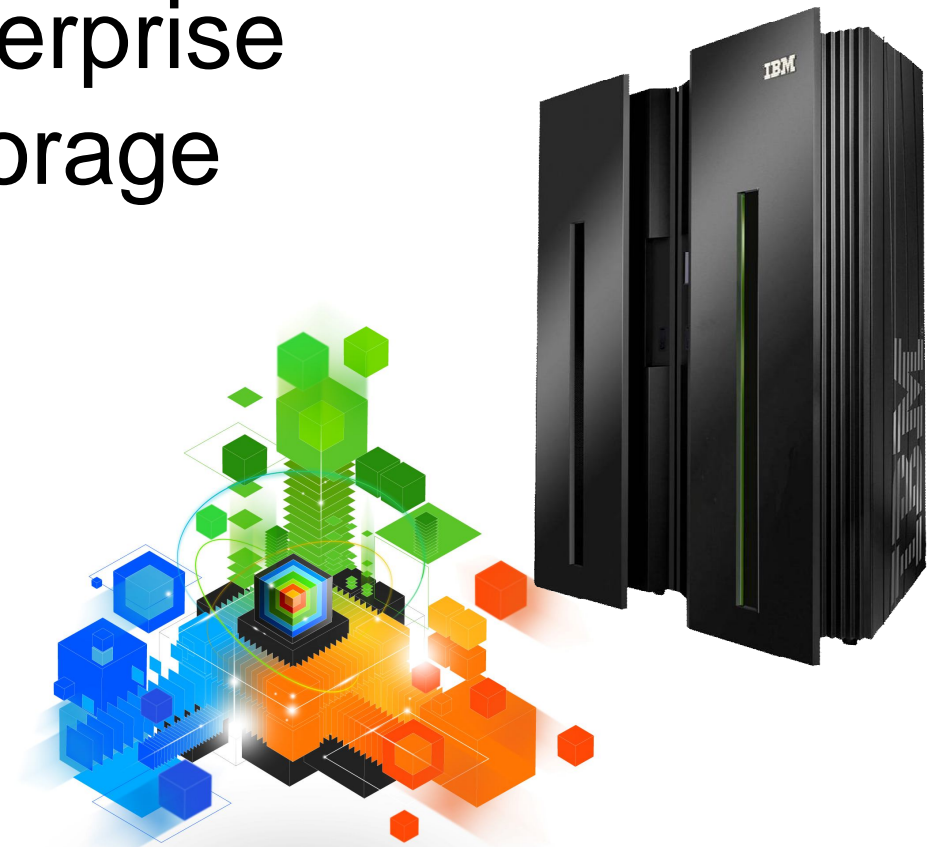

Introducing the zEnterprise z196 servers and storage



Notes to speaker:

- Abstract for this presentation: Session z – Manage your Business -- Not your Hardware -- Bringing Workload Awareness to a heterogeneous infrastructure
 - Issue – Despite the allure of a one-system-fits-all approach - the reality is complex solutions are optimally deployed on multi-tier heterogeneous infrastructures
 - Solution – Install the new zEnterprise System to realize the heterogeneous management, availability, security, and scalability that IBM System z brings to your shop
 - Products - IBM zEnterprise System, IBM zEnterprise 196 (z196), zEnterprise BladeCenter Extension (zBX), zEnterprise Unified Resource Manager

- There are several charts in this deck that may be removed to shorten the presentation. But you should make sure you cover the zDAC info in the operating system discussion, and talk about the new I/O drawer when you cover the server.

- Several charts require screen show. Make sure you verify those before you present.

Trademarks

The following are trademarks of the International Business Machines Corporation in the United States and/or other countries.

AIX*	HiperSockets	POWER7*	System z10	zSeries*
BladeCenter*	IBM*	PowerVM	WebSphere*	z/VM*
DataPower*	IBM eServer	RP/SM	z9*	z/VSE
DB2*	IBM (logo)*	RACF*	z10 BC	
FICON*	InfiniBand*	System x*	z10 EC	
GDPS*	Parallel Sysplex*	System z*	zEnterprise	
Geographically Dispersed Parallel Sysplex	POWER*	System z9*	z/OS*	

* Registered trademarks of IBM Corporation

The following are trademarks or registered trademarks of other companies.

Adobe, the Adobe logo, PostScript, and the PostScript logo are either registered trademarks or trademarks of Adobe Systems Incorporated in the United States, and/or other countries.

Cell Broadband Engine is a trademark of Sony Computer Entertainment, Inc. in the United States, other countries, or both and is used under license there from.

Java and all Java-based trademarks are trademarks of Sun Microsystems, Inc. in the United States, other countries, or both.

Microsoft, Windows, Windows NT, and the Windows logo are trademarks of Microsoft Corporation in the United States, other countries, or both.

InfiniBand is a trademark and service mark of the InfiniBand Trade Association.

Intel, Intel logo, Intel Inside, Intel Inside logo, Intel Centrino, Intel Centrino logo, Celeron, Intel Xeon, Intel SpeedStep, Itanium, and Pentium are trademarks or registered trademarks of Intel Corporation or its subsidiaries in the United States and other countries.

UNIX is a registered trademark of The Open Group in the United States and other countries.

Linux is a registered trademark of Linus Torvalds in the United States, other countries, or both.

ITIL is a registered trademark, and a registered community trademark of the Office of Government Commerce, and is registered in the U.S. Patent and Trademark Office.

IT Infrastructure Library is a registered trademark of the Central Computer and Telecommunications Agency, which is now part of the Office of Government Commerce.

* All other products may be trademarks or registered trademarks of their respective companies.

Notes:

Performance is in Internal Throughput Rate (ITR) ratio based on measurements and projections using standard IBM benchmarks in a controlled environment. The actual throughput that any user will experience will vary depending upon considerations such as the amount of multiprogramming in the user's job stream, the I/O configuration, the storage configuration, and the workload processed. Therefore, no assurance can be given that an individual user will achieve throughput improvements equivalent to the performance ratios stated here.

IBM hardware products are manufactured from new parts, or new and serviceable used parts. Regardless, our warranty terms apply.

All customer examples cited or described in this presentation are presented as illustrations of the manner in which some customers have used IBM products and the results they may have achieved. Actual environmental costs and performance characteristics will vary depending on individual customer configurations and conditions.

This publication was produced in the United States. IBM may not offer the products, services or features discussed in this document in other countries, and the information may be subject to change without notice. Consult your local IBM business contact for information on the product or services available in your area.

All statements regarding IBM's future direction and intent are subject to change or withdrawal without notice, and represent goals and objectives only.

Information about non-IBM products is obtained from the manufacturers of those products or their published announcements. IBM has not tested those products and cannot confirm the performance, compatibility, or any other claims related to non-IBM products. Questions on the capabilities of non-IBM products should be addressed to the suppliers of those products.

Prices subject to change without notice. Contact your IBM representative or Business Partner for the most current pricing in your geography.

The world is getting smarter



Smart traffic systems



Intelligent oil field technologies



Smart food systems



Smart healthcare



Smart energy grids



Smart retail

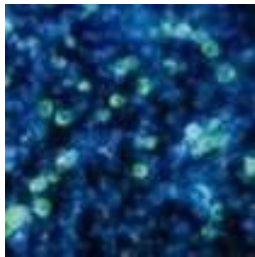

Smart water management



Smart supply chains

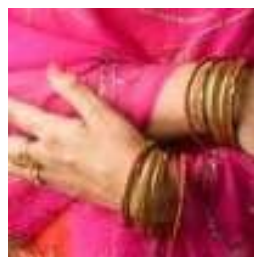

Smart countries



Smart weather



Smart regions



Smart cities

Today's data center is not built for what's coming

A smarter planet requires real-time data analytics and security for unprecedented scale and complexity

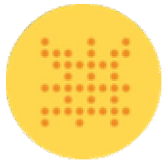

Terabytes of structured online data



Petabytes of unstructured data including real-time streams



Simple online transactions with back end processing



Complex transactions integrated with real time analytics



Online data security and intrusion detection



Security analytics for intrusion prediction and prevention

Especially in light of today's challenges

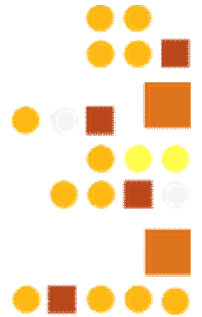

41%

of data center managers claim their data centers will max out their energy capacity within one to two years¹

Processor power doubles every 18 months,

but **85%** of this power sits idle²

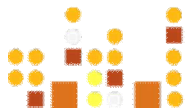

80%

of digital data is now unstructured³ and requires greater effort to transform it into usable intelligence



Despite the allure of a “one size fits all” server approach ...

Today’s enterprise computing environments are multi-platform for a reason. They’re optimized to run different workloads:

- Database and transaction processing
- Analytics
- Web-based interactions
- Enterprise applications such as ERP
- The myriad of x86 applications

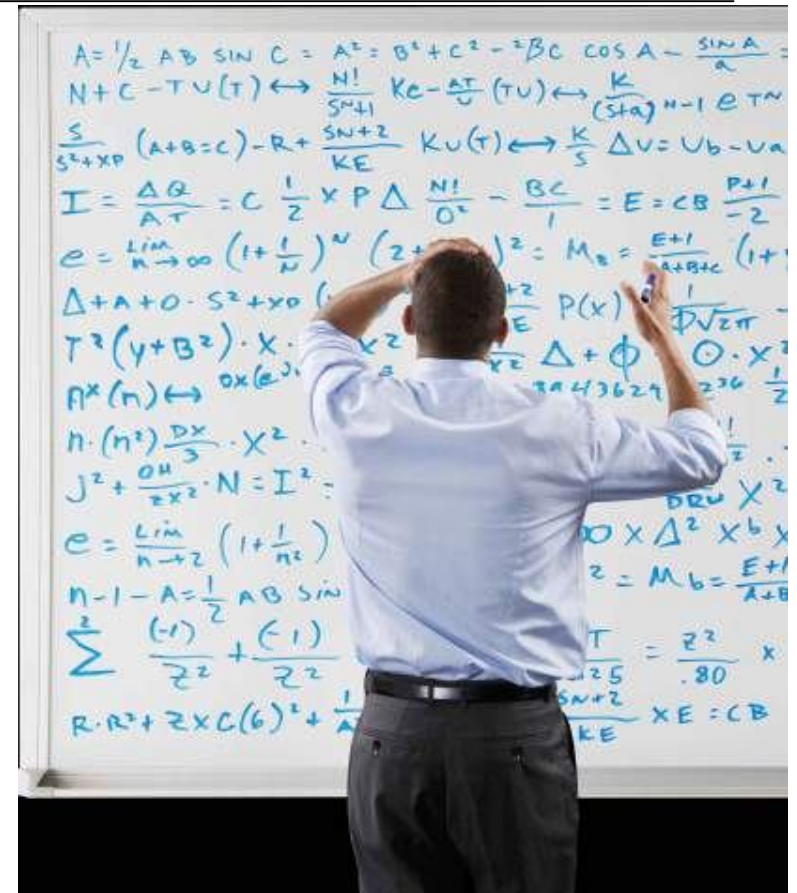

Complex solutions are optimally deployed on
multi-tier heterogeneous infrastructures

Information Technology Today: Limitations

Information technology today is limited by the technology and architecture configurations available.

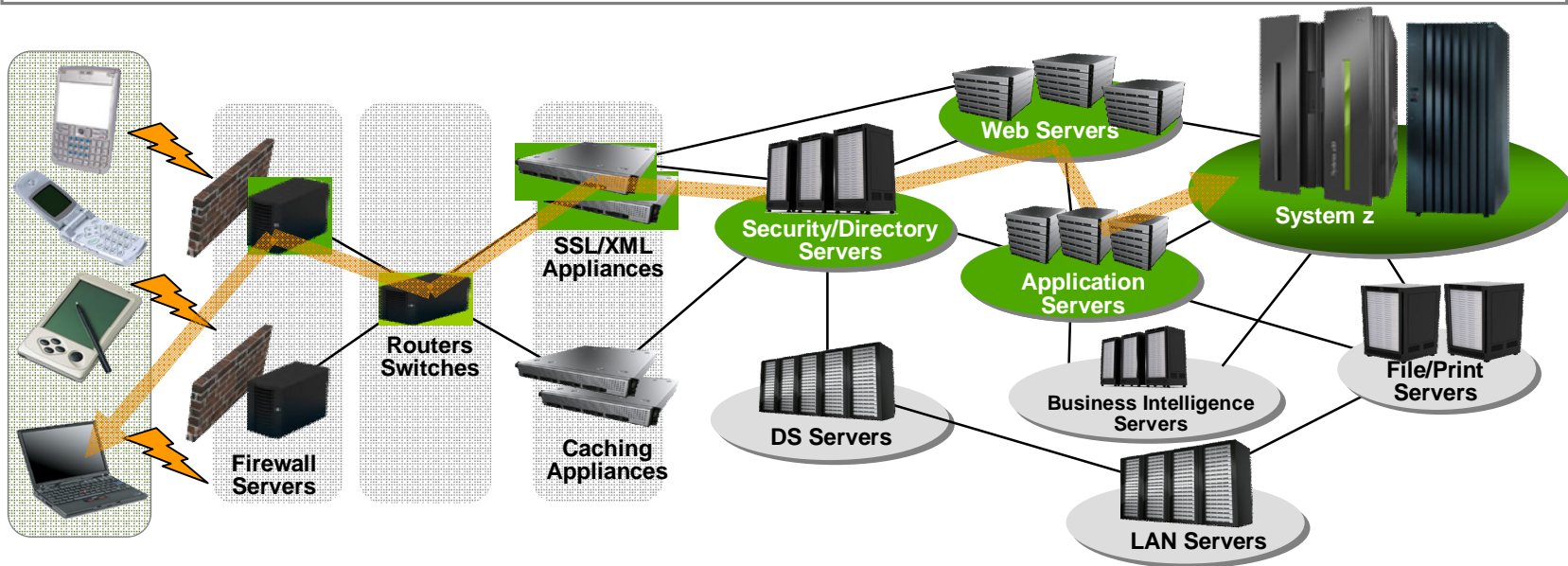

- Business processes and the applications that support them are becoming more service oriented, modular in their construction, and integrated.
- The components of these services are implemented on a variety of architectures and hosted on heterogeneous IT infrastructures.
- Approaches to managing these infrastructures along the lines of platform architecture boundaries cannot optimize: alignment of IT with business objectives; responsiveness to change; resource utilization; business resiliency; or overall cost of ownership.
- **Customers need better approach: The ability to manage the IT infrastructure and Business Application as an integrated whole.**

IBM zEnterprise System – Best in Class Systems and Software Technologies

A system of systems that unifies IT for predictable service delivery



Unified management for a smarter system: **zEnterprise Unified Resource Manager**

- Unifies management of resources, extending IBM System z® qualities of service end-to-end across workloads
- Provides platform, hardware and workload management

The world's fastest and most scalable system:
IBM zEnterprise™ 196 (z196)

- Ideal for large scale data and transaction serving and mission critical applications
- Most efficient platform for Large-scale Linux® consolidation
- Leveraging a large portfolio of z/OS® and Linux on System z applications
- Capable of massive scale up, over 50 Billion Instructions per Second (BIPS)

Scale out to a trillion instructions per second:
IBM zEnterprise BladeCenter® Extension (zBX)

- Selected IBM POWER7® blades and IBM x86 blades¹ for tens of thousands of AIX® and Linux applications
- High performance optimizers and appliances to accelerate time to insight and provide fast and flexible application integration
- Dedicated high performance private network



¹ All statements regarding IBM future direction and intent are subject to change or withdrawal without notice, and represents goals and objectives only.

The value begins at the heart of z196

zEnterprise 196 (z196)

Machine Type: 2817

Models: M15, M32, M49, M66, M80

- **New 5.2 GHz processor chip**
 - 100 new instructions, new out of order sequence, more on chip cache
- **Focus on the environment and data center**
 - Options to help eliminate hotspots and save on energy
- **Operating System Flexibility**
 - z/OS, z/VM[®], z/VSE[™], z/TPF and Linux on System z
- **Security and reliability**
 - Elliptic curve cryptography
 - Compliance and security improvements
 - Crypto Express3 enhancements
- **Backup and Disaster Recovery solutions**

1. For average LSPR workloads running z/OS 1.11.

zBX – A uniquely configured extension of the zEnterprise

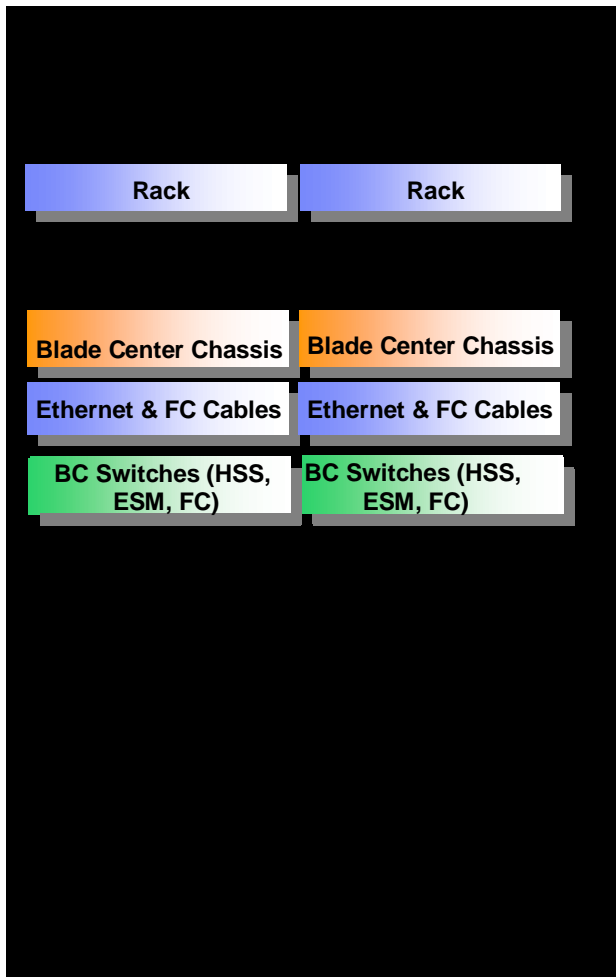

Looks like a rack with BladeCenters but much more...

- **zBX is assembled and built at the IBM plant**
 - All parts and microcode - tested and shipped as a completed package
- **zBX HW redundancy provides improved availability**
 - Redundant switches provide guaranteed connection between z196 and zBX
 - Redundant Power Distribution Units improve availability
 - Extra blowers manage heat dispersion/removal
- **zBX provides an isolated and secure network**
 - Four top-of-rack switches for connection to the controlling z196
 - Redundant 10 GB private data network (IEDN)
 - Traffic on user networks not affected

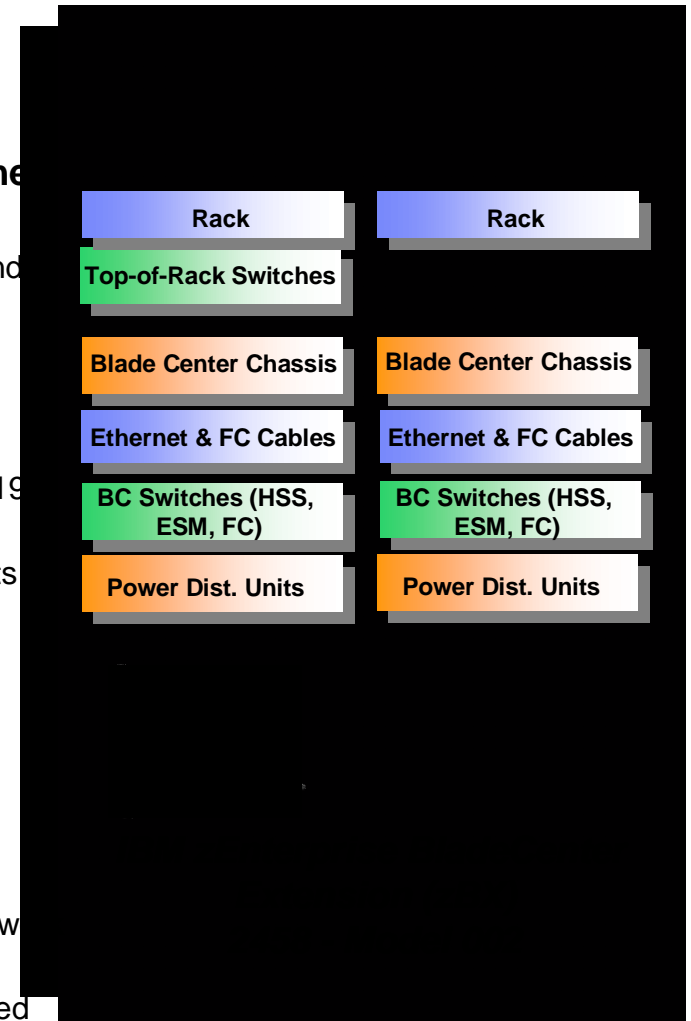

... delivering z-value to non-z platforms ...

IBM zEnterprise BladeCenter Extension (zBX) Machine Type: 2458 – Model 002

- Houses the solutions key to zEnterprise System
- System z support for problem management, hardware and firmware updates
- Expanding operating system support for zEnterprise
- Simplified management – central point of control
- Sharing of resources – up to eight z196 can access solutions on a zBX



... and the secure network provides the foundation for zEnterprise Unified Resou



IBM POWER7 and IBM x86¹ Blades

General purpose processors under one management umbrella

What is it?

The zBX infrastructure can host select IBM POWER7 and IBM x86¹ blades. Each blade comes with an installed hypervisor that offers the possibility of running an application that spans z/OS, Linux on System z, AIX on POWER[®], or Linux on System x¹ but have it under a single management umbrella.

How is it different?

- **Complete management**
- **Virtualized and Optimized**
- **Integrated**
- **Transparency**
- **More applications**

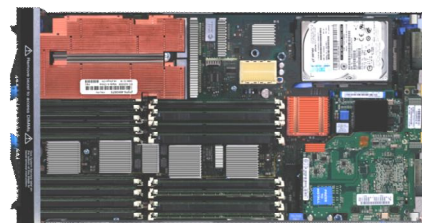

¹ All statements regarding IBM future direction and intent are subject to change or withdrawal without notice, and represents goals and objectives only.

IBM BladeCenter PS701 Express

Machine Type: 8406

Model 71Y

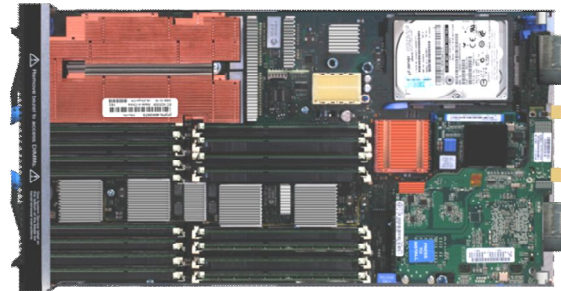

Processor Units, Memory, I/O:

- POWER7 8-core processor 3.0GHz
- Single wide blade server
- 3 configurations supported by zEnterprise System
 - 32 GB, 64 GB, 128 GB
- Flexibility in ordering – acquired through existing channels, including IBM

Environmental:

- EnergyScale Technology with dynamic energy optimization
- POWER7 Intelligent Threads technology enables workload optimization

Software:

- AIX OS 5.3 or greater
- PowerVM

Security and Reliability:

- Hot Swap Power Blades in BladeCenter Chassis
- Auto sensing by z196 initiates configuration and firmware updates done at HMC
- System z support
 - Problem reporting and 'phone home' capability
 - Blade warranty provided as part of zBX warranty and terms
 - Support by IBM System z Service Support Rep (SSR)

Note that the PS701 Express blade with features and software should be obtained through an IBM Business Partner or Distributor, an IBM sales representative, or through <http://www.ibm.com>. They do not automatically ship with the zBX.

IBM Smart Analytics Optimizer

Capitalizing on breakthrough technologies to accelerate business analytics

What is it?

The IBM Smart Analytics Optimizer is a workload optimized, appliance-like, add-on, that enables the integration of business insights into operational processes to drive winning strategies. It accelerates select queries, with unprecedented response times.

How is it different?

- Performance
- Integration
- Self-managed workloads
- Transparency
- Simplified administration



Faster insights for enabling new opportunities

WebSphere DataPower Appliance¹ in the zBX

Purpose-built hardware for simplified deployment and hardened security

What is it?

The IBM WebSphere DataPower appliance¹ integrated in the zEnterprise System, can help simplify, govern, and enhance the security of XML and IT services by providing connectivity, gateway functions, data transformation, protocol bridging, and intelligent load distribution.

How is it different?

- **Security**
- **Improved support**
- **System z packaging**
- **Operational controls**



Management Stack

Building an architectural construct of hardware, software, services

Service Management

- Visibility, Control and Automation for Applications, Transactions, Databases and Data Center Resources
- End-to End Workload Management and Service Level Objectives that Align IT Management with Business Goals
- Common Usage and Accounting for business accounting
- Dynamic/Centralized Management of Application Workloads based on Policies
- Business Resilience for multi-site recovery
- End-to-end Enterprise Security

Platform Management

Hardware Management

Extending with **Unified Resource Manager**

- Hypervisor management and creation of virtual networks
- Operational controls, service and support for hardware / firmware
- Network management of private and secure data and support networks
- Energy monitoring and management
- Workload awareness and platform performance management
- Virtualization management – single view of virtualization across the platform

zEnterprise extends Service Management for improved governance

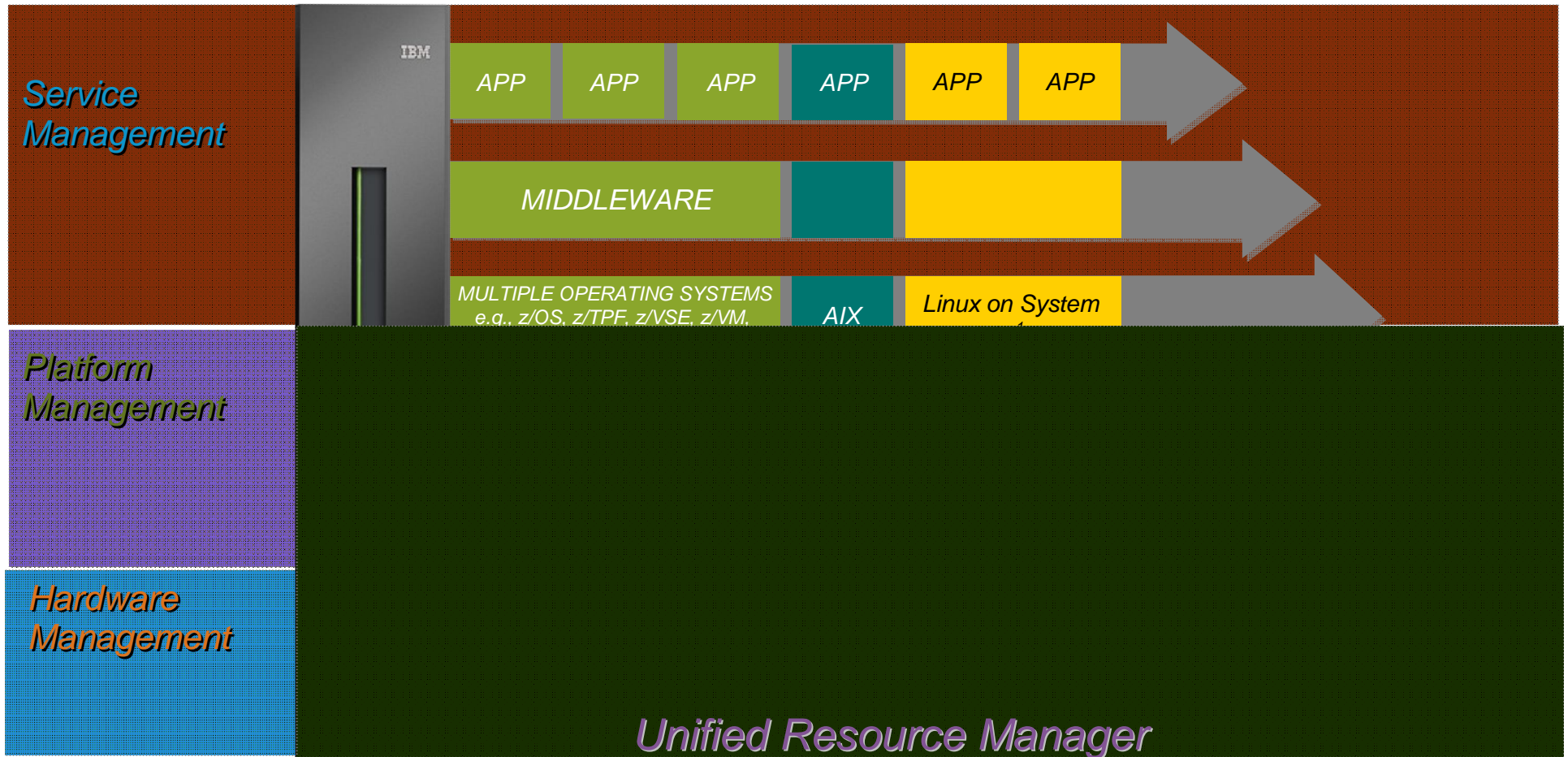

Focused, collaborative innovation
A “complete systems” approach

zEnterprise Unified Resource Manager

Transforming the way resources are managed and deployed

What is it?

- Unified Resource Manager provides *workload awareness* to optimize the system resources in accordance with understanding the policies assigned to that particular workload.
- Functions are grouped into two suites of tiered functionality that enable different levels of capability – Manage suite and Automate suite.

How is it different?

- Heterogeneous management across heterogeneous resources
- Integration with single point of control, common skills, reduced day to day
- New dashboard monitoring for CPU resources and energy management
- Simplified installation
- Improved network security
- Service and support management



... Value Made Possible By the Unified Resource Manager

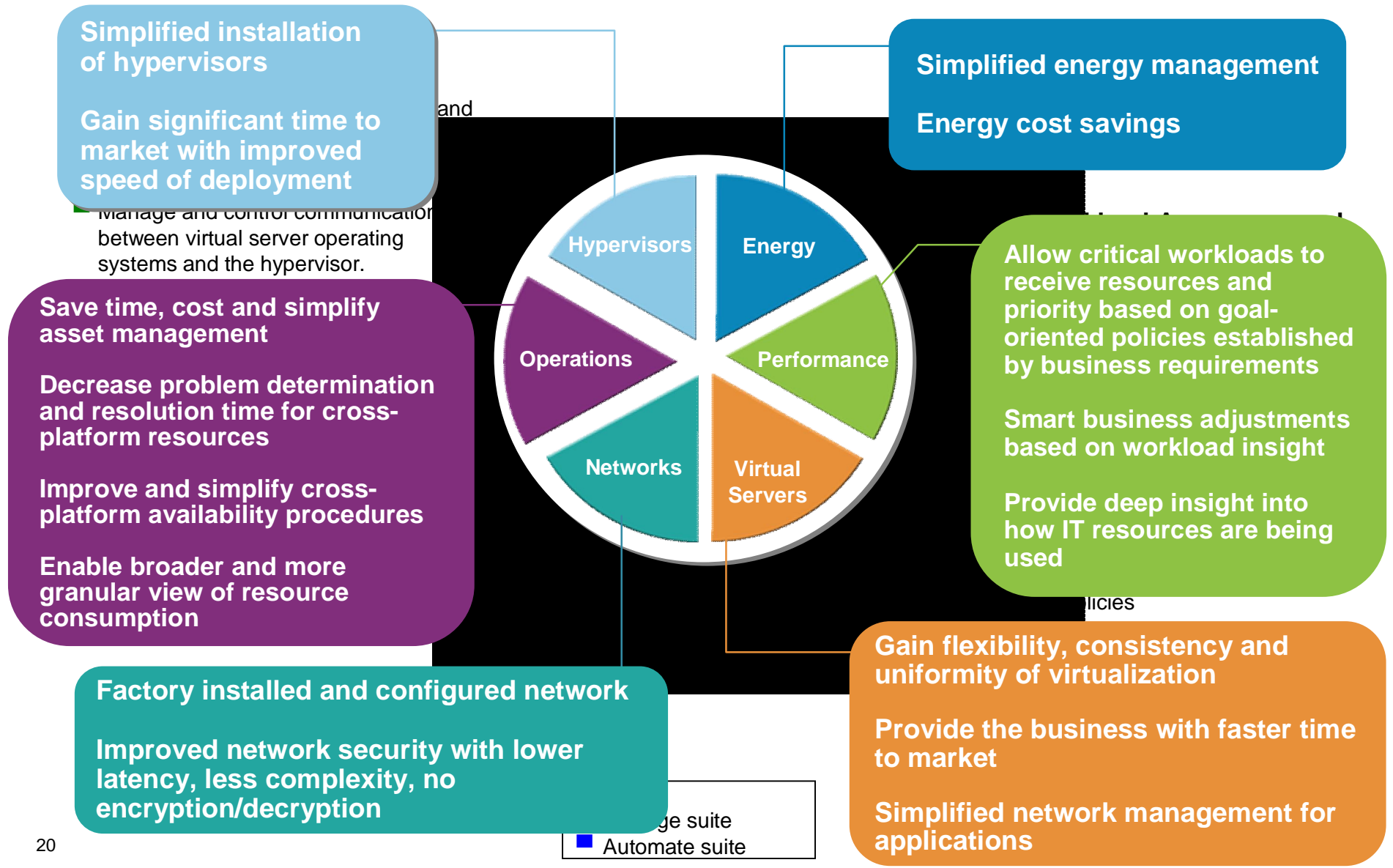

z196 – IBM Leadership Technology At the Core

- **New 5.2 GHz Quad Core Processor Chip boosts hardware price/performance**

- 100 new instructions – improvements for CPU intensive, Java™, and C++ applications
 - Over twice as much on-chip cache as System z10 to help optimize data serving environment
 - Out-of-order execution sequence gives significant performance boost for compute intensive applications
 - Significant improvement for floating point workloads
- **Performance improvement for systems with large number of cores – improves MP ratio**
 - **Data compression and cryptographic processors right on the chip**

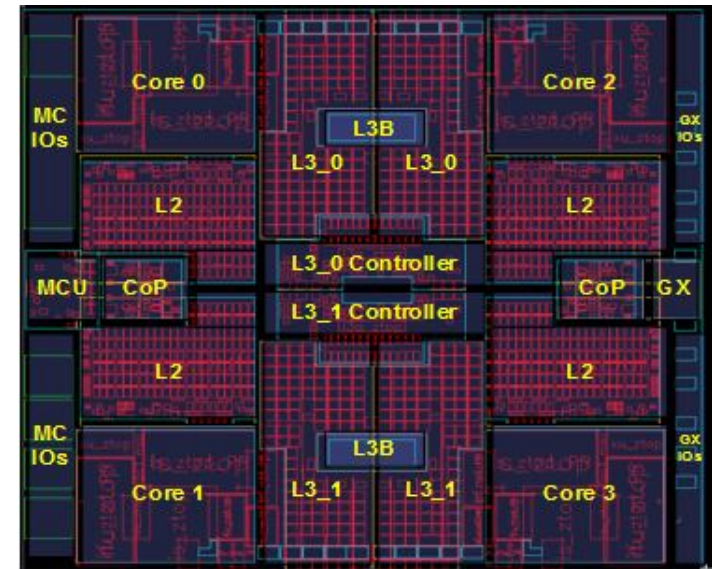

Protecting with IBM's World-Class Security and Business Resiliency Solutions

- **Cryptographic enhancements on z196**
 - Support for the next generation of public key technologies with ECC support that is ideal for constrained environments such as mobile devices.
 - Compliance and security improvements for the payment card industry.
 - With today's focus on compliance, the Crypto Express3 is enhanced for the banking and finance industry.
- **PR/SM™ designed for EAL5 certification.**
- **Policy driven flexibility to add capacity to real or virtual processors.**
- **Backup and Disaster Recovery solutions**
 - GDPS® offers:
 - Business continuity for Linux applications running on System z
 - Management and coordination of outages across z196 and distributed servers in zBX using clustering solutions
 - Reduce complexity by consolidating multiple open platform backup processes into a single System z-controlled process.
 - Simplify disaster recovery with TS7680 automated replication to remote site.



Storage Connectivity Has Gotten Easier and Performance Better

Designed, developed and tested together is key to unlocking value

- Simplified configuration of FICON® disk and tape with z/OS discovery and auto-configuration (zDAC)
- zHPF enhancements allows for increased exploitation transparently to applications and middleware
- Introduction of hot pluggable I/O drawer
- Extending for storage growth with new three subchannel sets per LCSS



z196 Parallel Sysplex coexistence of Servers/CFs and coupling connectivity

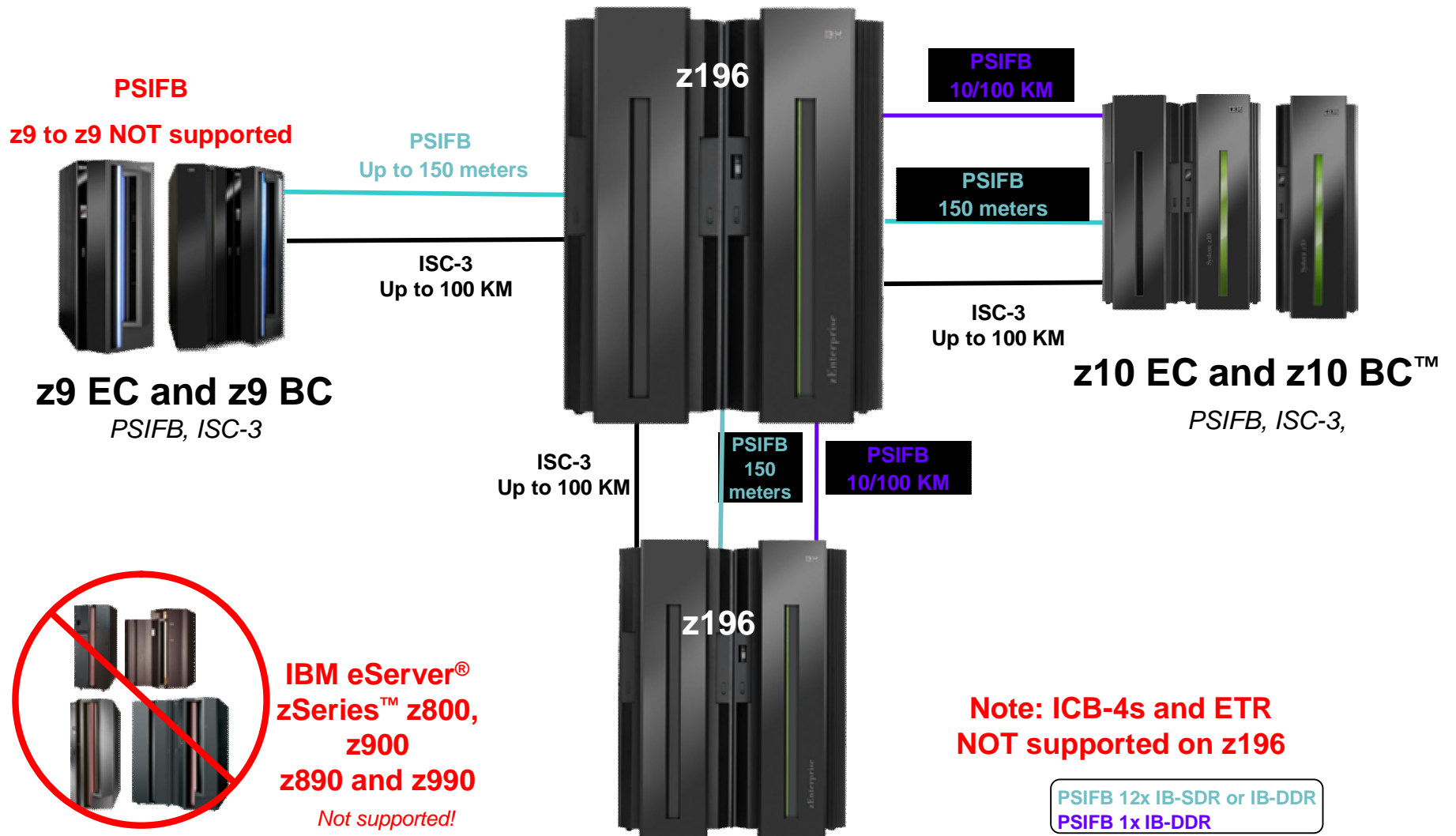

Synergy with z196 Operating Systems

z/OS



- New automatic discovery and configuration for fabric-attached FICON® disk and tape devices can save you hours on storage configuration time
- New definitions for new management network and data network
- New “off the wire” network traffic separation improves performance for your critical interactive and streaming workloads, as well as sysplex distributor traffic
- Support for the next generation of public key technologies with ECC support that is ideal for constrained environments such as mobile devices.
- Participation with new z196 management capabilities by allowing monitoring of z/OS workloads - a new agent can send high level z/OS WLM data to the Unified Resource Manager

z/VM and Linux on System z



- Server and application consolidation on System z using Linux and z/VM is the industry leader in large-scale, cost-efficient virtual server hosting
- zEnterprise introduces virtual server provisioning and management for Linux guests running on z/VM
 - Use the Unified Resource Manager to create z/VM virtual machines
 - Simplify the skill level needed to manage a Linux on z/VM environment
- Faster cores and a bigger system cache on the z196 let you do even more with less when running Linux on z/VM
- Plus integrated blades on zBX offer added dimension for workload optimization



Operating System Support for zEnterprise System

- **Currency is key to operating system support and exploitation of future servers**
- **The following are the minimum operating systems planned to run on z196:**
 - z/OS
 - z196: z/OS V1.9¹ for toleration only; exploitation starts with z/OS V1.10 with full exploitation with z/OS V1.12
 - Ensemble support: z/OS V1.10
 - Linux on System z distributions:
 - Novell SUSE SLES 10 and SLES 11
 - Red Hat RHEL 5
 - z/VM
 - z196: z/VM V5.4 or higher
 - Ensemble support: z/VM V6.1
 - z/VSE V4.1 or higher
 - z/TPF V1.1 or higher
- **Using the general purpose blades:**
 - AIX 5.3, 6.1
 - Linux on System x² (SOD)

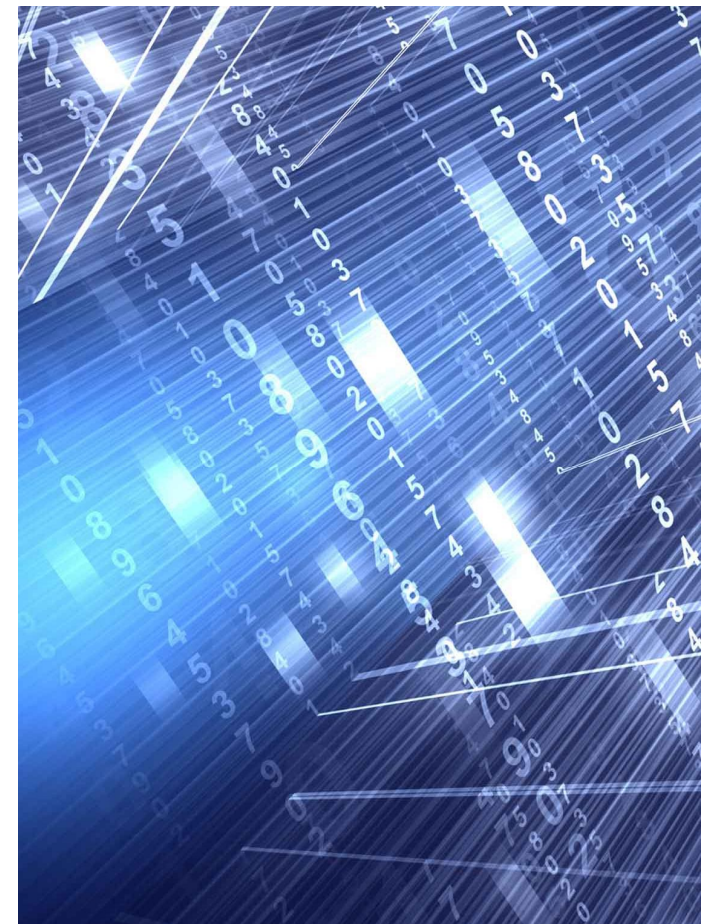

¹ z/OS V1.9 support ends on Sept. 30, 2010. Lifecycle Extension for z/OS 1.9 is available Oct. 1, 2010. Note that z/OS 1.8 with the Lifecycle Extension for z/OS 1.8 and z/OS 1.7 with the Lifecycle Extension for z/OS 1.7 are also available with toleration support only.

² All statements regarding IBM future direction and intent are subject to change or withdrawal without notice, and represents goals and objectives only.

Putting zEnterprise System to the task

Use the smarter solution to improve your application design

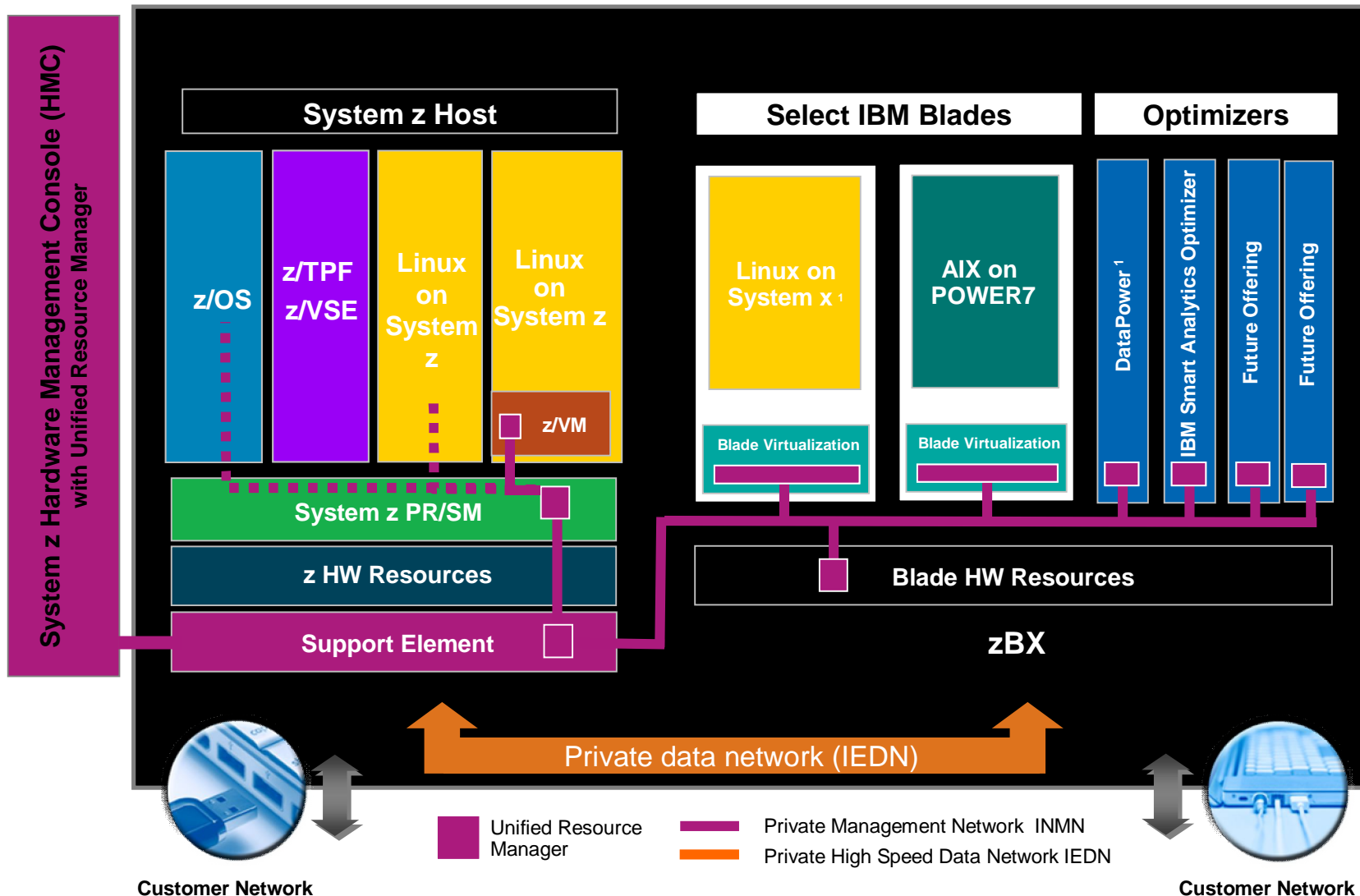

¹ All statements regarding IBM future direction and intent are subject to change or withdrawal without notice, and represents goals and objectives only.

Service Levels to Match Your Business Needs

Increased flexibility for your multi-architecture strategy when data is on z/OS

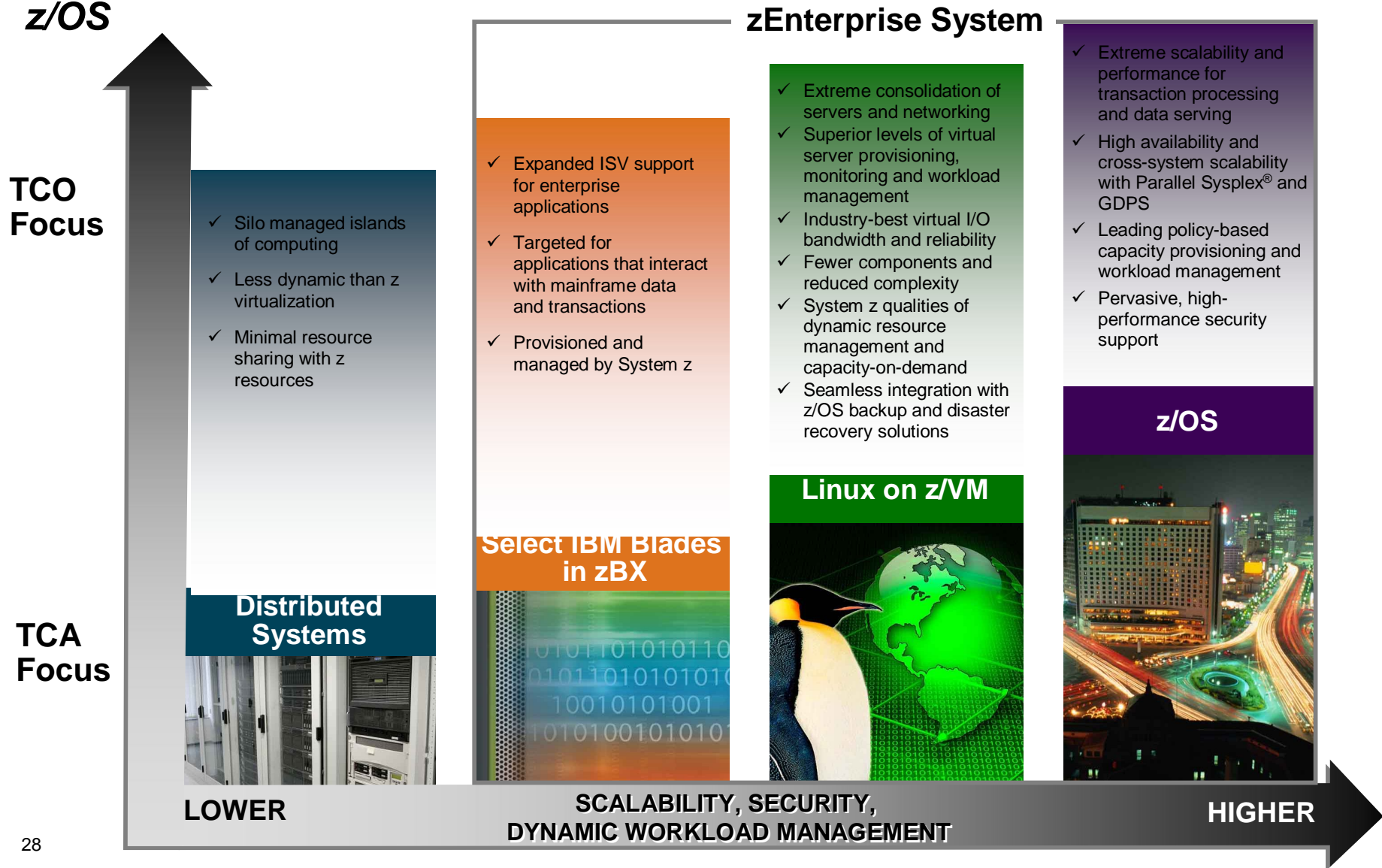

IBM zEnterprise System:

A revolutionary change has come to IT bringing a new dimension in computing

- Redefining IT frameworks to bring management to operational silos and extend System z governance to POWER7 and IBM x86¹ blades
- Driving business decisions based on insight rather than hindsight
- Improving agility to compete with consolidation and simplification
- Delivering consistent business controls across applications and platforms
- Focused on integration and collaboration to fuel business growth



¹ All statements regarding IBM future direction and intent are subject to change or withdrawal without notice, and represents goals and objectives only.



Thank you

zEnterprise System Functional Comparison to z10 EC

Processor / Memory	<ul style="list-style-type: none"> ▪ Uniprocessor Performance ▪ System Capacity ▪ Processor Design ▪ Models ▪ Processing cores ▪ Granular Capacity ▪ Memory ▪ Fixed HSA 	<ul style="list-style-type: none"> ▪ Up to 40% performance improvement over z10 EC uniprocessor ¹ ▪ Up to 60% system capacity performance improvement over z10 EC 64-way ¹ ▪ New 5.2GHz processor chip versus 4.4GHz ▪ z196 will have 5 and z10 EC has 5 models, both with up to 4 books ▪ z196 has up to 80 cores to configure, up to 64 on z10 EC ▪ z196 has up to 125 capacity settings versus 100 on the z10 EC ▪ z196 has up to 3 TB with improved RAS vs. up to 1.5 TB on z10 EC ▪ z196 and z10 EC both have fixed 16 GB HSA
Virtualization and Alternative Processors	<ul style="list-style-type: none"> ▪ Virtualization ▪ zEnterprise BladeCenter Extension (zBX) 	<ul style="list-style-type: none"> ▪ zEnterprise Unified Resource Manager has “workload awareness” where workloads consist of virtual images across the hybrid. This awareness allows Unified Resource Manager to optimize resources according to business policies established for a workload. ▪ zEnterprise System is a truly integrated hardware platform that is able to span and intelligently manage workloads across mainframe and distributed technologies – including POWER7 and IBM x86² ▪ Optimizers that will be supported are IBM Smart Analytics Optimizer and WebSphere DataPower Appliance² in the zBX..
Connectivity	<ul style="list-style-type: none"> ▪ HiperSockets™ ▪ FICON ▪ I/O subsystem ▪ Internal I/O Bandwidth ▪ Coupling ▪ Cryptography 	<ul style="list-style-type: none"> ▪ z196 support of 32 HiperSockets versus z10 EC supporting 16 ▪ High Performance FICON for z (zHPF) enhancements ▪ Both I/O cage and new I/O drawer (with concurrent add/remove/repair) versus only I/O cage on z10 EC ▪ z196 has industry standard 6 GBps InfiniBand® supports high speed connectivity and high bandwidth ▪ Coupling with InfiniBand – improved distance and potential consolidation savings ▪ z196 has programmable functions for Elliptic Curve Cryptography (ECC) not available on z10 EC
On Demand / RAS	<ul style="list-style-type: none"> ▪ On Demand Offerings ▪ RAS Focus 	<ul style="list-style-type: none"> ▪ Administrative Test for On/Off Capacity on Demand ▪ z196 offers advanced memory enhancements (RAIM) and advanced power and thermal optimization and management that can help to control heat / improve RAS
Environmentals	<ul style="list-style-type: none"> ▪ Energy ▪ Cooling 	<ul style="list-style-type: none"> ▪ z196 offers Power Save modes for processor, I/O and memory – not on z10 EC ▪ z196 offers optional water cooling and DC power – not available on z10 EC

¹ For average LSPR workloads running z/OS 1.11.

² All statements regarding IBM future direction and intent are subject to change or withdrawal without notice, and represents goals and objectives only

The following 6 slides look 'blank'. They aren't. You need to have them in screen show mode to view. These are some helpful charts to walk through the concepts of how zManager works. They are in back up for you to choose to use or not use them for a presentation.

Putting zEnterprise System to the task

Operational Controls

Putting zEnterprise System to the task

Network Management

Putting zEnterprise System to the task

Hypervisor Management and Virtual Server Management

Putting zEnterprise System to the task

Performance Management

Putting zEnterprise System to the task

Energy Management

Putting zEnterprise System to the task

Smart Analytics Optimizer