

IMS



Customization Guide

Version 9

IMS



Customization Guide

Version 9

Note

Before using this information and the product it supports, be sure to read the general information under "Notices" on page 589.

First Edition (October 2004)

This edition applies to Version 9 of IMS (product number 5655-J38) and to all subsequent releases and modifications until otherwise indicated in new editions.

© **Copyright International Business Machines Corporation 1974, 2004. All rights reserved.**

US Government Users Restricted Rights – Use, duplication or disclosure restricted by GSA ADP Schedule Contract with IBM Corp.

Contents

Figures	xiii
Tables	xv
About This Book	xix
Summary of Contents	xix
Prerequisite Knowledge	xx
Terminology and Related Information	xx
IBM Product Names Used in This Information	xx
How to Send Your Comments	xxi
Summary of Changes	xxiii
Changes to This Book for IMS Version 9	xxiii
Library Changes for IMS Version 9	xxiii

Part 1. General Guidelines for Writing IMS Routines 1

Chapter 1. Guidelines for Writing IMS exit routines	3
Introduction to Exit Routines	3
IMS Callable Services	10
Callable Services Return and Reason Codes	25
Example of a Callable Services Request	30
Control Block Usage	34
Customization Exit Routines	37

Part 2. Database Exit Routines 41

Chapter 2. Data Capture Exit Routine	45
About The Data Capture Exit Routine	46
Communications Between the Data Capture Exit Routine and IMS	49
Sample Extended Program Communication Block (XPCB)	55
Sample Extended Segment Data Block (XSDB)	58
Sample Data Capture Exit Routine	60
Chapter 3. Data Conversion User Exit Routine (DFSDBUX1)	71
About This Routine	71
Communicating with IMS	72
Chapter 4. Data Entry Database Randomizing Routine (DBFHDC40/ DBFHDC44)	75
About This Routine	75
Communicating with IMS	77
Using the Sample DEDB Randomizing Routines (DBFHDC40)	78
Extended Call Interface (XCI) Option	78
Chapter 5. Data Entry Database Resource Name Hash Routine (DBFLHSH0)	81
About This Routine	81
Communicating with IMS	82
Sample Hashing Routine Result Format	83

Chapter 6. Data Entry Database Sequential Dependent Scan Utility Exit Routine (DBFUMSE1)	85
About This Routine	85
Communicating with IMS	86
Sample DEDB Sequential Dependent Scan Utility Exit Routine (DBFUMSE1)	87
Chapter 7. HALDB Partition Selection Exit Routine (DFSPSE00)	91
About This Routine	91
Communicating with IMS	92
Using the Sample Partition Selection Exit Routine (DFSPSE00)	94
Using the Exit Interface Area Mapping	94
Chapter 8. HDAM and PHDAM Randomizing Routines (DFSHDC40)	97
About These Routines	97
Communicating with IMS	99
Using the Sample HDAM and PHDAM Generalized Randomizing Routine (DFSHDC40)	101
Chapter 9. Secondary Index Database Maintenance Exit Routine	103
About This Routine	103
Communicating with IMS	105
Sample Secondary Index Database Maintenance Exit Routine	106
Chapter 10. Segment Edit/Compression Exit Routine (DFSCMPX0)	109
About This Routine	109
Communicating with IMS	115
Hardware Data Compression Support	122
Chapter 11. Sequential Buffering Initialization Exit Routine (DFSSBUX0)	129
About This Routine	129
Communicating with IMS	130
Using the Sample SB Initialization Routines	132

Part 3. System Exit Routines 133

Chapter 12. Application Group Name (AGN) Exit Routine (DFSISIS0)	137
About This Routine	137
Communicating with IMS	138
Chapter 13. Buffer Size Specification Facility (DSPBUFFS)	139
About This Facility	139
Example of Specifying Buffers	141
Chapter 14. Command Authorization Exit Routine (DFSCCMD0)	143
About This Routine	143
Communicating with IMS	145
Chapter 15. DBRC Command Authorization Exit Routine (DSPDCAX0)	147
About This Routine	147
Communicating with IMS	148
Using the Sample DBRC Command Authorization Exit Routine	149
Chapter 16. Dependent Region Preinitialization Routines	151
About These Routines	151
Communicating with IMS	153

Chapter 17. Dump Override Table (DFSFDOT0)	155
About This Table	155
A Sample Dump Override Table (DFSFDOT0)	157
Chapter 18. ESAF (External Subsystem Attach Facility) Indoubt Notification Exit Routine (DFSFIDN0)	159
About this Routine	159
Communicating with IMS	159
Chapter 19. IMS Command Language Modification Facility (DFSCKWD0)	161
About This Facility	161
Using the Sample IMS Command Modification Facility	164
Chapter 20. Large System Definition Sort/Split Input exit routine (DFSSS050)	165
About This Routine	165
Communicating with IMS	166
Chapter 21. Large System Definition Sort/Split Output Exit Routine (DFSSS060)	169
About This Routine	169
Communicating with IMS	170
Chapter 22. Log Archive Exit Routine	173
About This Routine	173
Communicating with IMS	174
Sample Log Archive Exit Routine	176
Chapter 23. Log Filter Exit Routine (DFSFTFX0)	187
About This Routine	187
Communicating with IMS	189
Recovery Environment	190
Initialization and Termination Calls	190
IMS-Supplied Filter Exit Routine	190
Chapter 24. Logger Exit Routine (DFSFLGX0)	193
About This Routine	193
Communicating with IMS	195
Chapter 25. Partner Product Exit Routine (DFSPPUE0)	201
About This Routine	201
Communicating with IMS	201
Chapter 26. RECON I/O Exit Routine (DSPCEXT0)	203
About This Routine	203
Communicating with IMS	205
Using the Sample RECON I/O Exit Routine	208
Chapter 27. Resource Access Security Exit Routine (DFSRAS00)	209
About This Routine	209
Communicating with IMS	209
Chapter 28. SCI Registration Exit Routine (DSPSCIX0)	213
About This Routine	213
Communicating with IMS	213
Using the Sample SCI Registration Exit Routine	214

Chapter 29. System Definition Preprocessor Exit Routine (Input Phase) (DFSPRE60)	217
About This Routine	217
Communicating with IMS	218
Using the Sample System Definition Preprocessor Exit Routine	219
Chapter 30. System Definition Preprocessor Exit Routine (Name Check Complete) (DFSPRE70)	221
About This Routine	221
Communicating with IMS	221
Chapter 31. Type 2 Automated Operator Exit Routine (DFSAOE00)	223
About This Routine	223
Activating This Routine	228
Communicating with IMS	228
Chapter 32. User Message Table (DFSCMTU0)	235
About This Table	235
Sample User Message Table and Routine	236

Part 4. Transaction Manager Exit Routines 243

Chapter 33. Build Security Environment Exit Routine (DFSBSEX0)	249
About this Routine	249
Communicating with IMS	250
Chapter 34. Conversational Abnormal Termination Exit Routine (DFSCONE0)	253
About This Routine	253
Communicating with IMS	254
Chapter 35. Fast Path Input Edit/Routing Exit Routine (DBFHAGU0)	259
About This Routine	259
Communicating with IMS	261
Chapter 36. Front-End Switch Exit Routine (DFSFEBJ0)	263
About The Front-End Switch Exit Routine	263
Communications Between the Front-End Switch Exit Routine and IMS	273
Example of the Front-End Switch Exit Routine (DFSFEBJ0)	274
Chapter 37. Global Physical Terminal (Input) Edit Routine (DFSGPIX0)	279
About This Routine	279
Communicating with IMS	281
Chapter 38. Greeting Messages Exit Routine (DFSGMSG0)	283
About This Routine	283
Communicating with IMS	284
Chapter 39. IMS Adapter for REXX Exit Routine (DFSREXXU)	285
About This Routine	285
Parameters	286
Chapter 40. Initialization Exit Routine (DFSINTX0)	289
About This Routine	289
Communicating with IMS	291

Chapter 41. Input Message Field Edit Routine (DFSME000)	295
About This Routine	295
Communicating with IMS	297
Chapter 42. Input Message Segment Edit Routine (DFSME127)	299
About This Routine	299
Communicating with IMS	301
Chapter 43. Logoff Exit Routine (DFSLGFX0)	305
About This Routine	305
Communicating with IMS	306
Chapter 44. Logon Exit Routine (DFSLGNX0)	309
About This Routine	309
Communicating with IMS	311
Chapter 45. LU 6.2 Edit Exit Routine (DFSLUEE0)	313
About This Routine	313
Communicating with IMS	314
Chapter 46. Message Control/Error Exit Routine (DFSCMUX0)	319
About This Routine	319
Communicating with IMS	323
Chapter 47. Message Switching (Input) Edit Routine (DFSCNTE0)	329
About This Routine	329
Communicating with IMS	330
Using the Sample Message Switching Edit Routine (DFSCNTE0)	330
Chapter 48. Non-Discardable Messages Exit Routine (DFSNDMX0)	333
About This Routine	333
Communicating with IMS	335
Chapter 49. OTMA Destination Resolution Exit Routine (DFSYDRU0)	341
About This Routine	341
Communicating with IMS	342
Chapter 50. OTMA Input/Output Edit Exit Routine (DFSYIOE0)	345
About This Routine	345
Communicating with IMS	346
Chapter 51. OTMA Prerouting Exit Routine (DFSYPRX0)	349
About This Routine	349
Communicating with IMS	350
Chapter 52. Output Creation Exit Routine (DFSINSX0)	353
About This Routine	353
Communicating with IMS	358
Chapter 53. Physical Terminal (Input) Edit Routine (DFSPIXT0)	361
About This Routine	361
Communicating with IMS	363
Using the Sample Physical Terminal Input Edit Routine (DFSPIXT0)	364
Chapter 54. Physical Terminal (Output) Edit Routine (DFSCCTO0)	365
About This Routine	365

Communicating with IMS	366
Using the Sample Physical Terminal Output Edit Routine (DFSCCTO0).	368
Chapter 55. Queue Space Notification Exit Routine (DFSQSPC0/DFSQSSP0)	369
About This Routine	369
Communicating with IMS	372
Chapter 56. Security Reverification Exit Routine (DFSCCTSE0)	375
About This Routine	375
Communicating with IMS	376
Chapter 57. Shared Printer Exit Routine (DFSSIML0)	379
About This Routine	379
Communicating with IMS	380
Chapter 58. Signon Exit Routine (DFSSGNX0)	381
About This Routine	381
Communicating with IMS	387
Chapter 59. Signoff Exit Routine (DFSSGFX0)	389
About This Routine	389
Communicating with IMS	390
Chapter 60. Signon/off Security Exit Routine (DFSCSGN0)	393
About This Routine	393
Communicating with IMS	394
Chapter 61. Time-Controlled Operations (TCO) Exit Routine (DFSTXIT0)	397
About This Routine	397
Communicating with IMS	398
Chapter 62. Time-Controlled Operations (TCO) Communication Name Table (CNT) Exit Routine (DFSTCNT0)	401
About This Routine	401
Communicating with IMS	402
Chapter 63. TM and MSC Message Routing and Control User Exit Routine (DFSMSCE0)	405
About This Routine	405
Attributes of the Routine	409
Communicating with IMS	409
Chapter 64. Transaction Authorization Exit Routine (DFSCTRN0)	417
About This Routine	417
Communicating with IMS	418
Chapter 65. Transaction Code (Input) Edit Routine (DFSCSMB0)	421
About This Routine	421
Communicating with IMS	422
Using the Sample Transaction Code (Input) Edit Routine (DFSCSMB0)	423
Chapter 66. Type 1 Automated Operator Exit Routine (DFSAOUE0)	425
About This Routine	425
Activating This Routine	433
Communicating with IMS	433

Chapter 67. 2972/2980 Input Edit Routine (DFS2980)	451
About This Routine	451
Communicating with IMS	452
Chapter 68. 4701 Transaction Input Edit Routine (DFS36010)	453
About This Routine	453
Communicating with IMS	453

Part 5. Automated Operator Program Interface 455

Chapter 69. Automated Operator (AO) Application Program (GU, GN, CMD, and GCMD Calls)	457
About The AO Application Program (GU, GN, CMD, and GCMD Calls)	457
Supported Application Program Environments	458
Writing AO Applications for Shared-Queues	459
Using the Security Maintenance Utility	459
Issuing Commands from an AO Application	459
Getting Messages from an AO Exit Routine or a Terminal	463
Cross-Reference of Commands and Command Response Messages	463
Using the Sample AO Application (UETRANS)	466
Chapter 70. Automated Operator (AO) Application Program (GMSG, ICMD, and RCMD Calls)	467
About The AO Application Program (GMSG, ICMD, and RCMD Calls)	467
Supported Application Program Environments	469
Establishing Security	469
Issuing Commands from an AO Application	469
Cross-Reference of Commands and Command Response Messages	472
Restart and Recovery Considerations	475
Using the Sample AO Application (DFSAOPGM)	475

Part 6. Asynchronous Data Capture 477

Chapter 71. Propagating Captured Data Asynchronously	479
Changed Data Log Record	479
End of Job (EOJ) Call Log Record	482
SETS and ROLS Call Log Records	482
Format of the Data Capture Log Records	482

Part 7. DRA (Database Resource Adaptor) Exit Routines 489

Chapter 72. CCTL Exit Routines	491
Routine Attributes	491
Suspend Exit Routine	492
Resume Exit Routine	492
Control Exit Routine	492
Status Exit Routine	497
Example of the DRA and Exit Routines	499

Part 8. External Subsystem Attach Facility 503

Chapter 73. ESAF (External Subsystem Attach Facility) Overview	507
What the External Subsystem Must Provide	508
How External Subsystems Are Specified to IMS	509
The Basics of Attach Processing	510

Chapter 74. Creating the External Subsystem Module Table	517
DFSEMODL Macro	517
DFSEWAL Macro	520
Chapter 75. IMS Attach Facility Processing	525
Loading the External Subsystem Attachment Package	525
Initiating the External Subsystem Connection	527
Application Program Request Support	531
Resource Recovery Token	532
Terminating the External Subsystem Connection	533
Chapter 76. External Subsystem Exit Routines	537
General Exit Routine Interface	537
Abort Continue Exit Routine	541
Command Exit Routine	542
Commit Continue Exit Routine	544
Commit Prepare Exit Routine	544
Commit Verify Exit Routine	546
Create Thread Exit Routine	547
Echo Exit Routine	549
Identify Exit Routine	549
Initialization Exit Routine	552
Normal Call Exit Routine	553
Resolve Indoubt Exit Routine	555
Signoff Exit Routine	557
Signon Exit Routine	558
Subsystem Not Operational Exit Routine	560
Subsystem Termination Exit Routine	562
Terminate Identify Exit Routine	563
Terminate Thread Exit Routine	565
Chapter 77. IMS System Service Exit Routines	567
General System Service Exit Routine Interface	567
Log Service Exit Routine	568
Message Service Exit Routine	569
Subsystem Startup Service Exit Routine	571
Subsystem Termination Service Exit Routine	572

Part 9. Appendixes 575

Appendix A. DBCTL Function Requests	577
DRA Function Requests	577
PAPL Mapping Format	585
Appendix B. IMS Support for Synchronous DB2 to IMS Data Propagation	587
Notices	589
Programming Interface Information	591
Trademarks	592
Bibliography	593
IMS Version 9 Library	593
Supplementary Publications	594
Publication Collections	594
Accessibility Titles Cited in This Library	594

Index 595

Figures

1. ISWITCH Example	6
2. Example of a Callable Service Request	31
3. Calling Order with Data Capture	45
4. Control Block Flow with Data Capture	50
5. XPCB in Assembler Example	55
6. XPCB in COBOL Example	56
7. XPCB in PL/I Example	57
8. XSDB in Assembler	58
9. XSDB in COBOL example	58
10. XSDB in PL/I example	59
11. Data Capture Exit Routine in COBOL	61
12. Data Capture Exit Routine in PL/I.	65
13. Lock Resource Name	83
14. Format of a Hash Value	83
15. Sample DEDB Sequential Dependent Scan Utility Exit Routine	87
16. Index Maintenance Exit Routine Parameter List CSECT	106
17. Secondary Index Database Maintenance Exit Routine Example	107
18. Segment Compression	113
19. Segment Expansion	114
20. Data Handling Formats	119
21. Sample JCL Procedure	125
22. Layout of the DSPBUFFS CSECT	140
23. DSPBUFFS Example	141
24. Sample Log Archive Exit Routine	176
25. Processing When a System Message Is Generated	226
26. Processing When a Command is Entered at the Terminal	227
27. Processing When a Command is Entered from an AO Application	228
28. User Message Table Sample	237
29. User-modified DFSQSPC0 Sample Routine	238
30. Message Flow with the Front-End Switch Exit Routine	265
31. FEIB DSECT from ICLI FEIUBASE=0.	267
32. Old and New Buffer Formats	272
33. Routing Scheme of Front-End Switch Exit Routine Example	274
34. User Area of FEIB (FEIBUSER)	276
35. Logon Descriptor Search Order	310
36. User Descriptor Selection Order	384
37. Format of 20-byte Message Example	400
38. Format of 8-byte Message Example	400
39. Format of Message where the Address of a Message Set is Retrieved	400
40. Processing When a Command is Entered at the Terminal	427
41. Processing When a System Message is Generated	428
42. Message Segment Copy Format	431
43. Edited Command Buffer	432
44. AO Application Processing	458
45. EWAL, EEVTP, and EEVT Relationship	521
46. Specifying a Definition to Anchor a Work Area List in the EEVPEWA Field	523
47. Notify Message Format	530
48. SVC 34 command input format	530
49. Recovery Token Format	532
50. Exit Parameter List	538

Tables

1. Licensed Program Full Names and Short Names	xx
2. Version 1 Standard Exit Parameter List (Mapped by DFSSXPL)	5
3. Version 4 Standard Exit Parameter List (Mapped by DFSSXPL)	5
4. Exit Routines and Associated Callable Services	11
5. Control Blocks and Associated Fields and Flags.	34
6. Exit Routines and Associated Control Blocks	35
7. Customization Guide Exit Routines	37
8. Data Capture Support for IMS Environments	46
9. XPCB by Offset	50
10. XPCB Alphabetically	51
11. XSDB by Offset	52
12. XSDB Alphabetically	52
13. XPCB Return Codes	53
14. Data Entry Database Randomizing Routine Attributes	75
15. Sample Parameter List for a Randomizing Call	79
16. Sample Parameter List for an Initialization Call	79
17. Sample Parameter List for a Termination Call	79
18. Data Entry Database Resource Name Hash Routine Attributes	81
19. Segments of a Hash Value	83
20. Data Entry Database Sequential Dependent Scan Utility Exit Routine Attributes	85
21. HALDB Partition Selection Exit Routine Attributes	91
22. HDAM and PHDAM Randomizing Routine Attributes	97
23. Secondary Index Database Maintenance Exit Routine Attributes	103
24. Segment Edit/Compression Exit Routine Attributes	110
25. Segment Edit/Compression Control Section (DMBCPAC).	117
26. Program Messages and Codes - Abend Codes	120
27. Sequential Buffering Initialization Exit Routine Attributes	129
28. Application Group Name (AGN) Exit Routine Attributes	137
29. Command Authorization Exit Routine Attributes	143
30. Standard Exit Parameter List (Version 1, Mapped by DFSSXPL)	146
31. Command Authorization Exit Routine Attributes	147
32. DCA Interface Parameter Block Description	148
33. Dependent Region Preinitialization Routines Attributes	151
34. Dump Override Table Attributes	155
35. ESAF Indoubt Notification Exit Routine Attributes	159
36. ESAF Indoubt Notification Exit Routine Parameter List	160
37. IMS Command Language Modification Facility Attributes	161
38. Large System Definition Sort/Split Input Exit Routine Attributes	165
39. Large System Definition Sort/Split Output Exit Routine Attributes	169
40. Log Archive Exit Routine Attributes	173
41. Log Filter Exit Routine Attributes.	188
42. Logger Exit Routine Attributes	193
43. Function-Specific Parameter List for Initialization Call, Call Type 1 (Mapped by LGWXPLST, Which Is Included in LCDSECT).	196
44. Function-Specific Parameter List for OLDS/SLDS Write Call, Call Type 2 (Mapped by LGWXPLST, Which Is Included in LCDSEC	197
45. Function-Specific Parameter List for Termination Call, Call Type 3 (Mapped by LGWXPLST, Which Is Included in LCDSECT).	198
46. Partner Product Exit Routine Attributes	201
47. Function-Specific Parameter List for Partner Product Exit (Mapped by DFSPPE)	202
48. RECON I/O Exit Routine Attributes.	203
49. Resource Access Security Exit Routine Attributes	209
50. Function-Specific Parameter List Mapped by DFSRASL	210

51. SCI Registration Exit Routine (DSPSCIX0)	213
52. System Definition Preprocessor Exit Routine (Input Phase) Attributes	217
53. System Definition Preprocessor Exit Routine (Name Check Complete) Attributes	221
54. Automated Operator Exit Routine Attributes (DFSAOE00)	224
55. Translation of Control Characters in Commands	225
56. Function-Specific Parameter List for DFSAOE00 (Mapped by DFSAOE0)	229
57. Message Buffer	232
58. User Message Table Attributes	235
59. Build Security Environment Exit Routine Attributes	249
60. BSE Parameter List	252
61. Conversational Abnormal Termination Exit Routine Attributes	254
62. SPA Options Parameter List	256
63. Fast Path Input Edit/Routing Exit Routine Attributes	259
64. Fast Path Input Edit/Routing Exit Parameter List	261
65. DBFHAGU0 Extended Parameter List	262
66. Front-End Switch Exit Routine Attributes	263
67. Description of the FEIB Fields	267
68. FEIB Usage	269
69. FES Data Flow for Input Message Processing	270
70. FES Data Flow for Reply Message Processing	270
71. SFIMS2 Tables	274
72. LAIMS1 Tables	275
73. NYIMS1 Tables	275
74. Global Physical Terminal Input Edit Routine Attributes	280
75. Greeting Messages Exit Routine Attributes	283
76. Greeting Messages Exit Parameter List	284
77. IMS Adapter for REXX Exit Routine Attributes	285
78. User Exit Parameter List	286
79. DFSREXXU Parameter List	287
80. Initialization Exit Routine Attributes	290
81. IMS Initialization Exit Parameter List	291
82. IMS Initialization Exit Parameter List	293
83. Input Message Field Edit Routine Attributes	295
84. Input Message Segment Edit Routine Attributes	299
85. Input Message Segment Edit Routine Functions Based on the Entry Vector	303
86. Logoff Exit Routine Attributes	305
87. Logoff Exit Parameter List	306
88. Logon Exit Routine Attributes	310
89. Default Logon Descriptor Table	311
90. User Logon Exit Parameter List	312
91. LU 6.2 Edit Exit Routine Attributes	313
92. Format of Parameters	316
93. Message Control/Error Exit Routine Attributes	319
94. Rerouting Messages to New Destinations	322
95. Key Fields of Interface Block on Entry	324
96. Key Fields of Interface Block on Exit	326
97. Flags and Default Actions	328
98. Message Switching (Input) Edit Exit Routine Attributes	329
99. Non-Discardable Messages Exit Routine Attributes	333
100. Valid Alternate Destinations	334
101. NDM Interface Block	336
102. OTMA Destination Resolution Exit Routine Attributes	341
103. Canceling a Message Segment	345
104. Canceling a Message	345
105. OTMA Input/Output Edit Exit Routine Attributes	346
106. OTMA Prerouting Exit Routine Attributes	349

107. Contents of the OTMA Prerouting Exit Routine Parameter List	350
108. Output Creation Exit Routine Attributes	354
109. Resource Blocks Created by the Output Creation Exit Routine	357
110. Output Creation Exit Parameter List	358
111. Physical Terminal (Input) Edit Routine Attributes	361
112. Physical Terminal (Output) Edit Routine Attributes	365
113. Queue Space Notification Exit Routine Attributes	370
114. Security Reverification Exit Routine Attributes	375
115. Shared Printer Exit Routine Attributes	379
116. Signon Exit Routine Attributes	382
117. Case Numbers Identifying What Data DFSSGNX0 Can Provide	385
118. Signon Exit Parameter List	387
119. Signoff Exit Routine Attributes	389
120. Signoff Exit Parameter List	390
121. Signon/off Security Exit Routine Attributes	394
122. Time-Controlled Operations (TCO) Exit Routine Attributes	397
123. TCO CNT Exit Routine Attributes	401
124. TM and MSC Message Routing and Control User Exit Routine Attributes	409
125. Standard IMS User Exit Parameter List (DFSUSRX)	410
126. Main User Exit Parameter List Mapped by the DFSMSCEP Macro	410
127. Initialization Entry Parameters for User Exit Parameter List Mapped by the DFSMSCEP Macro	411
128. Termination Entry Parameters for User Exit Parameter List Mapped by the DFSMSCEP Macro	411
129. Terminal Routing Parameters for User Exit Parameter List Mapped by the DFSMSCEP Macro	411
130. Link Receive Routing Parameters for User Exit Parameter List Mapped by the DFSMSCEP Macro	412
131. Program Routing Parameters for User Exit Parameter List Mapped by the DFSMSCEP Macro	412
132. Labels for Entry Point Parameters Selected by the DFSMSCVT Macro	413
133. Transaction Authorization Exit Routine Attributes	417
134. Transaction Code (Input) Edit Exit Routine Attributes	421
135. Automated Operator Exit Routine Attributes (DFSAOUE0)	426
136. Translation of Control Characters in Commands	430
137. Exit Functions for Single Segment Messages	442
138. Exit Functions for Multisegment Messages	443
139. UEHB Field Descriptions	445
140. 2972/2980 Input Edit Exit Routine Attributes	451
141. 4701 Transaction Input Edit Routine Attributes	453
142. GU, GN, CMD, and GCMD Call Support by Application Region Type	458
143. IMS Commands and DFS Response Messages	463
144. GMSG, ICMD, and RCMD Call Support by Application Region Type	469
145. IMS Commands and DFS Response Messages	473
146. Prefix for Data Capture Log Records	482
147. Format for Changed Data Log Records	482
148. Format for Log Record Header	483
149. Format for CAPD Block (LOGID = X'00')	484
150. Format for CAPD_DATA (LOGID = X'0C')	486
151. Format for EOJ Call	487
152. Format for SETS and ROLS Call	487
153. Continuation of the Example of Events in a Multithreading System	499
154. EPL contents	543
155. Command Input Format	543
156. Determining the Signon User ID	558

About This Book

This information is available as part of the DB2® Information Management Software Information Center for z/OS® Solutions. To view the information within the DB2 Information Management Software Information Center for z/OS Solutions, go to <http://publib.boulder.ibm.com/infocenter/dzichelp>. This information is also available in the PDF and BookManager® formats. To get the most current versions of the PDF and BookManager formats, go to the IMS™ Library page at www.ibm.com/software/data/ims/library.html.

Customization is the task of using supplied services and built-in facilities to enhance or extend a program. The Customization Guide describes how programmers can use IMS-supplied services and facilities to customize an IMS Version 9 (hereafter called IMS) system.

It contains information about IMS-supplied routines and services that you can use to customize your IMS database, system, and transaction management systems. For the most part, these IMS-supplied routines should meet the needs of your facility. If you have special requirements, however, the Customization Guide provides you with programming details to help you write routines that customize IMS to function the way you want.

It is intended for the administrator of the database and transaction management system of IMS and the system programmer of the host system and supported logical units.

Summary of Contents

Part 1, “General Guidelines for Writing IMS Routines,” on page 1 provides general guidelines for customizing IMS routines.

Part 2, “Database Exit Routines,” on page 41, Part 3, “System Exit Routines,” on page 133, and Part 4, “Transaction Manager Exit Routines,” on page 243 provide guidance for customizing your IMS system and writing exit routines for:

- IMS Database Manager (Part 2)
- System (Part 3)
- Transaction Manager (Part 4)

Chapter 1, “Guidelines for Writing IMS exit routines,” on page 3 provides guidelines about writing exit routines; this information applies to Parts 2, 3, and 4. Information on how to use the callable services that IMS provides to perform certain functions is included here.

Within each of the Parts, the exit routines are organized alphabetically according to the routine’s functional name (such as “Command Authorization Exit Routine”). The sequence does not represent the order in which these sections should be read.

For the latest version of the source code for the sample IMS-supplied exit routines, see IMS.ADFSSRC. The source code is no longer provided here as the most current copy is available in the SOURCE libraries that IMS provides.

Part 5, “Automated Operator Program Interface,” on page 455 describes the Automated Operator Program Interface (AOI). AOI enables an application program

to issue IMS operator commands and to receive responses. It also enables an exit routine to monitor activity and take appropriate action.

Part 6, “Asynchronous Data Capture,” on page 477 describes the Data Propagator Interface log record formats that IMS uses to store captured data for asynchronous propagation.

Part 7, “DRA (Database Resource Adaptor) Exit Routines,” on page 489 describes the four exit routines to which the DRA passes control: “Suspend Exit Routine” on page 492, “Resume Exit Routine” on page 492, “Control Exit Routine” on page 492, and “Status Exit Routine” on page 497.

Part 8, “External Subsystem Attach Facility,” on page 503 describes the External Subsystem Attach facility that enables IMS application programs executing in IMS dependent regions to access data resources that are managed by other (external) MVS™ subsystems.

Part 9 includes the following appendixes:

Appendix A, “DBCTL Function Requests,” on page 577

Appendix B, “IMS Support for Synchronous DB2 to IMS Data Propagation,” on page 587

A bibliography and index follow the appendixes.

Prerequisite Knowledge

Before using the Customization Guide, you need to have a working knowledge of IMS, z/OS and its system definition, transaction manager, and the access methods used by IMS.

Terminology and Related Information

For definitions of terminology used in the Customization Guide and references to related information in other IMS publications, see *IMS Version 9: Master Index and Glossary*.

IBM Product Names Used in This Information

In this information, the licensed programs shown in Table 1 are referred to by their short names.

Table 1. Licensed Program Full Names and Short Names

Licensed program full name	Licensed program short name
IBM® Application Recovery Tool for IMS and DB2	Application Recovery Tool
IBM CICS® Transaction Server for OS/390®	CICS
IBM CICS Transaction Server for z/OS	CICS
IBM DB2 Universal Database™	DB2 Universal Database
IBM DB2 Universal Database for z/OS	DB2 UDB for z/OS
IBM Enterprise COBOL for z/OS and OS/390	Enterprise COBOL
IBM Enterprise PL/I for z/OS and OS/390	Enterprise PL/I

Table 1. Licensed Program Full Names and Short Names (continued)

Licensed program full name	Licensed program short name
IBM High Level Assembler for MVS & VM & VSE	High Level Assembler
IBM IMS Advanced ACB Generator	IMS Advanced ACB Generator
IBM IMS Batch Backout Manager	IMS Batch Backout Manager
IBM IMS Batch Terminal Simulator	IMS Batch Terminal Simulator
IBM IMS Buffer Pool Analyzer	IMS Buffer Pool Analyzer
IBM IMS Command Control Facility for z/OS	IMS Command Control Facility
IBM IMS Connect for z/OS	IMS Connect
IBM IMS Connector for Java™	IMS Connector for Java
IBM IMS Database Control Suite	IMS Database Control Suite
IBM IMS Database Recovery Facility for z/OS	IMS Database Recovery Facility
IBM IMS Database Repair Facility	IMS Database Repair Facility
IBM IMS DataPropagator™ for z/OS	IMS DataPropagator
IBM IMS DEDB Fast Recovery	IMS DEDB Fast Recovery
IBM IMS Extended Terminal Option Support	IMS ETO Support
IBM IMS Fast Path Basic Tools	IMS Fast Path Basic Tools
IBM IMS Fast Path Online Tools	IMS Fast Path Online Tools
IBM IMS Hardware Data Compression-Extended	IMS Hardware Data Compression-Extended
IBM IMS High Availability Large Database (HALDB) Conversion Aid for z/OS	IBM IMS HALDB Conversion Aid
IBM IMS High Performance Change Accumulation Utility for z/OS	IMS High Performance Change Accumulation Utility
IBM IMS High Performance Load for z/OS	IMS HP Load
IBM IMS High Performance Pointer Checker for OS/390	IMS HP Pointer Checker
IBM IMS High Performance Prefix Resolution for z/OS	IMS HP Prefix Resolution
IBM Tivoli® NetView® for z/OS	Tivoli NetView for z/OS
IBM WebSphere® Application Server for z/OS and OS/390	WebSphere Application Server for z/OS
IBM WebSphere MQ for z/OS	WebSphere MQ
IBM WebSphere Studio Application Developer Integration Edition	WebSphere Studio
IBM z/OS	z/OS

How to Send Your Comments

Your feedback is important in helping us provide the most accurate and highest quality information. If you have any comments about this or any other IMS information, you can take one of the following actions:

- Go to the IMS Library page at www.ibm.com/software/data/ims/library.html and click the Library Feedback link, where you can enter and submit comments.

- Send your comments by e-mail to imspubs@us.ibm.com. Be sure to include the title, the part number of the title, the version of IMS, and, if applicable, the specific location of the text on which you are commenting (for example, a page number in the PDF or a heading in the Information Center).

Summary of Changes

Changes to This Book for IMS Version 9

This book contains new technical information for IMS Version 9, changed technical information, and editorial changes.

New information on the following enhancements is included:

- FDBR Indoubt Notification:
 - A description of the ESAF (external subsystem attach facility) Indoubt Notification exit routine has been added to Chapter 18, “ESAF (External Subsystem Attach Facility) Indoubt Notification Exit Routine (DFSFDN0),” on page 159.
- RACF Enhancements to Replace SMU:
 - The name of the exit routine DFSISIS0 has changed from Resource Access Security to Application Group Name (AGN) Security. See Chapter 12, “Application Group Name (AGN) Exit Routine (DFSISIS0),” on page 137.
 - The new exit routine, Resource Access Security (DFSRAS00), replaces the AGN support of DFSISIS0. See Chapter 27, “Resource Access Security Exit Routine (DFSRAS00),” on page 209.
 - The following information has changed significantly: Message Routing and Control User Exit Routine. See Chapter 63, “TM and MSC Message Routing and Control User Exit Routine (DFSMSCE0),” on page 405.
- OTMA Serviceability and Usability Enhancements:
 - The description of the OTMA Destination Resolution exit routine has been improved. See Chapter 49, “OTMA Destination Resolution Exit Routine (DFSYDRU0),” on page 341.
 - The description of the ZZ flag for the OTMA Input/Output Edit exit routine has been changed. See Chapter 50, “OTMA Input/Output Edit Exit Routine (DFSYIOE0),” on page 345.
- IMS type -2 Command Environment:
 - A statement about using the Command Authorization Exit Routine (DFSCCMD0) to secure type–2 commands has been added to Chapter 14, “Command Authorization Exit Routine (DFSCCMD0),” on page 143.

This edition includes changes to the following chapters:

- Chapter 10, “Segment Edit/Compression Exit Routine (DFSCMPX0),” on page 109.
- Chapter 62, “Time-Controlled Operations (TCO) Communication Name Table (CNT) Exit Routine (DFSTCNT0),” on page 401.

For detailed information about technical enhancements for IMS Version 9, see the *IMS Version 9 Release Planning Guide*.

Library Changes for IMS Version 9

Changes to the IMS Library for IMS Version 9 include the addition of one title, a change of one title, organizational changes, and a major terminology change. Changes are indicated by a vertical bar (|) to the left of the changed text.

The IMS Version 9 information is now available in the DB2 Information Management Software Information Center for z/OS Solutions, which is available at

<http://publib.boulder.ibm.com/infocenter/dzichelp>. The DB2 Information Management Software Information Center for z/OS Solutions provides a graphical user interface for centralized access to the product information for IMS, IMS Tools, DB2 Universal Database (UDB) for z/OS, DB2 Tools, and DB2 Query Management Facility (QMF™).

New and Revised Titles

The following list details the major changes to the IMS Version 9 library:

- *IMS Version 9: IMS Connect Guide and Reference*

The library includes new information: *IMS Version 9: IMS Connect Guide and Reference*. This information is available in softcopy format only, as part of the DB2 Information Management Software Information Center for z/OS Solutions, and in PDF and BookManager formats.

IMS Version 9 provides an integrated IMS Connect function, which offers a functional replacement for the IMS Connect tool (program number 5655-K52). In this information, the term *IMS Connect* refers to the integrated IMS Connect function that is part of IMS Version 9, unless otherwise indicated.

- The information formerly titled *IMS Version 8: IMS Java User's Guide* is now titled *IMS Version 9: IMS Java Guide and Reference*. This information is available in softcopy format only, as part of the DB2 Information Management Software Information Center for z/OS Solutions, and in PDF and BookManager formats.
- To complement the IMS Version 9 library, a new book, *An Introduction to IMS* by Dean H. Meltz, Rick Long, Mark Harrington, Robert Hain, and Geoff Nicholls (ISBN # 0-13-185671-5), is available starting February 2005 from IBM Press. Go to the IMS Web site at www.ibm.com/ims for details.

Organizational Changes

Organization changes to the IMS Version 9 library include changes to:

- *IMS Version 9: IMS Java Guide and Reference*
- *IMS Version 9: Messages and Codes, Volume 1*
- *IMS Version 9: Utilities Reference: System*

The chapter titled "DLIModel Utility" has moved from *IMS Version 9: IMS Java Guide and Reference* to *IMS Version 9: Utilities Reference: System*.

The DLIModel utility messages that were in *IMS Version 9: IMS Java Guide and Reference* have moved to *IMS Version 9: Messages and Codes, Volume 1*.

Terminology Changes

IMS Version 9 introduces new terminology for IMS commands:

type-1 command

A command, generally preceded by a leading slash character, that can be entered from any valid IMS command source. In IMS Version 8, these commands were called *classic* commands.

type-2 command

A command that is entered only through the OM API. Type-2 commands are more flexible than type-2 commands and can have a broader scope. In IMS Version 8, these commands were called *IMSpIex* commands or *enhanced* commands.

Accessibility Enhancements

Accessibility features help a user who has a physical disability, such as restricted mobility or limited vision, to use software products. The major accessibility features in z/OS products, including IMS, enable users to:

- Use assistive technologies such as screen readers and screen magnifier software
- Operate specific or equivalent features using only the keyboard
- Customize display attributes such as color, contrast, and font size

User Assistive Technologies

Assistive technology products, such as screen readers, function with the IMS user interfaces. Consult the documentation of the assistive technology products for specific information when you use assistive technology to access these interfaces.

Accessible Information

Online information for IMS Version 9 is available in BookManager format, which is an accessible format. All BookManager functions can be accessed by using a keyboard or keyboard shortcut keys. BookManager also allows you to use screen readers and other assistive technologies. The BookManager READ/MVS product is included with the z/OS base product, and the BookManager Softcopy Reader (for workstations) is available on the IMS Licensed Product Kit (CD), which you can download from the Web at www.ibm.com.

Keyboard Navigation of the User Interface

Users can access IMS user interfaces using TSO/E or ISPF. Refer to the *z/OS V1R1.0 TSO/E Primer*, the *z/OS V1R5.0 TSO/E User's Guide*, and the *z/OS V1R5.0 ISPF User's Guide, Volume 1*. These guides describe how to navigate each interface, including the use of keyboard shortcuts or function keys (PF keys). Each guide includes the default settings for the PF keys and explains how to modify their functions.

Part 1. General Guidelines for Writing IMS Routines

Chapter 1. Guidelines for Writing IMS exit routines	3
Introduction to Exit Routines	3
What You Can Customize	3
Naming the Routines	4
Changeable Interfaces and Control Blocks	4
IMS Standard User Exit Parameter List	4
Using the ISWITCH Macro	6
Binding the Routines	7
Writing IMS Routines That Access Control Blocks	7
Writing ETO (Extended terminal Option) Exit Routines	8
Writing APPC/IMS Exit Routines	8
Saving Registers.	8
Considering Cross-Memory.	9
Considering Performance	10
IMS Callable Services	10
Types of Callable Services	10
Exit Routines Eligible for Callable Services.	11
Using Callable Services	12
How Callable Services Work	12
Requesting IMS Callable Storage Services	16
Requesting IMS Callable Control Block Services	19
Requesting IMS Callable AOI Services	23
Callable Services Return and Reason Codes.	25
Return Codes (CSPLRTRN)	25
Callable Service Interface Reason Codes (CSPLRESN)	25
Function-Specific Parameter List Reason Codes (CSPLRESN)	26
Example of a Callable Services Request	30
Control Block Usage	34
Customization Exit Routines	37

- Chapter 1, “Guidelines for Writing IMS exit routines,” on page 3

Chapter 1. Guidelines for Writing IMS exit routines

This chapter provides guidelines for writing IMS exit routines, a section about the callable services that IMS provides to enable exit routines to perform certain functions, and a section about the callable service return and reason codes.

In this Chapter:

- “Introduction to Exit Routines”
- “IMS Callable Services” on page 10
- “Callable Services Return and Reason Codes” on page 25
- “Example of a Callable Services Request” on page 30
- “Control Block Usage” on page 34
- “Customization Exit Routines” on page 37

Related Reading:

- Information on CQS client exit routines and CQS user exit routines can be found in *IMS Version 9: Common Queue Server Guide and Reference*.
- Information on Common Service Layer user exit routines can be found in *IMS Version 9: Common Service Layer Guide and Reference*.
- Information on BPE exit routines can be found in *IMS Version 9: Base Primitive Environment Guide and Reference*.

Introduction to Exit Routines

The section contains general guidelines for writing any exit routine that customizes IMS. Guidelines for writing Database Manager (DB), IMS system, and Transaction Manager (TM) exit routines are also provided in this chapter along with sections about the callable services that IMS provides and callable services return and reason codes. At the end of the chapter is a list of IMS-supplied programs for you to refer to when writing your own exit routines. (See Table 7 on page 37.)

Recommendation: Write IMS exit routines in assembler language rather than high-level languages. IMS does not support exit routines running under Language Environment[®] for z/OS. If an exit routine is written in a high-level language executing in the Language Environment for z/OS, you might incur performance problems or abends. Language Environment for z/OS is designed for applications running in key 8, problem program state. Most IMS exit routines execute in the IMS control region, in key 7 supervisor state. An abend in one of these exit routines causes the IMS control region to abend.

What You Can Customize

Some ways you can customize IMS:

- To edit messages
- To check security
- To edit transaction code input, message switching input, and physical terminal input and output
- To do additional clean-up
- To initialize dependent regions
- To control the number of buffers the RECON data sets use
- To keep track of segments that have been updated

Guidelines

You can write or include additional routines to customize your IMS system.

Sample exit routines are provided in IMS.ADFSSRC. Default routines are provided for these exit routines.

Related Reading: For information on how to avoid impacting z/OS system integrity, see *z/OS MVS Conversion Notebook*.

You can replace a default exit routine that does not meet your needs by writing one of your own. If you use IMS macros in your exit routine, you must reassemble the routine with the current release level macro library.

Naming the Routines

Using standard z/OS conventions, each routine can have any name up to eight characters in length. Be sure that this name is unique and that it does not conflict with the existing members of the data set into which you place the routine. Because most IMS-supplied routines begin with the prefix “DFS”, “DBF”, “DSP”, “DXR”, “BPE”, “CQS”, or “CSL”, you should not choose a name that begins with these letters, unless the specific routine requires it. Also, specify one entry point for the routine.

Related Reading: Refer to *IMS Version 9: Administration Guide: Database Manager* for more information on establishing naming conventions.

Naming requirements or exceptions that are specific to an exit routine are noted in the “Naming the Routine” section of each exit routine chapter.

Changeable Interfaces and Control Blocks

The interfaces that IMS supplies for use by the exit routines, including the ISWITCH macro, might change in future releases of IMS. IMS control blocks such as the SCD, PST, DMB, or VTCB might also change. Therefore, if you write an exit routine that uses these services or control blocks, you might need to change or reassemble the routine accordingly when you migrate to a new release of IMS.

IMS Standard User Exit Parameter List

Many of the IMS user exit routines use a standard user exit interface. This interface allows the exit routines to use callable services to access IMS blocks. At the same time, this interface creates a clearly differentiated programming interface (CDPI) between IMS and the exit routine. Part of the interface consists of a standard user exit parameter list. The list contains items such as a pointer to a version number and a pointer to a function-specific parameter list. All standard user exit parameter lists that have the same version number will contain the same parameters. If a new parameter is added, it is added to the end of the parameter list and the version number is increased by one.

There are currently two active versions of the standard user exit parameter list. The first version (version 1) contains only pointers to the version number and the function-specific parameter list. Table 2 on page 5 shows the content of the Version 1 standard exit parameter list. When the user exit routine is called, IMS passes it the address of this list in register 1.

Table 2. Version 1 Standard Exit Parameter List (Mapped by DFSSXPL)

Field	Offset	Length	Description
SXPL	X'00'	N/A	DSECT label for the IMS standard user exit parameter list
SXPLVER	X'00'	X'04'	Address of fullword containing version number of standard exit parameter list
SXPLATOK	X'04'	X'04'	Reserved
SXPLAWRK	X'08'	X'04'	Reserved
SXPLFSPL	X'0C'	X'04'	Address of function-specific parameter list
SXPLINTX	X'10'	X'04'	Reserved

The following user exit routines use the Version 1 parameter list:

- DFSCCMD0
- DBFHAGU0
- DFSGMSG0
- DFSINTX0
- DFSNPRT0
- DFSLGFX0
- DFSLGNX0
- DFSINSX0
- DFSSGFX0
- DFSSGNX0

The second active version (version 4) contains pointers to the version number, a callable services token, a 512-byte work area, the function-specific parameter list, and the address of a user data table (if applicable). Table 3 shows the content of the Version 4 standard exit parameter list. When the user exit routine is called, IMS passes it the address of this list in register 1.

Table 3. Version 4 Standard Exit Parameter List (Mapped by DFSSXPL)

Field	Offset	Length	Description
SXPL	X'00'	N/A	DSECT label for the IMS standard user exit parameter list
SXPLVER	X'00'	X'04'	Address of fullword containing version number of standard exit parameter list
SXPLATOK	X'04'	X'04'	0 or the address of a fullword containing the Callable Services token for this instance of the routine.
SXPLAWRK	X'08'	X'04'	Address of a 512-byte work area for use by the user exit routine. Some user exits receive the same work area every time that they are called, so they can store information in this area from call to call. Some user exits receive a different work area every time that they are called. Refer to the documentation for a specific user exit to determine whether the work area for that exit is permanently assigned or not.
SXPLFSPL	X'0C'	X'04'	Address of the function-specific parameter list

Guidelines

Table 3. Version 4 Standard Exit Parameter List (Mapped by DFSSXPL) (continued)

Field	Offset	Length	Description
SXPLINTX	X'10'	.X'04'	Address of the user data table loaded by DFSINTX0 at IMS initialization time. This field is valid only in IMS environments where DFSINTX0 is called. It will be X'80000000' in any other environment. For more information about the DFSINTX0 exit routine, see Chapter 40, "Initialization Exit Routine (DFSINTX0)," on page 289.

If an exit routine is written to use a parameter that was added in a later version, and the exit routine can execute in an environment in which earlier versions of the parameter list could be received, the exit routine should check the version of the parameter list it received to ensure that the data is available to the exit routine.

The following exit routines use the Version 4 parameter list:

- DFSAOE00
- DFSBSEX0
- DFSFLGX0
- DFSNDMX0
- DFSPPUE0
- DFSRAS00
- DFSYDRU0
- DFSYIOE0
- DFSYPRX0

Using the ISWITCH Macro

The ISWITCH macro changes execution from the dependent region TCB to the control or DL/I address space. ISWITCH also exits cross-memory mode.

ISWITCH must have addressability to the SCD and, for Figure 1, to the PST. The address of the SCD is obtained from the PSTSCDAD field in the PST.

For Fast Path exit routines, specify TO=CTL.

Figure 1 is an ISWITCH example:

```
ISWITCH TO=DLI,ECB=PSTDECB
SLR   R1,R1           Get a zero
ST    R1,PSTDECB     Clean ECB after target memory post
LTR   R15,R15        Successful?
BNZ   ERR1           No
```

Figure 1. ISWITCH Example

When a Fast Path exit routine issues an ISWITCH to the control region, it must issue a second ISWITCH call specifying TO=DEP to return to the dependent region before returning to the caller of the exit routine. This is done only in an exit routine that is entered from a Fast Path module.

The following is an example of the second ISWITCH call needed for Fast Path:

```

ISWITCH TO=DEP,ECB=PSTDECB
SLR    R1,R1          Get a zero
ST     R1,PSTDECB    Clean ECB after target memory post
LTR    R15,R15       Successful?
BNZ    ERR1          No

```

Exit routines should not use ISWITCH TO=RET, because unpredictable results might occur. (ISWITCH TO=RET could be used in previous IMS releases.) Ensure that all instances of ISWITCH TO=RET are changed to ISWITCH TO=DEP.

Binding the Routines

Most modules receive control and must return control in AMODE=31, and must be able to execute in cross-memory and TASK modes.

Recommendation: RMODE=ANY is recommended.

Recommendation: All TM exit routines can be entered simultaneously by multiple dispatchable tasks. Therefore, it is highly recommended that all TM exit routines are coded as *reentrant* (RENT).

All routines receive control and must return control in 31-bit addressing mode (AMODE 31) and must be able to execute in RMODE ANY and AMODE 31.

If you bind an exit routine as reentrant (RENT), it must be truly reentrant (for example, it cannot depend on *any* information from a previous iteration and it cannot store into itself).

If you bind an exit routine as reusable (REUSE), it must be truly reusable (it cannot depend on *any* information in itself from a previous iteration), but it can depend on information that it saves in the specific block passed to it. If you bind a routine that is serially reusable, it must be used for a single database only.

If you bind an exit routine as neither RENT nor REUSE, it can store into itself and depend on the information saved in the block that is passed to it.

If you bind an exit routine as reentrant, it is loaded in key 0 storage to automatically protect the exit routine from being accidentally or intentionally modified.

Specific requirements and exceptions are noted in each chapter. Refer to the section on “Binding the Routine” included in each exit routine chapter.

Writing IMS Routines That Access Control Blocks

If you use the online change function, you must modify exit routines that depend on control blocks being in contiguous storage. Control blocks for databases, programs, transactions, and routing codes might not be contiguous after an online modification. This applies specifically to:

- DMB Directory Entries (DDIR)
- PSB Directory Entries (PDIR)

If your routine accesses IMS control blocks, you can find DSECTs for these blocks in the following macros:

Macro	DSECT
ISCD	System content directory (SCD)
DFSDDIR	DMB Directory entry (DDIR)

Guidelines

DFSPDIR	PSB Directory entry (PDIR)
DFSDMB	Data management block (DMB)
DFSPSB	Program specification block (PSB)
DBFESCD	Extended system content directory (ESCD)
DBFRCTE	Routing code table entry (RCTE)

Writing ETO (Extended terminal Option) Exit Routines

Unless otherwise stated, all non-LU 6.2 exit routines are available to terminals defined both statically at system definition and dynamically using the Extended Terminal Option (ETO) feature. Some exit routines are loaded at initialization if ETO=Y. (If this is the case, it is noted in each chapter in the section on Binding or including the routine.) While these exit routines are only loaded if the ETO feature is used, they are available for use by static and dynamic ACF/VTAM terminals.

Related Reading: For more information on ETO, see *IMS Version 9: Administration Guide: Transaction Manager*.

Writing APPC/IMS Exit Routines

The LU 6.2 Edit exit routine (DFSLUEE0) is only available to LU 6.2 devices. The Message Control Error exit routine (DFSCMUX0), the Conversational Abnormal Termination exit routine (DFSCONE0), the Transaction Authorization exit routine (DFSCTRNO), and the Fast Path Routine for Input Edit/Routing exit routine (DBFHAGU0) also support LU 6.2 devices. No other exit routines support LU 6.2 devices or are affected by APPC/IMS.

Saving Registers

IMS exit routines need to save registers in the save area pointed to by Register 13. This save area is provided at entry. In general, the save area passed to the exit is in 31-bit storage. You should save and restore registers in 31-bit mode.

There are two types of save areas that exit routines use to save registers:

- A prechained save area passed to the exit routine by IMS or the calling application
- A single save area used by exit routines that use the Version 3 standard user exit parameter list

Using the Prechained Save Area

IMS or the application that calls the exit routine passes a prechained save area to the exit. The routine must step forward to the next save area in the save area set before processing any data.

The save area address given to the exit routine has a prechained forward save area pointer at offset 8 and a prechained backward pointer at offset 4. The exit routine can use the forward save area pointed to by offset 8 but **must not** alter the first three words of the save area.

Before returning control to IMS, the routine must step back to the original save area and restore IMS registers.

Using the Single Save Area

When an exit routine uses the version 4 standard user exit parameter list, it does not receive a prechained save area. Instead, the routine points to a single save area in register 13. The exit routine must use this save area to save registers from IMS or the calling application.

If the exit routine calls other applications or routines, including IMS Callable Services, the routine must provide an additional save area. The 512-byte dynamic work area passed to exit routines that use the version 4 parameter list can be used as one or more save areas.

Before returning control to IMS, the exit routine must restore the registers to IMS or the calling application. For more information on the standard user exit interface refer to “IMS Standard User Exit Parameter List” on page 4.

Considering Cross-Memory

IMS exit routines can be entered in cross-memory mode. Do not issue any SVC (except ABEND) or I/O request.

If the routine runs in the DL/I address space and you need to perform a function that cannot be done in cross-memory mode, issue an ISWITCH TO=DLI to exit cross-memory. Because of the overhead in performing a task switch from the dependent address space to the IMS control program, use ISWITCH infrequently. ISWITCH TO=DLI is not valid for TM exit routines.

If you are not using the DL/I address space option, execution after the ISWITCH continues in the control address space. With LSO=S, execution continues in the DL/I address space. TO=DLI on ISWITCH performs the correct switching in all environments.

With LSO=S, DL/I exits cannot address data in the control address space.

Most terminal-related control blocks are not addressable from the DL/I address space.

Sometimes your exit might need to test to determine whether it is running in cross-memory mode before making a particular function call. In IMS, when an exit is called in cross-memory mode, the primary address space will always be different from the secondary address space. You can use the instructions EPAR and ESAR to obtain the primary and secondary address space ASIDs and compare them. If they are equal, the exit is not in cross-memory mode. If they are unequal, the exit is in cross-memory mode.

The following code shows an example of checking for running in cross-memory mode. The code issues a branch-enter WTO macro call when it is in cross-memory mode; it issues a normal SVC WTO when not in cross-memory mode.

```

                EPAR  R0          Get primary ASID
ESAR           R1          Get secondary ASID
CLR           R0,R1       Primary = Secondary?
BNE          BEWTO       No, in XM mode, use BE WTO
WTO          'message'   Yes, use SVC WTO
B            ENDWTO
BEWTO        DS           0H
WTO          'message',LINKAGE=BRANCH
ENDWTO       DS           0H

```

Considering Performance

Efficiency of exit routines is a prime concern for IMS performance. Most routines are called from the IMS control region and get control in key 7 supervisor state. Some routines might be called from mainline processing code running under the IMS Control Region task. The amount and type of processing that is done by those routines can directly contribute to the total path length and time required to complete a unit of work. Other units of work that must wait to run under a task currently in use by an exit routine can also be impacted. An abend in a exit routine that executes in the IMS control region can cause the IMS control region to abend.

Recommendation: Code user-written routines in ways that minimize path length and processing time as much as possible.

Services such as OS WAITs, SVCs, and I/O can all contribute to poor performance and should be used sparingly. When an IMS callable service exists, it is recommended that you use it, rather than the z/OS equivalent, because the callable service is usually optimized to perform more efficiently in an IMS sub-dispatching environment.

Recommendation: Code user exit routines only in assembler. Exit routines written in other languages might functionally work, but, unacceptable performance can result. For example, using a high-level language runtime environment (such as Language Environment for z/OS) can result in unacceptable performance with the initialization and termination of the environment.

IMS Callable Services

IMS Callable Services are services provided by IMS for use by IMS exit routines. These services provide clearly defined interfaces that allow exit routines to request various functions.

Types of Callable Services

There are three types of IMS Callable Services: storage services, control block services, and automated operator interface (AOI) services.

Storage services support four functions:

- Get storage
- Free storage
- Load module
- Delete module

Control block services support two functions:

- Find control block
- Scan control block

AOI services support three functions:

- Insert message
- Enqueue message
- Cancel message

Exit Routines Eligible for Callable Services

Table 4 shows the exit routines that are eligible for callable services and the types of callable service that they can use. See the exit routine chapters for more information on how an exit routine uses callable services.

Table 4. Exit Routines and Associated Callable Services

Exit Name	Callable Services		
	Storage	Control Block	AOI
DBFHAGU0	X	X	
DFSAOE00 ¹	X		X
DFSAOUE0	X	X	
DFSBSEX0	X		
DFSCCMD0	X	X	
DFSCMLR0	X	X	
DFSCMLR1	X	X	
DFSCMPR0	X	X	
DFSCMPX0	X	X	
DFSCMTR0	X	X	
DFSCNTE0	X	X	
DFSCONE0	X	X	
DFSCSGN0	X	X	
DFSCSMB0	X	X	
DFSCTRN0	X	X	
DFSCTSE0	X	X	
DFSCTTO0	X	X	
DFSFEBJ0	X	X	
DFSLGX0	X		
DFSGMSG0	X		
DFSGPIX0	X	X	
DFSINSX0	X	X	
DFSINTX0	X	X	
DFSI7770	X	X	
DFSLGFX0	X	X	
DFSLGNX0	X	X	
DFSME000	X	X	
DFSME127	X	X	
DFSMSCE0	X	X	
DFSNDMX0	X		
DFSNPRT0	X	X	
DFS07770	X	X	
DFSPIXT0	X	X	
DFSPPE0	X		
DFSQSPC0	X	X	
DFSSGFX0	X	X	
DFSSGNX0	X	X	

1. DFSAOE00 is the only exit routine eligible to use AOI callable services.

Callable Services

Table 4. Exit Routines and Associated Callable Services (continued)

Exit Name	Callable Services		
	Storage	Control Block	AOI
DFSSIMLO	X	X	
DFSS7770	X	X	
DFS29800	X	X	
DFS36010	X	X	

Using Callable Services

To use a callable service, do the following:

1. Link your exit routine to the callable service interface module (DFSCSI00).
2. Initialize callable services for your exit routine (CALL DFSCSI0) each time your exit routine gets control.
3. Initialize the callable services parameter list.
4. Initialize the function-specific parameter list.
5. Invoke the callable service (CALL DFSCSIF0).

Repeat steps 3 through 5 as many times as necessary while your exit routine has control.

Not all exit routines perform all five of the preceding steps. See the section called "Using IMS Callable Services" in the description of a specific exit routine to see which steps apply.

Before looking at each of these steps in more detail, let's look briefly at how IMS Callable Services work.

How Callable Services Work

Exit routines must activate IMS Callable Services in AMODE 31.

The callable services interface module DFSCSI00 contains two entry points that your exit routine can activate: DFSCSI0 and DFSCSIF0.

Entry point DFSCSI0 initializes callable services. To activate initialization, issue CALL DFSCSI0 with the appropriate registers initialized. DFSCSI0 returns a callable services token and a parameter list address. The callable services token must be passed to IMS when you activate one of the callable services. The parameter list address directs reentrant programs to a storage area in which to build parameter lists needed to activate callable services.

Entry point DFSCSIF0 activates one of the callable services. To activate a callable service, issue CALL DFSCSIF0 with the appropriate information specified. You must tell IMS which service to activate. You do this by initializing two parameter lists. The first list, the callable services parameter list, contains information needed by callable services to route the request to the appropriate service. The second list, the function-specific parameter list, defines which service is to be used and provides information required by that service.

When your exit routine receives control back from callable services, register 15 contains a return code indicating whether the call was successful. The callable

services parameter list contains a return code and a reason code if the call did not complete successfully. The function-specific parameter list can contain data from a specific callable service.

Generating Parameter Lists in Your Exit Routine

You can use the following assembler macros in your exit routine. These macros generate the parameter list DSECTs you need.

Macro	Description
DFSCSIPL	Generates the DFSCSPL, DFSCSTRG, DFSCCBLK, and DFSAOI parameter list DSECTs for an exit routine.
DFSCSPL	Generates the callable services parameter list DSECT (CSPARMS).
DFSCSTRG	Generates the storage services function-specific parameter list DSECT (CSSTRG).
DFSCCBLK	Generates the control block services function-specific parameter list DSECT (CSBLK).
DFSAOI	Generates the AOI services function-specific parameter list DSECT (DFSAOI).

Step 1: Linking Your Exit Routine to DFSCSI00

To use callable services, your exit routine must be linked with the callable service interface module DFSCSI00. For some exit routines, this module is linked automatically by IMS. For others, you need to manually link this module to your exit routine.

Automatic Linking: The following exit routines are automatically linked to DFSCSI00 by IMS.

Exit Routines Linked to DFSCSI00	Exit Routines Linked to DFSCSI00
DBFHAGU0	DFSI7770
DFSCMLR0	DFSME000
DFSCMPR0	DFSME127
DFSCNTE0	DFSQSPC0
DFSCONE0	DFSSIML0
DFSCSGN0	DFSS7770
DFSCTRN0	DFS29800
DFSFEBJ0	

Manual Linking: To use callable services, you must manually link these exit routines to DFSCSI00.

Exit Routines to be manually linked to DFSCSI00	Exit Routines to be manually linked to DFSCSI00
DFSAOE00	DFSINTX0
DFSAOUE0	DFSLGFX0
DFSBSEX0	DFSLGNX0
DFSCCMD0	DFSMSCE0
DFSCMTR0	DFSNDMX0
DFSCSMB0	DFSNPRT0
DFSCCTSE0	DFSPPE00
DFSGMSG0	DFSSGFX0
DFSGPIX0	DFSSGNX0
DFSINSX0	

Callable Services

Typically, you must manually link DFSCSI00 if your exit routine is a stand-alone module (not linked as part of another IMS load module). When you perform this binding, include an ENTRY bind control statement that specifies the entry point of your exit routine. This ensures that your exit routine, and not DFSCSI00, receives control from IMS when it is called.

Step 2. Initializing IMS Callable Services (DFSCSI0)

Most exit routines must initialize callable services. To do this, issue a call to entry point DFSCSI0. DFSCSI0 returns a callable services token and a parameter list address.

The callable services token is used to request a specific callable service through a subsequent call to entry point DFSCSIF0.

The parameter list that is returned in register 1, contains the callable services token. You need to extract the token and save it, so it does not get overlaid. Then the parameter list can be formatted for your callable service request. The parameter list is large enough to contain the parameter lists that accompany your request.

Communicating with IMS: IMS uses the entry registers, parameter list, and exit registers to communicate with your exit routine. The contents of register 0 are not preserved on entry and exit.

The following two tables list the content of registers on entry and return to and from DFSCSI0.

Content of Registers on Entry to DFSCSI0:

Register	Content
1	ECB Address. On entry, IMS gives the address of an ECB to each exit routine that can issue callable service requests. The ECB address must be passed on the DFSCSI0 initialization call. See the section for each exit routine to determine where to find the ECB address for that exit routine.
13	Address of save area for use by DFSCSI0.
14	Caller's return address.
15	DFSCSI0 entry point address.

Content of Registers on Return from DFSCSI0:

Register	Content
1	Address of parameter list.
	Offset Description
	0 Callable services token, which is four bytes long.
15	Return Code
	Return Code Meaning
	0 Request was successful.
	4 Callable services are unavailable.
	8 Callable services are unavailable. Initialization failed due to insufficient storage.
	12 Callable services are unavailable. Initialization failed due to errors in IMS control blocks.

Step 3. Initializing the Callable Services Parameter List

CSPARMS is the callable services parameter list required for all callable service requests. Callable services use parameters in the list to route control from the module requesting the service to the service routine that processes the request. The list is also used to pass return and reason codes from the service to the exit routine.

Initialize the parameter list with the callable services token and the code of the callable service you want to use (storage services, control block services, or AOI services). All other fields should be cleared. If your exit routine issues multiple calls, you can save the callable services token in a register and restore it to CSPLTKN on subsequent calls.

Initialize the following fields:

Field	Offset	Length	Description
CSPLTKN	0	4	IMS Callable Services token
CSPLSERV	4	4	IMS Callable Service code. The values are as follows:
		1	Storage services
		2	Control block services
		3	AOI services

Step 4. Initializing the Function-Specific Parameter List

After specifying which service you want to use in the callable services parameter list, indicate which function of the service you want to use by initializing the appropriate function-specific parameter list.

The function-specific parameter lists are described in:

- “Requesting IMS Callable Storage Services” on page 16
- “Requesting IMS Callable Control Block Services” on page 19
- “Requesting IMS Callable AOI Services” on page 23

Step 5. Activating an IMS Callable Service (DFSCSIF0)

To activate a callable service, issue:

```
CALL DFSCSIF0
(callable services parameter list, function-specific
parameter list)
```

Communicating with IMS: IMS uses the entry registers, parameter lists, and exit registers to communicate with your exit routine.

The following tables list the content of registers on entry and exit to and from DFSCSIF0.

Content of Registers on Entry to DFSCSIF0:

Register	Content
1	Address of two-word parameter list built by CALL macro.
	Offset Description
	0 Callable services parameter list address
	4 Function-specific parameter list address

Callable Services

Register	Content
13	Address of save area for use by DFSCSIF0
15	DFSCSIF0 entry point address

Content of Registers on Return from DFSCSIF0:

Register	Content
15	Return Code

Return Code	Meaning
0	Request successful
4	Request unsuccessful

If the request is unsuccessful, refer to the return (CSPLRTRN) and reason code (CSPLRESN) fields in the callable services parameter list described in the following table.

Field	Description
CSPLRTRN	Return code set with error codes defined in DFSCSPL. For a list of these codes, refer to "Return Codes (CSPLRTRN)" on page 25.
CSPLRESN	Reason code set with error codes defined in DFSCSPL. For a complete description of the reason codes, see one of the following sections:

Reason Code	Reference
4	See "Callable Service Interface Reason Codes (CSPLRESN)" on page 25.
8	See "Function-Specific Parameter List Reason Codes (CSPLRESN)" on page 26.

Requesting IMS Callable Storage Services

CSSTRG is the function-specific parameter list used for IMS Callable Storage Service requests. It is defined by the DFSCSTRG macro.

The function-specific parameter list contains the information that storage services need to perform the function you requested (get or free storage, load or delete a module). The function-specific parameter list is also used to return data to the exit routine.

You must initialize the function-specific parameter list for storage services before calling DFSCSIF0 to activate storage services. All fields that are not used as input to DFSCSIF0 should be cleared.

Using the GET Storage Function

GET storage is the storage service for obtaining user storage. The storage can be obtained in private storage or CSA with either doubleword or page boundary alignment. The storage can be requested above (31-bit) or below (24-bit) the 16 MB line.

To request the GET storage function, initialize the following fields in the function-specific parameter list (CSSTRG):

Field	Offset	Length	Description
CSSTFUNC	0	4	IMS storage service function code value: 1 = GET storage
CSGTLEN	4	4	Length of storage to obtain
CSGTSP	8	4	Storage subpool identifier values: • 0 = private storage • X'FFF' = CSA storage
CSGTLOC	C	4	Storage location identifier values: • 0 = 31-bit storage • 1 = 24-bit storage
CSGTBN DY	10	4	Storage boundary identifier values: • 0 = doubleword boundary • 1 = page boundary

The following field (in CSSTRG) is returned from the GET storage function:

Field	Offset	Length	Description
CSGTADDR	14	4	Storage address

Using the FREE Storage Function

FREE storage is the storage service used to release user storage previously obtained by the GET storage service. The requestor specifies the address of the storage. The storage subpool (private or CSA) specified on the FREE request must be the same value specified on the GET request.

To request the FREE storage function, initialize the following fields in the function-specific parameter list (CSSTRG):

Field	Offset	Length	Description
CSSTFUNC	0	4	IMS storage service function code value: • 2 = FREE storage
CSFRSTAD	4	4	Address of storage to release
CSFRLEN	8	4	Length of storage to release
CSFRSP	C	4	Storage subpool identifier values: • 0 = private storage • X'FFF' = CSA storage

No data is returned from the FREE storage service.

Using the LOAD Module Function

LOAD module is the storage service used to load a module. The module can be loaded in private storage or CSA. The module can be loaded above (31-bit) or below (24-bit) the 16 MB line. The name of the module must be specified. If the module was loaded previously but you want a new copy of the module, you can request a load of a new copy.

The LOAD module function can be requested by callers running in cross memory mode. In this case, the LOAD module function determines if the primary address space is either CTL or DLI/SAS, and ensures that the call executes in the proper

Callable Services

address space in non-cross memory mode. The LOAD module function restores the cross memory environment before returning control to the caller.

There might be a noticeable performance impact for cross memory callers issuing the LOAD module function, because this call requires that the environment be switched from cross memory mode to non-cross memory mode and then restored. Use of the LOAD module function should be kept to a minimum for mainline path exit routines.

To use the LOAD module function, initialize the following fields in the function-specific parameter list (CSSTRG):

Field	Offset	Length	Description
CSSTFUNC	0	4	IMS storage service function code value: <ul style="list-style-type: none">• 5 = LOAD module
CSLDNAME	4	8	Name of module to load
CSLDSP	C	4	Storage subpool identifier values: <ul style="list-style-type: none">• 0 = private storage• X'FFF' = CSA storage
CSLDLOC	10	4	Module storage location identifier values: <ul style="list-style-type: none">• 0 = 31-bit storage• 1 = 24-bit storage
CSLDUSE	14	4	Module reuse identifier values: <ul style="list-style-type: none">• 0 = use existing copy of module if found• 1 = load a new copy of module

The following fields are returned from the LOAD module function:

Field	Offset	Length	Description
CSLDMEP	18	4	Module entry point
CSLDMLN	1C	4	Module length bit 0 is set to one when the module was previously loaded

Using the DELETE Module Function

DELETE module is the storage service used to delete a module previously obtained by the LOAD storage service. The requester specifies either the module name or module address. If more than one copy of the module was loaded, the address should be used instead of the name to ensure that the correct copy is deleted. The module storage subpool (private or CSA) specified on the DELETE request must be the same value specified on the LOAD request.

The DELETE module function can be requested by callers running in cross memory mode. In this case, the DELETE module function determines if the primary address space is either CTL or DLI/SAS, and ensures that the call executes in the proper address space in non-cross memory mode. The DELETE module function restores the cross memory environment before returning control to the caller.

There might be a noticeable performance impact for cross memory callers issuing the DELETE module function, because this call requires that the environment be

switched from cross memory mode to non-cross memory mode and then restored. Use of the DELETE module function should be kept to a minimum for mainline path exit routines.

To request the DELETE module function, initialize the following fields in the function-specific parameter list (CSSTRG):

Field	Offset	Length	Description
CSSTFUNC	0	4	IMS storage service function code value: 6 = DELETE module
CSDLNAME	4	8	Name of module to delete. Either module name or module address must be specified to delete a module. The unused field should be cleared. If the module name is not specified, this field should be cleared and CSDLEP must be specified.
CSDLEP	C	4	Address of module to delete. If more than one copy of the module was loaded, delete the module by specifying the module entry point. This ensures that the correct copy of the module is deleted. If both name and address are specified, the module is deleted using the address. If the address is not given, the name must be specified and all copies will be deleted.
CSDLSP	10	4	Storage subpool identifier values: 0 = private storage X'FFF' = CSA storage

No data is returned from the DELETE module function.

Requesting IMS Callable Control Block Services

CSCBLK is the function-specific parameter list used for IMS Callable Control Block Service requests. It is defined by the DFSCCBLK macro.

The function-specific parameter list contains the information control block services need to perform the function you requested (find or scan a control block). The function-specific parameter list is also used to return data to the exit routine.

If an IMSplex is sharing terminal or user information in Resource Manager (RM), callable services automatically and transparently return global resource information to the exit routine. However, if a routine wants to find or to scan resources that are only local to the current IMS, it can specify the local option (by setting CSFDL1). For resources that do not have global information such as transactions, the local option results in the same information as the default.

You must initialize the function-specific parameter list for control block services before calling DFSCSIF0 to activate control block services. All fields that are not used as input to DFSCSIF0 should be cleared.

Using the FIND Control Block Function

FIND control block is used to find a specific instance of a control block. The search type identifies the type of control block to locate. A search type can include more than one type of control block. A list of the search types is in the description of the CSFDTYPE field in the following table. The control block name or identifier is used to find a specific instance of the control block.

Callable Services

Initialize the function-specific parameter list before calling DFSCSIF0 to activate control block services. All fields that are not used as input to DFSCSIF0 should be cleared.

Initializing the Function-Specific Parameter List for FIND: In all instances, you need to initialize the following three fields:

Field	Offset	Length	Description
CSCBFUNC	0	1	IMS control block services function code value: <ul style="list-style-type: none"> • 1 = FIND control block
CSFDTYPE	4	4	Control block search type values: <ul style="list-style-type: none"> 1 = FIND CCB 2 = FIND CNT, or LNB 3 = FIND RCNT 4 = FIND CNT, LNB, or RCNT 5 = FIND SPQB 6 = FIND VTCB 7 = FIND CNT descriptor 8 = FIND LOGON descriptor 9 = FIND USER descriptor 10 = FIND transaction
CSFDL1	16	1	Input Flag Byte CSFDLOC1 EQU X'80' -Indicates that the FIND request is to return local information only.

Depending on the type of block you want to find, you must initialize the following fields:

Block Type to Find	Field to Initialize
CCB	Specify one of the first two fields, and clear the unused field. The lterm name field must always be specified. CSFDEID = EBCDIC CCB identifier CSFDBID = Binary CCB identifier CSFDNAME = associated LTERM name
CNT or LNB	Use the LTERM name to locate a specific CNT or LNB. CSFDNAME = LTERM name
RCNT	Use the LTERM name to locate a specific RCNT. CSFDNAME = LTERM name
CNT, LNB, or RCNT	Use the LTERM name to locate a specific CNT, LNB, or RCNT. CSFDNAME = LTERM name
SPQB	Use the USER name to locate a specific SPQB. CSFDNAME = USER name
VTCB	Either the node name alone or the node and user name are used to locate a specific VTCB. If the user name is not used on the request, clear the unused field. CSFDNODE = Node name CSFDUSER = User name
CNT, LOGON, or USER Descriptor	Specify the name of the descriptor you want to locate. CSFDNAME = CNT, LOGON, or USER descriptor name
Transaction	Specify the transaction code you want to find. CSFDNAME = Transaction name

Output Returned from FIND Control Block Services: Depending on the type of search specified, one of the following is returned in the CSFDBLKA field in the function-specific parameter list:

Search Type	Output from Service
FIND CCB	CCB address
FIND CNT or LNB	CNT or LNB address
FIND RCNT	RCNT address
FIND CNT, LNB, or RCNT	CNT, LNB, or RCNT address
FIND SPQB	SPQB address
FIND VTCB	CLB address
FIND CNT descriptor	USRD address
FIND LOGON descriptor	CLB address
FIND USER descriptor	USRD address
FIND Transaction	SMB address

FIND transaction also returns the PDIR address in field CSFCBLK2.

Using the SCAN Control Block Function

SCAN control block is used to scan control blocks of a certain type. The first time the SCAN function is activated, the current control block address should be 0. SCAN returns the first control block that meets the search criteria. The SCAN function can be subsequently activated to locate additional control blocks. Subsequent searches start where the previous scan left off.

On subsequent SCAN requests, the current block address is passed back to the service. The search starts with the current control block to locate the next control block meeting the criteria. The blocks are not retrieved in alphabetic sequence.

Qualifying the Scan: To further qualify the scan, a generic name or a name containing wild cards can be specified for CNT, LNB, RCNT, SPQB, and VTCB control block types.

- A generic name consists of one or more characters of the name followed by an asterisk. Generic names must be padded with blanks.
For example, assume valid names are DFSAAAAA, DFSZZZZZ, and DFSABBBB. Multiple scan requests using the generic name 'DFS*' can be used to obtain the control block addresses for DFSAAAAA and DFSABBBB. In this case, DFSZZZZZ would not be returned to the requester.
- A wild card character is represented by the '%' character. One or more wild cards can replace characters within the name when that position in the name can be any character.
For example, assume valid names are DFSAABBB, DFSZZBBB, and DFSABCDE. Multiple scan requests using the name DFS%%BBB containing wild card characters in positions 4 and 5 would return control block addresses for DFSAABBB and DFSZZBBB. DFSABCDE would not be returned to the requester.

You must initialize the function-specific parameter list before calling DFSCSIF0 to activate control block services. All fields that are not used as input to DFSCSIF0 should be cleared.

Callable Services

Initializing the Function-Specific Parameter List for SCAN: To request a SCAN and search type, you always need to initialize the first two fields as follows:

Field	Offset	Length	Description
CSCBFUNC	0	4	IMS control block service function code value: • 2 = SCAN control block
CSSCTYPE	4	4	Control block search type indicator values: 1 = SCAN CCB 2 = SCAN CNT or LNB 3 = SCAN RCNT 4 = SCAN CNT, LNB, or RCNT 5 = SCAN SPQB 6 = SCAN VTCB 7 = not used 8 = SCAN LOGON descriptor 9 = SCAN USER descriptor 10 = not used
CSSCFLG1	20	1	CSSCLOC1 EQU X'80' Indicates that the SCAN request is to return local information only

Depending on the type of search you want, you might also need to initialize one or more of the following fields in the function-specific parameter list.

To Scan	Initialize
CCB	Specify whether you want to scan for the first CCB or to start the scan at the current CCB. CSSCCBLK = Current CCB address or zero
CNT or LNB	Specify whether you want to scan for the first CNT or LNB or to start the scan at the current CNT or LNB. Use the LTERM name to narrow the scope of the scan. If the LTERM name is not used, clear the field. CSSCCBLK = Current CNT or LNB address or zero CSSCNAME = LTERM name
RCNT	Specify whether you want to scan for the first RCNT or to start the scan at the current RCNT. Use the LTERM name to narrow the output of the scan. If the LTERM name is not used, clear the field. CSSCCBLK = Current RCNT address or zero CSSCNAME = LTERM name
CNT, LNB, or RCNT	Specify whether you want to scan for the first CNT, LNB, or RCNT, or to start the scan at the current CNT, LNB, or RCNT. Use the LTERM name to narrow the output of the scan. If the LTERM name is not used, clear the field. CSSCCBLK = Current CNT, LNB, or RCNT address, or zero CSSCNAME = LTERM name
SPQB	Specify whether you want to scan for the first SPQB or to start the scan at the current SPQB. Specify the USER name to narrow the output of the scan. If the USER name is not specified, clear the field. CSSCCBLK = Current SPQB address or zero CSSCNAME = USER name

To Scan	Initialize
VTCB	Specify whether you want to scan for the first VTCB or to start the scan at the current CLB. Specify either the NODE name alone, or the NODE and USER name to narrow the output of the scan. If the name fields are not specified, clear the fields. CSSCCBLK = Current CLB address or zero CSSCNODE = NODE name CSSCUSER = USER name
LOGON Descriptor	Specify whether you want to scan for the first LOGON descriptor or to start the scan at the current LOGON descriptor. CSSCCBLK = Current LOGON descriptor address or zero
USER Descriptor	Specify whether you want to scan for the first USER descriptor or to start the scan at the current USRD. CSSCCBLK = Current USRD address or zero

Output Returned from SCAN Control Block Services: Depending on the type of scan specified, one of the following is returned in the CSSCNBLK field in the function-specific parameter list:

Search type	Output from service
SCAN CCB	Next CCB address
SCAN CNT or LNB	Next CNT or LNB address
SCAN RCNT	Next RCNT address
SCAN CNT, LNB, or RCNT	Next CNT, LNB, or RCNT address
SCAN SPQB	Next SPQB address
SCAN VTCB	Next CLB address
SCAN LOGON descriptor	CLB address of next LGND
SCAN USER descriptor	Next USRD address

Requesting IMS Callable AOI Services

DFSCAOI is the function-specific parameter list used for IMS Callable AOI Service requests. It is defined by the DFSCAOI macro.

The function-specific parameter list contains the information that AOI services needs to perform the function you requested (insert, enqueue, or cancel a message). The function-specific parameter list is also used to return data to your exit routine.

You must initialize this function-specific parameter list before calling DFSCSIF0 to activate AOI callable services. All fields that are not used as input to DFSCSIF0 should be cleared.

Using the INSERT Function

The INSERT function inserts the first, or a subsequent, message segment into a message buffer. The message segments are not available to the AO application until an enqueue is issued specifying an AOI token.

To request the INSERT function, initialize the following fields in the function-specific parameter list:

Field	Offset	Length	Description
CAOIFUNC	0	4	IMS AOI service function code value: 1 = INSERT message segment

Field	Offset	Length	Description
CAOIDMTK	4	4	Directed message token
CAINMSEG	8	4	Address of message segment

Using the ENQUEUE Function

The ENQUEUE function inserts the last or only message segment into the message buffer. It enqueues this message segment to the AOI token the requester has specified. Enqueue then makes the entire message available to the AO application. If ENQUEUE is requested with a message segment address of 0, all previously inserted message segments are made available to the AO application.

To request the ENQUEUE function, initialize the following fields in the function-specific parameter list (DFSCAOI):

Field	Offset	Length	Description
CAOIFUNC	0	4	IMS AOI service function code value: 2 = ENQUEUE segment to AOI token
CAOIDMTK	4	4	Directed message token
CAENMSEG	8	4	Address of message buffer
CAENTCNT	12	4	Number of AOI token names in the token list addressed by the next word in this parameter list
CAENTLST	16	4	Address of a token list. Each 12-byte entry in the list contains the following:

Offset Description

- +0** The 8-byte alphanumeric AOI token name to which the message is to be enqueued
- +8** The 4-byte code from the ENQUEUE function indicating whether the message was successfully enqueued to the AOI token. Possible codes are:

Code Meaning

- 0** Enqueue to AOI token was successful.
- 1** Enqueue was unsuccessful. AOI token name was blanks.
- 2** Enqueue was unsuccessful. AOI token name contained invalid characters.
- 3** Enqueue was unsuccessful. Enqueue could not get AOIP storage.
- 4** Enqueue was unsuccessful. An internal latch error occurred.

Using the CANCEL Function

The CANCEL function cancels messages that have been inserted into the message buffer but not yet enqueued to the AOI token. Canceled messages are not made available to the application program.

To request the CANCEL function, initialize the following fields:

Field	Offset	Length	Description
CAOIFUNC	0	4	IMS AOI service function code value: 3 = CANCEL message segments
CAOIDMTK	4	4	Directed message token

Callable Services Return and Reason Codes

This section describes the return and reason codes for IMS Callable Services. All return and reason codes are in hexadecimal format.

Return Codes (CSPLRTRN)

Return codes are in field CSPLRTPN in the callable services parameter list. Following are the return codes indicating why the request did not complete successfully:

Return Code	Meaning
4	A callable service interface error occurred. The service request was not processed.
8	Function-specific parameter list error. While processing the callable service request, an error occurred in the function-specific parameter list.
20	Service processing error. An error occurred while processing the callable service request. The error could be a user error or an internal system error.

Callable Service Interface Reason Codes (CSPLRESN)

Following are the reason codes when return code field CSPLRTRN is 4:

Reason Code	Meaning
4	Callable services token is 0. The field CSPLTKN in the callable services parameter list DFSCSPL is 0.
8	Callable services token is invalid. The field CSPLTKN in the callable services parameter list DFSCSPL does not contain a valid callable services token.
C	Service code is not specified. The field CSPLSERV in the callable services parameter list DFSCSPL is 0.
10	Service code is invalid. The field CSPLSERV in the callable services parameter list DFSCSPL does not contain a valid callable service code. The service code is too large.
14	Service is not supported. The field CSPLSERV in the callable services parameter list DFSCSPL contains a value for a callable service code that is not supported in the current environment or is a reserved function.
30	Function code is not specified. The function code field in the function-specific parameter list is 0.
34	Function code is invalid. The function code field in the function-specific parameter list contains a function code that is too large.
38	Function is not supported. The function code field in the function-specific parameter list contains a value for a callable service function code that is not supported in the current environment or is a reserved function.

Function-Specific Parameter List Reason Codes (CSPLRESN)

Following are the reason codes when return code field CSPLRTRN = 8 or 20: The reason codes are described by service and by function.

GET Storage Service Reason Codes

Following are the reason codes for GET function parameter errors:

When CSPLRTRN = 8:

Reason Code	Meaning
4	Invalid subpool parameter. The field CSGTSP in the function-specific parameter list DFSCSTRG contains an invalid subpool value.
8	Invalid location parameter. The field CSGTLOC in the function-specific parameter list DFSCSTRG contains an invalid storage location value.
C	Invalid boundary parameter. The next CSGTBN DY in the function-specific parameter list DFSCSTRG contains an invalid storage boundary value.
10	Length parameter not specified. The field CSGTLEN in the function-specific parameter list DFSCSTRG is 0.

When CSPLRTRN = 20: If you receive any reason code not listed in the following table, please contact IBM Service.

Reason Code	Meaning
06 00 00 04	Storage could not be allocated.
06 00 00 08	Parameter list error.

FREE Storage Service Reason Codes

Following are the reason codes for FREE function parameter errors:

When CSPLRTRN = 8:

Reason Code	Meaning
4	Invalid subpool parameter. The field CSFRSP in the function-specific parameter list DFSCSTRG contains an invalid subpool value.
8	Address parameter not specified. The field CSFRSTAD in the function-specific parameter list DFSCSTRG is 0.
C	Length parameter not specified. The field CSFRLEN in the function-specific parameter list DFSCSTRG is 0.

When CSPLRTRN = 20: If you receive any reason code not listed in the following table, please contact IBM service.

Reason Code	Meaning
07 00 00 04	Storage was not released. A value in the second byte of the reason code is provided by the associated z/OS Service. For example, the 04 in the second byte of reason code 07 04 00 04 is returned from z/OS FREEMAIN. Additional information can be found in the IMODULE FREESTOR Return Codes section of the <i>IMS Version 9: Messages and Codes, Volume 1</i> .
07 00 00 08	Parameter list error.
07 00 00 0C	Unable to locate storage descriptor block. Storage address might be invalid or storage subpool specification might be incorrect.

LOAD Storage Service Reason Codes

Following are the reason codes for LOAD function parameter errors:

When CSPLRTRN = 8:

Reason Code	Meaning
4	Invalid subpool parameter. The field CSLDSP in the function-specific parameter list DFSCSTRG contains an invalid subpool value.
8	Invalid location parameter. The field CSLDLOC in the function-specific parameter list DFSCSTRG contains an invalid module location value.
C	Invalid use parameter. The field CSLDUSE in the function-specific parameter list DFSCSTRG contains an invalid module reuse value.
10	Name parameter not specified. The field CSLDNAME in the function-specific parameter list DFSCSTRG does not contain a module name.
14	The caller is running in cross memory mode, and the primary address space is not CTL or DLI.

When CSPLRTRN = 20: If you receive any reason code not listed in the following table, please contact IBM Service.

Reason Code	Meaning
02 00 00 04	Module was not found.
02 00 00 08	DFSMODU0 allocation error.
02 00 00 0C	BLDL/FETCH allocation error.
02 00 00 10	FETCH/BLDL I/O error occurred loading the requested module.
02 00 00 24	DCB was not open for BLDL.
02 00 00 28	Caller was authorized, but module was found in unauthorized library.

DELETE Storage Service Reason Codes

Following are the reason codes for DELETE function parameter errors:

When CSPLRTRN = 8:

Reason Code	Meaning
4	Invalid subpool parameter. The field CSDLSP in the function-specific parameter list DFSCSTRG contains an invalid subpool value.
8	Name and address was not specified. The field CSDLNAME in the function-specific parameter list DFSCSTRG does not contain a module name, and CSDLLEP does not contain a module address.
C	The caller is running in cross memory mode, and the primary address space is not CTL or DLI.

When CSPLRTRN = 20: If you receive any reason code not listed in the following table, please contact IBM Service.

Reason Code	Meaning
04 00 00 04	Module was not found.
04 00 00 0C	Module storage was not released.

FIND Control Block Service Reason Codes

Following are the reason codes for FIND function parameter errors:

Return and Reason Codes

When CSPLRTRN = 8:

Reason Code	Meaning
4	FIND type was not specified. The field CSFDTYPE in the function-specific parameter list DFSCCBLK is 0.
8	FIND type was invalid. The field CSFDTYPE in the function-specific parameter list DFSCCBLK does not contain a valid control block search type value. The search type value is too large.
C	CCBID was not specified. The field CSFDEIB in the function-specific parameter list DFSCSTRG does not contain an EBCDIC CCB identifier, and CSFDBID does not contain a binary CCB identifier.
10	Control block name was not specified. The field CSFDNAME in the function-specific parameter list DFSCCBLK does not contain a name.

When CSPLRTRN = 20: Following are the reason codes you might get when searching CCB, CNT, LNB, RCNT, SPQB, CNT, descriptor and USER descriptor control block types:

Reason Code	Meaning
4	Block was not found.
40 00 00 00	CBTS latch held, cannot process request.

Following are the reason codes you might get when searching VTCB and LOGON descriptor control block types:

Reason Code	Meaning
4	Cannot find CLB with VTAM [®] CID or node/descriptor name.
8	NO VTCBs/LGNDs are in system.
40 00 00 00	CBTS latch held, cannot process request.

The following are the reason codes that can be encountered when searching for a transaction control block type.

Reason Code	Meaning
8	Transaction was not found.
40 00 00 00	CBTS latch held, cannot process request.

SCAN Control Block Service Reason Codes

Following are the reason codes for SCAN function parameter errors:

When CSPLRTRN = 8:

Reason Code	Meaning
4	SCAN type was not specified. The field CSSTYPE in the function-specific parameter list DFSCCBLK is 0.
8	SCAN type was invalid. The field CSSCTYPE in the function-specific parameter list DFSCCBLK does not contain a valid control block search type value. The search type value is too large or is a reserved function.

When CSPLRTRN = 20: Following are the reason codes you might get when searching CCB, CNT, LNB, RCNT, SPQB, and USER descriptor control block types:

Reason Code	Meaning
4	End of queue was found.
8	No block is in system.
14	Bad INUSE call. Verify that the CSSCCBLK and CSSCNAME fields are properly initialized.
18	Bad NOUSE call. Verify that the CSSCCBLK and CSSCNAME fields are properly initialized.
40 00 00 00	CBTS latch held, cannot process request.

Following are the reason codes you might get when searching VTCB and LOGON descriptor control block types:

Reason Code	Meaning
4	Cannot find VTCB matching arguments.
8	No VTAM nodes were in system.
40 00 00 00	CBTS latch held, cannot process request.

INSERT AOI Service Reason Codes

Following are the reason codes for INSERT function parameter errors:

When CSPLRTRN = 8:

Reason Code	Meaning
4	Directed message token was 0.
8	Directed message token was invalid.
C	Message segment address was 0.
10	Message segment length (LL field) was 0.

When CSPLRTRN = 20:

Reason Code	Meaning
4	IMS could not get the storage required to process the call.

ENQUEUE AOI Service Reason Codes

Following are the reason codes for ENQUEUE function parameter errors:

When CSPLRTRN = 8:

Reason Code	Meaning
4	Directed message token was 0.
8	Directed message token was invalid.
10	Message segment address was specified, but segment length (LL field) was 0.
14	AOI token count field was 0.
18	AOI list token address was 0.
1C	One or more tokens was processed successfully.
20	No tokens were processed successfully.

CANCEL AOI Service Reason Codes

Following are the reason codes for CANCEL function parameter errors:

When CSPLRTRN = 8:

Reason Code	Meaning
4	Directed message token was 0.
8	Directed message token was invalid.
C	No message exists to cancel.

Example of a Callable Services Request

Figure 2 on page 31 is an example of how an exit routine could use IMS Callable Services. In the example, the storage returned from DFSCSI0 is divided into three areas. These areas are for the parameter lists used for the call to DFSCSIF0. The first area is used for the z/OS CALL parameter list, the second for the IMS Callable Service parameter list, and the third for the function specific parameter list. The labels, CSICLLEN and CSPLPLEN, used in the examples are defined as EQU statements in the macro DFSCSIPL. These labels represent the length of the z/OS parameter list built by the CALL macro and the length of the IMS Callable Services parameter list.

```

*****
*
* -----
* GETSTOR - GET STORAGE SUBROUTINE
* -----
*
* THIS SUBROUTINE INVOKES IMS CALLABLE SERVICES TO
* GET WORKING STORAGE. THE CALLER PASSES THE REQUIRED
* STORAGE LENGTH. THE SUBROUTINE THEN OBTAINS PRIVATE,
* 31-BIT STORAGE ON A DOUBLEWORD BOUNDARY.
*
*
* INPUT REGISTERS:
*   R8 = REQUESTED STORAGE LENGTH
*   R9 = ECB ADDRESS
*   R10 = LINKAGE REGISTER
*         CALLED BY BAL 10,GETSTOR
*
* OUTPUT REGISTERS:
*   R1 = STORAGE ADDRESS
*   R9 = ECB ADDRESS
*   R10 = LINKAGE REGISTER
*   R15 = RETURN CODE
*         0 - CALL COMPLETED SUCCESSFULLY
*        NON-ZERO - STORAGE REQUEST FAILED
*                RETURN CODE FROM IMS CALLABLE STORAGE
*                SERVICES - GET STORAGE FUNCTION
*
* REGISTER USAGE:
*   R0 = WORK REGISTER
*   R1 = WORK REGISTER
*   R2 = IMS CALLABLE SERVICE TOKEN
*   R3 = IMS CALLABLE SERVICES PARAMETER LIST
*   R4 = IMS STORAGE SERVICES PARAMETER LIST
*   R5 = z/OS CALL PARAMETER LIST
*   R8 = REQUESTED STORAGE LENGTH
*   R9 = ECB ADDRESS
*   R14 = WORK REGISTER
*   R15 = WORK REGISTER
*
*****

```

Figure 2. Example of a Callable Service Request (Part 1 of 3)

Callable Services Example

```

GETSTOR DS    0H
        SPACE
*****
*      INVOKE CALLABLE SERVICES INITIALIZATION ENTRY POINT          *
*      DFSCSII0, TO OBTAIN THE CALLABLE SERVICE TOKEN AND          *
*      PARAMETER LIST STORAGE.                                     *
*****
        LR    1,9          ECB ADDRESS
        CALL  DFSCSII0     INVOKE INIT ENTRY POINT
        LTR   15,15       CALL SUCCESSFUL?
        BNZ  GSTREXIT     NO, ERROR RETURN
        SPACE
*****
*      R1 CONTAINS A PARAMETER LIST ADDRESS.                         *
*      OFFSET 0 IN THE LIST CONTAINS THE 4-BYTE CALLABLE           *
*      SERVICE TOKEN.  EXTRACT THE TOKEN FROM THE PARAMETER       *
*      LIST FOR USE ON THE GET STORAGE REQUEST.                   *
*****
        LR    5,1          COPY STORAGE ADDRESS
        L     2,0(,5)      CALLABLE SERVICE TOKEN
        SPACE
*****
*      R5 CONTAINS THE ADDRESS TO USE FOR THE PARAMETER           *
*      LIST FOR THE z/OS CALL MACRO.  USING THE EQU LABELS        *
*      IN MACRO DFSCSIPL, CARVE THE STORAGE RETURNED BY          *
*      DFSCSII0 INTO SEPARATE PARAMETER LISTS TO BE USED         *
*      ON THE CALL TO DFSCSIF0.                                    *
*****
        LA   3,CSICLLEN(,5)  CALLABLE SERVICE PARM LIST ADDR
        LA   4,CSPLPLEN(,3)  STORAGE SERVICES PARM LIST ADDR
        SPACE
*****
*      PARAMETER LIST RETURNED FROM DFSCSII0 HAS BEEN CARVED INTO *
*      THREE PARTS:                                             *
*                                                                 *
*      R5                R3                R4                *
*      -----          -----          -----          *
*      | Z/OS CALL AREA | IMS CALL SVC AREA | STG SVC AREA | *
*      -----          -----          -----          *
*                                                                 *
*****
        SPACE
*****

```

Figure 2. Example of a Callable Service Request (Part 2 of 3)

```

*      INITIALIZE CALLABLE SERVICE PARAMETER LIST.                *
*                                                                *
*      ENTIRE LIST IS CLEARED SO ALL RESERVED AND NON-INPUT     *
*      FIELDS (SUCH AS THE RETURN AND REASON CODES)              *
*      ARE SET TO ZERO.  THE CALLABLE SERVICE CODE IS           *
*      INITIALIZED TO REQUEST STORAGE SERVICES                   *
*      AND THE CALLABLE SERVICE TOKEN IS SAVED IN THE LIST.     *
*****
      USING CSPARMS,3          CALLABLE SERVICES PARM LIST DSECT
      XC  CSPARMS(CSPLPLEN),CSPARMS  CLEAR CALLABLE SERVICES LIST
      LA  0,CSPLSTRG          STORAGE SERVICE CODE
      ST  0,CSPLSERV          INSERT SERVICE CODE IN LIST
      ST  2,CSPLTOKN          INSERT CALLABLE SERVICE TOKEN
      SPACE
*****
*      INITIALIZE STORAGE SERVICE PARAMETER LIST                *
*                                                                *
*      ENTIRE LIST IS CLEARED SO ALL RESERVED AND NON-INPUT     *
*      FIELDS (SUCH AS THE RETURN AND REASON CODES)              *
*      ARE SET TO ZERO.  THE STORAGE SERVICES                     *
*      FUNCTION CODE IS INITIALIZED TO REQUEST THE GET STORAGE   *
*      FUNCTION.  PARAMETERS ARE INITIALIZED TO OBTAIN 31-BIT,   *
*      PRIVATE STORAGE IN SUBPOOL 0 ON A DOUBLEWORD BOUNDARY.   *
*                                                                *
*****
      USING CSSTRG,4          STORAGE SERVICES PARM LIST DSECT
      XC  CSSTRG(CSGTPLEN),CSSTRG  CLEAR STORAGE SERVICES LIST
      LA  0,CSSTGET          GET STORAGE FUNCTION CODE
      ST  0,CSSTFUNC          INIT FUNCTION CODE PARAMETER
      SPACE
      ST  8,CSGTLEN          INIT STORAGE LENGTH PARAMETER
      SPACE
      LA  0,CSGTPRI          PRIVATE STORAGE INDICATOR
      ST  0,CSGTSP          INIT STORAGE SUBPOOL INDICATOR
      SPACE
      LA  0,CSGT31B          31-BIT STORAGE INDICATOR
      ST  0,CSGTLOC          INIT STORAGE LOCATION PARAMETER
      SPACE
      LA  0,CSGTDBLW          DOUBLE WORD BOUNDARY INDICATOR
      ST  0,CSGTBN DY          INIT STORAGE BOUNDARY PARAMETER
      SPACE
*****
*      THE CALLABLE SERVICES PARAMETER LIST HAS BEEN INITIALIZED *
*      TO INVOKE IMS STORAGE SERVICES.  THE STORAGE SERVICES    *
*      PARAMETER LIST HAS BEEN INITIALIZED TO OBTAIN USER STORAGE.*
*      ISSUE THE IMS CALLABLE SERVICE REQUEST TO OBTAIN STORAGE.*
*****
      CALL DFSCSIF0,((3),(4)),MF=(E,(5))
      LTR  15,15          STORAGE REQUEST SUCCESSFUL?
      BNZ  GSTREXIT          NO, RETURN TO CALLER
      SPACE
      L    1,CSGTADDR          STORAGE ADDRESS
      SPACE
*****
*      RETURN TO CALLER                                          *
*****
GSTREXIT DS  0H
          BR   10          RETURN TO CALLER
          LTORG
          DFSCSIPL

```

Figure 2. Example of a Callable Service Request (Part 3 of 3)

Control Block Usage

This section is a directory of the control blocks and their associated fields that are intended for access by exit routines. This section also identifies and specifies limitations on the use of these control blocks. If only certain fields within a control block are intended for customer use, they are listed next to the control block name in the following table. Any field that does not appear next to the control block name is not intended for customer use.

Unless otherwise specified, the only information that is part of the interface for exit routines is the control block name and any specific fields associated with that control block. For a field that is part of the interface, the only information that is part of the interface for exit routines is the named field.

The following control blocks and their associated fields and flags, shown in Table 5, are intended for use as, or as part of, a product-sensitive interface. Flags are enclosed in parenthesis next to their associated fields.

Table 5. Control Blocks and Associated Fields and Flags.

Control Block Name	Fields and Flags Intended for Use
CCB	CCBNUMB
CIB	CIBMNAME, CIBDTYP (CIBDNDS)
CLB	CLBNAME, CLBCURR, CLBCNTQB
CNT, LNB	CNTDEQCT, CNTENQCT, CNTNAME, CNTDQCT, CNTCTBPT, CNTCNTPT
CTB	CTBCTT, CTBTERM, CTBFLAG1 (CTB1SIGN, CTB1PRES), CTBFLAG2 (CTB2LOCK, CTB2TEST, CTB2EXCL), CTBFLAG3 (CTB3SEG1), CTBACTL (CTBAEOM, CTBAINC), CTBFEAT, CTBINCT, CTBOUTCT, CTBCNT, CTBCIBPT, CTBPRSTN, CTBCNTPT, CTBFLAG6 (CTB6SDON, CTB6TRNI), CTBUSID, CTBOUSID
CTT	CTTDEVIC (CTTD3286, CTTDTYP1, CTTDLU4), CTTSEND, CTTEDIT, CTTIEDIT, CTTOPT2 (CTT2DIT), CTTOPT5 (CTT5DYN)
CVB	CVBCCMD
DFSPDA	PDAPDE, PDANUM, PDADORG, PDALSTRL, PDAUSR1, PDAUSR2, PDAUSR3, PDAUSR4, PDAUSR5, PDAPLEN
DFSPDAE	PDAPN, PDASTRG, PDAPID, PDARAP, PDABLK, PDASTRGL, PDAFLAG1 (PDAF101), PDAELEN
DFSPECA	PECDBN, PECRC, PECFDB, PECFDB2, PECKEY, PECCPID, PECKEYL, PECACT, PECFLAG1 (PEC1NEWP), PECFLAG2, PECUSER
FEIB	FEIBOFLG (FEIBRPQ1, FEIBERP, FEIBTMED), FEIBMSGN, FEIBLTRM, FEIBMSG, FEIBUNID, FEIBNDST, FEIBERP, FEIBLDST, FEIBULNG, FEIBUSER, FEIBIMID
MFSFLDE	FLDFLAG (FLDOPT, FLDEXIT, FLDATTR, FLDEATR), FLDELTH, FLDVECT, FLDLTH, FLDADDR (OPT3LTH, OPT3ID, OPT3DATA)
MFSSEGE	SEGFLAG, SEGOPT (SEGEXIT, SEGECHO), SEGVECT, SEGLTH, SEGFLDRC (SEGDL)
MSNB	MSNFLG1 (MSN1DEQ), MSNFLG3 (MSN3DQND, MSN3DQLM)

Table 5. Control Blocks and Associated Fields and Flags. (continued)

Control Block Name	Fields and Flags Intended for Use
PDIR	PDIRSYM, PDIRCODE (PDIRLOCK, PDIRNOSC, PDIRSCHD, PDIRDBST, PDIRBALG), PDIROPTC (PDIRRETN, PDIRGPSB, PDIRDOPT, PDIRPARL, PDIRBAD), PDIRFLG3 (PDIRIFPR, PDIRIFPM, PDIRIFPU)
RCNT	CNTDEQCT, CNTENQCT, CNTNAME, CNTDQCT
SCD	SSCDIMID, SCDQTU, SCDQTL, SCDSSTYP (SCDSSDBC, SCDSSDCC), SSCDIMSR, SSCDIMSL
SMB	SMBDEQCT, SMBENQCT, SMBTRNCD, SMBSTATS (SMBSRESP, SMBSMULT, SMBSNOQU, SMBNOSC, SMBLOCK, SMBSINQU, SMBSQERR), SMBFLAG1 (SMB1CONV, SMB1UPP, SMBCPIC, SMB1NORE, SMB1INIT), SMBFLAG2 (SMB2DRRT, SMBFPPTX, SMBFPXCL, SMB2SMS, SMB2RMT), SMBFLAG3 (SMB3WFI), SMBPRIOR, SMBCLASS, SMBSPAL, SMBLMTCT, SMBCOUNT, SMBSIDR, SMBSIDL, SMBMXRGN, SMBPARLM, SMBAOIFL (SMBTCMDA, SMBNOSCH), SMBPDIRN, SMBRCTEN
SPQB, USRD	SPQBHSQN

Table 6 provides a list, by exit, of the control blocks that are intended for use as, or as part of, a product-sensitive interface:

Table 6. Exit Routines and Associated Control Blocks

Exit name	Associated Control Blocks
DBFHAGU0	SCD
DBFHC40	none
DBFHDC44	none
DBFUMSE1	none
DBFLHSH0	none
DFSAOEE0	none
DFSAOUE0	CLB, CTB, SCD
DFSBSEX0	none
DFSCCMD0	CLB, CTB, CTT, CVB, SCD
DFSCKWD0	none
DFSCMPX0	none
DFSCMTR0	CLB, CTB, CTT, PDIR, SCD, SMB
DFSCMTU0	none
DFSCMUX0	MSNB
DFSCNTE0	CLB, CNT, CTB
DFSCONE0	CCB, CTB, PDIR, SCD, SPQB, SMB
DFSCSGN0	CTB, SCD
DFSCSMB0	CLB, CTB
DFSCTRNO	CLB, CNT, CTB, PDIR, SCD, SMB
DFSCTSE0	CNT, CTB, PDIR, SCD, SMB
DFSCTTO0	CLB, CNT, CTB, SCD
DFSFDOT0	none

Control Block Usage

Table 6. Exit Routines and Associated Control Blocks (continued)

Exit name	Associated Control Blocks
DFSFEBJ0	FEIB, PDIR, SMB
DFSFGLGX0	none
DFSFTFX0	none
DFSGMSG0	none
DFSGPIX0	PDIR, SMB
DFSHDC40	DMBDACS
DFSINSX0	CLB, SCD
DFSINTX0	CLB, SCD
DFSISIS0	none
DFSI7770	CLB, CNT, CTB, SCD
DFSLGFX0	CLB, SCD
DFSLGNX0	CLB, SCD
DFSLUEE0	none
DFSME000	MFSFLDE
DFSME127	MFSSEGE, CLB
DFSMSCE0	SCD
DFSNMX0	none
DFS07770	CLB, CTB, CTT, SCD
DFSPIXT0	CTB, PDIR, SMB
DFSPPE0	none
DFSPRE60	none
DFSPRE70	none
DFSPSE00	DFSPECA, DFSPDA, DFSPDAE
DFSQSPC0	PDIR, SCD, SMB
DFSSBUX0	none
DFSSGFX0	CLB, SCD
DFSSGNX0	CIB, CLB, CTB, CTT, SCD
DFSSIML0	CLB, CNT, CTB, CTT, SCD
DFSSS050	none
DFSSS060	none
DFSS7770	CLB, CNT, CTB, CTT, SCD
DFSTXIT0	none
DFSYORU0	none
DFSYIOE0	none
DFSYPRX0	none
DFS29800	CLB, CNT, CTB, PDIR, SCD, SMB
DFS36010	CLB, CTB, SCD
DSPCEXT0	none

Customization Exit Routines

The location of the sample exit routines and programs, and the chapter that describes them, are listed in Table 7.

Table 7. Customization Guide Exit Routines

Exit Routine	Chapter Title	Location
DBFHAGU0	Chapter 35, "Fast Path Input Edit/Routing Exit Routine (DBFHAGU0)," on page 259	IMS.ADFSSRC
DBFHC40/ DBFHDC44	Chapter 4, "Data Entry Database Randomizing Routine (DBFHC40/ DBFHDC44)," on page 75	IMS.ADFSSRC
DBFLHSH0	Chapter 5, "Data Entry Database Resource Name Hash Routine (DBFLHSH0)," on page 81	IMS.ADFSSRC
DBFUMSE1	Chapter 6, "Data Entry Database Sequential Dependent Scan Utility Exit Routine (DBFUMSE1)," on page 85	No sample
DFSAOE00	Chapter 31, "Type 2 Automated Operator Exit Routine (DFSAOE00)," on page 223	IMS.ADRSSMPL
DFSAOPGM	Chapter 70, "Automated Operator (AO) Application Program (GMSG, ICMD, and RCMD Calls)," on page 467	IMS.ADRSSMPL
DFSAOUE0	Chapter 66, "Type 1 Automated Operator Exit Routine (DFSAOUE0)," on page 425	IMS.ADFSSMPL
DFSBSEX0	Chapter 33, "Build Security Environment Exit Routine (DFSBSEX0)," on page 249	No sample
DFSCCMD0	Chapter 14, "Command Authorization Exit Routine (DFSCCMD0)," on page 143	IMS.ADFSSRC
DFSCKWD0	Chapter 19, "IMS Command Language Modification Facility (DFSCKWD0)," on page 161	IMS.ADFSSRC
DFSCMPX0	Chapter 10, "Segment Edit/Compression Exit Routine (DFSCMPX0)," on page 109	IMS.ADFSSRC
DFSCMTU0	Chapter 32, "User Message Table (DFSCMTU0)," on page 235	No sample
DFSCMUX0	Chapter 46, "Message Control/Error Exit Routine (DFSCMUX0)," on page 319	IMS.ADFSSRC
DFSCNTE0	Chapter 47, "Message Switching (Input) Edit Routine (DFSCNTE0)," on page 329	IMS.ADFSSRC
DFSCONE0	Chapter 34, "Conversational Abnormal Termination Exit Routine (DFSCONE0)," on page 253	IMS.ADFSSRC
DFSCSGN0	Chapter 60, "Signon/off Security Exit Routine (DFSCSGN0)," on page 393	IMS.ADFSSRC
DFSCSMB0	Chapter 65, "Transaction Code (Input) Edit Routine (DFSCSMB0)," on page 421	IMS.ADFSSRC
DFSCTRN0	Chapter 64, "Transaction Authorization Exit Routine (DFSCTRN0)," on page 417	IMS.ADFSSRC
DFSCTSE0	Chapter 56, "Security Reverification Exit Routine (DFSCTSE0)," on page 375	No sample
DFSCTTO0	Chapter 54, "Physical Terminal (Output) Edit Routine (DFSCTTO0)," on page 365	IMS.ADFSSRC

Exit Routines

Table 7. Customization Guide Exit Routines (continued)

Exit Routine	Chapter Title	Location
DFSFDOT0	Chapter 17, "Dump Override Table (DFSFDOT0)," on page 155	IMS.ADFSSMPL
DFSFEBJ0	Chapter 36, "Front-End Switch Exit Routine (DFSFEBJ0)," on page 263	IMS.ADFSSRC
DFSFIDN0	Chapter 18, "ESAF (External Subsystem Attach Facility) Indoubt Notification Exit Routine (DFSFIDN0)," on page 159	No sample
DFSFLGX0	Chapter 24, "Logger Exit Routine (DFSFLGX0)," on page 193	No sample
DFSFTFX0	Chapter 23, "Log Filter Exit Routine (DFSFTFX0)," on page 187	IMS.ADFSSRC
DFSGMSG0	Chapter 38, "Greeting Messages Exit Routine (DFSGMSG0)," on page 283	IMS.ADFSSMPL
DFSGPIX0	Chapter 37, "Global Physical Terminal (Input) Edit Routine (DFSGPIX0)," on page 279	IMS.ADFSSRC
DFSHDC40	Chapter 8, "HDAM and PHDAM Randomizing Routines (DFSHDC40)," on page 97	IMS.ADFSSRC
DFSINSX0	Chapter 52, "Output Creation Exit Routine (DFSINSX0)," on page 353	IMS.ADFSSRC
DFSINTX0	Chapter 40, "Initialization Exit Routine (DFSINTX0)," on page 289	IMS.ADFSSMPL
DFSISIS0	Chapter 12, "Application Group Name (AGN) Exit Routine (DFSISIS0)," on page 137	IMS.ADFSSMPL
DFSLGFX0	Chapter 43, "Logoff Exit Routine (DFSLGFX0)," on page 305	IMS.ADFSSMPL
DFSLGNX0	Chapter 44, "Logon Exit Routine (DFSLGNX0)," on page 309	No sample
DFSLUEE0	Chapter 45, "LU 6.2 Edit Exit Routine (DFSLUEE0)," on page 313	IMS.ADFSSRC
DFSME000	Chapter 41, "Input Message Field Edit Routine (DFSME000)," on page 295	IMS.ADFSSRC
DFSME127	Chapter 42, "Input Message Segment Edit Routine (DFSME127)," on page 299	IMS.ADFSSRC
DFSMSCE0	Chapter 63, "TM and MSC Message Routing and Control User Exit Routine (DFSMSCE0)," on page 405	IMS.ADFSSMPL
DFSNDMX0	Chapter 48, "Non-Discardable Messages Exit Routine (DFSNDMX0)," on page 333	IMS.ADFSSMPL
DFSPIXT0	Chapter 53, "Physical Terminal (Input) Edit Routine (DFSPIXT0)," on page 361	IMS.ADFSSRC
DFSPUE0	Chapter 25, "Partner Product Exit Routine (DFSPUE0)," on page 201	No sample
DFSPRE60	Chapter 29, "System Definition Preprocessor Exit Routine (Input Phase) (DFSPRE60)," on page 217	IMS.ADFSSMPL
DFSPRE70	Chapter 30, "System Definition Preprocessor Exit Routine (Name Check Complete) (DFSPRE70)," on page 221	IMS.ADFSSMPL

Table 7. Customization Guide Exit Routines (continued)

Exit Routine	Chapter Title	Location
DFSQSPC0	Chapter 55, "Queue Space Notification Exit Routine (DFSQSPC0/DFSQSSP0)," on page 369	IMS.ADFSSRC
DFSRAS00	Chapter 27, "Resource Access Security Exit Routine (DFSRAS00)," on page 209	IMS.ADFSSMPL
DFSSBUX0	Chapter 11, "Sequential Buffering Initialization Exit Routine (DFSSBUX0)," on page 129	No sample
DFSSGFX0	Chapter 59, "Signoff Exit Routine (DFSSGFX0)," on page 389	IMS.ADFSSMPL
DFSSGNX0	Chapter 58, "Signon Exit Routine (DFSSGNX0)," on page 381	IMS.ADFSSMPL
DFSSIML0	Chapter 57, "Shared Printer Exit Routine (DFSSIML0)," on page 379	IMS.ADFSSMPL
DFSSS050	Chapter 20, "Large System Definition Sort/Split Input exit routine (DFSSS050)," on page 165	IMS.ADFSSRC
DFSSS060	Chapter 21, "Large System Definition Sort/Split Output Exit Routine (DFSSS060)," on page 169	IMS.ADFSSRC
DFSTCNT0	Chapter 62, "Time-Controlled Operations (TCO) Communication Name Table (CNT) Exit Routine (DFSTCNT0)," on page 401	IMS.ADFSSMPL
DFSTXIT0	Chapter 61, "Time-Controlled Operations (TCO) Exit Routine (DFSTXIT0)," on page 397	IMS.ADFSSMPL
DFSYDRU0	Chapter 49, "OTMA Destination Resolution Exit Routine (DFSYDRU0)," on page 341	IMS.ADFSSMPL
DFSYIOE0	Chapter 50, "OTMA Input/Output Edit Exit Routine (DFSYIOE0)," on page 345	IMS.ADFSSMPL
DFSYPRX0	Chapter 51, "OTMA Prerouting Exit Routine (DFSYPRX0)," on page 349	IMS.ADFSSMPL
DFS29800	Chapter 67, "2972/2980 Input Edit Routine (DFS29800)," on page 451	IMS.ADFSSMPL
DFS36010	Chapter 68, "4701 Transaction Input Edit Routine (DFS36010)," on page 453	IMS.ADFSSRC
DSPBUFFS	Chapter 13, "Buffer Size Specification Facility (DSPBUFFS)," on page 139	
DSPCEXT0	Chapter 26, "RECON I/O Exit Routine (DSPCEXT0)," on page 203	IMS.ADFSSRC
UETRANS	Chapter 69, "Automated Operator (AO) Application Program (GU, GN, CMD, and GCMD Calls)," on page 457	IMS.ADFSSMPL

Exit Routines

Part 2. Database Exit Routines

Chapter 2. Data Capture Exit Routine	45
About The Data Capture Exit Routine	46
Attributes of the Routine	46
Specifying Data Options	47
Additional Guidelines.	47
Using IMS Callable Services with This Routine	49
Communications Between the Data Capture Exit Routine and IMS	49
Extended Program Communication Block (XPCB)	50
Extended Segment Data Block (XSDB)	52
Contents of Registers on Entry	52
Contents of Registers on Exit	53
Writing the Routine in Supported Languages	53
Data Security and Integrity	54
Sample Extended Program Communication Block (XPCB)	55
Assembler	55
COBOL	56
PL/I	57
Sample Extended Segment Data Block (XSDB)	58
Assembler	58
COBOL	58
PL/I	59
Sample Data Capture Exit Routine	60
COBOL	60
PL/I	65
Chapter 3. Data Conversion User Exit Routine (DFSDBUX1)	71
About This Routine	71
Attributes of the Routine	71
Other Considerations	71
Using IMS Callable Services with This Routine	72
Issuing SVC Calls.	72
Communicating with IMS	72
Contents of Registers on Entry	72
Contents of Register on Exit	72
Data Security and Integrity	72
Chapter 4. Data Entry Database Randomizing Routine (DBFHDC40/ DBFHDC44)	75
About This Routine	75
Loading the Routine	76
Activating the Routine	76
Communicating with IMS	77
Contents of Registers on Entry	77
Contents of Registers on Exit	78
Using the Sample DEDB Randomizing Routines (DBFHDC40)	78
Extended Call Interface (XCI) Option	78
Attributes of the Routine	78
Invoking the Routine	78
Communicating with IMS	79
Chapter 5. Data Entry Database Resource Name Hash Routine (DBFLHSH0).	81
About This Routine	81

Attributes of the Routine	81
Assembling the Routine	82
Communicating with IMS	82
Contents of Registers on Entry	82
Description of Parameters	82
EPST (Extended Program Specification Table) Input to the Routine	82
Sample Hashing Routine Result Format.	83
Chapter 6. Data Entry Database Sequential Dependent Scan Utility Exit Routine (DBFUMSE1)	85
About This Routine	85
Attributes of the Routine	85
Calling the Routine	86
Communicating with IMS	86
Contents of Registers on Entry	86
Contents of Registers on Exit	86
Sample DEDB Sequential Dependent Scan Utility Exit Routine (DBFUMSE1)	87
Chapter 7. HALDB Partition Selection Exit Routine (DFSPSE00)	91
About This Routine	91
Calling the Routine	92
Addressing Mode	92
Communicating with IMS	92
Contents of Registers on Entry	92
Area Mapping	93
Contents of Registers on Exit	93
Using the Sample Partition Selection Exit Routine (DFSPSE00)	94
Using the Exit Interface Area Mapping	94
Partition Exit Communication Area Mapping (DFSPECA)	94
Partition Definition Area Mapping (DFSPDA)	95
Chapter 8. HDAM and PHDAM Randomizing Routines (DFSHDC40)	97
About These Routines	97
Attributes of the Routine	97
Calling the Routine	99
Communicating with IMS	99
Contents of Registers on Entry	99
Contents of Registers on Exit	100
Results of the Routine on Exit	101
Sample HDAM and PHDAM Randomizing Routines	101
Using the Sample HDAM and PHDAM Generalized Randomizing Routine (DFSHDC40)	101
Chapter 9. Secondary Index Database Maintenance Exit Routine	103
About This Routine	103
Loading the Routine	104
Calling the Routine	104
Communicating with IMS	105
Contents of Registers on Entry	105
Contents of Registers on Exit	106
Sample Secondary Index Database Maintenance Exit Routine	106
Chapter 10. Segment Edit/Compression Exit Routine (DFSCMPX0)	109
About This Routine	109
Attributes of the Routine	110
How the Segment Edit/Compression Facility Works	111

Activating the Routine	112
Using the Routine with Tabled Data Information	114
Communicating with IMS	115
Contents of Registers on Entry	115
Contents of Registers on Exit	116
Description of Entry Codes	116
Description of Parameters	117
Restrictions	118
Description of Sample Segment Compression/Expansion Modules	118
Using the Sample Segment Compression/Expansion Exit Routine.	121
DFSKMPX0	121
Hardware Data Compression Support	122
How HDC Works.	122
How to Implement HDC Support	123
Sample JCL Procedure	124
HDC Tips	127
Return Codes from the HDCD Utility	127
Chapter 11. Sequential Buffering Initialization Exit Routine (DFSSBUX0)	129
About This Routine	129
Loading the Routine	130
Considering Performance	130
Communicating with IMS.	130
Contents of Registers on Entry	130
Contents of Registers on Exit	132
Using the Sample SB Initialization Routines	132

Chapter 2. Data Capture Exit Routine

This section documents General-Use Programming Interface and Associated Guidance Information.

When an application program updates an IMS database with a DL/I insert, replace, or delete call, the updated data is passed and made available to a Data Capture exit routine. You can write a Data Capture exit routine that receives control whenever a segment, for which the exit routine is defined, is updated. Your exit routine processes the data after the DL/I call completes but before control is returned to the application program. The DL/I call is considered complete and the PCB status set when the exit routine is called. Figure 3 shows how control passes among the application, the full-function or DEDB database, and the exit routine.

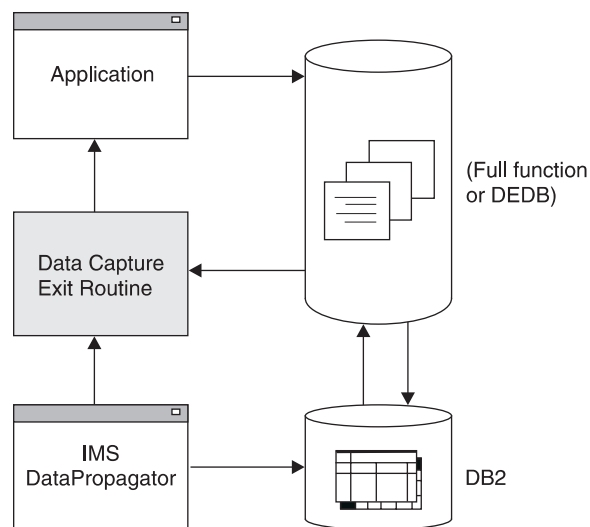

Figure 3. Calling Order with Data Capture

You might want to capture changed data to enable replication of that data to a DB2UDB for z/OS database as shown in Figure 3.

As an alternative to capturing data synchronously, you can also propagate captured data asynchronously by using either of the following methods:

- Use the logging option on the EXIT= parameter of DBDGEN.
- Use IMS DataPropagator and specify that the data is to be propagated asynchronously.

Related Reading: For more information on asynchronous data capture, see Chapter 71, “Propagating Captured Data Asynchronously,” on page 479. For more information about IMS DataPropagator, see *IMS DataPropagator for z/OS An Introduction*, or visit the IMS DataPropagator home page on the Web at:

www.ibm.com/software/data/db2imstools/imstools/imspdprop.html

Table 8 on page 46 describes data capture support for IMS environments for both full-function and DEDB databases.

Data Capture Exit Routine

Table 8. Data Capture Support for IMS Environments

	CICS DB/CTL	CICS Batch	IMS Batch	IMS IFP	IMS BMP	IMS MPP
Data Capture Exit EXIT=exitname	No	Yes ¹	Yes	Yes	Yes	Yes
Asynchronous Data Capture EXIT= *, LOG	Yes	Yes ¹	Yes	Yes	Yes	Yes

Note: ¹BATCH is a pure IMS batch environment that is available with CICS DB/CTL (no CICS code executing).

In this Chapter:

“About The Data Capture Exit Routine”

“Communications Between the Data Capture Exit Routine and IMS” on page 49

“Sample Extended Program Communication Block (XPCB)” on page 55

“Sample Extended Segment Data Block (XSDB)” on page 58

“Sample Data Capture Exit Routine” on page 60

About The Data Capture Exit Routine

The main purpose of capturing updated data and making it available to an exit routine is to propagate the IMS data to the relational environment of DB2 UDB for z/OS. You can write your own exit routine, use a separate product, IBM IMS DataPropagator for z/OS, or write a IMS DataPropagator-supported exit routine. If you write your own exit routine, you can code it to perform tasks other than data propagation. The sample Data Capture exit routine provided at the end of this chapter only propagates data.

Restriction: This exit routine cannot be used with CICS, because it conflicts with CICS architecture. (Asynchronous Data Capture does work with DBCTL.) Even though the exit routine works with captured IMS data, CICS cannot use it.

Attributes of the Routine

Regardless of its function, the exit routine must be written in assembler language, C language, COBOL, or PL/I. Routines written in high-level languages running under Language Environment for z/OS are not supported. A sample Data Capture exit routine in COBOL and a sample in PL/I are provided beginning in “COBOL” on page 60 and “PL/I” on page 65, respectively.

Restriction: Although IMS supports PASCAL and OS/VS COBOL, Data Capture exit routines written in these languages are not supported.

Recommendation: Do not run data capture exit routines under Language Environment for z/OS. Although the data capture exit routine might work running under Language Environment for z/OS, the user might experience performance problems or abends.

Binding the Routine

If you bind the exit routine as either RENT or REUSE, it remains in storage until the region terminates as if the exit routine was preloaded. However, non-REUSE exit routines must be loaded each time, because they are deleted from storage after each call.

Loading the Routine

IMS loads the exit routine the first time IMS calls it; preloading the exit routine is not necessary. However, run-time library routines used by high-level languages should be preloaded. After abnormal termination in an IMS Fast Path region (IFP) or in a message processing region (MPP), the exit routine is deleted and must be reloaded. The exit routine must be reloaded when:

- A pseudo or standard abend of the application that is running in the region occurs (regardless of whether the region itself abends along with the application).
- The data capture routine gets an XPCB return code of 16.

Specifying Data Options

In addition to the necessary control information, you can have the following data passed to your exit routine. The data is chained together using pointers.

Physical concatenated key	The fully concatenated key of each segment in the physical hierarchy, including the updated segment. For logical relationships and secondary indexes, this key differs from the key in the PCB feedback area.
Physical segment data	The physical segment updated by the application program, without any PSB field sensitivity.
Data before a replace	The data as it looked before it was updated. Your exit routine must determine what fields the application program changed.
Path data	The physical path data from the root segment to the parent of the updated segment.
Cascade delete data	The data deleted by IMS when an application program deleted a segment that is higher in the hierarchy.

The data is in the same format that was returned to the application program, excluding PSB field sensitivity. For logical children, the segment data follows the logical parent concatenated key. For segments with compression/edit exit routines defined for them, the data is in its expanded or encoded form. For variable-length segments, the first two bytes contain the length ('LL') for the segment.

Related Reading: For more information on these data options, see *IMS Version 9: Administration Guide: Database Manager*.

Additional Guidelines

The Data Capture exit routine is called whenever a segment is updated that has the exit routine defined, regardless of the execution environment. The exit routine use the INQY ENVIRON call to identify the execution environment (batch or online) and determine what functions are available.

Related Reading: For details on using the INQY ENVIRON call, see *IMS Version 9: Application Programming: Database Manager*.

The exit routine can issue any DL/I calls allowed by the PSB using the AIB Interface (AIBTDLI). However, any updates that the exit routine makes are not captured and do not call an exit routine.

Data Capture Exit Routine

The Data Capture exit routine is treated as an extension of the application program; IMS attributes SQL or DL/I calls made by the exit routine to the application program. The exit routine and the application run under the same unit of work. SQL and DL/I updates made by the exit routine are committed or aborted along with the application program at sync-point time with the same integrity as the application. The exit routine must follow the same rules as the application program whether the routine makes IMS or DB2 UDB for z/OS requests.

For data propagation, all DL/I updates must be passed to your exit routine to determine whether to propagate the change to DB2 UDB for z/OS or not. Both the IMS data and DB2 UDB for z/OS data must be available and on the same z/OS system for either update to occur.

The Data Capture exit routine is called based upon specification in the DBD rather than in the PSB. The exit routine is always called. It is also a global exit routine: once implemented for any segment, all activity in that segment causes IMS to call the exit routine, regardless of which PSB is active. Any performance impact that the exit routine causes occurs across the entire system.

Defining the Routine for Segments

The Data Capture exit routine is specified for a particular segment during DBDGEN. Failure to locate the exit routine during processing results in an application program abend.

DBDGEN supports a new parameter, EXIT=, on the DBD and SEGM statements. If specified on the DBD statement, the parameter applies to all segments within the physical database structure. If specified on the SEGM statement, you can override the specification on the DBD, or can limit the parameter so that only selected segments are propagated when updated. As a SEGM parameter, EXIT= does not apply to other segments; physical children do not inherit the parameters of any of their parents.

You can specify multiple exit routine names, each with different data options, on a single DBD or SEGM statement.

Related Reading: For details on using the EXIT= parameter, see *IMS Version 9: Utilities Reference: System*.

Multiple Exit Routines

A single DL/I call might call your exit routine more than once or it might call more than one exit routine. Multiple exit routines are called when there are:

- Multiple exit routines per segment
- Path calls
- Cascade deletes

Multiple exit routines are called in succession before returning to the application program. The sequence depends on the reason multiple exit routines are called:

- Multiple exit routines are defined.

When multiple exit routines are defined for a single physical segment, the routines are called based on DBDGEN definition order. The first exit routine listed in the DBD or SEGM statement is called, followed by each subsequent exit routine defined for that segment.

- Multiple segments are updated.

When multiple physical segments are updated in a single call, the routines are called in hierarchical order. IMS calls the exit routines for the segments in the same order that the segments were physically updated:

- Top-down for path inserts and path replaces

Parents must be inserted before dependents. The exit routine for the parent segment must be called before the dependent segment's exit routine.

- Bottom-up for cascade deletes

The dependent segment's exit routine is called before the parent's exit routine. The root segment's exit routine is called last. If the dependent segment has several exit routines defined for it, they are **all** called at this time. Calling the exit routines in bottom-up order allows propagation to DB2 UDB for z/OS without requiring referential integrity.

For each segment type, multiple segment occurrences might be deleted as part of the cascade delete. Each exit routine is called once for each segment occurrence that is deleted. The order the exit is called is the same order in which DL/I deleted the segments.

Using IMS Callable Services with This Routine

This exit is not eligible to use IMS Callable Services.

Communications Between the Data Capture Exit Routine and IMS

Each segment that is passed in a dependent region and has the Data Capture exit routine defined for it has two control blocks available for its use. Both the Extended Program Communication Block (XPCB) and the Extended Segment Data Block (XSDB) reside in private storage and have key 8. They are passed to the exit routine according to the AMODE of the exit: above the 16MB line for AMODE 31, and below the 16 MB line for AMODE 24.

The order in which the control blocks receive control depends on the type of data updated and passed to the Data Capture exit routine. Figure 4 shows how control flows between the XPCB and the XSDB.

Data Capture Exit Routine

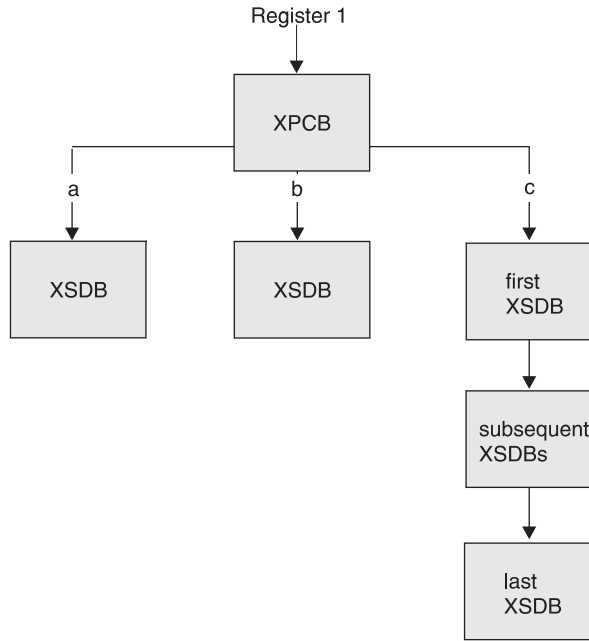

Figure 4. Control Block Flow with Data Capture

Extended Program Communication Block (XPCB)

The XPCB identifies the segment and call functions, provides the address of a work area, and contains additional information that is passed to the exit routine. Every XPCB identifies the physical function performed by DL/I (insert, replace, or delete) and points to the updated data that is passed to the exit routine. Table 9 and Table 10 on page 51 describe the contents of the XPCB. For examples of how to code the XPCB, see “Sample Extended Program Communication Block (XPCB)” on page 55.

For reentrant exit routines, the address of a 256-byte work area is passed in the XPCB. The exit routine can use the work area to save information. One work area exists for each exit routine, and it is initialized to binary zeros the first time the exit routine is given control.

Table 9. XPCB by Offset

Offset Decimal	Field Name	Offset Decimal	Field Name	Offset Decimal	Field Name
0	Eyecatcher	4	Version	6	Release
8	Exit_Name	16	Exit_Return_Code	18	Exit_Reason_Code
20	Database_Name	28	DED_Version_Ptr	32	Segment_Name
40	Call_Function	44	Physical_Function	48	reserved
52	DB_PCB_Ptr	56	DB_PCB_Name	64	INQY_Output_Ptr
68	IO_PCB_Ptr	72	Environment_Flags	73	reserved
74	Conc_Key_Length	76	Conc_Key_Ptr	80	Data_SCDB_Ptr
84	Before_XSDB_Ptr	88	Path_XSDB_Ptr	92	Set_Rols-Token
96	reserved	100	reserved	104	Exit_Work_Ptr
108	Null_Ptr	112	reserved	116	CPU Store Clock

Table 10. XPCB Alphabetically

Field Name	Offset Decimal	Data Type	Length Decimal	Field Description
Before_XSDB_Ptr	84	Pointer	4	Address of XSDB for data before it was replaced. Zero if not a physical replace or if data not captured.
Call_Function	40	Character	4	Call used by application to update segment: ISRT, DLET, REPL, or CASC (cascade).
Conc_Key_Length	74	Fixed	2	Length of segment's concatenated key for physical path. Zero if data not captured. Key is optional.
Conc_Key_Ptr	76	Pointer	4	Address of segment's concatenated key for physical path. Zero if data not captured. Key is optional.
CPU_Store_Clock	116	Character	8	CPU time stamp of completion of DL/I call. Obtained from Store Clock instruction.
Database_Name	20	Character	8	Physical database name of updated segment.
Data_XSDB_Ptr	80	Pointer	4	Address of XSDB for segment data. Zero if data not captured.
DBD_Version_Ptr	28	Pointer	4	Address of variable length character string to identify the DBD used for update. First two bytes contain length of string, followed by string itself. String is from DBD VERSION= parameter if was used for DBDGEN. Otherwise, string is date/time of DBDGEN.
DB_PCB_Ptr	52	Pointer	4	Address of database PCB used for DL/I call.
DB_PCB_Name	56	Character	8	The 8-byte name of database PCB used for DL/I call. Null if name not assigned during PSBGEN with the label or PCBNAME= parameter.
Environment_Flags	72	Flag byte	1	Flag bits describing execution environment.
Exit_Name	8	Character	8	Entry point name of exit routine.
Exit_Return_Code	16	Fixed	2	Return code from exit routine.
Exit_Reason_Code	18	Fixed	2	Reason code from exit routine.
Exit_Work_Ptr	104	Pointer	4	Address of 256-byte work area.
Eyecatcher	0	Character	4	'XPCB'
INQY_Output_Ptr	64	Pointer	4	Address of output of an INQY ENVIRON call.
IO_PCB_Ptr	68	Pointer	4	Address of I/O PCB.
Null_Ptr	108	Pointer	4	Zero address for use as null address for languages that do not recognize a zero address as null (such as PL/I).
Path_XSDB_Ptr	88	Pointer	4	Address of XSDB for physical root when path data option requested. XSDBs for path data are chained together, in descending hierarchical order, from physical root to parent of updated segment. Last XSDB has a zero pointer.
Physical_Function	44	Character	4	Physical call function performed: ISRT, DLET, or REPL.
Release	6	Character	2	XPCB release indicator. Along with version, identifies the level of the control block. Current release is R1.
Segment_Name	32	Character	8	Physical segment name of segment updated.
Sets_Rols-Token	92	Hexadecimal data	4	Token used to identify the processing scope between the SETS and ROLS calls.
Version	4	Character	2	XPCB version indicator. Along with release, identifies the level of the control block. Current version is V1.

Data Capture Exit Routine

Extended Segment Data Block (XSDB)

The XPCB points to the first XSDB. For path data, subsequent XSDBs are chained together. The XSDB points to the updated data that is passed to the exit routine. It contains additional information that is also passed. Table 11 and Table 12 describe the contents of the XSDB. For examples of how to code the XSDB, see “Sample Extended Segment Data Block (XSDB)” on page 58.

Table 11. XSDB by Offset

Offset		Offset		Offset	
Decimal	Field Name	Decimal	Field Name	Decimal	Field Name
0	Eyecatcher	4	Version	6	Release
8	Next_Ptr	12	Database_Name	20	Segment_Name
28	reserved	32	Segment_Level	34	Key_Length
36	Key_Ptr	40	LP_Key_Length	42	Segment_Length
44	Segment_Ptr	48	reserved		

Table 12. XSDB Alphabetically

Field Name	Offset Decimal	Data Type	Length Decimal	Field Description
Database_Name	12	Character	8	Physical database name for segment. Same as database name in XPCB.
Eyecatcher	0	Character	4	'XSDB'
Key_Length	34	Fixed	2	Length of key for segment. Zero if segment not keyed.
Key_Ptr	36	Pointer	4	Address of key for segment. Zero if segment not keyed.
LP_Key_Length	40	Fixed	2	Length of logical parent's concatenated key included in segment data for logical children.
Next_Ptr	8	Pointer	4	Address of next XSDB in chain for path data. Zero for last XSDB in chain.
Release	6	Character	2	XSDB release indicator. Along with version, identifies level of control block. Current release is R1.
Segment_Ptr	44	Pointer	4	Address of physical segment data.
Segment_Length	42	Fixed	2	Length of physical segment data.
Segment_Level	32	Fixed	2	Level of segment in physical database.
Segment_Name	20	Character	8	Physical segment name for segment data passed in this block. Different from segment name in XPCB for path data.
Version	4	Character	2	XSDB version indicator. Along with release, identifies level of control block. Current version is V1.

Contents of Registers on Entry

Upon entry, the exit routine must save all registers using the provided save area. The registers contain the following:

Register	Contents
1	Address of the XPCB address
13	Address of save area
14	Return address to IMS
15	Entry point of exit routine

Contents of Registers on Exit

Before returning to IMS, the exit routine must restore all registers. Return and reason codes are placed in the XPCB.

Return and Reason Codes

The XPCB contains fields for the exit routine to communicate its status to IMS. These fields are initialized to binary zeros. The return code allows the exit routine to define the type of condition encountered; the higher the number, the more severe the error. You can also assign a reason code to return codes of 8 or greater. This reason code allows you to identify the type and severity of the error. The reason code is for your use; IMS only uses the return code.

Table 13 outlines the return and reason codes that the exit routine returns and places in the XPCB. If the return code placed in the XPCB is invalid, an abend occurs and an invalid return code indicator is set.

Table 13. XPCB Return Codes

Return Code	Description	Action	DFS3314 Message
0	Good return.	Normal completion of exit routine.	No
4	Indicates the exit routine wants to ignore the DL/I call.	Exit routine is not called for any additional segments for this DL/I call.	No
8	Exit routine encountered an error during the DL/I call and wants to return to the application.	DL/I call is terminated without calling any other exit routines and control is returned to application program.	Yes
12	This copy of the exit routine is not to be called again. (Used with a “dummy” exit routine.)	Exit routine is deleted from storage.	Yes
16	Abend the exit routine and the application program.	Application program is abended with a U3314.	Yes
20	Updates to this region should not be captured nor should the exit routine be called.	Terminate data capture for this region.	Yes

Following an abend in an IFP or MPP region with return code 12 or 20, the interface control blocks are reinitialized and the exit work area is reset, enabling the exit routine to be called again.

Writing the Routine in Supported Languages

Although the Data Capture exit routine can be written in assembler, C, COBOL, or PL/I, you must follow certain guidelines depending upon which language you use. This section presents those guidelines.

Assembler

The exit routine is entered in primary mode, but the access registers can be nonzero.

Data Capture Exit Routine

C

C does not support variable-length character strings using integer lengths, such as those passed in the XPCB and XSDB. Key and segment data passed to the exit routine is terminated by “null” (binary zero) values. Any null value in the data itself might result in an invalid string length.

The following declarations and statements are used to locate the XPCB. Declare XPCB_TYPE_PTR as a pointer to the XPCB structure.

```
XPCB_TYPE_PTR *TPTR;  
TPTR = (XPCB_TYPE_PTR *) __sysplist;  
XPCB = *TPTR;
```

The exit routine must be defined as a main program with the PLIST(IMS) and ENV(IMS) options specified. Use the following format to specify these options:

```
#pragma runopt(env(IMS), plist(IMS))
```

COBOL

The exit routine operates under a separate run unit from the application program. The method used to establish the run unit depends on the compiler or on the RES/NORES compiler option. For all COBOL programs compiled with newer compilers, and older COBOL programs compiled with resident (RES), the exit routine is given control by LINK. For older COBOL programs compiled with nonresident (NORES), it is given control directly.

Recommendation: A newer compiler or RES is recommended because the exit routine can be reentrant (RENT) and AMODE 31. With older compilers and NORES, it must be AMODE 24 and it must not be reentrant.

You can use STOP RUN or GOBACK to terminate the exit routine run unit and return to the application program.

The procedure division is:

```
exitname USING XPCB
```

PL/I

The exit routine must be compiled as a main program. The entry point can be PLICALLA, so that the exit routine can use the assembler interface or use PL/I compile time option SYSTEM(IMS)

The procedure statement is:

```
exitname: PROCEDURE(XPCB_PTR) OPTIONS (MAIN);
```

Data Security and Integrity

The Data Capture exit routine is an extension of the application program with the same capabilities as the application program; the exit routine and the application have equal authorization and limitations. IMS and DB2 UDB for z/OS resources that the exit routine uses must be authorized in the application program's IMS PSB or DB2 PLAN. This assures that the application program can access any IMS or DB2 UDB for z/OS data that is available to the exit routine.

The data and the exit routine operate in unprotected, key-8 storage. The exit routine is able to modify data or control blocks that can affect the successful operation of the application program. The data passed to the exit routine is the physical segment data. With PSB field sensitivity, this data might include data that is unavailable to the application.

Sample Extended Program Communication Block (XPCB)

This section provides examples of the XPCB in assembler, COBOL, and PL/I.

Assembler

Figure 5 is an example of the XPCB in assembler.

```

                SPACE 3
XPCB          DSECT
XPCB_EYECATCHER      DS    CL4    "XPCB" EYECATCHER
XPCB_VERSION         DS    CL2    XPCB VERSION INDICATOR
XPCB_RELEASE         DS    CL2    XPCB RELEASE INDICATOR
XPCB_EXIT_NAME       DS    CL8    SEGMENT EXIT NAME
XPCB_EXIT_RETURN_CODE DS    H      RETURN CODE FROM EXIT
XPCB_EXIT_REASON_CODE DS    H      REASON CODE FROM EXIT
XPCB_DATABASE_NAME   DS    CL8    PHYSICAL DATA BASE NAME
XPCB_DBD_VERSION_PTR DS    A      ADDRESS OF DBD VERSION ID
XPCB_SEGMENT_NAME    DS    CL8    PHYSICAL SEGMENT NAME
XPCB_CALL_FUNCTION   DS    CL4    CALL FUNCTION
XPCB_PHYSICAL_FUNCTION DS    CL4    PHYSICAL CALL FUNCTION
                DS    CL4
XPCB_DB_PCB_PTR      DS    A      ADDRESS OF DB PCB
XPCB_DB_PCB_NAME     DS    CL8    NAME OF DB PCB
XPCB_INQY_OUTPUT_PTR DS    A      ADDRESS OF "INQY" OUTPUT
XPCB_IO_PCB_PTR      DS    A      ADDRESS OF I/O PCB
XPCB_ENVIRONMENT_FLAGS DS    X      ENVIRONMENT FLAGS
XPCB_IMS_ENH_SUPPORT EQU    X'80'  RRS SUPPORT IS AVAILABLE IN SYSTEM
XPCB_IMS_RRS_ENABLED EQU    X'40'  RRS=Y WAS SPECIFIED
XPCB_CALL_AT_COMMIT EQU    X'20'  SET BY EXIT - CALL DURING COMMIT
XPCB_LOGX_FORMAT     EQU    X'10'  REDUCED 9904 FORMAT
XPCB_EXIT_WAS_CALLED EQU    X'08'  INTERNAL FLAG USED BY IMS
XPCB_DPROP_EXIT      EQU    X'04'  SET BY DPROP EXIT ROUTINE
                DS    X      RESERVED
XPCB_CONC_KEY_LENGTH DS    H      LENGTH OF CONCATENATED KEY
XPCB_CONC_KEY_PTR    DS    A      ADDRESS OF CONCATENATED KEY
XPCB_DATA_XSDB_PTR   DS    A      ADDRESS OF XSDB FOR DATA
XPCB_BEFORE_XSDB_PTR DS    A      ADDRESS OF XSDB FOR REPL DATA
XPCB_PATH_XSDB_PTR   DS    A      ADDRESS OF XSDB FOR PATH DATA
XPCB_SETS_ROLS_TOKEN DS    F      TOKEN FOR SETS-ROLS CALL
                DS    F      RESERVED
                DS    F      RESERVED
XPCB_EXIT_WORK_PTR   DS    A      ADDRESS OF WORK AREA
XPCB_ZERO_POINTER    DS    A      ZERO ADDRESS
                DS    F      RESERVED
XPCB_TIMESTAMP       DS    CL8    TIMESTAMP OF CALL
                EJECT

```

Figure 5. XPCB in Assembler Example

Data Capture Exit Routine

COBOL

Figure 6 is an example of the XPCB in COBOL.

```
01 XPCB.
  05 EYECATCHER PIC X(04).
  05 VERSION PIC X(02).
  05 RELEASE-ID PIC X(02).
  05 EXIT-NAME PIC X(08).
  05 EXIT-RETURN-CODE PIC 9(04) COMP.
  05 EXIT-REASON-CODE PIC 9(04) COMP.
  05 DATABASE-NAME PIC X(08).
  05 DBD-VERSION-PTR POINTER.
  05 SEGMENT-NAME PIC X(08).
  05 CALL-FUNCTION PIC X(04).
  05 PHYSICAL-FUNCTION PIC X(04).
  05 FILLER PIC 9(08) COMP.
  05 DB-PCB-PTR POINTER.
  05 DB-PCB-NAME PIC X(08).
  05 INQY-OUTPUT-PTR POINTER.
  05 IO-PCB-PTR POINTER.
  05 ENVIRONMENT-FLAGS PIC X.
    88 IMS-ENH-SUPPORT VALUE X'80'.
  * RRS SUPPORT IS AVAILABLE IN SYSTEM
    88 IMS-RRS-ENABLED VALUE X'40'.
  * RRS=Y WAS SPECIFIED
    88 CALL_AT_COMMIT VALUE X'20'.
  * SET BY EXIT - CALL DURING COMMIT
    88 XPCB_LOGX_FORMAT VALUE X'10'.
  * REDUCED 9904 FORMAT
    88 XPCB_EXIT_WAS_CALLED VALUE X'08'.
  * INTERNAL FLAG USED BY IMS
    88 XPCB_DPROP_EXIT VALUE X'04'.
  * SET BY DPROP_EXIT ROUTINE
    05 FILLER PIC X.
  * RESERVED
    05 FILLER PIC 9(04) COMP.
    05 CONC-KEY-LENGTH PIC 9(04) COMP.
    05 CONC-KEY-PTR POINTER.
    05 DATA-XSDB-PTR POINTER.
    05 BEFORE-XSDB-PTR POINTER.
    05 PATH-XSDB-PTR POINTER.
    05 FILLER POINTER.
    05 FILLER POINTER.
    05 FILLER POINTER.
    05 EXIT-WORK-PTR POINTER.
    05 NULL-PTR POINTER.
    05 FILLER POINTER.
    05 TIMESTAMP PIC X(08).
```

Figure 6. XPCB in COBOL Example

PL/I

Figure 7 is an example of the XPCB in PL/I.

```

DECLARE
  1 XPCB          BASED(XPCB_PTR),
    3 EYECATCHER  CHAR(4), /* "XPCB" EYECATCHER          */
    3 VERSION     CHAR(2), /* XPCB VERSION INDICATOR */
    3 RELEASE     CHAR(2), /* XPCB RELEASE INDICATOR */
    3 EXIT_NAME   CHAR(8), /* SEGMENT EXIT NAME      */
    3 EXIT_RETURN_CODE FIXED BINARY (15), /* RETURN CODE          */
    3 EXIT_REASON_CODE FIXED BINARY (15), /* REASON CODE          */
    3 ATABASE_NAME CHAR(8), /* PHYSICAL DATA BASE NAME */
    3 DBD_VERSION_PTR POINTER, /* ADDRESS OF DBD VERSION ID */
    3 SEGMENT_NAME CHAR(8), /* PHYSICAL SEGMENT NAME    */
    3 CALL_FUNCTION CHAR(4), /* CALL FUNCTION            */
    3 PHYSICAL_FUNCTION CHAR(4), /* DL/I PHYSICAL FUNCTION   */
    3 FILLER1     FIXED BINARY (31), /* RESERVED                */
    3 DB_PCB_PTR  POINTER, /* ADDRESS OF DB PCB        */
    3 DB_PCB_NAME CHAR(8), /* NAME OF DB PCB           */
    3 INQY_OUTPUT_PTR POINTER, /* ADDRESS OF "INQY" OUTPUT */
    3 IO_PCB_PTR  POINTER, /* ADDRESS OF I/O PCB       */
    3 ENVIRONMENT-FLAGS CHAR(1), /* Environment Flags        */
      /* IMS-ENH-SUPPORT X'80' RRS SUPPORT AVAILABLE IN SYSTEM */
      /* IMS-RRS-ENABLED X'40' RRS=Y WAS SPECIFIED              */
      /* CALL_AT_COMMIT X'20' SET BY EXIT-CALL DURING COMMIT    */
      /* XPCB_LOGX_FORMAT X'10' REDUCED 9904 FORMAT              */
      /* XPCB_EXIT_WAS_CALLED X'08' INTERNAL FLAG USED BY IMS    */
      /* XPCB_DPROT_EXIT X'04' SET BY DPROT EXIT ROUTINE         */
    3 NEWFILLER   CHAR(1), /* Reserved                 */
    3 FILLER2     FIXED BINARY (15), /* RESERVED                 */
    3 CONC_KEY_LENGTH FIXED BINARY (15), /* LENGTH OF FULLY          */
      /* CONCATENATED KEY FOR SEGM */
    3 CONC_KEY_PTR POINTER, /* ADDRESS OF PHYSICAL FULLY */
      /* CONCATENATED KEY FOR SEGM */
    3 DATA_XSDB_PTR POINTER, /* ADDRESS OF XSDB FOR       */
      /* PHYSICAL SEGMENT DATA    */
    3 BEFORE_XSDB_PTR POINTER, /* ADDRESS OF XSDB FOR       */
      /* PHYSICAL BEFORE DATA     */
    3 PATH_XSDB_PTR  POINTER, /* ADDRESS OF XSDB FOR       */
      /* PHYSICAL PATH DATA       */
    3 FILLER3     POINTER, /* RESERVED                 */
    3 FILLER4     POINTER, /* RESERVED                 */
    3 FILLER5     POINTER, /* RESERVED                 */
    3 EXIT_WORK_PTR POINTER, /* ADDRESS OF 256 BYTE AREA  */
      /* FOR THE EXIT              */
    3 NULL_PTR    POINTER, /* NULL POINTER VALUE       */
    3 FILLER6     POINTER, /* RESERVED                 */
    3 CALL_TIMESTAMP CHAR(8), /* TIMESTAMP OF CALL        */
    3 FILLER7     POINTER; /* RESERVED FOR NULLS AT END */

DECLARE XPCB_PTR  POINTER;

```

Figure 7. XPCB in PL/I Example

Sample Extended Segment Data Block (XSDB)

This section provides examples of the XSDB in assembler, COBOL, and PL/I.

Assembler

Figure 8 is an example of the XSDB in assembler.

```
        SPACE 3
XSDB    DSECT
XSDB_EYECATCHER    DS    CL4    "XSDB" EYECATCHER
XSDB_VERSION       DS    CL2    XSDB VERSION INDICATOR
XSDB_RELEASE       DS    CL2    XSDB RELEASE INDICATOR
XSDB_NEXT_PTR      DS    A      NEXT XSDB POINTER
XSDB_DATABASE_NAME DS    CL8    PHYSICAL DATA BASE NAME
XSDB_SEGMENT_NAME  DS    CL8    PHYSICAL SEGMENT NAME
                DS    CL4    RESERVED
XSDB_SEGMENT_LEVEL DS    H      SEGMENT DATA BASE LEVEL
XSDB_KEY_LENGTH    DS    H      LENGTH OF PHYSICAL KEY
XSDB_KEY_PTR       DS    A      ADDRESS OF PHYSICAL KEY
XSDB_LP_KEY_LENGTH DS    H      LENGTH OF LOGICAL PARENT KEY
XSDB_SEGMENT_LENGTH DS    H      LENGTH OF SEGMENT DATA
XSDB_SEGMENT_DATA_PTR DS    A    ADDRESS OF SEGMENT DATA
                DS    F      RESERVED
                DS    F      RESERVED
```

Figure 8. XSDB in Assembler

COBOL

Figure 9 is an example of the XSDB in COBOL.

```
01 XSDB
   05 EYECATCHER          PIC X(4).
   05 VERSION             PIC X(2).
   05 RELEASE-ID         PIC X(2).
   05 NEXT-PTR           POINTER.
   05 DATABASE-NAME      PIC X(8).
   05 SEGMENT-NAME       PIC X(8).
   05 FILLER              PIC X(4).
   05 SEGMENT-LEVEL      PIC 9(4) COMP.
   05 KEY-LENGTH         PIC 9(4) COMP.
   05 KEY-PTR            POINTER.
   05 LP-KEY-LENGTH      PIC 9(4) COMP.
   05 SEGMENT-LENGTH     PIC 9(4) COMP.
   05 SEGMENT-DATA-PTR   POINTER.
   05 FILLER             POINTER.
   05 FILLER             POINTER.
```

Figure 9. XSDB in COBOL example

PL/I

Figure 10 is an example of the XSDB in PL/I.

```

DECLARE
  1 XSDB          BASED(XSDB_PTR),
    3 EYECATCHER  CHAR(4),      /* "XSDB" EYECATCHER      */
    3 VERSION     CHAR(2),      /* XSDB VERSION INDICATOR */
    3 RELEASE     CHAR(2),      /* XSDB RELEASE INDICATOR */
    3 NEXT_PTR    POINTER,      /* NEXT XSDB POINTER      */
    3 DATABASE_NAME CHAR(8),    /* PHYSICAL DATA BASE NAME */
    3 SEGMENT_NAME CHAR(8),    /* PHYSICAL SEGMENT NAME   */
    3 FILLER1     CHAR(4),      /* RESERVED                */
    3 SEGMENT_LEVEL FIXED BINARY (15), /* SEGMENT DATA BASE LEVEL */
    3 KEY_LENGTH  FIXED BINARY (15), /* LENGTH OF PHYSICAL KEY   */
    3 KEY_PTR     POINTER,      /* ADDRESS OF PHYSICAL KEY  */
    3 LP_KEY_LENGTH FIXED BINARY (15), /* RESERVED                */
    3 SEGMENT_LENGTH FIXED BINARY (15), /* LENGTH OF SEGMENT DATA */
    3 SEGMENT_DATA_PTR POINTER, /* ADDRESS OF SEGMENT DATA */
    3 FILLER3     POINTER,      /* RESERVED                */
    3 FILLER4     POINTER,      /* RESERVED                */
    3 FILLER5     POINTER;      /* RESERVED FOR NULLS AT END */

DECLARE XSDB_PTR          POINTER;

```

Figure 10. XSDB in PL/I example

Sample Data Capture Exit Routine

This section provides examples of the Data Capture exit routine in COBOL and PL/I. The exit routine can also be written in assembler or C.

The following topics provide additional information:

- “COBOL”
- “PL/I” on page 65

COBOL

Figure 11 on page 61 is an example of the Data Capture exit routine in COBOL.

```

IDENTIFICATION DIVISION.
PROGRAM-ID. DLICDCE.
*-----*
*REMARKS.
*-----*
*   DESCRIPTIVE NAME : HOSPITAL DATA BASE SEGMENT EXIT
*-----*
*   THIS IS A SAMPLE IMS EXIT. THIS WILL BE CALLED BY IMS.
*   THIS PROGRAM PROPAGATES DATA FROM IMS TO DB2 SYNCHRONOUSLY.
*   THE NAME OF THIS PROGRAM LOAD MODULE IS SPECIFIED
*   ON SEGM MACRO DURING DBDGEN FOR THE HOSPITAL DATA BASE.
*
*   THE DATA OPTIONS SELECTED FOR THIS EXIT :
*   EXIT=(KEY,DATA,NOPATH,CASCADE)
*-----*
*   INPUT FOR THIS PROGRAM : XPCB, XSDB.
*
*   OUTPUT:  DISPLAY A MESSAGE WHEN THE IMS UPDATE IS NOT
*            ISRT, REPL, DELE, CASC. DISPLAY 'SQLERRM' WHEN
*            SQLERROR OCCURS.
*
*   UPDATES: UPDATES DB2 ILLNESS TABLE
*-----*
*   LOGIC:  THIS PROGRAM IS CALLED BY IMS AFTER THE IMS UPDATE
*            TO ILLNESS SEGMENT AND BEFORE IMS RETURNS TO THE
*            IMS APPLICATION PROGRAM.
*
*            XPCB IS RECEIVED AS INPUT TO THIS PROGRAM.
*            IF THERE IS NO ADDRESS OF XSDB IN XPCB THIS
*            PROGRAM WILL RETURNS TO IMS OTHERWISE -
*
*   LOGIC:  THIS PROGRAM IS CALLED BY IMS AFTER THE IMS UPDATE
*            WE GET THE ADDRESS OF XSDB FROM XPCB, FROM XSDB
*            WE GET THE ADDRESS OF ILLNESS SEGMENT CONCATENATED
*            KEY, AND ADDRESS OF THE PHYSICAL SEGMENT DATA
*
*            UPDATE THE DB2 ILLNESS TABLE WITH THE UPDATED IMS
*            SEGMENT DATA.
*-----*
INSTALLATION.  IBM - SANTA TERESA LABORATORY.
DATE-WRITTEN.  JANUARY 1990.
ENVIRONMENT DIVISION.

CONFIGURATION SECTION.
SOURCE-COMPUTER.  IBM-3090.
OBJECT-COMPUTER.  IBM-3090.
DATA DIVISION.

WORKING-STORAGE SECTION.
EXEC SQL
    INCLUDE SQLCA
END-EXEC.

```

Figure 11. Data Capture Exit Routine in COBOL (Part 1 of 4)

Data Capture Exit Routine

```
*--- DB2 ILLNESS TABLE DECLARATION

EXEC SQL
  DECLARE SYSADM.ILLNESS TABLE
    (ILLDATE VARCHAR (6) NOT NULL,
     PATNO VARCHAR (5) NOT NULL,
     ILLNAME VARCHAR (10) NOT NULL)
  END-EXEC.

*---

01 W-POINTER POINTER.
01 W-POINTER-R REDEFINES W-POINTER PIC 9(8) COMP.
LINKAGE SECTION.
*--- EXIT SEGMENT CONTROL BLOCK

01 XPCB.
  05 EYECATCHER PIC X(04).
  05 VERSION PIC X(02).
  05 RELEASE-ID PIC X(02).
  05 EXIT-NAME PIC X(08).
  05 EXIT-RETURN-CODE PIC 9(04) COMP.
  05 EXIT-REASON-CODE PIC 9(04) COMP.
  05 DATABASE-NAME PIC X(08).
  05 DBD-VERSION-PTR POINTER.
  05 SEGMENT-NAME PIC X(08).
  05 CALL-FUNCTION PIC X(04).
  05 PHYSICAL-FUNCTION PIC X(04).
  05 FILLER PIC 9(08) COMP.
  05 DB-PCB-PTR POINTER.
  05 DB-PCB-NAME PIC X(08).
  05 INQY-OUTPUT-PTR POINTER.
  05 IO-PCB-PTR POINTER.
  05 ENVIRONMENT-FLAGS PIC X.
  88 IMS-ENH-SUPPORT VALUE X'80'.
* RRS SUPPORT IS AVAILABLE IN SYSTEM
  88 IMS-RRS-ENABLED VALUE X'40'.
* RRS=Y WAS SPECIFIED
  88 CALL_AT_COMMIT VALUE X'20'.
* SET BY EXIT - CALL DURING COMMIT
  88 XPCB_LOGX_FORMAT VALUE X'10'.
* REDUCED 9904 FORMAT
  88 XPCB_EXIT_WAS_CALLED VALUE X'08'.
* INTERNAL FLAG USED BY IMS
  88 XPCB_DPROP_EXIT VALUE X'04'.
* SET BY DPROP_EXIT ROUTINE
  05 FILLER PIC X.
* RESERVED
  05 FILLER PIC 9(04) COMP.
  05 CONC-KEY-LENGTH PIC 9(04) COMP.
  05 CONC-KEY-PTR POINTER.
  05 DATA-XSDB-PTR POINTER.
  05 BEFORE-XSDB-PTR POINTER.
  05 PATH-XSDB-PTR POINTER.
  05 FILLER POINTER.
  05 FILLER POINTER.
  05 FILLER POINTER.
  05 EXIT-WORK-PTR POINTER.
  05 NULL-PTR POINTER.
  05 FILLER POINTER.
  05 TIMESTAMP PIC X(08).
*--- EXIT SEGMENT DATA BLOCK
```

Figure 11. Data Capture Exit Routine in COBOL (Part 2 of 4)

```

01 DATA-XSDB.
   05 EYECATCHER          PIC X(4).
   05 VERSION             PIC X(2).
   05 RELEASE-ID         PIC X(2).
   05 NEXT-PTR           POINTER.
   05 DATABASE-NAME      PIC X(8).
   05 SEGMENT-NAME       PIC X(8).
   05 FILLER              PIC X(4).
   05 SEGMENT-LEVEL      PIC 9(4) COMP.
   05 KEY-LENGTH         PIC 9(4) COMP.
   05 KEY-PTR            POINTER.
   05 FILLER              PIC 9(4) COMP.
   05 SEGMENT-LENGTH     PIC 9(4) COMP.
   05 SEGMENT-DATA-PTR   POINTER.
   05 FILLER              POINTER.
   05 FILLER              POINTER.
*--- ILLNESS SEGMENT DATA

01 LS-SEGMENT.

   03 LS-ILLDATE          PIC X(6).
   03 LS-ILLNAME         PIC X(10).
*--- ILLNESS SEGMENT CONCATENATED KEY

01 XPCB-CONCKEY.

   02 LS-PATNO           PIC X(5).
   02 LS-ILLDT          PIC X(6).
PROCEDURE DIVISION USING XPCB.
  SET W-POINTER TO DATA-XSDB-PTR.
*--- LENGTH ZERO IF NOT CAPTURED

*   IF W-POINTER-R EQUAL ZEROES GOBACK
*   GOBACK
*   END-IF
*----

  SET ADDRESS OF DATA-XSDB TO DATA-XSDB-PTR.
  SET ADDRESS OF XPCB-CONCKEY TO CONC-KEY-PTR.
  SET ADDRESS OF LS-SEGMENT TO SEGMENT-DATA-PTR.
*----

  EXEC SQL
    WHENEVER SQLWARNING CONTINUE
  END-EXEC
  EXEC SQL
    WHENEVER SQLERROR GO TO BADSQL
  END-EXEC
  EXEC SQL
    WHENEVER NOT FOUND GO TO BADSQL
  END-EXEC
*----

  IF PHYSICAL-FUNCTION OF XPCB = "ISRT"

    EXEC SQL
      INSERT INTO SYSADM.ILLNESS
        VALUES (::LS-ILLDATE,::LS-PATNO,
          ::LS-ILLNAME)
    END-EXEC

```

Figure 11. Data Capture Exit Routine in COBOL (Part 3 of 4)

Data Capture Exit Routine

```
ELSE
  IF PHYSICAL-FUNCTION OF XPCB = "CASC" OR
    PHYSICAL-FUNCTION OF XPCB = "DLET"
    EXEC SQL
      DELETE FROM SYSADM.ILLNESS
      WHERE (PATNO = ::LS-PATNO AND
        ILLDATE = ::LS-ILLDATE)
    END-EXEC
  ELSE

    IF PHYSICAL-FUNCTION OF XPCB = "REPL"

      EXEC SQL
        UPDATE SYSADM.ILLNESS
        SET ILLNAME = ::LS-ILLNAME
        WHERE (ILLDATE = ::LS-ILLDATE AND
          PATNO = ::LS-PATNO)
      END-EXEC
    ELSE

      DISPLAY "FUNCTION WASNT ISRT, REPL, DLET, OR CASC"
      DISPLAY "--- NO SQL ACTION WAS TAKEN"
      DISPLAY "PHYS FUNCTION IS "
      DISPLAY PHYSICAL-FUNCTION OF XPCB
    END-IF
  END-IF
END-IF.
DISPLAY "SQLCODE " SQLCODE.
STOP RUN.

BADSQL.

DISPLAY "SQLERRM".
MOVE 8      TO EXIT-RETURN-CODE OF XPCB.
MOVE SQLCODE TO EXIT-REASON-CODE OF XPCB.
STOP RUN.
```

Figure 11. Data Capture Exit Routine in COBOL (Part 4 of 4)

PL/I

Figure 12 is an example of the Data Capture exit routine in PL/I.

```

DLI2DB2: PROCEDURE(XPCB_PTR) OPTIONS(MAIN);
/*
-----*
*REMARKS.                                     *
-----*
*   DESCRIPTIVE NAME : HOSPITAL DATA BASE SEGMENT EXIT   *
-----*
*   THIS IS A SAMPLE IMS EXIT THAT WILL BE CALLED BY IMS.  *
*   THIS PROGRAM PROPAGATES DATA FROM IMS TO DB2 SYNCHRONOUSLY.*
*   THE NAME OF THIS PROGRAM LOAD MODULE IS SPECIFIED    *
*   ON SEGM MACRO DURING DBDGEN FOR THE HOSPITAL DATA BASE.*
*                                                         *
*   THE DATA OPTIONS SELECTED FOR THIS EXIT ARE:         *
*   EXIT=(DLI2DB2,PATH,DATA,(CASCADE,PATH,DATA,NOKEY)    *
-----*
*   INPUT FOR THIS PROGRAM : XPCB, XSDB.                  *
*                                                         *
*   OUTPUT: DISPLAY 'SQLERRM' WHEN SQLERROR OCCURS.      *
*   UPDATES: UPDATES DB2 TREATMT TABLE                   *
*                                                         *
*           : RETURNS REASON CODE 14 RETURN CODE 16 WHEN PATH *
*           NOT SPECIFIED ON THE DBDGEN EXIT STATEMENT,  *
*           RESULTING IN AN ABEND U3314.                 *
*                                                         *
-----*
*   LOGIC: THIS PROGRAM IS CALLED BY IMS AFTER AN UPDATE TO *
*           THE TREATMT SEGMENT AND BEFORE IMS RETURNS TO *
*           IMS APPLICATION PROGRAM.                     *
*                                                         *
*           THE ADDRESS OF AN XPCB IS PASSED TO THIS PROGRAM *
*           FROM IMS. THE XPCB WILL PROVIDE THE ADDRESSES OF *
*           THE XSDB FOR DATA, PATH DATA AND BEFORE DATA. *
*                                                         *
*           UPDATE THE DB2 TREATMT TABLE WITH THE UPDATED IMS *
*           SEGMENT DATA.                                *
*                                                         *
*   HOSPITAL ***** *
*   DATA BASE *      *
*           * PATIENT * KEY FIELD IS PATNO *
*           *      * *
*           ***** *
*           *      * *
*           *      * *
*           ***** *
*           *      * *
*           * ILLNESS * KEY FIELD IS ILLDATE *
*           *      * *
*           ***** *
*           *      * *
*           *      * *
*           ***** KEY FIELD IS TRTDATE *
*           *      * FIELD, MEDICINE *
*           * TREATMT * FIELD, QUANTITY *

```

Figure 12. Data Capture Exit Routine in PL/I (Part 1 of 6)

Data Capture Exit Routine

```

*           *           * FIELD, DOCTOR (NOT IN DB2 TABLE) *
*           *           * ***** *
*
*
*           *           * TREATMENT TABLE *
*
*           *           * ***** *
*           * PATNUMB * DATEILL * DATETRT * MEDICAT * AMOUNT *
*           *           * ***** *
*
* ----- *
*/
/* ***** */
/*
/*           E X T E N D E D   D A T A   B A S E   P C B   --   X P C B
/*
/*
/* ***** */

DECLARE
1 XPCB          BASED(XPCB_PTR),
3 EYECATCHER   CHAR(4), /* "XPCB" EYECATCHER */
3 VERSION      CHAR(2), /* XPCB VERSION INDICATOR */
3 RELEASE      CHAR(2), /* XPCB RELEASE INDICATOR */
3 EXIT_NAME    CHAR(8), /* SEGMENT EXIT NAME */
3 EXIT_RETURN_CODE FIXED BINARY (15), /* RETURN CODE */
3 EXIT_REASON_CODE FIXED BINARY (15), /* REASON CODE */
3 ATABASE_NAME CHAR(8), /* PHYSICAL DATA BASE NAME */
3 DBD_VERSION_PTR POINTER, /* ADDRESS OF DBD VERSION ID */
3 SEGMENT_NAME CHAR(8), /* PHYSICAL SEGMENT NAME */
3 CALL_FUNCTION CHAR(4), /* CALL FUNCTION */
3 PHYSICAL_FUNCTION CHAR(4), /* DL/I PHYSICAL FUNCTION */
3 FILLER1      FIXED BINARY (31), /* RESERVED */
3 DB_PCB_PTR   POINTER, /* ADDRESS OF DB PCB */
3 DB_PCB_NAME  CHAR(8), /* NAME OF DB PCB */
3 INQY_OUTPUT_PTR POINTER, /* ADDRESS OF "INQY" OUTPUT */
3 IO_PCB_PTR   POINTER, /* ADDRESS OF I/O PCB */
3 ENVIRONMENT-FLAGS CHAR(1), /* Environment Flags */
/* IMS-ENH-SUPPORT X'80' RRS SUPPORT AVAILABLE IN SYSTEM */
/* IMS-RRS-ENABLED X'40' RRS=Y WAS SPECIFIED */
/* CALL_AT_COMMIT X'20' SET BY EXIT-CALL DURING COMMIT */
/* XPCB_LOGX_FORMAT X'10' REDUCED 9904 FORMAT */
/* XPCB_EXIT_WAS_CALLED X'08' INTERNAL FLAG USED BY IMS */
/* XPCB_DPROP_EXIT X'04' SET BY DPROP EXIT ROUTINE */
3 NEWFILLER   CHAR(1), /* Reserved */
3 FILLER2     FIXED BINARY (15), /* RESERVED */
3 CONC_KEY_LENGTH FIXED BINARY (15), /* LENGTH OF FULLY
/* CONCATENATED KEY FOR SEGM */
3 CONC_KEY_PTR POINTER, /* ADDRESS OF PHYSICAL FULLY
/* CONCATENATED KEY FOR SEGM */
3 DATA_XSDB_PTR POINTER, /* ADDRESS OF XSDB FOR
/* PHYSICAL SEGMENT DATA */
3 BEFORE_XSDB_PTR POINTER, /* ADDRESS OF XSDB FOR
/* PHYSICAL BEFORE DATA */
3 PATH_XSDB_PTR POINTER, /* ADDRESS OF XSDB FOR
/* PHYSICAL PATH DATA */
3 FILLER3     POINTER, /* RESERVED */
3 FILLER4     POINTER, /* RESERVED */
3 FILLER5     POINTER, /* RESERVED */
3 EXIT_WORK_PTR POINTER, /* ADDRESS OF 256 BYTE AREA
/* FOR THE EXIT */
3 NULL_PTR    POINTER, /* NULL POINTER VALUE */

```

Figure 12. Data Capture Exit Routine in PL/I (Part 2 of 6)

```

3 FILLER6          POINTER, /* RESERVED */
3 CALL_TIMESTAMP  CHAR(8), /* TIMESTAMP OF CALL */
3 FILLER7          POINTER; /* RESERVED FOR NULLS AT END */
DECLARE XPCB_PTR   POINTER;
/* ***** */
/*
/*      E X T E N D E D   S E G M E N T   D A T A   -- X S D B
/*
/* ***** */

DECLARE
1 XSDB             BASED(XSDB_PTR),
3 EYECATCHER      CHAR(4), /* "XSDB" EYECATCHER */
3 VERSION          CHAR(2), /* XSDB VERSION INDICATOR */
3 RELEASE          CHAR(2), /* XSDB RELEASE INDICATOR */
3 NEXT_PTR         POINTER, /* NEXT XSDB POINTER */
3 DATABASE_NAME    CHAR(8), /* PHYSICAL DATA BASE NAME */
3 SEGMENT_NAME     CHAR(8), /* PHYSICAL SEGMENT NAME */
3 FILLER1          CHAR(4), /* RESERVED */
3 SEGMENT_LEVEL    FIXED BINARY (15), /* SEGMENT DATA BASE LEVEL */
3 KEY_LENGTH       FIXED BINARY (15), /* LENGTH OF PHYSICAL KEY */
3 KEY_PTR          POINTER, /* ADDRESS OF PHYSICAL KEY */
3 FILLER2          FIXED BINARY (15), /* RESERVED */
3 SEGMENT_LENGTH   FIXED BINARY (15), /* LENGTH OF SEGMENT DATA */
3 SEGMENT_DATA_PTR POINTER, /* ADDRESS OF SEGMENT DATA */
3 FILLER3          POINTER, /* RESERVED */
3 FILLER4          POINTER, /* RESERVED */
3 FILLER5          POINTER; /* RESERVED FOR NULLS AT END */

DECLARE XSDB_PTR   POINTER;
DECLARE
1 SEGMENT_XSDB     LIKE XSDB BASED(XPCB.DATA_XSDB_PTR);
DECLARE /* TREATMENT SEGMENT */
1 SEGMENT_DATA     BASED(SEGMENT_XSDB.SEGMENT_DATA_PTR),
3 SEGMENT_DATA_TRTDATE CHAR(6), /* SEGMENT KEY */
3 SEGMENT_DATA_MEDICINE CHAR(10),
3 SEGMENT_DATA_QUANTITY CHAR(4),
3 SEGMENT_DATA_DOCTOR CHAR(10);
DECLARE
1 BEFORE_XSDB     LIKE XSDB BASED(XPCB.BEFORE_XSDB_PTR);
DECLARE /* BEFORE TREATMENT SEGMENT */
1 BEFORE_DATA     BASED(BEFORE_XSDB.SEGMENT_DATA_PTR),
3 BEFORE_DATA_TRTDATE CHAR(6), /* SEGMENT KEY */
3 BEFORE_DATA_MEDICINE CHAR(10),
3 BEFORE_DATA_QUANTITY CHAR(4),
3 BEFORE_DATA_DOCTOR CHAR(10);
DECLARE
1 PATH_XSDB       LIKE XSDB BASED(PATH_XSDB_PTR);
DECLARE /* PATIENT SEGMENT */
1 PATH_DATA       BASED(PATH_XSDB.SEGMENT_DATA_PTR),
3 PATHSEG_PATNO   CHAR(5), /* SEGMENT KEY */
3 PATHSEG_NAME    CHAR(10),
3 PATHSEG_ADDR    CHAR(30);

```

Figure 12. Data Capture Exit Routine in PL/I (Part 3 of 6)

Data Capture Exit Routine

```
DECLARE
  1 PATH2_XSDB LIKE XSDB BASED(PATH2_XSDB_PTR);
DECLARE /* PATIENT SEGMENT */
  1 PATH2_DATA BASED(PATH2_XSDB.SEGMENT_DATA_PTR),
  3 PATH2SEG_ILLDATE CHAR(6), /* SEGMENT KEY */
  3 PATH2SEG_ILLNAM CHAR(10);
DECLARE PATH2_XSDB_PTR POINTER;
DECLARE /* TREATMENT TABLE ROW */
  1 TREATROW BASED(XPCB.EXIT_WORK_PTR),
  3 COL_PATNUM CHAR(5), /* FROM LEVEL 1 KEY */
  3 COL_ILLDATE CHAR(6), /* FROM LEVEL 2 KEY */
  3 COL_TRTDATE CHAR(6), /* FROM LEVEL 3 KEY */
  3 COL_MEDICINE CHAR(10), /* FROM LEVEL 3 */
  3 COL_QUANTITY CHAR(4); /* FROM LEVEL 3 */
EXEC SQL
  INCLUDE SQLCA;
/* - DB2 TREATMENT TABLE DECLARATION */

EXEC SQL
  DECLARE SYSADM.TREATMNT TABLE
    (PATNUMB VARCHAR (5) NOT NULL,
     DATEILL VARCHAR (6) NOT NULL,
     DATETRT VARCHAR (6) NOT NULL,
     MEDICAT VARCHAR (10) NOT NULL,
     AMOUNT VARCHAR (4) NOT NULL);

DECLARE /* CALL FUNCTIONS */
  INSERT_FUNCTION CHAR(4) STATIC INIT('ISRT'),
  DELETE_FUNCTION CHAR(4) STATIC INIT('DLET'),
  REPLACE_FUNCTION CHAR(4) STATIC INIT('REPL'),
  CASCADE_FUNCTION CHAR(4) STATIC INIT('CASC');
DECLARE ZERO FIXED BINARY (31) STATIC
  INIT(0);
DECLARE SIXTEEN FIXED BINARY (31) STATIC
  INIT(16);

PATH2_XSDB_PTR = PATH_XSDB.NEXT_PTR;
TREATROW.COL_PATNUM = PATH_DATA.PATHSEG_PATNO;
TREATROW.COL_ILLDATE = PATH2_DATA.PATH2SEG_ILLDATE;
TREATROW.COL_TRTDATE = SEGMENT_DATA.SEGMENT_DATA_TRTDATE;
TREATROW.COL_MEDICINE = SEGMENT_DATA.SEGMENT_DATA_MEDICINE;
TREATROW.COL_QUANTITY = SEGMENT_DATA.SEGMENT_DATA_QUANTITY;

EXEC SQL
  WHENEVER SQLWARNING CONTINUE;
EXEC SQL
  WHENEVER SQLERROR GOTO BADSQL;
EXEC SQL
  WHENEVER NOT FOUND GOTO BADSQL;
IF XPCB.PATH_XSDB_PTR = XPCB.NULL_PTR
  THEN DO;
GOTO BADPATH; /* PATH NOT SPECIFIED */
END;
```

Figure 12. Data Capture Exit Routine in PL/I (Part 4 of 6)

```

ELSE DO;          /* PRE-SET CODES TO ZERO */
XPCB.EXIT_RETURN_CODE = ZERO;
XPCB.EXIT_REASON_CODE = ZERO;
END;
/*=====*/
/* IF CALLED FOR DELETE OR CASCADE, */
/* PERFORM THE DB2 DELETE. */
/*=====*/
IF XPCB.PHYSICAL_FUNCTION = DELETE_FUNCTION
THEN DO;

EXEC SQL
DELETE FROM SYSADM.TREATMNT
WHERE PATNUMB = ::TREATROW.COL_PATNUM AND
DATEILL = ::TREATROW.COL_ILLDATE AND
DATETRT = ::TREATROW.COL_TRTDATE;

END;
/*=====*/
/* IF CALLED FOR INSERT, DO DB2 INSERT CALL */
/*=====*/
IF XPCB.CALL_FUNCTION = INSERT_FUNCTION
THEN DO;
EXEC SQL
INSERT INTO SYSADM.TREATMNT
VALUES(::TREATROW.COL_PATNUM,
::TREATROW.COL_ILLDATE,
::TREATROW.COL_TRTDATE,
::TREATROW.COL_MEDICINE,
::TREATROW.COL_QUANTITY);

END;
/*=====*/
/* IF CALLED FOR REPLACE, UPDATE THE */
/* THE DB2 ROW, IF A FIELD DESTINED TO */
/* THE DB2 DATA BASE HAS BEEN CHANGED. */
/*=====*/
IF XPCB.CALL_FUNCTION = REPLACE_FUNCTION
THEN DO; /* REPLACE */
IF (SEGMENT_DATA.SEGMENT_DATA_MEDICINE ≠
BEFORE_DATA.BEFORE_DATA_MEDICINE) |
(SEGMENT_DATA.SEGMENT_DATA_QUANTITY ≠
BEFORE_DATA.BEFORE_DATA_QUANTITY)
THEN DO; /* UPDATE */
EXEC SQL
UPDATE SYSADM.TREATMNT
SET MEDICAT = ::SEGMENT_DATA.SEGMENT_DATA_MEDICINE,
AMOUNT = ::SEGMENT_DATA.SEGMENT_DATA_QUANTITY
WHERE PATNUMB = ::TREATROW.COL_PATNUM AND
DATEILL = ::TREATROW.COL_ILLDATE AND
DATETRT = ::TREATROW.COL_TRTDATE;
END; /* OF UPDATE */
END; /* OF REPLACE */
STOP;
BADSQL: DO;

```

Figure 12. Data Capture Exit Routine in PL/I (Part 5 of 6)

```
DISPLAY(SQLERRM);
XPCB.EXIT_RETURN_CODE = 16;
XPCB.EXIT_REASON_CODE = SQLCODE;
END;
BADPATH: DO;
XPCB.EXIT_RETURN_CODE = 16;
XPCB.EXIT_REASON_CODE = 14;
END;
END DLI2DB2B;
```

Figure 12. Data Capture Exit Routine in PL/I (Part 6 of 6)

Chapter 3. Data Conversion User Exit Routine (DFSDBUX1)

This section documents General-Use Programming Interface and Associated Guidance Information.

The Data Conversion user exit routine (DFSDBUX1) gets control at the beginning of a DL/I call and at the end of the call. In the exit routine, you can modify segment search arguments, the key feedback area, the I/O area, and the status code.

In this Chapter:

“About This Routine”

“Communicating with IMS” on page 72

About This Routine

The purpose of the Data Conversion exit routine (DFSDBUX1) is to provide a method for modifying segment search arguments, the key feedback area, the I/O area, and the status code.

Attributes of the Routine

Regardless of its function, the exit routine must be written in assembler language, C language, COBOL, or PL/I. Routines written in high-level languages running under Language Environment for z/OS are not supported.

Binding the Routine

Bind the exit routine DFSDBUX1 with the RENT attribute into an APF-authorized library. This library can be either IMS.SDFSRESL, SYS1.LINKLIB, or any partitioned data set that can be accessed by a JOBLIB or a STEPLIB DD statement for the IMS control, SAS, batch, or CICS region.

Loading the Routine

IMS attempts to load the exit routine upon the first database call. If the exit routine fails to load, IMS does not attempt to load it again.

Other Considerations

A DBDGEN is not required for IMS to call the exit routine. However, it is recommended that you perform a DBDGEN with the DATXEXIT=YES parameter for DBDs that require the exit routine.

If you do *not* specify DATXEXIT=YES for a DBD, the call analyzer (DFSDLA00) issues a DFS2097I message if the exit routine specifies that it should continue to be called for that DBD. After issuing the DFS2097I message, DFSDLA00 dynamically sets the DATXEXIT=YES indicator for the DBD and continues calling the exit routine. Thus, the DFS2097I message appears only once per DBD.

If you bind an exit routine and want to prevent it from being called, you must remove DFSDBUX1 from the library where you edited it.

If DFSDBUX1 is available to IMS, it is called regardless of what is specified by the DATXEXIT parameter. If the exit routine determines that the exit routine should not be called again for the DBD, the routine should return X'FF' in the SRCHFLAG field in the JCB (SRCHFLAG EQUA JCBWKR55). X'FF' causes DFSDLA00 to dynamically mark the DBD as not requiring the exit routine. In this case, the exit

routine is not called again for that DBD for the duration of the execution of this IMS or until the DMB is purged from the DMB pool.

You can also control which databases DFSDBUX1 acts upon, once called, by adding the database names to a table that the exit can check.

Preloading the exit routine is not necessary. Once loaded, the exit routine remains loaded until region termination.

Using IMS Callable Services with This Routine

This exit is not eligible to use IMS Callable Services.

Issuing SVC Calls

In an online environment, the exit routine might be running in cross-memory mode. To prevent 0F8 abends, the exit should avoid issuing SVC calls.

Communicating with IMS

IMS uses the general purpose registers and several IMS control blocks to communicate with the DFSDBUX1 exit routine.

Contents of Registers on Entry

Upon entry, the exit routine must save all registers using the provided save area. The registers contain the following:

Register	Contents
0	The characters 'IN' at the start of the DL/I call and the characters 'OUT' at the end of the DL/I call.
1	Address of the Partition Specification Table.
3	Address of the Database Program Control Block (DBPCB).
5	Address of the PSB Directory (PDIR).
6	Address of the System Contents Directory (SCD).
7	Address of the Program Specification Block (PCB).
9	Address of the Job Control Block (JCB).
10	Address of the Segment Descriptor Block (SDB).
13	Address of save area. The exit routine must not change the first three words.
14	Return address to IMS.
15	Entry point of exit routine.

Contents of Register on Exit

Before returning to IMS, the exit routine must restore registers 0 through 14. The value of Register 15 must be a 2-byte or less positive value set as follows:

Register	Contents
0	The exit routine has successfully processed the request.
non-0	The exit routine has set a status code or pseudoabend.

Data Security and Integrity

The exit routine is an extension of the application program with the same capabilities as the application program; the exit routine and the application have equal authorization and limitations.

In batch, the data and the exit routine operate in unprotected key-8 storage. Online, the data and the exit routine operate in unprotected key-7 storage. The exit routine is able to modify data or control blocks that can affect the successful operation of the application program.

Chapter 4. Data Entry Database Randomizing Routine (DBFHDC40/ DBFHDC44)

This chapter describes the Data Entry Database (DEDB) Randomizing routine. The chapter specifies the attributes of the routine and how the routine communicates with IMS.

In this Chapter:

“About This Routine”

“Communicating with IMS” on page 77

“Using the Sample DEDB Randomizing Routines (DBFHDC40)” on page 78

“Extended Call Interface (XCI) Option” on page 78

About This Routine

A DEDB randomizing module is required for placing root segments in or retrieving them from a DEDB. Several DEDBs can share the same routine, but all AREAs in a DEDB must use the same routine.

If you are using data sharing, you must use the same randomizing routine on both systems.

IMS supplies sample DEDB randomizing modules (DBFHDC40 and DBFHDC44) on IMS.DBSOURCE. You can use one of these IMS-supplied routines or you can write your own.

A randomizing module uses a mathematical technique to convert a key into an address. The same key always converts to the same address. The randomizing module required by IMS must convert a key field value into a relative anchor point number. A randomizing routine results in a relative anchor point number that can range from 0 to $2^{31}-1$.

The key field value is supplied by an application program in the data itself for inserting segments into the database, and in an SSA (segment search argument) for retrieving segments from a database.

Related Reading: For general guidelines on writing DL/I exit routines, see Chapter 1, “Guidelines for Writing IMS exit routines,” on page 3 of the Customization Guide.

You can write the routine and bind it as *reentrant* (RENT) like the one that IMS supplies. The routine receives control and must return control in 31-bit addressing mode (AMODE 31). It must be able to execute in cross-memory and TASK modes.

You must reassemble the modules you wrote for use with previous IMS releases because of changes to the control blocks.

Table 14 shows the attributes of the Data Entry Database Randomizing routine.

Table 14. Data Entry Database Randomizing Routine Attributes

Attribute	Description
IMS environments	DB/DC, DBCTL.

Table 14. Data Entry Database Randomizing Routine Attributes (continued)

Attribute	Description
Naming convention	The name given to the load module used for randomizing functions with a specific database should also appear in the DBD generation associated with the database. The load module name must be the value of the “mod” parameter of the RMNAME= operand on the DBD statement in the DEDB DBD generation. Related Reading: For details on coding this parameter, see the chapter on “DBD Generation” in <i>IMS Version 9: Utilities Reference: System</i> .
Binding	Follow the guidelines described in “Binding the Routines” on page 7. After you compile and test your randomizing module, bind it into IMS.SDFSRESL, SYS1.LINKLIB, or any operating system partitioned data set that can be accessed by a JOBLIB or STEPLIB JCL statement for the IMS control and SAS regions.
Including the routine	No special steps are needed to include this routine.
IMS callable services	This exit is not eligible to use IMS Callable Services.
Sample routine location	IMS.ADFSSRC (member name DBFHDC40). For more information, see “Using the Sample DEDB Randomizing Routines (DBFHDC40)” on page 78.

Loading the Routine

All randomizing modules are loaded from their resident library by IMS. The name of the module is the name you specified in the RMNAME parameter of the DBD statement of the database description (DBD).

Related Reading: For details on coding the RMNAME parameter, see *IMS Version 9: Utilities Reference: Database and Transaction Manager*.

The necessary randomizing module associated with a specific database is brought into main storage at initialization time. Though not recommended, the randomizing module can also be placed in the LPA (link pack area). This allows one copy of the module to service several databases that are concurrently open. When running under z/OS, the randomizing module is loaded into the Common Service Area (CSA). If you were to bind with RMODE ANY, you can load it into the Extended Common Service Area (ECSA).

Related Reading: For more information, see Chapter 1, “Guidelines for Writing IMS exit routines,” on page 3.

Activating the Routine

When an application program issues a Get Unique or Insert call that operates on a root segment of a DEDB database, the user-supplied randomizing module is activated.

The source of the root key that IMS supplies to the randomizing routine is as follows:

- For a root insert, it is taken from the I/O area containing the root to be inserted.

- For a call qualified on the root key, it is the key value in the segment search argument.

Related Reading: For information on processing Get Next (GN) calls qualified on the root key and calls with root qualification that allow a range of key values, see *IMS Version 9: Application Programming: Database Manager*.

The key is supplied to the randomizing module for conversion to a relative block number and anchor point number within the database. In addition to the key supplied by an application program, parameters from the DBD generation associated with the database being used are available to the randomizing module.

Communicating with IMS

IMS uses the entry and exit registers to communicate with the routine.

Contents of Registers on Entry

Upon entry to the randomizing module, the registers contain the following:

Register	Contents
0	Number of entries in the MRMB (total number of AREAs in the DEDB).
1	Address of first MRMB the routine uses.
2	Size of an entry in the MRMB.
3	Address of the root key.
4	Length of the root key in bytes.
5	Total number of RAPs in the DEDB.
6	Address of an eight-word area that the randomizing module can use.
10	Address of the EPST (Extended Partition Specification Table).
11	Address of the ESCD (Extended System Content Directory).
13	Address of save area. The routine must not change the first three words
14	Return address to IMS.
15	Entry point of randomizing module.

The randomizing module must neither change the key value nor modify any control blocks.

Exception: When you execute z/OS batch utilities (such as DBFUCDX0 or MSDB-to-DEDB conversion), register 10 contains zeros and register 11 contains decimal -1 (X'FFFFFFFF').

Description of Parameters

To support the facility of randomizing within an AREA, the routine is passed the address of a Randomizing Module Block (MRMB).

Each AREA has one 3-word entry. MRMB entries are built in the same order as their associated AREA macros in the DBDGEN for the database. The content of an entry is mapped by DBFMRMB macro and contains the following:

```
MRMB      DSECT
MRMBARTD  DS      0F  START IS WORD-ALIGNED
MRMBARTC  DS      F   ADDRESS OF THE AREA SELECTED
MRMBARTI  DS      F   NUMBER OF ANCHOR POINTS IN THIS AREA
MRMBARTN  DS      F   CUMULATIVE NUMBER OF ANCHOR POINTS
*         IN ALL AREAS OF THE DEDB UP TO AND
```

```

*           INCLUDING THIS ONE
MRMBARTZ   DS      0F  END OF THIS ENTRY, START OF NEXT
MRMBARTL   EQU     MBMBARTZ-MRMBARTD
*           LENGTH OF A SINGLE ENTRY

```

Contents of Registers on Exit

Before returning to IMS, your routine must restore all registers, except for registers 0, 1, and 15, which must contain the following:

Register	Contents								
0	Relative root anchor point number within the selected AREA (0 for first root anchor point).								
1	DMAC address of the AREA selected.								
15	Return code interpreted as follows: <table border="1"> <thead> <tr> <th>Return Code</th> <th>Meaning</th> </tr> </thead> <tbody> <tr> <td>0</td> <td>Register 1 contains the address of the area selected. If the area is not contained in the DMCB or the HSSP sublist, ABENDU1021 is issued.</td> </tr> <tr> <td>4</td> <td>Status 'FM' needs to be issued.</td> </tr> <tr> <td></td> <td>Any other return code causes ABENDU1021 to be issued.</td> </tr> </tbody> </table>	Return Code	Meaning	0	Register 1 contains the address of the area selected. If the area is not contained in the DMCB or the HSSP sublist, ABENDU1021 is issued.	4	Status 'FM' needs to be issued.		Any other return code causes ABENDU1021 to be issued.
Return Code	Meaning								
0	Register 1 contains the address of the area selected. If the area is not contained in the DMCB or the HSSP sublist, ABENDU1021 is issued.								
4	Status 'FM' needs to be issued.								
	Any other return code causes ABENDU1021 to be issued.								

When randomizing through the entire DEDB, the randomizing module must derive an AREA and a relative root anchor point number to conform to the exit interface. You can use the third word of the MRMB entry to accomplish this.

Using the Sample DEDB Randomizing Routines (DBFHDC40)

The sample exit routine is based on the generalized Randomizing Routine (DFSHDC40) and has been modified to work with DEDB databases. The modifications are:

1. The module uses the DEDB input and output interfaces.
2. The module can return an anchor point in block 1, because DEDB areas do not use a bit map at this location.

Extended Call Interface (XCI) Option

There is now an extended call interface (XCI) option that can be specified in the RMNAME= parameter list in the DBD statement of a DBDGEN

The XCI option specifies that this DEDB uses the extended call interface when making calls to the randomizer. This option allows the randomizer to be called in 3 different ways. On initialization of IMS, or during a /START DB command, IMS will first load the randomizer and then make an 'INIT' call to the randomizer to invoke its initialization routines. During a /DBR DB command, IMS will make a 'TERM' call to the randomizer to invoke the termination routines before unloading the randomizer. The normal randomizing call is made when the application issues a GU or ISRT call on a root segment. The XCI option is valid only for DEDBs.

Attributes of the Routine

The attributes of the routine are the same as the non-XCI randomizer.

Invoking the Routine

An XCI randomizer is invoked with an initialization call during Fast Path initialization and during a /START DB command. The XCI randomizer is invoked with a termination call during a /DBR DB command. Otherwise, a regular randomizing call is

made to the XCI randomizer when an application program issues a GU or ISRT call which operates on a root segment of a DEDB database, just as in a non-XCI randomizer.

Communicating with IMS

IMS uses the entry and exit registers to communicate with the routine.

Contents of Registers on Entry for a Randomizing Call

A register on entry of '0' for a randomizing call contains 'XCI.' A register on entry of '1' contains a parameter list. The address of the parameter list is as follows:

Table 15. Sample Parameter List for a Randomizing Call

Hex Offset	Contents	
+0	0	Number of Areas
+8	Address of MRMB	Size of MRMB
+10	Address of Key	Key Length
+18	Total RAPs	Address of Work Area
+20	Any User Data	

Contents of Registers on Entry for an Initialization Call

A register on entry of '0' for an initialization call contains 'XCI.' A register on entry of '1' contains a parameter list. The address of the parameter list is as follows:

Table 16. Sample Parameter List for an Initialization Call

Hex Offset	Contents	
+0	4	Address of DMCB
+8	Address of ECB	Any User Data

Contents of Registers on Entry for a Termination Call

A register on entry of '0' for a termination call contains 'XCI.' A register on entry of '1' contains a parameter list. The address of the parameter list is as follows:

Table 17. Sample Parameter List for a Termination Call

Hex Offset	Contents	
+0	8	Address of DMCB
+8	Address of ECB	Any User Data

Contents of Registers on Exit from a Randomizing Call

The contents of registers on exit from a randomizing call are the same as the contents for a non-XCI randomizer.

Contents of Registers on Exit from an Initialization Call

The contents of registers on exit from an initialization call are as follows:

Register	Contents
1	Reason code for a non-zero return code.
15	Return code.

Contents of Registers on Exit from a Termination Call

The contents of registers on exit from a termination call are as follows:

Register	Contents
1	Reason code for a non-zero return code.
15	Return code.

Chapter 5. Data Entry Database Resource Name Hash Routine (DBFLHSH0)

This chapter describes the IMS Data Entry Database (DEDB) Resource Name hash routine. The chapter discusses the attributes of the routine and how the routine communicates with IMS.

In this Chapter:

“About This Routine”

“Communicating with IMS” on page 82

“Sample Hashing Routine Result Format” on page 83

About This Routine

The IMS DEDB Resource Name hash routine is used with the Internal Resource Lock Manager (IRLM) and enables IMS and DBCTL to maintain and retrieve information about the control intervals (CIs) used by sharing subsystems. The routine does this by performing a hashing function on the high-order three bytes of the relative byte address (RBA) representing a CI and using the hashing result as a displacement into the hash table. If you are using IRLM in your system, the routine IMS supplies (DBFLHSH0) or the replacement routine that you write yourself is called automatically.

Related Reading: For guidance-level information to help you decide whether to write your own hashing routine, see the section on “Factors Influencing Fast Path Performance” in *IMS Version 9: Administration Guide: Database Manager*.

You can write the routine and bind it as *reentrant* (RENT) like the one supplied by IMS. It receives control and must return control in 31-bit addressing mode. It must be able to execute in cross-memory and TASK modes.

Attention: All IMS systems sharing data must use the same routine or DEDBs could be destroyed. IMS does not check to ensure that the routines are the same.

- “Attributes of the Routine”
- “Assembling the Routine” on page 82

Attributes of the Routine

Table 18 shows the attributes of the Data Entry Database Resource Name Hash routine.

Table 18. Data Entry Database Resource Name Hash Routine Attributes

Attribute	Description
IMS environments	DB/DC, DBCTL
Naming convention	You must name this exit routine DBFLHSH0.
Binding	Follow the guidelines described in “Binding the Routines” on page 7. After you compile and test the routine, bind it into IMS.SDFSRESL or to the library specified in the USERLIB= parameter of the IMSGEN macro statement.

Table 18. Data Entry Database Resource Name Hash Routine Attributes (continued)

Attribute	Description
Including the routine	At system definition time, you must specify the name of your routine in the USRHASH parameter of the FPCTRL macro. Related Reading: For details, see the section on the FPCTRL macro in <i>IMS Version 9: Installation Volume 2: System Definition and Tailoring</i> .
IMS callable services	This exit is not eligible to use IMS Callable Services.
Sample routine location	IMS.ADFSSRC (member name DBFLHSH0)

Assembling the Routine

In a multiple-IMS environment, all IMS systems must use the same hashing routine and compile that routine at the same time. If you write your own routine, you must store the compile time in the module using &SYSDATE and &SYSTIME. You also must place the address of the date and time in the first field of the routine's CSECT.

Communicating with IMS

IMS uses the entry registers and parameter list, and the exit registers to communicate with the routine.

Contents of Registers on Entry

Upon entry, the routine must save all registers using the provided save area. The registers contain the following:

Register	Contents
1	Address of Extended Partition Specification Table (EPST).
13	Address of save area. The routine must not change the first three words.
14	Return address to IMS.
15	Entry point of hash routine.

Description of Parameters

As input to the hashing routine, you need to supply *one* of the following:

- the high-order byte of an RBA.
- the names of both a database and an area.

The routine performs an EXCLUSIVELY OR on this input, stores it in a field, and returns a hash value result to the field EPSTRSHS.

EPST (Extended Program Specification Table) Input to the Routine

Register 1 points to the extended program specification table (EPST) that contains this input as follows:

Field Name	Content
EPSTRSHS	Hashing routine result. Only the low-order 14 bits are significant.
EPSTRSID	Start of the lock name to be hashed. Lock resource name consists the following are shown in Figure 13 on page 83:

Field Name	Content Name	Meaning
	EPSTLKID	A lock identifier. If EPSTLKID = 0, resource name is for CI. If EPSTLKID = nonzero, name is for the area. 1 byte See Figure 13.
	EPSTRBA	Bit 0 through 23 of RBA. 3 bytes.
	EPSTDMCB	DB Number as defined by DBRC. 2 bytes.
	EPSTAREA	Area number. 1 byte.
	EPSTDBNM	Database name. 8 bytes.
	EPSTARNM	Area name. 8 bytes.

CI resource name

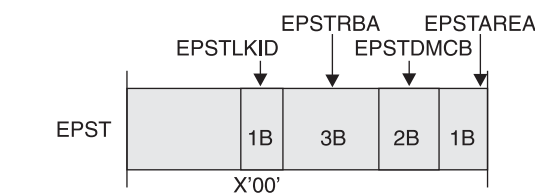

Area resource name

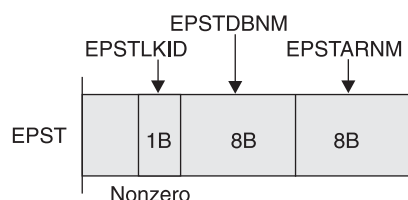

Figure 13. Lock Resource Name

EPST DSECT

The DSECT of the extended program specification table (EPST) (name: DBFEPST), and the DEDB area control list (DMAC) (name: DBFDMAC) can be used. The DMAC address is set at the EPSTDMAA field.

Sample Hashing Routine Result Format

The following shows the layout of the hash value stored in EPSTRSHS using the IMS-supplied routine DBFLHSH0.

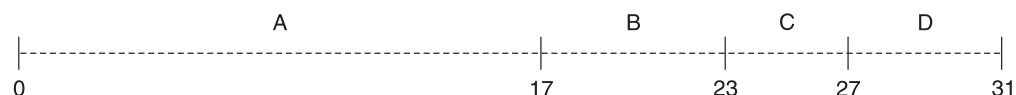

Figure 14. Format of a Hash Value

The following table describes the segments within a hash value and their sizes.

Table 19. Segments of a Hash Value

Segment	Description	Size
A	Bits 0 - 17 of EPSTRSHS	18 bits
B	Bits 21 - 25 of CI RBN XOR'd COMB value	5 bits
C	Bits 26 - 29 of CI RBN ¹	4 bits

Table 19. Segments of a Hash Value (continued)

Segment	Description	Size
D	Bits 16 - 20 of CI RBN XOR'd COMB value ²	5 bits

Notes:

1. COMB VALUE (bits 3 - 7) = bits 11 - 15 of DMCB XOR'd with bits 7, 6, 5, 4, and 3 of the area number.
2. CI RBN = RBA divided by the CI size.

Chapter 6. Data Entry Database Sequential Dependent Scan Utility Exit Routine (DBFUMSE1)

This chapter describes the Data Entry Data Base (DEDB) Sequential Dependent Scan Utility exit routine. The chapter provides information about the attributes of the routine, how the routine is called, and how the routine communicates with IMS. A sample routine is provided at the end of the chapter.

In this Chapter:

“About This Routine”

“Communicating with IMS” on page 86

“Sample DEDB Sequential Dependent Scan Utility Exit Routine (DBFUMSE1)” on page 87

About This Routine

The DEDB Sequential Dependent Scan utility allows you to write an exit routine that copies and processes a subset of the number of segments that the utility scans at a particular time. For example, such a routine might change both the content and length of the segments scanned. You can choose to sort or not to sort the segments.

If you do not write an exit routine, the Scan utility defaults to passing unchanged segment contents through the range you have specified for scanning. If you do not specify a limit on the range of segments that the utility can scan, the utility scans and copies all of the dependent segments.

Indoubt segments are not passed to this exit routine.

Related Reading: For guidance-level information to help you determine whether to write an exit routine for use with the Scan utility, see *IMS Version 9: Utilities Reference: Database and Transaction Manager*.

You can write the routine and bind it as *reentrant* (RENT) like the one supplied by IMS. The routine receives control and must return control in 31-bit addressing. The routine must be able to execute in cross-memory and TASK modes.

Attributes of the Routine

Table 20 shows the attributes of the Data Entry Database Sequential Dependent Scan Utility exit routine.

Table 20. Data Entry Database Sequential Dependent Scan Utility Exit Routine Attributes

Attribute	Description
IMS environments	DB/DC, DBCTL.
Naming convention	This exit routine has no specific naming requirements or restrictions; standard naming conventions apply.

Related Reading: For information about general guidelines, see “Naming the Routines” on page 4 in Chapter 1, “Guidelines for Writing IMS exit routines,” on page 3.

DEDB Scan Utility Exit Routine

Table 20. Data Entry Database Sequential Dependent Scan Utility Exit Routine Attributes (continued)

Attribute	Description
Link editing	Follow the guidelines described in “Binding the Routines” on page 7. After you compile your routine, include it into IMS.SDFSRESL or into any operating system partitioned data set to which access is provided with a JOBLIB or STEPLIB control region JCL statement.
Including the routine	No special steps are needed to include this routine.
IMS callable services	This exit routine is not eligible to use IMS Callable Services.
Sample routine location	Refer to “Sample DEDB Sequential Dependent Scan Utility Exit Routine (DBFUMSE1)” on page 87.

Calling the Routine

If you want IMS to call your routine instead of the IMS-supplied routine (DBFUMSE0), you must specify the name of your routine in the EXIT control statement of the SYSIN DD data set of the Scan Utility JCL.

Related Reading: For details, see *IMS Version 9: Utilities Reference: Database and Transaction Manager*.

Communicating with IMS

IMS uses the entry registers, parameter list, and exit registers to communicate with the routine.

Contents of Registers on Entry

Upon entry, the exit routine must save all registers using the provided save area. The registers contain the following:

Register	Contents
1	Address of parameter list.
13	Address of save area. The exit routine must not change the first three words.
14	Return address of IMS.
15	Entry point of exit routine.

Contents of Registers on Exit

Before returning to IMS, the routine must restore all registers except for register 15, which must contain one of the following:

Return Code	Meaning
00	Use segment.
04	Do not use segment.

Sample DEDB Sequential Dependent Scan Utility Exit Routine (DBFUMSE1)

The sample in Figure 15 is *not* a usable exit routine provided by IMS nor is it found in IMS.ADFSSRC library. It is an example showing entry and exit code to help you write your own scan routine.

```

      TITLE 'DBFUMSE1 IMS DEDB ONLINE UTILITY SCAN EXIT'
*****
*
*  MODULE NAME : DBFUMSE1
*
*  TITLE : STANDARD EXIT FROM SCAN UTILITY
*
*  CONTAINS RESTRICTED MATERIALS OF IBM
*  COPYRIGHT : REFERENCE MODULE DBFCOPYR
*
*  ENTRY POINT(S)/PURPOSE : DBFUMSE1
*
*  FUNCTION : THIS IS A SAMPLE OF THE SCAN UTILITY USER EXIT.
*             ITS PURPOSE IS TO DEFINE THE INTERFACE BETWEEN
*             THE UTILITY AND THE EXIT. IT IS NOT INTENDED TO
*             BE A USABLE EXIT. IN THIS EXAMPLE, OUTPUT TO THE
*             SCAN DATASET IS SUPPRESSED IF THE SEGMENT BEGINS
*             WITH HEX ZEROES.
*
*  ENTRY INTERFACES:
*
*  REGISTERS AT ENTRY : R1 ADDRESS OF USER PARAMETER LIST
*                      R13 ADDRESS OF SAVE AREA
*                      R14 ADDRESS OF RETURN POINT
*                      R15 ADDRESS OF ENTRY POINT
*                      REGISTERS ARE SAVED AND RESTORED BY THE
*                      CALLING MODULES.
*
*  CONTENT OF PARAMETER LIST (UTDWUSER) :
*      UTDWDATA - ADDRESS OF SEGMENT (FULLWORD)
*                ZERO AFTER LAST SEGMENT
*                1. AT ENTRY ADDRESS OF SEGMENT
*                2. AT EXIT ADDRESS OF DATA TO BE
*                PICKED UP AND PUT INTO SCAN
*                OUTPUT DATA SET REFERRED TO
*                BY SCANCOPY DD CARD.
*      UTDWMIN - MINIMUM LENGTH OF SEGMENT (HALFWORD)
*                AS IN DBD-GENERATION
*      UTDWMAX - MAXIMUM LENGTH OF SEGMENT (HALFWORD)
*                AS IN DBD-GENERATION
*      UTDWUFLD - FIELD FOR USER (FULLWORD)
*                ZERO WITH FIRST SEGMENT,
*                UNCHANGED BY THE UTILITY
*      UTDWMOUT - MAXIMUM SEGMENT LENGTH (HALFWORD)
*
*                NOTE: THE USER MAY CHANGE LENGTH AND
*                CONTENT OF THE SEGMENT USING HIS
*                OWN WORKSPACE. IF HOWEVER THE LENGTH*
*                EXCEEDS THE LENGTH OF THE SCAN
*                OUTPUT BUFFER - 8 THE UTILITY IS
*                TERMINATED.
*
*  DATA/OTHER : NONE

```

Figure 15. Sample DEDB Sequential Dependent Scan Utility Exit Routine (Part 1 of 3)

DBFUMSE1

```

*                                                                 *
* EXIT INTERFACES :                                           *
*   REGISTERS AT EXIT : R15 CONTAINS RETURN CODE             *
*   RETURN CODES :   00 USE SEGMENT                          *
*                   04 DO NOT USE SEGMENT                   *
*                                                                 *
*   DATA/OTHER : NONE                                       *
*                                                                 *
* EXTERNAL ROUTINES CALLED : NONE                             *
*                                                                 *
* TABLES/WORKAREAS : NONE                                    *
*                                                                 *
* REGISTER USAGE : R1  PARAMETER LIST                        *
*                  R2  SEGMENT ADDRESS                       *
*                  R12 MODULE BASE REGISTER                  *
*                  R14 RETURN ADDRESS                       *
*                  R15 RETURN CODE - 00 WRITE SEGMENT       *
*                   04 DO NOT WRITE SEGMENT                 *
*                                                                 *
* MESSAGE NUMBERS : NONE                                     *
*                                                                 *
* ABEND CODES : NONE                                        *
*                                                                 *
*****
EJECT ,
*PCODE:
*****
*
*   IF SEGMENT EXISTS
*   IF THE SEGMENT STARTS WITH X'00'S
*   SET RC=4 (DON'T WRITE THE SEGMENT)
*   ELSE
*   SET RC=0 (WRITE THE SEGMENT)
*   ENDIF
*   ELSE
*   SET RC=4 (DON'T WRITE THE SEGMENT)
*   ENDIF
*   RETURN
*
*****
*ENDPCODE:
      SPACE 10
      PRINT NOGEN
      REQUATE
      DBFUTDW           DSECT FOR PARM LIST
      SPACE 10
DBFUMSE1 CSECT
      USING DBFUMSE1,R12      MODULE BASE REGISTER
      USING UTDWUSER,R1      PARAMETER LIST BASE REGISTER
      L    R2,UTDWDATA        GET ADDRESS OF SEGMENT
      LTR  R2,R2              IS THERE A SEGMENT?
      BZ   NOWRITE           NO SEGMENT, DON'T WRITE
*

```

Figure 15. Sample DEDB Sequential Dependent Scan Utility Exit Routine (Part 2 of 3)

```

                LA    R2,2(,R2)          SKIP PAST SEGMENT LENGTH
                CLC   0(6,R2),ZEROES     DOES SEGMENT START WITH 0'S?
                BNE   WRITESEG           NON-ZERO DATA. WRITE IT.
*
NOWRITE DS    0H                       OTHERWISE, DON'T WRITE IT.
        LA    R15,4
        BR    R14
WRITESEG DS    0H
        XR    R15,R15
        BR    R14
ZEROES  DC    XL6'00'
        END

```

Figure 15. Sample DEDB Sequential Dependent Scan Utility Exit Routine (Part 3 of 3)

Chapter 7. HALDB Partition Selection Exit Routine (DFSPSE00)

This chapter describes the High Availability Large Database (HALDB) Partition Selection exit routine. It provides information about the attributes of the routine, how the routine is called, and how the routine communicates with IMS.

In this Chapter:

“About This Routine”

“Communicating with IMS” on page 92

About This Routine

PHDAM, PHIDAM, or PSINDEX databases use a HALDB Partition Selection exit routine. Develop a HALDB Partition Selection exit routine if you want to select partitions by some criteria other than high key.

Define the HALDB Partition Selection exit routine during DBDGEN processing, on the HALDB Partition Definition utility, or in the DBRC INIT.DB command. To define the HALDB Partition Selection exit routine during DBDGEN processing, specify the PSNAME keyword. The PSNAME keyword can also be specified on the HALDB Partition Definition utility. To define the HALDB Partition Selection exit routine when you register a HALDB with DBRC, specify the PARTSEL keyword on the DBRC INIT.DB command. If you do not specify an exit routine, IMS selects a partition using the high key method, and does not involve the HALDB Partition Selection exit routine.

Table 21 shows the attributes of the HALDB Partition Selection exit routine.

Table 21. HALDB Partition Selection Exit Routine Attributes

Attribute	Description
IMS environments	DB/DC, DBCTL.
Naming convention	The name given to the load module used for partition selection should appear in the DBD generation associated with the database, the HALDB Partition Definition utility, or the DBRC INIT.DB command. The load module name must be the value of the parameter of the PSNAME operand on the DBD statement, Partition Selection name in the HALDB Partition Definition utility, or value of the parameter PARTSEL on the DBRC INIT.DB command. Related Reading: For details on coding parameter PSNAME see: “Database Description (DBD) Generation”, <i>IMS Version 9: Utilities Reference: System</i> . For details on defining the partition selection exit using the HALDB PDU see “HALDB Interfaces”, <i>IMS Version 9: Application Programming: Database Manager</i> . For details on coding the parameter PARTSEL see: “INIT Commands”, <i>IMS Version 9: Database Recovery Control (DBRC) Guide and Reference</i> .
Binding	Follow the guidelines described in “Binding the Routines” on page 7. After you compile and test your exit routine, bind it into IMS.SDFSRESL, SYS1.LINKLIB, or any operating system partitioned data set that can be accessed by a JOBLIB or STEPLIB JCL statement for the IMS control and SAS regions.
Including the routine	No special steps are needed to include this routine.

Table 21. HALDB Partition Selection Exit Routine Attributes (continued)

Attribute	Description
IMS callable services	This exit is not eligible to use IMS Callable Services.
Sample routine location	IMS.ADFSSMPL.

Calling the Routine

IMS loads this routine at IMS initialization time.

The HALDB Partition Selection exit routine receives control during HALDB Partition Structure processing and when a DL/I call requires the selection of a partition. The following processing activities activate the HALDB Partition Selection exit routine:

- Structure initialization
- Structure termination
- Structure modification
- Selection of first partition
- Selection of next partition
- Selection of target partition

IMS calls a HALDB Partition Selection exit routine when an exit routine is specified for the database. When a HALDB structure is created, modified, or terminated, this call to the exit routine allows your installation to be aware of the partitioned structure and to have some influence on its validity for subsequent DL/I processing. The initialization call that indicates that a structure was created occurs prior to authorizing and opening the partition data sets.

Addressing Mode

The DL/I environment that is running determines the addressing mode when the HALDB Partition Selection exit routine is called. The addressing modes for the calls are as follows:

Call	Mode in Batch Environment	Mode in Online Environment
Structure Initialization	Task Mode	Task Mode
Structure Termination	Task Mode	Task Mode
Partition Selection	Task Mode	Cross Memory Mode

Communicating with IMS

IMS communicates with the HALDB Partition Selection exit routine through the entry registers.

Contents of Registers on Entry

The HALDB Partition Selection exit routine is called with the following registers established:

Register	Contents
1	Specifies the address of the parameter list that identifies the call. The parameters are: <ol style="list-style-type: none"> 1 Address of a full word that contains the number of parameters in the list. The value of 2 is specified.

	2	Address of the Exit Communication Area that is mapped by DFSPECA.
	3	Address of the Partition Definition Area that is mapped by DFSPDA.
	13	Specifies the address of a standard save area. Four pre-chained save areas are provided for this exit routine to use.
	14	Specifies the return address to IMS.
	15	Specifies the exit entry point address.

Area Mapping

DFSPECA	Partition Exit Communication Area Mapping. Dynamically initialized from static storage.
DFSPDA	Partition Definition Area Mapping. Allocated and initialized during structure initialization.

Related Reading: For more information on area mapping, see “Using the Exit Interface Area Mapping” on page 94.

Contents of Registers on Exit

The HALDB Partition Selection exit routine is involved in the processing of partition structure initialization, termination, rebuild, and partition selection. The exit routine can identify some processing and structure conditions as errors, according to your specifications. The exit routine informs IMS of the response to the error condition by specifying a return code. The return code is returned in field PECRC of the Partition Exit Communication Area (DFSPECA). The action that IMS takes depends on both the return code that is supplied by the exit routine and the call reason for invoking the exit routine. The exit routine can request IMS to stop the database or issue a pseudo abend. The following return codes can be sent to IMS:

Return Code	Description
0	Normal return. No exception processing required.
4	Abnormal return. IMS can stop the database during partition structure calls.
8	Pseudo abend return. IMS issues user abend 3499.
12	Exception return. No more partitions are available for Select Next processing. IMS treats this condition as the end of the HALDB.

Depending on the call reason and call history, IMS takes certain actions when return code 12 is received from the HALDB Partition Selection exit routine. The rules are as follows:

1. When the exit routine is called for partition structure initialization, termination, or modification (rebuild), the return codes can be 0, 4, or 8. A return code of 12 or above is not supported. Return code from Partition Structure Termination (PECTERM) call will be ignored by IMS if it is 0, 4, or 8 (12 and above are not supported). IMS will proceed to terminate the structure in all cases when the return code is 0, 4, or 8 for the PECTERM call.
2. When the exit routine is called for partition selection, return codes 0, 4, 8, and 12 are supported. If the partition selection is “Select Next”, return code 12 from

the exit routine indicates that no partitions are available. If the partition selection is "Select Target" or "Select First", return code 12 indicates a request for ABEND 3499.

- When the exit routine is called for any partition selection, a check is made to see whether any prior call from the Partition Structure Initialization, Termination, and Rebuild has resulted in a pending request for ABEND 3499. If such a request has been made, ABEND 3499 is issued.

IMS does not interrogate a return code from the exit routine that is provided for the Partition Termination invocation function.

Using the Sample Partition Selection Exit Routine (DFSPSE00)

You can develop a HALDB Partition Selection exit routine or use the sample HALDB Partition Selection exit routine (DFSPSE00) that IMS provides. DFSPSE00 contains code that supports Structure Initialization, Structure Termination, Structure Modification and Partition Selection calls. Be aware that the actual partition selection processing in the sample DFSPSE00 is based on a high key value and not a user defined "string" value. The sample exit is written in assembler language and located in the IMS Sample library.

The sample exit routine demonstrates the use of the interface and control blocks. The sample exit performs partition selection processing by using partition high key.

Using the Exit Interface Area Mapping

This section provides details on the information included in the DFSPECA and DFSPDA.

Partition Exit Communication Area Mapping (DFSPECA)

The DFSPECA storage area is dynamically initialized from static storage for each invocation of the HALDB Partition Selection exit routine. The DFSPECA DSECT can be obtained by assembling DFSPSEIB.

DFSPECA Field Definitions:

Field	Description
PECDBN	The name of the HALDB.
PECRSWD1	Not used; the contents are unpredictable.
PECRC	Return code indicating the result of exit processing.
PECFDB	Exit feedback area consisting of two halfword fields. The exit returns the partition ID of the partition selected in field PECFDB2.
PECKEY	Address of the key associated with the DL/I call.
PECCPID	Current Partition ID. The partition ID of the last partition selected.
PECKEYL	The length of the key minus 1.
PECACT	The invocation action informing the exit what processing is required.
PECFLAG1	IMS control data flag. Defines additional information for exit processing.

- PEC1NEWP** A flag indicating that one or more new partitions were added to the HALDB structure. To indicate that the entry defines a partition that was not previously defined, set flag PDAFLAG1 to PDAF101 in each related PDA entry. Set the flag for the exit REBUILD call and then reset.
- PECFLAG2** Flag byte available for exit use.
- Note:** The user exit can set PECFLAG2 to any value, but that value is not preserved across calls to the exit routine.
- PECVRSN** The PECVRSN will contain a halfword value set by IMS before invoking the user's partition selection exit. It will be set to the value of PECURVER. A user exit can check the version number in PECVRSN with the constant PECURVER to ensure it is using the same or higher version of the DFSPECA control block passed by IMS. If the PECVRSN value is less than PECURVER value there is a mismatch, since the exit has been compiled with a higher version of the DFSPECA than the one used by IMS.
- PECUSER** Dynamic work area for exit use. This work area storage is not preserved across calls to the exit routine.
- Note:** The user exit can use the DYNAMIC USER WORK AREA during the execution of a single call, but the area is meant to be used as a volatile work area so its content should not be assumed to still be there the next time the exit is called.

Partition Definition Area Mapping (DFSPDA)

The DFSPDA storage area is allocated and initialized during structure initialization. DFSPDA storage area is maintained until the structure changes. Any structure change causes the storage to be released and a new area allocated and initialized. Each invocation of the HALDB Partition Selection exit routine passes the DFSPDA area. The DFSPDA DSECT can be obtained by assembling DFSPSEIB.

DFSPDA Field Definitions

- PDAPDE** The address of the first partition definition entry.
- PDANUM** The number of DFSPDA entries.
- PDARSWD1** Not used; the contents are unpredictable.
- PDALSTRL** The length of the longest string that is defined for the partitions.
- PDADORG** The database organization: PHDAM, PHIDAM, or PSINDEX.
- PDAUSRn** Five words that are available for exit use (PDAUSR1, PDAUSR2, PDAUSR3, PDAUSR4, and PDAUSR5).
- The exit routine can use these words to anchor storage that has been allocated by the exit and these values will be available for use the next time the exit is called. The exit can also issue GETMAIN/FREEMAIN.
- PDAPLEN** The length of the Partition Definition Area Prefix.

DFSPDAE Field Definitions

- PDAPN** The name of the associated partition.
- PDASTRG** The address of the user-defined Partition String value. If PDASTRG is zero, it indicates a null Partition String. This 256-byte area

contains the string value that you define. You can modify this area during Structure Initialization processing to assist in selection processing.

PDAPID	The partition ID of the associated partition.
PDARAP	The number of Root Anchor Points defined for the partition. Provided for PHDAM organization only; otherwise, it contains zeros.
PDABLK	The number of blocks containing Root Anchor Points. Provided for PHDAM organization only; otherwise, it contains zeros.
PDASTRGL	The length of the user string minus 1.
PDAFLAG1	IMS control data flag. Defines unique PDA entry information for exit processing.
PDAF101	A flag indicating that this PDA entry defines a new partition that was not previously defined. Set PDAF101 to be PDAF101 on entry to the exit routine for the Rebuild call if this partition is new, and reset upon returning to IMS.
PDAELEN	The length of the Partition Definition Area Entry. Length added to the entry address to provide the address of the next entry.

Chapter 8. HDAM and PHDAM Randomizing Routines (DFSHDC40)

This chapter describes the HDAM and PHDAM randomizing routines. The chapter provides information about the attributes of the routines, how the routines are called, and how the routines communicate with IMS.

The following topics provide additional information:

“About These Routines”

“Communicating with IMS” on page 99

“Using the Sample HDAM and PHDAM Generalized Randomizing Routine (DFSHDC40)” on page 101

About These Routines

The DL/I HDAM and PHDAM access method requires you to supply a randomizing module for placing root segments in, or retrieving them from, an HDAM and PHDAM database. Several databases can share the same routine, but each of those databases must be associated with a single randomizing routine. If you are using data sharing, you must use the same randomizing routine for both systems.

A randomizing module uses a mathematical technique to convert a key into an address. The same key always converts to the same address. The randomizing module required by IMS must convert a key field value into a relative block number and an anchor point number. The result of a randomizing routine is a relative block number that ranges from 1 to $2^{24}-1$. The anchor point number ranges from 1 to 255.

The key field value is supplied by an application program in the data itself for inserting segments into the database and in an application program in an SSA (segment search argument) for retrieving segments from a database.

Four randomizing modules are supplied with IMS. Although four are supplied, DFSHDC40 is the only one recommended for use. You can use this one or write your own randomizing module.

Related Reading: To help you determine the module that best meets your need, see *IMS Version 9: Administration Guide: Database Manager*.

If you write your own module, follow the guidelines included in this chapter.

Attributes of the Routine

Table 22 shows the attributes of the HDAM and PHDAM Randomizing routine.

Table 22. HDAM and PHDAM Randomizing Routine Attributes

Attribute	Description
IMS environments	DB/DC and DBCTL.

HDAM and PHDAM Randomizing Routines

Table 22. HDAM and PHDAM Randomizing Routine Attributes (continued)

Attribute	Description
Naming convention	The name you give to the load module used for randomizing functions with a specific database must appear in the DBD generation associated with the database. The load module name must be the value of the “mod” parameter of the RMNAME= operand on the DBD statement in the HDAM and PHDAM DBD generation. Related Reading: For details on coding this parameter, see “DBD Generation”, in <i>IMS Version 9: Utilities Reference: Database and Transaction Manager</i> .
Link editing	After you compile and test a randomizing module, bind it into IMS.SDFSRESL, SYS1.LINKLIB, or into any operating system partitioned data set that can be accessed by a JOBLIB or STEPLIB JCL statement for the IMS control, SAS, and batch regions. To ensure that the routines run as they did in prior IMS releases, bind them as neither reentrant nor reusable.
Including the routine	No special steps are needed to include this routine.
IMS callable services	This exit routine is not eligible to use IMS Callable Services.
Sample routine location	For the latest version of the sample routine (DFSHDC40), see IMS.ADFSSRC; member name is DFSHDC40.

You must write, compile, and bind the randomizing module as one of the following:

REENTRANT

IMS does not serialize the database before calling the routine. A single copy of the routine is used for the databases.

REUSABLE

IMS serializes the database before calling the routine. If the routine is used for multiple databases, it must be written and compiled as reentrant, even if it is not bound as reentrant.

NONREUSE

IMS serializes the database before calling the routine. Each database has its own copy of the routine.

All modules receive control and must return control in 31-bit addressing mode. They must be able to execute in cross-memory and TASK modes.

Loading the Routine

IMS loads all randomizing modules from their resident library when the database is opened. IMS obtains the name of the randomizing module from the name you have specified in the RMNAME parameter of the DBD statement of the database description (DBD).

Related Reading: For details on coding the RMNAME parameter, see *IMS Version 9: Utilities Reference: Database and Transaction Manager*.

The necessary randomizing module associated with a specific database is brought into main storage at the time the associated database is opened. It can also be placed in the LPA (linkpack area). This allows one copy of the module to service several databases that are concurrently open.

If you use any of the Local Storage Options (LSO), the randomizing module is loaded in CTL or DL/I SAS private storage. Otherwise, the module is loaded into CSA.

Related Reading: For more information about general guidelines, see Chapter 1, “Guidelines for Writing IMS exit routines,” on page 3.

Calling the Routine

When an application program issues a Get Unique or Insert call that operates on a root segment of an HDAM and PHDAM database, the randomizing module is called.

The source of the root key that IMS supplies to the randomizing routine is as follows:

- For a root insert, IMS takes the key from the I/O area containing the root to be inserted.
- For a call qualified on the root key, IMS uses the key value in the segment search argument.

Related Reading: For information on processing Get Next (GN) calls qualified on the root key and calls with root qualification that allows a range of key values, see *IMS Version 9: Application Programming: Database Manager*.

The key is supplied to the randomizing module for conversion to a relative block number and anchor point number within the database. In addition to the key supplied by an application program, parameters from the DBD generation for the database are available to the randomizing module.

Communicating with IMS

IMS uses the entry and exit registers to communicate with the randomizing routine.

Contents of Registers on Entry

Upon entry, the randomizing routine must save all registers using the provided save area. The registers contain the following:

Register	Content
0	Address of Data Management Block (DMB).
1	Address of the DMBDACS CSECT.
7	Address of Partition Specification Table (PST).
9	Address of first byte of key field value supplied by an application program.
13	Address of save area. The exit routine must not change the first three words.
14	Return to IMS address.
15	Entry point of randomizing module.

If an HDAM and PHDAM database does not have a sequence field defined:

- The executable key length field in the CSECT named RDMVTAB is not initialized and must not be used.
- The value in register 9 module contains the address of the first byte of the segment.

HDAM and PHDAM Randomizing Routines

If an HDAM and PHDAM database does not have a sequence field defined at the root level, the randomizing module is given control on an insert call. All retrieval calls result in a scan of the root-level qualification. On Get Unique (GU) calls, the scan starts at the beginning of the database. On Get Next (GN) calls, the scan starts at the current root-level position within the database.

The randomizing module is invoked on Get calls, particularly when the database contains a secondary index or a logical relationship. The randomizing module must produce the same results on the Get call as it did on the Insert call.

The first eight words of the PST are available to the randomizing module as a work area. These words are also used by DL/I and must not be used by other exit routines. If an additional work area is needed, CSECT RDMVTAB can be expanded to provide additional space.

Internal IMS control blocks that can be of value to a randomizing routine are the Partition Specification Table (PST), the Physical Segment Description Block (PSDB) for the root segment, and the first Field Description Block (FDB). The FDB is the root segment key field format description.

Description of Parameters

The parameters from DBD generation are available to randomizing modules. Their area is described by the DMBDACS DSECT. It contains information such as the randomizing routine's name, anchor point information, and the total area length. You can extend the area by an assembly and bind process to contain any data or algorithm information.

The root 32 bytes of the RDMVTAB CSECT (described by the DMBDACS DSECT) contains constants defined by DBDGEN. If you extend the area to include additional parameters, this field must be duplicated. The DMBDASZE field must be updated to reflect the total length of this area (including the added parameters).

After assembly, you can bind the expanded RDMVTAB CSECT to replace the old one. Use an ENTRY statement specifying the name of the DBD and an ORDER statement to make sure the original order of the multiple CSECTs is maintained. For more information, see information on the z/OS binder and loader in the z/OS product library.

The following DSECT defines the format of the area pointed to by register 1:

DMBDACS	DSECT		
DMBDANME	DS	CL8	NAME OF ADDR ALGORITHM LOAD MODULE
DMBDAKL	DS	CL1	EXECUTABLE KEY LENGTH OF ROOT
	DS	CL3	
DMBDASZE	DS	H	SIZE OF THIS CSECT
DMBDARAP	DS	H	NUMBER OF ROOT ANCHOR POINTS/BLOCK
DMBDABLK	DS	F	NUM OF HIGHEST BLOCK DIRECTLY ADDRSD
DMBDABYM	DS	F	MAX NUMBER OF BYTES BEFORE OFLOW TO 2NDARY
DMBDARC	DS	CL1	RETURN CODE FROM RANDOMIZER
	DS	CL3	RESERVED
DMBDACP	DS	F	RESULT OF LAST ADDRESS CONVERSION

Contents of Registers on Exit

Before returning to IMS, the randomizing routine must restore all registers. The parameter list pointed to by register 1 and discussed in "Description of Parameters" can contain one of the following return codes:

Return Code	Meaning
0	Continue processing; randomizing properly.
4	Set FM status code and return to caller.
8	U812 abend.

For any randomizing routine that passes these return codes, ensure that application programs that use the database can accept the return codes.

The return code from a randomizing module can be in either character or binary form. In other words, X'F0' and X'0' are both valid for a return code of zero. This return code must be placed in the DMBDARC field of the CSECT addressed by register 1.

You do not need to explicitly set a return code of zero in DMBDARC, because it is the default return code and the field is preset to zero.

Results of the Routine on Exit

The result of a randomizing module conversion must be in the form *BBBB* where *BBB* is a 3-byte binary number of the block into which a root segment is inserted or from which it is retrieved and *R* is a 1-byte binary number of the appropriate anchor point, within a relative block, within a data set of the database.

This result must be placed in the CSECT addressed by register 1 in the 4-byte fixed name DMBDACP. If the result exceeds the content of the field DMBDABLK, the result is changed to the highest block and last anchor point of that block.

Sample HDAM and PHDAM Randomizing Routines

IMS supplies four randomizing module samples (DFSHDC10, DFSHDC20, DFSHDC30, and DFSHDC40) to help you write your own HDAM and PHDAM randomizing module. The modules are linked into the IMS.SDFSRESL data set during system definition. The modules use the following randomizing techniques:

- Modular or division method (DFSHDC10)
- Binary halving method (DFSHDC20)
- Hashing method (DFSHDC30 and DFSHDC40)

Module DFSHDC40 is recommended; the source code for all four modules resides in the IMS.SOURCE library. The next section provides guidelines for using the sample module, DFSHDC40.

Restriction: These routines do not support nonsequenced HDAM and PHDAM databases. They all use the key length in their calculations.

Using the Sample HDAM and PHDAM Generalized Randomizing Routine (DFSHDC40)

If root keys are unique and totally random storage is desired, this routine can be used for **any** HDAM and PHDAM database without performing an analysis of key distributions.

This randomizing routine works with the entire key and has the following characteristics:

- It is reentrant.

DFSHDC40

- Keys can contain any of the 256 characters, and key length can be from 1 to 256 bytes.
- It converts **any** key distribution (with unique key values) to a totally random address distribution.
- It never returns an address in block 1, which is always a bit map block in HDAM and PHDAM. The user can specify any number of blocks and RAPs.
- The number of blocks must be in the range between 2 and $(2^{24})-1$; the number of RAPs must be in the range of 2 to $(2^{31})-1$ when RAPs are multiplied by blocks. The RBN subparameter of the RMNAME= parameter of the DBD statement must be specified for the upper limit, together with DFSHDC40 as the “mod” subparameter, if this randomizing routine is chosen.
- It allows the insertion of a dummy root at the highest block-RAP to ensure the formatting of the entire root addressable area at load time.

The basic logic of the routine is:

1. Convert the key into a 4-byte binary number by translating the key digits twice. Determine the offset into the translation table using the key length and individual digits. For example:

Key 123456

Digits are used in series of threes. Two work areas are used. In the first pass, the first work area contains X'F2F3'; the second contains X'F1F2F3'.

The first work area is translated into the translation table with a zero point of 4 (key length 2). The second work area is translated into the translation table with a zero point of X'F5', the fifth digit. These two translated numbers are multiplied and added into an accumulator. The remaining digits are converted and added into the accumulator.

The conversion number for key 123456 is X'45683199'.

2. Translate the converted number, and set the top bit to zero to ensure a positive number.
3. Multiply the maximum number of blocks minus one by the number of RAPs. Multiply the result by the translated key.
4. After adjustment to ensure block 1 is not used, store the result in DMBDACP.

For the latest version of DFSHDC40 see the IMS.SOURCE library; member name is DFSHDC40).

Chapter 9. Secondary Index Database Maintenance Exit Routine

This chapter describes the Secondary Index Database Maintenance exit routine. It provides information about the attributes of the routine, how the routine is called, and how the routine communicates with IMS.

In this Chapter:

“About This Routine”

“Communicating with IMS” on page 105

“Sample Secondary Index Database Maintenance Exit Routine” on page 106

About This Routine

Two options are available to the Database Manager to control the volume of entries in secondary index databases: the NULLVAL operand and the index maintenance exit routine. To build and maintain a sparse index, you can use suppression of indexing, the process of withholding a prospective index pointer segment from the index.

Use the NULLVAL operand to suppress indexing when the entire indexed field contains one specified character or value. For example, you might want to use NULLVAL to suppress indexing when the indexed field contains only blanks. A different NULLVAL can be specified for each indexed segment.

Alternatively, secondary indexing allows you to specify, during the DBDGEN, a user-supplied exit routine that can selectively suppress secondary indexing. You can thereby control the density of a secondary index. One exit routine is allowed for every secondary index; however, one generalized routine can be written to serve several index relationships.

If you bind this exit routine as reentrant (RENT), it must be truly reentrant (it cannot depend on **any** information from a previous invocation and it cannot store into itself).

If you bind this exit routine as reusable (REUSE), it must be truly reusable (it cannot depend on **any** information in itself from a previous call), but it can depend on information that it saves in the specific database segment block that is passed to it. In addition, if the same exit routine is used for two different segments, the single copy of the exit can be called concurrently for each segment. In this case, the exit routine must be written as reentrant.

If you bind this exit routine so that it is neither RENT nor REUSE, it can store into itself and depend on the information saved in the database segment block that is passed to it.

Table 23 shows the attributes of the Secondary Index Database Maintenance exit routine.

Table 23. Secondary Index Database Maintenance Exit Routine Attributes

Attribute	Description
IMS environments	DB/DC, DBCTL.

Secondary Index

Table 23. Secondary Index Database Maintenance Exit Routine Attributes (continued)

Attribute	Description
Naming convention	<p>Each exit routine must have a name unique with respect to all IMS module names and to any other exit routines in the IMS libraries. The name corresponds to the name specified in the EXTRTN subparameter, in the XDFLD statement, for the DBD generation.</p> <p>Related Reading: For details about this subparameter, see the section on DBD generation in <i>IMS Version 9: Utilities Reference: System</i>.</p> <p>Before an index source segment in a database can be loaded or updated, its EXTRTN routine must be in the system library.</p>
Link editing	<p>Follow the guidelines described in “Binding the Routines” on page 7.</p> <p>After an exit routine has been compiled and tested, it can be placed into the IMS.SDFSRESL data set, from which it is loaded by IMS. It can also be placed in SYS1.LINKLIB, or in any operating system partitioned data set to which access is provided with a JOBLIB or STEPLIB JCL statement.</p>
Including the routine	No special steps are need to include this routine.
IMS callable services	This exit routine is not eligible to use IMS Callable Services.
Sample routine location	Refer to “Sample Secondary Index Database Maintenance Exit Routine” on page 106.

Loading the Routine

The first time that an exit routine associated with the specific database is referenced, it is loaded into storage in either the IMS online control program region or batch processing region when the associated database is opened. The loaded routine will be used by any other databases that require the same exit routine. This allows one copy of the module to service several databases that are open concurrently. The routine is not refreshed during the current IMS execution.

When an index maintenance exit routine is used in either the IMS online control region or a DL/I batch processing region and the exit routine does not exist in LINKPACK, you must provide space in the IMS control region or in the DL/I separate address space (DLISAS) to accommodate the exit routines that can be used for online databases.

Calling the Routine

When an application program issues a REPL, ISRT, or DLET call of a segment serving as an index source segment for one or more indexing relationships, the DL/I index maintenance routine is invoked.

DLET Call

In the case of DLET, an indexing segment is built corresponding to the existing index source segment. If it passes the null value test, the index exit routine is invoked. This routine indicates whether this indexing segment should appear in the index. If it should appear, the actual indexing segment is retrieved and deleted; otherwise, no delete is attempted.

ISRT Call

In the case of ISRT, the indexing segment is built to correspond to the segment to be inserted, and the null value test and the exit routine tests are performed. If no suppression of indexing is indicated by either, it is inserted into the index.

REPL Call

A REPL call can be a combination of a DLET call and an ISRT call, a simple replace, or a NOP, depending on the fields changed in the replace. If a field in the Index Source Segment (ISS) is changed by a REPL call that changes the indexed data or subsequent data, the existing indexing segment is deleted and a new one inserted. The index edit routine is invoked for each operation. If the change in the ISS affects a source data field, a replace operation on the indexing segment is executed, unless the index exit routine indicated that indexing was suppressed. If the ISS replace made no changes in the indexing segment, no action is taken.

The suppression of indexing by the exit routine must be consistent. The same indexing segment cannot be examined at two different times and have suppression indicated only once. If the indexing segment contains user data, this user data cannot be used to evaluate suppression, since the actual indexing segment is seen by the exit routine just before the insertion of a new one. In the cases of replace and delete, only a prototype is passed. The prototype contains the constant, indexed data, subsequence data, duplicate data, and any symbolic pointer that was added. Therefore, index suppression must not be based on any user data.

Parameters to be passed to the index routine are indicated in “Description of Parameters” on page 106. By issuing a return code, the exit routine indicates either that the present index pointer segment belongs in the index or that it should be suppressed. The exit routine must not change any IMS control blocks, or any fields in the indexing segment.

You can include additional information about the segment in the exit routine CSECT. This CSECT is part of the DBD, and as such can be replaced by a bind. It is of variable-length and contains a fixed-format header. A separate CSECT is provided for each XDFLD in the DBD for which an exit routine is specified. The availability of this CSECT is described in the exit routine specifications. You can replace this control section in the same manner as you can the segment compression control section.

For additional information about the segment edit/compression control section, see the “Description of Parameters” on page 117.

Communicating with IMS

IMS communicates with the exit routine through the entry and exit registers.

Contents of Registers on Entry

Upon entry, the exit routine must save all registers using the provided save area. The registers contain the following:

Register	Contents
1	Address of Partition Specification Table (PST).
2	Address of proposed or existing index segment.
3	Address of Index Maintenance Routine Parameters CSECT.
4	Address of Index Source Segment.
13	Address of save area. The exit routine must not change the first three words.
14	Return address to IMS.
15	Entry point of exit routine.

Secondary Index

Description of Parameters

Upon entry to the routine, IMS passes the address of the CSECT shown in Figure 16.

0	Indexed Segment Name	
8	Indexed Field (XDFLD) Name	
16	Indexed Maintenance Exit Routine Name	
24	Entry Point Address	
28	CSECT Length	RSVD
32	User Data	

Figure 16. Index Maintenance Exit Routine Parameter List CSECT

The following DSECT defines the format of this CSECT:

DMBXMPRM	DSECT		
DMBXMSGN	DS	CL8	Name of indexed segment
DMBXMNDN	DS	CL8	Name of indexed field
DMBXMNM	DS	CL8	Name of exit routine
DMBXMNEP	DS	A	Entry point addr
DMBXMLN	DS	H	Total length of CSECT
	DS	H	Not Used

Contents of Registers on Exit

Before returning to IMS, the exit routine must restore all registers except register 15, which contains one of the following return codes:

Return Code	Meaning
-------------	---------

0	The indexing segment should appear in the index for this database segment.
4	Indexing should be suppressed.

Sample Secondary Index Database Maintenance Exit Routine

The sample in Figure 17 on page 107 is **not** a usable exit routine provided by IMS, nor is it found in the IMS.ADFSSRC library. It is an example showing entry and exit code to help you write your own routine.

```

SAMPLE  TITLE 'SAMPLE OF SECONDARY INDEX EXIT ROUTINE'
* * * * *
*
* SAMPLE OF SECONDARY INDEX DATA BASE MAINTENANCE EXIT ROUTINE
*
* THIS SAMPLE IS NOT INTENDED TO BE A USABLE EXIT ROUTINE.
* IT IS PROVIDED HERE TO SHOW ENTRY AND EXIT CODE.
* THIS SAMPLE SUPPRESSES THE INDEX ENTRY IF ALL BYTES OF THE
* INDEX KEY ARE BLANK.
*
*
*   REGISTERS ON ENTRY
*   R1 - PARTITION SPECIFICATION TABLE (PST) ADDRESS
*   R2 - ADDRESS OF (PROPOSED OR EXISTING) INDEX SEGMENT
*   R3 - ADDRESS OF INDEX MAINTENANCE ROUTINE PARMS CSECT
*   R4 - ADDRESS OF INDEX SOURCE SEGMENT
*   R13 - SAVE AREA ADDRESS
*   R14 - RETURN ADDRESS
*   R15 - ENTRY ADDRESS
*
*   REGISTERS ON EXIT
*   R15 - 0 TO NOT SUPPRESS THE INDEX ENTRY
*         - 4 TO SUPPRESS THE INDEX ENTRY
*   R0 THRU R13 ARE RESTORED
*
* * * * *
      SPACE 1
INDEXXIT CSECT
      STM  R14,R12,12(R13) SAVE REGISTERS 14 THRU 12
      L    R13,8(R13)     SET 13 TO NEXT IMS PRE-CHAINED SAVE SET
      LR   R12,R15        SET 12 AS BASE
      USING INDEXXIT,R12  USE R12 AS BASE FOR PROGRAM
      USING PST,R1        USE R1 AS BASE FOR PST
      USING XRECORD,R2    USE R2 AS BASE FOR INDEX RECORD
      USING DMBXMPRM,R3   USE R3 AS BASE FOR INDEX CSECT
      USING XSOURCE,R4    USE R4 AS BASE FOR INDEX SOURCE SEGMENT
      SPACE 2
* * * * *
*
* LOGIC SHOULD BE PROVIDED HERE TO DECIDE WHETHER THE INDEX RECORD
* SHOULD BE SUPPRESSED.
*
* THE FOLLOWING CODE WILL TEST WHETHER THE KEY OF THE INDEX
* RECORD IS ALL BLANK. IF THE FIELD IS ALL BLANK, THE INDEX ENTRY
* WILL BE SUPPRESSED.
*
* * * * *
      SPACE 1
      CLC  XFIELD1,BLANKS IS FIELD BLANK
      BE   SUPPRESS      YES, SUPPRESS INDEX FOR FIELD
      B    NOSUPP        NO, ALLOW INDEX FOR FIELD
      SPACE 2
* * * * *
*
* SUPPRESS RETURN, SET 4 IN R15 TO TELL IMS TO SUPPRESS THE ENTRY
*
* * * * *
      SPACE 1
SUPPRESS DS  0H
      L    R13,4(R13)     BACK UP TO PRIOR SAVE AREA
      RETURN (14,12),RC=4 RETURN WITH 4 IN R15
      SPACE 2
* * * * *
*
* NORMAL RETURN, SET 0 IN R15 TO TELL IMS TO NOT SUPPRESS THE INDEX
*

```

Figure 17. Secondary Index Database Maintenance Exit Routine Example (Part 1 of 2)

Secondary Index

```

*
* * * * *
SPACE 1
NOSUPP DS 0H
L R13,4(R13) BACK UP TO PRIOR SAVE AREA
RETURN (14,12),RC=0 RETURN WITH 0 IN R15
SPACE 2
BLANKS DC CL255' ' CONSTANT OF 255 BLANKS
SPACE 2
* * * * *
*
* GENERATE DSECT FOR THE INDEX RECORD
*
* * * * *
SPACE 1
XRECORD DSECT
XFIELD1 DS CL5
SPACE 2
* * * * *
*
* GENERATE DSECT FOR THE INDEX SOURCE SEGMENT
*
* * * * *
SPACE 1
XSOURCE DSECT DSECT FOR INDEX SOURCE SEGMENT
XSFIELD1 DS CL5 FIELD 1 OF INDEX SOURCE SEGMENT
SPACE 2
* * * * *
*
* DSECT FOR INDEX MAINTENANCE EXIT ROUTINE PARAMETER CSECT
*
* * * * *
SPACE 1
DMBXMPRM DSECT
DMBXMSGN DS CL8 NAME OF INDEXED SEGMENT
DMBXMNDN DS CL8 NAME OF INDEXED FIELD
DMBXMNM DS CL8 NAME OF USER EXIT ROUTINE
DMBXMKEP DS A EXIT ROUTINE ENTRY POINT ADDRESS
DMBXMPLN DS H TOTAL LENGTH OF CSECT
DS H NOT USED
DMBUSERD DS C START OF USER DATA IF ANY
SPACE 2
* * * * *
*
* GENERATE DSECT FOR THE IMS PST WHICH IS PASSED IN R1
*
* * * * *
SPACE 1
PRINT NOGEN
IDLI PSTBASE=0
PRINT GEN
SPACE 2
* * * * *
*
* GENERATE EQUATES FOR SYMBOLIC REGISTERS
*
* * * * *
SPACE 1
REQUATE
SPACE 2
END

```

Figure 17. Secondary Index Database Maintenance Exit Routine Example (Part 2 of 2)

Chapter 10. Segment Edit/Compression Exit Routine (DFSCMPX0)

This chapter describes the Segment Edit/Compression exit routine, its attributes, how to activate it, how the routine communicates with IMS, and the restrictions that apply. The chapter also provides a description of sample Segment Compression/Expansion modules.

In addition, Hardware Data Compression support and its implementation are explained in “Hardware Data Compression Support” on page 122.

In this Chapter:

“About This Routine”

“Communicating with IMS” on page 115

“Hardware Data Compression Support” on page 122

About This Routine

You can write a Segment Edit/Compression exit routine to compress and expand segments of data. Segment compression saves space and can result in reduced logging. You can write an exit routine to:

- Edit or compress both fixed- and variable-length segments
- Accomplish either data edit/compression (DEDBs or full-function databases) or key edit/compression (full-function databases only).

If you write your own exit routine, you can also allow for editing, such as encoding and decoding segments for security purposes, and for validating and formatting data. The logic for data encoding and decoding (or for other desired editing or formatting) can be based on information contained within the user-written routine itself. It also can be based on information from an external source, such as data provided in the DBD block, or from tables examined at execution time.

Segment compression is possible for either full-function databases or data entry databases (DEDBs). Either routine (DFSCMPX0 or DFSKMPX0) can be used.

Recommendation: Use DFSCMPX0, because it uses z/OS services.

You can apply the same exit routine to multiple segment types within the same or different databases.

The Segment Edit/Compression exit routine is optional. No default routine is called. The sample exit routines only perform segment compression and expansion. The exit routines should be implemented by those having overall systems or database responsibility for an installation. These routines should be transparent to the application programs that access the databases.

Related Reading: For a list of the specific full-function databases that are supported and for additional guidance-level information, see *IMS Version 9: Administration Guide: Database Manager*.

Restriction: The DEDB Sequential Dependent Scan utility (DBFUMSC0) provides support for SDEP segment decompression only if the EXPANDSEG command is specified.

Related Reading: For details on coding the EXPANDSEG command, see *IMS Version 9: Utilities Reference: Database and Transaction Manager*.

Table 24 shows the attributes of the Segment Edit/Compression exit routine.

Table 24. Segment Edit/Compression Exit Routine Attributes

Attribute	Description
IMS environments	All environments that support databases.
Naming convention	According to user's naming convention.
Link editing	After an edit routine has been compiled and tested and before it is used by the IMS system, it must be placed into IMS.SDFSRESL, SYS1.LINKLIB, or into any operating system partitioned data set to which access is provided with a JOBLIB or STEPLIB control region JCL statement. You must also specify one entry point to the exit routine.
Including the routine	Routine is specified in the SEGM macro for the DBDGEN.
IMS callable services	To use IMS Callable Services with this routine, you must do the following: <ul style="list-style-type: none"> • Issue an initialization call (DFSCSI0) to obtain the callable service token and a parameter list in which to build the function-specific parameter list for the desired Callable Service. For details on using the initialization call, see "Step 2. Initializing IMS Callable Services (DFSCSI0)" on page 14. • Use the PST address found in register 1 as the ECB. • Link DFSCSI00 with your user exit.
Sample routine location	IMS.ADFSSRC.

Attributes of the Routine

The following are attributes of the Segment Compression/Edit exit routine.

Minimum Authorization

Supervisor state in key 7.

APF Authorization

Must reside in either in IMS.RESLIB, SYS1.LINKLIB, or in an authorized PDS library specified in JOBLIB or STEPLIB. It can also reside in any library specified in LNKLSTxx of SYS1.PARMLIB. It can also be in SYS1.LPALIB only if the library is included in IEAAPFxx of SYS1.PARMLIB.

Cross Memory Mode

Exit can be entered in cross memory mode in the online environment but not in batch mode.

AMODE, RMODE

Exit resides in 24-bit and can only be entered in 24-bit only.

Handling Abnormal Conditions

Any error conditions returned by system services on compression/expansion are handled by DFSCMPX0, which sets Register 0 and Register 15 with abend code (2990) and reason code (see various reason codes in Table. 26) before returning to caller. However, the action modules normally pseudoabend the application with a U840.

The following attributes of the Segment Compression/Edit exit routine differ depending upon the type of database that uses the routine.

Full-Function Database

When used with full-function databases, this exit routine has no specific binding requirements. For information about guidelines, see “Binding the Routines” on page 7 in Chapter 1, “Guidelines for Writing IMS exit routines,” on page 3.

The exit routine is serialized if it is called at initialization. When the exit routine is subsequently called, it can depend on any information saved in its control block.

DEDB

If the Segment Edit/Compression exit routine is used with DEDBs, you must write it and bind it as reentrant. In addition, the exit routine is loaded during control region initialization rather than during the opening of a database (as with a full-function database).

Loading the Routine

Each time a database is opened, IMS examines each segment description to determine whether edit/compression has been specified for that segment type. If so, the exit routine is loaded from its resident library by IMS. IMS obtains the name of the routine from the COMPRTN= parameter of the SEGM statement of the DBD.

Note: An IMS restart is required to refresh the loaded exit routine with a new version.

Related Reading: For details on coding the COMPRTN= parameter, see *IMS Version 9: Utilities Reference: System*. Adequate storage for the edit/compression routine must be provided for both batch and online systems.

How the Segment Edit/Compression Facility Works

When a segment requiring editing or compression is accessed, IMS gives your edit routine control and provides it with the following information:

- Address of the data portion of the segment.
- Address of the segment work area.

Definition: Although the exit can be used for functions other than compression, from this point on the use of the term *compression* refers to the process of converting the segment from the application program form to the form written to external storage. The term *expansion* refers to the process of converting the segment from the external storage form to the application program form.

Two types of segments can be presented to the routine: fixed length segments, with a data length that is static and is reflected in control blocks; and variable-length segments, with its data length contained within a field in the first two bytes of the segment itself. While a routine dealing with a single-segment type normally does not need to recognize the differences, a more general purpose module involved with multiple segment types can obtain sufficient information to differentiate between them. This is done by examining data provided in the segment compression control section.

Segments being processed using the segment edit/compression facility are stored as variable-length segments in the database. Variable-length segments have a size field in the first two bytes of the data portion of the segment. This size field defines the length of the data portion of the segment. When segments are defined to the application program as fixed length, your routine must expand it to the fixed length

expected by the application program. In reverse, if the application program presents a fixed-length segment, your edit routine must add the size field to the compression segment. If the segment is a variable-length segment, it must update the size field with the correct segment length.

Example

Although your edit routine can modify the key fields in a segment, the segment's position in the database is determined by the original key field.

Example: If the key field of a segment type is based on last names and the database has segments for people named McIvor, Hurd, and Caldwell, these segments are maintained in alphabetic sequence—Caldwell, Hurd, and McIvor. Assume your edit routine encodes the names as follows:

```
Caldwell -----> 29665
Hurd      -----> 16552
McIvor    -----> 24938
```

The encoded value is put in the key field. However, the segments in the database remain in their original sequence (Caldwell, Hurd, McIvor) rather than in the numeric sequence of the encoded values (16552, 24938, 29665). Because segments in the database are maintained in their original sequence, application programs can issue GN calls and retrieve the correct segment even though segments are encoded. This is also true for secondary index fields contained in index source segments.

Using the DBD Table

The DBD control block has a table appended to it in the form of an assembler language CSECT. One CSECT is filled in for each segment type that specifies the use of the segment edit/compression facility. The CSECT contains basic information, such as the name of your edit routine and the name of the segment type. You can extend the CSECT to contain any editing parameters or criteria you want. In other words, some or all of the logic for editing a segment type can be put in the CSECT. You can perform different editing operations on different segment types with a single edit routine. If you do not want the log for editing a segment type in your edit program, any external source can provide it, not just the table in the DBD.

Related Reading: For information on the DBD control statement SEGM, see the section “SEGM Statement” in *IMS Version 9: Administration Guide: Database Manager*.

Activating the Routine

When the application program is activated and begins accessing segments, IMS interfaces with the Segment Compression/Edit exit routine as described in this section. In all cases, IMS passes an entry code to the exit routine. Your exit routine must examine this entry code to determine the function to be performed.

Activating the Routine for Compression

For compression, regardless of the format at the source address, the segment at the destination address must be in variable-length format. Figure 18 on page 113 shows the input (a fixed- or variable- length segment) in expanded format that is passed to the edit/compression routine and output (as a variable-length segment) in compressed format. The first data field of the destination segment is a 2-byte segment size field.

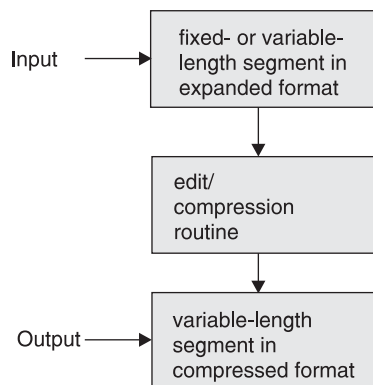

Figure 18. Segment Compression

Segment Length

If a fixed- or variable-length segment requires compression, and the data format is such that compression cannot take place, the addition of control information by your exit routine (indicating the segment could not be compressed) lengthens the segment beyond the maximum length definition. To allow for this expansion, and to allow IMS to check the validity of compression results, you can increase the size of your segment. You can increase the size of fixed-length segments by up to 10 bytes:

- For full-function fixed-length segments, you can increase the segment size by more than 10 bytes if the value for the COMPRTN= parameter of the DBD SEGM statement specifies more. You can increase the size of a full-function variable length segment up to the maximum defined size.
- You can increase the size of a DEDB variable length segment up to the maximum defined size plus 10 bytes, but it must not exceed 120 bytes less than the control interval (CI) size.

The length of the segment to be moved is provided in one of two places:

- If the segment length specified in the DBD is fixed, the source length is in the DMBCPSGL field.
- If the segment is defined as variable in length, the source length is provided as a binary value in the first two bytes at the source address.

In either case, the move operation provided by the edit/compression routine must result in a 2-byte length field, followed by the corresponding quantity of data in the segment work area.

IMS might pad a segment to a length greater than that created by your exit routine. IMS pads full-function variable-length segments to their minimum length. IMS pads full-function fixed-length segments to their pad length if it is specified on the COMPRTN= parameter of the DBD SEGM statement. IMS does not pad DEDB segments.

Activating the Routine for Expansion

For expansion, the input segment has a variable-length format. Figure 19 shows the input (a variable-length segment) in compressed format that is passed to the edit/compression routine and output (as a fixed- or variable- length segment) in expanded format.

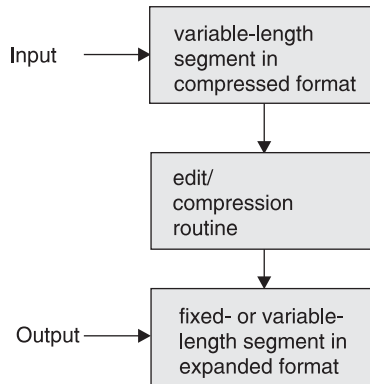

Figure 19. Segment Expansion

Entry Code Determination

For segment expansion that occurs during the segment retrieval process, IMS examines the application program request. If the request is satisfied by a compressed segment, a test is made to determine the type of compression used, either key or data. Then, depending upon the type of retrieval request, either entry code 4 or 8 is passed to the expansion routine. The following criteria are used as a basis for the decision:

- If the segment can be accepted without analysis of either a key or data field, control is transferred using entry code 4. The segment is expanded to the form presented to the user.
- If the value of the segment sequence field requires examination prior to segment selection, an additional check is performed to determine data or key compression. Data compression requires no additional processing, while key compression requires activation of entry code 8. If the segment is qualified for presentation after the key field is validated, IMS formats the segment using entry code 4 and passes it to the exit routine.
- If data field analysis is necessary to properly satisfy the DL/I call, proper expansion of the segment by entry code 4 occurs. When the correct segment is found, it is passed to the user.

The format of the segment presented through entry codes 4 and 8 of the compression routine is identical to that of a variable-length segment (a 2-byte segment size field followed by the appropriate quantity of data). The exit routine must expand the segment at the destination address in correct format, either fixed or variable-length. In the case of key compression, the exit routine must expand the segment from its start to the sequence field. For variable-length segments, the segment data length field, after processing by the key expansion, must reflect the length of the expanded portion of the segment at the destination address.

Using the Routine with Tabled Data Information

You have two options for processing tabled data information:

- Include the tabled data in the DBD module itself.
For each segment defined during DBDGEN as eligible for edit/compression, an entry is developed in an assembly language control section, described in "Description of Parameters" on page 117. This control section can be extended by assembling and binding it to contain any desired data or algorithm information.
- Load the tabled data when the exit routine is initialized.

Specifying INIT on the COMPRTN= parameter of the SEGM statement in the DBD causes the routine to be called for initialization processing. The routine can issue IMS Callable Services calls to provide functions equivalent to the LOAD/DELETE or GETMAIN/FREEMAIN macro instructions. These calls bring additional information into storage in the form of modules from IMS.SDFSRESL library. For example, the routine can maintain a table of substitution characters that is separate from the executable code. This table can reflect different combinations for different segments, resulting in a general purpose, table-driven routine capable of processing several segment types.

IMS provides two additional entry codes that allow you to process tabled data information. IMS calls a Segment Edit/Compression exit routine with these entry codes if you specify the INIT keyword on the COMPRTN= parameter of the SEGM statement. With these codes, IMS passes control to the initialization and termination subroutines immediately after the full-function database or DEDB area is opened, and immediately before the full-function database or DEDB area is closed. Any processing required for the database segments that cannot be directly related to any one segment can be done at this time using these options. Initialization processing and termination processing can include the loading and deleting of the compression algorithm table.

Code	Description
12	Initialization processing call. Control is obtained for algorithm initialization processing immediately after the full-function database or DEDB area is opened. Registers 2 and 3 are unpredictable.
16	Termination processing call. Control is obtained for algorithm termination processing immediately before the full-function database or DEDB area is closed. Registers 2 and 3 are unpredictable.

When control is passed to the exit routine as a result of these two entry codes, execution is not in cross-memory mode. For online systems, execution is in the control region address space or, if a DL/I separate address space is used (LSO=S), execution is in the DL/I separate address space.

Communicating with IMS

All IMS control blocks provided to the Segment Edit/Compression exit routine are for reference only; no data can be changed, including the segment at the source area address. The only modification allowed is the alteration of the segment during the move operation from the source to the destination address. DSECT addressability to the control blocks is provided by the IMS IDLI macro.

Contents of Registers on Entry

Upon entry to the exit routine, the registers contain the following:

Register	Contents
0	Set to zero before call to exit routine. Can contain Abend code U2990 upon return if the exit routine detected an error.
1	Address of the Partition Specification Table (PST).
2	Address of the first byte of the segment to be modified (source address).

Register	Contents
3	Address where the modified segment is returned (destination address). For DEDB segments, this area is 10 bytes larger than the maximum segment size. For full-function fixed-length segments, this area is 10 bytes larger than the maximum segment size, unless a larger size was specified in the DBD. For full-function variable-length segments, this area is the maximum segment size.
4	Address of the physical segment description block (PSDB). From this block, the field description blocks (FDB) can be located. (Register 4 is always zero when a DEDB is accessed by the exit routine, because the PSDB does not exist for DEDBs.)
5	Address of the Segment Edit/Compression control section.
6	Entry code (detailed in "Description of Entry Codes"): 0 Segment compression call 4 Entire segment expansion call 8 Partial segment expansion call (full-function databases only) 12 Full-function database or DEDB area open call 16 Full-function database or DEDB area close call
7	For DEDB only, the minimum length as coded in DBD (SDBLMIN). Register 7 is only valid for function code 0 (segment compression) and function code 4 (segment expansion).
13	Address of save area. The exit routine must not change the first three words.
14	Return address to IMS.
15	Entry point of exit routine.

Contents of Registers on Exit

Before returning to IMS, the exit routine must restore all registers.

Description of Entry Codes

The entry code that is passed to the exit routine in register 6 indicates the reason IMS called the exit routine. The five possible entry codes are described in the following sections.

Compressing and Expanding Segments

The following two entry codes are required for segment compression and expansion; they are used when you specify the DATA compression operand.

Code	Description
0	Segment compression call. The source address points to an uncompressed segment image as it appears in the application program input/output area.
4	Entire segment expansion call. The source address points to a compressed segment. Application program requests qualified on a data field require the use of entry code 4 for normal retrieval expansions.

To reduce the amount of processing overhead required with the movement of data, the following third entry is required when the KEY compression operand is used. The KEY operand is for use with full-function databases only. Key compression is not supported for DEDBs.

Code	Description
8	Partial segment expansion call with the KEY operand (full-function databases only). Expansion takes place from the start of the segment through the sequence field. This facility is required if you elect to use key compression, or if you compress any field that alters the starting position of the key field. All DL/I calls using sequence field qualification on key compressed segments require the use of this entry code.

Description of Parameters

The length of the segment to be moved is provided in one of two places:

1. If the segment length specified in the DBD is a fixed length, the source length is in the DMBCPSGL field.
2. If the segment is defined as variable in length, the source length is provided as a binary value in the first two bytes at the source address.

In either case, the move operation provided by the edit/compression routine must result in a 2-byte length field, followed by the corresponding quantity of data in the segment work area.

To help you provide parameters to the edit/compression routine, the DBD control block has a table appended to it that is made up of assembly language control sections. One control section is developed for each segment type to be edited or compressed. Each control section has a CSECT name equal to that of the segment name.

These control sections are placed at the end of the DBD module. They contain information such as the segment edit/compression routine name, the name of the segment, and the total length of that control section. Each control section can be extended to contain any desired data or algorithm information. A sample segment control section is shown in Table 25.

Table 25. Segment Edit/Compression Control Section (DMBCPAC)

Hex Offset	Contents			
+0	Segment Name			
+8	Routine Name			
+10	Entry Point Address	Flag Byte	Sequence Field Length -1	Sequence Field Offset
+18	Segment Length/Max Length	Total Length of CSECT	Reserved for Exit Routine	
+20	Any User Data (length varies)			

Information in the various fields shown in Table 25 is as follows:

DMBCPAC	DSECT		
DMBCPCNM	DS	CL8	Segment name
DMBCPCSG	DS	CL8	Edit/Compression routine name
DMBCPEP	DS	A	Entry point address
DMBCPFLG	DS	XL1	Flag byte
DMBCPKEY	EQU	X'02'	Segment has key compression option
DMBCPNIT	EQU	X'01'	Initialization processing is required
DMBCPVLR	EQU	X'04'	Segment is variable-length

DFSCMPX0

DMBCPSEQ	EQU	X'08'	Segment has key sequence field defined
DMBCPJJD	EQU	X'10'	Exit caller requests a return code rather than hard abending.
DMBCPSQF	DS	XL1	Executable length of sequence field, if defined
DMBCPSQL	DS	H	Sequence field offset
DMBCPSGL	DS	H	For fixed length segments - segment length; for variable length segments - maximum length
DMBCPLNG	DS	H	Total length of CSECT; fixed length plus length of user-defined parameters (always a multiple of 8)
DMBCPUSR	DS	0F	Any quantity of user-defined data.

The first 28 bytes are constants defined by DBDGEN. When the new table is defined to include additional parameters, these fields must be duplicated. The only exception to this rule is that the CSECT length field must be updated to reflect the new length. After an assembly of the new table, bind is done to exchange the new table for the old one. User-added code should not contain address constants, because this CSECT is moved after it is loaded. Use an ENTRY statement to specify the name of the DBD when this operation takes place, as well as an ORDER statement to ensure that the original order of multiple CSECTs is maintained. For details about this, see the section on automatic CSECT replacement in the z/OS product library.

If your exit routine references IMS control blocks other than the one shown in Table 25 on page 117, you need to reassemble the routine using the current release of IMS.

Restrictions

Keep the following in mind when using the Segment Edit/Compression Facility:

- Because this routine becomes a part of the IMS control or batch region, any abnormal termination of this routine terminates the entire IMS region. Any user-written Segment Edit/Compression exit routine should return to IMS with an abend code and a reason code instead of initiating a standard abend. See “Program Messages and Codes” on page 120 for more information.
- The exit routine cannot use operating system macros such as LOAD, GETMAIN, SPIE, or STAE.
- All editing or compression of segments occurs as the segments are described in a physical database only. For specific restrictions, see *IMS Version 9: Administration Guide: Database Manager*.
- The exit routine must not modify or alter the relative position of a key field in a DEDB segment. If the key field in a DEDB segment changes or moves during a compress or expand call, IMS issues abend 0799, subcode 1. For more information about this abend, see *IMS Version 9: Messages and Codes, Volume 1*.

Description of Sample Segment Compression/Expansion Modules

Compression/expansion examples are provided as guidance to the IMS system user.

DFSCMPX0 and DFSKMPX0 can be used by either full-function databases or DEDBs. Both routines perform segment compression. The only differences are:

- DFSCMPX0 compresses three or more repeated strings. This exit routine employs z/OS services to accomplish segment compression and expansion. For more information on these services, see the z/OS library. (DFSCMPX0 is the recommended compression routine.)
- DFSKMPX0 compresses four or more repeated strings. This exit routine relies on programming logic to accomplish segment compression and expansion. (DFSKMPX0 is not recommended, but it will continue to be supplied and supported for compatibility reasons.)

When control is given to DFSCMPX0 or DFSKMPX0, the program checks the entry code passed in register 6. The entry code indicates whether the request is for compression of a segment or for the partial (full-function databases only) or entire expansion of a compressed segment. It then branches to an appropriate routine to perform the required task. Upon normal completion of the task, it returns control to the IMS Control Program with a return code of 0.

Specific rules and restrictions followed in compression and expansion of a segment are detailed in this section. For sample code, see the IMS.ADFSSRC library.

The Compression Routine

Compression of a segment requires different data handling according to the data organization of the segment. The two data formats are:

- Fixed data
- Variable-length data

A user can specify the KEY (full-function databases only) or DATA operand for either of the two data formats. Figure 20 shows data before and after compression for both fixed- and variable-length segments.







Data before compression	Data after compression
Fixed length: 	KEY operand  DATA operand 
Variable length: 	KEY operand  DATA operand 

Figure 20. Data Handling Formats

- D** data
- K** pointer to the 1st CCB
- LL'** new statement
- LL** original segment length
- D' and K'** compressed data and key

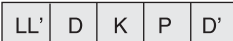
Compression of a segment results in one of the four formats listed in Figure 20 on page 119, depending upon the original record format and the operand specified.

The Initialization Processing Routine

When specified, IMS gives control to the segment edit/compression routine immediately after the databases are opened and immediately before the databases are closed.

When a command code is given to branch to the initialization processing routine or to the termination processing routine in the DFSKMPX0 program, the DFSKMPX0 program returns to the calling program. No processing of particular data is attempted at this stage.

Program Messages and Codes

When a Segment Edit/Compression exit routine detects a problem and initiates a standard abend, that abend can bring down the IMS. This severely impacts all other IMS applications running in an online IMS environment. The Segment Edit/Compression exit routines return to the caller with an abend code in register 0 and a reason code in register 14. Thus, abends in Segment Edit/Compression exit routines are converted to IMS abend U0840s so that only the dependent region that the abending application is running in is brought down.

Table 26 lists the abend codes.

Table 26. Program Messages and Codes - Abend Codes

User Abend	Description
2989	A segment data organization is variable-length, but its length field is 2>N>32767 A fixed-length record, but the segment length in Compaction Control Table indicates: 0>N>32767
2990	A command code passed by the control program is out of a valid range: 0>N>16 <ol style="list-style-type: none"> REASON - D4D7E701: During a compression request, the input length of the variable length segment is less than 2 bytes. REASON - D4D7E702: During an expansion request, the input length of the compressed segment is less than 2 bytes. REASON - D4D7E703: During an expansion request, a non-zero return code was returned by the z/OS expansion service. (CSRCEsrv). REASON - D4D7E704: INIT was not specified in the COMPRTN= parameter of the SEGM statement. REASON - D4D7E705: Invalid function code. A command code passed by the control program is out of valid range. REASON - D4D7E706: The key field length (sequence field) plus the offset of the key field within the segment is greater than the segment length indicated in the segment length field of a Compression Control Table. REASON - D4D7E707: The length of a segment indicated in the segment length field of a Compression Control Table is negative.
2991	A command code is passed to compress after, or expand up to, a sequence field of a segment. No sequence field is defined in the segment.

Table 26. Program Messages and Codes - Abend Codes (continued)

User Abend	Description
2992	<p>Any of the following conditions results in an abend with this code.</p> <p>Applicable to both fixed- and variable-length segments:</p> <ul style="list-style-type: none"> • A D/K length is greater than an SCL length of a segment. <p>Applicable only to a variable-length segment:</p> <ul style="list-style-type: none"> • A D/K length is greater than a LL length. • A LL length is greater than an SGL length. • A LL length is less than 2. • An SGL length is less than 2. <p>Applicable to a fixed segment:</p> <ul style="list-style-type: none"> • An SGL length is a negative value. <p>D/K length = A sum of length from the beginning of a segment to the end of a key field (SEQUENCE FIELD).</p> <p>SGL length = A length of a segment indicated in the segment length field of a Compression Control Table.</p> <p>LL length = A length of a variable-length record indicated in the first two bytes of a precompressed segment.</p>

Program Assumptions

All parameters and data passed by the IMS control program, such as the address of the input segment data, the output data area address, and the length of an input segment, are considered valid data.

The IMS control program passes an address of an input segment data area in register 2 and an address of an output data area in register 3.

The size of output data area is:

- A segment length plus two bytes for a fixed-length segment.
- The maximum segment length for a variable-length segment.
- No segment length greater than 32,767 bytes.

All segments processed by the compression routine are treated as variable-length by the IMS system control program, regardless of their precompression format.

Using the Sample Segment Compression/Expansion Exit Routine

For the latest versions of DFSCMPX0 and DFSKMPX0, see the IMS.ADFSSRC library; the member names are DFSCMPX0 and DFSKMPX0. Because DFSCMPX0 provides improved performance and possibly better compression, IBM does not recommend the use of DFSKMPX0.

DFSKMPX0

Recommendation: It is recommended that you use the DFSCMPX0 sample exit routine.

Although no DFSKMPX0 sample exit routine is provided here, the exit routine is supported and supplied in the IMS.ADFSSRC library.

Hardware Data Compression Support

You can compress or expand full-function and DEDB databases by using Hardware Data Compression support. Hardware Data Compression (HDC) reduces DASD storage requirements for databases, reduces database I/O, and improves database performance.

This section describes the following:

- “How HDC Works”
- “How to Implement HDC Support” on page 123
- “Sample JCL Procedure” on page 124
- “HDC Tips” on page 127
- “Return Codes from the HDCD Utility” on page 127

How HDC Works

With HDC support, you can generate exit routines to activate the hardware-assisted data compression available on processors. The processors use a compression technique that uses a fixed number of bits to replace a variable number of bytes.

If compression hardware is installed, the segment is compressed or expanded using the hardware instruction CMPSC. If compression hardware is not installed, the standard HDC exit routine calls the z/OS CSRCMPSC macro to compress or expand the segment by activating software simulation.

HDC compresses and expands segment data by calling a compression exit routine that has been specified on the SEGM statement during DBDGEN. This exit routine is created by binding a user-defined dictionary and an IMS-supplied base exit routine.

The space saved by compression depends on the user-defined dictionary, which performs the translation between compressed and uncompressed data. The dictionary always has 4,096 entries. The total size of the dictionary is 64 KB, because each entry is 16 bytes (8 for compression and 8 for expansion). Different dictionaries are built for different sets of data. You receive the best results by creating a dictionary that compresses the most frequently occurring data in the largest databases.

If a fixed or variable-length segment requires compression and the data format is such that compression cannot take place, then the exit routine adds control information which indicates that the segment could not be compressed. This addition of the control information will lengthen the segment beyond the maximum length definition. To allow for this expansion and to allow IMS to validity check the compression results, you can add an arbitrary value of 10 bytes to the segment length.

If the segment length specified in the DBD is variable and the database is a DEDB, the length can exceed the maximum by up to 10 bytes but must not exceed 120 bytes less than the control interval (CI) size. If the segment length specified in the DBD is variable and the database is a HIDAM, HISAM, HDAM, or PHADM the length cannot exceed the DBDGEN maximum.

How to Implement HDC Support

You can use HDC with HISAM, HIDAM, PHIDAM, HDAM, PHDAM, and DEDB databases.

To implement hardware data compression, follow these steps:

1. Create an HDC dictionary, using the Hardware Data Compression Dictionary utility (DFSZLDU0).
2. Bind the HDC dictionary to an IMS-supplied base exit routine, which produces a segment edit/compression routine. The base module is about 1 KB and is bound with 64-KB dictionaries. Therefore, the user exit routines require slightly more than 64 KB of memory.
3. In the DBDGEN SEGM statement COMPRTN= parameter, specify the newly created segment edit or compression routine and the INIT keyword.
4. Unload the database using the old DBD.
5. Create the new DBD specifying the new exit routine.
6. Reload the database using the new DBD. (A new DBD requires that you run ACBGEN.)

Building the HDC Dictionary

To build the HDC dictionary, use a sequential variable-length file as input to the HDCD utility. This must be a QSAM file of a variable record format and contain uncompressed segments, which are used to build the dictionary. You can create this QSAM file with a user-written unload program, or with the HD Reorganization Unload utility (DFSURGU0). Use your own data analysis to determine what uncompressed segments to use. Use the QSAM data set with the procedure shown in “Sample JCL Procedure” on page 124.

Exception: If you use a QSAM file created by the DFSURGU0 utility, the dictionary build process includes (will not ignore) the header and trailer records created by the DFSURGU0 utility. Also, the dictionary build process includes (will not ignore) the prefix added to each data segment by the DFSURGU0 utility.

Other HDCD Utility Functions

In addition to creating the HDC dictionary, the HDCD utility provides:

Compression statistics program, which is generated from the QSAM input file or from an alternate file. By using an alternate file, you can compare statistics and evaluate the dictionary’s effectiveness.

The compression statistics program:

- Calculates the potential storage savings percentage as follows:

$$\text{SAVINGS} = (100 - ((\text{avg compressed segsize} / \text{avg precompressed segsize}) * 100))$$

If the potential storage savings do not meet the HDCDCTL default parameter’s criteria, a dictionary object file is not built.

- Prints the following statistics:
 - HDCDCTL parameters.
 - Number of segments read.
 - Smallest precompressed and compressed segment sizes.
 - Largest precompressed and compressed segment sizes.
 - Average precompressed and compressed segment sizes.
 - Potential storage savings percentage.

Hardware Data Compression

The value shown for either the smallest or largest uncompressed segment could represent the length of the DFSURGU0 utility header or trailer segment.

- Produces data integrity validation option.
- Produces an object file for the specific HDC dictionary, provided that the following compression criteria are met:
 - Precompressed data matches expanded data if the data integrity validation option is specified.
 - Potential storage savings exceed the user-specified minimum percentage.

Sample JCL Procedure

You must create a QSAM data set that contains uncompressed database segments. Then use the QSAM data set with the following JCL procedure.

```

//HDCDBLD  PROC
//          HDCDNAM=DFSZHDCD, /*USER SUP. DICT NAME,8 CHARS*/
//          QSAMIN='USER.QSAM', /* INPUT QSAM FILE NAME */
//          QSAMIT='USER.QSAMALT', /* ALTERNATE QSAM FILE NAME*/
//          DICTLIB='HDC.DICTLIB', /* DICTIONARY LOAD LIBRARY */
//          DICTNAM='DFSZHXYZ', /* USER DICT. MEMBER NAME */
//          CMPXIT='USER.COMPLIB', /* COMPRESSION EXIT LIBRARY*/
//          CMPMBR='CMPXIT01', /* USER EXIT MEMBER NAME */
//          RGN=2048K,
//          SYS2=,
//          SOUT=*,
//          UNIT=SYSDA,
//          VOLSER=,

//          CYL=TRK,PRIM=5,SEC=2,BLKSZ=3120
//*****
//* CREATE STATISTICS AND HDC DICTIONARY OBJECT FILE. *
//*****

//HDCDGEN  EXEC PGM=DFSZLDU0,REGION=&RGN,PARM=&DICTNAM
//STEPLIB DD DSN=IMS.&SYS2.SDFSRESL,DISP=SHR
//SYSPRINT DD SYSOUT=&SOUT
//SYSUDUMP DD SYSOUT=&SOUT
//HDCDIN  DD DSN=&QSAMIN,DISP=SHR;
//HDCDIT  DD DSN=&QSAMIT,DISP=SHR;
//HDCDOU  DD DSN=IMS.&HDCDNAM.HDCDOBJ,
//          DISP=(,CATLG,DELETE),
//          UNIT=&UNIT,
//          SPACE=(&CYL,(&PRIM,&SEC),RLSE),
//          DCB=(LRECL=80,BLKSIZE=&BLKSZ,RECFM=FB)
//HDCDCTL DD DUMMY /* 'DUMMY' USES DEFAULT PARMS */
//*
//*****
//* CREATE LOAD MODULE FROM DICTIONARY OBJECT TEXT DECK. *
//*****

//LINK1   EXEC PGM=IEWL,COND=(0,NE),

//          PARM='SIZE=(180K,20K),RENT,REFR,NCAL,LET,XREF,LIST'
//SYSLMOD DD DSN=&DICTLIB(&DICTNAM),DISP=SHR
//SYSUT1  DD UNIT=&UNIT,DISP=(,DELETE),
//          SPACE=(CYL,(10,1),RLSE)
//SYSPRINT DD SYSOUT=&SOUT
//SYSLIN  DD DSN=IMS.&HDCDNAM.HDCDOBJ,DISP=(OLD,DELETE,KEEP)
//*
//*****
//* THE USER COMPRESSION EXIT ROUTINE IS BUILT BY LINKING *
//* MODULE DFSZLDX0 AND THE HDC DICTIONARY TOGETHER. THE *
//* THE HDC DICTIONARY MUST BE THE FIRST CSECT WITHIN THE *

```

Figure 21. Sample JCL Procedure (Part 1 of 2)

Hardware Data Compression

```
/** USER EXIT ROUTINE AND ALSO BE ON A PAGE BOUNDARY.      *
//*****
//LINK2 EXEC PGM=IEWL,

//          PARM='SIZE=(180K,20K),RENT,REFR,NCAL,LET,XREF,LIST'
//SYSLMOD DD DSN=&CMPXIT(&CMPMBR),DISP=SHR
<litdata>
//SYSUT1 DD UNIT=&UNIT,DISP=(,DELETE),
//          SPACE=(CYL,(10,1),RLSE)
//SYSPRINT DD SYSOUT=&SOUT
//SDFSRESL DD DSN=IMS.&SYS2.SDFSRESL,DISP=SHR
//DICTLIB DD DSN=&DICTLIB,DISP=SHR;
//*****
//*THE FOLLOWING CONTROL STATEMENTS MUST BE IN THE ORDER AS *
//* ILLUSTRATED.                                           *
//*                                                         *
//* DFSZHXYZ: THE HDC DICTIONARY NAME FOR THE SEGMENT.     *
//* (&DICTNAM) THIS HAS TO BE CHANGED TO A FIXED NAME OF  *
//* DFSZHDCD SO THAT THE COMPRESSION EXIT DRIVER          *
//* CAN BE LINKED TO IT.                                   *
//*                                                         *
//* DFSZLDX0: THE COMPRESSION EXIT DRIVER ROUTINE.         *
//*                                                         *
//* &CMPMBR: USER SPECIFIED COMPRESSION/EXPANSION EXIT    *
//* ROUTINE NAME THAT IS USED ON THE                       *
//* SEGM COMPRTN= (&CMPMBR,DATA) DBD STATEMENT.          *
//*****
//SYSLIN DD *
CHANGE &DICTNAM(DFSZHDCD)      (&DICTNAM) DICTIONARY NAME
INCLUDE DICTLIB(&DICTNAM)      DICTIONARY MUST BE 1ST CSECT
INCLUDE SDFSRESL(DFSZLDX0)     STANDARD COMPRESSION EXIT
PAGE DFSZHDCD
ENTRY DFSZLDX0
NAME &CMPMBR(R)                (&CMPMBR) COMPRESSION EXIT
/*
// PEND
```

Figure 21. Sample JCL Procedure (Part 2 of 2)

DD Name Descriptions

HDCDIN DD

The input sequential variable length data set that contains the IMS database segment data that you extracted.

HDCDIT DD

The input sequential variable length data set or an alternate file that is used to calculate the compression statistics.

HDCOUT DD

Output HDC dictionary object deck. The z/OS format dictionary is built and converted into a bind compatible object deck for subsequent use in the dictionary link edit step.

SYSPRINT DD

Compression analysis statistics.

HDCDCTL DD

A data set containing the following control statements. The value specified for a control statement must conform to the rules described for each control

statement. Code the value after the keyword for the control statement. Use a blank or a comma to separate control statements.

RECS=

The number of input records to be processed. The default is ALL. Specify a number between zero and 2147483647. If any number outside this range is specified, the default ALL is used.

PERC=

The percentage of storage savings to be realized. The default is 5 percent. One or two digits are allowed.

INTEG=

By specifying Y or N, this keyword checks or does not check the data integrity of compressed segments. The default is N.

HDC Tips

To decide whether to use HDC, run the HDCD utility and analyze the output statistics to determine how much storage and I/O savings you can achieve.

You might want to limit the use of HDC to one time per database, since its implementation requires an unload and reload of the database.

Recommendation: You should evaluate all of the segments in a database before implementing compression. If you use compression for multiple segment types, implement compression for all of them at the same time.

Because uniquely tailored dictionaries yield the most compression, you should use the dictionaries for high-volume segments to maximize savings.

You can create more generally-tailored dictionaries for other reasons. If you know the type of data in most segments, you can create dictionaries by using a sampling of similar data from many of those segments. For example, you might want general dictionaries for upper-case text, mixed-case text, numeric, alphabetic, and general mixed data. You can use these dictionaries for multiple segment types, eliminating the need to produce unique dictionaries for each segment type.

Compression usually saves I/O for sequential processing and can also save I/O for random processing. Typically, savings for random processing is realized with large database records, especially if the record is spread over multiple blocks or CIs. Compression can reduce the number of blocks or CIs that must be read to access a segment. This is likely to apply to twin chains of multiple blocks or CIs, even after reorganizations.

Return Codes from the HDCD Utility

The following return codes can be issued from the HDCD utility:

Code	Description
0	Utility ended successfully and issued the accompanying DFSZ1170I message.
4	Utility ended successfully and issued the accompanying DFSZ1171W message, but it did not build a dictionary because the requested storage savings percentage was not met.
8	Utility ended successfully and issued the accompanying DFSZ1172E message, but it did not build a dictionary because data integrity checks were detected between a source QSAM input record and its equivalent re-expanded record.

Hardware Data Compression

Code	Description
12	Utility ended unsuccessfully and issued the accompanying DFSZ1173W message, because z/OS CSRCMPSC is not installed on the machine.
16	Utility ended unsuccessfully and issued the accompanying DFSZ1174E message, because a logic error occurred during invocation of the CSRCMPSC compression service macro.

Related Reading: For more information about these messages, refer to *IMS Version 9: Messages and Codes, Volume 2*.

Chapter 11. Sequential Buffering Initialization Exit Routine (DFSSBUX0)

This chapter describes the Sequential Buffering Initialization exit routine. The chapter describes the attributes of the routine, performance considerations, and how the routine communicates with IMS.

In this Chapter:

“About This Routine”

“Communicating with IMS” on page 130

“Using the Sample SB Initialization Routines” on page 132

About This Routine

This exit routine can dynamically control the use of Sequential Buffering (SB) for online and batch IMS subsystems, as well as DBCTL. By using one of the five sample SB routines that IMS provides or one that you write, you can:

- Disallow the use of SB.
- Specify that SB be conditionally activated by default whenever IMS detects a sequential I/O pattern in batch or BMP regions.
- Change the IMS default values for the number of buffersets in each SB bufferpool.

The SB exit routine (DFSSBUX0) is called before each application program or utility. This enables the exit routine to dynamically change SB options and parameters and dynamically control how your system uses SB.

Related Reading:

- For more information about SB, see the section on OSAM sequential buffering in *IMS Version 9: Administration Guide: Database Manager*.
- For general guidelines on writing DL/I exit routines, see Chapter 1, “Guidelines for Writing IMS exit routines,” on page 3.

The following sections provide guidelines for writing your own SB exit routine and information about the sample SB routines that IMS supplies.

Table 27 shows the attributes of the Sequential Buffering Initialization exit routine.

Table 27. Sequential Buffering Initialization Exit Routine Attributes

Attribute	Description
IMS environments	DB/DC, DBCTL.
Naming convention	You must name this exit routine DFSSBUX0.
Binding	Follow the guidelines described in “Binding the Routines” on page 7. After you compile and test your module, bind it into IMS.SDFSRESL, SYS1.LINKLIB, or into any operating system partitioned data set that can be accessed by a JOBLIB or STEPLIB JCL statement for the IMS control, SAS, and batch regions.
Including the routine	No special steps are needed to include this routine.
IMS callable services	This exit is not eligible to use IMS Callable Services.
Sample routine location	See “Using the Sample SB Initialization Routines” on page 132.

Loading the Routine

IMS loads the routine at IMS initialization time.

Considering Performance

DFSSBUX0 is called frequently during the scheduling of MPPs and PSBs of CICS in a DBCTL environment. If you modify an SB sample routine or write your own routine, code it to minimize overhead during the routine's call for these programs.

Communicating with IMS

IMS uses the entry registers, parameter list, and exit registers to communicate with the exit routine.

Contents of Registers on Entry

Upon entry, the exit routine must save all registers using the provided save area. The registers contain the following:

Register	Contents
1	Address of parameter list.
10	Address of partition specification table (PST).
11	Address of SCD.
13	Address of save area. The exit routine must not change the first three words.
14	Return address of IMS.
15	Entry point of exit routine.

Description of Parameters

DFSSBUX0 receives the address of a parameter area in Register 1. This parameter area is mapped by the DFSSBUXP macro and contains:

- The region type (batch, BMP, MPP, Fast Path, DBCTL) in the SBPRMREG field.
- The job, program, and PSB names. (Exceptions: IMS utilities executed without a PSB have a DBD name instead of a PSB name.)
- The message classes of the message region (when running in an MPP region).
- The IMS default values for SB options and parameters.

The following paragraphs describe how DFSSBUX0 can change the default values of SB options in the SB parameter area. Each change applies only to the current application program or utility being invoked. The DSECT of the parameter area is presented at the end of the discussion.

Disallowing the Use of SB: The **SBPRMPDI** bit determines whether the use of SB is disallowed. The default value for this bit is *off*. DFSSBUX0 can set this bit *on*, however, to disallow the use of SB and cause IMS to ignore any PSBGEN or SB control card requests to the contrary. You can set this bit during peak periods of online use to save real storage space, especially if your system's real-storage is already constrained.

Conditionally Activating SB by Default: The **SBPRMPAD** bit determines whether IMS conditionally activates SB by default. The default value for this bit is *off*. DFSSBUX0 can set this bit *on*, however, so that IMS samples I/O reference pattern statistics of batch and BMP application programs. If IMS detects both a sequential I/O pattern and a reasonable activity rate, IMS activates SB. This occurs only if PSBGEN and SB control cards provide no specifications to override this process.

Exception: Since statistic sampling has an initialization overhead each time an application program is scheduled, IMS does **not** support conditionally activating SB by default for MPPs, Fast Path regions, or CICS applications.

You might want to use DFSSBUX0 to conditionally activate SB by default in the following situations:

- To activate SB for specific batch and BMP programs and for IMS utilities by setting the bit according to the program, job, or PSB name for a program
- To always set the bit to activate SB for all BMP and batch programs and for utilities for z/OS systems that are not storage-constrained
- To set the bit depending on the time of day (for example, during night batch processing when most sequential applications are running and a lot of storage is available for buffering purposes)

Changing the Number of SB Buffer Sets: The **SBPRMPNR** full word field specifies a default value for the number of buffer sets (BUFSETS) in each SB bufferpool. The default value for this field is **4**. However, DFSSBUX0 can set this field to a value ranging from 1 to 25, inclusive. If this value is greater than 1, SB can anticipate the future database calls of a BMP or batch program by concurrently reading the next set of blocks while IMS is processing current database calls.

Recommendation: If your databases are well organized, it is recommended that you set a default BUFSETS value of 2 or 3 to save virtual storage space. If your databases are poorly organized, however, you can set a default BUFSETS value of 6 or greater to increase the chance that what your application program or utility is looking for is already in a buffer set.

DFSSBUX0 can also change the default BUFSETS value based on the time of day. For example, you might want DFSSBUX0 to choose a small value for BUFSETS during daytime main online processing time and a larger value during night batch processing time.

The following DSECT describes the format of the SB parameter area:

```

SBPRMP  DSECT
*
SBPRMP1 EQU *      *****  READ-ONLY INFO FOR EXIT
SBPRMJOB DC  CL8' '  JOBNAME
SBPRMPGM DC  CL8' '  PGM NAME (BLANK FOR CICS)
SBPRMPSP DC  CL8' '  PSB NAME
SBPRMCLA DC  CL4' '  IMS MESSAGE CLASSES
SBPRMREG DC  X'00'   REGION-TYPE
SBPRMRE1 EQU  1      ...BATCH (EXCLUSIVE CICS)
SBPRMRE2 EQU  2      ...CICS
SBPRMRE3 EQU  3      ...BMP
SBPRMRE4 EQU  4      ...MPP
SBPRMRE5 EQU  5      ...IFP (FAST PATH)
                DC  XL3'00'  RESERVED
*
                DS  0F
SBPRMP2 EQU *      *****  MODIFIABLE SB PARMS FOR EXIT
SBPRMPNR DC  F'0'    NBR OF BUFFER-SETS
SBPRMPFL DC  X'00'   FLAGS
SBPRMPDI EQU  X'80'   ...DISALLOW USAGE OF SB
SBPRMPAD EQU  X'40'   ...CONDITIONAL SB ACTIVATION BY DEFAULT
*
SBPRMPL EQU  *-SBPRMP  LENGTH OF PARAMETER AREA

```

Contents of Registers on Exit

Before returning to IMS, the exit routine must restore all registers.

Using the Sample SB Initialization Routines

IMS supplies five SB sample routines (DFSSBU1, DFSSBU2, DFSSBU3, DFSSBU4, and DFSSBU9) for you to use in present form, modify, or use as guidelines for writing your own SB routine. The first module disallows the use of SB; the next four cause IMS to conditionally activate SB by default.

SB Sample Routines	Description
DFSSBU1	<p>The sample Sequential Buffering (SB) exit routine disallows the use of SB.</p> <p>For the latest version of the DFSSBU1 source code, see the IMS.ADFSSRC library.</p>
DFSSBU2	<p>This sample exit routine causes IMS to activate Sequential Buffering (SB) by default when IMS detects a sequential I/O reference pattern and reasonable activity rate. This exit routine can be used for DataRefresher™ IMS utilities that can benefit from SB in both batch and BMP regions.</p> <p>For the latest version of the DFSSBU2 source code, see the IMS.ADFSSRC library.</p>
DFSSBU3	<p>This sample exit routine causes IMS to activate Sequential Buffering (SB) by default when it detects a sequential I/O reference pattern and reasonable activity rate. In batch regions, this applies to all application programs and utilities; in BMP regions, this applies to DataRefresher, as well as those IMS utilities that can benefit from SB.</p> <p>For the latest version of the DFSSBU3 source code, see the IMS.ADFSSRC library.</p>
DFSSBU4	<p>This sample exit routine causes IMS to activate Sequential Buffering (SB) by default when it detects a sequential I/O reference pattern and reasonable activity rate. This applies to all application programs and utilities in both batch and BMP regions.</p> <p>For the latest version of the DFSSBU4 source code, see the IMS.ADFSSRC library.</p>
DFSSBU9	<p>This sample exit routine either disallows the use of sequential buffering (SB) or causes IMS to activate SB by default based on specific times of day. The routine is coded as follows:</p> <ul style="list-style-type: none"> • The time between 1100 hours and 1400 hours is the peak period for processing online transactions. During this time frame, SB is disallowed. • During the time between 0900 hours and 1100 hours, and 1400 hours and 1700 hours, SB is neither disallowed nor activated by default for batch and BMP regions. • The rest of the time, SB is conditionally activated by default for batch and BMP regions. <p>For the latest version of the DFSSBU9 source code, see the IMS.ADFSSRC library.</p>

Part 3. System Exit Routines

Chapter 12. Application Group Name (AGN) Exit Routine (DFSISIS0)	137
About This Routine	137
Communicating with IMS	138
Contents of Registers on Entry	138
Contents of Registers on Exit	138
Chapter 13. Buffer Size Specification Facility (DSPBUFFS)	139
About This Facility	139
Binding the CSECT	139
DSPBUFFS Layout	139
Using IMS Callable Services with This Routine	141
Example of Specifying Buffers	141
Chapter 14. Command Authorization Exit Routine (DFSCCMD0)	143
About This Routine	143
Using the Routine With AO (Automated Operator) Applications that Issue CMD or ICMD Calls	144
Using the Routine With LU 6.2 Application Programs	144
Using the Routine with Static Terminals	144
Using the Routine with ETO Terminals	145
Using the Routine with Commands from MCS/E-MCS Consoles	145
Using the Routine With IMS Open Transaction Manager Access	145
Using the Routine in a Shared-Queues Environment	145
Communicating with IMS	145
Contents of Registers on Entry	145
Contents of Registers on Exit	146
Chapter 15. DBRC Command Authorization Exit Routine (DSPDCAX0)	147
About This Routine	147
Communicating with IMS	148
Contents of Registers on Entry	148
Contents of Registers on Exit	149
Using the Sample DBRC Command Authorization Exit Routine	149
Chapter 16. Dependent Region Preinitialization Routines	151
About These Routines	151
Activating the Routine	152
Communicating with IMS	153
Contents of Registers on Entry	153
Contents of Registers on Exit	153
Chapter 17. Dump Override Table (DFSFDOT0)	155
About This Table	155
DFSFDOT Macro	156
DFSFDOT Parameters and Descriptions	156
A Sample Dump Override Table (DFSFDOT0)	157
Errors	157
Messages	157
Chapter 18. ESAF (External Subsystem Attach Facility) Indoubt Notification Exit Routine (DFSFDIN0)	159
About this Routine	159
Communicating with IMS	159

Contents of Registers on Entry	160
Contents of Registers on Exit	160
Chapter 19. IMS Command Language Modification Facility (DFSCKWD0)	161
About This Facility	161
Changing the Table	162
Error Messages	163
Using the Sample IMS Command Modification Facility	164
Chapter 20. Large System Definition Sort/Split Input exit routine (DFSSS050)	165
About This Routine	165
Attributes of the Routine	165
Restrictions.	165
Communicating with IMS.	166
Contents of Registers on Entry	166
Contents of Registers on Exit	166
Chapter 21. Large System Definition Sort/Split Output Exit Routine (DFSSS060)	169
About This Routine	169
Restrictions.	169
Communicating with IMS.	170
Contents of Registers on Entry	170
Contents of Registers on Exit	170
Chapter 22. Log Archive Exit Routine	173
About This Routine	173
Attributes of the Routine	173
Restrictions.	173
Using IMS Callable Services with this Routine	174
Communicating with IMS.	174
Contents of Registers on Entry	174
Contents of Registers on Exit	175
Sample Log Archive Exit Routine.	176
IMSLOG	184
Chapter 23. Log Filter Exit Routine (DFSFTFX0)	187
About This Routine	187
Communicating with IMS.	189
Contents of Registers at Entry.	189
Contents of Registers at Exit	190
Recovery Environment	190
Initialization and Termination Calls	190
IMS-Supplied Filter Exit Routine	190
Chapter 24. Logger Exit Routine (DFSFLGX0)	193
About This Routine	193
Attributes of the Routine	194
Calling the Routine	194
Restrictions.	195
Communicating with IMS.	195
Content of Registers on Entry	195
Standard Exit Parameter List	196
Function-Specific Parameter List on Entry	196
Content of Registers on Exit	199

Chapter 25. Partner Product Exit Routine (DFSPUE0)	201
About This Routine	201
Communicating with IMS	201
Content of Registers on Entry	201
Standard IMS User Exit Parameter List	202
Function-Specific Parameter List on Entry	202
Content of Registers on Exit	202
Chapter 26. RECON I/O Exit Routine (DSPCEXT0)	203
About This Routine	203
Attributes of the Routine	203
Calling the Routine	204
Considering Performance	205
Communicating with IMS	205
Contents of Registers on Entry	205
Contents of Registers on Exit	208
Using the Sample RECON I/O Exit Routine	208
Chapter 27. Resource Access Security Exit Routine (DFSRAS00)	209
About This Routine	209
Communicating with IMS	209
Contents of Registers on Entry	209
IMS Standard User Exit Parameter List (SXPL)	210
Resource Access Security Exit Routine Parameter List	210
Contents of Registers on Exit	212
Chapter 28. SCI Registration Exit Routine (DSPSCIX0)	213
About This Routine	213
Communicating with IMS	213
Contents of Registers on Entry	213
Contents of Registers on Exit	214
Using the Sample SCI Registration Exit Routine	214
Chapter 29. System Definition Preprocessor Exit Routine (Input Phase) (DFSPRE60)	217
About This Routine	217
Communicating with IMS	218
Contents of Registers on Entry	218
Contents of Registers on Exit	218
Using the Sample System Definition Preprocessor Exit Routine	219
Chapter 30. System Definition Preprocessor Exit Routine (Name Check Complete) (DFSPRE70)	221
About This Routine	221
Communicating with IMS	221
Contents of Registers on Entry	222
Contents of Registers on Exit	222
Chapter 31. Type 2 Automated Operator Exit Routine (DFSAOE00)	223
About This Routine	223
Restrictions	224
Using AOI Callable Services	224
Types of Messages Passed to This Routine	225
Activating This Routine	228
Communicating with IMS	228
Content of Registers on Entry	229

Standard Exit Parameter List	229
Function-Specific Parameter List	229
Message Buffer	232
Content of Registers on Exit	233
Chapter 32. User Message Table (DFSCMTU0)	235
About This Table	235
Writing a Routine to Use This Table	236
Including the Table During System Definition	236
Formatting the Table	236
Sample User Message Table and Routine	236
Sample Table	236
Sample Routine	237

Chapter 12. Application Group Name (AGN) Exit Routine (DFSISIS0)

The Application Group Name (AGN) exit routine provides users without the Resource Access Control Facility (RACF®) a mechanism for checking authorization to IMS application group names (AGNs). Do not use this routine if you are using the Resource Access Security exit routine (DFSRAS0).

Recommendation: Resource Access Security exit routine (DFSRAS0) is recommended. IBM recommends that you migrate from DFSISIS0 to DFSRAS0.

In this Chapter:

- “About This Routine”
- “Communicating with IMS” on page 138

About This Routine

The Application Group Name (AGN) exit routine receives control when the dependent region goes to the control region to start communication with the IMS control program or when a CCTL is connecting to IMS for DBCTL services. The exit routine is entered only once for each dependent region or CCTL. The routine can check the authorization of the dependent region or the CCTL to use the AGN. Each AGN represents a set of IMS resources defined through the Security Maintenance Utility (SMU). The resources are defined in the Security Maintenance Utility by the AGN control statement and data statements.

Related Reading: For details on specifying the AGN control and data statements and Resource Access security, see the security section in *IMS Version 9: Administration Guide: System*.

For this exit to be executed, the AGNEXIT keyword can be specified in the SECURITY macro for system definition.

The sample AGN exit routine supplied with the system refuses authorization to all callers by returning a code of 8 in register 15 to ensure that the installation replaces the dummy exit routine supplied with the system.

Table 28 shows the attributes of the Application Group Name (AGN) exit routine.

Table 28. Application Group Name (AGN) Exit Routine Attributes

Attribute	Description
IMS environments	DB/DC, DCCTL, and DBCTL
Naming convention	You must name this exit routine DFSISIS0.
Link editing	Follow the guidelines described in “Binding the Routines” on page 7. You must write this exit routine as reentrant.
Including the routine	No special steps are needed to include this routine.
IMS callable services	This exit routine is not eligible to use IMS Callable Services.
Sample routine location	IMS.ADFSSRC (member name DFSISIS0)

Communicating with IMS

IMS uses the entry and exit registers to communicate with the exit routine.

Contents of Registers on Entry

Upon entry, the exit routine must save all registers using the provided save area. The registers contain the following:

Register	Contents
0	A(SCD) Address of the SCD.
1	A(AGN) Address of the 8-byte Application Group Name (AGN).
3	A(A(AGN)) Address of the field that contains the address of the Application Group Name.
13	A(SAVE AREA) Address of the 18 fullword save area. This save area is pre-chained forward and backward. These pointers must not be modified.
14	Return address of IMS.
15	Entry point of exit routine.

Contents of Registers on Exit

Before returning to IMS, the exit routine must restore all registers except register 15, which must contain one of the following return codes:

Return Code	Meaning
0	AGN valid for this user.
8	AGN invalid for this user.

Chapter 13. Buffer Size Specification Facility (DSPBUFFS)

The Buffer Size Specification facility allows you to control the number of buffers used for RECON data sets when either the local shared resource (LSR) or the nonshared resource (NSR) buffering option is used.

In this Chapter:

“About This Facility”

“Example of Specifying Buffers” on page 141

About This Facility

DBRC provides a CSECT, DSPBUFFS, for you to override the default number of buffers used. The values in the CSECT are used to build the VSAM local shared resource pool for LSR support or to specify the number of index and data buffers if NSR buffering mode is used.

This facility can be used in DBRC environments.

Binding the CSECT

After assembling the source code, bind the object code of the CSECT into the IMS load module DSPCINT0.

DSPBUFFS Layout

Figure 22 on page 140 shows the layout of the DSPBUFFS CSECT. You can assemble your own version of this CSECT and replace it in load module DSPCINT0 using the standard binder setup included in the System Modification Program (SMP) process, or modify the existing version of the CSECT supplied by IBM.

DSPBUFFS

```
DSPBUFFS CSECT ,          DECLARE NBR OF INDEX & DATA BUFFERS
          DC    CL8'DSPBUFFS'  REQUIRED EYECATCHER FOR DUMPS
*
*  DECLARE THE NUMBER OF INDEX AND DATA BUFFERS TO BE USED IN EACH
*  OF THE DEFINED OPERATING MODES WHEN USING THE LSR OPTION OF VSAM.
*  APPLIES TO AN ESA* OR XA ENVIRONMENT ONLY. BOTH BUFFER NUMBERS GIVEN
*  IN EACH CASE MUST BE AT LEAST 4 ELSE DBRC REVERTS TO NSR MODE USING
*  THE NSR BUFFER NUMBERS BELOW THAT CORRESPOND TO THE SAME OPERATING
*  MODE. THIS FEATURE CAN BE USED TO INHIBIT THE USE OF LSR IN ANY OF
*  THE OPERATING MODES SHOULD SOME PROBLEM ARISE. REMEMBER THAT UNDER
*  LSR THE INDEX/DATA BUFFERS DEFINED APPLY TO ALL THE ACTIVE RECONS.
*
LSRONLIN DC    AL2(60,120)    IMS FOR VERSION 7 ENVIRON-IMS ONLINE DBRC
LSRCICS  DC    AL2(60,120)    IMS FOR VERSION 7 ENVIRON-CICS USE OF DBRC
LSRBATCH DC    AL2(60,120)    IMS FOR VERSION 7 ENVIRON-OFFLINE/BATCH DBRC
*
*  DECLARE THE NUMBER OF INDEX AND DATA BUFFERS TO BE USED IN EACH
*  OF THE DEFINED OPERATING MODES WHEN USING THE NSR OPTION OF VSAM.
*  APPLIES IF THE LSR OPTION HAS BEEN INHIBITED ABOVE FOR ONE OR
*  MORE OF THE DEFINED OPERATING MODES. THE MINIMUM NUMBER OF INDEX
*  AND DATA BUFFERS ASSIGNED TO EACH RECON IS TWO.
*  REMEMBER THAT UNDER NSR THE NUMBER OF INDEX/DATA BUFFERS
*  DEFINED APPLY TO EACH OF THE RECONS. NOT SHARED AS WITH LSR.
*
NSRONLIN DC    AL2(2,2)       IMS ONLINE DBRC
NSRCICS  DC    AL2(2,2)       CICS USE OF DBRC
NSRBATCH DC    AL2(2,2)       OFFLINE/BATCH DBRC
          END
```

Figure 22. Layout of the DSPBUFFS CSECT

As the comments and structure of Figure 22 indicate, the first three pairs of halfwords control the number of index and data buffers that are used for LSR. The second three pairs of halfwords control the number of index and data buffers that are used for NSR. DBRC always uses the VSAM LSR option unless it is inhibited through DSPBUFFS (see comments in the CSECT to see how this is done).

In either LSR or NSR mode, DBRC determines which pair of index/data values to use based on the “operating mode” for each execution. During initialization, DBRC:

1. Uses LSR/NSR pair 1 for IMS control regions
2. Uses LSR/NSR pair 3 for batch jobs or utilities

In effect, by changing or creating your own version of DSPBUFFS, you can specify separate buffering values for batch and online environments. If NSR buffering is used, individual values for BUFNI and BUFND can be specified in the JCL DD statements used to override the default buffer size. For VSAM LSR, only the first three pairs of values are used, so there is no advantage in allocating the RECON data sets through JCL and specifying BUFNI or BUFND values. Similarly, the BUFFERSPACE parameter used when defining a RECON data set through Access Method Services (AMS) is only applicable to the NSR buffering technique and is not used for LSR.

Because the VSAM LSR pools are built while the RECON data sets are open in NSR mode, values for the BUFFERSPACE, BUFNI, and BUFND parameters should not be specified when defining the VSAM clusters and when allocating the RECON data sets using JCL. Because the VSAM LSR pools are built prior to opening the RECON data sets for LSR, supplying values for BUFFERSPACE, BUFNI, or BUFND that exceed VSAM’s minimum default only increases the virtual storage needed to support DBRC for batch regions.

Use DSPBUFFS to specify the number of buffers for NSR, even though it is optional. With NSR specified, more efficient use of virtual storage can be achieved than by using the BUFFERSPACE parameter (when defining the RECON clusters) and adjusting the number of index and data buffers through the use of JCL. As a result, the RECON data sets can be dynamically allocated in nearly all applications.

Using IMS Callable Services with This Routine

IMS Callable Services are not applicable for use with this exit routine.

Example of Specifying Buffers

Company XYZ shares RECON data sets between two processors. Processor A is an ESA machine, processor B is not— a coexistence environment involving an earlier release of IMS is on processor B. In this case, each IMS system uses a separate copy of Figure 23.

XYZ frequently runs batch jobs using DBRC under TSO. However, tight region restrictions exist for jobs run under TSO, so they must limit the amount of storage used by DBRC in these circumstances. On the other hand, DBRC storage is not limited when executing as a control region task, so they have replaced DSPBUFFS with the following values:

```

DSPBUFFS CSECT ,          DECLARE NBR OF INDEX & DATA BUFFER
          DC    CL8'DSPBUFFS'  REQUIRED EYECATCHER FOR DUMPS
*
*                               processor A (LSR) SETUP
LSRONLIN DC    AL2(10,26)      ESA ENVIRON - IMS ONLINE DBRC
LSRCICS  DC    AL2(6,12)       ESA ENVIRON - CICS USE OF DBRC
LSRBATCH DC    AL2(6,14)       ESA ENVIRON - OFFLINE/BATCH DBRC
*
*                               processor B (NSR) SETUP
NSRONLIN DC    AL2(4,9)        NONESA ENVIRON - IMS ONLINE DBRC
NSRCICS  DC    AL2(2,2)        NONESA ENVIRON - CICS USE OF DBRC
NSRBATCH DC    AL2(3,5)        NONESA ENVIRON - OFFLINE/BATCH DBRC
          END

```

Figure 23. DSPBUFFS Example

When run as an IMS online region, DBRC in processor A (LSR) creates 10 index buffers and 26 data buffers to be shared between the 2 active RECON data sets. In processor B (NSR), DBRC assigns 4 index buffers and 9 data buffers to each RECON data set. When both active RECON data sets are opened for NSR, a total of 8 index and 18 data buffers are implied. Remember that under NSR, when the spare RECON data set is opened, it too will be assigned 4 index and 9 data buffers. For brief periods of time in processor B, the total number of index and data buffers used are 12 and 27, respectively.

Under LSR, when the spare RECON data set is opened (initially in NSR mode, a VSAM requirement), it is assigned 2 index and 2 data buffers. These values cannot be overridden. For brief periods of time in processor A, the total number of index and data buffers used are 12 and 28, respectively. Thus the total amount of storage that is used for RECON buffers is approximately the same in both processors.

When running batch jobs, DBRC in processor A creates 6 index buffers and 14 data buffers to be shared between the 2 active RECON data sets. In processor B, DBRC assigns 3 index buffers and 5 data buffers to each RECON data set opened with NSR buffering. Again, during those periods of time that all 3 RECON data sets are

DSPBUFFS

open, the total amount of buffer storage used is approximately the same in both processors (8 index and 16 data buffers in processor A, 9 index and 15 data buffers in processor B).

Chapter 14. Command Authorization Exit Routine (DFSCCMD0)

The Command Authorization exit routine (DFSCCMD0) can be used to verify that a command is valid from a particular origin. DFSCCMD0 is an optional exit routine for commands entered from IMS terminals, including LU 6.2 and OTMA.

DFSCCMD0 is a required exit routine if it is specified to authorize commands entered from:

- ICMD DL/I calls (from automated operator applications)
- z/OS MCS or E-MCS consoles

This exit routine verifies that the user is authorized to issue a particular command. IMS does not call this exit routine for internally generated or auto-restart commands.

In this Chapter:

“About This Routine”

“Communicating with IMS” on page 145

About This Routine

You can use the Command Authorization exit routine with a security product, such as SMU or RACF. The return code that the exit routine issues ultimately determines the success or failure of the command authorization; the exit routine can override the outcome of either SMU or RACF.

The Command Authorization exit routine is optional. For the latest version of DFSCCMD0, see the IMS.ADFSSMPL library; the member name is DFSCCMD0. This sample includes routines for terminals defined using the Extended Terminal Option (ETO) feature, commands entered with ICMD calls, and commands entered from MCS/E-MCS consoles.

Restrictions: The Command Authorization exit routine cannot be used to secure type-2 commands; it can secure only type-1 commands. Use the OM user exit routine to secure type-2 commands. See *IMS Version 9: Common Service Layer Guide and Reference* for more information on OM user exit routines.

Related Reading: For more information on LU 6.2 and ETO, see *IMS Version 9: Administration Guide: Transaction Manager*.

Table 29 shows the attributes for the Command Authorization exit routine.

Table 29. Command Authorization Exit Routine Attributes

Attribute	Description
IMS environments	DB/DC, DBCTL, DCCTL
Naming convention	You must name this exit routine DFSCCMD0.
Link editing	You can assemble the sample exit routine or one that you write using the standard IMS macro and copy files and include it in IMS.SDFSRESL. You must manually link edit this routine with DFSCSI00 to use IMS callable services.

DFSCCMD0

Table 29. Command Authorization Exit Routine Attributes (continued)

Attribute	Description
Including the routine	<p>Include DFSCCMD0 in IMS.SDFSRESL.</p> <p>This routine is required if one or both of the following parameters is specified in the IMS, DBC, or DCC procedures:</p> <ul style="list-style-type: none">• AOIS=A or C• CMDMCS=B or C <p>If you specify one of these parameters and do not include DFSCCMD0 in IMS.SDFSRESL, IMS system initialization ends with a U0718 abend.</p> <p>Otherwise, the routine is optional.</p>
IMS callable services	<p>This exit routine can use callable storage services. DFSCCMD0 is defined to IMS as a standard user exit. Exit routines that are defined to IMS receive the callable service token in the standard exit parameter list. This exit routine must issue an initialization call (DFSCSI00) to use callable services and you must manually bind with DFSCSI00.</p> <p>For guidelines on using callable services, see “IMS Callable Services” on page 10.</p>
Sample routine location	IMS.ADFSSMPL

Using the Routine With AO (Automated Operator) Applications that Issue CMD or ICMD Calls

The Command Authorization exit routine can be used with automated operator (AO) applications that issue a CMD or ICMD call. The routine is called for AO applications that issue ICMD calls when the AOIS parameter is specified as A or C in the IMS, DBC, or DCC procedure. The routine is called for AO applications that issue CMD calls when the AOI1 parameter is specified as A or C in the IMS or DCC procedure.

DFSCCMD0 is called during CMD and ICMD processing to check that the AO application is authorized to issue the command that it issued. DFSCCMD0 lets you secure commands issued in the CMD and ICMD calls at the command verb, keyword, and resource name level.

Using the Routine With LU 6.2 Application Programs

When an IMS command is received from an LU 6.2 application program, the Command Authorization exit routine is called. The exit routine is called after a RACF (or equivalent) call is made, regardless of the result of the RACF security check. If neither RACF or the Command Authorization exit routine is available to authorize the command, a default level of command security is provided by IMS for commands from LU 6.2 application programs. The commands included in the default are /BROADCAST, /LOG, and /RDISPLAY.

Using the Routine with Static Terminals

The Command Authorization exit routine can be used with terminals defined statically at system definition. If SMU is requested, it performs the command authorization. If SMU is not requested, default terminal security checks the authorization. The return code from SMU or default terminal security is passed to the Command Authorization exit routine. IMS calls the exit routine (if it is included in the system) regardless of the result of the SMU or the default terminal security check; the return code from the exit routine determines authorization.

Related Reading: For more information on default terminal security, see *IMS Version 9: Administration Guide: System*.

Using the Routine with ETO Terminals

The Command Authorization exit routine can be used with terminals that are defined dynamically using ETO. If RACF (or an equivalent security product) is requested and the user is signed on, RACF performs the command authorization. IMS passes the RACF return code to the Command Authorization exit routine. IMS calls the exit routine (if it is included in the system) regardless of the result of the RACF security check.

If RACF is not requested but the Command Authorization exit routine is included in the system, IMS calls the exit routine and performs command authorization only. If neither RACF nor the Command Authorization exit routine is included, IMS provides command authorization equivalent to the default terminal security available for static terminals.

The /SIGN and /RCLSDST commands are the only commands that can be entered from an ETO terminal before signon. Although these commands cause IMS to call the Command Authorization exit routine, neither RACF nor the exit routine authorizes the commands.

Using the Routine with Commands from MCS/E-MCS Consoles

This exit routine can be used with commands entered from MCS/E-MCS consoles. The routine is called for commands from MCS/E-MCS consoles when the CMDMCS parameter is specified as B or C in the IMS, DBC, or DCC procedure.

DFSCCMD0 is called during command processing to check that the console is authorized to issue the command. DFSCCMD0 lets you secure commands at the command verb, keyword, and resource levels.

Using the Routine With IMS Open Transaction Manager Access

The Command Authorization exit routine can be used with IMS Open Transaction Manager Access (OTMA).

Using the Routine in a Shared-Queues Environment

When running in a non-shared-queues environment, the name in the field CNTNAME1 of the CNT representing the WTOR LTERM will be WTOR. In a shared-queues environment, the name in field CTNAME1 of the CNT representing the WTOR LTERM will be IMSID if it is running in a non-XRF environment and RSENAME if it is running in an XRF environment.

Communicating with IMS

IMS uses the entry and exit registers, as well as parameter lists, to communicate with the exit routine.

Contents of Registers on Entry

Upon entry, the exit routine must save all registers using the provided save area. The registers contain the following:

Register	Contents
1	Address of the standard exit parameter list.

Register	Contents
13	Address of the save area. Your exit routine must not change the first three words of this save area.
14	Return address of IMS.
15	Entry point address of exit routine.

Table 30 shows the standard exit parameter list.

Table 30. Standard Exit Parameter List (Version 1, Mapped by DFSSXPL)

Field	Offset	Length	Content
SXPLVER	0	4	Address of word containing version number of standard exit parameter list
SXPLATOK	4	4	Reserved
SXPLAWRK	8	4	Reserved
SXPLFSPL	12	4	Address of the function-specific parameter list

The macro DFSCCMD generates the DSECT for the function-specific parameter list passed to DFSCCMD0 by IMS. For additional information, see DFSCCMD included in IMS.ADFSMAC.

Contents of Registers on Exit

Before returning to IMS, the exit routine must restore all registers except for register 15, which contains the return code. See the following table:

Register	Contents								
15	One of the following return codes: <table> <thead> <tr> <th>Return Code</th> <th>Meaning</th> </tr> </thead> <tbody> <tr> <td>0</td> <td>USER/TERMINAL is authorized to use command</td> </tr> <tr> <td>4</td> <td>USER/TERMINAL is not authorized</td> </tr> <tr> <td>Negative value</td> <td>USER/TERMINAL is not authorized. The specified user message is sent to the terminal where command originated.</td> </tr> </tbody> </table>	Return Code	Meaning	0	USER/TERMINAL is authorized to use command	4	USER/TERMINAL is not authorized	Negative value	USER/TERMINAL is not authorized. The specified user message is sent to the terminal where command originated.
Return Code	Meaning								
0	USER/TERMINAL is authorized to use command								
4	USER/TERMINAL is not authorized								
Negative value	USER/TERMINAL is not authorized. The specified user message is sent to the terminal where command originated.								

Chapter 15. DBRC Command Authorization Exit Routine (DSPDCAX0)

The DBRC Command Authorization exit routine (DSPDCAX0) can be used to verify that a user is authorized to issue a particular command.

In this Chapter:

“About This Routine”

“Communicating with IMS” on page 148

“Using the Sample DBRC Command Authorization Exit Routine” on page 149

About This Routine

DSPDCAX0 is an optional exit routine and is selected using the INIT.RECON or CHANGE.RECON commands. For more information about these commands, see the *IMS Version 9: Database Recovery Control (DBRC) Guide and Reference*. This exit can be used in conjunction with RACF or another security product. The security product is invoked first and return and reason codes are passed to the exit routine. The return code from the exit routine then determines the success or failure of the command authorization. This exit routine overrides the outcome of the security product. DBRC messages that are put out as a result of unsuccessfully invoking the security product will be suppressed.

DSPDCAX0 is a required exit routine if it is specified to authorize DBRC commands by specifying sub-parameter EXIT or BOTH in the CMDAUTH keyword on the INIT.RECON or CHANGE.RECON commands.

DSPDCAX0 must be found in an authorized library or in LINKLST. If DSPDCAX0 is found in a concatenated STEPLIB or JOBLIB, only the data set containing DSPDCAX0 must be authorized. If DSPDCAX0 is found in LINKLST, no authorization check is performed.

Table 31 shows the attributes for the DBRC Command Authorization exit routine.

Table 31. Command Authorization Exit Routine Attributes

Attribute	Description
IMS environments	DB/DC, DBCTL, DCCTL
Naming convention	You must name this exit routine DSPDCAX0.
Binding	Follow the guidelines described in “Binding the Routines” on page 7. You must bind this routine into an authorized data set as a separate reentrant (RENT) load module, DSPDCAX0.
Including the routine	No special steps are needed to include this routine. The exit is only included if DBRC command authorization (CMDAUTH) is set to EXIT or BOTH.
IMS callable services	This exit is not eligible to use IMS Callable Services.
Sample routine location	IMS.ADFSSMPL (member name DSPDCAX0)

Communicating with IMS

IMS uses the entry and exit registers to communicate with the routines.

Contents of Registers on Entry

Upon entry, the exit routine must save all registers using the provided save area. The registers contain the following:

Register	Contents
1	Address of the DBRC command authorization exit parameter list
13	Address of the save area
14	Return address to DBRC
15	Entry point address of exit routine

Table 32 lists the exit parameter list. It is mapped by the DBRC Command Authorization (DCA) Interface Parameter Block (DSPDCABK).

Table 32. DCA Interface Parameter Block Description

Field name	Length in bytes	Description
DCABLKID	8	Block identifier--"DSPCABK"
DCABLKLN	4	Length of the block
DCARNPTR	4	Address of the resource name
DCARNLEN	4	Total length of resource name
DCARHPTR	4	Address of RN High Level qualifier
DCARHLEN	4	Length of RN High Level qualifier
DCARVPTR	4	Address of RN Command Verb
DCARVLEN	4	Length of RN Command Verb
DCARMPTR	4	Address of RN Command Modifier
DCARMLLEN	4	Length of RN Command Modifier
DCARQPTR	4	Address of RN Command qualifier
DCARQLEN	4	Length of RN Command qualifier
DCAUserID	8	User ID of command issuer
DCAExitAddr	4	Address of Command Authorization exit, DSPDCAX0
DCAFlags	4	Misc. flags X'40000000'= Security exit DSPDCAX0 was called. X'20000000'= 1st call (REQUEST=LIST) done. X'80000000'= Security product was called.

Table 32. DCA Interface Parameter Block Description (continued)

Field name	Length in bytes	Description
DCASAFRetCode	4	Security product (RACF or equivalent) return code
DCARACFRetCode	4	RACF return code
DCARACFRsnCode	4	RACF reason code
DCAExitRetCode	4	DSPDCAX0 return code
DCAUserAreaPtr	4	Address of a 1024-byte user area
DCAUserAreaLen	4	Length of user area (1024 bytes)
DCARACRRReq	8	RACROUTE request type
Other	36	Reserved fields for future use (36 bytes)

Contents of Registers on Exit

Before returning to DBRC, the exit routine must restore all registers except for register 15, which contains the following return code.

Register	Contents						
15	One of the following return codes: <table> <thead> <tr> <th>Return Code</th> <th>Meaning</th> </tr> </thead> <tbody> <tr> <td>0</td> <td>USER is authorized to use the DBRC command.</td> </tr> <tr> <td>nonzero</td> <td>USER is not authorized to use the DBRC command.</td> </tr> </tbody> </table>	Return Code	Meaning	0	USER is authorized to use the DBRC command.	nonzero	USER is not authorized to use the DBRC command.
Return Code	Meaning						
0	USER is authorized to use the DBRC command.						
nonzero	USER is not authorized to use the DBRC command.						

Using the Sample DBRC Command Authorization Exit Routine

For the latest version of DSPDCAX0, see the IMS.ADFSSMPL library, member name DSPDCAX0.

Chapter 16. Dependent Region Preinitialization Routines

This chapter describes Dependent Region Preinitialization routines. Dependent Region Preinitialization routines enable you to perform any application-unique dependent region initialization.

In this Chapter:

“About These Routines”

“Communicating with IMS” on page 153

About These Routines

Dependent Region Preinitialization routines can activate any z/OS system or data management services for which they are authorized, although they cannot issue DL/I calls or activate IMS system services. Because they receive control after module preload, but before IMS scheduling, you might want to use these routines for such tasks as building an internal table for your applications to access during dependent region processing.

For example, you can use a preinitialization routine to build a table for application decision making. You can maintain this table by using z/OS services in the following manner:

- Using z/OS storage management services, the preinitialization routine can acquire and format a main storage table.
- Using z/OS Name/Token callable services, the preinitialization routine can establish a name/token pair for the storage that provides the user application access to the storage area.

This name/token pair can then be used by the dependent region applications using the Name/Token services to access the table. It is your responsibility to determine what these preinitialization routines do, and how the information is made available to user applications.

Preinitialization routines are not intended to control the IMS dependent region environment. These routines provide installation information that can be shared between applications. This information can be used to control the applications and allow the application to make decisions based on the information in these tables.

The preinitialization routines must not be system-type routines (for example, z/OS services, Language, or Access Method) but rather user-written routines.

Related Reading: For guidance-level information to help you decide whether or not you want to write these routines to initialize dependent regions, see “Establishing IMS Security” in *IMS Version 9: Administration Guide: System*.

Table 33 shows the attributes of Dependent Region Preinitialization routines.

Table 33. Dependent Region Preinitialization Routines Attributes

Attribute	Description
IMS environments	DB/DC, DBCTL.

Preinitialization Routines

Table 33. Dependent Region Preinitialization Routines Attributes (continued)

Attribute	Description
Naming convention	Using standard z/OS conventions, you can give the routine any name up to eight characters in length. Be sure that the name is unique and does not conflict with the existing members of the data set in which this routine is stored. Because most IMS-supplied routines begin with the prefix "BPE," "CQS," "CSL," "DFS," "DBF," "DSP," or "DXR," choose a name that does not begin with these letters.
Binding	<p>Before a dependent region can be initialized, you must assemble all required dependent region preinitialization routines and bind into a concatenation of //STEPLIB. Normally, this is IMS.PGMLIB or the associated application program library.</p> <p>You must bind the routine as <i>reentrant</i> (RENT).</p>
Including the routine	See "Activating the Routine."
IMS callable services	This exit routine is not eligible to use IMS Callable Services.
Sample routine location	None.

Activating the Routine

The Dependent Region Preinitialization routines get control **after** the dependent region has IDENTIFIED or SIGNED-ON to the associated Control Region, but **before** IMS scheduling is attempted. These routines execute under the IMS Program Control Task whenever it:

- Is attached or reattached in problem program state/user key 8
- Receives control in the order specified in the PROCLIB member

Each Preinitialization exit routine is identified by an 80-byte record in a DFSINTxx member of IMS.PROCLIB, where xx is a suffix specified by the PREINIT keyword of the IMS dependent region procedures IMSBATCH, DFSMPR, and IMSFP.

Related Reading: For details about these procedures, see *IMS Version 9: Installation Volume 2: System Definition and Tailoring*.

Each record identifies one program in IMS.PGMLIB that is to receive control during dependent region initialization (or reinitialization after an IMS user application program abnormal termination).

The 80-byte record identifying each preinitialization routine is as follows:

Column	Contents
1-71	Routine names and entry points. The last name on a record is denoted by a comma followed by one or more blanks; the last name on the last record is followed by one or more blanks.
72-80	Must remain blank. Ignored.

The routines are given control in the order specified in the member. If a requested routine is not found, the dependent region abnormally terminates with a U0588.

Communicating with IMS

IMS uses the entry and exit registers to communicate with the routines.

Contents of Registers on Entry

Upon entry, the routine must save all registers using the provided save area. The registers contain the following:

Register	Contents
1	Zero.
13	Address of save area. The routine must not change the first three words.
14	Return address to IMS.
15	Entry point of routine.

Contents of Registers on Exit

Before returning to IMS, the routine must restore all registers except register 15, which must contain the following:

Register	Contents
15	0

Preinitialization Routines

Chapter 17. Dump Override Table (DFSFDOT0)

This chapter describes the Dump Override Table (DFSFDOT0). Use the Dump Override Table to either force or suppress dumps for specified abends.

In this Chapter:

“About This Table”

“A Sample Dump Override Table (DFSFDOT0)” on page 157

About This Table

The IMS Dump Override Table is used to override default dump processing for IMS abends that occur after early IMS initialization. You can use this table to force a dump to be taken for abend codes for which dumps are normally suppressed. You can also use it to prevent dumps for abend codes for which dumps are normally taken.

If DFSFDOT0 is present in IMS.SDFSRESL, IMS will load it during IMS initialization. If an abend occurs, this table will be searched for an entry that matches the abend code. If a matching entry is found, IMS will either take a dump or not take a dump based on the action specified on the entry's DFSFDOT macro invocation (FORCE or SUPPRESS). If a matching entry is not found, or if DFSFDOT0 is not present in IMS.SDFSRESL, IMS will use its default logic to decide whether or not to take a dump.

The Dump Override Table suppresses only IMS Control Region, IMS DLS Region, and DBRC Region abend dumps. IMS Dependent region dumps cannot be suppressed with the Dump Override Table.

The only change that the Dump Override Table makes to the dumping process is to force or suppress the initial dump decision. IMS still creates only one dump, even when multiple abends occur and matching entries are found in the Dump Override Table.

A sample Dump Override Table is shipped with a default set of entries. The entries in this sample are the same as the default processing that IMS performs if there is no DFSFDOT0 present in IMS.SDFSRESL. Modify DFSFDOT0 to fit your own needs. If you want no entries in the Dump Override Table, you must create a DFSFDOT0 with no entries. After you assemble your customized version, link it into the system to activate the changes.

Table 34 shows the attributes of Dump Override table.

Table 34. Dump Override Table Attributes

Attribute	Description
IMS environments	DB/DC, DBCTL, DCCTL.
Naming convention	This table must be named DFSFDOT0.
Link editing	This table has no executable code. It must be linked into an authorized data set as a separate, serially reusable (REUS) load module, DFSFDOT0.
Including the routine	No special steps are needed to include this table. If DFSFDOT0 does not exist, IMS will use the default dump override values that are included in DFSFDMP0.

Table 34. Dump Override Table Attributes (continued)

Attribute	Description
IMS callable services	IMS Callable Services are not applicable for use with this table.
Sample routine location	IMS.ADFSSMPL (member name DFSFDOT0).

DFSFDOT Macro

The DFSFDOT macro is an IMS-provided macro that is used to generate the DFSFDOT0 table. A DFSFDOT macro call must be coded for each abend for which you want to force a dump to be taken, and for which you want to suppress a dump. Though this macro is used to build the Dump Override Table, the macro is separate from the Dump Override Table to maintain IMS integrity.

DFSFDOT Parameters and Descriptions

Parameters are required and must be specified when defining the Dump Override Table.

DFSFDOT BEGIN

This parameter is required at the start of the Dump Override Table definition. It must be coded before any other DFSFDOT invocations. When BEGIN is specified, no other options are allowed. If any options are specified, they are ignored.

DFSFDOT END

This parameter is required at the end of the Dump Override Table and must be the last DFSFDOT invocation in DFSFDOT0. When END is specified, no other options are allowed. If any options are specified, they are ignored.

ABEND=

This parameter specifies a user or system abend for which a dump is either to be forced or suppressed. The abend is specified in one of the following forms:

UNNNN, where NNNN is the four-digit decimal number (U0780, U4095) of the abend.

SXXX, where XXX is the three-digit hexadecimal number (S075, S3E7) of the abend.

DUMP=

This parameter specifies whether the abend dump is forced or suppressed. This parameter overrides IMS dump decision logic and the z/OS dump request bit. It has two options:

FORCE generates a dump for a non-dumping ABEND. There is no default value for DUMP=.

SUPPRESS prevents unwanted dumps. Default = none.

The Dump Override Table can specify an abend code and an action of SUPPRESS. However, IMS cannot suppress all dumps. For example, z/OS or another component can write the dump prior to IMS receiving control. In the case of system abend code S122, z/OS causes the dump to be written before the abend is issued and before IMS receives control. IMS then issues message DFS3984I stating that the dump has been suppressed. This message is misleading, but as far as IMS is concerned the dump has been suppressed. IMS cannot suppress dumps produced by abends that occur after IMS has already processed the Dump Override Table. In the case of ABENDU0002, IMS has already processed the Dump Override Table.

IMS documentation does not explicitly list every abend that supplies a dump that cannot be suppressed by using the Dump Override Table.

A Sample Dump Override Table (DFSFDOT0)

This example shows you how to use the DFSFDOT to construct a Dump Override Table. The table in this example forces dumps for ABENDS S075, U780, and S222; the table suppresses dumps for ABENDS S80A and U790.

```
DFSFDOT BEGIN
DFSFDOT ABEND=S075,DUMP=FORCE
DFSFDOT ABEND=U0780,DUMP=FORCE
DFSFDOT ABEND=S80A,DUMP=SUPPRESS
DFSFDOT ABEND=S222,DUMP=FORCE
DFSFDOT ABEND=U0790,DUMP=SUPPRESS
DFSFDOT END
```

Entries need not be in order.

You can generate a Dump Override Table with no FORCE or SUPPRESS by coding a single DFSFDOT BEGIN/END pair, as follows:

```
DFSFDOT BEGIN
DFSFDOT END
```

Errors

Possible errors include:

ASSEMBLY ERROR

An assembly error is issued when an invalid abend code is specified or conflicting dispositions for an abend code are found.

ABEND U0718

An ABEND U0718 (MODULE LOAD FAILURE) is issued if DFSFDOT0 cannot be loaded.

Messages

DFSFDMP0 issues message DFS3984I when a TCB ABEND code matches an entry in the Dump Override Table. The message appears as:

```
DFS3984I DUMP FOR ABEND _____ FORCED BY DUMP OVERRIDE TABLE
DFS3984I DUMP FOR ABEND _____ SUPPRESSED BY DUMP OVERRIDE TABLE.
```

Chapter 18. ESAF (External Subsystem Attach Facility) Indoubt Notification Exit Routine (DFSFIDN0)

IMS can provide to this user exit routine the identification of external subsystem indoubt units of work if there is an IMS failure. With this information, you can resolve the indoubt work before restarting the failed IMS. This is an optional routine and, if not used, IMS will attempt to resolve the indoubt data when it can.

Related Reading: For information about IMS access to external resources using the IMS External Subsystem Attach Facility (ESAF), see Chapter 73, “ESAF (External Subsystem Attach Facility) Overview,” on page 507.

About this Routine

To use this optional exit routine, you must name it DFSFIDN0 and put it in IMS.SDFSESL.

During an emergency restart or an FDBR start, when scanning the units of work for recovery, IMS provides to the user exit routine the identities of all external subsystem units of work, the names of the external subsystems, and the final resolutions of the data.

IMS synchronously calls the exit routine once for each indoubt external subsystem unit of work. Because these are synchronous calls, you should consider the performance impacts on FDBR when writing the exit routine.

In an XRF environment, you should also consider the performance impacts of the exit routine during an XRF takeover.

Attributes of the ESAF Indoubt Notification exit routine are listed in Table 35.

Table 35. ESAF Indoubt Notification Exit Routine Attributes

Attribute	Description
IMS environments	DB/DC, DCCTL, and DBCTL.
Naming convention	You must name this exit routine DFSFIDN0.
Binding	Follow the guidelines described in “Binding the Routines” on page 7.
Including the routine	No special steps are needed to include this routine.
IMS callable services	This exit routine is not eligible to use IMS Callable Services. The routine is called in TCB mode with AMODE=31. SVCs are allowed.
Sample routine location	No sample

Communicating with IMS

IMS uses the entry and exit registers to communicate with the exit routine.

Contents of Registers on Entry

The registers on entry contain the following:

Register	Contents
1	Address of the DF SRNID parameter list.
13	Address of the save area. This save area is not chained to any IMS save area.
14	Return address to IMS.
15	Entry address of this exit routine.

The DF SRNID parameter list contains the following:

Table 36. ESAF Indoubt Notification Exit Routine Parameter List

Offset	Length	Field Name	Description
0	4	RNIDID	Eye catcher
4	4	RNIDLEN	Length of DF SRNID block
8	2	RNIDVER	Version
10	2	RNIDREL	Release
12	4	RNIDIMS	IMS ID
16	4	RNIDSSYS	External subsystem ID that owns indoubt data
20	2	RNIDRESO	Unit-of-work resolution action: CO Commit AB Abort
22	4		Reserved
28	4	RNIDUOW	Address of unit of work identification
26	2	RNIDUOWL	Length of unit-of-work identification

Contents of Registers on Exit

All registers must be restored up return.

Chapter 19. IMS Command Language Modification Facility (DFSCKWD0)

This chapter describes how the IMS Command Language Modification Facility modifies the command keyword table.

Related Reading: For a complete explanation of the IMS command language, see *IMS Version 9: Command Reference*.

In this Chapter:

“About This Facility”

“Using the Sample IMS Command Modification Facility” on page 164

About This Facility

Several reasons exist for altering the keyword table. For example, you might want to tailor the keywords and synonyms to satisfy unique requirements. A new keyword or keyword synonym in a new IMS release can conflict with a name already assigned by your installation to a resource such as an LTERM or a transaction. If a new keyword “ABC” is introduced and you already have an LTERM with the name “ABC”, you can change the keyword name to “ABCDEFGH” and remove the source of the conflict. If the source of the conflict is the new keyword synonym, you can change or delete the synonym.

Another reason you might want to modify the table is to limit the use of the ALL parameter for certain keywords by changing the parameter’s default value from ALL=YES to ALL=NO or ALL=DIS. Using ALL=YES allows the operator to enter IMS commands with the ALL option; this requires a significant increase in storage in the IMS general pool and adversely affects IMS performance. To avoid these negative consequences, you can specify ALL=NO or ALL=DIS to be used with IMS commands except those associated with AOI transactions.

To obtain a listing of the command keyword table, print DFSCKWD0, a member of IMS.ADFSSRC. It contains the IMS keywords and synonyms described in the *IMS Version 9: Command Reference*.

Details about ALL=NO and ALL=DIS options and instructions for modifying them are discussed in the following sections.

Table 37 shows the attributes of the IMS Command Language Modification facility.

Table 37. IMS Command Language Modification Facility Attributes

Attribute	Description
IMS environments	DB/DC, DCCTL, DBCTL.
Naming convention	You must name this routine DFSCKWD0 with ALIAS CKWDTABL.

Table 37. IMS Command Language Modification Facility Attributes (continued)

Attribute	Description
Binding	<p>Follow the guidelines described in “Binding the Routines” on page 7.</p> <p>Example: This shows you how to bind the exit routine into IMS.SDFSRESL.</p> <pre>//LINKIT JOB 1,MSGLEVEL=1 //LINK EXEC PGM=IEWL,PARM=(RENT,REFR,NCAL,XREF,LIST) //SYSUT1 DD UNIT=SYSDA,SPACE=(TRK,(20,20),RLSE) //SYSPRINT DD SYSOUT=A //SYSLMOD DD DSN=IMS.SDFSRESL.,DISP=SHR //OBJJIN DD DSN=IMS.USERLIB.,DISP=SHR //SYSLIN DD * INCLUDE OBJJIN(DFSCKWD0) MODE AMODE(31),RMODE(ANY) ALIAS CKWDTABL ENTRY DFSCKWD0 NAME DFSCKWD0(R) /*</pre>
Including the routine	No special steps are needed to include this routine.
IMS callable services	IMS Callable Services are not applicable for use with this module.
Routine location	For the latest version of DFSCKWD0, see the IMS.ADFSSRC library; member name is DFSCKWD0.

Changing the Table

Two of the macro statements that appear in the table, KEYWD and SYN, can be replaced to modify the keywords and synonyms. One way of modifying the table is:

1. Edit module DFSCKWD0.
2. Change the KEYWD and SYN macro statements.
3. Reassemble DFSCKWD0.
4. Relink the reassembled DFSCKWD0 in IMS.SDFSRESL.

Related Reading: *IMS Version 9: Command Reference* contains the list of reserved words, including command keywords, keyword synonyms, and reserved parameters.

Changes to DFSCKWD0 cannot conflict with the names in this list. Keywords can be changed and keyword synonyms can be added, changed, or deleted, as long as the new keyword or synonym is not a reserved word. For example, a new synonym of “MSDB” for MSDBLOAD cannot be added, because “MSDB” is a reserved parameter. If “MSDB” is made a keyword synonym, the /DBDUMP DATABASE MSDB command fails with a syntax error.

KEYWD macro statements must be substituted one-for-one in the table. No new KEYWD macro statements can be added.

KEYWD Macro

KEYWD

keyword,LAST=NO|YES,ALL=YES|NO|DIS

Where *keyword* is the new or changed keyword. LAST=NO and ALL=YES are the defaults and need not be supplied. LAST=YES must be specified if it is the last macro call in the module. A keyword cannot exceed 12 characters in length.

Specifying ALL=NO prevents the use of the ALL parameter with all IMS commands that apply to the keyword being changed (except for commands issued from AOI programs).

For example, specifying ALL=NO for the keyword LTERM prevents the use of the ALL parameter for the following commands:

```
/BROADCAST LTERM ALL
/DISPLAY ASSIGNMENT LTERM ALL
/DISPLAY LTERM ALL
/LOCK LTERM ALL
/PSTOP LTERM ALL
/PURGE LTERM ALL
/START LTERM ALL
/STOP LTERM ALL
/UNLOCK LTERM ALL
```

Specifying ALL=DIS prevents the use of the ALL parameter with all /DISPLAY commands that apply to the keyword being changed (except for commands issued from AOI programs).

For example, specifying ALL=DIS for the keyword LTERM prevents the use of the ALL parameter for the following commands:

- /DISPLAY ASSIGNMENT LTERM ALL
- /DISPLAY LTERM ALL

SYN Macro

SYN *synonym*,LAST=YES|NO

Where *synonym* is the desired synonym. LAST=NO is the default and need not be specified. LAST=YES must be coded if this is the last macro call in the assembly. Synonyms cannot exceed 12 characters in length; they must be defined under the keyword to which they apply.

Error Messages

Any error in a macro statement terminates assembly of the keyword table and results in generation of an error message. The remaining macro statements are error checked, but nothing is generated. All macro assembly errors are severity code 16 errors.

KYTBL001 - SEQUENCE ERROR. XXX CANNOT FOLLOW IKEY

A macro was called which cannot immediately follow an IKEY macro call. XXX is either IKEY or SYN. IKEY calls cannot be modified.

KYTBL002 - XXX CALLED WITHOUT ANY PARAMETER

A macro was called without any parameter. XXX is either IKEY, KEYWD, or SYN.

KYTBL003 - XXX IS NOT A VALID INTERNAL KEYWORD

The parameter specified on an IKEY call (XXX) is not known to the system. IKEY calls cannot be modified.

KYTBL004 - KEYWORD TABLE ASSEMBLY TERMINATED

This message appears as a comment after the first error message in a keyword table assembly. All subsequent macro calls will only perform error checking. No code will be generated.

KYTBL005 - SEQUENCE ERROR. KEYWD MUST FOLLOW AN IKEY CALL

A KEYWD macro was called that does not immediately follow an IKEY call.

KYTBL006 - LENGTH ERROR. XXX TOO LONG

The parameter specified on a KEYWD or SYN macro is more than 12 characters in length.

KYTBL007 - INTERNAL KEYWORD 'XXX' HAS NOT BEEN USED

LAST=YES was specified on either a KEYWD or SYN macro call, but not all internal keywords known to the system have been generated. IKEY calls cannot be modified. LAST=YES must appear only on the last macro call in the assembly.

KYTBL008 - XXX CANNOT BE SPECIFIED AGAIN

Internal keyword 'XXX' has already been used. IKEY macro calls cannot be modified.

KYTBL009 - KEYWD MACRO PARAMETER ALL IS INVALID

ALL=NO was erroneously specified on the KEYWD macro at the time the IMS Command Keyword Table (DFSCWD0) was modified.

Message DFS058 COMMAND COMPLETED EXCEPT xxx y z... uses the keyword table to replace 'xxx' with the keyword associated with the command that caused the message. Therefore, keywords defined by KEYWD macro calls appear in this message. Other messages, however, are prebuilt, and keywords that might have changed will still appear in these.

Using the Sample IMS Command Modification Facility

For the latest version of DFSCWD0, see the IMS.ADFSSRC library; member name is DFSCWD0.

Chapter 20. Large System Definition Sort/Split Input exit routine (DFSSS050)

The Large System Definition Sort/Split Input exit routine enables you to alter the resource data for user-generated resources. User-generated resources are those that are built as partition data set (PDS) add members during the Stage 1 assembly and are designated for user customization only.

The following topics provide additional information;

“About This Routine”

“Communicating with IMS” on page 166

About This Routine

The Large System Definition Sort/Split Input exit routine uses a control record to process user resources and to call exit routines. Each user-generated resource type must have a control record created for the Resource Information File during Stage 1. The control record instructs the Sort/Split utility to process a user resource and to call the Sort/Split utility exit routines. The details of the control record layout are provided in the prolog of the LGNBLKS macro.

DFSSS050 is called by the Large System Definition Sort/Split routine following the reading of each user input resource and before the sort table is built.

Related Reading: For more information about the Large System definition Sort/Split routine, see *IMS Version 9: Administration Guide: System*.

DFSSS050 allows you to customize the resource data with a return code to the calling routine in register 15. You can insert, delete, or update the resource data.

Attributes of the Routine

Table 38 shows the attributes of the Large System Definition Sort/Split Input exit routine.

Table 38. Large System Definition Sort/Split Input Exit Routine Attributes

Attribute	Description
IMS environments	DB/DC, DCCTL
Naming convention	You must name this exit routine DFSSS050.
Binding	Follow the guidelines described in “Binding the Routines” on page 7.
Including the routine	No special steps are needed to include this routine.
IMS callable services	IMS Callable Services are not applicable for use with this exit routine.
Sample routine location	IMS.ADFSSRC (member name DFSSS050)

Restrictions

Only one function can be performed per call.

DFSSS050

If a return code other than those listed is returned to the calling routine, an error message is issued, and further processing ceases.

The length of the input buffer and the user buffer must be the same.

The length of the buffers cannot be altered or unpredictable results occur. The buffer length is equivalent to the length of the resource data in 80-byte increments, plus 10 bytes for the sort key.

This routine cannot be used in a DBCTL environment.

Communicating with IMS

The input buffer pointer, input buffer length, and user buffer pointer are passed to DFSSS050 on each call. The input buffer pointer and input buffer length (used for updates only) pertain to the buffer containing the current resource data.

The input buffer contains a “complete” resource. If the resource is a single record resource, the input buffer is 90 bytes in length, where:

- The first 10 bytes are the sort key.
- The following 80 bytes are the actual resource data.

If the resource comprises multiple records, the length of the input buffer is large enough to contain all the 80-byte increments for the resource, plus the 10-byte sort key. The sort key is in the first 10 bytes of the buffer. The resource records follow in 80-byte increments.

The user buffer pointer contains the address of the buffer where an insert is made. The length of the user buffer is the same as the input buffer.

Contents of Registers on Entry

Upon entry, the exit routine must save all registers using the provided save area. The registers contain the following:

Register	Contents
1	Address of the input parameter list (three words long).
13	Address of save area. The exit routine must not change the first three words.
14	Return address to IMS.
15	Entry point of exit routine.

Contents of Registers on Exit

Before returning to IMS, the exit routine must restore all registers except register 15, which must contain one of the following return codes:

Return Code	Meaning
X'10'	Return Next: You do not want to modify the current resource, but would like to be called with the next resource.

Return Code Meaning

X'20'	Insert: You want to make an insert into the data of the resource preceding the one currently in the input buffer. A pointer to the user buffer is provided for the insert. Once the insert is complete, the user buffer is cleared, and DFSSS050 is called again, with the current resource still in the input buffer. Subsequent inserts can be performed before processing the resource currently in the input buffer.
X'40'	Delete: You want to delete the resource currently in the input buffer. The return code of X'40' is all that is needed to delete the current resource.
X'60'	Update: You want to update the resource in the input buffer. The change is made to the input buffer, and then control is returned to the calling routine.
X'90'	Do not call: You want to process the remaining resources for this user type as a non-user type resource. After this return code is issued, DFSSS050 is not called again for this user resource type and prior to the sort step.

Altering the sort key can affect the sorting process of the resource type.

Chapter 21. Large System Definition Sort/Split Output Exit Routine (DFSSS060)

The Large System Definition Sort/Split Output exit routine enables you to alter the resource data for user-generated resources. User-generated resources are those resources that are built as partition data set (PDS) members during the Stage 1 assembly and are designated for user customization only.

The following topics provide additional information:

“About This Routine”

“Communicating with IMS” on page 170

About This Routine

The Large System Definition Sort/Split Output exit routine uses a control record to process user resources and to call exit routines. Each user-generated resource type must have a control record created for the Resource Information File during Stage 1. The control record instructs the Sort/Split utility to process a user resource and to call the Sort/Split exit routines. The details of the control record layout are provided in the prolog of the LGNBLKS macro.

DFSSS060 allows you to customize the resource data by means of a return code sent to the calling routine in register 15. You can alter the sorted resource at each of the three sections of a member.

DFSSS060 is called by the Large System Definition Sort/Split Routine after each user resource type is sorted and before writing each resource for the user resource type.

Related Reading: For more information about the Large System Definition Sort/Split Routine, see *IMS Version 9: Administration Guide: System*.

Table 39 shows the attributes of the Large System Definition Sort/Split Output exit routine.

Table 39. Large System Definition Sort/Split Output Exit Routine Attributes

Attribute	Description
IMS environments	Batch LGEN process.
Naming convention	You must name the exit DFSSS060.
binding	Follow the guidelines described in “Binding the Routines” on page 7.
Including the routine	No special steps are needed to include this routing.
IMS callable services	IMS Callable Services are not applicable for use with this exit routine.
Sample routine location	IMS.ADFSSRC.

Restrictions

There are some restrictions associated with this routine:

- Only one function can be performed per call.

- If a return code other than those listed is returned to the calling routine, an error message is issued, and further processing ceases.
- The length of the input buffer and the user buffer must be the same.
- The length of the buffers cannot be altered, or unpredictable results occur.
- This routine cannot be used in a DBCTL environment.

Communicating with IMS

The input buffer pointer, the input buffer length, the user buffer pointer, and the member section are passed to DFSSS060 on each call. The input buffer pointer and the input buffer length pertain to the buffer containing the current resource; they are used for updates only.

The user buffer pointer contains the address of buffer where an insert is made.

The output PDS contains members for a given resource type. Each member contains three sections where user resource type members can be altered. These sections are:

- BOM** Beginning of member, where a header record can be inserted
- RES** Resource section of the member, where a resource can be inserted, updated, or deleted
- EOM** End of member, where a trailer record can be inserted

Contents of Registers on Entry

Upon entry, the exit routine must save all registers using the provided save area. The registers contain the following:

Register	Contents
1	Address of the input parameter list (four words long).
13	Address of save area. The exit routine must not change the first three words.
14	Return address to IMS.
15	Entry point of exit routine.

Contents of Registers on Exit

Before returning to IMS, the exit routine must restore all registers except register 15, which must contain one of the following return codes, listed by section of the member:

BOM (beginning of member):

Return Code	Meaning
X'20'	Insert: You want to insert a header record before processing the resource section. The insert is performed from the user buffer. The CSECT record (if the END record exists) and the GEN record (if it exists), are written to the LGENOUT data set.

After the insert is processed by the calling routine, this exit is called again with the user buffer cleared.

Return Code Meaning

X'80'	Section done: You do not have any (or any more) header records to insert. This routine is not called again for the BOM section of this member of this user resource type. It is called again at the BOM section of the subsequent members of this resource type.
X'90'	Do not call: You want to process the remaining resources for this user resource type as a non-user resource. This routine is not called again for the remainder of this member or for any subsequent member for this resource type. This is the default request.

RES (resource section of the member):**Return Code Meaning**

X'10'	Return next: You do not want to change the current resource and, would like to be called with the next resource.
X'20'	Insert: You want to insert a resource before processing the current one. The insert is performed from the user buffer. After the insert is processed by the calling routine, this routine is called again with the original resource in the input buffer and the user buffer cleared.
X'40'	Delete: You want to delete this resource. A return code of X'40' is all that is required for the delete.
X'60'	Update: You want to update this resource. The update is performed in the input buffer.
X'80'	Section done: You do not have any (or any more) resources to insert, delete, or update. This routine is not called again for the RES section of this member for this user resource type. It is called again at the BOM section for the subsequent members of this resource type. This is the default request.
X'90'	Do not call: You want to process the remaining resources for this user resource type as a standard resource. This routine is not called again for the remainder of this member or for any subsequent member for this resource type.

EOM (end of member section):**Return Code Meaning**

X'20'	Insert: You want to insert a trailer record before the end record, if the end record exists. The insert is performed from the user buffer. After the insert is processed by the calling routine, this routine is called again with the user buffer cleared.
X'80'	Section done: You do not have any (or any more) trailer records to insert. This routine is not called again for the EOM section of this member for this resource type. It is called again at the BOM section of the subsequent members for this resource type. This is the default request.
X'90'	Do not call: You want to process the remaining resources for this user resource type as a standard (non-user type) resource. This routine is not called again for the remainder of this member or for any subsequent member for this resource type.

The count of resources written per member can be greater or less than the split count, due to the ability of this routine to insert into and delete members. The split count is the number of resources that will assemble in a 4096K-byte region.

Related Reading: Refer to *IMS Version 9: Administration Guide: System* for further information.

Chapter 22. Log Archive Exit Routine

The Log Archive exit routine produces an edited subset of the complete IMS log.

The following topics provide additional information;

“About This Routine”

“Communicating with IMS” on page 174

“Sample Log Archive Exit Routine” on page 176

About This Routine

You can use the sample Log Archive exit routine to produce an edited subset of the complete IMS log. The subset log contains the records needed by the Tivoli Performance Reporter z/OS, (Program Number 5695-101). The Tivoli Performance Reporter z/OS (PR) collects statistics about IMS transactions and schedules.

Related Reading: For details on the data collected by PR, see *Performance Reporter for z/OS IMS Performance Feature Guide and Reference*.

Restriction: The IBM-supplied sample exit routine is applicable only to an IMS DB/TM system and should not be used in a DBCTL environment.

However, a user-written exit routine can run in a DBCTL environment.

Table 40 shows the attributes of the Log Archive exit routine.

Table 40. Log Archive Exit Routine Attributes

Attribute	Description
IMS environments	Only used by the Log Archive utility.
Naming convention	Must match name specified on Log Archive EXIT statement.
Binding	Follow the guidelines described in “Binding the Routines” on page 7.
Including the routine	Use the Utility Control EXIT statement.
IMS callable services	This exit routine is not eligible to use IMS Callable Services.
Sample routine location	See Figure 24 on page 176.

Attributes of the Routine

You must write this exit routine in assembler language.

Restrictions

An abend in the exit routine causes the utility to abend. IMS macros cannot be used in the exit routine. Because the performance of the exit routine affects the total performance of the utility, the logic of the exit routine should not be so complicated as to delay the OLDS from being used by the online region.

Using IMS Callable Services with this Routine

This exit routine is not eligible to use IMS Callable Services.

Communicating with IMS

IMS communicates with the Log Archive exit routine through the entry registers, parameter list, and exit registers.

Contents of Registers on Entry

Upon entry, the exit routine must save all registers using the provided save area. The registers contain the following:

Register	Contents
1	Address of parameter list.
13	Address of save area. The exit routine must not change the first three words.
14	Return address to the calling RECON access routine.
15	Entry point of exit routine.

Parameter List

The parameter list contains the following:

Exit Routine Word (Word 1)

This word belongs to the exit routine. On the initialization call entry to the exit routine, this word contains binary 0. The routine can store any value in this word. For example, the word can point to an area allocated for use by the exit routine through the GETMAIN macro. On subsequent calls to the exit routine, this field contains the value left by the routine on its previous invocation.

Call Type Indicator Field Address (Word 2)

Address of a one-byte area containing the call type indicator.

- X'01'** Initialization call
- X'02'** Log record processing call
- X'03'** Termination call

The call type indicator identifies the reason for calling the exit routine, and the exit routine can have a separate routine for each call type. The user exit should not change this field.

Address of Area Containing the Current Input Log Record or Utility Return Code (Word 3)

The high-order bit of this word is ON to indicate the end of the list. The contents of the remainder of the word depends on the type of call:

- On an initialization call, this word is zero.
- On a log record processing call, this word will have the address of an area containing the current input log record. The first four bytes of the log record are a BSAM RDW (Record Descriptor Word).
- On a termination call, this word will contain the return code for the current utility.

Contents of Registers on Exit

Before returning to IMS, the exit routine must restore all registers except register 15, which must contain one of the following return codes:

X'00' Active utility continues processing

non-0 Active utility terminates and IMS issues an error message

Termination due to the exit routine on an initialization call or a log record processing call prevents successful execution of the utility. Termination due to the routine on a termination call results in an error message and a nonzero return code, but successful execution is not prevented, because DBRC has already been notified of archive completion.

Sample Log Archive Exit Routine

Figure 24 shows the Sample Log Archive exit routine.

```

IMSEXIT CSECT ,
**START OF MODULE SPECIFICATION*****
*
*  MODULE-NAME = IMSEXIT
*
*  DESCRIPTIVE-NAME = SAMPLE IMS ARCHIVE FUNCTION EXIT
*
*  COPYRIGHT = NONE
*
*
*  FUNCTION:
*  WRITES THE RECORDS USED BY SLR V3 (IBM PP, PROG NO 5665-397)
*  INTO THE FILE WITH DDNAME IMSLOG. THE FOLLOWING RECORD TYPES
*  ARE WRITTEN (ALL IN HEX): 01, 03, 06, 07, 31, 34, 35, 36, 38,
*  4001, 4003, 4004, 4098, 42. MESSAGE TEXTS OF 01 AND 03
*  RECORDS ARE TRUNCATED TO 24 BYTES.
*
*  LOGIC:
*  CASE INIT.
*  GETMAIN STORAGE FOR WORK AREAS AND ANCHOR IT IN THE USER
*  WORD.
*  OPEN OUTPUT FILE.
*  END CASE INIT.
*
*  CASE NORMAL.
*  SUBCASE RECORD TYPES 01, 03.
*  CALCULATE TOTAL LENGTH OF ALL TEXT SEGMENTS.
*  IF (LENGTH OF ALL TEXT SEGMENTS > 24 BYTES) THEN
*  TRUNCATE ANY MESSAGE PART TO 24 BYTES.
*  CHANGE SIGN OF TOTAL TEXT LENGTH AND STORE IT BACK AS AN
*  INDICATOR.
*  ELSE.
*
*  COPY RECORD.
*  END SUBCASE RECORD TYPES 01, 03.
*
*  SUBCASE RECORD TYPES 06, 07, 31, 34, 36, 38, 42.
*  COPY RECORD.
*  END SUBCASE RECORD TYPES 06, 07, 31, 34, 36, 38, 42.
*
*  SUBCASE RECORD TYPES 4001, 4003, 4004, 4098.
*  COPY RECORD.
*  END SUBCASE RECORD TYPES 4001, 4003, 4004, 4098.
*  END CASE NORMAL.
*
*  CASE TERMINATE.
*  CLOSE OUTPUT FILE.
*  FREEMAIN STORAGE FOR WORK AREAS AND RESET ANCHOR POINTER.
*  END CASE TERMINATE.
*
*  NOTES = SEE BELOW
*
*  DEPENDENCIES = NONE

```

Figure 24. Sample Log Archive Exit Routine (Part 1 of 9)

```

*
*   RESTRICTIONS = NONE
*
*   REGISTER CONVENTIONS = SEE LINKAGE
*
*   PATCH LABEL = NONE
*
*   MODULE-TYPE = PROCEDURE
*
*   PROCESSOR = ASSEMBLER
*
*   MODULE-SIZE = SEE ASSEMBLER LISTING
*
*   ATTRIBUTES = REENTRANT
*
*   ENTRY-POINT = IMSEXIT
*
*   PURPOSE = SEE FUNCTION
*
*   LINKAGE = STANDARD OS LINKAGE
*
*   INPUT:
*   REGISTER 1 POINTS TO A 3-WORD PARAMETER LIST:
*
*   USERWORD - PTR(31). CONTAINS ZERO AT INIT CALL, AND A POINTER
*               TO A WORKAREA AT NORMAL AND TERM CALLS.
*   TYPEPTR  - PTR(31). POINTS TO A 1-BYTE AREA, THAT CONTAINS:
*               X'01' - INIT CALL
*               X'02' - NORMAL CALL
*               X'03' - TERM CALL
*   RECPTTR  - PTR(31). FOR NORMAL CALL, POINTER TO A LOG RECORD.
*
*   FEEDBACK:
*   USERWORD - PTR(31). FILLED IN WITH A POINTER TO A GETMAINED
*               WORK AREA AT INIT CALL.
*
*   OUTPUT:
*   SELECTED LOG RECORDS WRITTEN TO DDNAME IMSLOG
*
*   MESSAGES:
*   001 - UNABLE TO GET STORAGE
*   002 - UNABLE TO OPEN FILE IMSLOG
*   003 - ERROR DURING PUT TO IMSLOG
*   004 - INVALID CALL TYPE
*
*   ABEND CODES:
*   NONE.
*
*   EXTERNAL-REFERENCES = NONE
*
*   ASSEMBLER MACROS:
*   DCB
*   DCBD

```

Figure 24. Sample Log Archive Exit Routine (Part 2 of 9)

IMSEXIT

```

*   FREEMAIN *
*   CLOSE *
*   GETMAIN *
*   OPEN *
*   PUT *
*
*
*   NOTES: *
*   THE FOLLOWING REGISTERS ARE IN THE CODE: *
*
*   R6 = RECPTR: POINTER TO THE INPUT RECORD *
*   R9 = PBLDREC: POINTER TO THE RECORD TO WRITE *
*   R10 = ENTIND: ENTRY TYPE *
*
**END OF MODULE SPECIFICATION*****
*-----*
*
*   PROLOG CODE *
*   - SET UP ADDRESSABILITY *
*   - GETMAIN STORAGE IF INIT CALL *
*
*-----*
*
*   USING *,R15
*   B PROLOG * BRANCH PAST MODULE ID
*   DC AL1(16) * MODULE ID LENGTH
*   DC C'IMSEXIT 82.103' * MODULE ID
*   DROP R15
PROLOG STM R14,R12,12(R13) * SAVE REGS
LR R12,R15 * SET NEW BASE REG
USING IMSEXIT,R12 * SET ADDRESSABILITY
LR R11,R1 * SAVE PARM LIST ADDRESS
L R1,0(,R1) * GET WORK AREA POINTER (OR 0)
L R7,4(,R11) * COPY
SLR ENTIND,ENTIND * ENTRY
IC ENTIND,0(,R7) * INDICATOR
LTR ENTIND,ENTIND * IS ENTRY TYPE ZERO ?
BZ OTHCASE * YES, SKIP TO ISSUE MSG
CL ENTIND,TERMCALL * IS ENTRY TYPE TOO GREAT ?
BH OTHCASE * YES, SKIP TO ISSUE MSG
C ENTIND,INITCALL * NO, IS THIS INIT ENTRY ?
BNE NOGETMAN * NO, DON'T ISSUE GETMAIN
L R0,SIZEWORK * GET SIZE OF DYNAMIC AREA
GETMAIN R,LV=(0) * GET STORAGE FOR DYNAMIC AREA
LTR R15,R15 * REQUEST OK ?
BZ GETMOK * YES, SKIP ON
* * NO, SEND A MESSAGE
WTO 'IMSE001 - UNABLE TO GET STORAGE',ROUTCDE=11,DESC=7
B NOFREEMN * SKIP TO EPILOG & RETURN
GETMOK ST R1,0(,R11) * SAVE ADDR IN USER WORD
NOGETMAN LTR R1,R1 * ANY STORAGE GOTTEN ?
BZ NOFREEMN * NO, SKIP TO EPILOG & RETURN
USING WORKAREA,R1 * SET TEMP LOCATE OF NEW SAVEAREA
ST R13,SAVEAREA+4 * SET CHAIN BACK PTR IN NEW SAVEAR

```

Figure 24. Sample Log Archive Exit Routine (Part 3 of 9)

```

DROP R1 * DROP TEMP LOCATE
ST R1,8(,R13) * SET CHAIN FORWARD PTR IN OLD SAV
LR R13,R1 * POINT TO NEW SAVE AREA
USING WORKAREA,R13 * LOCATE NEW SAVEAREA
L RECPTR,8(,R11) * COPY RECORD POINTER
SLR PBLDREC,PBLDREC * ZERO OUTPUT RECORD POINTER
C ENTIND,INITCALL * IS THIS INITIAL CALL ?
BNE NOTINIT * IF NOT, SKIP ON
*-----*
*
* INIT CALL *
*
*-----*
MVC DYNDCB(LEDCB),LISTDCB * COPY STATIC TO DYNAMIC DCB
OI DYNOPEN,X'80' * SET HIGH ORDER BIT IN OPEN LIST
LA R5,DYNDCB * POINT TO DYNAMIC DCB
OPEN ((R5),OUTPUT),MF=(E,DYNOPEN) * OPEN DYNAMIC DCB
USING IHADCB,R5 * LOCATE DCB
TM DCBOFLGS,DCBOFOPN * OPEN OK ?
BO EPILOG * YES, SKIP TO EPILOG
* NO, SEND A MESSAGE
WTO 'IMSE002 - UNABLE TO OPEN FILE IMSLOG',ROUTCDE=11,DESC=7
L ENTIND,TERMCALL * INDICATE TO TERMINATE
B EPILOG * SKIP TO EPILOG AND RETURN
DROP R5 * DROP DCB ADDRESS
*-----*
*
* NORMAL CALL *
*
*-----*
NOTINIT C ENTIND,NORMCALL * IS THIS NORMAL CALL ?
BNE TERMCase * IF NOT, SKIP TO TERMINATE CASE
SLR R7,R7 * INSERT RECORD TYPE
IC R7,RECTYPE(,RECPTR) * INTO WORK REGISTER
*-----*
* BRANCH TO APPROPRIATE RECORD PROCESSING ROUTINE *
* VIA BRANCH TABLE *
*-----*
C R7,TYPE01 * RECORD TYPE 01 ?
BL RECEND * NO, SOMETHING LESS, IGNORE IT
BE REC0103 * YES, GO PROCESS IT
C R7,TYPE42 * NO, RECORD TYPE 42 ?
BH RECEND * NO, SOMETHING LARGER, IGNORE
BE RECCOPY * YES, GO PROCESS IT
BCTR R7,0 * CONVERT RECORD TYPE 02 - 41
SLL R7,2 * TO A 4-BYTE INDEX
BRANCHTB B BRANCHTB(R7) * USED TO BRANCH IN TABLE
B RECEND * RECORD TYPE 02, NOT USED HERE
B REC0103 * RECORD TYPE 03
DC 2S(X'7F0'(4),RECEND) * RECORD TYPES 04 AND 05, NOT USED
* ABOVE INSTRUCTION IS EQUIVALENT TO 2 BRANCHES TO RECEND
B RECCOPY * RECORD TYPE 06
B RECCOPY * RECORD TYPE 07

```

Figure 24. Sample Log Archive Exit Routine (Part 4 of 9)

IMSEXIT

```

      DC 41S(X'7F0'(4),RECEND) * RECORD TYPES 08 - 30, NOT USED
* ABOVE INSTRUCTION IS EQUIVALENT TO 41 BRANCHES TO RECEND
      B RECCOPY * RECORD TYPE 31
      DC 2S(X'7F0'(4),RECEND) * RECORD TYPES 32 AND 33, NOT USED
* ABOVE INSTRUCTION IS EQUIVALENT TO 2 BRANCHES TO RECEND
      B RECCOPY * RECORD TYPE 34
      B RECCOPY * RECORD TYPE 35
      B RECCOPY * RECORD TYPE 36
      B RECEND * RECORD TYPE 37, NOT USED HERE
      B RECCOPY * RECORD TYPE 38
      DC 7S(X'7F0'(4),RECEND) * RECORD TYPES 39 - 3F, NOT USED
* ABOVE INSTRUCTION IS EQUIVALENT TO 7 BRANCHES TO RECEND
      B REC40 * RECORD TYPE 40
      B RECEND * RECORD TYPE 41, NOT USED HERE
*-----*
* RECORD PROCESSOR FOR 01, 03 RECORDS *
* - COPY AT MOST 24 BYTES OF MESSAGE TEXT *
*-----*
REC0103 DS 0H * PROCESS RECORDS 01, 03
      LA PBLDREC,RECAREA * POINT TO OUTPUT BUFFER
      LH R2,RECPRELL(,RECPTR) * LOAD RECORD PREFIX LENGTH
      LH R7,RECLL(R2,RECPTR) * SAVE LENGTH OF 1ST SEGMENT
      LH R5,RECLL(,RECPTR) * CALCULATE TEXT (REMAINING)
      SLR R5,R2 * LENGTH
      LA R8,24
      CR R5,R8 * MORE THAN 24 BYTES ?
      BNH LESS24 * NO, USE THIS LENGTH
*-----*
* - RECORD MUST BE TRUNCATED. *
* CALCULATE TEXT LENGTH OF ALL SEGMENTS *
* TO INDICATE THAT RECORD WAS TRUNCATED, CHANGE SIGN OF LENGTH *
*-----*
      LA R7,0(R2,RECPTR) * POINT TO 1ST TEXT SEGMENT
      S R5,SUFFLEN * SUBTRACT SEQUENCE NUMBER FROM LEN
      SLR R3,R3 * ZERO TEXT LENGTH COUNTER
NEXTSEG LH R4,0(R3,R7) * LOAD TEXT SEGMENT LENGTH
      LTR R4,R4 * TEST FOR ZERO
      BZ ALLSEGS * SKIP IF ZERO
      AR R3,R4 * ACCUMULATE LENGTH

      CR R3,R5 * COMPARE TO TOTAL LENGTH
      BL NEXTSEG * BRANCH IF LESS THAN TOTAL
ALLSEGS LNR R7,R3 * INDICATE RECORD WAS TRUNCATED
      LR R5,R8 * ONLY USE 1ST 24 BYTES OF TEXT
LESS24 ALR R5,R2 * GET WHOLE LENGTH TO MOVE
      LR R0,R5 * SAVE LENGTH
      LR R2,PBLDREC * POINT TO TARGET AREA
      LR R4,RECPTR * POINT TO SOURCE AREA
      LR R3,R5 * SET LENGTH OF SOURCE
      MVCL R2,R4 * MOVE RECORD
      STH R0,RECLL(,PBLDREC) * ADJUST TARGET LENGTH
      LH R2,RECPRELL(,RECPTR) * LOAD RECORD PREFIX LENGTH
      STH R7,RECLL(R2,PBLDREC) * ADJUST TARGET TEXT LENGTH
      B RECEND * END PROCESS RECORDS 01, 03

```

Figure 24. Sample Log Archive Exit Routine (Part 5 of 9)

```

*-----*
*   RECORD PROCESSOR FOR 06, 07, 31, 34, 36, 38, AND 42 RECORDS   *
*   - COPY RECORD AS IT IS                                       *
*-----*
RECCOPY DS    0H                * RECORDS TO COPY
        LR    PBLDREC,RECPTTR  * POINT TO INPUT RECORD
        B     RECEND           * END PROCESS COPY-ONLY RECORDS
*-----*
*   RECORD PROCESSOR FOR TYPE 40 (CHECKPOINT) RECORDS           *
*   - COPY SUBTYPES 01, 03, 04, 98                             *
*   - IGNORE THE REST                                          *
*-----*
REC40   DS    0H                * RECORD 40 - CHECKPOINT
        SR    R7,R7            * CLEAR WORK REGISTER
        IC    R7,RECSUBT(,RECPTTR) * GET RECORD SUBTYPE
        C     R7,TYPE03        * CNT TYPE RECORD ?
        BE    REC40USE        * YES, GO COPY IT
        C     R7,TYPE04        * SMB TYPE RECORD ?
        BE    REC40USE        * YES, GO COPY IT
        C     R7,TYPE01        * START CHECKPOINT RECORD ?
        BE    REC40USE        * YES, GO COPY IT
        C     R7,TYPE98        * END CHECKPOINT RECORD ?
        BNE   RECEND           * NO, IGNORE IT
REC40USE DS   0H                * YES,
        LR    PBLDREC,RECPTTR  * INDICATE TO COPY RECORD
*-----*
*   CHECK IF ANYTHING INTERESTING FOUND                         *
*   IF SO, PUT THE RECORD                                       *
*-----*
RECEM   DS    0H                * END PROCESS RECORDS
        LTR   PBLDREC,PBLDREC  * ANYTHING INTERESTING FOUND ?
        BZ    EPILOG          * NO, SKIP TO EPILOG
        LA    R1,DYNDCEB      * YES, LOAD DCB ADDRESS
        USING IHADCB,R1       * LOCATE DCB
        CLC   RECL(2,PBLDREC),DCBLRECL * IS DEFINED LRECL BIG ENOUGH?
        BH    SYNAD           * NO, TREAT AS I/O ERROR
        PUT   (1),(PBLDREC)   * YES, PUT RECORD
        DROP  R1              * DROP BASE REG FOR DCB
        B     EPILOG          * SKIP TO EPILOG
*-----*
*   SYNAD EXIT - SEND A MSG, CLOSE, AND DEACTIVATE             *
*-----*
SYNAD   WTO    'IMSE003 - ERROR DURING PUT TO IMSLOG',ROUTCDE=11,DESC=7
        L     ENTIND,TERMCALL  * INDICATE TO TERMINATE
        B     TERMCASE        * SKIP TO CLOSE AND TERMINATE
*-----*
*   END SYNAD EXIT                                             *
*-----*
*
*   TERMINATE CALL                                             *
*-----*

```

Figure 24. Sample Log Archive Exit Routine (Part 6 of 9)

IMSEXIT

```

TERMCASE C    ENTIND,TERMCALL    * IS THIS THE TERMINATE CASE ?
        BNE   OTHCASE            * IF NOT SKIP ON
        OI    DYNCLOSE,X'80'     * SET HIGH ORDER BIT IN CLOS LIST
        LA    R5,DYNDCB         * LOCATE DCB
        CLOSE ((R5)),MF=(E,DYNCLOSE) * CLOSE IT
        B     EPILOG            * END OF TERMINATE CASE
*-----*
*
*   OTHER CALL, ISSUE MESSAGE AND RETURN
*
*-----*
OTHCASE  DS    0H                * START OF OTHER CASE
*
        WTO   'IMSE004 - INVALID CALL TYPE',ROUTCDE=11,DESC=7
        B     NOFREEMN          * SKIP TO TERMINATE
*-----*
*
*   EPILOG
*   - FREEMAIN STORAGE FOR TERMINATE CALL
*
*-----*
EPILOG  DS    0H
        LR    R1,R13            * POINT TO DYNAMIC AREA
        L     R13,SAVEAREA+4    * POINT TO OLD SAVE AREA
        C     ENTIND,TERMCALL   * IS THIS TERMINATION CALL ?
        BNE   NOFREEMN          * NO, DON'T FREE STORAGE
        L     R0,SIZEWORK        * PICK UP LENGTH OF DYNAMIC AREA
        FREEMAIN R,LV=(0),A=(1) * FREE IT
        SLR   R15,R15           * GET A ZERO
        ST    R15,0(R11)        * STORE IT INTO THE USER WORD
NOFREEMN SLR   R15,R15           * CLEAR RETURN CODE
        L     R14,12(R13)       * RESTORE RETURN REGISTER
        LM    R0,R12,20(R13)    * RESTORE OTHER REGS
        BR    R14              * RETURN TO CALLER
*-----*
*
*   STATIC DATA AREA
*
*-----*
        DS    0F
INITCALL DC    F'1'
NORMCALL DC    F'2'
TERMCALL DC    F'3'
SUFFLEN  DC    F'16'
TYPE01   DC    XL4'01'
TYPE03   DC    XL4'03'
TYPE04   DC    XL4'04'
TYPE42   DC    XL4'42'
TYPE98   DC    XL4'98'
        DS    0F
SIZEWORK DC    AL1(0)
        DC    AL3(((ENDWORKA-WORKAREA+7)/8)*8)
        DS    0D
        PRINT NOGEN

```

Figure 24. Sample Log Archive Exit Routine (Part 7 of 9)

```

LISTDCB  DCB  MACRF=PM,DDNAME=IMSLG,DSORG=PS,EXLST=EXITLIST,      *
          SYNAD=SYNAD
LEND  CB  EQU  *-LISTDCB          * LENGTH OF DCB
EXITLIST DC  XL1'85',AL3(DCBEXIT) * DCB EXIT ADDRESS
          DCBD DSORG=PS
*-----*
*
*      DCB EXIT
*      - FORCE RECFM = VB
*      - ENSURE LRECL AND BLOCK SIZE ARE LARGE ENOUGH
*
*-----*
IMSEXIT  CSECT
DCBEXIT  DS    0H
          USING *,R15          * SET ADDRESSABILITY
          LR    DCBPTR,R1      * LOAD DCB POINTER
          USING IHADCB,DCBPTR * LOCATE DCB
          NI    DCBRECFM,DCBREC+DCBRECSB+DCBREC+DCBREC+DCBREC+DCBREC * SET NOT NEEDED FLAGS OFF
*
          OI    DCBRECFM,DCBREC+DCBREC+DCBREC * SET RECFM=VB
          CLC   DCBBLKSI,IMSBLOCK * IS BLOCK SIZE
          BNL   BLOCKOK        * GREAT ENOUGH ?
          MVC   DCBBLKSI,IMSBLOCK * NO, SET TO USUAL SIZE
BLOCKOK  EQU   *              * YES, OK
          CLC   DCBLRECL,TESTLREC * IS LRECL
          BNL   LRECLOK        * GREAT ENOUGH ?
          MVC   DCBLRECL,MAXLRECL * NO, SET TO MAX VALUE
LRECLOK  EQU   *              * YES, OK
          LH    R9,DCBLRECL     * LOAD LRECL
          S     R9,BDWLEN       * SUBTRACT BDW LENGTH
          CH    R9,DCBBLKSI     * LRECL > BLOCK SIZE - 4 ?
          BNH   SPANNOK        * NO, SKIP ON
          OI    DCBRECFM,DCBRECSB * YES, FORCE SPANNED RECORDS
SPANNOK  EQU   *              * SPANNED FLAG OK
          DROP  R15             * DROP BASE REG
          BR    R14             * RETURN TO OPEN

MAXLRECL DC  H'32756'
IMSBLOCK DC  H'6144'
TESTLREC DC  H'6140'
BDWLEN   DC  F'4'
*-----*
*      END DCB EXIT
*
*-----*
*
*      DYNAMIC WORK AREA
*
*-----*
WORKAREA DSECT
          DS    0F
SAVEAREA DS  18F
PARMLIST DS  3F

```

Figure 24. Sample Log Archive Exit Routine (Part 8 of 9)

IMSEXIT

```
DYNDCB   DCB   MACRF=PM,DDNAME=IMSLOG,DSORG=PS,EXLST=EXITLIST
DYNOPEN  OPEN  (,),MF=L
DYNCLOSE CLOSE (,),MF=L
RECAREA  DS    0D
          DS   128CL256
ENDWORKA EQU   *
IMSEXIT  CSECT
R0       EQU   00                      EQUATES FOR REGISTERS 0-15
R1       EQU   01
R2       EQU   02
R3       EQU   03
R4       EQU   04
R5       EQU   05
R6       EQU   06
R7       EQU   07
R8       EQU   08
R9       EQU   09
R10      EQU   10
R11      EQU   11
R12      EQU   12
R13      EQU   13
R14      EQU   14
R15      EQU   15
DCBPTR   EQU   R2
RECPTR   EQU   R6
ENTIND   EQU   R10
PBLDREC  EQU   R9
*-----*
*
*      IMS RECORD MAPPING
*
*-----*
RECORD   EQU   0                      * START OF RECORD
RECLL    EQU   RECORD                  * RECORD LENGTH
RECTYPE  EQU   RECORD+4                * RECORD TYPE
RECSUBT  EQU   RECORD+5                * RECORD SUBTYPE
RECPRELL EQU   RECORD+16               * TOTAL RECORD PREFIX LENGTH
END      IMSEXIT
```

Figure 24. Sample Log Archive Exit Routine (Part 9 of 9)

IMSLOG

The following record types are selected and written to the data set connected to the DD name IMSLOG:

Record Message type

- 01 Input message.
- 03 Output message.
- 06 IMS start/stop.
- 07 Application accounting (MPP or BMP end).
- 31 Message queue get unique.
- 34 Message cancel.
- 35 Message placed on message queue.
- 36 Message removed from message queue.
- 38 Transaction reschedule.
- 40 Checkpoint records. Only header, trailer, SMB, and CNT block records are written (subtypes 01, 03, 04, and 98 respectively).
- 42 IMS log header record.

To limit the size of the written log, the message text parts of the 01 and 03 records are truncated to 24 bytes. However, when this truncation occurs, the total length of all message segments is calculated and stored as a negative value in the length field of the first message segment. SLR uses this field to calculate the number of bytes transferred.

The following DCB information applies to the file IMSLOG:

Keyword	Accepted	Default
RECFM	VB	VB
BLKSIZE	6144 or greater	6144
LRECL	6140 or greater	32760 and RECFM=VBS

A program dependent on the sequence numbers of the IMS log records should not be used to process the written log data set.

Chapter 23. Log Filter Exit Routine (DFSFTFX0)

The RSR Log Filter exit routine allows you to control the amount of log data sent to the tracking subsystem, by acting as a filter. Thus you can choose which log records to send to the tracking site. IMS supplies a default filter exit routine, which eliminates database records for:

- Databases not defined as covered
- Diagnostic data
- Block padding data

The following topics provide additional information:

“About This Routine”

“Communicating with IMS” on page 189

“Recovery Environment” on page 190

“Initialization and Termination Calls” on page 190

“IMS-Supplied Filter Exit Routine” on page 190

About This Routine

You can replace the IMS default filter exit routine with one of your own. Your replacement exit routine must return valid IMS log records, valid log record lengths, and valid IMS log record sequence numbers. The exit routine can only filter a particular log record by replacing it with a X'4304' log record containing the same log sequence number as the record being filtered.

Keep in mind that your replacement exit routine's performance can affect both RSR and the active IMS subsystem's logging.

The Log Filter exit routine is called in the following three cases:

- IMS and ILS Initialization

The Log Filter exit routine is called during IMS initialization and during isolated log sender (ILS) instance initialization. You can use the log filter exit to perform setup or initialization work during IMS and ILS initialization.

The initialization call can return a token, which is passed to the filtering exit routine on each subsequent call. The second word of the parameter list, upon return, contains a 0 or the address of the token.

- Log Buffer Send

The Log Filter exit routine is called each time a log buffer is to be sent to the tracking site, so that you can filter which log records you want to be sent.

- IMS and ILS Termination

The Log Filter exit routine is called during IMS termination and during isolated log sender (ILS) instance termination. You can use the log filter exit to perform cleanup or termination work during IMS and ILS termination.

The Log Filter exit routine should take into account the fact that it is possible to have multiple instances of the isolated log sender in one address space.

The mapping definition for the X'4304' log record is contained in the source code of the IMS DFSLOG43 macro. See “IMS-Supplied Filter Exit Routine” on page 190 for more information.

You must write this exit routine so that it is reentrant. It must be compiled with AMODE=31 and RMODE=ANY. It runs in supervisor state in user protect key 7. Its primary address space can be either CTL, DBCTL, DCCTL, batch, or isolated log sender.

Table 41 shows the attributes of the Log Filter exit routine.

Table 41. Log Filter Exit Routine Attributes

Attribute	Description
IMS environments	DB/DC, DBCTL, batch.
Naming convention	Must be named DFSFTFX0.
Binding	Follow the guidelines described in "Binding the Routines" on page 7. You must bind the exit routine into IMS.SDFSRESL (or a library concatenated with it) as a separate reentrant load module. If the module is not present in the load library, the IMS logger does not load or call it. Example: This shows you how to bind the exit routine into IMS.SDFSRESL. <pre>//LINKIT JOB 1,MSGLEVEL=1 //LINK EXEC PGM=IEWL,PARM=RENT //SYSUT1 DD UNIT=SYSDA,SPACE=(TRK,(20,20)) //SYSPRINT DD SYSOUT=A //SYSLMOD DD DSN=IMS.SDFSRESL.,DISP=SHR //OBJJIN DD DSN=IMS.USERLIB.,DISP=SHR //SYSLIN DD * INCLUDE OBJJIN(DFSFLGX0) MODE AMODE(31),RMODE(ANY) NAME DFSFTFX0(R) /*</pre>
Including the routine	No special steps required.
IMS callable services	IMS Callable Services are not applicable for use with this exit routine.
Sample routine location	IMS.ADFSSRC.

The routine can be given process mode of SRB or TCB for log buffer send (see "Initialization and Termination Calls" on page 190 for the attributes of the routine for initialization and termination calls). Because an enabled unlock task (EUT) functional recovery routine (FRR) exists, no SVCs can be issued by the routine, nor can it hold any locks.

The input parameters are available until the exit routine returns to its caller; at that time, the storage is re-used. This means that the exit routine must copy any data it needs to preserve.

The log filter exit must ensure that filtered data has a format appropriate for the level of IMS that generated the data. X'4304' log records, for instance, must match the X'4304' log record DSECT for that level of IMS.

Use the RELEASE parameter of the ILOGREC macro to generate DSECTs for log records of different levels of IMS.

Communicating with IMS

IMS communicates with this exit through the entry and exit registers.

Contents of Registers at Entry

Upon entry, the exit routine must save all registers using the provided save area. The registers contain the following:

Register	Contents
1	Address of a standard parameter list (a series of words containing the parameters' addresses)
13	z/OS standard save area address (not an IMS pre-chained save area)
14	Return address (set with the assembly BALR instruction)
15	Filter exit routine entry address

The parameters are:

- Function Code.

This function code is one word in length and is set to the following:

 - X'0' for IMS or ILS initialization.
 - X'4' for log buffer send.
 - X'8' for IMS or ILS termination.
- Optionally created token from initialization entry point call.

If you do not provide a token, this parameter value is 0.
- Log data being sent (from 0 to *N* log records).

For both initialization and termination calls, this parameter value is 0.
- One-word length of log data in bytes.

For both initialization and termination calls, this parameter value is 0.
- Data area.

The exit routine moves the log data to this area. This area must be large enough to contain the unfiltered log data. For both initialization and termination calls, this parameter value is 0.
- Sink area data length in words.

This is filled in by the exit routine. For both initialization and termination calls, this parameter value is 0.
- Package descriptor.

The package descriptor contains information about the log data. If the filter exit will encounter data from more than one level of IMS, reference the package descriptor to determine which level of IMS generated the log data.

Two formats of package descriptor are possible:

 - Log data from IMS is accompanied by a package descriptor mapped by the DFSPKR macro.
 - Data from ILS is accompanied by a package descriptor described by the IPD DSECT in the DFSILT macro.

The halfword at offset 2 will contain a 1 for the DFSPKR type and a 2 for the IPD type.

The level of IMS that generated the log data is indicated by the value in field PKRRELSE (DFSPKR) or IPDRELSE (DFSILT). The values correspond to values defined in the DFSLOGRC macro.

Whether or not log data from more than one level of IMS will be encountered, the filter exit must ensure that filtered data has a format appropriate for the level of IMS that generated the data.

Use the **RELEASE** parameter of the **ILOGREC** macro to generate DSECTs for log records of different levels of IMS.

Contents of Registers at Exit

Before returning to IMS, the exit routine must restore all registers except for registers 0, 1, and 15.

Also before returning to IMS, be sure to set the token in the parameter list (on the initialization call) if you want to use a token, and be sure the data and data length have been set (on the send call). See "Contents of Registers at Entry" on page 189 for more on the parameter list.

Recovery Environment

For initialization and termination calls, an ESTAE is established for the recovery environment; for log buffer send calls, a functional recovery routine (FRR) is established for the recovery environment. If the FRR exit routine is driven, it will SDUMP. If retry is allowed, it turns off filtering for the duration of the IMS instance. (This exit routine is not reloaded as a result of a **/START SERVGRP** or **/STOP SERVGRP** command.) If an error is detected in the filtered record, filtering is turned off for the duration of the IMS instance. If retry is not allowed, the component abends.

Initialization and Termination Calls

IMS calls the Log Filter exit routine during IMS initialization and normal termination and for ILS instance initialization and termination. You can thereby prepare for log filtering or clean up after termination. If you do not return a token on the initialization call, IMS sets the token to zero for all subsequent filter exit routine calls.

The attributes of the routine for initialization and termination is the same as for log buffer send, except that the routine can only be given a process mode of TCB, thus allowing SVC calls.

The recovery environment for initialization and termination calls is different than for log buffer send calls. An ESTAE environment is created to cover the initialization and termination call. If the ESTAE is driven and retry is allowed, it turns off log filtering for the duration of the IMS instance and issues an error message. If retry is not allowed, the component abends (under certain circumstances, such as CANCEL, z/OS does not allow a retry).

IMS-Supplied Filter Exit Routine

This exit routine includes a summary of which log records can be filtered by the Log Filter exit routine. It also summarizes which log records can be filtered if you do not need to restart transaction manager at the tracking site.

The filter exit module supplied with IMS is table driven, with the tables already set up to filter some log records. These records are replaced with a X'4304' dummy log record. The log filter exit module contains complete information about which log records can be eliminated or changed. The name of this module is DFSFTFX0. Use the prolog and tables in the exit routine as a reference.

| The module also indicates how to eliminate data communication log records. This
| causes filtering of message queue records, scratch pad areas, Fast Path output
| messages, DC sequence number records, and DC-related checkpoint records.
| Using this option reduces log volume but requires a COLDCOMM emergency
| restart at the tracking site after remote takeover to restart transaction manager.

Recommendation: You should be very careful when writing the replacement for the Log Filter exit routine, because incorrect filtering of the log data can make the tracking SLDS data invalid or unusable. You also need to consider that multiple copies of the exit routine can run for concurrent IMS jobs and ILS instances.

Chapter 24. Logger Exit Routine (DFSFLGX0)

You can use the Logger exit routine for recovery purposes.

The following topics provide additional information;

“About This Routine”

“Communicating with IMS” on page 195

About This Routine

You can write a Logger exit routine that is called during IMS logger execution. IMS passes the exit routine all log data after the data has been written to the IMS log. Your exit routine can then process this data for recovery purposes.

IMS calls the Logger exit routine with an *initialization call* when the logger is opened and with a *termination call* when the logger is closed. At these times, your exit routine can get or free any additional storage that it needs to run. IMS also calls the exit routine and passes log data to it with a *write call* whenever a block of data is written to the logger.

This exit routine is optional. No default and no sample are provided. Be aware that the interface to this exit routine might change in future releases of IMS.

Table 42 shows the attributes of the Logger exit routine.

Attention: Remember that the IMS logger is critical to performance. Avoid coding the exit routine to do something that could negatively affect performance in the IMS logger, such as WAIT and other z/OS services that could cause long delays before returning to your exit routine.

Table 42. Logger Exit Routine Attributes

Attribute	Description
IMS environments	DB/DC, DBCTL, DCCTL, batch.
Naming convention	You must name this exit routine DFSFLGX0.
Binding	Follow the guidelines described in “Binding the Routines” on page 7.

You must bind the exit routine into IMS.SDFSRESL (or a library concatenated with it) as a separate **reentrant** load module. If the module is not present in the load library, the IMS logger does not load or call it.

Example: This shows you how to bind the exit routine into IMS.SDFSRESL.

```
//LINKIT JOB 1,MSGLEVEL=1
//LINK EXEC PGM=IEWL,PARM=RENT
//SYSUT1 DD UNIT=SYSDA,SPACE=(TRK,(20,20))
//SYSPRINT DD SYSOUT=A
//SYSLMOD DD DSN=IMS.SDFSRESL.,DISP=SHR
//OBJJIN DD DSN=IMS.USERLIB.,DISP=SHR
//SYSLIN DD *
          INCLUDE OBJJIN(DFSFLGX0)
          MODE AMODE(31),RMODE(ANY)
          NAME DFSFLGX0(R)
/*
```

Including the routine No special steps are needed to include this routine.

Table 42. Logger Exit Routine Attributes (continued)

Attribute	Description
IMS callable services	This exit routine can use IMS Callable Storage Services. This exit routine is defined to IMS as an IMS standard user exit. Exit routines that are defined to IMS receive the callable services token in the standard exit parameter list. This exit routine does not need to issue an initialization call (DFSCSI0) to use IMS Callable Services. You must manually bind this exit routine with DFSCSI00. For guideline on using IMS Callable Services, see "IMS Callable Services" on page 10.
Sample routine location	No sample exit routine is provided.

Attributes of the Routine

The Logger exit routine must be written as **reentrant**. The exit routine receives control running in 31-bit addressing mode and must return control in that mode. It is called in TASK mode, with no locks held, and in non-cross memory, non-AR mode. In an online IMS environment, the Logger exit routine runs in key 7, supervisor state, in the IMS control region address space. In batch and log recovery environments, it runs in key 8, problem state.

This information on various IMS environments is for the current release of IMS and might change in subsequent releases.

Calling the Routine

The Logger exit routine is called at each of the following times. When IMS calls the routine determines the "call type."

Initialization Call

IMS calls DFSFLGX0 when the logger is initialized. IMS makes this call when it opens the first output log.

An initialization call (call type 1) is made for the following:

- Normal initialization (DB/DC, DBCTL, DCCTL, batch)
- Initialization of log recovery during emergency restart processing if log recovery from the write ahead data set (WADS) is required
- Log Recovery utility initialization (CLS mode)
- Alternate IMS system logger initialization when the alternate IMS opens its first OLDS for output during an XRF takeover

OLDS/SLDS Write Call

IMS calls DFSFLGX0 after a block of data is successfully written to the online log data set (OLDS) or the system log data set (SLDS). The OLDS is accessed in a DB/DC, DBCTL, or a DCCTL environment and in the SLDS in a batch environment.

A pointer to the data that was written is passed to the exit routine. (The blocks of data might not be presented in sequence.) All processing of the data must be completed before returning to IMS, because the data address is not valid after leaving DFSFLGX0.

A write call (call type 2) is made for the following:

- Normal block write (a block of data is written to the log during normal IMS processing).

- Buffer purge (the final block(s) of log data are written to the log during IMS abnormal termination).
- Log recovery during emergency restart processing (blocks of data are recovered from the WADS and written to the OLDS).
- Log Recovery utility processing when recovering entries of complete log buffers from the WADS (CLS mode).

Under some abend or error conditions, one or more blocks might be written to the log and not passed to the exit routine. Under some abend or error conditions, IMS might pass the same blocks to DFSFLGX0 several times. Your exit routine must be able to tolerate both of these situations.

Termination Call

IMS calls DFSFLGX0 when the logger is terminated. IMS makes this call after it closes the output log and notifies DBRC.

A termination call (call type 3) is made for the following:

- Normal termination
- Abnormal termination (if a terminal call is possible)
- Termination of log recovery during emergency restart processing
- Log Recovery utility termination (CLS mode)

If IMS terminates abnormally, there might be cases when the logger is unable to make the termination call to DFSFLGX0. Therefore, your exit routine must be able to tolerate not being called for termination.

Restrictions

The Logger exit routine is subject to the following restrictions:

- This exit routine must not modify the log data passed to it on an OLDS/SLDS write call. It must not try to locate, access, or modify any IMS control blocks not specifically passed to it by IMS.
- All addresses, entry register contents, and parameter list contents can change from one call of DFSFLGX0 to the next call. One call should not depend on addresses from a prior call. Similarly, this exit routine must not assume what TCB it is running under, nor that the TCB is the same from one call to the next call.
- This exit routine can call only those z/OS services that it is authorized to call. It must **not** call any internal IMS services.

Communicating with IMS

IMS communicates with this routine through the entry registers, a parameter list, and the exit registers.

Content of Registers on Entry

Upon entry, the exit routine must save all registers using the provided save area. The registers contain the following:

Register	Content
1	Address of the standard exit parameter list.

Register	Content
13	Address of the save area. Your exit routine must not change the first three words of this save area. This save area is not chained to any other IMS save area.
14	Return address to IMS.
15	Entry point of this exit routine.

Standard Exit Parameter List

This exit routine uses the Version 4 standard exit parameter list. See Table 3 on page 5 for the content of the Version 4 standard exit parameter list. The address of the work area passed to this exit routine in SXPLAWRK will be the same each time that this exit routine is called.

Function-Specific Parameter List on Entry

The address of the function-specific parameter list is in the standard exit parameter list field SXPLFSPL. The content of the function-specific parameter list depends on whether this exit routine is called by a call type 1, 2, or 3. Table 43 through Table 45 outline the contents of the parameter list for each of these calls.

Table 43. Function-Specific Parameter List for Initialization Call, Call Type 1 (Mapped by LGWXPLST, Which Is Included in LCDSECT)

Field	Offset	Length	Content
LGWXTYPE	0	1	Call type: 1
LGWXENVR	1	1	Environment type: X'01' = DB/DC online system X'02' = Batch IMS system (includes CICS/DLI) X'03' = Log Recovery utility X'04' = DBCTL system X'05' = DCCTL system
LGWXFLG1	2	1	Flag byte: X'10' 0 = not XRF takeover, 1 = XRF takeover X'20' 0 = not /ERE log recovery, 1 = /ERE log recovery X'08' 1 = field LGWXTODN exists All other flag bits reserved.
	3	1	Reserved.
LGWXTOD	4	8	This field has been left here for backwards compatibility. The old timestamp format value is in the 00YYDDDF HHMMSSSTF format.
LGWXDODN	1C	12	This field contains the current date and time fields, but in the IMS internal packed-decimal format. For further information on the internal packed-decimal time-stamp format, see or <i>IMS Version 9: Database Recovery Control (DBRC) Guide and Reference</i> .
LGWXSSID	C	8	IMS subsystem ID (IMSID for non-XRF, RSE name for XRF).

Table 43. Function-Specific Parameter List for Initialization Call, Call Type 1 (Mapped by LGWXPLST, Which Is Included in LCDSECT) (continued)

Field	Offset	Length	Content
LGWXBUFR	14	4	Unused on this call.
LGWXBSIZ	18	4	Unused on this call.
LGWXTMST	1C	12	This field contains the current date and time fields, but in the IMS internal packed-decimal format. For further information on the internal packed-decimal time-stamp format, see or <i>IMS Version 9: Database Recovery Control (DBRC) Guide and Reference</i> . See the LGWXTOD field for the timestamp format used prior to IMS/ESA® V6.

Table 44 shows the parameter list for call type 2.

Table 44. Function-Specific Parameter List for OLDS/SLDS Write Call, Call Type 2 (Mapped by LGWXPLST, Which Is Included in LCDSEC)

Field	Offset	Length	Content
LGWXTYPE	0	1	Call type: 2
LGWXENVR	1	1	Environment type: X'01' = DB/DC online system X'02' = Batch IMS system (includes CICS/DLI) X'03' = Log Recovery utility X'04' = DBCTL system X'05' = DCCTL system
LGWXFLG1	2	1	Flag byte: X'20' 0 = Not /ERE log recovery, 1 = /ERE log recovery X'08' 1 = field LGWXTMST exists
	3	1	Reserved
LGWXTOD	4	8	This field has been left here for backwards compatibility. The old timestamp format value is in the 00YYDDDF HHMMSSTF format.
LGWXTODN	1C	12	This field contains the current date and time fields, but in the IMS internal packed-decimal format. For further information on the internal packed-decimal time-stamp format, see <i>IMS Version 9: Application Programming: Transaction Manager</i> or <i>IMS Version 9: Database Recovery Control (DBRC) Guide and Reference</i> .
LGWXSSID	C	8	IMS subsystem ID.
LGWXBUFR	14	4	Address of IMS log block data that has been successfully written to the OLDS/SLDS. (This might be a copy of the original IMS buffer.)
LGWXBSIZ	18	4	Length of log data, in bytes.

Table 44. Function-Specific Parameter List for OLDS/SLDS Write Call, Call Type 2 (Mapped by LGWXPLST, Which Is Included in LCDSEC (continued))

Field	Offset	Length	Content
LGWXTMST	1C	12	This field contains the current date and time fields, but in the IMS internal packed-decimal format. For further information on the internal packed-decimal time-stamp format, see <i>IMS Version 9: Application Programming: Transaction Manager</i> or <i>IMS Version 9: Database Recovery Control (DBRC) Guide and Reference</i> . See the LGWXTOD field for the timestamp format used prior to IMS/ESA V6.

Table 45 shows the parameter list for call type 3.

Table 45. Function-Specific Parameter List for Termination Call, Call Type 3 (Mapped by LGWXPLST, Which Is Included in LCDSECT)

Field	Offset	Length	Content
LGWXTYPE	0	1	Call type: 3
LGWXENVR	1	1	Environment type: X'01' = DB/DC online system X'02' = Batch IMS system (includes CICS/DLI) X'03' = Log Recovery utility X'04' = DBCTL system X'05' = DCCTL system
LGWXFLG1	2	1	Flag byte: X'80' 0 = normal termination, 1 = abnormal termination X'40' 0 = buffer purge succeeded, 1 = buffer purge failed, (abend only) X'20' 0 = not /ERE log recovery, 1 = /ERE log recovery X'08' 1 = field LGWTODN exists All other flag bits reserved.
	3	1	Reserved.
LGWXTOD	4	8	This field has been left here for backwards compatibility. The old timestamp format value is in the 00YYDDDF HHMMSSTF format.
LGWXTODN	1C	12	This field contains the current date and time fields, but in the IMS internal packed-decimal format. For further information on the internal packed-decimal time-stamp format, see <i>IMS Version 9: Application Programming: Transaction Manager</i> or <i>IMS Version 9: Database Recovery Control (DBRC) Guide and Reference</i> .
LGWXSSID	C	8	IMS subsystem ID.
LGWXBUFR	14	4	Unused on this call.
LGWXBSIZ	18	4	Unused on this call.

Table 45. Function-Specific Parameter List for Termination Call, Call Type 3 (Mapped by LGWXPLST, Which Is Included in LCDSECT) (continued)

Field	Offset	Length	Content
LGWXTMST	1C	12	This field contains the current date and time fields, but in the IMS internal packed-decimal format. For further information on the internal packed-decimal time-stamp format, see <i>IMS Version 9: Application Programming: Transaction Manager</i> or <i>IMS Version 9: Database Recovery Control (DBRC) Guide and Reference</i> . See the LGWXTOD field for the timestamp format used prior to IMS/ESA V6.

For calls made during normal IMS operation, the time in the field at offset X'10' contains the start time of the **current** IMS system. For calls made during emergency restart log recovery, this field contains the start time of the **previous** IMS system, the one whose log is being recovered.

If log recovery is required during emergency restart processing, DFSFLGX0 is called for two sets of initialization/write/termination call sequences. The first set of calls occurs during log recovery and sets a flag indicating that log recovery is processing. Only the data from the buffers (recovered from the WADS and written to the OLDS to close it) is passed. The second set of calls occurs for normal IMS processing.

Content of Registers on Exit

Before returning to IMS, the exit routine must restore all registers except for register 15, which must contain the following:

Register	Contents
15	0

DFSFLGX0

Chapter 25. Partner Product Exit Routine (DFSPPE0)

This chapter documents General-Use Programming Interface and Associated Guidance Information. This is a user exit routine.

The following topics provide additional information:

“About This Routine”

“Communicating with IMS”

About This Routine

The Partner Product exit routine is entered immediately before IMS is ready for startup (before the DFS994I start complete message is issued). The exit routine is provided to allow the initialization of products that run with IMS. The exit routine can load or link one or more partner product routines. The exit routine is deleted after control returns to IMS.

Be aware that the interface to this exit routine might change in future releases of IMS.

The exit routine must reside on the library pointed to by the STEPLIB DD statement. If the exit routine exists, it is called.

Table 46 shows the attributes of the Partner Product exit routine.

Table 46. Partner Product Exit Routine Attributes

Attribute	Description
IMS environments	DB/DC, DCCTL.
Naming convention	You must name this exit routine DFSPPE0.
Binding	Follow the guidelines described in “Binding the Routines” on page 7.
Including the routine	No special steps are needed to include this routine.
IMS callable services	This exit routine can use IMS Callable Storage Services. This exit routine is defined to IMS as an IMS standard user exit. Exit routines that are defined to IMS receive the callable services token in the standard exit parameter list. This exit routine does not need to issue an initialization call (DFSCSI0) to use IMS Callable Services. You must manually bind this exit routine with DFSCSI0. Related Reading: For guidelines on using IMS Callable Services, see “IMS Callable Services” on page 10.
Sample routine location	No sample exit routine is provided.

Communicating with IMS

IMS uses the entry registers, a parameter list, and the exit registers to communicate with the exit routine.

Content of Registers on Entry

Upon entry, the exit routine must save all registers using the provided save area. The registers contain the following:

Register	Contents
1	Address of the standard exit parameter list.
13	Address of the save area. Your exit routine must not change the first three words of this save area. This save area is not chained to any other IMS save area.
14	Return address to IMS.
15	Entry point of this exit routine.

Standard IMS User Exit Parameter List

This exit routine uses the Version 4 standard exit parameter list. See Table 3 on page 5 for the content of the Version 4 standard exit parameter list. The address of the work area passed to this exit routine in SXPLAWRK will be the same each time that this exit routine is called.

Function-Specific Parameter List on Entry

Table 47 shows the content of the function-specific parameter list. The address of this parameter list is in the standard IMS user exit parameter list field SXPLFSPL.

Table 47. Function-Specific Parameter List for Partner Product Exit (Mapped by DFSPPE0)

Field	Offset	Length	Content
PPUEIMSD	0	4	IMS identifier
PPUEREL	4	1	IMS level
PPUETYP	5	1	IMS subsystem type
PPUEOSL	6	1	z/OS level
Reserved	7	1	

Content of Registers on Exit

Before returning to IMS, the exit routine must restore all registers except register 15, which must contain one of the following return codes:

Return Codes	Meaning
0	Processing continues.
non-0	IMS abends with U0740. The exit routine should return this code if critical tasks do not complete successfully.

Chapter 26. RECON I/O Exit Routine (DSPCEXT0)

DBRC gives control to the RECON I/O exit routine during I/O operations to the RECON.

The following topics provide additional information:

“About This Routine”

“Communicating with IMS” on page 205

“Using the Sample RECON I/O Exit Routine” on page 208

About This Routine

This exit routine tracks changes to the RECON data set, which you can log in a journal. You can code this routine so that it updates the journal each time a record of the data set is updated, inserted, deleted, or read. You can also record changes that are internal to the RECON access modules, such as header record extension control item changes, or the addition and deletion of multiple update control records within the data set.

You can use the journal, in turn, as a trace facility, to monitor the activity of specific record types, or as a means of writing your own recovery utility for the RECON data set.

Related Reading: For additional detailed information about how DBRC accesses records on the RECON data set, see *IMS Version 9: Diagnosis Guide and Reference*.

Table 48 shows the attributes of the RECON I/O exit routine.

Table 48. RECON I/O Exit Routine Attributes

Attribute	Description
IMS environments	DB/DC, DBCTL.
Naming convention	You must name this exit routine DSPCEXT0.
Link editing	Follow the guidelines described in “Binding the Routines” on page 7. You must write and bind this routine as reentrant (RENT). After assembling the source code, you need to bind the object code for this module into the IMS load module DSPCINT0.
Including the routine	No special steps are needed to include this routine.
IMS callable services	This exit is not eligible to use IMS Callable Services.
Sample routine location	IMS.ADFSSRC (member name DSPCEXT1)

Attributes of the Routine

You must write and bind this routine as reentrant. It is entered from DBRC in 31-bit addressing mode and must return to DBRC in 31-bit addressing mode. All parameters and data areas supplied to this exit routine by DBRC are located above the 16 MB line. In addition, load module DSPCINT0, in which the routine is located,

resides above the line. Note that due to the residency of DSPCINT0, unless you specify otherwise, GETMAIN will acquire storage above the 16 MB line when issued for the exit routine.

No further calls to the exit routine will occur if it terminates abnormally. DBRC will recover the termination and carry on normally thereafter.

Calling the Routine

Control is passed to the routine whenever a RECON record has been successfully read, written or modified on **COPY 1** of the RECON data set, not necessarily for every physical I/O operation. Header record extension control item changes, such as the RECON open flag, RESERVE count, or change copy field, also cause this routine to be called.

The IMS-supplied module is called only once. Thereafter, the module prevents further exit calls and their performance impacts from taking place. It is by replacing the IMS-supplied module with one that you write yourself that the exit routine is called continually.

Whenever a record of data is to be inserted, updated, deleted, or read, this routine is called after the call or change has been made to the RECON data set. For each insert, delete, and read call, the routine receives a copy of the inserted, deleted, or read record, respectively. For each update call, the routine receives a copy of the record as it appeared both before and after it was updated. For delete and update, the copy of the record read can be incomplete if DBRC is unable to locate all segments for that record. In this case, X'40' will be set in byte 2 of word 17 in the I/O exit parameter list.

The records passed to the exit routine are in the format of the release level of the RECON, and not necessarily the release level of the DBRC calling the exit. For instance, in coexistence mode with a Version 6 IMS and a Version 7 IMS, the RECON must be at a Version 7 level. The records seen by the Version 6 IMS are in a Version 7 format. An indication of the RECON release level exists in the parameter list that is passed to the exit. When the RECON is upgraded to a new release, the exit routine can use both the old release format and the new release format. During the upgrade process, the release level in the parameter list shows the old release level. A flag in the parameter list indicates that an upgrade is in progress.

Prior to IMS Version 7, the release level of the RECON did not change from one Begin Series call to another (within the same job), except during upgrade. All activity to the RECON had to be stopped during this upgrade. With Online Upgrade in IMS Version 7, the release level of the RECON can change from one Begin Series call to another. Except during the upgrade process, the release level does not change between the Begin Series call and the Terminate Series call.

Any modifications to storage that this routine makes must be made to storage obtained by the routine, **not** to the data areas pointed to by DBRC/IMS or to those contained within the routine itself.

Each series of I/O accesses that DBRC makes to the RECON data set is indicated to the routine by a Begin Series call. When the series of I/O operations is complete, the routine receives a Terminate Series call.

Considering Performance

While this routine is running, the RECON data set is reserved so that no other jobs can access RECON records. To minimize the affect that this routine's execution has on your system's performance, you need to:

- Limit the I/O operations that the routine itself performs and simplify the routine's functions to make efficient use of processing time.
- Be sure that any resources needed solely by the routine (that is, those **not** needed by DBRC/IMS in general) are immediately available to z/OS when DBRC is initialized and in control. You should therefore avoid operations that can put the routine, and therefore DBRC, in a prolonged wait state (for example, the ENQUEUE/DEQUEUE of resources that cannot be readily accessed by the routine or write to operator messages that require waiting for a reply).

DBRC has been enhanced so that the size of a record in the RECON is no longer limited by the defined RecordSize of the data set. DBRC divides its own records into segments, each of which fits into a single Control Interval (CI) and is sent by VSAM as a complete record. Segmenting allows a logical RECON record to be as large as 16,777,215 bytes. The DSPCEXT0 exit routine will be presented with complete, unsegmented logical records.

Communicating with IMS

IMS uses the entry and exit registers to communicate with the exit routine.

Contents of Registers on Entry

Upon entry, the exit routine must save all registers using the provided save area. The registers contain the following:

Register	Contents
1	Address of a standard z/OS parameter list. This list consists of a fullword with the high-order bit ON, indicating the last entry in the list. The remaining bits comprise the address of a data area containing information about the specific call.
13	Address of save area. The exit routine must not change the first three words.
14	Return address to the calling RECON access routine.
15	Entry point of exit routine.

Description of Parameters

This routine receives the parameter list from the calling RECON access module at the first Begin Series call for a job. The parameter list points to the same data area for all subsequent calls for that job.

The data area pointed to by the parameter list is 20 words (80 bytes) long and starts on a fullword boundary. Words 9 through 16 of the list are free to be used by the exit routine and remain unchanged by DBRC and IMS after the first Begin Series call. They initially contain all zeros.

The first byte of word 17 of the list indicates the release level of the RECON in hexadecimal format. Bytes 2 to 4 and words 18 to 20 are reserved for future use. A Version 7 RECON has the value X'71' as the RECON release level. A X'61' indicates a Version 6 level RECON, and a X'51' indicates a Version 5 level.

These are the contents of the data area at various exit points in the routine:

Begin Series exit call

Words	Meaning or Content
1	Eye-catcher "CEXT."
2	A binary 1 , indicating a Begin Series call to this routine as a result of a RESERVE function having been performed on the RECON data set.
3-4	RESERVE sequence number from control record extension. This number is incremented by one in the control record extension each time DBRC completes a successful RESERVE of the RECON data set. This lets the routine know which series (within a sequence of series in a job) is about to be performed.
	When located within one IMS system in a shared RECON data set environment, this routine might not necessarily see an increment of one from one logical Begin Series call to the next.
5	Changed record count from the control record extension. The changed record count is a 32-bit logical value that can eventually wrap back to zero. This is the count as of the last DEQUEUE function performed by DBRC, or that value plus one if the last DBRC abends. A change to the RECON data set has occurred if an ENQUEUE sequence detects that the last DBRC abended. For more information about the changed record count, see Terminate Series exit call.
6-8	Not used.
9-16	Binary zeros on the first Begin Series call. Free to be used by the routine for this first call and all subsequent calls.
17-20	17, Byte 1 indicates the release level of the RECON.
	Byte 2 contains the value X'80' when upgrade is in progress. Otherwise, it contains X'00'.
	Bytes 3-4 and 18-20 are reserved.

Insert exit call

Words	Meaning or Content
1	Eye-catcher "CEXT."
2	A binary 3 , indicating an insert call to this routine as a result of a record having been inserted into the RECON data set.
3-4	Unchanged from the first Begin Series call.
5	Length of the record that's been inserted.
6	Address of the record that's been inserted.
7-8	Not used.
9-16	Free to be used by the routine as desired.
17-20	17, Byte 1 indicates the release level of the RECON.
	Byte 2 contains the value X'80' when upgrade is in progress. Otherwise, it contains X'00'.
	Bytes 3-4 and 18-20 are reserved.

Update exit call

Words	Meaning or Content
1	Eye-catcher "CEXT."
2	A binary 4 , indicating an update call to this routine as a result of a record having been updated on the RECON data set.
3-4	Unchanged from the first Begin Series call.
5	Length of the record pointed to by Word 6 .
6	Address of a copy of the record as it appeared before the update.

Words	Meaning or Content
7	Length of the replacement record.
8	Address of the replacement record.
9-16	Free to be used by the routine as desired.
17-20	17, Byte 1 indicates the release level of the RECON. Byte 2 contains the following flags: <ul style="list-style-type: none"> • Bit 0 is ON when upgrade is in progress. • Bit 1 is ON if the record prior to being changed had a missing segment. Bytes 3-4 and 18-20 are reserved.

Delete exit call

Words	Meaning or Content
1	Eye-catcher "CEXT".
2	A binary 5 , indicating a delete call to this routine as a result of a record having been deleted from the RECON data set.
3-4	Unchanged from the first Begin Series call.
5	Length of the record that has been deleted.
6	Address of the record that has been deleted.
7-8	Not used.
9-16	Free to be used by the routine as desired.
17-20	17, Byte 1 indicates the release level of the RECON. Byte 2 contains the following flags: <ul style="list-style-type: none"> • Bit 0 is ON when upgrade is in progress. • Bit 1 is ON if the record prior to being changed had a missing segment. Bytes 3-4 and 18-20 are reserved.

Read exit call

Words	Meaning or Content
1	Eye-catcher "CEXT."
2	A binary 6 , indicating a read call to this routine as a result of a record having been read from the RECON data set.
3-4	Unchanged from the first Begin Series call.
5	Length of the record that's been read.
6	Address of the record that's been read.
7-8	Not used.
9-16	Free to be used by the routine as desired.
17-20	17, Byte 1 indicates the release level of the RECON. Byte 2 contains the value X'80' when upgrade is in progress. Otherwise, it contains X'00'. Bytes 3-4 and 18-20 are reserved.

Terminate Series exit call

Words	Meaning or Content
1	Eye-catcher "CEXT."
2	A binary 2 , indicating a Terminate Series call to this routine as a result of a DEQUEUE function having been performed on the RECON data set.
3-4	Unchanged from the Begin Series call.

Words	Meaning or Content
5	Final changed record count as it now appears on the control record extension. The changed record count is a 32-bit logical value that can eventually wrap back to zero. The count is either the same as the Begin Series call value, or it is that value plus one if any change has been made, other than to the record extension itself, to the RECON data set since the Begin Series call. By monitoring the value of this counter between its value here and the next Begin Series exit call, you can detect changes made to the RECON data set by other occurrences of DBRC.
6-8	Not used.
9-16	Free to be used by the routine as desired.
17-20	17, Byte 1 indicates the release level of the RECON. Byte 2 contains the value X'80' when upgrade is in progress. Otherwise, it contains X'00'. Bytes 3-4 and 18-20 are reserved.

Contents of Registers on Exit

Before returning to DBRC, the exit routine must restore all registers except register 15, which must contain one of the following return codes:

Return Code	Meaning
0	The exit routine is called.
non-0	No further calls to this exit routine are made.

Using the Sample RECON I/O Exit Routine

The sample RECON I/O exit routine records I/O activity that has taken place on the RECON data set. To minimize the performance impact that the routine's execution has upon DBRC, the routine spools its copy of RECON data records to a data set (specified by a DD statement with the name **DBRCDATA**) for later off-line processing outside the DBRC/IMS environment. Any data sets that your routine references need to be accessed by DD statements as well.

Chapter 27. Resource Access Security Exit Routine (DFSRAS00)

The Resource Access Security exit routine (DFSRAS00) authorizes IMS resources. Do not use this exit routine if you are using the Application Group Name (AGN) exit routine.

Recommendation: IBM recommends that you use this exit routine instead of the Application Group Name (AGN) exit routine (DFSISIS0).

The following topics provide additional information:

“About This Routine” on page 147

“Communicating with IMS” on page 148

About This Routine

This exit routine is called after the SAF interface is called. The exit routine authorizes IMS resources such as transactions, PSBs, or output LTERM names. This exit routine cannot be used with DFSISIS0.

You specify the requirement to call the SAF interface and exit routine in the SECURITY macro at system definition or using the ISIS parameter at system initialization.

This exit routine does not support Callable Services.

Table 49 shows the attributes for the Resource Access Security exit routine.

Table 49. Resource Access Security Exit Routine Attributes

Attribute	Description
IMS environments	DB/DC, DBCTL, DCCTL
Naming convention	You must name this exit routine DFSRAS00.
Binding	Follow the guidelines described in “Binding the Routines” on page 7. You must write the exit routine as reentrant.
Including the routine	No special steps are needed to include this routine.
IMS Callable Services	This routine is not eligible for IMS Callable Services.
Sample routine location	IMS.ADFSSMPL

Communicating with IMS

IMS uses the entry and exit registers, as well as parameter lists, to communicate with the exit routine.

Contents of Registers on Entry

Upon entry, the exit routine must save all registers using the provided save area. The registers contain the following:

Register	Contents
1	Address of the standard exit parameter list.

Register	Contents
13	Address of the save area.
14	Return address of IMS.
15	Entry point address of exit routine.

IMS Standard User Exit Parameter List (SXPL)

This exit routine uses the Version 4 standard exit parameter list. See Table 3 on page 5 for the content of the Version 4 standard exit parameter list. The address of the work area passed to this exit routine in SXPLAWRK can be different each time that this exit routine is called.

Resource Access Security Exit Routine Parameter List

Table 50 shows the function-specific parameter list that is mapped by DFSTRASL.

Table 50. Function-Specific Parameter List Mapped by DFSTRASL

Field	Offset	Length	Content
RASLVER	0	4	Version number for DFSTRASL
RASLFUNC	4	1	Reason for entering DFSTRAS00:
			X'01' Initialization
			X'02' Authorize transaction (MPP, JMP)
			X'03' Authorize PSB (IFP, non-message-driven BMP, JBP, DRA/CCTL ODBA)
			X'04' Authorize transaction and PSB (message-driven BMP) ¹
			X'05' Authorize PSB and output LTERM (non-message-driven BMP, JBP) ¹
			X'06' Authorize PSB and output transaction (non-message-driven BMP, JBP) ¹
RASLENVR	5	1	Type of dependent region for which exit was called:
			X'01' MPP
			X'02' IFP
			X'03' Message-driven BMP
			X'04' Non-message-driven BMP
			X'05' JMP
			X'06' JBP
			X'07' DRA thread from a CCTL task
			X'08' DRA thread from an ODBA task
RASLESV	6	2	Reserved

Table 50. Function-Specific Parameter List Mapped by DFSTRASL (continued)

Field	Offset	Length	Content
RASLTRAN	8	8	Transaction code (for BMPs, from IN= if message driven, and from OUT= if non-message-driven)
RASLTSRC	16	4	SAF return code for transaction
RASLTRRC	20	4	RACF (or equivalent) return code for transaction
RASLTRRS	24	4	RACF (or equivalent) reason code for transaction
RASLPSB	28	8	PSB name
RASLPSRC	36	4	SAF return code for PSB
RASLPRRC	40	4	RACF (or equivalent) return code for PSB
RASLPRRS	44	4	RACF (or equivalent) reason code for PSB
RASLLTRM	48	8	Output LTERM name
RASLLSRC	56	4	SAF return code for LTERM
RASLLRRC	60	4	RACF (or equivalent) return code for LTERM
RASLLRRS	64	4	RACF (or equivalent) reason code for LTERM
RASLECB	68	4	ECB address
RASLTCDE	72	8	Input transaction code
RASLPGM	80	8	Program name
RASLUSID	88	8	User ID of dependent region
RASLGRPN	96	8	Group name
RASLSSTY	104	1	IMS environment flag: X'01' DB/DC system X'01' DCCTL system X'03' DBCTL system
RASLROLE	105	1	XRF and RSR role flag: X'01' XRF active IMS X'01' XRF alternate IMS X'03' RSR active IMS X'04' RSR tracking IMS
RASLMVSL	106	1	z/OS version and release on which IMS was generated
RASLUIDI	107	1	User ID indicator: RASLUIDU User ID in RASLUSID field RASLUIDL LTERM in RASLUSID field RASLUIDP PSB name in RASLUSID field RASLUIDO Other in RASLUSID field
RASLIMSI	108	8	IMS subsystem identifier
RASLIMSL	116	4	IMS version and release

Notes:

1. When DFSRAS00 is used to authorize two resources, the exit routine is called twice: once for each resource. On the first call, one resource field (RASLTRAN, RASLPSB, or RASLLTRM) contains the resource name and the other resource field contains binary zeros. If the first call is successful, on the second call, the resource field that contained zeros in the first call contains the resource name and the other resource field that contained the resource name contains binary zeros.

For example, to authorize a PSB and output LTERM, the first call is made with the RASLPSB containing the PSB name and RASLLTRM containing binary zeros. On the second call, RASLPSB contains zeros and RASLLTRM contains the LTERM name.

Contents of Registers on Exit

Before returning to IMS, the exit routine must restore all registers except for register 15, which contains one of the following return codes:

Return Code	Meaning
0	Resources valid for this user
8	Resources invalid for this user

Chapter 28. SCI Registration Exit Routine (DSPSCIX0)

The SCI Registration exit routine (DSPSCIX0) supplies the IMSplex name needed for Structured Call Interface (SCI) registration.

The following topics provide additional information:

“About This Routine”

“Communicating with IMS”

“Using the Sample SCI Registration Exit Routine” on page 214

About This Routine

The SCI Registration exit routine (DSPSCIX0) is called by DBRC before registering with the SCI. DSPSCIX0 supplies the IMSplex name needed for SCI registration. If the exit is not used, DBRC will behave as if the sample version of the exit was being used.

DSPSCIX0 must be found in an authorized library or in LINKLST. If DSPSCIX0 is found in a concatenated STEPLIB or JOBLIB, only the data set containing DSPSCIX0 must be authorized. If DSPSCIX0 is found in LINKLST, no authorization check is performed. In a TSO environment, the library must be located in the task library (TASKLIB).

Table 51 shows the attributes for the SCI Registration exit routine.

Table 51. SCI Registration Exit Routine (DSPSCIX0)

Attribute	Description
IMS environments	DB/DC, DBCTL, DCCTL.
Naming convention	You must name this exit routine DSPSCIX0.
Binding	Follow the guidelines described in “Binding the Routines” on page 7. You must bind this routine into an authorized data set as a separate reentrant (RENT) load module, DSPSCIX0.
Including the routine	No special steps are needed to include this routine. If the exit is not used, DBRC will behave as if the sample version of the exit was being used.
IMS callable services	This exit is not eligible to use IMS Callable Services.
Sample routine location	IMS.ADFSSRC (member name DSPSCIX0).

Communicating with IMS

IMS uses the entry and exit registers to communicate with the routines.

Contents of Registers on Entry

Upon entry, the exit routine must save all registers using the provided save area. The registers contain the following:

Register	Contents
1	Address of the DBRC command authorization exit parameter list
13	Address of the save area
14	Return address to DBRC
15	Entry point address of exit routine

DSPSCIX0 uses standard linkage conventions. It is passed three parameters using a standard format parameter list. For more information, see “IMS Standard User Exit Parameter List” on page 4. The following three parameters are passed to DSPSCIX0:

- A RECON data set name. Any one of the RECON data set names in use can be passed to the exit.
- A 5 byte area in which DSPSCIX0 returns an IMSplex name.
- If the IMSPLEX EXEC statement parameter is specified, the value of the IMSPLEX parameter is passed as this parameter. The EXEC statement referred to can be on any jobstep that uses DBRC.

Contents of Registers on Exit

Before returning to DBRC, the exit routine must restore all registers except for register 15, which contains the following return code.

Register	Contents												
15	One of the following return codes: <table border="1"> <thead> <tr> <th>Return Code</th> <th>Meaning</th> </tr> </thead> <tbody> <tr> <td>0</td> <td>DBRC expects a valid IMSplex name to be returned in the parameter list. This name is used for registration with SCI.</td> </tr> <tr> <td>4</td> <td>RECON Loss Notification is not active and RECON access is attempted without SCI registration. If the RECON indicates that RECON Loss Notification is active, DSP1136I is issued and RECON access fails.</td> </tr> <tr> <td>8</td> <td>RECON Loss Notification is not active and RECON access is forced without regard to RECON content. DSP1143I is issued.</td> </tr> <tr> <td>12</td> <td>RECON access fails and message DSP1139I is issued.</td> </tr> <tr> <td>Any other value</td> <td>Reserved for future use. Will behave as RC12 in this implementation.</td> </tr> </tbody> </table>	Return Code	Meaning	0	DBRC expects a valid IMSplex name to be returned in the parameter list. This name is used for registration with SCI.	4	RECON Loss Notification is not active and RECON access is attempted without SCI registration. If the RECON indicates that RECON Loss Notification is active, DSP1136I is issued and RECON access fails.	8	RECON Loss Notification is not active and RECON access is forced without regard to RECON content. DSP1143I is issued.	12	RECON access fails and message DSP1139I is issued.	Any other value	Reserved for future use. Will behave as RC12 in this implementation.
Return Code	Meaning												
0	DBRC expects a valid IMSplex name to be returned in the parameter list. This name is used for registration with SCI.												
4	RECON Loss Notification is not active and RECON access is attempted without SCI registration. If the RECON indicates that RECON Loss Notification is active, DSP1136I is issued and RECON access fails.												
8	RECON Loss Notification is not active and RECON access is forced without regard to RECON content. DSP1143I is issued.												
12	RECON access fails and message DSP1139I is issued.												
Any other value	Reserved for future use. Will behave as RC12 in this implementation.												

Using the Sample SCI Registration Exit Routine

For the latest version of DSPSCIX0, see the IMS.ADFSSRC library, member name DSPSCIX0.

The sample version of DSPSCIX0 will issue a return code 4 in register 15 unless an IMSplex name is supplied through the IMSPLEX EXEC parameter. If an IMSplex name is supplied, DSPSCIX0 will return the IMSPLEX parameter value.

The sample version of DSPSCIX0 contains a table of RECON data set names and associated IMSplex names. As shipped, the exit responds to any RECON name with return code 4 and the table has no other entries. To activate the RECON Loss Notification, either specify an IMSplex name through the IMSPLEX EXEC parameter on all jobs which use DBRC, or add RECON data set names and associated IMSplex names to the table.

The first entry in the table follows the label PLEXTABL. Each entry consists of a 44-byte RECON data set name, left justified and padded with blanks, followed by a 5-byte character IMSplex name and a 4-byte hexadecimal return code. The last entry is the default entry consisting of an asterisk for a RECON data set name and, unless altered by the user, a blank IMSplex name and a return code of 4. While the default response can be changed, the entry containing the asterisk marks the end of the table and should not be removed unless the associated exit logic is changed as well.

A table modified for a production IMSplex and a test IMSplex could appear as follows:

```

PLEXTABL DS    0H
* production RECONS and associated IMSplex
      DC  CL44'PROD.RECON1'    RECON name
      DC  CL5'PLEXA'          IMSplex name
      DC  XL4'00000000'       RC00 = use the IMSplex name
      DC  CL44'PROD.RECON2'    RECON name
      DC  CL5'PLEXA'          IMSplex name
      DC  XL4'00000000'       RC00 = use the IMSplex name
      DC  CL44'PROD.RECON3'    RECON name
      DC  CL5'PLEXA'          IMSplex name
      DC  XL4'00000000'       RC00 = use the IMSplex name
* test RECONS and associated IMSplex
      DC  CL44'TEST.RECON1'    RECON name
      DC  CL5'PLEXT'          IMSplex name
      DC  XL4'00000000'       RC00 = use the IMSplex name
      DC  CL44'TEST.RECON2'    RECON name
      DC  CL5'PLEXT'          IMSplex name
      DC  XL4'00000000'       RC00 = use the IMSplex name
      DC  CL44'TEST.RECON3'    RECON name
      DC  CL5'PLEXT'          IMSplex name
      DC  XL4'00000000'       RC00 = use the IMSplex name
* end of table - default exit response is not to use SCI for unknown RECONS
      DC  CL44'*'              RECON name
      DC  CL5'                unusable IMSplex name
      DC  X14'00000004'       RC04 = no SCI registration

```

DSPSCIX0

Chapter 29. System Definition Preprocessor Exit Routine (Input Phase) (DFSPRE60)

System Definition Preprocessor exit routine (Input Phase) can be used to alter, insert, or delete data from stage 1 input before the Preprocessor record scan occurs.

The following topics provide additional information:

“About This Routine”

“Communicating with IMS” on page 218

“Using the Sample System Definition Preprocessor Exit Routine” on page 219

About This Routine

DFSPRE60 is a System Definition Preprocessor exit routine. This routine is entered following the reading each stage 1 input record.

Control passes to DFSPRE60 after each stage 1 input record is read from SYSIN, and also after each record (if any) is read from SYSLIB, but before any such records are scanned by the preprocessor. Stage 1 data is presented to DFSPRE60 exactly as read by the preprocessor. Data can be altered, inserted, or deleted during this exit routine phase. However, the alterations, insertions, or deletions are not passed to Stage 1.

Related Reading: For a description of the system definition preprocessor, see *IMS Version 9: Installation Volume 2: System Definition and Tailoring*.

You can also use this exit routine for construction of tables or for verification as required by installation practices. For example, if you want to check if transaction codes (which are also IMS command keywords) are accidentally defined, this routine can insert TRANSACT macros for each IMS command keyword. The results of changes appear in the listing produced by the preprocessor, unless the exit routine returns a return code of 4. However, no update of the original input is performed.

If this exit routine is used, you must specify Y as the first positional parameter in the parameter field of the EXEC card. The routine module must be named DFSPRE60, and it must reside on the library pointed to by the STEPLIB DD statement. If concatenation is used, the libraries are searched according to z/OS rules.

Table 52 shows the attributes of the System Definition Preprocessor (Input Phase) exit routine.

Table 52. System Definition Preprocessor Exit Routine (Input Phase) Attributes

Attribute	Description
IMS environments	DB/DC, DCCTL, and DBCTL (with modifications).
Naming convention	You must name this exit routine DFSPRE60.
Binding	Follow the guidelines described in “Binding the Routines” on page 7. You must bind this routine with RMODE=24; otherwise, an abend can occur.
Including the routine	No special steps are required to include this routine.

Table 52. System Definition Preprocessor Exit Routine (Input Phase) Attributes (continued)

Attribute	Description
IMS callable services	IMS Callable Services are not applicable for use with this exit routine.
Sample routine location	IMS.ADFSSMPL (member name DFSPRE60).

Communicating with IMS

IMS communicates with the System Definition Preprocessor exit routine through the entry and exit registers.

Contents of Registers on Entry

Upon entry, the exit routine must save all registers using the provided save area. The registers contain the following:

Register	Contents
1	Address of parameter list.
10	Address of vector table.
13	Address of save area. The exit routine must not change the first three words.
14	Return address to IMS.
15	Entry point of exit routine.

Description of Parameters

The parameters are listed in parameter list format and vector table format.

Parameter List Format

A(INPUT) (or A(0) at end of file)
 INPUT: These stage 1 source statements reside on the data set pointed to by the DD statement SYSIN or the copy members from SYSLIB.

Vector Table Format

A(DFSPRE30) - Entry point to QUICKSORT routine
 A(DFSPRE40) - Entry point to duplicate check routine
 A(DFSPRE50) - Entry point to cross check routine
 A(0) - Reserved for user

Contents of Registers on Exit

Before returning to IMS, the exit routine must restore all registers except for register 15, which must contain one of the following return codes:

Return Code	Meaning
00	Normal return; record is processed.
04	Do not process record. Record is not printed.
08	Return to exit routine. Pass control to this exit routine before reading another input record. The input buffer, as modified by the exit routine, is processed as an input record.
0C	Do not call this exit routine again. Record is processed.

Using the Sample System Definition Preprocessor Exit Routine

The input statements are scanned for a comment card indicating that TRANSACT macros are to be read from a user file, and passed to the preprocessor in the input buffer area whose address is passed on entry. While the user file is read, the exit routine returns a code of X'08', indicating that the preprocessor is to continue calling the exit routine, instead of reading input records from the SYSIN file.

When the end of file is reached on the user file, the exit routine returns a code of X'0C', indicating that the exit routine is not to be invoked again. The statements passed to the preprocessor are handled identically to the statements on the SYSIN file. However, these statements are not written out to the SYSIN file for later processing by Stage 1.

Chapter 30. System Definition Preprocessor Exit Routine (Name Check Complete) (DFSPRE70)

The System Definition Preprocessor exit routine (name check complete) DFSPRE70, can be used to build tables that contain resource names that have been cross-checked.

The following topics provide additional information:

“About This Routine”

“Communicating with IMS”

About This Routine

This exit routine is entered when all cross-checking of resource names is completed.

To track the changes between IMS system definitions, you can access all tables constructed by the preprocessor, and write them on files for input to a user program.

If this exit routine is used, you must specify Y as the second positional parameter in the parameter field on the EXEC card. The exit module, which must be named DFSPRE70, must reside on the library pointed to by the STEPLIB DD statement. If concatenated, the libraries are searched according to z/OS rules. The processing in this exit routine does not affect the previous preprocessor results or error messages.

Table 53 shows the attributes of the System Definition Preprocessor exit routine (name check complete).

Table 53. System Definition Preprocessor Exit Routine (Name Check Complete) Attributes

Attribute	Description
IMS environments	DB/DC, DCCTL.
Naming convention	You must name this exit routine DFSPRE70.
Binding	Follow the guidelines described in “Binding the Routines” on page 7.
Including the routine	No special steps are required to include this routine.
IMS callable services	IMS Callable Services are not applicable for use with this exit routine.
Sample routine location	IMS.ADFSSMPL (member name DFSPRE70). In the sample routine, the source name tables are written out for later processing by user programs. The end of each exit routine is indicated by the insertion of high values (X'FF').

Communicating with IMS

IMS communicates with the System Definition Preprocessor exit routine through the entry and exit registers.

Contents of Registers on Entry

Upon entry, the exit routine must save all registers using the provided save area. The registers contain the following:

Register	Contents
1	Address of parameter list.
10	Address of vector table.
13	Address of save area. The exit routine must not change the first three words.
14	Return address to IMS.
15	Entry point of exit routine.

Description of Parameters

These are the addresses and sizes of tables of resource names. The contents of the count field (fullword) determine the usefulness of the table field. If the count field is zero, the contents of the table field are not guaranteed and should be ignored. If the count field is nonzero, the table field contains the address of the table of resource names.

Parameter List:

A(Table1)	- DBD names
A(Count1)	- Number of entries in Table1
A(Table2)	- PSB names
A(Count2)	- Number of entries in Table2
A(Table3)	- Transaction codes
A(Count3)	- Number of entries in Table3
A(Table4)	- MSNAME linknames
A(Count4)	- Number of entries in Table4
A(Table5)	- VTAM node names
A(Count5)	- Number of entries in Table5
A(Table6)	- LTERM names
A(Count6)	- Number of entries in Table6
A(Table7)	- Subpool names
A(Count7)	- Number of entries in Table7
A(Table8)	- Routing codes
A(Count8)	- Number of entries in Table8
A(Table9)	- Physical link names
A(Count9)	- Number of entries in Table9
A(Table10)	- Remote system VTAM node names
A(Count10)	- Number of entries in Table10
A(Table11)	- MSLINK partner IDs
A(Count11)	- Number of entries in Table11

Vector Table Format:

A(DFSPRE30)	- Entry point to QUICKSORT routine
A(DFSPRE40)	- Entry point to duplicate check routine
A(DFSPRE50)	- Entry point to cross check routine
A(0)	- Reserved for user

Contents of Registers on Exit

Before returning to IMS, the exit routine must restore all registers. Register 15 can contain a return code, but the preprocessor ignores it.

Chapter 31. Type 2 Automated Operator Exit Routine (DFSAOE00)

You can write two types of automated operator (AO) exit routines. The AO exit routine described in this chapter (DFSAOE00) is called a type 2 AO exit routine. It can be used in the DB/DC, DCCTL, and DBCTL environments.

The other AO exit routine (DFSAOUE0) is called a type 1 and can be used in the DB/DC and DCCTL environments. It is described in Chapter 66, “Type 1 Automated Operator Exit Routine (DFSAOUE0),” on page 425.

If both DFSAOUE0 and DFSAOE00 are provided in a DB/DC or DCCTL environment, DFSAOE00 is called first. DFSAOE00 determines which exit routine will process the message, or command.

Related Reading: For an overview and comparison of the two AO exit routines, see *IMS Version 9: Operations Guide*.

In this Chapter:

“About This Routine”

“Activating This Routine” on page 228

“Communicating with IMS” on page 228

About This Routine

IMS calls DFSAOE00 for:

- IMS system messages destined for the master terminal (the z/OS system console in the DBCTL environment)
- Commands entered from a terminal and the responses to those commands
- Commands issued from an AO application using the DL/I ICMD call
- Commands generated internally by IMS

DFSAOE00 intercepts these communications before IMS sends the system message, executes the command, or sends the command response.

With DFSAOE00, you can:

- Modify the text of IMS system messages. DFSAOE00 can also add up to 20 bytes of additional text to the end of a message.
Any synchronous system “messages” generated by IMS after a command has been entered (such as DFS058 cccc COMMAND IN PROGRESS) are not really messages; they are command responses and cannot be modified.
- Delete IMS system messages. In a DBCTL environment, no trace of the original IMS message to the z/OS system console is kept if the message is deleted or modified.
- Direct any message, command, or command response to an AO application.
- Start a BMP job (for example, an AO application). DFSAOE00 can issue SVC 34 to start a BMP. The /START command can override the APARM value on the EXEC statement. The APARM parameter is a way of passing information to the AO application. To retrieve the value specified on the APARM parameter, the AO application can issue the DL/I INQY call.

Table 54 on page 224 shows the attributes for the type 2 AO exit routine.

DFSAOE00

Table 54. Automated Operator Exit Routine Attributes (DFSAOE00)

Attribute	Description
IMS environments	DB/DC, DBCTL, DCCTL
Naming convention	You must name this exit routine DFSAOE00.
Binding	Follow the guidelines in “Binding the Routines” on page 7. This exit routine must be reentrant. You must manually link edit the routine with DFSCSI00 to include the routine.
Including the routine	<p>DFSAOE00 is a stand-alone, 31-bit reentrant module that you provide.</p> <p>You specify DFSAOE00 by linking it with DFSCSI00 in the IMS.SDFSRESL concatenation as a stand-alone module. DFSAOE00 can then be loaded and called. If you link both DFSAOE00 and DFSAOUE0 (the other AO exit routine), both are loaded. DFSAOE00 is called first and can either process the message, or command, or it can return a code indicating DFSAOUE0 should do the processing instead.</p>
IMS callable services	<p>DFSAOE00 can use callable services for storage and AOI functions. It is defined to IMS as a standard exit and receives the callable services token in the standard exit parameter list. This routine does not need to issue an initialization call (DFSCSI10).</p> <p>For guidelines on using callable services, see “IMS Callable Services” on page 10. For information on how this exit routine uses AOI callable services see “Using AOI Callable Services.”</p>
Sample routine location	IMS.ADFSSMPL

Restrictions

All messages queued to an AO application by DFSAOE00 remain in the IMS subsystem in which they are queued. Only AO applications in the local subsystem can issue a DL/I GMSG call to access the queued messages. Because these messages are not written to a shared-queues structure, applications on other IMS subsystems cannot access them.

You cannot use DFSAOE00 to modify or delete commands and command responses. This includes commands from a terminal or an application program, or internally generated commands.

Using AOI Callable Services

DFSAOE00 can use IMS AOI Callable Services to communicate with an AO application. Using AOI Services, DFSAOE00 can pass a message containing one or more message segments to one or more AO applications. AOI callable services functions include:

- INSERT, which inserts a message segment to a message buffer.
- ENQUEUE, which sends a message to one or more AO applications using AOI token names. The message sent on the ENQUEUE request can be a single-segment or multisegment message built with INSERT requests or a single-segment message supplied on the ENQUEUE request. An AO application issues a GMSG call, specifying an AOI token name, to retrieve a message sent from DFSAOE00.
- CANCEL, which removes inserted segments when you decide not to send the message to an AO application.

Related Reading: For guidelines on using callable services, see “IMS Callable Services” on page 10.

Types of Messages Passed to This Routine

The following types of messages can be passed to DFSAOE00:

- IMS system messages destined for the master terminal (the z/OS system console in the DBCTL environment).
- Commands entered from a terminal, with the following exceptions:
 - /FORMAT
 - /LOOPTEST
 - /MSVERIFY
 - /RELEASE
 - /NRESTART (sent to the exit routine, however, in the DBCTL environment)
 - /ERESTART (sent to the exit routine, however, in the DBCTL environment)

IMS passes the command after basic edit and optional editing routines have had a chance to modify it. This modified input can contain carriage control characters.
- IMS command responses to the terminal.
- Commands issued from an AO application using the ICMD call.
- Commands generated internally by IMS.

Figure 25 on page 226 shows how processing proceeds when a system message is generated. Figure 26 on page 227 and Figure 27 on page 228 show how processing proceeds when a command is entered at a terminal or from an AO application.

IMS does not pass all system messages, operator-entered commands, and command responses to DFSAOE00. The following are types of messages IMS does **not** pass to DFSAOE00:

- Command responses to an AO application
- Commands issued from an AO application using the CMD call (including the responses to those commands)
- System messages for which the destination is not the master terminal
- Command responses to IMS internally generated commands

Changes the Command Editor Makes

The command editor translates certain control characters in any command you enter from a terminal or in any ICMD call. You need to accommodate this translation when writing your exit routine.

The translation is shown in Table 55.

Table 55. Translation of Control Characters in Commands

From	To
X'14' Restore	X'5D' Right Parenthesis
X'15' New Line	X'40' Blank
X'24' Bypass	X'4D' Left Parenthesis
X'40' Blank	X'40' Blank
X'4B' Period	X'4B' Period
X'4D' Left Parenthesis	X'4D' Left Parenthesis
X'5D' Right Parenthesis	X'5D' Right Parenthesis
X'60' Dash	X'60' Dash

Table 55. Translation of Control Characters in Commands (continued)

From	To
X'6B' Comma	X'6B' Comma
X'6D' Dash	X'40' Blank
X'7E' Equal	X'40' Blank

Commands with Network-Qualified LU Names

If you use network-qualified LU names at your installation, the LU name for LU 6.2 application programs can be 17 bytes long. For IMS commands, the network-qualified LU names must be enclosed in single quotation marks (for example, 'NETID.LUNAME').

If an IMS command with the network-qualified LU name is passed to AO exit routine DFSAOE00, IMS modifies the network-qualified LU name in the input command before the command is passed to the AO exit routine. The single quotes around the network-qualified LU name are replaced with blanks, and the period separating the network-identifier and the LU name is replaced with a colon.

Example: A /DISPLAY command with a network-qualified LU name entered at the terminal as:

```
/DISPLAY LUNAME 'NETWORK1.LUNAME1' LUNAME2 INPUT
```

is passed to the AO exit routine or logged to the secondary master as:

```
/DISPLAY LUNAME NETWORK1:LUNAME1 LUNAME2 INPUT
```

Figure 25 shows processing when a system message is generated.

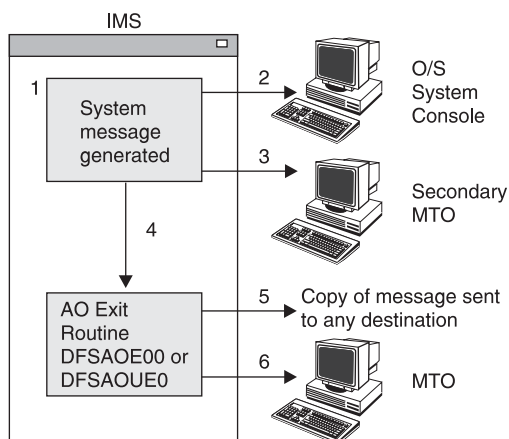

Figure 25. Processing When a System Message Is Generated

Notes:

1. IMS generates a system message destined for the master terminal.
2. A copy of the message can be sent to the z/OS system console. This depends on the specific message and is determined by IMS.
3. A copy of the message can be sent to the secondary master terminal if it exists and if you have specified that this is to be done.
4. The copy of the message destined for the master terminal is passed to DFSAOE00.

5. DFSAOE00 can send a copy of the message to an AO application. This is done by enqueueing the message to an AOI token. DFSAOE00 can alter or delete any segment of the message.
6. The message is sent (unless it has been deleted) to the master terminal.

If both DFSAOE00 and DFSAOUE0 had been loaded, this picture would be conceptually the same. However, when DFSAOE00 got control it could either process the message, or it could return a code indicating DFSAOUE0 should be called to do the processing instead.

Figure 26 shows processing when a command is entered at the terminal.

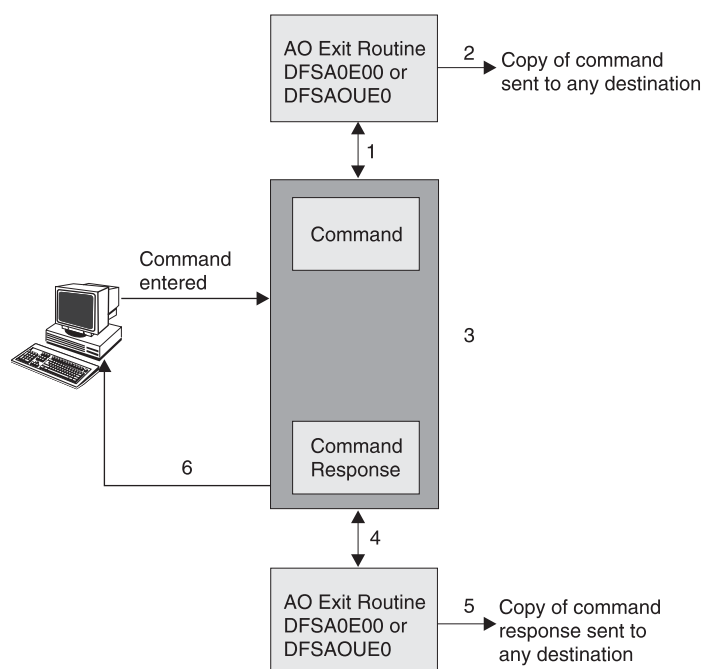

Figure 26. Processing When a Command is Entered at the Terminal

Notes:

1. When a command is entered from a terminal, IMS sends a copy of the command to DFSAOE00 before executing the command.
2. DFSAOE00 can send a copy of the command to any AO application (using the AOI token).
3. IMS executes the command and generates a command response.
4. IMS passes the command response to DFSAOE00. DFSAOE00 can send a copy of the command response to any AO application (using the AOI token).
5. The command response is sent to the terminal that originated the command.

If both AO exit routines (DFSAOE00 and DFSAOUE0) had been loaded, this picture would be conceptually the same. However, when DFSAOE00 got control, it could either process the command or return a code indicating DFSAOUE0 should be called to do the processing instead.

Figure 27 shows processing when a command is entered from an AO application.

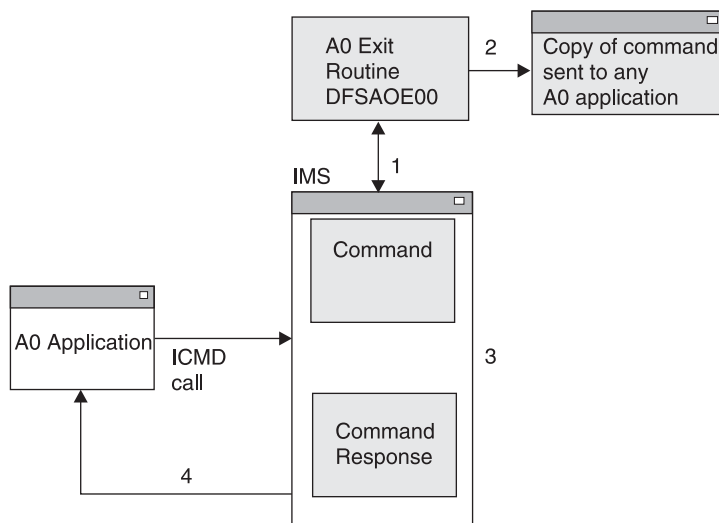

Figure 27. Processing When a Command is Entered from an AO Application

Notes:

1. When a command is entered from an AO application using an ICMD call, IMS sends a copy of the command to DFSAOE00 before executing the command.
2. DFSAOE00 can send a copy of the command to any AO application (using the AOI token).
3. IMS executes the command and generates a command response.
4. IMS sends the command response back to the AO application.

The type 1 AO exit routine (DFSAOUE0) cannot process commands entered from an AO application.

Activating This Routine

DFSAOE00 is activated:

- During IMS initialization. The purpose of this first entry is so that DFSAOE00 can, if you want, do its own initialization.
- After IMS restart is complete. DFSAOE00 is activated for each system message, command, and command response, as explained in “Types of Messages Passed to This Routine” on page 225.

After IMS shutdown processing has begun, DFSAOE00 is disabled and no longer receives control.

Communicating with IMS

IMS communicates with DFSAOE00 through the entry registers and a parameter list.

Content of Registers on Entry

The content of the registers passed from IMS to this exit routine each time it is activated follows:

Register	Content
1	Address of the standard exit parameter list.
13	Address of the save area. Your exit routine must not change the first three words of this save area. This save area is not chained to any other IMS save area.
14	Return address to IMS.
15	Entry point of this exit routine.

Standard Exit Parameter List

This exit routine uses the Version 4 standard exit parameter list. See Table 3 on page 5 for the content of the Version 4 standard exit parameter list. The address of the work area passed to this exit routine in SXPLAWRK will be the same each time that this exit routine is called.

Function-Specific Parameter List

Table 56 shows the contents of the function-specific parameter list. The address of this parameter list is in the standard exit parameter list field SXPLFSPL.

Table 56. Function-Specific Parameter List for DFSAOE00 (Mapped by DFSAOE0)

Field	Offset	Length	Description
AOE0VER	0	4	Address of word containing version number for DFSAOE0.
AOE0FUNC	4	4	Reason for entering DFSAOE00: <ul style="list-style-type: none"> 1 Initial entry. DFSAOE00 can do initialization functions. 2 Message segment to process. 3 Command is aborted.
AOE0SEG	8	4	Address of message buffer or 0 if this is initial entry. (Table 57 on page 232 shows the message buffer.)
AOE0WRKA	12	4	Address of 256-byte work area used by DFSAOE00. The area is static for the segments of a message, or for a command and the related command responses.
AOE0FLG1	16	1	Entry codes: <ul style="list-style-type: none"> X'80' First segment of multiple segments or first and only segment when X'20' is also on. X'40' Middle segment of multiple segments. X'20' Last or only segment. X'10' Command response will be sent for this command. X'20' is also set when X'10' is set. X'08' No segment presented. Last entry to exit.

Table 56. Function-Specific Parameter List for DFSAOE00 (Mapped by DFSAOE0) (continued)

Field	Offset	Length	Description
AOE0FLG2	17	1	Segment or command type: X'80' Command entered at terminal. X'40' Command response segment. X'20' Command (ICMD) issued by AO application. X'10' Command generated internally by IMS. X'08' IMS system message segment.
AOE0FLG3	18	1	X'80' Command input entered at a terminal exceeded 256 bytes.
AOE0USII	19	1	Indicator for contents of user ID field: U user ID L LTERM P PSB name O Other name
AOE0DMTK	20	4	Directed message token required to issue AOI callable service requests.
AOE0IMSI	24	8	IMS subsystem identifier.
AOE0IMSL	32	4	IMS version and release.
AOE0SSTY	36	1	X'01' DB/DC system X'02' DCCTL system X'03' DBCTL system
AOE0ROLE	37	1	X'01' XRF active X'02' XRF alternate IMS X'03' RSR active IMS X'04' RSR tracker
AOE0MVSL	38	1	z/OS version and release on which IMS was generated.
AOE0ENVR	39	1	AO exit routine environment: 1 DFSAOUE0 is loaded. Commands and messages can be passed to DFSAOUE0 to process.

Table 56. Function-Specific Parameter List for DFSAOE00 (Mapped by DFSAOE0) (continued)

Field	Offset	Length	Description
AOE0ORGC	40	4	Origin of the command: 0 Origin fields not set. Fields are set for commands entered from a terminal, an MCS console, LU 6.2 conversation, or OTMA client in a DB/DC or DCCTL system. 1 Origin other than that defined by a specific code 2 VTAM terminal 3 LU 6.2 conversation 4 MCS/E-MCS console 5 OTMA client
AOE0LINE	44	4	Terminal line number (AOE0ORGC=1).
AOE0NODE	44	8	VTAM node name (AOE0ORGC=2).
AOE0NWID	44	8	Network ID (AOE0ORGC=3).
AOE0CONS	44	4	The 4-byte MSC/E-MSC terminal ID (AOE0ORGC=4).
AOE0TMEM	44	16	OTMA member name (AOE0ORGC=5).
AOE0PTRM	48	4	Physical terminal number (AOE0ORGC=1).
AOE0MCSU	48	8	User identification (AOE0ORGC=4).
AOE0LTRM	52	8	Logical terminal name or blanks if LTERM does not exist (AOE0ORGC=1,2).
AOE0LUNM	52	8	Logical unit name (AOE0ORGC=3).
AOE0USID	60	8	Signed-on user ID or blanks (AOE0ORGC=1,2).
AOE0LUUS	60	8	User ID (AOE0ORGC=3).
AOE0TPIP	68	8	Pipe (AOE0ORGC=5).
AOE0USER	68	8	VTAM user, subpool name, or blanks (AOE0ORGC=2).
AOE0ORGC	68		(AOE0ORGC=3)

Table 56. Function-Specific Parameter List for DFSAOE00 (Mapped by DFSAOE0) (continued)

Field	Offset	Length	Description
AOE0RPLY	76	4	Return code from DFSAOE00. This is the only field in this parameter list that DFSAOE00 can modify.
		0	DFSAOE00 is not interested in this message or command segment. IMS will process the message as if the exit routine did not exist. Subsequent segments of the message or command response are presented to DFSAOE00.
		1	DFSAOE00 is not interested in this message or command segment. Call DFSAOUE0 for processing. Do not call DFSAOE00 for subsequent segments of this message.
		2	Send no more segments for this message or command to DFSAOE00.
		3	Delete the IMS system message segment.
		4	Delete the IMS system message segment and all subsequent segments of this message.
		5	DFSAOE00 modified the IMS system message segment.

Message Buffer

The message buffer contains an IMS message, command, or command response. Table 57 shows the format of the message buffer. The function-specific parameter list points to this buffer.

Table 57. Message Buffer

Field	Length	Description
LL	2	Length of the message on first entry to exit routine. Length includes the length of the LL and ZZ fields but excludes length of the 20-byte work area. (If your exit routine deletes or changes a message or uses the work area, it must update this field.)
ZZ	2	Zeros.
Message text	Variable	Text of the message, command, or command response. System message: The first segment of the message text begins with the DFSxxxx number, indicating which message caused IMS to call the exit routine. The message number is followed by the text of the system message. If it is a multisegment message, the remaining segments contain additional text, but do not contain the DFSxxxx message number. Command: The message text is one segment long and begins with the delimiter '/', followed by the command. Command response: The command response is usually a DFSxxxx message or one segment of a multisegment command.

Table 57. Message Buffer (continued)

Field	Length	Description
CR	1	Carriage return character. This field is optional. If it is there, one byte is included in the LL. Input commands do not include a carriage control character.
Work area	20	Additional area DFSA0E00 can use to add text to the message.

Content of Registers on Exit

There is no requirement for exit registers. DFSA0E00 communicates using the reply field in the function-specific parameter list. DFSA0E00 is passed this list when it is entered. Upon exit, the registers contain the following:

Register	Contents
14	Return Address
15	0

DFSAOE00

Chapter 32. User Message Table (DFSCMTU0)

Although there are IMS system message tables containing messages that IMS returns to edit and exit routines, these messages might not be appropriate for your installation's needs. If this is the case, you can create your own messages and list them in your own message table.

The following topics provide additional information:

“About This Table”

“Sample User Message Table and Routine” on page 236

About This Table

IMS assigns the prefix of the user text from the message table with DFSUxxx, where xxx is the message number. You can then use this message table with the following user edit and exit routines:

- Command Authorization exit routine (DFSCCMD0)
- Front-End Switch exit routine (DFSFEBJ0)
- Global Physical Terminal edit routine (DFSGPIX0)
- Logoff exit routine (DFSLGFX0)
- Message Switching Input edit routine (DFSCNTE0)
- Input Message Segment edit routine (DFSME127)
- Physical Terminal Input edit routine (DFSPIXT0)
- Queue Space Notification exit routine (DFSQSPC0)
- Signon/off Security exit routine (DFSCSGN0)
- Signon exit routine (DFSSGNX0)
- Signoff exit routine (DFSSGFX0)
- Transaction Code Input edit routine (DFSCSMB0)

Table 58 shows the attributes of the User Message table.

Table 58. User Message Table Attributes

Attribute	Description
IMS environments	DB/DC, DCCTL.
Naming convention	You must name the message table module DFSCMTU0 , assemble it, and place it in the operating system partitioned data set defined by the USERLIB= operand of the IMSGEN macro. Related Reading: For details about this, see the IMSGEN macro statement description in <i>IMS Version 9: Installation Volume 2: System Definition and Tailoring</i> .
Link editing	No special steps are required to include this table.
Including the routine	You need to specify OPTIONS=(...USERMSG...) in the COMM macro.
IMS callable services	IMS Callable Services are not applicable for use with this table.
Sample routine location	No sample available.

Restriction: This table cannot be used in a DBCTL environment.

Writing a Routine to Use This Table

In order for a routine to use the messages you've placed in the message table, you'll need to choose a key that represents a message number in the table. In the case of the Queue Space Notification exit routine (DFSQSPC0) and the Signon exit routine (DFSSGNX0), the **negative** value of the message key needs to be placed in register 15 on return from the routine. For the other exit routines listed in the previous section, the **positive** value of the message key needs to be placed in register 1 on return from the routine along with a specific return code in register 15.

Exception: The Front-End Switch exit routine (DFSFEBJ0) is an exception to this. Refer to the descriptions of each exit routine for more information.

Including the Table During System Definition

Before Stage 1 of IMS system definition, you need to specify `OPTIONS=(...USERMSGs,...)` in the COMM macro.

Related Reading: For more information, see the COMM macro statement description in *IMS Version 9: Installation Volume 2: System Definition and Tailoring*.

Formatting the Table

The format of your message table (DFSCMTU0) must be as follows:

- The table must start with the instruction BALR 15,14.
- Message numbers range from 1 to (and including) 999, in ascending sequence.
- The maximum size for the text of each message is 100 characters, if the message text exceeds 78 characters, it will be truncated if it is sent to a 3270 terminal that is formatted using IMS-supplied default formats.
- The message length must be an even value (otherwise, an erroneous character might appear following the last character of the text).
- Exclude device control characters from the text of your messages. IMS always adds NEW LINE (NL) control characters to the beginning and end of each message. For messages processed by the Message Format Service (MFS), the device control characters will be changed to X'00' for a 3270 display and to X'40' for other devices.
- Each message entry must start on a half-word boundary. The entry format is:

```
label DC H'message number'
      DC AL2 (entry length including number
          and length fields)
      DC C'message text of even length'
```
- An entry with message number X'7FFF' signals the end of the message table.

Sample User Message Table and Routine

This example shows how you would use user message tables to change the text of the messages issued by a revised version of the Queue Space Notification exit routine.

Sample Table

Figure 28 on page 237 contains the messages specified by an IMS user and has been included in the IMS system.

```

DFSCMTU0 CSECT
*
*                               USER MESSAGE TABLE FOR USER QUEUE
*                               SPACE NOTIFICATION EXIT EXAMPLE.

M013  BALR 15,14
      DC  H'513'                QMGR0
      DC  AL2(M014-M013)
M014  DC  C'RECORDS IN QBLKS DATASET EXCEED UPPER THRESHOLD '
      DC  H'514'                QMGR0
      DC  AL2(M015-M014)
M015  DC  C'RECORDS IN SMSGQ DATASET EXCEED UPPER THRESHOLD '
      DC  H'515'                QMGR0
      DC  AL2(M016-M015)
M016  DC  C'RECORDS IN LMSGQ DATASET EXCEED UPPER THRESHOLD '
      DC  H'516'                QMGR0
      DC  AL2(M017-M016)
M017  DC  C'RECORDS IN QBLKS DATASET BELOW LOWER THRESHOLD'
      DC  H'517'                QMGR0
      DC  AL2(M018-M017)
M018  DC  C'RECORDS IN SMSGQ DATASET BELOW LOWER THRESHOLD'
      DC  H'518'                QMGR0
      DC  AL2(M999-M018)
M999  DC  C'RECORDS IN LMSGQ DATASET BELOW LOWER THRESHOLD'
      DC  X'7FFF'
      END

```

Figure 28. User Message Table Sample

Sample Routine

In this sample routine, the IMS-supplied exit routine (DFSQSPC0) has been replaced by a modified version of the routine that a user has written. The user-modified DFSQSPC0 has the following characteristics:

1. Existing IMS message equates have been replaced by user equates.
2. The list of messages used by the routine code has been changed to refer to the user messages.
3. Load Negative Register (LNR) instructions have been added to store the negative of the user message key in register 15 before returning to the caller of DFSQSPC0. This causes IMS to look in the User Message Table (DFSCMTU0) rather than the system tables for the text of the message.

Figure 29 on page 238 is the modified Queue Space Notification exit routine, DFSQSPC0:

```

*****
*
*           M O D U L E       P R O L O G           *
*
*****
*
*  MODULE NAME: DFSQSPC0
*
*  DESCRIPTIVE NAME: SAMPLE USER QUEUE SPACE NOTIFICATION EXIT
*
*  FUNCTION:
*
*    INTERROGATES NUMBER OF RECORDS CURRENTLY IN USE FOR A
*    DATASET AND DETERMINES WHETHER OR NOT TO DISPLAY
*    THRESHOLD MESSAGES (SEE OUTPUT)
*
*  NOTES:
*
*    RESTRICTIONS:
*
*    DFSQSPC0 MUST NOT IWAIT. THERE IS ONLY ONE PARAMETER AREA
*    (IN QPOOL), HENCE THE QUEUE MANAGER MUST NOT IWAIT BETWEEN
*    THE TIME IT SETS UP THE PARAMETER LIST AND THE TIME IT NO
*    LONGER NEEDS IT, FOLLOWING INVOCATION OF THE EXIT (DFSQSPC0)
*
*    IN ORDER TO UPDATE THE "IN USE" COUNT WITHOUT FIRST ZEROING
*    THE HIGH ORDER BYTE THE HIGH ORDER BIT OF THE FLAG BYTE MUST
*    ALWAYS BE 0.
*
*    DEPENDENCIES: NONE
*
*    REGISTER CONVENTIONS: STANDARD IMS
*
*    MODULE TYPE:
*
*    IMS DC - QUEUE MANAGER EXIT (MAY BE REPLACED BY USER EXIT)
*
*    ATTRIBUTES: REENTRANT
*
*  ENTRY POINT: DFSQSPC0
*
*  PURPOSE: SEE FUNCTION
*
*  LINKAGE: BALR R14,R15 FROM DFSQMGR0 WHENEVER AN LRECL (DRRN)
*  IS ASSIGNED OR FREED
*  NOTE: IN ORDER TO REDUCE THE NUMBER OF INSTRUCTIONS IN THE
*  EXIT ONLY THE WORK REGISTERS (4 AND 5) ARE SAVED AND RESTORED
*
*  INPUT:
*
*    R0 = DATASET INDICATOR
*         00 IF QBLKS
*         04 IF SMSGQ
*

```

Figure 29. User-modified DFSQSPC0 Sample Routine (Part 1 of 5)

```

*          08 IF LMSGQ
*
* R2 = POINTER TO PARAMETER LIST...
*     1ST WORD, 1ST BYTE
*         = FLAG CONTAINING BIT (X'40') THAT INDICATES
*         WHETHER (ON) OR NOT (OFF) # OF RECORDS IN
*         USE EXCEEDED THE UPPER THRESHOLD BUT HAS
*         NOT YET DROPPED BELOW THE LOWER THRESHOLD
*     1ST WORD, 2ND-4TH BYTE
*         = # OF RECORDS CURRENTLY IN USE
*     2ND WORD = MAX # OF RECS ASSIGNABLE BEFORE SHUTDOWN
*
* R10 = SCD ADDRESS
*
* R14 = RETURN ADDRESS
*
* THE UPPER AND LOWER THRESHOLD VALUES ARE OBTAINED FROM SCD
* FIELDS SCDQTU AND SCDQTL. THE QUEUE MANAGER INITIALIZATION
* MTHE JCL USED TO BRING UP THE CONTROL REGION.
* CORRESPONDING FIELDS IN RGPparms. RGQTU AND RGQTL ARE
* 1) IMS DEFAULTS (75% AND 60%), 2) USER DEFAULTS ESTABLISHED
* BY SPECIFYING VALUES FOR QTU AND QTL IN THE DFSPBxxx MEMBER
* OR 3) EXEC PARAMETER VALUES FOR QTU AND QTL ON
* THE JCL USED TO BRING UP THE CONTROL REGION.
*
* OUTPUT:
*
* R0, R2, AND R10 ARE UNCHANGED
* R15 = RETURN CODE
*     = 0 IF NO THRESHOLDS PASSED
*     = ONE OF THE FOLLOWING MESSAGE KEYS IF THRESHOLD PASSED:
*
DFS513 EQU 513 RECS IN QBLKS EXCEED UPPER THRESHOLD
*       IF QBLKS UPPER THRESHOLD EXCEEDED (BIT X'40' IN
*       PARAMETER LIST FLAG BYTE WILL BE TURNED ON)
*
DFS514 EQU 514 RECS IN SMSGQ EXCEED UPPER THRESHOLD
*       IF SMSGQ UPPER THRESHOLD EXCEEDED (BIT X'40' IN
*       PARAMETER LIST FLAG BYTE WILL BE TURNED ON)
*
DFS515 EQU 515 RECS IN LMSGQ EXCEED UPPER THRESHOLD
*       IF LMSGQ UPPER THRESHOLD EXCEEDED (BIT X'40' IN
*       PARAMETER LIST FLAG BYTE WILL BE TURNED ON)
*
DFS516 EQU 516 RECS IN QBLKS DATASET BELOW LWR THRESHOLD
*       IF QBLKS LOWER THRESHOLD PASSED (BIT X'40' IN
*       PARAMETER LIST FLAG BYTE WILL BE TURNED OFF)
*
DFS517 EQU 517 RECS IN SMSGQ DATASET BELOW LWR THRESHOLD
*       IF SMSGQ LOWER THRESHOLD PASSED (BIT X'40' IN FLAG
*       PARAMETER LIST FLAG BYTE WILL BE TURNED OFF)
*
DFS518 EQU 518 RECS IN LMSGQ DATASET BELOW LWR THRESHOLD

```

Figure 29. User-modified DFSQSPC0 Sample Routine (Part 2 of 5)

```

*           IF LMSGQ LOWER THRESHOLD PASSED (BIT X'40' IN           *
*           PARAMETER LIST FLAG BYTE WILL BE TURNED OFF)           *
*                                                                     *
*           NOTE: IF DFSQSPC0 IS REPLACED BY A USER EXIT THE USER  *
*           MESSAGE NUMBERS MUST BE RETURNED IN R15 AS THE         *
*           NEGATIVE OF THE POSITIVE MESSAGE NUMBER (LNR).         *
*           NORMAL EXIT: SEE OUTPUT                                 *
*                                                                     *
*           ERROR EXIT: NONE                                       *
*                                                                     *
*           EXTERNAL REFERENCES: NONE                               *
*                                                                     *
*           CHANGE ACTIVITY: SEE CHANGEID                           *
*                                                                     *
*****
EJECT
*****
*
*           PSEUDO CODE
*
*****
*
*           IF THE BIT IN THE PARAMETER FLAG INDICATING # OF RECORDS
*           EXCEEDED UPPER THRESHOLD IS ON
*
*           THEN
*           IF # OF RECORDS CURRENTLY IN USE HAS DROPPED BELOW LOWER
*           THRESHOLD (60% OF MAXIMUM # OF ASSIGNABLE RECORDS BEFORE
*           SHUTDOWN)
*
*           THEN
*           TURN OFF BIT IN PARAMETER FLAG INDICATING # OF RECORDS
*           EXCEEDED UPPER THRESHOLD.
*           SET R15 = KEY FOR MESSAGE INDICATING DATASET OK AGAIN.
*
*           ELSE
*           NULL
*
*           ELSE
*           IF # OF RECORDS CURRENTLY IN USE > UPPER THRESHOLD (75% OF
*           MAXIMUM # OF ASSIGNABLE BYTES BEFORE SHUTDOWN)
*
*           THEN
*           SET BIT IN PARAMETER FLAG INDICATING # OF RECORDS
*           EXCEEDED UPPER THRESHOLD.
*           SET R15 = KEY FOR MESSAGE INDICATING UPPER THRESHOLD
*           EXCEEDED.
*
*           ELSE
*           NULL
*
*           RETURN TO CALLER.
*

```

Figure 29. User-modified DFSQSPC0 Sample Routine (Part 3 of 5)

```

*
*****
EJECT
DFSQSPC0 CSECT
CHANGEID NAME=DFSQSPC0&SYSDATE,BASE=R12, LINKAGE=IMS, X
          SAVE=(4,,5,,12,)
CHANGEID IDEND=YES
*
          USING PARM,R2      ADDRESSABILITY TO PARM AREA.
          USING SCD,R10     ADDRESSABILITY TO SCD.
*
          TM   PFLAG,PFEXCD  EXCEEDED UPPER THRESHOLD?
          BZ   QSPC100      NO... CONTINUE.
*
          L    R5,PMAX      CALCULATE LOWER THRESHOLD
          M    R4,SCDQTL    (60% OF MAXIMUM NUMBER
          D    R4,=F'100'   OF RECORDS ASSIGNABLE).
*
          L    R4,PINUSE    GET FLAG + IN USE COUNT.
          LA   R4,0(,R4)    GET RID OF FLAG.
          CR   R5,R4        LOWER THRESHOLD : # CRNTLY IN USE
          BNH  RETURN      BR IF LOWER THRESHLD <= CUR IN USE.
*
          NI   PFLAG,X'FF'-PFEXCD TURN OFF EXCEEDED FLAG.
          LR   R15,R0      SET UP
          SRL  R15,1      INDEX.
          LH   R15,MSGTBL1(R15) GET APPROPRIATE MESSAGE KEY.
          LNR  R15,R15    INDICATE USER MESSAGE KEY.
          B    RETURN1
*
          L    R5,PMAX      CALCULATE UPPER THRESHOLD
          M    R4,SCDQTU    (75% OF MAXIMUM NUMBER
          D    R4,=F'100'   OF RECORDS ASSIGNABLE).
*
          L    R4,PINUSE    GET FLAG + IN USE COUNT.
          LA   R4,0(,R4)    GET RID OF FLAG.
          CR   R5,R4        UPPER THRESHOLD : # CURNTLY IN USE
          BNL  RETURN      BR IF UPPER THRESHLD >= CUR IN USE.
*
          OI   PFLAG,PFEXCD SHOW CURRENT IN USE EXCEEDED MAX.
          LR   R15,R0      SET UP
          SRL  R15,1      INDEX.
          LH   R15,MSGTBL2(R15) GET APPROPRIATE MESSAGE KEY.
          LNR  R15,R15    INDICATE USER MESSAGE KEY.
          B    RETURN1
*
RETURN   EQU   *
          SR   R15,R15     RC FOR NO THRESHOLDS PASSED.
*
RETURN1  EQU   *
          LEAVE RC=(15),RESTORE=(4,,5,,12,)
          EJECT
*****

```

Figure 29. User-modified DFSQSPC0 Sample Routine (Part 4 of 5)

```

*
*      MESSAGES RETURNED WHEN THRESHOLDS PASSED
*
*****
*
MSGTBL1 DS    0H
        DC    AL2(DFS516) RECS IN QBLKS BELOW LOWER THRESH
        DC    AL2(DFS517) RECS IN SMSGQ BELOW LOWER THRESH
        DC    AL2(DFS518) RECS IN LMSGQ BELOW LOWER THRESH
MSGTBL2 DS    0H
        DC    AL2(DFS513) RECS IN QBLKS EXCEED UPPER THRESH
        DC    AL2(DFS514) RECS IN SMSGQ EXCEED UPPER THRESH
        DC    AL2(DFS515) RECS IN LMSGQ EXCEED UPPER THRESH
EJECT
LTORG
EJECT
REQUATE
PRINT NOGEN
ISCD
PRINT GEN
EJECT
DFSPARM
END

```

Figure 29. User-modified DFSQSPC0 Sample Routine (Part 5 of 5)

Part 4. Transaction Manager Exit Routines

Chapter 33. Build Security Environment Exit Routine (DFSBSEX0)	249
About this Routine	249
Communicating with IMS	250
Contents of Registers on Entry	250
Contents of Registers on Exit	251
IMS Standard User Exit Parameter List (SXPL)	251
Build Security Environment Exit (BSE) Parameter List	252
Chapter 34. Conversational Abnormal Termination Exit Routine (DFSCONE0)	253
About This Routine	253
Attributes of the Routine	254
Communicating with IMS	254
Contents of Registers on Entry	254
Contents of Registers on Exit	256
Chapter 35. Fast Path Input Edit/Routing Exit Routine (DBFHAGU0)	259
About This Routine	259
Restrictions.	260
Expanding the Routine	260
Using the Routine with Shared EMH Queues	260
Communicating with IMS	261
Contents of Registers on Entry	261
Contents of Registers on Exit	262
Chapter 36. Front-End Switch Exit Routine (DFSFEBJ0)	263
About The Front-End Switch Exit Routine.	263
Attributes of the Routine	263
Terminal Input Processing	264
IBE Input Processing	265
Restrictions.	265
Front-End Interface Block	266
Description of the FEIB Fields	267
Input and Output.	269
Routing Information.	271
Message Expansion	272
Timer Facility	272
FEIBRPQ1 Indicator	273
Communications Between the Front-End Switch Exit Routine and IMS	273
Contents of Registers on Entry	273
Contents of Registers on Exit	273
Example of the Front-End Switch Exit Routine (DFSFEBJ0)	274
Routing Scheme	274
Description of Sample Exit Routine	275
Chapter 37. Global Physical Terminal (Input) Edit Routine (DFSGPIX0)	279
About This Routine	279
Bypassing Basic Edit	280
Specifying the Routine	281
Communicating with IMS.	281
Contents of Registers on Entry	281
Contents of Registers on Exit	282

Chapter 38. Greeting Messages Exit Routine (DFSGMSG0)	283
About This Routine	283
Communicating with IMS	284
Contents of Registers on Entry	284
Contents of Registers on Exit	284
Chapter 39. IMS Adapter for REXX Exit Routine (DFSREXXU)	285
About This Routine	285
Parameters	286
Chapter 40. Initialization Exit Routine (DFSINTX0)	289
About This Routine	289
Attributes of the Routine	290
About User Data Areas	290
Communicating with IMS	291
Contents of Registers on Entry	291
Contents of Registers on Exit	292
Chapter 41. Input Message Field Edit Routine (DFSME000)	295
About This Routine	295
Calling the Routine	296
Defining Edit Routines	296
Considering Performance	297
Communicating with IMS	297
Contents of Registers on Entry	297
Contents of Registers on Exit	298
Function of the Sample Routine	298
Chapter 42. Input Message Segment Edit Routine (DFSME127)	299
About This Routine	299
Calling the Routine	299
Considering Performance	300
Defining Edit Routines	300
Communicating with IMS	301
Contents of Registers on Entry	301
Contents of Registers on Exit	302
Function of the Sample Routine	303
Chapter 43. Logoff Exit Routine (DFSLGFX0)	305
About This Routine	305
Extended Recovery Facility (XRF) Considerations	305
Resetting the Significant Status	306
Communicating with IMS	306
Contents of Registers on Entry	306
Contents of STATUS_IN	307
Contents of STATUS_OUT	307
Contents of Registers on Exit	307
Chapter 44. Logon Exit Routine (DFSLGNX0)	309
About This Routine	309
Extended Recovery Facility (XRF) Considerations	310
Selecting a Logon Descriptor	310
Communicating with IMS	311
Contents of Registers on Entry	311
Contents of Registers on Exit	312
Interfaces	312

Chapter 45. LU 6.2 Edit Exit Routine (DFSLUEE0)	313
About This Routine	313
Changing a Message Segment	314
Network-Qualified Names	314
MOD Name Support for APPC	314
Communicating with IMS	314
Contents of Registers on Entry	314
Contents of Registers on Exit	315
Data Format of Parameters	316
Chapter 46. Message Control/Error Exit Routine (DFSCMUX0)	319
About This Routine	319
Calling the Routine	320
Rerouting Messages	321
Communicating with IMS	323
Contents of Registers on Entry	323
Contents of Registers on Exit	324
Message Control/Error Exit Interface Block (MSNB)	324
Valid Flags and Default Actions	328
Chapter 47. Message Switching (Input) Edit Routine (DFSCNTE0)	329
About This Routine	329
Communicating with IMS	330
Contents of Registers on Entry	330
Contents of Registers on Exit	330
Using the Sample Message Switching Edit Routine (DFSCNTE0)	330
Chapter 48. Non-Discardable Messages Exit Routine (DFSNDMX0)	333
About This Routine	333
Restrictions	334
Processing Options	334
Communicating with IMS	335
Contents of Registers on Entry	336
Standard User Exit Parameter List	336
NDM Interface Block	336
Contents of Registers on Exit	340
Chapter 49. OTMA Destination Resolution Exit Routine (DFSYDRU0)	341
About This Routine	341
Communicating with IMS	342
Contents of Registers at Entry	342
Contents of Registers at Exit	343
Using the Sample OTMA Destination Resolution Exit Routine	344
Error Conditions	344
Chapter 50. OTMA Input/Output Edit Exit Routine (DFSYIOE0)	345
About This Routine	345
Communicating with IMS	346
Contents of Registers at Entry	346
Contents of Registers at Exit	347
Chapter 51. OTMA Prerouting Exit Routine (DFSYPRX0)	349
About This Routine	349
Communicating with IMS	350
Contents of Registers at Entry	350
Contents of Registers at Exit	351

Using the Sample OTMA Prerouting Exit Routine	351
Error Conditions	351
Chapter 52. Output Creation Exit Routine (DFSINSX0)	353
About This Routine	353
Restrictions.	354
LTERM Processing for ETO.	355
Using the Exit Routine with Shared-Queues.	356
Resource Control Block Creation	357
Communicating with IMS.	358
Contents of Registers on Entry	358
Contents of Registers on Exit	359
Chapter 53. Physical Terminal (Input) Edit Routine (DFSPIXT0)	361
About This Routine	361
Bypassing Basic Edit	362
Specifying the Routine	362
Communicating with IMS.	363
Contents of Registers on Entry	363
Contents of Registers on Exit	363
Using the Sample Physical Terminal Input Edit Routine (DFSPIXT0).	364
Chapter 54. Physical Terminal (Output) Edit Routine (DFSCCTO0)	365
About This Routine	365
Specifying the Routine	366
Communicating with IMS.	366
Contents of Registers on Entry	366
Contents of Registers on Exit (If No Cancel Request)	367
Contents of Registers on Exit (If Cancel Request)	368
Using the Sample Physical Terminal Output Edit Routine (DFSCCTO0).	368
Chapter 55. Queue Space Notification Exit Routine (DFSQSPC0/DFSQSSP0)	369
About This Routine	369
Restrictions.	371
Exit Routine Call Types	372
Communicating with IMS.	372
Contents of Registers on Entry	373
Contents of Registers on Exit	374
Threshold Values	374
Chapter 56. Security Reverification Exit Routine (DFSCCTSE0)	375
About This Routine	375
Communicating with IMS.	376
Contents of Registers on Entry	376
Contents of Registers on Exit	377
Chapter 57. Shared Printer Exit Routine (DFSSIML0)	379
About This Routine	379
Attributes of the Routine	379
Special Considerations	379
Communicating with IMS.	380
Contents of Registers on Entry	380
Contents of Registers on Exit	380
Chapter 58. Signon Exit Routine (DFSSGNX0)	381

About This Routine	381
Assembling and Loading the Routine	382
User ID	383
Extended Recovery Facility (XRF) Considerations	383
Supporting Associated Printing	384
Selecting a User Descriptor	384
Providing Queue (LTERM) Data	385
Communicating with IMS	387
Contents of Registers on Entry	387
Contents of Registers on Exit	388
Chapter 59. Signoff Exit Routine (DFSSGFX0)	389
About This Routine	389
Restrictions	389
Extended Recovery Facility (XRF) Considerations	389
Resetting the Significant Status	390
Communicating with IMS	390
Contents of Registers on Entry	390
Contents of STATUS_IN	391
Contents of STATUS_OUT	391
Contents of Registers on Exit	391
Chapter 60. Signon/off Security Exit Routine (DFSCSGN0)	393
About This Routine	393
Communicating with IMS	394
Contents of Registers on Entry	394
Contents of Registers on Exit	394
Chapter 61. Time-Controlled Operations (TCO) Exit Routine (DFSTXIT0)	397
About This Routine	397
Communicating with IMS	398
Contents of Registers on Entry	398
Status Codes	399
Chapter 62. Time-Controlled Operations (TCO) Communication Name Table (CNT) Exit Routine (DFSTCNT0)	401
About This Routine	401
Communicating with IMS	402
Contents of Registers on Entry	402
Contents of Registers on Exit	403
Chapter 63. TM and MSC Message Routing and Control User Exit Routine (DFSMSCE0)	405
About This Routine	405
Sample IMS Configurations	406
Defining Entry Points	407
Authorization Checking	408
Attributes of the Routine	409
Communicating with IMS	409
Contents of Registers on Entry	410
Callable Services	413
Coexistence of DFSMSCE0	415
Using User Prefixes	415
Chapter 64. Transaction Authorization Exit Routine (DFSCTRN0)	417
About This Routine	417

Communicating with IMS	418
Contents of Registers on Entry	418
Contents of Registers on Exit	420
Chapter 65. Transaction Code (Input) Edit Routine (DFSCSMB0)	421
About This Routine	421
Communicating with IMS	422
Contents of Registers on Entry	422
Contents of Registers on Exit	422
Using the Sample Transaction Code (Input) Edit Routine (DFSCSMB0)	423
Chapter 66. Type 1 Automated Operator Exit Routine (DFSAOUE0)	425
About This Routine	425
Restrictions	426
How This Routine Processes Messages	427
Types of Messages Passed to This Routine	428
Types of Messages Not Passed to This Routine	430
Single- and Multisegment Messages	430
Format of Message Segment Copies	431
Viewing the Edited Command Buffer	432
Activating This Routine	433
Communicating with IMS	433
Content of Registers on Entry	433
Content of Registers on Exit	435
Messages Inserted to Transactions by This Routine	437
AO Functions and How to Implement Them	437
Setting Up the Exit Registers	442
User Exit Header Block (UEHB)	445
Chapter 67. 2972/2980 Input Edit Routine (DFS29800)	451
About This Routine	451
Communicating with IMS	452
Contents of Registers on Entry	452
Contents of Registers on Exit	452
Chapter 68. 4701 Transaction Input Edit Routine (DFS36010)	453
About This Routine	453
Communicating with IMS	453
Contents of Registers on Entry	453
Contents of Registers on Exit	454

Chapter 33. Build Security Environment Exit Routine (DFSBSEX0)

The Build Security Environment exit routine provides users with a mechanism to tell IMS whether or not to build the RACF or equivalent security environment in an IMS dependent region for an application that has received its input message from neither OTMA nor an LU 6.2 device.

For example, you might want to use this exit routine to tell IMS to build the security environment for an IMS modified application (that is, the application issues an APPC/MVS outbound allocate) that you know does not receive its input from an LU 6.2 device.

The following topics provide additional information:

“About this Routine”

“Communicating with IMS” on page 250

You can also use this exit routine to request that IMS bypass some part of the security processing in the dependent region when one of the following occurs for a message that did not originate from an OTMA or LU6.2 device:

- CHNG call.
- AUTH call.
- Deferred conversational program switch on the local system (when the system where the inputting terminal is active). Security authorization for the deferred conversational program switch occurs only on the local system.

About this Routine

The Build Security Environment exit routine receives control before the first or next input message is given to an IMS application program and the input message is from neither OTMA nor an LU 6.2 device.

This routine executes in key 7, non-cross-memory mode under the dependent region TCB.

Table 59 shows the attributes of the Build Security Environment exit routine.

Table 59. Build Security Environment Exit Routine Attributes

Attribute	Description
IMS environments	DB/DC, DCCTL. Note: Also supported in a DBCTL environment for non-message driven BMPs.
Naming convention	You must name this exit routine DFSBSEX0.

Table 59. Build Security Environment Exit Routine Attributes (continued)

Attribute	Description
Binding	<p>Follow the guidelines described in “Binding the Routines” on page 7.</p> <p>You must write this routine using reentrant coding techniques. You must link your routine into the IMS.SDFSRESL library.</p> <p>If you choose to use IMS Callable Services, you must link DFSCSI00 with your routine. The following is an example of the bind JCL statements needed:</p> <pre> INCLUDE LOAD(DFSBSEX0) INCLUDE LOAD(DFSCSI00) ENTRY DFSBSEX0 NAME DFSBSEX0(R) </pre>
Including the routine	No special steps are required to include this routine.
IMS callable services	<p>In order to use IMS Callable Services with this routine, you must determine if IMS passed a Callable Services token to you by examining field SXPLATOK in the IMS Standard User Exit Parameter List. See “IMS Standard User Exit Parameter List (SXPL)” on page 210 for more information on the IMS Standard User Exit Parameter List for this routine.</p> <p>If SXPLATOK is zero, you cannot use IMS Callable Services with this routine. If SXPLATOK is non-zero, the only IMS Callable Service you can use is storage services. You do not have to invoke DFSCSI00 to initialize IMS Callable Services. You can use the 256-byte work area pointed to by SXPLAWRK in the IMS Standard User Exit Parameter List for the required parameter lists for your call to DFSCSIF0. See “IMS Callable Services” on page 10 for more information.</p>
Sample routine location	No sample exit routine is provided.

Communicating with IMS

IMS uses the entry registers, the Standard User exit parameter list (SXPL), and the Build Security Environment exit (BSE) parameter list to communicate with this routine.

This routine uses register 15 to communicate with IMS.

Contents of Registers on Entry

The contents of the registers on entry are as follows:

Register	Contents
Register	Contents
1	Address of the IMS Standard User exit parameter list (SXPL). See “IMS Standard User Exit Parameter List (SXPL)” on page 210.
13	Address of a single standard z/OS save area.
14	Return address to IMS.
15	Address of DFSBSEX0.

All other registers are undefined.

Contents of Registers on Exit

The contents of the registers on exit are as follows:

Register	Contents
15	Return code indicating requested action:
	Return Code Meaning
00	IMS is not to build the security environment during the scheduling phase of the transaction. The security environment can be built later if needed for processing a CHNG call, AUTH call, or a deferred conversational program switch.
04	IMS is to build the security environment during the scheduling phase of the transaction. If the security environment is needed later by a CHNG call, AUTH call, or a deferred conversational program switch, this same security environment is used. If the application program does not ever need the security environment, the build of the security environment is unnecessary.
08	Invoke the SAF interface (RACF, or equivalent product) on a CHNG call, an AUTH call, and a deferred conversational program switch, but bypass the dynamic creation of the security environment. If the transaction is running in the local system, and the user who entered the transaction is still signed on, the security environment created by SIGNON is used. Otherwise, the default security environment of the IMS control region or the IMS dependent region is used for the SAF call. Normally, the security environment of the dependent region is used. However, if the dependent region is running with LSO=Y or is a BMP with PARDLI=1 specified, then the security environment of the Control Region is used.
12	Bypass invoking the SAF interface on a CHNG call, an AUTH call, and a deferred conversational program switch.
16	Bypass invoking the SAF interface on a CHNG call, an AUTH call, and a deferred conversational program switch, and bypass the calls to the DFSCSTRN0 and DFSCTSE0 user exits.
20	Invoke the SAF interface on a CHNG call, an AUTH call, and deferred conversational program switch, and bypass the calls to the DFSCSTRN0 and DFSCTSE0 user exits.

Notes:

1. For return codes 08, 12 and 16, IMS does not dynamically build the security environment during transaction scheduling, or later for a CHNG call, an AUTH call, or a deferred conversational program switch.
2. When return code 16 is used, the application gets a status code in the IOPCB of blanks. For the AUTH call, the status field in the I/O area has the value 24 (X'18'): transaction authorization not active.

All other registers are to be restored by this routine.

IMS Standard User Exit Parameter List (SXPL)

This exit routine uses the Version 4 standard exit parameter list. See Table 3 on page 5 for the content of the Version 4 standard exit parameter list. The address of the work area passed to this exit routine in SXPLAWRK can be different each time that this exit routine is called.

Build Security Environment Exit (BSE) Parameter List

The address of the BSE parameter list on entry to this routine is contained in field SXPLFSPL of the IMS Standard User Exit parameter list. Table 60 describes the BSE parameter list.

Table 60. BSE Parameter List

Offset	Field Length	Description
X'00'	4 bytes	Transaction scheduling class.
X'04'	8 bytes	Transaction code of the input transaction.
X'0C'	8 bytes	PSB name.
X'14'	8 bytes	Program name.
X'1C'	8 bytes	User ID. Specifies one of the following: <ul style="list-style-type: none"> • Actual user ID of the user who entered the transaction. • LTERM name of the terminal from which the transaction was entered. • Blanks. <p>This is the user ID for which the security environment will be built if requested by this exit routine.</p>
X'24'	8 bytes	Group name.
X'2C'	32 bytes	Application parameter (APARM= on dependent region JCL).
X'4C'	64 bytes	First 64 bytes of the input message or zeros if the input transaction is conversational.
X'8C'	8 bytes	User ID of the dependent region address space.
X'94'	1 byte	Indicator for contents of user ID field: <ul style="list-style-type: none"> U User ID L LTERM P PSB name O Other name
X'95'	3 bytes	Reserved.

Chapter 34. Conversational Abnormal Termination Exit Routine (DFSCONE0)

A conversational process terminates abnormally when:

- A conversation is ended by an /EXIT or /START command.
- A conversational application program terminates abnormally during a conversation.
- A conversational program fails to insert a message into a response PCB or into an alternate PCB that represents another conversational program.
- A noncorrectable IMS conversational error occurs.

If used, the Conversational Abnormal Termination exit routine can be scheduled twice: once when an /EXIT or /START command is issued, and again either when an application program inserts a SPA, or when the conversational response is received from a remote system.

In this Chapter:

“About This Routine”

“Communicating with IMS” on page 254

About This Routine

You can provide an application program to clean up, if required, when a conversation is prematurely terminated. Upon entry, this program's I/O PCB contains the name of the terminal that had its conversation abended. An exit routine to schedule the application program is required. IMS provides a sample exit routine named DFSCONE0, or you can write your own. To use the IMS-provided routine, you must:

- Define a transaction code named DFSCONE.
- Write a nonconversational application program to be activated by DFSCONE.

When the sample exit routine (DFSCONE0) is finished, the IMS conversational processor determines whether the transaction DFSCONE has been defined. If DFSCONE is not defined, conversation terminates and the SPA is discarded. If DFSCONE is defined, the conversational processor schedules the transaction DFSCONE with the SPA of the terminated conversation as a nonconversational single-segment message.

As an alternative, you can provide a more tailored exit routine. For example, you might want to interrogate the conversation control block (CCB) to determine which transaction was in process when the conversation terminated, or you might want to inspect the SPA to find out what had occurred before the conversation terminated. No DL/I calls can be issued by your exit routine. A message processing program should be scheduled to handle database inquiries and updates or extensive analysis of the conversation. The application program can send messages to the terminal associated with the terminated conversation.

To cause your application program to be scheduled, your exit routine must:

- Place the 8-byte name of the nonconversational transaction into the SPA (offset 6 bytes into the SPA).
- Set the desired length of the SPA.

DFSCONE0

- Insert information to be communicated to the scheduled program into the SPA.
- Set a return code of X'10' in register 15.

The transaction code inserted into the SPA must be for a valid, nonconversational transaction. Otherwise, no transaction will be scheduled, the SPA is discarded, and the response message (if available) is sent to the input terminal.

If you do not provide a DFSCONE0 exit routine, IMS processing is the same as if an exit routine existed and it returned a return code of 0. The default IMS action is as follows:

1. Terminate the conversation if it is still active.
2. Discard the SPA.
3. Discard the response message if available.

Attributes of the Routine

Table 61 shows the attributes for the Conversational Abnormal Termination exit routine.

Table 61. Conversational Abnormal Termination Exit Routine Attributes

Attribute	Description
IMS environments	DB/DC, DCCTL.
Naming convention	You must name this exit routine DFSCONE0.
Binding	Follow the guidelines described in “Binding the Routines” on page 7. You must write this routine using reentrant coding techniques. You must link your routine into the IMS.SDFSRESL library. If you choose to use IMS Callable Services, you must link DFSCSI00 with your routine. The following is an example of the bind JCL statements needed: <pre>INCLUDE LOAD(DFSCONE0) INCLUDE LOAD(DFSCSI00) ENTRY DFSCONE0 NAME DFSCONE0(R)</pre>
Including the routine	No special steps are required to include this routine. To use the sample user exit, you need to define the transaction DFSCONE.
IMS callable services	To use IMS Callable Services with this routine, you must issue an initialization call (DFSCSI0) to obtain the callable service token and a parameter list in which to build the function specific parameter list for the desired callable service. For details on using the initialization call, see “Step 2. Initializing IMS Callable Services (DFSCSI0)” on page 14. Use the ECB in Register 9 for IMS Callable Services.
Sample routine location	IMS.ADFSSRC (member name DFSCONE0).

Communicating with IMS

IMS uses the entry and exit registers to communicate with the exit routine.

Contents of Registers on Entry

The contents of **register 0** identifies the cause of conversation termination as follows:

Byte	Contents
0	<p>Flags Meaning</p> <p>01 Request for termination that is no longer active.</p> <p>02 The /EXIT or /START command was issued by a different terminal than the one in conversation; this causes the conversation to be terminated. If this flag is not on, the request for termination of the conversation is from the terminal in conversation.</p> <p>04 The input CNT could not be found. The master terminal of the current system is set as the input terminal.</p> <p>08 The transaction was discarded by the processing of the /EXIT command.</p>
1	<p>Return Code Meaning</p> <p>01 Conversation was terminated previously by an /EXIT, /START, or IMS cold start. The conversation transaction processed successfully, and IMS is sending (queuing) the response message to the input terminal. See the return code meanings in "Contents of Registers on Exit" on page 256 for options you can use to process the response message and scratch pad (SPA).</p>
2	Reserved
3	Vector describing the calling reason:
	<p>Vector Reason</p> <p>00 Conversational application program abended.</p> <p>04 Reserved.</p> <p>08 /EXIT command for input or other (remote) terminal processed.</p> <p>0C /START LINE or NODE command processed for terminal in conversation. The /START LINE command is valid only if no PTERMs are specified.</p> <p>10 SPA received for an inactive conversation.</p> <p>14 Inconsistent conversational definitions found in a multisystem conversation. Execute the /MSVERIFY command to show the inconsistencies.</p> <p>18 /EXIT command terminated the conversation and the latest SPA is not currently available. (It is queued for processing in this system, or it is in the MSC network.) The SPA passed to the exit routine is the one from the previous step of the conversation.</p> <p style="padding-left: 2em;">The exit routine is called with vector 10 when the current step in progress completes; at this time the latest (and last) SPA for the conversation is passed to the exit routine. This can not occur if an IMS restart results in the loss of the SPA in this or another IMS system.</p> <p>1C The explanation for the /START LINE or NODE command is the same as for Vector 18.</p> <p>20 A conversational application program terminated without inserting to a response PCB or an alternate PCB that represents another conversational program.</p> <p>28 /EXIT command for input or other (remote) ISC terminal processed.</p> <p>30 The link receive entry point of the TM and MSC Message Routing and Control user exit routine (DFSMSCE0) canceled the input transaction.</p>

The contents of the remaining registers are as follows:

Register	Contents
1	Address of the SPA.
2	Pointer to a parameter list that contains SPA processing options. See "SPA Options Parameter List" for a list of the parameters.
6	Address of the CCB for the terminal in conversation, if the conversation is still active. Zero if the conversation is already terminated.
7	If zero, the conversation is already terminated. If positive, the register contains the address of the CTB for the terminal in conversation (if the conversation is active). If negative, the register contains the complemented address of the SPQB for the signed-off user, which can be the result of the exit being called because of an /EXIT CONV USER command.
09	Address of the ECB.
11	Address of the SCD.
13	Address of save area. The exit routine must not change the first three words.
14	Return address to IMS.
15	Entry point of DFSCONE0.

Table 62 lists the SPA options parameters.

Table 62. SPA Options Parameter List

Field	Description
CONESPAH	Maximum SPA length
CONESPAL	Current SPA length
CONEFLG1	Flag 1. This flag can be set as follows: CONE1TDO (X'80') If this flag is set, register 1 points to a SPA buffer that contains the SPA at the maximum length. If this flag is not set, register 1 points to a SPA that is the length of the SPA for the current transaction. Truncated data option is set for the SPA parameter in the TRANSACT macro. CONE1SQ (X'40') Shared-queues are active.

Contents of Registers on Exit

Upon return to IMS, all registers must be restored except for register 15, which must contain one of the following return codes:

Reason Code	Meaning
00	Exit has completed all cleanup required; no further action is necessary. IMS does the following: <ul style="list-style-type: none"> • Terminates the conversation (if still active). • Discards the SPA. • Discards the response message (if available).

Reason Code	Meaning
04	<p>The conversation is ended. The name field is used as a transaction code for a new nonconversational transaction. The remaining data in the SPA is used as input data for a new transaction.</p> <p>IMS does the following:</p> <ul style="list-style-type: none"> • Terminates the conversation (if still active). • Attempts to queue the SPA to the indicated transaction and schedule it. See note 1. • Discards the response message (if available). See note 1.
08	<p>Exit has completed all cleanup required. No further action is necessary.</p> <p>IMS does the following:</p> <ul style="list-style-type: none"> • Terminates the conversation (if still active). • Discards the SPA. • Sends the response message to the input terminal (if available). See note 2.
0C	<p>The conversation is ended. The name field is used as a transaction code for a new non-conversational transaction. The remaining data in the SPA is used as input for a new transaction.</p> <p>IMS does the following:</p> <ul style="list-style-type: none"> • Terminates the conversation (if still active). • Attempts to queue the SPA to the indicated transaction and schedule it. • Sends the response message to the input terminal (if available). See note 2.
10	<p>The conversation is ended. The name field is used as a transaction code for a new non-conversational transaction. The remaining data in the SPA is used as input data for a new transaction.</p> <p>IMS does the following:</p> <ul style="list-style-type: none"> • Terminates the conversation (if still active). • Attempts to queue the SPA to the indicated transaction and schedule it. See note 3. • Discards the response message (if available). See note 3.

Notes for Contents of Registers on Exit:

1. If the SPA cannot be queued to the transaction because the transaction is not defined or defined incorrectly, the response message is still discarded.
2. Upon entry, if bit 7 in register 0, byte 1, is set on (R0='XX01XXXX'), the response message is available.
3. If the SPA cannot be queued to the transaction because the transaction is not defined or defined incorrectly, the response message is not discarded but is sent to the input terminal. Upon entry, if bit 7 in register 0, byte 1, is set on (R0='XX01XXXX'), the response message is available.

DFSCONE0

Chapter 35. Fast Path Input Edit/Routing Exit Routine (DBFHAGU0)

IMS systems with a very high transaction rate use Fast Path's Expedited Message Handling Facility (EMH). EMH is a performance option that speeds up message processing by imposing restrictions upon message lengths and segmentation. To use EMH, an edit/routing routine must receive control from the Input exit routine and determine the eligibility of an incoming message for Fast Path processing. The sample exit provides the minimum level of support required to use IMS Fast Path.

In this Chapter:

“About This Routine”

“Communicating with IMS” on page 261

About This Routine

The Fast Path EMH buffer is dynamically allocated and might not be present at entry. Therefore, DBFHAGU0 can receive the message in an EMH buffer or queue buffer, depending on the terminal type. The exit routine is not permitted to move the data out of the input location. If the message is in a queue buffer at entry, the Fast Path system moves it to an EMH buffer. In editing the input message, the application should not increase the length beyond a length that fits in any message buffer.

If an EMH buffer cannot be obtained, the following message is sent to the input terminal:

```
DFS3971 Unable to process Fast Path due to EMH buffer shortage
```

Table 63 shows the attributes for the Fast Path Input Edit/Routing exit routine.

Table 63. Fast Path Input Edit/Routing Exit Routine Attributes

Attribute	Description
IMS environments	DB/DC, DCCTL
Naming convention	You must name this exit routine DBFHAGU0. You cannot override this name on the FPCTRL system definition macro.
Binding	This exit routine must be reentrant if APPC/IMS support is active.
Including the routine	DBFHAGU0 is a separately linked module in the IMS.SDFSRESL. IMS automatically loads it during Fast Path initialization. If IMS cannot find DBFHAGU0, IMS terminates abnormally with ABENDU1011 and displays the following message: <pre>DFS2730A UNABLE TO LOAD FP INPUT ROUTING EXIT: DBFHAGU0</pre>
IMS callable services	To use IMS Callable Services with this routine, you must issue an initialization call (DFSCSI0) to obtain the callable service token and a parameter list in which to build the function-specific parameter list for the desired callable service. Use the ECB found at offset X'0' of the Fast Path Input Edit/Routing Exit parameter list for the DFSCSI0 call. For details on using the initialization call, see “Step 2. Initializing IMS Callable Services (DFSCSI0)” on page 14. This exit routine is automatically linked to DFSCSI00 by IMS. No additional linking is required to use callable services.

Table 63. Fast Path Input Edit/Routing Exit Routine Attributes (continued)

Attribute	Description
Sample routine location	IMS.ADFSSRC (member name DBFHAGU0).

Restrictions

You must rewrite your Fast Path Input Edit/Routing exit routine for this release of IMS, based on the DBFHAGU0 sample (located in the IMS.ADFSSRCE library) and the guidelines in this chapter.

The exit routine cannot move the data out of the input location.

The exit routine must not increase the length of the message beyond a length that fits in any message buffer.

Expanding the Routine

A transaction that is not Fast Path-exclusive can be directed to EMH processing by an expanded edit/routing routine, based on some condition or conditions beyond transaction code. For example, certain transactions can be routed to EMH if they originate at specified physical or logical terminals or if they reference the content of some portion of the message (for example, account number). The user-supplied DBFHAGU0 would have to develop appropriate routing codes based on such conditions.

Using the Routine with Shared EMH Queues

If your installation uses shared EMH queues, DBFHAGU0 can place messages on the shared-queue structure for processing by any sharing IMS subsystem in the sysplex.

You can modify the exit routine to specify an application name for the application program used to process Fast Path input messages. If you do not specify an application name, Fast Path locates the transaction or routing code in the local IMS subsystem. Fast Path rejects the input message if it cannot locate the transaction or routing code.

You can also specify a sysplex processing code that determines how a message transaction or routing code is processed. The following sysplex routing options are available:

- Local First** Specifies that the message is processed on the local subsystem if an IFP region is available. If no IFP region is available, the message is passed to the EMH queue structure. A program name specified in the exit routine for message processing overrides the transaction or routing code. Local First is the default.
- Local Only** Specifies that Fast Path does not place the message on the EMH queue structure. Fast Path input messages are processed on the local IMS subsystem.
- Global Only** Specifies that Fast Path places the input message on the EMH queue structure. The application program that processes the input message must be active on all sharing IMS subsystems. If the application is not active, Fast Path discards the input message and

issues an error message. A program name specified in the exit routine for message processing overrides the transaction or routing code.

Recommendation: To avoid implicit priority for Local Only messages over Local First messages, process Local First and Local Only messages under separate program names. IMS places Local Only messages on the balancing group (BALG) queue and Local First messages on the shared EMH queue. When an IFP region becomes available, it checks the BALG queue for messages to process before it checks the shared EMH queue. This sequence gives implicit priority to Local Only messages that are processed in the same program.

Communicating with IMS

IMS uses the entry and exit registers, as well as parameter lists, to communicate with the exit routine.

Contents of Registers on Entry

Upon entry, the exit routine must save all registers using the provided save area. The registers contain the following:

Register	Contents
R1	Address of Standard Exit Parameter List.
R13	Save area address.
R14	Return address to IMS.
R15	Entry point address of exit routine.

This exit routine uses the Version 1 standard exit parameter list. See Table 2 on page 5 for the content of the Version 1 standard exit parameter list.

Table 64 lists the Fast Path exit parameters. The address of this parameter list is in the standard exit parameter list field SXPLFSPL.

Table 64. Fast Path Input Edit/Routing Exit Parameter List

Offset	Length	Description
+0	4	ECB address.
+4	4	SCD address.
+8	4	Input message.
+12	4	Address of routing code table entry if this is a Fast Path exclusive transaction, or zero.
+16	4	Eight-character work area to supply a routing code name.
+20	4	Address of ESCD.
+24	4	The length of the EMH Buffer for this application.
+28	4	Address of the DBFHAGU0 extended parameter list. This parameter list exists if shared EMH queues are used. Otherwise, the extended parameter list is 0.

Table 65 lists the Extended Parameter list parameters.

Table 65. DBFHAGU0 Extended Parameter List

Offset	Length	Description
+0	4	Address of the 8-byte PSB name
+4	4	Sysplex processing code 0 Local First (Default) 4 Local Only 8 Global Only
+8	4	Address of the Local PSB name table ¹
+12	4	Address of the Global PSB name table ¹
+16	4	System definition code 0 Transaction Defined in local system 4 Transaction not defined in local system
+20	4	Input message code 0 Fast Path exclusive transaction 4 Fast Path potential transaction

Notes:

1. The sample DSECT for the local program name table and the global program name table can be found in the DBFPGNT macro.

Contents of Registers on Exit

Upon return, all registers must be restored except for register 1 and 15, which must contain the following:

Register	Contents
1	Message number to send to inputting terminal.
15	One of the following return codes: Return Code Meaning 00 Schedule with Fast Path. Register 3 points to the RCTE to be used. 04 Schedule with Fast Path using transaction code as the routing code. 08 Schedule with Fast Path using the routing code you provide. 12 Return to IMS for processing. 16 Schedule with Fast Path using transaction code if the routing code equal to transaction code is active; otherwise, let IMS process it. 20 Schedule with Fast Path using routing code provided the routing code is active; otherwise, let IMS process it. This is the same action as user exit return code 08. 24 Discard input, send message from user table back to inputting terminal. 28 Discard input, send message from system message table.

Chapter 36. Front-End Switch Exit Routine (DFSFEBJ0)

The Front-End Switch (FES) exit routine allows you to keep the input terminal in response mode while it is waiting for the reply from the processing system for messages entered in an IMS system by a front-end switchable VTAM node and processed in another system (such as IMS or CICS).

The following topics provide additional information:

- “About The Front-End Switch Exit Routine”
- “Communications Between the Front-End Switch Exit Routine and IMS” on page 273
- “Example of the Front-End Switch Exit Routine (DFSFEBJ0)” on page 274

About The Front-End Switch Exit Routine

During system definition, you specify the FES exit routine on the COMM macro with the FESEXIT parameter, and you specify which VTAM nodes can do front-end switching.

The connection between intermediate IMS systems must be through Intersystem Communication (ISC), although connections with non-IMS back-end systems can be any VTAM protocol that IMS supports, such as SLUTYPEP or SLUTYPE2.

IMS-to-IMS and IMS-to-non-IMS interconnections are referred to as intermediate/back-end or IBE links, and front-end systems are referred to as FE systems.

Front-End Switch is not related to Multiple Systems Coupling (MSC), and cannot be used with MSC for the processing of the same transaction. Front-End Switch is designed to connect an IMS network to non-IMS systems, and MSC is used for homogeneous IMS networks.

Attributes of the Routine

Table 66 shows the attributes of the Front-End Switch exit routine.

Table 66. Front-End Switch Exit Routine Attributes

Attribute	Description
IMS environments	DB/DC, DCCTL.
Naming convention	You must name this exit routine DFSFEBJ0.
Binding	Follow the guidelines described in “Binding the Routines” on page 7. This routine must be reentrant.
Including the routine	If you want IMS to call the exit, include it in an authorized library in the JOBLIB, STEPLIB, or LINKLIST library concatenated in front of IMS.SDFSRESL. If the exit routine is included, IMS automatically loads it each time IMS is initialized.

Table 66. Front-End Switch Exit Routine Attributes (continued)

Attribute	Description
IMS callable services	To use IMS Callable Services with this routine, you need to issue an initialization call (DFSCSI0) to obtain the callable service token and a parameter list in which to build the function-specific parameter list for the desired callable service. Related Reading: For details on using the initialization call, see “Step 2. Initializing IMS Callable Services (DFSCSI0)” on page 14. Use the ECB found in Register 9 for IMS Callable Services. This exit is automatically linked to DFSCSI00 by IMS. No additional linking is required to use IMS Callable Services.
Sample routine location	IMS.ADFSSRC.

You must code the exit routine for AMODE=31. You can define the RMODE as ANY.

Terminal Input Processing

The Front-End Switch exit routine gains control from an IMS system when the first segment of an input message is received before IMS determines the destination of the message. All input from FES-capable nodes and from ISC links are processed by this exit routine. By the time the message arrives, it already has been edited by routines such as Basic Edit, ISC (Intersystem Communication), and MFS Edit. Both MFS Edit and Basic Edit can remove characters that have a value less than X'41'.

For a diagram of the relationships among the front-end system, the intermediate system, and the back-end system with regard to message switching, see Figure 30 on page 265.

This exit routine can do any of the following:

- Indicate a destination change for an input message to an IBE destination or local transaction program defined in this IMS system. Changing the destination forces the originating terminal to be in response mode. (Front-end system processing.)
- Indicate a destination change for an input message from an IBE link to another IBE destination or to a local transaction program defined in this IMS system. (Intermediate system processing.)
- Define a transaction code that can be initiated when a specified time interval expires after switching the message. (Timeout processing.)
- Specify the message that can be sent directly to the input terminal for timeout processing.
- Provide IMS with additional routing information to expand the original message for any IBE system.
- Specify the name of a transaction program (full-function response mode or Fast Path) that processes or logs input messages due to user exit routine failures detected in other than the original terminal input (for example, ISC input).

The exit routine must provide additional routing information to identify the reply to this message when it comes back to the IMS front-end system. The user can tell IMS to remove the added information before the reply message is sent to the original terminal.

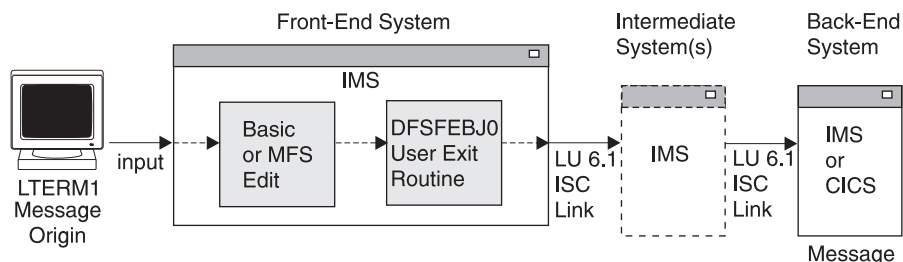

Figure 30. Message Flow with the Front-End Switch Exit Routine

In Figure 30, the reply path is not shown to keep the diagram simple. The reply would usually follow the same path back through the intermediate system(s) to the front-end, and then to the originating terminal.

IBE Input Processing

The exit routine takes control of each message that comes from an ISC or FES-defined link. It is the user's responsibility to correlate the reply message to a previously switched input message. A reply to an input message, when received from another system, is treated by IMS as an input message.

The exit routine at this point can:

- Analyze the message text.
- Copy the LTERM name from the message text into the FEIBLTRM field.
- Copy the message identifier from the message text into the FEIBUNID field.
- Specify a destination for a late reply message in the FEIBLDST field.
- Tell IMS to remove the routing data from the message by specifying a length > 0 in the FEIBULNG field.
- Set the FEIBRPQ1 indicator if the reply message has to be sent directly to the original input terminal.
- Indicate the change of the destination code to a local transaction code (full-function non-response mode) in the FEIBNDST field.
- Set FEIBRPN to an error processing program (ERP) name that receives the input message if errors are detected in the verification of the exit parameters. An error message appears on the MTO of the system detecting the error.

Restrictions

The following restrictions apply to the Front-End Switch exit routine:

- The FES function can be used with the COMM macro statement specifying `OPTIONS=BLKREQD` or `NOBLANK`. However, you must specify a blank following the transaction code regardless of the option specified.
- If the back-end or intermediate system detects an error for an input transaction, the error message can not be sent back to the input terminal. It is sent to the MTO of the system detecting the error. It also can be sent back over the IBE session that sent the original input, or the input message can be sent to an ERP, if one is specified.

If an error is sent over the ISC session, IMS will CLSDST the session thus making the error more visible and keep future ones from occurring. This can be valuable during a debugging period of a new FES exit or application; however, it can prove bothersome during production time. To avoid this, specify a FEIBERP when processing input from an ISC session and develop an application to log or process these errors should they occur.

- Conversational transactions are not supported.
- If the front-end system is part of an XRF complex, the terminal operator might not get the reply to a switched message in case of a takeover even if the reply comes in time. The terminal receives an IMS message instead.
- For a local transaction defined as full-function, nonresponse mode, the exit routine switches a transaction (TXNA) to a local transaction (TXNB) and turns on the timer facility. TXNB executes locally and replies to the originating terminal. However, the terminal is left in response mode. When the timeout transaction processes, a response is sent to the terminal, which resets the response mode.
- If the back-end system is non-IMS, the reply message that the back-end system sends to IMS must be asynchronous (nonresponse) and expect no counter-response from IMS. You can do this in one of two ways:
 - End the response with an end bracket (EB).
 - Append the FMH6 SCHEDULER header to the FMH5 header at attach time, and use a change direction (CD) indicator.

Related Reading: For more information, see *IMS Version 9: Administration Guide: Transaction Manager*.

Front-End Interface Block

A Front-End Interface Block (FEIB) is created for each FES capable terminal. The FEIB is used to communicate between the Front-End Switch exit routine and IMS.

For a VTAM node (excluding ISC) defined as FES capable (by an OPTIONS=FES on the TERMINAL, or TYPE macro, or ETO logon descriptor), the FEIB is allocated when the session has been established. The block is released when the VTAM session terminates and no reply for an FES message is outstanding.

Related Reading: For more information on the Extended Terminal Option (ETO) feature, see *IMS Version 9: Administration Guide: Transaction Manager*.

The interface block is also allocated for each ISC parallel session. This is done automatically without special system definition at LOGON or OPEN DEST time. The interface block is destroyed at LOGOFF time, at CLOSE DEST time, or at session failure.

If the exit routine is not defined in the system or if the VTAM node is not defined as FES capable, the FEIB will not be allocated.

Register 1 upon entry to the exit contains the address of the interface block.

The FEIB layout is in Figure 31 on page 267. The FEIB usage is shown in Table 68 on page 269.

```

*-----*
*       FEIB - FRONT END MESSAGE SWITCH INTERFACE BLOCK DSECT       *
*-----*

FEIB      DSECT
FEIBIFLG DS      X          USER EXIT INPUT FLAGS
FEIBISC  EQU     X'80'      MESSAGE FROM AN ISC LINK
*        EQU     X'40'      RESERVED BY IBM
*        EQU     X'20'      RESERVED BY IBM
*        EQU     X'10'      RESERVED BY IBM
*        EQU     X'08'      RESERVED BY IBM
*        EQU     X'04'      RESERVED BY IBM
*        EQU     X'02'      RESERVED BY IBM
*        EQU     X'01'      RESERVED BY IBM
FEIBOFLG DS      X          USER EXIT OUTPUT FLAGS
FEIBRPQ1 EQU     X'80'      QUEUE RESPONSE TO ORIG DEVICE
*                               ELSE QUEUE SMB NAMED IN FEIBNDST
FEIBERP  EQU     X'40'      ON TIMEOUT CALL ERP, ELSE ERR MSG
*        EQU     X'20'      RESERVED BY IBM
FEIBTMED EQU     X'10'      TIME RESPONSE WITH SYSDEF VALUE
*        EQU     X'08'      RESERVED BY IBM
*        EQU     X'04'      RESERVED BY IBM
*        EQU     X'02'      RESERVED BY IBM
*        EQU     X'01'      RESERVED BY IBM
FEIBMSGN DS      H          TIMEOUT ERROR MESSAGE NUMBER
*                               ONLY USED IF FEIBERP OFF
FEIBLTRM DS      CL8       LTERM NAME OF ORIGINAL TERMINAL
*                               ONLY AVAILABLE IF FEIBISC OFF
FEIBMSG  DS      A          POINTER TO INPUT MESSAGE BUFFER
FEIBUNID DS      F          UNIQUE ID NUMBER (FULL WORD BIN)
FEIBNDST DS      CL8       NAME OF NEW DEST TO QUEUE MESSAGE
FEIBERP  DS      CL8       NAME OF ERP TO CALL ON TIMEOUT
*                               ONLY USED IF FEIBERP ON
FEIBLDST DS      CL8       NAME OF DEST TO QUEUE LATE MESSAGE
FEIBULNG DS      H          LENGTH OF DATA IN USER AREA
FEIBUSER DS      CL40      USER AREA FOR DATA TO PREFIX MSG
*                               ONLY USED IF FEIBULNG > 0.
FEIBIMID DS      CL4       IMS IDENTIFIER
FEIBTIME DS      H          TIMEOUT INTERVAL (SECONDS)
FEIBPRN DS      CL8       PRIMARY RESOURCE NAME ADDED
                          TO USER DATA BY ISC EDIT

```

Figure 31. FEIB DSECT from ICLI FEIUBASE=0

Description of the FEIB Fields

Table 67 provides a description of the FEIB fields.

Table 67. Description of the FEIB Fields

Field	Description
FEIBIFLG	Input flag: FEIBISC (bit 0) <ul style="list-style-type: none"> • on: message is from an ISC link • off: message is from an FES capable device FEIBISC (bits 1–7) Reserved

Table 67. Description of the FEIB Fields (continued)

Field	Description
FEIBOFLG	<p>Output flags:</p> <p>FEIBRPQ1 (bit 0)</p> <ul style="list-style-type: none"> on: reply message has to be sent directly to the original input terminal off: reply message has to an SMB named in FEIBNDST <p>FEIBERP (bit 1)</p> <ul style="list-style-type: none"> on: on timeout, schedule the SMB named in FEIBERP off: on timeout send text of error message defined in FEIBMSGN to the original input terminal (only used if FEIBTMED is ON.) <p>FEIBTMED (bit 3)</p> <ul style="list-style-type: none"> on: release terminal from response mode when the timeout value is exceeded off: timeout facility is not used for this message <p>FEIBDELT (bit 4)</p> <ul style="list-style-type: none"> on: defer timeout facility until FP sync-point off: timeout facility will be activated immediately at input message processing (only used if FEIBTMED is ON) <p>FEIBDELT (bits 2, 5-7) Reserved</p>
FEIBMSGN	User message number from table (DFSCMTU0) which is sent to the original input terminal in the case of a timeout. The message number can only be specified if the FEIBERP bit is off. Values range from 1-999. (Binary Number.)
FEIBLTRM	Logical Terminal Name (LTERM) of the input terminal. For a reply message, DFSFEBJ0 must store the LTERM name into this field, padding with blanks on the right. (For more information, see "Routing Information" on page 271)
FEIBMSG	Pointer to the DC buffer containing the input message.
FEIBUNID	Unique message identifier is only available if the FEIBISC bit is off on input to the exit routine. The exit routine must store the unique identifier (a binary number) into this field. (For more information, see "Routing Information" on page 271) for a reply message.
FEIBNDST	New destination name for the message. This identify an IBE destination or a transaction code. (Blank padded on right.)
FEIBERP	Error processing program name (transaction code) to be scheduled in the case of a timeout. The FEIBERP bit must be set on if the program name is specified. (Blank padded on right.) This field is also used to specify an optional ERP if the input is from an IBE session. In this case, FEIBERP need not be set, and the ERP is scheduled with the input from the IBE session.
FEIBLDST	Transaction name that is scheduled when a reply message arrives after timeout. (Blank padded on right.)
FEIBULNG	This field must contain the length of the user data for an input message. It is used by IMS to expand the original message. This field can contain the length of the user data to be removed by IMS from the reply message for an output message.
FEIBUSER	User data area for routing information that IMS uses to expand the message. This field is used for input messages only if the FEIBULNG field is greater than zero.
FEIBIMID	At input to the exit routine, this field contains the identifier for the IMS system as specified during system definition on the IMSCTRL macro.
FEIBTIME	Timeout interval override (in seconds). This field is used to override the system Front-End-Switch timeout value as supplied on the COMM macro. If a value of 0 is in this field, the system default override value is used.

Table 67. Description of the FEIB Fields (continued)

Field	Description
FEIBPRN	At input to the exit routine, this field contains the primary resource name that was added to the user data by ISC edit.

Table 68 shows the FEIB usage.

Table 68. FEIB Usage

Entry Name and Data Type	Input Message Processing						Reply Message Processing					
	Front-End System		Back-End System		Intermediate System		Front-End System		Intermediate System		Back-End System	
	In	Out	In	Out	In	Out	In	Out	In	Out	In	Out
FEIBMSG DS A	X		X		X		N/A	N/A	X		X	
FEIBLTRM DS CL8	X		X		X		N/A	N/A	X		X	X
FEIBERPN DS CL8		X		X			N/A	N/A		X		X
FEIBMSGN DS H		X					N/A	N/A				
FEIBNDST DS CL8		X		X			N/A	N/A		X		X
FEIBUNID DS F	X						N/A	N/A				X
FEIBLDST DS CL8							N/A	N/A				X
FEIBULNG DS H		X					N/A	N/A				X
FEIBUSER DS CL40		X					N/A	N/A				
FEIBISC EQU BIT	X(0)		X(1)		X(1)		N/A	N/A	X(1)		X(1)	
FEIBRPQ1 EQU BIT							N/A	N/A				X
FEIBERP EQU BIT		X					N/A	N/A				
FEIBTMED EQU BIT		X					N/A	N/A				
FEIBIMID DS CL4	X		X		X		N/A	N/A	X		X	
FEIBTIME DS H		X					N/A	N/A				
FEIBPRN DS CL8	X		X		X		N/A	N/A				
Return Code (R15)	2-New Dest from FE		6-New Dest from IBE		0-Nothing		N/A		6-New Dest from IBE		8-Reply	

Note: X(0) = off
X(1) = on

Input and Output

Table 69 on page 270 and Table 70 on page 270 show the input fields, which are stored by IMS and the output fields, which are stored by the exit routine.

Table 69. FES Data Flow for Input Message Processing

System	Input	Output
Front-End System	FEIBLTRM (CL8)	FEIBERPM (CL8)
	FEIBMSG (A)	FEIBMSGN (H)
	FEIBUNID (F)	FEIBNDST (CL8)
	FEIBIMID (CL4)	FEIBUSER (CL40)
	FEIBPRN (CL8)	FEIBULNG (H)
		FEIBTIME (H)
		Return Code: 0 - nothing 12 - Table error
	Flags: FEIBISC	Flags: FEIBERP, FEIBTMED
Intermediate System	FEIBMSG (A)	FEIBNDST (CL8)
	FEIBIMID (CL4)	FEIBERPN (CL8)
	FEIBLTRM (CL8)	
	FEIBPRN (CL8)	
		Return Code: 6 - New Dest from IBE 12 - Table error
	Flags: FEIBISC	Flags: N/A
Back-End System	FEIBMSG (A)	
	FEIBIMID (CL4)	
	FEIBLTRM (CL8)	
	FEIBPRN (CL8)	
		Return Code: 0 - Nothing
	Flags: FEIBISC	Flags: N/A

Table 70 shows the input fields for reply message processing.

Table 70. FES Data Flow for Reply Message Processing

System	Input	Output
Front-End System	FEIBMSG (A)	FEIBLTRM (CL8)
	FEIBIMID (CL4)	FEIBUNID (F)
	FEIBLTRM (CL8)	FEIBLDST (CL8)
		FEIBNDST (CL8)
		FEIBULNG (H)
		FEIBERPN (CL8)
		Return Code: 0 - nothing 8 - Reply 12 - Table error
	Flags: FEIBISC	Flags: FEIBRPQ1
Intermediate System	FEIBMSG (A)	FEIBNDST (CL8)
	FEIBIMID (CL4)	FEIBERPN (CL8)
	FEIBLTRM (CL8)	
		Return Code: 0 - Nothing 6 - New Dest from IBE 12 - Table error
	Flags: FEIBISC	Flags: N/A

Table 70. FES Data Flow for Reply Message Processing (continued)

System	Input	Output
Back-End System	N/A	N/A

Routing Information

If the value of the FEIBULNG field is greater than zero, IMS adds the user data on an input message from an FE device to the input message between the old destination and the message text. You are responsible for the format and the contents of the routing information. Both MFS edit and Basic Edit can remove characters that have a value less than X'41'. As part of the routing information, the following is required:

- A unique identifier assigned to the input message from the originating terminal. This identifier must be sent with the user data to identify the reply to this message when it comes back to IMS. For messages being processed by either MFS or Basic Edit, the identifier value must be translated into unpacked format.
- The LTERM name of the originating terminal. IMS does not have access to the control blocks of the originating terminal when the reply to a switched message arrives. Therefore the exit routine must add the LTERM name of the originating terminal to the user data. This LTERM name is to be rerouted with the reply from the back-end system and must not be removed or changed by any intermediate system.

When the exit routine gains control from IMS on input of the reply message, it obtains the LTERM name and the unique identifier from the message text and stores them into the corresponding fields of the FEIB. IMS then determines the original input terminal and checks if timeout has already occurred. The destination of the message is determined by the result of this check.

If the timer has not expired, one of the following occurs:

- The message is sent directly to the original input terminal.
- The message is queued to a local transaction, which can cause a reply message to be sent to the originating LTERM using the I/O PCB.

Be aware that the TPCBTSYM field of the I/O (TPPCB) might contain the ISC LTERM name when the application does an ISRT reply back to the originating LTERM. This choice is decided by the exit routine.

If the timer has expired, the message is no longer expected at the original terminal, because it is already released from response mode. The message is then sent to the destination defined by the exit routine for late reply messages.

Besides required routing information, the routine can store additional information, such as a unique system identification throughout all connected systems.

Application programs processing FES messages must understand that the input message contains routing information which must be rerouted to the front-end system. The routing information in all the involved systems must be in agreement. The routing information in the input message must be included in the output message.

Message Expansion

Because the DC buffer is not large enough to store the routing information, use the FEIBUSER field of the FEIB. The length of the user data must be stored in the FEIBULNG field of the FEIB. The maximum length of user data is 40 bytes. IMS combines the original message with the user data and stores both into the new buffer. The new destination (FEIBNDST) is also stored into the new buffer.

Figure 32 shows the original and new buffer formats.

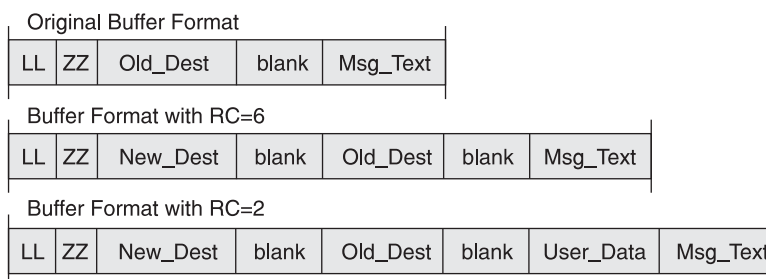

Figure 32. Old and New Buffer Formats

New_Dest

New destination from FEIBNDST field

User_Data

User data from FEIBUSER field

The old destination and the new destination are both followed by a blank. You must lay out the routing information. After IMS has expanded the message, the routing information should precede the original message text.

Timer Facility

A timer facility controls each input message that is routed to a back-end system. When the specified time interval expires without a reply to the input message, the input terminal is released from response mode. The timeout value is specified during system definition on the COMM macro and can be overwritten by the FESTIM parameter on the IMS procedure, or by specifying a non-zero value in the FEIBTIME field during front-end processing of an input message. To make use of the timer, set the FEIBTMED flag in the FEIB. In addition, you must specify the action which has to be taken at timeout. This can be done by specifying either the name of a program that is to be given control (FEIBERPN field) or a message that is to be issued (FEIBMSGN field). The message number must be included in the user message table DFSCMTU0. See DFSCMTU0 for more information. The program can send a message to the input terminal using the I/O PCB. This response releases the terminal from response mode. The message text is directly sent to the input terminal if you define a message number.

If the reply comes in time, the timer request for the input message is canceled. No timeout can occur if you don't set the FEIBTMED indicator. If no reply is received, the terminal is not released from response mode.

If the input terminal is in an active conversation status, the timer facility will not be activated.

If the input terminal is in an active conversation status, the timer facility will not be activated.

When switching to a local Fast Path transaction, the timeout facility can be deferred until Fast Path sync-point by setting the FEIBDELT flag.

FEIBRPQ1 Indicator

This indicator can only be set when a reply message has a return code of 8 in register 15. To have the message sent directly to the original input terminal, the FEIBRPQ1 indicator must be set in the FEIB. If you don't set it, you have to store a new destination into the FEIBNDST field of the FEIB. IMS checks the indicator and sends the message, depending on the values in the FEIB.

If you change the destination code of an input message to a local transaction which sends a message across a link, the timer supervisor includes the elapsed time for the local transaction.

If the destination of a reply message is changed to a local transaction, the original input terminal is released from the timer supervisor before the local transaction is scheduled. If the transaction is not available or if the application program does not send an output message to the original input terminal, the terminal is not released from response mode.

Communications Between the Front-End Switch Exit Routine and IMS

IMS uses the entry and exit registers to communicate with the exit routine.

Contents of Registers on Entry

Upon entry, the exit routine must save all registers using the provided save area. The registers contain the following:

Register	Content
1	Address of the FEIB. The FEIB contains all the information necessary for the exit to function. The exit routine must store additional information in the FEIB which is required for successful processing.
9	Address of ECB.
13	Address of save area. The exit routine must not change the first three words.
14	Return address to IMS.
15	Entry point of exit routine.

Contents of Registers on Exit

Before returning to IMS, the exit routine must restore all registers except for register 15, which must contain one of the following return codes:

Return Code	Meaning
Return Code	Meaning
0	No message switching
2	New destination from FE
6	New destination from IBE
8	Reply message
12	User table error

Example of the Front-End Switch Exit Routine (DFSFEBJ0)

This section contains an example of the Front-End Switch exit routine.

Routing Scheme

In Figure 33, three IMS systems are connected by ISC links. SFIMS2 acts as the front-end system, and LAIMS1 and NYIMS1 can act as a back-end system. In addition, LAIMS1 can act as an intermediate system.

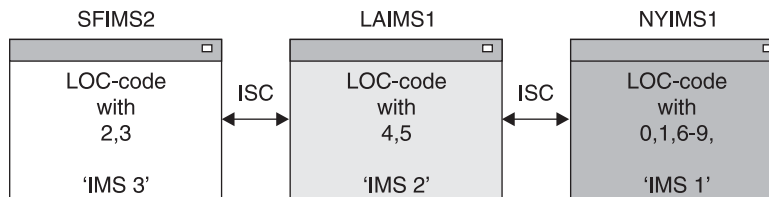

Figure 33. Routing Scheme of Front-End Switch Exit Routine Example

In each system, the user can enter a transaction FESTX1. This is not defined as a transaction in the system, but is a special transaction code used by the sample exit routine that identifies this message as an FES transaction. The exit routine in the front-end system (SFIMS2) changes the transaction code to FESTX2, which must be defined in the system as a valid transaction.

There is an eight-digit location code (LOC-code) in the user data. The decision as to which system processes the transaction depends on this LOC-code. If the transaction is to be processed in another system, the exit routine changes the destination to LAIMS1 so that either LAIMS1 or NYIMS1 processes the transaction FESTX2.

The following location codes are defined:

System	LOCation-code
SFIMS2	20000000 - 39999999
LAIMS1	40000000 - 59999999
NYIMS1	00000000 - 19999999 60000000 - 99999999

The system that processes the transaction FESTX2 generates an output message containing the transaction code FESTX3 in front of the message text. As with FESTX1, this is not defined as a transaction in the system, but is a special transaction code used by the sample exit routine that identifies this message as a reply to an FES transaction. This output message has to be routed to the front-end system where the corresponding FESTX1 transaction was entered which is now the target system for the reply message.

The following tables show routing information for each system.

Table 71. SFIMS2 Tables

SFIMS2 -Table I		SFIMS2 -Table II ¹	
1st digit of LOC-code	Next system	Target system	Next system

Table 71. SFIMS2 Tables (continued)

SFIMS2 -Table I		SFIMS2 -Table II ¹	
0	LAIMS1	LAIMS1	LAIMS1
1	LAIMS1	NYIMS1	LAIMS1
4	LAIMS1		
5	LAIMS1		
6	LAIMS1		
7	LAIMS1		
8	LAIMS1		
9	LAIMS1		

Note: ¹ This table is used only if it is an intermediate system

Table 72. LAIMS1 Tables

LAIMS1 -Table I		LAIMS1 -Table II	
1st digit of LOC-code	Next system	Target system	Next system
0	NYIMS1	SFIMS2	SFIMS2
1	NYIMS1	NYIMS1	NYIMS1
2	SFIMS2		
3	SFIMS2		
6	NYIMS1		
7	NYIMS1		
8	NYIMS1		
9	NYIMS1		

Table 73. NYIMS1 Tables

NYIMS1 -Table I		NYIMS1 -Table II ¹	
1st digit of LOC-code	Next system	Target system	Next system
2	LAIMS1	LAIMS1	LAIMS1
3	LAIMS1	SFIMS2	LAIMS1
4	LAIMS1		
5	LAIMS1		

Note: ¹ This table is used only if it is an intermediate system

Description of Sample Exit Routine

The example in this section is based on the assumption that ISCEDIT is used for editing the messages going across ISC links. ISCEDIT removes the first data field of the message text on output to an ISC destination.

The exit routine is designed to run in each of the three systems without modifying the code. It has to process different tables with routing information for each system, and has to know the name of the owning system. This is obtained from the FEIBIMID field. In this example:

- NYIMS1='IMS1' back-end system
- LAIMS1='IMS2' back-end or intermediate system
- SFIMS2='IMS3' front-end system

The exit routine in each system must analyze the transaction code and the LOC-code in the message text:

- If the transaction code is FESTX1, and
 - Change the transaction code to FESTX2.
 - If the LOC-code is in table I:
 - Change the transaction code to FESTX2.
 - Change the destination to the corresponding destination from table I (FEIBNDST).
 - Set the FEIBTMED indicator on, if appropriate.
 - Set the FEIBERP indicator on, if appropriate.
 - Set the transaction code for ERP (FEIBERPN), if appropriate.
 - Store the following routing information into the user area of the FEIB (FEIBUSER) as shown in Figure 34.
The FEIBUNID value, stored into the user area, is unpacked into zoned

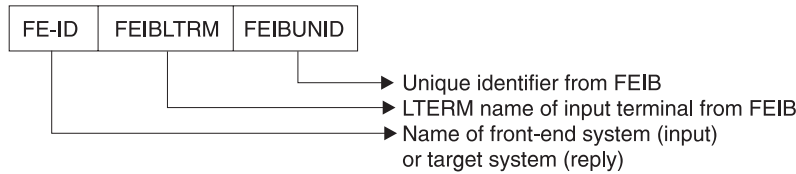

Figure 34. User Area of FEIB (FEIBUSER)

- format to prevent MFS Edit or Basic Edit from removing characters less than X'41'.
- Set the user data length field to 24 (FIEBULNG).
- Set the RC=02 in register 15.
- Else Set RC=00 in register 15.
- If the transaction code is FESTX2 and the LOC-code is in table I:
 - Change the destination to the corresponding destination from table I (FEIBNDST).
 - Set the RC=06 in register 15.
- If the transaction code is FESTX3:
 - Analyze the routing information.
 - If the name of the target system in the routing information (FE-ID) is not the name of the owning system:
 - Change the destination to the corresponding destination from table II (FEIBNDST).
 - Set the RC=06 in register 15.
 - If the name of the target system is not table II, set RC=12 in register 15.
 - If the name of the target system in the routing information is the name of the owning:
 - Get the Lterm name from the routing information and store it into the interface block (FEIBLTRM).
 - Get a unique identifier from the routing information, change it from zoned to packed format, and store it in the interface block (FEIBUNID).
 - Set the transaction code for a message which comes too late (FEIBLDST).
 - Set the FEIBRPQ1-indicator.
 - Set the user data length field to 31 (FIEBULNG).
 - Set the RC=08 in register 15.

- In all other cases no action is taken by the exit routine.²

2. In an IMS back-end system, which processes TX2, an application program generates the output message with TX3.

Chapter 37. Global Physical Terminal (Input) Edit Routine (DFSGPIX0)

This chapter describes the Global Physical Terminal Input edit routine. This routine is a user-written edit routine that is called before the IMS Basic Edit routine and performs the same functions as the Physical Terminal Input edit routine (DFSPIXT0).

The following topics provide the following information:

- “About This Routine”
- “Communicating with IMS” on page 281

About This Routine

If you write and include the routine in your system, IMS calls it for all terminals that do not have the Physical Terminal Input edit routine specified. By using the Global Physical Terminal Input edit routine instead of the Physical Terminal Input edit routine, you can eliminate the overhead associated with defining the edit routine for each terminal through system definition. For more information, see “Specifying the Routine” on page 281.

If the input message is processed by MFS, the Global Physical Terminal (Input) edit routine is not called. This edit routine is only called when a non-LU 6.2 message is entered from a terminal; it is not called when the message is inserted by a program-to-program switch.

Message segments are passed one at a time to the Global Physical Terminal (Input) edit routine, and the edit routine can handle them in one of the following ways:

- Accept the segment and release it for further editing by the IMS Basic Edit routine.
- Modify the segment (for example, change the transaction code or reformat the message text) and release it for further editing by the IMS Basic edit routine. Examples of segment modifications that can be made are:
 - changing the transaction code.
 - reformatting the message text.
- You can make any required modifications within the original segment because IMS has not yet performed destination or security checking.
- You cannot, however, alter the length of this segment. If you need to do so, see “Bypassing Basic Edit” on page 280.
- Cancel the segment.
- Cancel the message and request that IMS send a corresponding message to the terminal operator.
- Cancel the message and request that IMS send a specific message from the User Message Table to the terminal operator.

Table 74 on page 280 shows the attributes of the Global Physical Terminal (Input) Edit exit routine.

Table 74. Global Physical Terminal Input Edit Routine Attributes

Attribute	Description
IMS environments	DB/DC, DCCTL.
Naming convention	You must name this exit routine DFSGPIX0.
Binding	Follow the guidelines described in “Binding the Routines” on page 7.
Including the routine	No special steps are required to include this routine.
IMS callable services	To use IMS Callable Services with this routine, you must do the following: <ul style="list-style-type: none"> • Issue initialization call (DFSCSI0) to obtain the Callable Service token and a parameter list in which to build the function-specific parameter list for the desired callable service. For details on using the initialization call, see “Step 2. Initializing IMS Callable Services (DFSCSI0)” on page 14. • Use the ECB found in register 9 for the DFSCSI0 call. • Link DFSCSI00 with your user exit.
Sample routine location	IMS.ADFSSRC (member name DFSPIXT0). The sample is identical to the sample described in Chapter 53, “Physical Terminal (Input) Edit Routine (DFSPIXT0),” on page 361, because the two edit routines perform the same function. This routine performs the following functions: <ul style="list-style-type: none"> • Scans the input message segment for an expected format—TESTEXIT. • Generates return codes (XX) based on the input request (TESTEXIT,XX). • Verifies the user message number (YYY) if specified (TESTEXIT,XX,YYY). • Replaces TESTEXIT with ERROR if return code or message number is invalid and passes the segment to IMS (return code 0).

Bypassing Basic Edit

If the IMS application program supplies DFS.EDTN in the MOD name parameter for the output message, IMS bypasses the Basic Edit routine, except for transaction code and password validation.

Related Reading: For further information see “MFS Bypass for 3270 or SLU 2” in the “Application Programming Using MFS” chapter in *IMS Version 9: Application Programming: Transaction Manager*.

The Physical Terminal Input edit routine must position the transaction code, and optionally the password, if the terminal is not operating in conversational or preset destination mode. The edit routine should detect errors and have IMS send a message to the terminal operator if the routine finds any errors.

IMS maintains a flag in the CTB (bit CTB6TRNI in the CTBFLAG6 field) to indicate when 3270 MFS bypass, nonconversational, no preset destination and first segment exist upon input to the Global Physical Terminal (Input) edit routine. This flag notifies the Global Physical Terminal Input edit routine that it can add a minimum of one and a maximum of 18 bytes to the front of the message segment for a transaction code and optional password. The minimum of one byte to be added to the front of the message segment consists of a one-byte transaction code. If NOBLANK is not specified at system definition, a minimum of two bytes is added to

the front of the message segment, consisting of a one-byte transaction code and one blank, which is necessary as a separator. To add a transaction code and optional password, the exit routine can put a return code of 16 in register 15 and set register 1 to point to an LLZZ field followed by the data to be added. You cannot, however, alter the length of the segment passed in to the exit. If you need to insert a transaction or destination code, and an optional password, set register 1 to the address of a static data field that consists of a halfword length (LL), a halfword of binary zeroes (ZZ), and zero to 14 bytes of user data.

Specifying the Routine

You must assemble and bind the edit routine into the IMS execution time library or user library concatenated in front of the IMS execution time library.

IMS calls the Global Physical Terminal Input edit routine (DFSGPIX0) for each terminal that does **not** have EDIT=(,YES) coded on the TERMINAL macro or ETO logon descriptor.

For terminals that do have EDIT=(,YES) specified on the TERMINAL macro or ETO logon descriptor, IMS calls the Physical Terminal Input edit routine (DFSPIXT0).

Related Reading:

- For more information on the TERMINAL macro, see *IMS Version 9: Installation Volume 2: System Definition and Tailoring*.
- For more information on the Physical Terminal Input edit routine, see Chapter 53, "Physical Terminal (Input) Edit Routine (DFSPIXT0)," on page 361.

Communicating with IMS

IMS uses the entry and exit registers to communicate with the exit routine.

Contents of Registers on Entry

Upon entry to the edit routine, all registers must be saved using the save area provided. The registers contain the following:

Register	Content
1	Address of the input message segment buffer. IMS editing has not been performed. The first two bytes of the buffer contain the segment length (binary length includes the 4-byte overhead). The third and fourth bytes of the buffer are binary zeros. The message text begins in the fifth byte of the buffer. If the device was defined with MFS support, but this message is not being processed by MFS, the first segment of the message has backspace error correction performed before entry to this edit routine. If escape (**) was entered by the terminal operator, the first two data bytes have been changed to binary zeros.
7	Address of CTB for the physical terminal from which the message was entered.
9	Address of CLB for the physical terminal from which the message was entered.
13	Address of save area. The exit routine must not change the first three words.
14	Return address to IMS.
15	Entry point of edit routine.

The edit routine you supply can edit the message segment in the buffer pointed to by register 1.

You can reduce the length of the message segment to any size by replacing the length in the buffer with the appropriate value. The length field must appear in the same place at exit as at entry, and bytes 3 and 4 must not be changed.

Contents of Registers on Exit

Before returning to IMS, the edit routine must restore all registers except for register 1, which contains a message number if register 15 contains a value of 12; otherwise register 1 is ignored. Register 15 contains one of the following return codes:

Return Codes	Meaning
00	Segment is processed normally.
04	Segment is canceled.
08	Message is canceled and the terminal operator is notified.
12	Message is canceled, and the message identified by register 1 is sent to the terminal.
16	Insert the transaction code and optional password following the LLZZ pointed to by register 1. This return code is only valid for 3270 MFS bypass terminals.

When the entering terminal is not a 3270 MFS bypass terminal, and the physical terminal input exit gives a return code of 16, IMS issues an error message, and the transaction code is not inserted in the message.

Any other return code causes the message to be canceled and the terminal operator to be notified.

Chapter 38. Greeting Messages Exit Routine (DFSGMSG0)

The Greeting Messages exit routine (DFSGMSG0) allows you to tailor how IMS handles messages issued during the logon and signon process. The exit also allows you to:

- Change the MFS Message Output Description (MOD) name without changing the message. (However, if the terminal is the Master Terminal and is master formatted, the request to change the MOD name is ignored.)
- Change the message without changing the MOD name.
- Send a null message (no data) for formatting purposes.

The following topics provide additional information:

- “About This Routine”
- “Communicating with IMS” on page 284

About This Routine

IMS builds a message based upon the calling module’s request. This message, plus information useful to the exit and a buffer for returning an alternate message built by the exit, are passed as input to the exit. The exit indicates by a return code if the message built by IMS should be used, or if an alternate message has been returned and should be used. The message length returned must be at least five bytes (four bytes for the length field and a one-byte message).

Table 75 shows the attributes of the Greeting Messages exit routine.

Table 75. Greeting Messages Exit Routine Attributes

Attribute	Description
IMS environments	DB/DC, DCCTL.
Naming convention	You must name this exit routine DFSGMSG0.
Binding	Follow the guidelines described in “Binding the Routines” on page 7.
Including the routine	You can assemble the sample exit routine, or one that you write (using the standard IMS macro and copy files), and include it in an authorized library in the JOBLIB, STEPLIB, or LINKLIST library concatenated in front of the IMS.SDFSRESL. If the Greeting Messages exit routine is included, IMS automatically loads it each time IMS is initialized.
IMS callable services	To use IMS Callable Services with this routine, you must do the following: <ul style="list-style-type: none">• Issue an initialization call (DFSCSI0) to obtain the Callable Service token and a parameter list in which to build the function-specific parameter list for the desired callable service. For details on using the initialization call, see “Step 2. Initializing IMS Callable Services (DFSCSI0)” on page 14.• Use the ECB found at offset 0 of the Greeting Messages Exit parameter list.• Link DFSCSI00 with your user exit.
Sample routine location	IMS.ADFSSMPL (member name DFSGMSG0). The sample exit uses the DFS3649 and DFS2467 messages built by IMS, but it converts the DFS3650 message to a single-segment message. You can also write your own exit routine.

Communicating with IMS

IMS uses the entry and exit registers, as well as parameter lists, to communicate with the exit routine.

Contents of Registers on Entry

Upon entry, the exit routine must save all registers using the provided save area. The registers contain the following:

Register	Contents
R1	Address of Standard Exit Parameter List
R13	Save area address
R14	Return address to IMS
R15	Entry point address of exit routine

This exit routine uses the Version 1 standard exit parameter list. See Table 2 on page 5 for the content of the Version 1 standard exit parameter list.

Table 76 shows the greeting messages exit parameters. The address of this parameter list is in the standard exit parameter list field SXPLFSPL.

Table 76. Greeting Messages Exit Parameter List

Offset	Length	Description
+0	4	ECB address.
+4	4	SCD address.
+8	4	Pointer to User Table.
+12	4	Address of parameter list for this exit. For additional details on the content and the format of these parameters, see the prolog in the sample routine.

Contents of Registers on Exit

Before returning to IMS, the exit routine must restore all registers except for register 15, which contains the return code. The returns codes are as follows:

Register	Contents												
15	One of the following return codes:												
	<table> <thead> <tr> <th>Return Code</th> <th>Meaning</th> </tr> </thead> <tbody> <tr> <td>00</td> <td>Use the message built by IMS.</td> </tr> <tr> <td>04</td> <td>Use the message in the alternate buffer (single segment).</td> </tr> <tr> <td>08</td> <td>Use the message in the alternate buffer (multiple segment).</td> </tr> <tr> <td>0C</td> <td>Send a null message so that the device is formatted with the MFS format specified by IMS or returned by the exit.</td> </tr> <tr> <td>10</td> <td>Bypass password reverification. Valid only for message DFS3656A.</td> </tr> </tbody> </table>	Return Code	Meaning	00	Use the message built by IMS.	04	Use the message in the alternate buffer (single segment).	08	Use the message in the alternate buffer (multiple segment).	0C	Send a null message so that the device is formatted with the MFS format specified by IMS or returned by the exit.	10	Bypass password reverification. Valid only for message DFS3656A.
Return Code	Meaning												
00	Use the message built by IMS.												
04	Use the message in the alternate buffer (single segment).												
08	Use the message in the alternate buffer (multiple segment).												
0C	Send a null message so that the device is formatted with the MFS format specified by IMS or returned by the exit.												
10	Bypass password reverification. Valid only for message DFS3656A.												

Related Reading: See *IMS Version 9: Messages and Codes, Volume 2* for further information.

Chapter 39. IMS Adapter for REXX Exit Routine (DFSREXXU)

You can use DFSREXXU with the IMS adapter for the REXX environment. It is optional and can be omitted from the bind step. The user exit routine is used more for an installation than for a specific execution. The user exit routine is provided by the IMS adapter for REXX and is called only when a new REXX transaction is scheduled and ends. The user exit is not associated with the standard REXX exits provided by TSO. A sample user exit routine (DFSREXXU) is shipped with IMS (in source code only). For the latest version of the DFSREXXU source code, see the IMS.SDFSSRC distribution library; member name is DFSREXXU.

The exit routine gets control before the environment is built, just before an exec is executed, and just after it ends. The routine has the ability to do the following:

- Override the exec name to be executed. This name defaults to the IMS program name.
- Choose not to execute any exec and have the IMS adapter for REXX return to IMS.

It is the exit routine's responsibility to do any required processing such as issuing a GU (Get-Unique) call if the region type is MPP.

- Issue DL/I calls using the AIB interface as part of its logic in determining what exec to execute.
- Set REXX variables (through IRXEXCOM) before the exec is started. The variables are then available to the exec.
- Extract REXX variables (through IRXEXCOM) after the exec ends. These variables were set earlier by the exec or exit routine.
- Change the initial default IMSRXTRC tracing level.

The user exit routine must conform to all of the restrictions that apply to IMS application programs.

The following topics provide additional information:

- "About This Routine"
- "Parameters" on page 286

About This Routine

Table 77 shows the attributes of the IMS Adapter for REXX exit routine.

Table 77. IMS Adapter for REXX Exit Routine Attributes

Attribute	Description
IMS environments	DB/DC, DBCTL, DCCTL.
Naming convention	The user exit routine must be named DFSREXX0.
Binding	You must bind the user exit with DFSREXX1 during installation of the IMS adapter for REXX.
Including the routine	No special steps are required to include this routine.
IMS callable services	This exit routine is not eligible to use IMS Callable Services.
Sample routine location	IMS.SDFSSRC distribution library.

Parameters

The routine must be written to be reentrant (RENT), AMODE 31, RMODE ANY.

Parameters

Entry parameters are:

- R0** Pointer to REXX Environment Block as described in *z/OS TSO/E REXX Reference*.
- R1** Pointer to parameter list
- R13** Pointer to save area
- R14** Return address
- R15** Entry point address

Upon exit, all registers except R15 must be restored. Only the parameters can be altered. The content of R15 is ignored on exit.

The parameter list contains a list of pointers to the parameters. All character data is left justified and padded with blanks, if necessary. Omitted fields are set to blanks. All fields are read-only unless otherwise specified. Table 78 on page 286 shows the user exit parameter list format.

Table 78. User Exit Parameter List

Name	Offset (Dec)	Data Type	Length (Dec)	Description
Function	0	Pointer	4	Pointer to one word function type. Func=0 on Setup Call, Func=1 on Entry Call, Func=2 on Exit Call.
EXECParm ¹	4	Pointer	4	Pointer to 128-byte area containing parameters that are passed to the REXX interpreter. The format of the area is a halfword length field that contains the length of the text string that follows. The first blank separated word or the entire string if no blanks are present is the exec name to execute. On entry this field is set to the program name followed by one blank and the transaction code if available. The exit can rebuild this field when called on entry to alter the exec name or parameters that are passed. The length field can be set to zero indicating no exec is to be executed.
PgmName ¹	8	Pointer	4	Pointer to 8-byte area containing the Program name that was scheduled.
TranCode ¹	12	Pointer	4	Pointer to 8-byte area containing the Transaction Code that was scheduled, if available (MPP,BMP,IFP).

Table 78. User Exit Parameter List (continued)

Name	Offset (Dec)	Data Type	Length (Dec)	Description
User_ID ¹	16	Pointer	4	Pointer to 8-byte area containing the current user ID for the scheduled program, if available (MPP,BMP,IFP).
IMSRXTRC	20	Pointer	4	Pointer to one word IMSRXTRC level. This value defaults to 1 at exec startup but can be overridden by the user exit. See <i>IMS Version 9: Application Programming: Transaction Manager</i> for more information on values. Note that the level field here is a FULLWORD and not EBCDIC.
UserArea	24	Pointer	4	Pointer to 8-byte (word aligned) user area that is passed on entry and is preserved verbatim on exit. This field is set to binary zeros whenever the REXX environment is built in the dependent region. The user area can be altered by the user exit and is provided as an anchor.
RetCode	28	Pointer	4	Pointer to one word return code. The return code must be set to zero.
UseridInd	32	Pointer	4	Pointer to one-byte Userid Indicator that describes the content of the userid field. The indicator can be: U-Userid, L-Lterm, P-PSBname, or O-Other.

Note:

1. When on a Setup call the next four parameters are not available; their addresses are 0.

For each user exit parameter described in Table 78 on page 286, Table 79 shows the corresponding DFSREXXU parameter.

Table 79. DFSREXXU Parameter List

User Exit Parameter	DFSREXXU Parameter
Function Pointer	FUNCTION_CODE DS F FUNC_SETUP EQU 0 FUNC_BEFORE EQU 1 FUNC_AFTER EQU 2
EXECParm Pointer	EXEC_PARM DS 0CL128 EXEC_PARM_LL DS H EXEC_PARM_TXT DS CL126
PgmName Pointer	PGM_NAME DS CL8
TranCode Pointer	TRAN_CODE DS CL8
User_ID Pointer	USER_ID DS CL8
IMSRXTRC Pointer	IMSRXTRC_LEV DS F

Parameters

Table 79. DFSREXXU Parameter List (continued)

User Exit Parameter	DFSREXXU Parameter
UserArea Pointer	USER_AREA DS 2F
RetCode Pointer	RETURN_CODE DS F
Useridind Pointer	USERID_IND DS F

Chapter 40. Initialization Exit Routine (DFSINTX0)

IMS calls the Initialization exit routine during initialization as a common Transaction Manager exit routine.

You can use the Initialization exit routine to create two user data areas that can be used by some of your installation's exit routines.

- General user data area

The address of this user data area is passed as part of the IMS standard user exit interface. Any exit routine that uses this interface will have access to this data area (if it exists). The address of this data area is also passed as part of the nonstandard interface to the following exit routines:

- Build Security Environment exit routine (DFSBSEX0)

- Command Authorization exit routine (DFSCCMD0)

- Greeting Messages exit routine (DFSGMSG0)

- Logoff exit routine (DFSLGFX0)

- Logon exit routine (DFSLGNX0)

- Non-discardable Messages exit routine (DFSNDMX0)

- Output Creation exit routine (DFSINSX0)

- Signoff exit routine (DFSSGFX0)

- Signon exit routine (DFSSGNX0)

Other TM exit routines can address the user data table through SCDINTXP. Refer to the chapter for each exit routine for information on the routine's parameter list.

- LU 6.2 user data area

The LU 6.2 user data area is not passed as part of the IMS standard user exit interface. It is passed as part the nonstandard interface to the LU 6.2 Edit exit routine. Refer to Chapter 45, "LU 6.2 Edit Exit Routine (DFSLUEE0)," on page 313 for information on the routine' parameter list.

You can also use this exit routine to alter the setting for the Extended Terminal Option (ETO) feature. You can leave ETO activated or override the setting to indicate that ETO is not required, even if you previously requested it.

This exit is also used to enable password reverification. The IMS default processing is to disable password reverification. With password reverification, users signing on to VTAM terminals that change their password are prompted to verify the new password.

The following topics provide additional information:

- "About This Routine"
- "Communicating with IMS" on page 291

About This Routine

The Initialization exit routine is optional. If the exit is included in the system, IMS calls it before IMS loads the ETO descriptors and any exit routine that requires ETO to be active. If ETO is required for an exit routine, the documentation for the routine states that requirement. If the Initialization exit routine returns a return code indicating that ETO should not be made available, the ETO exit routines and descriptors will not be loaded. If this exit is not included in the system, IMS

proceeds using the setting for the ETO= keyword that is specified as an EXEC parameter or in the DFSPBxx of IMS.PROCLIB.

The initialization exit routine can optionally enable password verification and an alternate ETO ALOT=0 option by setting the appropriate flags in the exit routine parameter list.

Attributes of the Routine

Table 80 shows the attributes of the Initialization exit routine.

Table 80. Initialization Exit Routine Attributes

Attribute	Description
IMS environments	DB/DC, DCCTL.
Naming convention	You must name this exit routine DFSINTX0.
Binding	This exit routine must be reentrant.
Including the routine	If you want IMS to call the Initialization exit routine, include it in an authorized library in the JOBLIB, STEPLIB, or LINKLIST library concatenated in front of the IMS.SDFSRESL. If the exit routine is included, IMS automatically loads it and calls it at initialization.
IMS callable services	<p>DFSINTX0 can use callable storage services. To use IMS Callable Services with this routine, you must do the following:</p> <ul style="list-style-type: none"> • Issue an initialization call (DFSCSI0) to obtain the callable service token and a parameter list in which to build the function-specific parameter list for the desired callable service. For details on using the initialization call, see “Step 2. Initializing IMS Callable Services (DFSCSI0)” on page 14. • Use the ECB found at offset X'0' of the IMS Initialization exit parameter list. • Link DFSCSI00 with your user exit. <p>For more information on using callable services refer to “IMS Callable Services” on page 10.</p>
Sample routine location	IMS.ADFSSMPL (member name DFSINTX0).

About User Data Areas

The user data areas can be used to provide access to user tables that can then be referenced by any user exit that has access to the data area. An example of the use of general user data area is for ETO. You can use the general user data area to define access limits for terminals or users by total number, department, time of day, or other criteria. You can also use the data area to define LTERM-to-user or user-to-terminal relationships to aid your installation logon and signon exit routine processes.

For APPC, you can use the LU6.2 user data area along with the LU6.2 User Edit exit routine to emulate MFS. To do so, the LU6.2 user data area is built by DFSINTX0 to hold a list of LTERM and MOD names available to the I/O PCB. IMS then passes the address of the LU6.2 user data area LU 6.2 Edit exit routine for input and output messages from a LU6.2 destination. The LU 6.2 Edit exit routine can use the list of LTERM names to redirect output to a non-LU6.2 destination, or the list of MOD names to format a message.

Related Reading: Refer to Chapter 45, “LU 6.2 Edit Exit Routine (DFSLUEE0),” on page 313 and *IMS Version 9: Administration Guide: Transaction Manager* for more information on using MOD names and the LTERM interface.

Communicating with IMS

IMS uses the entry and exit registers, as well as parameter lists, to communicate with the exit routine.

Contents of Registers on Entry

Upon entry, the exit routine must save all registers using the provided save area. The registers contain the following:

Register	Contents
R1	Address of Standard Exit Parameter List
R13	Save area address
R14	Return address to IMS
R15	Entry point address of exit routine

This exit routine uses the Version 1 standard exit parameter list. See Table 2 on page 5 for the content of the Version 1 standard exit parameter list.

Table 81 shows the IMS initialization exit parameters. The address of this parameter list is in the standard exit parameter list field SXPLFSPL.

Table 81. IMS Initialization Exit Parameter List

Offset	Length	Description
+0	4	CLB address
+4	4	SCD address
+8	4	0, as an indication that no user table exists
+12	4	0, as an indication that no LU 6.2 user table exists
+16	1	Input/Output Flag Byte
		X'80'
		0 No password verification (default)
		X'40'
		0 Default ETO ALOT=0 process
		X'10'
		0 Static ISC resource sharing (default)
		X'08'
		0 ETO LU type 3 is not allowed to log on as a SLU1 (default)
		X'04'
		0 ETO LU type 3 is not allowed to log on as a 3270 printer (default)

Contents of Registers on Exit

Before returning to IMS, the exit routine must restore all registers except for register 15, which contains the return code.

The address of the general user data area created by this exit routine can be returned in the Initialization exit parameter list at +8. If zero, no general user data area was created. If non-zero, IMS saves the address in the SCD control block at SCDINTXP.

The address of the LU 6.2 user table created by this exit routine can be returned in the Initialization exit parameter list at +12. If zero, no LU 6.2 user table was created.

Register	Contents								
15	One of the following return codes: <table> <thead> <tr> <th>Return Code</th> <th>Meaning</th> </tr> </thead> <tbody> <tr> <td>0</td> <td>Initialization of IMS continues.</td> </tr> <tr> <td>4</td> <td>Regardless of ETO specification, ETO terminal support is not required. Message DFS3648 is sent to the system console. Setting RC=4 resets both ETO function and logon user data support.</td> </tr> <tr> <td>8</td> <td>Regardless of ETO specification, ETO terminal support is not required but logon user data is supported for static terminals. Message DFS3648 is sent to the system console. Setting RC=8 resets ETO function only.</td> </tr> </tbody> </table>	Return Code	Meaning	0	Initialization of IMS continues.	4	Regardless of ETO specification, ETO terminal support is not required. Message DFS3648 is sent to the system console. Setting RC=4 resets both ETO function and logon user data support.	8	Regardless of ETO specification, ETO terminal support is not required but logon user data is supported for static terminals. Message DFS3648 is sent to the system console. Setting RC=8 resets ETO function only.
Return Code	Meaning								
0	Initialization of IMS continues.								
4	Regardless of ETO specification, ETO terminal support is not required. Message DFS3648 is sent to the system console. Setting RC=4 resets both ETO function and logon user data support.								
8	Regardless of ETO specification, ETO terminal support is not required but logon user data is supported for static terminals. Message DFS3648 is sent to the system console. Setting RC=8 resets ETO function only.								

Table 82. IMS Initialization Exit Parameter List

Offset	Length	Description
+16	1	Input/Output Flag Byte
		X'80'
		0 No password verification (default)
		1 Enable password verification
		X'40'
		0 Default ETO ALOT=0 process
		1 Alternate ETO ALOT=0 process
		X'20'
		0 Default VGR for ISC
		1 Disable VGR for ISC
		X'10'
		0 Normal static ISC resource sharing (default)
		1 Disable resource sharing for static ISC terminals in the IMSplex
		X'08'
		0 ETO LU type 3 is not allowed to log on as a SLU1 (default)
		1 ETO LU type 3 is allowed to log on as a SLU1 ¹
		X'04'
		0 ETO LU type 3 is not allowed to log on as a 3270 printer (default)
		1 ETO LU type 3 is allowed to log on as a 3270 printer ¹

Notes:

1. ETO LU type 3 is allowed to log on either as SLU1 or 3270 printer, but not both.

DFSINTX0

Chapter 41. Input Message Field Edit Routine (DFSME000)

This section describes how to write an Input Message Field edit routine. Because this routine is usually used with the Input Message Segment edit routine, you'll find references to both routines throughout the following paragraphs. For specific information about the Input Message Segment edit routine, see its description in Chapter 42, "Input Message Segment Edit Routine (DFSME127)," on page 299.

In this Chapter:

- "About This Routine"
- "Communicating with IMS" on page 297

About This Routine

MFS application designers should consider the use of Input Message Field and Segment edit routines to perform common editing functions such as numeric validation or conversion of blanks to numeric zeros. Field and Segment edit routines can simplify programming by using standard field edits to perform functions that would otherwise have to be coded in each application program.

Table 83 shows the attributes of the Input Message Field Edit routine.

Table 83. Input Message Field Edit Routine Attributes

Attribute	Description
IMS environments	DB/DC, DCCTL.
Naming convention	You must name this exit routine DFSME000.
Binding	Follow the guidelines described in "Binding the Routines" on page 7. A Field edit routine must have a CSECT name of DFSME nnn , where nnn is a number from 001 to 126 that corresponds with the routine number specified in the MFLD statement. The edit routine needs to be linked into the library specified by the USERLIB parameter of the IMSGEN Stage 1 macro before running the IMSGEN. The default for this parameter is IMS.SDFSRESL. The Field edit routine can only modify the data in the field created by MFS and must not cause any waits.
Including the routine	No special steps are required to include this routine.
IMS callable services	To use IMS Callable Services with this routine, you must issue an initialization call (DFSCSI00) to obtain the Callable Service token and a parameter list in which to build the function-specific parameter list for the desired callable service. Related Reading: For details on using the initialization call, see "Step 2. Initializing IMS Callable Services (DFSCSI00)" on page 14. Use the ECB found in register 9 for IMS Callable Services. This exit is automatically linked to DFSCSI00 by IMS. No additional linking is required to use IMS Callable Services.
Sample routine location	IMS.ADFSSRC (member name DFSME000).

Calling the Routine

Field edit routines are given control after MFS editing (before Segment edit routines, uppercase translation for all options, and null compression for option 1 or 2). The routine can validate or alter the data and pass a return code to MFS. MFS maintains the highest return code of all Field edit routines for each segment and passes that code to the Segment edit routine after all fields for that segment are edited.

Defining Edit Routines

Field edit routines are defined in the MID's MFLD statements in terms of a routine number and entry vector.

Routine numbers identify the routine to be used for this field/segment. Routine numbers range from 000 to 127. IMS-provided routines use numbers 000 (field edit, DFSME000) and 127 (segment edit, DFSME127).

If you are using both the Field edit and Segment edit routines with your IMS system, the Field edit routine should be assigned routine numbers that are lower than the numbers assigned for the Segment edit routine. Therefore, the Field edit number should be a decimal number greater than or equal to 0, and less than the default or specified value for the Segment edit routine number parameter. The default for the Field edit routine is 0.

An installation standard should be established regarding the assignment of routine numbers. For example, you could assign Field edit routines numbers in ascending sequence from 001 to 063 (and if you're using Segment edit routines as well, assign them numbers in descending sequence from 126 to 064).

These values are specified in the MFSEXIT= parameter in the COMM macro.

Related Reading: For details about this, see the description of the COMM Macro in the chapter on macros, in *IMS Version 9: Installation Volume 2: System Definition and Tailoring*.

Recommendation: It is recommended that the lower-numbered exit routines be Field exit routines, but the lower-numbered exit routines can be Segment exit routines, or a mixture of Field and Segment exit routines. It is recommended that the higher-numbered exit routines be Segment exit routines, but the higher-numbered exit routines can be Field exit routines, or a mixture of Field and Segment exit routines.

Entry vectors are passed to the edit routine when it is activated. Entry vector values can range from 0 to 255. The entry vector value can be thought of as an additional qualification of the routine to be activated. For example, routine number 025 can perform numeric validation of a field; entry vector 0 can replace leading blanks with zeros, and entry vector 1 can perform numeric validation.

If data is entered from the terminal in lowercase, the data is in lowercase when it is presented to the edit routine. If data in an input segment is in nongraphic form, GRAPHIC=NO should be specified in the SEG statement to prevent null compression and uppercase translation. A valid byte value of a binary field could be equivalent to a null character (X'3F') or some lowercase alphanumeric (for example, a=X'81'). In this case, GRAPHIC=NO should be specified.

Related Reading: For a description of which characters MFS considers graphic, see the SEG statement section in the *IMS Version 9: Application Programming: Transaction Manager*.

Considering Performance

When Field and Segment edit routines are used, extra processing occurs in the IMS control region and, if used extensively, a measurable performance cost is incurred. At the same time, these edit routines can improve performance by reducing processing time in the message processing region, by reducing logging and queuing time, and by allowing field verification and correction to be accomplished without scheduling an application program. Efficiency of these user-written routines should be a prime concern. Because these routines execute in the IMS control region, an abend in the edit routine causes the IMS control region to abend.

Communicating with IMS

IMS uses the entry and exit registers, as well as parameter lists, to communicate with the edit routine.

Contents of Registers on Entry

Upon entry, the edit routine must save all registers using the provided save area. The registers contain the following:

Register	Contents
1	Address of parameter list.
9	Address of CLB/ECB.
13	Address of save area. The exit routine must not change the first three words.
14	Return address to IMS.
15	Entry point of edit routine.

Description of Parameter List Format

IMS.ADFSMAC contains a DSECT of the parameter list addressed by register 1 (use COPY MFSFLDE) as follows:

Byte	Contents																
0	<table> <thead> <tr> <th>Bit</th> <th>Contents</th> </tr> </thead> <tbody> <tr> <td>0,1</td> <td>Message formatting option: <ul style="list-style-type: none"> • 00 = option 1 • 01 = option 2 • 11 = option 3 </td> </tr> <tr> <td>2</td> <td>Zero (Field edit routine)</td> </tr> <tr> <td>3</td> <td>Reserved</td> </tr> <tr> <td>4</td> <td>1 if the first 2 bytes in the field contains attribute information</td> </tr> <tr> <td>5</td> <td>1 if the field contains extended field attribute information</td> </tr> <tr> <td>6</td> <td>Reserved</td> </tr> <tr> <td>7</td> <td>Reserved</td> </tr> </tbody> </table>	Bit	Contents	0,1	Message formatting option: <ul style="list-style-type: none"> • 00 = option 1 • 01 = option 2 • 11 = option 3 	2	Zero (Field edit routine)	3	Reserved	4	1 if the first 2 bytes in the field contains attribute information	5	1 if the field contains extended field attribute information	6	Reserved	7	Reserved
Bit	Contents																
0,1	Message formatting option: <ul style="list-style-type: none"> • 00 = option 1 • 01 = option 2 • 11 = option 3 																
2	Zero (Field edit routine)																
3	Reserved																
4	1 if the first 2 bytes in the field contains attribute information																
5	1 if the field contains extended field attribute information																
6	Reserved																
7	Reserved																
1	Zeros																
2	The number of reserved extended field attribute bytes in the field. These bytes appear immediately after the 3270 attribute bytes, if any.																
3	The entry vector in binary (0 to 255).																

Byte	Contents
4-7	The execute length (length-1) of the field as defined in the MFLD statement. If ATTR=YES is specified, this field contains (length-3).
8-11	The field address after MFS editing (before uppercase translation and null compression for option 1 and 2 fields). If ATTR=YES is specified, this is the address of the first data byte after the two attribute bytes. For option 3, this is the address of the 2-byte field length, which begins the completed option 3 field.

Contents of Registers on Exit

Before returning to IMS, the edit routine must restore all registers except for register 15, which must contain one of the following return codes:

Register	Contents
15	Return code value from 0 to 255

Function of the Sample Routine

The functions of this IMS-supplied routine are as follows:

Vector	Resulting Action
0	Converts blanks to zoned decimal zeros (X'F0').
1	Converts blanks to zoned decimal zeros (X'F0') and replaces non-zoned decimal characters with a question mark (?). If ? is inserted, the routine sets a return code of 8 and, if an attribute (ATTR) area is present, sets the CURSOR,HI attributes.
2	Converts the binary cursor address field to zoned decimal if its length is 4 bytes. If the field is not 4 bytes, a return code of 8 is set.
>2	Sets a return code equal to the entry vector (if the vector is greater than 2).

This routine will handle option 1, 2, and 3 formats. For option 1 and 2, MFLD FILL=NULL and an entry vector of 1 can produce undesirable results.

Chapter 42. Input Message Segment Edit Routine (DFSME127)

This section describes how to write an Input Message Segment edit routine. Because this routine is usually used with the Input Message Field edit routine, you will find references to both routines throughout the following paragraphs.

Related Reading: For specific information about the Input Message Field edit routine, see its description in Chapter 41, “Input Message Field Edit Routine (DFSME000),” on page 295.

In this Chapter:

- “About This Routine”
- “Communicating with IMS” on page 301

About This Routine

MFS application designers should consider the use of Input Message Field and Segment edit routines to perform common editing functions such as numeric validation or conversion of blanks to numeric zeros. Field and Segment edit routines can simplify programming by using standard field edits to perform functions that would otherwise have to be coded in each application program.

Table 84 shows the attributes of the Input Message Segment edit routine.

Table 84. Input Message Segment Edit Routine Attributes

Attribute	Description
IMS environments	DB/DC, DCCTL.
Naming convention	You must name this exit routine DFSME127.
binding	Follow the guidelines described in “Binding the Routines” on page 7. A Segment edit routine must have a CSECT name of DFSMEnnn, where nnn is a number from 001 to 126 that corresponds with the routine number specified in the SEG statement. It must be stored in USERLIB before Stage 2 of IMS system definition is executed.
Including the routine	No special steps are required to include this routine.
IMS callable services	To use IMS Callable Services with this routine, you must issue an initialization call (DFSCSI0) to obtain the Callable Service token and a parameter list in which to build the function-specific parameter list for the desired callable service. Related Reading: For details on using the initialization call, see “Step 2. Initializing IMS Callable Services (DFSCSI0)” on page 14. Use the ECB found in register 9 for IMS Callable Services. This exit is automatically linked to DFSCSI00 by IMS. No additional linking is required to use IMS Callable Services.
Sample routine location	IMS.ADFSSRC (member name DFSME127)

Calling the Routine

Segment edit routines are given control when all of the MFS editing and editing by Field edit routines is complete for a message (before uppercase translation, but

after null compression for messages using option 1 and 2, and after field sort for option 3 messages). Based on the return code received from Field or Segment edit routine, the Segment edit routine can:

- Continue processing.
- Modify the segment.
- Cancel the segment.
- Cancel the message and IMS will notify the operator using the message DFS298 INPUT MESSAGE CANCELED BY MFS EXIT.
- Return a predefined message to the terminal.
- Return the input message to the terminal.

Restriction: The following applies only to IMS releases with ETO. During the ETO dynamic terminal signon process, the Input Message Segment edit routine cannot use return code 16 to return the input message to the terminal. This is because a valid output LTERM has not yet been established.

Considering Performance

When Field and Segment edit routines are used, extra processing occurs in the IMS control region and, if used extensively, a measurable performance cost is incurred. At the same time, these edit routines can improve performance by reducing processing time in the message processing region, by reducing logging and queuing time, and by allowing field verification and correction to be accomplished without scheduling an application program. Efficiency of these user-written routines should be a prime concern.

Defining Edit Routines

Segment edit routines are defined in the MID's SEG statements. Each routine is defined in terms of a routine number and an entry vector.

Routine numbers identify the routine to be used for this field or segment. Routine numbers range from 000 to 127. IMS-provided routines use numbers 000 (Field edit, DFSME000) and 127 (Segment edit, DFSME127).

If you are using both the Field edit and Segment edit routines with your IMS system, the Field edit routine should be assigned routine numbers lower than the numbers assigned for the Segment edit routine. Therefore, the Field exit number should be a decimal number greater than or equal to 0, and less than the default or specified value for the Segment exit routine number parameter. The default for the Field edit routine is 0.

An installation standard should be established regarding the assignment of routine numbers. For example, you could assign Segment edit routines numbers in descending sequence from 126 to 064 (and if you're using Field edit routines as well, assign them numbers in ascending sequence from 001 to 063).

These values are specified in the MFSEXIT= parameter in the COMM macro.

Related Reading: For details about this, see the description of the COMM Macro in the chapter on Macros in *IMS Version 9: Installation Volume 2: System Definition and Tailoring*.

Recommendation: It is recommended that the lower-numbered exit routines be Field exit routines, but the lower-numbered exit routines can be Segment exit

routines, or a mixture of Field and Segment exit routines. It is recommended that the higher-numbered exit routines be Segment exit routines, but the higher-numbered exit routines can be Field exit routines, or a mixture of Field and Segment exit routines.

Entry vectors are passed to the edit routine when it is activated. Entry vector values can range from 0 to 255. The entry vector value can be thought of as an additional qualification of the routine to be activated. For example, routine number 025 can perform numeric validation of a field; entry vector 0 can replace leading blanks with zeros, and entry vector 1 can perform numeric validation.

If data is entered from the terminal in lowercase, the data is in lowercase when it is presented to the edit routine. If data in an input segment is in nongraphic form, GRAPHIC=NO should be specified in the SEG statement to prevent null compression and uppercase translation. A valid byte value of a binary field could be a null character (X'3F') or some lowercase alphanumeric (for example, a=X'81'). In this case, GRAPHIC=NO should be specified.

Related Reading: For a description of which characters MFS considers graphic, see the SEG statement section in *IMS Version 9: Application Programming: Transaction Manager*.

Communicating with IMS

IMS uses the entry registers, parameter list, and exit registers to communicate with the edit routine.

Contents of Registers on Entry

Upon entry to the edit routine, all registers must be saved using the save area provided. The registers contain the following:

Register	Contents
0	Address of CLB.
1	Address of parameter list.
9	Address of CLB/ECB.
13	Address of save area. The edit routine must not change the first three words.
14	Return address to IMS.
15	Entry point of edit routine.

Description of Parameter List Format

IMS.ADFSMAC contains a DSECT of the parameter list addressed by register 1 (use COPY MFSSEGE) as follows:

Byte	Contents
0	

Byte	Contents	Contents
	Bit	Contents
0, 1		Message formatting option: 00 = option 1 01 = option 2 11 = option 3
2		1 (Segment edit routine)
3		1 If this message can be routed back to the device by specifying return code 16. This bit is set on when the following conditions are met: <ul style="list-style-type: none"> • PAGDEL=YES or OPTIONS=(...,PAGDEL,...) is specified in the TERMINAL macro for this device. • The device has an output logical terminal. If the message contains a valid operator logical paging request, bit 3 can be set on. However, this message is not returned to the terminal if requested.
	4-7	Reserved
1,2	Zeros	
3	The entry vector is binary (0 to 255).	
4-7	The maximum segment length.	
8-11	The segment address.	
12-15	The highest return code from the Field edits for this segment.	
16-23	The next MOD name.	

The Segment Edit routine can modify only the segment contents, the save area, and the next MOD name field of the parameter list. The MOD name field name should be changed when the edit routine returns the input message to the device. If the segment is option 1 or 2, the routine can set the segment length field to any value from 0 to the maximum segment length. The Segment Edit routine must not cause any waits.

Contents of Registers on Exit

Upon return to IMS, all registers must be restored except for register 15, which must contain one of the following return codes:

Return Code	Meaning
0	Continue processing.
4	Cancel this segment.
8	Cancel this message (IMS sends the message DFS298 INPUT MESSAGE CANCELED BY MFS EXIT).
12	Cancel this message and return to the user the message whose number is in register 1.
16	Return this message to the input device. This code is allowed only when bit 3 of byte 0 in the parameter list is set on.

All segments of a multisegment message are edited before the message is returned to the device (return code 16); if return code 8 or 12 is specified for a segment other than the final one, the message is canceled immediately and the remaining segments are not edited.

In IMS releases with ETO, the Input Message Segment edit routine cannot use return code 16 during the ETO signon process. This is due to the lack of a valid output LTERM.

Function of the Sample Routine

The functions of this routine are based upon the entry vector and the highest Field edit routine return code (FLD-RC) for the segment, and it only performs modifications of messages using formatting options 1 and 2. These functions are shown in Table 85.

Table 85. Input Message Segment Edit Routine Functions Based on the Entry Vector

Input Vector	FLD-RC	Resulting Function Action	SEG-RC
0	< 4	None.	0 ¹
	>= 4	Places EBCDIC return code in last 3 bytes of the segment.	0
1	< 4	None.	0
	>= 4	Places EBCDIC return code in last 3 bytes of the segment.	0
	< 8	None.	4 ²
2	< 4	None.	0
	=4 <8	Places EBCDIC return code in last 3 bytes of the segment.	0
	>= 8	None.	8 ³
3	<4	None.	0
	=4 <8	Places EBCDIC return code in last 3 bytes of the segment.	
	>=8	None.	6 ⁴
4	ANY	Sets FLD-RC as user message number.	12 ⁵

Notes:

1. To continue processing
2. To cancel this segment
3. To cancel this message
4. To send this message back to the entering terminal
5. To cancel this message and send the user message, whose number is in register 1, back to the entering terminal

Chapter 43. Logoff Exit Routine (DFSLGFX0)

This chapter describes how you can use the Logoff exit routine to perform processing that complements the Logon exit routine (DFSLGNX0) described in Chapter 44, “Logon Exit Routine (DFSLGNX0),” on page 309.

The following topics provide additional information:

- “About This Routine”
- “Communicating with IMS” on page 306

About This Routine

The Logoff exit routine must handle all non-MSA, non-LU 6.2 VTAM nodes with which IMS communicates. IMS calls the Logoff exit routine for all master terminal operator (MTO) logoffs, even if it did not call the Logon exit routine for the MTO at logon. (Keep this in mind if your installation maintains a logon count.) All attempts to log off of ACF/VTAM terminals cause IMS to call this exit routine.

Related Reading: For more information on the Extended Terminal Option (ETO) feature, see *IMS Version 9: Administration Guide: Transaction Manager*.

Recommendation: Although the Logon exit routine and the Logoff exit routine are optional, if you include one, you should also include the other to perform any necessary cleanup operations.

Table 86 shows the attributes of the Logoff exit routine.

Table 86. Logoff Exit Routine Attributes

Attribute	Description
IMS environments	DB/DC, DCCTL.
Naming convention	You must name this exit routine DFSLGFX0.
Binding	Follow the guidelines described in “Binding the Routines” on page 7.
Including the routine	If you want IMS to call this exit routine, include it in an authorized library in the JOBLIB, STEPLIB, or LINKLIST library concatenated in front of the IMS.SDFSRESL. If the Logoff exit routine is included, IMS automatically loads it each time IMS is initialized.
IMS callable services	To use callable services with this routine, you must do the following: <ul style="list-style-type: none">• Issue an initialization call (DFSCSI00) to obtain the callable service token and a parameter list in which to build the function-specific parameter list for the desired callable service. For details on using the initialization call, see “Step 2. Initializing IMS Callable Services (DFSCSI00)” on page 14.• Use the ECB found at offset 0 of the Logoff user exit parameter list.• Link DFSCSI00 with your user exit.
Sample routine location	IMS.ADFSSMPL (member name DFSLGFX0).

Extended Recovery Facility (XRF) Considerations

Each time IMS calls the Logoff exit routine, the exit routine receives information on the XRF status of IMS. IMS calls the exit routine if XRF tracking fails.

Resetting the Significant Status

You can use this exit to reset the significant status for a terminal in one of the following states:

- Conversational
- Exclusive
- Test
- Preset
- MFS test
- Full-function response
- Fast Path response

Note: Test, preset, and full-function response states are nonrecoverable, so IMS resets the significant status automatically. However, it is still valid, although unnecessary, to use this exit routine to reset the significant status for these states.

A parameter passed to the exit routine indicates the status of the terminal or ETO user at signoff. All users except ETO terminals can reset the status in the output parameters.

For conversation mode, IMS performs the equivalent of an /EXIT command for the conversation.

Related Reading: For more information on recoverable states, see *IMS Version 9: Administration Guide: Transaction Manager*.

Communicating with IMS

IMS uses the entry and exit registers, as well as parameter lists, to communicate with the exit routine.

Contents of Registers on Entry

Upon entry, the exit routine must save all registers using the provided save area. The registers contain the following:

Register	Contents
R1	Address of Standard Exit Parameter List
R13	Save area address
R14	Return address to IMS
R15	Entry point address of exit routine

This exit routine uses the Version 1 standard exit parameter list. See Table 2 on page 5 for the content of the Version 1 standard exit parameter list.

Table 87 lists the logoff exit parameters. The address of this parameter list is in the standard exit parameter list field SXPLFSPL.

Table 87. Logoff Exit Parameter List

Offset	Length	Description
+0	4	Current ECB address
+4	4	SCD address

Table 87. Logoff Exit Parameter List (continued)

Offset	Length	Description
+8	4	Address of User Table
+12	4	Address of the STATUS_IN and STATUS_OUT vectors. The status vectors are mapped by the DFSSTCHK macro. For the contents of the STATUS_IN vector see "Contents of STATUS_IN." For the contents of the STATUS_OUT vector see "Contents of STATUS_OUT."

Contents of STATUS_IN

The input status vector is a two-byte field that indicates the significant status of a terminal when the exit routine is called. The second byte of the field is reserved. The first byte of the field contains a value that indicates the significant status as follows:

Value	Description
X'80'	Conversation
X'40'	Exclusive
X'20'	Test
X'10'	Preset
X'08'	MFS test
X'04'	Full-function response
X'02'	Fast Path response

Contents of STATUS_OUT

The output status vector is a two-byte field that indicates changes to the terminal's significant status made by the exit routine. IMS uses the contents of STATUS_OUT as an indicator to exit a conversation and reset significant status. The default for this field is zeros, indicating that no significant status is reset.

The second byte of the field is reserved. The first byte of the field contains a value that indicates the significant status as follows:

Value	Description
X'80'	Exit conversation
X'40'	Reset exclusive
X'20'	Reset test
X'10'	Reset preset
X'08'	Reset MFS test
X'04'	Reset full-function response
X'02'	Reset Fast Path response

Contents of Registers on Exit

Before returning to IMS, the exit routine must restore all registers except for register 15. The content of registers on exit is as follows:

Register	Contents
15	Ignored by IMS in all cases.

DFSLGFX0

Chapter 44. Logon Exit Routine (DFSLGNX0)

This chapter describes the Logon exit routine. The Logon exit routine enables you to control the way logons are processed.

In this Chapter:

- “About This Routine”
- “Communicating with IMS” on page 311

About This Routine

The exit routine must handle all non-MSA, non-LU 6.2 VTAM nodes (excluding MTOs at IMS initialization) with which IMS communicates. All attempts to log on to ACF/VTAM terminals if ETO is active cause IMS to call this exit routine.

Related Reading: For more information on the Extended Terminal Option (ETO) feature, see *IMS Version 9: Administration Guide: Transaction Manager*.

Depending on your installation’s needs, you can write the Logon exit routine to:

- Select the logon descriptor that you want IMS to reference when building the terminal control block structure for the logical unit (LU) that is logging on. (For more information, see “Selecting a Logon Descriptor” on page 310.)
- Create or modify the user data that you want IMS to pass to the Signon exit routine (DFSSGNX0). The user data can be entered as autologon data, with the /OPNDST command, or with the VTAM internal commands INITSELF or INITOTHER. Alternatively, the Logon exit routine can build the user data.
- Allow or disallow a logon attempt based on the maximum number of sessions, or manage logons according to the time of day, certain terminal names, or other criteria that you specify.
- Specify or override the autologoff (ALOT), autosignoff (ASOT), screen size, or model values.
- Override the default status recovery mode for the following terminals:
 - Static terminals
 - SLUP dynamic terminals
 - FINANCE dynamic terminals
 - ISC dynamic terminals

The Logon exit routine is optional.

Recommendation: If you include this exit routine, you should also include the Logoff exit routine (DFSLGFX0) to perform any necessary cleanup operations.

Related Reading: The Logoff exit routine is described in Chapter 43, “Logoff Exit Routine (DFSLGFX0),” on page 305.

If you do not supply the Logon exit routine, logons proceed as usual with the logon descriptor chosen according to “Selecting a Logon Descriptor” on page 310.

Table 88 on page 310 shows the attributes of the Logon exit routine.

DFSLGNX0

Table 88. Logon Exit Routine Attributes

Attribute	Description
IMS environments	DB/DC, DCCTL.
Naming convention	You must name this exit routine DFSLGNX0.
Binding	Follow the guidelines described in “Binding the Routines” on page 7.
Including the routine	If you want IMS to call the Logon exit routine, include it in an authorized library in the JOBLIB, STEPLIB, or LINKLIST library concatenated in front of the IMS.SDFSRESL. If the exit routine is included, IMS automatically loads it each time IMS is initialized if ETO=Y (after the Initialization exit routine, DFSINTX0, changed the ETO= keyword).
IMS callable services	To use callable services with this routine, you must do the following: <ul style="list-style-type: none">• Issue an initialization call (DFSCSI0) to obtain the callable service token and a parameter list in which to build the function-specific parameter list for the desired callable service. For details on using the initialization call, see “Step 2. Initializing IMS Callable Services (DFSCSI0)” on page 14.• Use the current address ECB found at offset 0 for the DFSCSI0 call.• Link DFSCSI00 with your user exit.
Sample routine location	No sample exit routine is provided.

Extended Recovery Facility (XRF) Considerations

During XRF tracking mode, IMS calls the Logon exit routine in the alternate system when the terminal control blocks are created for an XRF type 1 session with an ETO terminal. If processing is on an XRF alternate system, IMS ignores the contents of register 15 on exit. The exit routine is called during XRF alternate tracking only for the logon of a class 1 terminal.

Selecting a Logon Descriptor

If the terminal control block structure already exists for the terminal that is logging on, no logon descriptor is needed, and IMS uses the existing terminal control block structure.

If no terminal control block structure exists for the terminal, you can write the Logon exit routine to select the logon descriptor, select a logon descriptor by using the LOGOND= keyword, or let IMS select the logon descriptor using the LU name or default descriptor. Figure 35 shows the search order IMS uses to select the logon descriptor. IMS selects the first valid logon descriptor that it finds and uses that logon descriptor to build the terminal control block structure. If IMS cannot find a valid logon descriptor, including the default logon descriptor, it rejects the logon request.

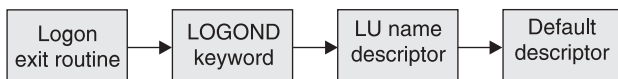

Figure 35. Logon Descriptor Search Order

If the exit routine supplies the name of a valid logon descriptor, IMS uses the logon descriptor associated with that name to build the terminal control block structure. If the Logon exit routine does not choose a logon descriptor, or if the exit routine is not included in the system, IMS uses the logon descriptor requested on the LOGOND= keyword (entering the keyword and descriptor as user data when you log on). If neither the exit routine nor the LOGOND= keyword identifies a valid logon

descriptor, IMS searches for a logon descriptor with the same name as the logical unit (LU). If IMS cannot locate a logon descriptor with this name, IMS uses the default logon descriptor table shown in Table 89 to select the logon descriptor.

Table 89. Default Logon Descriptor Table

CINIT LUTYPE	CINIT TS	Default Logon Descriptor
X'06'	Not applicable	DFSLU61
X'04'	Not applicable	DFSSLU4
X'02'	Not applicable	DFSSLU2
X'01'	Not applicable	DFSSLU1
X'00'	X'04'	DFSSLUP
X'00'	X'03'	DFS3270

IMS cannot generate DFSFIN or DFSNTO logon descriptors because of conflicting CINIT information. The wrong default logon descriptors are chosen for the FINANCE and NTO terminal types unless you do all of the following:

- Write the Logon exit routine so that it always supplies the appropriate logon descriptor name.
- Rename DFSFIN to DFSSLUP if no SLU P terminals exist.
- Rename DFSNTO to DFSSLU1 if no SLU1 terminals exist.

If you do not want dynamic logons for a certain LU type, delete the default logon descriptor for that type from the system, and be sure that the exit routine does not attempt to choose it.

Regardless of how the logon descriptor is selected, the descriptor must agree with the LUTYPE and TS fields (in the MODEENT macro of the VTAM mode table), or IMS rejects the logon request.

Communicating with IMS

IMS uses the entry and exit registers, as well as parameter lists, to communicate with the exit routine.

Contents of Registers on Entry

Upon entry, the exit routine must save all registers using the provided save area. The registers contain the following:

Register	Contents
Register	Contents
R1	Address of Standard Exit Parameter List
R13	Save area address
R14	Return address to IMS
R15	Entry point address of exit routine

This exit routine uses the Version 1 standard exit parameter list. See Table 2 on page 5 for the content of the Version 1 standard exit parameter list.

Table 90 on page 312 list the user logon parameters. The mapping for this parameter list is DSECT LGNXPARM in DFSLGNXP macro. The address of this parameter list is in the standard exit parameter list field SXPLFSPL.

Table 90. User Logon Exit Parameter List

Offset	Length	Description
+0	4	Current ECB address.
+4	4	SCD address.
+8	4	Pointer to User Table.
+12	4	Pointer to the parameter list received from ACF/VTAM when application logon or SCIP bind exit routines are scheduled. For details about this parameter list, see the information about the LOGON Exit Routine in the <i>VTAM Programming Guide</i> . If processing is on an XRF system, this value is zero.
+16	4	Pointer to multi-word parameter list, mapped by DSECT LGNXPARM in DFSLGNXP macro.
+20	4	CLB pointer for the node trying to logon. If the node does not yet exist, this value is zero. The node always exists on an XRF system.

Contents of Registers on Exit

Before returning to IMS, the exit routine must restore all registers except for register 15, which contains one of the following return codes:

Register	Contents						
15	One of the following return codes: <table> <thead> <tr> <th>Return Code</th> <th>Meaning</th> </tr> </thead> <tbody> <tr> <td>0</td> <td>LOGON accepted</td> </tr> <tr> <td>4</td> <td>LOGON rejected</td> </tr> </tbody> </table>	Return Code	Meaning	0	LOGON accepted	4	LOGON rejected
Return Code	Meaning						
0	LOGON accepted						
4	LOGON rejected						

Interfaces

ETO Logon Exit (DFSLGNX0) Interface

For more information, see the DFSLGNXP macro in the source code.

Chapter 45. LU 6.2 Edit Exit Routine (DFSLUEE0)

This section describes the LU 6.2 Edit exit routine. This routine enables you to edit input and output LU 6.2 messages for IMS-managed LU 6.2 conversations. It is also called if a message is inserted from an alternate PCB destined for an LU 6.2 destination. This exit routine is for use with standard IMS and modified IMS application programs. It is not called for CPI Communications driven application programs.

In this Chapter:

- “About This Routine”
- “Communicating with IMS” on page 314

About This Routine

You can write the LU 6.2 Edit exit routine to:

- Change the synchronization level of an asynchronous LU 6.2 conversation.
- View the contents of a message segment and continue processing.
- Change the contents of a message segment and continue processing.
- Discard a message segment.
- Perform a DEALLOCATE_ABEND of the LU 6.2 conversation.

For input messages, IMS calls the LU 6.2 Edit exit routine for each message segment before the message segment is inserted to the IMS message queue. The exit routine can edit message segments as necessary before the application program processes the input message.

For output messages, IMS calls the LU 6.2 Edit exit routine for each message segment before the message segment is sent to the LU 6.2 program. The exit routine can intercept the data sent by the application program and edit it for the particular destination.

Related Reading: For more information on LU 6.2, see *IMS Version 9: Administration Guide: Transaction Manager*.

Table 91 shows the attributes of the LU 6.2 Edit exit routine.

Table 91. LU 6.2 Edit Exit Routine Attributes

Attribute	Description
IMS environments	DB/DC, DCCTL.
Naming convention	You must name this exit routine DFSLUEE0.
Binding	Follow the guidelines described in “Binding the Routines” on page 7. The LU 6.2 Edit exit routine must be reentrant. The IMS-provided default exit routine specifies a return code of zero. If you write your own exit routine, replace the IMS default routine by binding the one you wrote into the IMS.SDFSRESL or including it in an authorized library in the JOBLIB, STEPLIB, or LINKLIB library concatenated in front of IMS.SDFSRESL.
Including the routine	No special steps are required to include this routine.
IMS callable services	This exit routine is not eligible to use IMS Callable Services.

DFSLUEE0

Table 91. LU 6.2 Edit Exit Routine Attributes (continued)

Attribute	Description
Sample routine location	IMS.ADFSSRC (member name DFSLUEE0). This sample is a default exit routine, which IMS always calls for LU 6.2 messages processed under the DL/I call interface.

Changing a Message Segment

The LU 6.2 Edit exit routine can change the message length and contents, provided that it resets the message length field to reflect the new length. The exit routine can increase the message length by up to 256 bytes, but the total length (length field, flag field, and message) cannot exceed 32,767 bytes. If the message exceeds this limit, IMS truncates the message and issues DFS1967 to the master terminal operator (MTO) to indicate a message buffer overlay. The exit routine can reduce the message length without restriction.

Network-Qualified Names

Network-qualified LU names can be up to 17 bytes long.

Related Reading: For more information on network-qualified names, see *IMS Version 9: Administration Guide: Transaction Manager*.

MOD Name Support for APPC

An LU 6.2 application program can send the LTERM and the MOD name in the first segment of the message. IMS saves the LTERM and MOD name in the I/O PCB.

At entry, IMS provides the address of the MOD name in the first segment of the message sent to the LU 6.2 Edit exit routine (DFSLUEE0). DFSLUEE0 checks the contents of the first message segment. If IMS finds the MOD name, it uses the MOD name to format the output message. If IMS finds the LTERM, it can use the LTERM to change the destination of the output.

Use the Initialization exit routine (DFSINTX0) to create the user table. This exit routine must pass the address of the user table to IMS, and IMS passes the address to DFSLUEE0.

Communicating with IMS

IMS uses the entry and exit registers and a parameter list to communicate with the exit routine.

Contents of Registers on Entry

Upon entry, the exit routine must save all registers using the provided save area. The registers contain the following:

Register	Contents																										
1	Address of parameter list. The parameter list contains the following addresses. (For the format of the fields pointed to by the parameter list, see "Data Format of Parameters" on page 316.)																										
	<table border="1"> <thead> <tr> <th>Bytes</th> <th>Content</th> </tr> </thead> <tbody> <tr> <td>00-03</td> <td>Address of a flag field indicating what type of message caused IMS to call the exit routine. This field contains one of the following flags (fixed length, right justified, padded with zeros): 0 Input message 4 Output message</td> </tr> <tr> <td>04-07</td> <td>Address of the area containing either the input or output message segment length, message flag, and message segment (variable length, left justified). The value in the length field includes the length field, flag field, and message.</td> </tr> <tr> <td>08-11</td> <td>Address of transaction code (fixed length, left justified, padded with blanks).</td> </tr> <tr> <td>12-15</td> <td>Address of LU name (fixed length, left justified, padded with blanks).</td> </tr> <tr> <td>16-19</td> <td>Address of user ID (fixed length, left justified, padded with blanks).</td> </tr> <tr> <td>20-23</td> <td>Address of return code, which is an exit parameter.</td> </tr> <tr> <td>24-27</td> <td>Address of LTERM (fixed length, left justified, padded with blanks).</td> </tr> <tr> <td>28-31</td> <td>Address of MOD name (fixed length, left justified, padded with blanks).</td> </tr> <tr> <td>32-35</td> <td>Address of user table, which is an entry parameter.</td> </tr> <tr> <td>36-39</td> <td>Address of message flag (if bit zero of the message flag equals 1, it is the first segment).</td> </tr> <tr> <td>40-43</td> <td>Address of user ID indicator byte, which describes the content of the user ID field and can have a value of one of the following: U (user ID), L (LTERM), P (PSBname), or O (Other).</td> </tr> <tr> <td>44-47</td> <td>Address of the synchronization level (one byte). The synchronization level can be N (None), C (Confirm), or S (Syncpoint). For asynchronous conversations the exit can change the synchronization level. Note that only synchronization level N and C are supported for synchronous conversations.</td> </tr> </tbody> </table>	Bytes	Content	00-03	Address of a flag field indicating what type of message caused IMS to call the exit routine. This field contains one of the following flags (fixed length, right justified, padded with zeros): 0 Input message 4 Output message	04-07	Address of the area containing either the input or output message segment length, message flag, and message segment (variable length, left justified). The value in the length field includes the length field, flag field, and message.	08-11	Address of transaction code (fixed length, left justified, padded with blanks).	12-15	Address of LU name (fixed length, left justified, padded with blanks).	16-19	Address of user ID (fixed length, left justified, padded with blanks).	20-23	Address of return code, which is an exit parameter.	24-27	Address of LTERM (fixed length, left justified, padded with blanks).	28-31	Address of MOD name (fixed length, left justified, padded with blanks).	32-35	Address of user table, which is an entry parameter.	36-39	Address of message flag (if bit zero of the message flag equals 1, it is the first segment).	40-43	Address of user ID indicator byte, which describes the content of the user ID field and can have a value of one of the following: U (user ID), L (LTERM), P (PSBname), or O (Other).	44-47	Address of the synchronization level (one byte). The synchronization level can be N (None), C (Confirm), or S (Syncpoint). For asynchronous conversations the exit can change the synchronization level. Note that only synchronization level N and C are supported for synchronous conversations.
Bytes	Content																										
00-03	Address of a flag field indicating what type of message caused IMS to call the exit routine. This field contains one of the following flags (fixed length, right justified, padded with zeros): 0 Input message 4 Output message																										
04-07	Address of the area containing either the input or output message segment length, message flag, and message segment (variable length, left justified). The value in the length field includes the length field, flag field, and message.																										
08-11	Address of transaction code (fixed length, left justified, padded with blanks).																										
12-15	Address of LU name (fixed length, left justified, padded with blanks).																										
16-19	Address of user ID (fixed length, left justified, padded with blanks).																										
20-23	Address of return code, which is an exit parameter.																										
24-27	Address of LTERM (fixed length, left justified, padded with blanks).																										
28-31	Address of MOD name (fixed length, left justified, padded with blanks).																										
32-35	Address of user table, which is an entry parameter.																										
36-39	Address of message flag (if bit zero of the message flag equals 1, it is the first segment).																										
40-43	Address of user ID indicator byte, which describes the content of the user ID field and can have a value of one of the following: U (user ID), L (LTERM), P (PSBname), or O (Other).																										
44-47	Address of the synchronization level (one byte). The synchronization level can be N (None), C (Confirm), or S (Syncpoint). For asynchronous conversations the exit can change the synchronization level. Note that only synchronization level N and C are supported for synchronous conversations.																										
13	Address of save area. The exit routine must not change the first three words.																										
14	Return address to IMS.																										
15	Entry point of exit routine.																										

Contents of Registers on Exit

Before returning to IMS, the exit routine must restore all registers. The registers contain the following:

Register	Contents																														
1	Address of parameter list (provided at entry). The parameter list contains the following addresses. (For the format of the fields pointed to by the parameter list, see “Data Format of Parameters.”)																														
	<table border="1"> <thead> <tr> <th>Bytes</th> <th>Content</th> </tr> </thead> <tbody> <tr> <td>00-03</td> <td>Used on entry only. (For contents, see “Contents of Registers on Entry” on page 314.)</td> </tr> <tr> <td>04-07</td> <td>Address of the area containing the message segment length, message flag, and message segment (variable length, left justified). The value in the length field is the total length and includes the length field, flag field, and message. For information on the restrictions associated with changing a message’s length and contents, see “Changing a Message Segment” on page 314.</td> </tr> <tr> <td>08-19</td> <td>Used on entry only.</td> </tr> <tr> <td>20-23</td> <td>Address of the area for one of the following return codes from the exit routine. (IMS treats any other value as 0.)</td> </tr> <tr> <td>24-27</td> <td>Address of LTERM (exit parameter).</td> </tr> <tr> <td>28-31</td> <td>Address of MOD name (entry and exit parameter).</td> </tr> <tr> <td>32-35</td> <td>Address of User Table (entry parameter).</td> </tr> <tr> <td>36-39</td> <td>Address of message flag (Bit 0 = 1 then first segment) (entry parameter).</td> </tr> <tr> <td></td> <td> <table border="1"> <thead> <tr> <th>Return Code</th> <th>Meaning</th> </tr> </thead> <tbody> <tr> <td>0</td> <td>IMS performs the default action: continue processing.</td> </tr> <tr> <td>4</td> <td>Discard this message segment.</td> </tr> <tr> <td>8</td> <td>DEALLOCATE_ABEND the conversation.</td> </tr> </tbody> </table> </td> </tr> <tr> <td>40-43</td> <td>Address of user ID indicator.</td> </tr> </tbody> </table>	Bytes	Content	00-03	Used on entry only. (For contents, see “Contents of Registers on Entry” on page 314.)	04-07	Address of the area containing the message segment length, message flag, and message segment (variable length, left justified). The value in the length field is the total length and includes the length field, flag field, and message. For information on the restrictions associated with changing a message’s length and contents, see “Changing a Message Segment” on page 314.	08-19	Used on entry only.	20-23	Address of the area for one of the following return codes from the exit routine. (IMS treats any other value as 0.)	24-27	Address of LTERM (exit parameter).	28-31	Address of MOD name (entry and exit parameter).	32-35	Address of User Table (entry parameter).	36-39	Address of message flag (Bit 0 = 1 then first segment) (entry parameter).		<table border="1"> <thead> <tr> <th>Return Code</th> <th>Meaning</th> </tr> </thead> <tbody> <tr> <td>0</td> <td>IMS performs the default action: continue processing.</td> </tr> <tr> <td>4</td> <td>Discard this message segment.</td> </tr> <tr> <td>8</td> <td>DEALLOCATE_ABEND the conversation.</td> </tr> </tbody> </table>	Return Code	Meaning	0	IMS performs the default action: continue processing.	4	Discard this message segment.	8	DEALLOCATE_ABEND the conversation.	40-43	Address of user ID indicator.
Bytes	Content																														
00-03	Used on entry only. (For contents, see “Contents of Registers on Entry” on page 314.)																														
04-07	Address of the area containing the message segment length, message flag, and message segment (variable length, left justified). The value in the length field is the total length and includes the length field, flag field, and message. For information on the restrictions associated with changing a message’s length and contents, see “Changing a Message Segment” on page 314.																														
08-19	Used on entry only.																														
20-23	Address of the area for one of the following return codes from the exit routine. (IMS treats any other value as 0.)																														
24-27	Address of LTERM (exit parameter).																														
28-31	Address of MOD name (entry and exit parameter).																														
32-35	Address of User Table (entry parameter).																														
36-39	Address of message flag (Bit 0 = 1 then first segment) (entry parameter).																														
	<table border="1"> <thead> <tr> <th>Return Code</th> <th>Meaning</th> </tr> </thead> <tbody> <tr> <td>0</td> <td>IMS performs the default action: continue processing.</td> </tr> <tr> <td>4</td> <td>Discard this message segment.</td> </tr> <tr> <td>8</td> <td>DEALLOCATE_ABEND the conversation.</td> </tr> </tbody> </table>	Return Code	Meaning	0	IMS performs the default action: continue processing.	4	Discard this message segment.	8	DEALLOCATE_ABEND the conversation.																						
Return Code	Meaning																														
0	IMS performs the default action: continue processing.																														
4	Discard this message segment.																														
8	DEALLOCATE_ABEND the conversation.																														
40-43	Address of user ID indicator.																														

Data Format of Parameters

Table 92 shows the data type, length, and format of the fields to which the parameter list (addressed by register 1) points.

Table 92. Format of Parameters

Bytes	Data Address	Parameter Use	Data Type	Data Length	Data Format ¹
00-03	Address of flag	Fixed length, right justified, padded with zeros	Input	4 bytes	<i>X'flag'</i>
04-07	Address of message segment length, message flag, and message segment	Variable length, left justified	Input and output	n bytes ²	LLZZ <i>message</i>
08-11	Address of transaction code	Fixed length, left justified, padded with blanks	Input	8 bytes	<i>codebbbb</i>
12-15	Address of LU name	Fixed length, left justified, padded with blanks	Input	17 bytes	<i>namebbbb</i>

Table 92. Format of Parameters (continued)

Bytes	Data Address	Parameter Use	Data Type	Data Length	Data Format ¹
16-19	Address of user ID	Fixed length, left justified, padded with blanks	Input	8 bytes	<i>user IDbb</i>
20-23	Address of return code	Fixed length, right justified, padded with zeros	Output	4 bytes	<i>X'code'</i>
24-27	Address of LTERM	Fixed length, right justified, padded with zeros	Output	8 bytes	<i>ltermname</i>
28-31	Address of MOD name	Fixed length, left-justified, padded with blanks	Input and output	8 bytes	<i>modname</i>
32-35	Address of user table	Variable length	Output	? bytes ³	<i>usertablename</i>
36-39	Address of message flag	Fixed length	Output	1 byte	<i>X'code'</i>
40-43	Address of user ID indicator	Fixed length	Input	1 byte	<i>indicator</i>
44-47	Address of synchronization level	Fixed length	Input and Output	1 byte	APPC synchronization level

Note:

¹**ZZ** = flag field; **LL** = length field; bb = blanks; words in *italics* represent data values. The value in the length field **LL** includes the length field, flag field, and message.

²The exit routine can increase the message length by up to 256 bytes, but the total length cannot exceed 32,767 bytes.

³The length of this user table is determined by the user.

DFSLUEE0

Chapter 46. Message Control/Error Exit Routine (DFSCMUX0)

This chapter describes the Message Control/Error exit routine. This routine lets you control transactions, responses, and message switches that are in error. The exit routine can request that IMS handle the messages that are in error, depending on the condition that led IMS to call the exit routine. The /DEQUEUE command supports the MSNAME keyword so that this control is extended to messages queued on Multiple Systems Coupling (MSC) links.

In this Chapter:

- “About This Routine”
- “Communicating with IMS” on page 323

About This Routine

You can write the Message Control/Error exit routine to:

- Perform processing at MSC link start and link termination time that is unique to your installation, such as obtaining and freeing additional storage, and activating and deactivating a program.
- Reroute a message to a different local or remote transaction, local or remote LTERM, or an LU 6.2 destination. The target LTERM must be an existing LTERM; IMS does *not* dynamically create the LTERM, even if the Extended Terminal Option (ETO) feature is active. For more information, see “Rerouting Messages” on page 321. For more information on the ETO feature, see *IMS Version 9: Administration Guide: Transaction Manager*.
- Discard a message and send an informational message to the current master terminal operator (MTO) or input terminal indicating that the message is discarded.
- Suppress the /DEQUEUE command, or suppress the command and send an informational message to the entering terminal indicating that the command is suppressed.

A sample exit routine is available from the IMS library. The sample exit routine is the default routine. IMS calls the sample exit routine unless you replace it with your own version. The sample exit routine includes code that supports the following keywords on the /DEQUEUE command:

lterm
node
msname
luname plus *tpname*

The default action for this exit routine is to proceed with the /DEQUEUE command.

Table 93 shows the attributes of the Message Control/Error exit routine.

Table 93. Message Control/Error Exit Routine Attributes

Attribute	Description
IMS environments	DB/DC, DCCTL.
Naming convention	You must name this exit routine DFSCMUX0.

Table 93. Message Control/Error Exit Routine Attributes (continued)

Attribute	Description
Binding	<p>Follow the guidelines described in “Binding the Routines” on page 7. This exit routine must be reentrant.</p> <p>The sample exit routine is a default routine. If you write your own exit routine, you must bind it with the IMS control region SDFSRESL.</p>
Including the routine	Include this routine by link editing it as described in 320.
IMS callable services	This exit routine cannot use callable services.
Sample routine location	<p>IMS.ADFSSRC (member name DFSCMUX0).</p> <p>The sample routine provided is completely compatible with the MSC error handling and /DEQUEUE command processing that exists for prior releases of IMS. You can ensure compatibility by including this sample exit routine logic in your customized version.</p> <p>The MSNB DSECT appears on IMS.ADFSSRC (member name MSNB).</p>

Calling the Routine

IMS calls the Message Control/Error exit routine and sets an entry flag in the interface block as a result of one of the following:

- Link start.

A RSTART LINK command is entered to start an MSC link or when the MSC link is started by the partner system (MSC environment only).
- Link termination.

This exit routine is called at link termination time mainly when a PSTOP link command is entered from IMS, or the link is stopped by the partner IMS, for all access methods of MSC. Most errors (such as, invalid data, queue error, or access method) in MSC do not cause the link to be terminated.

For MSC VTAM, the exit routine is also called in the following cases:

 - CLSDST/TERMSESS complete
 - Lost term error
 - Request canceled by CLSDST
 - Error during start up
 - Cleanup or Notify
 - Z-net or cancel
- Send error.
 - XCF send failed.
 - An invalid data block (send error) is detected during a transmission (MSC environment only). The sender must handle the message that is in error. You can write the exit routine to check if the link is down or stopped at this time. DFS2140 with reason code 2146 indicates a send error.
 - An LU 6.2 session failed while sending an output message to an LU 6.2 program. The exit routine can only reroute or discard the message. The default action is to discard the message.
 - A send to an LU 6.2 program is rejected with a deallocate or with a send error. The exit routine can only ask IMS to reroute or discard the message. The default action is to discard the message.

Restriction: When the exit routine discards a message from an LU 6.2 conversation because a send error occurred, the exit routine must not send an informational message to the originating LU 6.2 application. The informational message can be rejected for the same reason that the original message was rejected.

If a send error occurs while sending a reply from an IMS local conversational transaction or a Fast Path transaction to an LU 6.2 program, this exit routine is not called. If the reply is from a remote transaction or a local nonconversational transaction, this exit routine is called.

- Receive error
An input message error (receive error) is detected by the receiver of a message (MSC environment only). The following messages indicate a receive error: DFS064, DFS065, DFS067, DFS076, DFS1959E, DFS2125, DFS2126, DFS2127, DFS2128, DFS2129, DFS2130, DFS2131, DFS2132, DFS2133, DFS2134, DFS2137, DFS2141, DFS2143, DFS2163, DFS2164, DFS2165, DFS2167, DFS2174, DFS2175, DFS2176, and DFS3470.
- A /DEQUEUE command with the specified *lterm*, *node*, *msname*, *luname* plus *tpname* and *tmember name* plus *tpipe name* keyword is entered. IMS calls the exit routine before processing each message on the queue.

Related Reading:

See *IMS Version 9: Command Reference* for information on commands and keywords.

See *IMS Version 9: Messages and Codes, Volume 2* for message descriptions.

See “Message Control/Error Exit Interface Block (MSNB)” on page 324 and “Valid Flags and Default Actions” on page 328 for more information on IMS calls to this exit routine and possible message processing actions.

Rerouting Messages

The Message Control/Error exit routine enables you to reroute transactions, responses, and message switches that are in error. When you reroute a message to a different destination, that destination must be a local or remote transaction, a local or remote LTERM, an LU 6.2 destination, or OTMA *tmember* and *tpipename*. The new destination must be capable of processing the message.

Restriction: You cannot reroute a message to a CPI-C driven application program.

Definition: An LU 6.2 destination is the LU 6.2 application program and is always defined with the LU name, plus the TP name.

A message that is rerouted to a transaction (conversational or nonconversational) can include the interface block if your exit routine sets the MSX2QBK bit in the MSXFLG2 field of the MSNB interface block. If this bit is on, a new message (with the interface block included) is built and enqueued to the new destination. If this bit is off, the original message is enqueued. For more information on these fields, see “Message Control/Error Exit Interface Block (MSNB)” on page 324.

The format of the message depends on the message type and the new destination type as shown in Table 94 on page 322. Each destination type is discussed in the sections following the figure.

Table 94. Rerouting Messages to New Destinations

Message Type	New Destination	Message Format (if MSX2QBK is turned on)
1. Conversational	Conversational transaction	SPA + interface block + message
2. Conversational	Nonconversational transaction	Interface block + unpacked SPA + message
3. Nonconversational (but not message switch)	Nonconversational transaction	Interface block + message
4. Message switch	Nonconversational transaction	Interface block + message
5. Message switch	LTERM	Original message
6. All types	Luname, tpname	
7. OTMA	Transaction, lterm, luname + tpname, or OTMA member name + tpipe name	Interface block + message if the new destination is transaction or lterm, the message format rules for message types 1 through 5 are applicable.

Recommendation: If a message must be rerouted, it is recommended that you reroute it to a local nonconversational transaction to avoid further error. This nonconversational transaction is a special-purpose error processing transaction and can process all messages that are rerouted to it.

Attention: During the rerouting process, the original message is dequeued first, and then the newly built message is enqueued to the new destination. If a system failure occurs between the dequeue and enqueue processing, the message can be lost.

Rerouting to a Conversational Transaction

When a conversational message is rerouted to another conversational transaction, the scratch pad area (SPA) is the first segment, and the interface block is the next segment (if your exit routine sets the MSX2QBK bit). If you reroute a conversational transaction to a different conversational transaction, make sure that both transactions have the same SPA size.

Rerouting to a Nonconversational Transaction

When the new destination is a nonconversational transaction, the interface block is the first segment of the rerouted message (if your exit routine sets the MSX2QBK bit).

If the message is conversational, the segment following the interface block is the unpacked SPA and should be treated as a data segment by the new destination's application program. If the message is conversational or is in response mode (or both), it is the user's responsibility to end the conversation and take the input terminal out of response mode. One of the following can be done to end the conversation or take the terminal out of response mode:

- Enter the /EXIT command from the input terminal, if the keyboard is not locked.
- If the input terminal is a static terminal, from the MTO or system console of the input system, enter:

- /DISPLAY CONVERSATION HELD NODE nodenameor
/DISPLAY CONVERSATION BUSY NODE nodename
(to determine the conversation ID)
- /STOP NODE nodename
- /EXIT CONVERSATION conversation id NODE nodename
- /START NODE nodename
(if appropriate)

These commands can also be issued from an AOI program.

- If the input terminal was dynamically created using the Extended Terminal Option (ETO) feature, from the MTO or system console of the input system, enter:

- /DISPLAY CONVERSATION HELD USER username or
/DISPLAY CONVERSATION BUSY USER username
(to determine the conversation ID)
- /STOP USER username
- /EXIT CONVERSATION conversation id USER username
- /START USER username
(if appropriate)

These commands can be issued from an AOI program.

Related Reading: For more information on these commands, see *IMS Version 9: Command Reference*.

Rerouting to an LTERM

When the new destination for a message is an LTERM and a message is rerouted from one physical terminal type to another, IMS rejects the message and issues an error message (such as DFS2078) if the new destination cannot handle the data.

Related Reading: For more information, see *IMS Version 9: Messages and Codes, Volume 2*.

Communicating with IMS

IMS uses the entry and exit registers, and the MSNB interface control block to communicate with the exit routine.

Contents of Registers on Entry

Upon entry, the exit routine must save all registers using the save area provided. The registers contain the following:

Register	Contents
1	Address of Message Control/Error exit interface block, MSNB. (For the format of the interface block, see Contents of Interface Block on Entry.)
13	Address of save area. The exit routine must not change the first three words.
14	Return address to IMS.
15	Entry point of exit routine.

Contents of Registers on Exit

Before returning to IMS, the exit routine must restore all registers. The contents of the interface block pointed to by register 1 can be different. (For the format of the interface block on exit, see “Contents of Interface Block on Exit” on page 325.)

Message Control/Error Exit Interface Block (MSNB)

The interface block for the Message Control/Error exit routine contains all of the information about the message. The entry flag (MSNFLG1) indicates the reason the exit routine is called, and the exit flag (MSXFLG1) determines what action will be performed when control is returned to IMS. MSNBSEG1 points to the first segment of the message. If the segment is a SPA, IMS unpacks it before passing control to the exit routine. The exit routine can place any information that it needs into the user work area (MSNBUSRA); IMS does not disturb the contents of this work area.

The Message Control/Error exit routine can **only** modify seven fields: MSNBRTPG, MSNBRTPN, MSNBDEST, MSNBRINF, MSNBUSRA, MSXFLG1, and MSXFLG2. All other fields are read-only. If the exit routine modifies MSNBDEST, it must modify MSNBRINF. If the exit routine modifies MSNBRTPG and MSNBRTPN, it must modify MSNBRINF. In addition, the exit routine can modify MSXFLG2 if the exit routine modifies MSNBDEST and MSNBRINF, or MSNBRTPG, MSNBRTPN and MSNBDEST. (For more information about these fields, see “Contents of Interface Block on Entry” on page 324.)

Contents of Interface Block on Entry

Table 95 shows the contents of key fields in the Message Control/Error exit interface block as they appear on entry.

Table 95. Key Fields of Interface Block on Entry

Byte	Field Name	Contents	
X'C'	MSNFLG1	Entry Flag	Meaning
		X'02'	DFS message send error detected
		X'80'	MSC link start
		X'40'	MSC link termination
		X'20'	Send error detected
		X'10'	Receive error detected
		X'08'	/DEQUEUE command entered
X'D'	MSNFLG2	Entry Flag	Meaning
		X'80'	Message prefix error detected
		X'40'	Invalid data block detected
		X'20'	LU 6.2 session failed or send action was rejected
		X'04'	XCF send action failed

Table 95. Key Fields of Interface Block on Entry (continued)

Byte	Field Name	Contents	
X'E'	MSNFLG3	Entry Flag	
		Meaning	
		X'80'	DEQUEUE NODE command entered
		X'40'	DEQUEUE LTERM command entered
		X'20'	DEQUEUE MSNAME command entered
		X'10'	DEQUEUE LUNAME TPNAME command entered
X'08'	DEQUEUE TMEMBER TPIPE name entered		
X'F'	MSNFLG4	Entry Flag	
		Meaning	
		X'80'	Message is a transaction
		X'40'	Message is a message switch
		X'20'	Message is a response
		X'10'	SPA in the message
		X'08'	Response mode message
		X'04'	Conversation starting
X'02'	Message switch from DFSAPPC		
X'01'	Message from APPC type message		
X'26'	MSNBOSID	Source SYSID (if MSC)	
X'28'	MSNBDSID	Destination SYSID (if MSC)	
X'2A'	MSNBMGID	Error message number (if receive error)	
X'2C'	MSNBORGN	Message origin source name ¹	
X'5C'	MSNBDSNM	Final destination of message	
X'88'	MSNBRTPG	Length of TP name from /DEQ LU name TP name command	
X'8A'	MSNBRMEM	Rerouted destination member name for OTMA or tmember name of /DEQ tmem/tpipe	
X'8A'	MSNBRTPN	TP name from /DEQ LU name TP name command	
X'CA'	MSNBDEST	<ul style="list-style-type: none"> • Node if /DEQ node command • LTERM if /DEQ lterm command • MSNAME if /DEQ msname command • LU name TP name if /DEQ luname tpname command 	
X'14E'	MSNBUSRA	User work area	

Note: ¹ In an LU 6.2 conversation, when the outbound message is re-enqueued across restart, the message origin source name (MSNBORGN) is blank.

Contents of Interface Block on Exit

Table 96 on page 326 shows the contents of key fields in the Message Control/Error exit interface block as they appear on exit. The exit routine uses these fields to return information to IMS.

Table 96. Key Fields of Interface Block on Exit

Byte	Field Name	Contents	
X'84'	MSXFLG1	Exit Flag	
		Meaning	
		X'00'	No message is involved. (Perform the default action, which is the same action as in the prior release.) You can modify the exit routine to perform: <ul style="list-style-type: none"> Initialization processing (including external IMS System Services) at link start Clean-up processing at link termination
		X'80'	Reroute the message to a different local or remote transaction, a local or remote LTERM, or an LU 6.2 destination. The exit routine must provide the new destination name in the MSNBDEST field, and set MSNBRINF to indicate an LTERM, a transaction, or an LU 6.2 destination.
		X'60'	Perform actions of both X'20' and X'40'.
		X'40'	Discard the message or proceed with the /DEQUEUE command.
		X'30'	Perform actions of both X'10' and X'20'.
		X'20'	If the exit routine selects this action, IMS sends an informational message: <ul style="list-style-type: none"> If the /DEQUEUE command was entered, IMS sends DFS2185 to the entering terminal. If IMS detected a receive error, IMS sends DFS2184 to the current MTO or input terminal. If IMS detected a send error, IMS sends DFS2184 to the current MTO. <p>If this action is selected by default and not by the exit routine, IMS sends an informational message:</p> <ul style="list-style-type: none"> On a send error, IMS sends DFS2140. On a receive error, IMS sends the message number in the MSNBMGID field. <p>This exit flag can be specified only in combination with exit flag X'10' or X'40'.</p>
		X'10'	Suppress the /DEQUEUE command. The /DEQUEUE PURGE operation is terminated if the exit routine requests to suppress the command.
		X'85'	MSXDFT1
Meaning			
X'00'	No message involved (link start or link termination) or the default action.		
X'80'	Reroute message to a different destination.		
X'40'	Discard the message or proceed with the /DEQUEUE command.		
X'20'	Send error message to current MTO or input terminal.		
X'10'	Suppress the /DEQUEUE command.		

Table 96. Key Fields of Interface Block on Exit (continued)

Byte	Field Name	Contents	
X'86'	MSXFLG2	Exit Flag	Meaning
		X'80'	MSX2QBK field; include interface block in the message when rerouting to a different destination.
X'88'	MSNBRTPG	Length of rerouted TP name.	
X'8A'	MSNBREMEM	Rerouted destination member name for OTMA or tmember name of /DEQ tmem/tpipe	
X'8A'	MSNBRTPN	Rerouted TP name.	
X'CA'	MSNBDEST	Destination name of local or remote transaction or local or remote LTERM, or reroute LU name or reroute netid.luname (left-justified, padded with blanks) if reroute the message.	
X'105'	MSNBRINF	Exit Flag	Meaning
		X'80'	Destination is a transaction.
		X'40'	Destination is an LTERM.
		X'20'	Destination is a dynamic local LTERM.
		X'10'	Destination of LU name plus TP name.
		X'08'	Destination of OTMA member plus tpipe.
X'107'	MSNBRFL1	Exit Flag	Meaning
		X'80'	Destination is a local transaction.
		X'40'	Destination is a remote transaction.
		X'20'	Destination is a remote LTERM.
X'10D'	MSMFLG1	Exit Flag	Meaning
		X'80'	Next segment is a SPA.
		X'40'	The two-byte SID was provided in the MSC extension.
X'12A'	MSNBMSG	Message area when error encountered in the interface module.	
X'14E'	MSNBUSRA	User work area.	

Logging the Interface Block

Two copies of the interface block are added to the existing X'6701' log record. The first copy is labeled "MSNB" and represents the interface block before IMS calls the Message Control/Error exit routine with the log record ID of CMEA. The second copy is labeled "USR MSNB" and represents the interface block after IMS calls the exit routine with the log record ID of CMEB. The X'6701' log record can be logged for informational reasons or to indicate an error in preparing to call the exit routine, or in performing the action(s) requested by the exit routine. The trace ID is CMEI. These log entries are forced entries for a send error, a receive error, and a /DEQUEUE command, regardless of any trace options that are specified. For link start and link termination, the interface block is only logged if the trace option is in effect on the link or node involved.

Related Reading: For more information on this log record, see *IMS Version 9: Diagnosis Guide and Reference*.

Valid Flags and Default Actions

IMS performs the default actions (specified in the MSXDFT1 field) if the exit routine returns control to IMS without modifying the exit flag field (MSXFLG1) in the interface block. IMS also performs the default actions if the exit routine requests an invalid exit flag, or if IMS encounters an error while trying to perform the action requested by the exit routine. If an invalid exit flag is requested, IMS sends error message DFS2184 to the current MTO, in addition to performing the default action.

Table 97 shows valid entry flags, exit flags, and default actions. The entry and exit flags are described in “Contents of Interface Block on Entry” on page 324 and “Contents of Interface Block on Exit” on page 325.

Table 97. *Flags and Default Actions*

Entry Flag (MSNFLG1)	Valid Exit Flags (MSXFLG1)	Default Action (MSXDFT1)
X'80'	X'00'	X'00'
X'40'	X'00'	X'00'
X'20'	X'00', X'40', X'60', X'80'	X'60' + stop MSNAME
X'10'	X'00', X'40', X'60', X'80'	X'60'
X'08'	X'00', X'10', X'30', X'40', X'80'	X'40'

Note: The default action for a send error (entry flag = X'20') includes STOP MSNAME. In addition, the default action for the DEQUEUE command is to proceed with the command. If you do not want these actions to take place, specify a different exit flag depending on the actions that you want to occur.

If any errors are encountered while IMS tries to perform the requested action, the action is ignored and the default action is performed. The MSNBMSG field of the interface block of the forced 6701 CMEI log record will contain one of the following brief descriptions that describe the error encountered, if applicable:

- No storage for message buffer
- Invalid destination for reroute
- Cannot reroute MSG switch to CONV
- Error while building rerouted MSG
- Reroute destination not found
- Cannot reroute CONV MSG to LTERM
- Cannot reroute non-CONV MSG to CONV

Chapter 47. Message Switching (Input) Edit Routine (DFSCNTE0)

This chapter describes the Message Switching (Input) Edit routine. Information about using a sample routine is provided at the end of this chapter.

In this Chapter:

- “About This Routine”
- “Communicating with IMS” on page 330

About This Routine

A facility similar to the Transaction Code (Input) Edit is provided for message switching. The optional user-written routine, whose CSECT and load module name must be DFSCNTE0, is included in the system at IMS system definition time. Only one Message Switching edit routine can be specified for an IMS online control program. This routine is specified for inclusion with the online control program by specifying EDIT=(YES,...) in one or more NAME macros during system definition. This routine is called when a message is entered from a terminal with EDIT=(YES,...) in the NAME macro to another terminal. It is not called when the message is inserted using a program-to-program switch.

The Message Switching (Input) edit routine does not support terminals that are defined dynamically using the Extended Terminal Option (ETO) feature.

Related Reading: For more information on ETO, see *IMS Version 9: Administration Guide: Transaction Manager*.

Table 98 shows the attributes of the Message Switching (Input) edit exit routine.

Table 98. Message Switching (Input) Edit Exit Routine Attributes

Attribute	Description
IMS environments	DB/DC, DCCTL.
Naming convention	You must name this exit routine DFSCNTE0.
Binding	Follow the guidelines described in “Binding the Routines” on page 7.
Including the routine	No special steps are required to include this routine.
IMS callable services	To use IMS Callable Services with this routine, you must issue an initialization call (DFSCSI0) to obtain the Callable Service token and a parameter list in which to build the function-specific parameter list for the desired callable service. Use the ECB found in register 9 for the DFSCSI0 call. Related Reading: For details on using the initialization call, see “Step 2. Initializing IMS Callable Services (DFSCSI0)” on page 14. This exit routine is automatically linked to DFSCSI00 by IMS. No additional linking is required To use IMS Callable Services.
Sample routine location	IMS.ADFSSRC (member name DFSCNTE0).

Communicating with IMS

IMS uses the entry and exit registers to communicate with the routine.

Contents of Registers on Entry

Upon entry, the edit routine must save all registers using the provided save area. The registers contain the following:

Register	Contents
1	The buffer location of the input message segment after translation to EBCDIC and after IMS Basic Editing. The first two bytes of the buffer contain a binary message length. The third byte of the buffer is binary zeros. The binary count includes the 4-byte prefix. The fifth byte contains the first byte of message text.
7	Address of CTB.
9	Address of CLB.
13	Address of save area. The exit routine must not change the first three words.
14	Return address to IMS.
15	Entry point of edit routine.

Use the message segment in the buffer addressed by register 1 as input to the edit routine.

The edit routine must place the text of the edited message segment to be returned to IMS in the buffer addressed by register 1. If the input was processed by the IMS Basic Edit, this buffer is always 10 bytes greater than the 2-byte binary count at the beginning of the message segment. The length of the message segment can be expanded or reduced to any desired size. The format of the edited message segment in the buffer upon return to IMS must be two bytes of binary count (LL), two bytes of binary zeros (ZZ), and edited text. The second two bytes (ZZ) should not be changed or edited. The LLZZ field is the first four bytes of the message segment.

Contents of Registers on Exit

Before returning to IMS, the edit routine must restore all registers except register 15, which must contain one of the following return codes.

Return Code	Meaning
00	Segment is processed normally.
04	Segment is canceled.
08	Message is canceled and the terminal operator is notified.
12	Message is canceled and the user message identified by register 1 is sent to the terminal.

Register 1 contains the message number if register 15 contains a return code of 12; otherwise it is ignored. Any other value causes the message to be canceled and the terminal operator to be notified.

Using the Sample Message Switching Edit Routine (DFSCNTE0)

The edit routine can be used to identify, in the text of the message to the output terminal, the logical terminal name from which the message was entered and the message number.

In the example, the input logical terminal name is used. This name is found in the Communication Name Table (CNT), which is the IMS control block for the input logical terminal. The CNT is addressed by a field called CTBCNTPT in the Communication Terminal Block. The field in the CNT containing the logical terminal name is called CNTNAME. Control blocks are defined in the *IMS Version 9: Diagnosis Guide and Reference*.

Chapter 48. Non-Discardable Messages Exit Routine (DFSNDMX0)

The Non-Discardable Messages exit routine provides users with a mechanism to tell IMS what to do with the input message associated with an abended application program. Otherwise, IMS can arbitrarily discard messages from the system and issue message DFS555I.

In this Chapter:

“About This Routine”

“Communicating with IMS” on page 335

About This Routine

The Non-Discardable Messages exit routine receives control when an IMS application abends with an input message in process.

Table 99 shows the attributes of the Non-Discardable Messages exit routine.

Table 99. Non-Discardable Messages Exit Routine Attributes

Attribute	Description
IMS environments	DB/DC, DCCTL.
Naming convention	You must name this exit routine DFSNDMX0.
Binding	Follow the guidelines described in “Binding the Routines” on page 7. This exit routine must be reentrant. It executes in non-cross-memory mode.
Including the routine	If you write your own exit routine and plan to use IMS callable services, you must manually link edit the routine with DFSCSI00 and you must link the routine with IMS.SDFSRESL. The following example shows the required bind JCL statements. <pre>INCLUDE LOAD(DFSNDMX0) INCLUDE LOAD(DFSCSI00) ENTRY DFSNDMX0 NAME DFSNDMX0(R)</pre>
IMS callable services	To use callable services with this routine examine the value of the SXPLATOK field in the IMS standard user exit parameter list to see if a callable services token is passed to the routine. <ul style="list-style-type: none">• If SXPLATOK is zero, you cannot use callable services with this routine.• If SXPLATOK is non-zero, the callable services token is included, and you can use callable services. You can use the 256-byte work area addressed by SXPLAWRK in the standard user exit parameter list to call DFSCSIF0. See “IMS Standard User Exit Parameter List” on page 4 for more information on the standard user exit parameter list. See “IMS Callable Services” on page 10 for more information in IMS callable services.
Sample routine location	IMS.ADFSSMPL (member name DFSNDMX0). The mapping of the NDM interface block is available from the IMS library IMS.ADFSMAC (member name DFSNDM).

Restrictions

Not all destinations are valid alternates for input messages. If you use this exit routine to requeue messages to alternate destinations, see “Queue the Message to an Alternate Destination” for information on valid destinations.

Processing Options

The following sections describe the valid processing options for DFSNDMX0. If you request an option that is not valid, IMS ignores your request and continues normal processing (the default option).

Continue normal processing

Continue normal processing is the default option. Request this option by setting register 15 to zero before returning to IMS. IMS proceeds as if this exit routine had not been called.

Depending on the type of application abend that initiated the exit routine, IMS might delete the message, issue a DFS555I message to the originating terminal and master terminal, and issue a DFS554A message to the master terminal.

Delete the Input Message from the System

Request this option by setting register 15 to 4 before returning to IMS. If you request this option, IMS does the following:

1. Issues a DFS555I message to the originating terminal (if possible) and to the master terminal
2. Deletes the input message from the system
3. Issues a DFS554A message to the master terminal

Queue the Message to the Suspend Queue

Request this option by setting register 15 to 8 before returning to IMS. If you request this option, IMS queues the input message to the suspend queue of the transaction that was being processed when the application abended. IMS suspends the transaction and, depending on the type of abend, might issue a DFS554A message to the master terminal.

Requeue the Input Message to the Original Transaction

Request this option by setting register 15 to 12 before returning to IMS. If you request this option, IMS queues the input message to the normal processing queue of the transaction that was being processed when the application abended. IMS USTOPs the transaction unless directed to do otherwise by the contents of NDMTRNST and, depending upon the type of abend, might issue a DFS554A message to the master terminal.

Queue the Message to an Alternate Destination

Request this option by setting register 15 to 16 before returning to IMS and placing a valid destination name in the NDMDEST field of the NDM interface block. Table 100 shows the valid destination types and how to specify them in NDMDEST.

Table 100. Valid Alternate Destinations

Alternate Destination	NDMDEST Value
LTERM	Specify a local, remote, or ETO LTERM, using the LTERM name or ETO user descriptor name.
OTMA	Specify the OTMA TPIPE name, or a name that is meaningful to the OTMA exit routines.

Table 100. Valid Alternate Destinations (continued)

Alternate Destination	NDMDEST Value
LU 6.2	Specify a local LU 6.2 device descriptor. The LU 6.2 device must be on the local IMS subsystem.
Transaction	<p>Specify a local or remote transaction code. The following transaction types are not valid destinations:</p> <ul style="list-style-type: none"> • Fast Path exclusive transaction. • Conversational transaction. • SAA communications-driven transaction (that is, a CPI-C driven transaction). <p>If you specify an invalid transaction type, IMS ignores the request and continues normal processing.</p>

If NDMDEST contains an invalid destination, such as zeros or blanks, IMS ignores the request to change the destination and continues normal processing.

If NDMDEST contains a destination that is unknown to IMS, processing depends on whether OTMA, and ETO or shared-queues are active.

With OTMA, and ETO or shared-queues active

IMS invokes the OTMA exit routines before invoking the Output Creation exit routine (DFSINSX0).

Without OTMA, ETO, or shared-queues

IMS ignores the request and continues normal processing.

When IMS requeues the input message to a valid destination, IMS completes the message processing as follows:

1. Issues a DFS550I message (succeeded version) to the master terminal
2. Issues a DFS555I message to the originating terminal (if possible) and to the master terminal
3. Deletes the input message from the abended transaction
4. Issues a DFS554A message to the master terminal

Related Reading:

- For more information on OTMA exit routines, see the following:
 - Chapter 49, “OTMA Destination Resolution Exit Routine (DFSYDRU0),” on page 341
 - Chapter 50, “OTMA Input/Output Edit Exit Routine (DFSYIOE0),” on page 345
 - Chapter 51, “OTMA Prerouting Exit Routine (DFSYPX0),” on page 349
 - *IMS Version 9: Open Transaction Manager Access Guide and Reference*
- For more information on DFSINSX0 and ETO, see the following:
 - Chapter 52, “Output Creation Exit Routine (DFSINSX0),” on page 353
 - *IMS Version 9: Administration Guide: Transaction Manager*
- For more information on shared-queues, see *IMS Version 9: Administration Guide: Transaction Manager*.

Communicating with IMS

This exit routine uses a parameter list, entry and exit registers, and the Non-Discardable Messages interface block (NDM) to communicate with IMS.

Contents of Registers on Entry

At entry, the exit routine must save all registers using the provided save area. The registers contain the following:

Register	Content
1	Address of the standard exit parameter list.
13	Address of a single standard z/OS save area.
14	Return address to IMS.
15	Entry point of this exit routine.

Standard User Exit Parameter List

This exit routine uses the Version 4 standard exit parameter list. See Table 3 on page 5 for the content of the Version 4 standard exit parameter list. The address of the work area passed to this exit routine in SXPLAWRK can be different each time that this exit routine is called.

NDM Interface Block

Table 101 shows the contents of the NDM interface block. The address of this parameter list is in the standard user exit parameter list (field name SXPLFSPL). The mapping of the NDM interface block is available from the IMS library IMS.ADFSMAAC (member name DFSNDM).

Related Reading:

- For more information on the LU 6.2 device description fields in the NDM interface block shown in Table 101, see *OS/390 V1R1 MVS Planning: APPC Management*.
- For more information on the OTMA description fields in the NDM interface block, see *IMS Version 9: Open Transaction Manager Access Guide and Reference*.

Table 101. NDM Interface Block

Field	Offset	Length	Content
NDMEYE	X'00'	4	NDM eye catcher.
NDMTRAN	X'04'	8	Transaction that the application was processing when it abended. This transaction is associated with the input message pointed to by NDMMSGA.
NDMPSBN	X'0C'	8	PSB associated with the application that abended.
NDMUSID	X'14'	8	User ID.
NDMGRPNM	X'1C'	8	Group name.
NDMUSIDI	X'24'	1	Indicator for contents of user ID field NDMUSID: U User ID L LTERM P PSB name O Other name

Table 101. NDM Interface Block (continued)

Field	Offset	Length	Content								
NDMSRCFL	X'25'	1	A flag that indicates the origin of the input message. This flag is set with one of the following values: <table border="0"> <thead> <tr> <th>Value</th> <th>Description</th> </tr> </thead> <tbody> <tr> <td>0</td> <td>NDMLTERM The source of the input message is an LTERM. Subsequent fields contain information about the LTERM.</td> </tr> <tr> <td>1</td> <td>NDMOTMA The source of the input message is OTMA. Subsequent fields contain information about the OTMA source.</td> </tr> <tr> <td>2</td> <td>NDMLU62 The source of the input message is an LU 6.2 device. Subsequent fields contain information about the LU 6.2 device.</td> </tr> </tbody> </table>	Value	Description	0	NDMLTERM The source of the input message is an LTERM. Subsequent fields contain information about the LTERM.	1	NDMOTMA The source of the input message is OTMA. Subsequent fields contain information about the OTMA source.	2	NDMLU62 The source of the input message is an LU 6.2 device. Subsequent fields contain information about the LU 6.2 device.
Value	Description										
0	NDMLTERM The source of the input message is an LTERM. Subsequent fields contain information about the LTERM.										
1	NDMOTMA The source of the input message is OTMA. Subsequent fields contain information about the OTMA source.										
2	NDMLU62 The source of the input message is an LU 6.2 device. Subsequent fields contain information about the LU 6.2 device.										
NDMSRCIN	X'26'	1	Start of source description.								
NDMLTERM	X'26'	8	Name of the originating LTERM if NDMSRCFL is set to NDMLTERM (value 0).								
NDMTPIPE	X'26'	8	OTMA TPIPE name if NDMSRCFL is set to NDMOTMA (value 1).								
NDMMEM	X'2E'	16	OTMA member name.								
NDMTPSYN	X'3E'	1	OTMA TPIPE synchronization level.								
NDMMGSYN	X'3F'	1	OTMA message synchronization level.								
NDMLUNM	X'26'	8	LU name if NDMSRCFL is set to NDMLU62 (value 2).								
NDMNWID	X'2E'	8	Network identifier.								
NDMSIDE	X'36'	8	APPC side information name.								
NDMMODE	X'3E'	8	VTAM mode table name.								
NDMTPNML	X'46'	2	Length of TP name contained in NDMTPNM.								
NDMTPNM	X'48'	64	TP name.								
NDMCONV	X'88'	1	APPC conversation type.								
NDMSYNC	X'89'	1	APPC synchronization level.								
	X'8A'	18	Reserved.								
NDMABEND	X'9C'	4	Abend code in system format 00sssuuu, where: <table border="0"> <tbody> <tr> <td>sss</td> <td>z/OS system abend code</td> </tr> <tr> <td>uuu</td> <td>IMS user abend code</td> </tr> </tbody> </table>	sss	z/OS system abend code	uuu	IMS user abend code				
sss	z/OS system abend code										
uuu	IMS user abend code										
NDMTSLCL	X'A0'	8	The local time stamp of the arrival of the input message in the system. NDMTSLCL contains the two fields NDMDLCL and NDMTLCL.								

Table 101. NDM Interface Block (continued)

Field	Offset	Length	Content
NDMDLCL	X'A0'	4	<p>The local date that the message arrived in the system. The date format is YYYYDDdf, where:</p> <p>YYYY Year</p> <p>DDD Julian day</p> <p>f X'F'</p>
NDMTLCL	X'A4'	4	<p>The local time that the message arrived in the system. The time format is HHMMSSf, where:</p> <p>HH Hour</p> <p>MM Minutes</p> <p>SS Seconds</p> <p>T Tenths of the second</p> <p>f X'F'</p>
NDMTSUTC	X'A8'	12	<p>The UTC time stamp of the arrival of the input message in the system. The time-stamp format is the following:</p> <p>Year/day YYYYDDdf</p> <p>Time HHMMSSThmi.ju</p> <p>Offset Aqq\$</p> <p>The time-stamp fields include the following:</p> <p>YYYY Year</p> <p>DDD Julian day</p> <p>f X'F'</p> <p>HH Hour</p> <p>MM Minutes</p> <p>SS Seconds</p> <p>T Tenths of the second</p> <p>H Hundredths of the second</p> <p>m Milliseconds</p> <p>i Tenths of a millisecond</p> <p>j Hundredths of a millisecond</p> <p>u Microseconds</p> <p>A Attribute of the time value</p> <p>qq Quarter-hours of offset from UTC</p> <p>\$ Decimal sign for the offset, either positive (X'C') or negative (X'D')</p>

Table 101. NDM Interface Block (continued)

Field	Offset	Length	Content
NDMSPAA	X'B4'	4	<p>Address of the SPA if the transaction in NDMTRAN is a conversational transaction. Otherwise, this field contains zeros.</p> <p>If the SPA is present, the format is as follows: LL ZZZZ transaction_code data</p> <p>LL Two-byte length field that includes the length of LLZZZZ</p> <p>ZZZZ Four-byte field that always contains zeros</p> <p>transaction_code Eight-byte field that contains the transaction code for the conversation or blanks</p> <p>data SPA user data</p>
NDMMSGGA	X'B8'	4	<p>Address of the input message. The message format is as follows: LL ZZ message-segment</p> <p>LL Two-byte length field that includes the length of LLZZ</p> <p>ZZ Two-byte field that always contains zeros, except for the last message segment which contains X'FFFF'</p> <p>message-segment input</p> <p>message segment</p> <p>For a single-segment message: LL=NDMMSGGL and ZZ=X'FFFF'</p> <p>For a multi-segment message, the pattern is:</p> <ul style="list-style-type: none"> • NDMMSGGA=address of first segment • NDMMSGGA+LL=address of second segment • NDMMSGGA+LL+LL= address of third segment
NDMMSGGL	X'BC'	4	Total length of input message
	X'C0'	24	Reserved

Table 101. NDM Interface Block (continued)

Field	Offset	Length	Content								
NDMTRNST	X'D8'	4	Transaction status flag. DFSNDMX0 can set this field to any one of the following values. IMS examines this field upon return from DFSNDMX0. <table border="1"> <thead> <tr> <th>Value</th> <th>Description</th> </tr> </thead> <tbody> <tr> <td></td> <td>Do not (U)STOP the abended transaction and do not STOP the abended program.</td> </tr> <tr> <td>2</td> <td>Do not send the DFS555I message.</td> </tr> <tr> <td>3</td> <td>Do not (U)STOP the abended transaction and do not STOP the abended program, <i>and</i>, do not send the DFS555I message.</td> </tr> </tbody> </table>	Value	Description		Do not (U)STOP the abended transaction and do not STOP the abended program.	2	Do not send the DFS555I message.	3	Do not (U)STOP the abended transaction and do not STOP the abended program, <i>and</i> , do not send the DFS555I message.
Value	Description										
	Do not (U)STOP the abended transaction and do not STOP the abended program.										
2	Do not send the DFS555I message.										
3	Do not (U)STOP the abended transaction and do not STOP the abended program, <i>and</i> , do not send the DFS555I message.										
NDMDEST	X'DC'	8	Name of the alternate destination to which the input message is to be queued. IMS only examines this field if you pass return code 16 in register 15. Otherwise, IMS ignores this field. See "Queue the Message to an Alternate Destination" on page 334 for more information on NDMDEST. See "Contents of Registers on Exit" for the valid return codes for register 15.								

Contents of Registers on Exit

Before returning to IMS, the exit routine must restore all registers except register 15, which must contain one of the following return codes:

Return Code	Meaning
0	Continue normal processing.
4	Delete the input message from the system.
8	Queue the input message to the suspend queue.
12	Requeue the input message to the original transaction.
16	Queue the message to an alternate destination that is named in the NDMDEST field in the NDM interface block.

Chapter 49. OTMA Destination Resolution Exit Routine (DFSYDRU0)

The OTMA Destination Resolution exit routine can determine and change the final destination of OTMA member names or translation pipe (Tpipe) names that are used for OTMA asynchronous output messages. This exit routine can also format the User Prefix section of an OTMA asynchronous output message.

In this Chapter:

- “About This Routine”
- “Communicating with IMS” on page 342

About This Routine

The following rules apply for this exit routine:

- This routine is optional.
- This routine is not called if the destination is an IMS scheduler message block (SMB) name.
- This routine cannot override the originating LTERM name.
- This routine can only set the final destination once.

If output is routed from one OTMA client to another, that client cannot use its own Destination Resolution exit routine to set a different final destination.

Recommendation: Within a shared-queues group, be sure that the DFSYDRU0 exit routine is the same for both front-end and back-end IMS systems. If these exit routines differ on one or more back-end IMS systems, asynchronous output might be sent to different destinations, depending on which back-end IMS system processed the input.

An OTMA client should not use a transaction name as a transaction pipe name (or routing key) because of potential conflict with the SMB name.

In a single IMS, multiple OTMA Destination Resolution exit routines are allowed.

IMS locates the OTMA Destination Resolution exit routine for an OTMA client by searching in the following places in the order listed:

1. The exit routine specified on the client-bid call
2. The OTMA descriptor
3. The default exit routine name, DFSYDRU0, if it exists

The exit routine specified on the client-bid call overrides the OTMA descriptor. The OTMA descriptor overrides the default exit routine name. If the default exit routine name does not exist, the OTMA Destination Resolution exit routine is not used.

Table 102 shows the attributes of the OTMA Destination Resolution exit routine.

Table 102. OTMA Destination Resolution Exit Routine Attributes

Attribute	Description
IMS environments	DB/DC, DCCTL.

Table 102. OTMA Destination Resolution Exit Routine Attributes (continued)

Attribute	Description
Naming convention	Different clients can have different exit routine names, or the clients can all use the default exit routine name of DFSYDRU0.
Binding	Follow the guidelines described in “Binding the Routines” on page 7. The OTMA Destination Resolution exit routine must be reentrant. The OTMA Destination Resolution exit routine must be included in an authorized library in the JOBLIB, STEPLIB, or LINKLIST library concatenated in front of the IMS.SDFSRESL. This exit routine is optional.
Including the routine	No special steps are required to include this routine.
IMS callable services	This exit routine is eligible to use IMS Callable Services.
Sample routine location	IMS.ADFSSMPL (member name DFSYDRU0).

Communicating with IMS

IMS uses the entry and exit registers, as well as parameter lists, to communicate with the exit routine.

Contents of Registers at Entry

At entry, the exit routine must save all registers using the provided save area. The registers contain the following:

Register	Contents
R1	Address of standard IMS user exit routine parameter list
R13	Save area address (points to a single SAVEAREA, not a SAVEAREA chain)
R14	Return address
R15	Entry point address

This exit routine uses the Version 4 standard exit parameter list. See Table 3 on page 5 for the content of the Version 4 standard exit parameter list. The address of the work area passed to this exit routine in SXPLAWRK can be different each time that this exit routine is called.

The following are the contents of the OTMA Destination Resolution exit routine parameter list. The address of this parameter list is in the standard exit parameter list field SXPLFSPL.

Offset	Contents						
+0	Name of the originating LTERM or OTMA transaction pipe						
+8	Destination name. If the destination is for OTMA and no Tpipe name is specified in the output area, this field is used as the name of the Tpipe to queue and deliver the output message.						
+16	Transaction name or program name						
+24	Flag Type						
	<table border="1"> <thead> <tr> <th>Flag</th> <th>Description</th> </tr> </thead> <tbody> <tr> <td>X'80'</td> <td>An OTMA prefix exists.</td> </tr> <tr> <td>X'40'</td> <td>The exit routine can override the client name.</td> </tr> </tbody> </table>	Flag	Description	X'80'	An OTMA prefix exists.	X'40'	The exit routine can override the client name.
Flag	Description						
X'80'	An OTMA prefix exists.						
X'40'	The exit routine can override the client name.						
+25	Synchronization level						

Offset	Contents
+26	Destination type
	Flag Description
	X'80' Transaction pipe exists for the client.
	X'40' LTERM exists in IMS (Legacy).
	X'20' LU 6.2 descriptor exists.
	X'10' ETO is available.
	X'08' Client is active.
	X'04' Tpipe trace is active.
+27	Reserved
+28	User ID
+36	Group name
+44	Name of the destination OTMA client
+60	Address of the PST block
+64	Name of the originating OTMA client, if the message originated from an OTMA client; otherwise zeros
+80	Address of the input Message Control Information prefix section of the OTMA message
+84	Address of the input State Data prefix section of the OTMA message
	Check the prefix flag in the Message Control Information section to determine the specific type of State Data section specified.
+88	Address of the input User Data prefix section of the OTMA message
	The area is also used to return new or modified user data, up to a maximum of 1024 bytes.
+92	Address of the SCD block
+96	Address of the output parameter list This parameter list is used to return information to IMS. The following are the contents of the output parameter list:
	Offset Contents
	+0 The 16 byte client override name, if any
	This field is used when the destination is a different OTMA client. A return code of 8 must also be set.
	+16 Output flag
	X'80' If this flag is set, a synchronized transaction pipe needs to be created. This flag can only be set if the return code is 0.
	However, if the OTMASP initialization parameter is set to Y in the DFSPBxxx PROCLIB member, the synchronized transaction pipe is always created.
	X'40' If this flag is set, it indicates that the message is persistent and a recoverable sequence number needs to be set. This is only valid if a synchronized transaction pipe is specified.
	+17 Reserved (3 bytes)
	+20 The 8-byte Tpipe name, if any. This field specifies the name of the Tpipe that is used for queuing and transmitting the output message. If it contains all blanks, the destination name is used for the Tpipe name. (This is only valid when return code is 0.)

Contents of Registers at Exit

Before returning to IMS, the exit routine must restore all registers, except register 15, which must contain one of the following return codes:

DFSYDRU0

Return Code	Meaning
0	Destination is the OTMA client transaction pipe.
4	Destination is a non-OTMA LTERM name.
8	Destination is a different OTMA client.
	The new client name must be stored in the DFSYDRU0 parameter list.
12	Destination is invalid.

Using the Sample OTMA Destination Resolution Exit Routine

A sample exit routine is provided. See the IMS.ADFSSMPL library; the member name is DFSYDRU0. For more information on this exit routine, see *WebSphere MQ for z/OS System Setup Guide*.

Error Conditions

An A1 status code will be returned to the application program when the following errors occur:

- Incorrect 16-byte OTMA client override name is specified. The client name cannot contain all blanks or zeroes. If the client name is shorter than 16 bytes, it must be padded with blanks.
- The length of modified OTMA user data is over 1K.
- Incorrect return code is specified for the exit.

Chapter 50. OTMA Input/Output Edit Exit Routine (DFSYIOE0)

The OTMA Input/Output Edit exit routine is provided to allow you to modify or cancel IMS Open Transaction Manager Access (OTMA) input and output messages. This exit routine can also format the User Prefix section of an OTMA input or output message.

In this Chapter:

- “About This Routine”
- “Communicating with IMS” on page 346

About This Routine

This exit routine can do the following for OTMA input and output messages:

- Modify the length or data of a message segment.
IMS sends the modified message once it receives control from the exit routine.
- Cancel a message segment.

Table 103. Canceling a Message Segment

Segment Being Canceled	IMS Sends
First	The full OTMA message prefix, with null data.
Last	The last segment, with null data.
Other	Nothing. IMS does not send the message segment.

- Cancel a message.

Table 104. Canceling a Message

Segment Being Canceled	IMS Sends
First	Nothing. IMS does not send the message, and returns a status code.
Other	The last segment, with null data. In the OTMA prefix, the “discard chain” flag is set.

The length of each message segment is limited to 32K bytes. If a message segment exceeds this limit, IMS issues message DFS1294E, and processes the message as follows:

Segment Being Processed	IMS Sends
First	The full OTMA message prefix, with null data.
Last	The last segment, with null data.
Other	Nothing. IMS does not send the message segment.

Table 105 on page 346 shows the attributes of the OTMA Input/Output edit exit routine.

Table 105. OTMA Input/Output Edit Exit Routine Attributes

Attribute	Description
IMS environments	DB/DC, DCCTL.
Naming convention	You must name this exit routine DFSYIOE0.
Binding	Follow the guidelines described in “Binding the Routines” on page 7. The OTMA Input/Output Edit exit routine must be reentrant. The OTMA Input/Output Edit exit routine must be included in an authorized library in the JOBLIB, STEPLIB, or LINKLIST library concatenated in front of the IMS.SDFSRESL. This exit routine is optional.
Including the routine	No special steps are required to include this routine.
IMS callable services	This exit routine is eligible to use IMS Callable Services.
Sample routine location	IMS.ADFSSMPL (member name DFSYIOE0).

Communicating with IMS

IMS uses the entry and exit registers, as well as parameter lists, to communicate with the exit routine.

Contents of Registers at Entry

At entry, the exit routine must save all registers using the provided save area. The registers contain the following:

Register	Contents
R1	Address of standard IMS user exit routine parameter list
R13	Save area address
R14	Return address
R15	Entry point address

This exit routine uses the Version 4 standard exit parameter list. See Table 3 on page 5 for the content of the Version 4 standard exit parameter list. The address of the work area passed to this exit routine in SXPLAWRK will be the same each time that this exit routine is called.

Function-Specific Parameter List on Entry

The following are the contents of the OTMA Input/Output Edit exit routine parameter list. The address of this parameter list is in standard exit parameter list field SXPLFSPL.

Offset	Contents
+0	Input/output flag. Set to 0 for an input message segment; set to 4 for an output message segment.
+1	Segment-type flag. Set to 0 for the first message segment; set to 4 for any other message segment.
+2	Reserved.

Offset	Contents
+4	Address of the message segment. The segment has the format LLZZDD:
	LL Total length (2 bytes)
	ZZ Flag (2 bytes). Z1 is reserved for IMS. The exit routine can change Z2.
	DD Message segment
	If the exit routine modifies the message segment, it must also modify the LL with the new segment length. For null segments, LL must be set to 4 (2 bytes for LL and 2 bytes for ZZ).
	The exit routine can increase any segment to a maximum of 256 bytes. The overall message, however, cannot exceed 32767 bytes (including the LL and ZZ fields). If a segment exceeds the 256-byte limit, IMS truncates it and issues message DFS1967.
+8	Address of the transaction code.
+12	Address of the OTMA transaction pipe name.
+16	Address of the XCF member name.
+20	Address of the user ID.
+24	Address of the OTMA user table, if any.
+28	Address of the message control region, available from input/output message prefix. This is an entry parameter only.
+32	Address of state data, available from input/output message prefix. This is an entry parameter only.
+36	Address of user data, available from input/output message prefix. This area can be used to return modified user data, but the length of user data cannot be changed.
	The format of the user data is:
	0-1 Length of the user data that follows (including this length field). This user exit cannot change the length of user data.
	2 User data.
+40	Address of the output parameter list.
	The output parameter list is used to return information to IMS and is defined as follows:
+00	8-byte LTERM override. This field is used to override the destination override specified in the state data.
+08	8-byte map name override. This field is used to override the map name specified in the state data.
+16	Reserved.
+44	Address of the SCD.

Contents of Registers at Exit

Before returning to IMS, the exit routine must restore all registers, except register 15, which must contain one of the following return codes:

Return Code	Meaning
0	Processing continues.
4	Discard the message segment.
8	Terminate processing for the transaction.
12	Destination is invalid.

Status AX will be returned to the application program and a 67D0 log record will be issued indicating error return code X'24'.

DFSYIOE0

IMS treats any return code other than 4 or 8 as if it were 0, and processing continues.

Chapter 51. OTMA Prerouting Exit Routine (DFSYPRX0)

The OTMA Prerouting exit routine determines whether an asynchronous output message needs to be routed to an OTMA destination or a non-OTMA destination. If the message should be routed to an OTMA destination, the OTMA Destination Resolution exit routine can then determine the final OTMA destination client or Tpipe.

Related Reading: For more information on setting OTMA destinations, see Chapter 49, “OTMA Destination Resolution Exit Routine (DFSYDRU0),” on page 341.

In this Chapter:

- “About This Routine”
- “Communicating with IMS” on page 350

About This Routine

The following rules apply for this exit routine:

- This routine is optional, and can be written so that IMS data is not prerouted.
- If the destination name is an IMS scheduler message block (SMB) name, this routine cannot change it.
- Transaction output can be directed to an OTMA client, even if the transaction originated from a non-OTMA source.
- Transaction output can be directed to a non-OTMA destination, even if the transaction originated from an OTMA client.

Recommendation: Within a shared-queues group, be sure that the DFSYPRX0 exit routine is the same for both front-end and back-end IMS systems. If these exit routines differ on one or more back-end IMS systems, asynchronous output might be sent to different destinations, depending on which back-end IMS system processed the input.

In an IMS subsystem, only one OTMA Prerouting exit routine is allowed.

Table 106 shows the attributes of the OTMA Prerouting exit routine.

Table 106. OTMA Prerouting Exit Routine Attributes

Attribute	Description
IMS environments	DB/DC, DCCTL.
Naming convention	You must name this exit routine DFSYPRX0.
Link editing	Follow the guidelines described in “Binding the Routines” on page 7. The OTMA Prerouting exit routine must be reentrant. The OTMA Prerouting exit routine must be included in an authorized library in the JOBLIB, STEPLIB, or LINKLIST library concatenated in front of the IMS.SDFSRESL. This exit routine is optional.
Including the routine	No special steps are required to include this routine.
IMS callable services	This exit routine is eligible to use IMS Callable Services.
Sample routine location	IMS.ADFSSMPL (member name DFSYPRX0).

Communicating with IMS

IMS uses the entry and exit registers, as well as parameter lists, to communicate with the exit routine.

Contents of Registers at Entry

At entry, the exit routine must save all registers using the provided save area. The registers contain the following:

Register	Contents
R1	Address of standard IMS user exit routine parameter list
R13	Save area address (points to a single SAVEAREA, not a SAVEAREA chain)
R14	Return address
R15	Entry point address

This exit routine uses the Version 4 standard exit parameter list. See Table 3 on page 5 for the content of the Version 4 standard exit parameter list. The address of the work area passed to this exit routine in SXPLAWRK will be the same each time that this exit routine is called.

Function Specific Parameter List on Entry

The following are the contents of the OTMA Prerouting exit routine parameter list. The address of this parameter list is in standard exit parameter list field SXPLFSPL.

Table 107. Contents of the OTMA Prerouting Exit Routine Parameter List

Offset	Description
+0	Name of the originating LTERM or OTMA transaction pipe
+8	Destination name
+16	Transaction name or program name
+24	Flags <ul style="list-style-type: none"> • If the first flag (+24) is set, an input OTMA prefix exists.
+25	Synchronization level
+26	Reserved
+28	User ID
+36	Group name
+44	Address of the PST block
+48	Name of the originating OTMA client, if the message originated from an OTMA client; otherwise zeros
+64	Address of the input Message Control Information prefix section of the OTMA message
+68	Address of the input State Data prefix section of the OTMA message <p>Check the prefix flag in the Message Control Information section to determine the specific type of State Data section specified.</p>
+72	Address of the input User Data prefix section of the OTMA message
+76	Address of SCD control block

Table 107. Contents of the OTMA Prerouting Exit Routine Parameter List (continued)

Offset	Description
+80	<p>Address of the 16-byte client override name, if any, to be returned to IMS</p> <p>This field is set by IMS at entry. It points to a 16-byte buffer area to which the OTMA client name should be written, if one did not exist at entry. Do not alter this address.</p> <p>The OTMA client name is written when the transaction originates from a non-OTMA LTERM and is to be routed to an OTMA destination.</p> <p>If the transaction is invoked from an OTMA client and the OTMAMD initialization parameter is set to Y in the DFSPBxxx PROCLIB member, the client override name is accepted.</p>
+84	<p>Address of the 8-byte Tpipe override name, if any, to be used for OTMA output message queuing and transmission. If blank, this field is ignored.</p>

Contents of Registers at Exit

Before returning to IMS, the exit routine must restore all registers, except register 15, which must contain one of the following return codes:

Return Code	Meaning
0	Route output to current destination.
4	Route OTMA output to an OTMA destinations, and route non-OTMA output to non-OTMA destinations. OTMA should process the message.
8	If the transaction was entered from a non-OTMA LTERM, the OTMA client name must be provided in the OTMA Prerouting exit routine parameter list. IMS (not OTMA) should process the message. The transaction was invoked from an OTMA TPIPE, but the destination is non-OTMA.

Using the Sample OTMA Prerouting Exit Routine

A sample exit routine is provided. See the IMS.ADFSSMPL library; the member name is DFSYPRX0. For more information on this exit routine, see *MQSeries for z/OS/ESA System Management Guide*.

Error Conditions

An A1 status code will be returned to the application program when the following errors occur:

- Incorrect 16-byte OTMA client override name is specified. The client name cannot contain all blanks or zeroes. If the client name is shorter than 16 bytes, it must be padded with blanks.
- Incorrect return code is specified for the exit.

DFSYPRX0

Chapter 52. Output Creation Exit Routine (DFSINSX0)

Using the Output Creation exit routine, you can validate both an unknown destination for a message and the creation of an unknown user. IMS calls the Output Creation exit routine under the following conditions:

- The Extended Terminal Option (ETO) feature is active (ETO=Y) and an LTERM (local or remote) that is needed to queue a message for a user does not exist. The exit routine is called to create LTERMs for terminals for which ETO is active. IMS creates the LTERM from information in the user descriptor or from information that the Output Creation exit routine supplies. (For more information on ETO, see *IMS Version 9: Administration Guide: Transaction Manager*.)
- The Extended Terminal Option (ETO) feature is active (ETO=Y), and the destination user to whom you want to assign an LTERM or USER does not exist. The user control block is created using the appropriate user descriptor. DFSUSER is used, unless your installation has defined a user descriptor for this user. IMS builds a complete user structure, including user and LTERM control blocks, based on the user descriptor definition. If an LTERM is not available (that is, it is already assigned to another user), the user is created with no LTERMs. LTERMs are added as a result of the /ASSIGN command used when creating the user.
- Shared-queues are active (SHAREDQ=*name*) and the destination for the message cannot be found on the local IMS subsystem. The exit routine identifies the message destination as a transaction, LTERM, or an invalid destination. (To identify the message as an LTERM, ETO must also be active, and all of the rules that apply to the exit routine for ETO also apply for LTERMs identified for shared-queues.) For valid transactions or LTERMs, IMS creates a resource block from information provided in the exit routine. Refer to “Using the Exit Routine with Shared-Queues” on page 356 for more information on using the exit routine with shared-queues.

In this Chapter:

- “About This Routine”
- “Communicating with IMS” on page 358

About This Routine

When ETO=Y, you can write the Output Creation exit routine to perform the following tasks:

- Supply queue data to create LTERMs. This data can override the queue data that the user descriptor provides. If the user descriptor chosen is DFSUSER, the exit routine can also supply queue data to add additional LTERMs to the structure.
- Provide the correct user ID for the user receiving messages, overriding the one derived from the LTERM name. This name is also used as the name of the user control block structure. If no user ID is supplied, the name of the user structure is the name of the target LTERM (the LTERM to which the message is destined).
- Supply autologon parameters such as LU name, user ID, logon descriptor name, and mode table name. IMS automatically allocates the user to the indicated node and attempts to establish a session with that node.

Related Reading: For more information, see “Providing Queue Data and Autologon Parameters” on page 355.

DFSINSX0

The Output Creation exit routine is optional, unless you provide the Signon exit routine (DFSSGNX0, described in Chapter 58, “Signon Exit Routine (DFSSGNX0),” on page 381) because these two exit routines are corequisite. If you provide one exit routine to supply queue data for additional LTERMs, you must provide the other exit routine also. They both create the user control block structure and related LTERMs (including multiple LTERMs for a user): DFSINSX0 using an LTERM name and DFSSGNX0 using the user ID. Both exit routines must contain the same logic so that the user structure is identical, regardless of which exit routine created it.

When SHAREDQ=*name*, you can write the exit routine to perform the following tasks:

- Supply a destination type for an output message when the shared-queues feature is active. The destination can be a transaction or an LTERM. IMS places the message on the appropriate shared queue.
- Supply transaction data to create transactions, such as whether the transaction is in conversational or response mode.

Table 108 shows the attributes of the Output Creation exit routine.

Table 108. Output Creation Exit Routine Attributes

Attribute	Description
IMS environments	DB/DC, DCCTL.
Naming convention	You must name this exit routine DFSINSX0.
Binding	Follow the guidelines described in “Binding the Routines” on page 7. This exit routine must be reentrant. The exit routine can be called in cross-memory mode.
Including the routine	If you want IMS to call the Output Creation exit routine, include it in an authorized library in the JOBLIB, STEPLIB, or LINKLIST library concatenated in front of the IMS.SDFSRESL. If the exit routine is included, IMS automatically loads it each time IMS is initialized if ETO=Y (after the Initialization exit routine, DFSINTX0, has changed the ETO= parameter) or if SHAREDQ= <i>name</i> .
IMS callable services	To use IMS Callable Services with this routine, you must do the following: <ul style="list-style-type: none">• Issue an initialization call (DFSCSI0) to obtain the Callable Service token and a parameter list in which to build the function-specific parameter list for the desired callable service. For details on using the initialization call, see “Step 2. Initializing IMS Callable Services (DFSCSI0)” on page 14.• Use the ECB found at offset 0 of the Output Creation exit routine parameter list for the DFSCSI0 call.• Link DFSCSI0 with your user exit.
Sample routine location	IMS.ADFSSMPL (member name DFSINSX0).

Restrictions

The Output Creation exit routine is not called during XRF tracking on an XRF alternate system.

Transaction control blocks created by the exit routine are not available for you to use in programming. These control blocks are used by IMS to place the transaction input message on the appropriate shared queue.

LTERM Processing for ETO

The following sections describe how the exit routine processing message for LTERMs when ETO=Y. See “Using the Exit Routine with Shared-Queues” on page 356 for information on transaction and LTERM processing for shared-queues.

Remote LTERM Creation for Multiple Systems Coupling

If Multiple Systems Coupling (MSC) is being used, the exit routine can request that a remote LTERM (RCNT) be built instead of a local ETO LTERM (CNT) if the destination of the message is an LTERM in a remote system. The exit routine supplies the associated MSC MSNAME and the remote LTERM name in field INSXMSN in the INSXDATA input parameter list. This name is a link name (MSNAME) rather than a descriptor name.

The MSNAME and remote LTERM input creates the RCNT, similar to if an MSC descriptor had been used. Do not change any other parameter values in the INSXDATA DSECT. The RCNT is assigned to the link name (LNB) representing the MSNAME.

Related Reading: For more information on MSC descriptors, see *IMS Version 9: Installation Volume 2: System Definition and Tailoring*.

Identifying Which User Descriptor IMS Selected

If the user control block structure already exists for the user for whom messages need queueing but for which the target LTERM is missing, IMS selects the user descriptor that was used to build the user structure and calls the exit routine.

Unlike the Signon exit routine, the Output Creation exit routine cannot return the address of a user descriptor. If no user control block structure exists, IMS searches for a descriptor that has the target LTERM defined. If IMS locates the target LTERM name, it selects that user descriptor and calls the Output Creation exit routine.

If IMS does not find a descriptor that contains the target LTERM name, it selects DFSUSER to create the user structure. IMS renames the descriptor, giving it the name of the target LTERM, and equates the user ID to this name. IMS then calls the Output Creation exit routine, which can supply the **correct** user ID, overriding the one derived from the target LTERM. If no user descriptor can be found, including DFSUSER, IMS rejects the LTERM creation request.

Providing Queue Data and Autologon Parameters

Depending on the user descriptor selected, the Output Creation exit routine can provide queue data (LTERM data) and autologon parameters. If the exit routine returns data that it is not allowed to return (as discussed in the following cases), IMS rejects the LTERM creation attempt.

There are two cases which describe what data the Output Creation exit routine can supply. The two cases are based on whether a DFSUSER (Case 1) or a non-DFSUSER (Case 2) descriptor is selected. (For this exit routine, non-DFSUSER descriptors are descriptors based on the target LTERM name.) Each case is discussed in the sections that follow. (For details on how your exit routine can supply this information, see “Contents of Registers on Exit” on page 359.)

If the Output Creation exit routine does not provide data to override the existing queue data, IMS proceeds as if you did not include the Output Creation exit routine; IMS uses the information in the selected user descriptor to create the LTERMs.

Case 1: If the DFSUSER descriptor is selected, the Output Creation exit routine:

- Can supply any of the fields defined in the interface (including LTERM names). The exit routine can change LTERM data, but not the actual name of the first LTERM provided.
- Can provide data for additional LTERMs.
- Can provide the correct user ID to override the user ID derived from the target LTERM.
- Can override autologon parameters. If the user structure already exists, the user's existing autologon parameters are not changed.

IMS verifies the additional LTERMs that are specified against the LTERMs that already exist in the system. If an LTERM that is specified as an additional LTERM already exists in the system, IMS assumes that this LTERM has been assigned to a different user, and it is not made part of the user structure of the user for which messages are queued.

Case 2: If a non-DFSUSER descriptor is selected, the Output Creation exit routine can only specify queue data to override data derived from the user descriptor. The exit routine:

- Can supply queue data (except LTERM names) to override data that the descriptor provides,
- Can override autologon parameters. If the user structure already exists, the user's existing autologon parameters are not changed.
- **Cannot** provide data for additional LTERMs or override the user ID.

IMS verifies the LTERMs specified in the descriptor against the LTERMs that already exist in the system. If an LTERM that is specified in the descriptor already exists in the system, IMS assumes that this LTERM has been assigned to a different user, and it is not made part of the user structure of the user for which messages are queued.

Using the Exit Routine with Shared-Queues

IMS calls the exit routine if shared-queues are active and the destination for the message is not found on the local subsystem. The exit routine determines the destination type for the message.

IMS uses the information returned by the exit routine to create a resource block for the destination. The resource control block can be an LTERM, or a transaction control block.

When the exit routine indicates that the destination is a transaction, IMS creates a transaction control block. DFSINSX0 returns information to IMS about the transaction, including whether the transaction is in conversational or response mode, and the SPA size if applicable. The transaction control block is not deleted until IMS restart. IMS can use the same transaction control block if it encounters additional instances of the undefined transaction input message.

Restriction: You cannot use the transaction control block for any purpose, such as scheduling the transaction to run in the local IMS subsystem. The transaction control block is only used by IMS to enqueue the input message on the appropriate shared queue.

Resource Control Block Creation

The resource control blocks created by the output creation process are shown in Table 109.

Table 109. Resource Blocks Created by the Output Creation Exit Routine

ETO Active	Shared-Queues Active	DFSINSX0 Included	Force Create (IOPCB)	ETO Descriptor Found ¹	Exit Routine Action
No	No				No control block created.
No	Yes	No			No control block created.
No	Yes	Yes	No		Transaction control block created.
No	Yes	Yes	Yes		No control block created.
Yes	No			No	No control block created.
Yes	No			Yes	LTERM created.
Yes	Yes	No		No	No control block created.
Yes	Yes	No		Yes	LTERM created.
Yes	Yes	Yes	No	No	Transaction control block created.
Yes	Yes	Yes	No	Yes (DFSUSER only)	LTERM or transaction control block created.
Yes	Yes	Yes	No	Yes (non-DFSUSER)	LTERM created.
Yes	Yes	Yes	Yes	No	No control block created.
Yes	Yes	Yes	Yes	Yes	LTERM created.

Notes:

1. ¹ Unless otherwise noted, the ETO descriptor can be any type of ETO user descriptor.

Communicating with IMS

IMS uses the entry and exit registers, as well as parameter lists, to communicate with the exit routine.

Contents of Registers on Entry

Upon entry, the exit routine must save all registers using the provided save area. The registers contain the following:

Register	Contents
R1	Address of Standard Exit Parameter List
R13	Save area address
R14	Return address to IMS
R15	Entry point address of exit routine

This exit routine uses the Version 1 standard exit parameter list. See Table 2 on page 5 for the content of the Version 1 standard exit parameter list.

Table 110 shows the Output Creation exit routine parameters. The address of this parameter list is in the standard exit parameter list field SXPLFSPL.

This parameter list is mapped by DSECT INSXMAIN, which can be found in the DFSINSXP macro.

Table 110. Output Creation Exit Parameter List

Offset	Length	Description
+0	4	ECB address.
+4	4	SCD address.
+8	4	User Table address.
+12	4	Address of a buffer for use by the exit routine to return user ID and queue data. The mapping of the buffer is DSECT USEQDATA in USEQDATA COPY. For additional details on the content and format, refer to the prolog in the sample routine (DFSINSX0 in IMS.ADFSSRC).

The value is zero for the following conditions:

- An XRF alternate system.
 - The destination must be a transaction and there is an indicator at offset +20. See Table 109 on page 357 for the conditions that indicate a transaction destination type.
-

Table 110. Output Creation Exit Parameter List (continued)

Offset	Length	Description
+16	4	<p>Address of a buffer for use by the exit routine to return Autologon Override parameters. The mapping of the buffer is DSECT ATLGPARM in DFSINSXP macro. For additional details on the content and format, refer to the prolog in the sample routine (DFSINSX0 in IMS.ADFSSRC).</p> <p>The value is zero for the following conditions:</p> <ul style="list-style-type: none"> • An XRF alternate system. • The destination must be a transaction and there is an indicator at offset +20. See Table 109 on page 357 for the conditions that indicate a transaction destination type.
+20	4	<p>Address of a buffer containing destination name, and other environment flags, including indicators for the following:</p> <ul style="list-style-type: none"> • ETO or shared-queues is enabled. • LTERMs or transaction control blocks can be created. • The exit routine output is an LTERM or a transaction control block. <p>The mapping of the buffer is DSECT INSXDATA in DFSINSXP macro.</p>
+24	4	<p>Address of a buffer for use by the exit routine. The mapping of the buffer is DSECT INSXTRNQ in DFSINSXP macro. The buffer returns information that is used to create a transaction control block if the destination is a transaction. The value is zero if the destination is an LTERM. See Table 109 on page 357 for the conditions that indicate a transaction destination type.</p>

Contents of Registers on Exit

Before returning to IMS, the exit routine must restore all registers except for register 15, which contains one of the following return codes. If an application INSERT call forced the LTERM creation, IMS ignores the return code.

Return Code Meaning

0	IMS creates the destination.
nonzero	IMS rejects the destination creation attempt for alternate PCBs. If an application INSERT call caused IMS to attempt the destination creation, the nonzero return code is returned to the application as an 'A1' status code. I/O PCBs force LTERM creation and ignore the return code.

In addition to the return codes, the exit routine can indicate whether to create an LTERM or a transaction control block (INSXTYPE in INSXDATA dsect).

Chapter 53. Physical Terminal (Input) Edit Routine (DFSPIXT0)

This chapter describes the Physical Terminal (Input) Edit routine. This user-written edit routine gains control before the IMS Basic Edit routine. If the input message is processed by MFS, the Physical Terminal (Input) edit routine is not called. This edit routine is called only when inserted from a terminal; it is not called when the message is inserted by a program-to-program switch. This edit routine is not called for LU 6.2 terminal input.

In this Chapter:

- “About This Routine”
- “Communicating with IMS” on page 363
- “Using the Sample Physical Terminal Input Edit Routine (DFSPIXT0)” on page 364

About This Routine

Message segments are passed one at a time to the Physical Terminal Input edit routine, and the edit routine can handle them in one of the following ways:

- Accept the segment and release it for further editing by the IMS basic edit routine.
- Modify the segment and release it for further editing by the IMS basic edit routine. Examples of segment modifications that can be made are changing the transaction code and reformatting the message text. Make any required modifications, because IMS has not yet performed destination or security checking.
- Cancel the segment.
- Cancel the message and request that the terminal operator be notified accordingly.
- Cancel the message and request that a specific message from the User Message Table be sent to the terminal operator.

The Physical Terminal Input edit routine requests these actions by specifying different return codes that are interpreted and acted upon by IMS.

Table 111 shows the attributes of Physical Terminal (Input) edit routine.

Table 111. Physical Terminal (Input) Edit Routine Attributes

Attribute	Description
IMS environments	DB/DC, DCCTL.
Naming convention	You must provide 1-byte to 8-byte name.
Binding	Follow the guidelines described in “Binding the Routines” on page 7. This routine must be reentrant.
Including the routine	If you want IMS to call the exit, include it in an authorized library in the JOBLIB, STEPLIB, or LINKLIST library concatenated in front of the IMS.RESLIB. If the exit routine is included, IMS automatically loads it each time IMS is initialized.

Table 111. Physical Terminal (Input) Edit Routine Attributes (continued)

Attribute	Description
IMS callable services	To use IMS Callable Services with this routine, you must issue an initialization call (DFSCSI0) to obtain the Callable Service token and a parameter list in which to build the function-specific parameter list for the desired callable service. Use the ECB found in register 9 for the DFSCSI0 call. Related Reading: For details on using the initialization call, see “Step 2. Initializing IMS Callable Services (DFSCSI0)” on page 14. This exit is automatically linked to DFSCSI00 by IMS. No additional linking is required to use IMS Callable Services.
Sample routine location	IMS.ADFSSRC.

Bypassing Basic Edit

If the IMS application program supplies DFS.EDTN in the MOD name parameter for the output message, the IMS basic edit routine will be bypassed except for transaction code and password validation.

Related Reading: For further information, see “MFS Bypass for the 3270 or SLU 2” in the “Application Programming Using MFS” chapter in *IMS Version 9: Application Programming: Transaction Manager*.

The Physical Terminal Input edit routine must position the transaction code, and optionally the password, if the terminal is not operating in conversational or preset destination mode. The exit routine should detect errors and return a message to the terminal operator if any errors are found.

IMS maintains a flag in the CTB (bit CTB6TRNI in the CTBFLAG6 field) to indicate when 3270 MFS bypass, nonconversational, no preset destination, and first segment exist upon input to the Physical Terminal Input exit routine. This flag notifies the Physical Terminal Input exit routine that it can add a minimum of 1 and a maximum of 18 bytes to the front of the message segment for a transaction code and optional password. The minimum of 1 byte to be added to the front of the message segment consists of a 1-byte transaction code. If NOBLANK is not specified at system definition, a minimum of 2 bytes is added to the front of the message segment, consisting of a 1-byte transaction code and 1 blank, which is necessary as a separator. To add a transaction code and optional password, the exit routine can put a return code of 16 in register 15 and set register 1 to point to an LLZZ field, followed by the data to be added.

Specifying the Routine

The Physical Terminal Input exit routine (DFSPIXT0) is specified on the LINEGRP or TYPE macros as part of the EDIT= parameter. If you are using **both** the Physical Terminal Input and Output edit routines, you must specify (YES,YES) on the EDIT= parameter of the TERMINAL macro or Extended Terminal Option (ETO) logon descriptor.

The CSECT name for this edit routine is the name specified in the TYPE or LINEGRP macro statement for which this edit routine applies. You must also specify YES in the EDIT= parameter of the TERMINAL macro statement or ETO logon descriptor.

The Global Physical Terminal Input edit routine (DFSGPIX0) performs the same functions as this edit routine but does not require system definition.

Related Reading:

For information on coding the LINEGRP, TYPE, and TERMINAL macros, see *IMS Version 9: Installation Volume 2: System Definition and Tailoring*.

For more information on the ETO feature, see *IMS Version 9: Administration Guide: Transaction Manager*.

For more information on this edit routine, see Chapter 37, "Global Physical Terminal (Input) Edit Routine (DFSGPIX0)," on page 279.

Communicating with IMS

IMS uses the entry and exit registers to communicate with the exit routine.

Contents of Registers on Entry

Upon entry to the edit routine, all registers must be saved using the save area provided. The registers contain the following:

Register	Contents
1	Address of the input message segment buffer. IMS editing has not been performed. The first two bytes of the buffer contain the segment length (binary length includes the 4-byte overhead). The third and fourth bytes of the buffer are binary zeros. The message text begins in the fifth byte of the buffer. If the device was defined with MFS support but this message is not being processed by MFS, the first segment of the message has backspace error correction performed before entry to this edit routine. If escape (**) was entered by the terminal operator, the first two data bytes have been changed to binary zeros.
7	Address of CTB for the physical terminal from which the message was entered.
9	Address of CLB for the physical terminal from which the message was entered.
13	Address of save area. The first three words must not be changed.
14	Return address to IMS.
15	Entry point of edit routine.

The edit routine you supply can edit the message segment in the buffer pointed to by register 1.

You can reduce the length of the message segment to any size by replacing the length in the buffer with the appropriate value. The length field must appear in the same place at exit as at entry, and bytes 3 and 4 must not be changed.

Contents of Registers on Exit

Upon return to IMS, all registers must be restored except for register 1, which contains a message number if register 15 contains a value of 12; otherwise it is ignored. Register 15 contains one of the following return codes:

Return Code	Meaning
00	Segment is processed normally.
04	Segment is canceled.

DFSPIXT0

Return Code	Meaning
-------------	---------

08	Message is canceled and the terminal operator is notified.
12	Message is canceled, and the message identified by register 1 is sent to the terminal.
16	Insert the transaction code and optional password following the LLZZ pointed to by register 1. This return code is only valid for 3270 MFS bypass terminals.

When the entering terminal is not a 3270 MFS bypass terminal, and the physical terminal input exit gives a return code of 16, IMS issues an error message, and the transaction code is not inserted in the message.

Any other return code causes the message to be canceled and the terminal operator to be notified.

Using the Sample Physical Terminal Input Edit Routine (DFSPIXT0)

This routine performs the following functions:

- Scans the input message segment for an expected format (TESTEXIT)
- Generates return codes (XX) based on the input request (TESTEXIT,XX)
- Verifies the user message number (YYY) if specified (TESTEXIT,XX,YYY)
- Replaces TESTEXIT with ERROR if return code or message number is invalid and passes the segment to IMS (return code 0)

Chapter 54. Physical Terminal (Output) Edit Routine (DFSCCTO0)

This chapter describes the Physical Terminal (Output) edit routine.

In this Chapter:

- “About This Routine”
- “Communicating with IMS” on page 366
- “Using the Sample Physical Terminal Output Edit Routine (DFSCCTO0)” on page 368

About This Routine

The Physical Terminal (Output) edit routine enables you to edit output messages immediately before they are sent to a terminal. During system definition, you specify which physical terminals or set of VTAM nodes use the defined edit routine for output editing. You can specify one Physical Terminal (Output) edit routine for each BTAM telecommunication line group. You can use these edit routines to meet your special editing needs associated with different communication terminals.

An output message can be processed by 1) a Physical Terminal Output edit routine and the IMS Basic Edit routine or 2) a Physical Terminal Output edit routine and MFS (Message Format Service). Output editing is performed in this sequence. Therefore, the input to the edit routine is the output of the application program, and the output of the edit routine is the input to MFS or the IMS Basic Edit routine.

You can also specify that this edit routine cancel an output message so that it is not delivered to the terminal. Instead, the routine can optionally request that an error message be sent in place of the canceled message.

The following criteria apply to message cancellation:

- Output messages can be canceled if they are destined for VTAM terminals only. Requests to cancel a message to a BTAM terminal are ignored by IMS (for example, if an LTERM is reassigned from a VTAM to a BTAM terminal, IMS ignores requests to cancel an output message).
- Conversational output and IMS in-core system messages cannot be canceled. Such cancellation requests from the exit are ignored, and the output message is sent.
- The request to cancel must be made for the first segment of a message. Requests for non-first segments of a message to be canceled are ignored, causing normal output processing to continue for the message.
- This routine is not activated for messages going across an MSC VTAM link, so these messages cannot be canceled.

Table 112 shows the attributes of the Physical Terminal (Output) edit routine.

Table 112. Physical Terminal (Output) Edit Routine Attributes

Attribute	Description
IMS environments	DB/DC, DCCTL.
Naming convention	You must provide a 1-byte to 8-byte name.

Table 112. Physical Terminal (Output) Edit Routine Attributes (continued)

Attribute	Description
Binding	Follow the guidelines described in “Binding the Routines” on page 7. This routine must be reentrant.
Including the routine	If you want IMS to call the exit, include it in an authorized library in the JOBLIB, STEPLIB, or LINKLIST library concatenated in front of IMS.SDFSRESL. If the exit routine is included, IMS automatically loads it each time IMS is initialized.
IMS callable services	To use IMS Callable Services with this routine, you must issue an initialization call (DFSCSI0) to obtain the Callable Service token and a parameter list in which to build the function-specific parameter list for the desired callable service. Use the ECB found in register 9 for the DFSCSI0 call. Related Reading: For details on using the initialization call, see “Step 2. Initializing IMS Callable Services (DFSCSI0)” on page 14. If this exit routine is used exclusively by static terminals, this exit is included in the IMS nucleus and is therefore automatically linked to DFSCSI00 by IMS. No additional linking is required to use IMS Callable Services. If this exit routine is used exclusively by ETO terminals, this exit must exist standalone in SDFSRESL and an additional link is required to use IMS Callable Services. For information about linking to IMS Callable Services, see “Step 1: Linking Your Exit Routine to DFSCSI00” on page 13. If you do not perform this additional link, the IMS control region will abnormally terminate with a SOC1 code. If this exit routine is used by both static and ETO terminals, then this exit is automatically linked to DFSCSI00 in the same manner as exits that are used by only static terminals.
Sample routine location	IMS.ADFSSRC.

Specifying the Routine

The Physical Terminal Output edit routine (DFSCCT00) is specified on the LINEGRP or TYPE macro as part of the EDIT= parameter. If you are using **both** the Physical Terminal Input and Output edit routines, you must specify (YES,YES) on the EDIT= parameter of the TERMINAL macro.

Related Reading: For information on coding the LINEGRP, TYPE, and TERMINAL macros, see the section on “Macros” in *IMS Version 9: Installation Volume 2: System Definition and Tailoring*.

Communicating with IMS

IMS uses the entry and exit registers to communicate with the exit routine.

Contents of Registers on Entry

Upon entry, the edit routine must save all registers using the provided save area. The registers contain the following:

Register	Contents
1	<p>The address of a buffer containing the output message segment to be edited. The first two bytes are a binary count of the message segment length. The second two bytes are control information provided by the application program that constructed the message. The text of the output message starts in byte 5. The count includes the first four bytes in length.</p> <p>This register contains zeros if flag CTBAEOM in field CTBACTL of the CTB is on, indicating end-of-message. Any exit that modifies the contents of the buffer passed in register 1 should test for an end-of-message condition.</p>
2	<p>The address of an 8-byte field that contains either binary zeros or the user ID associated with the output message. The contents of the user ID field are described in the <i>IMS Version 9: Application Programming: Database Manager</i> in the section on "I/O PCB Masks" in "Defining Application Program Elements".</p> <p>The user ID in the output message can be compared to the user ID in the CTB (CTBUSID) to determine editing requirements. The user ID is only checked on the first segment of a multisegment message. DFSCCT00 uses CTBAEOM and ENTSTAT to determine which segment is being processed.</p>
3	Address of storage area. For details of the format of this storage area, see the prolog in the sample routine (IMS.ADFSSRC; member name is DFSCCT00).
7	<p>CTB address for the destination terminal.</p> <p>CTBFLAGC field: CTBCDSDT bit <i>on</i> means that session restart has occurred for this terminal. If the edit routine is called with the CTBCDSDT on, the edit can assume that this is the first application output message selected for output processing since the session has restarted (provided that the bit is turned off by the edit routine after the first message is processed).</p> <p>IMS turns this bit on every time SDT (Start Data Traffic) for VTAM occurs. The edit routine is responsible for resetting this flag after it receives the first message.</p> <p>CTBFLAG4 field: CTB4RESP bit on means that the terminal is in response mode. After a system restart, IMS resets CTB4RESP.</p>
9	Address of CLB. This block starts with a DECB. The content of the DECAREA field in the DECB is equivalent to the content of register 1.
11	Address of SCD.
13	Address of save area. The edit routine must not change the first three words.
14	Return address to IMS.
15	Entry point of edit routine.

The output message segment that your edit routine returns to IMS from must be pointed to by the contents of the DECAREA field of the DECB. The first four bytes must be in a format as received at input with the binary count updated to the edited message segment length inclusive of the four bytes of prefix.

Contents of Registers on Exit (If No Cancel Request)

Before returning to IMS, the edit routine must restore all registers. If you are editing the message in place, you can increase its length by a **maximum** of ten bytes.

When the last segment of a message has been edited, IMS returns control to the routine. The routine has no new message data to edit.

Whenever a Physical Terminal Output edit routine is called, the CTB is in register 7. A 1-byte field, CTBACTK, in the CTB contains a 1 in the second bit position if this entry to the routine is for end of message (EOM).

Contents of Registers on Exit (If Cancel Request)

Upon return, registers must be restored except for register 15, which must contain the following return code.

Return Code	Meaning
0	Message canceled without error message DFS3489. The buffer length must be set to zero.
4	Message canceled. The buffer length must be set to zero.

All registers are not restored when a cancel request is made and the edit requests that IMS send an error message DFS3489 to the terminal for a non-response-mode message.

In order for IMS to cancel an output message before it is sent to the terminal, the Physical Terminal Output edit routine must make a request when the first segment of an output message is presented to it. The edit makes this request by setting the length of the first segment to zero in the buffer pointed to by DECAREA.

If the edit routine wants IMS to send error message DFS3489 in place of the canceled message, it places a return code of 4 in register 15 (in addition to zeroing the length field of the first segment).

If the terminal is in response mode, IMS always replaces the canceled message with error message DFS3489. Across a system restart, response mode is reset. Therefore, if an output message is canceled after the system restart, no error message is sent.

If the terminal is not in response mode, the edit routine is not required to have IMS send error message DFS3489. Nevertheless, it might be necessary to have IMS send the error message to prevent a hang condition for certain device types that are expecting a message.

Related Reading: For an explanation of error message DFS3489, see *IMS Version 9: Messages and Codes, Volume 2*.

Using the Sample Physical Terminal Output Edit Routine (DFSCCT00)

The sample example shows how to extend an output message and how to attach a prefix. IMS Callable Services are used to get and release storage. This example applies to single-segment or multisegment messages, and to as many devices as the edit routine's table is assembled to handle. The default table size allows for five devices, but can be changed by modifying the label NUMENTS. If the table capacity is exceeded, an ABENDU55 results. If the prefix had not increased the message length by more than ten bytes, it could have been attached without the creation of an additional buffer area.

Chapter 55. Queue Space Notification Exit Routine (DFSQSPC0/DFSQSSP0)

The Queue Space Notification exit routine (DFSQSPC0) is activated when a logical record is assigned to or released from a message queue data set. This routine causes a message to be issued when one of the following occurs:

- The number of records currently in use exceeds the upper threshold percentage value of the maximum number assignable before initiation of automatic shutdown.
- The number of records currently in use falls below the lower threshold percentage value of the same maximum.

IMS sets an upper threshold value of 75 percent, and a lower threshold value of 60 percent. You can modify these values using the QTU and QTL parameters of the IMS procedure.

Related Reading: For details on these parameters, see *IMS Version 9: Installation Volume 2: System Definition and Tailoring*.

QTU has a range of 2 percent through 100 percent, and QTL has a range of 1 percent through 99 percent.

In a shared-queues environment the Queue Space Notification exit routine is DFSQSSP0. The following information is passed when this exit routine runs.

- The shared queue structure is in an overflow state.
- The destination queue in a shared-queues environment is in an overflow state.

The following topics provide additional information:

- “About This Routine”
- “Communicating with IMS” on page 372

About This Routine

The SHUTDWN parameter of the MSGQUEUE macro allows you to reserve a number of records in each message queue data set. If the data set fills up with unprocessed messages, one of the following occurs:

- The system automatically shuts down with an internal CHECKPOINT DUMPQ.
- In a shared-queues environment the system automatically shuts down with a CHECKPOINT FREEZE.

If unprocessed messages overflow a message queue data set before the automatic shutdown completes, a U0758 abend occurs.

This exit routine provides a warning before the automatic shutdown is initiated, so you can reduce message queue buildup, possibly avoiding the automatic shutdown and, most importantly, the U0758 abend.

You can replace the IMS-supplied exit routine with your own to establish your own threshold algorithm or issue user messages, which can then be captured by the AOI exit routine to reduce queue usage.

As an option, for certain units of work, you can modify this exit to find the number of records currently in use by the calling task. You can also request information that

can be used to terminate the unit of work. For each application, LU 6.2 conversation, or OTMA session, IMS maintains counts of short and long message queue records (DRRNs) assigned, and supplies them to DFSQSPC0/DFSQSSP0 if this option is used.

If you use this option, the expanded parameter list contains an output field that allows you to tell IMS that you want the unit of work stopped because one or both of the counts have exceeded specified limits. Different count limits can be established for different tasks.

For most program types, the record counts are reset when one of the following occurs:

- A message is retrieved (GU call) from the message queues.
- A sync point occurs.
- A rollback occurs.
- The application terminates normally.

Exception: For non-message-driven BMPs, and for multiple-mode transactions (MODE=MULT specified on the TRANSACT macro), the queue counts are not reset until normal termination. If the unit of work is a DC transaction or conversation the counts are not provided.

For LU 6.2 conversations, the record counts are reset for each new message.

For OTMA sessions, the record counts are reset:

- For each new incoming message.
- For each IMS conversational iteration.
- When MSC remote output is received at the original IMS. The original IMS will then deliver the output to the OTMA client.

The exit routine terminates a unit of work in the following ways:

- For an application program, an 'A7' status code is returned to the application. If the AIBTDLI call interface was used, the application also gets an AIB return code (X'104') and a reason code (X'190'). If the application tries to insert a message after the unit of work terminates or to a destination that is stopped, the application immediately receives an 'A7' status code and the call is not processed.
- For an LU 6.2 conversation, message DFS0777I is sent and the conversation is deallocated.
- For an OTMA session, message DFS1289I is sent.

After the unit of work terminates, message queue records in use are released.

The sample exit routine DFSQSPC0/DFSQSSP0 (IMS.ADFSSRC) describes how to enable this option. Using this option creates some additional overhead from building the expanded parameter list. The default for this option is NO.

Table 113 shows the attributes of the Queue Space Notification exit routine.

Table 113. Queue Space Notification Exit Routine Attributes

Attribute	Description
IMS environments	DB/DC, DCCTL.

Table 113. Queue Space Notification Exit Routine Attributes (continued)

Attribute	Description
Naming convention	You must name this exit routine DFSQSPC0 (or DFSQSSP0 for shared-queues).
Binding	<p>Follow the guidelines described in “Binding the Routines” on page 7.</p> <p>This routine must be reentrant. It can be called in cross-memory mode.</p> <p>DFSCSI00 (Callable Services module) must be included in this load module if you plan to use IMS Callable Services from this exit routine. An example of the bind control statements is:</p> <pre> INCLUDE LOAD(DFSQSPC0) SPACE NOTIFY USER EXIT INCLUDE LOAD(DFSCSI00) IMS CALLABLE SERVICES MODE AMODE(31),RMODE(ANY) ENTRY DFSQSPC0 NAME DFSQSPC0(R) </pre>
Including the routine	DFSQSPC0 is a separately linked composite module in the IMS.SDFSRESL. If you write your own exit routine, it must be linked into IMS.SDFSRESL.
IMS callable services	<p>To use callable services with this routine, you must issue an initialization call (DFSCSI0) to obtain the callable service token and a parameter list in which to build the function-specific parameter list for the desired callable service. For details on using the initialization call, see “Step 2. Initializing IMS Callable Services (DFSCSI0)” on page 14.</p> <p>The IMS-provided version of DFSQSPC0/DFSQSSP0 includes an example that uses callable services to obtain working storage during an initialization call to DFSQSPC0/DFSQSSP0.</p> <p>Use the ECB passed in parameter list QSPCECB for IMS Callable Services.</p>
Sample routine location	<p>IMS.ADFSSRC (member name DFSQSPC0 or DFSQSSP0).</p> <p>The DFSPARM macro is in IMS.ADFSMAC (member name DFSPARM).</p>

Restrictions

The following restrictions apply to DFSQSPC0/DFSQSSP0:

- z/OS services are unavailable to programs running in cross-memory mode unless the service’s documentation specifically states that it is available.
- Code running in cross-memory mode cannot issue any SVCs except ABEND.

Because this exit is called every time a message queue data set record is assigned or released, the logic you add to this exit can have a negative effect on system performance. IWAITS, time consuming algorithms, and excessive use of IMS Callable Services should be avoided.

If you want to issue user messages instead of IMS system messages DFS2013 through DFS2018, you must provide an exit which returns user message keys in register 15. The value returned in register 15 is actually the negative of the key in the user message table. In addition to returning the appropriate message key in register 15, be sure the message text is in the user-supplied message table, DFSCMTU0.

Related Reading: See Chapter 32, “User Message Table (DFSCMTU0),” on page 235 for information on creating and including a table.

Exit Routine Call Types

The following call types are recognized by the Queue Space Notification exit routine. Some of the parameters passed to the exit routine vary with the call type.

Call Type	Description
1	Initialization call
2	Application assigned DRRN (for example, a DL/I application)
3	LU 6.2 assigned DRRN
4	BTAM, VTAM DRRN ASSIGN CALL
5	Free the DRRN
6	OTMA assigned DRRN
7	MSC DRRN ASSIGN CALL

Communicating with IMS

The queue space notification exit routine is called whenever a logical record is assigned to or released from a message queue data set. A parameter list is passed to the exit routine. Its contents depend on whether the user-provided DFSQSPC0/DFSQSSP0 takes advantage of the optional capabilities provided by IMS. The IMS-provided DFSQSPC0/DFSQSSP0 does not use the optional capabilities, although it does describe how they can be used.

To take advantage of the optional capabilities, you must modify DFSQSPC0/DFSQSSP0 to recognize the initialization call type (Type 1) and, when the call is made, turn on the bit QSPCF2IN in the parameter list field QSPCFLG2. IMS responds to this flag being set by setting a flag in the SCD. The SCD flag tells IMS to support the new capabilities and provide the expanded parameter list to DFSQSPC0/DFSQSSP0. This call is made only during early IMS (Queue Manager) initialization to enable the user exit to obtain working storage that is always to be available to DFSQSPC0 through the parameter list.

User-provided versions of DFSQSPC0/DFSQSSP0 need not change if the message record count capability is not used.

The parameter list is mapped by the macro DFSPARM. The parameter list has five parts:

1. Message queue data set in-use count and threshold status
 - The number of records currently in use
The high-order byte of the in-use count is used as a flag byte.
 - The maximum number of records assignable before shutdown (not provided for shared-queues)
The exit routine interrogates these values and sets the parameter flag and a return code (register 15) based on their values. The return code is either zero or an error message number.
2. Pointers to control blocks and thresholds
These fields are always passed to DFSQSPC0/DFSQSSP0:
 - Address of the SCD control block
 - Address of the ECB (required for IMS Callable Services).
 - Address of user exit's workarea or zero
 - During the initialization call to DFSQSPC0/DFSQSSP0, you can use IMS Callable Services to obtain working storage for your exit. The address you store in the parameter list is saved by IMS and returned to your exit on

every call. IMS only saves the address returned by the exit during the initialization call. Addresses returned during other calls are overlaid by the address returned from the initialization call, or by zero if no address was returned.

- User-provided exit is responsible for obtaining the workarea during the initialization call to DFSQSPC0/DFSQSSP0 and storing its address in the parameter list.
 - Upper and lower threshold limits (Same values as found in SCDQTU and SCDQTL)
 - DFSQSSP0 is passed the same fields as DFSQSPC0, except for the upper and lower threshold limits.
3. Type of Call and other input/output flags
- The following fields are only used while processing Call Types: 1, 2, 3, 5, and 6. In all other cases, the Call Type is set to zero.

- Call type
- Assign/Free DRRN indicator
- Message Queue record count exceeded flag - set by exit

The following flags can be set if shared-queues are active (DFSQSSP0):

- Shared queue structure is in an overflow state.
- Destination queue is in an overflow state.

4. Unit of Work Information

These fields are only used while processing a DL/I (Call Type 2) application, an LU 6.2 (Call Type 3) terminal request, or an OTMA (Call Type 6) request:

- Accumulated counts of short and long message queue records assigned by this unit of work
- Identification of the unit of work making the call:
 - For a DL/I application: TRAN Name, PSB Name, and Terminal Symbolic
 - For an LU6.2 Terminal: LU Name, TP Name and length, Side Name
 - For an OTMA client: Tpipe name, XCF member name, and override LTERM name

5. Message destination name

The message destination name is used while processing Call types 2, 3, 5, and 6. If the destination name is not available at the time of the call, this field is set to zero.

The IMS-supplied Queue Space Notification exit routine found in IMS.ADFSSRC can be used as a guide in creating your own exit routine.

If you want to change the threshold notification algorithm, note the following interface requirements.

Contents of Registers on Entry

Upon entry, the exit routine must save all registers using the provided save area. The registers contain the following:

Register	Contents
0	Data set indicator:
00	QBLKS data set
04	SMSGQ data set
08	LMSGQ data set

DFSQSPC0

Register	Contents
2	Address of parameter list
9	Address of ECB
10	Address of SCD
14	Return address to IMS
15	Entry point of exit routine

Description of Parameters

The macro DFSPARM generates the DSECT for the parameter area passed to DFSQSPC0/DFSQSSP0 by IMS. For additional information, refer to DFSPARM included in IMS.ADFSMAC.

A pointer to the SCD is contained in the input field QSPCSCD as well as in Register 10.

Recommendation: It is recommended that you get addressability to the SCD from the parameter list in anticipation of a future release when Register 10 will no longer pass the SCD.

Contents of Registers on Exit

Before returning to IMS, the exit routine must restore all registers except for register 15, which must contain one of the following return codes:

Return Code	Meaning
0	No message issued
Message key	Queue Manager issues a message
Negative	User-defined message sent

Threshold Values

The parameter list fields QSPCQTU and QSPCQTL contain the upper and lower threshold values (DFSQSPC0 only).

The thresholds are either:

- IMS defaults (75 percent and 60 percent).
- Your default values specified in QTU and QTL in the DFSPBxxx member.
- QTU and QTL values specified in the IMS procedure. (See Chapter 1, "Guidelines for Writing IMS exit routines," on page 3.)

Chapter 56. Security Reverification Exit Routine (DFSCTSE0)

This chapter describes the Security Reverification exit routine (DFSCTSE0). This exit routine allows you to reevaluate transaction authorization checking on the DL/I CHNG Call. Transaction Manager applications that use Multiple System Coupling (MSC), CHNG calls, and AUTH calls on a remote IMS system can benefit from coding this exit routine. By coding this exit routine, you can avoid a security failure that occurs when RACF or a non-RACF security environment is called in a destination MSC system by a user that is not signed on to that particular IMS system.

IMS dynamically creates a security environment in a remote IMS backend system (or a local IMS system if the user has signed off) to accomplish the RACF authorization check. Therefore, you might not need to use this exit routine. You can control the creation of the security environment by using the DFSBSEX0 exit routine. IMS calls this routine, if available, to provide compatibility.

Related Reading: This exit routine can be written as part of the Transaction Authorization exit routine. See Chapter 64, “Transaction Authorization Exit Routine (DFSCTRN0),” on page 417 for more information.

The following topics provide additional information:

- “About This Routine”
- “Communicating with IMS” on page 376

About This Routine

This exit routine is an entry point in DFSCTRN0. If you do not code this entry point, IMS does not call it.

Table 114 shows the attributes of the Security Reverification exit routine.

Table 114. Security Reverification Exit Routine Attributes

Attribute	Description
IMS environments	DB/DC, DCCTL.
Naming convention	You must name this exit routine DFSCTSE0.
Binding	DFSCTSE0 must be link edited to DFSCTRN0, or coded as an explicit part of DFSCTRN0. If you code this entry point, it should have access to a table of valid user IDs, passwords, and transactions associated with each valid user ID, or contain some algorithm to derive this authorization information. For addressability, this table should reside in this module, in the /SIGN ON exit (DFSCSGN0), or in the IMS nucleus.
Including the routine	If DFSCTSE0 is link edited to DFSCTRN0, it is called upon return from DFSCTRN0. See “Communicating with IMS” on page 376 for more information on the way IMS calls DFSCTSE0.
IMS callable services	To use callable services with this routine, you must do the following: <ul style="list-style-type: none">• Issue an initialization call (DFSCSI0) to obtain the callable service token and a parameter list in which to build the function-specific parameter list for the desired callable service. For details on using the initialization call, see “Step 2. Initializing IMS Callable Services (DFSCSI0)” on page 14.• Use the ECB found in register 9 for the DFSCSI0 call.• Link DFSCSI00 with your user exit routine.

DFSCCTSE0

Table 114. Security Reverification Exit Routine Attributes (continued)

Attribute	Description
Sample routine location	No sample exit routine is provided.

Communicating with IMS

You can call the exit routine in either a RACF environment or a non-RACF environment.

If you are operating in a RACF environment, you can activate this routine in the following place:

- If the RACF FRACHECK call returns a valid return code (0 or 4), IMS immediately calls the exit routine DFSCCTRN0 if DFSCCTRN0 exists. Upon returning from DFSCCTRN0, regardless of its return code, IMS immediately calls DFSCCTSE0 if DFSCCTSE0 exists. This applies to AUTH and CHNG calls only.

If you are operating in a non-RACF environment, you must activate this routine in the following place:

- If DFSCCTSE0 is coded as an entry point, IMS calls this entry point following each call to DFSCCTRN0 if DFSCCTRN0 exists. This applies to AUTH and CHNG calls only. IMS calls this entry point regardless of the return code received from DFSCCTRN0.

Whether you are operating in a RACF or non-RACF environment, DFSCCTRN0 passes the return code directly to DFSCCTSE0 in register 3.

Contents of Registers on Entry

Upon entry, the exit routine must save all registers using the save area provided. The registers contain the following:

Register	Contents
0	Address of the user ID from PST (PSTUSID)
1	Address of the password or zero For AUTH call, address of GENERIC class For TRAN call, address of TRAN class For FIELD call, address of FIELD class For DATABASE call, address of DATABASE class For SEGMENT call, address of SEGMENT class For OTHER call, address of OTHER class
2	Calling routine number as follows: 12 (X'0C') DFSDLA30 for DFSCCTSE0 only, CHNG call 32 (X'20') DFSDLA30 for DFSCCTSE0 only, AUTH call 12 (X'0C') DFSDLA30 for DFSCCTSE0 only, CHNG call 32 (X'20') DFSDLA30 for DFSCCTSE0 only, AUTH call
3	Return code from prior routines
4	For details of the format of this storage area, see the prolog in the sample routine (IMS.ADFSSRC; member name is DFSCCTSE0).

Register	Contents
7	Address of source CTB or zeros.
	Recommendation: The contents of this register vary depending on the type of call to the exit routine and on the environment from which the call was made. It is recommended that applications not require the contents of this register for processing.
9	Address of PST.
10	Address of transaction code or resource name.
11	Address of SCD.
13	Address of save area. The exit routine must not change the first three words.
15	Entry point of exit routine.

Contents of Registers on Exit

Upon return, all registers must be restored except for register 15, which must contain one of the return codes shown in the following table, to indicate the success or failure of the user's authorization to issue a AUTH or CHNG call.

Return Code	Meaning
0	IMS accepts the CHNG call.
4	The resource is not protected.
8	The user is not authorized.
Positive	IMS rejects the CHNG call.
Negative	User is authorized. The negative value is the complemented address that points to user data provided by RACF (AUTH call).

DFSCTSE0

Chapter 57. Shared Printer Exit Routine (DFSSIML0)

This chapter describes the Shared Printer exit routine.

The following topics provide additional information:

- “About This Routine”
- “Communicating with IMS” on page 380

About This Routine

To acquire SLU 1, or 328X BSC/VTAM printers that are defined to IMS as shared, the IMS message router activates a Shared Printer exit routine. This is a routine that you write to decide whether a terminal that is unavailable can be automatically acquired by IMS or an AOI application program. The Shared Printer exit routine should return the name of the AOI application program.

A Shared Printer exit routine is not necessary to use shared printing. If no exit routine exists, the message router simulates a /OPN command when the terminal is defined as shared.

Attributes of the Routine

Table 115 shows the attributes of the Shared Printer exit routine.

Table 115. Shared Printer Exit Routine Attributes

Attribute	Description
IMS environments	DB/DC, DCCTL.
Naming convention	You must name this exit routine DFSSIML0.
Binding	Follow the guidelines described in “Binding the Routines” on page 7.
Including the routine	No special steps are required to include this routine.
IMS callable services	To use IMS Callable Services with this routine, you must issue an initialization call (DFSCSI0) to obtain the Callable Service token and a parameter list in which to build the function-specific parameter list for the desired callable service. Use the ECB found in register 9 for the DFSCSI0 call. Related Reading: For details on using the initialization call, see “Step 2. Initializing IMS Callable Services (DFSCSI0)” on page 14. This exit is automatically linked to DFSCSI00 by IMS. No additional linking is required to use IMS Callable Services.
Sample routine location	IMS.ADFSSMPL (member name DFSSIML0).

Special Considerations

If you decide to write a Shared Printer exit routine, here are some things you need to know:

- If the exit routine returns a bad return code, it is disabled and message DFS2084 is sent to the master terminal operator. A bad return code, in this case, is a return code of 8 when no transaction name is in the area pointed to by register 1 or when the transaction name returned is invalid. After the exit routine has been disabled, a return code of 0 is assumed. For the exit routine to be enabled, IMS must be restarted.

- The exit routine must not issue any waits, OS macros, or SVCs.
- The exit routine can examine output destination but cannot modify it.
- The exit routine should return the name of the AOI application program in the field provided by the message router.
- The exit routine receives control of the messages after they are queued.
- Because the exit routine runs in the IMS control region, your installation must maintain security. Installation procedures should not let an unauthorized routine be linked into the nucleus.

Communicating with IMS

IMS uses the entry and exit registers to communicate with the routine.

Contents of Registers on Entry

Upon entry, the exit routine must save all registers using the provided save area. The registers contain the following:

Register	Contents
1	Address of the area where the AOI transaction name is to be returned.
6	Address of CNT.
7	Address of CTB.
9	Address of CLB.
11	Address of SCD.
13	Address of save area. The exit routine must not change the first three words.
14	Return address to IMS.
15	Entry point of exit routine.

Contents of Registers on Exit

Before returning to IMS, the exit routine must restore all registers except for register 15, which must contain one of the following return codes:

Return Code	Meaning
0	A SIMLOGON with the Q and RELRQ options is issued. This tells the other subsystem or VTAM application connected to the printer that IMS needs the printer.
4	No special processing is required. Normal processing continues.
8	The AOI transaction is activated. This transaction cannot be a conversational, Fast Path, remote, or password-protected transaction.

Chapter 58. Signon Exit Routine (DFSSGNX0)

This chapter describes the Signon exit routine. IMS calls the Signon exit routine for signon processing if ETO=Y is specified as an execution parameter. All attempts to sign on to ACF/VTAM terminals if the Extended Terminal Option (ETO) feature is active cause IMS to call this exit routine. The Signon exit routine cannot be used by LU 6.2 terminals.

IMS calls the Signon exit routine before RACF validation (if requested) is performed and before the Signon/off Security exit routine (DFSCSGN0) is called. This exit routine contains logic and function that complement the Signon/off Security exit routine. Review your use of the Signon/off Security exit routine to determine if the function that it provides is necessary or conflicts with the Signon exit routine.

Related Reading:

- For more information on ETO and LU 6.2, see *IMS Version 9: Administration Guide: Transaction Manager*.
- For more information on the Signon/off Security exit routine, see Chapter 60, “Signon/off Security Exit Routine (DFSCSGN0),” on page 393.

In this Chapter:

- “About This Routine”
- “Communicating with IMS” on page 387

About This Routine

You can write the Signon exit routine to:

- Select the user descriptor (based on the user ID, node name, or DFSUSER) that you want IMS to reference when building the control block structure for the user that is signing on. For more information, see “Selecting a User Descriptor” on page 384.
- Provide queue data for the user that is signing on. This could be data to override the queue data derived from the user descriptor. If the user descriptor is DFSUSER, the exit routine can also supply queue data to add additional LTERMs to the structure. For more information, see “Providing Queue (LTERM) Data” on page 385.
- Supply parameters that you want IMS to reference when building associated printer control block structures. For more information, see “Supporting Associated Printing” on page 384.
- Allow or disallow a signon attempt based on a maximum number of users, or according to any criteria that you specify.
- Specify, or override, autologoff parameter and autosignoff (ASOT) value.
- Override the default Status Recovery Mode for dynamic non-STSN terminals (terminals other than SLUP, FINANCE, and ISC).

For the latest version of DFSSGNX0, see the IMS.ADFSSMPL library; member name is DFSSGNX0. If you write your own Signon exit routine or modify the sample, you must include the portion of the sample exit routine (or the equivalent logic) that removes extraneous blank fields that RACF (if used) creates. (When the Signon exit routine is **not** included in the system, internal IMS logic removes these extraneous blank fields.) The sample exit routine also provides an example of associated printing.

When the Signon exit routine (DFSSGNX0) is not included in the system and the MFS formats for the DFS3649 message have not been modified, internal IMS logic removes these extraneous blank fields. If the MFS formats for the DFS3649 message have been modified, corresponding changes to the logic in the Signon exit routine that removes the extraneous blank fields might be necessary. This logic is included in the Signon exit routine so that adjustments can be made when changes are made to the DFS3649 MFS formats.

The Signon exit routine and the Output Creation exit routine (DFSINSX0) are corequisite exit routines, under the following conditions. If you provide one exit routine to supply queue data for additional LTERMs, you must provide the other exit routine also. They both create the user control block structure and related LTERMs (including multiple LTERMs for a user): the Signon exit routine using the user ID and the Output Creation exit routine using an LTERM name. Both exit routines must have the same logic so that the structure created is identical, regardless of which exit routine created it.

You can use the Signoff exit routine (DFSSGFX0) to complement any processing that the Signon exit routine performs.

Table 116 shows the attributes of the Signon exit routine.

Table 116. Signon Exit Routine Attributes

Attribute	Description
IMS environments	DB/DC, DCCTL.
Naming convention	You must name the Signon exit routine DFSSGNX0.
Binding	Follow the guidelines described in “Binding the Routines” on page 7.
Including the routine	If you want IMS to call the Signoff exit routine, include it in an authorized library in the JOBLIB, STEPLIB, or LINKLIST library concatenated in front of the IMS.SDFSRESL.
IMS callable services	To use IMS Callable Services with this routine, you must do the following: <ul style="list-style-type: none"> • Issue an initialization call (DFSCSI0) to obtain the Callable Service token and a parameter list in which to build the function-specific parameter list for the desired callable service. For details on using the initialization call, see “Step 2. Initializing IMS Callable Services (DFSCSI0)” on page 14. • Use the current address ECB found at offset 0 for the DFSCSI0 call. • Link DFSCSI00 with your user exit.
Sample routine location	IMS.ADFSSMPL.

Assembling and Loading the Routine

A sample Signon exit routine is provided in IMS.ADFSSMPL. Alternatively, you can write your own exit routine. You can assemble the sample exit routine or one that you write (using the standard IMS macro and copy files), and include it in an authorized library in the JOBLIB, STEPLIB, or LINKLIST library concatenated in front of the IMS.SDFSRESL. If the Signon exit routine is included, IMS automatically loads it each time IMS is initialized if ETO=Y (after the Initialization exit routine, DFSINTX0, has changed the ETO= parameter).

If you want associated printing, be sure to specify the following when you assemble the sample exit routine:

```
&ASSOCprt SETC 'YES'
```

This specification ensures that the associated printing sample code is generated.

User ID

The Signon exit routine informs the external subsystem of the user ID associated with the transaction input message. The user ID can be one of the following:

- The inputting LTERM name if the terminal user is not signed on
- The ID of the terminal user
- The RACF/user-authorized user ID associated with a non-message driven BMP or CPIC application
- The PSB name specified on the job card

IMS determines the user ID in the following order.

For CPIC application:

1. RACF ID if the ACEE is cloned in the dependent region
2. PSTBUSER if the field does not contain binary zeros or blanks
3. PSTUSID if the field does not contain blanks
4. PSTSYMB0 if the field does not contain blanks
5. PDIRSYM

For a message driven BMP that has done a GU, or IFP that has done a GU, or MPP:

1. PSTUSID if the field does not contain blanks
2. PSTSYMB0 if the field does not contain blanks
3. PSTBUSER if the field does not contain binary zeros or blanks
4. PDIRSYM

For message driven BMP that has not done a GU or IFP that has not done a GU:

1. PSTBUSER if the field does not contain binary zeros or blanks
2. PDIRSYM

For non-message driven BMP:

1. PSTBUSER if the field does not contain binary zeros or blanks and the DFSDCxxx PROCLIB member specifies BMPUSID=USERID
2. PDIRSYM

When a dependent region connection is initially established, the Signon exit routine is activated before a thread is created by the Create Thread exit routine. All subsequent Signon requests result in the exit routine being activated after a thread is created. For example, Signon is activated for each message processed during a single scheduling, whether or not the messages are separated by commit processing.

Extended Recovery Facility (XRF) Considerations

IMS calls the Signon exit routine in the XRF alternate system for a type 1 session with ETO. When IMS calls the exit routine in the alternate system, the exit routine is

not allowed to change **anything** related to the terminal or user structures, including fields that the exit routine can normally change.

Each time IMS calls the Signon exit routine, the exit routine receives information on the XRF status of IMS.

Supporting Associated Printing

Associated printing is the ability to direct application printer output to a printer logical unit (LU) name. This LU name is provided at either logon or sign on time. If the Logon exit routine (DFSLGNX0) is written to detect LU names entered as logon user data, IMS passes these LU names to the Signon exit routine.

If you modify the DFS3649A MFS format to allow LU names to be entered as /SIGN ON user data, the Signon exit routine must be able to detect the LU names. If the user can enter LU names directly at sign on, the exit routine must determine the queue name that is allocated to each printer. There should be a unique relationship between the user ID and the queue name. The Signon exit routine passes the queue name to IMS, which creates the control block structure. An application program can use the same algorithm to determine the queue name when the application processes a transaction scheduled for a particular user ID.

The exit routine must insert a period (.) in the sign-on user verification string (UVS) after building the associated printer buffer.

Selecting a User Descriptor

If the user control block structure already exists for the user that is signing on, IMS searches for the user structure and passes the addresses of the existing nodename structure along with the address of any existing user ID structure to the exit routine in the parameter list ESPQBTAB.

The exit routine can determine whether to use the user ID structure or the nodename structure by examining the passed structure without making an explicit IMS Callable Service routine call to find the nodename user structure.

If the exit routine chooses the nodename as the user structure name, the user ID is hashed to a non-SPQB user hash table.

If no user control block structure exists, you can select a user descriptor by using the USERD= keyword, write the Signon exit routine to select the user descriptor, or let IMS select a descriptor. Figure 36 shows the search order that IMS uses to select the user descriptor.

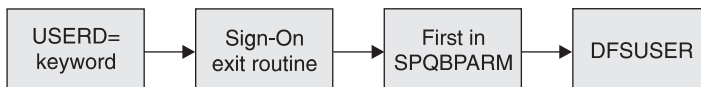

Figure 36. User Descriptor Selection Order

You can use the USERD keyword (entering it as user data with the /SIGN ON command) to select the user descriptor. If your Signon exit routine does not choose a user descriptor, IMS uses the user descriptor requested by the USERD parameter.

The Signon exit routine is called with the parameter list SPQBPTRS, which contains the address of the USERD= keyword specified, and the addresses of the user ID descriptor, node name descriptor, and DFSUSER descriptor. The exit routine can choose among these descriptors by specifying the descriptor's address in the USEQUSED field of the USEQDATA DSECT. If the exit routine selects one of these user descriptors, IMS uses it to create the user control block structure. (A user descriptor that the exit routine specifies overrides any descriptor specified on the USERD= keyword.)

The exit routine can also create an arbitrary user structure name by specifying the name in the eight-byte USEQUSTN field in the USEQDATA parameter list. IMS creates the user structure with the name from this field and stores the returned name in the SPQB user hash table. Security is based on the original user ID that the user signed on with and is stored in the non-SPQB user hash table.

If no user descriptor is specified on the USERD= keyword and the Signon exit routine does not return the address of a user descriptor, IMS selects the first descriptor address that it finds in the SPQBPTRS among the user ID descriptor, node name descriptor, and the DFSUSER descriptor, respectively. IMS uses this descriptor to create the user control block structure.

If none of these methods returns a user descriptor, IMS uses DFSUSER to create the user structure. If no user descriptor can be found, including DFSUSER, IMS rejects the signon request.

Regardless of how the user descriptor is chosen, only DFSUSER or descriptors associated with the user ID or node name are valid. There is no user-based output security if the selected descriptor is the node name descriptor.

Providing Queue (LTERM) Data

Depending on the user descriptor selected, the exit routine can provide queue data. If the exit routine returns data that it was not authorized to return, IMS rejects the sign-on request.

Table 117 identifies four cases which describe what data the Signon exit routine can supply. The four cases are based on whether the user structure exists and whether DFSUSER or a non-DFSUSER descriptor is selected. For this exit routine, non-DFSUSER descriptors are descriptors based on the user ID or node name. Each case is discussed in the sections that follow. (If the exit routine does not exist, refer to "Selecting a User Descriptor" on page 384.)

Table 117. Case Numbers Identifying What Data DFSSGNX0 Can Provide

Descriptor	User Structure Exists	User Structure does not Exist
DFSUSER	Case 1	Case 2
Non-DFSUSER	Case 3	Case 4

Case 1

The Signon exit routine is called using the descriptor, DFSUSER, that was used to create the user control block structure. The exit routine can:

- Supply queue data (except LTERM names) to override data of the existing structure
- Provide data for additional LTERMs, if it supplies the data for the existing LTERMs first and in the order in which they are chained

IMS verifies the additional LTERMs that are specified (but are not in the existing user structure) against the LTERMs that already exist in the system. If an LTERM that is specified as an additional LTERM already exists in the system, IMS assumes that this LTERM has been assigned to a different user, and it is not made part of the user structure of the user that is signing on. If this is the only LTERM that the descriptor or the Signon exit routine specifies for this user, IMS rejects the signon attempt.

Case 2

If DFSUSER is selected and no user control block structure exists, the Signon exit routine:

- Can supply any queue data desired (including LTERM names)

If the exit routine does not provide queue data, one LTERM (named for the user ID) is created. If **any** queue data is passed, this default user ID LTERM is not created and must be specified in the queue data if it is desired.

IMS verifies the additional LTERMs that are specified against the LTERMs that already exist in the system. If an LTERM that is specified already exists in the system, IMS assumes that this LTERM has been assigned to a different user, and it is not made part of the user structure of the user that is signing on. If this is the only LTERM that the descriptor or exit routine specifies for this user, IMS rejects the sign-on attempt.

Case 3

The Signon exit routine is called with the same non-DFSUSER descriptor that was used to create the user control block structure (either the user ID or node name descriptor). The exit routine:

- Can supply any queue data (except LTERM names) to override data of the existing structure
- Cannot provide data for additional LTERMs

IMS verifies the LTERMs that are specified in the descriptor (but are not in the existing structure) against the LTERMs that already exist in the system. If an LTERM is specified in the descriptor but is not in the existing structure, IMS assumes that this LTERM has been assigned to a different user and deleted. The LTERM is given back to the user and is made part of the user structure of the user that is signing on.

Case 4

If a non-DFSUSER descriptor is selected and no user control block structure exists, the Sign On exit routine:

- Can supply queue data (except LTERM names) to override data that the descriptor provides
- Cannot provide data for additional LTERMs

IMS verifies the LTERMs specified in the descriptor against the LTERMs that already exist in the system. If an LTERM that is specified in the descriptor already exists in the system, IMS assumes that this LTERM has been assigned to a different user, and it is not made part of the user structure of the user that is signing on. If this is the only LTERM that the descriptor or exit routine specifies for this user, IMS rejects the signon attempt.

Communicating with IMS

IMS uses the entry and exit registers, as well as parameter lists, to communicate with the exit routine.

Contents of Registers on Entry

Upon entry, the exit routine must save all registers using the provided save area. The registers contain the following:

Register	Contents
R1	Address of Standard Exit Parameter List
R13	Save area address
R14	Return address to IMS
R15	Entry point address of exit routine

This exit routine uses the Version 1 standard exit parameter list. See Table 2 on page 5 for the content of the Version 1 standard exit parameter list.

Table 118 lists the signon exit parameters. The address of this parameter list is in the standard exit parameter list field SXPLFSPL.

Table 118. Signon Exit Parameter List

Offset	Length	Description
+0	4	Current ECB address.
+4	4	SCD address.
+8	4	Address of the user table created by Initialization User Exit routine DFSINTX0 or zero, if none.
+12	4	Address of a buffer for use by your user exit to return user descriptor and queue data exit parameters. For additional details on the content and the format, refer to the prolog in the sample routine. Set to zero: <ul style="list-style-type: none"> • For a static terminal. • If processing on an XRF alternate system. • If processing /SIGN ON ETO STSN device. The USEQDATA DSECT is provided for parameter area mapping.
+16	4	Address of a buffer for use by your user exit to return associated printer exit parameters. For additional details on the content and the format, refer to the prolog in the sample routine. Set to zero, if processing on an XRF alternate system.

Table 118. Signon Exit Parameter List (continued)

Offset	Length	Description
+20	4	<p>Address of a parameter list created by one of the following:</p> <ul style="list-style-type: none"> • Session initiation from LOGON data. • Input from the /SIGN ON command. <p>For additional details on the content and the format, refer to the prolog in the sample routine.</p> <p>Set to zero, if processing XRF alternate.</p>
+24	4	<p>Address of a parameter list, which contains pointers to available user control block structures (SPQBs) and default autosignoff values. For additional details on the content and the format, refer to the prolog in the sample routine.</p> <p>Set to zero:</p> <ul style="list-style-type: none"> • For a static terminal. • If processing on an XRF alternate system. • If processing /SIGN ON ETO STSN device.
+28	4	CLB address.
+32	4	Table of existing user structures. For additional details on the content and the format, refer to the prolog in the sample routine.
+36	4	Address of general Input/Output parameters. For additional details see DSECT DFSSGNXP macro for the format.

Contents of Registers on Exit

Before returning to IMS, the exit routine must restore all registers except for register 15, which contains one of the following return codes.

The content of register 15 will be ignored if processing is on an XRF alternate system.

Return Code	Meaning
0	IMS continues SIGNON processing.
4	IMS rejects the SIGNON attempt. The SIGNON required message, DFS3649, is resent to the terminal with some added information indicating the reason for rejection.
Negative	The same as return code 4, but IMS sends the specified user message instead of DFS3649.

Chapter 59. Signoff Exit Routine (DFSSGFX0)

This chapter describes the Signoff exit routine.

You can write the Signoff exit routine to perform processing that complements the Signon exit routine (DFSSGNX0). You can also use this exit routine to reset the significant status for terminals during user signoff.

The following topics provide additional information:

- “About This Routine”
- “Communicating with IMS” on page 390

About This Routine

All attempts to sign off from ACF/VTAM terminals cause IMS to call this exit routine. The Signoff exit routine is also called if either RACF or the Signon/off Security exit routine (DFSCSGN0) fails a signon attempt.

Recommendation: Although the Signon exit routine and this exit routine are optional, if you include one, you should also include the other to perform any cleanup operations that are necessary.

Table 119 shows the attributes of the Signoff exit routine.

Table 119. Signoff Exit Routine Attributes

Attribute	Description
IMS environments	DB/DC, DCCTL.
Naming convention	You must name this exit routine DFSSGFX0.
Binding	Follow the guidelines described in “Binding the Routines” on page 7.
Including the routine	If you want IMS to call the Signoff exit routine, include it in an authorized library in the JOBLIB, STEPLIB, or LINKLIST library concatenated in front of the IMS.SDFSRESL.
IMS callable services	To use callable services with this routine, you must do the following: <ul style="list-style-type: none">• Issue an initialization call (DFSCSI0) to obtain the callable service token and a parameter list in which to build the function-specific parameter list for the desired callable service. For details on using the initialization call, see “Step 2. Initializing IMS Callable Services (DFSCSI0)” on page 14.• Use the current address ECB found at offset 0 for the DFSCSI0 call.• Link DFSCSI00 with your user exit.
Sample routine location	IMS.ADFSSMPL (member name DFSSGFX0).

Restrictions

The Signoff exit routine cannot be used by LU 6.2 terminals.

Extended Recovery Facility (XRF) Considerations

Each time IMS calls the Signoff exit routine, the exit routine receives information on the XRF status of IMS. The exit routine can check this information and return the appropriate error message if necessary. IMS calls the exit routine if XRF tracking fails.

Resetting the Significant Status

You can use this exit to reset the significant status for a terminal in one of the following states:

- Conversational
- Exclusive
- Test
- Preset
- MFS test
- Full-function response
- Fast Path response

Note: Test, preset, and full-function response states are nonrecoverable, so IMS resets the significant status automatically. However, it is still valid, although unnecessary, to use this exit routine to reset the significant status for these states.

A parameter passed to the exit routine indicates the status of the terminal or ETO user at sign off. You can reset the status in the output parameters.

For conversation mode, IMS performs the equivalent of an /EXIT command for the conversation.

Related Reading: For more information on recoverable states, see *IMS Version 9: Administration Guide: Transaction Manager*.

Communicating with IMS

IMS uses the entry and exit registers, as well as parameter lists, to communicate with the exit routine.

Contents of Registers on Entry

Upon entry, the exit routine must save all registers using the provided save area. The registers contain the following:

Register	Contents
R1	Address of Standard Exit Parameter List
R13	Save area address
R14	Return address to IMS
R15	Entry point address of exit routine

This exit routine uses the Version 1 standard exit parameter list. See Table 2 on page 5 for the content of the Version 1 standard exit parameter list.

Table 120 lists the sign off parameters. The address of this parameter list is in the standard exit parameter list field SXPLFSPL.

Table 120. Signoff Exit Parameter List

Offset	Length	Description
+0	4	Current ECB address.
+4	4	SCD address.
+8	4	Address of the user table created by initialization user exit DFSINTX0 or zero, if none.

Table 120. Signoff Exit Parameter List (continued)

Offset	Length	Description
+12	4	Address of USERID associated with Sign Off.
+16	4	CLB address.
+20	4	Address of the STATUS_IN and STATUS_OUT vectors. The status vectors are mapped by the DFSSTCHK macro. For the contents of the STATUS_IN vector, see "Contents of STATUS_IN." For the contents of the STATUS_OUT vector, see "Contents of STATUS_OUT."

Contents of STATUS_IN

The input status vector is a 2-byte field that indicates the terminal's significant status when the exit routine is called. The second byte of the field is reserved. The first byte of the field contains a value that indicates the significant status as follows:

Value	Description
X'80'	Conversation
X'40'	Exclusive
X'20'	Test
X'10'	Preset
X'08'	MFS test
X'04'	Full-function response
X'02'	Fast Path response

Contents of STATUS_OUT

The output status vector is a two-byte field that indicates changes to the significant status made by the exit routine. IMS uses the contents of STATUS_OUT as an indicator to exit a conversation and reset significant status. The default for this field is zeros, indicating that no significant status is reset.

The second byte of the field is reserved. The first byte of the field contains a value that indicates the significant status to be reset as follows:

Value	Description
X'80'	Exit conversation
X'40'	Reset exclusive
X'20'	Reset test
X'10'	Reset preset
X'08'	Reset MFS test
X'04'	Reset full-function response
X'02'	Reset Fast Path response

Contents of Registers on Exit

Before returning to IMS, the exit routine must restore all registers except for register 15, which contains one of the following return codes:

Return Code	Meaning
0	Normal return.
Negative value	The specified user message is sent to the terminal signing off. This message can be used to trigger an AOI facility following a signoff operation.

DFSSGFX0

Chapter 60. Signon/off Security Exit Routine (DFSCSGN0)

This chapter describes the Signon/off Security exit routine. You can use this exit routine to verify a user's ID and password.

Related Reading:

- This exit routine can conflict with the Signon exit routine (DFSSGNX0). See Chapter 58, "Signon Exit Routine (DFSSGNX0)," on page 381 for information on DFSSGNX0.
- The Transaction Authorization and the Security Reverification exit routines provide additional user verification for transactions. See Chapter 64, "Transaction Authorization Exit Routine (DFSCTRNO)," on page 417 and Chapter 56, "Security Reverification Exit Routine (DFSTSE0)," on page 375 for more information.

The following topics provide additional information:

- "About This Routine"
- "Communicating with IMS" on page 394

About This Routine

You can use the Signon/off Security exit routine with or without RACF to verify the user ID and password. If both the RACF option and the Signon/off Security exit routine are selected in the IMS system definition, IMS calls this exit routine after RACF /SIGN ON verification has been performed. If the /SIGN ON request is rejected by RACF, IMS does not call this exit routine. If the RACF option is not selected in the IMS system definition, you can use this exit routine to verify the user's identification and passwords at /SIGN ON time.

If ETO=Y is specified as an execution parameter, the Signon exit routine (DFSSGNX0) performs signon processing before IMS calls RACF or the Signon/off Security exit routine. If the Signon exit routine rejects the signon attempt, IMS does not call the Signon/off Security exit routine.

Related Reading: For more information on the Extended Terminal Option (ETO) feature, see *IMS Version 9: Administration Guide: Transaction Manager*.

If shared-queues are active and the security environment for a transaction is created on the back-end IMS subsystem, IMS does not call this exit routine.

The Signon/off Security exit routine should have access to a table of valid user IDs and the passwords associated with each ID. The exit routine should note successful /SIGN ONs to prevent additional attempts to perform the /SIGN ON function. When the /SIGN ON command is executed, the exit routine should mark that user ID as available for /SIGN ON. For logging purposes, the exit routine can also place information into the data portion of the user verification string that is passed to the exit.

If you plan to use the Signon exit routine, review how you use the Signon/off Security exit routine to determine if the function that this exit routine provides is necessary or might even conflict with the Signon exit routine.

Table 121 on page 394 shows the attributes of the Signon/off Security exit routine.

DFSCSGN0

Table 121. Signon/off Security Exit Routine Attributes

Attribute	Description
IMS environments	DB/DC, DCCTL.
Naming convention	You must name this exit routine DFSCSGN0.
Binding	Follow the guidelines described in “Binding the Routines” on page 7.
Including the routine	No special steps are required to include this routine.
IMS callable services	To use callable services with this routine, you must issue an initialization call (DFSCSI0) to obtain the callable service token and a parameter list in which to build the function-specific parameter list for the desired callable service. For details on using the initialization call, see “Step 2. Initializing IMS Callable Services (DFSCSI0)” on page 14. Use the ECB found in register 9 for callable services. This exit is automatically linked to DFSCSI00 by IMS. No additional linking is required to use callable services.
Sample routine location	IMS.ADFSSRC (member name DFSCSGN0).

Communicating with IMS

IMS uses the entry and exit registers to communicate with the exit routine.

Contents of Registers on Entry

Upon entry to the exit routine, all registers must be saved using the save area provided. The registers contain the following:

Register	Contents
0	/SIGN function (ON or OFF): 0 /SIGN ON 1 /SIGN OFF 2 /SIGN ON in XRF alternate system. 3 /SIGN OFF in XRF alternate system.
1	Pointer to the variable-length user verification string, if the SIGN function is /SIGN ON. The string format is LLZZ (4 bytes), followed by the text, starting with the first character of the user ID. Address of the user ID if the SIGN function is /SIGN ON in an XRF environment. Insignificant if the SIGN function is /SIGN OFF.
7	Address of source CTB or zeros. Recommendation: The contents of this register vary depending on the type of call to the exit routine and on the environment from which the call was made. It is recommended that applications not require the contents of this register for processing.
9	Address of ECB.
11	Address of SCD.
13	Address of save area. The exit routine must not change the first three words.
14	Return address to IMS.
15	Entry point of exit routine.

Contents of Registers on Exit

Upon return to IMS, all registers must be restored except for register 15, which contains one of the following return codes:

Return Code **Meaning**

0	IMS accepts the /SIGN ON
Positive	IMS rejects the /SIGN ON. IMS sends message DFS2467 if sign-on is not required and message DFS3649 if sign-on is required. This return causes a "BY IMS EXIT" to be appended to the message to indicate that the exit routine caused the return code.
Negative	IMS rejects the /SIGN ON command and sends a user-defined message. The message number is complemented into a message number. This number must be less than -24, otherwise a DFS2467 message is sent instead. You must list the absolute value of this message number in the User Message Table, DFSCMTU0. (See Chapter 32, "User Message Table (DFSCMTU0)," on page 235 for more information on the user message table.)

Exception: The exit routine does not check this return code on return from RACF or during /SIGN OFF processing.

DFSCSGN0

Chapter 61. Time-Controlled Operations (TCO) Exit Routine (DFSTXIT0)

The TCO exit routine inserts messages in the message queue at a specific time for processing.

The following topics provide additional information:

- “About This Routine”
- “Communicating with IMS” on page 398

About This Routine

The TCO exit routine inserts messages that are the commands, transactions, and message switches that you specify in the time schedule requests and message sets that make up a script member. The TCO exit routine passes any data found in columns 56 through 71 of the time schedule request to IMS to be processed.

You do not have to write your own exit routine. You can schedule predefined commands, transactions, and message switches at predefined times with DFSTXIT0, the TCO exit routine IMS supplies. If you do write your own, you can write it in COBOL or assembler.

Restriction: PL/I and C language exit routines are not supported. Cobol routines running under Language Environment for z/OS are not supported.

This routine cannot be used in a DBCTL environment.

Table 122 shows the attributes of the Time-Controlled Operations (TCO) exit routine.

Table 122. Time-Controlled Operations (TCO) Exit Routine Attributes

Attribute	Description
IMS environments	DB/DC, DCCTL.
Naming convention	If you are writing your own routine, you can name it anything you wish. If you are using the IMS-supplied routine, use the name DFSTXIT0.

DFSTXIT0

Table 122. Time-Controlled Operations (TCO) Exit Routine Attributes (continued)

Attribute	Description
Binding	<p>You should write, compile, and bind the routine as serially reusable (REUS).</p> <p>The following JCL is an example of binding a routine named MYEXIT to DFSTDLI0.</p> <pre>//XIT JOB 1, MSGLEVEL=1 //LINK EXEX PGM=IEWL, PARM=REUS //SYSUT1 DD UNIT=SYSDA,SPACE=(TRK,(20,20)) //SYSPRINT DD SYSOUT=A //SYSMOD DD DSN=IMS.SDFSRESL,DISP=SHR //INLIB DD DSN=IMS.OBJ,DISP=SHR //SYSLIN DD * INCLUDE INLIB(MYEXIT) INCLUDE INLIB(DFSTDLI0) NAME MYEXIT(R) /*</pre> <p>In this example, IMS.SDFSRESL is an authorized library that contains all load modules. IMS.OBJ is a library that contains all object modules. The JCL in this example expects to find the object modules of the exit routine (MYEXIT) and the TCO Language Interface module (DFSTDLI0) in IMS.OBJ and places the result of the bind into IMS.SDFSRESL.</p> <p>After you've compiled and tested your routine (or if you are using the routine supplied by IMS), you must bind the exit routine with the TCO Language Interface module (DFSTDLI0) and place them into IMS.SDFSRESL.</p>
Including the routine	<p>To load and execute the routine, it must be referred to in a time schedule request in the script member that is executing.</p> <p>Related Reading: For more information about time schedule requests and script members, see <i>IMS Version 9: Operations Guide</i>.</p> <p>The following is an example of a time schedule request in a script member that wants the routine "MYEXIT" to be executed.</p> <pre>*TIME 1200 MYEXIT</pre> <ul style="list-style-type: none">• Columns 1-5 contain the Identification field. '*TIME' is in this field.• Columns 7-10 contain the initial dispatch time. In this example it is 12:00 p.m.• Columns 12-19 contain the name of the exit routine, left-justified and padded with blanks. The name in this example is 'MYEXIT'.
IMS callable services	This exit is not eligible to use IMS Callable Services.
Sample routine location	IMS.ADFSSMPL (member name DFSTXIT0).

Communicating with IMS

IMS uses the entry and exit registers, and parameters to communicate with the exit routine.

Contents of Registers on Entry

Upon entry, the exit routine must save all registers using the provided save area. The registers contain the following:

Register	Contents
1	Address of a parameter list that contains the address of the program communication block (PCB) used in the exit routine calls.
10	Reserved for TCO.
13	Address of save area. The exit routine must not change the first three words.
14	Return address to IMS.

Register	Contents
15	Entry point of exit routine.

The PCB

The program communication block (PCB) contains the actual scheduling time for the time-initiated message processing. It is in the PCBTIME field (PCB + 16). Under most circumstances, this is the same time as the time initiated request. In very busy systems, however, that actual scheduled time can differ from the schedule request. For example, if you request your exit routine to be scheduled at 12:01 and a busy system prevents it from being scheduled until 12:03, the PCB contains 12:03.

DL/I Calls

The calls you can use in this exit routine are:

- GU** Get the message that caused scheduling.
- ISRT** Put a message segment into the queue for processing.
- PURG** Terminate the prior segments as a message and insert the first segment on the next message (if an I/O area is provided).
- GSCD** Get the address of the IMS system contents directory. The address is returned in the first word of the I/O area, which must begin on a word boundary.

The TCO exit routine calls the TCO Language Interface module (DFSTDLI0) to process these calls. You can call DFSTDLI0 or CBLTDLI0 (for COBOL) to process the call.

You must pass a parameter list with the call in standard DL/I format (for example, register 1 contains the address of a 2- or 3-word parameter list whose end is indicated by a X'80' in the high-order byte). The PURG call can have two or three parameters. The other calls require three parameters.

The parameter list consists of:

1. The call function
2. The address of the I/O PCB
3. The address of the I/O area (optional with PURG)

Status Codes

A blank status code is returned to the exit routine after a successful call.

The following status codes can be returned to the exit routine after an unsuccessful call:

- AB** The call didn't specify an I/O area.
- AD** The function parameter on the call is invalid or is not supplied. The functions recognized by TCO are GU, ISRT, PURG, and GSCD.
- AX** The I/O PCB name was invalid.
- AZ** An ISRT or PURG call with an unacceptable message count was issued.
- QC** There are no additional input messages to process for this time request.
- QX** The ISRT or PURG call could not be processed because of insufficient storage.

Message Formats

A GU call always retrieves a message in one of these formats:

- A 20-byte example as shown in Figure 37.

LL 20	ZZ	16-byte user data found in time required (col. 56-71 of time schedule request)
2	2	16

Figure 37. Format of 20-byte Message Example

- An 8-byte example as shown in Figure 38.

LL 8	ZZ	Address of the first segment of a message set (col. 56-59 of the time schedule request was ****)
2	2	4

Figure 38. Format of 8-byte Message Example

- An example in which the address of a message set is retrieved as shown in Figure 39.

Next Segment Pointer	LL	ZZ	Data
4	2	2	Variable Length

Figure 39. Format of Message where the Address of a Message Set is Retrieved

The last message of the message set contains binary zeros in the “next segment” field.

If the message set is broken into individual messages and segments (by the use of a space and an **S** in column 72), this is shown in the ZZ field of each segment. The values are as follows:

Value	Meaning
0001	First segment of a message
0000	Middle segment of a message
0002	Last segment of a message
0003	First and last (only) segment of a message

Chapter 62. Time-Controlled Operations (TCO) Communication Name Table (CNT) Exit Routine (DFSTCNT0)

The Time-Controlled Operations (TCO) Communication Name Table (CNT) controls which IMS LTERMs are allowed to load TCO scripts.

The following topics provide additional information;

- “About This Routine”
- “Communicating with IMS” on page 402

About This Routine

The Time-Controlled Operations (TCO) Communication Name Table (CNT) exit routine gets control from the IMS Communication Analyzer module (DFSICIO0) whenever both of the following conditions are true:

- TCO is active.
- A message switch occurs for the DFSTCF LTERM.

The message switch acts as a load command from DFSTCF to load another TCO script. Use this exit routine to control which LTERMs are allowed to load TCO scripts.

The default exit routine immediately returns control to DFSICIO0, thus with the default exit routine, any terminal is allowed to load TCO scripts.

This routine cannot be used in a DBCTL environment.

Table 123 shows the attributes of the TCO CNT exit routine.

Table 123. TCO CNT Exit Routine Attributes

Attribute	Description
IMS environments	DB/DC, DCCTL.
Naming convention	If you are writing your own routine, you can give it any name. If you are using the IMS-supplied routine, use the name DFSTCNT0.

DFSTCNT0

Table 123. TCO CNT Exit Routine Attributes (continued)

Attribute	Description
Binding	<p>You should write, compile, and bind the routine as re-entrant (RENT).</p> <p>The following JCL is an example of binding a routine named MYEXIT to DFSICIO0.</p> <pre>//XIT JOB 1, MSGLEVEL=1 //LINK EXEX PGM=IEWL, PARM=RENT //SYSUT1 DD UNIT=SYSDA,SPACE=(TRK,(20,20)) //SYSPRINT DD SYSOUT=A //SYSMOD DD DSN=IMS.SDFSRESL,DISP=SHR //INLIB DD DSN=IMS.OBJ,DISP=SHR //SYSLIN DD * INCLUDE INLIB(MYEXIT) INCLUDE INLIB(DFSICIO0) NAME MYEXIT(R) /*</pre> <p>In this example, IMS.SDFSRESL is an authorized library that contains all load modules. IMS.OBJ is a library that contains all object modules. The JCL in this example expects to find the object modules of the exit routine (MYEXIT) and the IMS Communication Analyzer module (DFSICIO0) in IMS.OBJ and places the result of the into IMS.SDFSRESL.</p> <p>After you've compiled and tested your routine (or if you are using the routine supplied by IMS), you must bind the exit routine with the TCO Language Interface module (DFSTDLI0).</p>
IMS callable services	This exit is not eligible to use IMS Callable Services.
Sample routine location	IMS.ADFSSMPL (member name DFSTCNT0).

Communicating with IMS

IMS uses the entry and exit registers to communicate with the routine.

Contents of Registers on Entry

Upon entry, the exit routine must save all registers using the provided save area. The registers contain the following:

Register	Contents
1	The buffer location of the input message segment after translation to EBCDIC and after IMS Basic Editing. The first two bytes of the buffer contain a binary message length. The third byte of the buffer is binary zeros. The binary count includes the 4-byte prefix. The fifth byte contains the first byte of message text.
7	Address of CTB.
9	Address of CLB.
13	Address of save area. The exit routine must not change the first three words.
14	Return address to IMS.
15	Entry point of edit routine.

Use the message segment in the buffer addressed by register 1 as input to the exit routine.

The exit routine must place the text of the edited message segment to be returned to IMS in the buffer addressed by register 1. If the input was processed by the IMS Basic Edit, this buffer is always 10 bytes greater than the 2-byte binary count at the beginning of the message segment. The length of the message segment can be

expanded or reduced to any desired size. The format of the edited message segment in the buffer upon return to IMS must be two bytes of binary count (LL), two bytes of binary zeros (ZZ), and edited text. The second two bytes (ZZ) should not be changed or edited. The LLZZ field is the first four bytes of the message segment.

Contents of Registers on Exit

Before returning to IMS, the exit routine must restore all registers except register 15, which must contain one of the following return codes.

Return Code	Meaning
00	Segment is processed normally.
04	Segment is canceled.
08	Message is canceled and the terminal operator is notified.
12	Message is canceled and the user message identified by register 1 is sent to the terminal.

Register 1 contains the message number if register 15 contains a return code of 12; otherwise it is ignored. Any other value causes the message to be canceled and the terminal operator to be notified.

Chapter 63. TM and MSC Message Routing and Control User Exit Routine (DFSMSCE0)

This chapter describes the TM and MSC Message Routing and Control user exit routine. It provides information about the attributes of the routine, how the routine is called, and how the routine communicates with IMS.

In this Chapter:

“About This Routine”

“Attributes of the Routine” on page 409

“Communicating with IMS” on page 409

About This Routine

The TM and MSC Message Routing and Control user exit routine replaces the following MSC exit routines:

- Input Message Routing (DFSNPRT0)
- Link Receive (DFSCMLR0/DFSCMLR1)
- Program Routing (DFSCMPR0)
- Terminal Routing (DFSCMTR0)

Note: IMSs in the MSC network can be at different versions and using different exit routines. An IMS using DFSMSCE0 is compatible with an IMS using DFSCMTR0, DFSNPRT0, or DFSCMLR0/DFSCMLR1 in the MSC network.

The DFSMSCE0 user exit routine does the following:

- Provides maximum routing control for TM and MSC messages.
- Eases TM and MSC coding and maintenance requirements, and reduces the number of exit modules.
- Supports a consistent set of routing capabilities across all of the exit entry points (or functions).

It receives control (in other words, is called by IMS) for all User Type messages from:

- Terminal/message input
- MSC link input
- Application program output

In turn, the exit is allowed to affect the routing of most of these messages. Exceptions are cases where rerouting would violate IMS architecture or cause problems such as hung terminals or incorrect application program operation. For example, rerouting application program output messages to the I/O PCB is one of these exceptions (it is not allowed).

For details on the routing capabilities for each exit entry point (Terminal, Link, Application), see the DFSMSCEP user parameter list mapping tables in “Contents of Registers on Entry” on page 410. The user reroute request flags are MSTRFL2 (terminal), MSLRFL2 (MSC link), and MSPRFL2/MSPRFL3 (application). Setting (see following note) one or more of these flags in conjunction with changing destination type fields, causes the message to be canceled or rerouted.

See the DFSMSCE0 sample exit for examples of message routing.

Note: DFSMSCEP parameters that the exit can set or change to affect message routing are marked with a "U" or "B" as follows:

I IMS SETS (EXIT MUST NOT CHANGE)

U USER EXIT SETS

B BOTH IMS/USER EXIT SET (OR CHANGE)

- Provides a common parameter list interface and linkage interface to the various entry points (or functions).
- Provides the ability to append an optional user prefix segment to TM and MSC messages which TM and MSC user exit routines can use to communicate and control user-customized routing needs.
- Provides new entry points:
 - Control at IMS initialization and termination
 - Control of messages in an MSC intermediate system
 - Application program inserts to a non-modifiable PCB

All the entry points are optional, using a vector table that you code at the beginning of the common exit module.

- Logs routing errors and footprints in the message to indicate those exit routines that reroute the message.

Sample IMS Configurations

This section describes four separate IMS configurations and the points where the DFSMSCE0 exit routine receives control during the flow of a transaction and response message.

Related Reading: For more information and illustrations of the environment scenarios described here, see the sample DFSMSCE0 user exit routine that is provided with IMS.

Single IMS System

In a single IMS environment, the TR exit routine can receive control when a message is received from the terminal. The PR exit routine receives control when an application program issues a CHNG call to a modifiable PCB or on a ISRT call to insert a message.

Multiple Systems Coupling Environment

In an MSC environment, the following occurs:

1. The TR exit routine receives control when a message is received from a terminal.
2. The PR exit routine receives control when the application program issues a CHNG or ISRT call to insert a message.
3. The LR exit routine receives control each time a message is received on an MSC link.

Shared-Queues Environment

A shared-queues environment is similar to a single-IMS environment. The TR exit routine receives control on the front-end IMS system, when the message is received from the terminal. The TR exit routine receives control on the back-end IMS system when the application program receives control and issues a CHNG or ISRT call to insert a message (PR).

Shared-Queues MSC Environment

The following occurs in a shared-queues MSC environment:

1. The TR exit routine receives control in the front-end IMS system when the transaction message is received from the terminal.
2. The PR exit routine receives control in the remote IMS system when the application program receives control and issues a CHNG or ISRT call.
3. The LR exit routine receives control in the remote IMS system when the transaction message is received on the MSC link (LR1), and then in the back-end IMS system when the response message is received on the MSC link (LR2).

Defining Entry Points

You can define the entry points and conditions for IMS to call the DFSMSCE0 exit routine by coding the user vector table macro (DFSMSCVT). In the front of the module, code the VECTOR=MSCVTABLE parameter in the DFSMSCSV macro to point to the resulting vector table. The DFSMSCVT macro supports 12 entry points that you can specify to select those conditions for which the exit routine is called (2 for IMS initialization and termination, and 10 entry points in the flow of TM message processing).

The entry points enable:

- Rerouting a message to a different destination name or IMS
- Requesting affinity processing (processing messages on the current IMS)
- Rejecting the message

The DFSMSCE0 user exit routine can change the routing of a message by setting flags and fields in the user parameter list that IMS passes to the exit routine. This parameter list is mapped by the DFSMSCEP macro, and then returned to IMS. The parameter list contains:

- Fields and flags to indicate IMS conditions, such as MSC or shared-queues system definition
- Information regarding the message, such as source and destination names and MSC system identifiers (SYSIDs) for routing control

Some of the information in the parameter list is for reference only, while other information can be changed to affect the rerouting of the message. See the DFSMSCEP macro, described in Table 126 on page 410 through Table 131 on page 412, for more information.

At any of the user exit entry points (other than the initialization or termination entry points), the exit routine can request a user prefix segment to be added to the message. If a user prefix is already obtained for this message by a previous call to the exit routine, IMS passes the address of the user prefix to the exit routine. The exit routine can reference or change the user prefix, but cannot delete it or change its length. This prefix can contain user routing information that can be passed to the other routing exit entry points to be used to reroute the message. After the user prefix is obtained, it remains appended to the message and is logged with the message (for example, a type 01 or type 03 message log record is mapped by the QLOGMSGP macro).

Related Reading: For more information on the user prefix, see “Using User Prefixes” on page 415.

For each routing request, the user exit routine is passed a 512-byte work area that is initialized to zeros and that the user exit routine can use as a work area, such as for creating a user prefix.

No IMS System Definition changes are needed to invoke the DFSMSCE0 exit routine, and MSC does not need to be available; however, several of the routing functions are only available for MSC messages. The DFSMSCE0 exit routine is loaded at IMS initialization, provided that the load module is link edited into IMS.SDFSRESL or a user library concatenated to IMS.SDFSRESL.

Authorization Checking

The exit call during link receive processing controls the level of authorization checking. The level of authorization is controlled by the field MSLRFL3 of the parameter list during link receive. IMS sets one of the flags in MSLRFL3 when calling the link receive entry points to indicate which level of security checking is active. If the message is a local transaction message, resetting or changing this flag will override the level of security to be performed for this message. Flag MSLRFL1 can be tested to determine if the message is a local transaction. The following parameters in the MSLRFL3 field specify the level of authorization:

- MSLR3MSN** Authorization by MSNAME. ACEE dynamically created for first authorization, then reused.
- The specification of MSLR3MSN causes the security environment based upon the MSNAME to be built the first time it is needed for an authorization check. Thereafter, the environment is saved and is reused for subsequent checking.
- MSLR3CTL** Authorization by CTL address space security. The specification of MSLR3CTL uses the security environment of the CTL address space that already exists.
- MSLR3USR** Authorization by user ID of input terminal. ACEE dynamically created and deleted for each authorization.
- The specification of MSLR3USR causes the security environment based upon the user ID of the input terminal (that entered the transaction) to be built each time it is needed for an authorization check.
- MSLR3XIT** Authorization by user exit (DFSCTRN0). MSLR3XIT can be specified by itself, or with either MSLR3MSN, MSLR3CTL, or MSLR3USR. The specification of MSLR3XIT causes DFSCTRN0 or DFSCTSE0 to be called, if they exist.
- MSLR3NON** No security authorization checking.
- MSLR3NON can only be specified without any of the other four options. The specification of MSLR3NON bypasses all security checking, and allows the use of the transaction destination.

MSLR3MSN, MSLR3CTL, and MSLR3USR are mutually exclusive. The use of MSLR3MSN, MSLR3CTL, or MSLR3USR causes RACF (or an equivalent product) to be called for authorization of the use of the transaction destination.

On entry, the MSLRFL3 field contains the system default value from MSCSEC=(,xxx) in the DFSDCxxx PROCLIB member. The exit can then override the system default, or leave it as is.

Attributes of the Routine

The TM and MSC Message Routing and Control user exit routine must be written as reentrant. The exit routine receives control while running in a 31-bit addressing mode, and must return control in that mode. The exit routine is called in TASK mode, with no locks held, and can be in cross memory, non_AR mode.

Table 124 shows the attributes of the TM and MSC Message Routing and Control User exit routine.

Table 124. TM and MSC Message Routing and Control User Exit Routine Attributes

Attribute	Description
IMS environments	DB/DC, DCCTL.
Naming convention	Must be named DFSMSCE0.
Binding	<p>Follow the guidelines described in "Binding the Routines" on page 7. This exit routine must be reentrant.</p> <p>The sample exit routine is a default routine. If you write your own exit routine, you must bind it with the IMS control region SDFSRESL.</p> <p>Link edit stand alone, NAME/ENTRY = DFSMSCE0, RMODE=ANY, AMODE=31, and Reentrant (RENT). Program routing entry points (DFSMSCVT ENTRYYP=PRCHNG, PRISRT) execute in cross-memory mode under the dependent region TCB. All other entry points execute under the control region TCB.</p>
Including the routine	IMS loads and initializes the exit if found in IMS.SDFSRESL or concatenated library. The module has 12 possible entry points selectable by the ENTRYYP = parameter of the DFSMSCVT macro coded in the module (see sample DFSMSCE0).
IMS callable services	See "Callable Services" on page 413.
Sample routine location	<p>Recommendation: Use the sample DFSMSCE0 exit routine that is shipped in IMS.ADFSSMPL and tailor it when first coding the user exit routine. This sample contains examples of the following:</p> <ul style="list-style-type: none"> • Routing messages, using all the supported routing options (by setting the appropriate flags and fields in the DFSMSCEP area). • Canceling messages. • Using the DFSMSCVT (entry vector table) macro and all 12 entry points. • Using the DFSMSCSV (save) macro to set up the entry environment. • Using the DFSMSCLV (leave) macro to return to IMS. • Chaining and using the 6 save sets that are passed to the exit routine. • Using the 512-byte work area to build a user prefix and requesting that IMS obtain a prefix buffer to build a prefix. • Storing information in the user prefix

Communicating with IMS

This section provides information about how to communicate with IMS using the DFSMSCE0 user exit routine.

Contents of Registers on Entry

Upon entry, the exit routine must save all registers using the provided save area. The registers contain the following:

Register	Contents
R1	Address of Standard IMS User Exit Parameter List (see Table 125)
R13	Address of save area
R14	Return address
R15	Address of entry point

Table 125 lists the parameters for DFSUSRX.

Table 125. Standard IMS User Exit Parameter List (DFSUSRX)

Field	Offset	Length	Content
A(PL VER)	00	4	Address of the Parameter List Version 4
A(Token)	04	4	Address of token (Callable Services token)
A(WORK)	08	4	Address of 512-byte work area
A(UserParm)	12	4	Address of user exit parameter list (see Table 126)
A(User Table)	16	4	Address of user table obtained as IMS initialization by DFSINTX0 exit.

The DFSMSCE0 user parameter list and field definitions are mapped by the DFSMSCEP macro (see Table 126).

Table 126. Main User Exit Parameter List Mapped by the DFSMSCEP Macro

Field	Offset	Length	Description
MSCEIMID	00	8	IMSID of this IMS
MSCEIMSR	08	1	Source IMS Release Number
MSCEIMSL	09	1	Source IMS Mod Level
MSCEPVER	10	2	DFSMSCEP Parameter List Version (current version=0001)
MSCEFL1	12	4	XL1 Main Flag1
MSCEFL2	13	4	XL1 Main Flag2
MSCEFL3	14	4	XL1 Main Flag3
MSCEFL4	15	4	XL1 Main Flag4
MSCEECB	16	4	Address of ECB
MSCESCD	20	4	Address of SCD
MSCESIDT	24	4	Address of SID_Table
MSCESEG	28	4	Address of MSG_Segment
MSCEUPR	32	4	Address of User_PFX_Seg
MSCEIPR	36	4	Address of IMS_PFX_Seg
MSCEUPRL	40	2	User_PFX_Len (Halfword)
MSCEIPRL	42	2	IMS_PFX_Len (Halfword)
MSCESSET	44	4	Address of Save_sets

Table 126. Main User Exit Parameter List Mapped by the DFSMSCEP Macro (continued)

Field	Offset	Length	Description
MSCEMSEB	48	4	Address of DFSMSCEB
	52	4	Reserved
MSCEUSID	56	8	User ID
MSCEGRPN	64	8	Group name
MSCEUSII	72	1	User ID indicator
	73	7	Reserved

The initialization entry parameter list and field definitions are mapped by the DFSMSCEP macro (see Table 127).

Table 127. Initialization Entry Parameters for User Exit Parameter List Mapped by the DFSMSCEP Macro

Field	Offset	Length	Description
MSINFL1	80	1	XL1 IN Flag1
MSINFL2	81	1	XL1 IN Flag2
MSINFL3	82	1	XL1 IN Flag3
MSINFL4	83	1	XL1 IN Flag4
	84	12	Reserved
	96		End of IMS initialization parameters

The termination entry parameter list and field definitions are mapped by the DFSMSCEP macro (see Table 128).

Table 128. Termination Entry Parameters for User Exit Parameter List Mapped by the DFSMSCEP Macro

Field	Offset	Length	Description
MSTEFL1	80	1	XL1 TE Flag1
MSTEFL2	81	1	XL1 TE Flag2
MSTEFL3	82	1	XL1 TE Flag3
MSTEFL4	83	1	XL1 TE Flag4
	84	12	Reserved
	96		End of IMS termination parameters

The terminal routing parameter list and field definitions are mapped by the DFSMSCEP macro (see Table 129).

Table 129. Terminal Routing Parameters for User Exit Parameter List Mapped by the DFSMSCEP Macro

Field	Offset	Length	Description
MSTRFL1	80	1	XL1 TR Flag1
MSTRFL2	81	1	XL1 TR Flag2
MSTRFL3	82	1	XL1 TR Flag3
MSTRFL4	83	1	XL1 TR Flag4

Table 129. Terminal Routing Parameters for User Exit Parameter List Mapped by the DFSMSCEP Macro (continued)

Field	Offset	Length	Description
MSTRDEST	84	8	DEST_NAME
MSTRSRCE	92	8	SRCE_NAME
MSTRLUNM	100	4	LU_NAME
MSTRMSGR	104	4	APPC_WORK
MSTRDMSN	108	8	MSNAME
MSTRDSID	116	2	Dest_SID
MSTRKEY	118	2	MSG_KEY
MSTRLTMN	120	8	OTMA Destination Override Name
	128		End of terminal routing parameters

The link receive parameter list and field definitions are mapped by the DFSMSCEP macro (see Table 130).

Table 130. Link Receive Routing Parameters for User Exit Parameter List Mapped by the DFSMSCEP Macro

Field	Offset	Length	Description
MSLRFL1	80	1	XL1 LR Flag1
MSLRFL2	81	1	XL1 LR Flag2
MSLRFL3	82	1	XL1 LR Flag3
MSLRFL4	83	1	XL1 LR Flag4
MSLRDEST	84	8	DEST_NAME
MSLRSRCE	92	8	SRCE_NAME
MSLRDMSN	100	4	DST_MSNAME
MSLRDSID	104	4	DEST_SID
MSLRSMSN	108	8	SRC_MSNAME
MSLRSSID	116	2	Source_SID
MSLRKEY	118	2	MSG_KEY
	120	10	Reserved
	130		End of link receive routing parameters

The program routing parameter list and field definitions are mapped by the DFSMSCEP macro (see Table 131).

Table 131. Program Routing Parameters for User Exit Parameter List Mapped by the DFSMSCEP Macro

Field	Offset	Length	Description
MSPRFL1	80	1	XL1 PR Flag1
MSPRFL2	81	1	XL1 PR Flag2
MSPRFL3	82	1	XL1 PR Flag3
MSPRFL4	83	1	XL1 PR Flag4
MSPRDEST	84	8	DEST_NAME

Table 131. Program Routing Parameters for User Exit Parameter List Mapped by the DFSMSCEP Macro (continued)

Field	Offset	Length	Description
MSPRSRCE	92	8	SRCE_NAME
MSPRDMSN	100	8	DST_MSNAME
MSPRDSID	108	2	DEST_SID
MSPRDMSN	110	8	DEST_MSNAME
MSPRSSID	118	2	Source_SID
MSPRSTAT	120	2	Status_Code
	122	10	Reserved
	132		End of program routing parameters

The DFSMSCEO exit routine is called with one caller save area in R13. Field MSCESSET in DFSMSCEP points to six preformatted save sets for the exit routine's use. The routine (INITSAV) in the sample exit routine (DFSMSCEO) chains these save sets to the caller save set and moves R13 to the first save set in MSCESSET. This allows the DFSMSCEO exit routine to call other routines and to pass a save set chain. When DFSMSCEO returns to IMS, the DFSMSCLV macro (Linkage=Yes) returns to the caller save set and restores registers.

Callable Services

Storage services and control block services can be performed by invoking IMS callable services. This exit routine can use callable services with the ECB passed at MSCEECB of the user exit PARMLIST.

This exit routine can use IMS Callable Storage Services. This exit routine is defined to IMS as an IMS standard user exit. Exit routines that are defined to IMS receive the callable services token in the standard exit parameter list. This exit routine does not need to issue an initialization call (DFSCSII0) to use IMS Callable Services.

The exit routine receives control at the following points: the Terminal Routing (TR) call, the Link Receive (LR) call, and the Program Routing (PR) call. In each situation, if the DFSMSCEO user exit routine is called (based on the DFSMSCVT vector entry) and obtains a user prefix, IMS attaches the prefix to the message and passes it on to other DFSMSCEO entry points.

The DFSMSCVT macro has the following syntax:

```
DFSMSCVT FUNC = VECTOR,ENTRYP = (INIT | TRBTAM | TRVTAM | TRAPPC | TROTMA | LRTRAN |
                                  LRLTERM | LRDIR | LRINT | PRCHNG | PRISRT | TERM)
```

For each entry point parameter selected by the DFSMSCVT macro, the exit routine must provide a label for the entry point, as shown in Table 132.

Table 132. Labels for Entry Point Parameters Selected by the DFSMSCVT Macro

Parameter	Label	Function/when called
1. INIT	IMS_INITIALIZATION	IMS initialization
2. TERM	IMS_TERMINATION	IMS Termination
3. TRBTAM	TERMINAL_ROUTING_BTAM	BTAM, SYS CON messages
4. TRVTAM	TERMINAL_ROUTING_VTAM	VTAM messages

Table 132. Labels for Entry Point Parameters Selected by the DFSMSCVT Macro (continued)

Parameter	Label	Function/when called
5. TRAPPC	TERMINAL_ROUTING_APPC	APPC messages
6. TROTMA	TERMINAL_ROUTING_OTMA	OTMA messages
7. LRTRAN	LINK_RECEIVE_LOCAL_TRANSACTION	Local tran messages
8. LRLTERM	LINK_RECEIVE_LOCAL_LTERM	Local LTERM messages
9. LRDIR	LINK_RECEIVE_LOCAL_DIRECT_ROUTING	Local DIR RTE messages
10. LRINT	LINK_RECEIVE_INTERMEDIATE	Intermediate messages
11. PRCHNG	PROGRAM_ROUTING_CHNG_CALL	Application program CHNG call
12. PRISRT	PROGRAM_ROUTING_ISRT_CALL	First message segment ISRT call

The DFSMSCVT macro parameters listed in Table 132 on page 413 have the following characteristics:

INIT entry point

Receives control at IMS initialization, immediately after the exit routine is loaded.

TERM entry point

Receives control at IMS termination when IMS is shutting down. The INIT and TERM entry points are not associated with a message.

The next 4 entry points are for the Terminal Routing (TR) user exit routine:

TRBTAM	Receives control for any message from a BTAM device.
TRVTAM	Receives control for any message from a VTAM device.
TRAPPC	Receives control for any message from a APPC/LU6.2 device.
TROTMA	Receives control for any message from an OTMA device.

The next 4 entry points are for the Link Receive (LR) user exit routine:

LRTRAN	Receives control when a message is received on an MSC link, and the destination is a local transaction in the received system.
LRLTERM	Receives control when a message is received on an MSC link, and the destination is a local LTERM in the received system.
LRDIR	Receives control when a direct-routed message is received for the local IMS system. The destination can be an LTERM or a transaction. Direct-routed messages are created by an application program running in a remote MSC system that inserts messages using directed routing (in other words, inserts messages to a PCB MSNAME destination).
LRINT	Receives control for any message received on an intermediate IMS system (in other words, a message received on an MSC link that is destined to another remote MSC system). This includes intermediate messages that are inserted by a remote IMS system using directed routing.

The next 2 entry points are for the Program Routing (PR) user exit routine:

PRCHNG	Receives control when an application program issues a CHNG call to a modifiable PCB.
PRISRT	Receives control when an application program issues the first ISRT call (first segment) to a modifiable PCB, non-modifiable PCB, or I/O PCB.

Coexistence of DFSMSCE0

The DFSMSCE0 user exit routine can co-exist with the other MSC routing exit routines (DFSCMTR0, DFSNPRT0, DFSCMLR0, and DFSCMPR0). If any of the terminal routing entry points are specified in the DFSMSCVT macro (TRBTAM, TRVTAM, TRAPPC, or TROTMA), DFSCMTR0 or DFSNPRT0 are not called. If any of the link receive entry points are coded (LRTRAN, LRLTERM, LRDIR, or LRINT), DFSCMLR0 and DFSCMLR1 are not called. If either of the program routing entry points are coded (PRCHNG or PRISRT), DFSCMPR0 is not called. This allows you to migrate older MSC routing exit routines to DFSMSCE0, replacing one exit routine at a time.

Restriction: New routing functions in DFSMSCE0 are not supported in the other MSC routing exit routines (DFSCMTR0, DFSNPRT0, DFSCMLR0, and DFSCMPR0), including the user message prefix support.

Using User Prefixes

Messages contain a variety of prefixes that IMS uses to route and process the message. These prefixes are mapped by the QLOGMSGP macro, and are in front of the message, before the user data segments. These prefixes are for internal IMS use. DFSMSCE0 can add a user prefix to this message. This prefix is mapped by the DFSMSCUP macro. The exit routine can build this prefix in one of two ways:

- Test the field MSCEUPR in DFSMSCEP for zero to see if a user prefix already exists. If not obtained (zero), build a prefix in the 512-byte work area by addressing some area in the work area that is large enough to hold the prefix. Set bytes 0 and 1 to the prefix length (5 to 512 bytes), storing the address back in MSCEUPR. The exit routine can then alter the user data portion of the prefix (bytes 4 to 512). When the exit routine returns control to IMS, IMS sets the prefix code (byte 2 = 8E) and the reserved flag (byte 3) and copies the prefix to the message.
- Test the field MSCEUPR in DFSMSCEP for zero to see if a user prefix already exists. If not obtained (zero), set flag MSCE2UPR=1 and field MSCEUPRL to the length of the requested prefix (5 to 512 bytes) and return to IMS. IMS obtains storage that is large enough for the user prefix and stores the address in MSCEUPR, resets flag MSCE2UPR, and returns control to the exit routine. The exit routine can then alter the user data portion of the prefix (bytes 4 to 512). When the exit routine returns control to IMS, IMS sets the prefix code (byte 2 = 8E) and the reserved flag (byte 3) and copies the prefix to the message, and then frees the original prefix storage.

Note: If the user prefix is obtained for the DFSMSCE0 exit, the size of that prefix should be considered along with the accumulated size of the other prefix items when calculating the record lengths for the short and long message queue records.

DFSMSCE0

Related Reading: For more information on MSGQUEUE macro message prefix sizes for each supported IMS release, see *IMS Version 9: Installation Volume 2: System Definition and Tailoring*.

Chapter 64. Transaction Authorization Exit Routine (DFSCTRNO)

This chapter describes the Transaction Authorization exit routine. The Transaction Authorization exit routine works with the Security Reverification exit routine (DFSCTSE0) and the Signon/off Security exit routine (DFSCSGN0) to check an individual user ID for authority to use a transaction.

Related Reading: See Chapter 56, “Security Reverification Exit Routine (DFSCTSE0),” on page 375 and Chapter 60, “Signon/off Security Exit Routine (DFSCSGN0),” on page 393 for more information on these exit routines and the transaction security they provide.

The following topics provide additional information:

- “About This Routine”
- “Communicating with IMS” on page 418

About This Routine

This exit routine can be used with or without RACF to verify that the user’s ID is authorized to run a transaction. If both the RACF option and the Transaction Authorization exit routine are selected in the IMS system definition, the exit is activated after RACF verifies the transaction. If the transaction request is rejected by RACF, the exit is not called. If the RACF option is not selected in the IMS system definition, this exit routine can be used to verify the user’s authorization and the password, if required, for that transaction.

The exit routine should have access to a table of valid user IDs, and the passwords and transactions associated with each valid user ID.

If you want to generate your own messages for the routine, you need to make the message number negative in register 15 to issue a specific message, and you need to list the absolute value of this message number in the User Message Table, DFSCMTU0. For details, see the description of the User Message Table presented in DFSCMTU0.

If you do not list this message in the User Message Table, message DFS060I is issued instead of the message you wanted to send.

Table 133 shows the attributes of the Transaction Authorization exit routine.

Table 133. Transaction Authorization Exit Routine Attributes

Attribute	Description
IMS environments	DB/DC, DCCTL.
Naming convention	You must name this exit routine DFSCTRNO.
Binding	Follow the guidelines described in “Binding the Routines” on page 7. The Security Reverification exit routine (DFSCTSE0) can be written as part of DFSCTRNO. See Chapter 56, “Security Reverification Exit Routine (DFSCTSE0),” on page 375 for more information about writing DFSCTSE0.
Including the routine	To implement this exit routine, specify TYPE=TRANEXIT in the SECURITY macro during Stage 1 input.

DFSTRN0

Table 133. Transaction Authorization Exit Routine Attributes (continued)

Attribute	Description
IMS callable services	To use callable services with this routine, you must issue an initialization call (DFSCSI0) to obtain the callable service token and a parameter list in which to build the function-specific parameter list for the desired callable service. Use the ECB in register 9 for the DFSCSI0 call. For details on using the initialization call, see “Step 2. Initializing IMS Callable Services (DFSCSI0)” on page 14. This exit is automatically linked to DFSCSI00 by IMS. No additional linking is required to use callable services.
Sample routine location	IMS.ADFSSMPL (member name DFSTRN0).

Communicating with IMS

IMS uses the entry and exit registers to communicate with the exit routine.

Contents of Registers on Entry

Upon entry to the exit routine, all registers must be saved using the save area provided. The registers contain the following:

Register	Contents
0	Register contents is dependent upon what is processed: To process a deferred program-to-program switch (R2 = 8), or DL/I CHNG call (R2 = C), then R0 = pointer to user ID (PSTUSID). To process receipt of a transaction received on an MSC link from a remote IMS system (R2 = 4), then R0 = pointer to user ID in the security prefix of the message. This exit routine is called when R2 = 4 depending on the MSCSEC parameter in DFSDCxxx and on the MSLRFL3 response in the DFSMSCE0 parameter list for Link Receive. For more information on the MSCSEC parameter, see <i>IMS Version 9: Installation Volume 2: System Definition and Tailoring</i> .
1	Address of the password or 0: For AUTH call, address of GENERIC class For TRAN call, address of TRAN class For FIELD call, address of FIELD class For DATABASE call, address of DATABASE class For SEGMENT call, address of SEGMENT class For OTHER call, address of OTHER class

Register	Contents																														
2	Calling routine number, as follows: <table border="0" style="margin-left: 2em;"> <thead> <tr> <th style="text-align: left;">Number</th> <th style="text-align: left;">Name</th> </tr> </thead> <tbody> <tr><td>X'0'</td><td>Transaction input from terminal</td></tr> <tr><td>X'4'</td><td>Transaction from remote MSC system</td></tr> <tr><td>X'8'</td><td>Deferred conversation program-to-program switch</td></tr> <tr><td>X'C'</td><td>CHNG DL/I call</td></tr> <tr><td>X'10'</td><td>/SET command</td></tr> <tr><td>X'14'</td><td>/LOCK command</td></tr> <tr><td>X'1C'</td><td>/RELEASE command</td></tr> <tr><td>X'20'</td><td>AUTH call</td></tr> <tr><td>X'24'</td><td>LU 6.2 AUTH call</td></tr> <tr><td>X'28'</td><td>Transaction input from OTMA</td></tr> <tr><td>X'2C'</td><td>/LOCK and /UNLOCK transaction</td></tr> <tr><td>X'30'</td><td>/LOCK and /UNLOCK program</td></tr> <tr><td>X'34'</td><td>/LOCK and /UNLOCK database</td></tr> <tr><td>X'38'</td><td>/LOCK and /UNLOCK LTERM</td></tr> </tbody> </table>	Number	Name	X'0'	Transaction input from terminal	X'4'	Transaction from remote MSC system	X'8'	Deferred conversation program-to-program switch	X'C'	CHNG DL/I call	X'10'	/SET command	X'14'	/LOCK command	X'1C'	/RELEASE command	X'20'	AUTH call	X'24'	LU 6.2 AUTH call	X'28'	Transaction input from OTMA	X'2C'	/LOCK and /UNLOCK transaction	X'30'	/LOCK and /UNLOCK program	X'34'	/LOCK and /UNLOCK database	X'38'	/LOCK and /UNLOCK LTERM
Number	Name																														
X'0'	Transaction input from terminal																														
X'4'	Transaction from remote MSC system																														
X'8'	Deferred conversation program-to-program switch																														
X'C'	CHNG DL/I call																														
X'10'	/SET command																														
X'14'	/LOCK command																														
X'1C'	/RELEASE command																														
X'20'	AUTH call																														
X'24'	LU 6.2 AUTH call																														
X'28'	Transaction input from OTMA																														
X'2C'	/LOCK and /UNLOCK transaction																														
X'30'	/LOCK and /UNLOCK program																														
X'34'	/LOCK and /UNLOCK database																														
X'38'	/LOCK and /UNLOCK LTERM																														
3	Address of storage area. For details of the format of this storage area, see the prolog in the sample routine (IMS.ADFSSRC; member name is DFSCTRNO).																														
7	Address of source CTB or zeros. <p>Recommendation: The contents of this register vary depending on the type of call to the exit routine and on the environment from which the call was made. It is recommended that applications not require the contents of this register for processing.</p>																														
9	Address of ITASK control block as follows: <table border="0" style="margin-left: 2em;"> <thead> <tr> <th style="text-align: left;">If Register 2 is</th> <th style="text-align: left;">Address of Register 9 will be</th> </tr> </thead> <tbody> <tr><td>X'0'</td><td>CLB</td></tr> <tr><td>X'4'</td><td>LLB</td></tr> <tr><td>X'8'</td><td>PST</td></tr> <tr><td>X'C'</td><td>PST</td></tr> <tr><td>X'10'</td><td>CLB</td></tr> <tr><td>X'14'</td><td>CLB</td></tr> <tr><td>X'1C'</td><td>CLB</td></tr> <tr><td>X'20'</td><td>PST</td></tr> <tr><td>X'24'</td><td>CLB</td></tr> <tr><td>X'28'</td><td>PST</td></tr> <tr><td>X'2C'</td><td>CLB</td></tr> <tr><td>X'30'</td><td>CLB</td></tr> <tr><td>X'34'</td><td>CLB</td></tr> <tr><td>X'38'</td><td>CLB</td></tr> </tbody> </table>	If Register 2 is	Address of Register 9 will be	X'0'	CLB	X'4'	LLB	X'8'	PST	X'C'	PST	X'10'	CLB	X'14'	CLB	X'1C'	CLB	X'20'	PST	X'24'	CLB	X'28'	PST	X'2C'	CLB	X'30'	CLB	X'34'	CLB	X'38'	CLB
If Register 2 is	Address of Register 9 will be																														
X'0'	CLB																														
X'4'	LLB																														
X'8'	PST																														
X'C'	PST																														
X'10'	CLB																														
X'14'	CLB																														
X'1C'	CLB																														
X'20'	PST																														
X'24'	CLB																														
X'28'	PST																														
X'2C'	CLB																														
X'30'	CLB																														
X'34'	CLB																														
X'38'	CLB																														
10	Address of transaction code or resource name.																														
11	Address of SCD.																														
13	Address of save area. The exit routine must not change the first three words.																														

Register	Contents
14	Return address to IMS.
15	Entry point of exit routine.

Contents of Registers on Exit

Upon return to IMS, all registers must be restored except for register 15, which must contain one of the following return codes to indicate the success or failure of the user's authorization to a transaction.

Return Code Meaning

0	Accept the transaction.
4	The resource is not protected.
8	The user is not authorized.
Positive	Reject the transaction and send DFS2469 message with register 15 halfword contents as a subcode if the transaction is entered from a terminal. The IMS system translates the subcode of message DFS2469 as follows:

Subcode Meaning

08	Transaction not authorized (user is not authorized).
12	RACF is not active.
16	Invalid exit return code.
36	No password (password reverification is required, but no password was supplied).
40	Wrong password (password reverification failed).
Others	IMS exit CD (subcode generated by IMS exit).

Negative For Resource Authorization:

User is authorized. The negative value is the complemented address that points to user data provided by RACF (AUTH call).

Negative For Transaction Authorization:

Reject the transaction and send a user-defined message number, if appropriate, to the user. If the calling routine is DFSCON10 or DFSDLA30, no message is sent, but an A4 status code is passed to the application program. The message number passed must be less than -24.

Chapter 65. Transaction Code (Input) Edit Routine (DFSCSMB0)

This chapter describes the Transaction Code (Input) Edit routine.

The following topics provide additional information:

- “About This Routine”
- “Communicating with IMS” on page 422
- “Using the Sample Transaction Code (Input) Edit Routine (DFSCSMB0)” on page 423

About This Routine

During system definition, IMS gives you the ability to specify one or more Input edit routines in the IMS control program nucleus. This allows you to edit input messages before they are enqueued for scheduling. When IMS is executed, this edit function is performed in addition to IMS Basic Edit or MFS (Message Format Service) editing. The edit routine is entered before translating to upper case. You can specify at system definition up to 255 editing routines and you can also specify, by transaction type, which edit routine is to be used.

The edit routine must store the edited message segment to be returned to IMS in the buffer addressed by register 1. If the input was processed by the IMS Basic Edit, this buffer is always 10 bytes greater than the 2-byte binary count at the beginning of the message segment, and the message segment can be expanded or reduced to any desired size. The format of the edited message segment in the buffer upon return to IMS must be two bytes of binary count followed by bytes 3 and 4 unchanged from the original message and edited text.

If the input was processed by MFS, the length of this buffer is in the first two bytes of the buffer. No extra space is provided in this buffer for edit routines.

This edit routine is called only when a transaction is entered from a terminal; it is not called when the transaction is inserted by a program-to-program switch or for LU 6.2 terminals.

If specified, an Input edit routine gains control after each message data segment is processed by Basic Edit or MFS. Transaction code validity and security will have already been checked. If the transaction code is the only data in the message segment and the transaction is a conversational transaction, an edit routine is not entered.

Table 134 shows the attributes of the Transaction Code (Input) Edit exit routine.

Table 134. Transaction Code (Input) Edit Exit Routine Attributes

Attribute	Description
IMS environments	DB/DC, DCCTL.
Naming convention	You must name this exit routine DFSCSMB0.
Binding	Follow the guidelines described in “Binding the Routines” on page 7.
Including the routine	No special steps are required to include this routine.

Table 134. Transaction Code (Input) Edit Exit Routine Attributes (continued)

Attribute	Description
IMS callable services	To use IMS Callable Services with this routine, you must do the following: <ul style="list-style-type: none"> • Issue an initialization call (DFSCSI0) to obtain the Callable Service token and a parameter list in which to build the function-specific parameter list for the desired callable service. For details on using the initialization call, see “Step 2. Initializing IMS Callable Services (DFSCSI0)” on page 14. • Use the ECB found in register 9 for the DFSCSI0 call. • Link DFSCSI00 with your user exit.
Sample routine location	IMS.ADFSSRC (member name DFSCSMB0).

Communicating with IMS

IMS uses the entry and exit registers to communicate with the exit routine.

Contents of Registers on Entry

Upon entry to the edit routine, all registers must be saved using the save area provided. The registers contain the following:

Register	Contents
1	Address of the buffer location of the input message segment after translation to EBCDIC and after IMS Basic Editing. The first two bytes of the buffer contain the binary message length. The third byte of the buffer is binary zeros. The binary count includes the 4-byte prefix. If Basic Edit is used, the fourth byte of the message segment (Z2) is X'00'. If MFS is used, the fourth byte can contain either a X'01', X'02', or X'03' signifying that option 1, 2, or 3 respectively was selected for the message by the format designer. The fifth byte contains the first byte of the message text. If the input was processed by MFS, the length of this buffer is in the first two bytes of the buffer. No extra space is provided in this buffer for edit routines.
7	CTB address of the physical terminal from which the message is entered.
9	Address of CLB for the communication line from which the message is entered.
10	Address of SMB.
11	Address of SCD.
13	Address of save area. The first three words must not be changed.
14	Return address to IMS.
15	Entry point of edit routine. The entry point name and load module name for an edit routine must be the same as the name used for the edit routine in system definition.

Contents of Registers on Exit

Upon return to IMS, all registers must be restored except for register 15, which must contain one of the return codes shown in the following table. Register 1 contains the message number if register 15 contains a value of 12; otherwise it is ignored. Any other value causes the message to be canceled and the terminal operator to be notified.

Return Code	Meaning
00	Segment is processed normally.

Return Code	Meaning
04	Segment is canceled.
08	Message is canceled and the terminal operator is notified.
12	Message is canceled and the message identified by register 1 is sent to the terminal.

Using the Sample Transaction Code (Input) Edit Routine (DFSCSMB0)

Assume a multisegment transaction named ICS. Normally, the first segment of this message contains ICS GN (meaning to get the next segment of a given message), or it contains ICS CAN (meaning to cancel this message). A user-supplied edit routine allows further input flexibility, as shown in the following decision table.

Segment	Message as Received and Edited by IMS	Message as Reedited by User Edit Routine
First Segment	ICS GN	As received
	ICS	ICS GN
	ICS CAN	Cancel Message
	Any other	Cancel Message
Other Segment	GN	As received
	CAN	Cancel Message
	Any other	Cancel Message

The Transaction Code edit routine allows the input for the ICS GN message segment to be shortened.

Chapter 66. Type 1 Automated Operator Exit Routine (DFSAOUE0)

You can write two types of automated operator (AO) exit routines. The AO exit routine described in this chapter is called a type 1 AO exit routine. It can be used in the DB/DC and DCCTL environments.

The other AO exit routine (DFSAOE00) is called a type 2 and can be used in the DB/DC, DCCTL, and DBCTL environments.

If both DFSAOUE0 and DFSAOE00 are provided in a DB/DC or DCCTL environment, DFSAOE00 is called first. DFSAOE00 determines which exit routine will handle the message, command, or command response.

Related Reading:

- DFSAOE00 is described in Chapter 31, “Type 2 Automated Operator Exit Routine (DFSAOE00),” on page 223.
- For an overview and comparison of the two AO user exit routines, see *IMS Version 9: Operations Guide*.

The following topics provide additional information:

“About This Routine”

“Activating This Routine” on page 433

“Communicating with IMS” on page 433

About This Routine

This AO exit routine is called continuously for system messages destined for the master terminal, operator-entered commands, and command responses. The AO exit routine intercepts these messages before IMS sends the system message, executes the command, or sends the command response. System messages destined for terminals other than the master terminal operator (MTO) and certain commands and command responses do not cause IMS to call this exit routine. (For more information, see “Types of Messages Not Passed to This Routine” on page 430.)

You can write the exit routine to handle both single and multisegment messages, and to perform the following functions:

- Ignore selected segments or an entire message.
- Send a copy of a system message, command, or command response to an alternate destination.
- Send a new message to an alternate destination for a system message, command, or command response.
- Change a system message.
- Change a system message and send a copy to an alternate destination.
- Change a copy of a command or command response and send the copy to an alternate destination.
- Delete a system message.
- Delete a system message and send a copy to an alternate destination.
- Request the edited command buffer (when the input is a command).

Table 135 shows the attributes for DFSAOUE0.

Table 135. Automated Operator Exit Routine Attributes (DFSAOUE0)

Attribute	Description
IMS environments	DB/DC, DCCTL.
Naming convention	You must name this exit routine DFSAOUE0.
Binding	DFSAOUE0 is a stand-alone, 31-bit module that you must provide. Recommendation: It is recommended, but not required, that the module be reentrant. You must manually link edit the routine with DFSCSI00 to include the routine. See “Binding the Routines” on page 7 for general guidelines on link editing exit routines.
Including the routine	You specify DFSAOUE0 by linking it in the IMS.SDFSRESL concatenation as a stand-alone module. DFSAOUE0 is then loaded and called. If you specify both DFSAOUE0 and DFSAOE00 (the other AO exit routine), both are loaded. DFSAOE00 is called first and can either process the message, command, or command response, or it can return a code indicating DFSAOUE0 should be called to do the processing instead.
IMS callable services	DFSAOUE0 can use callable services for storage and control block functions. To use callable services, issue an initialization call (DFSCSI00) to get the callable services token and a parameter list in which to build the function-specific parameter list for the callable service you want to use. Use the ECB found in register 9 for the DFSCSI00 call. For guidelines on using callable services, see “IMS Callable Services” on page 10.
Sample routine location	IMS.ADFSSMPL The AO exit routine can work with an AO application. The exit routine can insert a message to an alternate destination that is an AOI transaction without using an AO application. (For more information, see “Using the Sample AO Application (UETRANS)” on page 466.) The AO exit routine and the AO application used together serve as an example of how to use AOI.

Restrictions

The exit routine can change or delete system messages only. It can modify the copy of the system message that the original destination (the master terminal) receives. It can also modify the copy that an alternate destination receives. The exit routine **cannot** change or delete the original command or command response. It can modify the copy of a command or command response that is destined for an alternate destination, but it **cannot** change the copy that the primary destination receives.

Some transactions must reside on the same IMS subsystem as DFSAOUE0 to process correctly. If your installation uses shared-queues, define these local transactions as SERIAL to guarantee that they are processed on the local IMS subsystem. A transaction that is not defined as SERIAL can be processed on any IMS subsystem that has that transaction defined.

How This Routine Processes Messages

Figure 40 shows an AO exit routine intercepting a command entered from a master terminal.

1. The command is entered.
2. The command controller passes a copy of the command to the exit routine before executing the command. The exit routine can send a copy of the command to any destination (LTERM or transaction).
3. The exit routine returns to the command controller, where the command is executed.
4. When the response to the command is returned to the command controller, a message is generated for the master terminal.
5. Before the message is sent, the exit routine receives control and can route a copy of the message to any destination (LTERM or transaction).
6. The message is then sent to the master terminal.

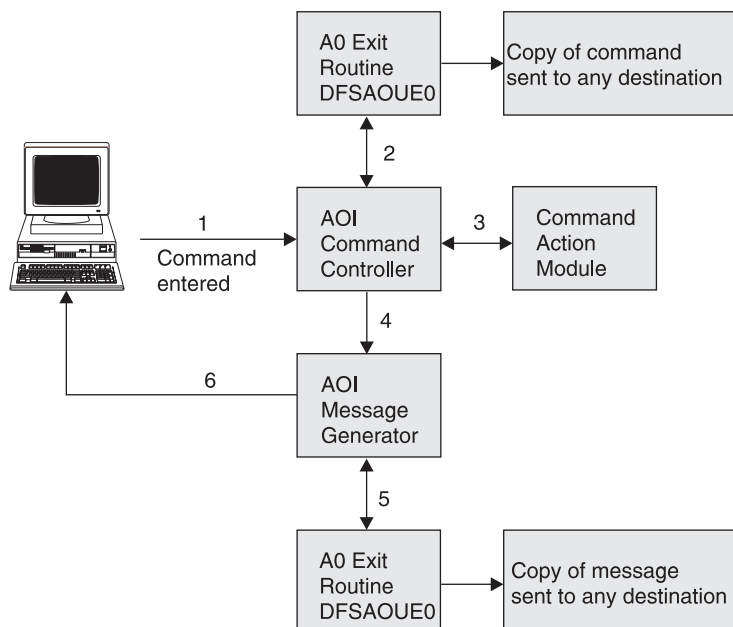

Figure 40. Processing When a Command is Entered at the Terminal

Figure 41 shows an exit routine processing a system message destined for the master terminal. When a system message is generated, the exit routine receives a copy of the message before the message is sent to the master terminal. The exit routine can route a copy of the message to any destination. It can alter or delete any segment of the message.

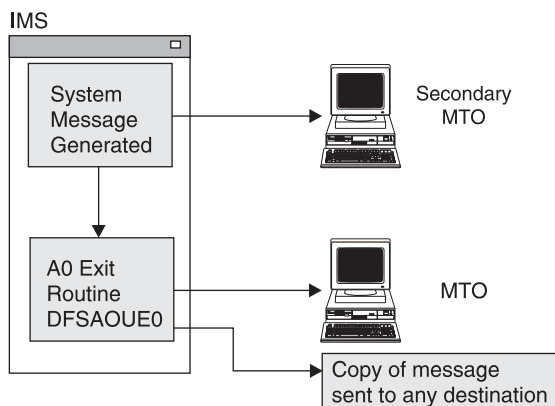

Figure 41. Processing When a System Message is Generated

A sample exit routine is described in Table 135 on page 426. The contents of the User Exit Header Block (UEHB) are described in “User Exit Header Block (UEHB)” on page 445.

Related Reading: If you use the exit routine with AOI transactions, refer to Part 5, “Automated Operator Program Interface,” on page 455 for more information on AOI.

Types of Messages Passed to This Routine

The following sections contain information about which messages are passed to the exit routine. IMS passes a copy of commands and command responses, and system messages destined for the master terminal. (For the format of a copy, see “Format of Message Segment Copies” on page 431.)

A message that is passed to the exit routine can contain multiple segments. For more information on how to write the exit routine to handle multisegment messages, see “Supporting Multisegment Messages” on page 431.

System Messages

A system message is a DFS message that is not a direct (synchronous) response to a command. IMS passes to the exit routine system messages that are destined for the master terminal. (If the system message is destined for the secondary master terminal or z/OS system console, IMS does not pass the exit routine a copy of the message.) Bit UEH1CPYP in the UEHFLG1 flag field of the UEHB (user exit header block) indicates that the input to the exit routine is a system message. In most cases, the first system message that causes IMS to call the exit routine is the DFS994 checkpoint message.

Related Reading: For more information, see *IMS Version 9: Messages and Codes, Volume 2*.

While IMS passes a system message destined for the master terminal, it can also send a copy of this message to the secondary master terminal or the z/OS system console. IMS sends this copy before passing the original message to the master terminal. The exit routine can only change the original message destined for the master terminal. The copy that the secondary master terminal or z/OS system console receives does not reflect any changes the exit routine makes to the original message.

Most system messages are single-segment messages. Some system messages are multisegment messages (such as DFS802, DFS970, DFS2503, and DFS3222).

Commands

IMS passes the exit routine a copy of each IMS command entered except:

- Internally generated commands.
- Commands issued by a CMD or ICMD call from an AO application.
- /FORMAT
- /LOOPTEST
- /MSVERIFY
- /RELEASE
- /NRESTART
- /ERESTART

IMS passes the command after basic edit and optional editing routines have had a chance to modify it. This modified input can contain carriage control characters.

Commands with Network-Qualified LU Names: If you use network-qualified LU names at your installation, the LU name can be 17 bytes long. For IMS commands, the network-qualified LU names must be enclosed in single quotes (for example, 'NETID.LUNAME').

If an IMS command with the network-qualified LU name is passed to the AO exit routine, IMS modifies the network-qualified LU name in the input command before the command is passed to the AO exit routine. The single quotes around the network-qualified LU name are replaced with blanks, and the period separating the network-identifier and the LU name is replaced with a colon.

Example: A /DISPLAY command with a network-qualified LU name entered at the terminal as:

```
/DISPLAY LUNAME 'NETWORK1.LUNAME1' LUNAME2 INPUT.
```

is passed to the AO exit routine or logged to the secondary master as:

```
/DISPLAY LUNAME NETWORK1:LUNAME1 LUNAME2 INPUT.
```

Command Responses

IMS passes a copy of command responses to the exit routine. A command response is a copy of the original response that IMS sent to the terminal that entered the command. Any asynchronous system message that IMS produces as a result of a command is **not** considered a command response, and is passed to the exit routine only if its destination is the master terminal (as is the case with all system messages that IMS passes to the exit routine). The exit routine can request that the edited command buffer be made available on the last entry by setting a flag in the UEHB (user exit header block). (For information on the use and format of this buffer, see “Viewing the Edited Command Buffer” on page 432.)

To receive a command response, the exit routine must handle multisegment messages and check for subsequent segments; this is because the first segment of a command response is considered the second segment of a command, even if the response has only one segment. Responses to the /DISPLAY, /RDISPLAY and /RMxxxx commands are multiple segment responses.

Changes the Command Editor Makes

The command editor translates certain control characters in any commands you enter from a terminal. You need to accommodate this translation when writing your exit routine.

The translation is shown in Table 136:

Table 136. Translation of Control Characters in Commands

From	To
X'14' Restore	X'5D' Right Parenthesis
X'15' New Line	X'40' Blank
X'24' Bypass	X'4D' Left Parenthesis
X'40' Blank	X'40' Blank
X'4B' Period	X'4B' Period
X'4D' Left Parenthesis	X'4D' Left Parenthesis
X'5D' Right Parenthesis	X'5D' Right Parenthesis
X'60' Dash	X'60' Dash
X'6B' Comma	X'6B' Comma
X'6D' Dash	X'40' Blank
X'7E' Equal	X'40' Blank

Types of Messages Not Passed to This Routine

IMS does not pass all system messages, operator-entered commands, and command responses to this exit routine. The following are messages that IMS does **not** pass to the exit routine:

- Messages resulting from a /BROADCAST command, other than the command and the initial response
- Messages associated with the /FORMAT, /LOOPTEST, /MSVERIFY, and /RELEASE commands and their responses
- Copies of system messages destined for the secondary master terminal or the z/OS system console
- Copies of message switches, messages inserted by application programs, or messages resulting from the /BROADCAST command
- All system messages, commands, and command responses **if** message queues are unavailable (which is possible when initializing, restarting, or shutting down IMS)

Single- and Multisegment Messages

The exit routine cannot determine from the first segment of a message whether it is a multisegment message or not. You can determine which messages are single-segment messages, and write the exit routine so that IMS only calls it once. This will enable your installation to avoid any overhead incurred when the exit routine is written to always test for subsequent segments. To handle those messages that are multisegment messages or for which you can't predetermine the number of segments, you can write the exit routine to request all remaining segments.

If you write the exit routine so that it doesn't differentiate between single and multisegment messages and always checks for remaining segments, IMS always calls it at least twice. A message segment can accompany the last entry to the exit routine when the message is a multisegment message. No segment is presented to the exit routine when the message is a single-segment message.

Supporting Multisegment Messages

Although most messages contain only one segment, some messages are multisegment messages. System messages DFS970 and the response to a /DISPLAY command are examples of multisegment messages. Even if a command response is a single-segment response, the exit routine must be written to handle multisegment messages; this is because a command always precedes a command response. If the exit routine does not check for subsequent segments, IMS does not pass the segments containing the command response.

You can write the exit routine so that IMS calls it for each segment of a message. If you write the exit routine to request the remaining segments, the exit routine is called at least twice for each message, even if the message has only one segment. In this case, the last entry to the exit routine is not accompanied by a segment; this is because the message is a single segment. If the message is a multisegment message, the exit routine is called for the subsequent segments. The exit routine must test for a segment the last time it is entered.

For subsequent entries to the exit routine for a multisegment message, bit UEH1SEG is set in the UEHBFLG1 field of the UEHB (user exit header block) when another segment is being presented. UEHCPYBF points to the next segment of the message.

The exit routine cannot necessarily tell which segment belongs to which message; this is because the presentation of segments associated with any one message can be interspersed with segments associated with a different message. The UEHB is unique for each message, and you can use the UEHURSVD field to keep track of which message IMS presents to the exit routine. (For more information, see “User Exit Header Block (UEHB)” on page 445.)

Format of Message Segment Copies

IMS uses the UEHB (user exit header block) to pass a copy of the message segment to the exit routine and places the address of that message segment in the UEHCPYBF field of the UEHB. The format of the copy of a system message, operator-entered command, or command response is shown in Figure 42.

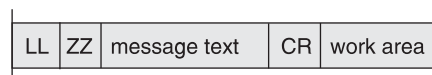

Figure 42. Message Segment Copy Format

The message segment copy contains the following fields:

- LL** 2-byte field containing the length of the message on first entry to the exit routine, not including the length of the 20-byte work area. (If your exit routine deletes or changes a message, or uses the work area, it must update this length field.)
- ZZ** 2-byte field reserved for IMS.
- message text** System message: The first segment of the message text begins with the DFSxxxx number, indicating which message caused IMS to call the exit routine. The message number is followed by the text of the system message. If it is a multisegment message, the remaining segments contain additional text, but do not contain the DFSxxxx message number.

Command: The message text is one segment long and begins with the delimiter '/', followed by the command.

Command response: The command response is usually a DFSxxxx message or one segment of a multisegment command.

- CR** Optional 1-byte field containing carriage control characters (for example, X'15'). Input commands do not include a carriage control character. If the CR field is included, one byte is included in LL.
- work area** A 20-byte work area added to the end of the system message, command, or command response; the exit routine can use this work area to communicate with the alternate destination for that segment.

Viewing the Edited Command Buffer

IMS expands certain commands and places this expanded view into the edited command buffer. You can examine this buffer by setting the appropriate exit registers.

One occasion for examining the buffer is when command processing exceptions occur, indicated by the DFS058 XXX COMMAND COMPLETED EXCEPT message. When a LINE, LINK, NODE, or PTERM keyword is used with inclusive or range parameters, or when a LINE, LINK, PTERM, or SUBSYS keyword is used with the ALL parameter, IMS expands the command in the edited command buffer to include the actual resource names or numbers, except for the /BROADCAST command. The PTERM ALL keywords are only expanded for the /PSTOP, /PURGE, /RSTART, /START, /STOP, and /MONITOR commands. When a NODE, LTERM, or USER keyword is used with a generic parameter and exceptions occur, IMS expands the edited command buffer with up to ten of the specific resource names that are invalid and that match the generic parameter.

Only parameter passwords (as in the /IAM command) are shown in the edited command buffer; command passwords are not shown.

Figure 43 shows the format of the edited command buffer.

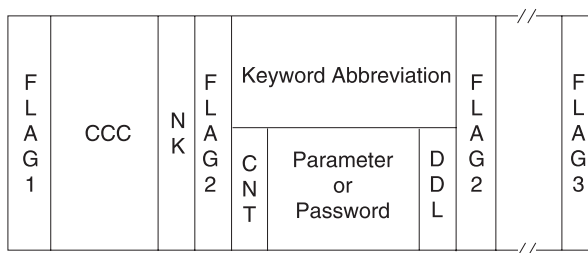

Figure 43. Edited Command Buffer

The fields contain the following:

FLAG1

Field containing one of the following flags:

- X'FE'—Beginning of the edited command.
- X'FC'—An error was found in a parameter and this flag was set by the command action modules (except for /IAM command processing).

CCC First 3 bytes of command.

NK Hexadecimal value of the number of keywords in the edited command buffer.

FLAG2

Field containing one of the following flags:

- X'FC'—Parameter that follows is in error.
- X'FF'—3-byte keyword abbreviation follows.
- X'FE'—Count (CNT) field and parameter follow.
- X'('—Count (CNT) field and password follow.

Keyword Abbreviation

Refer to DFSCKWD0 to obtain the abbreviation. In some cases, the abbreviation is the first three characters of the keyword.

CNT Number of characters in the parameter or password that immediately follow the CNT. (This CNT field is a 1-byte binary field.)

Parameter or Password

Parameter exactly as entered from the terminal.

DDL Delimiter entered after the parameter or password. If the ALL parameter is expanded to individual parameters, the delimiter is X'80'. If the parameter is generic, the delimiter is X'10'.

FLAG3

Period indicating the end of the command.

Activating This Routine

DFSAOUE0 is activated after IMS restart is complete. DFSAOUE0 is activated for each system message, command, and command response, as explained in previous sections.

When IMS shutdown processing has begun, DFSAOUE0 is disabled and no longer receives control.

Communicating with IMS

IMS communicates with this exit routine through the entry and exit registers, and the user exit header block (UEHB). IMS creates a UEHB for **each** message and passes it to the exit routine every time the exit routine is called for that message. Your exit routine can use the UEHURSVD field in the UEHB to store information about the message between each call to the exit routine for that message. The UEHB is freed and any values that were previously saved are lost when processing of the last segment of the message is complete. For the contents of key UEHB fields on entry and exit, see “Key UEHB Data Fields on Entry” on page 434 and “Key UEHB Data and Flag Fields on Exit” on page 436. See “User Exit Header Block (UEHB)” on page 445 for the UEHURSVD field and the entire UEHB.

Content of Registers on Entry

Upon entry, the exit routine must save all registers using the provided save area. The registers contain the following:

Register	Contents												
0	One of the following entry codes: <table border="1"> <thead> <tr> <th>Entry Code</th> <th>Meaning</th> </tr> </thead> <tbody> <tr> <td>0</td> <td>First (initial) entry to the exit routine for the message. A segment is always presented to the exit routine (and the UEH1SEG field in the UEHB is set) with this entry code. The buffer pointed to by the UEHCPYBF field contains the first segment of the message being processed. The flag in the UEHBFLG1 field indicates what kind of message it is.</td> </tr> <tr> <td>4</td> <td>Subsequent entry to the exit routine for the message. This entry code only applies to multisegment messages with three or more segments. The segment presented with this entry code is neither the first nor the last segment.</td> </tr> <tr> <td>8</td> <td>Last (final) entry to the exit routine for the message. This entry code only applies if the exit routine returned a return code of 0, 4, or 20 the last time it was called for this message (indicating that IMS continues to present the remaining segments to the exit routine).</td> </tr> <tr> <td>12</td> <td>Entry to exit routine after it requests storage. IMS passes the address of the buffer in the UEHUBUFF field. If storage is not available, UEHUBUFF contains 0 and the UEH1NSTG flag in the UEHBFLG1 field is set. The exit routine can attempt to get storage a second time, but if the second attempt is also unsuccessful, one of the following occurs: <ul style="list-style-type: none"> • If IMS is processing a command, it aborts further processing of this command. • If IMS is processing a system message, it examines the size of the requested storage. If the size requested is greater than twice the value of UEHCPYSZ (the size of the current segment plus 20 bytes), IMS terminates the exit routine for that message. If the size is equal to or less than this value, the exit routine waits for the storage to become available. </td> </tr> <tr> <td>16</td> <td>No message is presented to the exit routine. IMS aborted command processing because of errors in the command. IMS issues error messages, termination messages, or both. Command responses that have been built and passed to the exit routine are canceled. A new response is built if the error is encountered while a /DISPLAY command response is being built.</td> </tr> </tbody> </table>	Entry Code	Meaning	0	First (initial) entry to the exit routine for the message. A segment is always presented to the exit routine (and the UEH1SEG field in the UEHB is set) with this entry code. The buffer pointed to by the UEHCPYBF field contains the first segment of the message being processed. The flag in the UEHBFLG1 field indicates what kind of message it is.	4	Subsequent entry to the exit routine for the message. This entry code only applies to multisegment messages with three or more segments. The segment presented with this entry code is neither the first nor the last segment.	8	Last (final) entry to the exit routine for the message. This entry code only applies if the exit routine returned a return code of 0, 4, or 20 the last time it was called for this message (indicating that IMS continues to present the remaining segments to the exit routine).	12	Entry to exit routine after it requests storage. IMS passes the address of the buffer in the UEHUBUFF field. If storage is not available, UEHUBUFF contains 0 and the UEH1NSTG flag in the UEHBFLG1 field is set. The exit routine can attempt to get storage a second time, but if the second attempt is also unsuccessful, one of the following occurs: <ul style="list-style-type: none"> • If IMS is processing a command, it aborts further processing of this command. • If IMS is processing a system message, it examines the size of the requested storage. If the size requested is greater than twice the value of UEHCPYSZ (the size of the current segment plus 20 bytes), IMS terminates the exit routine for that message. If the size is equal to or less than this value, the exit routine waits for the storage to become available. 	16	No message is presented to the exit routine. IMS aborted command processing because of errors in the command. IMS issues error messages, termination messages, or both. Command responses that have been built and passed to the exit routine are canceled. A new response is built if the error is encountered while a /DISPLAY command response is being built.
Entry Code	Meaning												
0	First (initial) entry to the exit routine for the message. A segment is always presented to the exit routine (and the UEH1SEG field in the UEHB is set) with this entry code. The buffer pointed to by the UEHCPYBF field contains the first segment of the message being processed. The flag in the UEHBFLG1 field indicates what kind of message it is.												
4	Subsequent entry to the exit routine for the message. This entry code only applies to multisegment messages with three or more segments. The segment presented with this entry code is neither the first nor the last segment.												
8	Last (final) entry to the exit routine for the message. This entry code only applies if the exit routine returned a return code of 0, 4, or 20 the last time it was called for this message (indicating that IMS continues to present the remaining segments to the exit routine).												
12	Entry to exit routine after it requests storage. IMS passes the address of the buffer in the UEHUBUFF field. If storage is not available, UEHUBUFF contains 0 and the UEH1NSTG flag in the UEHBFLG1 field is set. The exit routine can attempt to get storage a second time, but if the second attempt is also unsuccessful, one of the following occurs: <ul style="list-style-type: none"> • If IMS is processing a command, it aborts further processing of this command. • If IMS is processing a system message, it examines the size of the requested storage. If the size requested is greater than twice the value of UEHCPYSZ (the size of the current segment plus 20 bytes), IMS terminates the exit routine for that message. If the size is equal to or less than this value, the exit routine waits for the storage to become available. 												
16	No message is presented to the exit routine. IMS aborted command processing because of errors in the command. IMS issues error messages, termination messages, or both. Command responses that have been built and passed to the exit routine are canceled. A new response is built if the error is encountered while a /DISPLAY command response is being built.												
1	Address of the UEHB. (See 434 and 436 for key entry and exit fields. See 445 for the meaning and location of all UEHB fields.)												
7	Address of the communication terminal block (CTB).												
9	Address of the communication line block (CLB) or partition specification table (PST).												
11	Address of the system contents directory (SCD).												
13	Address of the save area. The exit routine must not change the first three words. For external requests, the exit routine can chain down one save area to obtain the next available save area.												
14	Return address to IMS.												
15	Entry point of exit routine.												

Key UEHB Data Fields on Entry

The following are key UEHB entry fields. For the meaning and location of these and other fields in the UEHB, see 445.

UEHCPYBF	Address of the copy of the message IMS passed to the exit routine. If the UEH1SEG flag is set, the buffer contains a pointer to a copy of the message. If the UEH1CPYP flag in the UEHBFLG1 field is set, the buffer contains a copy of the first segment of a system message. If the UEH1CMD flag is set, the buffer contains a copy of the first segment of a command. If the UEH1CMD flag is set and the entry code is non-0, this field contains a copy of a segment of a command response.
UEHECMD	Address of the edited command buffer if this is the final entry to the exit routine and the UEH1ECMD flag in the UEHBFLG1 field was set (requesting the edited command buffer) the first time IMS called the exit routine.
UEHUBUFF	Address of an additional storage buffer, if the exit routine requests storage. If additional storage was not available, this field contains 0, and the UEH1NSTG flag in the UEHBFLG1 field is set.

Content of Registers on Exit

Before returning to IMS, the exit routine must restore all registers except for registers 0, 1, and 15, which contain the following:

Register	Contents
0	<p>If register 15 contains a return code of 0 or 8 (and your exit routine sets the destination for the first time or changes it), this register contains the address of the alternate destination name. The alternate destination can be a transaction or an LTERM. The alternate destination name must be 8 bytes, left-justified with blanks. If the alternate destination is not a valid transaction or LTERM and the Extended Terminal Option (ETO) is set, a dynamic LTERM is created. (For more information on the ETO feature, see the <i>IMS Version 9: Administration Guide: Transaction Manager</i>.)</p> <p>If register 15 contains a return code of 16 (requesting additional storage), this register contains the size of storage requested for the user buffer.</p> <p>If the alternate destination was set with a previous return code of 0 (and your exit routine does not change it), this register contains 0.</p>
1	<p>If register 15 contains a return code of 0 or 8, this register contains the address of the segment to insert to the alternate destination or register 1 contains 0 to enqueue a previously inserted segment. If the segment to be inserted is the final segment, register 1 must contain the address of the message segment.</p> <p>If the segment is longer than the original segment (such as when your exit routine changes a message), and the device associated with the LTERM does not support the segment length, the terminal device can truncate the segment.</p>
15	One of the following return codes:

Register	Contents	Return Code	Meaning
0			Insert the segment to the alternate destination and continue presenting the remainder of the segments to the exit routine.
4			Do not insert the segment to an alternate destination. The exit routine can change the segment, or it can set the segment length to 0 to delete the segment. IMS continues to present remaining segments to the exit routine, which it can also change or delete.
8			<p>If register 0 contains 8 on entry, this return code causes all previously inserted segments to be enqueued.</p> <p>If register 1 contains 0, this return code instructs IMS to enqueue the previously inserted segments to the alternate destination (not to insert new segments). Processing is considered complete.</p> <p>If register 1 contains the address of the segment to insert, this return code instructs IMS to insert the current segment, if there is one, to the alternate destination and enqueue all inserted segments. Even if there are additional segments, this return code indicates that the remaining segments are not to be presented to the exit routine. Processing is considered complete.</p>
12			Cancel any segment already inserted to the alternate destination and indicate processing is complete.
16			Cancel any segment already inserted to the alternate destination and indicate processing is complete.
20			Cancel all prior segments inserted to an alternate destination and continue presenting the remainder of the segments to the exit routine.

IMS checks to make sure that the return codes and alternate destination name are valid. If an invalid return code or an invalid alternate destination is returned, the exit routine is disabled for the remainder of the segments and is not called. IMS sends a trace record and a DFS2180I AUTOMATED OPERATOR USER EXIT ERROR - CODE=x message to the master terminal.

Key UEHB Data and Flag Fields on Exit

The following are key UEHB exit fields. For the meaning and location of these and other fields in the UEHB, see 445.

UEHCPYBF

Address of buffer that contains a copy of the segment going to the master terminal if a system message is being processed. If the exit routine changes the length of the segment in UEHCPYBF, the LL field must also be changed to reflect the new length. The LL field can be increased by up to 20 bytes or can be set to 0 (to delete the system message destined for the master terminal).

UEH1ECMD

Flag in the UEHBFLG1 field indicating that the exit routine requests the edited command buffer. The exit routine must set this flag the first time it is called.

UEHURSVD

The 20 bytes of storage reserved for the exit routine. The exit routine can use UEHURSVD to save the message being processed, entry codes, or flags between each invocation of the exit routine for a particular message.

Messages Inserted to Transactions by This Routine

When an AO application obtains a message that was inserted by the exit routine by issuing a GU call, the application I/O PCB contains an input LTERM name. IMS determines the LTERM name as follows:

- If IMS calls the exit routine because of a system message, the input LTERM name is the master terminal name.
- If IMS calls the exit routine because of command input, the input LTERM name is the LTERM that entered the command.

Restriction: In a shared-queues environment, transactions that must be processed by the local IMS subsystem must be defined as SERIAL to process correctly. A transaction that is not defined as SERIAL can be processed on any IMS subsystem that has that transaction defined.

AO Functions and How to Implement Them

You can write this exit routine to perform a number of functions. The following sections describe how to use the functions supported by the exit routine as listed in “About This Routine” on page 425. You can use this example as a guideline for writing your own exit routine. This example shows how to perform each of the functions on all segments of a multisegment message. You can write the exit routine to support only single-segment messages. This example requests a user buffer for some of the functions in which to store a copy of the message segment. You can use a different storage area to store a copy of the message segment. The functions and register contents are summarized in Table 137 on page 442 and Table 138 on page 443.

Ignore Selected Segments or an Entire Message

The exit routine is called for system messages destined for the master terminal, operator-entered commands, and command responses regardless of whether the exit routine is interested in the message. If the exit routine is not interested in the message segment, it can set the exit registers to ignore them and resume processing. The segment is ignored by setting the following register:

Register 0 on entry	Registers on exit
0	Register 15 = 12

Send Copy of Message to Alternate Destination

You can write the exit routine so that IMS sends a copy of a system message destined for the master terminal, an operator-entered command, or a command response to an alternate destination in addition to the original destination. For the first entry to the exit routine, insert the segment to the alternate destination and request remaining segments, if there are any, by setting the following register:

Register 0 on entry	Registers on exit
0	Register 0 = address of alternate destination name
	Register 1 = address of message (UEHCPYBF)
	Register 15 = 0

For subsequent entries that are not the last entry, insert the segment to the alternate destination and request remaining segments by setting the following register:

Register 0 on entry

4

Registers on exit

Register 0 = address of alternate destination name

Register 1 = address of message (UEHCPYBF)

Register 15 = 0

For the last entry to the exit routine, insert the segment to the alternate destination, enqueue all of the segments, and indicate that processing is complete by setting the following register:

Register 0 on entry

8

Registers on exit

Register 0 = address of alternate destination name

Register 1 = address of message (UEHCPYBF)

Register 15 = 8

Send New Message to Alternate Destination

You can write the exit routine to send a new message to an alternate destination for each system message, operator-entered command, or command response that is passed to the exit routine. The original message proceeds to its destination unchanged, and a completely new message is sent to an alternate destination.

For the first entry to the exit routine for this message, the exit routine must request the storage in which to build each segment of the new message. The buffer requested during this initial entry must be large enough to fit the largest message segment you plan to send. The exit routine cannot request additional storage during subsequent entries for this message. Request enough storage for a message segment by setting the following register:

Register 0 on entry

0

Registers on exit

Register 0 = size of message segment

Register 15 = 16

For the next entry to the exit routine after successfully getting storage for this message segment, move the first segment of the new message to the user buffer (UEHUBUFF), and set the message length in the first 2 bytes. Insert the message segment to the alternate destination and request remaining segments, if any, by setting the following register:

Register 0 on entry

12

Registers on exit

Register 0 = address of alternate destination name

Register 1 = address of message segment (UEHUBUFF)

Register 15 = 0

For subsequent entries that are not the last entry, move the next segment of the new message into the user buffer. The user buffer is reused for each segment of the message. Set the message length in the first 2 bytes of the user buffer. Insert the message segment to the alternate destination and request the remaining message segments by setting the following register:

Register 0 on entry

4

Registers on exit

Register 0 = address of alternate destination name
 Register 1 = address of message segment (UEHUBUFF)
 Register 15 = 0

For the last entry to the exit routine for this message, move the last segment of the new message into the user buffer. Set the message length in the first 2 bytes. Insert the segment to the alternate destination, and indicate that processing is complete by setting the following register:

Register 0 on entry

8

Registers on exit

Register 0 = address of alternate destination name
 Register 1 = address of message segment (UEHUBUFF)
 Register 15 = 8

Change System Message Text

The original text of a system message destined for the master terminal can be changed. The system message that is passed to the exit routine includes 20 bytes that are added to the end of the message. The exit routine can use these 20 bytes. Changes to the system message are limited to the original message length, plus 20 bytes. If the changed message includes the 20-byte area provided at the end, the exit routine must increment the message length field by 20. (The exit routine cannot change original command and command response messages, but it can change a copy of these messages. For more information, see "Change Message Text and Send to Alternate Destination.")

For each entry to the exit routine for this message, change the system message text. For the first entry to the exit routine, allow the changed segment to proceed to its master terminal destination and request remaining message segments by setting the following register:

Register 0 on entry

0 or 8

Registers on exit

Register 15 = 4

Change Message Text and Send to Alternate Destination

The exit routine can change the copy of a system message destined for the master terminal and send the changed message to both the master terminal and an alternate destination. (If the copies sent to the master terminal and the alternate destination are different, your exit routine needs to request storage for the user buffer for the copy sent to the alternate destination.) The exit routine cannot change the copy of the command or command response that is in the copy buffer.

The copy of the message passed to the exit routine has an additional 20 bytes added to the end, which the exit routine can use. Changes to the message are limited to the original message length, plus this 20 bytes. If the changed message includes the 20-byte area, the exit routine must increment the message length field by 20.

For the first entry to the exit routine for this message, change the message text. If the changed message includes the 20-byte area provided at the end, increment the message length field by 20. Insert the segment to an alternate destination, and

request the remaining segments by setting the following register:

Register 0 on entry	Registers on exit
0	Register 0 = address of the alternate destination name Register 1 = address of the message (UEHCPYBF) Register 15 = 0

For subsequent entries that are not the last entry, change the message segment text. If the changed message includes the 20-byte area provided at the end, increment the message length field by 20. Insert the message segment, and send it to an alternate destination by setting the following register:

Register 0 on entry	Registers on exit
4	Register 0 = address of the alternate destination name Register 1 = address of the message (UEHCPYBF) Register 15 = 0

For the last entry to the exit routine for this message, change the message text. If the changed message includes the 20-byte area provided at the end, increment the message length field by 20. Insert the segment to an alternate destination, enqueue all of the segments, and indicate that processing is complete by setting the following register:

Register 0 on entry	Registers on exit
8	Register 0 = address of the alternate destination name Register 1 = address of the message (UEHCPYBF) Register 15 = 8

Delete System Message to MTO

Your exit routine can delete a system message segment that is destined for the master terminal. (It cannot delete commands and command responses.) Delete a segment by setting the length field in the message buffer (the first two bytes) to 0.

For the first entry to the exit routine for the message, set the length field of the message to 0, and obtain the second segment by setting the following register:

Register 0 on entry	Registers on exit
0	Register 15 = 4

For subsequent entries that are not the last entry, set the length field of the message to 0, and obtain the next segment by setting the following register:

Register 0 on entry	Registers on exit
4	Register 15 = 4

For the final entry to the exit routine for the message, set the length field of the message to 0, and indicate that processing is complete by setting the following register:

Register 0 on entry
8

Registers on exit
Register 15 = 12

Delete System Message to MTO and Send Copy to Alternate Destination

Your exit routine can delete a system message destined for the master terminal and send a copy to an alternate destination instead. (It cannot delete commands and command responses.) Before deleting the system message, the exit routine must request storage for a user buffer in which to put a second copy of the message. Your exit routine must request enough storage to fit the largest segment of the message.

For the first entry to the exit routine for the system message, your exit routine can request storage by setting the following register:

Register 0 on entry
0

Registers on exit
Register 0 = size of the largest message segment
Register 15 = 16

For the next entry after successfully getting storage for the largest message segment, move the first segment of the message from UEHCPYBF into the user buffer (UEHUBUFF), including the length in the first 2 bytes. Delete the message destined for the master terminal by setting the length field of the message segment pointed to by UEHCPYBF to 0. Insert the message copy to the alternate destination, and request the next segment by setting the following register on exit:

Register 0 on entry
12

Registers on exit
Register 0 = address of the alternate destination name
Register 1 = address of message segment (UEHUBUFF)
Register 15 = 0

For the last entry to the exit routine for this message, move the last segment of the message into the user buffer. The user buffer is reused for each segment of the message. Delete the last segment destined for the master terminal by setting the length field of the message segment pointed to by UEHCPYBF to 0. Insert the last segment, enqueue the entire message, and indicate that processing is complete by setting the following register on exit:

Register 0 on entry
8

Registers on exit
Register 0 = address of alternate destination name
Register 1 = address of the message segment (UEHUBUFF)
Register 15 = 8

Request the Edited Command Buffer

Your exit routine can request the edited buffer that was created for an input command. (For the format of the command buffer, see Figure 43 on page 432.)

On first entry, request the edited command buffer by setting flag UEH1ECMD on in the UEHBFLG1 field. Request the next command response segment by setting the following register on exit:

Register 0 on entry
0

Registers on exit
Register 15 = 4

For subsequent entries that are not the last entry to the exit routine for this command response, continue requesting the next command response segment by setting the following register on exit:

Register 0 on entry
4

Registers on exit
Register 15 = 4

For the last entry to the exit routine for this command response message, the UEHECMD field contains the address of the edited command buffer. If the edited command buffer is not available (such as when there are command syntax errors), the UEH1CBNA flag is set in the UEHBFLG1 field, and the UEHECMD field contains 0.

Setting Up the Exit Registers

The following figures describe how to set up exit registers to perform certain functions for single- and multisegment messages. (Each function is described in greater detail in “AO Functions and How to Implement Them” on page 437.) Refer to both figures if you are writing your exit routine to support single- and multisegment messages. If you can identify which messages are single-segment messages and which are multisegment messages, you can write the exit routine to handle each type differently. (For more information on these messages, see “Single- and Multisegment Messages” on page 430.)

Single Segment Messages

Table 137 shows how to set up registers on exit for single-segment messages. If your exit routine only examines single-segment messages, or if you can identify which messages are single segment messages (and can use this logic), you can use the information in this figure to write your exit routine.

Table 137. Exit Functions for Single Segment Messages

Function	UEHCPYBF		Register 0 on exit	Register 1 on exit	Register 15 on exit
	Register 0 on entry	Length Field on exit			
Ignore entire message	0				12
Send copy of message segment to alternate destination	0		Address of alternate destination name	Address of message (UEHCPYBF)	8
Send new message to alternate destination	0		Size of message		16
	12		Address of alternate destination name	Address of message (UEHUBUFF)	8
Change system message	0	Length + 20			8

Table 137. Exit Functions for Single Segment Messages (continued)

Function	UEHCPYBF		Register 0 on exit	Register 1 on exit	Register 15 on exit
	Register 0 on entry	Length Field on exit			
Change message segment and send to alternate destination	0	Length + 20	Address of alternate destination name	Address of message (UEHCPYBF)	8
Delete system message to master terminal	0	0			8
Delete system message to master terminal and send copy to alternate destination	0 12	0	Size of message Address of alternate destination name	Address of message (UEHUBUFF)	16 8

Multisegment Messages

Table 138 shows how to set up the registers on exit for multisegment messages. If your exit routine examines multisegment messages, or if you can identify which messages are multisegment messages (and can use this logic), you can use the information in this figure to write your exit routine.

Table 138. Exit Functions for Multisegment Messages

Function	UEHCPYBF		Register 0 on exit	Register 1 on exit	Register 15 on exit
	Register 0 on entry	Length Field on exit			
Ignore entire message	0				12
Send copy of message to alternate destination for each segment	0		Address of alternate destination name	Address of message (UEHCPYBF)	0
	4		Address of alternate destination name	Address of message (UEHCPYBF)	0
	8		Address of alternate destination name	Address of message (UEHCPYBF)	8

Table 138. Exit Functions for Multisegment Messages (continued)

Function	UEHCPYBF		Register 0 on exit	Register 1 on exit	Register 15 on exit
	Register 0 on entry	Length Field on exit			
Send new message to alternate destination for each segment	0			Size of storage to get for largest message segment	16
	12			Address of alternate destination name	Address of message segment (UEHUBUFF) with length field set
	4			Address of alternate destination name	Address of message segment (UEHUBUFF) with length field set
	8			Address of alternate destination name	Address of message segment (UEHUBUFF) with length field set
Change each segment of system message	0	Length + 20			4
	8	Length + 20			4
Change each segment of a message and send to alternate destination	0	Length + 20		Address of alternate destination name	Address of message (UEHCPYBF)
	4	Length + 20		Address of alternate destination name	Address of message (UEHCPYBF)
	8	Length + 20		Address of alternate destination name	Address of message (UEHCPYBF)
Delete each segment of system message to master terminal	0	0			4
	8	0			12

Table 138. Exit Functions for Multisegment Messages (continued)

Function	UEHCPYBF				
	Register 0 on entry	Length Field on exit	Register 0 on exit	Register 1 on exit	Register 15 on exit
Delete each system segment to master terminal and send copy to alternate destination	0		Size of storage to get for largest message segment		16
	12	0	Address of alternate destination name	Address of message segment (UEHUBUFF)	0
	8	0	Address of alternate destination name	Address of message segment (UEHUBUFF) with length field set	8
Request the Edited Command Buffer	0				4
	4				4
	8				12

User Exit Header Block (UEHB)

The UEHB contains the following data and flag fields. Table 139 indicates the field name, length in bytes, and description of the data fields, and it indicates the field name, hexadecimal value, and meaning of the flag fields. (For more high-level information on the UEHB's use, see "Communicating with IMS" on page 433.)

Data and flag fields in the UEHB can be grouped into one of three categories, depending on how the exit routine can use them.

Modifiable

The exit routine can change these fields to communicate with IMS or to use as a work field.

Read only

The exit routine can read but not modify these fields.

Reserved

The exit routine cannot use these fields. They are reserved for use by IMS.

Table 139. UEHB Field Descriptions

Field	Length/Value	Description
UEHSRCE	4 bytes	Address of source CNT. Usage = read only. This field points to the source LTERM of the message segment. For a system message, the source is the master LTERM. For a command, the source is the LTERM where the command was entered.

Table 139. UEHB Field Descriptions (continued)

Field	Length/Value	Description
UEHDEST	4 bytes	Address of destination CNT. Usage = read only. This field points to the destination of message segment. This is the destination of the 'presented' message segment, not the alternate destination that the exit routine can define.
UEHUBUFF	4 bytes.	Address of user buffer. Usage = read only. The buffer pointed to by this field is acquired when the exit routine returns a return code of 16 in register 15. The buffer can contain a copy of a message to be inserted to an alternate destination. If the buffer contains a copy of a message, the exit routine must update the 2-byte length field. If there is no message in the buffer, the length field is not necessary.
UEHCPYBF	4 bytes	Address of exit routine copy buffer. Usage = read only. The buffer pointed to by this field contains a copy of the system message segment, command, or command response that IMS passes to the exit routine. This area is the size of the message segment + 20 bytes (for modification). The first two bytes are the length field. For each entry to the exit routine, IMS reuses the copy buffer if the buffer created for a prior call is greater than or equal to the size that the current call requires. Otherwise, IMS frees the prior buffer and creates a new one.
UEHECMD	4 bytes	Address of edited command buffer. Usage = read only. On last entry to the exit routine, this field contains the address of the edited command buffer if the UEH1ECMD flag in the UEHBFLG1 field was set during the first entry to the exit routine for the message.
UEHIPCB	4 bytes	Address of input PCB. Usage = reserved.
UEHIWRK1	4 bytes	Internal work area. Usage = reserved.
UEHIWRK2	4 bytes	Internal work area. Usage = reserved.
UEHIWRK3	4 bytes	Internal work area. Usage = reserved.
UEHBMODN	8 bytes	MFS MOD name. Usage = modifiable. The MFS MOD name sent with the message to the alternate destination that the exit routine specifies.
UEHPOPCB	28 bytes	Alternate PCB. Usage = reserved. Used for either AO transaction or any other transaction or LTERM destination that the AO specifies.
UEHSCPCB	28 bytes	Secondary master PCB. Usage = reserved.
UEHCPYSZ	2 bytes	Size of UEHCPYBF copy buffer. Usage = reserved.

Table 139. UEHB Field Descriptions (continued)

Field	Length/Value	Description
UEHLINE	4 bytes	Line number. Usage = read only. BTAM line number (in binary) or 0. If a command was entered, this is the line number of the BTAM terminal that entered the command. If a system message is being passed and the master terminal is a BTAM line, this is the line number of the BTAM master terminal.
UEHTERM	4 bytes	PTERM number. Usage = read only. BTAM PTERM number (in binary) or 0. If a command was entered, this is the PTERM number of the BTAM terminal that entered the command. If a system message is being passed and the master terminal is a BTAM line, this is the PTERM number of the BTAM master terminal.
UEHNODE	8 bytes	Nodename. Usage = read only. VTAM nodename or 0. This field references the same 8 bytes of storage as the UEHLINE and UEHTERM fields. If a command was entered, this is the nodename of the VTAM terminal that entered the command. If a system message is being passed and the master terminal is a VTAM node, this is the nodename of the VTAM master terminal node.
UEHHSQN	8 bytes	User name. Usage = read only. User name of user signed on to node or the Intersystem Communication (ISC) user associated with the node that entered the command, if UEH1CMD is set on in UEHBFLG1. User name or 0.
UEHOCALL	2 bytes	Usage = reserved.
UEHBFLG1	1 byte	Flag byte 1 for AOI and exit routine as follows:
UEH1ECMD	X'80'	Indicates that the exit routine requests the edited command buffer. Usage = modifiable. If the exit routine sets this flag on the first entry, the UEHECMD field points to the edited command buffer on the last entry. Also see UEH1CBNA flag.
UEH1SEG	X'40'	Indicates that a segment is presented to the exit routine. Usage = read only. This flag is set when a segment is present in the UEHCPYBF field for the exit routine's examination. It is reset if entry code = 8 and prior call was PUT MOVE (segment already presented to exit routine on previous call with entry code = 0 or 4).

Table 139. UEHB Field Descriptions (continued)

Field	Length/Value	Description
UEH1CPYP	X'20'	Indicates that the exit routine was called for a system message destined for the master terminal. Usage = read only. This flag is set when an asynchronous system message caused IMS to call the exit routine. A UEHB is created and the message is present in the UEHCPYBF field. The copy buffer contains the message plus 20 bytes (which the exit routine can modify).
UEH1CMD	X'10'	Indicates that the exit routine was called for a command or command response (if the entry code is non-0). Usage = read only. This flag is set when a command caused IMS to call the exit routine. A UEHB (user exit header block) is created and the command is present in the UEHCPYBF field. This flag is set until command processing is completed.
UEH1NSTG	X'08'	Storage not available for the user buffer. Usage = read only. Set when a conditional request for storage for the user buffer cannot be satisfied.
UEH1CBNA	X'04'	Edited command buffer not available Usage = read only. Set if the edited command buffer was not constructed by the command processor due to errors.
UEH1PSTD	X'02'	PST dispatch. Usage = reserved. System message being issued as a result of application program processing.
UEHBFLG2	1 byte	Flag byte 2 for AOI.
UEH2BYP	X'80'	Exit routine does not want rest of message. Usage = reserved. Set when the exit routine returns a return code of 8 or 12 indicating no more message segments are to be presented.
UEH2POTR	X'40'	Alternate destination found. Usage = reserved. Set after the alternate destination is successfully found, when register 15 contains a 0 return code and an 8-byte alternate destination name is in register 0. The alternate destination can be a transaction or LTERM.
UEH2ILOC	X'10'	INSERT LOCATE was last call. Usage= reserved. Indicates that the prior segment is to be presented to the exit routine.
UEH2UENT	X'08'	Exit routine was entered at least once. Usage = reserved. Used to determine if entry code 0 is to be set.

Table 139. UEHB Field Descriptions (continued)

Field	Length/Value	Description
UEH2LAST	X'04'	Set when entry code 8 is set upon entry. Usage = reserved. Used to indicate that the exit routine was entered for the last time.
UEH2NCUR	X'02'	Set when current call is not yet processed. Usage = reserved. Used when entered for a final call but the exit routine had not yet been entered for the first time.
UEH2QNOP	X'01'	Set when call is not to be passed to the queue manager (QMGR). Usage = reserved. Used to indicate that a PUT MOVE should not be done if the exit routine is deleting a system message to the primary master terminal.
UEHBFLG3	1 byte	Flag byte 3 for AOI.
UEH3ILOC	X'80'	Current call is INSERT LOCATE. Usage = reserved.
UEH3PUTM	X'40'	Current call is PUT MOVE. Usage = reserved.
UEH3CANO	X'20'	Current call is CANCEL OUTPUT. Usage = reserved.
UEH3ENQ	X'10'	Current call is ENQUEUE. Usage = reserved.
UEH3TERM	X'08'	Current call is AOI TERMINATION. Usage = reserved.
UEH3VSEG	X'04'	Segment exists for M/T. Usage = reserved.
UEHBFLG4	1 byte	Error flag byte.
UEH4ERRM	X'80'	AOI error message in progress. Usage = reserved.
UEH4SMER	X'40'	Secondary master terminal error. Usage = reserved.
UEH4FAIL	X'20'	Current call will be failed. Usage = reserved.
UEH4UEHB	X'10'	Previous UEHB exists. Usage = reserved.
UEHBERRC	1 byte	QAOI error code as follows:
UEHBERR1	C'1'	Invalid alternate destination. Usage = reserved.
UEHBERR2	C'2'	Queue manager return code. Usage = reserved.
UEHBERR3	C'3'	Invalid exit routine return code. Usage = reserved.
UEHBERR4	C'4'	Multiple user buffer request. Usage = reserved.
UEHBERR5	C'5'	User buffer storage not available. Usage = reserved.

Table 139. UEHB Field Descriptions (continued)

Field	Length/Value	Description
UEHBERR6	C'6'	Previous UEHB exists. Usage = reserved.
UEHBERR7	C'7'	Usage= reserved.
UEHBFLG5	1 byte	Flag byte 5 for AOI.
UEH5LTRM	X'80'	Usage = reserved. Dynamic LTERM marked in use.
UEHIRSVD	2 bytes	Usage = reserved.
UEHURSVD	20 bytes	Work area reserved for exit routine. Usage = modifiable. The exit routine can use this field to keep track of message numbers, entry codes, and flags between invocations of the exit routine for a particular message. UEHURSVD can be used to tie segments of a multisegment message together, since remaining segments do not contain the message number.

Chapter 67. 2972/2980 Input Edit Routine (DFS29800)

This chapter describes the 2972/2980 Input Edit routine.

The following topics provide additional information:

- “About This Routine”
- “Communicating with IMS” on page 452

About This Routine

An input edit routine is required to perform terminal-related functions inherent in the design of the 2972/2980 General Banking Terminal system. IMS passes control to the 2972/2980 Input Edit Routine to process each entered message segment after that message segment has been translated by IMS.

The 2972/2980 Input edit routine must perform the following functions:

1. Determine the IMS destination (SMB or CNT) of messages entered from a 2980 teller or administrative station.
2. Determine end-of-message of multisegment messages (by setting DECCSWST bit 7 to indicate EOM).
3. Reposition the entered data at the beginning of the input buffer for IMS processing. The entered segment must be in standard IMS input message format after edit processing; a two-byte length field is followed by the text.

In addition to performing the preceding required functions, the 2972/2980 Input edit routine can add input terminal status information to the entered segment, such as the presence or absence of a passbook or auditor key on the input terminal. The 2972/2980 Input edit routine can initiate retransmission of the last successfully transmitted message to a 2980 logical terminal by a return code to the calling routine.

Table 140 shows the attributes of the 2972/2980 Input Edit exit routine.

Table 140. 2972/2980 Input Edit Exit Routine Attributes

Attribute	Description
IMS environments	DB/DC, DCCTL.
Naming convention	You must name this exit routine DFS29800.
Binding	Follow the guidelines described in “Binding the Routines” on page 7.
Including the routine	Because the Input Edit Routine will be called directly by the IMS 2972/2980 device dependent module (DFSDN110), you must bind the input edit routine with the IMS control region nucleus.
IMS callable services	To use IMS Callable Services with this routine, you must issue an initialization call (DFSCSI0) to obtain the Callable Service token and a parameter list in which to build the function-specific parameter list for the desired callable service. Use the ECB in register 9 for the DFSCSI0 call. For details on using the initialization call, see “Step 2. Initializing IMS Callable Services (DFSCSI0)” on page 14. This exit is automatically linked to DFSCSI00 by IMS. No additional linking is required to use IMS Callable Services.
Sample routine location	IMS.ADFSSMPL (member name DFS29800).

Communicating with IMS

Familiarity with IMS terminal handling procedures and control blocks is required for a user to write an Input edit routine to interface with IMS routines in the IMS control region. Examination of these control blocks might be required, but modification of IMS control blocks by a user-written routine seriously endangers the integrity of the entire system.

Contents of Registers on Entry

Upon entry to the exit routine, all registers must be saved using the save area provided. The registers contain the following:

Register	Contents
0	Length of input buffer.
1	Address of the input area.
2	Length of input data. (The length of the area pointed to in register 1.)
7	Address of CTB.
9	Address of CLB.
11	Base of SCD.
13	Address of save area. The first three words must not be changed.
14	Return address to IMS.
15	Entry point of exit routine.

The format of the data contained in the buffer pointed to by register 1 at entry to the 2972/2980 Input edit routine is as follows:

- 9 blanks
- Terminal address
- Entered text

If the entered text is from a 2980-4, the first byte of the entry is the teller identification.

Contents of Registers on Exit

Upon return to IMS, all registers must be restored except for registers 2, 10, and 15, which must contain the following:

Register	Contents						
2	Data length after edit (a zero length signifies a no-data segment).						
10	The inputting CNT address if a retransmission of the last successfully outputted message is required.						
15	One of the following return codes: <table> <thead> <tr> <th>Return Code</th> <th>Meaning</th> </tr> </thead> <tbody> <tr> <td>0</td> <td>Process the entered segment.</td> </tr> <tr> <td>4</td> <td>Resend the last message to the CNT in register 10.</td> </tr> </tbody> </table>	Return Code	Meaning	0	Process the entered segment.	4	Resend the last message to the CNT in register 10.
Return Code	Meaning						
0	Process the entered segment.						
4	Resend the last message to the CNT in register 10.						

Chapter 68. 4701 Transaction Input Edit Routine (DFS36010)

This chapter describes the 4701 Transaction Input Edit routine.

The following topics provide additional information:

- “About This Routine”
- “Communicating with IMS”

About This Routine

This exit is provided as a sample routine that appends a blank and the eight-byte node name to a transaction input message. If you have established a naming convention that relates node names to LTERM names, the node name can be used by the MPP to set up the appropriate change call for output.

Table 141 shows the attributes of the 4701 Transaction Input Edit routine.

Table 141. 4701 Transaction Input Edit Routine Attributes

Attribute	Description
IMS environments	DB/DC, DCCTL.
Naming convention	You must name this exit routine DFS36010.
Binding	Follow the guidelines described in “Binding the Routines” on page 7.
Including the routine	No special steps are required to include this routine.
IMS callable services	To use IMS Callable Services with this routine, you must issue an initialization call (DFSCSI0) to obtain the Callable Service token and a parameter list in which to build the function-specific parameter list for the desired callable service. Use the ECB found in register 9 for the DFSCSI00 call. For details on using the initialization call, see “Step 2. Initializing IMS Callable Services (DFSCSI0)” on page 14. This exit is automatically linked to DFSCSI00 by IMS. No additional linking is required to use IMS Callable Services.
Sample routine location	IMS.ADFSSRC (member name DFS36010).

Communicating with IMS

IMS uses the entry and exit registers to communicate with the exit routine.

Contents of Registers on Entry

Upon entry to the exit routine, all registers must be saved using the save area provided. The registers contain the following:

Register	Contents
1	Address of the input buffer
7	Address of CTB
9	Address of CLB
11	Address of SCD
13	Address of save area
15	Entry point of exit routine

Contents of Registers on Exit

Upon return to IMS, all registers must be restored except for register 15, which must contain the following return code:

Return Code	Meaning
0	Normal processing

Part 5. Automated Operator Program Interface

Chapter 69. Automated Operator (AO) Application Program (GU, GN, CMD, and GCMD Calls)	457
About The AO Application Program (GU, GN, CMD, and GCMD Calls)	457
Supported Application Program Environments	458
Writing AO Applications for Shared-Queues	459
Using the Security Maintenance Utility	459
Issuing Commands from an AO Application	459
Format of Commands	459
Responses to Commands	460
Synchronization Point Processing	461
/DISPLAY Command	461
Getting Messages from an AO Exit Routine or a Terminal.	463
Cross-Reference of Commands and Command Response Messages	463
Using the Sample AO Application (UETRANS)	466
Chapter 70. Automated Operator (AO) Application Program (MSG, ICMD, and RCMD Calls)	467
About The AO Application Program (MSG, ICMD, and RCMD Calls)	467
Retrieving Messages (MSG Call)	467
Issuing Commands and Retrieving Command Responses (ICMD and RCMD Calls)	468
Restriction	469
Supported Application Program Environments	469
Establishing Security	469
Issuing Commands from an AO Application	469
Format of Commands	470
Responses to Commands	470
/DISPLAY Command	471
Cross-Reference of Commands and Command Response Messages	472
Restart and Recovery Considerations	475
Using the Sample AO Application (DFSAOPGM)	475

This section documents General-Use Programming Interface and Associated Guidance Information.

Chapter 69. Automated Operator (AO) Application Program (GU, GN, CMD, and GCMD Calls)

There are two types of automated operator (AO) application programs you can write. The AO application described in this chapter is called a type 1 AO application. *Type 1 AO applications* issue DL/I GU, GN, CMD, and GCMD calls in the DB/DC and DCCTL environments to:

- Retrieve messages from AO exit routine DFSAOUE0 (GU and GN calls).
- Issue a subset of IMS operator commands (CMD call).
- Retrieve command responses for commands issued on the CMD call (GCMD call).

Related Reading:

- *Type 2 AO applications* are described in Chapter 70, “Automated Operator (AO) Application Program (GMSG, ICMD, and RCMD Calls),” on page 467. They use GMSG, ICMD, and RCMD calls and are applicable in the DB/DC, DCCTL, and DBCTL environments.
- For an overview and comparison of the two types of AO applications, see *IMS Version 9: Operations Guide*.

The following topics provide additional information:

- “About The AO Application Program (GU, GN, CMD, and GCMD Calls)”
- “Supported Application Program Environments” on page 458
- “Writing AO Applications for Shared-Queues” on page 459
- “Using the Security Maintenance Utility” on page 459
- “Issuing Commands from an AO Application” on page 459
- “Getting Messages from an AO Exit Routine or a Terminal” on page 463
- “Cross-Reference of Commands and Command Response Messages” on page 463
- “Using the Sample AO Application (UETRANS)” on page 466

About The AO Application Program (GU, GN, CMD, and GCMD Calls)

The Automated Operator Interface (AOI) consists of several IMS functions that allow installations to better monitor and control IMS activities. These functions can be used separately or in conjunction with user-written programs and the master terminal operator.

For example, one function includes a system definition option and an operator command that gives the master terminal operator more control of the command messages sent to the secondary master terminal.

An AO application can issue a subset of IMS commands normally reserved for the master terminal operator and receive responses to those commands by using the following DL/I calls:

- CMD (to issue commands and receive the first command response segment)
- GCMD (to receive subsequent command response segments)

Type 1 AO

If there are any response segments, the first is returned to the user's I/O work area. Subsequent segments are retrieved with GCMD. GCMD, similar to a get next (GN), places subsequent command response segments in the user's I/O work area.

The AO application receives control from IMS whenever a message with the correct transaction code has been queued for processing.

Figure 44 on page 458 shows an AO application issuing a command with the CMD call **1** and receiving the initial response segment to the command **2**. The AO application uses the GCMD call **3** to obtain additional response segments **4**, if they exist.

Another AOI function lets an AO application retrieve messages. GU and GN calls retrieve messages. The retrieved message can be from either:

- A terminal from which the transaction was entered
- AO exit routine DFSAOUE0

An AO application using this function typically retrieves messages from the AO exit routine and then takes specific actions based on the content of the message.

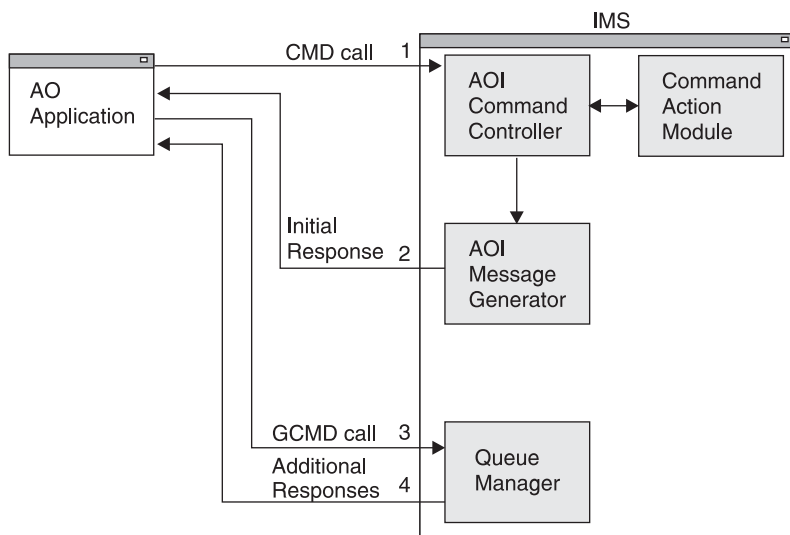

Figure 44. AO Application Processing

Supported Application Program Environments

Table 142 shows, by IMS environment, the types of AO applications that can issue GU, GN, CMD, and GCMD calls.

Table 142. GU, GN, CMD, and GCMD Call Support by Application Region Type

Application Region Type	IMS Environment		
	DBCTL	DB/DC	DCCTL
DRA thread	No	No	N/A
BMP (non-message-driven)	No	No	No
BMP (message-driven)	N/A	Yes	Yes
MPP	N/A	Yes	Yes
IFP	N/A	No	No

Writing AO Applications for Shared-Queues

Some transactions must reside on the same IMS subsystem as DFSAOUE0 to process correctly. If your installation uses shared-queues, define these local transactions as SERIAL to guarantee that they are processed on the local IMS subsystem. A transaction that is not defined as SERIAL can be processed on any IMS subsystem that has that transaction defined.

Using the Security Maintenance Utility

IMS Version 9 is the last release to support the Security Maintenance utility (SMU). You can use the Resource Access Control Facility (RACF) or the DFSCCMD0 user exit routine to provide security for the CMD call. Startup parameter AOI1= controls which facility provides the security. The AOI= parameter on the TRANSACT system definition macro provides control over which transactions are allowed to issue CMD calls and how the security is enforced if RACF is used. For more information on establishing IMS security, see *IMS Version 9: Administration Guide: System*.

Use SMU to define the authorized application programs by coding the TRANCMD5 keyword on the SECURITY macro. The SECCNT and MACLIB keywords on the MSGEN macro must also be coded. The COPYLOG keyword must be coded on the COMM macro if the secondary logging feature is desired.

Related Reading: For details on coding the MSGEN and SECURITY macros and using SMU to authorize transactions, see *IMS Version 9: Installation Volume 2: System Definition and Tailoring*.

Using SMU, you can specify:

- Which AO applications can issue commands using the CMD call.
- Which commands can be issued by an AO application.
- That an AO application can issue all commands allowed as indicated by the system-definition-produced list of allowed commands.

Only those AO applications specified to SMU are allowed to enter commands. Also, SMU only applies to AO applications issuing commands using the CMD call. If an AO application is not specified to SMU (in other words, if default security is in effect), it cannot issue commands.

Related Reading: For more information on SMU, see *IMS Version 9: Administration Guide: System*.

Issuing Commands from an AO Application

See the *IMS Version 9: Command Reference* for a list of commands that can be issued from an AO application using CMD. To receive responses to these commands, use the GCMD call.

Format of Commands

The syntax and synonyms for commands are the same whether the command is entered using a CMD call or from a terminal. All messages returned in response to a CMD call or a command entered from the terminal are the same.

Related Reading:

All commands are documented in *IMS Version 9: Command Reference*.

Type 1 AO

All messages are documented in *IMS Version 9: Messages and Codes, Volume 1* and *IMS Version 9: Messages and Codes, Volume 2*.

The general format of your I/O work area on a CMD call is:

LLZZ/verb	KEYWORD1 P1 KEYWORD2 P2, P3.	<i>Comments</i>
LL	Two-byte field containing the length of the command text, including LLZZ	
ZZ	Two-byte field reserved for IMS	
/	Indicates that an IMS command follows	
<i>verb</i>	The command you issued	
KEYWORDx	Keywords that apply to the command you issued	
Px	Parameters for the keywords you specified	
. (period)	End of the command	

The length of a command is limited by the size of the I/O area; the size is specified in the IOASIZE parameter in the PSBGEN macro during PCB generation. LL is the length of the command text. The size of the I/O area is the length of the actual command text, plus 4 bytes for LLZZ. The minimum size of the I/O work area is 132 bytes. The fifth byte must be a slash (/), and the verb must follow immediately. The /BROADCAST and /LOOPTEST commands must have a period between the command segment and text segment, and must be preceded by an LLZZ field that includes the size of the text. Comments can be added by placing a period (.) after the last parameter.

When issuing the /SSR command, do not code an end-of-message indicator (period) as shown in *IMS Version 9: Command Reference*. If a period is used, it is considered part of the text.

Responses to Commands

The execution of a command with a CMD call might result in a response that comprises one or more segments. The response is similar to that received by a terminal operator upon entering the same command. The maximum size response returned by IMS to the AO application is 132 bytes (including the 4-byte LLZZ field).

DFS messages that are the initial response to the command will be time-stamped even if the NOTIMESTP keyword was coded on the COMM macro.

No Response Segments

This condition is indicated by a PCB status of blanks, showing that the execution of the command was successful or is in progress and would have resulted in one of the following command responses had the command been entered from a terminal:

```
DFS058 XXX COMMAND COMPLETED (No EXCEPT phrase)
DFS058 XXX COMMAND IN PROGRESS.
```

where XXX is the command issued by the automated operator.

DFS058 COMMAND COMPLETED indicates that no exceptional conditions are reported.

When DFS058 COMMAND IN PROGRESS is issued, one or more additional messages are issued to indicate whether the command was successful. These messages are sent to the master terminal rather than to AOI. Commands such as /DBDDUMP,

/DBRECOVERY, /START DATABASE, /STOP DATABASE, and /SSR can result in message DFS058, followed by one or more asynchronous messages. Asynchronous messages are not returned as responses to the AO application.

Response Segments

Response segments are identical to the response to a command entered by the operator, with preceding LLZZ and carriage control (optional) and trailing carriage controls (optional). A command might have executed successfully even though a nonblank PCB status code is returned. The status code CC indicates that one or more response segments have been produced, which occurs when a command partially executes. For example, the EXCEPT condition of this message might be returned as multisegments.

Synchronization Point Processing

When the AO application regains control after a CMD call, IMS produces an initial response to the command. Command processing might be incomplete because additional IMS processing initiated by the command is still in progress.

Command responses that are not retrieved by a GCMD call are discarded at a synchronization point or by another CMD call.

A *synchronization point* is reached when any of the following events occur:

- The AO application requests the next input message with a GU call, assuming the program is defined as MODE=SINGLE on the TRANSACT macro statement.
- The program makes a CHKP call.
- The program makes a SYNC call.
- The program terminates.

Therefore, when IMS is restarted or resets to an earlier checkpoint, it is possible that a previously-issued command will be rescheduled for execution. An input message, generated by an AO exit routine and destined for an AO application, could be rescheduled although the resources are no longer held by the AO application. PCB status codes indicate more precisely which condition, or combination of conditions, exists.

/DISPLAY Command

When a /DISPLAY command is entered with a CMD call, a command response segment is always produced. Normally, the response is a multisegment message. Each segment contains EBCDIC and line control characters. Each segment varies in length with a maximum of 132 but usually less than 80 characters.

Output from the /DISPLAY command includes a format identifier (FID) on each output segment. /DISPLAY commands generally return multiple lines with different formats to the AO application. Your AO application uses the FID to determine what type of line it is processing. A DFS message might be produced with no FID when there is a syntax error.

The FID is 3 bytes of EBCDIC characters. It appears at the beginning of each line, after the LLZZ and any optional carriage control character. The format of the FID is:

FID character 1

Specific /DISPLAY command class (A-Z) as follows:

FID characters 2-3

Type of output line

Type 1 AO

The following are the values you can receive in FID characters 1-3 when issuing /DISPLAY using an ICMD.

FID char 1	Defines specific /DISPLAY command:
A	/DISPLAY ACTIVE, /DIS A0ITOKEN, /DISPLAY APPC
B	/DISPLAY PSB
C	/DISPLAY CONVERSATION
D	/DISPLAY AREA, /DISPLAY DATABASE, /DISPLAY DESCRIPTOR
E	/DISPLAY MSNAME
F	/DISPLAY LTERM
G	/DISPLAY SHUTDOWN STATUS
H	/DISPLAY ASMT LINE/PTERM/LTERM/NODE/USER, /DISPLAY HSB
I	/DISPLAY ASMT LINK/MSPLINK/SYSID/MSNAME
J	/DISPLAY DBD
K	/DISPLAY LINK
L	/DISPLAY LINE, /DISPLAY LUNAME, /DISPLAY PTERM
M	/DISPLAY MASTER (/RDISPLAY)
N	/DISPLAY NODE
P	/DISPLAY PROGRAM
Q	/DISPLAY Q
R	/DISPLAY RTCODE
S	/DISPLAY STATUS
T	/DISPLAY TRANSACTION, /DISPLAY TIMEOVER, /DISPLAY SYSID TRANSACTION
U	/DISPLAY USER, /DISPLAY TRACE
V	/DISPLAY CCTL, /DISPLAY OASN SUBSYS, /DISPLAY SUBSYS
W	/DISPLAY OLDS
X	Timestamp, /DISPLAY POOL DSECTS
Y	/DISPLAY MODIFY
Z	/DISPLAY HSSP

FID chars 2-3 Defines type of output line:

00-49	Data line
50-69	Message line
70-89	Heading line
90-98	Reserved
99	Time stamp line

The response to the /DISPLAY POOL command does not include a FID. You can get similar information about a buffer pool using a DL/I STAT call, although the STAT call returns no Fast Path information.

Getting Messages from an AO Exit Routine or a Terminal

Your AO application receives control whenever a message with the appropriate transaction code is queued for processing. Your AO application retrieves messages from an AO exit routine or a terminal using the GU call.

Cross-Reference of Commands and Command Response Messages

Table 143 associates IMS commands used in an AO application and the resulting DFS response messages. You'll want to refer to Table 143 when writing your AO application to know what error messages to expect and be able to plan for them in your application.

Most of the messages in Table 143 are error messages that the AO application receives when an IMS command executes improperly. When an IMS command **does** execute properly, the program does not receive message DFS058 confirming that the command completed successfully.

Exception: This is true for all commands except the /DISPLAY, /RDISPLAY, and the /RMxxxxxx commands. When /DISPLAY, /RDISPLAY, or /RMxxxxxx is successfully completed, the AO application receives the data it requested to be displayed rather than message DFS058.

Related Reading: If you want detailed descriptions of the messages in Table 143, see "DFSMessages", in *IMS Version 9: Messages and Codes, Volume 2*.

Table 143. IMS Commands and DFS Response Messages

Command	DFS Response Message
/ACTIVATE	107 127 158 163 181 182 2103
/ALLOCATE	107 108 121 127 158 163 182 216 1950 1952 1953 2038 3110
/ASSIGN	107 119 124 127 131 138 139 147 150 151 152 157 158 161 163 164 182 201 210 211 212 213 214 232 243 289 794 795 2034 2035 2036 2104 2105 3102 3103 3104 3105 3108 3115 3632 3636 3637 3638
/BROADCAST	099 100 102 113 115 127 147 158 163 182 2105 3633
/CHANGE	107 108 121 125 126 127 130 163 181 182 216 696 1951 1953 2038 2105 2231 2232 3458 3619 3630 3632 3633 3639 3805 3811 3812 3817 3818 3819 3826 3827 3832 3833
/CHECKPOINT	107 127 130 140 141 142 163 182 2038 2717
/CLSDST/OPNDST	107 121 127 128 130 140 147 163 181 182 2037 2081 2103 2108 2109 2477 3101 3105 3106 3107 3108 3110 3111 3112 3113 3114 3116 3630 3633 3634 3639 3862
/COMPT	107 127 163 182 2103 2104 2254 2255 2256 2257 2261 3106 3108
/DBDUMP	107 127 130 132 140 141 142 160 163 174 175 182 2038 2717 3316 3319
/DBRECOVERY	107 121 127 130 132 140 141 142 158 160 163 174 175 178 182 2038 2537 2717 3316 3319 3327
/DELETE	102 106 107 109 113 114 115 116 117 123 127 128 130 146 150 158 163 2103 2104 2105 3654

Table 143. IMS Commands and DFS Response Messages (continued)

Command	DFS Response Message
/DEQUEUE	107 113 114 115 121 127 128 130 150 151 152 158 163 182 189 216 236 237 238 239 240 1191 1192 1952 1953 2038 2103 2104 2153 2183 2185 3104 3106 3107 3108 3110 3117 3824
All DISPLAYs	074 107 127 130 163 182 1924 2038 2093
/DISPLAY APPC	127 163 182 1953
/DISPLAY ASSIGNMENT SYSID	147
MSNAME	147
MSPLINK	147
LINK	147
/DISPLAY AREA	116 132
/DISPLAY ASSIGNMENT NODE	182 2103 3106 3630 3639
LTERM	114
LINE-PTE	113 115 150
USER	3108
/DISPLAY CCTL	182 216
/DISPLAY CONVERSATION	099 113 115 163 182 216 2103 3108
/DISPLAY DATABASE	116 132 3653
/DISPLAY DBD	182
/DISPLAY DESCRIPTOR	121 127 163 182 1953
/DISPLAY HSB	182 3813
/DISPLAY LINE-PTE	113 115 150 182 216
/DISPLAY LINK	147 2038
/DISPLAY LTERM	114 216 2038
/DISPLAY LUNAME	107 121 127 130 158 163 182 1953 1954 3110
/DISPLAY MASTER	
/DISPLAY MODIFY	163 182 237 3431 3443 3451 3452 3455 3460 3461
/DISPLAY MSNAME	114 216 2038
/DISPLAY NODE	182 216 2103 3106 3114 3630 3639 3831
/DISPLAY OASN SUBSYS	147 182 216 3601
/DISPLAY OLDS	182 216 2038 3828
/DISPLAY PROGRAM	117
/DISPLAY PSB	147 182
/DISPLAY Q	127 147 156 163 170 216 2038
/DISPLAY RTCODE	147
/DISPLAY SHUTDOWN STATUS	134 198
/DISPLAY SUBSYS	147 182 216 3601
/DISPLAY SYSID TRAN	147
/DISPLAY TRANSACTION	146 216
/DISPLAY USER	3108 3653
/END	113 115 150 152 158 181 182 189 285 2103 2104 3106 3108 3635 3654
/EXCLUSIVE	113 115 150 152 158 181 182 189 241 2103 2104 3106 3108 3635 3654

Table 143. IMS Commands and DFS Response Messages (continued)

Command	DFS Response Message
/EXIT	107 180 181 182 183 184 189 576 577 2103 2104 2105 3106 3108 3635 3655
/FORMAT	070 182 244 3824
/IDLE	107 127 130 134 147 163 181 216 2105 2109 3633
/LOCK	062 107 114 116 117 127 146 158 162 163 182 2038 3250
/LOG	
/LOOPTEST	113 115 143 150 152 181 195 196 203
/MONITOR	099 107 113 115 130 140 150 163 182 216
/MSASSIGN	107 127 147 163 164 182 2038 2151 2152 2153 2154 2155 2156 2157 2233 2240 2244 2252 2259 2260 3200 3214
/PSTOP	099 107 113 114 115 117 130 140 146 147 150 156 163 181 182 216 232 2152 2270 2272 2273 2297 3204 3630 3633 3824
/PURGE	099 107 108 113 114 115 117 127 130 140 146 150 156 163 182 216 1953 2038 3630 3633 3824
/QUIESCE	107 130 140 158 163 181 182 216 2103 3106 3630 3632 3633 3824
/RDISPLAY	
/RM	181 182 2038 3322
/RSTART	099 107 113 115 130 140 147 150 163 181 182 216 2103 2152 3104 3106 3108 3204 3630 3633 3639 3824
/SECURE	107 127 163 182 1953
/SMCOPY	165 181 182
/SSR	182 696 2038 3601 3609 3610 3618
/START	099 107 108 113 114 115 117 127 130 132 140 146 150 156 158 163 170 175 176 178 179 182 216 232 696 1953 2010 2020 2021 2022 2023 2024 2025 2038 2103 2105 2475 3104 3106 3108 3110 3315 3316 3319 3601 3604 3609 3630 3633 3639 3798 3799 3805 3806 3807 3808 3809 3816 3817 3824 3829 3843
/STOP	099 107 108 113 114 115 117 127 130 132 140 146 150 156 158 163 170 175 176 178 179 182 216 232 696 1953 2010 2020 2021 2022 2023 2024 2025 2038 2103 2105 2109 2475 3104 3106 3108 3110 3315 3316 3319 3601 3604 3630 3633 3639 3805 3806 3808 3824 3825 3829
/SWITCH	107 127 140 163 696 2038 3810 3813 3814 3824
/TEST	113 115 143 150 152 158 181 182 189 196 282 283 284 2103 2104 2158 3106 3108 3635 3654
/TRACE	107 108 113 130 147 150 158 163 182 216 237 279 280 281 314 775 1953 2028 2029 2030 2031 2032 2038 2093 2103 2104 2155 2460 3106 3108 3110 3630 3633 3639 3813
/UNLOCK	062 107 114 116 117 127 146 158 162 163 182 2038 3250 3813
/VUNLOAD	107 130 140 163 182 216

Using the Sample AO Application (UETRANS)

A sample AO application is available from the IMS library (IMS.ADFSSRC, member name UETRANS).

The sample shows use of AOI by an AO application and an associated AO exit routine. The AO application is written in PL/I for the Optimizing Compiler.

The sample AO application:

- Accepts only messages originating from the exit routine (indicated by a CG PCB status code).
- Upon receipt of a DFS994 message, looks for the character string EMERGENCY. If found, it issues the command /RSTART LINE ALL. Otherwise, it issues the following commands:

```
/RSTART LINE ALL  
/START DATABASE ALL  
/START TRAN ALL
```
- Upon receipt of a terminal error message, it issues the command /RDISPLAY to determine on which line and PTERM is the master terminal. If the error occurred on that line, it issues a /DISPLAY LINE ALL to determine the first available started line, and reassigns the master terminal to that line and PTERM.
- Upon receipt of an /ASSIGN command, if the response is a DFS119 message, reissues the command until it is successful. If the response is a DFS138 message, it restarts the line with an /RSTART command and reissues the /ASSIGN command. It reissues the /ASSIGN command a maximum of 20 times; if the command is not successfully completed after the 20th attempt, an appropriate message is issued.

The associated AO exit routine is assumed to:

- Pass all DFS994 (checkpoint identifier) messages to the AO application.
- Pass all terminal error messages to the AO application. The line number of the terminal in error is placed in the last 20 bytes of the buffer. Message numbers passed are DFS001, DFS025, DFS026, DFS027, DFS029, DFS072, DFS250, DFS251, DFS253, DFS260, DFS269, DFS973, DFS998.
- Pass all /ASSIGN commands that receive a DFS119 or DFS138 message to the AO application. These messages indicate that either the LTERM is busy or the line is not started and cannot be reassigned.
- Ignore all other messages.

Chapter 70. Automated Operator (AO) Application Program (GMSG, ICMD, and RCMD Calls)

There are two types of automated operator (AO) application programs you can write. The AO application described in this chapter is called a type 2 AO application. It is applicable in the DB/DC, DCCTL, and DBCTL environments. *Type 2 AO applications* can issue DL/I GMSG, ICMD, and RCMD calls to:

- Retrieve messages from AO exit routine DFSAOE00 (GMSG call).
- Issue a subset of IMS operator commands (ICMD call).
- Retrieve command responses for commands issued on the ICMD call (RCMD calls).

Related Reading:

- Type 1 AO applications are described in Chapter 69, “Automated Operator (AO) Application Program (GU, GN, CMD, and GCMD Calls),” on page 457. They use GU, GN, CMD, and GCMD calls and are applicable in DB/DC and DCCTL environments.
- For an overview and comparison of the two types of AO applications, see *IMS Version 9: Operations Guide*.

The following topics provide additional information:

- “About The AO Application Program (GMSG, ICMD, and RCMD Calls)”
- “Supported Application Program Environments” on page 469
- “Establishing Security” on page 469
- “Issuing Commands from an AO Application” on page 469
- “Cross-Reference of Commands and Command Response Messages” on page 472
- “Restart and Recovery Considerations” on page 475
- “Using the Sample AO Application (DFSAOPGM)” on page 475

About The AO Application Program (GMSG, ICMD, and RCMD Calls)

This automated operator (AO) application can help you monitor and control IMS activities. You can use it separately or with AO exit routine DFSAOE00.

This AO application can:

- Issue DL/I calls to retrieve messages from DFSAOE00 (GMSG call).
- Issue a subset of IMS operator commands (ICMD call).
- Retrieve responses to those commands from DFSAOE00 (RCMD call).

Related Reading: For detailed information on the GMSG, ICMD, and RCMD calls, see *IMS Version 9: Application Programming: Database Manager* or *IMS Version 9: Application Programming: Transaction Manager*.

Retrieving Messages (GMSG Call)

When AO exit routine DFSAOE00 is used to route messages to an AO application, the IMS message queues are not used. Instead, applications that cannot access the message queues or that do not wish to use the message queues retrieve the messages from an AO exit routine.

Type 2 AO

The AO application retrieves messages using the GMSG call. GMSG associates an AOI token name with a message. The application passes an 8-byte AOI token to IMS, and IMS returns to the application a message associated with the AOI token. By using different AOI tokens, DFSAOE00 can direct messages to different AO applications.

The GMSG call, specifying an 8-byte token, retrieves the first segment of the message associated with the token. Subsequent GMSG calls, with no token specified, retrieve the second through n segments of a multisegment message. If an application needs all segments of a multisegment message, it must issue GMSG until all segments are retrieved before issuing another GMSG call with a token specified. IMS discards all remaining message segments from the previous GMSG call when a new GMSG call specifying an AOI token is issued from the same AO application.

An application can specify a wait on the GMSG call. If there are no messages for the specified AOI token, the application is put into a wait state until a message is available. The decision to wait is specified by the application, unlike a WFI (wait for input) transaction where the wait is specified in the transaction definition.

Defining the AOI Token

You define the AOI token value. You also decide how the AO application gets the AOI token value. Some possible methods for doing these follow:

- The token could be a hard-coded value understood by both DFSAOE00 and the AO application.
- A naming convention could be established that relates the name of an AOI token to an AO application. For example, an AO application with the name ABCAOI02 might use AOI token AOI02nnn.
- The AO application could issue an ICMD '/LOG data ' call with the AOI token in the data. The application would then issue a GMSG call with WAITAOI specified for the AOI token named in the LOG call.

DFSAOE00 will see the ICMD and can parse the data in the LOG command to get the AOI token name and any other information in the data. DFSAOE00 inserts messages to the AOI token name; the messages are then returned to your AO application when the GMSG call is issued.

- DFSAOE00 could create a dynamic AOI token when it processes an IMS message. Then DFSAOE00 could issue an SVC 34 to start a BMP. The START command can override the APARM parameter on the EXEC statement. The APARM parameter is a way of passing information to the AO application. To retrieve the value specified on the APARM parameter, the AO application can issue the DL/I INQY call.
- DFSAOE00 could store an AOI token in an area that both DFSAOE00 and the AO application have access to. The AO application, when it starts, could get the AOI token from this area.

Issuing Commands and Retrieving Command Responses (ICMD and RCMD Calls)

ICMD issues an IMS command and retrieves the first command response segment if one exists. RCMD retrieves subsequent command response segments. When the response to an ICMD call results in a multisegment message, you might want to retrieve all message segments. If you need all message segments, you must issue RCMDs until all segments are retrieved before issuing another ICMD call. IMS discards all remaining message segments from the previous ICMD call when a new ICMD is issued from the same AO application.

Restriction

All messages queued to an AO application by DFSAOE00 remain in the IMS subsystem to which they are queued. Only AO applications in the local subsystem can issue a DL/I GMSG call to access the queued messages. Because these messages are not written to a share-queue structure, applications on other IMS subsystems cannot access them.

Supported Application Program Environments

Table 144 shows, by IMS environment, the types of AO applications that can issue GMSG, ICMD, and RCMD. In addition, these calls are supported from a CPI-C driven program.

Table 144. GMSG, ICMD, and RCMD Call Support by Application Region Type

Application Region Type	IMS Environment		
	DBCTL	DB/DC	DCCTL
DRA thread	Yes	Yes	N/A
BMP (non-message-driven)	Yes	Yes	Yes
BMP (message-driven)	N/A	Yes	Yes
MPP	N/A	Yes	Yes
IFP	N/A	Yes	Yes

Establishing Security

Security consists of controlling which applications can issue the ICMD call and which commands they can specify using ICMD.

ICMD security is implemented using RACF (or equivalent), the Command Authorization Exit Routine (DFSCCMD0), or both. To specify one or both methods of securing ICMD, use the AOIS parameter in the DBC, DCC, and IMS procedures.

Related Reading: See the documentation for these procedures in *IMS Version 9: Installation Volume 2: System Definition and Tailoring* for more information on the AOIS parameter.

You need to use the following RACF commands to implement security for AO applications:

```
ADDGROUP
ADDUSER
PERMIT
RDEFINE
```

Related Reading: See *IMS Version 9: Administration Guide: System* and the RACF library for more detailed information on these topics.

Issuing Commands from an AO Application

See *IMS Version 9: Command Reference* for a list of commands that can be issued from an AO application using ICMD. To receive responses to these commands, use the RCMD call.

Format of Commands

The syntax and synonyms for commands are the same whether the command is entered using an ICMD call or from a terminal.

Related Reading: All commands are documented in *IMS Version 9: Command Reference*.

All messages returned in response to an ICMD call or a command entered from the terminal are the same. All messages are documented in *IMS Version 9: Messages and Codes, Volume 2*.

The general format of your I/O work area on an ICMD call is:

LLZZ/verb KEYWORD1 P1 KEYWORD2 P2, P3. Comments

LL	Two-byte field containing the length of the command text, including LLZZ .
ZZ	Two-byte field reserved for IMS.
/ or CRC	Indicates an IMS command follows. CRC (command recognition character) rather than a slash (/) is used in the DBCTL environment.
<i>verb</i>	The command you issued.
KEYWORDx	Keywords that apply to the command you issued.
Px	Parameters for the keywords you specified.
. (period)	End of the command.

The length of a command is limited by the size of the I/O area; the size is specified in the IOASIZE parameter in the PSBGEN macro during PCB generation. LL is the length of the command text. The size of the I/O area is the length of the actual command text, plus 4 bytes for LLZZ. The minimum size of the I/O work area is 132 bytes.

The fifth byte must be a slash (/) (or CRC for DBCTL), and the verb must follow immediately. The /BROADCAST and /LOOPTEST commands must have a period between the command segment and text segment, and must be preceded by an LLZZ field that includes the size of the text. Comments can be added by placing a period (.) after the last parameter.

When issuing the /SSR command, do not code an end-of-message indicator (period) as shown in the *IMS Version 9: Command Reference*. If a period is used, it is considered part of the text.

Responses to Commands

The execution of a command with an ICMD call might result in a response that comprises one or more segments. The response is similar to that received by a terminal operator upon entering the same command.

The maximum size of the response returned by IMS to the AO application is 132 bytes (including the 4-byte LLZZ field). DFS messages that are the initial response to the command are time-stamped even if the NOTIMESTP keyword is coded on the COMM macro.

No Response Segments

This condition is indicated when AIB return and reason codes are zero and the length of the message returned is zero. These indicators tell you execution of the command was successful or is in progress and would have resulted in one of the following command responses had the command been entered from a terminal:

```
DFS058 XXX COMMAND COMPLETED (No EXCEPT phrase)
DFS058 XXX COMMAND IN PROGRESS.
```

where XXX is the command issued by the automated operator.

When DFS058 COMMAND COMPLETED is issued, no exceptional conditions are reported.

When DFS058 COMMAND IN PROGRESS is issued, one or more additional messages are issued to indicate whether the command was successful. These messages are sent to the master terminal rather than to AOI. Commands such as /DBDDUMP, /DBRECOVERY, /START DATABASE, /STOP DATABASE, and /SSR can result in message DFS058, followed by one or more asynchronous messages. Asynchronous messages are not returned as responses to the AO application.

Response Segments

Response segments are identical to the response to a command entered by the operator, with preceding LLZZ and carriage control (optional) and trailing carriage controls (optional). Command responses not retrieved by an RCMD call are discarded on the next ICMD call.

/DISPLAY Command

When a /DISPLAY command is entered with an ICMD call, a command response segment is always produced. Normally, the response is a multisegment message. Each segment contains EBCDIC and line control characters. Each segment varies in length with a maximum of 132 but usually less than 80 characters.

Output from the /DISPLAY command includes a format identifier (FID) on each output segment. /DISPLAY commands generally return multiple lines with different formats to the AO application. Your AO application uses the FID to determine what type of line it is processing. A DFS message might be produced with no FID when there is a syntax error.

The FID is 3 bytes of EBCDIC characters. It appears at the beginning of each line, after the LLZZ and any optional carriage control character. The format of the FID is:

FID character 1	Specific /DISPLAY command class (A-Z)
FID characters 2-3	Type of output line

The following are the values you can receive in FID characters 1-3 when issuing /DISPLAY using an ICMD.

FID char 1	Defines specific /DISPLAY command:
A	/DISPLAY ACTIVE, /DIS A0ITOKEN, /DISPLAY APPC
B	/DISPLAY PSB
C	/DISPLAY CONVERSATION
D	/DISPLAY AREA, /DISPLAY DATABASE, /DISPLAY DESCRIPTOR
E	/DISPLAY MSNAME
F	/DISPLAY LTERM

Type 2 AO

G	/DISPLAY SHUTDOWN STATUS
H	/DISPLAY ASMT LINE/PTERM/LTERM/NODE/USER, /DISPLAY HSB
I	/DISPLAY ASMT LINK/MSPLINK/SYSID/MSNAME
J	/DISPLAY DBD
K	/DISPLAY LINK
L	/DISPLAY LINE, /DISPLAY LUNAME, /DISPLAY PTERM
M	/DISPLAY MASTER (/RDISPLAY)
N	/DISPLAY NODE
P	/DISPLAY PROGRAM
Q	/DISPLAY Q
R	/DISPLAY RTCODE
S	/DISPLAY STATUS
T	/DISPLAY TRANSACTION, /DISPLAY TIMEOVER, /DISPLAY SYSID TRANSACTION
U	/DISPLAY USER, /DISPLAY TRACE
V	/DISPLAY CCTL, /DISPLAY OASN SUBSYS, /DISPLAY SUBSYS
W	/DISPLAY OLDS
X	Timestamp, /DISPLAY POOL DSECTS
Y	/DISPLAY MODIFY
Z	/DISPLAY HSSP

FID chars 2-3 Defines type of output line:

00-49	Data line
50-69	Message line
70-89	Heading line
90-98	Reserved
99	Timestamp line

The response to the /DISPLAY POOL command does not include a FID. You can get similar information about a buffer pool using a DL/I STAT call, although the STAT call returns no Fast Path information.

Cross-Reference of Commands and Command Response Messages

Table 145 on page 473 associates IMS commands used in an AO application and the resulting DFS response messages. You'll want to refer to Table 145 on page 473 when writing your AO application to know what error messages to expect and to be able to plan for them in your application.

Most of the messages in Table 145 on page 473 are error messages that the AO application receives when an IMS command executes correctly. When an IMS command executes correctly, the program **does not** receive message DFS058 confirming that the command completed successfully.

This is true for all commands except the /DISPLAY, /RDISPLAY, and the /RMxxxxx commands. When /DISPLAY, /RDISPLAY, or /RMxxxx is successfully completed, the AO application receives the data it requested to be displayed rather than message DFS058.

Related Reading: For detailed descriptions of the messages in Table 145, see “DFS Messages” in *IMS Version 9: Messages and Codes, Volume 2*.

Table 145. IMS Commands and DFS Response Messages

Command	DFS Response Message
/ACTIVATE	107 127 158 163 181 182 2103
/ALLOCATE	107 108 121 127 158 163 182 216 1950 1952 1953 2038 3110
/ASSIGN	107 119 124 127 131 138 139 147 150 151 152 157 158 161 163 164 182 201 210 211 212 213 214 232 243 289 794 795 2034 2035 2036 2104 2105 3102 3103 3104 3105 3108 3115 3632 3636 3637 3638
/BROADCAST	099 100 102 113 115 127 147 158 163 182 2105 3633
/CHANGE	107 108 121 125 126 127 130 163 181 182 216 696 1951 1953 2038 2105 2231 2232 3458 3619 3630 3632 3633 3639 3805 3811 3812 3817 3818 3819 3826 3827 3832 3833
/CHECKPOINT	107 127 130 140 141 142 163 182 2038 2717
/CLSDST/OPNDST	107 121 127 128 130 140 147 163 181 182 2037 2081 2103 2108 2109 2477 3101 3105 3106 3107 3108 3110 3111 3112 3113 3114 3116 3630 3633 3634 3639 3862
/COMPT	107 127 163 182 2103 2104 2254 2255 2256 2257 2261 3106 3108
/DBDUMP	107 127 130 132 140 141 142 160 163 174 175 182 2038 2717 3316 3319
/DBRECOVERY	107 121 127 130 132 140 141 142 158 160 163 174 175 178 182 2038 2537 2717 3316 3319 3327
/DELETE	102 106 107 109 113 114 115 116 117 123 127 128 130 146 150 158 163 2103 2104 2105 3654
/DEQUEUE	107 113 114 115 121 127 128 130 150 151 152 158 163 182 189 216 236 237 238 239 240 1191 1192 1952 1953 2038 2103 2104 2153 2183 2185 3104 3106 3107 3108 3110 3117 3824
All DISPLAYs	074 107 127 130 163 182 1924 2038 2093
/DISPLAY APPC	127 163 182 1953
/DISPLAY ASSIGNMENT SYSID	147
MSNAME	147
MSPLINK	147
LINK	147
/DISPLAY AREA	116 132
/DISPLAY ASSIGNMENT NODE	182 2103 3106 3630 3639
LTERM	114
LINE-PTE	113 115 150
USER	3108
/DISPLAY CCTL	182 216
/DISPLAY CONVERSATION	099 113 115 163 182 216 2103 3108
/DISPLAY DATABASE	116 132 3653
/DISPLAY DBD	182

Table 145. IMS Commands and DFS Response Messages (continued)

Command	DFS Response Message
/DISPLAY DESCRIPTOR	121 127 163 182 1953
/DISPLAY HSB	182 3813
/DISPLAY LINE-PTE	113 115 150 182 216
/DISPLAY LINK	147 2038
/DISPLAY LTERM	114 216 2038
/DISPLAY LUNAME	107 121 127 130 158 163 182 1953 1954 3110
/DISPLAY MASTER	
/DISPLAY MODIFY	163 182 237 3431 3443 3451 3452 3455 3460 3461
/DISPLAY MSNAME	114 216 2038
/DISPLAY NODE	182 216 2103 3106 3114 3630 3639 3831
/DISPLAY OASN SUBSYS	147 182 216 3601
/DISPLAY OLDS	182 216 2038 3828
/DISPLAY PROGRAM	117
/DISPLAY PSB	147 182
/DISPLAY Q	127 147 156 163 170 216 2038
/DISPLAY RTCODE	147
/DISPLAY SHUTDOWN STATUS	134 198
/DISPLAY SUBSYS	147 182 216 3601
/DISPLAY SYSID TRAN	147
/DISPLAY TRANSACTION	146 216
/DISPLAY USER	3108 3653
/END	113 115 150 152 158 181 182 189 285 2103 2104 3106 3108 3635 3654
/EXCLUSIVE	113 115 150 152 158 181 182 189 241 2103 2104 3106 3108 3635 3654
/EXIT	107 180 181 182 183 184 189 576 577 2103 2104 2105 3106 3108 3635 3655
/FORMAT	070 182 244 3824
/IDLE	107 127 130 134 147 163 181 216 2105 2109 3633
/LOCK	062 107 114 116 117 127 146 158 162 163 182 2038 3250
/LOG	
/LOOPTEST	113 115 143 150 152 181 195 196 203
/MONITOR	099 107 113 115 130 140 150 163 182 216
/MSASSIGN	107 127 147 163 164 182 2038 2151 2152 2153 2154 2155 2156 2157 2233 2240 2244 2252 2259 2260 3200 3214
/PSTOP	099 107 113 114 115 117 130 140 146 147 150 156 163 181 182 216 232 2152 2270 2272 2273 2297 3204 3630 3633 3824
/PURGE	099 107 108 113 114 115 117 127 130 140 146 150 156 163 182 216 1953 2038 3630 3633 3824
/QUIESCE	107 130 140 158 163 181 182 216 2103 3106 3630 3632 3633 3824
/RDISPLAY	

Table 145. IMS Commands and DFS Response Messages (continued)

Command	DFS Response Message
/RMx	181 182 2038 3322
/RSTART	099 107 113 115 130 140 147 150 163 181 182 216 2103 2152 3104 3106 3108 3204 3630 3633 3639 3824
/SECURE	107 127 163 182 1953
/SMCOPY	165 181 182
/SSR	182 696 2038 3601 3609 3610 3618
/START	099 107 108 113 114 115 117 127 130 132 140 146 150 156 158 163 170 175 176 178 179 182 216 232 696 1953 2010 2020 2021 2022 2023 2024 2025 2038 2103 2105 2475 3104 3106 3108 3110 3315 3316 3319 3601 3604 3609 3630 3633 3639 3798 3799 3805 3806 3807 3808 3809 3816 3817 3824 3829 3843
/STOP	099 107 108 113 114 115 117 127 130 132 140 146 150 156 158 163 170 175 176 178 179 182 216 232 696 1953 2010 2020 2021 2022 2023 2024 2025 2038 2103 2105 2109 2475 3104 3106 3108 3110 3315 3316 3319 3601 3604 3630 3633 3639 3805 3806 3808 3824 3825 3829
/SWITCH	107 127 140 163 696 2038 3810 3813 3814 3824
/TEST	113 115 143 150 152 158 181 182 189 196 282 283 284 2103 2104 2158 3106 3108 3635 3654
/TRACE	107 108 113 130 147 150 158 163 182 216 237 279 280 281 314 775 1953 2028 2029 2030 2031 2032 2038 2093 2103 2104 2155 2460 3106 3108 3110 3630 3633 3639 3813
/UNLOCK	062 107 114 116 117 127 146 158 162 163 182 2038 3250 3813
/VUNLOAD	107 130 140 163 182 216

Restart and Recovery Considerations

Because AOI does not use the IMS message queues in this environment, messages directed to an AO application cannot be recovered at restart.

When a recoverable command is issued by the ICMD call, log record X'02' is generated when the command completes. If a failure occurs, the command is not reprocessed at restart time. If a failure occurs after a command is completed but before the command response is returned, the command response is lost. Your AO application could issue the appropriate /DISPLAY command if applicable to determine if the ICMD call executed successfully (as is required with asynchronous commands).

Using the Sample AO Application (DFSAOPGM)

A sample AO application is available from the IMS library IMS.ADFSSMPL, member name DFSAOPGM.

Part 6. Asynchronous Data Capture

Chapter 71. Propagating Captured Data Asynchronously	479
Changed Data Log Record	479
Elements of Captured Data	480
Reducing the Amount of Captured Data	481
Example of Logged Data Elements	481
End of Job (EOJ) Call Log Record	482
SETS and ROLS Call Log Records	482
Format of the Data Capture Log Records.	482
Data Capture Log Record Prefix	482
Changed Data Log Record Format	482
Format for Data Element Header.	483
CAPD Block Format (LOGID=X'00').	484
CAPD_DATA Format (LOGID=X'0C')	486
End of Job Call Log Record Format.	487
SETS and ROLS Call Log Record Format	487

Chapter 71. Propagating Captured Data Asynchronously

As an alternative to using the Data Capture exit routine discussed in Chapter 2, “Data Capture Exit Routine,” on page 45, you can propagate captured data asynchronously. This alternative is available with the addition of a logging option on the EXIT= parameter of DBDGEN. You can use the logging option to capture database changes for selected segment types and environmental information in IMS Data Capture log records. Captured information is compressed using z/OS compression services to minimize the space needed to store the captured data on the IMS online data sets (OLDS). After it is stored, the captured data is available for use, for example to propagate to a DB2 UDB for z/OS environment.

This chapter describes the format of the Data Capture log records.

Related Reading: For details on the logging option, and on using the EXIT= parameter, see *IMS Version 9: Utilities Reference: System*. For information about IMS DataPropagator, see *IMS DataPropagator for z/OS An Introduction*, or visit the IMS DataPropagator home page on the Web at www.ibm.com/software/data/db2imstools/imstools/imspdprop.html.

The Data Capture log records use the X'99' log code and have the following data capture subcodes to indicate the type of record being logged:

- X'04'** Changed data
- X'28'** End of job (EOJ)
- X'30'** SETS call
- X'34'** ROLS call

All of the Data Capture log records contain a common prefix, which is described in “Data Capture Log Record Prefix” on page 482. This prefix contains the subcode that defines the type of record being logged. End of job records and SETS and ROLS call records consist entirely of this log record prefix and contain no additional information. Changed data log records, however, contain information in addition to the prefix and can span multiple physical log records to contain all of the captured data.

The following topics provide additional information:

- “Changed Data Log Record”
- “End of Job (EOJ) Call Log Record” on page 482
- “SETS and ROLS Call Log Records” on page 482
- “Format of the Data Capture Log Records” on page 482

Changed Data Log Record

For each DL/I call, there is one logical log record that comprises all the data requested for that call. However, because all the data might not fit in one log buffer, one logical log record can actually be composed of several physical log records. To retrieve all the data logged for a particular call, you must examine the physical log records to determine where the logical log record begins and ends.

The data captured for a DL/I call is stored as elements within the changed data log record. For each DL/I call, there are multiple data elements recorded in the changed data log record. The different types of data elements are described in the

Propagating Captured Data Asynchronously

next section, “Elements of Captured Data.” For an example of the recorded data elements, and the order in which they are recorded, see “Example of Logged Data Elements” on page 481.

Elements of Captured Data

The captured data elements are logged in the DCAP_DATA field within the changed data log record. The format of data elements is broken down into the header information and the actual logged data. See “Format for Data Element Header” on page 483 for the format of the log record header.

Each data element contains a 4-byte header. The header contains a 1-byte LOGID field describing the type of data being logged in this element, a 1-byte LOG_FLAG and a 2-byte LOG_LL field. The LOG_LL field contains the length of the data that follows the header. This length is used to locate the header for the next element. The header is followed by the actual data defined in the LOGID field. The data is compressed using the z/OS/ESA compression services, if such services are available. If so, the COMPR_ALGORITHM field in LOG_DCAP_DATA indicates the algorithm used to compress the data.

If FLAG_1 of the changed data log record contains X'60' or X'E0' (FIRST_RECORD and FIRST_CALL flags set), the next data element is LOG_INQY_DATA. This element is only present in the first physical record of the logical log record.

The type of data element is identified in the LOGID field of the header and can be one of the following:

LOGID X'00'

There is a CAPD block for each EXIT= logging request. For the format of the CAPD block, see “CAPD Block Format (LOGID=X'00')” on page 484.

LOGID X'04'

The DBD version for the data base, as specified on the VERSION= parameter of the DBD macro during DBDGEN. A character string of up to 63 characters.

LOGID X'08'

The concatenated key for the segment in the CAPD. The format of the physical concatenated key is a character string of up to 3,824 (255 x 15) characters.

LOGID X'0C'

The capture data segment data block (CAPD_DATA). This block is used for captured segment data, which can be path data, segment data, or before-image data. There is a CAPD_DATA block for each segment that was captured for the call. The blocks are logged in the following order: path data, segment data, before-image data. For the format of this block, see “CAPD_DATA Format (LOGID=X'0C')” on page 486.

LOGID X'10'

The segment data for the path or segment data deleted, inserted, or replaced (for a replace, this data would represent the after-image). The length of the segment data is a character string of up to 30,700 characters.

LOGID X'14'

The before-image of the segment data changed by the replace operation. Only the first changed byte through the last changed byte is logged. The unchanged beginning and ending portions of the segment are reconstructed from the after-image contained in segment data. The before-image data is a

halfword offset value (the offset of the changed data within the segment) followed by a character string of up to 30,700 characters. Only the actual before-image is compressed. The halfword offset value is not compressed. Within the changed data log record, there can be one before-image for every changed segment.

If all the data elements do not fit in a single log record, the next log record (with the same PST_NUMBER) contains the remaining data elements, starting where the previous record left off. Before-image data, however, is unique in that the offset (2 bytes) of the data in the segment is logged preceding the changed data. Therefore, the length of the data in DCAP_DATA (LOG_LL) is 2 bytes greater than the actual length of the data logged. The offset field is not compressed.

Reducing the Amount of Captured Data

The changed data log record can contain a large amount of data for cascade deletes, especially when path data is requested. The data is staged in an internal area prior to logging. If this internal area is not large enough to hold all of the data, the ERROR_LOG flag is set in the log record to indicate that the data is not complete, although, the IMS data is committed and the call completes normally.

To avoid large amounts of data being written to the log and possible incomplete log records, specify CASCADE,KEY,NODATA,NOPATH in the EXIT= parameter in the DBDGEN if cascade is required. This specification results in just the concatenated key being written to the log during DLET operations, which significantly reduces the amount of data that is captured during a cascade delete. For data propagation to DB2 UDB for z/OS where the primary key is derived from the concatenated key, the segment data is not required for the delete in DB2 UDB for z/OS.

Example of Logged Data Elements

Changed data log records contain many data elements as a result of a call. Consider a situation where a third-level segment is replaced and path data is requested to be logged (Root segment is A, second-level segment is B, and the replaced segment is C). In this situation, the data elements are logged in the following order:

1. CAPD
2. DBD Version ID
3. Physical concatenated key
4. CAPD_DATA block for A
5. Segment data for A
6. CAPD_DATA block for B
7. Segment data for B
8. CAPD_DATA block for C
9. Segment data for C
10. CAPD_DATA block for C (before data)
11. Before-image data for C

If path data had not been requested, the CAPD_DATA blocks and segment data elements for A and B would not be logged.

End of Job (EOJ) Call Log Record

The EOJ call log record (X'28' subcode) is written when a batch DL/I (DLI or DBB) program that has written changed data log records terminates normally. The record is written to indicate that the updates have been committed, since a commit record is not written to the log when a batch job terminates.

See “End of Job Call Log Record Format” on page 487 for the format of the EOJ Call Record.

SETS and ROLS Call Log Records

The SETS (X'30' subcode) and the ROLS (X'34' subcode) call log records are written whenever an application that might cause data to be captured issues a SETS or ROLS call using a token. The log records are written to indicate that any changed data log records written after the SETS call for the token used in the ROLS call will have been aborted (backed out). The records are written even if exits are defined without a logging request.

For the format of the SETS/ROLS call record, see “SETS and ROLS Call Log Record Format” on page 487.

Format of the Data Capture Log Records

This section shows the formats for the log record prefix, the data element header, and each of the data capture log records.

Data Capture Log Record Prefix

Table 146 lists the prefix for data capture log records.

Table 146. Prefix for Data Capture Log Records

Field Name	Data Type	Field Description
LL	H	The length of the log record, including a 4-byte log sequence number added by IMS to the end of the record
ZZ	H	Always zero
LOGCODE	XL1	X'99' log record code
SUBCODE	XL1	Data capture subcode
PST_NUMBER	H	PST number
RECOVTKN	XL16	The recovery token for the unit-of-recovery, which is used to associate the commit log records or the abort log records for this unit-of-recovery
STORE_CLOCK	XL8	The CPU store clock time stamp of the time the call completed and the log record was written

Changed Data Log Record Format

Table 147 lists the record formats for data capture log records.

Table 147. Format for Changed Data Log Records

Field Name	Data Type	Field Description
FLAG_1	XL1	Flag 1: Bit definitions follow:
LAST_RECORD	X'80'	The last log record written for this call. If this bit is not on, the remaining data for this DL/I call is in the log records that follow.

Table 147. Format for Changed Data Log Records (continued)

Field Name	Data Type	Field Description
FIRST_RECORD	X'40'	The first log record written for this call. If this bit is not on, the data logged at LOG_DATA_OFFSET is the data that would not fit in the preceding record.
FIRST_CALL	X'20'	The first log record written for this unit-of-recovery, so LOG_INQY_DATA is present in this log record. (FIRST_RECORD is on.)
	X'10'	Reserved for future use.
	X'08'	Reserved for future use.
ERROR_LOG	X'04'	This log record is not complete because there was an error during the processing of the log records for this call. Data for the call might not have been logged.
DBLEWORD_SEQNUM	X'02'	The log sequence number is a double word.
STCK_AT_END	X'01'	Store clock at end of the log record.
FLAG_2	XL1	Reserved for future use.
LOG_DATA_OFFSET	H	The offset in the log record where the DCAP_DATA elements start. When FIRST_RECORD is not on (indicating a split log record), this is the offset to the continuation of the data from the previous log record.
COMPR_ALGORITHM	XL1	The z/OS compression algorithm used to compress DCAP_DATA.
	XL1	Reserved for future use.
LOQ_SEQ_NUMBER	CL6	The IRLM lock sequence number used when IRLM SCOPE=GLOBAL used for block-level data sharing.
LOG_INQY_DATA		The following is logged when FIRST_CALL is on.
LOG_INQY_PSBNAME	CL8	The application PSB name.
LOG_INQY_TRANNAME	CL8	The application transaction name.
LOG_INQY_USERID	CL8	The user ID for the call.
DCAP_DATA	CL0	The data element being logged.

Format for Data Element Header

Table 148 lists the format for data element headers.

Table 148. Format for Log Record Header

Field Name	Data Type	Field Description
LOGID	XL1	The type of data being logged. X'00'- CAPD block X'04'- DBD Version ID X'08'- Physical concatenated key X'0C'- CAPD_DATA X'10'- Segment data X'14'- Before-image data
LOG_FLAGS	XL1	Flags. Bit definitions follow:
COMP_DATA	X'20'	The data is compressed using z/OS compression services.
	X'10'	Reserved for future use.

Propagating Captured Data Asynchronously

Table 148. Format for Log Record Header (continued)

Field Name	Data Type	Field Description
	X'08'	Reserved for future use.
	X'04'	Reserved for future use.
	X'02'	Reserved for future use.
	X'01'	Reserved for future use.
LOG_LL	H	Length of LOG_DATA.
LOG_DATA	CL0	Log data that is compressed if the z/OS services are available. The 4-byte data element header is followed by the type of data that is being logged: X'00' CAPD block (see "CAPD Block Format (LOGID=X'00')"). X'04' The log data is the DBD Version ID. X'08' The log data is the physical concatenated key. X'0C' CAPD_DATA (see "CAPD_DATA Format (LOGID=X'0C')" on page 486). X'10' The log data is the Segment data. X'14' The log data is the Before-image data. Before-image data is preceded by a halfword offset of the changed data within the segment. The halfword offset is not compressed.

CAPD Block Format (LOGID=X'00')

Table 149 lists the CAPD block format.

Table 149. Format for CAPD Block (LOGID = X'00')

Field Name	Data Type	Field Description
NEXT_PTR	AL4	Internal use only. Not valid.
PREVIOUS_PTR	AL4	Internal use only. Not valid.
USER_EXIT_NAME	CL8	The name of the exit routine that is to be given control when an exit routine is requested in addition to logging. Blanks if the exit routine is not defined or is logged by DBCTL.
DATA_BASE_NAME	CL8	The name of the physical database.
DBD_VERSION_PTR	AL4	Internal use only. Not valid.
SEGMENT_NAME	CL8	The name of the physical segment that was updated and for which the log data was requested.
SEGMENT_CODE	XL1	Segment code for compare.
FLAGS	XL1	Flag: Bit definition follows:
DEDB_DB	X'80'	DEDB database.
KEY_NEEDED	X'40'	Concatenated key needed.
DATA_NEEDED	X'20'	Segment data needed.
PATH_NEEDED	X'10'	Path data needed.
	X'08'	Reserved for IMS.

Propagating Captured Data Asynchronously

Table 149. Format for CAPD Block (LOGID = X'00') (continued)

Field Name	Data Type	Field Description
	X'04'	Reserved for IMS.
	X'02'	Reserved for future use.
	X'01'	Reserved for future use.
	XL1	Reserved for IMS.
CALL_SEGMENT_LEVEL	XL1	Reserved for future use.
CALL_FUNCTION	CL4	Call function of request: REPL Replace call. ISRT Insert call. DLET Delete call. CASC Cascade delete as result of application delete call. DLLP Delete of a logical parent segment through its logical path because: <ul style="list-style-type: none"> • It was marked as previously deleted from its physical path. • It is vulnerable to delete from both the physical and logical paths. • And, the last logical child segment is being deleted.
PHYS_FUNCTION	CL4	Physical function performed by DL/I: REPL Segment physically replaced. ISRT Segment physically inserted. DLET Segment physically deleted. DLPP Delete this segment on its physical path, but do not physically remove because logical paths to the segment from a logical child still exist.
CALL_TIMESTAMP	XL8	STCK time stamp of call completion.
AREA_NAME	CL8	The AREA name for a DEDB database.
LOWEST_LVL_KEY_OR_DATA	XL1	The lowest level number for which path data or a part of the concatenated key is added.
	XL63	Reserved for future use.
SAVED_DLTWA	AL4	Saved DLTWA for compare.
PHYSICAL_ROOT_RBA	AL4	RBA of root segment.
STORAGE_SIZE	F	Internal use only. Not valid.
CONC_KEY_PTR	AL4	Internal use only. Not valid.
CONC_KEY_LENGTH	H	Length of physical concatenated key.
ROOT_KEY_LENGTH	XL1	Length of root key.

Propagating Captured Data Asynchronously

Table 149. Format for CAPD Block (LOGID = X'00') (continued)

Field Name	Data Type	Field Description
CAPD_DATA_DIMEN	XL1	Dimension of data array. This value reflects the number of CAPD_DATA Block elements that will be logged for this call. If path data is requested, the first CAPD_DATA block element will be for the root segment, followed by CAPD_DATA block elements for each segment in the path. The next CAPD_DATA block element (first if no path data) is for the segment associated with this request, followed by the CAPD_DATA block element (if any) associated with the before-image data (physical replace operations).
CAPD_DATA_PTR(16)	16AL4	Internal use only. Not valid.

CAPD_DATA Format (LOGID=X'0C')

Table 150 lists the format for CAPD_DATA.

Table 150. Format for CAPD_DATA (LOGID = X'0C')

Field Name	Data Type	Field Description
NEXT_PTR	AL4	Internal use only. Not valid.
	AL4	Reserved for IMS.
SEGMENT_NAME	CL8	The name of the physical segment that is captured.
	XL4	Reserved for future use.
	XL1	Level of physical segment.
	XL1	Reserved for future use.
DATA_TYPE	XL1	The type of data being captured: X'00' Segment X'01' Before data X'02' Cascade data X'03' Segment path data
DATA_FLAGS	XL1	Flag byte: Bit definitions follow:
DATA_USER_IO	X'80'	Data in user I/O area.
DEL_ON_PHY_PATH	X'40'	Segment is deleted on physical path.
	X'20'	Reserved for future use.
	X'10'	Reserved for future use.
	X'08'	Reserved for future use.
	X'04'	Reserved for future use.
	X'02'	Reserved for future use.
	X'01'	Reserved for future use.
LP_KEY_LENGTH	H	The length of the segment's logical parent key concatenated in front of the segment data. Zero if segment is not a logical child.
KEY_LENGTH	H	The length of the segment's key. Zero if the segment does not have a key.
KEY_OFFSET	H	The offset of the segment's key. Zero if the segment does not have a key.
SEGMENT_LENGTH	H	The length of the segment data.
SEGMENT_PTR	AL4	Internal use only. Not valid.

End of Job Call Log Record Format

Table 151 lists the end of job call log record formats.

Table 151. Format for EOJ Call

Field Name	Data Type	Field Description
LL	H	The length of the log record, including a 4-byte log sequence number added by IMS to the end of the record.
ZZ	XL2	Always zero.
LOGCODE	XL1	X'99' log record code.
SUBCODE	XL1	X'28' log subcode.
PST_NUMBER	H	PST number.
RECOVTKN	XL16	The recovery token for the unit-of-recovery, which is used to associate the commit log records or the abort log records for this unit-of-recovery.
STORE_CLOCK	XL8	The CPU store clock time stamp of the time the program terminated and wrote the log record.

SETS and ROLS Call Log Record Format

Table 152 lists the format for the SETS and ROLS call log records.

Table 152. Format for SETS and ROLS Call

Field Name	Data Type	Field Description
LL	H	The length of the log record, including a 4-byte log sequence number added by IMS to the end of the record.
ZZ	XL2	Always zero.
LOGCODE	XL1	X'99' log record code.
SUBCODE	XL1	X'30' log subcode for SETS call; X'34' log subcode for ROLS call.
PST_NUMBER	H	PST number.
RECOVTKN	XL16	The recovery token for the unit-of-recovery, which is used to associate the commit log records or the abort log records for this unit-of-recovery.
STORE_CLOCK	XL8	The CPU store clock time stamp of the time the call completed and the log record written.
TOKEN	CL4	The SETS/ROLS token used by the call.

Propagating Captured Data Asynchronously

Part 7. DRA (Database Resource Adaptor) Exit Routines

Chapter 72. CCTL Exit Routines	491
Routine Attributes	491
Suspend Exit Routine	492
Resume Exit Routine	492
Control Exit Routine	492
Status Exit Routine	497
Example of the DRA and Exit Routines	499

Chapter 72. CCTL Exit Routines

There are four exit routines to which the DRA passes control. The CCTL can provide the code for any or all of these routines. If the CCTL passes an address (in the INIT request) of zero for a particular routine, the DRA uses a default exit routine.

The following topics provide additional information:

- “Routine Attributes”
- “Suspend Exit Routine” on page 492
- “Resume Exit Routine” on page 492
- “Control Exit Routine” on page 492
- “Status Exit Routine” on page 497
- “Example of the DRA and Exit Routines” on page 499

Routine Attributes

All CCTL exit routines called by the DRA have control passed to them in 31-bit addressing mode and must return to the DRA in the same mode. Since much of the DRA has RMODE=31, registers 13 and 14 can point to locations above the 16 MB line. When the DRA calls the Control exit routine, the PAPL that it passes can also be above the line.

Upon entry to a CCTL exit routine, the PAPLTOK and PAPLUSER fields are the same as they were when DFSPRRC0 first received the PAPL. (For more information on the requests use these fields, see Appendix A, “DBCTL Function Requests,” on page 577.) The CCTL uses the PAPLUSER field to pass information to the exit routines (for example, the address of the control blocks).

If you want the DRA to use the default exit routines supplied with IMS DB, pass a value of binary zero as the address of the exit routine in the INIT request.

Related Reading: For more information, see the section on CCTL DRA function requests in *IMS Version 9: Application Programming: Database Manager*.

The functions performed by the IMS DB-supplied routines are as follows:

Routine	Function
Suspend	z/OS wait
Resume	z/OS post
Control	Always return with PAPL return code = 0 (PAPLRETC field)
Status	Free the storage area that contains user PCBs and the PCB list

To use the default Suspend exit routine and Resume exit routine, each DRA request must have the field PAPLTECB set with the address of a CCTL ECB is waited or posted.

The following sections contain the information needed for the CCTL-provided exit routines.

CCTL Exit Routines

Related Reading: For more details on the return codes, see *IMS Version 9: Messages and Codes, Volume 1* and *IMS Version 9: Messages and Codes, Volume 2*.

Suspend Exit Routine

The suspend exit routine receives control whenever the DRA Router routine needs to suspend a DRA request and allows the CCTL to use its own processing technique to suspend its thread. The suspend exit routine can execute before or after the Resume exit routine.

The suspend exit routine executes in the CCTL's environment. The contents of the registers upon entry are:

Register	Contents
1	Address of the PAPL
14	Return address
15	Entry point address

This routine can use a PAPL 16-word save area (PAPLSREG) to save the DRA's registers. The DRA does not expect any output from this routine.

Resume Exit Routine

The resume exit routine allows the CCTL to use its own processing technique to resume a DRA request suspended by the Suspend exit routine. This routine can execute before or after the Suspend exit routine executes.

This routine receives control whenever a request has completed its process. The contents of the registers upon entry are:

Register	Contents
1	Address of the PAPL
13	Address of an 18-word save area that this routine can use to save DRA registers
14	Return address
15	Entry point address

The DRA does not expect any output from this routine.

Control Exit Routine

The Control exit routine allows the DRA to notify the CCTL about events occurring within the DRA or IMS DB. It also allows the CCTL to notify the DRA how to respond to those events. This routine receives control whenever the DRA must notify the CCTL of the following events:

- The DRA successfully identifies itself to IMS DB.
- The identify attempt to IMS DB fails.
- The CCTL's INIT request is canceled.
- The DRA fails.
- IMS DB fails.
- IMS DB terminates normally using the /CHECKPOINT FREEZE command.

- The DRA terminates due to a Control exit routine request.

The Control exit routine uses a PAPL that belongs to the DRA, never a CCTL PAPL that is a DRA request.

For all of these events (except the last one), the CCTL must tell the DRA what action to execute next. This is done using a return code that the CCTL places in the PAPLRETC field prior to passing the PAPL back to the DRA. The DRA then acts accordingly.

The contents of the registers upon entry are:

Register	Contents
1	Address of the PAPL
13	Address of standard 18-word save area that the Control exit routine can use
14	Return address
15	Entry point address

A list of possible events about which the DRA notifies the CCTL follows. With each event, the contents of the PAPL are listed with possible actions for the CCTL to take.

- After the DRA successfully identifies to IMS DB, the contents of the PAPL passed to the CCTL are:

Field	Contents						
PAPLFUNC	Resync function code, PAPLRSYN						
PAPLRSLT	Resync list address, list of recovery tokens of indoubt UORs. First 4 bytes in the list is the number of tokens in the list. Following this number are the actual tokens, each being 16 bytes.						
PAPLUSER	User data (passed on the INIT request).						
PAPLDBCT	IMS DB identifier.						
PAPLMTCB	Minimum thread count specified in the startup table or INIT request.						
PAPLJOBN	IMS DB jobname.						
PAPLCRC	IMS DB command recognition character.						
PAPLIDTK	IMS DB identify token (unique store clock value representing the time the CCTL identified with IMS DB).						
PAPLDSID	IMS DB ASID.						
PAPLRSEN	DBRSE (IMS DB warmstandby name, =DBRSENM, IMS DB execution parameter). See <i>IMS Version 9: Installation Volume 2: System Definition and Tailoring</i> for more information.						
PAPLRGTY	IMS region type. The possible region types are: <table border="0" style="margin-left: 20px;"> <tr> <td>PAPLDBCX</td> <td>DB/DC with XRF.</td> </tr> <tr> <td>PAPLDBCO</td> <td>DB/DC only.</td> </tr> <tr> <td>PAPLDBCL</td> <td>IMS DB</td> </tr> </table>	PAPLDBCX	DB/DC with XRF.	PAPLDBCO	DB/DC only.	PAPLDBCL	IMS DB
PAPLDBCX	DB/DC with XRF.						
PAPLDBCO	DB/DC only.						
PAPLDBCL	IMS DB						

CCTL Exit Routines

After the routine has completed analyzing the PAPL, it can insert the following return codes in the PAPLRETC field to notify the DRA of the next action to take:

Code Returned

Meaning

- 0** IMS DB environment OK.
- 4** Terminate the DRA (the Control exit routine is not called again during this DRA session).

- After the identify to IMS DB fails, the contents of the PAPL passed to the CCTL are:

Field	Contents
PAPLFUNC	Failure function code
PAPLSFNC	Identify request failed subfunction code
PAPLUSER	User data (passed on the INIT request)
PAPLDBCT	IMS DB identifier
PAPLRETC	Code returned from subsystem interface or IMS DB
PAPLRCOD	Reason code. The possible reason codes are: <ul style="list-style-type: none">PAPLNTUP Subsystem exists but is not upPAPLNOSS Subsystem does not existPAPLINT IMS DB is in initialization processPAPLRSTN IMS DB waiting for restart commandPAPLRST In restart processPAPLBRST DB/DC XRF backup in tracking modePAPLTKOV Backup in takeover mode

After the routine analyzes the PAPL, it can insert the following data in the output fields in the PAPL to notify the DRA of the next action to take:

Field	Contents
PAPLDBCN	New IMS DB identifier
PAPLRETC	Code returned from the CCTL to the DRA. PAPLRETC is passed to the Control exit routine and must be reset.

Code Returned

Meaning

- 0** Issue a DFS0690 message and try to identify IMS DB again.
 - 4** Proceed with DRA termination (the Control exit routine will not be called again).
 - 8** Reidentify with new IMS DB identifier (in the PAPLDBCN field).
- After the DRA INIT request is canceled by a cancel response to the DRF690 message, the contents of the PAPL passed to the CCTL are:

Field	Contents
PAPLFUNC	Failure function code
PAPLSFNC	Cancelled INIT request subfunction code
PAPLUSER	User data (from the INIT request).

- PAPLDBCT** IMS DB identifier.
- PAPLRETC** Code returned from IMS DB.
- PAPLRCOD** Reason code. The possible reason codes are:
 - PAPLDBNZ** IMS DB rejected identify request.
 - PAPLOPC** Operator responded cancel to DFS690 message.

After the routine has completed analyzing the PAPL, it can insert the following return codes in the PAPLRETC field to tell the DRA what to do next:

Code Returned

	Meaning
0	Wait for a DRA TERM request.
4	Proceed with DRA termination (the Control exit routine will not be called again).

PAPLRETC is passed to the Control exit routine and must be reset.

- When the DRA fails, the contents of the PAPL passed to the CCTL are:

Field	Contents
PAPLFUNC	Failure function code
PAPLDRAF	DRA failure subfunction code.
PAPLUSER	User data.
PAPLDBCT	IMS DB identifier.
PAPLRCOD	Reason code
	The reason codes possible are:
	PAPLGMF GETMAIN failed.
	PAPLSSF Subsystem interface failure.
	PAPLDRAA DRA abend.
	PAPLESTF Unable to establish DRA ESTAE.

The DRA expects no return code in PAPLRETC. The DRA fails and the Control exit routine is not called when the failure occurs while processing a TERM request. In this case, the PAPL return code of the returned TERM PAPL contains the failure code.

- When IMS DB fails, the DRA first issues a U002 abend to all DRA thread TCBs. In some cases, the DRA itself can also get a U002 abend and call the Control exit routine as in the previous failure event. Otherwise, the contents of the PAPL passed to the CCTL are:

Field	Contents
PAPLFUNC	Failure function code.
PAPLDBCF	IMS DB failure subfunction code.
PAPLUSER	User data.
PAPLDBCT	IMS DB identifier.
PAPLRETC	Code returned from IMS DB.
PAPLRCOD	Reason code. The reason code is:
	PAPLABND IMS DB abend.

CCTL Exit Routines

The DRA expects no return code in PAPLRETC.

After the exit routine analyzes the PAPL, it can insert the following identifier and return codes in the output fields of the PAPL to notify the DRA of the next action to take:

Field	Contents
PAPLDBCN	New IMS DB identifier.
PAPLRETC	Code returned.

PAPLRETC is passed to the Control exit routine and must be reset.

Code Returned

Meaning

0	Wait for a DRA TERM request.
4	Wait for DRA termination.
8	Try to identify again with the new IMS DB identifier in the PAPLDBCN field.

- After IMS DB terminates using a /CHECKPOINT FREEZE command, the contents of the PAPL passed to the CCTL are:

Field	Contents
PAPLFUNC	Failure function code.
PAPLDBCC	IMS DB /CHE FREEZE subfunction code.
PAPLUSER	User data.
PAPLDBCT	IMS DB identifier.

After the exit routine analyzes the PAPL, it can insert the following identifier and return codes in the output fields of the PAPL to notify the DRA of the next action to take:

Field	Contents
PAPLDBCN	IMS DB identifier.
PAPLRETC	Code returned.

Code Returned

Meaning

0	Allow the DRA to shut itself down.
4	Terminate DRA immediately.
8	The current DRA threads are allowed to complete all current calls and are then terminated. The DRA then reidentifies with the new IMS DB identifier.

After the CCTL sets the return code equal to 0, the DRA follows the rules of the /CHECK FREEZE command (for example, it allows the current threads to complete their units of work). After the last thread completes, the DRA terminates. The invocation of the Control exit routine signals the completion of the DRA shutdown process.

- After the DRA terminates due to a Control exit routine request, the contents of the PAPL passed to the CCTL are:

Field	Contents
--------------	-----------------

PAPLFUNC	Failure function code.
PAPLDRAF	DRA failure subfunction code.
PAPLUSER	User data.
PAPLDBCT	IMS DB identifier.
PAPLRCOD	Reason code.

The possible reason codes are:

PAPLITCF	DRA terminated due to a Control exit routine request.
PAPLMXN2	Statistic #1 (see <i>IMS Version 9: Application Programming: Database Manager</i>)
PAPLMIN2	Statistic #2 (see <i>IMS Version 9: Application Programming: Database Manager</i>)
PAPLHIT2	Statistic #3 (see <i>IMS Version 9: Application Programming: Database Manager</i>)
PAPLTIM2	Statistic #4 (see <i>IMS Version 9: Application Programming: Database Manager</i>)

Since the DRA terminated, the CCTL does not pass any return codes to IMS DB. Control is passed to this exit routine at the end of the DRA cleanup when the DRA termination is due to a previous Control exit routine request. For example, after being notified of a IMS DB failure or a /CHE FREEZE command, the Control exit routine terminates the DRA.

Status Exit Routine

The function of the Status exit routine is to prevent a z/OS S0C4 abend from occurring when a CCTL thread attempts to access nonexistent storage.

The DRA passes control to the Status exit routine when a TCB for a DRA thread in a scheduled state is collapsing.

Definition: The scheduled state is the time between the DRA's successful processing of a schedule request and the DRA's successful processing of one of the following thread function requests:

ABTTERM	Abort Unit of Work.
COMTERM	Commit Unit of Work.
TERMTHRD	Terminate Thread.

Related Reading: Refer to the section on CCTL DRA function requests in *IMS Version 9: Application Programming: Database Manager* for a description of the thread functions.

The status exit is called to:

- Notify CCTL that the DRA thread is about to terminate for a reason other than a request from the CCTL.
- Allow CCTL to stop reference, by the CCTL thread, to storage that IMS DB acquired on behalf of the thread.
- Notify CCTL to free the storage that IMS DB acquired for the thread.

CCTL Exit Routines

When a DRA thread successfully processes a schedule request, the address of the storage that IMS DB acquired in the CCTL's private storage is returned to the CCTL. The storage is acquired and initialized with the user's PCBLIST and PCBs. The CCTL thread uses the PCBLIST and PCBs to make DL/I requests and to receive the results of the requests. The storage is referred to as user private storage (UPSTOR).

Related Reading: Refer to the section on CCTL DRA function requests in *IMS Version 9: Application Programming: Database Manager* for PAPL fields returned to CCTL when the schedule request is completed.

The CCTL thread has access to UPSTOR for the duration of the thread's scheduled state. When the scheduled state terminates normally by a request from the CCTL, IMS DB manages UPSTOR storage.

Reference to UPSTOR by the CCTL thread after the normal end of a scheduled state can result in a z/OS S0C4 abend if IMS DB has freed the storage. If IMS DB allocated the same storage to another thread, reference to UPSTOR can overlay the second thread's data.

When the thread terminates abnormally during the scheduled state, the Status exit routine notifies the CCTL. The CCTL is responsible for freeing UPSTOR. The responsibility for freeing UPSTOR is assigned to the CCTL to ensure that UPSTOR is freed at the proper time.

The UPSTOR area is acquired using the GETMAIN macro by DRA thread TCBs out of subpool 0 (subpool 132 if the CCTL application is running with the public key option set).

The default Status exit routine provided by the DRA frees UPSTOR. If the CCTL chooses the default exit routine, it can incur a program check abend trying to access that storage because the CCTL might execute after the DRA has freed the storage.

The contents of the registers upon entry are:

Register	Contents
1	Address of the PAPL.
13	Address of standard 18-word save area that the Status exit routine can use.
14	Return address.
15	Entry point address.

If DRA thread termination occurs during processing of a CCTL request, the CCTL's PAPL is passed to the Status exit routine. Otherwise, the DRA builds a PAPL.

The contents of the PAPL that are significant for the call are:

Field	Contents
PAPLUSR3	The value CCTL passed in PAPLUSR3 on the INIT request.
PAPLTOKT	The thread token set up by the CCTL. This is the token which the CCTL passed, in PAPLTOK, on the SCHED request.
PAPLUPSA	Address of UPSTOR.

PAPLUPSL Length of UPSTOR.

The DRA expects no return code in PAPLRETC.

Example of the DRA and Exit Routines

Table 153 illustrates how the DRA works in situations involving the functions presented in this chapter.

In this example, events in a multithreading system are shown in chronological order. To illustrate the concept of concurrent processing, the figure is split into two columns. Events that occur under the CCTL TCB (TCB with DFSPRRC0) are shown in the left column. Those events associated with the DRA or DRA thread TCBs are shown in right column. There are two CCTL threads and two DRA threads in this example.

Highlights of this example are as follows:

- One CCTL thread makes a DL/I request that fails, resulting in the Status exit routine being called.
- Another CCTL thread issues a PREP request successfully, putting that UOR in an in-doubt state in IMS DB. At this point, IMS DB fails.
- Because of the IMS DB failure, the Control exit routine is called.
- After IMS DB is restarted, the DRA identifies itself to IMS DB successfully and the Control exit routine is called for this event.
- The CCTL issues a RESYNC request to resolve the in-doubt UOR.

At the end of Table 153 are two DRA threads that were created as the result of successful SCHED requests. Assume that application programs have made several successful calls to update databases (DL/I requests). These requests, as all DRA and thread requests, are handled exactly the same with respect to multithreading as illustrated in the table found in the section on CCTL multithread examples in *IMS Version 9: Application Programming: Database Manager*.

Table 153. Continuation of the Example of Events in a Multithreading System

CCTL TCB Events	DRA TCB Events
CCTL thread1 events:	
<ul style="list-style-type: none"> • DFSRTNA builds the DL/I PAPL and calls DFSPRRC0. • DFSPRRC0 finds the correct DRA thread. • DFSPRRC0 activates thread TCB1. • DFSPRRC0 calls the Suspend exit routine. • The Suspend exit routine suspends CCTL thread1. 	
<p>Application program2 completes. The CCTL will make sync-point requests to IMS DB to commit the processing of this UOR. The CCTL flags the UOR for application program2 as in-doubt prior to issuing a phase 1 request. The CCTL will keep a record of this in-doubt UOR until the CCTL can make a successful phase 2 call to IMS DB.</p>	<p>DRA thread TCB1 events:</p> <ul style="list-style-type: none"> • The DRA processes the DL/I PAPL and asks IMS DB to perform a DL/I process. • The DL/I call is in progress.
CCTL thread2 events:	

CCTL Exit Routines

Table 153. Continuation of the Example of Events in a Multithreading System (continued)

CCTL TCB Events	DRA TCB Events
<ul style="list-style-type: none"> • DFSRTNA issues a PREP request and calls DFSPRRC0. 	
<ul style="list-style-type: none"> • DFSPRRC0 activates thread TCB2. 	
<ul style="list-style-type: none"> • DFSPRRC0 calls the Suspend exit routine. 	
<ul style="list-style-type: none"> • The Suspend exit routine suspends CCTL thread2. 	<p>DRA thread TCB2 events:</p> <ul style="list-style-type: none"> • The DRA sends the PREP request to IMS DB. • IMS DB logs Phase 1 complete. This IMS DB UOR is now in-doubt. • The PREP request completes successfully and calls the Resume exit routine.
<ul style="list-style-type: none"> • The PREP request results are returned to DFSRTNA (by the PREP PAPL), and thread2 becomes inactive. 	<p>DRA thread TCB1 events:</p> <ul style="list-style-type: none"> • IMS DB detects a DL/I failure. This failure results in termination of this DRA thread and a termination of this thread TCB. • Since this thread was in a schedule state, the DRA calls the Status exit routine and passes the DL/I PAPL back to the CCTL after putting UPSTOR information in it. • The Status exit routine associates UPSTOR with a CCTL thread, and the routine passes the PAPL to the DRA. • The DRA calls the Resume exit routine. • The DRA takes an SDUMP and terminates thread TCB1.
<p>CCTL thread1 events:</p> <ul style="list-style-type: none"> • After thread1 has been resumed, control is passed back to DFSRTNA. • The CCTL notices that the DL/I request failed (returning PAPLRETC=4) and takes a diagnostic dump that includes UPSTOR. • The CCTL terminates this CCTL thread and frees UPSTOR because thread1 failed. 	
<p>Before CCTL sends a commit request for thread2, IMS DB fails.</p>	
	<p>DRA TCB events:</p> <ul style="list-style-type: none"> • The DRA calls the Control exit routine to notify the CCTL that IMS DB failed. • The Control exit routine returns a code (PAPLRETC=8) that tells the DRA to reconnect to IMS DB.

Table 153. Continuation of the Example of Events in a Multithreading System (continued)

CCTL TCB Events	DRA TCB Events
	<ul style="list-style-type: none"> The DRA terminates any existing thread TCBs. If the CCTL makes any subsequent requests to these terminated DRA threads, the DRA will respond with a return code indicating that the request cannot be processed.
	<ul style="list-style-type: none"> After IMS DB has been restarted, the DRA successfully connects to IMS DB (for more information, refer to the INIT Request section of <i>IMS Version 9: Application Programming: Database Manager</i>).
	<ul style="list-style-type: none"> The DRA calls the Control exit routine to notify the CCTL that it successfully connected to IMS DB.
<p>Because there is an entry in the resynchronization list for the IMS DB in-doubt UOR, the CCTL creates a new task to resolve this indoubt status.</p>	<ul style="list-style-type: none"> The DRA passes the address of the resynchronization list (PAPLRST) to the CCTL. The list contains one entry for the IMS DB indoubt UOR for CCTL thread2.
	<ul style="list-style-type: none"> The Control exit routine returns a code (PAPLRETC=0) that tells the DRA to continue running.
<p>CCTL thread3 events:</p>	<ul style="list-style-type: none"> The DRA completes the setup process by creating new DRA thread TCBs.
<ul style="list-style-type: none"> The CCTL matches the in-doubt UOR in the re synchronization list with an in-doubt UOR in its own list. The CCTL in-doubt UOR is flagged for commit processing as its Phase 2 action. DFSRTNA issues a RESYNC request to DFSPRRC0 asking for commit processing. RESYNC is a DRA request, not a thread request. DFSPRRC0 activates the DRA TCB to process the request and calls the Suspend exit routine. 	
	<ul style="list-style-type: none"> DRA calls IMS DB to commit its UOR. After successful processing, DRA calls the Resume exit routine.
<ul style="list-style-type: none"> After thread3 has been resumed, DFSRTNA receives a return code of PAPLRETC=0. The CCTL discards its indoubt UOR because the RESYNC request was successful. 	

CCTL Exit Routines

Part 8. External Subsystem Attach Facility

Chapter 73. ESAP (External Subsystem Attach Facility) Overview	507
What the External Subsystem Must Provide	508
External Subsystem Attachment Package (ESAP)	508
External Subsystem Module Table (ESMT)	508
Resource Translation Table (RTT)	508
How External Subsystems Are Specified to IMS	509
The Basics of Attach Processing	510
Subsystem Connections	510
Application Call Processing	513
Resource Coordination	513
External Subsystem Command Support	514
IMS Services Available to the ESAP	514
Chapter 74. Creating the External Subsystem Module Table	517
DFSEMODL Macro	517
DFSEWAL Macro	520
Chapter 75. IMS Attach Facility Processing	525
Loading the External Subsystem Attachment Package	525
Creating the EEVT Control Block	525
Loading External Subsystem Modules	526
Creating Work Areas for the ESAP	527
Initiating the External Subsystem Connection	527
Deferring the Control Region Identify	528
Using the IMS Subsystem Startup Service	528
Establishing Dependent Region Connections	529
Notify Message	529
Application Program Request Support	531
Language Interface Definition	531
Language Interface Entry Points Unique to External Subsystems	531
Accessing Multiple External Subsystems	532
Resource Recovery Token	532
Terminating the External Subsystem Connection	533
Termination Requested by the External Subsystem	533
Dependent Region Connections	534
Explanation of Stopped Status	534
Chapter 76. External Subsystem Exit Routines	537
General Exit Routine Interface	537
Exit Parameter List (EPL)	537
Contents of Registers	538
Return Codes	538
Exit Routine Interface Control Blocks	539
Control Block Mapping	540
Abort Continue Exit Routine	541
Activating the Routine	542
Contents of Register 15 on Return	542
Command Exit Routine	542
Activating the Routine	543
Contents of Register 15 on Return	543
Commit Continue Exit Routine	544
Activating the Routine	544
Contents of Register 15 on Return	544

Commit Prepare Exit Routine	544
Activating the Routine	545
Contents of Register 15 on Return	545
Commit Verify Exit Routine	546
Activating the Routine	546
Contents of Register 15 on Return	547
Create Thread Exit Routine	547
Activating the Routine	547
Contents of Register 15 on Return	548
Echo Exit Routine	549
Activating the Routine	549
Contents of Register 15 on Return	549
Identify Exit Routine	549
Activating the Routine from the Control Region	550
Contents of Register 15 on Return	551
Activating the Routine from the Dependent Region	551
Contents of Register 15 on Return	551
Initialization Exit Routine	552
Activating the Routine from the Control Region	552
Contents of Register 15 on Return	552
Activating the Routine from the Dependent Region	553
Contents of Register 15 on Return	553
Normal Call Exit Routine	553
Activating the Routine	554
Contents of Register 15 on Return	554
Resolve Indoubt Exit Routine	555
Activating the Routine	555
Contents of Register 15 on Return	556
Signoff Exit Routine.	557
Activating the Routine	558
Contents of Register 15 on Return	558
Signon Exit Routine.	558
Activating the Routine	559
Contents of Register 15 on Return	559
Subsystem Not Operational Exit Routine	560
Activating the Routine	561
Contents of Register 15 on Return	562
Subsystem Termination Exit Routine	562
Activating the Routine	563
Contents of Register 15 on Return	563
Terminate Identify Exit Routine	563
Activating the Routine from the Control Region	564
Contents of Register 15 on Return	564
Activating the Routine from the Dependent Region	564
Contents of Register 15 on Return	565
Terminate Thread Exit Routine.	565
Activating the Routine	565
Contents of Register 15 on Return	565
Chapter 77. IMS System Service Exit Routines	567
General System Service Exit Routine Interface.	567
Log Service Exit Routine	568
Activating the Routine	568
Contents of Register 15 on Return	568
Message Service Exit Routine	569
Activating the Routine	569

Contents of Register 15 on Return	571
Subsystem Startup Service Exit Routine	571
Activating the Routine	571
Contents of Register 15 on Return	572
Subsystem Termination Service Exit Routine	572
Activating the Routine	573
Contents of Register 15 on Return	573

This section documents General-Use Programming Interface and Associated Guidance Information.

Chapter 73. ESAF (External Subsystem Attach Facility) Overview

The External Subsystem Attach Facility enables MPP, BMP, and IFP application programs to access databases managed by other subsystems in addition to DL/I databases.

An external subsystem (ESS) product that wants to enable access to its data resources from IMS applications must provide functions necessary for it to “attach” to the IMS subsystem and to, jointly with IMS, coordinate data access. Part 8, “External Subsystem Attach Facility,” on page 503 describes the IMS Attach Facility programming interface presented to the external subsystem product. Installation requirements are also described (or references to other IMS publications are given where applicable).

Multiple external subsystems can only be attached by an online IMS system. These subsystems can be of the same, or of different, product types. The installation defines the external subsystems to IMS. A given IMS dependent region can have access to all external subsystems defined to the IMS system, to just a subset, or to none according to installation specifications. An application program executing in a dependent region can access more than one different subsystem. The installation defines a unique token for each subsystem, which IMS uses in routing application calls for external resources. Application program access to more than one subsystem of the same type is supported by IMS, but might not be supported by the external subsystem.

The facility provides for synchronization of external subsystem data resources with IMS data resources. For synchronization processing, IMS is the recovery coordinator and is responsible for directing commit or abort actions on behalf of its application programs. External subsystems are participants in the process and commit or abort data updates by IMS applications according to direction given by IMS. When resources are to be committed, IMS polls the participants as to whether or not they are ready to commit before giving final commit (or abort) direction.

For IMS batch, IMS is only allowed to attach to one external subsystem. IMS expects this external subsystem to be the Recovery Coordinator. This external subsystem has no way of coordinating with any other external subsystem that IMS attaches to, so IMS is restricted to only one external subsystem attachment in batch.

The External Subsystem Attach Facility is different from the coordinator controller (CCTL) associated with DBCTL.

Note: JMP and JBP applications use the DB2 Recoverable Resource Manager Services Attach Facility (RRSAF) instead of ESAF (external subsystem attach facility) to attach DB2 databases. For information on DB2 database access from JMP and JBP regions, see *IMS Version 9: IMS Java Guide and Reference*.

The following topics provide additional information:

- “What the External Subsystem Must Provide” on page 508
- “How External Subsystems Are Specified to IMS” on page 509
- “The Basics of Attach Processing” on page 510

What the External Subsystem Must Provide

The External Subsystem must provide an:

- External Subsystem Attachment Package (ESAP)
- External Subsystem Module Table (ESMT)
- Resource Translation Table (RTT)

External Subsystem Attachment Package (ESAP)

The IMS Attach Facility uses an exit routine interface. That is, to accomplish external subsystem access from dependent regions, IMS activates exit routines at certain processing points. These exit routines must be supplied by the external subsystem. The exit routine functions are prescribed by IMS; the external subsystem supplies its unique implementation. The exit routines must, in fact, provide the actual linkage to the external subsystem. IMS is not sensitive to the linkage mechanism used.

IMS loads external subsystem-supplied exit routine modules in the control region and in each dependent region that can access the external subsystem. The external subsystem can supply additional modules needed for attach exit routine processing; IMS loads these modules as well. The external subsystem modules provided for attach processing in the IMS regions make up what IMS calls the External Subsystem Attachment Package (ESAP).

External Subsystem Module Table (ESMT)

The external subsystem must specify the modules that IMS is to load in an external subsystem module table (ESMT). The external subsystem creates the module table using macros provided by IMS and makes it available to the installation. The installation specifies the name of the ESMT to IMS by including it on the definition of the external subsystem to IMS.

Related Reading: For an explanation of how to generate the ESMT, refer to Chapter 74, “Creating the External Subsystem Module Table,” on page 517.

Resource Translation Table (RTT)

IMS uses a PSB (program specification block) to define the DL/I resources required by an application program. For an MPP, the PSB name is the same as the application program name; for a BMP or IFP, the PSB name can be different. The external subsystem can use a name other than the PSB name or the IMS application program name for the entity it uses to define the external subsystem resources required by the application program. If the external subsystem uses a different name, the external subsystem can provide a resource translation table (RTT) to map either PSB names or application program names to its entity names.

The external subsystem creates the RTT and makes it available to the installation. The installation specifies the name of the RTT on the definition of the external subsystem to IMS. IMS loads the RTT when it loads the ESAP.

The external subsystem is responsible for doing the actual mapping. IMS does not access the RTT; it merely loads the table and makes its address available to the ESAP. IMS does not prescribe the format of the RTT.

How External Subsystems Are Specified to IMS

In an IMS.PROCLIB member, define all external subsystems that are to be accessed by IMS applications. The EXEC statement of the control region points to this member with the SSM parameter.

For each external subsystem defined to IMS, specify in the IMS.PROCLIB member:

- The external subsystem type
- The z/OS name of the external subsystem
- The name of the external subsystem module table (ESMT) that specifies the modules in the external subsystem attachment package (ESAP)
- The language interface token (LIT) that IMS uses to route application calls to the external subsystem
- The name of a resource translation table (RTT) supplied by the external subsystem, if needed, to identify the external resources required by IMS application programs
- The command recognition character (CRC) that IMS uses to route operator commands to the external subsystem
- The region error option (REO) code indicating the action to be taken when application calls to the external subsystem cannot be processed

You must also supply the external subsystem-supplied tables (ESMT and RTT) in the appropriate load module library.

You have the option to supply external subsystem definitions for MPP, BMP, and IFP dependent regions. If the SSM EXEC parameter is not specified for these types of dependent regions, the region can access all subsystems defined to the control region. If the SSM EXEC parameter is specified, the dependent region can access only those subsystems defined in the identified PROCLIB member. (The subsystems also must have been defined to the control region.) Use a dummy PROCLIB member (one having no definitions) if the dependent region is not to have access to any external subsystem.

Note: JMP and JBP regions can access control-region-defined DB2 subsystems that use the COORD=RRS parameter in the IMS.PROCLIB member. You cannot use the SSM parameter in JMP or JBP EXEC statements. In the DFSJMP and DFSJBP procedures, you must add a DD statement (DFSDB2AF) that point to the DB2 libraries.

The following tasks must be performed to attach an external subsystem to IMS. For detailed information about these tasks, see the external subsystem section of *IMS Version 9: Installation Volume 2: System Definition and Tailoring*.

To attach an external subsystem to IMS:

1. Define external subsystems to IMS:
 - a. In the IMS procedure library (IMS.PROCLIB), add a member that contains the information about each external subsystem with which IMS communicates.
 - b. On the EXEC statement of the control region, MPP region, IFP region, or BMP region, specify with the parameter SSM the IMS.PROCLIB member created in the previous step. When you are using a DB2 group name to access DB2 databases, the SSM parameter is required for an MPP, BMP, or IFP region.

Attach Facility

2. Define a language interface module if you want to use one other than the IMS-supplied one.
3. In the IMS OPTIONS statement, specify whether you want tracing of the external subsystem link.
4. For the external subsystem, provide the ESMT and optionally the RRT.
5. Ensure that the external subsystem modules and databases used by IMS are in appropriate AFP-authorized libraries.

The Basics of Attach Processing

An external subsystem is attached to an IMS subsystem by means of a connection established from the IMS control region to the external subsystem. A connection is also established from each dependent region that accesses the external subsystem. IMS is responsible for initiating these connections.

Subsystem Connections

The connection between an IMS application program and the external subsystem is called a *thread*. Application threads are two-way communication paths between IMS application programs and external subsystem resources. An application program can have more than one thread since it can access more than one external subsystem in one execution. However, access to multiple subsystems of the same type (multiple instances of the same subsystem type) while supported by IMS, might not be supported by the external subsystem product.

Establishing Connections

IMS uses an 'identify' process to establish a connection to the external subsystem. IMS activates an Identify exit routine contained in the ESAP to identify the control region or dependent region TCB to the external subsystem. The external subsystem can then monitor IMS TCBs in order to respond to IMS abnormal terminations. A connection is established upon successful completion of the identify process, in other words, once the region has been successfully identified to the external subsystem.

IMS provides a notify message mechanism so that if the external subsystem has not been started when IMS attempts to connect the control region, the external subsystem, once started, can notify IMS to establish the connection. If the external subsystem makes use of the notify capability, the order in which IMS and the external subsystem are started is not important.

The connection from the control region is established first before any dependent region connections are established. If the control region connection has not been established when a dependent region is started, the dependent region does not identify itself to the external subsystem. IMS uses a hierarchical relationship between control region and dependent region connections to allow the control region to act as recovery coordinator for dependent regions. If a dependent region fails, the control region takes recovery actions on its behalf.

The external subsystem can optionally provide an Initialization exit routine. IMS activates the Initialization exit routine, if provided, during control region and dependent region initialization before the region identifies itself to the external subsystem. This exit routine allows the external subsystem the chance to do any initialization processing it requires before each connection being established.

IMS can establish the control region connection automatically during control region initialization, provided the external subsystem has been started. However, the

connection can be delayed to a later time. If an Initialization exit routine is not provided, or if the exit routine returns the appropriate return code, the control region identify is not done automatically. In this case, the external subsystem can activate the Subsystem Startup Service provided by IMS when it wants the connection established. Or, IMS attempts to establish the connection when a dependent region is ready to identify itself.

IMS also establishes the control region connection in response to a /START SUBSYS operator command.

User Authorization Processing

After a dependent region connection has been established, a signon process is performed to inform the external subsystem of the user ID associated with the IMS transaction being processed by the region. IMS activates a Signon exit routine provided by the external subsystem for this purpose. This initial signon for the region must be successful in order for a thread to be created for the application.

Signon processing can occur again during application program execution (that is, after the thread has been created). The Signon exit routine is activated for each message processed by the application program. The initial signon performed after the dependent region identify is related to the first message processed by the application (first get unique call to the message queue). Each subsequent message processed causes the Signon exit routine to be activated again to pass the new user ID. In the case of multiple mode transactions, this means that multiple signons can occur without intervening commit processing.

The external subsystem supplies a Signoff exit routine which IMS activates before terminating the dependent region connection. In the case of multiple signons for an application, signoff processing does not precede a new signon for a new message. A new signon rather replaces the previous.

Application Threads

When the application program issues its first call for data resources owned by an external subsystem, a thread is created to connect the application to the external subsystem. IMS activates a Create Thread exit routine supplied in the ESAP to identify the application program to the external subsystem. The external subsystem is expected to prepare to receive data requests from the specific application program as necessary (that is, reserve resources, create a processing structure, and so on). When the application terminates, IMS activates a Terminate Thread exit routine to terminate the thread.

Terminating Connections

A Terminate Identify exit routine must be provided in the ESAP. IMS activates this exit routine when a connection is to be terminated. Termination of the control region connection can be initiated by IMS, by the external subsystem, or by operator command (/STOP SUBSYS). IMS terminates the connection when it is shutting down. The /STOP SUBSYS command causes the connection to be terminated and also puts it in stopped status. IMS does not allow the connection to be reestablished until a /START SUBSYS command has been processed.

The external subsystem can request that the control region connection be terminated in one of two ways. One way is by posting a termination ECB. IMS provides, on the Identify exit routine invocation, the address of an ECB that is expected to be used by the external subsystem when it is terminating. When the external subsystem posts the termination ECB, IMS, after allowing dependent

Attach Facility

region connections to quiesce, terminates the connection and also puts the connection in stopped status (as it does for the /STOP SUBSYS command). The second way that the control region connection can be terminated is by activating the IMS-supplied Subsystem Termination Service from an external subsystem exit routine.

After activating the Terminate Identify exit routine in the control region, IMS activates the Subsystem Termination exit routine supplied in the ESAP. This exit routine, which can be thought of as the reverse of the Initialization exit routine, might be used by the external subsystem to reset work areas or free storage, for example.

A dependent region connection is maintained for as long as the region is active unless IMS has been requested, either by the external subsystem or by an IMS /STOP SUBSYS command, to terminate the (control region) connection. In general, it is only when IMS has been requested to terminate the connection that the external subsystem Terminate Identify exit routine is driven for dependent regions. Thus, the exit routine is not necessarily activated when a dependent region terminates. This is true also for the Signoff exit routine. Terminate Identify exit routine invocation always follows Signoff exit routine invocation.

The external subsystem is expected to monitor, through the z/OS end-of-task exit routines, the IMS TCBs identified to it and to perform the necessary signoff and terminate identify processing when an identified TCB ends.

Terminate Thread exit routine invocation always precedes normal termination of the dependent region connection if the region had a thread to the external subsystem. Thus the Terminate Thread exit routine is activated before the Signoff and Terminate Identify exit routines are activated (if they are) or before the dependent region is terminated.

Since IMS does not allow dependent region connections to exist unless the control region has a connection, the Terminate Identify exit routine is not activated for the control region until after each dependent region has either terminated or had its Terminate Identify exit routine activated.

The Subsystem Termination exit routine is not activated for dependent regions.

Inquiry Parameter Processing

The INQ parameter is only checked when the IMS transaction issues a Create Thread exit routine. The INQ parameter on subsequent transactions is not checked. Therefore, if any updates are to be done in a Fast Path region between the Create Thread exit routine and the Terminate Thread exit routine, the inquiry flag in the first transaction must be INQ=NO.

For example, if the first transaction that calls DB2 UDB for z/OS from a given Fast Path region is only going to read the DB2 UDB for z/OS data and not update it, the transaction will set the INQ=YES flag in the Create Thread Parameter list indicating that this first transaction and all subsequent transactions in that Fast Path region are treated as inquiry only transactions. If a subsequent transaction running under the same Fast Path region calls DB2 UDB for z/OS for update, the thread to that Fast Path region will still be set to INQ=YES, even though the transaction is correctly defined as INQ=NO. This will result in an SQLCODE817 error.

Application Call Processing

Once a thread from the application program to the external subsystem has been created, application calls for external data resources are passed to the Normal Call exit routine supplied in the ESAP. The language interface bound with the application provides the language interface token (LIT) for the external subsystem when it activates IMS to process calls to the external subsystem. The installation specifies a unique LIT for each external subsystem it defines to IMS. IMS matches the LIT provided by the language interface stub with the LIT specified in the definition to route the call to the external subsystem.

Resource Coordination

IMS, as recovery coordinator, directs commit processing for updates to external subsystem resources initiated by IMS application programs. IMS uses a two-phase commit process to synchronize resources across external subsystems. External subsystems are participants in the process. In the first phase of the commit process for an application, IMS polls the participants for a vote as to whether or not they are prepared to commit the updates. In the second phase, IMS directs the participants to commit or to abort. If all participants voted 'yes' on the first phase, IMS directs them to commit on the second phase; otherwise, IMS directs them to abort.

When an external subsystem determines that its resources are associated with non-update transactions (for which commit processing is not necessary), the external subsystem can perform all commit processing during the first phase, eliminating the need for the second phase. In this case, the external subsystem returns to IMS from the Commit Prepare exit routine with return code X'C' indicating that the first phase successfully completed and the second phase is not required. IMS will not initiate the second phase of commit processing for this external subsystem.

IMS uses a 16-byte recovery token to identify a unit of work across one or more subsystems. The recovery token for a unit of work is initially passed on the Signon exit routine invocation.

When application updates are to be committed, IMS activates the Commit Prepare exit routine supplied by the external subsystem. The associated recovery token is passed on the invocation. The external subsystem indicates, by the return code from the exit routine, whether or not it is prepared to perform commit processing for the recovery token. When an application is executing in a Distributed Syncopate environment (also known as a Protected Conversation environment) and requires a subsystem SIGNON, IMS obtains the XID token and places its address in the exit parameter list before calling the subsystem's SIGNON exit.

For the second phase of the commit process, if it is required, IMS can activate either of three external subsystem exit routines: the Commit Continue exit routine, the Abort Continue exit routine, or the Terminate Thread exit routine. When the application is not terminating and all participants are prepared to commit, IMS drives the Commit Continue exit routine. At completion of the commit process, the application will continue processing the current PSB on the existing thread. When the updates are to be aborted but the application is not terminating, or being terminated, the Abort Continue exit routine is activated. In this case, the application will continue processing under the same recovery token.

The external subsystem Terminate Thread exit routine must be able to process the second phase of commit. At application termination, IMS passes the recovery token

Attach Facility

and a commit option on the Terminate Thread exit routine invocation. The commit option indicates whether to commit or abort outstanding updates.

When IMS, the external subsystem, or an application program terminates abnormally, units of work that have not been committed or aborted are left outstanding. To resolve outstanding units of work, IMS activates the external subsystem Resolve Indoubt exit routine. IMS always activates the Resolve Indoubt exit routine at least once after establishing the control region connection. IMS activates the exit routine once for each outstanding recovery token indicating whether to commit or abort the unit of work. When there are no units of work to be resolved or when IMS has exhausted the list of outstanding recovery tokens, IMS activates the exit routine to inform the external subsystem of that fact. When IMS encounters an outstanding recovery token associated with RRS, IMS will delay the subsystem Resolve Indoubt exit call until RRS or the IMS user has indicated (ABORT or COMMIT) which action to take. When called for RRS Resolve Indoubt, it is the subsystem's responsibility to ensure that recovery tokens are resolved in their proper order.

IMS maintains outstanding recovery tokens across normal (warm) and emergency restarts of IMS, and reconnections of the subsystems. IMS permits a connection without all recovery tokens being resolved (that is, the Resolve Indoubt exit routine return code can indicate that the recovery action was not taken). IMS destroys outstanding recovery tokens when it is cold started.

The Resolve Indoubt exit routine is also used to coordinate resources in the event of abnormal termination of an application program. Following an application program abend, the exit routine is activated from the control region if the application had a thread connection to the external subsystem.

External Subsystem Command Support

IMS provides a command, /SSR, which allows the IMS operator to send commands to the external subsystem. To receive commands from IMS the external subsystem must supply a Command exit routine. IMS passes the command contained in the /SSR input to this exit routine. AOI (automated operator interface) programs can also send commands to external subsystems using /SSR. The /SSR command input contains identification, a command recognition character (CRC), of the external subsystem to which the command is directed. The CRC for a subsystem is specified as part of the definition of the subsystem to IMS.

Related Reading:

- For information on the /SSR command, see *IMS Version 9: Command Reference*.
- For information on the CRC, see *IMS Version 9: Installation Volume 2: System Definition and Tailoring*.

IMS Services Available to the ESAP

IMS provides exit routines that an external subsystem can activate to access certain IMS system services. The external subsystem can:

- Request that a connection be initiated (Subsystem Startup Service).
- Request that connections be quiesced (Subsystem Termination Service).
- Have a log record written to the IMS log (Log Service).
- Have a message sent to an IMS destination (Message Service).

Related Reading: For a description of these exit routines, refer to Chapter 77, “IMS System Service Exit Routines,” on page 567.

Chapter 74. Creating the External Subsystem Module Table

The external subsystem creates the external subsystem module table (ESMT) to supply definitions of the external subsystem modules that IMS is to load. External subsystem exit routine modules, as well as any other modules needed in the ESAP, are defined in the ESMT. The installation provides the name of the ESMT to IMS as part of the definition of the external subsystem. During initialization for attach processing in the control and dependent regions, IMS loads the ESMT and then loads the modules defined therein.

The external subsystem optionally provides in the ESMT definitions of work areas needed for its ESAP. If work area definitions are provided, IMS obtains the specified work area storage in each region after loading the defined modules.

IMS provides two macros to be used by the external subsystem to create the ESMT. The DFSEMODL macro is used to define the ESAP modules that IMS is to load. The DFSEWAL macro is used to define the work areas that IMS is to create. A series of DFSEMODL statements defining modules, optionally followed by DFSEWAL statements defining workareas, and ending with a DFSEMODL statement specifying END=LAST, generates the table.

The following topics provide additional information:

- “DFSEMODL Macro”
- “DFSEWAL Macro” on page 520

DFSEMODL Macro

The ESMT is generated from a series of DFSEMODL statements, one for each module definition. In addition to module definition information, information about the control block that is to contain the addresses of the modules when they are loaded is also supplied on DFSEMODL statements. IMS creates this control block before it loads the modules.

IMS provides the capability for up to three sets of modules to be loaded and anchored on separate control blocks. Accordingly, the ESMT consists of one to three subtables, each containing the specifications for a set of modules and their module address control block. The module address control block for external subsystem exit routines is the EEVT (external entry vector table).

When the module address control block is created, IMS stores its address into a source control block, which is the EEVTP (EEVT prefix).

The format of the DFSEMODL macro is:

```
(label)  DFSEMODL  DSNAME=,SOURCE=,MODNAME=,DSLABEL=,  
          SUBPOOL=,OPTION=,END=
```

where:

(label) Is optional. If coded, the macro generates ESMT subtable labels. The last label on a macro statement in the series from which a subtable is generated is used as the subtable label.

Attach Facility

The following parameters provide control block information and need only be specified once per subtable (for example, on the first DFSEMODL statement in the series). If specified on more than one statement, the first specifications encountered are used in generating the table.

- DSNAME=** (p1,p2,p3)
- p1** Name of the module address control block. The name must be specified (at least on one DFSEMODL statement) for each ESMT subtable.
 - p2** Module address control block size. The size must be specified. IMS obtains storage of the specified size to create the module address control block.
 - p3** Subpool number for the module address control block storage request. This parameter is optional. If 251 is not specified, IMS obtains the storage from subpool 230.
- SOURCE=** (p1,p2)
- p1** Name of the source control block. This parameter is required. DFSEEVTP must be specified. (See the following discussion.)
 - p2** Label in the source control block of the location to store module address control block address. This parameter is required.

The following parameters provide module definition information.

- MODNAME=** Name of the module IMS is to load. MODNAME must be specified on all DFSEMODL statements that do not specify the END parameter. (END can be specified with or without MODNAME.)
- DSLABEL=** Label in the module address control block of the location to store the module address after it is loaded. DSLABEL must be specified (when MODNAME is specified).
- SUBPOOL=** Subpool into which IMS is to load the module. SUBPOOL must be specified (when MODNAME is specified). For the control region, IMS loads the module into the subpool specified. For dependent regions, IMS loads the module into subpool 251 if SUBPOOL=251 is specified; otherwise, the module is loaded into subpool 230. Valid specifications are: 0, 229, 230, 231, 241, 251, 252.
- OPTION=** (p,p)
- This parameter is optional. Two options, NOCTL and NODEP, are supported. (Position of an option in the subparameter list is not important.)
- NOCTL**
The module is not to be loaded in the control region.
- NODEP**
The module is not to be loaded in dependent regions.

The END parameter controls ESMT generation.

- END=**
- YES** Must be specified to indicate the end of a subtable in the ESMT being generated. END=YES is used only when the

ESMT is to contain more than one subtable. It is specified to end each subtable except the last (or only). DFSEMODL statements for the next subtable in the ESMT are to follow the END=YES specification.

LAST Must be specified on the last DFSEMODL definition statement for the ESMT being generated. The next DFSEMODL or DFSEWAL statement (if any) causes a new ESMT generation to be started.

You must bind the ESMT module into a program library (SDFSRESL) using a binder ENTRY statement that specifies MAINEP as the entry point. A table definition header is generated at the end of the ESMT module. The ENTRY statement allows IMS to correctly reference the header for subsequent processing.

DFSEMODL supports an execute form (MF=E) for internal use only. It cannot be used for ESMT generation. The list form (MF=L) described is the default.

Mapping DSECTs for the module address and source control blocks must be included in the ESMT generation source, otherwise the assembly will fail.

The following restrictions apply to external subsystems:

- Specifying the source control block.
DFSEEVTP must be specified as the source control block name (SOURCE(p1)) for all IMS-defined subtables. Otherwise, although DFSEMODL accepts other specifications, the module load process will fail, prohibiting a connection for the region experiencing the failure. The user must use the EEVTP mapping layout, as this is the layout that IMS expects.
- Defining subsystem exit routine modules.
DFSEEVTP must be specified as the module address control block name (DSNAME(p1)) for the subtable that contains the subsystem exit routine module definitions.
The module address control block size (DSNAME(p2)) must be specified according to the size indicated by the EEVT mapping (EEVTLGTH) as shown in "Control Block Mapping" on page 540.
EEVPEEA must be specified as the label in the source control block (SOURCE(p2)) to anchor the module address control block (EEVT). IMS does not check for this (nor does the macro) but uses the offset generated from the label specified to store the address. If the offset is incorrect, IMS will not be able to activate the exit routines.
The label (DSLABEL) specified for a particular subsystem exit routine module is used to generate the offset that IMS uses to store the exit routine address in the module address control block (for example, in the EEVT). Thus these labels must be specified according to the EEVT mapping.
- Generating additional subtables.
The ESMT must always have one subtable containing definitions for exit routine modules. The external subsystem could choose to have other modules needed in its ESMT anchored on a separate control block, which means that another subtable would be generated.
Although the DFSEMODL macro does not restrict the number of subtables that can be generated, problems can occur during processing if more than three (3) are generated. For each subtable, IMS creates a module address control block

and stores its address in the EEVTP. There are only three fields in the EEVTP that could be used as anchors for these control blocks, one of them being the anchor for the EEVT.

The EEVTLDIR and EEVPEWA fields are not used by IMS and thus are available for this purpose. The discussion on defining external subsystem work areas in “DFSEWAL Macro” suggests how EEVPEWA might be used to anchor a work area address control block.

- Defining external subsystem-unique modules.

If the ESAP needs non-IMS exit routine modules (for example, modules that the external subsystem activates without any knowledge of or support from IMS), the external subsystem can define these modules in an additional subtable as previously discussed. The external subsystem must supply the mapping DSECT for the module address control block for these modules.

Recommendation: Although other modules can be defined in the subtable containing exit routine modules and the EEVT size extended to include their addresses, IMS recommends that this not be done. The EEVT is an IMS control block which IMS reserves the right to extend at any time, which could require the external subsystem to regenerate the ESMT and re-compile modules.

DFSEWAL Macro

The work areas that IMS is to create for the external subsystem must be defined by including DFSEWAL macro statements along with the DFSEMODL statements provided for ESMT generation. The DFSEWAL statements, one for each work area defined, follow the DFSEMODL statements, except that the last statement in the series must be a DFSEMODL statement specifying END=LAST. The DFSEWAL statements cause a table of work area definitions to be built in the generated ESMT.

Work areas can be defined in each subtable generated in the ESMT. At least one module must be defined in each subtable. If a subtable is generated containing only work area definitions, an error occurs during IMS processing of the ESMT.

IMS creates the work areas defined in a subtable after loading the modules defined in the subtable. IMS stores the addresses of the created work areas in a work area list control block. This control block is also defined by the DFSEWAL macro and can either be contained in the module address control block for the subtable or be created as a separate control block. For this discussion, EWAL is used to refer to the external subsystem work area list control block.

Recommendation: It is recommended that the EWAL be contained in the module address control block rather than created as a separate control block. The reason is that when IMS creates the EWAL, its address is not (explicitly) provided to the external subsystem. If, instead, the EWAL is contained in the module address control block, which IMS anchors in the EEVTP, the external subsystem specifies its location (with DFSEWAL) and thus knows how to access it. (When IMS creates the EWAL, it stores its address in the in-storage ESMT for internal use. The format of the ESMT is not included in the documented attach interface.) Figure 45 shows a representation of the relationship between the EWAL, EEVTP, and EEVT.

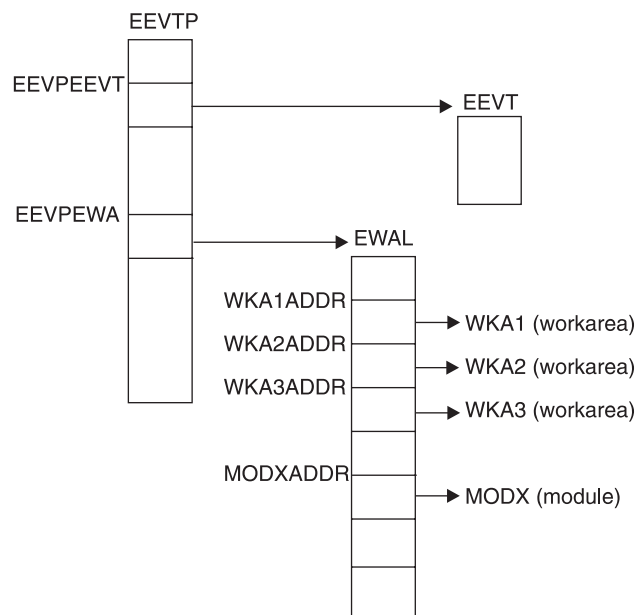

Figure 45. EWAL, EEVTP, and EEVT Relationship

If the external subsystem wants IMS to create work areas for its ESAP, it should define two (possibly three) subtables in the ESMT. Modules definitions would be contained in one subtable. The module address control block for this subtable is the EEVT. The second subtable would contain work area definitions. The module address control block for this subtable would either contain the EWAL or be used as the EWAL, and would be anchored in the EEVTP along with the EEVT. (As mentioned under “DFSEMODL Macro” on page 517, modules could be defined in two subtables: one for exit routines and one for other external subsystem modules that are activated by exit routines.)

Figure 46 on page 523 illustrates how the external subsystem might specify work area definitions.

The format of the DFSEWAL macro is as follows:

```
DFSEWAL DSNAME, SOURCE=, WALSP=, NAME=, DSLABEL=,
        SUBPOOL=, LV=, OPTION=
```

where:

The following parameters provide control block information and need only be specified once per subtable (for example, on the first DFSEWAL statement in the series). If specified on more than one statement, the first specifications encountered are used in generating the table.

DSNAME= (p1,p2)

- p1** Name of the work area list control block mapping DSECT. The DSECT name must be specified. If IMS creates the work area list, this name is given to the job pack entry for the storage acquired.
- p2** Work area list size. If the size is specified, IMS obtains storage of the specified size to create the work area list. If the size is not specified IMS does not create the work areas unless the source control block for the work area list

Attach Facility

(DFSEWAL SOURCE(p1) specification) is the module address control block specified for the modules defined in the subtable (DFSEMODL DSNAME(p1)). (See the following discussion.)

- SOURCE=** (p1,p2)
- p1** DSECT name for the control block in which the work area list is to be anchored. This parameter must be specified. (See the following discussion).
- p2** Label in the source control block DSECT of the location that is to contain the work area list. This parameter is required. IMS does not store the work list area address into this control block. (See the following discussion.)
- WALSP=** Subpool number for the work area list storage request. This parameter is optional. If WALSP=251 is not specified, IMS obtains the storage from subpool 230.

The following parameters provide work area definition information and must be specified on each DFSEWAL statement.

- NAME=** The name given to the job pack directory entry created for the work area storage acquired. This parameter is required.
- DSLABEL=** Label in the work area list control block DSECT of the location into which IMS is to store the work area address. DSLABEL must be specified.
- SUBPOOL=** Subpool from which IMS is to obtain storage for the work area. The subpool must be specified. IMS acquires subpool 251 storage if SUBP00L=251 is specified; otherwise, the work area is created in subpool 230. The macro allows 0, 229, 230, 231, 241, 251, or 252 to be specified.
- LV=** Work area size. The size must be specified.
- OPTION=** (p,p)
- This parameter is optional. Two options, NOCTL and NODEP, are supported. (Position of an option in the subparameter list is not important.)
- NOCTL**
Work area is not to be created in the control region.
- NODEP**
Work area is not to be created in dependent regions.

Mapping DSECTs for all referenced control blocks must be included in the ESMT generation source, otherwise the assembly will fail.

The source control block DSECT name and label must be specified. However, IMS does not store the EWAL address into this control block.

To indicate that the EWAL is to be contained in the module address control block:

- The size for the EWAL (DFSEWAL DSNAME(p2)) must not be specified.
- The module address control block DSECT name (DFSEMODL DSNAME(p1)) must be specified as the EWAL source control block DSECT name (DFSEWAL SOURCE(p1)).

- The source control block label (SOURCE(p2)) must specify the location of the work area list in the module address control block.

If the size for the EWAL is specified, IMS obtains storage for the EWAL without checking if the module address control block was specified as the EWAL source. If the EWAL size is not specified and the module address and EWAL source control block DSECT names do not match, IMS does not create the work areas. (IMS does not know the address of the source control block. IMS does not indicate that the work areas were not created.)

IMS reserves the EEVPEWA field in the EEVTP control block for the address of an EWAL. Figure 46 illustrates how definitions can be specified to anchor a work area list in this field. What really happens is that a module address control block is created, anchored at EEVPEWA, and used as the EWAL.

```

DFSEMODL DSNAME=(DFSEEVTP,68,230),SOURCE=(DFSEEVTP,EEVPEEA),
          MODNAME=INITEXIT,DSLABEL=EEVTINIT,SUBPOOL=230
DFSEMODL MODNAME=IDEXIT,DSLABEL=EEVTID,SUBPOOL=230
DFSEMODL MODNAME=RIDEXIT,DSLABEL=EEVTRID,SUBPOOL=230,
          OPTION=NODEP
          .
          .
          .
          .
DFSEMODL MODNAME=CMDEXIT,DSLABEL=EEVTCMD,SUBPOOL=230,
          OPTION=NODEP
DFSEMODL END=YES
DFSEMODL DSNAME=(ESSEWAL,40,230),SOURCE=(DFSEEVTP,EEVPEWA),
          MODNAME=MODX,LABEL=MODXADDR,SUBPOOL=230
DFSEWAL  DSNAME=(ESSEWAL),SOURCE=(ESSEWAL,ESSEWAL),WALSP=230,
          NAME=WKA1,DSLABEL=WKA1ADDR,SUBPOOL=230,LV=200
DFSEWAL  NAME=WKA2,DSLABEL=WKA2ADDR,SUBPOOL=230,LV=100
DFSEWAL  NAME=WKA3,DSLABEL=WKA3ADDR,SUBPOOL=230,LV=100
DFSEMODL END=LAST

```

Figure 46. Specifying a Definition to Anchor a Work Area List in the EEVPEWA Field

Notes to example:

- The existence of a DSECT named ESSEWAL created by the external subsystem to map the EWAL is assumed.
- Two subtables are defined for completeness:
 - The first subtable contains exit routine module definitions.
 - The second subtable contains work area definitions:
 - A module is defined in this subtable with EEVPEWA specified as the anchor field for the module address control block. (If the external subsystem does not really want a module loaded for this subtable, both the NOCTL and NODEP options can be specified.)
 - The module address control block DSECT, ESSEWAL, is specified as the EWAL source control block DSECT and the EWAL size is not specified, indicating that the EWAL is to be contained in the module address control block.
 - ESSEWAL is also specified as the label in the source block for the EWAL, indicating that the EWAL starts at offset zero in the module address control block. Thus, the module address control block itself is the EWAL, anchored at EEVPEWA in the EEVTP.

Attach Facility

Chapter 75. IMS Attach Facility Processing

This chapter describes the processing that the IMS External Subsystem Attach Facility does during control region initialization.

The following topics provide additional information:

- “Loading the External Subsystem Attachment Package”
- “Initiating the External Subsystem Connection” on page 527
- “Application Program Request Support” on page 531
- “Resource Recovery Token” on page 532
- “Terminating the External Subsystem Connection” on page 533

Loading the External Subsystem Attachment Package

During control region initialization, IMS loads external subsystem-supplied tables using the table names specified by the installation (in the external subsystem definition member in IMS.PROCLIB). IMS loads the external subsystem module table (ESMT) and then loads the external subsystem modules defined in the table. The resource translation table (RTT) is also loaded, if provided. If an error occurs during this process, IMS puts the subsystem in 'stopped' status and does not establish a connection. However, IMS will reaccess the definition (PROCLIB) and reattempt this process if a /START SUBSYS command is received. Possible errors are:

- Unable to process the PROCLIB member
- Unable to open the external subsystem load library
- Unable to load the ESMT (incorrect name specified, not in library)

IMS stores the addresses of the ESMT and the RTT in the EEVTP control block fields EEVPESMT and EEVPRTTA, respectively.

Creating the EEVT Control Block

IMS creates and initializes the EEVT control block based on information contained in the ESMT. (The IMS DFSEMODL macro is used to generate the ESMT. ESMT generation is described in Chapter 74, “Creating the External Subsystem Module Table,” on page 517.) The size and subpool for the EEVT storage request are obtained from the ESMT. The EEVT is created in subpool 230 unless subpool 251 is specified in the ESMT. The external subsystem must ensure that the size specified for the EEVT is at least as large as the size indicated in the IMS EEVT mapping.

IMS stores the EEVT address into the EEVTP control block based on an offset specified in the ESMT. The external subsystem must ensure, therefore, that the offset generated in the ESMT (using the DFSEMODL macro) points to the EEVPEEA field in the IMS EEVTP mapping.

IMS does not check whether the EEVT pointer field, EEVPEEA, in the EEVTP is initialized by this process. In fact, the offset in the ESMT could cause IMS to store the address into some other field in the EEVTP designated for some other use, possibly causing a problem. Thus, **the external subsystem must ensure that the correct offset is generated into the ESMT.**

Attach Facility

This process allows the external subsystem to specify another set of modules for IMS to load (IMS would not activate these modules). Both lists of module addresses, one being the EEVT, would be anchored in the EEVTP.

IMS does not use the EEVTLDIR field. Actually more than two sets of modules could be defined in the ESMT (subtables) and loaded by IMS except that there aren't enough fields in the EEVTP to anchor the address lists.

Loading External Subsystem Modules

As IMS loads external modules defined in the ESMT, the module addresses are stored in the EEVT. The module definitions provide the offsets to the locations in the EEVT for the addresses. IMS does not check whether or not required exit routine addresses have been set by the module loading process. If the external subsystem chooses, the ESAP can set exit routine addresses in the EEVT once IMS has passed control to it. For example, the external subsystem can provide multiple exit routines in one load module and have the ESAP set the individual exit routine module addresses.

Whether through module definitions in the ESMT or through ESAP processing, the external subsystem must ensure that the address of an exit routine is present in the EEVT when IMS needs to activate the exit routine. Exit routine addresses must be placed in the EEVT according to the IMS EEVT mapping.

Some of the exit routines prescribed by IMS are activated only in the control region; some are activated only in the dependent regions. The external subsystem can indicate, in the module definition, if a module is not to be loaded in the control region or in dependent regions. Exit routine module definitions should specify loading according to the following:

- Exit routines activated in the control and dependent regions:
 - Identify
 - Initialization
 - Terminate Identify
- Exit routines activated only in the control region:
 - Command
 - Echo
 - Resolve Indoubt
 - Subsystem Termination
- Exit routines activated only in dependent regions:
 - Abort Continue
 - Commit Continue
 - Commit Prepare
 - Commit Verify
 - Create Thread
 - Normal Call
 - Signoff
 - Signon
 - Subsystem Not Operational
 - Terminate Thread

In the control region, IMS loads external subsystem modules into the subpools specified in the module definitions. If subpool 251 is specified for a module in dependent regions, IMS loads the module in subpool 251; otherwise, it is loaded in subpool 230.

An external subsystem uses only those exit routines that it needs to communicate with IMS, although some exit routines are required and others are optional. When a required exit routine does not exist, IMS generates an error message when it tries to call the exit routine and terminates the connection with the external subsystem.

If your external subsystem does not need the function that an exit routine is designed to perform, you can write the exit routine so that one exists when IMS calls it but that so no operations are performed. (An exit routine can contain common code, such as SR 15,15 and BR 14 logic, which ESS branches to when the exit routine is called and which doesn't perform any specific operation.) During processing of the Initialization exit routine, the external subsystem can update the addresses in the DFSEEV T DSECT (from both the control region and dependent regions, if necessary) and point to these exit routines. This action allows IMS to function normally yet not issue error messages and terminate an external connection if an exit routine does not exist.

Creating Work Areas for the ESAP

After loading the ESAP modules, IMS obtains work area storage for the ESAP if work area definitions are contained in the ESMT.

Related Reading: The IMS DFSEWAL macro is used to generate work area definitions in the ESMT. For more information, refer to Chapter 74, "Creating the External Subsystem Module Table," on page 517.

The process IMS uses to create the work areas is similar to the process used to load ESAP modules except that IMS can either:

- Create the control block for the work area addresses (as it creates the EEVT for the ESAP module addresses), or
- Store the work area addresses into the same control block that has the module addresses.

The intended use of the EEVPEWA field in the EEVTP is to hold the address of a control block referred to as the external subsystem work area list (EWAL) that contains the addresses of the work areas created for the ESAP. However, the external subsystem must have provided the appropriate specifications in the ESMT to cause IMS to store the address of the EWAL in this field.

Related Reading: To see how this can be done, refer to the discussion in Chapter 74, "Creating the External Subsystem Module Table," on page 517.

IMS creates each work area either in the control region or in dependent regions or both, according to the definition. Storage is obtained in subpool 251, if specified; otherwise it is obtained in subpool 230.

Initiating the External Subsystem Connection

IMS automatically connects to the external subsystem during control region initialization processing (for example, when IMS is started) unless the external subsystem chooses to defer the control region identify to a later time.

Attach Facility

The external subsystem defers the connection by returning from the control region Initialization exit routine with return code 4 (do not identify), or by not providing an Initialization exit routine for the control region. Use of this option is further discussed under “Deferring the Control Region Identify.”

If the external subsystem uses the notify message mechanism provided by IMS (and if the external subsystem is not up when IMS activates the Identify exit routine) the connection is automatically established when the external subsystem is started. Return Code 4 from the Identify exit routine causes IMS to wait for the external subsystem to send the notify message passed to the exit routine, and to reactivate the exit routine when the message is received. “Notify Message” on page 529 further describes the use of the notify mechanism.

If the notify mechanism is not used, the Identify exit routine should return with return code 12, in which case the connection is put in stopped status. Stopped status must be removed by a /START SUBSYS command before IMS will establish a connection.

Once the connection has been established, IMS performs Resolve Indoubt processing to resolve any outstanding recovery tokens with the external subsystem. If outstanding recovery tokens exist and a Resolve Indoubt exit routine was not supplied, IMS terminates and stops the connection; otherwise dependent regions are allowed to connect to the external subsystem.

Deferring the Control Region Identify

The external subsystem can defer the control region identify if it prefers to have the connection established at some later time. IMS schedules and gives control to application programs whether or not a connection exists to the external subsystem. The external subsystem thus could choose to wait until an application program call has to be serviced (first call for its resources) before connecting to IMS. Of course, to process calls, the control and dependent region connections and the application thread must exist.

When the control region identify is deferred, the identify is done when:

- The external subsystem, with an exit routine, activates the IMS Subsystem Startup Service.
- An MPP or IFP dependent region that can access the external subsystem is started.
- A /START SUBSYS command naming the external subsystem is processed.

Using the IMS Subsystem Startup Service

When the control region identify is deferred, the external subsystem can activate the IMS Subsystem Startup Service when it wants the control region Identify exit routine to be driven. To be more specific, if a connection does not exist when the first application call for external subsystem services is processed by a dependent region, IMS does not automatically attempt to identify. The external subsystem must activate the Startup Service to establish the connection (if it **wants** to process application calls).

As discussed under “Establishing Dependent Region Connections” on page 529, the Startup Service is also used to establish dependent region connections.

When an external subsystem call from an application is processed before the control region or dependent region has been identified to the external subsystem,

the dependent region activates the Subsystem Not Operational exit routine. The external subsystem is expected to call the Subsystem Startup Service from this exit routine to establish the connection.

When activated, the Startup Service establishes the control and dependent region connections, if the control region identify has not been done. If the control region identify has been done, it establishes only the dependent region connection. If IMS is waiting for the external subsystem to send the notify message, which it accepted on a previous Identify exit routine invocation, the Startup Service returns an error return code and does not establish the connection. For details on activating the Startup Service, see “Subsystem Startup Service Exit Routine” on page 571.

Establishing Dependent Region Connections

MPP and IFP Regions

Identify processing for an MPP or an IFP dependent region is similar to identify processing for the control region in that the dependent region automatically activates its Identify exit routine to establish a connection during dependent region initialization, unless the external subsystem defers the identify.

If the control region connection has not been established when the dependent region would automatically identify, IMS attempts to identify the control region. If successful, the dependent region identify is performed. Thus, if the control region identify is deferred but dependent regions are allowed to connect automatically, the control region Identify exit routine might be activated (automatically) when a dependent region is started.

When the identify for a dependent region is deferred, the connection to the external subsystem is established when the first application program call to the external subsystem is issued in the region. In this case, connection processing is the same as for a BMP dependent region.

BMP Regions

The connection from a BMP dependent region is not established until the first application call to the external subsystem is processed by the region. The connection is automatically established.

Return code 4 from the Initialization exit routine (deferred identify) for a BMP region has no effect.

Notify Message

IMS passes the address of a notify message on the Identify exit routine invocation for the control region. If the external subsystem is not active (has not been started), the Identify exit routine can indicate (return code 4) to IMS that the notify message has been accepted and will be sent to IMS when the external subsystem is active. The external subsystem, once started, sends the message to IMS using an internal z/OS MODIFY command (SVC 34) to alert IMS that it is ready to connect. On receipt of the notify message, IMS reactivates the Identify exit routine to establish the connection.

External subsystem code that is always present in the z/OS system (*early code*), for example, might be used as the means to pass the notify message to the external subsystem. The Identify Exit queues the message to the early code so that it is available to the external subsystem whenever it is started.

Attach Facility

IMS passes the notify message to the Identify exit routine in the format shown in Figure 47.

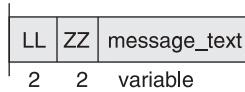

Figure 47. Notify Message Format

where:

- LL** Is a 2-byte field containing the message length (LL + ZZ + MESSAGE_TEXT).
- ZZ** Is a 2-byte field containing binary zeroes.
- MESSAGE_TEXT** Is the notify message text that IMS expects to receive by the MODIFY command. The message text must not be altered.

Issue the MODIFY (F) command as follows:

```
MODIFY ims_jobname,message_text
```

The external subsystem must prefix the notify message text passed by IMS with MODIFY ims_jobname, (or F ims_jobname,) before sending the message. Figure 48 shows the format for the SVC 34 command input.

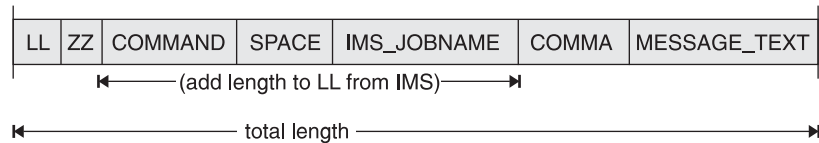

Figure 48. SVC 34 command input format

where:

- LL** Is a 2-byte field containing the total length of the command input area (COMMAND + SPACE + IMS_JOBNAME + COMMA added to the length in the LL field passed to the Identify exit routine).
- ZZ** Is a 2-byte field containing binary zeroes.
- COMMAND** Contains the MODIFY command verb (C'MODIFY' or C'F').
- SPACE** Is a 1-byte field containing a blank (C' ').
- IMS_JOBNAME** Is an 8-byte field containing the IMS control region jobname left justified and padded with blanks on the right. The Identify exit routine can obtain the jobname from the TIOT pointed to by the current TCB.
- COMMA** Is a 1-byte field containing a comma (C',').
- MESSAGE_TEXT** Is the notify message text passed to the Identify exit routine.

Application Program Request Support

Application calls are passed to IMS from the language interface module which you must bind with the application program. The language interface branches to the appropriate IMS program request handler passing the application program call parameter list. For calls directed to external subsystems, the language interface must also pass an external subsystem parameter list which it constructs. The purpose of this parameter list is to pass the LIT (language interface token) for the external subsystem to which the call is directed. IMS routes the application call to the external subsystem whose LIT value matches the LIT value passed on the call.

IMS passes both the call parameter list and the external subsystem parameter list to the Normal Call exit routine for the intended external subsystem. The first word of the external subsystem parameter list contains the address of a 4-byte field containing the LIT value in character format, left justified and padded on the right with blanks. IMS prescribes only the first word in the external subsystem parameter list (address of the LIT). The parameter list can be extended to provide external subsystem-dependent information to the Normal Call exit routine.

Language Interface Definition

IMS provides a language interface module, DFSLI000, which supports the value of SYS1. The installation can use this module or it can define its own language interface if it wants to use a LIT value other than SYS1. When two or more external subsystems are accessed by the IMS system, the installation must define its own language interface modules because each subsystem has a unique LIT.

IMS provides the DFSLI macro to assist the installation in generating a language interface module. The code necessary to perform the language interface function is generated in the DFSLI macro expansion. The IMS macro library must be supplied when the macro statements are compiled to generate the module.

Related Reading: For more information on using the DFSLI macro, see *IMS Version 9: Installation Volume 2: System Definition and Tailoring*

Language Interface Entry Points Unique to External Subsystems

The IMS language interface module provides three entry points that application calls directed to an external subsystem can exclusively use. Two of the entry points are associated with an implied LIT value specified with the DFSLI macro. (The language interface module, generated by the DFSLI macro, contains the specified LIT value as a hard-coded constant.) The third entry point is not associated with an implied LIT value; it allows the application program to specify the LIT value when it makes the application call. For all entry points, register 1 contains the address of the parameter list which IMS passes to the external subsystem. The following are language interface entry points to external subsystems:

DSNHLI Entry point associated with an implied LIT value.

The application program does not need to know which subsystem provides access to the external resources it uses. (If the external subsystem is DB2 UDB for z/OS, this entry point is used for SQL calls.)

DSNWLI Entry point associated with an implied LIT value.

Attach Facility

The application program does not need to know which subsystem provides access to the external resources it uses. (If the external subsystem is DB2 UDB for z/OS, this entry point is used for Instrument Facility calls.)

DFSESS Entry point allowing an application program to specify an LIT value.

The application program must know which subsystem provides access to the external resources it uses. The application program must specify the address of the LIT value as the first parameter in the application call list. Before it passes control to the external subsystem, IMS increments the address of the application call list by four to skip over the LIT value parameter.

Restriction: This entry point should **not** be used to communicate with a DB2 UDB for z/OS subsystem.

Accessing Multiple External Subsystems

An application program can access DL/I and an external subsystem in the same execution. Whether or not an application program can access more than one external subsystem in the same execution can be restricted by the language interface.

Where the data (call) interface provided to application programs by one external subsystem (product) is distinct from the interface provided by another external subsystem (for example, DL/I calls vs. SQL calls), an application can access both subsystems because the language interface paths can be different. Where the data interface is the same, as in the case of two external subsystems of the same type (two instances of the external subsystem) or two external subsystem products that use the same call interface (for example, SQL), an application cannot access both in the same execution unless the application is written to be dependent on data location. (The dependency is intrinsic in the case of different call interfaces.)

Resource Recovery Token

A 16-byte recovery token is used to uniquely identify a unit of work across all subsystems to which the application has thread connections. IMS passes the token to the SignOn exit routine before the thread is created. For commit and resolve indoubt processing, IMS passes the recovery token to identify the unit of work for which the requested action is to be taken.

The recovery token is constructed as shown in Figure 49.

IMS_id	OASN	commit_number
8	4	4

Figure 49. Recovery Token Format

where:

IMS-id Is the IMS system ID (1 to 4 characters), left justified and padded with blanks on the right to eight bytes.

OASN Is a 4-byte binary origin application sequence number assigned to the application when it is scheduled. The OASN is assigned based on the scheduling order within the IMS system since the last cold start. It is also referred to as the application schedule number.

commit_number

Is a 4-byte binary commit number. The commit number is initialized to binary zeroes when the application is scheduled and then incremented after each commit is processed for the application.

The external subsystem should check the recovery token passed at signon for uniqueness. Cold starts of IMS can cause a recovery token to be generated that is a duplicate of a recovery token that is indoubt in the external subsystem. The Signon exit routine can indicate to IMS that the recovery token passed was found to be a duplicate, in which case IMS terminates the application program with an abend. The Commit Prepare exit routine can also indicate that the token is a duplicate that supports external subsystems that choose not to associate the recovery token with the unit of work until commit is processed.

The installation uses the /DISPLAY SUBSYS command with the OASN keyword to determine what units of work are in indoubt status in IMS. The installation can use the /CHANGE command (when necessary) to manually delete indoubt units of work in IMS. The /CHANGE command only affects unit of work status in IMS. There is no communication with the external subsystem. These commands use only the OASN and not the full recovery token; /DISPLAY lists only the OASN portion of the recovery token (in decimal format) and /CHANGE accepts just the OASN (again in decimal format). (Within IMS, the OASN is unique across all known units of work.)

Terminating the External Subsystem Connection

IMS terminates the external subsystem connection (control region connection) in an orderly manner when one of the following occurs:

- IMS processes a /STOP SUBSYS command.
- The external subsystem (ESAP) activates the IMS subsystem termination service exit routine.
- The external subsystem posts the termination ECB provided on the Identify exit routine invocation.
- Certain attach processing errors are encountered.
- IMS is shutting down.

IMS allows existing threads to the external subsystem to complete processing. When all threads have terminated, IMS terminates the connection by activating the Terminate Identify exit routine from the control region.

When the connection is terminated due to a /STOP SUBSYS command, the termination ECB being posted, or processing errors, IMS puts the external subsystem connection in stopped status. Once in stopped status, IMS does not allow a connection to be reestablished. A /START SUBSYS command is required to remove the stopped status.

Termination Requested by the External Subsystem

The external subsystem can cause the connection to be terminated either by posting the termination ECB or by activating the Subsystem Termination Service exit routine from the ESAP. The connection is not put in stopped status when the service is used.

The termination service might be used in conjunction with the external subsystem command exit function. For example, when the command exit routine is activated with an external subsystem termination command supplied on an IMS /SSR

Attach Facility

command, the exit routine could activate the Subsystem Termination Service exit routine to cause the connection to the external subsystem to be terminated.

Related Reading: The termination service is described in “Subsystem Termination Service Exit Routine” on page 572.

On the initial identify performed in the control region, IMS provides the external subsystem with the address of a termination notification ECB. When the subsystem wishes the connection to be terminated, it should post the ECB. The ECB is located in CSA. Depending on the post code, IMS terminates the connection in the following manner:

Deactivate all active threads, prohibit the initiation of any new threads, and then terminate the connection. Upon completion of the terminate function, the connection is set in a stopped state.

Supported Post Codes:

- X'40000000'** Reserved for IMS.
- X'40000008'** External subsystem is terminating in an orderly fashion.
- X'4000xxxx'** All other post codes are interpreted as a quick or catastrophic shutdown of the external subsystem.

Dependent Region Connections

At dependent region termination, the Signoff and Terminate Identify exit routines are **not** activated **unless** the control region connection is to be terminated. That is, it is only when the IMS system will continue to run but without a connection to the external subsystem that the dependent region Signoff and Terminate Identify exit routines are activated. This is the case when either the external subsystem has posted the termination ECB provided on the identify, the ESAP has activated the IMS Subsystem Termination Service, or IMS has processed a /STOP SUBSYS command.

When none of these has occurred, IMS does not communicate dependent region termination to the external subsystem. IMS expects the external subsystem to monitor the dependent TCB with a z/OS End Of Task (EOT) exit routine. The subsystem should do any signoff and terminate identify processing it requires when the EOT exit routine is notified of the region termination.

The external subsystem must also monitor EOT exit routine for dependent regions for which a thread was created. When an application program terminates abnormally, the Terminate Thread exit routine is not called.

When the control region connection is to be broken, a signoff followed by a terminate identify is done for the dependent region at region termination or after thread termination if a thread was active when the request to break the system connection was received. The Signoff exit routine is called only once even though more than one signon might have been done for the region. IMS continues its signoff and terminate identify processing and does not reactivate these exit routines if they encounter errors.

Explanation of Stopped Status

The installation should be aware of the conditions that cause IMS to stop the external subsystem connection. Once stopped, the /START SUBSYS command must

be used to reestablish the connection. Stopped status is carried across restarts. The following list includes the conditions that cause the stopped status to be set:

- When the external subsystem posts the subsystem termination ECB provided during identify processing. Regardless of the post code type (for example, orderly or catastrophic), the connection is stopped upon completion of the termination processing.
- On abnormal termination of the IMS task (TCB) in the control region under which the ESAP is activated, the external subsystem connection is marked stopped. If the control region abends, it is unlikely the stopped state will be set. After a successful IMS restart, the connection is in the state it was prior to the abend.
- The obvious case is after processing of the /STOP command. Even if IMS abends while processing the /STOP command, the stopped state is set.
- When IMS restarts, if outstanding recovery tokens exist for an external subsystem that is no longer defined to IMS (for example, the installation deleted its definition from the external subsystem definition member in IMS.PROCLIB), stopped status is set for that external subsystem.

Attach Facility

Chapter 76. External Subsystem Exit Routines

IMS activates external subsystem-supplied exit routines to perform prescribed subsystem unique attachment functions. IMS uses the module names in the external subsystem module table (ESMT) specified for the control region to load the exit routines during control region initialization. The ESMT specified (or defaulted to) for a dependent region is used to load the exit routines into the dependent region.

Most of the exit routines execute functions that are required for attach processing; others are optional. When an exit routine required to support connection processing is not present, IMS terminates the connection to the external subsystem, if one exists, and issues an informational message (DFS3068I). If an application program is involved, it is terminated with a user abend (U3049).

The following topics provide additional information:

- “General Exit Routine Interface”
- “Abort Continue Exit Routine” on page 541
- “Command Exit Routine” on page 542
- “Commit Continue Exit Routine” on page 544
- “Commit Prepare Exit Routine” on page 544
- “Commit Verify Exit Routine” on page 546
- “Create Thread Exit Routine” on page 547
- “Echo Exit Routine” on page 549
- “Identify Exit Routine” on page 549
- “Initialization Exit Routine” on page 552
- “Normal Call Exit Routine” on page 553
- “Resolve Indoubt Exit Routine” on page 555
- “Signoff Exit Routine” on page 557
- “Signon Exit Routine” on page 558
- “Subsystem Not Operational Exit Routine” on page 560
- “Subsystem Termination Exit Routine” on page 562
- “Terminate Identify Exit Routine” on page 563
- “Terminate Thread Exit Routine” on page 565

General Exit Routine Interface

This section describes general interfaces for all the External Subsystem exit routines. You need to familiarize yourself with these interfaces.

Exit Parameter List (EPL)

IMS activates an external subsystem exit routine, passing the address of an exit parameter list (EPL) in register 1 (see Figure 50). The EPL contains the addresses of the parameters required by the exit routine. IMS passes to an exit routine only the specific parameters it requires, so the contents and length of the EPL differ between exit routines. The parameters for each exit routine are specified in the individual exit routine description sections that follow.

The general format of the EPL is an array of fullword fields (4-byte fields, fullword aligned), each containing the address of a parameter required for the exit routine being activated. The first word in the EPL always contains the address of a 4-byte

General Exit Routine Interface

parameter count field. The binary value in the count field is the number of parameters being passed minus the count parameter (see Figure 50).

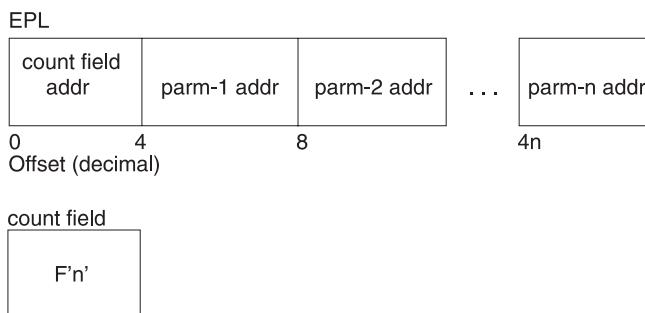

Figure 50. Exit Parameter List

Contents of Registers

Upon entry, the exit routine must save all registers using the provided save area. The registers contain the following:

Register	Contents
1	Address of exit parameter list (EPL).
13	Address of save area. The exit routine must not change the backward chain field, but it can alter the forward chain field.
14	Return address to IMS.
15	Entry point of exit routine.

Before returning to IMS, the exit routine must restore all registers except for register 15, which must contain a return code. IMS provides one standard register save area (address in register 13) in the appropriate storage protect key into which the exit routine can save the entry register contents. The save area backward chain field must not be altered (such as to chain the save area into a save area set). The exit routine can alter the forward chain field.

Return Codes

Return codes are exit routine specific. The return codes are shown in hexadecimal format. Return Code 20 is supported for all exit routines and is described as follows.

Unsupported Return Codes

If register 15 on return from an exit routine contains a return code that is not supported for the exit routine, it is treated as an error. IMS terminates the connection for the region that activated the exit routine if one exists. If an application program is involved, it terminates with a U3049 abend.

Return Code 20

Return code 20 is used by all exit routines to indicate a 'should not occur' condition and is described as follows:

Return Code	Meaning
--------------------	----------------

20	Should not occur. The exit routine encountered a 'should not occur' condition while processing the request. Such conditions include invalid save areas, protocol violations, invalid work areas, and invalid parameter lists.
----	---

Action:

- If an application program is involved, it terminates with abend U3044. If the external subsystem does not respond or responds incorrectly to the control region echo request, the connection to that subsystem terminates.
- If the external subsystem does respond, the identify for the dependent region terminates. A subsequent external subsystem request causes the structure to be rebuilt.
- If a connection exists when the error is encountered, it terminates by activating the Terminate Identify exit routine (see “Terminate Identify Exit Routine” on page 563).

Exit Routine Interface Control Blocks

This section describes the prefix for the external entry vector table and the vector table itself.

External Entry Vector Table Prefix (EEVTP)

The address of an **external entry vector table prefix (EEVTP)** control block is always passed in the EPL on exit routine activations. The EEVTP is the primary external subsystem interface control block and contains the:

- Address of the external entry vector table (EEVT)
- Address of the resource translation table (RTT)
- Environment indicator (control or dependent region TCB)
- Address of the IMS service exit routine router module

External Entry Vector Table (EEVT)

The external entry vector table (EEVT) contains the addresses of external subsystem exit routine modules. IMS gets exit routine addresses from this control block to activate the exit routines. IMS creates an EEVT (and EEVTP) in the control region and in each dependent region before loading the modules defined in the ESMT into the region. When the modules are loaded their addresses are stored in the EEVT.

The EEVT is an IMS control block, however, module addresses are placed in the control block based on the module definitions contained in the ESMT. Therefore, the external subsystem, in creating the ESMT, must make sure that exit routine module definitions provide for placement of exit routine addresses in the EEVT according to the EEVT mapping layout used by IMS. The ESAP can manipulate addresses in this vector table if it chooses.

Related Reading:

- Chapter 74, “Creating the External Subsystem Module Table,” on page 517 describes how external subsystem modules are defined.
- The EEVT layout is shown in “Control Block Mapping” on page 540.

General Exit Routine Interface

In addition to exit routine modules, the external subsystem can define other modules in the ESMT, for example, modules that would be activated by exit routines and not by IMS. IMS loads all modules defined in the ESMT and stores their addresses as specified in the definitions.

Because of how definition and loading of external subsystem modules is done, it is possible for the external subsystem to 'extend' the EEVT to include the addresses of non-exit-routine modules.

Recommendation: Extending the EEVT to include the addresses of non-exit-routine modules is not recommended. IMS might add fields to the EEVT at a later time, in which case, the external subsystem might have to respecify module definitions (that is, regenerate the ESMT) and recompile modules.

Related Reading: For suggestions about how to define non-exit-routine modules and have their addresses stored in a separate control block, refer to Chapter 74, "Creating the External Subsystem Module Table," on page 517.

Control Block Mapping

The following DSECTs map the control blocks discussed in Exit Routine Interface Control Blocks.

DFSEEVTP

The DFSEEVTP DSECT maps the EEVTP control block. (The EEVTP is the prefix of the EEVT and contains the address of the EEVT.) The following fields are of interest to the external subsystem:

Offset Hex	Field Length (Hex)	Field Name	Description
0	4	EEVPNAME	Eyecatcher - 'EEVP'
8	4	EEVPEEA	EEVT ADDRESS
10	4	EEVPEWA	Available for external subsystem
14	4	EEVPRTA	Recovery token address
1C	4	EEVPRTTA	Resource translation table address
20	4	EEVTDIR	Available for external subsystem
28	4	EEVPESGL	DFSESGLO address
2E	1	EEVPF1	Environment indicators
-	-	EEVPCR	= X'01'; Control region
-	-	EEVPMPP	= X'02'; MPP dependent region
-	-	EEVPBMP	= X'04'; BMP dependent region
-	-	EEVPIFPN	= X'08'; Fast Path non-message driven
-	-	EEVPIFPM	= X'10'; Fast Path message driven
-	-	EEVPBMPN	= X'20'; Non-message driven BMP
-	-	EEVPBDB2	= X'80'; Batch DB2 region
2F	1	EEVPF2	Environment indicators
-	-	EEVPDRPG	= X'01'; Running under dependent region....program controller TCB
34	8	EEVPSOTN	Signon token
3C	4	EEVPESMT	ESMT address

Offset Hex	Field Length (Hex)	Field Name	Description
40	4	EEVPSVA	EESV address
-	-	EEVPLGTH	= X'44'; Length of EEVP

DFSEEV

The DFSEEV DSECT maps the EEVT control block. The following fields are of interest to the external subsystem:

Offset Hex	Field Length (Hex)	Field Name	Description
0	4	EEVTNAME	Eyecatcher - 'EEVT'
4	4	EEVTINIT	Initialization exit address
8	4	EEVTID	Identify exit address
C	4	EEVTRID	Resolve indoubt exit address
10	4	EEVTSO	Signon exit address
14	4	EEVTCT	Create thread exit address
18	4	EEVTCP	Commit prepare exit address
1C	4	EEVTCC	Commit continue exit address
20	4	EEVTA	Abort exit address
24	4	EEVTTT	Terminate thread exit address
28	4	EEVTSF	Signoff exit address
2C	4	EEVTTI	Terminate identify exit address
30	4	EEVTSNO	Subsystem not operational exit address
34	4	EEVTSST	Subsystem termination exit address
38	4	EEVTNC	Normal call exit address
3C	4	EEVTECHO	Echo exit address
40	4	EEVTCMD	Command exit address
44	4	EEVTCV	Commit verify exit address
48	4	EEVTIC	Not used
4C	4	EEVTABE	Not used
50	4		Reserved
54	4		Reserved
-	-	EEVTLGTH	= X'58'; Length of EEVT

Abort Continue Exit Routine

The Abort Continue exit routine is activated by IMS for all transaction types. The external subsystem resource managers hold onto the resources they have acquired on behalf of the application. The application will continue using the current recovery token. The Abort Continue exit routine is activated when:

- The application issues an IMS DL/I ROLB call.
- An external subsystem votes 'no' to a commit prepare request.

Abort Continue Exit Routine

Activating the Routine

The exit routine is activated in key 7, supervisor state. The EEVT prefix (EEVTP) indicates a dependent region environment (dependent region TCB).

The EPL contains:

Offset		
Hex	Decimal	Content
0	0	Address of the parameter count field. The count field contains the value F'2'.
4	4	Address of the EEVT prefix.
8	8	Address of the 16-byte recovery token associated with this instance of the transaction. The recovery token identifies the unit of work across one or more subsystems.

Contents of Register 15 on Return

Processing of return codes received from the exit routine:

Return Code	Meaning
0	Abort Continue successful. Action: IMS continues normal processing.
4	Abort Continue unsuccessful. ESAP or external subsystem processing of the request failed. Action: IMS terminates the application with abend U3045 (the input message is discarded; DL/I resources are backed out). The control region performs resolve indoubt processing for the recovery token. (See "Resolve Indoubt Exit Routine" on page 555 for more information about this exit routine.) The dependent region is terminated; which implicitly terminates the dependent region connection to the external subsystem; the Signoff and Terminate Identify exit routines are not called). BMP jobs must be resubmitted; they resume processing at the prior commit point.
20	Should not occur. See "Return Codes" on page 538 for more information.

Command Exit Routine

IMS activates the optional external subsystem Command exit routine when IMS discovers the subsystem's unique command recognition character (CRC) as the first non-blank character in the text portion of the /SSR command. This exit routine allows external subsystem commands to be entered from IMS terminals and Automated Operator Interface (AOI) applications.

IMS passes the command output destination name (LTERM name) to the exit routine. The external subsystem can send a command response to this destination by using the IMS Message Service.

Related Reading: For more information about using the IMS Message Service, refer to "Message Service Exit Routine" on page 569.

For commands from an AOI program or from an input-only device not associated with an output device, the output destination is the IMS MTO; otherwise it is the inputting terminal.

IMS also provides the user ID associated with the command, if any, that the external subsystem might use for security authorization checking.

IMS sends message DFS3612I to the inputting terminal if an /SSR command is entered and a Command exit routine was not provided by the external subsystem.

Activating the Routine

The exit routine is activated in key 7, supervisor state. The EEVT prefix (EEVTP) indicates a control region environment (control region TCB). Table 154 explains the contents of the EPL.

Table 154. EPL contents

Offset		
Hex	Decimal	Content
0	0	Address of the parameter count field. The count field contains the value F'5'.
4	4	Address of EEVT prefix.
8	8	Address of the variable length external subsystem command input. See Table 155 for the format of the command input.
C	12	Address of the 8-byte alphanumeric destination name (that is, LTERM name) where the command response message, if any, is to be sent. The name is left justified and padded with blanks on the right.
10	16	Address of the 8-character user ID associated with the command input message. The user ID is left justified and padded with blanks on the right. If IMS extended security (SIGNON SIGNOFF) is not active, or the inputting terminal did not sign on, the user ID field contains the output destination LTERM name.
14	20	Address of the 8-byte RACF group name for the user ID that entered the command. The name is left justified and padded with blanks on the right. The area contains blanks if RACF checking is not in effect.

Table 155. Command Input Format

Offset Hex	Offset Dec	Name	Length/Alignment	Description
0	2	MSGLL	2	record length
2	2	MSGZZ	2	reserved length
4	4	CRC	1	command recognition character
5	5	CMDDATA	nnn	external subsystem command

Contents of Register 15 on Return

Processing of return codes received from the exit routine:

Return Code	Meaning
0	Command exit routine successful. The Command exit routine accepted the command input message.
4	Command exit routine unsuccessful. The Command exit routine rejected the command input message.
20	Should not occur. See "Return Codes" on page 538 for more information.

Commit Continue Exit Routine

The Commit Continue exit routine provides the second phase of the two-phase commit process. In other words, the data associated with the current PSB is committed to the database, locks are released, and cleanup is preformed. This exit routine is activated after all participating subsystems have voted 'yes' (return code 0 from Commit Prepare exit routine) to the commit prepare request. (See "Commit Prepare Exit Routine" for more information.)

Activating the Routine

The exit routine is activated in key 7, supervisor state. The EEVT prefix (EEVTP) indicates a dependent region environment (dependent region TCB).

The EPL contains:

Offset		
Hex	Decimal	Content
0	0	Address of the parameter count field. The count field contains the value F'2'.
4	4	Address of the EEVT prefix.
8	8	Address of the 16-byte recovery token associated with this instance of the transaction. The recovery token identifies the unit of work across one or more subsystems.

Contents of Register 15 on Return

Processing of return codes received from the exit routine:

Return Code	Meaning
0	Commit Continue successful.
4	Action: IMS continues normal processing. Commit Continue unsuccessful. ESAP or external subsystem processing of the request failed. Action: IMS terminates the application with abend U3046 (the input message is processed; DL/I resources are committed). The control region performs resolve indoubt processing for the recovery token. (See "Resolve Indoubt Exit Routine" on page 555 for more information about this exit routine.) The dependent region is terminated, which implicitly terminates the dependent region connection to the external subsystem (Signoff and Terminate Identify exit routines are not called). BMP jobs that must be resubmitted resume processing after the commit point.
20	Should not occur. See "Return Codes" on page 538 for more information.

Commit Prepare Exit Routine

The Commit Prepare exit routine is activated by IMS when an update or non-update transaction reaches a sync point. Sync points include:

- Get unique (GU) call to the message queue
- Application-initiated checkpoint
- Application program termination

Upon return, the exit routine must indicate whether it is prepared to commit all uncommitted changes initiated by the currently scheduled application. The exit

routine can indicate whether or not the second phase of the commit process (commit continue) is required. If the transactions associated with the sync point processing are non-update transactions, they do not need to be committed, in which case the exit routine returns with a return code of 'X'C', requesting that IMS **not** call the Commit Continue exit routine.

Activating the Routine

The exit routine is activated in key 7, supervisor state. The EEVT prefix (EEVTP) indicates a dependent region environment (dependent region TCB).

The EPL contains:

Offset Hex	Decimal	Content
0	0	Address of the parameter count field. The count field contains the value F'2'.
4	4	Address of the EEVT prefix.
8	8	Address of the 16-byte recovery token associated with this instance of the transaction. The recovery token identifies the unit of work across one or more subsystems.

Contents of Register 15 on Return

Processing of return codes received from the exit routine:

Return Code	Meaning
0	Commit Prepare successful.
4	<p>Action: IMS continues normal processing.</p> <p>Commit Prepare unsuccessful. The external subsystem is not prepared to perform commit processing at this time.</p> <p>Action:</p> <ul style="list-style-type: none"> If the application is not terminating, IMS drives the Abort Continue exit routine. An internal ROLB is performed, which returns the input message to the application. If the sync point was the result of the application terminating, IMS activates the Terminate Thread exit routine with the abort option. (See "Terminate Thread Exit Routine" on page 565 for more information about this exit routine.) The application is terminated with abend U3055, updates are discarded, and the input message is re-enqueued.
8	<p>Commit Prepare unsuccessful. Prepare processing failed in the external subsystem.</p> <p>Action: IMS activates the Abort Continue exit routine for all participating subsystems (if the application is not terminating) or the Terminate Thread exit routine with the abort option. The application terminates with abend U3044 and updates are discarded.</p>
C	<p>Commit Prepare successful for nonupdate transactions.</p> <p>Action: IMS continues normal processing but does not call the Commit Continue exit routine. The external subsystem indicated that it is processing nonupdate transactions that do not need to be called for the second phase of commit processing. If the application program is terminating, IMS calls the Terminate Thread exit routine.</p>

Commit Prepare Exit Routine

Return Code	Meaning
18	Commit Prepare unsuccessful. The request was rejected because the recovery token presented by IMS at commit prepare already existed in the external subsystem. One of the following conditions occurred: <ul style="list-style-type: none">Outstanding recovery was not resolved by the Resolve indoubt exit routine, probably due to errors in the external subsystem. (See "Resolve Indoubt Exit Routine" on page 555 for more information about this exit routine.)IMS was cold started and the contents of the recovery token occurred once again.
20	Action: IMS pseudo abends the application program with abend U3053 and backs out the previous updates. The application is immediately rescheduled. The dependent region connection is reestablished whereupon a new recovery token is presented to the Signon exit routine. Should not occur. See "Return Codes" on page 538 for more information.

Commit Verify Exit Routine

IMS calls the Commit Verify exit routine during Get Unique (GU) message processing when the transaction is defined as MODE=MULTI. This kind of transaction allows multiple messages to be processed without an intervening commit action.

IMS calls the exit routine before the next message is dequeued and presented to the application program. The exit routine allows the external subsystem to decide if it can properly process a new message without initiating a commit for the previous message. The external subsystem returns to IMS with a return code that requests that IMS continue with normal MODE=MULTI processing or initiate a commit action. If a commit action is requested, IMS will initiate the commit action before dequeuing the next message and will terminate the application program with a "QC" status code.

Activating the Routine

The exit routine is activated in key 7, supervisor state. The EEVT prefix (EEVTP) indicates a dependent region environment (dependent region TCB).

The EPL contains:

Offset	Hex	Decimal	Content
	0	0	Address of the parameter count field. The count field contains the value F'3'.
	4	4	Address of the EEVT prefix.
	8	8	Address of the 8-character user ID, left justified and padded with blanks. The user ID is associated with the message that is currently being processed (the next message has not yet been dequeued) and is identical to the one that was presented to the external subsystem at the time IMS last called the Signon exit routine.
	C	12	Address of the 16-byte recovery token associated with this instance of the transaction. The recovery token identifies the unit of work across one or more subsystems. This recovery token is identical to the one that was presented to the external subsystem when IMS last called the Signon exit routine.

Contents of Register 15 on Return

Processing of return codes received from the exit routine:

Return Code	Meaning
0	Commit Verify processing successful. The external subsystem indicates that it can support MODE=MULTI processing without initiating a commit action. Action: IMS continues normal MODE=MULTI processing. The next message will be dequeued and presented to the application program without initiating a commit action.
4	Commit Verify processing successful. The external subsystem indicates that it cannot support MODE=MULTI processing at this time. IMS needs to initiate a commit action. Action: IMS terminates the application with a "QC" status and initiates commit processing. Following the commit action, IMS reschedules the application program and the next message is presented for processing.
8	Commit Verify unsuccessful. Commit Verify processing failed in the external subsystem. Action: IMS terminates the application program with abend U3044 and discards all updates.
20	Should not occur. See "Return Codes" on page 538 for more information.

Create Thread Exit Routine

The Create Thread exit routine is activated by IMS to create a thread to the external subsystem. Threads can be created only after the TCB that the application runs under has been identified to the external subsystem. A thread is created for each application that makes a request to the external subsystem. The first request by the application program directed at the selected subsystem initiates the activation. Once the thread is created, application requests flow directly to the external subsystem through the Normal Call exit routine. (See "Normal Call Exit Routine" on page 553 for information about the Normal Call exit routine.)

Activating the Routine

The exit routine is activated in key seven, supervisor state. The EEVT prefix (EEVTP) indicates a dependent region environment (dependent region TCB).

The EPL contains:

Offset	Hex	Decimal	Content
	0	0	Address of the parameter count field. The count field contains the value F'5'.
	4	4	Address of the EEVT prefix.
	8	8	Address of the eight-character application program name, left justified and padded with blanks to the right.
	C	12	Address of the eight-character PSB name, left justified and padded on the right with blanks.
	10	16	Address of the contents of register 0 in the application save area. When register 0 was saved, it contained the address of the external subsystem-directed parameter list constructed by the language interface.

Create Thread Exit Routine

Offset Hex	Decimal	Content
14	20	Address of a two-character transaction characteristic field. The fields are described from left to right. Byte one contains one of the following: U Indicates the transaction was defined by the installation as capable of update. N Indicates the transaction was defined by the installation as non-update. Byte two contains one of the following: S Indicates the transaction was defined by the installation as mode=single. M Indicates the transaction was defined by the installation as mode=multiple.

Contents of Register 15 on Return

Processing of return codes received from the exit routine:

Return Code	Meaning
0	Create Thread successful. Action: IMS continues normal processing.
4	Create Thread unsuccessful. The external subsystem rejected the specified request. Action: IMS activates the Subsystem Not Operational exit routine. The return code from the Subsystem Not Operational exit routine determines further processing. (See "Subsystem Not Operational Exit Routine" on page 560 for more information on this exit routine.) Return code 4, coupled with a return code 4 out of the Subsystem Not Operational exit routine, causes an application loop unless the application checks the return code presented by the API.
8	Create Thread temporarily unsuccessful. The external subsystem was unable to complete the request due to the unavailability of a required resource (resource allocation failure). Action: IMS terminates the application program with abend U3048.
C	Create Thread permanently unsuccessful. The request failed in the external subsystem. Action: IMS terminates the application program with abend U3045.
10	Create Thread unsuccessful. The request failed in the external subsystem because communications with it are broken. Action: IMS terminates the application program with abend U3044.
14	Create Thread unsuccessful. The external subsystem was unable to complete the request due to a definitional conflict. Action: IMS terminates the application program with abend U3047.
20	Should not occur. See "Return Codes" on page 538 for more information.

Return Code	Meaning
24	Create Thread unsuccessful. A resource deadlock was detected by the external subsystem. Action: IMS terminates the application program with abend U777. All changes are backed out and the application is rescheduled.

Echo Exit Routine

The Echo exit routine is activated to determine whether IMS can communicate with the external subsystem. Activation normally occurs after IMS terminates an application program due to an error processing an external subsystem request. The Echo exit routine is expected to send a 'are you there' message or signal to the external subsystem, soliciting a response. This exit routine is called before the Resolve Indoubt exit routine, described in 555.

Activating the Routine

The exit routine is activated in key seven, supervisor state. The EEVT prefix (EEVTP) indicates a control region environment (control region TCB).

The EPL contains:

Offset	Hex	Decimal	Content
	0	0	Address of the parameter count field. The count field contains the value F'1'.
	4	4	Address of the EEVT prefix.

Contents of Register 15 on Return

Processing of return codes received from the exit routine:

Return Code	Meaning
0	Echo successful. The external subsystem responded to the Echo exit routine indicating it is able to continue communication. Action: IMS continues normal application scheduling and processing.
4	Echo unsuccessful. The external subsystem has not responded to the Echo exit routine or responded in error. Action: IMS PSTOPs the transaction in question.
20	Should not occur. See "Return Codes" on page 538 for more information.

Identify Exit Routine

IMS activates the Identify exit routine to establish a connection from the control region or a dependent region to the external subsystem. Initial contact from the region to the external subsystem is through this exit routine. (The Identify exit routine is expected to communicate with the external subsystem whereas the Initialization exit routine, if provided, might only perform ESAP initialization and not actually communicate with the external subsystem.) Successful activation of the exit routine (for example, return code 0) is necessary in order for the region to be able to communicate with the external subsystem.

Identify Exit Routine

An aspect of the identify concept is the identification of IMS TCBs to the external subsystem. When an IMS TCB terminates abnormally and in some cases when a dependent region terminates normally, IMS does not inform the external subsystem of the termination. The external subsystem should monitor, with z/OS end-of-task (EOT) exit routines, the TCBs for the regions that identify so that it can be notified by z/OS of a termination that was not communicated by IMS.

In the control region and in an MPP- or IFP-dependent region, the Identify exit routine is activated during region initialization processing unless the Initialization exit routine returned with return code 4 (do not identify). The Identify exit routine (control or dependent region) is also activated when the external subsystem activates (through an exit routine) the Subsystem Startup Service supplied by IMS.

IMS passes a notify message on the control region identify request. If the exit routine returns with return code 4 (notify message accepted), IMS waits for the external subsystem to send the notify message before reactivating the exit routine to establish the connection. This return code is intended to be used (optionally) in the case where the external subsystem is not active when IMS attempts to identify.

Related Reading: See “Notify Message” on page 529 for more information.

IMS also passes the address of a termination ECB to the control region Identify exit routine. The external subsystem can post this ECB to cause IMS to terminate the connection; for example, when the external subsystem is shutting down.

Related Reading: Refer to “Terminating the External Subsystem Connection” on page 533 for more information.

Activating the Routine from the Control Region

The exit routine is activated in key seven, supervisor state. The EEVT prefix (EEVTP) indicates control region environment (control region TCB).

The exit parameter list (EPL) contains:

Offset Hex	Decimal	Content
0	0	Address of the parameter count field. The count field contains the value F'5'.
4	4	Address of the EEVT prefix.
8	8	Address of the 4-character external subsystem name.
C	12	Address of the 8-character field containing the IMS system ID (4 characters blank filled to 8 bytes). In an XRF complex, this field contains the RSENAME.
10	16	Address of the notify message area. See “Notify Message” on page 529.
14	20	Address of the subsystem termination ECB.

Contents of Register 15 on Return

Processing of return codes received from the exit routine:

Return Code	Meaning
0	Identify successful. Action: IMS performs resolve indoubt processing in the control region. (See “Resolve Indoubt Exit Routine” on page 555).
4	Identify unsuccessful. The external subsystem will send the notify message when it is ready to connect. Action: The external subsystem connection is not established. IMS waits for receipt of the notify message before activating the Identify exit routine again. Calling the IMS Subsystem Startup Service after Identify return code 4 does not cause the Identify exit routine to be reactivated.
8	Identify unsuccessful. The notify message was accepted on a previous identify request. Action: IMS waits for receipt of the notify message before activating the exit routine again.
C	Identify unsuccessful. The identify process failed, either in the ESAP or the external subsystem. Action: If an application is involved, it terminates with abend U3044.
20	Should not occur. See “Return Codes” on page 538 for more information.

Activating the Routine from the Dependent Region

The exit routine is activated in key seven, supervisor state. The EEVT prefix (EEVTP) indicates a dependent region environment (dependent region TCB).

The EPL contains:

Offset	Hex	Decimal	Content
	0	0	Address of the parameter count field. The count field contains the value F'3'.
	4	4	Address of the EEVT prefix.
	8	8	Address of the four-character external subsystem name.
	C	12	Address of the IMS system ID.

Contents of Register 15 on Return

Processing of return codes received from the exit routine:

Return Code	Meaning
0	Identify successful. The dependent region TCB has successfully identified to the external subsystem. Action: Signon processing follows.
C	Identify unsuccessful. The identify process failed, either in the ESAP or the external subsystem. Action: If an application is involved, it terminates with abend U3044.
20	Should not occur. See “Return Codes” on page 538 for more information.

Initialization Exit Routine

IMS activates the optional Initialization exit routine to allow the ESAP to initialize work areas or control blocks in the following instances:

- During the initial stages of establishing a connection from the control or dependent regions. Activation occurs after IMS has constructed its required control blocks as well as the control blocks for the external subsystem. This action takes place before the control or dependent regions have their respective Identify exit routine activated.
- In a dependent region after an application program abend.

If the Initialization exit routine sets the 'do not identify' return code (return code 4), or if an Initialization exit routine is not supplied, IMS does not automatically perform identify processing for the region. "Initiating the External Subsystem Connection" on page 527 describes how the identify is eventually performed.

Activating the Routine from the Control Region

The exit routine is activated in key 7, supervisor state. The EEVT prefix (EEVTP) indicates a control region environment (control region TCB).

The EPL contains:

Offset		
Hex	Decimal	Content
0	0	Address of the parameter count field. The count field contains the value F'2'.
4	4	Address of the EEVT prefix.
8	8	Address of the 1-byte alphabetic region error option (REO) character defined by the installation. The exit routine should save the error option for future reference when a decision concerning the application is required.

Contents of Register 15 on Return

Processing of return codes received from the exit routine:

Return Code	Meaning
0	Initialization successful. Action: IMS attempts to initiate a connection with the external subsystem by activating the Identify exit routine.
4	Initialization successful. Do not identify to the external subsystem. Action: IMS does not perform identify processing during control region initialization. It is now the responsibility of the external subsystem to initiate the connection using the IMS Subsystem Startup Service (see "Subsystem Startup Service Exit Routine" on page 571).
8	Initialization unsuccessful. Action: IMS does not initiate a connection to the subsystem. The external subsystem is marked as unstartable. The /START SUBSYS command resets the condition.
20	Should not occur. See "Return Codes" on page 538 for more information.

Activating the Routine from the Dependent Region

The exit routine is activated in key 7, supervisor state. The EEVT prefix (EEVTP) indicates a dependent region environment (dependent region TCB).

The EPL contains:

Offset Hex	Decimal	Content
0	0	Address of the parameter count field. The count field contains the value F'2'.
4	4	Address of the EEVT prefix.
8	8	Address of the 1-byte alphabetic region error option character. The region error option is user-defined as part of the SSM.PROCLIB member. The exit routine code should save the error option for future reference when a decision concerning the application is required.

Contents of Register 15 on Return

Processing of return codes received from the exit routine:

Return Code	Meaning
0	Initialization successful. Action: For an MPP or IFP region, IMS initiates a connection to the external subsystem during region initialization. (IMS does not automatically initiate a connection for a BMP region. See the description for return code 4.)
4	Initialization successful. Do not identify to the external subsystem. Action: IMS does not automatically initiate a connection for the dependent region. When the region processes the first application call to the external subsystem, the ESAP is expected to activate the IMS Subsystem Startup Service (from the Subsystem Not Operational exit routine, see "Subsystem Not Operational Exit Routine" on page 560) to initiate the connection. This is always the case for BMP regions (that is, when return code 0 is set). Return code 4 has significance only for MPP and IFP regions.
8	Initialization unsuccessful. Action: IMS does not initiate a connection to the subsystem for the life of the execution of this dependent region.
20	Should not occur. See "Return Codes" on page 538 for more information.

Normal Call Exit Routine

The subsystem-supplied Normal Call exit routine is activated by IMS when a subsystem-directed request is made by an application program and a thread to the subsystem is present. It is the responsibility of the Normal Call exit routine to:

- Communicate normal call and data to the external subsystem.
- Handle responses.
- Supply status codes to the application program.

Activating the Routine

The exit routine is activated in the caller's key. The caller is IMS, an application program, or an external subsystem-supplied exit routine, and is either authorized or unauthorized. If the caller is authorized, the exit routine is activated in key 7,

Normal Call Exit Routine

supervisor state. If the caller is unauthorized, the exit routine is activated in key 8, problem program state. The EEVT prefix (EEVTP) indicates a dependent region environment (dependent region TCB).

The EPL contains:

Offset Hex	Decimal	Content
0	0	Address of the parameter count field. The count field contains the value F'6'.
4	4	Address of the EEVT prefix.
8	8	Address of the contents of register 0 in the application save area. At this time register 0 contains the address of the external subsystem-directed parameter list as constructed by the language interface.
C	12	Address of the contents of register 1 in the application save area. Register 1 contains the address of the application parameter list.
10	16	Address of the 16-byte recovery token associated with this instance of the transaction. The recovery token identifies the unit of work across one or more subsystems.
14	20	Address of a one-character field which identifies the authorization state: <ul style="list-style-type: none"> A The caller is authorized and the exit routine is activated in key seven, supervisor state. U The caller is unauthorized and the exit routine is activated in key eight, problem program state.
18	24	Address of a 12-word buffer area provided for specific language function calls. External subsystems that require IMS to call internal exit routines for post-normal call processing can use this buffer to pass data to the internal exit routine. If post-normal call processing is required, IMS passes the address of the buffer to the associated internal exit routine. If post-normal call processing is not required, the external subsystem should not use this parameter. For more information, see return code 12. <p>Restriction: The use of this address field is restricted to those external subsystems that have negotiated the definition and use of an internal exit routine for post-normal call processing. Requests for this support should be made through the IBM User Requirements Process, which includes GUIDE, SHARE, and vendor requirements processing.</p>

Contents of Register 15 on Return

Processing of return codes received from the exit routine:

Return Code	Meaning
0	Normal Call successful. <p>Action: IMS continues normal processing.</p>
4	Normal Call unsuccessful. A resource deadlock is detected by the external subsystem. <p>Action: IMS terminates the application program with abend U777. All changes are backed out and the application is rescheduled.</p>
8	Normal Call unsuccessful. A failure in the external subsystem occurred while processing the request. <p>Action: IMS terminates the application with abend U3044.</p>

Return Code Meaning

C Normal Call successful. The external subsystem requested the scheduling of an associated internal exit routine for post-normal call processing. IMS calls the internal exit routine before returning control to the application program.

Action: If there is an internal exit routine associated with the language function call, IMS calls the associated internal exit routine and passes the address of the buffer. If there are no internal exit routines associated with it, IMS ignores the request and performs the processing associated with return code 0.

The actual interface to an internal exit routine is unique to that routine and depends on the type of external subsystem. The external subsystem-specific interfaces are not documented.

20 Should not occur. See "Return Codes" on page 538 for more information.

Resolve Indoubt Exit Routine

The Resolve Indoubt exit routine provided by the external subsystem aids in the coordination of recovery between the two subsystems. IMS, as the recovery coordinator, always calls this exit routine after successful completion of the identify process. IMS indicates in the EPL whether or not recovery must take place for the units of work in question.

The Resolve Indoubt exit routine is activated once for each outstanding IMS recovery token. It is called after the Echo exit routine. The external subsystem directs IMS to save or destroy the recovery token. More information on exit routine responses is in "Contents of Register 15 on Return" on page 556.

The Resolve Indoubt exit routine has the option of allowing the two subsystems to continue communication with or without all recovery tokens resolved. If communication continues and outstanding recovery tokens exist, an authorized operator can direct IMS to delete its recovery tokens using the /CHANGE command.

Related Reading: Refer to *IMS Version 9: Command Reference* for information on the /CHANGE command.

If the Resolve Indoubt exit routine address is not present in the EEVT and outstanding recovery tokens do not exist, IMS allows the connection process to continue. However, if a recovery token does exist, IMS terminates the connection and informs the MTO with message DFS3602I.

The Resolve Indoubt exit routine is also activated after the abend of an application program that had a connection (thread) to the external subsystem.

Activating the Routine

The exit routine is activated in key seven, supervisor state. The EEVT prefix (EEVTP) indicates a control region environment (control region TCB).

The EPL contains:

Offset Hex	Decimal	Content
0	0	Address of the parameter count field. The count field contains the value F'4'.

Resolve In-Doubt Exit Routine

Offset Hex	Decimal	Content
4	4	Address of the EEVT prefix.
8	8	Address of a two-character field: <ul style="list-style-type: none"> Byte 1 contains an indicator, either 'C' or 'W', on the first activation of the Resolve Indoubt exit routine during the current IMS execution. On subsequent activations, the byte contains binary zeroes. (For example, if the external subsystem terminates and restarts while IMS remains active, when the connection is reestablished, the byte will contain binary zeroes.) <ul style="list-style-type: none"> C Indicates IMS was cold started. All subsequent fields in the parameter list contain binary zeroes. W Indicates IMS was warm started. Byte 2 is set to 'L' after the last recovery token of the current sequence is processed. For all other activations, the byte is set to binary zeroes. <ul style="list-style-type: none"> L Indicates either that there are no recovery tokens to be resolved, or that all recovery tokens that were to be resolved at this time have been processed. If 'L' is not set on an activation of the exit routine, the exit routine should expect to be activated one or more times (once per recovery token) until 'L' is set. A recovery token is not passed on the last ('L') activation. <p>When 'C' is set in byte one, 'L' is always set because IMS does not save recovery information across a cold start.</p>
C	12	Address of a two-character field indicating whether the recovery unit should be aborted or committed. <ul style="list-style-type: none"> CO Commit AB Abort
10	16	Address of the 16-byte recovery token associated with this instance of the transaction. The recovery token identifies the unit of work across one or more subsystems.

Contents of Register 15 on Return

Processing of return codes received from the exit routine:

Return Code	Meaning
0	Resolve Indoubt successful.
4	<p>Action: IMS continues normal processing. The recovery token is destroyed.</p> <p>Resolve Indoubt unsuccessful. Return code 4 should be set when the external subsystem chooses not to resolve (commit or abort as directed) the unit of work at this time and expects IMS to pass the recovery token for resolve indoubt processing at a later time. This return code is not intended for the case where resources have become inconsistent or the possibility exists (see return code C).</p> <p>Action: IMS saves the recovery token. The connection status remains unchanged. IMS assumes that the indicated unit of work is indoubt status in the external subsystem (for example, resources have not become inconsistent). The saved recovery token will be included in the resolve indoubt processing for the next establishment of the connection. IMS does not inform the installation that the unit of work was not resolved.</p>

Return Code Meaning

8	<p>Resolve Indoubt unsuccessful. Return code 8 can be used when the external subsystem chooses not to resolve the unit of work during exit processing but saves the commit direction so that IMS does not need to save the recovery token. This return code is not intended for the case where resources have become inconsistent (see return code C).</p> <p>Return code 8 might be used when the indicated unit of work is not in indoubt status in the external subsystem but resource consistency is not jeopardized, however, caution is advised. External subsystem-specific processing that is not coordinated with IMS can result in IMS holding a recovery token in indoubt status when the unit of work is not indoubt in the external subsystem (for example, external subsystem “cold start”, or manual recovery of a unit of work by the installation if allowed by the external subsystem). If the external subsystem can determine that its prior resolution of a unit of work (explicit or implicit) agrees with the commit direction passed to the exit routine, return code 8 can be set; otherwise, return code C should be set.</p> <p>Action: IMS destroys the recovery token. The connection status remains unchanged (IMS assumes that resource consistency is maintained).</p> <p>The IMS action is the same as for return code 0. Setting return code 8 allows for an audit trail of the “not-quite-normal” cases.</p>
C	<p>Resolve Indoubt unsuccessful. Return code C should be used when resources in IMS and the external subsystem have become inconsistent or when the possibility exists. It is intended to be used, for example, when the recovery token passed to the exit does not exist (is unknown) in the external subsystem, or when the external subsystem has indoubt recovery tokens remaining when IMS has finished processing its indoubt list. The external subsystem should take appropriate additional action to maintain integrity and assist the installation in resolving resource inconsistencies.</p> <p>Action: IMS terminates the connection and saves all remaining recovery tokens. IMS also issues message DFS3602I to notify the installation of a resource problem.</p> <ul style="list-style-type: none"> • If a recovery token was passed on the exit routine activation (for example, L was not set), IMS terminates the connection to the external subsystem. The recovery token passed and all remaining recovery tokens are saved. • If this is the last activation (L was set), the connection status is unchanged. Dependent regions are allowed to connect to the external subsystem.
20	<p>Should not occur. See “Return Codes” on page 538 for more information.</p>

Signoff Exit Routine

The Signoff exit routine is activated by IMS when:

- IMS is shutting down.
- The external subsystem activates the IMS Subsystem Termination Service.
- The subsystem termination notification ECB is posted.
- The /STOP SUBSYS command is entered and IMS is terminating all the subsystem connections.

IMS attempts to activate the exit routine as part of an orderly/catastrophic shutdown process of the two subsystems.

Activating the Routine

The exit routine is activated in key 7, supervisor state. The EEVT prefix (EEVTP) indicates a dependent region environment (dependent region TCB).

Signoff Exit Routine

The EPL contains:

Offset Hex	Decimal	Content
0	0	Address of the parameter count field. The count field contains the value F'1'.
4	4	Address of the EEVT prefix.

Contents of Register 15 on Return

Processing of return codes received from the exit routine:

Return Code	Meaning
0	Signoff successful.
8	Signoff unsuccessful. The ESAP or external subsystem processing of the request failed.
	Action: IMS terminates the dependent region connection with the external subsystem, allowing other dependents to continue processing.
20	Should not occur. See "Return Codes" on page 538 for more information.

Signon Exit Routine

The Signon exit routine informs the external subsystem of the user ID associated with the transaction input message. The user ID can be:

- The inputting LTERM name (if the terminal user is not signed on)
- The RACF/user-authorized user ID associated with a non-message driven BMP or CPI-C application
- The PSB name specified on the job card
- The ID of the terminal user

The following table lists, in search order, the fields that IMS will check when it searches for a user ID. For each field, it lists the criteria that IMS uses to validate the user ID. When IMS finds a valid user ID, IMS extracts the ID and passes it to the Signon exit routine.

Table 156. Determining the Signon User ID

Type of Application	Field	Criteria for Authorized User ID
CPI-C	1. RACF user ID if the ACEE is cloned in the dependent region	Value passed without validation
	2. PSTBUSER	The value is not binary zeroes or blanks
	3. PSTUSID	The value is not blanks
	4. PSTSYM80	The value is not blanks
	5. PDIRSYM	Value passed without validation
Message-driven BMP that has done a Get Unique IFP that has done a Get Unique MPP	1. PSTUSID	The value is not blanks
	2. PSTSYM80	The value is not blanks
	3. PSTBUSER	The value is not binary zeroes or blanks
	4. PDIRSYM	Value passed without validation

Table 156. Determining the Signon User ID (continued)

Type of Application	Field	Criteria for Authorized User ID
Non-message-driven BMP Message-driven BMP that has not done a Get Unique IFP that has not done a Get Unique	1. PSTBUSER	The value is not binary zeroes or blanks
	2. PDIRSYM	Value passed without validation

When a dependent region connection is initially established, the Signon exit routine is activated before a thread is created by the Create Thread exit routine. All subsequent requests result in the exit routine being activated after a thread is created. For example, Signon is activated for each message processed during a single scheduling, whether or not the messages are separated by commit processing.

Activating the Routine

The exit routine is activated in key 7, supervisor state. The EEVT prefix (EEVTP) indicates a dependent region environment (dependent region TCB).

The EPL contains:

Offset Hex	Decimal	Content
0	0	Address of the parameter count field. The count field contains the value F'5'.
4	4	Address of the EEVT prefix.
8	8	Address of the eight-character user ID, left justified and padded on the right with blanks.
C	12	Address of the 16-byte recovery token associated with this instance of the transaction. The recovery token identifies the unit of work across one or more subsystems.
10	16	Address of the 8-byte RACF group name for the user ID that entered the transaction. The name is left justified and padded with blanks on the right. The area contains blanks if RACF checking is not in effect.
14	20	Address of the field containing the performance block token for z/OS workload management support.
18	24	Address of the XID token associated with this transaction. The XID token identifies participants in a Distributed Syncpoint environment.

Contents of Register 15 on Return

Processing of return codes received from the exit routine:

Return Code	Meaning
0	Signon successful.

Action: IMS continues normal processing.

Signon Exit Routine

Return Code	Meaning
4	Signon unsuccessful. The external subsystem rejected the specified request. Action: IMS activates the Subsystem Not Operational exit routine. (See “Subsystem Not Operational Exit Routine” for more information on this exit routine.) The return code from the Subsystem Not Operational exit routine determines further processing.
8	Signon temporarily unsuccessful. The external subsystem was unable to complete the request due to the unavailability of a required resource (resource allocation failure). Action: IMS terminates the application program with abend U3048.
C	Signon permanently unsuccessful. The request failed in the external subsystem. Action: IMS terminates the application program with abend U3045.
10	Signon unsuccessful. The request failed in the external subsystem because communications with it are broken. Action: IMS terminates the application program with abend U3044.
14	Signon unsuccessful. The external subsystem was unable to complete the request due to a resource definitional conflict between the two subsystems. Action: IMS terminates the application program with abend U3047.
18,1C	Signon unsuccessful. The request was rejected because the recovery token presented by IMS at signon already exists in the external subsystem. One of save following conditions occurred: <ul style="list-style-type: none">• Outstanding recovery was not resolved by the Resolve Indoubt exit routine, probably due to errors in the external subsystem. (See “Resolve Indoubt Exit Routine” on page 555 for more information on this exit routine.)• IMS was cold started and the contents of the recovery token occurred once again. Action: IMS pseudo abends the application program with abend U3053 and backs out the previous updates. The application is immediately rescheduled. The dependent region connection is re-established whereupon a new recovery token is presented to the Signon exit routine.
20	Should not occur. See “Return Codes” on page 538 for more information.

Subsystem Not Operational Exit Routine

The Subsystem Not Operational exit routine is viewed as a utility type of exit routine. It is typically activated when IMS encounters an unusual situation. IMS activates this exit routine when:

- An application program directs a request to the external subsystem and a connection does not exist. The Subsystem Not Operational exit routine can activate the IMS Subsystem Startup Service exit routine to initiate a connection.
- Return code 4 is returned from the Signon or Create Thread exit routines. (See “Signon Exit Routine” on page 558 and “Create Thread Exit Routine” on page 547 for more information about these exit routines.)
- The external subsystem tells IMS it is quiescing before creation of a thread.

Activating the Routine

The exit routine is activated in the caller’s key. The caller is IMS, an application program, or an external subsystem-supplied exit routine, and is either authorized or unauthorized. If the caller is authorized, the exit routine is activated in key seven, supervisor state. If the caller is unauthorized, the exit routine is activated in key

Subsystem Not Operational Exit Routine

eight, problem program state. The EEVT prefix (EEVTP) indicates a dependent region environment (dependent region TCB).

The EPL contains:

Offset Hex	Decimal	Content
0	0	Address of the parameter count field. The count field contains the value F'10'.
4	4	Address of the EEVT prefix.
8	8	Address of the contents of register 0 in the application program save area. At this time register 0 contains the address of the external subsystem-directed parameter list as constructed by the language interface.
C	12	Address of the contents of register 1 in the application program save area. Register 1 contains the address of the application parameter list.
10	16	Address of a one-character information field. The contents indicate why the Subsystem Not Operational exit routine is being activated. The field contains: <ul style="list-style-type: none"> A Return code 4 was returned by the Signon or Create Thread exit routines. (See "Signon Exit Routine" on page 558 and "Create Thread Exit Routine" on page 547 for more information about these exit routines.) C The IMS control region has not identified to the external subsystem. This condition was discovered when an application directed a request to the subsystem. The Subsystem Not Available exit routine can activate the IMS Subsystem Startup Service to initiate a connection. D An application issued a call to the external subsystem but the dependent region has not identified. The Subsystem Not Operational exit routine can activate the IMS Subsystem Startup Service to initiate a connection. Q The external subsystem notified IMS that it is terminating in a quiesce fashion. Prior to the creation of a thread is the only interval where 'Q' is passed to the external subsystem (applicable mainly when the region error option (REO) is an 'R'). T The external subsystem notified IMS that it is either abnormally terminating or terminating in a quick fashion. It is highly likely that a subsystem-directed request will fail. IMS notifies the external subsystem when servicing a subsystem request (such as Create Thread).
14	20	Address of a one-character default application option field. This field contains the region error option (REO) defined by the installation in the external subsystem PROCLIB member to take effect in the event an application issues a subsystem-directed request when a complete authorized connection does not exist. This field is always valid. If an option is not specified, IMS uses its elected default ('R').
18	24	Address of a four-byte character format field containing the name of the subsystem associated with the request. The name is left justified and padded with blanks.
1C	28	Address of a fullword where the Subsystem Not Operational exit routine optionally returns a z/OS format abend code.
20	32	Address of the application program name scheduled at this time. The name is assumed to be left justified and padded with blanks to the left. The maximum length is eight bytes.

Subsystem Not Operational Exit Routine

Offset Hex	Decimal	Content
24	36	Address of the 16-byte recovery token associated with this instance of the transaction. The recovery token identifies the unit of work across one or more subsystems.
28	40	Address of a one-character field which identifies the authorization state: A The caller is authorized and the exit routine is activated in key seven, supervisor state. U The caller is unauthorized and the exit routine is activated in key eight, problem program state.

Contents of Register 15 on Return

Processing of return codes received from the exit routine:

Return Code	Meaning
0	Subsystem Not Operational call successful. Action: IMS continues normal processing. Normal processing in this case means activating the Signon and Create Thread exit routines to complete the external subsystem connection. (See “Signon Exit Routine” on page 558 and “Create Thread Exit Routine” on page 547 for more information about these exit routines.)
4	Subsystem Not Operational call successful/unsuccessful. This exit routine elected to pass status feedback to the application. Action: IMS returns control to the application program. The application is permitted to continue running. A loop between the Create Thread exit routine and the Subsystem Not Operational exit routine might result if the application program does not check for nonzero return codes from the API.
8	Subsystem Not Operational call unsuccessful. Action: IMS terminates the application program with abend U3044. The transaction input is saved and all uncommitted changes are backed out. The dependent region remains available for application processing.
C	Subsystem Not Operational call unsuccessful. Action: IMS terminates the application program with abend U3047 and discards the input. The dependent region remains available for application processing.
10	Subsystem Not Operational call unsuccessful. Action: IMS uses the z/OS format abend code returned by this exit routine to abend the application.
20	Should not occur. See “Return Codes” on page 538 for more information.

Subsystem Termination Exit Routine

The Subsystem Termination exit routine is activated in the control region when IMS or the external subsystem terminate; activation follows the Terminate Identify exit routine. It is used for cleaning up work areas or freeing memory.

The Subsystem Termination exit routine should execute in parallel with normal and abnormal IMS or external subsystem termination processing. External subsystem termination is recognized when the subsystem posts the termination ECB.

Activating the Routine

The exit routine is activated in key 7, supervisor state. The EEVT prefix (EEVTP) indicates a control region environment (control region TCB).

The EPL contains:

Offset Hex	Decimal	Content
0	0	Address of the parameter count field. The count field contains the value F'2'.
4	4	Address of the EEVT prefix.
8	8	Address of a 1-byte character format field indicating the reason for subsystem termination. The field contains one of the following: <ul style="list-style-type: none"> A IMS is shutting down in a normal fashion (/CHECKPOINT FREEZE). IMS makes sure new connections are not established and permits existing ones to terminate normally. B IMS is shutting down abnormally (abend). Some abend conditions might prohibit the activation of this exit routine. C The external subsystem notified IMS that it is terminating in a quiesce fashion. IMS makes sure new connections are not established and permits existing ones to terminate normally. D The external subsystem notified IMS that it is terminating abnormally (catastrophic). IMS makes sure new connections are not attempted and terminates existing ones. E The connection between the subsystems is being quiesced by IMS. IMS is not shutting down but remains available. The termination of the connection is the result of the /STOP command, a bad return code from an exit routine, or a required exit routine missing. F The connection between the subsystems is being terminated because the IMS Subsystem Termination Service exit routine was activated by an external subsystem exit routine.

Contents of Register 15 on Return

Processing of return codes received from the exit routine:

Return Code	Meaning
0	Subsystem Termination successful.
8	Subsystem Termination unsuccessful. The ESAP or the external subsystem encountered a failure in processing the termination notification. Action: IMS continues subsystem termination.
20	Should not occur. See "Return Codes" on page 538 for more information.

Terminate Identify Exit Routine

Each IMS region that has an external subsystem connection must first identify to the subsystem. Identify must first be complete for the control region before any dependent regions identify. This hierarchical structure allows the control region to act as recovery coordinator for the dependent regions. If a dependent region were

Terminate Identify Exit Routine

to fail, the control region intervenes and instructs the external subsystem to commit or abort the dependent region units of work.

The Terminate Identify exit routine is activated by IMS to terminate this hierarchical structure when:

- IMS is shutting down.
- The subsystem activates the IMS Subsystem Termination Service.
- The subsystem termination notification ECB is posted.
- The /STOP SUBSYS command is entered.

Activation is part of an orderly/catastrophic shutdown or disconnecting process of the two subsystems.

Activating the Routine from the Control Region

The exit routine is activated in key 7, supervisor state. The EEVT prefix (EEVTP) indicates a control region environment (control region TCB).

The EPL contains:

Offset Hex	Decimal	Content
0	0	Address of the parameter count field. The count field contains the value F'1'.
4	4	Address of the EEVT prefix.

Contents of Register 15 on Return

Processing of return codes received from the exit routine:

Return Code	Meaning
0	Terminate Identify successful. Action: IMS continues termination processing.
8	Terminate Identify unsuccessful. The ESAP or external subsystem processing of the request failed. Action: IMS continues connection termination processing without affecting other dependent region connections.
20	Should not occur. See "Return Codes" on page 538 for more information.

Activating the Routine from the Dependent Region

The exit routine is activated in key 7, supervisor state. The EEVT prefix (EEVTP) indicates a dependent region environment (dependent region TCB).

The EPL contains:

Offset Hex	Decimal	Content
0	0	Address of the parameter count field. The count field contains the value F'1'.
4	4	Address of the EEVT prefix.

Contents of Register 15 on Return

Processing of return codes received from the exit routine:

Return Code	Meaning
0	Terminate Identify successful.
8	<p>Action: IMS continues termination processing.</p> <p>Terminate Identify unsuccessful. The ESAP or external subsystem processing of the request failed.</p> <p>Action: IMS continues connection termination processing without affecting other dependent region connections.</p>
20	Should not occur. See "Return Codes" on page 538 for more information.

Terminate Thread Exit Routine

The Terminate Thread exit routine disconnects the application from the external subsystem. It is activated when the application program terminates normally.

The second phase of the commit processing at application termination is done through the Terminate Thread exit routine. Therefore, a commit option is specified on the activation. The options are described under "Activating the Routine."

Activating the Routine

The exit routine is activated in key 7, supervisor state. The EEVT prefix (EVTTP) indicates a dependent region environment (dependent region TCB).

The EPL contains:

Hex	Decimal	Content
0	0	Address of the parameter count field. The count field contains the value F'3'.
4	4	Address of the EEVT prefix.
8	8	Address of the four-byte commit option character string: <ul style="list-style-type: none"> COMM Commit and terminate the thread. (Normal application termination is an example of when this option is set). ABRT Abort and terminate the thread. DEAL Deallocate resources with terminate thread (nothing to commit).
C	12	Address of the 16-byte recovery token associated with this instance of the transaction. The recovery token identifies the unit of work across one or more subsystems.

Contents of Register 15 on Return

Processing of return codes received from the exit routine:

Return Code	Meaning
0	Terminate Thread successful.
	Action: IMS continues normal processing.

Terminate Thread Exit Routine

Return Code	Meaning
4	<p>Terminate Thread unsuccessful. The ESAP or external subsystem processing of the request failed.</p> <p>Action: IMS terminates the application with an abend. The dependent region connection to the external subsystem is also terminated. Resolve indoubt processing for the recovery token is performed in the control region. (See “Resolve Indoubt Exit Routine” on page 555 for more information about this exit routine.)</p> <ul style="list-style-type: none">• For the COMM (commit) option: The application is terminated with abend U3046 (the input message is processed; DL/I resources are committed). BMP jobs must be resubmitted; they resume processing after the commit point.• For the ABRT (abort) option: The application is terminated with abend U3045 (the input message is deleted; DL/I resources are backed out). BMP jobs must be resubmitted; they resume processing at the prior commit point.
8	<p>Terminate Thread unsuccessful. The Terminate Thread exit routine has either detected an error with the request information or considers the request invalid at this time. This return code should only be used when the commit option character string is 'DE'.</p> <p>Action: IMS continues normal processing.</p>
20	<p>Should not occur. See “Return Codes” on page 538 for more information.</p>

Chapter 77. IMS System Service Exit Routines

The external subsystem can activate IMS-supplied synchronous exit routines to provide prescribed IMS services. External subsystem exit routines can request IMS to:

- Write a log record on the IMS log (Log Service exit routine).
- Send a message to an IMS destination (Message Service exit routine).
- Initiate a connection (Subsystem Startup Service exit routine).
- Terminate a connection (Subsystem Termination Service exit routine).

External subsystem exit routines are organized alphabetically and described on “Log Service Exit Routine” on page 568.

The following topics provide additional information:

- “General System Service Exit Routine Interface”
- “Log Service Exit Routine” on page 568
- “Message Service Exit Routine” on page 569
- “Subsystem Startup Service Exit Routine” on page 571
- “Subsystem Termination Service Exit Routine” on page 572

General System Service Exit Routine Interface

To activate an IMS system service exit routine, the ESAP loads the address of an IMS service router module from EEVPESGL in the EEVTP control block and branches to it. The ESAP passes required parameters using an exit routine parameter list (EPL) in the same general format as the EPL passed to external subsystem exit routines. Each exit routine has a unique function code. The address of the function code defined for the exit routine being activated must be supplied in the EPL. If a function code address is not passed, the invalid parameter list return code, X'20', is returned to the caller.

Upon entry, the system service exit routine saves all registers using the provided save area. The registers contain the following:

Register	Contents
1	Address of exit parameter list (EPL)
13	Address of save area
14	Return address
15	Address obtained from EEVPSEGL in the EEVTP

Before returning to the ESAP, the system service exit routine restores all registers except register 15, which contains a return code. The parameters and return codes for each system service exit routine are described in the following sections.

The storage key of the save area should be that of the caller, for example, key 8 for the Normal Call exit routine; key 7 for the Subsystem Termination exit routine.

The key of the storage passed to the system service exit routines (Log exit routine, Message exit routine) must be the same as the caller's. For example, if the Identify exit routine wants to place data on the IMS log, that data must exist in storage obtained while the Identify exit routine was running in key 7 before calling the Log exit routine.

Attach Facility

IMS system service exit routines should not be activated from TCBs attached by the ESAP. The system service modules expect to be activated under an IMS internal structure that is only available under IMS TCBs.

Log Service Exit Routine

An external subsystem uses this exit routine when it wants IMS to write a log record. IMS reserves log record type X'55' for external subsystem usage. The exit routine does not accept any other log record types.

Activating the Routine

The EPL contains:

Offset	Hex	Decimal	Content
	0	0	Address of the parameter count field. The count field must contain the value F'3'.
	4	4	Address of the 1-character logging service function code, X'16'. If an address is not present, return code X'20' is returned to the caller.
	8	8	Address of the EEVT prefix. The EEVT prefix must be fully initialized.
	C	12	Address of the log record area. The exact contents are written to the log. IMS does not alter this area. The log record must be in the following format:

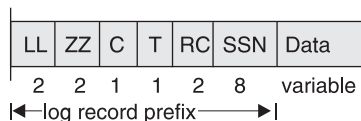

The log record prefix must contain the LL, ZZ, and C fields as follows:

- LL** A 2-byte field that must contain the total length of the record. The total length (prefix + data) cannot exceed the logical record length (LRECL) for the system log data set minus 4 bytes.
- ZZ** A 2-byte field that must contain binary zeroes.
- C** A 1-byte field that must contain the log record type, X'55'.

Recommendation: The remaining prefix fields are suggested to allow log records for a particular external subsystem to be identified.

IMS does not check the contents of the fields.

- T** A 1-byte field that contains a system or function type.
- RC** A 2-byte field that contains a reason code.
- SSN** An 8-byte field that contains the external subsystem name.

Contents of Register 15 on Return

Register 15 contains one of the following return codes on return:

Return Code	Meaning
0	Log request successful. The log record passed by the caller was written to the IMS log.
4	Log request unsuccessful. A failure (or error) was encountered in attempting to process the log request. The record was not logged.

Return Code Meaning

8	Log request unsuccessful. The caller attempted to log an invalid log record type. Only type X'55' log records are accepted by the Log exit routine. The record was not logged.
20	Log request unsuccessful. Invalid data was detected in the exit parameter list. The record was not logged.

Possible errors:

- Invalid log record address—the EPL contains zeroes or a negative value.
- Invalid log record length—the length field contains zeroes or a negative value.

Message Service Exit Routine

An external subsystem uses this exit routine when it wants IMS to send a message to an IMS destination (MTO or input terminal). Two types of messages are accepted by the exit routine: preedit (prebuilt) and key call (message number).

Preedit messages are assumed to be formatted by the caller. Single or multiple segment preedit messages are accepted. The address of the message is passed to the exit routine.

On a key call, the address of the message number is passed. The message itself is supplied in the user message table.

Related Reading: For more information, refer to Chapter 32, “User Message Table (DFSCMTU0),” on page 235.

Activating the Routine

The EPL contains:

Offset Hex	Decimal	Content
0	0	Address of the parameter count field. The count field must contain the value F'5'.
4	4	Address of the 1-character message service function code, X'15'. If an address is not present, return code X'20' is returned to the caller.
8	8	Address of the EEVT prefix. The EEVT prefix must be fully initialized.
C	12	Address of the message area for preedit messages; address of the message number for key call (user) messages. IMS assumes the message number to be a two-byte binary value. IMS does not alter the message area.
10	16	Address of the 8-byte alphanumeric destination name (that is, the LTERM name). If this field contains binary zeroes, the default message destination is the IMS master terminal. The name is left justified and padded with blanks on the right.

Attach Facility

Offset Hex	Decimal	Content
14	16	Address of the 2-character message type indicators. The first character indicates the message type. The second character indicates system versus pageable message.

The supported message types in character format are:

- S** Message is a single segment and can be pre-edited.
- M** Message might consist of a variable number of segments, each segment is prefixed by its own length. The entire message is prefixed by the entire message length.
- U** Indicates a user message is sent. When specified, IMS expects the address of a message number passed in the input parameter list. The message is assumed to be present in the IMS user message table.

The second character indicates to IMS where the message is to be placed on the master terminal in the event the z/OS split screen master terminal format is used. Traditionally, the top part of the screen is reserved for unsolicited output such as I/O error messages and immediate command response message (that is, command complete, command in progress, invalid keyword or parameter).

The lower portion of the screen is where display output (/DISPLAY LTERM ALL) is directed. This allows the MTO to page through the output message using the PA keys. If the split screen master terminal format is not being used, output is displayed, taking advantage of the entire screen.

The supported screen format indicators in character format are:

- S** Indicates the message being sent is to be placed on the top portion of the screen (system area)
- P** Indicates the message being sent is to be placed on the lower portion of the screen (pageable area, typically used for /DISPLAY command output)

The format for single segment messages (message type **S**) is:

OFFSET		NAME	LENGTH/		DESCRIPTION
HEX	DEC		ALIGNMENT		
0	0	MSGLL	2		record length
2	2	MSGZZ	2		reserved bytes
4	4	MSGDATA	nnn		substance of message

The format for multiple segment messages (message type **M**) is:

OFFSET		NAME	LENGTH/		DESCRIPTION
HEX	DEC		ALIGNMENT		
0	0	MSGLL	2		total record length
2	2	MSGZZ	2		reserved bytes
4	4	MSGLL	2		message segment length
6	6	MSGZZ	2		reserved bytes
8	8	MSGDATA	10		first segment of message
12	18	MSGLL	2		message segment length
14	20	MSGZZ	2		reserved bytes
16	22	MSGDATA	20		second segment of message

Contents of Register 15 on Return

Return Code	Meaning
0	Message request successful. The message was enqueued to the master terminal or the specified destination.
4	Message request unsuccessful. The message did not pass validity checking. The message was not sent.
8	Message request unsuccessful. A failure occurred in processing the message request. The message was not sent.
20	Message request unsuccessful. Invalid data was detected in the exit parameter list (that is, invalid destination name specified). The message was not sent.

Possible errors:

- Invalid EEVTP address—the EPL contains zeroes.
- Invalid destination name—the destination name area contains blanks.
- Invalid message type.

Subsystem Startup Service Exit Routine

The IMS Subsystem Startup Service exit routine is activated by an external subsystem exit routine to cause IMS to initiate a connection to the external subsystem. If the control region identify or an MPP or IFP dependent region identify was deferred (for example, not done automatically during region initialization processing), this service is to be used to establish the necessary connection. It can also be used to establish the connection for a BMP dependent region. The external subsystem activates the service from the Subsystem Not Operational exit routine in the dependent region (key 8) when the first application call to the external subsystem is processed in the dependent region.

Related Reading: See “Initiating the External Subsystem Connection” on page 527 for further discussion.

If the control region connection has not been established, the Startup Service exit routine activates the control region identify process before activating the dependent region identify process. The startup exit routine activation fails if the notify message passed to the control region Identify exit routine (on a previous activation) was accepted by the exit routine but the external subsystem has not sent the message to IMS to indicate that it is ready to establish a connection.

Activating the Routine

The EPL contains:

Offset Hex	Decimal	Content
0	0	Address of the parameter count field. The count field must contain the value F'2'.
4	4	Address of the one-character startup service function code, X'17'. If an address is not present, return code X'20' is returned to the caller.
8	8	Address of the EEVT prefix. The EEVT prefix must be fully initialized.

Contents of Register 15 on Return

Register 15 contains one of the following return codes on return:

Return Code	Meaning
0	Subsystem connection successful. The identify has been performed. IMS continues normal processing.
4	Subsystem connection unsuccessful. The identify process initiated by IMS resulted in the notify message being queued to the external subsystem. However, the subsystem has not yet been started. IMS waits for the receipt of the notify message before continuing the connection process.
8	Subsystem connection unsuccessful. The control region identify was previously attempted, at which time the Identify exit routine accepted the notify message. IMS continues to wait for the external subsystem to send the notify message before reactivating the exit routine to establish the control region connection.
C	Subsystem connection unsuccessful. The connection attempt failed either in the ESAP or in the external subsystem.
10	Subsystem identify unsuccessful. IMS is shutting down.
14	Subsystem connection unsuccessful. IMS is notified that the external subsystem is terminating either in a quiesce or catastrophic fashion.
18	Subsystem connection unsuccessful. During the connection initialization process, the external subsystem Initialization exit routine was activated. The exit routine responded with the never connect return code (return code 8).
1C	Subsystem connection unsuccessful. Resources required to process the connection request were unavailable. When this condition exists, IMS sends message DFS3620I to the MTO indicating the resource type. When a required exit routine is missing, message DFS3608 is also sent to the MTO indicating the exit routine name. Refer to <i>IMS Version 9: Messages and Codes, Volume 2</i> for more information on these messages.
20	Subsystem connection unsuccessful. Invalid data was detected in the exit parameter list. IMS did not initiate the startup (identify) process.
24	Subsystem connection unsuccessful. The startup request is rejected because an external subsystem exit activated the IMS Terminate Service exit routine. IMS is still in the process of terminating the connection between the two subsystems. Additional dependent region connections are prohibited while in this state.
28	Subsystem connection unsuccessful. The startup request is rejected because IMS is terminating the connection due to a /STOP SUBSYS command entered. Additional dependent region connections are prohibited while in this state.

Subsystem Termination Service Exit Routine

This IMS-provided exit routine prohibits new connections to the external subsystem but allows the existing connections to terminate normally (quiesce). When all dependent region connections are terminated, the control region connection is terminated.

The subsystem Termination exit routine is activated by the ESAP, possibly when a subsystem termination command is intercepted by the ESAP exit routine. The intercepting routine is available whether or not the subsystem is attached and running in user key.

To perform the necessary processing, the subsystem Termination exit routine switches to key 7 supervisor state.

Activating the Routine

The EPL contains:

Hex	Decimal	Content
0	0	Address of the parameter count field. The count field must contain the value F'2'.
4	4	Address of the one-character termination service function code, X'18'. If an address is not present, return code X'20' is returned to the caller.
8	8	Address of the EEVT prefix. The EEVT prefix must be fully initialized.

Contents of Register 15 on Return

Register 15 contains one of the following return codes on return:

Return Code	Meaning
0	Subsystem termination successful. IMS terminates subsystem connections in all dependent regions. When the dependent region connections are all terminated, the control region connection is terminated.
4	Subsystem termination unsuccessful. A failure (or error) was encountered in attempting to process the termination request. IMS terminates the connection to the subsystem as stated under return code 0.
20	Subsystem termination unsuccessful. Invalid data was detected in the exit parameter list. IMS did not initiate termination processing.

Part 9. Appendixes

Appendix A. DBCTL Function Requests

This appendix documents General-Use Programming Interface and Associated Guidance Information.

DBCTL allows access to IMS full-function databases and to data entry databases (DEDBs) from a coordinator controller (CCTL). The Database Resource Adapter (DRA) is the interface between DBCTL and a CCTL.

In this Appendix:

- “DRA Function Requests”
- “PAPL Mapping Format” on page 585

DRA Function Requests

This section discusses the requests available to the CCTL that allow it to communicate with DBCTL. These requests are passed to the DRA through the PAPL.

For all DRA requests, there are PAPL fields that the CCTL must fill in. When the DRA completes the request, there are some output PAPL fields that the DRA fills in. Some fields in the returned PAPL might contain the original input value.

(The PAPLTOK and PAPLUSER fields **do** retain the original input values.)

The PAPLUSER field is a field to be used at the CCTL's discretion. One possible use for it is to pass data to exit routines.

The DRA returns a code (in the PAPLRETC field) to the CCTL after processing a DRA request. The code indicates the status of the request and can be either an IMS code, a DRA code, or a z/OS code. Failed DRA requests return a nonzero value in the PAPLRETC field.

Related Reading:

- For more information on the codes returned when a DRA request fails, see *IMS Version 9: Application Programming: Database Manager*.
- For a complete list and description of all DRA return codes, see *IMS Version 9: Messages and Codes, Volume 1* and *z/OS System Codes*.

INIT Request

The INIT request initializes the DRA. The DRA startup parameter table contains all of the required parameters that you need to define the DRA. You can use the parameters given in the default module, DFSPZP00, or you can write your own module and bind it into the IMS.SDFSRESL.

Related Reading: For more information on enabling the DRA, see *IMS Version 9: Application Programming: Database Manager*.

The INIT PAPL also contains some parameters needed to initialize the DRA. If the same parameter appears in both the INIT PAPL and in the DRA startup parameter table, the specification in the INIT PAPL will override that in the startup table.

DBCTL Requests

In addition to the required parameters, you can also include the following optional parameters in the INIT PAPL:

Field	Contents
PAPLFUNC	PAPLINIT
PAPLSUSP	The address of the Suspend exit routine
PAPLRESM	The address of the Resume exit routine
PAPLCNTL	The address of the Control exit routine
PAPLTSTX	The address of the Status exit routine

After the INIT request and the startup table have been processed, the DRA returns the following data to the CCTL in the INIT PAPL:

Field	Description
PAPLDBCT	The DBCTL identifier (this is the IMSID parameter generated from the DBCTL startup).
PAPLCTOK	The request token that identifies the CCTL to the DRA.
PAPLTIMO	DRA TERM request timeout value (in seconds).
PAPLRETC	A code returned to the CCTL specifying the status of the request.
PAPLDLEV	A flag indicating to CCTL which functions the DRA supports. (For the latest version of PAPL mapping format see the IMS.ADFSMAC library; member name is DFSPAPL.)

INIT Request, Identify to DBCTL

To make the DRA functional, the DRA must identify itself to DBCTL, thus establishing a link between DBCTL and the CCTL. The identify process occurs in two cases:

- As a direct result of an INIT request.
- As part of a terminate/reidentify request from a Control exit routine invocation. (For additional information on the Control exit routine, see *IMS Version 9: Application Programming: Database Manager*.)

The DRA identifies itself to the DBCTL subsystem specified in the final DRA startup parameters. The identify process executes asynchronously to the INIT process. Therefore, it is possible for the INIT request to complete successfully while the identify process fails. In this case, the Control exit routine notifies the CCTL that the connection to DBCTL failed.

Related Reading: For more information on responses from the Control exit routine, see *IMS Version 9: Application Programming: Database Manager*.

If DBCTL is not active, the console operator will receive a DFS690 message (a code of 0 was returned in the PAPLRETC field). You must reply with either a CANCEL or WAIT response. If you reply with WAIT, the DRA waits for a specified time interval before attempting to identify again. The waiting period is necessary because the identify process won't succeed until the DBCTL restart process is complete. You specify the length of the waiting period on the TIMER DRA startup parameter. If subsequent attempts to identify fail, the console operator will receive message DFS691, WAITING FOR DBCTL.

If the DRA cannot identify to DBCTL because the subsystem does not reach a restart complete state, there are two ways to terminate the identify process:

- The Control exit routine is called with each identify failure. This sets a PAPL return code of 4 or 8, which terminates the identify process.

- The CCTL can issue a TERM request.

If you reply with CANCEL to message DFS690, control is passed to the Control exit routine, and the DRA acts upon the routine's decision.

After the identify process successfully completes, the DRA makes the CCTL address space non-swappable and calls the Control exit routine with a list of indoubt UORs. If no indoubt UORs exist, a null list is passed. The CCTL can use the RESYNC request to resolve any indoubt UORs that do exist.

The INIT request will attempt to create the MINTHRD number of thread TCBs. The actual number of TCBs created might be less than this value due to storage constraints.

INIT Request after a Previous DRA Session Termination

If a prior DRA session ended with a TERM request that received a PAPL return code=0, this INIT request must specify PAPLCTOK=0. If PAPLCTOK other than 0 is sent, the INIT request will fail.

The INIT request must pass the prior session's PAPLCTOK value in the current PAPLCTOK field if a DRA session ended one of the following ways:

- A nonzero return code from a TERM request
- An internal TERM request from a Control exit routine request
- A DRA failure

RESYNC Request

The RESYNC request tells DBCTL what to do with indoubt UORs. The following four subfunction values indicate possible actions:

Value	Action
PAPLRCOM	Commit the indoubt UOR.
PAPLRABT	Abort the indoubt UOR. Changes made to any recoverable resource are backed out.
PAPLSCLD	The UOR was lost to the transaction manager due to a cold start.
PAPLSUNK	The indoubt UOR is unknown to the CCTL. This can occur when the CCTL's indoubt period does not include the start of phase 1. (See information on two-phase sync point processing in <i>IMS Version 9: Application Programming: Database Manager</i> for an illustration of indoubt periods.)

You must fill in the following input fields of the PAPL:

Field	Contents
PAPLCTOK	Request token. This token identifies the CCTL to the DRA. The DRA establishes the token and returns it to the CCTL in the parameter list on the startup INIT request. The request token must be passed on to the DRA for all RESYNC requests.
PAPLR TOK	Recovery token. This 16-byte token is associated with a UOR. The first 8 bytes must be the transaction manager subsystem ID. The second 8 bytes must be unique for one CCTL thread. This is one of the indoubt recovery tokens passed to the Control exit routine.
PAPLFUNC	PAPLRSYN.

DBCTL Requests

Field	Contents
PAPLSNC	PALPRCON, PALPRABT, PALPSCLD, or PAPLSUNK.

TERM Request

The TERM request results in a termination of the DBCTL/CCTL connection and a removal of the DRA from the CCTL environment. The DRA terminates after all threads have been resolved. No new DRA or thread requests are allowed, and current requests in progress must complete.

You must fill in the following input fields in the PAPL:

Field	Contents
PAPLFUNC	PAPLTERM, DRA terminate function code
PAPLCTOK	The DRA request token (output from an INIT request)

After receiving the TERM request results, the CCTL can remove DFSPPRC0.

The following output fields are returned in the PAPL to the CCTL:

Field	Contents
PAPLRETC	The return code
PAPLMXNB	The number of times the maximum thread count was encountered during this DRA session
PAPLMTNB	The number of times the minimum thread count was encountered during this DRA session
PAPLHITH	The largest number of thread TCBs that were scheduled during this DRA session
PAPLTIMX	The elapsed time at maximum thread for this DRA session

Thread Function Requests

The Thread Function requests consist of the SCHED, IMS, SYNTerm, PREP, COMTERM, ABTTerm, and TERMTHRD requests and are described in this sections.

SCHED Request

The SCHED request schedules a PSB in DBCTL. The first SCHED request made by a CCTL thread requires a new DRA thread. If any existing DRA thread TCBs are not currently processing a DRA thread, one of these is used. If no TCBs are available, the DRA either creates a new thread TCB (until the maximum number of threads as specified by the MAXTHRD parameter in the INIT request is reached), or makes the SCHED request wait until a thread becomes available.

The value in the PAPLWCMD field indicates whether the thread to which the SCHED request applies is a short or long thread. The type of thread determines the action that IMS takes when a database command is entered for a database scheduled to the thread. The /STOP DATABASE, /DBDUMP DATABASE, or /DBRECOVERY DATABASE command issued against a database scheduled on a short thread will wait for the database to be unscheduled. IMS rejects these commands if they are entered for a database scheduled on a long thread.

You must fill in the following input fields in the PAPL:

Field	Contents
PAPLFUNC	PAPLTFUN, thread function code.
PAPLSFNC	PAPLSCHE, schedule request subfunction code.
PAPLCTOK	The DRA request token (output from an INIT request).
PAPLTTOK	The thread token set up by the CCTL.
PAPLRTOK	The 16-byte UOR token (RTOKEN). For more information about UORs, see information on sync points in <i>IMS Version 9: Application Programming: Database Manager</i> .
PAPLPSB	The PSB name.
PAPLWRTH	Deadlock Worth Value.
	If this thread hits a deadlock condition with any other DRA thread or with any IMS region, DBCTL collapses the thread with the lower deadlock worth value.
PAPLWCMD	This bit defines the thread as either a short or long thread which determines what action IMS takes on a /STOP DATABASE, /DBDUMP DATABASE, or /DBRECOVERY DATABASE command for a database scheduled to the thread. If the bit is set on (X'80'), the database is scheduled on a short thread; if the bit is set off, the database is scheduled for a long thread.
PAPLFTRD	Fast Path Trace Option.
	If this bit is on (X'40'), Fast Path tracing in DBCTL is activated.
PAPLKEYP	Public Key Option.
	If this bit is set (X'10'), DBCTL will build UPSTOR area in a special subpool so that applications running in public key can fetch the UPSTOR area.
PAPLLKGV	Lockmax Option.
	If this bit is set (X'08'), DBCTL uses the value in PAPLLKMX as the maximum number of locks that this UOR can hold. Exceeding the maximum results in a U3301 abend.
PAPLLKMX	Lockmax Value, 0 to 255.
	This value overrides any LOCKMAX parameter specified on the PSBGEN for the PSB referenced in the SCHED request.
PAPLALAN	Application language type.

Specifying the following input field is optional:

Field	Contents
PAPLSTAT	Address of an area where scheduled statistical data is returned to the CCTL.
PAPLPBTK	Address of the token for the z/OS Workload Manager performance block obtained by the CCTL.
	You must specify this field for z/OS Workload Manager support for DRA threads.

The following output fields are returned in the PAPL to the CCTL:

Field	Contents
PAPLRETC	The return code.

DBCTL Requests

Field	Contents
PAPLCTK2	The thread request token number 2. This is another DRA token required on future DRA requests originating from this thread.
PAPLPCBL	The address of the PCB list. There is one entry in the list for each PCB in the PSB that was scheduled, even if the PCB cannot be used with DBCTL.
PAPL1PCB	The address of the PCBLIST entry pointing to the first database PCB.
PAPLIOSZ	The size of the maximum I/O area.
PAPLPLAN	The language type of the PSB.
PAPLMKEY	The maximum key length.
PAPLSTAT	The address of the schedule statistical data area. This address must be specified on the input field.

CCTLs currently using the IMS Database Manager and migrating to DBCTL will experience a change in the PCBLIST and user PCB area on a schedule request. The first PCB pointer in the PCBLIST contains the address of an I/O PCB. The I/O PCB is internally allocated during the schedule process in a DBCTL environment. The I/O PCB is normally used for output messages or to request control type functions to be processed. The PCBLIST and the PCBs reside in a contiguous storage area known as UPSTOR. If the PSB was generated with LANG=PLI, the PCBLIST points to pointers for the PCBs. If LANG= was not PLI, the PCBLIST points to the PCBs directly.

IMS Request

This request makes a IMS or Fast Path database request against the currently scheduled PSB.

You must fill in the following input fields in the PABL:

Field	Contents
PAPLFUNC	PAPLTFUN.
PAPLSFNC	PAPLDLI, DLI request subfunction code.
PAPLCTOK	DRA request token (output from an INIT request).
PAPLCTK2	Thread Token number 2. This is the DRA request token that is part of the output from a SCHED request.
PAPLTTOK	Thread token set up by the CCTL.
PAPLR TOK	RTOKEN
	A 16-byte UOR token. See <i>IMS Version 9: Application Programming: Database Manager</i> for more information about UORs.
PAPLCLST	The address of an IMS call list. See <i>IMS Version 9: Application Programming: Database Manager</i> for call list formats.
PAPLALAN	Application language type. This must reflect how the call list is set up. If PAPLALAN=PLI, the DRA expects the call list to contain pointers to the PCB's pointers. For any other programming language, the DRA expects direct pointers.

PAPLALAN does not have to match PAPLPLAN which schedules request returns. For example, if PAPLPLAN=PLI, the PCBLIST in UPSTOR points to an indirect list. If desired, the CCTL can use this to create a PCBLIST that application programs use. If the application programs are written in COBOL, the CCTL can create a new PCBLIST without pointers as long as the new list actually points to PCBs in UPSTOR. The application program IMS call lists can specify PAPLALAN=COBOL, and the DRA will not expect pointers in the call list.

The following output fields are returned in the PABL to the CCTL:

Field	Contents
PAPLRETC	Code returned.
PAPLSEGL	Length of data returned.

SYNTERM Request

This is a single-phase sync-point request to commit the UOR. It also releases the PSB.

You must fill in the following input fields in the PABL:

Field	Contents
PAPLFUNC	PAPLTFUN.
PAPLSFNC	PAPLSTRM, sync-point commit/terminate subfunction code.
PAPLCTOK	DRA request token (output from INIT request).
PAPLCTK2	The thread request token number 2. This DRA token is the output from the SCHED request.
PAPLTTOK	The thread token set up by the CCTL.
PAPLRTOK	A 16-byte UOR token (RTOKEN). For information on UORs see <i>IMS Version 9: Application Programming: Database Manager</i> .

You can also specify the following, optional input fields:

Field	Contents
PAPLSTAT	Address of an area where transaction statistical data is returned to the CCTL.

The following output fields are returned in the PABL to the CCTL:

Field	Contents
PAPLRETC	Code returned.
PAPLSSCC	State of the single-phase sync-point request at the time of the thread failure. This field is set if PAPLRETC is not equal to zero.
PAPLSTAT	The address of the transaction statistical data area. The address must be specified on the input field.

PREP Request

This is a phase 1 sync-point request that asks DBCTL if it is ready to commit this UOR.

You must fill in the following input fields of the PABL:

Field	Contents
PAPLFUNC	PAPLTFUN.
PAPLSFNC	PAPLPREP, sync-point prepare subfunction code.
PAPLCTOK	DRA request token (output from an INIT request).
PAPLCTK2	Thread Token number 2. This is the DRA request token which is output from a SCHED request.
PAPLTTOK	The thread token set up by the CCTL.
PAPLRTOK	A 16-byte UOR token (RTOKEN). See <i>IMS Version 9: Application Programming: Database Manager</i> for more information about UORs.

DBCTL Requests

The following output fields are returned in the PAPAN to the CCTL:

Field	Contents
PAPLRETC	Code returned.
PAPLSTCD	Fast Path status code.

If the value in the PAPLRETC field is decimal 35, the PAPLSTCD field contains a status code that further describes the error.

COMTERM Request

This is a phase 2 sync-point request to commit the UOR. It also releases the PSB. You must issue a PREP request prior to issuing a COMTERM request.

You must fill in the following input fields in the PAPAN:

Field	Contents
PAPLFUNC	PAPLTFUN.
PAPLSFNC	PAPLCTRM, sync-point commit/terminate subfunction code.
PAPLCTOK	DRA request token (output from an INIT request).
PAPLCTK2	Thread Token number 2. This is the DRA request token, which is output from a SCHED request.
PAPLTTOK	The thread token set up by the CCTL.
PAPLRTOK	A 16-byte UOR token (RTOKEN). See <i>IMS Version 9: Application Programming: Database Manager</i> for more information about UORs.

Specifying the following input field is optional:

Field	Contents
PAPLSTAT	Address of an area where transaction statistical data is returned to the CCTL.

The following output fields are returned in the PAPAN to the CCTL:

Field	Contents
PAPLRETC	Code returned.
PAPLSTAT	The address of the transaction statistical data area. This address must be specified on the input field.

ABTTERM Request

This is a phase 2 sync-point request for abort processing. It also releases the PSB. It does not require a preceding PREP request.

You must fill in the following input fields of the PAPAN:

Field	Contents
PAPLFUNC	PAPLTFUN.
PAPLSFNC	PAPLATRM, sync-point abort/terminate subfunction code.
PAPLCTOK	DRA request token (output from an INIT request).
PAPLCTK2	Thread Token number 2. This is the DRA request token, which is output from a SCHED request.
PAPLTTOK	The thread token set up by the CCTL.
PAPLRTOK	A 16-byte UOR token (RTOKEN). See <i>IMS Version 9: Application Programming: Database Manager</i> for more information about UORs.

Specifying the following input field is optional:

Field	Contents
PAPLSTAT	Address of an area where transaction statistical data is returned to the CCTL.

The following output fields are returned in the PAPL to the CCTL:

Field	Contents
PAPLRETC	Code returned.
PAPLSTAT	The address of the transaction statistical data area. This address must be specified on the input field.

TERMTHRD (PAPLSFNC - PAPLTTHD) Request

This request terminates the DRA thread.

You must fill in the following input fields of the PAPL:

Field	Contents
PAPLFUNC	PAPLTFUN.
PAPLSFNC	PAPLTTHD, thread terminate subfunction code.
PAPLCTOK	DRA request token (output from an INIT request).
PAPLCTK2	Thread Token number 2. This is the DRA request token which is output from a SCHED request.
PAPLTOK	The thread token set up by the CCTL.

Specifying the following input field is optional:

Field	Contents
PAPLSTAT	Address of an area where transaction statistical data is returned to the CCTL.

The following output fields are returned in the PAPL to the CCTL:

Field	Contents
PAPLRETC	Code returned.
PAPLSTAT	The address of the transaction statistical data area. This address must be specified on the input field.

PAPL Mapping Format

The PAPL is the parameter list used by the DRA interface. For the latest version of PAPL mapping format, see the IMS.ADFSMAC library; member name is DFSPAPL.

Appendix B. IMS Support for Synchronous DB2 to IMS Data Propagation

DB2 UDB for z/OS Version 3 Release 1 notifies an IMS subsystem that table data has been captured on the DB2 UDB for z/OS log.

IMS loads the DB2CDCEX exit routine and passes control to DB2CDCEX for processing and migration of table data to IMS. DB2CDCEX receives control in 31-bit addressing mode (AMODE 31) and passes a register save area that is in 31-bit storage (above the 16 MB line). Control must be returned to IMS from the exit in 31-bit addressing mode.

Related Reading: For more information regarding synchronous DB2 UDB for z/OS to IMS data propagation, see *IMS DataPropagator for z/OS Administrator's Guide for MQSeries Asynchronous Propagation*, *IMS DataPropagator for z/OS Administrator's Guide for Log Asynchronous Propagation*, and *IMS DataPropagator for z/OS Administrator's Guide for Synchronous Propagation*.

Notices

This information was developed for products and services offered in the U.S.A. IBM may not offer the products, services, or features discussed in this document in other countries. Consult your local IBM representative for information on the products and services currently available in your area. Any reference to an IBM product, program, or service is not intended to state or imply that only that IBM product, program, or service may be used. Any functionally equivalent product, program, or service that does not infringe any IBM intellectual property right may be used instead. However, it is the user's responsibility to evaluate and verify the operation of any non-IBM product, program, or service.

IBM may have patents or pending patent applications covering subject matter described in this document. The furnishing of this document does not give you any license to these patents. You can send license inquiries, in writing, to:

IBM Director of Licensing
IBM Corporation
North Castle Drive
Armonk, NY 10504-1785
U.S.A.

For license inquiries regarding double-byte (DBCS) information, contact the IBM Intellectual Property Department in your country or send inquiries, in writing, to:

IBM World Trade Asia Corporation
Licensing
2-31 Roppongi 3-chome, Minato-ku
Tokyo 106, Japan

The following paragraph does not apply to the United Kingdom or any other country where such provisions are inconsistent with local law:

INTERNATIONAL BUSINESS MACHINES CORPORATION PROVIDES THIS PUBLICATION "AS IS" WITHOUT WARRANTY OF ANY KIND, EITHER EXPRESS OR IMPLIED, INCLUDING, BUT NOT LIMITED TO, THE IMPLIED WARRANTIES OF NON-INFRINGEMENT, MERCHANTABILITY OR FITNESS FOR A PARTICULAR PURPOSE. Some states do not allow disclaimer of express or implied warranties in certain transactions, therefore, this statement may not apply to you.

This information could include technical inaccuracies or typographical errors. Changes are periodically made to the information herein; these changes will be incorporated in new editions of the publication. IBM may make improvements and/or changes in the product(s) and/or the program(s) described in this publication at any time without notice.

Any references in this information to non-IBM Web sites are provided for convenience only and do not in any manner serve as an endorsement of those Web sites. The materials at those Web sites are not part of the materials for this IBM product and use of those Web sites is at your own risk.

IBM may use or distribute any of the information you supply in any way it believes appropriate without incurring any obligation to you.

Licensees of this program who wish to have information about it for the purpose of enabling: (i) the exchange of information between independently created programs

and other programs (including this one) and (ii) the mutual use of the information which has been exchanged, should contact:

IBM Corporation
J46A/G4
555 Bailey Avenue
San Jose, CA 95141-1003
U.S.A.

Such information may be available, subject to appropriate terms and conditions, including in some cases, payment of a fee.

The licensed program described in this information and all licensed material available for it are provided by IBM under terms of the IBM Customer Agreement, IBM International Program License Agreement, or any equivalent agreement between us.

Any performance data contained herein was determined in a controlled environment. Therefore, the results obtained in other operating environments may vary significantly. Some measurements may have been made on development-level systems and there is no guarantee that these measurements will be the same on generally available systems. Furthermore, some measurement may have been estimated through extrapolation. Actual results may vary. Users of this document should verify the applicable data for their specific environment.

Information concerning non-IBM products was obtained from the suppliers of those products, their published announcements or other publicly available sources. IBM has not tested those products and cannot confirm the accuracy of performance, compatibility or any other claims related to non-IBM products. Questions on the capabilities of non-IBM products should be addressed to the suppliers of those products.

All statements regarding IBM's future direction or intent are subject to change or withdrawal without notice, and represent goals and objectives only.

This information is for planning purposes only. The information herein is subject to change before the products described become available.

This information contains examples of data and reports used in daily business operations. To illustrate them as completely as possible, the examples include the names of individuals, companies, brands, and products. All of these names are fictitious and any similarity to the names and addresses used by an actual business enterprise is entirely coincidental.

COPYRIGHT LICENSE:

This information contains sample application programs in source language, which illustrates programming techniques on various operating platforms. You may copy, modify, and distribute these sample programs in any form without payment to IBM, for the purposes of developing, using, marketing or distributing application programs conforming to the application programming interface for the operating platform for which the sample programs are written. These examples have not been thoroughly tested under all conditions. IBM, therefore, cannot guarantee or imply reliability, serviceability, or function of these programs. You may copy, modify, and distribute these sample programs in any form without payment to IBM for the purposes of developing, using, marketing, or distributing application programs conforming to IBM's application programming interfaces.

Each copy or any portion of these sample programs or any derivative work, must include a copyright notice as follows:

© (your company name) (year). Portions of this code are derived from IBM Corp. Sample Programs. © Copyright IBM Corp. _enter the year or years_. All rights reserved.

If you are viewing this information softcopy, the photographs and color illustrations may not appear.

Programming Interface Information

This information is intended to help programmers customize an IMS system. It primarily documents Product-Sensitive Programming Interface and Associated Guidance Information provided by IMS.

Product-Sensitive programming interfaces allow the customer installation to perform tasks such as diagnosing, modifying, monitoring, repairing, tailoring, or tuning IMS. Use of such interfaces creates dependencies on the detailed design or implementation of the IBM software product. Product-Sensitive programming interfaces should be used only for these specialized purposes. Because of their dependencies on detailed design and implementation, it is to be expected that programs written to such interfaces may need to be changed to run with new product releases or versions, or as a result of service.

However, the Customization Guide also documents General-Use Programming Interface and Associated Guidance Information provided by IMS.

General-Use programming interfaces allow the customer to write programs that obtain the services of IMS.

General-Use Programming Interface and Associated Guidance Information is identified where it occurs, either by an introductory statement to a chapter or by the following marking:

```

|----- General-Use Programming Interface -----|
|
| General-Use Programming Interface and Associated Guidance Information...
|
|----- End of General-Use Programming Interface -----|

```

IMS provides no macros that allow a customer installation to write programs that use the services of IMS.

Attention: Do not use any IMS macros as programming interfaces.

Trademarks

The following terms are trademarks of the IBM Corporation in the United States or other countries or both:

BookManager	Language Environment
CICS	MVS
DataRefresher	NetView
DataPropagator	OS/390
DB2	RACF
DB2 Universal Database	Tivoli
IBM	VTAM
IMS	WebSphere
IMS/ESA	z/OS

Java and all Java-based trademarks and logos are trademarks or registered trademarks of Sun Microsystems, Inc. in the United States and other countries.

Other company, product, and service names may be trademarks or service marks of others.

Bibliography

This bibliography lists all of the information in the IMS Version 9 library.

- *IMS DataPropagator for z/OS Administrator's Guide for MQSeries Asynchronous Propagation*, SC27-1217
- *IMS DataPropagator for z/OS Administrator's Guide for Log Asynchronous Propagation*, SC27-1216
- *IMS DataPropagator for z/OS Administrator's Guide for Synchronous Propagation*, SC27-1215
- *IMS DataPropagator for z/OS An Introduction*, GC27-1211
- *z/OS MVS Conversion Notebook*, GC28-1747
- *OS/390 V1R1 MVS Planning: APPC Management*, GC28-1807.
- *Service Level Reporter Installation and Customization*, SH19-6437
- *Tivoli Performance Reporter for z/OS IMS Performance Feature Guide and Reference*, SH19-6825
- *WebSphere MQ for z/OS System Setup Guide*, SC34-6052.
- *z/OS MVS System Codes*, SA22-7626
- *z/OS TSO/E REXX Reference*, SA22-7790

IMS Version 9 Library

Title	Acronym	Order number
<i>IMS Version 9: Administration Guide: Database Manager</i>	ADB	SC18-7806
<i>IMS Version 9: Administration Guide: System</i>	AS	SC18-7807
<i>IMS Version 9: Administration Guide: Transaction Manager</i>	ATM	SC18-7808
<i>IMS Version 9: Application Programming: Database Manager</i>	APDB	SC18-7809
<i>IMS Version 9: Application Programming: Design Guide</i>	APDG	SC18-7810
<i>IMS Version 9: Application Programming: EXEC DLI Commands for CICS and IMS</i>	APCICS	SC18-7811
<i>IMS Version 9: Application Programming: Transaction Manager</i>	APTM	SC18-7812
<i>IMS Version 9: Base Primitive Environment Guide and Reference</i>	BPE	SC18-7813

Title	Acronym	Order number
<i>IMS Version 9: Command Reference</i>	CR	SC18-7814
<i>IMS Version 9: Common Queue Server Guide and Reference</i>	CQS	SC18-7815
<i>IMS Version 9: Common Service Layer Guide and Reference</i>	CSL	SC18-7816
<i>IMS Version 9: Customization Guide</i>	CG	SC18-7817
<i>IMS Version 9: Database Recovery Control (DBRC) Guide and Reference</i>	DBRC	SC18-7818
<i>IMS Version 9: Diagnosis Guide and Reference</i>	DGR	LY37-3203
<i>IMS Version 9: Failure Analysis Structure Tables (FAST) for Dump Analysis</i>	FAST	LY37-3204
<i>IMS Version 9: IMS Connect Guide and Reference</i>	CT	SC18-9287
<i>IMS Version 9: IMS Java Guide and Reference</i>	JGR	SC18-7821
<i>IMS Version 9: Installation Volume 1: Installation Verification</i>	IIV	GC18-7822
<i>IMS Version 9: Installation Volume 2: System Definition and Tailoring</i>	ISDT	GC18-7823
<i>IMS Version 9: Master Index and Glossary</i>	MIG	SC18-7826
<i>IMS Version 9: Messages and Codes, Volume 1</i>	MC1	GC18-7827
<i>IMS Version 9: Messages and Codes, Volume 2</i>	MC2	GC18-7828
<i>IMS Version 9: Open Transaction Manager Access Guide and Reference</i>	OTMA	SC18-7829
<i>IMS Version 9: Operations Guide</i>	OG	SC18-7830
<i>IMS Version 9: Release Planning Guide</i>	RPG	GC17-7831
<i>IMS Version 9: Summary of Operator Commands</i>	SOC	SC18-7832
<i>IMS Version 9: Utilities Reference: Database and Transaction Manager</i>	URDBTM	SC18-7833
<i>IMS Version 9: Utilities Reference: System</i>	URS	SC18-7834

Supplementary Publications

Title	Order number
<i>IMS Connector for Java 2.2.2 and 9.1.0.1 Online Documentation for WebSphere Studio Application Developer Integration Edition 5.1.1</i>	SC09-7869
IMS Version 9 Fact Sheet	GC18-7697
<i>IMS Version 9: Licensed Program Specifications</i>	GC18-7825

Publication Collections

Title	Format	Order number
IMS Version 9 Softcopy Library	CD	LK3T-7213
IMS Favorites	CD	LK3T-7144
Licensed Bill of Forms (LBOF): IMS Version 9 Hardcopy and Softcopy Library	Hardcopy and CD	LBOF-7789
Unlicensed Bill of Forms (SBOF): IMS Version 9 Unlicensed Hardcopy Library	Hardcopy	SBOF-7790
OS/390 Collection	CD	SK2T-6700
z/OS Software Products Collection	CD	SK3T-4270
z/OS and Software Products DVD Collection	DVD	SK3T-4271

Accessibility Titles Cited in This Library

Title	Order number
<i>z/OS V1R1.0 TSO Primer</i>	SA22-7787
<i>z/OS V1R5.0 TSO/E User's Guide</i>	SA22-7794
<i>z/OS V1R5.0 ISPF User's Guide, Volume 1</i>	SC34-4822

Index

Special characters

/DISPLAY command 471
 CMD-generated 461
/SSR command 514

Numerics

2 Edit exit routine (DFSLUEE0).
 See LU 6.2
2972/2980 Input edit routine (DFS29800)
 attributes 451
 binding 451
 data format on entry 452
 description 451
 example 451
 IMS callable services 451
 IMS environments 451
 including the routine 451
 interfaces 452
 link editing 451
 naming convention 451
 registers
 contents on entry 452
 contents on exit 452
 required functions 451
 sample routine location 451
 system definition requirements 451
 using callable services 451
4701 Transaction Input edit routine (DFS36010) 453
 attributes 453
 binding 453
 IMS callable services 453
 IMS environments 453
 including the routine 453
 interfaces 453
 link editing 453
 naming convention 453
 registers
 contents on entry 453
 contents on exit 454
 sample routine location 453
 using callable services 453

A

Abort Continue exit routine 541
ABTTERM request 584
accessing control blocks 7
accessing real storage
 register save conventions 8
AGN (application group name) 137
AIB Interface
 DL/I calls
 Data Capture exit routine 47
AO (automated operator) application 459
 /DISPLAY command 471

AO (automated operator) application (*continued*)
 after status codes
 CMD call 461
 GU call 461
 allowed commands 459
 AOI token 468
 CMD call
 format 460
 status codes 460
 use 458
 command editor 429
 command format
 CMD call 460
 GCMD call 460
 command response
 no response segment 460
 response segment 461
 size 460
 cross-reference of commands to responses 463,
 472
 definition 457
 described 457, 467
 DISPLAY command
 command 461
 environment 469
 environments 458
 functions 457
 GCMD call
 format 460
 GMSG call 467
 GU call status codes 461
 ICMD call 468
 issuing commands 468, 469
 RCMD call 468
 recovery 475
 responses to commands 460, 470
 restart 475
 restriction 469
 retrieving command responses 468
 retrieving messages 467
 sample application
 DFSAOPGM 475
 UETRANS 466
 security 459, 469
 segments
 no response 460
 response 461
 size 460
 shared queues 469
 synchronization processing
 occurrences 461
 rescheduling 461
 with shared queues 459
AO (automated operator) exit routine
 activating 433
 commands and responses passed to exit routine
 asynchronous messages 429
 editing IMS 429

- AO (automated operator) exit routine *(continued)*
 - commands and responses passed to the exit
 - entering 429
 - IMS-generated 429
 - data fields
 - on entry 434
 - on exit 436
 - edited command buffer 432
 - exit routine interface
 - entry codes 434
 - exit codes 435
 - exit codes validation 436
 - Extended Terminal Option (ETO)
 - considerations 432, 435
 - messages not passed to exit routine 430
 - messages passed to exit routine
 - format 431
 - network-qualified LU name 429
 - registers
 - contents on entry 434
 - contents on exit 435
 - restrictions
 - queue unavailable 430
 - use with secondary master terminal 430
 - sample exit routine 426
 - system messages passed to exit routine 428
 - type 1 (DFSAOUE0)
 - callable services 426
 - described 425, 451
 - functions 425
 - naming 426
 - specifying 426
 - type 2 (DFSAOE00)
 - activating 228
 - attributes 223
 - callable services 223
 - command editor 225
 - communicating with an AO application 224
 - communicating with IMS 228
 - described 223
 - function-specific parameter list 229
 - functions 223
 - message buffer 232
 - naming 223
 - network-qualified LU name 226
 - registers on entry 229
 - registers on exit 233
 - restrictions 224
 - sample exit routine 223
 - specifying 223
 - standard exit parameter list 229
 - types of messages received 225
 - UEHB
 - contents 445
 - flags 445
 - AOI (automated operator interface)
 - See AO (automated operator) 223
 - See AO exit routine or AO application 425
 - AOI (automated operator interface) callable
 - services 23
 - AOI token 468

- application call processing 513
- application group name
 - See AGN
- Application Group Name (AGN) exit routine (DFSISIS0)
 - attributes 137
 - binding 137
 - description 137
 - IMS callable services 137
 - IMS environments 137
 - including the routine 137
 - naming convention 137
 - registers
 - contents on entry 138
 - contents on exit 138
 - sample routine location 137
 - specifying 137
 - using callable services 137
- application threads 511
- associated printing 381
- Asynchronous Data Capture 479
 - Changed data log record 479
 - End of Job Call log record 482
- authorization
 - Resource Access Security exit routine 209
- authorization checking
 - /SIGN ON 393
 - commands 143
 - resource 417
 - transaction 417
- authorization checking, resource access 137

B

- Build Security Environment Exit Parameter List 252
- Build Security Environment exit routine (DFSBSEX0)
 - attributes 249
 - binding 250
 - IMS callable services 250
 - IMS environments 249
 - including the routine 249, 250
 - link editing 249
 - naming convention 249
 - registers
 - contents on entry 250
 - contents on exit 251
 - sample routine location 249, 250
 - using callable services 249

C

- callable services
 - AOI (automated operator interface) 23
 - associated exits 11
 - CANCEL function 24
 - control block services 19
 - DELETE module function 18
 - described 10
 - ENQUEUE function 24
 - example of a request 30
 - FIND control block function 19
 - FREE storage function 17

- callable services (*continued*)
 - function-specific parameter list 15
 - GET storage function 16
 - how they work 12
 - how to use 12
 - initializing 14
 - initializing callable services parameter list 15
 - INSERT function 23
 - invoking 15
 - linking to 13
 - LOAD module function 17
 - requesting 16
 - return and reason codes 25, 30
 - SCAN control block function 21
 - storage services 16
 - types 10
- callable services parameter list
 - described 15
- calls
 - GMSG 467
 - ICMD 468
 - RCMD 468
- CANCEL function 24
- Changed data log record 479
- changed-data propagation 46
- CMD call
 - format 460
 - status codes 460
 - use 458
- command and command response message
 - cross-reference 473
- Command Authorization exit routine (DFSCCMD0) 143
 - AO applications 144
 - attributes 143, 147
 - binding 143
 - description 143
 - environments supported 143, 147
 - ETO terminals 145
 - IMS callable services 144
 - IMS environments 143
 - IMS Open Transaction Manager Access 145
 - including the routine 144
 - link editing 143, 147
 - LU 6.2 application program 144
 - naming convention 143, 147
 - non-shared queues environment 145
 - registers 145
 - contents on entry 145
 - contents on exit 146
 - sample routine location 143, 144, 147
 - shared queues environment 145
 - static terminals 144
 - with callable services 143, 147
 - with MCS/E-MCS consoles 145
- command editor 225, 429
- Command exit routine 542
- command keyword table
 - contents 161
 - error messages 163
 - listing 161
 - modification 161
- command recognition character (CRC) 514
- command responses 460, 470
- commands 511
 - /CHANGE 533
 - /DISPLAY 471
 - /DISPLAY SUBSYS 533
 - /SSR 514
 - /START SUBSYS 511, 533
 - /STOP SUBSYS 511, 533
 - AO application 469
 - automated operator 459
 - CRC (command recognition character) 514
- commands and responses
 - message cross-reference 463
 - not passed to exit routine 430
 - passed to exit routine 429
- Commit Continue exit routine 544
- Commit Prepare exit routine 544
- Commit Verify exit routine 546
- COMTERM request 584
- control block callable services 19
- control block mapping
 - EEVT 519, 541
 - EEVTP 540
- control blocks
 - EEVT 539
 - EEVTP 539
 - mapping control blocks.
 - See control block mapping
- Conversational Abnormal Termination exit routine (DFSCONE0)
 - attributes 254
 - binding 254
 - description 253
 - IMS callable services 254
 - IMS environments 254
 - including the routine 254
 - interface 254
 - link editing 254
 - naming convention 254
 - registers
 - contents on entry 254
 - contents on exit 256
 - sample location 254
 - sample routine location 254
 - using callable services 254
- CRC (command recognition character) 514
- Create Thread exit routine 547
- creating ESMT 517
- creating work areas for ESAP 527
- cross-memory
 - considerations 9
 - mode 9
- CSCBLK parameter list 19
- CSPARMS parameter list 15
- CSPLRESN field 25
- CSPLRTRN field 25
- CSSTRG parameter list 16

D

- Data Capture exit routine 45
 - AIB Interface 47
 - attributes 46
 - calling order with data capture figure 45
 - control blocks 49
 - XPCB 50, 55
 - XSDB 52, 58
 - data security/integrity 54
 - description 45
 - loading/initializing 46
 - registers 52
 - contents on entry 52
 - contents on exit 53
 - return and reason codes 53
 - sample COBOL routine 60
 - sample PL/I routine 65
 - supported languages 46, 53
 - synchronous data capture 45
- Data Capture, asynchronous support 479
- data compression 116, 122
- Data Conversion exit routine 71
- data entry database (DEDB).
 - See DEDB Randomizing routine
- Data Entry Database Randomizing routine
 - attributes 75
 - IMS environments 75
 - including the routine 75
 - link editing 75
 - naming convention 75
 - sample routine location 75
 - using callable services 75
- Data Entry Database Randomizing Routine (DBFHDC40/DBFHDC44)
 - callable services 76
 - IMS environments 75
 - including the routine 76
 - naming convention 76
 - sample routine location 76
- Data Entry Database Resource Name Hash Routine (DBFLHSH0)
 - binding 81
 - IMS callable services 82
 - IMS environments 81
 - including the routine 82
 - naming convention 81
 - sample routine location 82
- Data Entry Database Sequential Dependent Scan Utility exit routine (DBFUMSE1)
 - attributes 85
 - IMS environments 85
 - including the routine 85
 - link editing 85
 - naming convention 85
 - sample routine location 85
 - using callable services 85
- data formatting, exit routine 109
- data propagation 46, 59
- data validation, exit routine 109
- database segment, load/insert 111
- DB2, propagating DL/I updates to 45, 479
- DBB (database buffer pool) size, specification 118
- DBFHAGU0.
 - See Fast Path Input Edit/Routing exit routine (DBFHAGU0)
- DBFHDC40/DBFHDC44.
 - See DEDB Randomizing routine
- DBFLHSH0.
 - See DEDB Resource Name Hash routine
- DBFUMSE1.
 - See DEDB Sequential Dependent Scan Utility exit routine
- DBRC Command Authorization exit routine (DSPDCAX0)
 - binding 147
 - IMS callable services 147
 - IMS environments 147
 - including the routine 147
 - naming convention 147
 - sample routine location 147
- DEDB (data entry database)
 - Sequential Dependent Scan exit routine 379
- DEDB Randomizing routine (DBFHDC40/DBFHDC44) 75
 - attributes 75
 - binding 75
 - description 75
 - invoking 76
 - loading 76
 - naming 75
 - parameters 77
 - randomizing module 75
 - registers 77
 - contents on entry 77
 - contents on exit 78
 - sample routine 78
 - DBFHDC40 78
 - XCI registers 79
 - contents on entry for a randomizing call 79
 - contents on entry for a termination call 79
 - contents on entry for an initialization call 79
 - contents on exit from a randomizing call 79
 - contents on exit from a termination call 80
 - contents on exit from an initialization call 79
- DEDB Resource Name Hash routine (DBFLHSH0)
 - assembling 82
 - binding 81
 - default routine 81
 - description 81
 - EPST 83
 - EPST fields 83
 - EPST input to the routine 82
 - EPSTDMAA 83
 - EPSTRSHS 83
 - naming 81
 - parameters 82
 - registers, contents on entry 82
 - sample result format 83
- DEDB segment edit/compression
 - See Segment Edit/Compression exit routine

DEDB Sequential Dependent Scan Utility exit routine (DBFUMSE1)
 attributes 85
 binding 85
 calling 86
 description 85
 randomizing module 85
 registers 86
 contents on entry 86
 contents on exit 86
 sample routine 87

DELETE module function 18

dependent region connections 534

Dependent Region Preinitialization routines 152
 activating 152
 description 151
 interfaces 153
 registers
 contents on entry 153
 contents on exit 153

Dependent Region Preinitialization Routines
 binding 152
 IMS callable services 152
 IMS environments 151
 including the routine 152
 naming convention 152
 sample routine location 152

descriptors, ETO
 logon 310
 user 355, 384

DFS29800
 2972/2980 Input edit routine (DFS29800) 451

DFSABOE00
 AO (automated operator) exit routine 223

DFSABOUE0
 Type 1 Automated Operator exit routine (DFSABOUE0) 425

DFSBSEX0
 Build Security Environment exit routine (DFSBSEX0) 249

DFSCAOI
 macro 23
 parameter list 23

DFSCCBLK macro 19

DFSCCMD0
 Command Authorization exit routine (DFSCCMD0) 143

DFSCKWD0
 IMS command language modification facility (DFSCKWD0) 161

DFSCMPX0
 Segment Edit/Compression exit routine 109

DFSCMTU0
 User Message Table 235

DFSCMUX0
 Message Control/Error exit routine (DFSCMUX0) 319

DFSCNTE0
 Message Switching (Input) edit routine (DFSCNTE0) 329

DFSCONE0
 Conversational Abnormal Termination exit routine (DFSCONE0) 253

DFSCSGN0
 Sign On/Off Security exit routine (DFSCSGN0) 393

DFSCSI00 module 13

DFSCSIF0 entry point 15

DFSCSII0 entry point 14

DFSCSMB0
 Transaction Code Input edit routine (DFSCSMB0) 421

DFSCSTRG macro 16

DFSCSTRN0
 Transaction Authorization exit routine (DFSCSTRN0) 417

DFSCCTSE0
 Security Reverification exit routine (DFSCCTSE0) 375

DFSCCTO0
 Physical Terminal Output edit routine (DFSCCTO0) 365

DFSDLOC0, randomizing module, loading 98

DFSEMODL macro 517

DFSEWAL macro 520

DFSFDOT0
 Dump Override Table 155

DFSFEBJ0
 Front-End Switch exit routine (DFSFEBJ0) 263

DFSFDNO
 ESAF Subsystem Indoubt Notification exit routine 159

DFSFLGX0
 Logger exit routine (DFSFLGX0) 193

DFSFTFX0
 Log Filter exit routine (DFSFTFX0) 187

DFSGPIX0
 Global Physical Terminal Input edit routine (DFSGPIX0) 279

DFSHDC40
 HDAM and PHDAM randomizing routines 97
 sample HDAM and PHDAM Generalized randomizing routine 101

DFSINSX0
 Output Creation exit routine (DFSINSX0) 353

DFSINTX0
 Initialization exit routine (DFSINTX0) 289

DFSISIS0
 Application Group Name (AGN) exit routine 137

DFSLGFX0
 Logoff exit routine (DFSLGFX0) 305

DFSLGNX0
 Logon exit routine (DFSLGNX0) 309

DFSME000
 Input Message Field edit routine (DFSME000) 295

DFSME127
 Input Message Segment edit routine (DFSME127) 299

DFSMSCE0
 and the DFSMSCEP macro 410
 and the DFSMSCVT macro 413
 attributes of the exit routine 409

DFMSMCE0 (*continued*)
 coexistence with earlier MSC exit routines 405
 defining entry points 407
 in a multiple systems coupling environment 406
 in a shared queues environment 406
 in a shared queues MSC environment 407
 in a single IMS system 406
 restrictions for use 415
 sample IMS configurations 406
 System Definition changes 408
 user parameter list 410
 vector control table 413
 DFMSMCE0 405
 DFMSMCEVT macro 413
 DFNSDMX0
 Non-Discardable Messages exit routine
 (DFNSDMX0) 333
 DFSPIXT0
 Physical Terminal Input edit routine
 (DFSPIXT0) 361
 DFSPPE0
 Partner Product exit routine (DFSPPE0) 201
 DFSPRE60
 System Definition Preprocessor exit routine (input
 phase) 217
 DFSPRE70
 System Definition Preprocessor exit routine (name
 check complete) 221
 DFSQSPC0
 Queue Space Notification exit routine
 (DFSQSPC0) 369
 DFSRAS00
 Resource Access Security exit routine 209
 DFSREXXU
 IMS Adapter for REXX exit routine 285
 DFSSBU1 (sample SB Initialization exit routine) 132
 DFSSBU2 (sample SB Initialization exit routine) 132
 DFSSBU3 (sample SB Initialization exit routine) 132
 DFSSBU4 (sample SB Initialization exit routine) 132
 DFSSBU9 (sample SB Initialization exit routine) 132
 DFSSBUX0
 Sequential Buffering Initialization exit routine
 (DFSSBUX0) 129
 DFSSGFX0
 Signoff exit routine (DFSSGFX0) 389
 DFSSGNX0
 Sign-On exit routine (DFSSGNX0) 381
 DFSSIML0
 Shared Printer exit routine (DFSSIML0) 379
 DFSSO50
 Large System Definition Sort/Split Input exit
 routine 165
 DFSSO60
 Large System Definition Sort/Split Output exit
 routine 169
 DFSTCNT0
 Time-Controlled Operations (TCO) Communication
 Name Table (CNT) exit routine (DFSTCNT0) 401
 DFSTXIT0
 Time-Controlled Operations (TCO) exit routine
 (DFSTXIT0) 397
 DFSUSER user descriptor 355, 384
 DFSYDRU0 341
 DFSYIOE0 345
 DFSYPRX0 349
 DL/I
 accessing control blocks 7
 address space 6
 binding 7
 exit routine, writing 7
 DL/I segment edit/compression
 See Segment Edit/Compression exit routine
 DRA
 function request 577
 identify process 578
 initializing 577
 DSPBUFFS
 Buffer Size Specification Facility 139
 DSPCEXT0.
 See RECON I/O exit routine
 Dump Override Table (DFSFDOT0) 156
 binding 155
 coding 156
 description 155
 errors 157
 example table 157
 IMS callable services 156
 IMS environments 155
 including the routine 155
 messages 157
 naming convention 155
 purpose and use 155
 sample routine location 156
 duplicating DL/I updates 45, 479

E

Echo exit routine 549
 edit routines 298, 303
 Field edit routine 298
 definition 296, 300
 interface 295
 use 295
 LU 6.2 Edit exit routine 313
 Sample Input edit routine 453
 Segment edit routine
 interface 301
 performance 297
 use 298, 299
 edit/compression 109
 editing LU 6.2 messages 313
 EEVPEEA 525
 EEVPEWA 527
 EEVT (external entry vector table) 526, 539
 EEVT mapping 526, 541
 EEVTP (external entry vector table prefix) 539
 EEVTP mapping 540
 End of Job log record 481
 ENQUEUE function 24
 entry points
 DFSCSI00 13
 DFSCSIF0 15

entry points *(continued)*
 DFSCSI0 14

environments
 AO application 458, 469

EPL (exit parameter list) 537, 567

EPST (extended program specification table) 82

EPSTDMAA (DEDB Resource Name Hash routine) 83

EPSTRSHS (DEDB Resource Name Hash routine) 83

error handling 319

ESAF Subsystem Indoubt Notification exit routine 159

ESMT (external subsystem module table) 537
 creating 517
 for loading exit routines 537
 loading external subsystem modules 526
 work area definitions 520

establishing connections for external subsystems 510

ETO 289
 keyword setting 289
 LTERM processing 355

EWAL 520

EXEC parameter, SSM 509

exit parameter list (EPL) 537, 567

exit routine
 destination resolution 341
 Destination Resolution exit routine 341
 DFSYDRU0 341
 input/output edit 345
 DFSYIOE0 345
 Input/Output Edit exit routine 345
 Open Transaction Manager Access
 DFSYPRX0 349
 prerouting input messages 349
 sample, location of 37

exit routine interface control blocks 539

exit routines
 data communication
 Signoff exit routine (DFSSGFX0) 389

database support
 Data Capture exit routine 45
 Data Conversion exit routine 71
 DEDB Randomizing routine
 (DBFHDC40/DBFHDC44) 75
 DEDB Resource Name Hash routine
 (DBFLHSH0) 81
 DEDB Sequential Dependent Scan Utility exit
 routine (DBFUMSE1) 85
 HALDB Partition Selection exit routine 91
 HDAM and PHDAM Randomizing routines
 (DFSHDC40) 97
 Secondary Index Database Maintenance exit
 routine 103
 Segment Edit/Compression exit routine
 (DFSCMPX0) 109
 Sequential Buffering Initialization exit routine
 (DFSSBUX0) 129

Fast Path
 DEDB Sequential Dependent Scan exit
 routine 379
 Fast Path Input Edit/Routing exit routine
 (DBFHAGU0) 259

exit routines *(continued)*
 LU 6.2
 LU 6.2 Edit exit routine 313

Remote Site Recovery
 Log Filter exit routine (DFSFTFX0) 187

security
 Command Authorization exit routine
 (DFSCCMD0) 143
 Resource Access Security exit routine
 (DFSRAS00) 209
 Security Reverification exit routine
 (DFSCCTSE0) 375
 Sign On/Off Security exit routine
 (DFSCSGN0) 393
 Transaction Authorization exit routine
 (DFSCTRN0) 417

system support
 Application Group Name (AGN) exit routine
 (DFSISIS0) 137
 Automated Operator exit routine
 (DFSAOUE0) 425
 Dependent Region Preinitialization routines 151
 Dump Override Table (DFSFDOT0) 155
 IMS command language modification facility
 (DFSCKWD0) 161
 Large System Definition Sort/Split Output exit
 routine (DFSSS060) 169
 Log Archive exit routine (IMSEXIT) 173
 Logger exit routine (DFSFLGX0) 193
 Partner Product exit routine (DFSPPE0) 201
 RECON I/O exit routine (DSPCEXT0) 203
 System Definition input exit routine
 (DFSSS050) 165
 System Definition Preprocessor exit routine (input
 phase) (DFSPRE60) 217
 System Definition Preprocessor exit routine (name
 check complete) (DFSPRE70) 221
 Time-Controlled Operations (TCO) exit routine
 (DFSTXIT0) 397
 User Message Table (DFSCMTU0) 235

transaction manager
 2972/2980 Input edit routine (DFS29800) 451
 4701 Transaction Input edit routine
 (DFS36010) 453
 Build Security Environment exit routine
 (DFSBSEX0) 249
 Conversation Abnormal Termination exit routine
 (DFSCONE0) 253
 Global Physical Terminal Input edit routine
 (DFSGPIX0) 279
 Greeting Messages exit routine
 (DFSGMSG0) 283
 Initialization exit routine (DFSINTX0) 289
 Input Message Field edit routine
 (DFSME000) 295
 Input Message Segment edit routine
 (DFSME127) 299
 Logoff exit routine (DFSLGFX0) 305
 Logon exit routine (DFSLGNX0) 309
 Message Control/Error exit routine
 (DFSCMUX0) 319

exit routines (*continued*)
 transaction manager (*continued*)
 Message Switching Input edit routine
 (DFSCNTE0) 329
 Non-Discardable Messages exit routine
 (DFSNDMX0) 333
 Output Creation exit routine (DFSINSX0) 353
 Physical Terminal Input edit routine
 (DFSPIXT0) 361
 Physical Terminal Output edit routine
 (DFSCCTO0) 365
 Queue Space Notification exit routine
 (DFSQSPC0) 369
 Shared Printer exit routine (DFSSIML0) 379
 Sign-On exit routine 381
 Time-Controlled Operations (TCO)
 Communication Name Table (CNT) exit routine
 (DFSTCNT0) 401
 Transaction Code Input edit routine
 (DFSCSMB0) 421
 exit routines, external subsystem
 register conventions 538
 exit routines, writing 7
 EXIT=
 Data Capture exit routine 48
 expansion routine 113
 explanation of stopped status 534
 extended call interface (XCI) option 78
 Extended Program Communication Block
 See XPCB
 Extended Segment Data Block
 See XSDB
 Extended Terminal Option
 See ETO
 external entry vector table (EEVT) 526, 539
 external entry vector table prefix (EEVTP) 539
 external subsystem attach facility 507
 Abort Continue exit routine 541
 accessing multiple external subsystems 532
 application call processing 513
 application threads 511
 CHANGE command 533
 Command exit routine 542
 Commit Continue exit routine 544
 Commit Prepare exit routine 544
 Commit Verify exit routine 546
 CRC 514
 Create Thread exit routine 547
 creating ESMT 517
 creating work areas for ESAP 527
 dependent region connections 534
 DFSEMODL macro 517
 DFSEWAL macro 520
 DISPLAY SUBSYS command 533
 Echo exit routine 549
 EEVPEEA 525
 EEVPEWA 527
 EEVT 526
 EEVT mapping 526, 541
 EEVTP 539
 EPL 537, 567
 external subsystem attach facility (*continued*)
 ESAF Indoubt Notification exit routine 159
 ESMT
 creating 517
 description 508
 for loading exit routines 537
 establishing connections 510
 EWAL 520
 exit routine interface 508
 exit routine interface control blocks 539
 explanation of stopped status 534
 external subsystem command support 514
 External Subsystem exit routines 537
 functions supplied by external subsystem 508
 Identify exit routine 549
 identify process 510
 IMS services available to ESAP 514
 Initialization exit routine 552
 INQ parameter 512
 language interface module 531
 loading ESAP 525
 loading external subsystem modules 526
 Log Service exit routine 568
 Message Service exit routine 569
 Normal Call exit routine 553
 notify message 510
 notify Message 529
 OASN 532
 overview 507
 recovery coordinator 507
 recovery token 513, 532
 register conventions for exit routine activation 538
 Resolve In-Doubt exit routine 555
 resource coordination 513
 RTT 508
 Signoff exit routine 557
 Signon exit routine 558
 signon process 511
 specifying external subsystems to IMS 509
 SSR command 534
 Startup Service exit routine 571
 subsystem connections 510
 Subsystem Not Operational exit routine 560
 subsystem termination 533
 Subsystem Termination exit routine 562
 system services 567
 Terminate Identify exit routine 563
 Terminate Thread exit routine 565
 terminating connections 511
 termination ECB 511, 533
 termination requested by external subsystem 533
 Termination Service exit routine 572
 thread 510
 token 507
 two phase commit process 513
 unique language interface entry points 531
 user authorization processing 511
 External Subsystem Attachment Package (ESAP) 508
 external subsystem command support 514
 External Subsystem exit routines 537

F

Fast Path
 DEDB
 Sequential Dependent Scan exit routine (DFSSIML0) 379
 DL/I exit routines 6
Fast Path Input Edit/Routing exit routine (DBFHAGU0)
 attributes 259
 binding 259
 description 259
 example 259
 IMS callable services 259
 IMS environments 259
 including 259
 including the routine 259
 link editing 259
 naming convention 259
 registers
 contents on entry 261
 contents on exit 262
 sample routine location 260
 using with shared EMH queues 260
Fast Path.
 See *also* DEDB Randomizing routine
 See *also* DEDB Resource Name Hash routine
 See *also* DEDB Sequential Dependent Scan Utility exit routine
 See Fast Path Input Edit/Routing Sample (DBFHAGU0)
FID (format identifier) 461, 471
Field edit routine 298
 definition 296, 300
 interface 295
 use 295
filtering log data 187
FIND control block function 19
format
 AO commands 459, 469
format identifier (FID) 461, 471
FREE storage function 17
Front-End Switch exit routine (DFSFEBJ0) 263
 Basic Edit 271
 binding 263
 description 263
 example 274
 FEIB
 description 266
 fields 267
 FEIB DSECT 266
 IMS callable services 264
 IMS environments 263
 including the routine 263
 message expansion 272
 message flow 264
 MFS edit 271
 naming convention 263
 registers
 contents on entry 264
 contents on exit 273
 restrictions 265
 routing 271, 274

Front-End Switch exit routine (DFSFEBJ0) (*continued*)
 sample routine location 264
 timer facility 272, 273
 Timer Facility 272
full-function database segment edit/compression
 See Segment Edit/Compression exit routine
function-specific parameter list
 AO exit routine (DFSAE00) 229
 described 15

G

GCMD call
 format 460
general user data area 289
GET storage function 16
Global Physical Terminal (Input) edit routine (DFSGPIX0)
 binding 280
 IMS callable services 280
 IMS environments 280
 including the routine 280
 naming convention 280
 sample routine location 280
Global Physical Terminal Input edit routine (DFSGPIX0)
 attributes 279
 description 279
 IMS environments 279
 including the routine 279
 link editing 279
 naming convention 279
 operation 279
 registers
 contents on entry 281
 contents on exit 282
 sample routine location 279
 using callable services 279
GMSG call 467
Greeting Messages exit routine (DFSGMSG0) 283
 attributes 283
 binding 283
 IMS callable services 283
 IMS environments 283
 including the routine 283
 link editing 283
 naming convention 283
 registers 284
 contents on entry 284
 contents on exit 284
 sample routine location 283
 using callable services 283
GU call status codes 461

H

HALDB Partition Selection exit routine (DFSPSE00) 91
 binding 91
 description 91
 IMS callable services 92
 IMS environments 91
 including the routine 91

HALDB Partition Selection exit routine (DFSPSE00)
(continued)
 naming convention 91
 sample routine location 92

Hardware Data Compression (HDC) Support
 building HDC dictionary 123
 DD name descriptions 126
 HDCD utility
 building HDC dictionary 123
 compression statistics program 123
 data integrity validation option 123
 object file, HDC dictionary 123
 return codes 127

how HDC works 122
 Segment length 122

how to implement 123

introduction 122

sample JCL procedure 124

using HDCD utility 123

Hardware Data Compression Dictionary (HDCD) utility (DFSZLDU0)
 building HDC dictionary 123
 compression statistics program 123
 data integrity validation option 123
 object file, HDC dictionary 123
 return codes 127

hash routine.
 See DEDB Resource Name Hash routine

HDAM and PHDAM Randomizing routines (DFSHDC40)
 binding 98

HDAM and PHDAM Randomizing Routines (DFSHDC40)
 attributes 98
 calling 99
 description 97
 IMS callable services 98
 IMS environments 97
 IMS.SDFSRESL 101
 including the routine 98
 loading 98
 naming convention 98
 parameters 100
 registers
 contents on entry 99
 contents on exit 101
 sample generalized routine 101
 sample routine location 98
 sample routines 101

I

ICMD call 468

Identify exit routine 549

identify process 510

IMS Adapter for REXX exit routine
 binding 285
 IMS callable services 285
 IMS environments 285
 including the routine 285
 naming convention 285
 sample routine location 285

IMS Callable Services
 See callable services 10

IMS Command Language Modification Facility (DFSCKWD0)
 binding 162
 command keyword table, modifying 161
 error messages 163
 IMS callable services 162
 IMS environments 161
 including the routine 162
 KEYWD macro 162
 naming convention 161
 routine location 162
 SYN macro 163

IMS Data Capture exit/function
 See Data Capture exit routine

IMS Data Conversion exit/function.
 See Data Conversion exit routine

IMS DataPropagator 46

IMS log 193

IMS request 582

IMS services available to ESAP 514

IMS Standard User Exit Parameter List 210, 251

IMS system services 567

IMSEXIT.
 See Log Archive Utility exit routine

INIT request
 initializing DRA 577

Initialization exit routine 552

Initialization exit routine (DFSINTX0)
 attributes 290
 binding 290
 description 289
 ETO= keyword setting 289
 IMS callable services 290
 IMS environments 290
 including the routine 290
 naming convention 290
 registers 291
 contents on entry 291
 contents on exit 292
 sample routine location 290
 using callable services 290

input edit/routing sample
 Fast Path 259

Input Message Field edit routine (DFSME000)
 attributes 295
 binding 295
 calling 296
 defining edit routines 296
 description 295
 example 295
 IMS callable services 295
 IMS environments 295
 including the routine 295
 interfaces 297
 link editing 295
 naming convention 295
 parameter list format 297
 performance considerations 297

Input Message Field edit routine (DFSME000)
(continued)
 registers
 contents on entry 297
 contents on exit 298
 sample routine location 295
 using callable services 295

Input Message Segment edit routine (DFSME127)
 attributes 299
 binding 299
 calling 299
 defining edit routines 300
 description 299
 example 303
 IMS callable services 299
 IMS environments 299
 including the routine 299
 interfaces 301
 naming convention 299
 parameter list format 301
 performance considerations 300
 registers
 contents on entry 301
 contents on exit 302
 sample routine location 299
 Segment edit routine 303
 using callable services 299

inquiry flag processing 512
 INSERT function 23
 intermediate/back-end (IBE) links 263
 isolated log sender 187
 ISWITCH macro
 description 6
 exiting cross-memory mode 9

K

key compression 116
 KEYWD macro statement
 modifying command keyword table 161

L

language interface 531
 language interface entry points 531
 language interface module 531

Large System Definition Sort/Split Input exit routine (DFSSS050)
 attributes 165
 binding 165
 description 165
 IMS callable services 165
 IMS environments 165
 including the routine 165
 naming convention 165
 registers
 contents on entry 166
 contents on exit 166
 restrictions 165
 sample routine location 165
 using callable services 165

Large System definition Sort/Split Output exit routine (DFSSS060)
 description 169
 IMS environments 169

Large System Definition Sort/Split Output exit routine (DFSSS060)
 binding 169
 IMS callable services 169
 including the routine 169
 naming convention 169
 registers
 contents on entry 170
 contents on exit 170
 restrictions 169
 sample routine location 169

LOAD module function 17
 loading ESAP 525
 loading external subsystem modules 526
 loading TM exit routines 289
 log (data) recovery 193
 emergency restart (online) 194
 Log Recovery utility 194

Log Archive exit routine (IMSEXIT)
 Binding 173
 description 173
 IMS callable services 173
 IMS environments 173
 including the routine 173
 naming convention 173
 parameters 173
 record types 184
 sample routine 176
 sample routine location 173
 termination 175
 written log 185

Log Filter exit routine (DFSFTFX0) 187
 attributes 187
 binding 188
 communicating with IMS 189
 description 187
 IMS callable services 188
 IMS environments 188
 IMS-supplied Log Filter exit routine 190
 including the routine 188
 initialization and termination calls 190
 naming convention 188
 recovery environment 190
 sample routine location 188

Log Service exit routine 568

Logger exit routine (DFSFLGX0) 193
 attributes 194
 binding 193
 description 193
 IMS callable services 194
 IMS environments 193
 including the routine 193
 initialization call 194
 naming convention 193
 OLDS/SLDS write call 194
 parameter list 196

- Logger exit routine (DFSFLGX0) *(continued)*
 - registers
 - contents on entry 195
 - contents on exit 199
 - sample routine location 194
 - termination call 195, 198
 - using callable services 193
- Logger exit routine (DFSFLGX0))
 - registers 195
- Logoff exit routine (DFSFLGFX0) 305
 - attributes 305
 - binding 305
 - description 305
 - IMS callable services 305
 - IMS environments 305
 - including the routine 305
 - naming convention 305
 - registers 306
 - contents on entry 306
 - contents on exit 307
 - sample routine location 305
 - using callable services 305
 - XRF considerations 305
- Logon exit routine (DFSFLGNX0) 309
 - attributes 309
 - binding 310
 - description 309
 - IMS callable services 310
 - IMS environments 310
 - including the routine 310
 - logon descriptors 310
 - LOGOND= keyword 310
 - naming convention 310
 - registers 311
 - contents on entry 311
 - contents on exit 312
 - sample routine location 310
 - using callable services 309
 - XRF considerations 310
- LOGOND= keyword 310
- LSO= 9
- LTERM creation 353
- LTERM support for APPC 314
- LTERM, remote
 - ETO, and 355
- LU 6.2 Edit exit routine (DFSLEUE0)
 - attributes 313
 - binding 313
 - changing a message 314
 - description 313
 - IMS callable services 313
 - IMS environments 313
 - including the routine 313
 - LTERM support for APPC 314
 - MOD name support for APPC 314
 - naming convention 313
 - parameter list format 316
 - registers 314
 - contents on entry 314
 - contents on exit 315
 - sample routine location 314

- LU 6.2 Edit exit routine (DFSLEUE0) *(continued)*
 - using callable services 313
- LU 6.2 user data area 289

M

- macros
 - DFSCAOI 23
 - DFSCCBLK 19
 - DFSCSTRG 16
- mapping control blocks.
 - See control block mapping
- Message Control/Error exit routine (DFSCMUX0) 319
 - attributes 319
 - binding 320
 - calling the routine 320
 - default actions 328
 - description 319
 - exit flags 328
 - IMS callable services 320
 - IMS environments 319
 - including the routine 320
 - interface block (MSNB) 324
 - contents on entry 324
 - contents on exit 325
 - interface block (MSNB), description 324
 - naming convention 319
 - registers 323
 - contents on entry 323
 - contents on exit 324
 - rerouting messages 321
 - sample routine location 320
 - using callable services 319
 - X'6701' log record 327
- message routing routines
 - non-discardable messages 333
- Message Service exit routine 569
- Message Switching (Input) edit routine (DFSCNTE0)
 - binding 329
 - description 329
 - example 330
 - IMS callable services 329
 - IMS environments 329
 - including the routine 329
 - naming convention 329
 - registers
 - contents on entry 330
 - contents on exit 330
 - sample routine location 329
 - using callable services 329
- Message Switching (Input) edit routine (DFSCNTE0))
 - attributes 329
- MOD name support for APPC 314
- MSC (Multiple Systems Coupling)
 - ETO, and 355
 - LTERM, remote 355
 - Message Control/Error exit routine 319
 - TM and MSC exit routine 406
- MSC message routing control user exit 405
- MSC Routing exit routine 405
 - description 405

MSNB interface block 319
multiple external subsystems 532

N

network-qualified LU name 226, 429
non-discardable messages 333
Non-Discardable Messages exit routine
(DFSNDMX0) 333
 alternate destinations 334
 attributes 333
 binding 333
 description 333
 IMS callable services 333
 IMS environments 333
 including the routine 333
 naming convention 333
 processing options 334
 registers 336
 contents on entry 336
 contents on exit 340
 restrictions 334
 sample routine location 333
 using callable services 333
non-shared queues environment 145
Normal Call exit routine 553
notify message 510
notify Message 529
NULLVAL operand, use 103

O

OASN (origin application sequence number) 532
OLDS (online log data set) 194
OTMA Destination Resolution exit routine
(DFSYDRU0) 341
 attributes 341
 binding 342
 IMS callable services 342
 IMS environments 341
 including the routine 341, 342
 naming convention 341, 342
 registers at entry 342
 registers at exit 343
 sample routine location 342
 using callable services 341
OTMA Input/Output Edit exit routine (DFSYIOE0) 345
 attributes 345
 binding 346
 IMS callable services 346
 IMS environments 346
 including the routine 346
 naming convention 346
 registers at entry 346
 registers at exit 347
 sample routine location 346
 using callable services 345
OTMA Prerouting exit routine (DFSYPHX0)
 attributes 349
 IMS callable services 349
 IMS environments 349

OTMA Prerouting exit routine (DFSYPHX0) (*continued*)
 including the routine 349
 link editing 349
 naming convention 349
 prerouting input messages 349
 registers at entry 350
 registers at exit 351
 sample routine location 349
 using callable services 349
Output Creation exit routine (DFSINSX0)
 attributes 354
 binding 354
 description 353
 IMS callable services 354
 IMS environments 354
 including the routine 354
 naming convention 354
 registers 358
 contents on entry 358
 contents on exit 359
 sample routine location 354
 supplying data 355
 user descriptors 355
 using callable services 354

P

parameter list
 Field edit routine 295, 298
 Segment edit routine 301, 303
parameter list format
 in DFSPRE60 218
 in DFSPRE70 222
parameter lists
 CSCBLK 19
 CSSTRG 16
 DFSCAOI 23
 generating in your exit routine 13
Partner Product exit routine (DFSPPE0)
 attributes 201
 binding 201
 description 201
 IMS callable services 201
 IMS environments 201
 including the routine 201
 naming convention 201
 registers
 content on entry 201
 contents on exit 202
 sample routine location 201
 using callable services 201
password reverification 289
PDS (partition data set) member sections 170
Physical Terminal (Input) edit routine (DFSPIXT0)
 binding 361
 description 361
 example 364
 IMS callable services 362
 IMS environments 361
 including the routine 361
 interface 362

Physical Terminal (Input) edit routine (DFSPIXT0) *(continued)*
 naming convention 361
 operation 361
 registers
 contents on entry 363
 contents on exit 363
 sample routine location 362

Physical Terminal (Output) edit routine (DFSCCTO0)
 binding 366
 description 365
 example 368
 IMS callable services 366
 IMS environments 365
 including the routine 366
 naming convention 365
 registers
 contents on entry 366
 contents on exit (if cancel request) 368
 contents on exit (if no cancel request) 367
 sample routine location 366

prechained save area 8

PREP request 583

Propagating captured data asynchronously
 IMS support for 479

propagating data 46

Q

Queue Space Notification exit routine (DFSQSPC0/DFSQSSP0) 369
 attributes 370
 binding 371
 call types 372
 description 369
 IMS callable services 371
 IMS environments 370
 including the routine 371
 naming convention 371
 parameters 374
 registers
 contents on entry 373
 contents on exit 374
 sample routine location 371
 special considerations 371
 threshold values 374
 using callable services 370

R

randomizing modules 75

RCMD call 468

reason codes
 callable service 25

RECON I/O exit routine (DSPCEXT0) 203, 204, 205
 attributes 203
 description 203
 IMS callable services 203
 IMS environments 203
 including the routine 203
 link-editing 203

RECON I/O exit routine (DSPCEXT0) *(continued)*
 naming convention 203
 parameters 205
 performance considerations 205
 registers
 contents on entry 205
 contents on exit 208
 sample routine location 203
 using callable services 203

recovery
 messages for AO application 475

recovery coordinator 507

recovery token 513, 532

registers
 prechained save area 8
 saving 8
 single save area 9

Remote Site Recovery 187

rerouting messages 319

resetting significant status 306, 390

Resolve In-Doubt exit routine 555

Resource Access Security exit routine (DFSRAS00)
 attributes 209
 binding 209
 Callable Services, with 209
 description 209
 environments supported 209
 IMS callable services 209
 IMS environments 209
 including the routine 209
 link editing 209
 naming convention 209
 registers 209
 contents on entry 209
 sample routine location 209

resource coordination 513

resource translation table
 See external subsystem attach facility

responses to commands 460, 470

restart
 AO application 475

RESYNC request 579

return codes
 callable service 25

REXX, IMS adapter
 entry parameters 286
 environment 286
 exec name, choosing 285
 installation 285
 user exit routine (DFSREXXU) 285

routing messages
 when applications abend 333

RTT (resource translation table) 508

S

sample AO application
 DFSAOPGM 475
 UETRANS 466

sample AO exit 426

- sample, location of
 - routines, location of 37
- save area
 - for registers 8
 - prechained 8
 - single, registers 9
- SCAN control block function 21
- SCHED request 580
- SCI Registration exit routine (DSPSCIX0)
 - binding 213
 - IMS callable services 213
 - IMS environments 213
 - including the routine 213
 - naming convention 213
 - sample routine location 213
- Secondary Index Database Maintenance exit routine 103
 - attributes 103
 - binding 104
 - Calling 104
 - CSECTs 105
 - description 103
 - IMS callable services 104
 - IMS environments 103
 - including the routine 104
 - indexing, suppression 103
 - loading 104
 - naming convention 104
 - parameters 106
 - registers
 - contents on entry 105
 - contents on exit 106
 - residing 103
 - sample routine 106
 - sample routine location 104
 - use 103
 - using callable services 103
- security
 - AO applications 459, 469
- security exit routines
 - resource access 137
- Security Reverification exit routine (DFSCCTSE0) 375
 - attributes 375
 - binding 375
 - description 375
 - IMS callable services 375
 - IMS environments 375
 - including the routine 375
 - naming convention 375
 - registers
 - contents on entry 376
 - contents on exit 377
 - sample routine location 376
 - using callable services 375
- Segment edit routine 303
 - interface 301
 - use 297, 299
- Segment Edit/Compression exit routine (DFSCMPX0) 109
 - activating 112
 - attributes 110
- Segment Edit/Compression exit routine (DFSCMPX0)
 - (continued)
 - DEDB 111
 - full-function database 111
 - binding 110
 - compression routine 112
 - description 109
 - entry codes 116
 - entry parameters, DL/I 115
 - how it works 111
 - IMS callable services 110
 - IMS environments 110
 - including the routine 110
 - initialization routine 120
 - loading 111
 - messages and codes 120
 - naming convention 110
 - parameters 117
 - CSECTs used for parameter passing 117
 - registers 115
 - contents on entry 115
 - contents on exit 116
 - sample routine 118
 - DFSCMPX0 118
 - DFSKMPX0 121
 - sample routine location 110
 - segment types, applicable 111
 - tabled data information 114
- Sequential Buffering Initialization exit routine (DFSSBUX0) 132
 - attributes 129
 - binding 129
 - calling 130
 - description 129
 - IMS callable services 129
 - IMS environment 129
 - including the routine 129
 - loading 130
 - naming convention 129
 - parameters 130
 - performance considerations 130
 - registers
 - contents on entry 130
 - contents on exit 132
 - sample routine location 129
 - sample routines
 - DFSSBU1 132
 - DFSSBU2 132
 - DFSSBU3 132
 - DFSSBU4 132
 - DFSSBU9 132
 - using callable services 129
- services available to ESAP 514
- SETS and ROLS Call log record 482
- setting inquiry parameters 512
- Shared Printer exit routine (DFSSIML0)
 - attributes 379
 - binding 379
 - description 379
 - example 379
 - IMS callable services 379

Shared Printer exit routine (DFSSIML0) *(continued)*
 IMS environments 379
 including the routine 379
 naming convention 379
 registers
 contents on entry 380
 contents on exit 380
 sample routine location 379
 using callable services 379
 shared queues environment 145
 SHUTDOWN parameter
 MSGQUEUE macro 369
 Sign On/Off Security exit routine (DFSCSGN0) 393, 394
 attributes 393
 binding 394
 description 393
 IMS callable services 394
 IMS environments 394
 including the routine 394
 naming convention 394
 registers
 contents on entry 394
 contents on exit 394
 sample routine location 394
 using callable services 393
 Sign-On exit routine (DFSSGNX0)
 associated printing 382, 384
 binding 382
 description 381
 IMS callable services 382
 IMS environments 382
 including the routine 382
 loading 382
 naming 382
 naming convention 382
 registers 387
 contents on entry 387
 contents on exit 388
 restrictions 354
 sample routine location 382
 supplying data 385
 user descriptors 384
 USERD= keyword 384
 XRF considerations 354, 383
 Signoff exit routine 557
 Signoff exit routine (DFSSGFX0) 389
 attributes 389
 binding 389
 description 389
 IMS callable services 389
 IMS environments 389
 including the routine 389
 naming convention 389
 registers 390
 contents on entry 390
 contents on exit 391
 restrictions 389
 sample routine location 389
 using callable services 389
 with generic resources 390
 Signoff exit routine (DFSSGFX0) *(continued)*
 XRF considerations 389
 Signon exit routine 558
 signon process for external subsystem
 connections 511
 single save area, registers 9
 SLDS (system log data set) 194
 sparse index, building 103
 specifying external subsystems to IMS 509
 SPQBPARAM parameter list 384
 standard user exit interface
 parameter lists
 description 4
 version 1 4
 version 3 6, 9
 user data areas 289
 Startup Service exit routine 571
 status codes
 TCO exit routine 399
 stopped status 534
 storage services 16
 subsystem connections 510
 Subsystem Not Operational exit routine 560
 subsystem termination 533
 Subsystem Termination exit routine 562
 suppress indexing 103
 SYN macro statement
 modifying command keyword table 163
 synchronous data capture
 IMS DataPropagator 46
 SYNTERM request 583
 System Definition Preprocessor exit routine (Input Phase) (DFSPRE60)
 attributes 217
 binding 217
 description 217
 IMS callable services 218
 IMS environments 217
 including the routine 217
 naming convention 217
 parameters 218
 registers
 contents on entry 218
 contents on exit 218
 sample routine 219
 sample routine location 218
 using callable services 217
 System Definition Preprocessor exit routine (Name Check Complete) (DFSPRE70)
 binding 221
 IMS callable services 221
 IMS environments 221
 including the routine 221
 naming convention 221
 sample routine location 221
 System Definition Preprocessor exit routine (termination) (DFSPRE70)
 attributes 221
 description 221
 IMS environments 221
 including the routine 221

- System Definition Preprocessor exit routine (termination) (DFSPRE70) *(continued)*
 - link editing 221
 - naming convention 221
 - parameters 222
 - registers
 - contents on entry 222
 - contents on exit 222
 - sample routine location 221
 - using callable services 221
- system services 567

T

- TCO exit routine (DFSTXIT0)
 - attributes 397
 - description 397
 - DL/I calls 399
 - IMS environments 397
 - including the routine 397
 - link editing 397
 - loading 397
 - message formats 400
 - naming convention 397
 - PCB (program communication block) 399
 - registers, contents on entry 398
 - sample routine location 397
 - status codes 399
 - using callable services 397
- TERM request 580
- Terminal Routing exit routine (DFSCMTR0)
 - binding 159
 - IMS callable services 159
 - IMS environments 159
 - including the routine 159
 - naming convention 159
 - sample routine location 159
- Terminate Identify exit routine 563
- Terminate Thread exit routine 565
- terminating connections with external subsystems 511
- termination ECB 511, 533
- termination requested by external subsystem 533
- Termination Service exit routine 572
- TERMTHRD request 585
- thread function requests 580
 - ABTTERM 584
 - COMTERM 584
 - IMS 582
 - PREP 583
 - SCHED 580
 - SYNTERM 583
 - TERMTHRD 585
- thread, external subsystem 510
- Time-Controlled Operations (TCO) Communication Name Table (CNT) exit routine (DFSTCNT0)
 - binding 402
 - description 401
 - IMS callable services 402
 - IMS environments 401
 - naming convention 401

- Time-Controlled Operations (TCO) Communication Name Table (CNT) exit routine (DFSTCNT0) *(continued)*
 - registers
 - contents on entry 402
 - contents on exit 403
 - sample routine location 402
- Time-Controlled Operations (TCO) exit routine
 - See TCO exit routine
- Time-Controlled Operations (TCO) exit routine (DFSTXIT0)
 - binding 398
 - IMS callable services 398
 - IMS environments 397
 - including the routine 398
 - naming convention 397
 - sample routine location 398
- TM and MSC Message Routing and Control User exit routine (DFSMSCE0)
 - binding 409
 - IMS callable services 409
 - IMS environments 409
 - including the routine 409
 - naming convention 409
 - sample routine location 409
- TM message routing control user exit 405
- TRANSACT macros (DFSPRE60) 219
- Transaction Authorization exit routine (DFSCTRN0) 417
 - attributes 417
 - binding 417
 - description 417
 - IMS callable services 418
 - IMS environments 417
 - including the routine 417
 - link editing 417
 - naming convention 417
 - registers
 - contents on entry 418
 - contents on exit 420
 - sample routine location 417, 418
 - using callable services 417
- Transaction Code (Input) edit routine (DFSCSMB0)
 - attributes 421
 - binding 421
 - description 421
 - example 423
 - IMS callable services 422
 - IMS environments 421
 - including the routine 421
 - naming convention 421
 - registers
 - contents on entry 422
 - contents on exit 422
 - sample routine location 422
 - using callable services 421
- Transaction Code Input edit routine (DFSCSMB0)
 - interfaces 422
- two phase commit process 513
- type 1 (DFSAOUE0)
 - See AO exit routine or AO application 425

- Type 1 Automated Operator exit routine (DFSAOUE0)
 - binding 426
 - IMS callable services 426
 - IMS environments 426
 - including the routine 426
 - naming convention 426
 - sample routine location 426
- Type 2 Automated Operator exit routine (DFSAOE00)
 - binding 224
 - IMS callable services 224
 - IMS environments 224
 - including the routine 224
 - naming convention 224
 - sample routine location 224

U

- UEHB (User Exit Header Block)
 - contents 445
 - description 445
 - flags 445
- updating DB2 data 59
- user authorization processing 511
- user data area
 - creating 289
 - uses for 290
- user exit header block
 - See UEHB
- user exit routine 37
- user message table (DFSCMTU0)
 - example
 - routine 237
- User Message Table (DFSCMTU0)
 - coding 236
 - description 235
 - example
 - table 236
 - formatting 236
 - IMS callable services 235
 - naming 235
 - naming convention 235
 - purpose and use 235
 - rules for defining 236
- USERD= keyword 384
- USRHASH=, with DEDB Resource Name Hash
 - routine 81

V

- vector table format
 - DFSPRE60 218
 - DFSPRE70 222

W

- WADS (write ahead data set) 194
- work areas, creating for ESAP 527
- writing exit routines 7

X

- XCI option 78
- XPCB (Extended Program Communication Block) 50
 - assembler example 55
 - COBOL example 56
 - PL/I example 57
- XSDB (Extended Program Communication Block)
 - assembler example 58
 - COBOL example 58
 - PL/I example 59
- XSDB (Extended Segment Data Block) 52



Program Number: 5655-J38

Printed in USA

SC18-7817-00



Spine information:



IMS

Customization Guide

Version 9