



**E50**

# IMS V8 Overview

**Tom Ramey**

**Manager, IMS Development,  
Test and Service**

**IBM Silicon Valley Laboratory  
ramey@us.ibm.com**



**IMS Technical Conference**

**St. Louis, MO**

**Sept. 30 - Oct. 3, 2002**



IBM

## Agenda

IMS V7 Recap

IMS V8 Overview

IMS Strategic Architecture





# IMS Version 8

## Providing Integrated e-business Solutions

### *Ideal for e-business*

- ✓ Continuous Availability
- ✓ Systems Management
- ✓ Performance/Capacity
- ✓ Connectivity
- ✓ Application Development

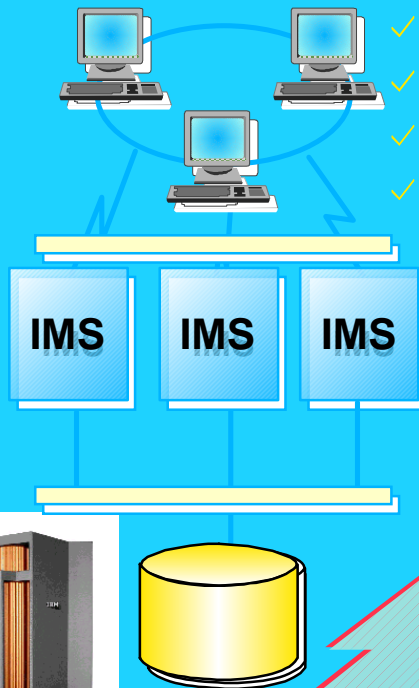

### **Enhancements**

- Sysplex Terminal Management
- Sysplex-wide Resource Mgmt
- Sysplex-wide Operations with Single Point of Control
- Enhanced DB Recovery Ctrl
- Simplified Installation Process
- Enhanced Systems/Data Mgmt Tools
- Enhanced Java and XML

### **Benefits**

- ✓ Enable Customer Growth
- ✓ Enhance Workload Balancing
- ✓ Increase Availability; Ease of Use
- ✓ Preserve Current Application Investment
- ✓ Enable New Applications

**Strategic Open Access  
for S/390 and zSeries  
Enterprise Servers**





## *IMS Runs the World...*

### Most Corporate Data is Managed by IMS

- Over 95% of Fortune 1000 Companies use IMS
- IMS Manages over 15 Billion GBs of Production Data
- \$2.5 Trillion/day transferred through IMS by one customer

### Over 50 Billion Transactions a Day run through IMS

- IMS Serves Close to 200 Million Users a Day
- Over 79 Million IMS Trans/Day Handled by One Customer on Single Production Sysplex, 30M Trans/Day on single CEC
- 120M IMS Trans/day, 7M per hour handled by one customer
- 6000 Trans/sec across TCP/IP to single IMS
- 11,400 Trans/sec (**1 Billion/day**) with IMS Data/Queued sharing on a 2-CEC Sysplex

Gartner Group: "A large and loyal IMS installed base. Rock-solid reputation of a transactional workhorse for very large workloads. Successfully proven in large, Web-based applications. IMS is still a viable, even unmatched, platform to implement very large OLTP systems, and, in combination with Web Application Server technology, it can be a foundation for a new generation of Web-based, high-workload applications."



## IMS V8 Status

- General Availability planned for 10/02
- Release quality looks good
  - Tracking better than V7 in internal test stages
- IMS Quality Partnership Program
  - 14 Customers
  - Running since March



# IMS V7 - V8 Test Comparison

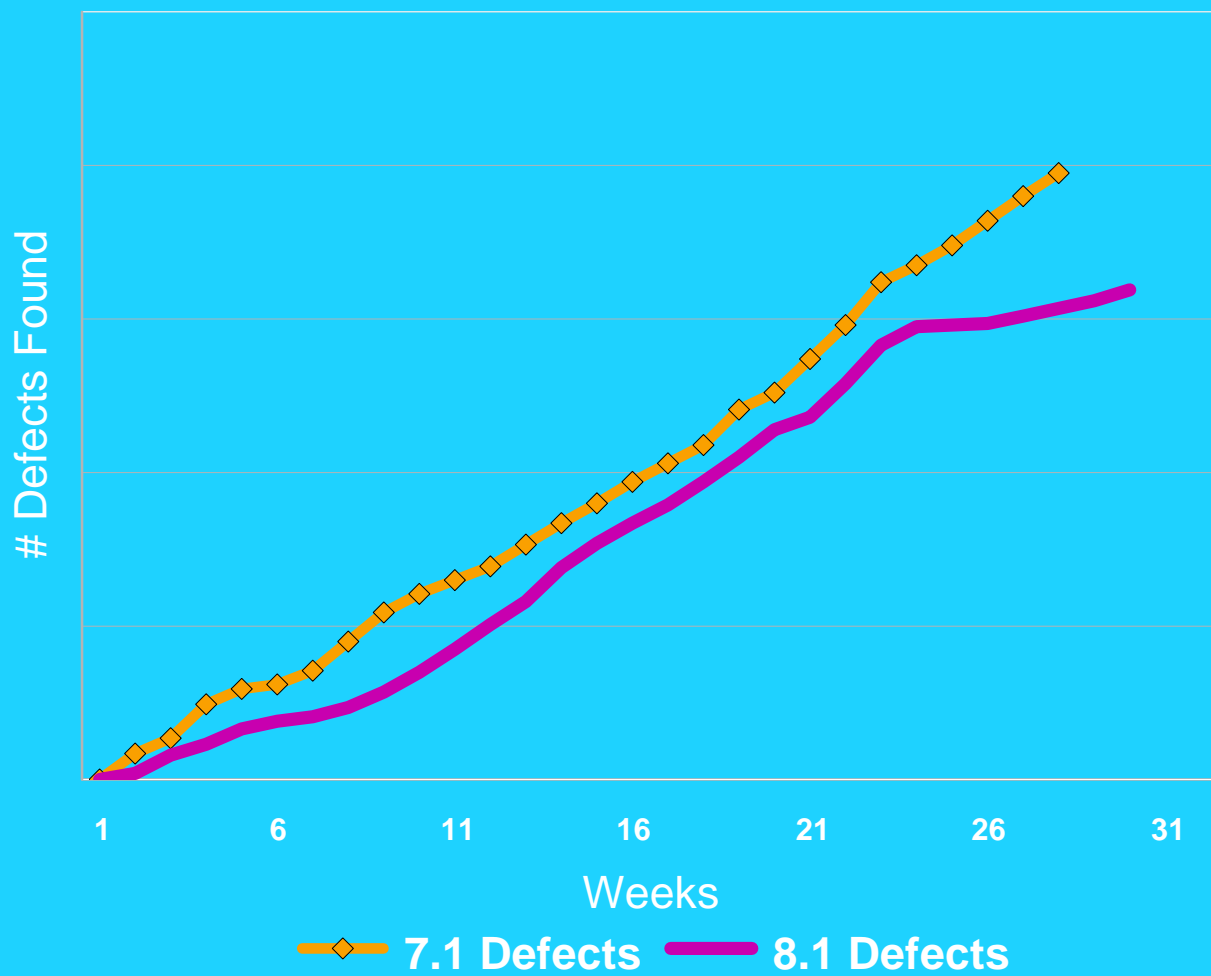

# New and Improved IMS Architecture

- New function supported in IMSplex
  - Single Point of Control (SPOC)
  - Global Online Change
  - Sysplex Terminal Management (STM)
  
- New address spaces
  - Structured Call Interface (SCI)
    - IMSplex member registration
    - Communications between IMSplex members
  - Operations Manager (OM)
    - IMSplex-wide command entry
  - Resource Manager (RM)
    - Global resource management

# IMS in a Parallel Sysplex Today

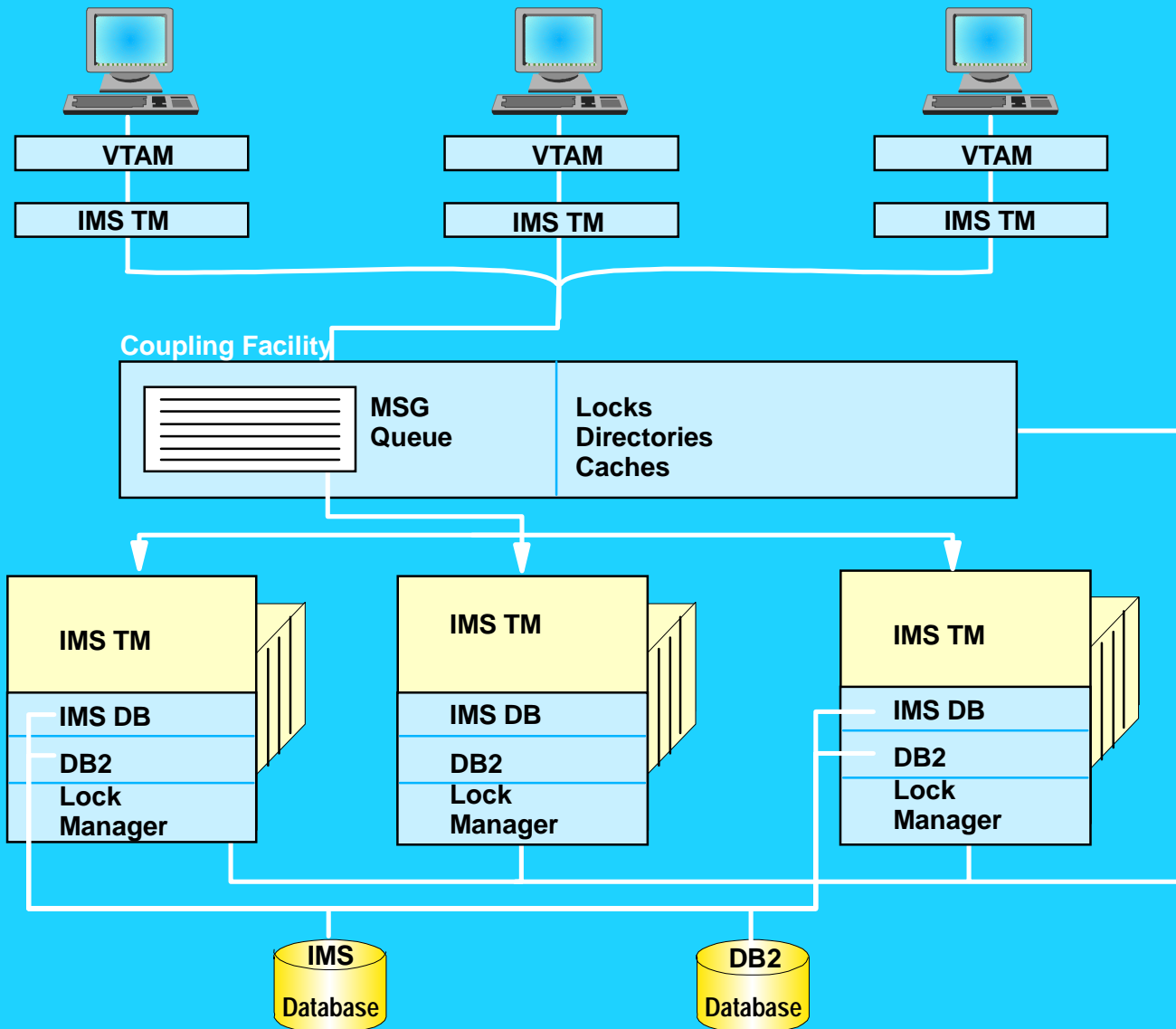

Allocation  
of  
workstations

Dynamic  
Workload  
Balancing

Data  
Sharing  
▸ IMS DB  
▸ DB2



# IMS V8 IMSplex

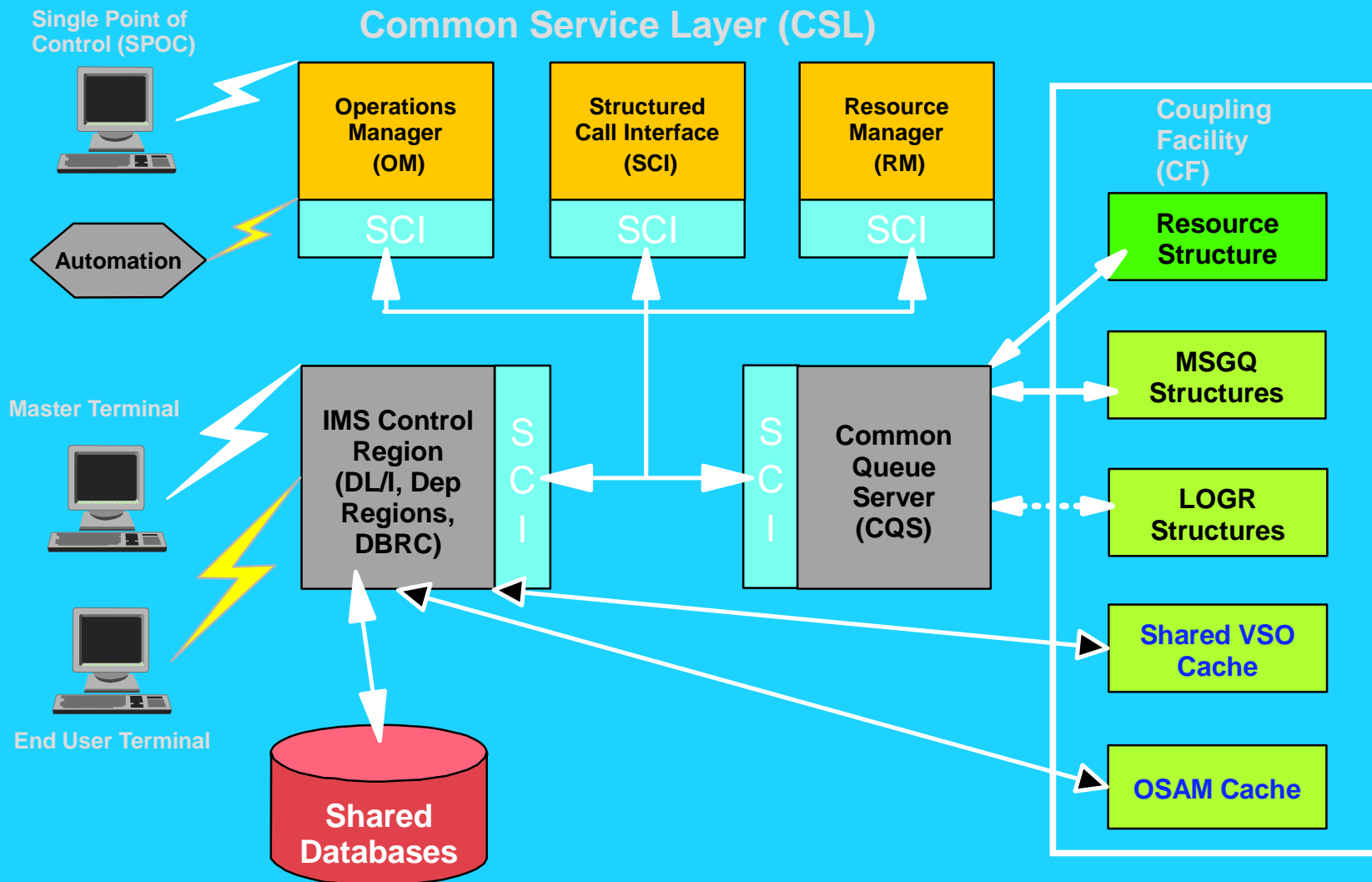

# IMS V8 Sysplex Operations Manager

## A New Address Space

- Automation and user entered commands may be routed through the Operations Manager to any or all IMSs in the Parallel Sysplex
- Responses to these commands from different IMSs are consolidated as a single response
- Does not require use of same MVS Command Recognition Character (CRC) by each IMS

- Provides an API
- A SPOC and supporting TSO/ISPF Application for entering commands is also provided

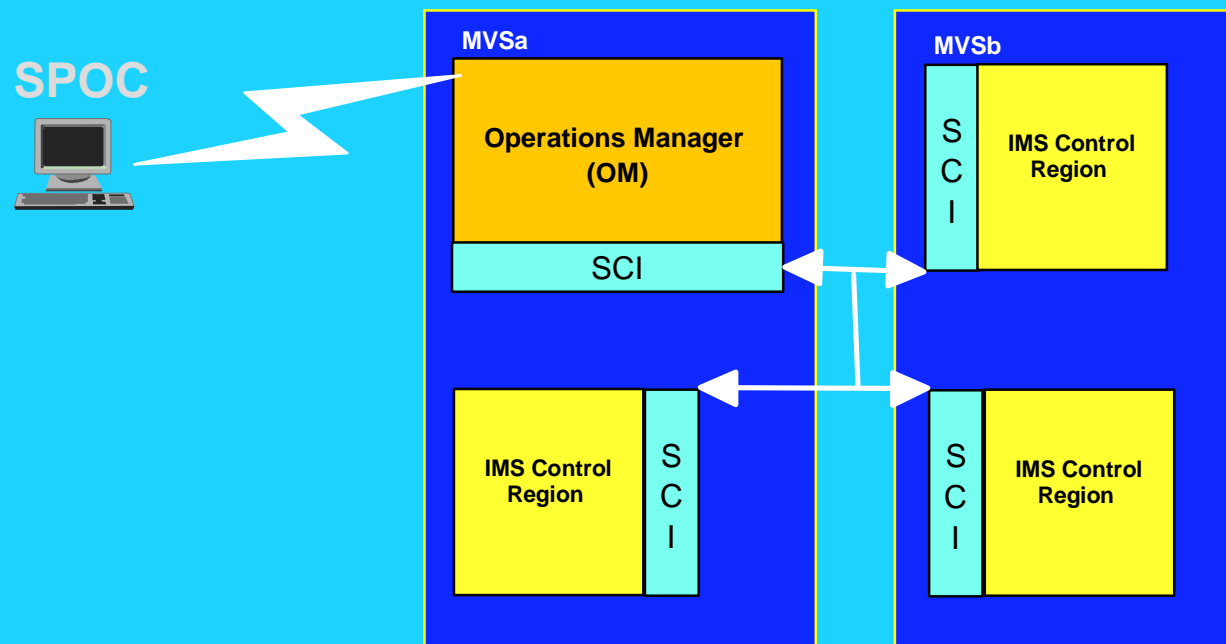

## SPOC features

### The SPOC application will:

- Support traditional (/START, etc.) and new commands (INIT, QUERY, etc.)
- Consolidate command responses into a single response
- Allow the user to sort IMSplex command response by column
- Allow the user to set default command parameters
- Keep a history of commands
- Allow the user to enter long commands
- Allow user specified grouping of IMSplex members

## SPOC - IMSplex Command response

File Display View Options Help

-----  
IMS Single Point of Control

Command ==> \_\_\_\_\_

----- Plex . \_\_\_\_\_ Route . \_\_\_\_\_ Wait . \_\_\_\_\_  
Response for: QRY IMSPLEX SHOW(TYPE,STATUS)

IMSplex	MbrName	CC	Member	Type	Status
IMSPLEXA	OM1	0	IMS2	DBDC	ACTIVE
IMSPLEXA	OM1	0	IMS3	DBDC	ACTIVE

F13=Help F15=Exit F16=Showlog F18=Expand F21=Retrieve F24=Cancel



# SPOC - IMSplex Command response

File Display View Options Help

-----  
IMS Single Point of Control

Command ==> \_\_\_\_\_

----- Plex . \_\_\_\_\_ Route . \_\_\_\_\_ Wait . \_\_\_\_\_

Response for: QRY TRAN NAME(SKS\*) SHOW(ALL)

More: >

Trancode	MbrName	CC	PSBname	QCnt	LCls	LQCnt	LLCT	LPLCT	LCPRI	LNPRI
SKS1	IMS2	0		5						
SKS1	IMS2	0	STLDDLT1		1	0	65535	65535	8	8
SKS1	SYS3	0	STLDDLT1		1	0	65535	65535	8	8
SKS2	IMS2	0		0						
SKS2	IMS2	0	STLDDLT2		2	0	65535	65535	8	8
SKS2	SYS3	0	STLDDLT2		2	0	65535	65535	8	8
SKS3	IMS2	0		0						
SKS3	IMS2	0	STLDDLT3		3	0	65535	65535	8	8
SKS3	SYS3	0	STLDDLT3		3	0	65535	65535	8	8
SKS4	IMS2	0		0						

F13=Help F15=Exit F16=Showlog F18=Expand F21=Retrieve F24=Cancel





# SPOC - Classic IMS /DBR DB Command

File Display View Options Help

-----  
IMS Single Point of Control

Command ==> \_\_\_\_\_

----- Plex . \_\_\_\_\_ Route . \_\_\_\_\_ Wait . \_\_\_\_\_

Log for . . : DBR DB BANKATMS BANKTERM BANKLDGR BE3ORDER

IMSpIex . . . . . : PLEX1

Routing . . . . . :

Start time . . . . : 2002.023 12:15:14.13

Stop time . . . . . : 2002.023 12:15:14.62

Return code . . . . : 00000000

Reason code . . . . : 00000000

Command master. . : IMS2

MbrName Messages

-----  
IMS2 DFS0488I DBR COMMAND COMPLETED. DBN= BANKATMS RC=04  
IMS2 DFS0488I DBR COMMAND COMPLETED. DBN= BANKTERM RC=04  
IMS2 DFS0488I DBR COMMAND COMPLETED. DBN= BANKLDGR RC=04  
IMS2 DFS0488I DBR COMMAND COMPLETED. DBN= BE3ORDER RC= 0  
SYS3 DFS0488I DBR COMMAND COMPLETED. DBN= BANKATMS RC=04  
SYS3 DFS0488I DBR COMMAND COMPLETED. DBN= BANKTERM RC=04  
SYS3 DFS0488I DBR COMMAND COMPLETED. DBN= BANKLDGR RC=04  
SYS3 DFS0488I DBR COMMAND COMPLETED. DBN= BE3ORDER RC= 0  
IMS3 DFS3466I DDIR FOR DATABASE BANKATMS NOT FOUND  
IMS3 DFS3466I DDIR FOR DATABASE BANKTERM NOT FOUND  
IMS3 DFS3466I DDIR FOR DATABASE BANKLDGR NOT FOUND  
IMS3 DFS0488I DBR COMMAND COMPLETED. DBN= BE3ORDER RC= 0



# SPOC - Command Status

File Display View Options Help

-----  
 IMS Single Point of Control

COMMAND ===> \_\_\_\_\_

----- Plex . \_\_\_\_\_ Route . \_\_\_\_\_ Wait . \_\_\_\_\_

Enter '/' to view command response, 'I' to reissue a command, or 'd' to delete a command.

Act	Status	Command
_____	Executing	QRY IMSPLEX NAME (PLEX1, PLEXB)
_____	Complete	UPDATE TRAN NAME (ABC007) SET (CLS (4))
_____		QRY TRAN NAME (*) CLS (4) SHOW (CLS)

\*\*\*\*\* Bottom of data \*\*\*\*\*

# SPOC - Command Shortcuts

File Display View Options Help

-----  
**SPOC Command Shortcuts**

Command ==> \_\_\_\_\_

----- Plex . \_\_\_\_\_ Route . \_\_\_\_\_ Wait . \_\_\_\_\_

Act	Command	Additional Parameters
_____	_____	_____
_____	&QRYPLX _____	QRY_ IMSPLEX SHOW (STATUS) _____
_____	QRY_ USER _____	SHOW (ALL) _____
_____	QRY_ TRAN _____	SHOW (CLS PSB QCNT STATUS) _____
_____	MON_ LINE_ ABC07	PTERM_ ALL _____

\*\*\*\*\* Bottom of data \*\*\*\*\*





IBM

## IMS V8 Global Online Change

Eases, manages, and automates change across the IMS Sysplex

- Online Change Commands can be entered on one IMS
  - INIT OLC ... commands
- Uses one set of libraries for all IMSs in the IMSplex
- Online Change phases are managed by the Resource Manager
- Resource Structure is optional
  - used to ensure that all IMSs are using the same datasets

# Global Online Change Example

File Display View Options Help

-----  
 IMS Single Point of Control

Command ==> \_\_\_\_\_

----- Plex . \_\_\_\_\_ Route . \_\_\_\_\_ Wait . \_\_\_\_\_

Response for: INIT OLC PHASE(PREPARE) TYPE(ALL)

Member	CC	ACBLIB	FMTLIB	MODBLKS	ModId
IMS2	0	A	A	A	1
IMS2	0				
IMS2	0				

F13=Help F15=Exit F16=Showlog F18=Expand F21=Retrieve F24=Cancel

# INIT OLC PHASE(PREPARE) API Example

## OM API Input:

```
CMD(INITIATE OLC PHASE(PREPARE) TYPE(ALL))
```

## OM API Output:

```
<imsout>
```

```
.
```

```
.
```

```
OM command and control information
```

```
.
```

```
.
```

```
<cmdrspdata>
```

```
<rsp>MBR(IMSB) IMSMBR(IMSA) CC(0)
```

```
</rsp>
```

```
<rsp>MBR(IMSB) IMSMBR(IMSB) CC(0) ACBL(A) FMTL(A) MODB(A) MODI(1)
```

```
</rsp>
```

```
<rsp>MBR(IMSB) IMSMBR(IMSC) CC(0)
```

```
</rsp>
```

```
</cmdrspdata>
```

```
</imsout>
```

# Resource Manager

## Provides a new IMS address space for

- Coordination of Global Online Change across the IMSplex
- Sysplex Management of IMS VTAM Terminal resources
  - Enables a user to resume work on another IMS after a failure
  - Optionally enforces single user signon in IMS Sysplex
  - Enables name uniqueness enforcement for message destinations
  - Uses a Resource Structure in the Coupling Facility

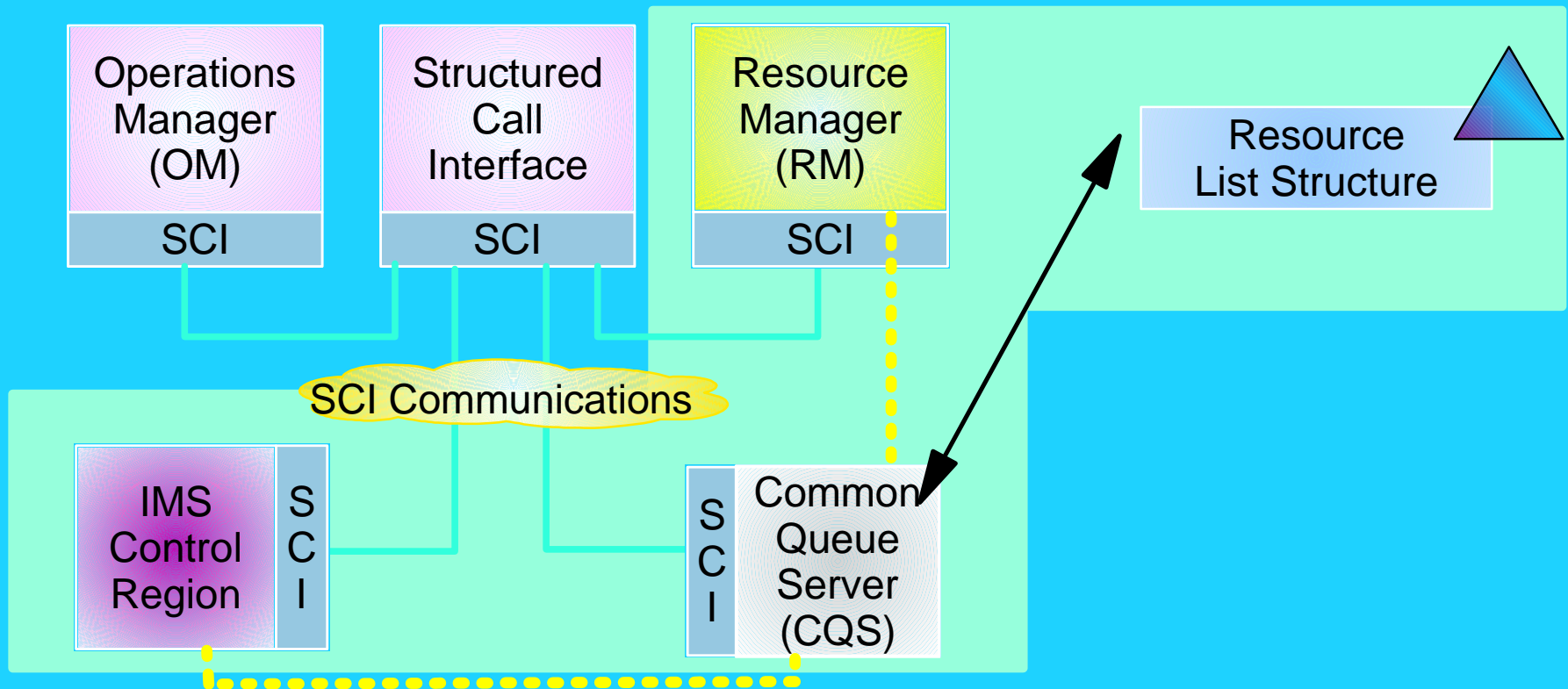

# Resource Structure

**Resource structure contains global resource information for uniquely named resources**

- Transactions
- Nodes, lterms, msnames, APPC descriptors, users, userids
- Global processes
- IMSplex local and global information

## **Resource structure is optional**

- If no resource structure defined
  - Terminal/user resource status saved locally; cannot be shared
  - Sysplex terminal management disabled
- Resource structure not required for global online change
  - Therefore, not required for DBCTL
  - Structure will be used if available to check dataset consistency

## **One resource structure may be defined per IMSplex**

- The same resource structure must be defined across the IMSplex

# Sysplex Terminal Management Highlights

**Single System Image for end-Users - Allows the terminal user to log back onto any other IMS in the plex after a failure**

**The Resource Structure is used to track Terminal/USER status**

- For example,
  - conversation status
  - STSN sequence numbers
  - command status (STOPped, etc.)
- Allows VTAM to manage Generic Resource affinity while IMS manages Terminal and USER state data
- Control of what is tracked for which Terminal/USER is possible
  - system defaults
  - overrides by LOGON or SIGNON Exits

**IMS enforces resource type consistency for message destinations**

**IMS enforces resource name uniqueness**

**IMS supports global callable services for terminals/users**

- User exits can now obtain node and user information IMSplex-wide

# IMSplex Configuration

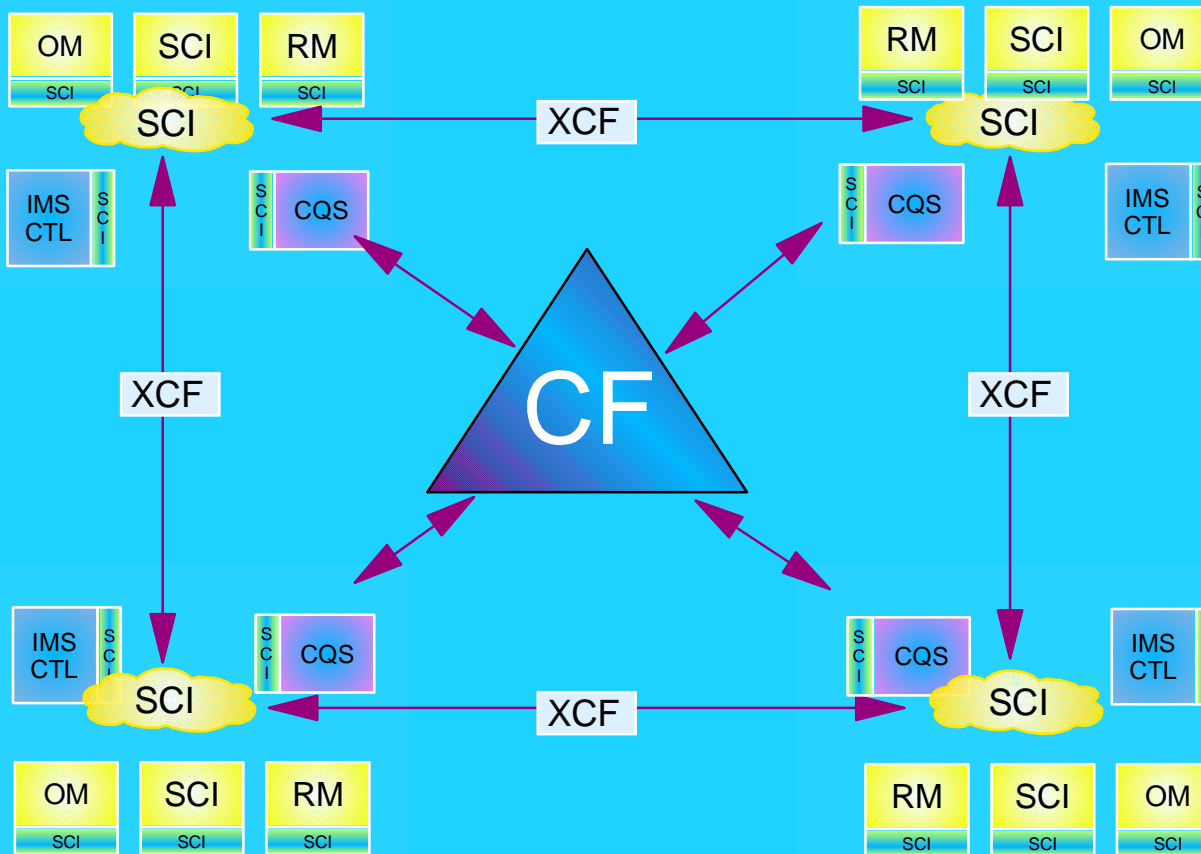

Resource List Structure
LOGR
List Structures
SMQ
List Structures
OSAM
Cache Structure
VSAM
Cache Structure
Shared VSO
Cache Structures
IRLM
Lock Structure
VGR
List Structure

- ★ An SCI Address Space is required on every OS image
- ★ At least one OM and one RM is required
- ★ With no Resource Structure, only one RM is allowed
- ★ CQS/SQ is required on every image (if SQ is being used)

## Other Parallel Sysplex Enhancements

- Synchronous APPC and OTMA shared queue support
- Coupling facility structure management
  - System managed duplexing
  - System managed rebuild
  - Automatic alter of structure size and entry-to-element ratio
- Transaction Trace





# Synchronous Shared Queues Support

Provides for Sharing OTMA and APPC Messages between Sysplex Systems

- MVS APPC synchronous transactions
- OTMA Clients (MQ, IMS Connect, ... ) - Send\_then\_commit (CM1)

- ▶ Synchronous transactions can run on any back-end system
- ▶ Front-end system sends message back to client
- ▶ Uses MVS RRS Multi-System-Cascaded-Transaction
  - If RRS is not active function will be deactivated
- ▶ Program to Program switch
  - Not supported for distributed syncpoint
  - Transaction will be forced to same system

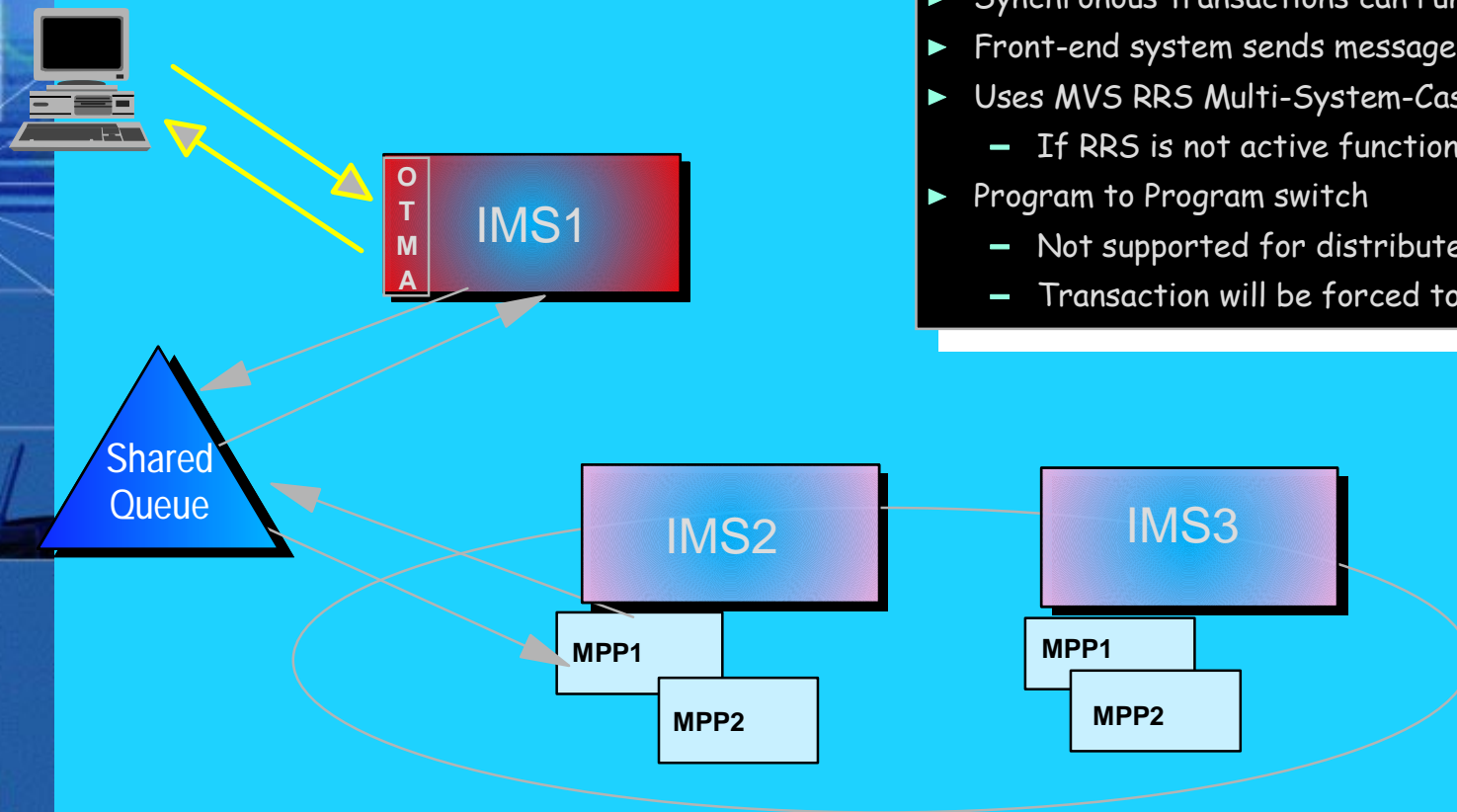

## Why Duplex?

- Near-continuous availability for CF structure data
- Moving structures during planned reconfiguration for exploiters that don't support rebuild
- Enable use of an all-ICF configuration

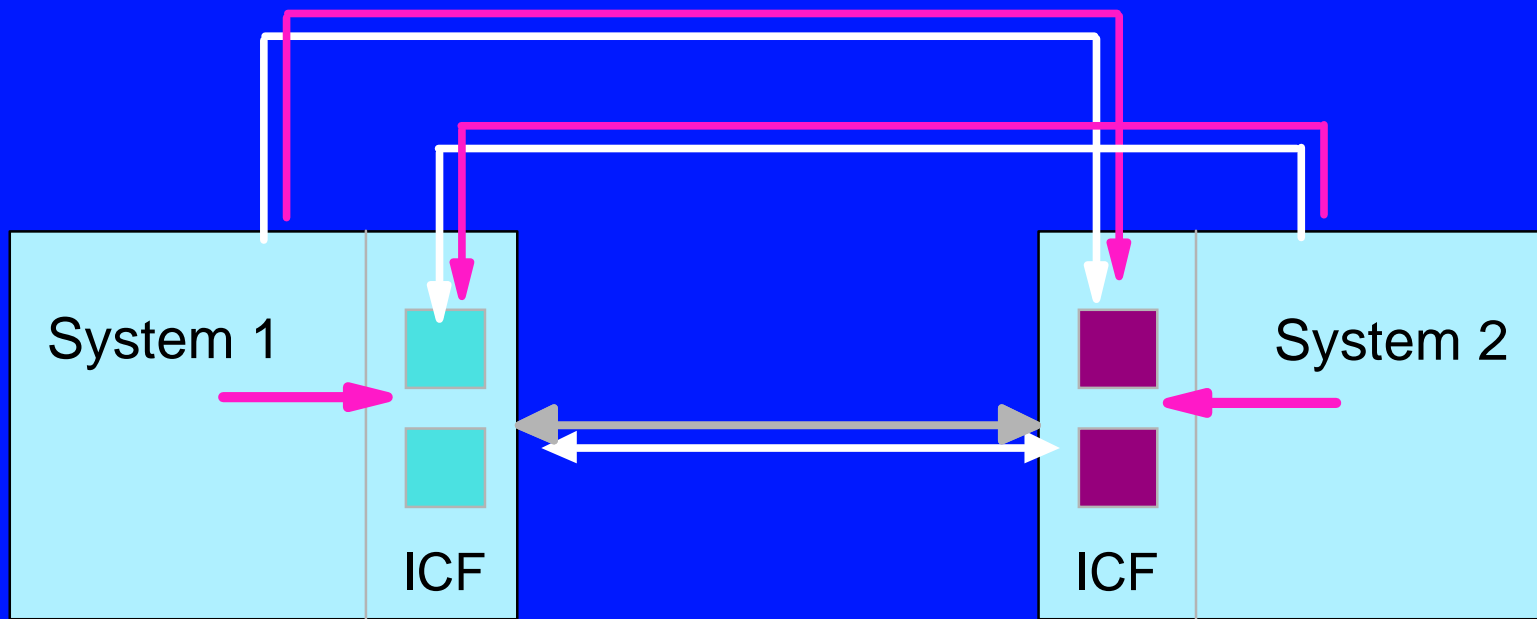

# Sysplex Enhancements - Duplexing

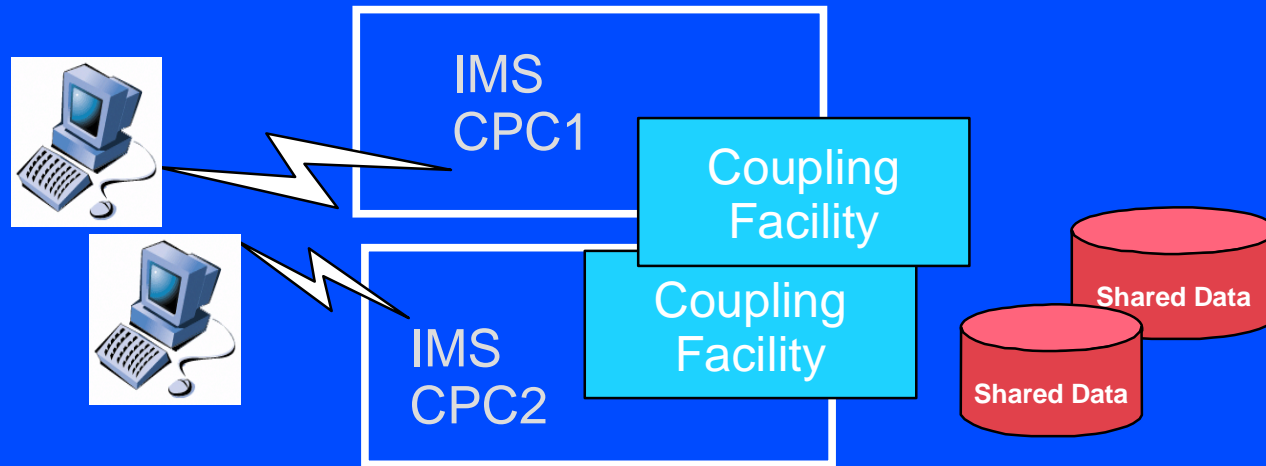

## IMS V8 Provides Support for

- AutoAlter
  - system changes size of structure based on specified threshold and maximum
  - applies to SVSO, SQ, IRLM and OSAM/VSAM
- System Managed Rebuild
  - allows structure to be moved by operator command
  - applies to SVSO, SQ, and IRLM
- System Managed Duplexing
  - applies to SVSO, SQ and IRLM

# Transaction Trace

## IMS Serviceability Enhancement

Utilizes OS/390 and z/OS Transaction Trace facility for

- **Tracing a unit of work** through subsystems
- **Enabling show of flow** through components
- **Providing a consolidated place** to store tracking information
- **IMS Trace points** provided for
  - IMS Entry
  - IMS Exit
  - DL/I Entry
  - DL/I Exit

# Performance and Capacity Enhancements

- Parallel database open processing
- Fast path DEDB enhancements
  - Support for 2048 areas
  - Support for Non-recoverable DEDBs
- VSCR for private and common areas
- MSC FICON support

# Parallel Database Open Processing

Reduces recovery time for IMS after a restart -  
increasing end user availability

- Objective is to get full function DBs authorized and OPEN as soon as possible
  - At /NRE or /ERE
- Applies to all DBs that were allocated at previous IMS closedown
  - It is NOT an option
- During IMS restart
  - 10 parallel TCBs are used for database ALLOCATION and OPEN processing
    - Each database is assigned to a TCB
  - For DBRC authorization
    - Each TCB issues one DBRC AUTH call to authorize all its assigned databases
      - only 10 authorization calls to DB

# DEDB Enhancements

- DEDBs with greater than 240 Areas
  - ▶ Increases capacity of DEDBs
  - ▶ Greater design flexibility
  - ▶ Max is now 2048 areas
- Non-recoverable DEDBs
  - ▶ For use as work databases where recovery not required
  - ▶ Reduces log record/checkpoint info, thus improving IMS performance

## CSA/VSCR

Relieves storage constraints with IMS using less local and common storage below 16M

- Addresses two dynamic storage areas in CSA that can grow dramatically when IMS is stressed
  - QSAV Areas and AWEs moved from CSA to ECSA
- VSCR is provided for Fast DB Recovery (FDBR) address space
  - 378K moved from CSA to Private
  - 420K moved from ECSA to EPrivate
- Additionally
  - System PSTs moved from CSA to ECSA



# IMS MSC Fiber Connection CTC Support

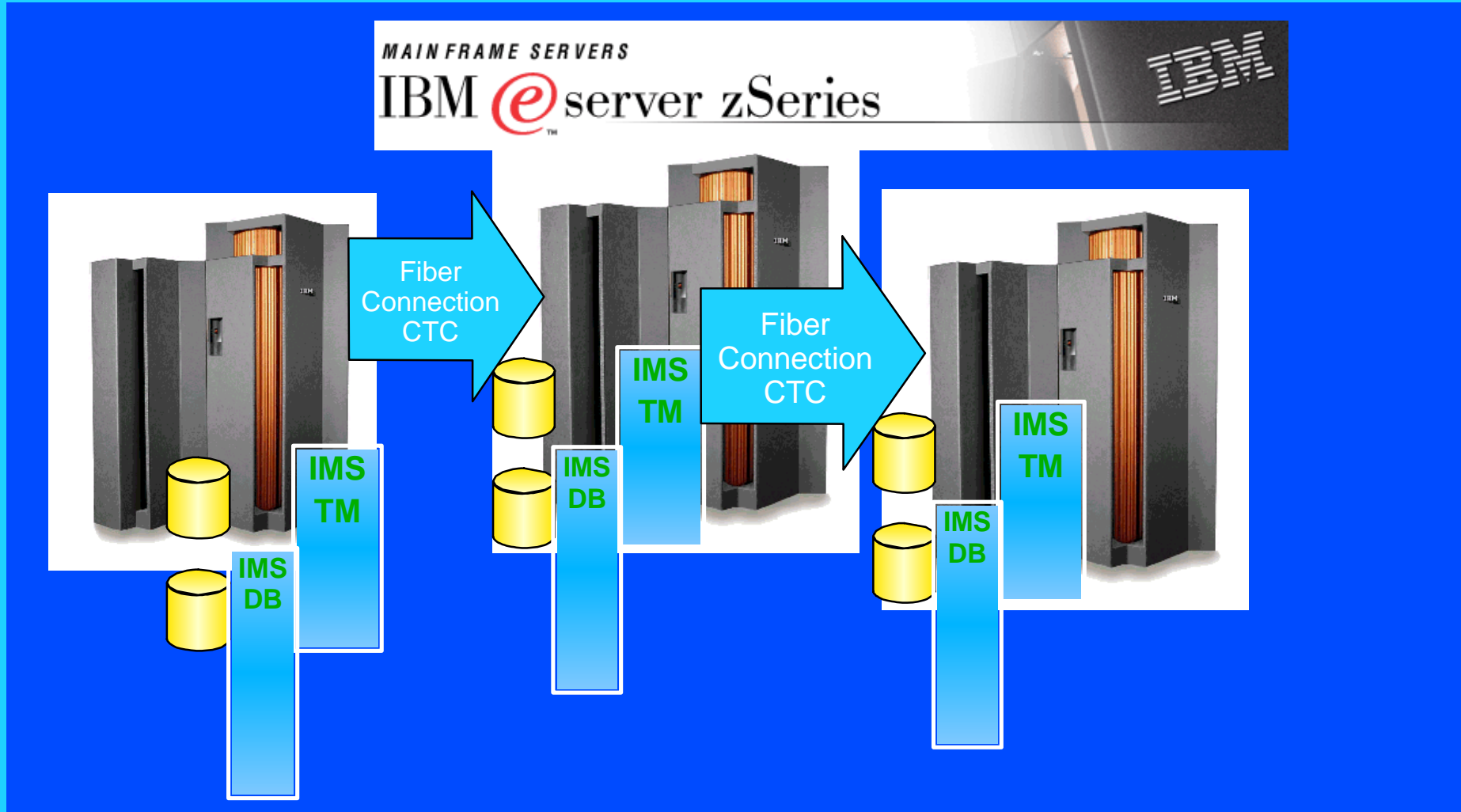

Providing Reliable, High Bandwidth Host-to-Host Communications Support between IMS systems.

# Availability and Recovery

- Image Copy 2 enhancements
- IMS/DB2 coordinated disaster recovery support
- DBRC enhancements
  - 16M RECON record size
  - PRILOG compression
  - RECON command authorization support
  - Automatic RECON loss notification
- Batch Resource Recovery Services (RRS) support
- ORS Enhancements to support V8

# Image Copy 2 Enhancements

Enhance Image Copy coordination and management

- IC2 enables a Non-Fuzzy image copy to be taken, but with only a very short time when DB is offline
- IMS V8 offers a number of enhancements
  - Multiple ICs in parallel by a single execution of IC2
  - "Logical Copy Complete" and "Physical Copy Complete" messages on a database level
  - Can be given a group name
    - completion messages relate to group
  - Exploited automatically by DBRC GENJCL.IC
  - Single output data set can be created for multiple image copies
  - DFSMSdss Optimize option supported

# IMS/DB2 Coordinated Disaster Recovery

## Making RSR More Attractive to DB2-IMS Users

- IMS RSR came out with IMS V5
  - requires small bandwidth to support shadow DBs (or DB recovery) at a remote site
- IMS V8 RSR addresses the needs of customers who want
  - coordinated IMS and DB2 recovery
  - with limited bandwidth to remote site
- Uses RSR for IMS Log Data
  - with option of shadow DBs
- Uses XRC for DB2 Log Data
  - can be used for DB2 rolling recoveries

# 16MB RECON Record Size/PRILOG Compression

Relieves RECON record size constraints resulting in higher availability

- DBRC implements its own RECON record spanning
  - Is automatic
- Maximum record size is 16MB
  - unlikely that any RECON record will ever reach 16MB!
- Each RECON can have a different CI/RecSize
- PRILOG Compression will now be attempted whenever an OLDS archive job is run
  - Oldest allocation info for each DBDS is kept in the LOGALL record
    - Will reduce overhead of compression attempts

# RECON Command Authorization Support

Allows an installation to control the use of DBRC commands

- Commands authorized at the following level:
  - ▶ command verb (ex. LIST)
  - ▶ resource type (ex. DB)
  - ▶ resource (DBD - XYZ)
    - ▶ With wild card character support
- Supports DBRC Utility (DSPURX00) and HALDB Partition Definition Utility
- Examples
  - ▶ User A can use LIST.DB for any test database
  - ▶ User B can only issue LIST.DB DBD(XYZ) (only able to list database XYZ)

# Automatic RECON Loss Notification

- If a RECON is lost, RECON reconfiguration is performed on that system
  - Operators can not delete "lost" RECON until all active IMS systems have accessed RECONS and performed reconfiguration themselves
    - only then will lost RECON be deallocated by MVS
  - Problem is knowing when it is OK to DELETE the old RECON and DEFINE a new SPARE
- V7 helped by issuing a list of active DBRC systems
  - still up to operators to check when all have accessed RECONS
- V8 (as an option) uses Structured Call Interface (SCI) to notify all other DBRC subsystems
  - all other systems immediately perform RECON reconfiguration
- Applies for all users of DBRC
  - Online Systems
  - Batch Jobs
  - IMS Utilities

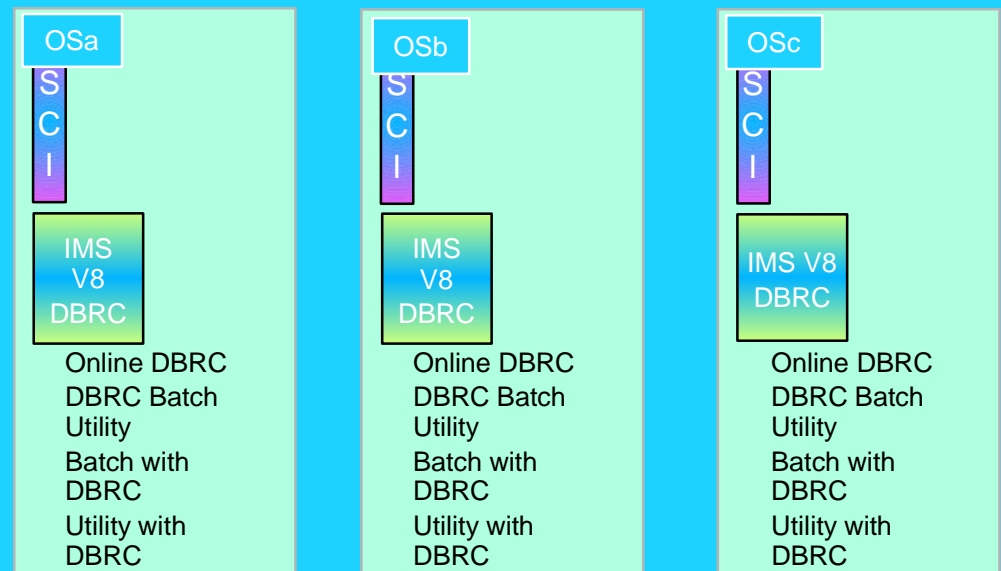



# Batch RRS Support

## In a Stand-alone IMS Batch environment

- IMS V8 now provides full coordinated two phase commit with attached subsystems
  - DB2 V6 or MQ V5.2
- batch program requires connection to RRS
  - New JCL PROC parameter "RRS=Y"
  - RRS uses System Logger for saving coordination data
- batch program requires DASD logging and BKO=Y

## Utilized by IMS DataPropagator V3R1

- uses MQ to give "asynchronous near real time" data propagation for Batch DL/1

Note: Retrofitted to V7







# Online Recovery Service Benefits

## Faster recoveries

- Inputs read once for all database data sets
- Parallel input and output processes

**Performance**

**Eliminates database outages to create recovery points**

**Eliminates redoing work from recovery point to time of error**

**Simple online recovery process**

- No JCL or batch jobs

**Availability**

**Usability**



## ORS V1 Enhancements for IMS V8

- Support for 2048 DEDB Areas
- **IMS V8 Image Copy 2 Enhancements - SMS Same DS Support**
- Log data caching
  - Tape management system environments
  - Logs cached while image copies are restored
- Catalog entries can be automatically deleted
  - Local disaster (reformatted volume) recovery via SMS
  - Image Copy 2 generated image copies
- Data set migration support
  - Catalog used if different from RECON data
- **IMS ORS Enhanced Automation Support**
  - ORS Messages to the IMS MTO

# Online Recovery Service



# Applications Enhancements

- Dynamic Change of LE Runtime Options
- New Java Dependent Regions
  - using Resettable JVM
- Supporting new Java Standards
  - JDBC 2.1
- New ISPF tool for generating IMS Metadata
- Access to IMS DB from Java applications outside of IMS
  - CICS DBCTL
  - DB2 Stored Procedures
- Access to IMS DB and Transactions from Websphere EJBs and Servlets
- XML

# LE Dynamic Runtime Options

## Today's Environment

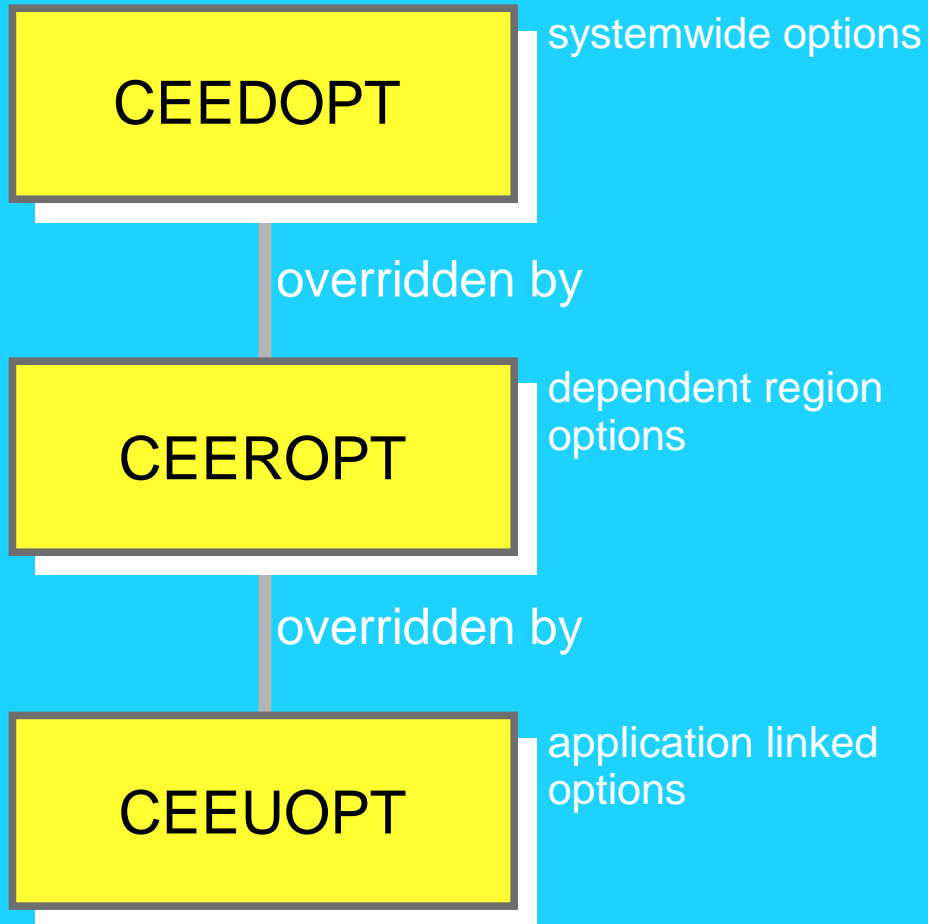

**Changing runtime options is sometimes needed**

- eg. to get diagnostic information

**Changing options is not trivial!**

# Dynamic LE Runtime Parameters

Makes IMS application deployment and testing easier

- Dynamically updates Language Environment (LE) runtime parameters for IMS Transaction or Batch Message Programs
  - ▶ Makes it easier to use the Debug Tool for application testing
  - ▶ Done without requiring CEEROPT and CEEUOTP to be changed, reassembled, and relinked when parameters need to be changed

# IMS Java for Integrated e-business Application Development



- **Application programmer productivity**
  - Java access to IMS input/output message queues
  - JDBC to access IMS DB and DB2 data
  - Java Compiler support in VisualAge for Java, Enterprise Edition/390 Version 2
  - Uses VisualAge tools for development
- **New Enhancements**
  - Java Dependent Region support for Scalable Java Virtual Machine in IBM Developer Kit/390, Java 2 Technology Edition
  - JDBC access from additional environments
  - Java Standards enhancements

# The Big Picture: JDBC Access to IMS Data

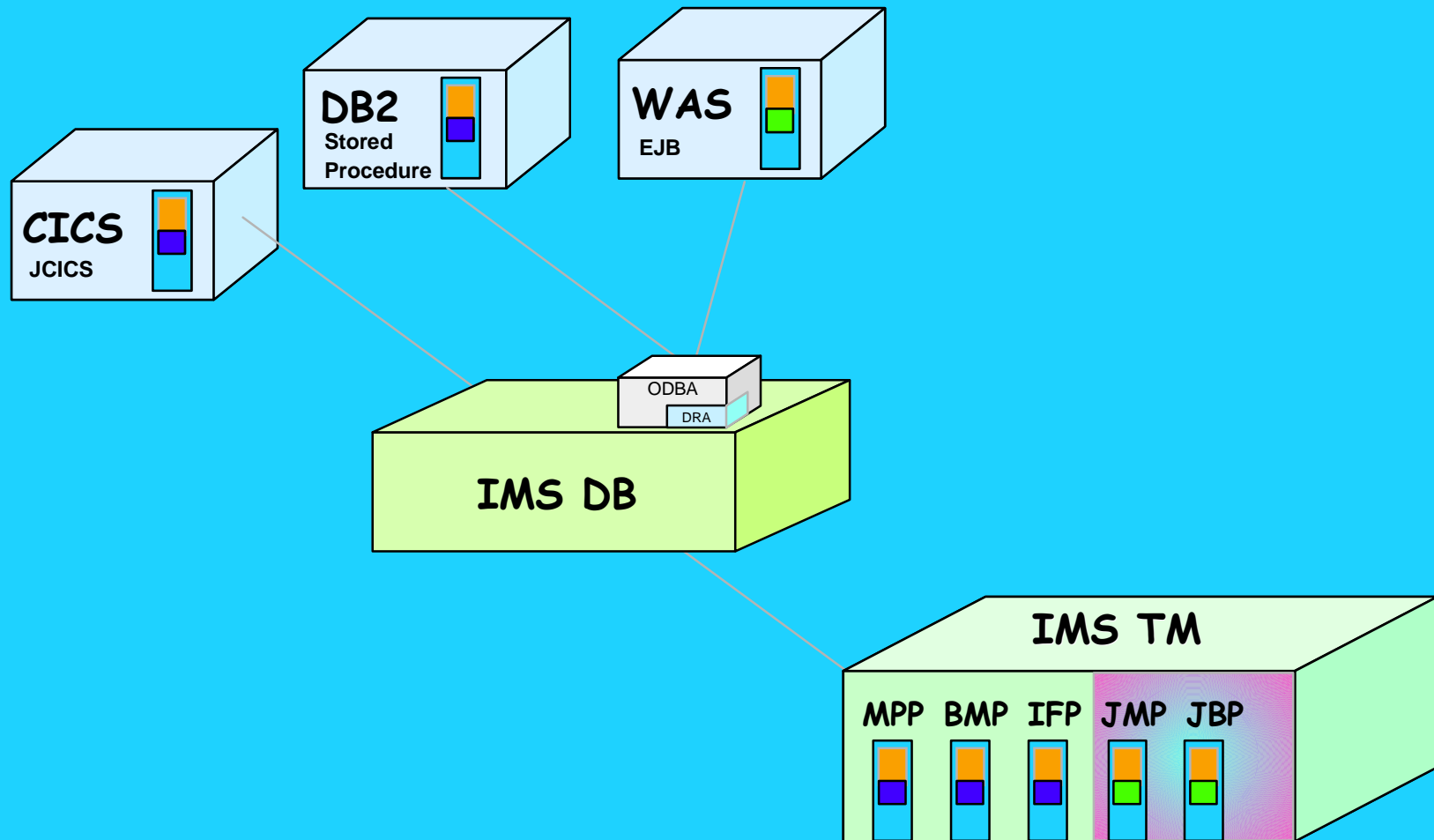

```
"SELECT CheckingAcct.Balance, SavingAcct.Balance,CheckingAcct.Name" +
"FROM MyBankPCB.Accounts " +
"WHERE CheckingAcct.Balance > 10000" +
"AND SavingAcct.Balance > 20000 "
```

# New JDBC Standards

**IMS Java applications can, as an option, use JDBC to access IMS Databases**

- using SQL

**IMS V7 implements JDBC 1.0**

**IMS V8 implements JDBC 2.1**

- Updateable Result Sets
  - implicit DB updating
- “get previous row”, “get row n”, etc..
- Agregate functions (MIN, MAX, etc..)



# Java Tooling

- IMS Java programs require database descriptions to be coded in Java “metadata”
- Problems:
  - Confusion generating IMS Java Metadata (DLIDatabaseView)
  - Time consuming
  - Too prone to simple mistakes
- Solution:
  - ISPF Utility to:
    - Parse DBD and PSB
    - Produce XML to act as a standard form of IMS Metadata
    - Generate the IMS Java Metadata from the XML

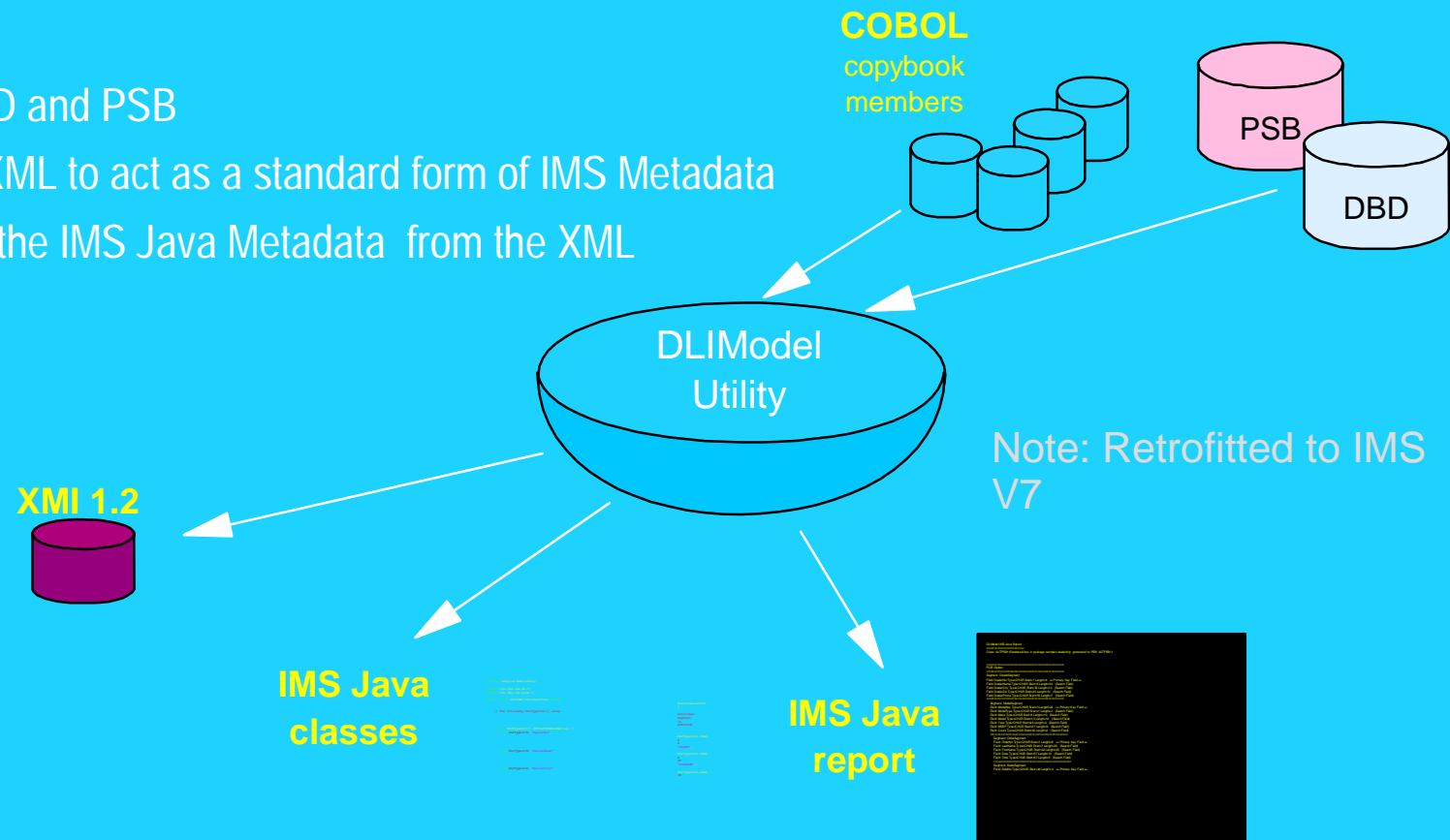

# IMS Access with J2EE

The "Java World" has defined a distributed transactional processing architecture

- Java 2 Platform Enterprise Edition (J2EE)
- Business logic written as Enterprise Java Beans (EJBs)
  - run inside a "container"
  - container provides transactional functions, security, etc.
    - ◆ just as IMS TM does for IMS transactions
- J2EE recognizes long term dependency on existing legacy systems (EIS)
- J2EE defines an API to access EIS
  - supplier of EIS must provide the implementation of the API
    - J2EE Connector
    - or
    - Resource Adapter

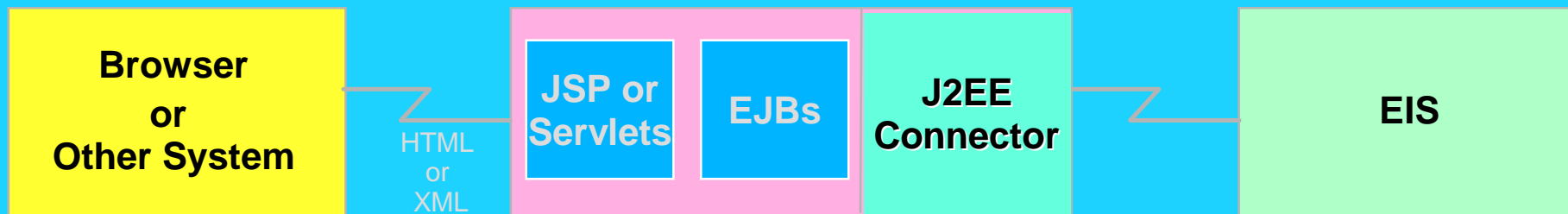

# Websphere EJB Access to IMS Database

## IMS provides the Resource Adapter

- enables EJB or Servlet DL/1 or JDBC calls to access IMS DB via ODBA

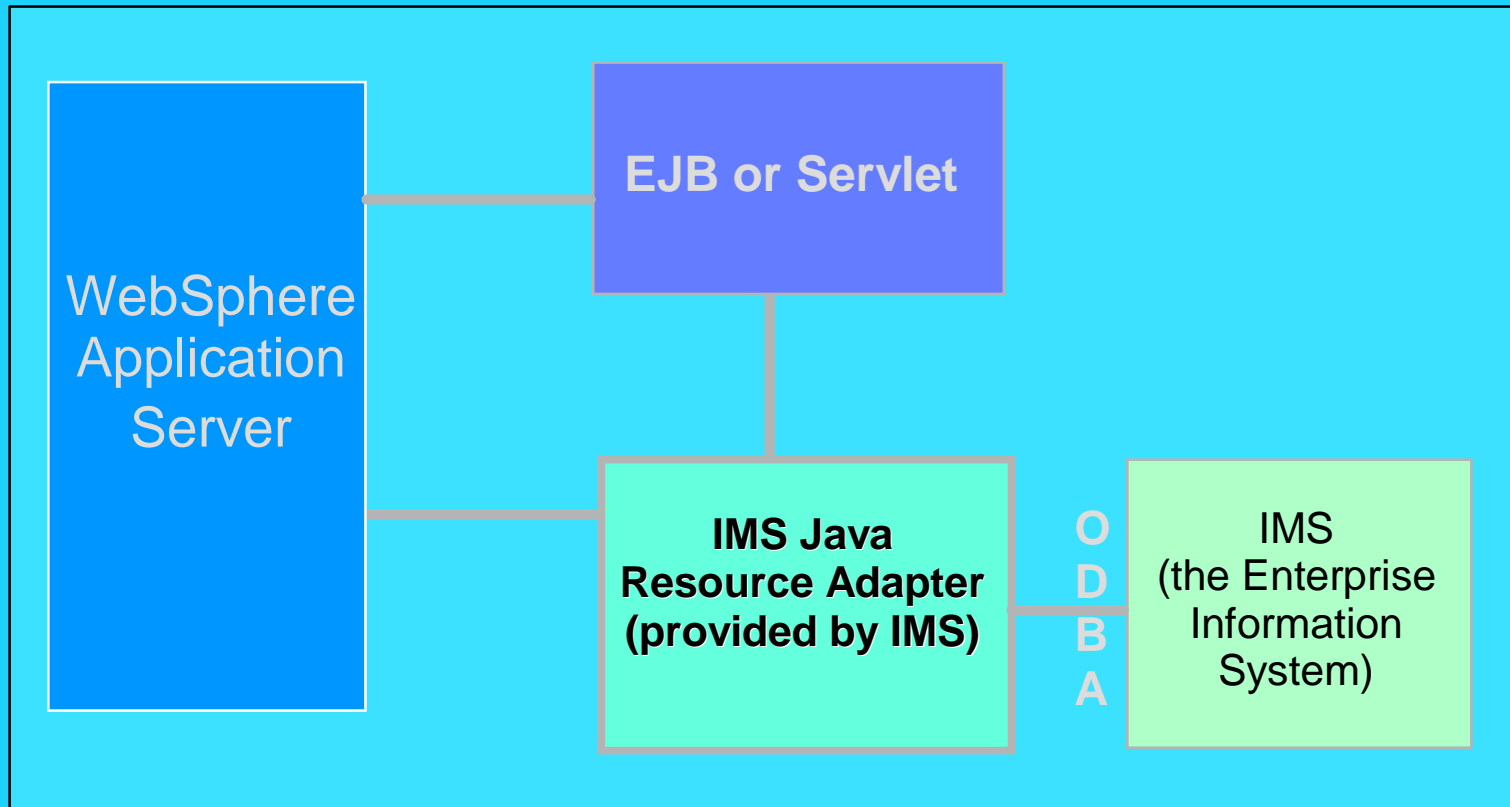

# Websphere EJB Access to IMS Transactions

For access to Transactions, the Resource Adaptor is provided by IMS Connect 1.2

- Visual Age for Java provides the “IMS Connector for Java” for development usage
- IMS Connect 1.2 provides the “IMS Connector for Java” runtime support

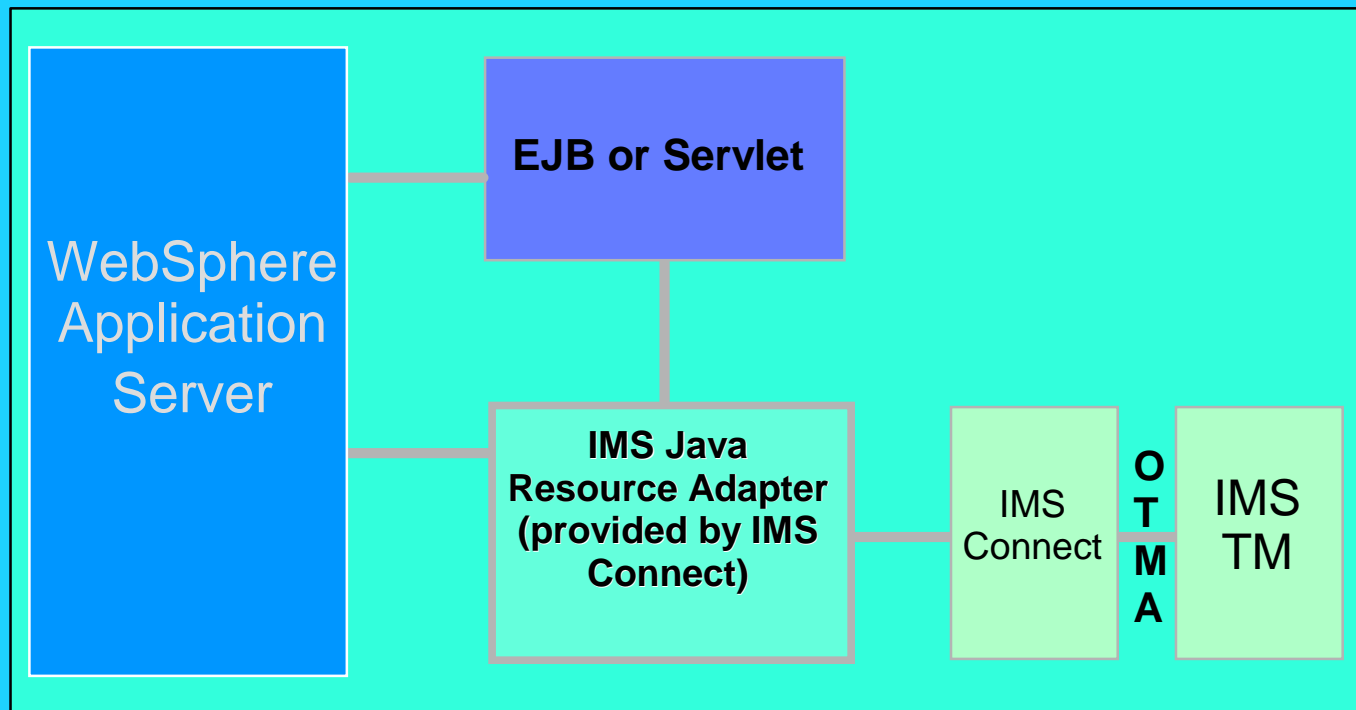

## Other System/TM Enhancements

- SLDS Read Enhancements
- APPC Enhancements
  - Dynamic add/delete LU 6.2 descriptors
  - Use of another LU as an outbound LU
  - Use of a CPU time limit for CPI-C transactions
  - LU Manager Trace formatting enhancements
- Syntax checker

# System Log Data Set (SLDS) Read Support

- The IMS Logger is now able to read SLDSs for Dynamic Backout, avoiding the need for batch backout in some cases
  - ▶ Example -- A long running application requires uncommitted updates on the SLDS after the OLDS have wrapped
- Also applies in a Shared Message Queue environment

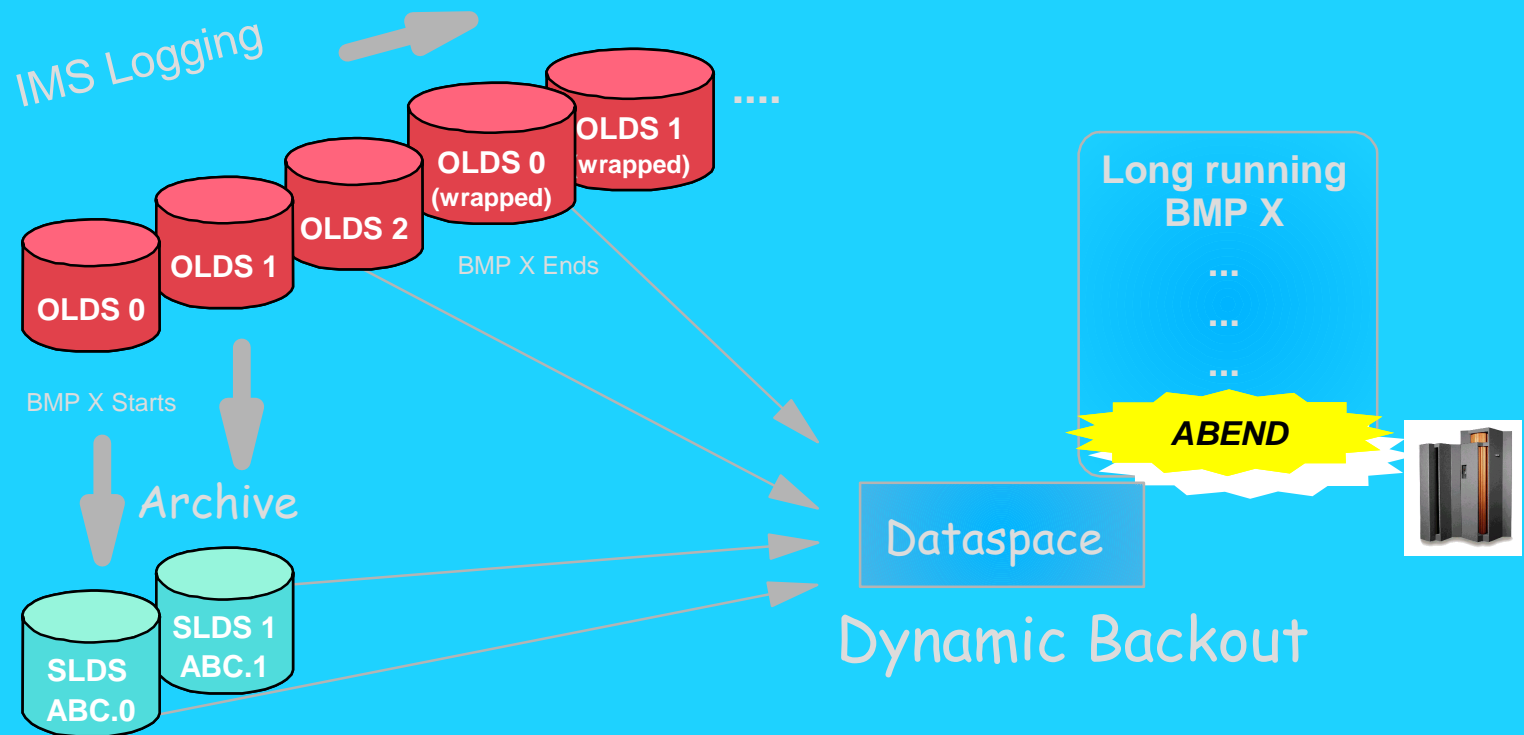

# APPC Enhancements

## Improves APPC availability

- Dynamically add/delete LU 6.2 descriptors for online change
- Use of another Logical Unit (LU) as an outbound LU for rerouting where resources are disabled
- Use a CPU-time limit for CPI-C (explicit) transactions to help prevent tying up of resources
- Synchronous Shared Queues support for enhanced workload distribution

# IMS Syntax Checker

Helps reduce system definition effort

- New IMS ISPF application which assists Systems Programmers in defining and maintaining the IMS parmlib members in the IMS PROCLIB
  - ▶ Reads the IMS.PROCLIB member, displays the parameters, lets you modify them, and saves them back to the IMS.PROCLIB member
  - ▶ Parameter and value checking and detailed help text at the parameter level tailored to the IMS version
  - ▶ V8 Syntax Checker supports members, DFSPBDBC, DFSPBDCC, DFSPBIMS
- Assists in moving from release to release by identifying new parameters and obsolete parameters
- Provides the ability to ensure parameters are valid prior to shutting down and restarting your IMS Control Regions



# Invalid Parameter

```
File Edit View Help
```

```
-----  
                    IMS 7.1 Parameters for DB/DC
```

```
Command ==>
```

```
DFSI920 Parameter value invalid
```

```
Press enter to check the syntax.
```

```
Data Set Name . . . : IMS81.IMS1.PROCLIB(DFSPBIMS)
```

```
IMS Release . . . : 7.1
```

```
Sel Codes: C = Comment D = Delete / = Select
```

Sel	Keyword	Value	Description
—	_____	= _____	
—	ALOT	= 9	ETO Auto Logon Off Time
—	AOIS	= A	ICMD Security Option
—	APPC	= Y	Activate APPC/IMS (Y N)
—	APPLID1	= IMS1	VTAM Applid of Active IMS System
—	APPLID2	= IMS2	VTAM Applid of XRF Alternate System
—	CHTS	= 1000	Number of CCB Hash Table Slots
—	CMDMCS	= N	MCS/EMCS Command Option: N Y R C B
—	DBBF	= 1000	Number of Database Buffers
—	DBFX	= 10	Num. DB Buffs available at FP Reg Start
—	DBRCNM	= DBCPROC	DBRC Proplib Member Name

# Keyword ALOT Help

File Edit View Help

## ALOT Autologoff Time

More: +

KEYWORD: ALOT

Specifies the autologoff time in minutes. Valid values are 0 and from 10 to 1440. If the ALOT value is not specified, the value from the JCL member is used except for FINANCE, SLU P, and ISC. If ALOT is not specified on the logon descriptor or overridden by the logon exit (DFSLGNX0) for FINANCE, SLU P, and ISC, a value of 1440 is used (the value from the JCL member is ignored).

\_ DBRCNM = DBCPROC DBRC Proplib Member Name

# Not Valid in Release

```

File Edit View Help
-----
                    IMS 8.1 Parameters for DB/DC
Command ==>
DFSI926 Keyword CHTS not valid in Release 8.1
Press enter to check the syntax.

Data Set Name . . . : IMS81.IMS1.PROCLIB(DFSPBIMS)
IMS Release . . . : 8.1

Sel Codes: C = Comment D = Delete / = Select

Sel Keyword      Value      Description      More: -
-  CHTS      = 1000      Number of CCB Hash Table Slots
-  CMDMCS      = N          MCS/EMCS Command Option: N|Y|R|C|B
-  DBBF        = 1000      Number of Database Buffers
-  DBFX        = 10          Num. DB Buffs available at FP Reg Start
-  DBRCNM      = DBCPROC     DBRC Proplib Member Name
    
```

# IMS V8 Packaging, Installation, and IVP Enhancements

- Packaging
  - Installation and IVP are separate processes
- Installation
  - ADFSBASE | SDFSBASE contain sample jobs to install IMS
    - DFSALA and DFSALB sample jobs provided to install IMS in its own SMP/E environment
  - Non SYSGEN elements built during SMP/E APPLY processing
  - SMP/E processing done using RECEIVE, APPLY, and ACCEPT
- Samples and some user exits
  - Are located in new IMS V8 libraries - ADFSSMPL | SDFSSMPL
  - Line update maintenance provided for user exits
- Installation Verification Program (IVP)
  - New name, install jobs removed, panels updated, variables removed
  - Includes IMS V8 samples
    - OM, RM, SCI, SPOC sample
    - Syntax Checker sample
  - Provides option to include/exclude Fast Path samples

# IMS V8 Software Prerequisites and Migration SPEs

## IMS V8 MINIMUM RELEASE LEVELS

### OS/390 V2R10 (5647-A01) with DFSMS

- ✓ RACF (included in separately orderable SecureWay Security Server), or equivalent, if security is used.
- ✓ High Level Assembler Toolkit

### z/OS V1R2

- ✓ Required for APPC/OTMA Synchronous Shared Qs
- ✓ Required for MSC FICON CTC support
- ✓ Required for Shared Qs/EMH CF Duplexing support
- ✓ Required for System Mgd Duplexing of VSO structures
- ✓ Recommended for Resource Mgr and Coordinate OLC
- ✓ Enhances usability for Sysplex Terminal Manager

### **DBRC Migration/Coexistence SPE**

- on IMS V6
- on IMS V7

*Also being provided through the IMS V7 Service process*

## IMS Transaction Manager

- Multiple Systems Coupling (MSC) Facility FICON Channel-To-Channel support
- Sysplex Coupling Facility (CF) enhanced support
  - CF Duplexing for IMS Shared Queues and Fast Path (FP) Expedited Message Handler (EMH)
- New Java Region types for new Scalable JVM

## IMS Database Manager

- Sysplex Coupling Facility (CF) enhanced support
  - IMS Fast Path Virtual Storage Option (VSO) CF support
  - IMS DB Data Sharing support provided through IRLM
- JDBC support for DB2, CICS, and WebSphere
- Batch Remote Recovery Service (RRS) support
- SLDS Read Support

# IMS: Leading the Industry

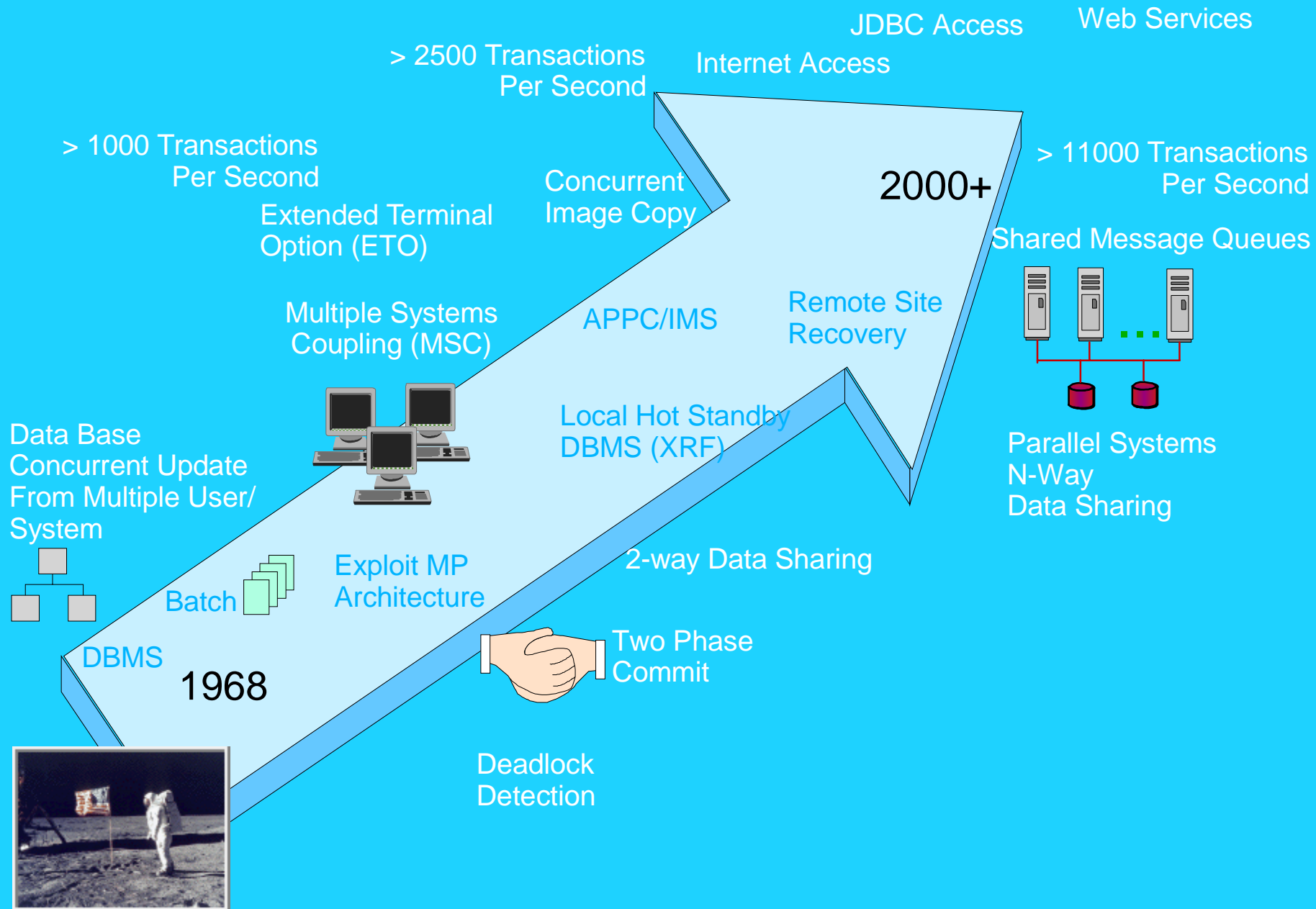

# Strategic IMS Architecture

## ■ Goals:

- ▶ Restructure IMS into independent units
- ▶ Support unlimited growth for new e-business driven workloads
- ▶ Provide scalability by allowing multiples of units
- ▶ Provide for fault toleration (self-healing system)

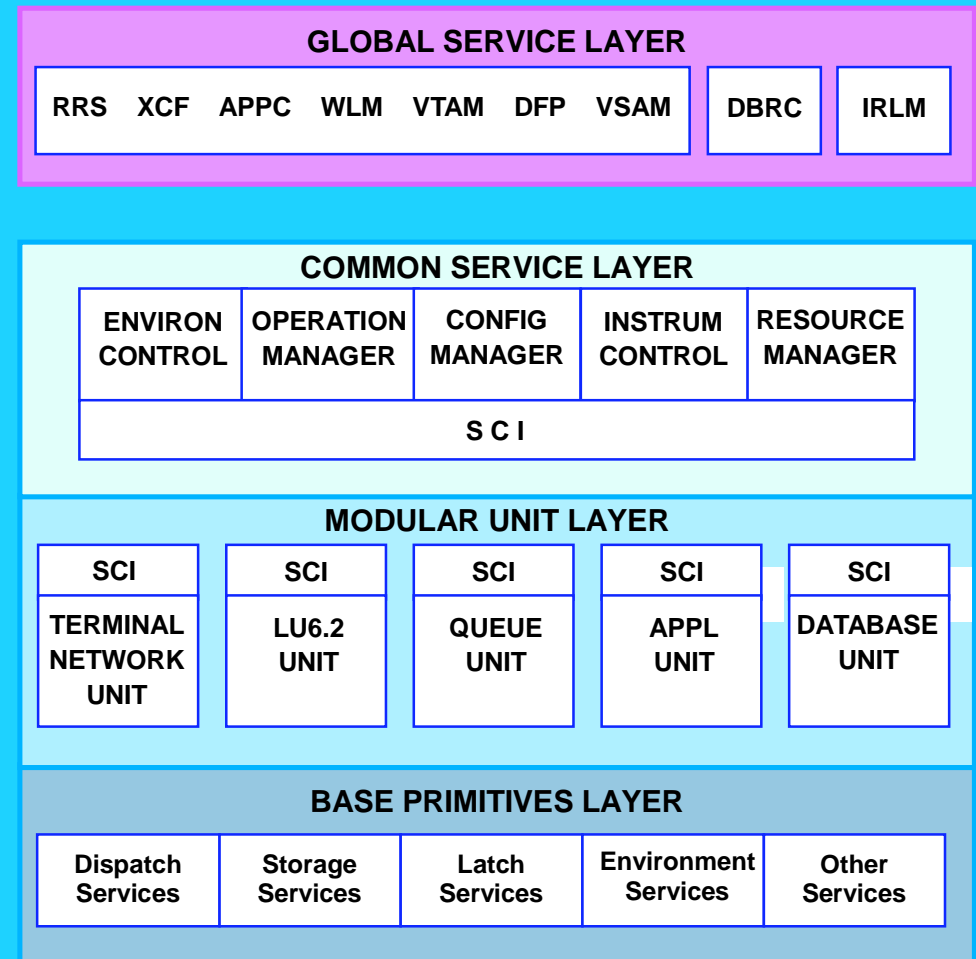



## IMS V8 - Summary

- The IMSplex support provides a Single System Image to operations and end users
- Exploits the latest system enhancements for CF structure management
- Eliminates various issues of large systems (VSCR, large RECON records, DB OPEN, etc.)
- Provides state of the art support for Java applications and as an Enterprise Information System with J2EE

