



**B05**

## **What's New with IMS Since General Availability of IMS V7**

Tom Ramey



Miami Beach, FL

October 22-25, 2001

- ▶ Intro
- ▶ Enhancements to IMS since GA
  - ▶ Additional 2001 IMS enhancements
- ▶ New/Enhanced IMS Tools since GA
  - ▶ September Tools Announcement
- ▶ IMS and XML
- ▶ What's Coming Next
- ▶ Reference

# IMS - Version 7

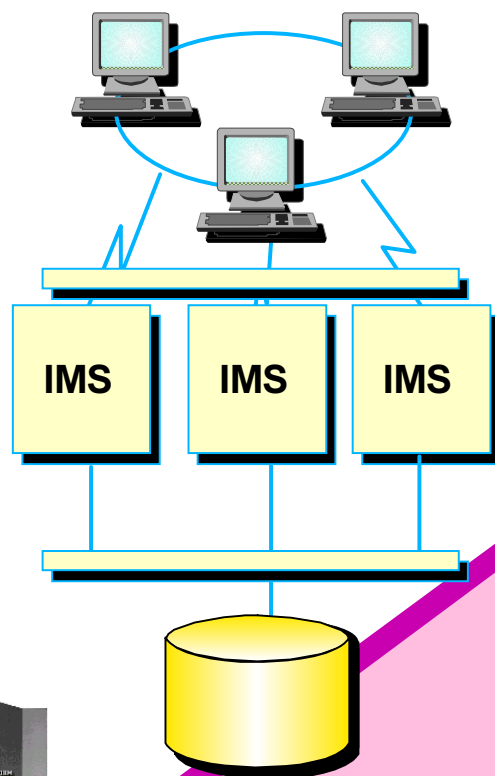

### Ideal for e-business

- ✓ Continuous Availability
- ✓ Systems Management
- ✓ Performance/Capacity
- ✓ Connectivity

### Enhancements

- Extended Large DB support
- Enhanced DB recovery
- Faster Restart with Multinode Persistent Sessions
- Enhanced Systems Mgmt Tools
- Enhanced Connectivity
- IMS Java

### Benefits

- ✓ Enable Customer Growth
- ✓ Enhance Workload Balancing
- ✓ Increase Availability; Ease of Use
- ✓ Preserve Current Application Investment
- ✓ Enable New Applications



MAINFRAME SERVERS

IBM *e*server zSeries

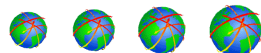



## Availability/Performance/Capacity

- High Availability Large Database
- Open Database Access (ODBA)
- Application Control Block Generation (ACBGEN) enhancements
  - ▶ increased number of program limits
  - ▶ time/version info added
- DBRC Enhancements
  - ▶ Recovery Control (RECON) online upgrade, online access, large record warning, loss notification, improved diagnostics
  - ▶ Image Copy Genmax and Recovery enhancement
  - ▶ DB administration enhancements
- Forward Recovery enhancements
  - ▶ Change accumulation spill record handling for smaller, faster change accums
- Image Copy 2 Enhancements
  - ▶ Compression option added for space savings
- I/O Performance enhancements
  - ▶ Ficon support
  - ▶ ESS support
- CSA Constraint relief

## Systems Management

- Installation enhancements
  - ▶ Usability enhancements
  - ▶ HALDB samples
- Logger enhancements
  - ▶ Administration and Control
- External Subsystem Attach Facility diagnostic enhancements
- IMS systems parameter display
- Fast Path Enhancements
  - ▶ I/O toleration enhancements
  - ▶ Performance monitoring support
  - ▶ Multiple Area Data Set I/O Timing
  - ▶ Expansion of compressed data for Sequential Dependent Segment (SDEP) Scan
  - ▶ IMS Monitor enhancements for FP

# IMS V7 Transaction Manager Enhancements



## Availability/Performance/Capacity

- Rapid Network Reconnect
- Deferred VTAM ACB Open to prevent time-outs
- Improved checkpoint frequency control
- SLUP Finance Session Coldstart capability
- VTAM Generic Resources enhancement for VTAM to manage the affinity
- Queue Space Notification Exit
- I/O SPOOL usability and performance enhancements
- SLU2 exception response enhancement

## Systems Management/Usability

- Sysplex Queue Sharing Enhanced
  - ▶ CQS enhancements for Shared Queues
  - ▶ Asynch APPC/OTMA for Shared Queues
- Routing Exit enhancements
- RACF Pass Ticket Support
- USERID clarification for applications
- External Storage Attach Facility (for DB2) Trace enhancements
- Installation enhancements
  - ▶ Usability enhancements
  - ▶ Java samples
- IMS systems parameter display

## Application Devt/Connectivity

- IMS Java and XML support
- OTMA Callable Interface
- ETO Enhancements
  - ▶ Associated Printer support
  - ▶ Autologon enhancements
  - ▶ LTERM assignment flexibility
  - ▶ ETO descriptor record limit removed
  - ▶ Command Compatibility

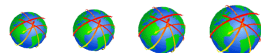

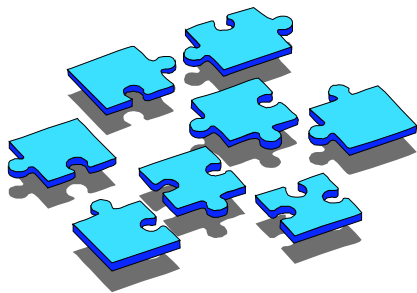

## ■ Administration

- ▶ IMS High Performance Load
- ▶ IMS High Performance Unload
- ▶ IMS Index Builder
- ▶ IMS Fast Path Basic Tools
- ▶ IMS Fast Path Online Tools
- ▶ IMS ETO Support
- ▶ IMS Library Management
- ▶ IMS Advanced ACB Generator
- ▶ IMS DB Repair Facility
- ▶ IMS HD Compression -Extended
- ▶ IMS High Performance Pointer Checker
- ▶ IMS High Performance Prefix Resolution
- ▶ IMS Sequential Randomizer Generator

## ■ Application Management

- ▶ IMS Program Restart Facility
- ▶ IMS Connect

## ■ Database Recovery and Replication Management

- ▶ IMS DEDB Fast Recover
- ▶ IMS Image Copy Extensions
- ▶ IMS Recovery Saver
- ▶ IMS Database Recovery Control Facility

## ■ Database Performance Management

- ▶ IMS Performance Analyzer
- ▶ IMS Queue Control Facility

*Manage  
Automate  
Monitor  
Tune...*

IBM

# Enhancements to IMS V7 Since GA

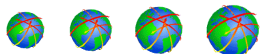
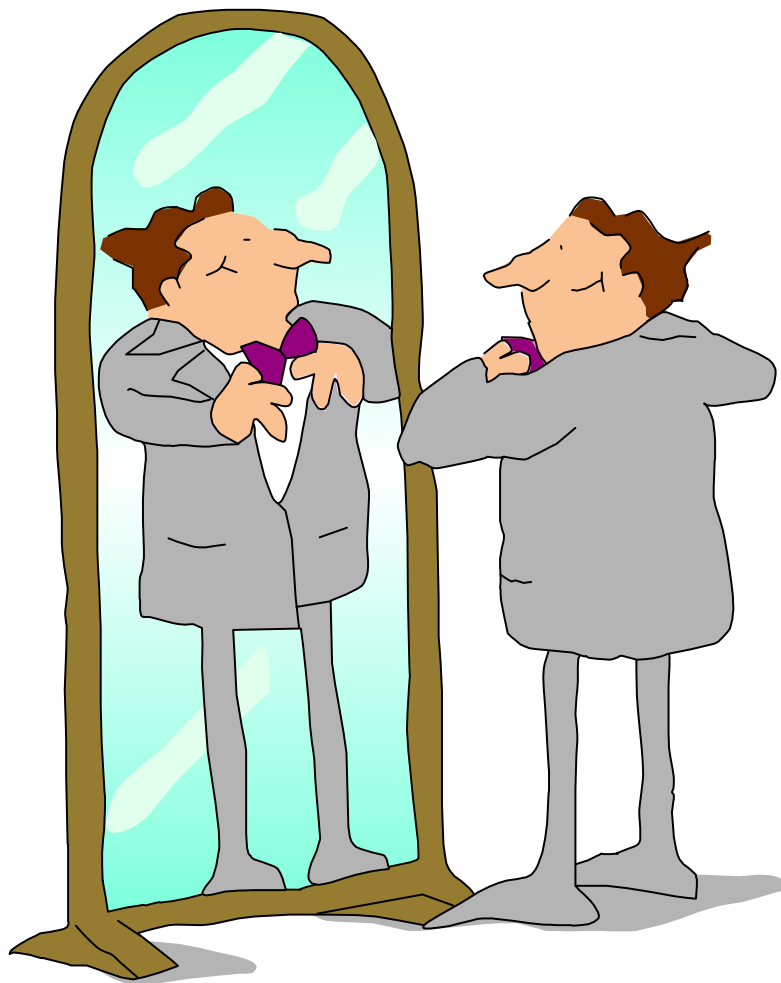

IMS - the world depends on it!



© Copyright IBM Corporation 2001

# IMS V7 Enhancements through the Service Process



## Enhancements we've already announced:

- ▶ 64-bit Real support
- ▶ 250 OSAM Database Buffer Subpools
- ▶ Additional Sense Codes/Message Information
- ▶ IMS External Subsystem Attach for DB2 Groups
- ▶ High Availability Large Database (HALDB) performance and management enhancements
- ▶ JDBC access to IMS DB from CICS/390 and DB2/390 environments

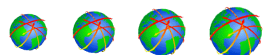



# IMS 64-bit Real Support



- ▶ OS/390 V2R10 or z/OS support 64-bit real addresses on z900
  - ▶ Addresses above the 31-bit address limit of 2 gigabytes are "above the bar"
  - ▶ IMS V7, V6, and V5 are enabled for 64-bit
- ▶ OSAM supports real addresses above the 2GB bar
  - ▶ I/Os may be done with buffers above the bar
  - ▶ Database buffers may reside in real storage above the bar
  - ▶ Log buffers may reside in real storage above the bar
    - ▶ In previous releases of IMS, data in buffers which are above the bar must be moved below the bar before I/O is done
- ▶ Fast Path storage moved above the 2GB bar



IBM @server. For the next generation of e-business.

# 250 OSAM Database Buffer Subpools



- ▶ Up to 250 OSAM database buffer subpools may be defined
  - ▶ Previous limit was 100
  - ▶ Provides additional buffer pool tuning possibilities
  - ▶ Also available in IMS V6

# IBM IMS Message Enhancements



## Additional Information for use with z/OS Communications Manager

- ▶ Providing Signon screen after LUSTAT x"082b'
- ▶ Including the TCP/IP address in IMS messages

```
DFS3672I 10:30:22 SESSION ERROR. TYPE=aaa CODE=bb QUAL.=cc MSG=dddd IPADDR..PORT=eee.ddd.ddd.ddd..ffff
```

```
eee.ddd.ddd.ddd The TCP/IP address  
ffff           The TCP/IP port number
```

```
DFS3650I SESSION STATUS FOR IMS SYS3
```

```
DATE: 10/12/00 TIME: 14:34:24
```

```
NODE NAME: TCP00001 IPADDR: 9.112.46.101..3049
```

```
USER: USRT001
```

```
PRESET DESTINATION:
```

```
CURRENT SESSION STATUS:
```

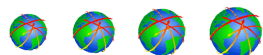

# IMS External Subsystem Attach for DB2 Groups



## Allows easy movement of BMPs between data sharing systems

- ▶ For all IMS online region types
  - ▶ SSM members do not have to be changed
- ▶ IMS dependent region may attach to any DB2 using the DB2 group attach name
  - ▶ DB2 group attach name is specified as the subsystem name in the dependent region IMS SSM member (instead of DB2 subsystem name)
- ▶ Restart 'resolve in-doubt' processing automatically uses the specific name
  - ▶ Emergency restart must have 'original' DB2 available

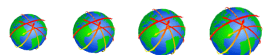
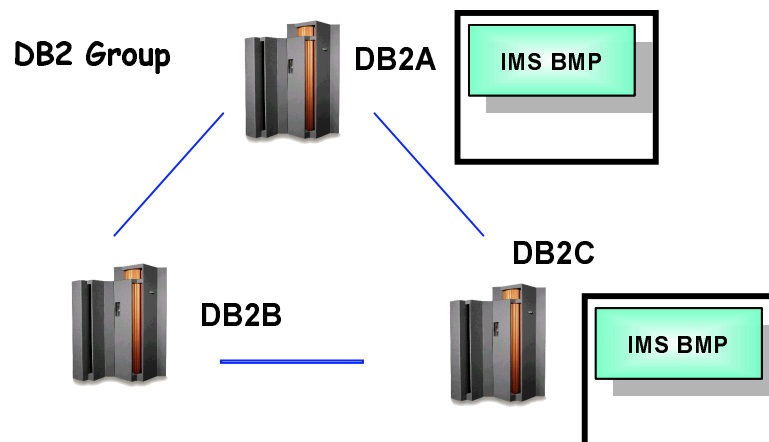

# IMS Group Attach for DB2



▶ **Example:**

- ▶ DB2A and DB2B defined with group attach name DB2X
- ▶ IMSA and IMSB executed with IMSGROUP=IMSX
- ▶ BMP may be run on either system without JCL or PROCLIB member changes

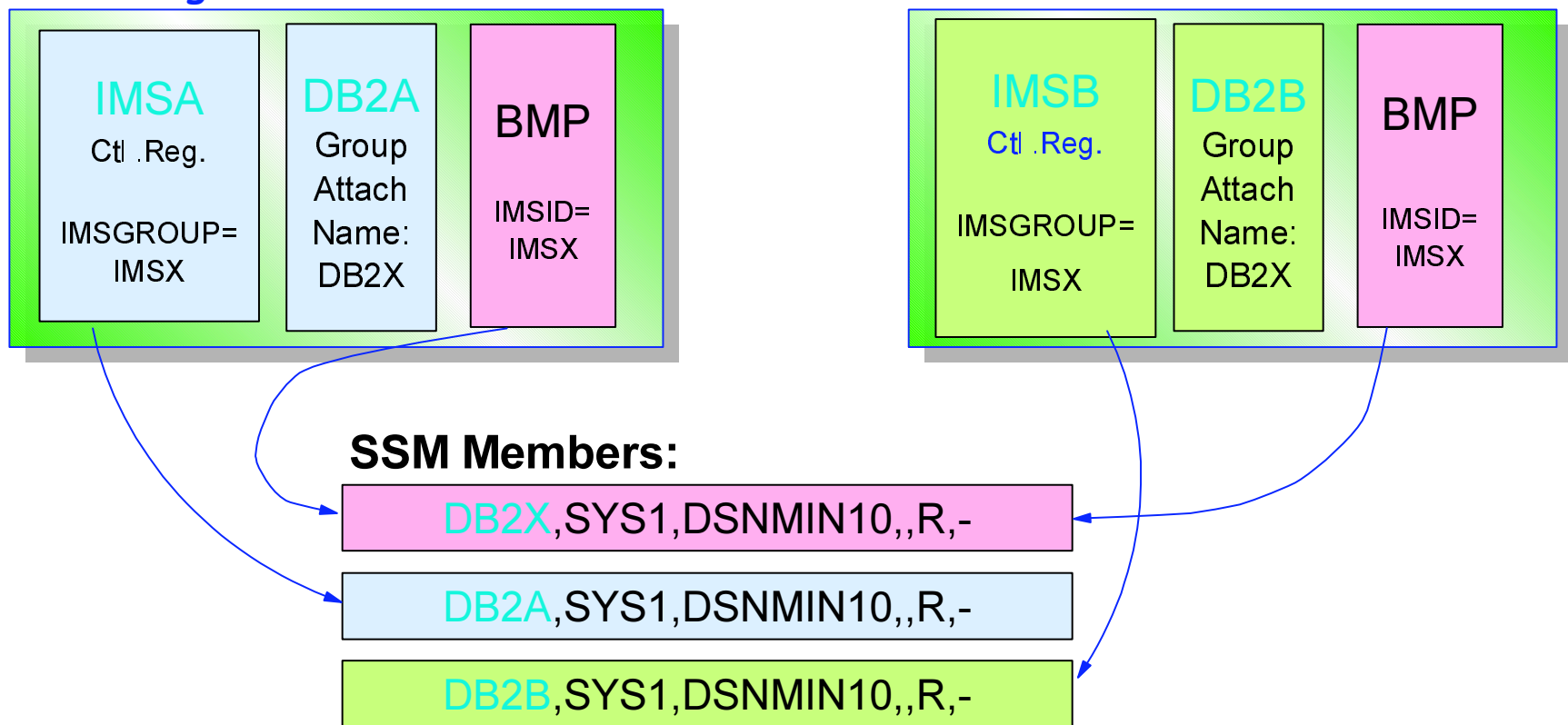

# IMS HALDB Enhancements



## ▶ Performance Improvements in

- ▶ Secondary Index migration to HALDB
- ▶ ILDS creation in HD Reload Utility
- ▶ Migration Aid Utility (DFSMAID0)

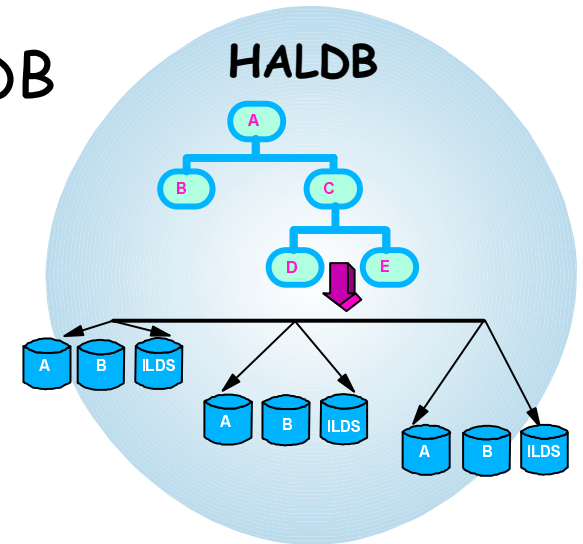

## ▶ Management Improvements with

- ▶ RECON Partition List Command support
- ▶ Batch command initialization of HALDB and associated partitions
- ▶ Unconditional HALDB partition initialization
  - CHANGE.DB PINIT no longer required

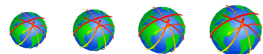

# DB2 Stored Procedure Example

(Using IMS V7 Java JDBC interface)

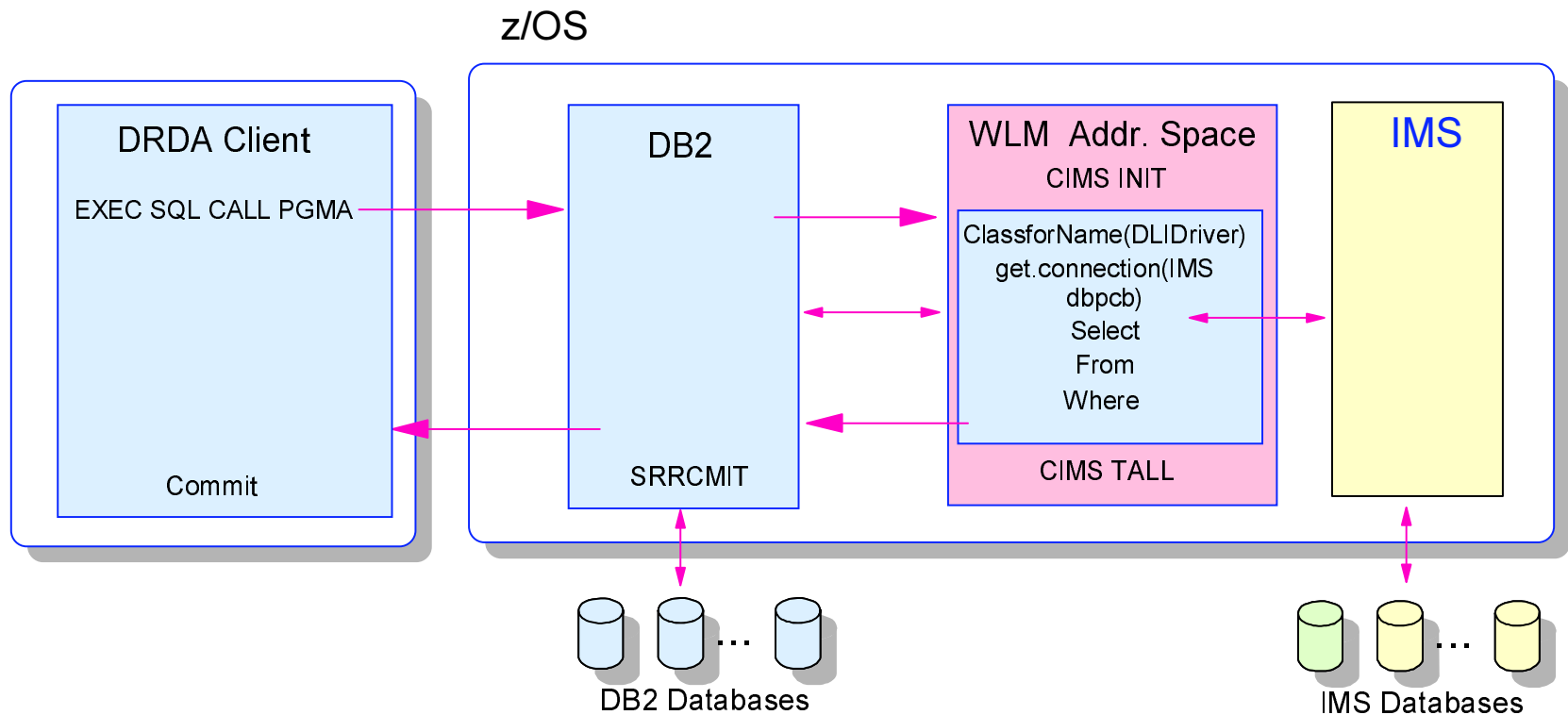

- **DB2 Java stored procedure example**
  - IMS Java Classes can be used to access IMS DB

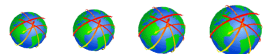

# CICS Example

(Using IMS V7 Java JDBC interface)

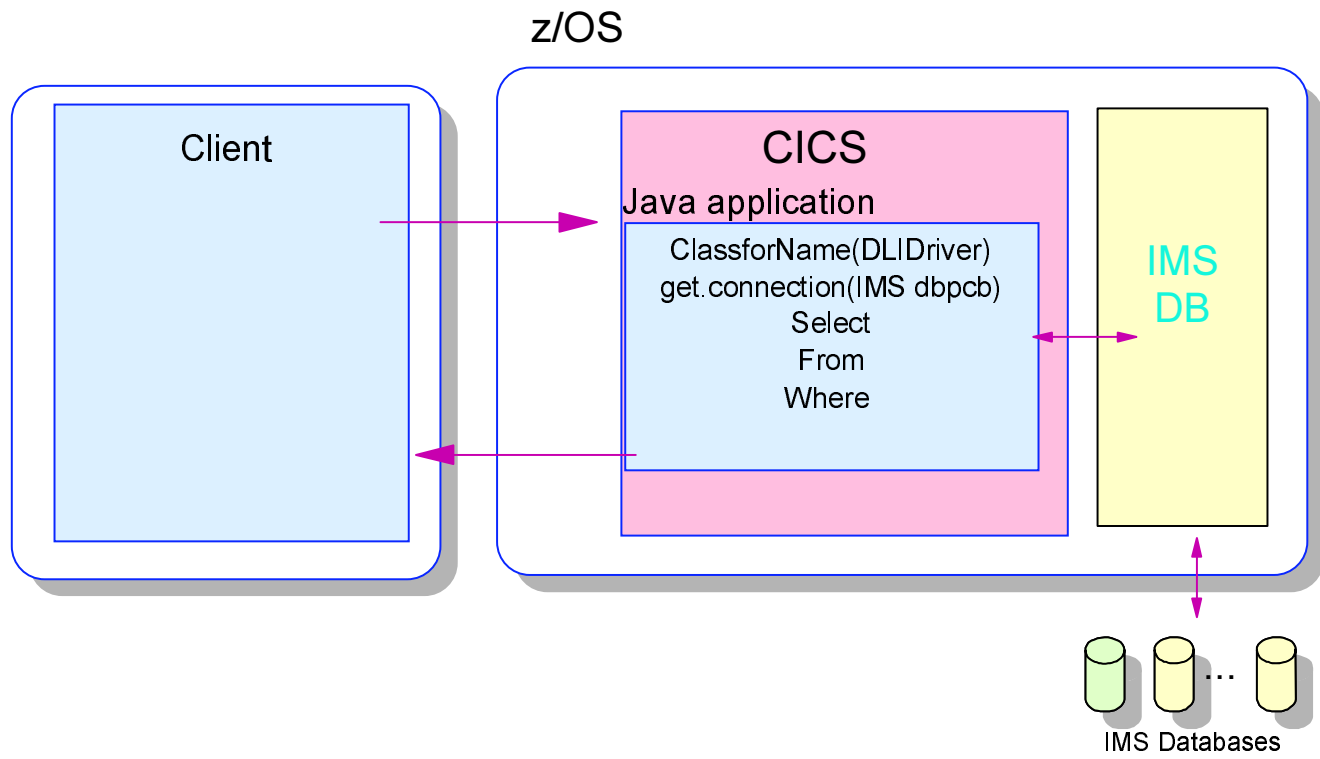

- **CICS Java Application example**
  - IMS Java Classes can be used to access IMS DB



# Additional 2001 IMS Enhancements

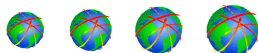

# Additional 2001 Enhancements through the IMS V7 Service process



## Enhancements we're announcing:

- ▶ System Log Data Set (SLDS) Read Support
- ▶ Fiber Connection (FICON) CTC Support
- ▶ Sysplex Enhancements
- ▶ New Java Dependent Region Types (for new Scalable JVM)
- ▶ JDBC access to IMS DB from WebSphere z/OS V4
- ▶ Batch Remote Recovery Service (RRS) Support

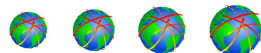

# System Log Data Set (SLDS) Read Support



- ▶ The IMS Logger is now able to read SLDSs for Dynamic Backout, avoiding the need for batch backout in some cases
  - ▶ Example -- A long running application requires uncommitted updates on the SLDS after the OLDS have wrapped
- ▶ In a Shared Message Queue environment SLDS will now be dynamically mounted when /CHE is issued and the messages are only available on SLDS

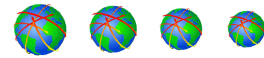
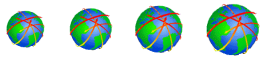
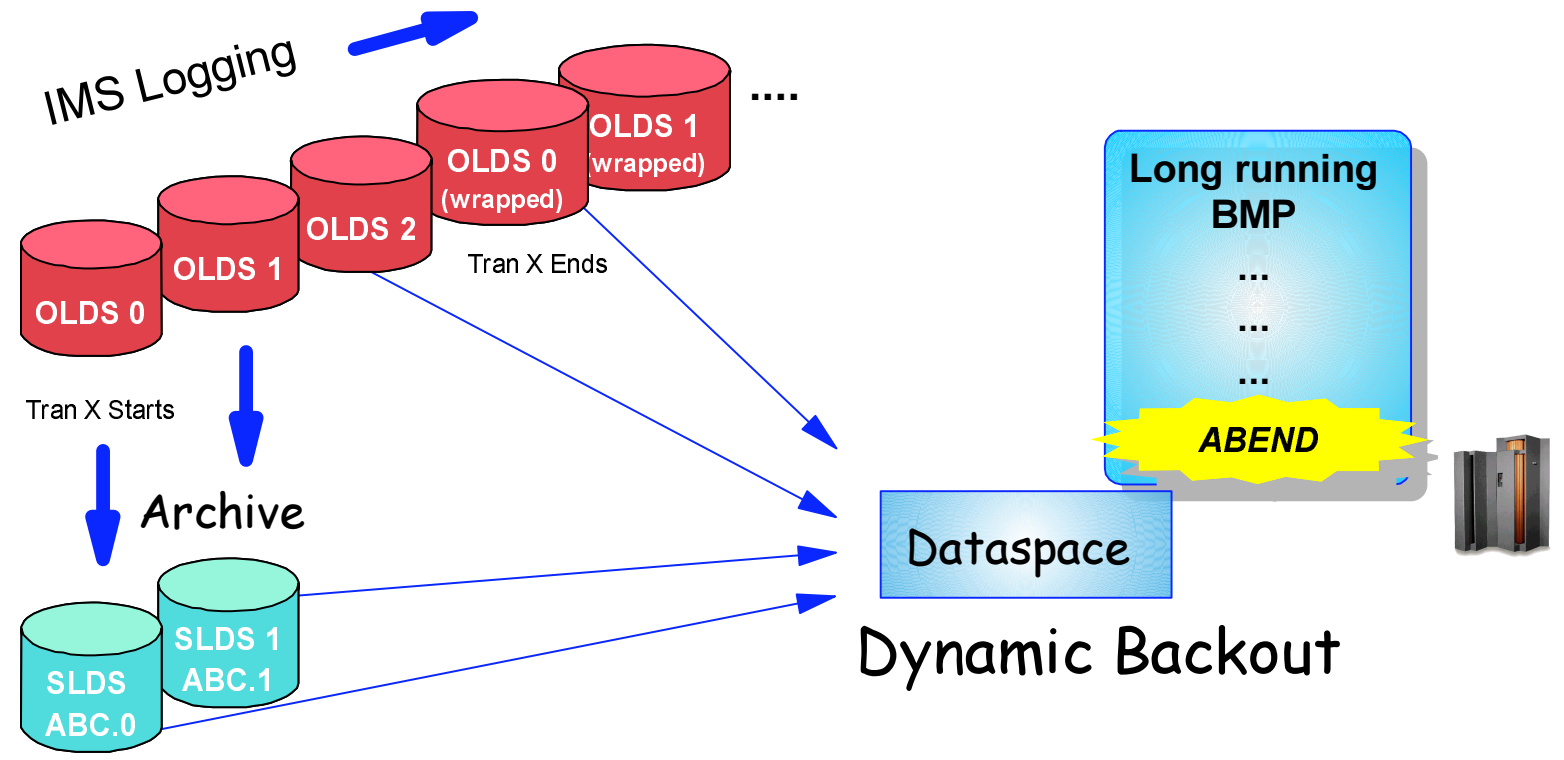

# IMS MSC Fiber Connection CTC Support



MAINFRAME SERVERS

IBM *e*server zSeries

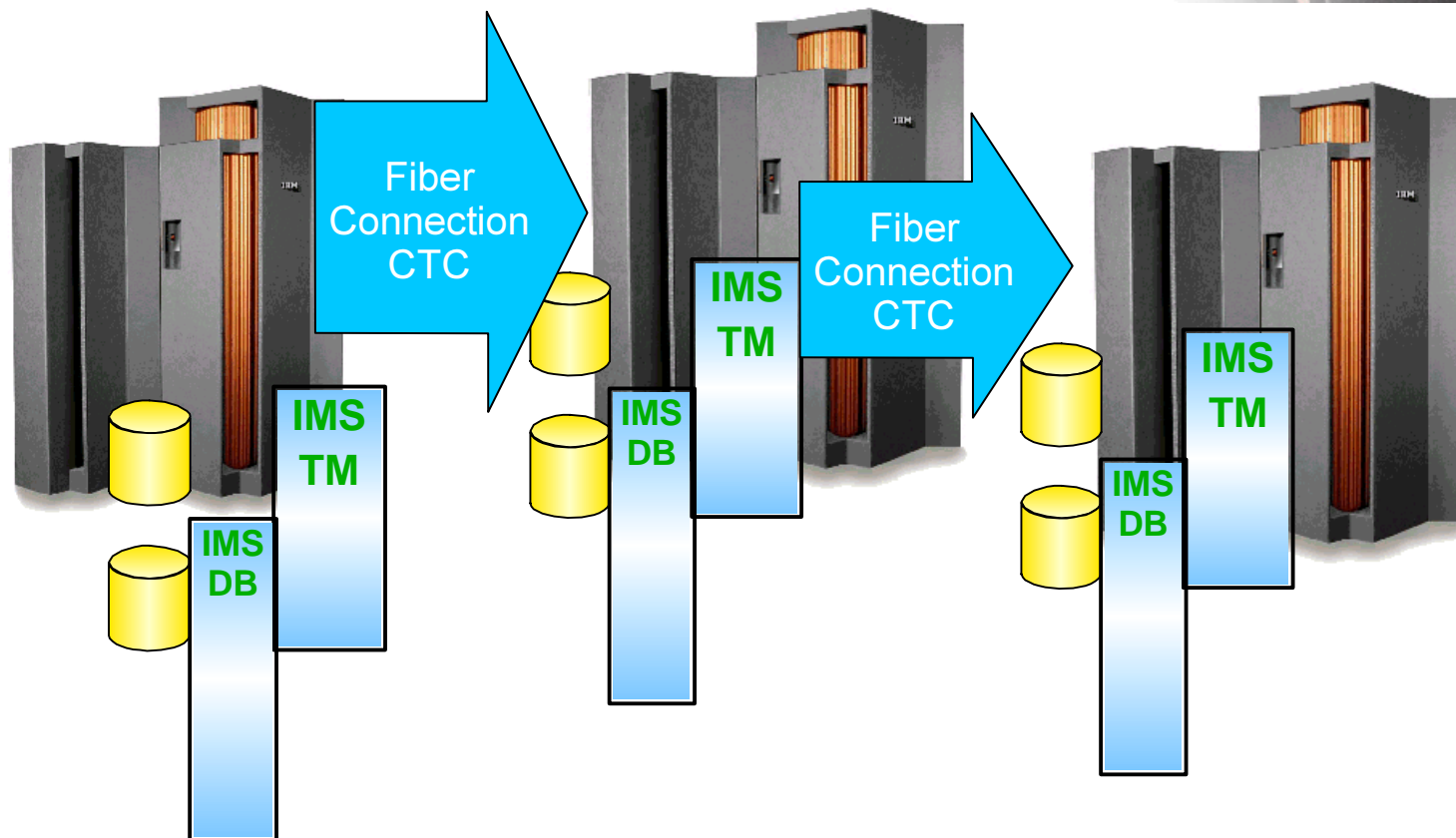

Providing Reliable, High Bandwidth Host-to-Host Communications Support between IMS systems.

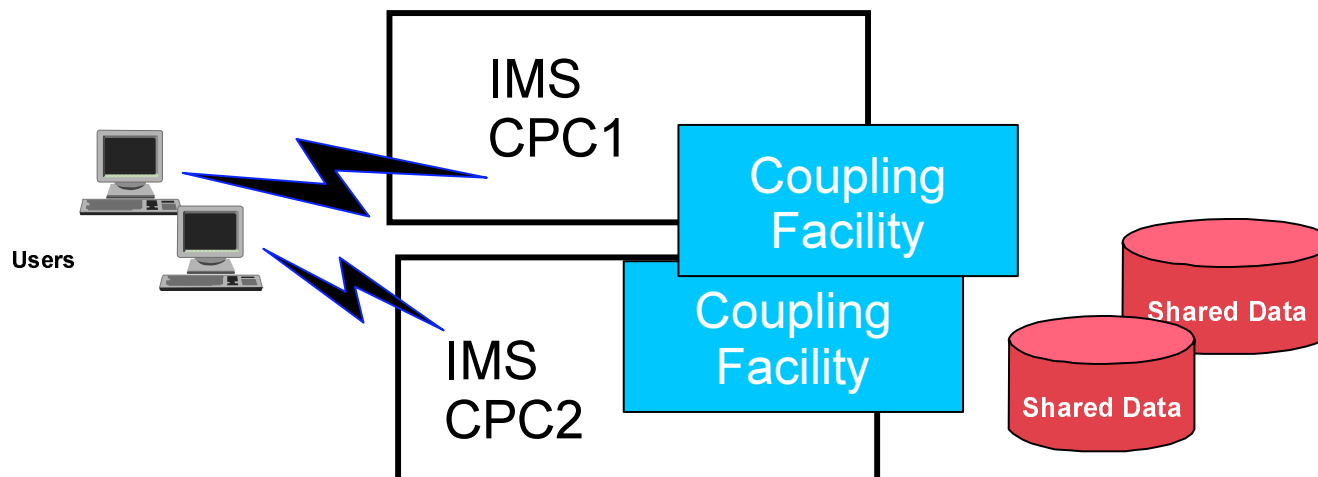

- ▶ CF Duplexing for IMS Shared Queues and Fast Path Expedited Message Handler (EMH)
- ▶ CF Duplexing for IMS Data Sharing through IMS Resource Lock Manager (IRLM)
- ▶ IMS Fast Path Virtual Storage Option (VSO) CF support
  - ▶ System Managed Duplexing
  - ▶ Automatic Altering
  - ▶ System Managed Rebuild

# VSO CF Enhancement Support



## ► Provide support for Coupling Facility capability enhancements:

### ■ System-Managed Rebuild

- Rebuild a VSO structure from one CF to another for planned reconfiguration without taking it off-line
- Does not support rebuild for loss of connectivity, structure or coupling facility failure cases
- All structures in a coupling facility can be migrated using one single command

### ■ Auto Alter

- Dynamically expand or contract a VSO structure size or element-to-entry ratio at a system event, based upon its actual storage usage
- Over-configured coupling facility storage can be reclaimed when OS/390 needs coupling facility storage

### ■ System-Managed Duplexing

- Allow dual VSO structure support without explicitly defining both primary and secondary structures in DBRC and in a CFRM policy
- Automatically switch to Simplex mode from Duplex mode when a loss of connectivity, a structure failure or a coupling facility failure occurs in one of the VSO structure instances.

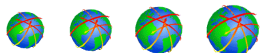

# VSO CF Enhancement Support ...



## ► Software and Hardware Requirements:

- System-Managed Rebuild
  - OS/390 V2R10
  - CF Level 9
  
- Auto Alter
  - OS/390 V2R10
  - CF Level 9
  
- System-Managed Duplexing
  - zOS/1.2
  - CF Level 10
  - CF-to-CF links (e.g. Hiper link, ICB link, IC link, etc.)

# IMS Java for Integrated e-business Application Development



- ▶ Application programmer productivity
  - Java access to IMS input/output message queues
  - JDBC to access IMS DB and DB2 data
  - Java Compiler support
  - Uses VisualAge tools for development



# New Java Dependent Region Types



## ▶ New Environment

- ▶ IMS TM with JVM -- no HPJ needed!
- ▶ Two new IMS dependent region types
  - ▶ JMP, JBP using the resetable JVM
    - Use is no different for user
    - JDK 1.3.1S (JDK 1.3 with Persistent Reusable JVM)
    - Environment Variables (no more hardcode during compile)

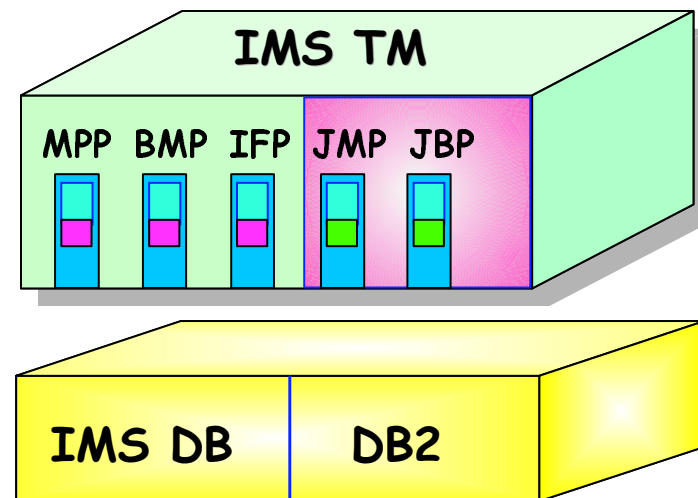

# OS/390 (z/OS) WebSphere Application Server (Using IMS V7 Java JDBC Interface)

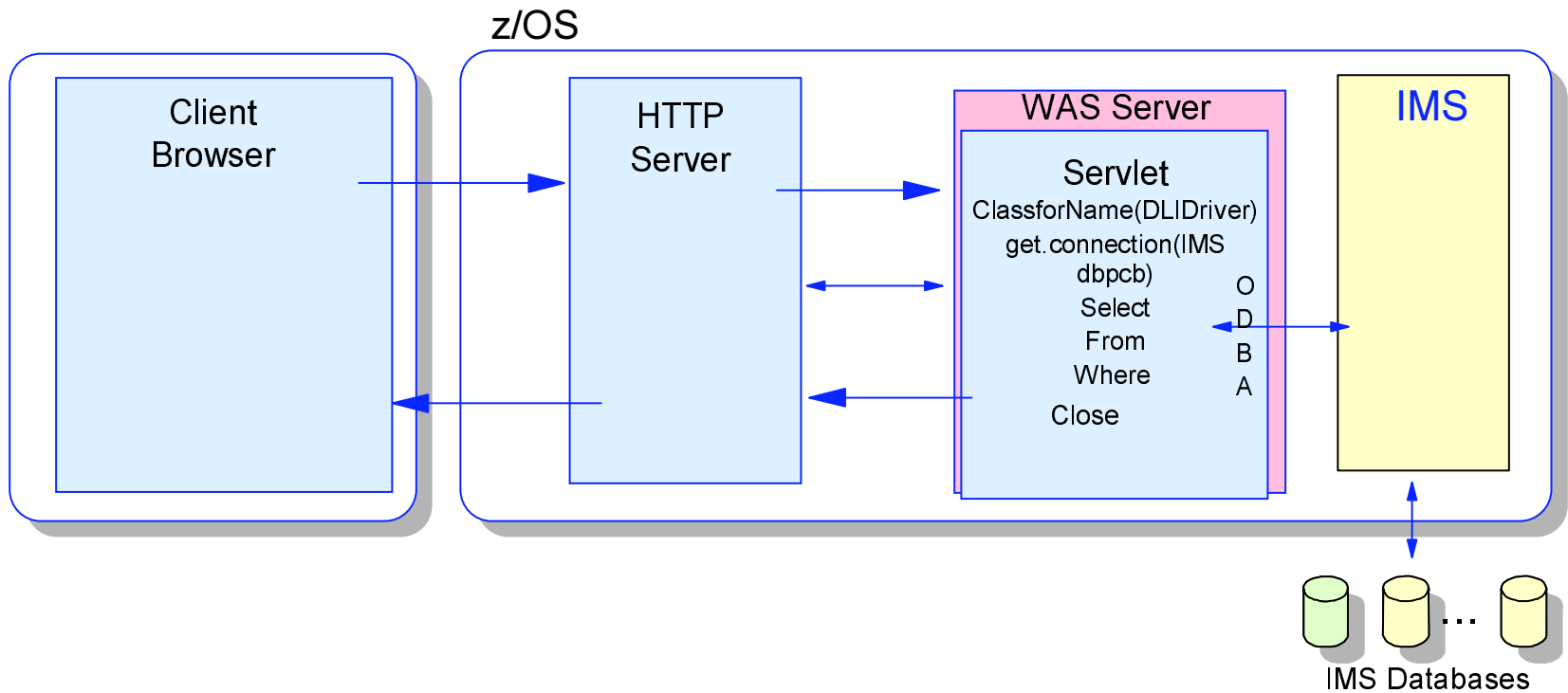

*Providing OS/390 WebSphere Application Server JDBC  
access to IMS DB resources*

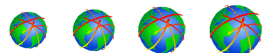

IMS - the world depends on it!



# The Big Picture: JDBC Access to IMS Data

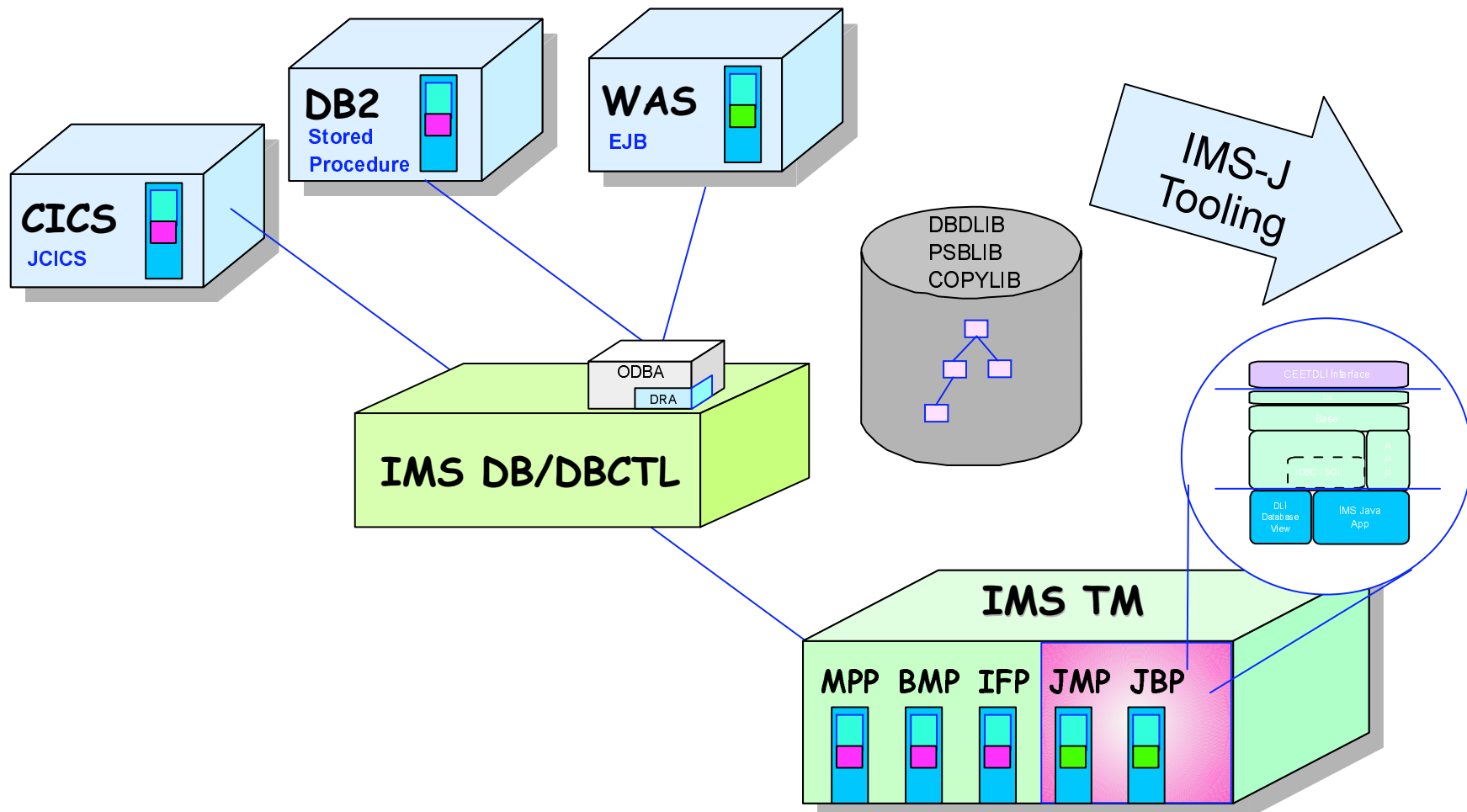

```
"SELECT CheckingAcct.Balance, SavingAcct.Balance,CheckingAcct.Name" +
"FROM MyBankPCB.Accounts " +
"WHERE CheckingAcct.Balance > 10000" +
"AND SavingAcct.Balance > 20000 "
```

# Batch RRS Support



- ▶ Allows batch programs to use MQ with coordinated commit
- ▶ Provides for a full two phase commit for batch programs accessing DB2 and IMS DB
  - ▶ Today's Batch Attach from DB2 does not support coordinated commit
- ▶ Allows for work which captures data and propagates it to another system (ex. DPROP for IMS -> DB2) to participate in the 2-phase syncpoint process

# New/Enhanced IMS Tools since IMS V7 GA

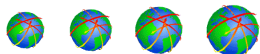

# New/Enhanced IMS Tools (Listed by Type)



## Database Administration Tools

- ▶ IMS Database Control Suite V2
- ▶ IMS Command Control Facility
- ▶ IMS High Performance Sysgen Tools
- ▶ IMS MFS Reversal Utilities
- ▶ IMS High Performance Pointer Checker Enhancements
- ▶ IMS Fast Path Online Tools V2

*In Addition To  
Tools  
Available in  
2000*

## Recovery & Replication Management Tools

- ▶ IMS Image Copy Extensions (ICE) Enhancements
- ▶ IMS Online Recovery Service

## Performance

- ▶ IMS Dynamic Resource Control Facility V1 R2
- ▶ IMS Workload Router V2 R2

## Application Management

- ▶ IMS Connect Enhancements

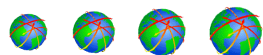

# New/Enhanced IMS Tools (Listed by GA Date)



## January 2001

- ▶ IMS Command Control Facility
- ▶ IMS High Performance Sysgen Tools
- ▶ IMS MFS Reversal Utilities

## March 2001

- ▶ IMS Dynamic Resource Control Facility V1 R2
- ▶ IMS Workload Router V2 R2

## April 2001

- ▶ IMS Online Recovery Service

## May 2001

- ▶ IMS HP Pointer Checker Enhancements
- ▶ IMS Image Copy Extensions Enhancements
- ▶ IMS Connect Enhancements

## June 2001

- ▶ IMS Database Control Suite V2

## July 2001

- ▶ IMS Fast Path Online Tools V2
- ▶ IMS Database Repair Facility Enhancements

***In Addition To  
Tools  
Available in  
2000***

# Administration...



*NEW Tools*

## IMS Database Control Suite

- ▶ Supports IMS Base Utilities and Data Management IMS Utilities
- ▶ Intuitive, easy to manage, task-oriented design saves time and increases DBA productivity

## IMS Command Control Facility

- ▶ Processes IMS commands across all regions in a sysplex using the batch command processor
- ▶ Executes IMS Commands from a batch utility or from a TSO session via an ISPF interface
- ▶ Synchronizes Online Change and database commands across all regions in a Sysplex

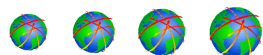

IMS - *the world depends on it!*





*NEW Tools*

## IMS High Performance System Generation Tools

- ▶ Perform IMS sysgens for application resource changes (transactions, programs, databases and route codes) in a single job step -or online
- ▶ Create and maintain IMS Sysplex sysgen configurations

## IMS Message Format Services Reversal Utilities

- ▶ Convert Message Format Services MID/MOD/DIF/DOF control blocks back into Message Format Services utility control statements
- ▶ Compare Message Format Services source libraries

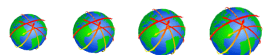

*NEW  
Functions*

## IMS High Performance Pointer Checker

- ▶ Performance and report improvements delivered via PTF UQ52963
  - ▶ Space Monitor Feature new Threshold values
    - ▶ Number of Available extents
    - ▶ CA and CI splits
    - ▶ Last extent of dataset
    - ▶ Last space on volume
  - ▶ HD Pointer Checker
    - ▶ Single step Hash Check for ICE

## IMS Fast Path Online Tools Ver 2

- ▶ Online Pointer Checker support
- ▶ Online Data Extract
- ▶ Pointer Checker output can be used by IMS Fast Path Online Reorg Utility

**NEW  
Functions**

## IMS Image Copy Extensions

- ▶ New Function via PTF UQ52882:
  - ▶ Allows the user to compress output and do HASH pointer checking on Fast Path and full function IMS Databases in a single Job Step

## IMS Online Recovery Service

**NEW  
Tool**

- ▶ Recovers databases and Fast Path Areas using either complete or incomplete Change Accumulation and Image Copies
- ▶ Applies Fully Function Database and Fast Path Area changes simultaneously in single pass of IMS log data sets
- ▶ Performs time stamp forward recovery
- ▶ Starts databases and areas automatically after recovery

# IBM IMS Online Recovery Service

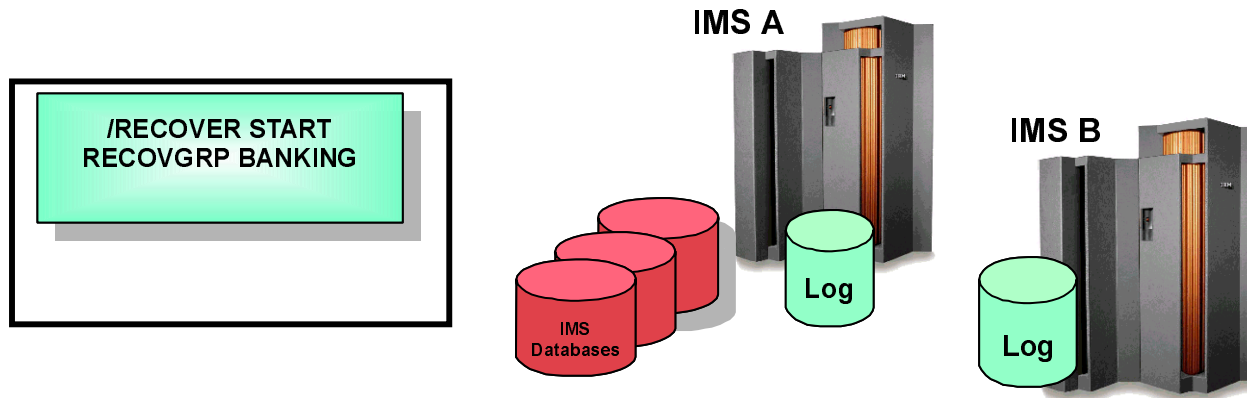

- ▶ **Increased performance in recovery situations**
  - ▶ Reduce the time that critical databases are unavailable
- ▶ **Increased flexibility in recovery options**
  - ▶ Perform 'logical recoveries' - true Point-In-Time recovery
- ▶ **Increased simplicity of the recovery process**
  - ▶ IMS manages the recovery
- ▶ **Additional enhancements to ORS V1R1 since GA**
  - ▶ Stacked image copy support
  - ▶ Compressed Image copy support
  - ▶ Stacked log data set support

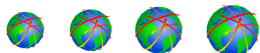

IMS - the world depends on it!



**NEW  
Release**

## IMS Dynamic Resource Control Facility V1R2

- ▶ **IMS Version 7 support**

## IMS Workload Router V2R2

- ▶ **IMS Version 7 support**

# Application Management...



## IMS Connect V1R1 Enhancements

- ▶ Local Support
- ▶ Unicode Support
- ▶ ACK/NAK required notification support
- ▶ Output message structure change

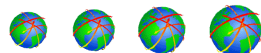
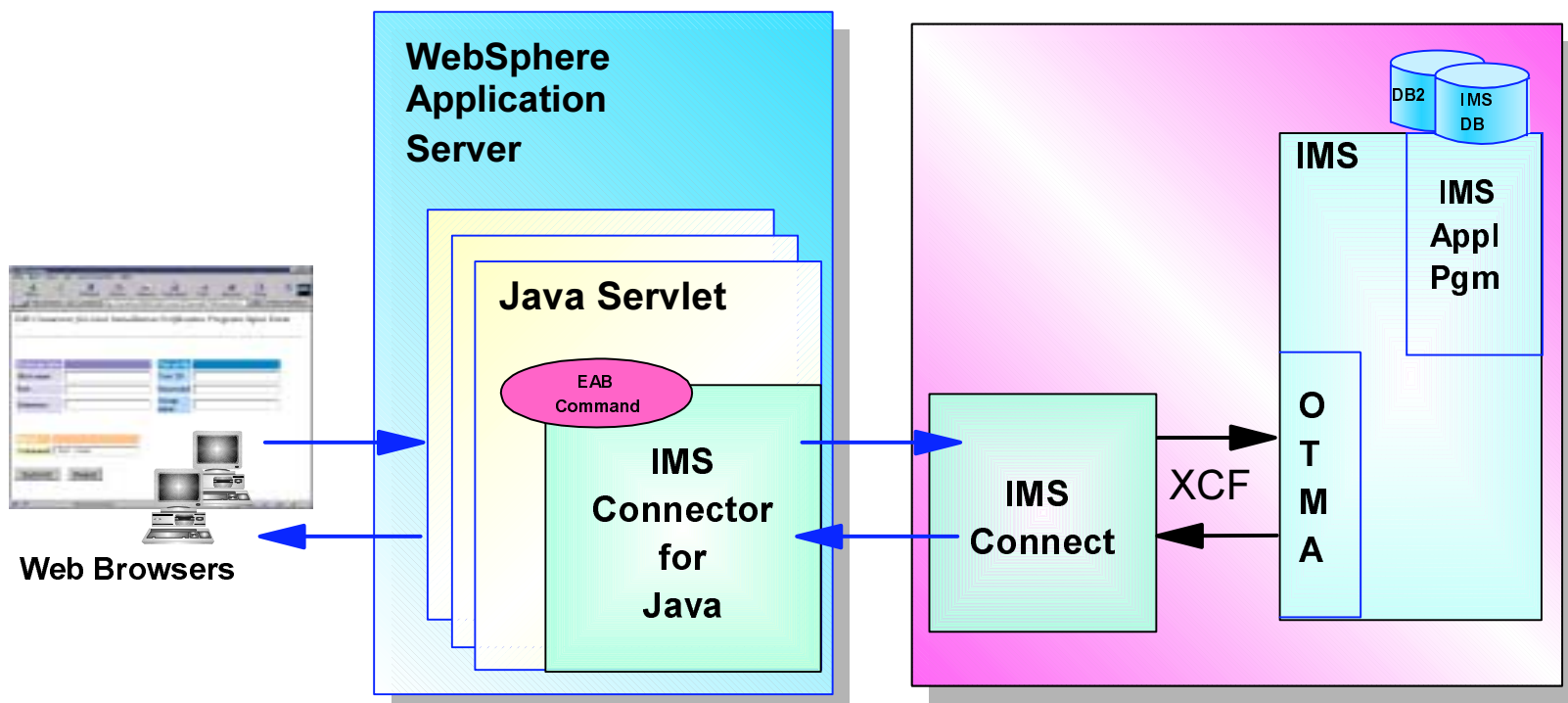

IBM

# September IMS Tools Announcement



W.W.



e  
Business

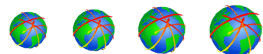

IMS - the world depends on it!



© Copyright IBM Corporation 2001



# Newly Announced/Enhanced IMS Tools



## Database Administration Tools

- ▶ IMS High Performance Change Accum for z/OS
- ▶ IMS Fast Path Basic Tools for z/OS V2.1
- ▶ IMS Extended Terminal Option for z/OS V2R2
- ▶ IMS Parallel Reorganization for z/OS V2R1

## Recovery & Replication Management Tools

- ▶ IMS DataPropagator for z/OS V3R1

## Performance

- ▶ IMS Network Compression Facility for z/OS

## Application Management

- ▶ IMS Connect V1R2 (J2EE Runtime support)
  - ▶ VAJava's IMS Connector for Java J2EE Development Support

# IMS DataPropagator V3



- ▶ Decision Support - Data Warehouse
  - User access to stable data
  - Propagate only data of interest
  - Exploit relational query tools
- ▶ Application coexistence
  - Two masters with applications in both systems accessing data
  - Data in both systems synchronized
- ▶ **IMS DPROP V3** offers :
  - Asynchronous near real-time propagation improves performance
  - Operations/administration simplified/less error prone use
  - A new capture component captures the IMS database changes performed by IMS Batch, IMS BMP, and IMS TM application programs

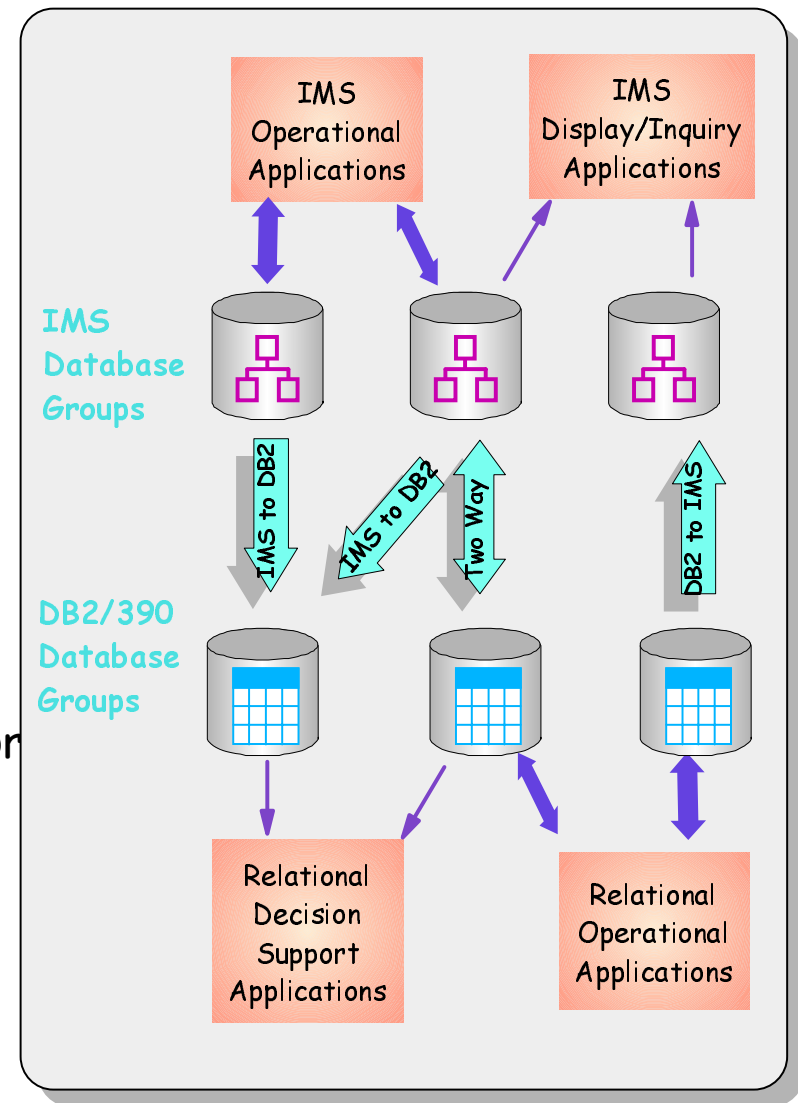

# Asynchronous, Near Real-Time IMS-to-DB2 Propagation

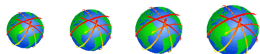
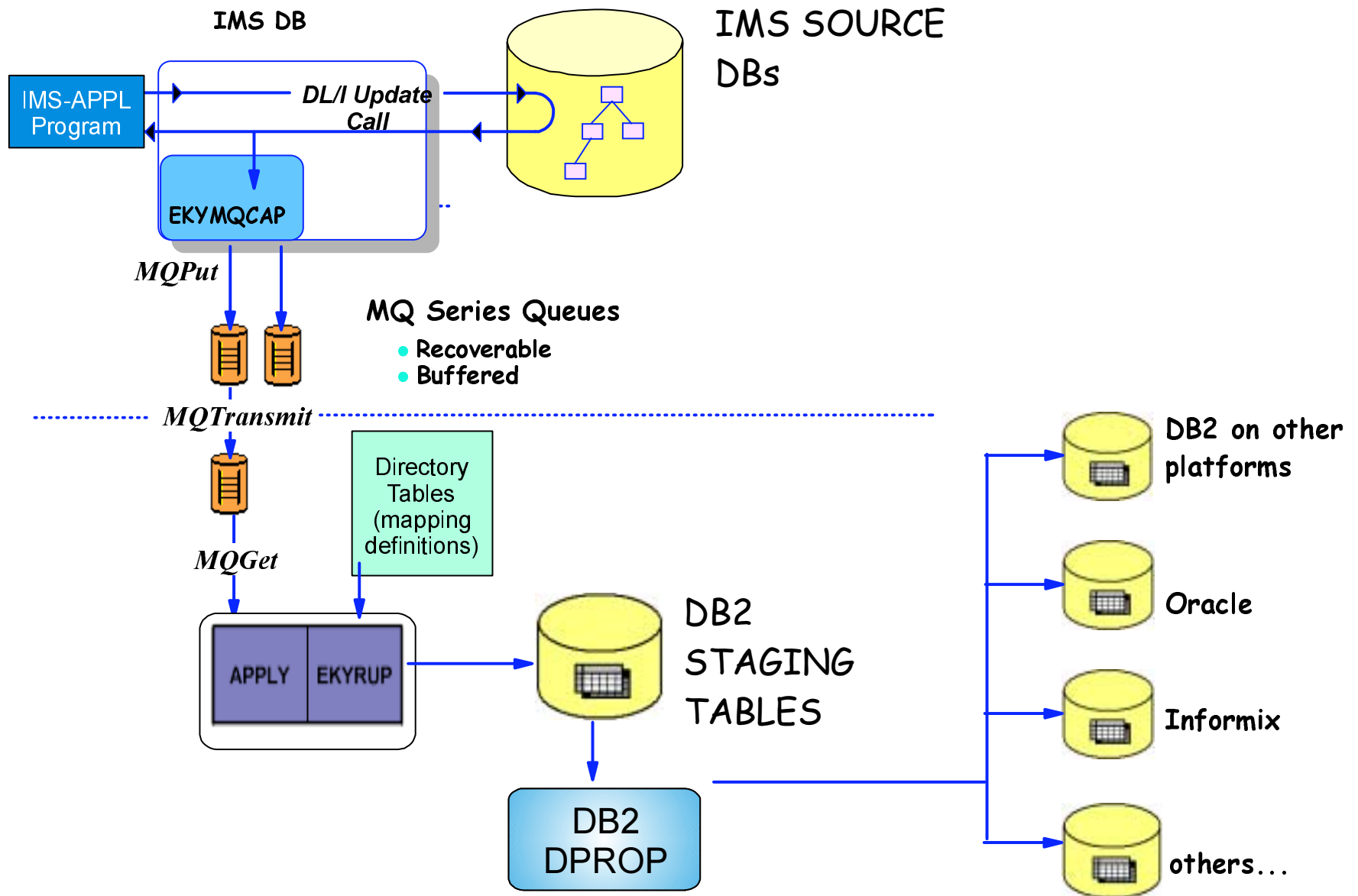

# Insurance Industry Example

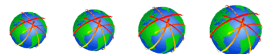
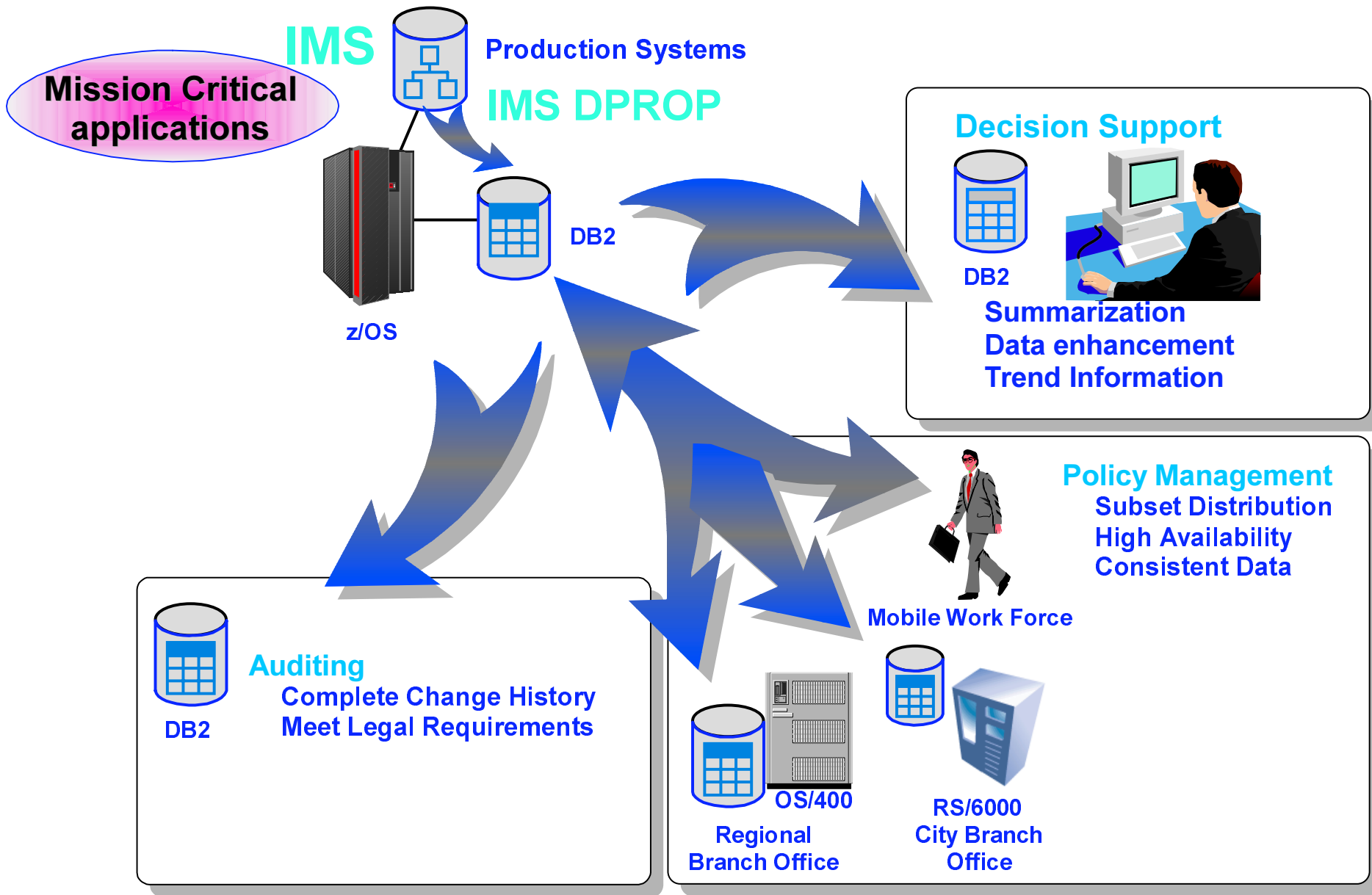

# IMS Connect V I R2 Enhancements



- ▶ Incorporation of the IMS Connector for Java J2EE Runtime support
- ▶ Used with VAJava's IMS Connector for Java J2EE Development support
- ▶ EJB Support (2 Phase Commit for z/OS WebSphere)

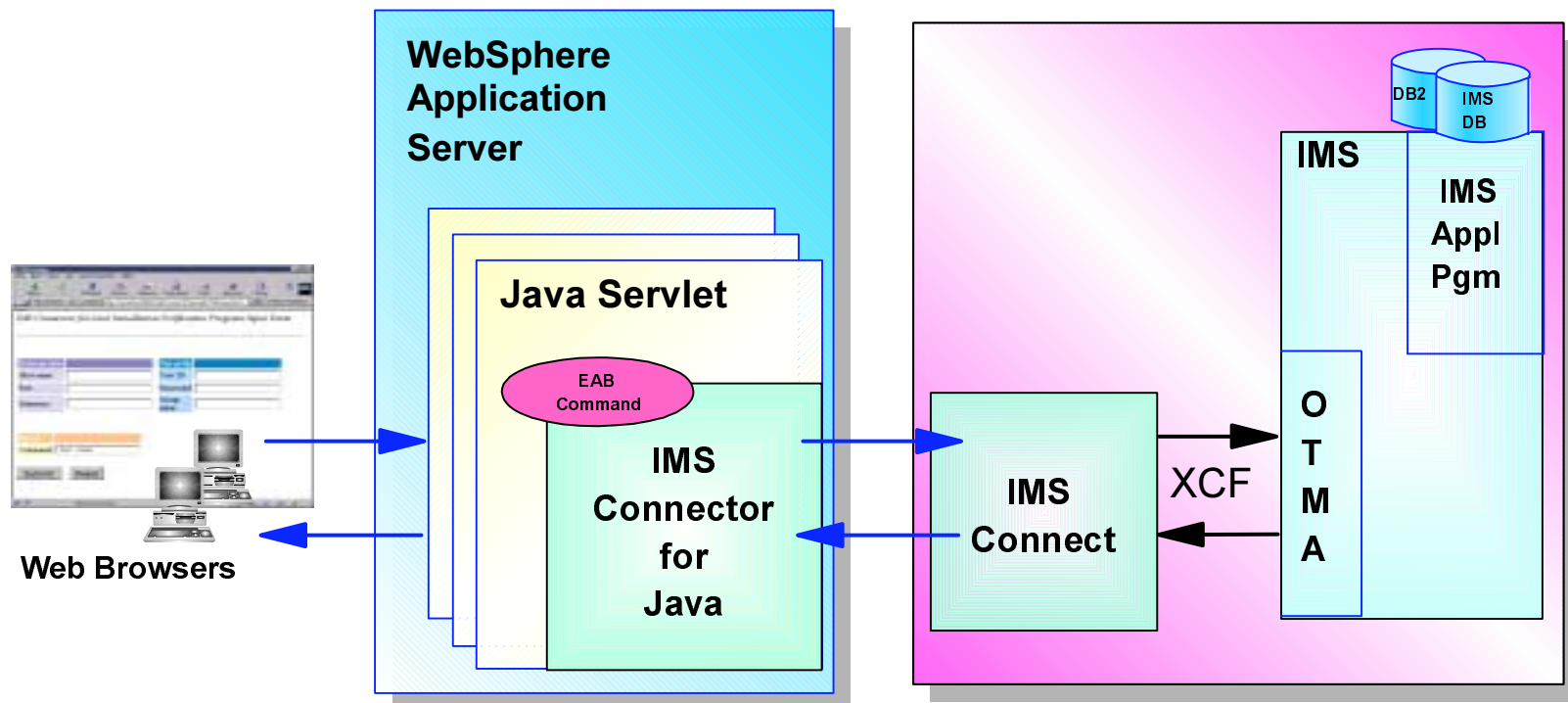

# Leveraging IMS Applications and Data

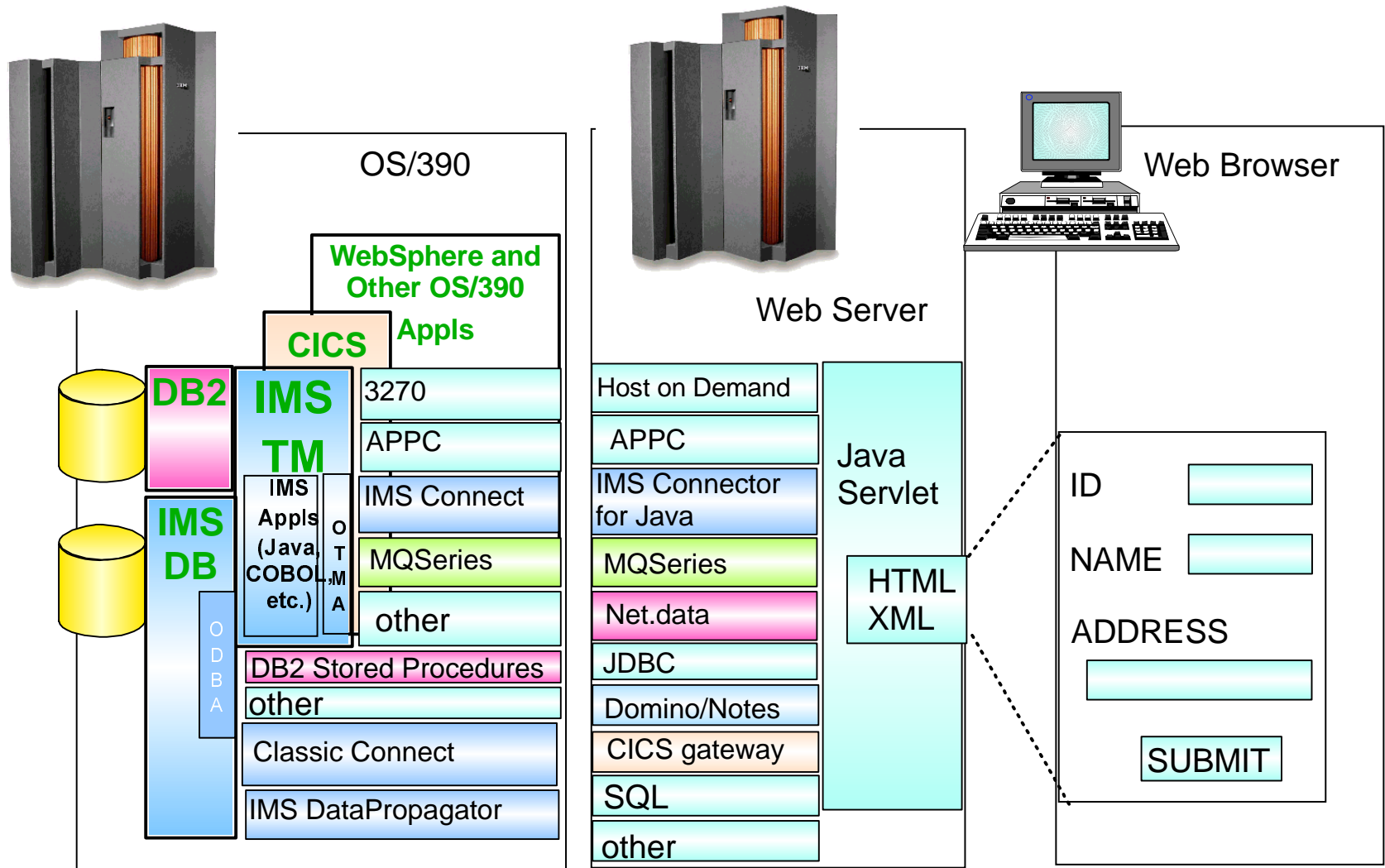

## September 2001

- ▶ IMS Network Compression Facility for z/OS

## October 2001

- ▶ IMS DataPropagator for z/OS V3.1

## November 2001

- ▶ IMS Connect for z/OS V1.2
- ▶ IMS Fast Path Basic Tools for z/OS V1.2

## December 2001

- ▶ IMS High Performance Change Accumulation Utility for z/OS
- ▶ IMS Extended Terminal Support for z/OS V2.2

# IMS and XML

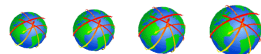



- ▶ Processing XML Documents in New IMS Applications **Today**
  - ▶ Customers can write IMS C++ or IMS Java applications using the XML Toolkit for OS/390
    - ▶ Tran code still must be EBCDIC, rest of data can be XML
    - ▶ Java/C++ program can invoke XML parser to convert to non-tagged data
- ▶ Bridging XML and Existing IMS Applications Today
  - ▶ Using MQSeries Integrator
    - ▶ Dictionary support for messages
    - ▶ Routing and processing based on message content
    - ▶ US Utility built cost-effective e-business infrastructure to IMS
- ▶ XML and IMS Requirements
  - ▶ Processing XML Documents in new/changed IMS COBOL and PL/I applications using the XML Toolkit for OS/390
  - ▶ Supporting SOAP(Simple Object Access Protocol)-compliant XML documents for Industry tooling and evolution to Web Services
  - ▶ Transforming XML for existing IMS applications using Web Server and/or IMS Connect
  - ▶ Using XML as an IMS Data Definition language

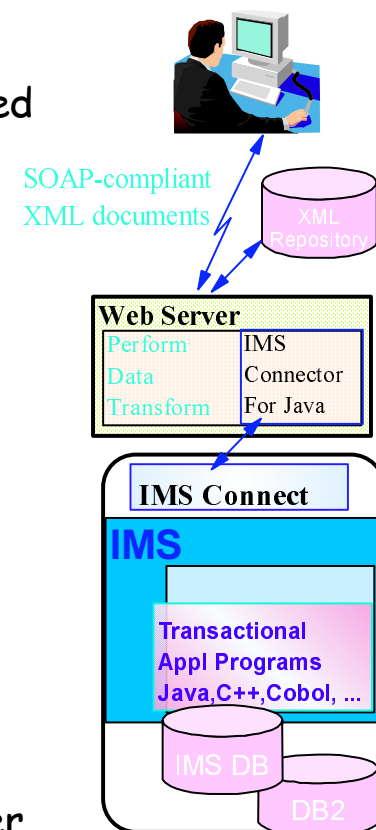

IBM

# What's Coming Next



WWW

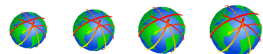

IMS - *the world depends on it!*



# Next Steps in IMS Providing Integrated e-business Solutions

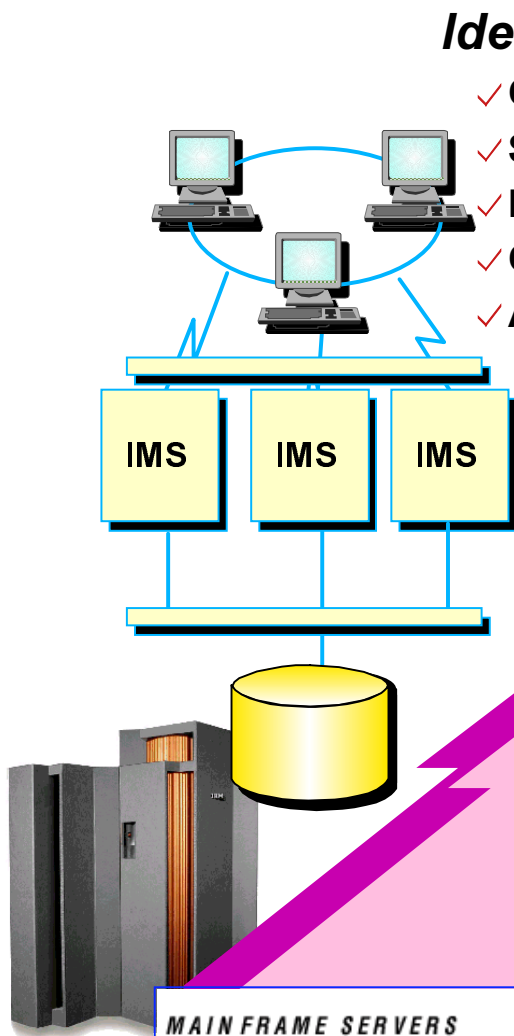

## *Ideal for e-business*

- ✓ Continuous Availability
- ✓ Systems Management
- ✓ Performance/Capacity
- ✓ Connectivity
- ✓ Application Development

## *Enhancements*

- Sysplex Terminal Management
- Sysplex-wide Resource Mgmt
- Sysplex-wide Operations with Single Point of Control
- Enhanced DB Recovery Ctrl
- Simplified Installation Process
- Enhanced Systems/Data Mgmt Tools
- Enhanced XML

## *Benefits*

- ✓ Enable Customer Growth
- ✓ Enhance Workload Balancing
- ✓ Increase Availability; Ease of Use
- ✓ Preserve Current Application Investment
- ✓ Enable New Applications

MAIN FRAME SERVERS

IBM *e*server zSeries

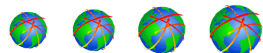

IMS - the world depends on it!



# Reference

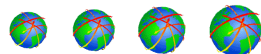

# Reference



IMS V7 Enhancements	Available in
<b>64-bit Real Support</b>	
IMS V7 Toleration	GA tape
OSAM/Log buffers above 2GB bar	PQ42127
Fast Path storage above the 2GB bar	PQ51419
250 OSAM Database Buffer Subpools	PQ41126
<b>Additional Sense Codes/Message Information</b>	
Providing Signon screen after LUSTAT x"082b'	PQ42530
Including the TCP/IP address in IMS messages	PQ41143
<b>Sysplex Restart with DB2 MVS group support</b>	PQ42180
<b>High Availability Large Database (HALDB) performance and management enhancements</b>	
Secondary index migration to HALDB	PQ37015
ILDS creation in HD Reload Utility	PQ36991
DFSMAIDO	PQ37127
Recon Partition List Command support	PQ38822
Batch command initialization of HALDB and associated partitions	PQ35893 PQ44468
Unconditional HALDB Partition Initialization	PQ49638
<b>JDBC access to IMS DB from CICS/390 and DB2/390 environments</b>	Coming
System Log Data Set (SLDS) Read Support	PQ50657
Add System-Managed Rebuild, System-Managed Duplexing and Auto Alter Support to Shared VSO Structures	PQ50661

ORS Enhancements	Available in
Stacked image copy support	PQ42443, PQ46522, PQ47471, PQ51623
Compressed Image copy support	PQ47216
Stacked log data set support	PQ45321

IMS Connect 1.1 Enhancements	Available in
Local Support	PQ45057, VAJ 3.5.3 + JR15813
Unicode Support	PQ47906
ACK/NAK required notification support	PQ46195
Output message structure change	PQ48182

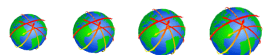

IMS - the world depends on it!



# What's New with IMS Since General Availability of IMS V7

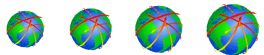

IMS - the world depends on it!

