



IMS Version 8

Barbara Klein
bk@us.ibm.com

The IBM Information Management System (IMS) is unsurpassed in database and transaction processing availability and speed. With the demands of the evolving e-business environment, and a marketplace working in Web time, IMS delivers the integrity, capability, and performance customers have learned to expect from IBM.

IBM is enhancing the IMS Database Manager (IMS DB) and the IMS Transaction Manager (IMS TM) with IMS Version 8 (V8), which enables you to shape how you:

Transform the way you do business with integrated information

Build e-business applications that tolerate the rigors of doing business on the net

Run a scalable, available, safe, and easily manageable environment

Leverage everything you learn in the process, and mine all your information to make better decisions

IMS V8 TM continues as IBM's premier transaction server for environments that employ relational and hierarchical data stores and require the utmost in integrity, capacity, availability, and performance for e-business and enterprise computing environments.

IMS V8 DB continues as IBM's premier hierarchical database server to provide and enhance high performance/capacity, superior integrity, and continuously available database management solutions for IMS TM and CICS users.



e-business

IMS Continues to Address Challenges of a Rapidly Changing World

Providing Quality through

- **Information Integration with New Application Development/Connectivity**
 - ✓ Ease/broaden user access
 - ✓ Web, Java, XML and Linux access
 - ✓ Ease application developer effort
 - ✓ Auto-application-generation tools
- **Manageability**
 - ✓ Ease installation and operations efforts
 - ✓ High levels of security
 - ✓ End-to-end transaction integrity
 - ✓ Real time data currency
 - ✓ Highest code quality
- **System Scalability in Performance/Capacity/Availability/Recovery**
 - ✓ Handling increasing workload
 - ✓ Handling unpredictable volumes
 - ✓ More hours for workload
 - ✓ Continuous up time for applications and user access
- **e-business with IMS extends the investment**



© Copyright IBM Corporation 2003

IMS meets extreme IT needs for e-transaction processing with the ultimate in performance/capacity, availability and systems management and technological leadership in connectivity and new application development.

IMS along with the S/390 and the zSeries have been delivering on the promise of e-business and continue to do so with new enhancements for e-transaction processing bandwidths capable of supporting the largest web sites and transaction rates through GB ethernet. Fiber connection technology and industry leading webserving with IMS and the IBM WebSphere Application Server, Security and Communications Servers. A balanced system is provided for world class solutions. IMS together with the S/390 and zSeries are delivering more comprehensive security protection, featuring centralized management and a strong suite of end-to-end products. We continue to provide and enhance our leading edge end-to-end transaction integrity and real time data currency with the sharing of data, networks, and messages, utilizing the sysplex and its coupling facility. Our technology transition from bipolar to CMOS had allowed us to deliver exponentially improving price/performance to our customers. Customers are using this power to take on new e-business related applications.



IMS Version 8: Providing Integrated e-business Solutions



e-business

the world depends on it

Ideal for e-business

- ✓ Integration with Application Development/Connectivity
- ✓ Manageability
- ✓ Scalability in Performance, Capacity, and Availability

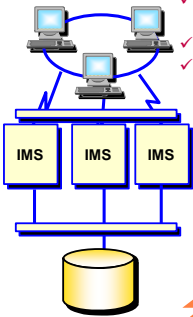

Enhancements

- Sysplex Terminal Management
- Sysplex-wide Resource Mgmt
- Sysplex-wide Operations with Single Point of Control
- Enhanced DB Recovery Ctrl
- Simplified Installation Process
- Enhanced Systems/Data Mgmt Tools
- Enhanced JAVA and XML16

Benefits

- Enable Customer Growth
- Enhance Workload Balancing
- Increase Availability; Ease of Use
- Preserve Current Application Investment
- Enable New Applications

Strategic Open Access S/390 Enterprise Servers



© Copyright IBM Corporation 2003

With IMS V8, IMS is focused on further strengthening its support as the e-business Server of choice. This is in support of IBM's Strategy for helping customers in their e-business enablement and the growth, availability, and systems management that the e-business environment requires. IMS focus thus is on providing Information Integration with open access and supporting tools for the e-business environment, continually improving, systems management/usability, and system scalability with increased availability, performance and capacity. With V8 IMS is delivering the next stage of this function.

IMS has been providing support as an e-business Server with improvements in data, workload, and network sharing. IMS V8 provides more transparent Sysplex Terminal Management to enhance e-business availability.

Systems Management too has been a key area with IMS customers in managing their e-business servers. IMS has focused traditionally on ensuring a single system image. IMS provided workload management information and support of VTAM's Generic resources to help with the balancing of work across the Sysplex. IMS is providing additional e-business Server management enhancements with Sysplex-wide Resource Management, Sysplex-wide Single Image Operations, Simplified System Definition and Improved Diagnostics.

IMS is also providing continued enhancements to eliminate bottlenecks and impediments to growth. Java is a key area for new application development. IMS Java support and the IMS Connector for Java provide Java application development/execution in IMS and in applications/servlets accessing IMS. These IMS Java enablers utilize the VAJava development tools. IMS V8 is providing enhanced performance for this environment, and providing better integration with the VisualAge and WebSphere development tool set.

New Technology as it evolves with XML continues to be exploited to enable new Application Development tooling. IMS is forging a strong alliance with the AD community to provide an integrated tool solution for enhancing support for IMS Java applications and connectivity to the Internet.

Additional Systems/Data Management and Business Intelligence tools are also being provided to better integrate and ease use of IMS as an e-business server. As tooling evolves we will continue to take advantage of the latest technologies for our customers to enhance their ability to use our products with these tools.

In addition we continue to provide whatever we can for education and usability of our products. We are planning major changes to the way our users use our information through a graphical Information Center that they can use to build their own custom books.



IMS V8 Database Manager Enhancements

Information Integration with Appl. Devt and Connectivity

- Java and XML enhancements
- Dynamic LE Runtime Parameters

Manageability

- Coordinated Online Change
- Single Image Operations Manager
- Syntax Checker
- Fast Path Shared VSO CF enhancements

Scalability in Availability/Recovery/ Performance/Capacity

- IMS/DB2 Coordinated disaster recovery support
- DBRC Enhancements
- DB Image Copy 2 Enhancements
- Parallel Database Processing
- Fast Path DEDB Enhancements
- CSA/VSCR Enhancements



© Copyright IBM Corporation 2003

IMS V8 Database Management enhancements include:

Enhanced application development and connectivity with Java and XML

Improved availability in database restart and recovery

Increased performance/capacity in logging, recovery, and in database size

Improved manageability with single point of operations control and concurrent online change for the sysplex, and in easing systems generation.



IMS V8 Transaction Manager Enhancements

Information Integration with Appl. Devt and Connectivity

- Java and XML enhancements
- Dynamic LE Runtime Parameters

Manageability

- Sysplex Wide Resource Manager
- Coordinated Online Change
- Single Image Operations Management
- Sysplex Terminal Mgmt
- Transaction Trace
- Syntax Checker

Scalability in Availability/Recovery/Performance/Capacity

- APPC/OTMA Synchronous Shared Queues support
- APPC enhancements
- CSA/VSCR enhancements

© Copyright IBM Corporation 2003

IMS V8 Transaction Management enhancements include:

Enhanced application development/execution and connectivity with Java and XML

Improved systems availability in error handling and network reconnection

Increased performance/capacity in routing and in workload balancing

Improved manageability with single point of operations control and concurrent online change for the sysplex, and in easing systems generation

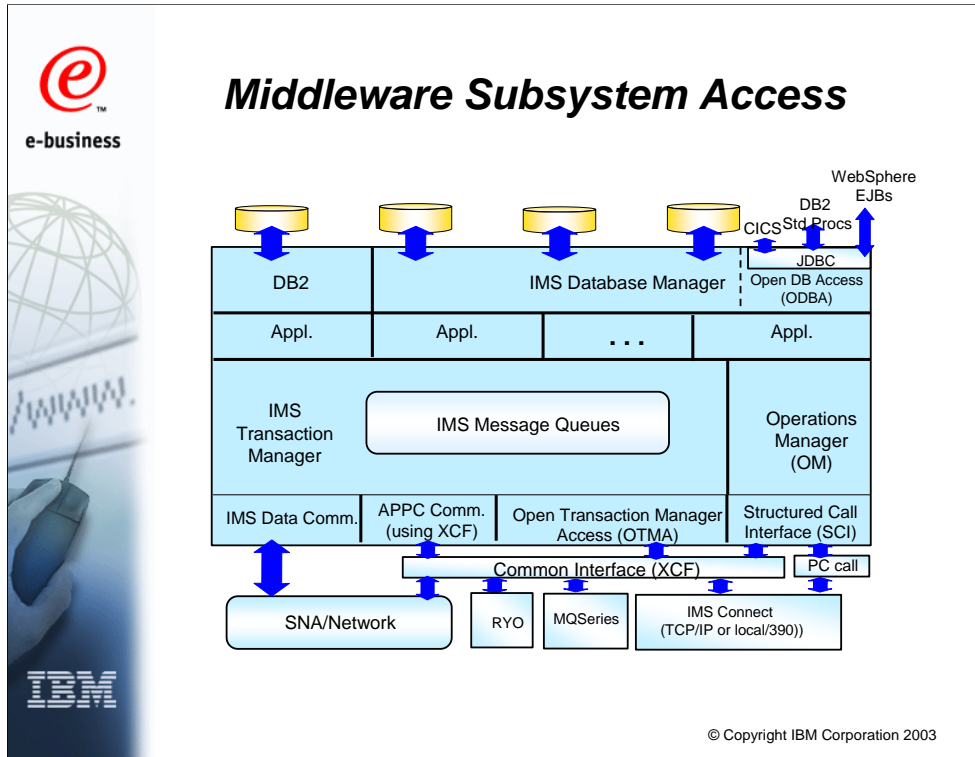

Traditionally messages come into IMS through its SNA data communication protocol from VTAM. With APPC/IMS support in Version 4, IMS took advantage of the new Cross Coupling facility (XCF) to communicate with APPC/MVS. This was a software facility that allowed MVS subsystems to communicate more efficiently. With the IMS Version 5 Open Transaction Management Access (OTMA) facility, IMS extended its use of XCF for use by other IBM subsystems, such as TCP/IP, MQSeries, and DCE/RPC, providing them more efficient and richer capabilities in accessing IMS. OTMA allows access to existing, unchanged IMS applications on any IMS TM system on any MVS system of an MVS sysplex as well.

The Open Database Access facility (ODBA), for easier database access, has also been provided.

With IMS Version 8, IMS extended its use of XCF for use by other IBM subsystems, such as IMS Connect, for distributed operations access through the Structured Call Interface to the Operations Manager from the DB2 Version 8 Control Center as a single point of control.



Integrated/Open Access with IMS e-business Application Development/Enablement Solutions

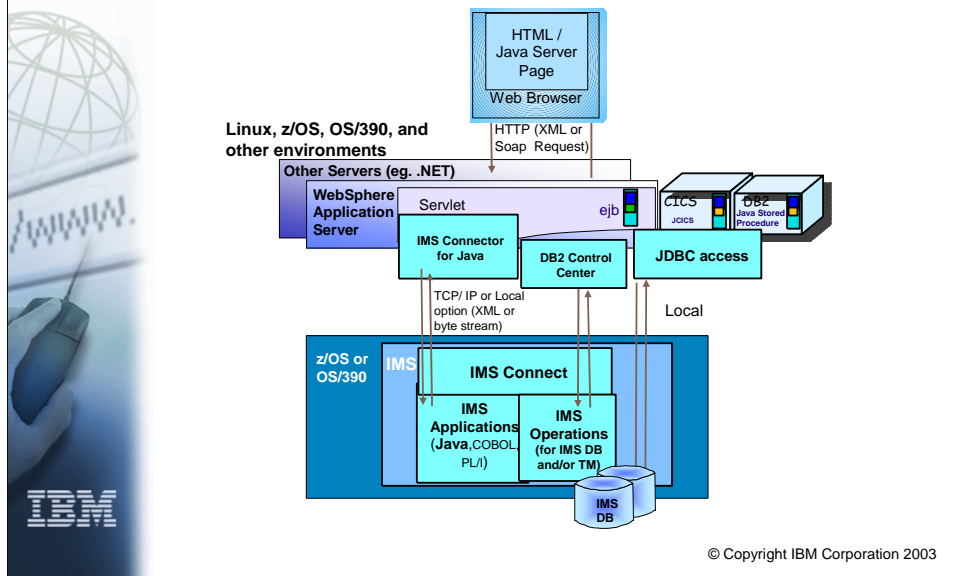

© Copyright IBM Corporation 2003

For application and information integration and for operational integration IMS is exploiting the latest programming technologies for the Internet and Java. This includes enablement of interactive and multimedia applications in a simplified fashion. With the industry standard, open interfaces of Java, users can transparently download and seamlessly run applications. It is becoming widely used and is platform independent.

IBM initially provided a common connector framework and subsequently supported the industry standard J2EE with a set of common, consistent Java interfaces that connectors for any subsystem can and are implementing, making it easier for programmers not to worry about the differences between those subsystems. For such, IMS has provided IMS Connector for Java development code in WebSphere Studio Application Developer Integration Edition for development. IMS has also provided IMS Connector for Java runtime code in IMS Connect for access to IMS applications and data. By being compliant with the connector standards, IMS Connector for Java can be used in component server environments that support the standard.

This shows the runtime environment of a Java Servlet Application (running under OS/390, z/OS, Linux or another environment). When a user executes the application and provides the appropriate input data, IMS Connector for Java within the Java Application establishes a connection with IMS Connect through a TCP/IP (or Local Option, if in the same LPAR as Connect) connection. IMS Connect, running under OS/390 or z/OS can run in the same or separate LPAR from IMS. It will forward the transaction request to the IMS application through the IMS OTMA (Open Transaction Manager Access) interface, using MVS XCF (Cross-system This shows the runtime environment of a Java Servlet Application (running under OS/390, z/OS, Linux or another environment). When a user executes the application and provides the appropriate input data, IMS Connector for Java within the Java Application establishes a connection with IMS Connect through a TCP/IP (or Local Option, if in the same LPAR as Connect) connection. IMS Connect, running under OS/390 or z/OS can run in the same or separate LPAR from IMS. It will forward the transaction request to the IMS application through the IMS OTMA (Open Transaction Manager Access) interface, using MVS XCF (Cross-system Coupling Facility). The IMS application could be written in Java or another language. IMS Connect would also send the output back to the IMS Connector for Java application in a similar manner.

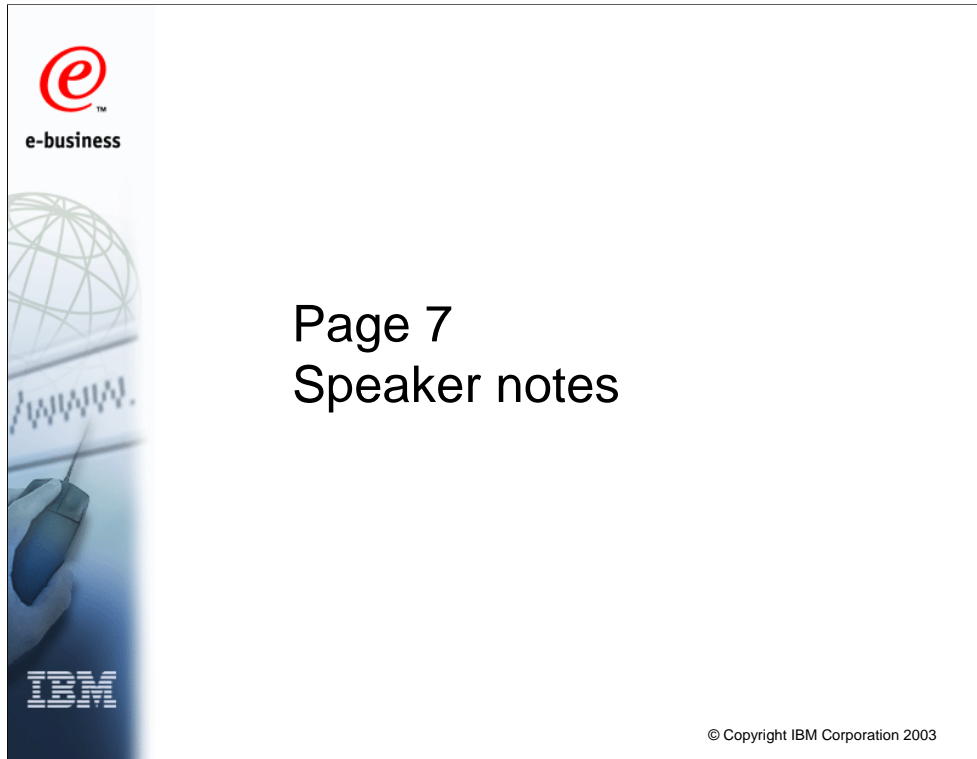

In the servlet runtime environment, the user can invoke the HTML page using the web browser and put in the input data. The request will be sent to webserver and the corresponding servlet will be invoked by the WebSphere application server. The servlet will then use the IMS Connector for Java to establish and connection with IMS and invoke the requested transaction with the input data through IMS Connect. The output result will be handed back to the IMS Connector for Java in the servlet via IMS Connect and send to the output HTML page by the web server. Development on NT can be deployed in any WebSphere environment.



In addition IMS has also recently provided Java application support with JDBC access to IMS DB. Local JDBC access to IMS DB from DB2, CICS, and Websphere on the S/390 or z/Series environments is also available. Java applications in these environments could use JDBC calls for access to IMS DB data.

The IMS Connector for Java environment is also being used to provide new IMS applications that map XML documents. XML mapping is already being enhanced for COBOL and PL/I as well. XML mapping to existing IMS MFS applications is also being provided. Additional Java standards, enhancements, and tooling continue to be provided. Additional requirements in this area are also for providing distributed JDBC access to IMS DB data.

IMS Operations Integration too is being provided through the new IMS V8 Operations Manager and a common interface, the structured call interface. The DB2 V8 Control Center through IMS Connect, now takes advantage of that interface for integrated operations with DB2.



**IMS Java for Integrated e-business
Application Development**





✓ **Application programmer productivity**

- Java access to IMS input/output message queues
- JDBC to access IMS DB and DB2 data
- Java Compiler support in VisualAge for Java, Enterprise Edition/390 Version 2
- Uses VisualAge tools for development

✓ **New Enhancements**

- Java Dependent Region support for Scalable Java Virtual Machine in IBM Developer Kit/390, Java 2 Technology Edition
- JDBC access from additional environments
- **Java Standards enhancements in IMS V8**



© Copyright IBM Corporation 2003

Included in base IMS Version 7 is our IMS Java application support to enhance the ability of our customers and business partners to provide integrated e-business application development with IMS.

The object of this function is to provide support for you to write Java applications and run them as IMS applications using Visual Age workstation and host tools for development and testing.

Compiling is provided through the High Performance Java compiler provided in the VisualAge for Java Enterprise Edition for OS/390 Version 2.

Access is provided to IMS TM message queues

Database access is provided to IMS DB and DB2 data through JDBC.

Enhancements are now being provided for using the new scaleable JVM, for JDBC access from other environments, and for supporting the latest standards.

JDBC support enhances IMS Java support for enabling JDBC access to IMS DB data not only from IMS TM environments but also now from a CICS/390 Java application, DB2/390 Java Stored procedure, and/or a WebSphere/390 Enterprise Java Bean.

New Java Region Type support enhances the IMS V7 Java support to run with the new Scalable JVM, provided in the IBM Developer Kit for OS/390, Java 2 Technology Edition. This provides for enhanced tooling support for developing these Java applications to run in IMS.



e-business

IMS Connect Internal Structure Provides Connectivity Base for the Future

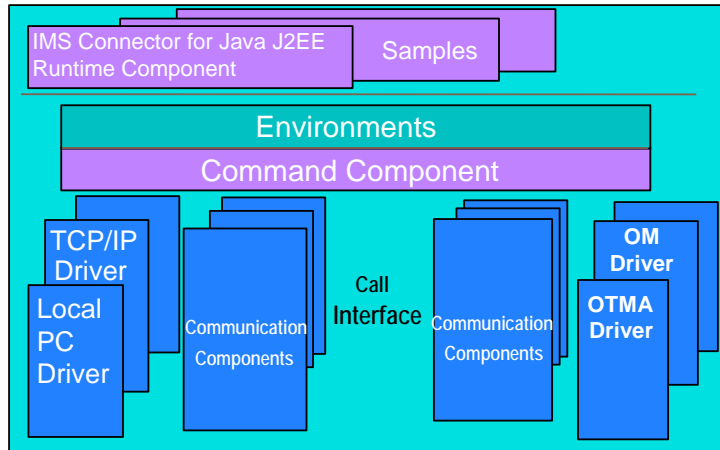

© Copyright IBM Corporation 2003

IMS Connect is part of the overall restructure of IMS for the 21st Century and is architected as the base for all future IMS Connectivity. Much of the function of IMS Connect can also be used with IMS V6 so you can start to take advantage of it before migrating your networks/applications/databases to IMS V7. The structure of IMS Connect is designed such that drivers can be interchangeable. That is, alternatives for the TCP/IP frontend or OTMA back end interfaces are already being provided. These are allowing IMS to exploit newer, additional, and enhanced protocols and/or interfaces. Along with IMS Connect is provided the IMS Connector for Java for access from Java applications and samples for other language access as well.

With this structure IMS Connect could evolve to address other connectivity requirements, such as distributed database access to IMS DB.



XML and IMS for Transparent Application Integration

- **Processing XML Documents in New IMS Applications Today**
 - Customers can write IMS C++ or IMS Java applications using the XML Toolkit for OS/390
 - Customers can write IMS Cobol or PL/I application using XML support for COBOL and PL/I
 - Tran code must be EBCDIC, rest of data can be XML
 - The IMS program can invoke XML parser to convert to non-tagged data
- **Bridging XML and Existing IMS Applications Today**
 - **Using MQSeries Integrator**
 - Dictionary support for messages
 - Routing and processing based on message content
 - US Utility built cost-effective e-business infrastructure to IMS
 - Customers can enable existing IMS applications as Web Services via WAS
- **XML and IMS Requirements**
 - Enable MFS-based IMS application programs as web services
 - Transform XML for existing IMS applications using IMS Connect
 - Using XML as an IMS Data Definition language

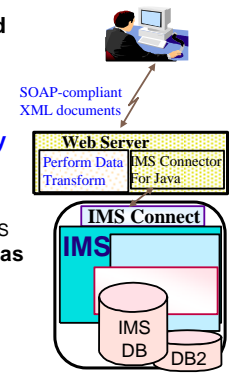

© Copyright IBM Corporation 2003

And IMS Tools are also taking advantage of XML which is critical for future transparent application integration.

Today, IMS documents can be processed in new IMS Java and C++ Applications, through use of the XML Parser, and/or access existing IMS applications using MQSeries.

We are also making available IMS COBOL and PL/I XML Application Capability, using the IBM Enterprise Cobol and PL/I compilers, which allows you to develop new or modify existing IMS applications using XML support for COBOL and PL/I. This can be used to enhance your existing high performance IMS transactions written in COBOL and PL/I in a Business-to-Business environment by receiving and sending XML documents. IMS supports the transmission of XML documents in the data portion of the IMS message. The messages can be placed and retrieved for the IMS messages queue for all messages regions for IMS Message Processing Programs, Fast Path Programs and Batch Message Processing Programs.

You can also enable existing IMS Cobol and C applications as Web Services by connecting SOAP and EJBs to IMS.

Future requirements also offer enhanced support for industry tooling, additional languages, transformation, and the use of XML as an IMS Data Definition language.

With the new WebSphere tooling you would be able to generate XML documents for outputs from new COBOL and PL/I applications.

You would be able to web enable your MFS applications using XML.

You would also be able to transform your MFS based IMS applications into web services.

XML transformation processing could eventually be contained within IMS Connect.

IBM's IMS E-Commerce Connectors Team at the Silicon Valley Laboratory developed the Common Application Metamodel (CAM). CAM is an IBM open standard initiative



IMS V8 Dynamic LE Runtime Parameters

Eases Application development

- **Dynamically updates Language Environment (LE) runtime parameters for an IMS Transaction or Batch Message Program**
- **Makes it easier to use Debug Tool for application testing**
- **Done without requiring CEEROPT and CEEUOTP to be changed, reassembled, and relinked when parameters need to be changed**



© Copyright IBM Corporation 2003

Dynamic LE Runtime Parameters provide the ability to dynamically update Language Environment (LE) runtime parameters for an IMS transaction or Batch Message Program and make it easier to use the Debug Tool for application testing. This would be done without requiring CEEROPT and CEEUOTP to be changed, reassembled, and relinked when parameters need to be changed.

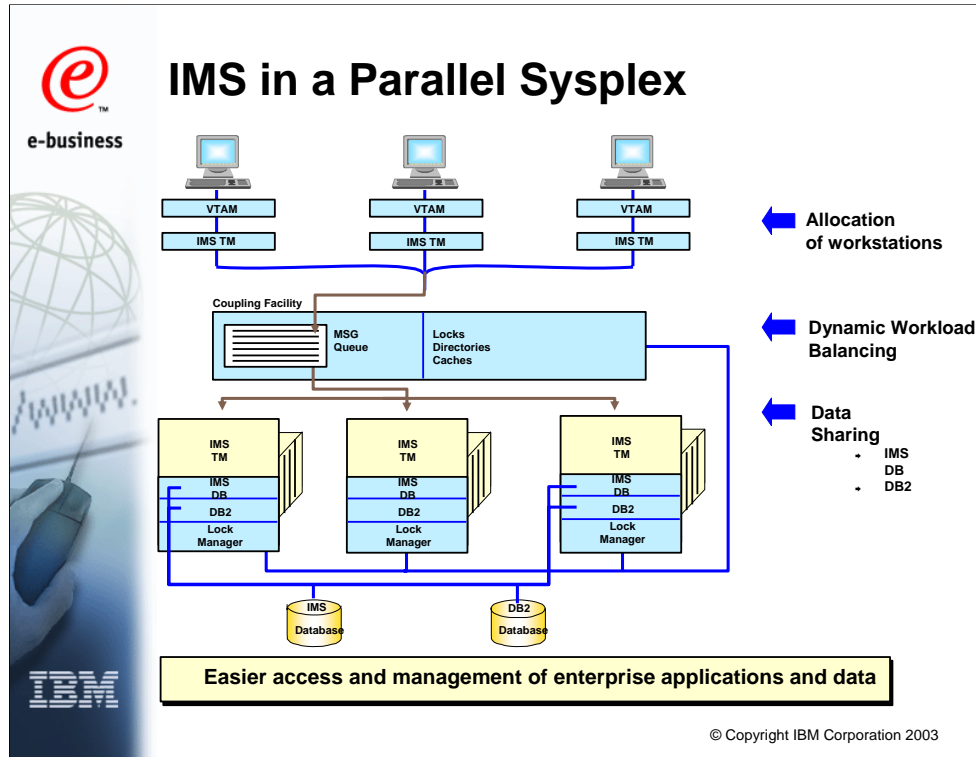

IMS continues to strengthen its support of the Enterprise by providing the highest in performance, availability, security, integrity, at the least cost per transaction. In doing this it has been exploiting the hardware/software environments that it has grown up along side of. IMS fully exploits for customer advantage the new technology and power of OS/390 and the Parallel Sysplex. Existing IMS data sharing capability was enhanced with IMS Version 5 to take advantage of the coupling facility for storing lock information and for easy availability of that information by all systems in the Sysplex environment. The lock manager in each system could access the locks as they needed to. In addition to data sharing, IMS V5 provided necessary information to the MVS workload manager to assist with workload balancing of resources across the Sysplex. IMS also enhanced message routing between systems to take advantage of workload balancing information, and IBM provided the IMS Workload Router to use these facilities to push the work to the available system. Significant enhancements for IMS V6 were added to those provided in IMS V5 to complement the Parallel Sysplex hardware and operating systems facilities. IMS V5 also provided Remote Site Recovery, which allowed backing up an IMS system with another at a different location. A database at another system is maintained to match the primary database and/or a log is maintained that can dynamically and quickly update that remote data base to allow takeover in the event of failure.

IMS V6 improved the IMS V5 Data Sharing and Workload manager enhancements with additional data sharing (storing changes and unaltered data on the coupling facility for Sysplex access, and providing additional Fast Path sharing), message sharing (providing message queues and fast path messages on the coupling facility for Sysplex access), and message routing enhancements (utilizing VTAM Generic resource support). As customer workload grows, the power that distributing data and applications across the Sysplex provides is needed. End users want to be able to access applications and data transparently, regardless where the work is processing. This enhanced support provides improved end user interaction, improved IMS availability, improved workload balancing, and offers increased capacity and growth in moving into Parallel Sysplex environments.

IMS's Fast Path capabilities continue to be enhanced to provide the fastest access through the system, continuing to lead database products. Against industry standard benchmarks it continues to show as the best price performance at the lowest cost, confirming that nothing in the transaction market matched the speed and power of the IBM S/390 with IMS.

IMS V7 and V8 continue to enhance this environment.



IMS Sysplex Manageability

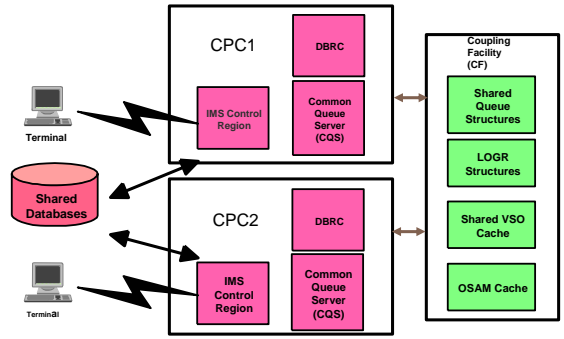

SYSTEMS MANAGEMENT REQUIREMENTS

- PRESENT A SINGLE SYSTEM IMAGE AND PROVIDE EASE OF USE THROUGH A SINGLE POINT OF CONTROL ACROSS THE SYSPLIX
- ENABLE USERS TO RESUME STATUS ON ANOTHER IMS IN IMSPLIX

ADDITIONAL REQUIREMENTS

- COORDINATE/MANAGE ONLINE CHANGE ACROSS THE IMSPLIX
- ADDITIONAL REQUIREMENTS

© Copyright IBM Corporation 2003

IMS Version 8 continued to enhance the management of IMS.

In the sysplex area we are helping our customers address the following requirements:

The IMS Sysplex should present a single system image and provide ease of use through a single point of control.

-- System management of IMSs sharing databases and/or message queues in a sysplex becomes more difficult as you add IMSs

-- Most commands and automation processes today can only affect an individual IMS

-- Commands may be entered using E-MCS console to route command to all IMSs in IMSplex

-- Commands that affect the sysplex can be issued on each IMS

VTAM Generic resource users need to be able to resume state on another IMS in the sysplex

-- User cannot resume state if routed to another IMS

Online Change should be coordinated and managed across the IMS Sysplex

-- Manual online change process is extremely difficult in IMSplex

-- Each IMS today manages its resources locally

-- Resources must be genned on each IMS

-- Resource definition consistency is not enforced. A transaction defined on one IMS can be defined as an lterm on another

-- Multiple users with the same name can sign on at the same time

-- Multiple nodes with the same name can log on at the same time

- -Multiple lterms with the same name can be active at the same time

Additional IMS requirements

-- Eliminate restriction that resource names and IMS keywords must be unique

-- Provide synchronous responses for IMS commands

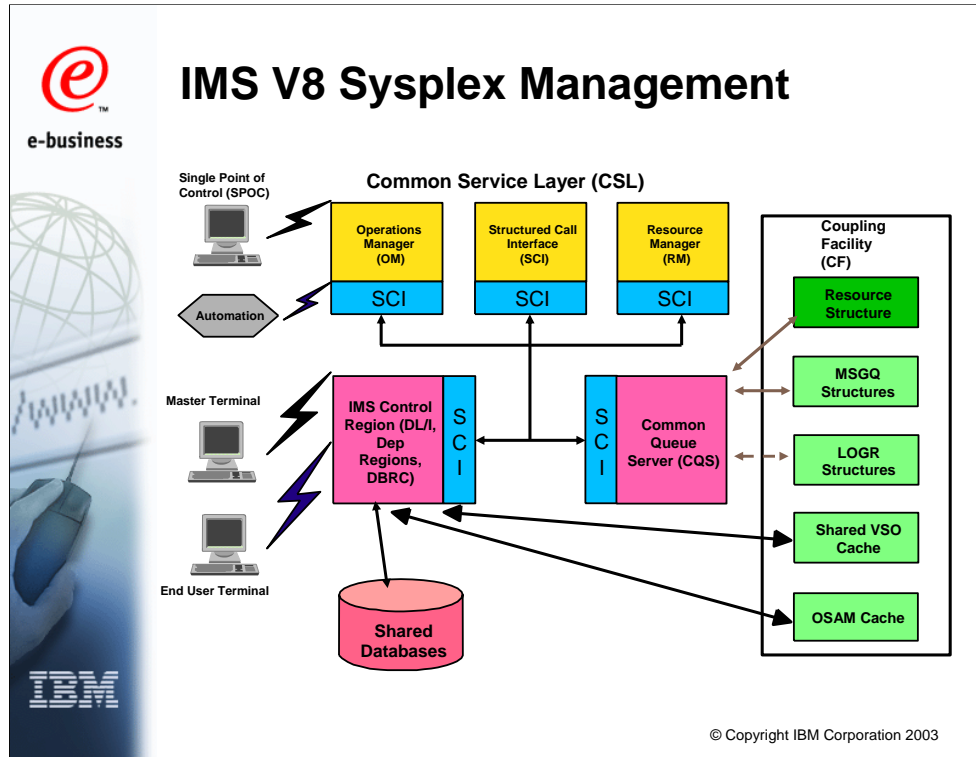

IMS V8 provides the following management infrastructure and enhanced support:

The Structured Call Interface is a new IMS address space which provides an interface for communication between IMS address spaces and provides communication on the same CPC or across CPC's using XCF

The Resource Manager is a new IMS address space maintaining global resource information accessible by IMSs in the IMS Sysplex. It enables a user to resume work on another IMS and to enforce single active user signon in and IMS Sysplex, if requested. It enables name uniqueness enforcement for message destinations and provides support for IMS to coordinate Online Change across IMS Sysplex. It maintains local transaction tables to optimize performance

Operations Manager. It is an IMS Address space which routes IMS Commands to interested IMS Modular Units across the IMSplex and consolidates IMS command responses. It provides an Application Programming Interface to allow a user or vendor to write tools to automate IMS operations. And it supports a Single Point of Control (SPOC) to present a single system image for the IMSplex by allowing the user to enter commands to all IMSs in the IMSplex from a single console. This SPOC is a 3270 TSO/ISPF Application running on S/390. It could also support a workstation Application connecting to OM.

Sysplex Terminal Management allows VTAM to manage Generic Resource affinity while IMS can maintain VTAM terminal and user state data, if requested. It enforces resource type consistency for message destinations and resource name uniqueness. It supports global callable services for terminals/users allowing user exits to obtain node and user information across IMS Sysplex. It uses the Resource Manager (RM) to share VTAM terminal-related resources in the IMS Sysplex.

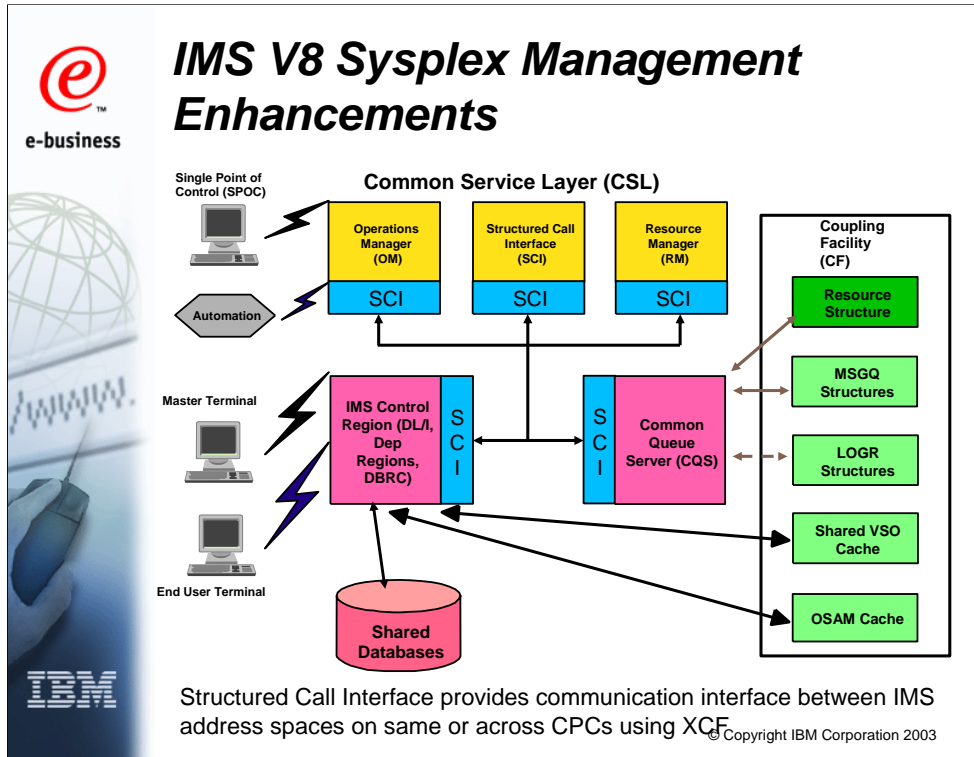

IMS is providing more componentization, rewriting systems services with cleaner interfaces and extending its layered approach for Systems Management. The Structured Call Interface (SCI) ties it all together. The BPE (Base Primitives Environment) was first delivered in V5 and is exploited further with each subsequent version. Shared Queues (CQS- Common Queue Server) is the "Queue Unit", the first modular unit, delivered with IMS V6 and enhanced with IMS V7.

The Common Service Layer is providing a single system image and easier systems management for the Sysplex environment.

The IMS V8 Structured Call Interface is a new IMS address space which provides an interface for communication between IMS address spaces. Communication is provided on the same CPC or across CPC's using the MVS Cross Coupling Facility (XCF).



**Integrated/Eased Management through
IMS Single Point of Operations Control**

IMS V8 Operations Manager

- Routes Commands
- Provides an API
- Provides Single Point of Control and supporting code for entering commands

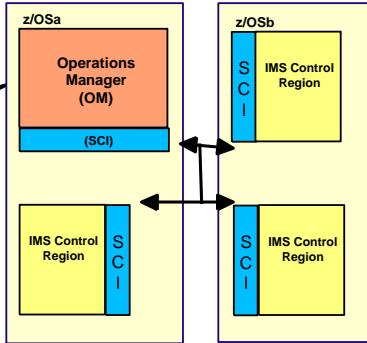

Single Point of Control (SPOC) can be used to control any IMS, with or without the presence of a Sysplex using

- TSO/ISPF Application, or
- Distributed IMS Control Center in DB2 V8 through IMS Connect to IMS

© Copyright IBM Corporation 2003

IMS V8 Operations Manager

Provides an IMS Address space which routes IMS Commands to interested IMSs across the IMS Sysplex and consolidates IMS command responses.

Provides an Application Programming Interface to allow a user or vendor to write tools to automate IMS operations.

Supports a Single Point of Control (SPOC) to present a single system image for the IMS Sysplex by allowing the user to enter commands to all IMSs in the IMS Sysplex from a single console.

Although designed with Sysplex in mind to optimize operations across a Sysplex, the new V8 SPOC can also be used to improve systems management of commands in general, and the SPOC can be used to control any IMS, without the presence of a Sysplex. This support can provide operations management for a DBCTL environment, as well as for an IMS TM/DB environment. In addition, a GUI SPOC is being provided as part of the DB2 V8 Control Center early in 2003.

Access to IMS from this IMS Control Center is provided through IMS Connect in through the new IMS V8 Structured Call Interface.

Provides a 3270 TSO/ISPF Application running on S/390 or z/OS

Provides DB2 V8 IMS Control Center code for distributed operations access to IMS operations management through IMS Connect.



IMS V8 Resource Manager

Provides a new IMS address space for

- **Coordination of online change across the IMS Sysplex**
- **Global management of IMS Terminal resources**
 - Enables a user to resume work on another IMS and to enforce single active user
 - Enforces single user signon in IMS Sysplex, if requested
 - Enables name uniqueness enforcement for message destinations

© Copyright IBM Corporation 2003

The new Resource Manager provides for coordination of online change across the IMS Sysplex and for global management of IMS terminal resources. This maintains resource information for clients using a resource structure. It enhances availability by enabling a user to resume work on another IMS and to enforce single active users. It provides systems management by enforcing single user signon in the IMS Sysplex, if requested, and enabling name uniqueness enforcement for message destinations. The resource structure supports Automatic Altering and System-Managed Rebuild. It also supports Structure Copy, where the IMS Common Queue Server performs the rebuild to copy the contents from one resource structure to another. Resource structures could also be duplexed to keep from losing resources on the structure, should it fail, since these structure resources would not be checkpointed or logged.



**IMS V8 Coordinated
Online Change**

**Eases, manages, and automates change
across the IMS Sysplex**

- Commands can be entered on one IMS
- Requests can be handled for coordinating change across all the IMSs in the IMS Sysplex
- Replaces manual coordination



© Copyright IBM Corporation 2003

Coordinated Online Change eases, manages, and automates change across the IMS Sysplex. With coordinated online change, commands can be entered on one IMS and request that the new IMS Resource Manager coordinate an online change across all the IMSs in the IMS Sysplex, replacing the earlier manual coordination process.



e-business



IMS V8 Sysplex Terminal Manager

Recovers terminal state information after a session reconnect, and allows the terminal user to log back onto another IMS after a failure.

- Allows VTAM to manage Generic Resource affinity while IMS can maintain VTAM terminal and user state data, if requested
- Enforces resource type consistency for message destinations and resource name uniqueness
- Supports global callable services for terminals/users, allowing user exits to obtain node and user information across IMS Sysplex
- Uses the Resource Manager to share VTAM terminal-related resources in the IMS Sysplex
- Autologons can be initiated from a single IMS in the Sysplex

© Copyright IBM Corporation 2003

Sysplex Terminal Management recovers terminal state information after a session reconnect, and allows the terminal user to log back onto another IMS after a failure. The Resource Manager is used to share VTAM terminal-related resources between IMS systems in the IMS Sysplex. IMS-managed VTAM Generic Resources affinity can be eliminated, while maintaining terminal and user state data. IMS will maintain VTAM terminal and user state data if requested. IMS enforces resource type consistency for message destinations and enforces resource name uniqueness. IMS supports the global Callable Services for terminals/users, enabling user exits to obtain node and user information across the IMS Sysplex.

Sysplex Terminal Management

Allows VTAM to manage Generic Resource affinity while IMS can maintain VTAM terminal and user state data, if requested

Enforces resource type consistency for message destinations and resource name uniqueness

Supports global callable services for terminals/users allowing user exits to obtain node and user information across IMS Sysplex

Uses the Resource Manager (RM) to share VTAM terminal-related resources in the IMS Sysplex

Autologons can now be initiated from a single IMS in the IMSplex. The installation designates one or more IMS systems as 'autologon frontend-capable' systems and IMS designates one of these as the active autologon system. When autologon output is generated from any system, IMS will initiate the autologon from the active autologon system. This eliminates printer 'thrashing'



e-business



IMS V8 Transaction Trace

Eases serviceability

Utilizes OS/390 and z/OS Transaction Trace facility for

- **Tracing a unit of work** through subsystems
- **Enabling show of flow** through components
- **Providing a consolidated place** to store tracking information
- **IMS Trace points** provided for
 - > IMS Entry
 - > IMS Exit
 - > DL/I Entry
 - > DL/I exit

© Copyright IBM Corporation 2003

IMS V8 Transaction trace takes advantage of the OS/390 and z/OS Transaction trace facility to ease serviceability by providing transaction tracing information. Customers have asked for the ability to track a unit of work through multiple subsystems. This would enable the user to more easily debug problems in this type of environment.



IMS Resource Definition Manageability

Current System Generation Process

- **Two stage, Batch, Assembler process**
 - **Cold Start**
 - **Online Change**
 - Databases, Trans route codes, Appls, Security
 - Quiesces whole system

Requirements

- **Reduce system generation time/effort**
- **Improve availability during change**



© Copyright IBM Corporation 2003

Another area of Manageability that IMS is addressing is that of the IMS Resource Definition. Currently this requires two stage, batch, assembler system generation process. This originally requiring cold start, has provided online change for some resources. These resources are the Databases, Trans route codes, Appls, Security. But this online change requires a quiesce of the entire system

Requirements in this are are to reduce system generation time/effort and to improve availability during change.



IMS Resource Definition Manageability Staging



Reducing IMS System Generation effort

- **IMS V4 stopped using sysgen to support new function**
- **IMS V5/6 removed conditional assembly modules**
- **IMS V7 put non-conditional link-edit modules under SMP control**
- **IMS V8**
 - ➔ Removed RSR RLT/DLT feature install checking
 - ➔ Resource Manager/Coordinated Online Change
 - ➔ Syntax Checker
 - ➔ Packaging/Installation/IVP enhancements

© Copyright IBM Corporation 2003

In the more recent IMS versions we have been focused on reducing the IMS System Generation time and effort

IMS V4 stopped using sysgen to support new function

IMS V5/6 removed conditional assembly modules

IMS V7 put non-conditional link-edit modules under SMP control

IMS V8 provided the Resource Manager/Coordinated Online Change, Syntax Checker, Packaging/Installation/IVP enhancements, and removed the RSR RLT/DLT features install checking.



e-business



IMS V8 Syntax Checker

Helps Reduce System Generation effort

- **New IMS ISPF application** which assists Systems Programmers in defining and maintaining the IMS parmlib members residing in the IMS PROCLIB
- **Parameter and value checking and detailed help text** at the parameter level tailored to the IMS version
- **Assists in moving from release to release** by identifying new parameters and obsolete parameters
- **Provide ability to ensure parameters are valid** prior to shutting down and restarting your IMS Control Regions.

© Copyright IBM Corporation 2003

Syntax Checker is a new addition to the IMS installation process. Syntax Checker helps reduce the system generation effort by assisting the system programmers in defining and maintaining selected input parameter members residing in the IMS PROCLIB. It provides parameter syntax checking, parameter value verification and detailed help text at the parameter level tailored to the IMS release. It also provides assistance in migrating to a new release by identifying any new and/or obsolete parameters. Syntax Checker displays the proclib member in an ISPF panel. Any parameters or values in error are highlighted. The user may add, change or correct the value of the parameters. Detailed help text for a parameter is also available at the touch of a key. Using Syntax Checker, the system programmer can ensure the parameters are valid prior to shutting down and restarting IMS control regions. It eliminates the risk of parameter error during a start-up of IMS and the time-consuming process of tracking down and correcting parameter syntax or value errors.



IMS V8 Packaging, Installation and IVP Enhancements

New IMS Packaging and Installation Process

- SMP/E jobs removed from Install/IVP Dialog Process
- SMP/E Receive, Apply, Accept processing
- New Target and Distribution datasets
- No DFSJCLIN Job provided

Installation Verification Program Enhancements

- OM, RM, SCI, SPOC Sample Application
- Syntax Checker Sample Application

© Copyright IBM Corporation 2003

New IMS Packaging and Installation Changes

The SMP/E jobs have been removed from the Install/IVP Process.

Instead: JCL is provided in the Program Directory to unload jobs that perform the SMP/E processing. The SMP/E install jobs contain instructions to customize the install to the customers site.

This is a major change to the IMS install process. It was made to be consistent with IBM's installation standards.

"Install/IVP" will be renamed "IVP" (Installation Verification Program). The IVP process will continue to provide the facility for verifying (testing) the installation of IMS.

SMP/E Receive Apply Accept Processing

The SMP/E install portion of IMS will use the standard Receive, Apply, Accept process. SYSGEN is still required to complete the IMS install process.

New SMP/E target and distribution datasets provided a target dataset for source code, target and distribution datasets for optional user exits, and Java libraries.

No DFSJCLIN job provided.

The job was used to install non-SYSGEN parts. These part are now created by the SMP/E Apply process.

The SMP/E GENERATE command will be used to build any JCL necessary to recreate the non-SYSGEN parts after the install.

IVP Enhancements

OM, RM, SCI, SPOC Sample Application

IVP will provide jobs and tasks to test and demonstrate the defining and starting of an IMSPLEX and the use of SPOC to issue commands to the IMSPLEX.

Syntax Checker Sample Application

IVP will provide tasks to demonstrate the general use of

Syntax Checker and the use of Syntax Checker to convert the IMS "PB" Proclib members (DFSPBxxx) from V7.1 to V8.1



e-business

IMS V8 Parallel DB Processing

Helps Reduce Recovery time for increased availability

- **Exploits Parallel TCB for Full Function DBs**
 - **Dynamic allocation, OPEN, CLOSE, EOVS**
 - **Faster processors with more engines**
 - **Provides for elapsed time improvement**
 - **Faster steady state response time**

The IBM logo, consisting of the letters 'IBM' in a bold, sans-serif font, is positioned at the bottom of a vertical graphic strip on the left side of the slide. The strip also contains a wireframe globe and a computer mouse pointing at a document with a URL.

© Copyright IBM Corporation 2003

Parallel Database (DB) Processing support allows IMS to do DB authorization, allocation, open and close processing using multiple MVS threads. This replaces the earlier serialized process. For systems with large numbers of databases, this can significantly reduce the amount of time required to re-open databases after an outage and returning the system to steady state, increasing system availability. This function is automatically provided and controlled by IMS.



**IMS V8 Fast Path
Data Entry Database
Enhancements**

- **DEDBs Greater than 240 Areas**
 - Increases capacity
 - Greater design flexibility
- **Non-recoverable DEDBs**
 - For use as work databases where recovery not required
 - Reduces log record/checkpoint info, thus improving IMS performance

© Copyright IBM Corporation 2003

IMS's Fast Path capability continues to be enhanced to provide the fastest access through the system, continuing to lead database products. Against industry standard benchmarks it continues to show as the best price performance at the lowest cost, confirming that nothing in the transaction market matched the speed and power of the IBM S/390 and z/Series with IMS.

IMS V8 Fast Path Data Entry Database (DEDB) Enhancements include DEDBs Greater than 240 Areas (to 2048) extends capacity of Fast Path Databases above the previous 240 area restriction and significantly increases the number of Areas supported by Data Entry Databases. This provides more data storage capacity in each DEDB and could lead to greater design flexibility.

Non-recoverable DEDBs are provided for use as work databases where recoverability is not a requirement. Marking the DEDB non-recoverable would reduce the amount of log record and checkpoint information, thus improving on the performance of IMS.



IMS V8 Database Recovery Control Enhancements

- **Automatic Recon Loss Notification** for quicker loss recovery
- **Eliminate abends** when authorizing database
- **RECON Command Authorization** controls RECON access/update via DBRC batch commands
- **16M RECON Record Size** helps users avoid problems caused by Recon Record size exceeding VSAM record size max
- **Prilog Compression** reduces overhead, improves performance



© Copyright IBM Corporation 2003

IMS V8 Database Recovery Control Enhancements include:

Automatic Recon Loss Notification adds support to automatically propagate a Recovery Control Data Set (RECON) reconfiguration to other DBRC instances. When an error on a RECON data set results in a RECON reconfiguration on one IMS subsystem, other DBRC instances using the same RECONS are notified. The result is that all IMS subsystems automatically deallocate the failed RECON data set so that the user can quickly recover from the loss.

Eliminate abends - When authorizing databases or recording Extended Error Queue Elements (EEQEs), DBRC would no longer ABEND and be less likely to cause IMS to ABEND due to RECON record size problems. DBRC also would no longer abend when attempting to deallocate a database that is recorded in RECON as "already deallocated".

RECON Command Authorization support allows users to control RECON access/update via DBRC batch commands as well as the High Availability Large Database (HALDB) Partition Definition Utility. User exit implementation allows user flexibility to customize security criteria and maintain an audit trail. This helps customers protect the integrity of database data by allowing finer control over the data one can access.

16M RECON Record Size helps users avoid problems caused by RECON records (such as the PRILOG record which identifies the primary log for an active system) exceeding the VSAM RECORDSIZE maximum. This eliminates planned and unplanned outages that are due to RECON record size. DBRC implements its own RECON record spanning.

Prilog Compression has been enhanced to reduce its overhead, improving performance. Since DBRC now supports RECON records of unlimited size, compression is attempted whenever an Online Log Data Set (OLDS) is archived.



IMS V8 Image Copy 2 Enhancements

Eases Image Copy coordination and management

- **Multiple utility control statements** can be copied per execution
- **Group name support** names the datasets in one execution so can start and/or stop as a group
- **Single output data set** can be created for multiple image copies
- **DFSMSdss Optimize option** supported



© Copyright IBM Corporation 2003

The Image Copy 2 enhancements allow multiple database data sets to be copied in one utility execution. The utility passes the data sets to DFSMSdss on multiple DUMP commands to be processed in parallel. Optionally the user can specify that the data sets are to be processed by a single DFSMSdss DUMP command which results in the image copies being written to the same output data set. Logical completion in most cases would be achieved for all of the database data sets in a very brief period of time. Also, the utility supports specification of a group name for the database data sets being copied. Logical completion is then indicated for the group rather than for the individual database data sets. With the added capabilities, users are able to better manage and automate image copy processing.



IMS V8/DB2 Coordinated Disaster Recovery

Aids in disaster recovery coordination in installations accessing DB2 via IMS

- **'eXtended Recovery Copy (XRC) tracking' added to IMS RSR**
- **Eases task synchronizing IMS and DB2 logs for disaster recovery**
- **Supports**
 - **IMS RSR For logs and (optionally) Databases**
 - **XRC for DB2 logs and boot strap data sets (BSDSs)**



© Copyright IBM Corporation 2003

IMS/DB2 Coordinated disaster recovery support: The IMS Remote Site Recovery (RSR) function is extended to provide support for coordinated IMS/DB2 disaster recovery by working with XRC (eXtended Remote Copy) for the DB2 logs. Without this support, if IMS and DB2 logs, log control information, and (optionally) database data to a remote site by independent transfer mechanisms, the customer has to synchronize the IMS and DB2 logs and ensure that the IMS and DB2 databases are consistent when a disaster occurs. This can be a time-consuming and error-prone process and puts data integrity at risk. The new support enhances IMS RSR for coordination of IMS and DB2 disaster recovery processing at a remote recovery site, offering an IBM-provided solution for synchronizing the logs. In the supported configuration, XRC is used for DB2 logs. With this support, the steps required by the user to synchronize the logs are greatly reduced.



IMS V8 Synchronous Shared Queues support

- Provides for Sharing Messages between Sysplex Systems through IMS Queue Manager
 - > MVS APPC programs
 - > OTMA Clients (MQ, IMS Connect, ...)

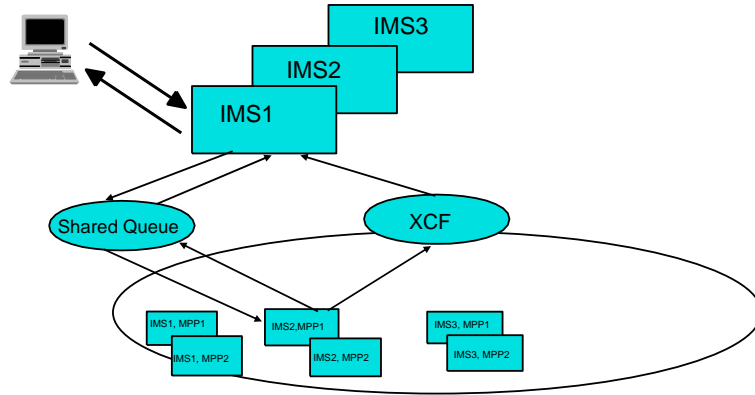

© Copyright IBM Corporation 2003

IMS V8 Synchronous shared Queues support allows users to run synchronous transactions entered from APPC on any IMS system in the Shared queues group. Synchronous transactions can run on any back-end system from any front-end system; the output message is sent back to the client from the front end system. Previously only asynchronous transactions for these environments were supported. This new support uses the z/OS Resource Recovery Services (RRS) Multi-System Cascaded Transactions support. This Synchronous Shared Queues support is provided for MVS APPC programs, as well as for the Open Transaction Manager (OTMA) facility workload as well.



e-business

IMS V8 APPC Enhancements

Improves APPC availability

- **Dynamically add/delete LU 6.2 descriptors** for online change
- **Use of another Logical Unit (LU) as an outbound LU** for rerouting where resources are disabled
- **Use a CPU-time limit for CPI-C (explicit) transactions** to help prevent tying up of resources
- **Synchronous Shared Queues support** for enhanced workload distribution



© Copyright IBM Corporation 2003

IMS V8 APPC Enhancements include:

Dynamically add/delete LU 6.2 descriptors increases availability by not needing to bring the system down for this

Use of another Logical Unit (LU) as an outbound LU increases availability caused by problems if the only outbound LU were disabled

Use a CPU-time limit for CPI-C (explicit) transactions increases availability by helping to prevent looping programs so that the resources are not tied up.

APPC Synchronous Shared Queues support enhances distribution of workload in an IMS Sysplex environment.



IMS V8 Common Storage Area (CSA)/Virtual Storage Constraint Relief (VSCR)

- Relieves storage constraints with IMS using less local and common storage below 16M
 - Moves from local to above the 16M line:
 - ✓ System Program Status Tables
 - ✓ Code paths

© Copyright IBM Corporation 2003

Common Storage Area (CSA)/Virtual Storage Constraint Relief (VSCR) Enhancements relieve storage constraints by IMS using less local and common storage below 16M. This is done by moving the system Program Status Tables and code paths from local to above the 16M line.



e-business

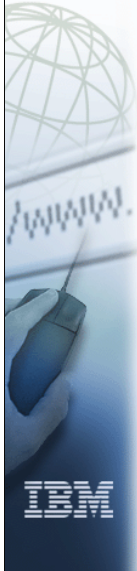

Enabling Migration

Provide on a regular schedule, staged, more frequent, deliverables of key customer function to:

- > **Ease customer**
 - **planning for the new deliverables,**
 - **installation of and migration to the new releases,**
 - **integration into your system,**
 - **manageability of the new releases**
 - **maintenance on these deliverables,**
- > **Ensure timeliness, minimized disruption, and quality through enhanced testing of the smaller enhancements delivered through the shorter release cycle, rather than through the service process.**
- > **Improve integration and quality through staged delivery of the larger enhancements**
- > **Provide opportunity for higher quality and more timely IBM and vendor tools**
- > **Increase opportunity for integration and visibility of IMS support for new technologies**

© Copyright IBM Corporation 2003

We are also helping to enable migration with Version 8 by changing the to a staged, more frequent, regular deliverable schedule of key customer function to:

Ease customer

planning for the new deliverables,

installation of and migration to the new releases,

integration into your system,

manageability of the new releases

maintenance on these deliverables,

Ensure timeliness, minimized disruption, and quality through enhanced testing of the smaller enhancements delivered through the shorter release cycle, rather than through the service process.

Improve integration and quality through staged delivery of the larger enhancements

Provide opportunity for higher quality and more timely vendor tools

Increase opportunity for integration and visibility of IMS support for new technologies in strategic announcements and conferences.



e-business

Strategic IMS Architecture

Goals:

- Integration with open interfaces from and between IMS parts
- Manageability with Restructured IMS components into independent units
- Scalability through allowing multiples of units (mix and match different multiples of each) in a Sysplex environment

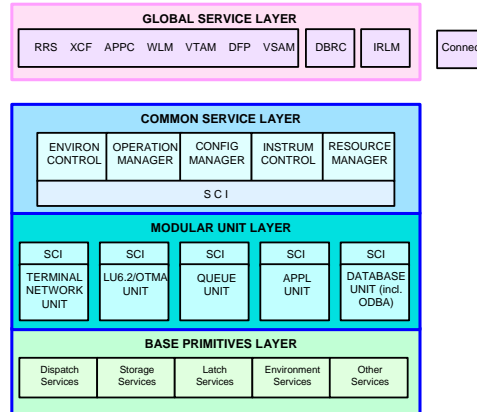

(BPE in V5, CQS in V6, ... and SCI in V8 ties it all together)

© Copyright IBM Corporation 2003

IMS is being transformed through restructuring and rebuilding to enable and exploit the latest technological advancements and continue enhancing integration, manageability and scalability for the 21st Century.

The goals for this Architecture are

Integration with open interfaces from and between IMS parts

Manageability with Restructured IMS components into independent units

Scalability through allowing multiples of units (mix and match different multiples of each) in a Sysplex environment.



IMS V8 Software Prerequisites and Migration SPEs

IMS V8 MINIMUM RELEASE LEVELS

- OS/390 V2R10 (5647-A01) with DFSMS
 - RACF (included in separately orderable SecureWay Security Server), or equivalent, if security is used.
 - High Level Assembler Toolkit
- z/OS V1R2
 - Required for APPC/OTMA Synchronous Shared Qs
 - Required for MSC Ficon CTC support
 - Required for Shared Qs/EMH CF Duplexing support
 - Required for System Mgd Duplexing of VSO structures
 - Recommended for Resource Mgr and Coordinate OLC
 - Enhances usability for Sysplex Terminal Manager

DBRC Migration/Coexistence SPE

- on IMS V6
- on IMS V7

© Copyright IBM Corporation 2003

IMS V8 operates under OS/390 V2R10 configurations, or subsequent versions, releases and modification levels, including z/OS (5694-A01), unless otherwise stated, and requires the following minimum version, or release or modification levels:

OS/390 V2R10 (5647-AQ1) with DFSMS (a base element of OS/390 V2R10)

RACF (included in a separately orderable SecureWay Security Server feature of OS/390 V2R10), or equivalent, if security is used

IBM High-level Assembler Toolkit (5696-234), a separately orderable feature of OS/390

IMS V8 also operates in a virtual machine (VM) under control of OS/390 V2R10 and is intended for use in a customer program development, testing and non-XRF production environment with some restrictions.

z/OS V1 R2 is required for IMS MSC Ficon CTC support.

z/OS V1 R2 is required for Shared Queues/EMH CF Duplexing support and for System Managed Duplexing of VSO structures.

z/OS V1R2 Communications Server Affinity enhancement can be optionally used with IMS V8 Sysplex Terminal Management for enhanced usability.

z/OS V1R2 CF Duplexing is recommended, though not required, for IMS V8 Resource Manager and Coordinated Online Change.

In order to take full advantage of the Coordinated Online Recovery, Sysplex Terminal Management, Single Image Operations Manager, and/or Sysplex Wide Resource Management, IMS on all the Sysplex systems involved should be on IMS V8.

All systems involved in using APPC/OTMA Synchronous Shared Queues support need to be on IMS V8 and z/OS V1 R2 for its Multi-System Cascaded Transactions support. Resource Recovery Services must also be active on all these systems.

IMS Java application support requires the IBM Developer Kit for OS/390, Java 2 Technology Edition (5655-D35), with a special enhancement, referred to as the Persistent Reusable Java Virtual Machine (JVM). This is required for the IMS V8 Java Dependent Region support.

JDBC access to IMS DB for DB2 Stored Procedures requires DB2 UDB for OS/390 and z/OS V7 (5675-DB2).



e-business

IMS: Providing Leadership in the Marketplace

Simplifying Information Integration through Connectivity and New Application Development



Easing Manageability Reducing the Cost of Computing

Enabling System Scalability with Availability/Recoverability Performance/Capacity



© Copyright IBM Corporation 2003

The e-business cycle focuses on leveraging your existing knowledge and information and transforming your core business processes, managing technology in building new applications, and providing organizational efficiency. In all this you need to be running a high performance, available, scalable, secure environment. You use existing data to sharpen decision making and responsiveness. You prioritize which processes and applications need to be extended. You build new reusable applications integrated with existing ones. And you maximize deployment on secure platforms. And for each of these elements of the cycle, we are providing you the IMS solutions that you will need to help make all this work easily. Built on the power of the S/390, billions of dollars worth of IMS applications have been developed to run your mission-critical work in a safe environment with IMS. If you have money in a bank, feed, house, clothe your family, or protect them with health or insurance services, use educational or government information, etc., most of the information about this is kept securely in IMS databases, accessed through high performance IMS transactions and rapidly being processed across the internet for wider use. IBM will continue to invest heavily in IMS to enhance IMS to meet the stringent requirements of its customers -- to help them transform their core business processes with emerging technologies using IMS. Exploiting the latest in technologically-advanced hardware and software, IMS will help customers achieve new levels of price-performance and, at the same time, leverage their exiting investment in skills and applications for information access across the internet.