



IMS: What's New and What's Next

Barbara Klein
Senior IMS Strategic Plan and Brand Manager
IBM Santa Teresa Laboratory, San Jose, California
bk@us.ibm.com

Powering On Demand Solutions



© IBM Corporation 2004

The IBM Information Management System (IMS) is unsurpassed in database and transaction processing availability and speed. With the demands of the evolving e-business environment, and a marketplace working in Web time, IMS delivers the integrity, capability, and performance customers have learned to expect from IBM.

IBM has been enhancing the IMS Database Manager (IMS DB) and the IMS Transaction Manager (IMS TM) with new enhancements to Version 7 and 8 as well as introducing V9, which enable you to shape how you:

- Transform the way you do business with integrated information
- Build e-business applications that tolerate the rigors of doing business on the net
- Run a scalable, available, safe, and easily manageable environment
- Leverage your business decisions to make more informed decisions

IMS TM continues as IBM's premier transaction server for environments that employ relational and hierarchical data stores and require the utmost in integrity, capacity, availability, and performance for e-business and enterprise computing environments.

IMS DB continues as IBM's premier hierarchical database server to provide and enhance high performance/capacity, superior integrity, and continuously available database management solutions for IMS TM and CICS users.

Infrastructure Trends: Complex System Topology

The increasing challenge of managing large systems is due to the inherent complexity of the solution and the sheer number of heterogeneous components

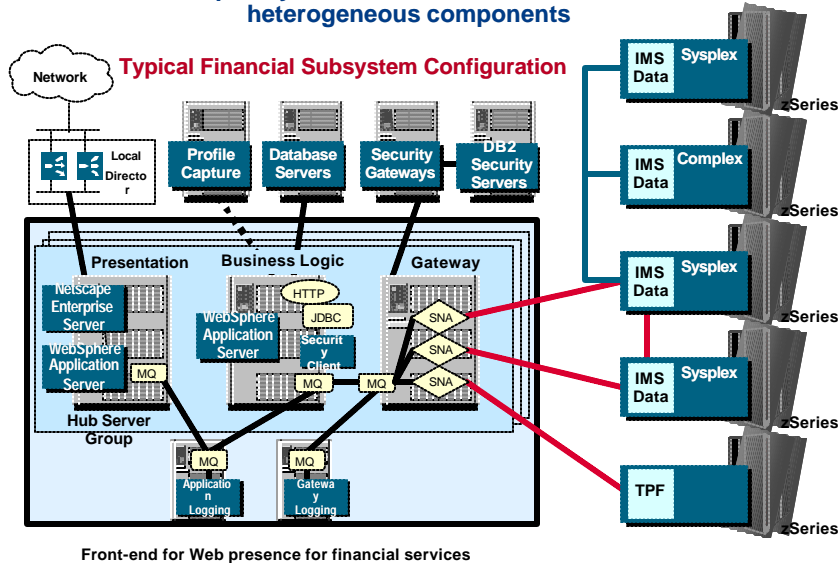

Information technology has significantly changed to address the changing world of business. Market forces have been changing the way we do business. Regulation, economics, have been changing as businesses become more global. Growth of the Internet, the global reach, the new commerce channels are changing the way everybody does business, like the upswing in mergers and acquisitions. Views into information are becoming as important as the information itself. Amalgamation and aggregation have become widespread in the industry. Businesses are exploiting new technologies to enable new customers with new information across the web, in a global day. Businesses are being challenged with balancing priorities and need new ways to gain and retain competitive edge to address increasing demands and sophistication of their customers. IMS customers are at the bleeding edge of this reality. Yet at its heart, business stays the same. Industry forces are making the highest demands for performance and availability, along with interoperability, flexibility, and support for new, emerging technologies. This is something IMS people have been hearing for years. And IMS continues to help efficiently provide heterogeneous access across global networks and in addressing companies' changing needs. IBM is providing integrated solutions with IMS to help our customers with on demand processing. And the increasing challenges of managing the complexity of the solution and the sheer number of heterogeneous components are being addressed by IMS and the environment/products with which it runs.

IMS Continues to Address Challenges of a Rapidly Changing World

Providing Quality through On-Demand Solutions

- **Information Integration and Open Access with New Application Development/Connectivity**
 - ✓ Ease/broaden user access
 - ✓ Web, Java, XML and Linux access
 - ✓ Ease application developer effort
 - ✓ Auto-application-generation tools
- **Manageability Ease with Autonomic Computing**
 - ✓ Ease installation and operations efforts
 - ✓ High levels of security
 - ✓ End-to-end transaction integrity
 - ✓ Real time data currency
 - ✓ Highest code quality
- **System Scalability for Virtualization in Performance/Capacity/Availability/Recovery**
 - ✓ Handling increasing workload
 - ✓ Handling unpredictable volumes
 - ✓ More hours for workload
 - ✓ Continuous up time for applications and user access
- **IMS extends the investment for your on demand business needs**



© IBM Corporation 2004

IMS is continuing to address the challenges of a rapidly changing world. It is providing the utmost in quality through Information Integration with new Application Development/Connectivity solutions. These solutions ease and broaden user access, opening IMS applications and data up to the Web, Java, XML and Linux environments. New technology and automatic application generation tooling ease application developer efforts.

IMS along with the S/390 and the z/Series have been providing solutions to ease Manageability as well. These solutions ease installation and operations efforts, provide a high level of security, end-to-end transaction integrity, and real time data currency,

Systems Scalability is also provided to handle the increasing workload and unpredictable volumes, as well as more hours for workload and the continuous uptime demands for applications and user access.

All of this is provided with the highest quality and availability and for the lowest cost of computing. Customers are using this power to take on new on demand business related applications, greatly extending their investments.

Middleware Subsystem Access

-- Providing Open Database and Transaction access

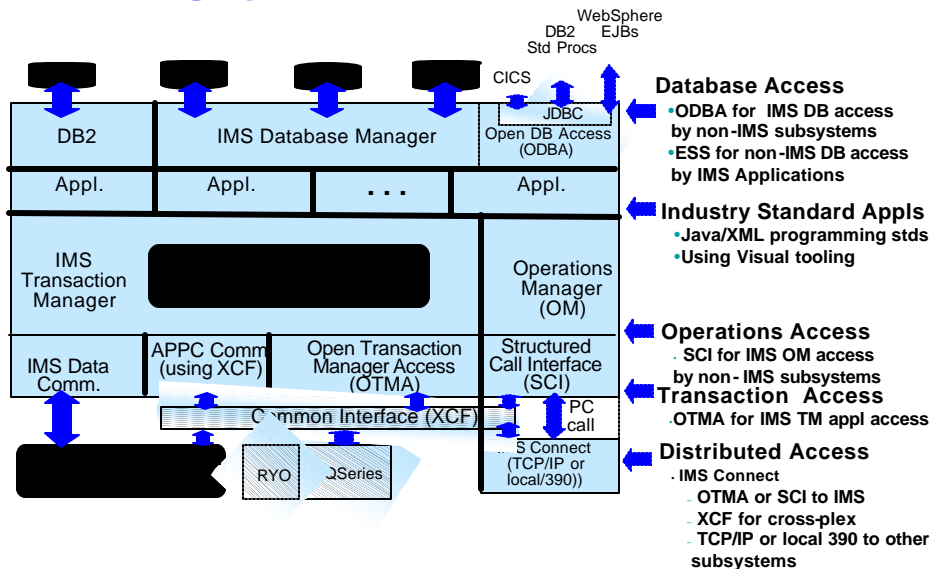

Traditionally messages come into IMS through its SNA data communication protocol from VTAM. With APPC/IMS support in Version 4, IMS took advantage of the new Cross Coupling facility (XCF) to communicate with APPC/MVS. This was a software facility that allowed MVS subsystems to communicate more efficiently. With the IMS Version 5 Open Transaction Management Access (OTMA) facility, IMS extended its use of XCF for use by other IBM subsystems, such as TCP/IP, MQSeries, and DCE/RPC, providing them more efficient and richer capabilities in accessing IMS. OTMA allows access to existing, unchanged IMS applications on any IMS TM system on any MVS system of an MVS Sysplex as well.

The Open Database Access facility (ODBA), for easier database access, has also been provided.

With IMS Version 8, IMS extended its use of XCF for use by other IBM subsystems, such as IMS Connect, for distributed operations access through the Structured Call Interface (SCI) to the Operations Manager (OM) from the DB2 Version 8 Control Center as a single point of control.

IMS V7 Database Manager Enhancements

Integration with Applic Devt/Connectivity

- IMS Java and XML support
- Open Database Access (ODBA)

Manageability

- Installation enhancements**
 - f Usability enhancements
 - f HALDB samples
- Logger enhancements**
 - f Administration and Control
- External Subsystem Attach Facility diagnostic enhancements**
- IMS systems parameter display**
- Fast Path Enhancements**
 - f I/O error handling enhancements
 - f Performance monitoring support
 - f Multiple Area Data Set I/O Timing
 - f Expansion of compressed data for Single dependent segment Scan
- IMS Monitor enhancements for FP and FF**

Scalability in Performance/Capacity and Availability/Recovery

- High Availability Large Database**
- Application Control Block Generation (ACBGEN) enhancements**
 - f increased number of program limits
 - f time/version info added
- DBRC Enhancements**
 - f Recovery Control (RECON) online upgrade, online access, large record warning, loss notification, improved diagnostics
 - f Image Copy Genmax and Recovery enhancement
 - f DB administration enhancements
- Forward Recovery enhancements**
 - f Change accumulation spill record handling for smaller, faster change accrums
- Image Copy 2 Enhancements**
 - f compression option added for space savings
- I/O Performance enhancements**
 - f FICON support
 - f ESS support
- CSA Constraint relief**

© IBM Corporation 2004

IMS V7 Database Management enhancements also include: Improved availability in database recovery and reorganization, increased performance in database size, and improved systems management in diagnostics and error handling. To name a few of these additional enhancements:

High Availability Large Databases provided significant increase to database size to provide virtually unlimited databases and provide for partitioning of that data for reorganization without taking the database down.

IMS Database Recovery Control (DBRC) enhancements improve diagnostics information, improve Database integrity protection, eliminate abends, provide large Recon record support, Recon loss notification, and online upgrade for migration/coexistence.

Storage relief is provided through the use of: Common Storage Area (CSA) constraint relief, providing more below -the-line 16M Common Storage Area usage is made available by moving modules and control blocks above the 16M line.

Image Copy 2 Enhancements - IMS V7 provides a specification in the control card to allow the user to invoke compression for the copy. Alternatively, the DBRC.GENJCLIC command can be used.

Change Accumulation Enhancements - In a block level data sharing environment, the Change Accum Utility creates spill records which are used for later runs of the utility whenever the utility does not have all the logs that were produced while data sharing was active. IMS V7 will produce fewer spill records than in IMS V6. The Database Recovery utility cannot accept change accum date sets with spill records; however the Online Recovery Service facility will accept these inputs.

Application Control Block (ACB) Gen Enhancements - IMS V7 adds a time and IMS version to FP DMBs in ACBLIB, similar to that available for Full Function DBs and provides other miscellaneous changes to ACBGEN to improve performance and diagnostics.

Logger enhancements are provided with more dynamic capability to change system checkpoint frequency which improves system management and availability. A number of other systems management enhancements to the logger are also provided.

The Installation and installation verification process (IVP) panels are changed to have the same look and feel as panels for other IBM products. Support is also provided for Data Facility Storage Management Facility (DFSMS) constructs and HALDB sample applications

Fast Path database enhancements are provided for Data Entry Database (DEDB) I/O Tolerant improving handling of write errors, as well as the addition of support for performance monitoring capabilities.

MADSIOT=(list structure name, timeout value) is a new keyword in DFSVSMxx that controls the detection of a "long busy" state. This support is applicable only in a MADS environment. The timeout value, expressed in seconds, causes no further access to the ADS and all read/write operations go to a good ADS. When the "long busy" condition is over, the ADS is recovered using the contents of the good ADS from the list of CIs saved in the Coupling Facility.

A new keyword, EXPANDSEG, is allowed on the SCAN Utility SYSIN stream. The SCAN Utility detects the Compression Exit specified on the DBD. The SCAN user exit is passed the expanded segment for both the SORT and NOSORT cases. The DFS2671 message is changed to indicate which user exit is used and the number of segments expanded.

The IMS V7 Monitor provides monitoring of Fast Path resources. It also supports "constraints" or limitations which can be placed on what is monitored for both the full function database and fast path environments. For example, monitoring can be limited to specific databases, areas, dependent regions or to a specific time interval. only.

IMS V7 Transaction Manager Enhancements

Integration with Application Devt and Connectivity

- IMS Java and XML support
- OTMA Callable Interface
- ETO Enhancements
 - f Associated Printer support
 - f Autologon enhancements
 - f LTERM assignment flexibility
 - f ETO descriptor record limit removed
 - f Command Compatibility

Manageability

- Sysplex Queue Sharing Enhanced
 - f CQS enhancements for Shared Queues
 - f Asynch APPC/OTMA for Shared Queues
- Routing Exit enhancements
- RACF Pass Ticket Support
- Clarified USERID for applications
- External Subsystem Attach Facility (for DB2) Trace enhancements
- Installation enhancements
 - f Usability enhancements
 - f Java samples
- IMS systems parameter display

Scalability in performance, capacity, and availability

- Rapid Network Reconnect
- Deferred VTAM ACB Open to prevent time-outs
- Improved checkpoint frequency control
- SLUP Finance Session Coldstart capability
- VTAM Generic Resources enhancement for VTAM to manage the affinity
- Queue Space Notification Exit
- I/O SPOOL usability and performance enhancements
- SLU2 exception response enhancement

© IBM Corporation 2004

The IMS V7 Transaction Manager is also providing many additional enhancements -- in the area of application development and connectivity, systems management, Sysplex sharing, network load balancing, capacity and availability. To name a few of these additional enhancements:

Rapid Network Reconnect, utilizing the facilities of VTAMs Multinode Persistent Sessions, permits IMS TM to automatically reconnect terminal sessions following any kind of IMS failure and subsequent IMS restart, thereby reducing network reconnect time after IMS, MVS or VTAM failure in a Sysplex environment. It provides fast terminal reconnect to IMS by eliminating terminal logons and VTAM session startup traffic. IMS restart is required after IMS failure.

Shared Queues and Fast Path sharing enhancements, utilizing the coupling facility, provide asynchronous APPC/OTMA (open transaction manager access facility) shared message queue enablement, additional client support (multiple clients and additional client information and control), enable user autologon for a printer when application output becomes available and performance and miscellaneous enhancements to shared Fast Path Expedited Message Handler (EMH) and Sequential Dependent Segments (SDEP's).

Associated Printer Support: By enabling autologon to a printer, enqueued messages from a backend application can be delivered to the associated front end printer when shared queues is

Queue Space Notification Exit enhancement: The exit is notified of a stopped destination so that action could be taken to prevent the system from being saturated with undeliverable messages.

RACF (or equivalent) Pass Ticket Support: The /SIGN ON command accepts a new keyword, APPL, which allows an application name to be specified when creating a Pass Ticket . A Pass Ticket is used as an alternative to a password and removes the need to send RACF (or equivalent) passwords across the network.

Spool Enhancements: A new IMSWT= specification is allowed in DFSDCxxx. A five character specification replaces the first five characters of the IMSWTxxxJOBNAME in the /START REGION IMSWTxxx for auto scheduling the spool print utility.

Autologon (ETO enhancement): When a user is signed on to an ETO terminal interactively, such as in an interactive signon, or using the /OPNDST command, that terminal is not available for autologon of other users until the first user is signed off, either via /SIGN OFF or via an ASOT timeout.

ETO descriptor limit: The existing limit of 50 records per descriptor for ETO descriptors is removed.

IMS is being made Tivoli ready and enhancements are being provided for management of IMS through the Tivoli Global Enterprise Manager, and the Tivoli Manager for OS/390.

What is Open Database Access?

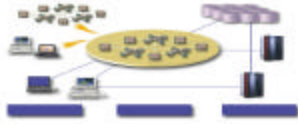

- Open Database Access (ODBA) is a callable interface for accessing data managed by IMS DB
 - Based on the DRA interface provided for CICS applications
 - Also provided through the IMS V6 service process
- ODBA allows IMS DB and OS/390 application programs to be developed, installed, and maintained independently of each other
- ODBA provides for failure isolation and independent resource recoverability
 - Requires OS/390 Resource Recovery Services (RRS)

© IBM Corporation 2004

Open Database Access (ODBA) for IMS is making it easier for customers to access the valuable information stored in their IMS Databases. ODBA makes it possible to access IMS DB subsystems from any OS/390 application address space.

In fact because synchpoint processing is coordinated through the use of OS/390 Resource Recovery Services (RRS) from one address space, you can connect to more than one IMS DB subsystem on the same MVS image, as well as commit or back out changes with just one call.

ODBA is also easy to use. Your application issues DL/I calls to an IMS database application interface block (AIB). The application supplies the AIB, an IMS connection table suffix, and a program specification block (PSB) name. ODBA connects you to IMS and schedules your PSB in a single bound. To make DL/I calls, you have to supply only a program communication block (PCB) name. In addition the DB2 Stored Procedures function has added support for ODBA in DB2 Version 5, allowing DB2 to coordinate synchpoint processing through RRS.

IMS V7 Java for Integrated On Demand Business and Application Development/Connectivity Ease

✓ Application Programmer Productivity

- Provide a set of packages (groups of classes) for I/O message handling and access to IMS services and support APIs familiar to Java programmers
- Java access to IMS input/output message queues
- Provide JDBC access to IMS DB and DB2 data for IMS TM/Batch applications
- Use Visual tools for development



✓ Enhancements since IMS V7 GA

- New Java Dependent Regions (JMP and JBP) provided to support Persistent Reusable Java Virtual Machine replacing HPJ compiler
- JDBC access to IMS DB from CICS Java applications, DB2 Stored Procedures, or WebSphere ejbs in local OS/390 and z/OS environments
- New Java Tool support
- Java Installation and Usability Enhancements
- Java-Cobol Interoperability/Usability enhancement to improve productivity and simplify operations (2003)
- COBOL-XML support for parsing/transforming XML documents through WSED-generated XML converters (2003)

© IBM Corporation 2004

Java is the base for new application development and connectivity.

In the base of IMS Version 7 is our IMS Java application support to enhance the ability of our customers and business partners to provide integrated e-business application development with IMS. The object of this function is to provide support for you to write Java applications and run them as IMS applications using WebSphere workstation and host tools for development and testing.

We provide access to IMS TM message queues and to IMS DB and DB2 data through JDBC.

2002 enhancements were provided to this support for IMS DB access from CICS/390 Java applications, DB2/390 Java Stored procedures and WebSphere applications, opening IMS DB up to better integration and use across platforms and across application environments. New Java Region Types were also being provided to replace initial support utilizing the High Performance Java Compiler. The newer support enhances the IMS V7 Java support to run with the new Scalable JVM, providing enhanced tool support for developing these Java applications to run in IMS.

And we are providing new Java Tooling, as well as installation and usability enhancements and supporting Java/Cobol and XML Interoperation.

IMS support for Java is augmented by IBM's Eclipse-based Application Development tools for J2EE programmers, as well as a broad array of AIM tools designed to facilitate building Innovative Services Oriented Architecture based applications that provide the best of the z/Series world with the best of the Java world.

JDBC Access to IMS Data with IMS Java

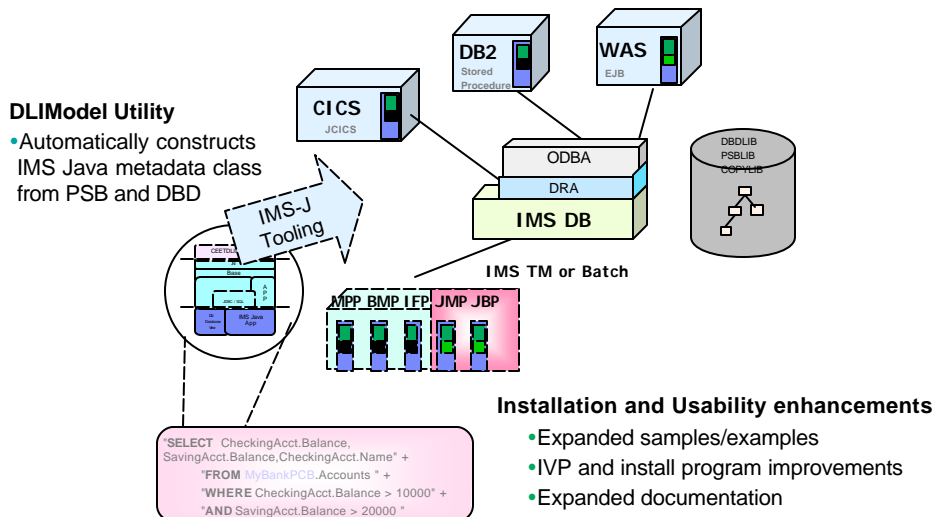

© IBM Corporation 2004

IMS has been taking advantage of the Java environment for Web connectivity to IMS applications, for writing IMS applications running in IMS, and for writing applications running in other environments that access IMS DB data. And IMS continues to enhance its Java application support and access to IMS DB through JDBC.

JDBC support enhances the IMS Java support for enabling JDBC access to IMS DB data not only from IMS TM environments but also now from a CICS/390 Java application, DB2/390 Java Stored procedure, and/or a WebSphere/390 Enterprise Java Bean.

Java tooling can be used. Java Tooling introduces a new IMS utility called DLIModel, which automatically constructs the required IMS Java metadata class from PSB and DBD source (earlier V7 users were responsible for creating this class manually). This utility allows information on additional fields, long Java-style names and data types to be supplied from user-coded control statements and/or from XMI descriptions of COBOL copybook members. If desired, it will produce XML descriptions of databases that conform to the OMG's Common warehouse Metamodel 1.1. This greatly eases development of Java applications and JDBC access to IMS DB.

Java Installation and Usability enhancements are also being provided - with expanded sample applications for IMS, WebSphere, CICS and DB2 Stored Procedures, expanded examples for logically related databases and secondary indexes, improvements for installation and Installation Verification program (IVP) applications and expanded documentation.

DB2 Stored Procedure Example

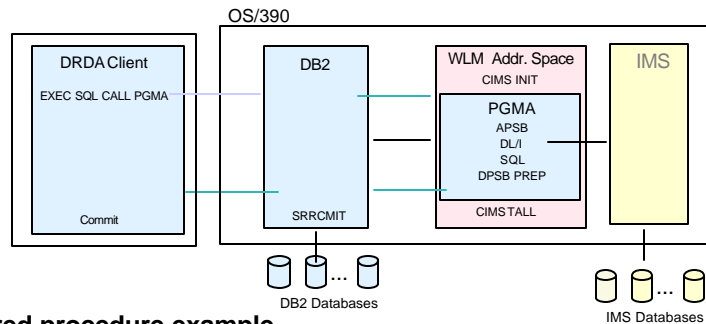

●DB2 stored procedure example

- DL/I calls to IMS DB
- Client program does commit when stored procedure returns or DB2 can issue SRRRCMIT

●Enhancements since IMS V7 GA

- JDBC calls to IMS DB from DB2 Java Stored Procedures, IMS and CICS/390 Java applications, and WebSphere ejbs
- Calls to IMS TM from DB2 Stored Procedures (2004)

© IBM Corporation 2004

This example shows a DRDA client issuing an SQL call which invokes a DB2 stored procedure. The call could be issued by any DB2 program, including one running in the MVS system where DB2 and IMS are executing.

The DB2 Stored Procedure must run in a Workload Manager (WLM) established stored procedures address space. This is required for support of recoverable resources (RRS/MVS). DB2 Version 5 or a later release is required for the use of these WLM established address spaces.

The stored procedure application program does not issue the CIMS calls. These are done by DB2 when it establishes and shuts down the address space. There may be multiple WLM stored procedures address spaces and each address space may have multiple tasks (TCBs). These characteristics are determined by WLM and DB2 parameters.

Those interested in implementing DB2 Stored Procedures may want to refer to redbook, Getting Started with DB2 Stored Procedures: Give Them a Call through the Network, SG24-4693.

Built on the ODBA support is the JDBC access to IMS DB provided through the IMS V7 service stream. This is available in S/390 or z/OS environments from IMS TM, DB2, CICS, and WebSphere application servers.

Accessing IMS DB

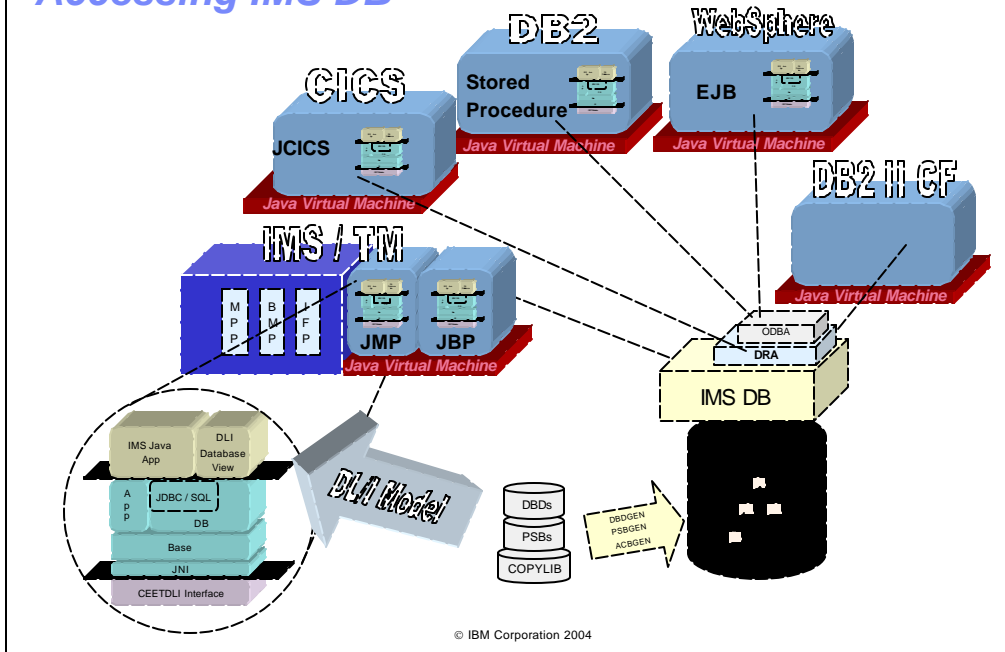

In addition to building IMS Java access on ODBA, SQL/JDBC access is also provided through DB2 II CF.

DB2 Information Integrator Classic Federation

- IMS access using SQL SELECT, INSERT, UPDATE, DELETE & stored procedure call
- ODBC, JDBC or Call-Level-Interface (CLI) clients
- No mainframe programming required
- Multi-threaded with native DBCTL/DRA IMS driver for scalable, multi-user performance
- Designed to work with existing mainframe tools & application infrastructure
- Enterprise ready: 2 phase commit, transactional throughputs, seamless integration

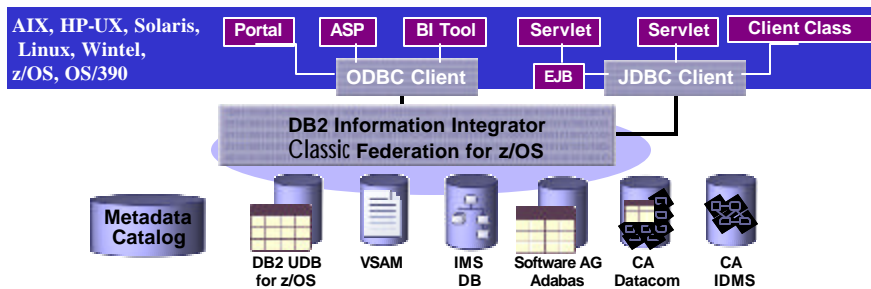

© IBM Corporation 2004

DB2 Information Integrator Classic Federation can also provide SQL and JDBC access to IMS Data through ODBA. This allows distributed common access to IMS Databases as well as other non-IMS databases using the DB2 Information Integration product set.

It provides IMS access using SQL SELECT, INSERT, UPDATE, DELETE & stored procedure calls for ODBC, JDBC or Call-Level-Interface (CLI) clients. No mainframe programming is required. It is multi-threaded with native DRA IMS driver originally provided for CICS access to IMS Databases for scalable, multi-user performance. It is designed to work with existing mainframe tools & application infrastructure. And offers enterprise ready 2-phase commit, transactional throughputs, and seamless integration.

IMS V7 HALDB for IMPROVED CAPACITY AND DATA AVAILABILITY

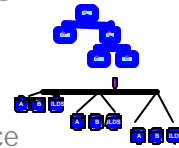

- ✓ Scaling up the IMS Full Function database size
 - ➔ 1001 Partitions x 10 data set groups x 4G = 40 Terabytes
- ✓ Providing data availability through partition independence
- ✓ Providing easier manageability with smaller partitions of the database
- ✓ Enhancements since IMS V7 GA:
 - Performance Improvements in
 - f Secondary index migration
 - f Indirect list data sets (ILDS) creation
 - f DFSMAID0
 - f Secondary index option during Load
 - Management Improvements with
 - f Recon Partition List Command support
 - f Batch command initialization and change/delete of HALDB and associated partitions
 - f Limit BMP/Batch/JBP Calls to one partition
 - f Unload Reload status enhancement
 - f PCB label Processing (2003)
 - f Partition Definition Utility, DBRC/HALDB commands, and usability (2003)
 - f DBRC Option, Processing Control Statement, and Partition Selection Exit Enhancements (2004)

© IBM Corporation 2004

Since IMS V7, High Availability Large Data Base Support had allowed for 1001 partitions to a max capacity of 40 gigabyte each. This means you can have over 40 Terabytes OSAM and VSAM databases. That would be 20,000 3390 devices. This works out to 6600 bytes for each person on earth. This compares to V5/6 when we just expanded to allow 8 gigabyte databases

This support also allows for a partition to be taken offline, have something done to it and be independently brought back online. This means each partition could be individually unloaded and reloaded and while offline a batch reorg could be done to on it. Or the entire database could be taken offline and each partition could be reorged in parallel, greatly speeding up the offline reorg process.

Since delivery of IMS V7 HALDB we have been providing additional enhancements for performance and manageability to ensure this as the base for any future database activity.

Performance improvements were provided in secondary index migration, Indirect list data sets (ILDS) creation, and DFSMAID0. Management enhancements were provided with RECON partition LIST command support and Batch Command initialization of HALDB and its associated partitions.

Also provided is an option to not build secondary indexing so as to reduce time to load, command support is enhanced with Recon Partition List Command support, and Batch command initialization and now also change/delete of HALDB and associated partitions. And also provided is the ability to limit BMP, Batch, and JBP calls to a single partition. And we are also enhancing the unload/reload status report to display unload/reload statistics for each partition. We are also providing PCB Label processing for ease rather than using an offset.

And we provided enhancements to Partition Definition Utility, DBRC/HALDB commands, and for HALDB usability.

2003/2004 IMS V7 HALDB Enhancements through the Service Process

- **Label Processing, easing use of a label**
- **Partition Definition Utility, DBRC/HALDB Commands, and Usability enhancements**
- **DBRC Option for batch programs, where no DB calls refer to HALDB during execution, providing more flexibility and reducing efforts**
- **Increase of Processing Control Statements from 10 to 20, allowing up to 20 DB PCBs that can perform single partition processing in a HALDB**
- **Ease use of Partition Selection Exit DSECT by user-written partition selection exits.**

© IBM Corporation 2004

To help with Manageability of HALDB Database, label processing was provided to enable use of a label.

Users could also provide DBRC commands for recon definition initialization and changes for HALDB so they require the HALDB Partition Definition utility for this.

DBRC Option enhancement for HALDB allows a batch program that references a HALDB to run without DBRC so long as no database calls refer to the HALDB during execution. This provides more flexibility in running a single program in different environments, thus reducing application developer and operations efforts that might be needed to convert programs and ensure their running only in specific environments.

HALDB Processing Control Statement enhancement increases the number of HALDB single partition processing control statements from 10 to 20 for usability. This allows a customer's application to specify up to 20 DB PCBs that are allowed to perform single partition processing in a HALDB.

HALDB Partition Selection Exit DSECT enhancement allows customers to use the DFSPSEIB macro to get the partition selection exit DSECTs. This makes HALDB with a user-written partition selection exit easier to use. Customers no longer have to create their own DSECTs for the partition selection exit parameters.

IMS V7 DBRC Enhancements for Eased Recovery and Manageability

- **DBRC Concurrent RECON Upgrade**
 - f RECON can be upgraded without stopping pre-IMS V7 systems
- **RECON Loss Notification**
 - f MVS console message for RECON loss, aiding automation
- **DBRC Support for PROCOPT=L/LS**
 - f Image Copy required at initial database load, improving data integrity
- **DBRC Image Copy GENMAX**
 - f GENMAX no longer automatically increased when number of image copies specified is exceeded, enhancing usability
- **Large RECON record warning**
 - f Warning message, easing automation and increasing availability
- **RECON Access improvement**
 - f Change to scheme to serialize accesses to RECON (online system favored over batch jobs), reducing I/O bottlenecks that impact online systems
- **DBRC serviceability**
 - f LIST.DBDSGRP, LIST.HISTORY enhancements
- ✓ **Enhancements since IMS V7 GA:**
 - **Support of HALDB performance/management enhancements**
 - **List History timeline - can just point to the timeline only**
 - **DD Cards - alt DD for SYSIN**
 - **Genjcl user partition support**
 - **HALDB Partition Init Utility enhancement (2004) - Providing parallel execution of multiple job tasks for the Partition Initialization Utility**

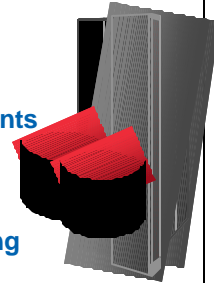

© IBM Corporation 2004

Numerous other enhancements in IMS V7 relate to IMS Database Recovery Control (DBRC):

DBRC Support for PROCOPT=L/LS -- In IMS V7, DBRC requires an image copy after a load application (PROCOPT=L/LS) has run and will issue a warning message for databases being updated without an image copy. Prior to IMS V7, DBRC did not require a valid recovery point after a load application had been run.

DBRC Concurrent RECON Upgrade -- Prior to IMS V7, all IMS activity needs to be shut down in order to upgrade the RECON to a new release level. IMS V7 provides a new CHANGE.RECON.UPGRADE command that can be issued from a DBRC batch job. The RECON must have been created by DBRC in IMS V6 or been upgraded to the V6 level. The RECON Batch Upgrade Utility is still supported for pre-V6 RECONS.

DBRC IC GENMAX Changes -- In IMS V7, the GENMAX value will no longer be increased automatically. It can only be changed using the CHANGE.DBDS command.

DBRC Serviceability enhancements -- Debugging recovery problems often requires knowing the precise order in which different events affecting a database occurred. The LIST.HISTORY command provided much information, but the user was required to construct his own timeline. IMS V7 DBRC provides a graphical timeline that interrelates all activities and reduces the amount of records printed for any given Database Definitions (DBDs) or areas. Also prior to IMS V7, there was no option to provide a list of DBDSGRP names which have a member for a specific named DBD. IMS V7 provides a new optional value on the existing ALL parameter which lists all of the DBDSGRP records containing the specified member(s).

In addition, DBRC enhancements have been provided since GA in 2001 and we've continued providing these into 2002 to ensure support of the new HALDB performance and management enhancements as well as:

to provide List History timeline to allow you to just point to the timeline only - The timeline is a graphic representation of the output produced from a LIST.HISTORY request. It is included at the end of the listing of records for the given request - the amount of this output can be sizable. There are times when it is desired to only view the timeline. This item provides this option.

DD Cards providing alt DD for SYSIN - This is an interface into DBRC that allows the caller to specify and alternate SYSIN, SYSPRINT and/or IMS datasets.

Genjcl user partition support - A GENJCL.USER command that specified a partition dataset would repeat the process for each DBDS under the Master data base rather than just the DBDSs under the specified partition data base. This produced duplicate and unwanted output. This item provides an option to specify that only DBDSs under the partition DB be processed.

In 2004, support is provided through the service process for IMS V7 and V8 for Parallel HALDB Partition Initialization utility enhancements to support parallel execution of multiple job tasks.

IMS V7 Enhancements in 2003/2004 via Service process

Integration/Openness

- Java/XML enhancements for programmer productivity
- OTMA enhancements for security/manageability
 - Dynamic Refresh of Aging value for OTMA messages in a security environment
 - OTMA Auto option for delivery of a single message (Mar 2004)

Manageability

- HALDB and DBRC enhancements to ease usability
- Autonomic adjustment of the Global Database directory table (2004)
- /Exit Conversation Enhancements
- Option to disable STM for static ISC
- Fast Path enhancements
 - VSO RSR/XRF enhancements
 - Availability/Serviceability/usability enhancements
- Long Locks Module User Exit to support real time monitoring of lock data for the Performance Monitor tool support enhancements
- DEQ/DIS Commands support for Shared Queues

Scalability

- RRS = Y/N to avoid unnecessary overhead.
- Dynamic LTERM creation
- Enhanced Sysplex Coupling Facility support (duplexing, auto alter, rebuild, commands)

© IBM Corporation 2004

In 2003/2004 IMS continued provided enhancements for IMS V7 and forward fitting them to IMS V8.

For Integration/Openness, we have the Java/XML enhancements for COBOL Interoperability and for COBOL parsing and transforming of XML documents .

We also have some additional security and management enhancements for OTMA -- Dynamically refreshing of the aging value for the OTMA messages in a security environment and providing an Option with OTMA Auto for delivering only one message.

HALDB and DBRC enhancements were added to ease use.

IMS provided Autonomic adjustment of the Global Database directory table, ensuring more effective management and enhancing performance during data sharing process

/Exit Conversation Enhancements deletes the conversation off the shared queue where previously it would continue to get processed.

Option was added to disable Sysplex TM for Static ISC allow backup through duplicate names for multiple sessions between systems

Fast Path continued to be updated -- Shared VSO, to support making them as recovery needed at a disaster site since PPRC doesn't support the structures, facilitating the handling of the FP structures at a disaster site; Local VSO eXtended Recovery Facility Tracking performance enhancement enhances performance for a large number of updates for XRF; Reduce abends which can that take down the control region in the case of certain errors so as to improve availability.

Additional FP serviceability/usability enhancements are also being provided. This includes --

Put the IMS jobname of the HSSP job in the DMAC; Log NBA/OBA count; HSRE option - # UOWs skipped before termination; Add the EPST/EMHB/ESRT to the 6706 log record; Bypass need for dataspace if no VSO. Adding area name to certain messages and adding number of processed SDEP CIs in SDEP SCAN job output. And activating OFR with a /STA DB command instead of multiple /STA Area commands

For scalability, an option was added at to whether you wanted to use RRS or not to avoid any unnecessary overhead.

Dynamic LTERM creation provides the ability to create dynamic remote LTERMs, where you could only previously dynamically create only local LTERMs

IMS is taking advantage of z/OS's Coupling Facility (CF) duplexing function for IMS Shared Message Queue structures and IMS Fast Path Expedited Message Handler (EMH) structures. When CF duplexing is enabled, z/OS creates a duplex copy of the structure for failure recovery. If the IMS Shared Queues structure or the EMH structure fails or a connection to the structure is lost, z/OS switches to the unaffected structure instance without the overhead of a structure rebuild. CF duplexing also enables system-managed rebuild. MVS does the structure rebuild for a planned reconfiguration to do the structure copy if no IMS Common Queue Server (CQS) is up. The advantage to system rebuild is that CQS does not have to be up. CQS managed rebuild is still needed to address CF failure, structure failure, or loss of connectivity.

CF Structure Duplexing support for IMS Data Sharing is being provided through the IRLM 2.1 service process.

IMS in a Parallel Sysplex

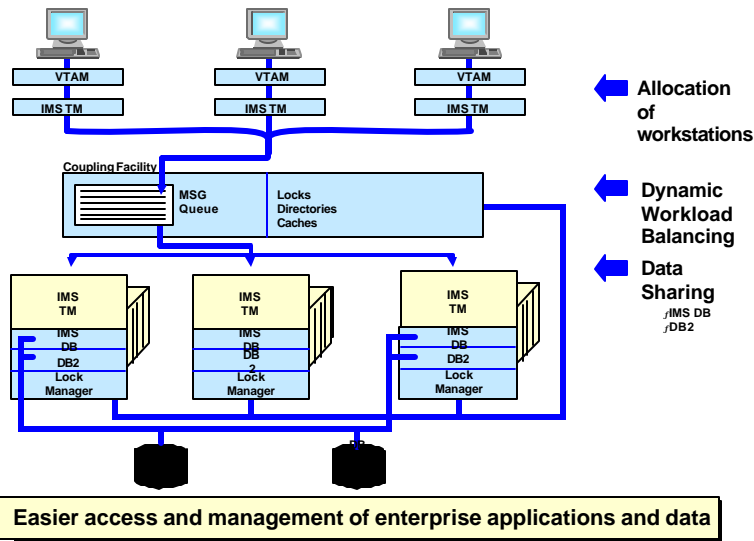

© IBM Corporation 2004

IMS continues to strengthen its support of the Enterprise by providing the highest in performance, availability, security, integrity, at the least cost per transaction. In doing this it has been exploiting the hardware/software environments that it has grown up along side of. IMS fully exploits for customer advantage the new technology and power of OS/390 and the Parallel Sysplex. Existing IMS data sharing capability was enhanced with IMS Version 5 to take advantage of the coupling facility for storing lock information and for easy availability of that information by all systems in the Sysplex environment. The lock manager in each system could access the locks as they needed to. In addition to data sharing, IMS V5 provided necessary information to the MVS workload manager to assist with workload balancing of resources across the Sysplex. IMS also enhanced message routing between systems to take advantage of workload balancing information, and IBM provided the IMS Workload Router to use these facilities to push the work to the available system. Significant enhancements for IMS V6 are being added to those provided in IMS V5 to complement the Parallel Sysplex hardware and operating systems facilities. IMS V5 also provided Remote Site Recovery, which allowed backing up an IMS system with another at a different location. A database at another system is maintained to match the primary database and/or a log is maintained that can dynamically and quickly update that remote data base to allow takeover in the event of failure.

IMS V6 improved the IMS V5 Data Sharing and Workload manager enhancements with additional data sharing (storing changes and unaltered data on the coupling facility for Sysplex access, and providing additional Fast Path sharing), message sharing (providing message queues and fast path messages on the coupling facility for Sysplex access), and message routing enhancements (utilizing VTAM Generic resource support). As customer workload grows, the power that distributing data and applications across the Sysplex provides is needed. End users want to be able to access applications and data transparently, regardless where the work is processing. This enhanced support provides improved end user interaction, improved IMS availability, improved workload balancing, and offers increased capacity and growth in moving into Parallel Sysplex environments.

IMS's Fast Path capabilities continue to be enhanced to provide the fastest access through the system, continuing to lead database products. Against industry standard benchmarks it continues to show as the best price performance at the lowest cost, confirming that nothing in the transaction market matched the speed and power of the IBM S/390 with IMS.

IMS V8 Database Manager Enhancements

Integration/Open with Application Development and Connectivity

- **Dynamic LE Runtime Parameters**

Manageability

- **Single Image Operations Manager**
- **Syntax Checker**
- **Removed RSR RLT/DLT install checking**
- **Packaging/Install/IVP enhancements**

Scalability in Availability/Recovery/Performance/Capacity

- **IMS/DB2 Coordinated disaster recovery support**
- **DBRC Enhancements**
 - **Automatic Recon Loss Notification** for quicker loss recovery
 - **Eliminate ABENDs** when authorizing database
 - **RECON Command Authorization** controls RECON access/update via DBRC batch commands
 - **16M RECON Record Size** helps users avoid problems caused by Recon Record size exceeding VSAM record size max
 - **Prilog Compression** reduces overhead, improves performance
- **Parallel Database Processing**
- **Fast Path DEDB Enhancements**
 - f* **Non Recoverable DEDBs**
 - f* **DEDBs increased to 2048 areas**
- **CSA/VSCR Enhancements**

© IBM Corporation 2004

IMS V8 Database Management enhancements include:

Enhanced application development/execution and connectivity with Java standards enhancements and XML support of IMS TM messages and Dynamic LE Runtime Parameters which provide the ability to dynamically update Language Environment (LE) runtime parameters for an IMS transaction or Batch Message Program and make it easier to use the Debug Tool for application testing. This would be done without requiring CEEROPT and CEEUOTP to be changed, reassembled, and relinked when parameters need to be changed.

Improved manageability with single point of operations control, Sysplex- wide resource management, Sysplex terminal management, easing serviceability with transaction trace, and in easing systems generation with a new Syntax Checker and packaging/install/IVP enhancements

Improved systems availability in error handling and database restart and recovery.

Increased performance/capacity in easing constraint relief, in logging and recovery. And Parallel Database (DB) Processing support allows IMS to do DB authorization, allocation, open and close processing using multiple MVS threads. This replaces the earlier serialized process. For systems with large numbers of databases, this can significantly reduce the amount of time required to re-open databases after an outage, normal or abnormal, thus returning the system to steady state thereby increasing system availability.

IMS V8 Transaction Manager Enhancements

Information Integration with Application Development and Connectivity

- Dynamic LE Runtime Parameters
- **Manageability**
- Sysplex Wide Resource Manager
- Single Image Operations Management
- Sysplex Terminal Management
- Transaction Trace
- Syntax Checker
- Packaging/Install/IVP enhancements.

Scalability in Availability/Recovery/Performance/Capacity

- APPC/OTMA enhancements
- CSA/VSCR enhancements
- Common Service Layer address spaces

IMS V8 Transaction Management enhancements include:

Enhanced application development/execution and connectivity with Java standards enhancements and XML support of IMS TM messages and Dynamic LE Runtime Parameters which provide the ability to dynamically update Language Environment (LE) runtime parameters for an IMS transaction or Batch Message Program and make it easier to use the Debug Tool for application testing. This would be done without requiring CEEROPT and CEEUOTP to be changed, reassembled, and relinked when parameters need to be changed.

Improved manageability with single point of operations control, Sysplex-wide resource management, Sysplex terminal management, easing serviceability with transaction trace, and in easing systems generation with a new Syntax Checker and packaging/install/ivp enhancements

Improved systems availability in error handling and network reconnection for APPC

Increased performance/capacity in easing constraint relief and in providing parallelism with new Common Service Layer address spaces.

IMS Resource Definition Manageability

- **Current System Generation Process:** 2-stage, batch, assembler, process requiring cold start; system quiesce required with online change (DBs, Trans route codes, Appls, Security)
- **Requirements:** Reduce system generation time/effort and Improve availability during change

Staging

- **IMS V4** stopped using sysgen to support new function
- **IMS V5/6** removed conditional assembly modules
- **IMS V7** put non-conditional link-edit modules under SMP control
- **IMS V8**
 - f Removed RSR RLT/DLT feature install checking
 - f Resource Manager/Coordinated Online Change
 - f Syntax Checker
 - f Packaging/Installation/IVP enhancements
- **IMS V9**
 - f Conditional link-edit elimination
 - f Online change modules moved from the Nucleus
 - f Dynamic change/addition of Type 4 SVC and resource cleanup module
 - f IVP and syntax Checker enhancements

© IBM Corporation 2004

Another area of Manageability that IMS is addressing is that of the IMS Resource Definition. Currently this requires two stage, batch, assembler system generation process. This originally requiring cold start, has provided online change for some resources. These resources are the Databases, Trans route codes, Appls, Security. But this online change requires a quiesce of the entire system

Requirements in this area are to reduce system generation time/effort and to improve availability during change.

In the more recent IMS versions we have been focused on reducing the IMS System Generation time and effort

IMS V4 stopped using sysgen to support new function

IMS V5/6 removed conditional assembly modules

IMS V7 put non-conditional link-edit modules under SMP control

IMS V8 provided the Resource Manager/Coordinated Online Change, Syntax Checker, Packaging/Installation/IVP enhancements, and removed the RSR RLT/DLT features install checking.

IMS V8 Syntax Checker

Helps Reduce System Generation effort

- **New IMS ISPF application** which assists Systems Programmers in defining and maintaining the IMS parmlib members residing in the IMS PROCLIB
- **Parameter and value checking and detailed help text** at the parameter level tailored to the IMS version
- **Assists in moving from release to release** by identifying new parameters and obsolete parameters
- **Provide ability to ensure parameters are valid** prior to shutting down and restarting your IMS Control Regions.

© IBM Corporation 2004

Syntax Checker is a new addition to the IMS installation process. Syntax Checker helps reduce the system generation effort by assisting the system programmers in defining and maintaining selected input parameter members residing in the IMS PROCLIB. It provides parameter syntax checking, parameter value verification and detailed help text at the parameter level tailored to the IMS release. It also provides assistance in migrating to a new release by identifying any new and/or obsolete parameters. Syntax Checker displays the proclib member in an ISPF panel. Any parameters or values in error are highlighted. The user may add, change or correct the value of the parameters. Detailed help text for a parameter is also available at the touch of a key. Using Syntax Checker, the system programmer can ensure the parameters are valid prior to shutting down and restarting IMS control regions. It eliminates the risk of parameter error during a start-up of IMS and the time-consuming process of tracking down and correcting parameter syntax or value errors.

IMS V8 Packaging, Installation and IVP Enhancements

New IMS Packaging and Installation Process

- SMP/E jobs removed from Install/IVP Dialog Process
- SMP/E Receive, Apply, Accept processing
- New Target and Distribution datasets
- No DFSJCLIN Job provided

Installation Verification Program Enhancements

- OM, RM, SCI, SPOC Sample Application
- Syntax Checker Sample Application

© IBM Corporation 2004

New IMS Packaging and Installation Changes

The SMP/E jobs have been removed from the Install/IVP Process.

Instead: JCL is provided in the Program Directory to unload jobs that perform the SMP/E processing. The SMP/E install jobs contain instructions to customize the install to the customers site.

This is a major change to the IMS install process. It was made to be consistent with IBM's installation standards.

"Install/IVP" will be renamed "IVP" (Installation Verification Program). The IVP process will continue to provide the facility for verifying (testing) the installation of IMS.

SMP/E Receive Apply Accept Processing

The SMP/E install portion of IMS will use the standard Receive, Apply, Accept process. SYSGEN is still required to complete the IMS install process.

New SMP/E target and distribution datasets provided a target dataset for source code, target and distribution datasets for optional user exits, and Java libraries.

No DFSJCLIN job provided.

The job was used to install non-SYSGEN parts. These part are now created by the SMP/E Apply process.

The SMP/E GENERATE command will be used to build any JCL necessary to recreate the non-SYSGEN parts after the install.

IVP Enhancements

OM, RM, SCI, SPOC Sample Application

IVP will provide jobs and tasks to test and demonstrate the defining and starting of an IMSPLEX and the use of SPOC to issue commands to the IMSPLEX.

Syntax Checker Sample Application

IVP will provide tasks to demonstrate the general use of

Syntax Checker and the use of Syntax Checker to convert the IMS "PB" Proclib members (DFSPBxxx) from V7.1 to V8.1

IMS V8 Enhancements in 2003/4 via Service process

- Java and XML enhancements
- DB Image Copy 2 Enhancements eases image copy coordination and management
- Coordinated Online Change eases, manages, and automates change across the Sysplex
- APPC/OTMA Enhancements (1H04)
- Recon I/O Reduction (1Q04)
- Sysplex TM Y/N Option
 - For Static ISC
 - For all TM resources (1Q04)
- Items from V7 Enhancements in 2003/2004

Also provided as part of DB2 V8 Control Center via a Fixpack

- IMS Control Center

© IBM Corporation 2004

A number of enhancements have already been rolling out for IMS V8 via the service process. They include Java and XML enhancements, Database Image Copy 2 enhancements, Coordinated Online Change, Sysplex Terminal Manager Y/N option, and APPC/OTMA Enhancements.

And soon we are also providing the APPC/OTMA Shared Queues support.

IMS V7 enhancements in 2003 via the service process are also being retrofit to V8.

In addition, the IMS Control Center was delivered as part of the DB2 Control Center via a Fixpack.

IMS V8 Java and XML enhancements

Eases Application Integration

- **WSADIE Service Definition creation for MFS-based applications to enable use as Web Services**
- **MFS Web Services support enabling customers to publish existing transactions as Web Services and connect to IMS via SOAP and EJB bindings.**
- **SQL enhancements for new SQL keywords and Aggregate functions enhancements**
- **JDBC 2.0 support, including the ability to obtain scroll insensitive result sets.**
- **IMS DB-DB2 Interoperability from within a Java dependent region**
- **JDK 1.4 support**

© IBM Corporation 2004

Java and XML enhancements were provided for IMS V8 to ease integration with application development and access.

Items are provided for Web Services definition and enablement of existing IMS MFS applications.

Support is also provided for the latest SQL and JDBC standards and enhance interoperability between IMS DB and DB2 for JDBC access within a Java Dependent region.

IMS V8 APPC/OTMA Enhancements

- OTMA/MQSeries Performance enhancements
- APPC/OTMA exit enhancements (1Q04)
 - Allow user exit DFSLUEE0 to change synclevel for APPC outbound conversations.
 - Pass DFS messages to user exit DFSCMUX0 if input is from an APPC or OTMA device.
- OTMA enhancements
 - Purge CM0 IOPCB output notification easing recovery
 - /Display TPIPE command enhancement to show wait status easing usability
 - New Resume TPIPE option easing performance
- APPC/OTMA Shared Queues Support (2Q04) provides for sharing messages between Sysplex systems through IMS Queue Manager
 - MVS/APPC programs
 - OTMA programs (eg. MQ, Connect, etc.)

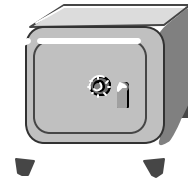

© IBM Corporation 2004

Access to IMS through APPC/OTMA continues to be enhanced for security and manageability:

OTMA/MQ Performance enhancements

APPC/OTMA exit enhancements

1. Allow user exit DFSLUEE0 to change synclevel for APPC outbound conversations.
2. Pass DFS messages to user exit DFSCMUX0 if input is from an APPC or OTMA device.

APPC/OTMA Shared Queues Support

IMS V8 Synchronous shared Queues support allows users to run synchronous transactions entered from APPC on any IMS system in the Shared queues group. Synchronous transactions can run on any back-end system from any front-end system; the output message is sent back to the client from the front end system. Previously only asynchronous transactions for these environments were supported. This new support uses the z/OS Resource Recovery Services (RRS) Multi-System Cascaded Transactions support. This Synchronous Shared Queues support is provided for MVS APPC programs, as well as for the Open Transaction Manager (OTMA) facility workload as well.

IMS V8 Image Copy 2 Enhancements

Eases Image Copy coordination and management

- **Multiple utility control statements** can be copied per execution
- **Group name support** names the datasets in one execution so can start and/or stop as a group
- **Single output data set** can be created for multiple image copies
- **DFSMSdss Optimize option** supported

© IBM Corporation 2004

The Image Copy 2 enhancements allow multiple database data sets to be copied in one utility execution. The utility passes the data sets to DFSMSdss on multiple DUMP commands to be processed in parallel. Optionally the user can specify that the data sets are to be processed by a single DFSMSdss DUMP command which results in the image copies being written to the same output data set. Logical completion in most cases would be achieved for all of the database data sets in a very brief period of time. Also, the utility supports specification of a group name for the database data sets being copied. Logical completion is then indicated for the group rather than for the individual database data sets. With the added capabilities, users are able to better manage and automate image copy processing.

IMS V8 Coordinated Online Change

Eases, manages, and automates change across the IMS Sysplex.

- Commands can be entered on one IMS
- Requests can be handled for coordinating change across all the IMSs in the IMS Sysplex
- Improves change processing
- Commands now provide more meaningful information in cases of failure or to query state information
- Avoids impact of a partial commit
- Simplifies error handling
- Replaces manual coordination

© IBM Corporation 2004

Global, Coordinated Online Change eases, manages, and automates change across the IMS Sysplex. Prior to IMS V8 Online Change required off line processes and was a complicated process across IMSs. With coordinated online change, commands can be entered on one IMS and request that the new IMS Resource Manager coordinate an online change across all the IMSs in the IMS Sysplex, replacing the earlier manual coordination process. It uses a shared dataset and global online change utility. Also were added new commands to commit, terminate, etc.

IMS V8 Easing Sysplex Operations Manageability

Operations Manager

- Routes Commands
- Provides an API
- Provides Single Point of Control and supporting code for entering commands



Single Point of Control (SPOC) can be used to control any IMS, with or without the presence of a Sysplex using

- TSO/ISPF Application, or
- DB2 V8 Control Center through IMS Connect into IMS

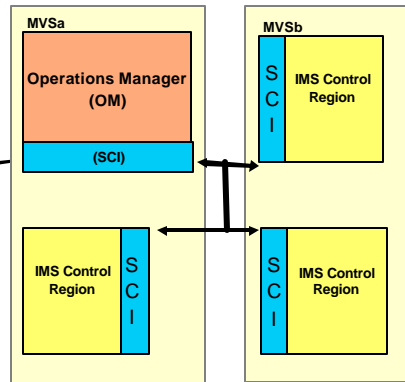

© IBM Corporation 2004

IMS V8 Operations Manager

Provides an IMS Address space which routes IMS Commands to interested IMSs across the IMS Sysplex and consolidates IMS command responses.

Provides an Application Programming Interface to allow a user or vendor to write tools to automate IMS operations.

Supports a Single Point of Control (SPOC) to present a single system image for the IMS Sysplex by allowing the user to enter commands to all IMSs in the IMS Sysplex from a single console.

Although designed with Sysplex in mind to optimize operations across a Sysplex, the new V8 SPOC can also be used to improve systems management of commands in general, and the SPOC can be used to control any IMS, without the presence of a Sysplex. This support can provide operations management for a DBCTL environment, as well as for an IMS TM/DB environment. In addition, a GUI SPOC is being provided as part of the DB2 V8 Control Center early in 2003. Access to IMS from this IMS Control Center is provided through IMS Connect in through the new IMS V8 Structured Call Interface.

Provides a 3270 TSO/ISPF Application running on S/390 or z/OS

Provides DB2 V8 IMS Control Center code for distributed operations access to IMS operations management through IMS Connect.

Enterprise Modernization: Value Chain

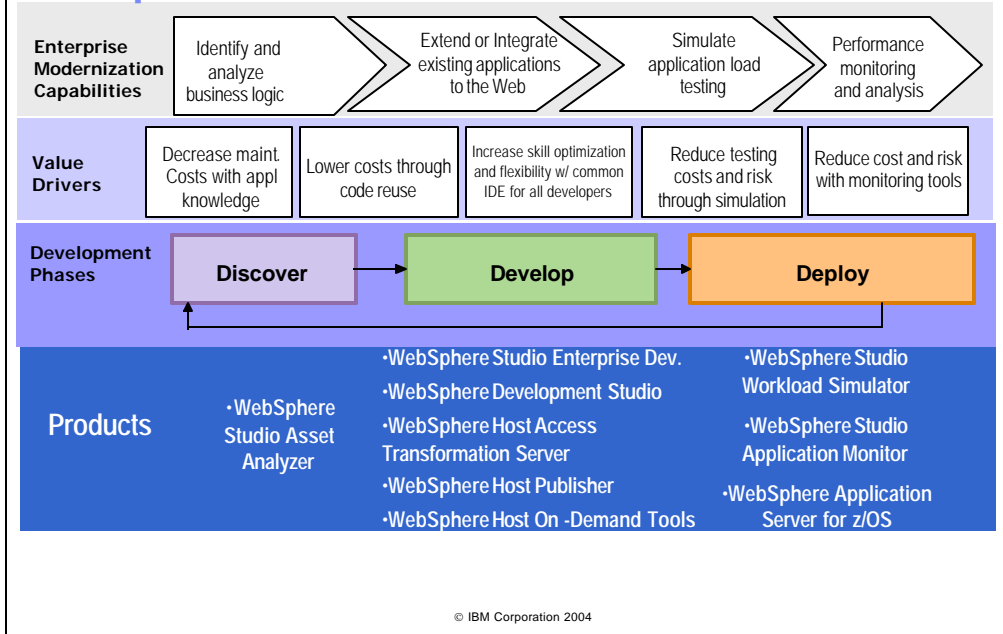

Stepping back into the Development, we look at some of the Tools to help with IMS Application Development.

This chart maps the development cycle and its tasks, to the value drivers that our customers demand and the large number of IBM products available to satisfy that demand.

Application Integration Management Tools for IMS Innovation

Discover

f **WebSphere Studio Asset Analyzer V5R0** 5655-L21

Develop

f **WebSphere Studio Enterprise Developer V5R0** 5724-B67

f **WebSphere Studio Enterprise Developer Server V5R0** 5655-I57

f **WebSphere Studio Host on Demand 5xxxx-xxx**

f **WebSphere Host Publisher V4R1** 5655-I03

f **WebSphere Host Access Transformation Services V5R1**

f **Debug Tool for z/OS and OS/390 V4R1** 5655-L24 and **Debug Utilities for z/OS V4R1** 5655-L23

- Provides user controlled IMS debug sessions

f **Enterprise COBOL for z/OS and OS/390 V3R2** 5655-G53

f **Enterprise PL/I for z/OS and OS/390 V3R2** 5655-H31

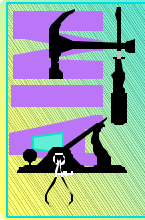

Discover
Develop
Deploy
Innovate
!

Deploy

f **WebSphere Studio Workload Simulator V2R1** 5655-I14

f **WebSphere Studio Application Server for z/OS V2R1** 5655-L42

f **WebSphere Application Server for z/OS V5R0**

f **Fault Analyzer for z/OS V4R1** 5655-L25

- Includes support for IMS/TM fault analysis

f **FileManager for z/OS V4R1** 5655-L26

- Ability to manage IMS/DB data

f **Application Monitor for z/OS V2R1** 5655-L22

- Provides IMS/TM-DB application drill down

f **Workload Simulator for OS/390 and z/OS V1.1** 5655I39

- Simulate IMS workloads for regression testing

In addition to IMS, IBM provides a broad array of Application Development tools designed to support existing enterprises in their transition to "On-demand" applications. This is true particularly in the areas of discovery, development and deployment. These tools range from compilers designed to support XML, tools to assist in the identification of impacts due to program modifications, debug and performance aids as well as support to aid error correction and file manipulation. IBM's Application Development thrust is towards helping customers provide innovative "SOA" (Services Oriented Architecture) based IT solutions, while leveraging their existing asset base.

IMS Tools Easing Systems Manageability

Database Administration

- IBM Data Encryption for IMS and DB2 Databases, V1.1 5799-GWD
- **IMS Database Repair Facility**, V1.2 5655-E03
- IMS HALDB Conversion and Maintenance Aid, V2.1 5655-K47
- IMS HD Compression- Extended, V2.2 5655-E02
- IMS Library Integrity Utilities, V1.1 5655-I42
- **IMS Parameter Manager**, V1.1 5655-L69
- IMS Sequential Randomizer Generator, V1.1 5655-E11

Recovery Management

- IBM Application Recovery Tool for IMS and DB2 Databases, V1.2 5697-F56
- IMS Database Recovery Facility, V2.1 5655-I44
- IMS DEDB Fast Recovery, V2.2 5655-E32
- **IMS High Perf Image Copy**, V3.2 5655-J56
- IMS High Perf Change Accumulation, V1.2 5655-F59

Utilities Management

- ✓ Fast Path
 - IMS Fast Path Basic Tools, V1.2 5655-E30
 - IMS Fast Path Online Tools, V2 5655-F78
 - **IMS High Perf Fast Path Utilities**, V2.1 5655-K94
- ✓ Full Function
 - IMS High Performance Unload, V1.1 5655-E06
 - **IMS High Performance Load**, V2.1 5655-E07
 - **IMS High Performance Prefix Resolution**, V3.1 5655-M27
 - IMS Index Builder, V2.3 5655-E24
 - **IMS Parallel Reorganization**, V3.1 5655-M28
 - IMS High Performance Pointer Checker, V2.1 5655-K53
- ✓ Administration
 - IMS Database Control Suite, V3.1 5655-L08

Information Integration Management

- IMS DataPropagator, V3.1 5655-E52
- **DB2 II Classic Event Publisher for IMS**, V8.2 5655-M38
- **DB2 II Classic Event Publisher for VSAM**, V8.2 5655-M35
- **DB2 II Classic Federation for z/OS**, V8.2 5697-I82

Performance Management

- IMS Buffer Pool Analyzer, V1.1 5697-H77
- IMS Network Compression Facility, V1 5655-E41
- **IMS Performance Analyzer**, V3.3 5655-E15
- IMS Problem Investigator, V1 5655-K50
- IMS Performance Monitor, V1.1 5655-G50
- **OMEGAMON for IMS**

Application Management

- IMS Batch Terminal Simulator, V3.1 5655-J57
- IMS Batch Backout Manager, V1.1 5697-H75
- **IMS Connect**, V2.2 5655-K52
- **IMS Connect Extensions V1.1 5655-K48**
- IMS MFS Reversal Utilities, V1 5655-F45
- IMS Program Restart Facility, V2 5655-E14

TM Management

- IMS Command Control Facility, V1.1 5655-F40
- IMS ETO Support, V3.2 5655-L61
- IMS HP Sysgen Tool, V1.1 5655-F43
- IMS Multi-Dialog Manager, V1 5697-H91
- IMS Queue Control Facility, V1.2 5697-E9
- IMS Workload Router, V2.4 5697-B87

In addition to the IBM Application Development tools, IBM has also been providing a wide range of price/performance, competitive Systems Management tools for IMS. This shows a summary of the IBM IMS tools currently available. The tools provide support for speeding up and reporting on performance, extend the functions of and assist with testing of IMS, and provide system tools for querying, validating, managing, and tuning the IMS Database, These include for example tools necessary to maintain and repair databases. Many tools serve multiple purposes. IBM offers tool functionality like IMS Control Suite that is not available from any other vendor. IBM offers high performance tools that are competitive within the industry at an affordable price. In fact when taken together "price/performance and functionality", IBM's IMS tool can be considered the best in the industry.

We have over 30 products to support all aspects of IMS usage.

Utilities for full function and fast path database provide a high performance solution that improves IMS availability.

Administrative tools make managing large and small IMS systems easier and faster.

Performance management tools help you tune IMS systems and avoid outages.

Recovery and replication tools enable fast and effective transfer of data from transactional to informational systems.

And application management tools make application runtime environments more effective

New/Enhanced IMS Tools - 2003

- IBM Data Encryption for IMS and DB2 Databases *(new)*
 - f Efficiently secure sensitive and private data at the IMS segment and DB2 table level
- IMS HALDB Conversion and Maintenance Aid [Version 2 Release 2](#)
 - f Partition maintenance aid for splitting partitions that are too large and enhanced DBRC support
- IMS Library Integrity Utilities [Version 2 Release 1](#)
 - f Combines LMU and Advanced ACB Gen and adds consistency and integrity checker functionalities
- IMS Database Recovery Facility [Version 2 Release 1](#)
 - f Follow on product to Online Recovery Service V1 with all it's features and functions
- IMS High Performance Pointer Checker [Version 2 Release 1](#)
 - f Performance upgrade with IMS V8 ImageCopy2 support
- IMS Problem Investigator *(new)*
 - f Enhanced IMS Log reporting and formatting utility for log record analysis
- IMS Connect [Version 2 Release 1](#)
 - f Two phase commit support for distributed environments and enhanced security
- IMS Multi-Dialog Manager *(new)*
 - f Allows terminal users to suspend and hold conversations
- IBM High Performance Change Accumulation [Version 2 Release 1](#)
 - f Performance upgrade with usability enhancements
- IMS Database Control Suite [Version 3 Release 1](#)
 - f New Batch Collect function and support for IMS Library Integrity Utilities and IMS Parallel Reorganization
- IMS High Performance Image Copy [Version 3 Release 1](#)
 - f Follow on product to Image Copy Extensions with improved performance, and usability and reporting enhancements
- IMS Performance Monitor *(new)*
 - f Real time performance monitoring, management, and troubleshooting

© IBM Corporation 2004

IMS Tools provided in 1H2003 were:

IMS Library Integrity Utilities V1 combines all of the features and functions of the IMS Library Management Utilities for OS/390, V1.1 and IMS Advanced ACB Generator for OS/390, V1.1. It provides additional features: Integrity Checker and Consistency Checker.

IMS HALDB Conversion and Maintenance Aid V2 provides a new conversion capability with some usability and performance enhancements, and maintenance functions.

IMS High Performance Pointer Checker V2 is designed to significantly improve performance and eliminate cumbersome job steps, making the product faster and easier to use. IMS HP Pointer Checker operates in 2 modes: HASH Checking, Full Pointer Checking

Encryption for IMS and DB2 V1 helps with the encryption exit build

IMS Connect V2 provides enhanced connectivity to IMS with Distributed 2 phase commit, SSL security, and other enhancements

IMS HP Pointer Checker V2 provides performance enhancements

IMS Multi-Dialog Manager *(new)* - End-user productivity aid providing an easy method for suspending work processes to be resumed later (Conversational Trans), which does not require changes to IMS or application programs and uses standard IMS Exit. IMS Multi-Dialog Manager V1 complements the existing IMS support for conversational transactions by managing the process of holding and resuming conversations for the end user.

IMS Problem Investigator *(new)* - Provides problem determination tools, a replacement for Log Formatting and Reporting Utility (DFSERA10). IMS Problem Investigator V1 features an enhanced level of problem determination services for IMS Transaction Manager (IMS TM) and IMS Database Manager (IMS DB) systems. These services include navigation aids, formatted and personalized reporting, and investigative procedures for IMS log data.

IMS DB Recovery Facility [Version 2 Release 1](#) - Follow-on to Online Recovery Service, provides Online and batch initiation. IMS Region no longer required and recovery lists are provided.

... In September we added two new versions -- for the IMS Database Control Suite and the IMS High Performance Change Accum for simplified setup and improved performance.

And in December we added an additional release, a new version, and a new product, the IMS Performance Monitor V1, which provides views of IMS overall performance .

Services Deliveries were also provided for: Parallel Reorg; Advance ACBGEN; HP Load; IMS PA; and HP Change Accum

New/Enhanced IMS Tools - 1H2004

■ **IMS Performance Analyzer** [Version 3 Release 3](#)

- f* The standard for IMS Resource and Performance Management, supporting IMS TM, IMS DB or Batch
 - Supporting IMS V9 Log and Monitor reports
 - Comprehensive reporting for IMS Connect Extensions for z/OS Event Collection
 - New Dashboard report, providing a quick overview of critical systems performance indicators
 - BMP Checkpoint report, measuring batch checkpoint frequency that can impact online performance and system restartability
 - Transaction History File, collecting detailed transaction performance data to export it into DB2, and used in long-term trend analysis and capacity planning
 - Improved IMS Performance Analyzer for z/OS Report Analysis (SC27-0913), providing additional information to aid in the interpretation of reports
- New Transaction Substitution Exit, Message Queue Transit and Fast Path Buffer Usage reports

■ **IMS Connect** [Version 2 Release 2](#)

- f* Provide enhancements to Connect and Connector for Java for improved performance, availability, and usability

■ **IMS Connect Extensions** (new)

- f* Provides comprehensive event recording for IMS Connect internal events and users can monitor & display IMS Connect activity and utilization in real time
- f* Enhances IMS Connect availability/ performance and system security
- f* Provides the ability to measure and analyze the activities that take place within your IMS Connect system, providing a powerful performance and problem analysis tool
- f* Combined with IMS Performance Analyzer, you can identify performance bottlenecks, over-utilized ports and many unexpected exception conditions

© IBM Corporation 2004

And in June 2004 we added new releases of the IMS Performance Analyzer and IMS Connect and a new product, IMS Connect Extensions V1, which provides performance and analysis reporting for IMS Connect.

IMS Performance Analyzer Version 3 Release 3

The standard for IMS Resource and Performance Management, supporting IMS TM, IMS DB or Batch

Supporting IMS V9 Log and Monitor reports

Comprehensive reporting for IMS Connect Extensions for z/OS Event Collection

New Dashboard report, providing a quick overview of critical systems performance indicators

BMP Checkpoint report, measuring batch checkpoint frequency that can impact online performance and system restartability

Transaction History File, collecting detailed transaction performance data to export it into DB2, and used in long-term trend analysis and capacity planning

Improved IMS Performance Analyzer for z/OS Report Analysis (SC27-0913), providing additional information to aid in the interpretation of reports

New Transaction Substitution Exit, Message Queue Transit and Fast Path Buffer Usage reports

IMS Connect Version 2 Release 2

Provide enhancements to Connect and Connector for Java for performance/availability/usability

IMS Connect Extensions (new)

Provides comprehensive event recording for IMS Connect internal events

Users can monitor & display IMS Connect activity and utilization in real time

Enhances IMS Connect availability, dynamically managing workloads and providing availability extensions that enhance services for user exits, transaction pacing, dynamic routing, workload balancing and extended control and reporting

Enhances IMS Connect performance with transaction pacing feature to protect against overloading IMS, rejecting transactions when user defined thresholds exceeded

Improves system security, providing a greater degree of access control

Provides the ability to measure and analyze the activities that take place within your IMS Connect system, providing a powerful performance and problem analysis tool

Combined with IMS Performance Analyzer, you can identify performance bottlenecks, over-utilized ports and many unexpected exception conditions

New/Enhanced IMS Tools - Announced September 2004

- **IMS Database Repair Facility** [Version 1 Release 2](#)
 - Teams with IMS HP Pointer Checker to quickly find, report, and repair database pointers or data errors
- **IMS Parameter Manager** (*new*)
 - Controls the specification and maintenance of IMS parameter library members
- **IMS High Performance Image Copy** [Version 3 Release 2](#)
 - Runs an Image Copy function with the hash checking of IMS HP Pointer Checker V2 under control of IMS Parallel Reorg V3
- **IMS High Performance Fast Path Utilities** [Version 2 Release 1](#)
 - Combines features and function of IMS FP Basic and IMS FP Online Tools and adds a new HP FP Reorg tool component
- **IMS High Performance Load** [Version 2 Release 1](#)
 - Contains restructured code that reduces CPU, and I/O wait times. It supports reorganization reload of HALDB partitions and is required to create an image copy during database reorg with IMS Parallel Reorganization V3
- **IMS High Performance Prefix Resolution** [Version 3 Release 1](#)
 - Supports IMS Parallel Reorganization, V3 single job step execution of database reorganization, prefix resolution, and prefix update tasks
- **IMS Parallel Reorganization** [Version 3 Release 1](#)
 - Runs utility jobs in parallel instead of sequentially and includes selected consecutive HALDB partitions

© IBM Corporation 2004

In Sept 2004 announcement:

IMS Database Repair Facility, V1.2

- Runs in interactive mode: Entire blocks of data or individual IMS segments can be viewed; Can navigate to other segments via the display of pointers; Any change will be tracked and can be undone
- Runs in batch mode: Dump blocks from the data set or submit changes to block data; No undo capability

IMS Parameter Manager, NEW:

- Support for 19 IMS startup parameter members
- Parameter specification by ISPF dialog panels or integrated ISPF editor
- Parameter syntax and value checking
- Automatic parameter card construction
- View of active (current) parameter members by IMS system
- Automatic 'backup' member creation

IMS High Performance Image Copy, V3.2:

- Major reduction in run-time of the reorganization process
- Supports processing parallel within an IMS Parallel Reorganization
- New optional parameter for controlling the secondary image copy data set

IMS HP FP Utilities, V2.1

- Combines features and functions of IMS FP Basic Tools, V1.2 and IMS FP Online Tools, V2
- Contains a new HP Fast Path Reorganization Tool component:
 - Provides JCL ease-of-use
 - Determines utility use based on control statements
 - Performs dynamic allocation of databases and SORT work data sets
 - Allows DEDBs to be available to IMS after reloading
 - Supports single SYSIN DD statement which can be a non-positional control statement
 - Supports multiple area data sets (ADS)
- Teams with IMS HP Pointer Checker to quickly find, report, and repair database pointers or data errors

IMS HP Load, V2.1:

- Contains restructured code that reduces CPU time
- Improved I/O processing to reduce I/O wait time
- Exploits the High Performance I/O Driver
- Supports reorganization reload of HALDB partitions
- Required to create an image copy during database reorganization with IMS Parallel Reorganization, V3
- Supports various formats of the unloaded data sets

New/Enhanced IMS Tools - Announced September 2004

- **DB2 Information Integrator Classic Event Publisher for IMS** [Version 8 Release 2](#)
- **DB2 Information Integrator Classic Event Publisher for VSAM** [Version 8 Release 2](#)
 - f* Makes it easy to link data events with business processes
 - f* Captures database changes in IMS and/or VSAM by reading the active or recovery log
 - f* Formats changes into XML messages
 - f* Publishes changes to WebSphere MQ

- **DB2 Information Integrator Classic Federation for z/OS** [Version 8 Release 2](#)
 - f* Standards-based access via ODBC, JDBC, or Call Level Interface
 - f* Multi-threaded with native drivers for scalable performance
 - f* Works with existing and new mainframe and application infrastructure and toolsets
 - f* Read from and write to mainframe data sources using SQL

In September we also added some new releases of the DB2 Information Integrator (II) Classic Event Publishers for IMS and VSAM as well as the DB2 Information Integration Classic Federation (CF) for z/OS.

The Classic Event publisher enhancements make it easier to link data events with business processes, capture database changes in IMS and/or VSAM by reading the active recovery log, format changes into XML messages and Publish changes to WebSphere MQ.

The Classic Federation enhancements provide standards based access via ODBC, JDBC or Call level interfaces, provide multithreading with native drivers for scalable performance, work with existing and new Mainframe and application infrastructure and tools, from and write to mainframe data sources using SQL.

IMS On Demand Business Application Development and Connectivity Environment

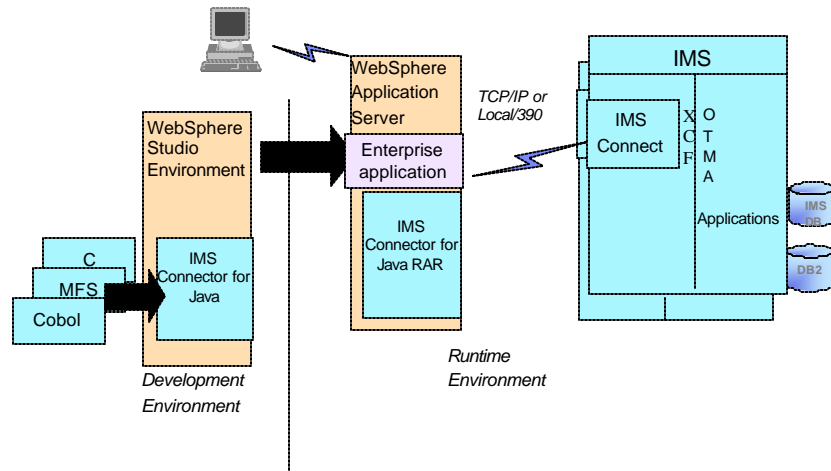

© IBM Corporation 2004

The IMS Connector for Java Development support, which enables development of Java applications running under WebSphere Servers, originally shipped with VisualAge Java, evolved and now provides mapping of Cobol, C, and MFS IMS applications, and ships as part of the WebSphere Studio Application Development Integration Edition (WSADIE). The IMS Connector for Java J2EE Runtime piece, ships as part of IMS Connect and can be downloaded to a WebSphere Server platform for deployment in connecting to IMS transactions via IMS Connect. IMS Connector for Java interacts with the J2EE server to provide you transparent support of Quality of Service (like Transaction management, Connection management, Security management). Your application is unaware of all the complicated issues.

Integrated/Open Access with IMS for On Demand Business Application Enablement and Connectivity Solutions

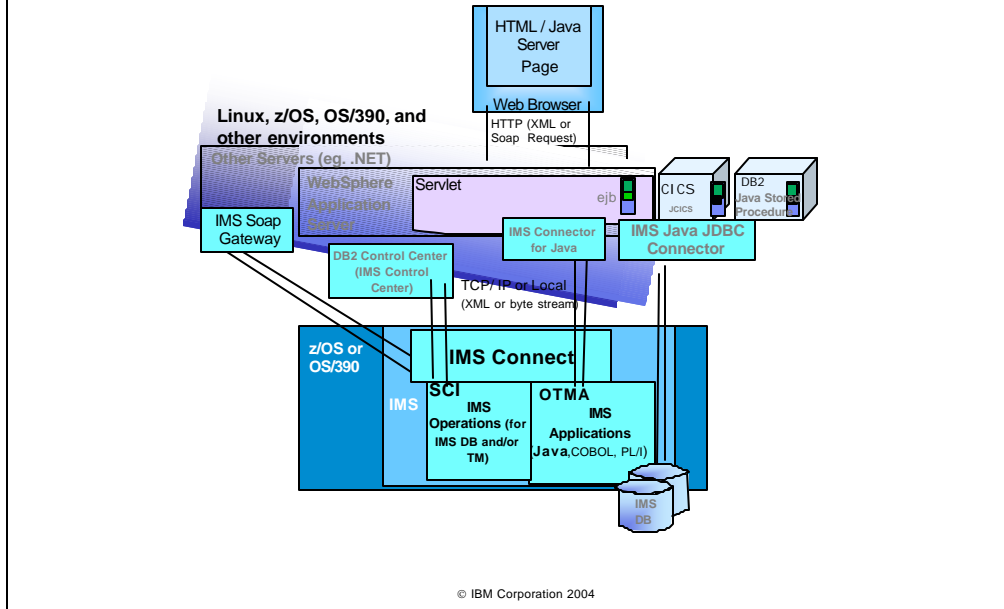

For application, information, and operational integration, IMS exploits the latest programming technologies for the Internet and Java. With industry standard, open interfaces of Java, users can transparently download and seamlessly run applications. It is platform independent and widely used.

IBM supports industry standard J2EE with a set of common, consistent Java interfaces that connectors from any subsystem implement, making it easier for programmers to deal with differences between subsystems. For such, IMS has provided 2 resource adapters – the IMS Connector for Java for IMS Application access and the IMS Java JDBC Connector for IMS Database access.

In the middle here is the runtime environment of a Java Servlet Application running under OS/390, z/OS, Linux, or other environments. IMS Connector for Java within the Java Application establishes a connection with IMS Connect through TCP/IP (or the Local Option, if in the same LPAR as Connect). IMS Connect, running under OS/390 or z/OS can run in the same or separate LPAR from the rest of IMS. It passes the transaction request to the IMS application through IMS OTMA (Open Transaction Manager Access) interface, using MVS XCF (Cross-system Coupling Facility). The IMS application could be written in Java or another language. Similarly IMS Connect sends the output back to the IMS Connector for Java application. In the servlet runtime environment, the user invokes an HTML page using the browser and submits data to a webserver servlet invoked by the WebSphere application server. The servlet uses the IMS Connector for Java to establish a connection with IMS and invoke the requested transaction through IMS Connect. The output is handed back to the IMS Connector for Java in the servlet via IMS Connect and out to the HTML page.

The IMS Connector for Java environment is also being used to provide new IMS applications that map XML documents. XML mapping has already been enhanced for COBOL and PL/I as well. XML mapping to existing IMS MFS applications is provided. Additional Java standards, enhancements, and tooling continue to be provided. IMS V9 is also providing distributed JDBC access to IMS DB data from a distributed WebSphere Server.

On the right, this shows IMS-provided Java application support with the IMS Java JDBC Connector as a second IMS Resource Adapter -- for access to IMS DB. Local JDBC access to IMS DB from DB2, CICS, and Websphere environments is also available. Java applications in these environments could use JDBC calls for access to IMS DB data. New Java applications can be developed in all these areas with access to existing IMS applications and data.

On the left, this also shows distributed, integrated IMS Operations provided through the IMS Operations Manager, the Structured Call Interface, the DB2 Control Center, and IMS Connect.

IMS Connect enhancements for distributed Application and Operations access

V1.1/1.2 - GA 10/2000-2002

- Asynchronous output
- Unicode
- **Sample clients**
- **IMS Connector for Java 1.2 J2EE support**
- Two-phase Commit Support in Local 390 environments
- Security enhancements
- Passticket support
- SSL support
- Trusted User
- More Granular timeout (eg. by message)
- IPv6 support
- Auto Reconnect to OTMA
- 255 User Message Exit support
- **IMS V8 Operations Manager distributed interface** (requires IMS V8)

V2.1 - GA 6/2003 – 2004

- IMS V8 required for enhancements
- Distributed two phase commit
- Secure Socket Layer (SSL)
- Commit Mode 0 and Persistent Sockets support
- IMS Connector for Java 2.1.0
 - WAS 5.0 and WAS z/OS 5.0
 - Commit- then-send (Commit Mode 0)
 - Asynchronous output message retrieval
 - Security - Container Managed SignOn
 - MFS Web Services Support
- IMS Connector for Java 2.2 (**4/04 eGA**)
 - Commit Mode 0 and Persistent Socket for improved performance
 - Socket timeout for enhanced usability
 - Retry for improved availability
- Purge Not Deliverable (**4/04 service stream**)

Following an earlier Technology Preview, IMS Connect was initially provided alongside the IMS V7 GA as a new separately-priced product and has been enhanced significantly since then. We provide a selection of sample clients but also the IMS Connector for Java which with 1.2 supported J2EE. IMS Connect not only provides distributed application access, but through the IMS V8 Structured Call Interface, it also provides for distributed IMS Operations access as well.

IMS Connect 2.2 and IMS Connectivity Requirements

■ **IMS Connect 2.2 GA June 25, 2004**

- Command enhancements for ease of manageability
- Improved performance and availability reporting
- Cancel timer support to enhance usability
- Connector for Java also adds
 - Commit Mode 0/persistent socket for improved performance
 - Socket timeout for enhanced usability
 - Retry for improved availability

■ **IMS V9 GA Oct 29, 2004 provides Integrated Connect Function**

■ **Enhanced IMS Connectivity Requirements**

- Event Logging support
- Client READ time-out
- Reroute request
- Set of routines for easing additional clients standard API for Transaction Access
- Command Automation and Extensions
- WAS follow -on and 64 bit virtual support
- Direct XML SOAP for IMS
- XML Processor (MFS and COBOL Adapters)
- Support for IMS Multiple Systems Coupling (MSC)
- Support for New Technology
- RAS enhancements

© IBM Corporation 2004

A number of additional items are now being delivered with IMS Connect V2R2. The IMS Connect V2.2 enhancements include:

- Command enhancements for ease of manageability - IMS Connect commands can now be issued through the MVS modify interface. This is an MVS command and the response to it will be presented by MVS to the issuer of the command, thus enhancing consistency and ease of use. In addition, Query Member Command enhancements add IMS Connect IP address and version.
- Commit Mode 0 / Persistent Socket to improve performance
- IMS Connect Extensions for z/OS, V1.1 support to enhance performance and availability reporting
- Cancel Timer support to enhance usability
- IMS Connector for Java™ also adds Commit Mode 0/ Persistent Socket for improved performance, Socket timeout for enhanced usability, and Retry to broaden availability

IMS V9 with its GA is providing Integrated Connect Function, supporting the existing function and working to provide a base for future enhancements.

Additional customer requirements for enhanced IMS Connectivity are also being investigated. They include enhancements to SOAP support, Security, Automation, Multiple Systems Coupling facility support, Distributed Database access, Event Logging and Client Read time-out.

IMS Version 9

Ideal for Driving On Demand Business

- ✓ Integration with Application Development and Connectivity
- ✓ Manageability
- ✓ Scalability in Performance, Capacity, Availability, Recovery

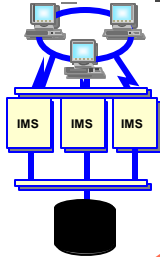

**Strategic Open Access
z/OS Enterprise Servers**

Benefits

- ✓ Enable Customer Growth
- ✓ Enhance Workload Balancing
- ✓ Increase Availability; Ease of Use
- ✓ Preserve Current Application Investment
- ✓ Enable New Applications

Enhancements

-Integration

- f Integrated Connect Function
- f Enhanced Security
- f XML data in IMS Databases
- f Broadened Java/XML Tooling

-Manageability

- f Eased Sysplex Manageability
- f Eased Serviceability/Usability
- f Simplified Install/Definition Process
- f Enh Systems/Data Mgmt Tools

-Scalability

- f Integrated HALDB Online Reorganization
- f Enhanced Recovery/Control
- f System Growth

© IBM Corporation 2004

IMS V9 continues further strengthening the IMS leadership role, helping customers in their e-business enablement and the growth, availability, and systems management that the newer environments and cost measures require. IMS focus thus is on providing Information Integration with open access and supporting tools for the e-business environment, continually improving, systems management/usability, and system scalability with increased availability, performance and capacity. The goal is to deliver the next stage of this function.

IMS is providing enhanced availability of IMS High Availability Large Databases (HALDB) introduced in V7, with fully integrated Online Reorganization support. This provides concurrent online update and availability of data.

IMS has been providing Sysplex support to ensure the highest in availability/performance for Systems growth. IMS V9 continues to enhance support for this environment and provide support for new capabilities in it. IMS is also extending its XRF network switchover capability to newer SNA controllers using VTAM Multinode persistent sessions technology.

Systems Management through autonomic computing continues to be a key area with IMS customers in managing their systems. IMS V9 continues to enhance its single system image with expanded standard user-friendly commands and interfaces accessible across environments. IMS also continues to ease the installation process, reducing/eliminating the gen requirement. Enhanced security and serviceability for application access and database usage are also being provided.

IMS is also providing continued enhancements to eliminate bottlenecks and impediments to growth in the IMS systems and in connectivity to the IMS systems. IMS is improving availability, performance, and capacity in the Fast Path and Database Recovery Control (DBRC) areas of IMS.

Java continues to be a key area for new application development. IMS Java support and the IMS Connector for Java are being enhanced for the latest in standards and ease of use to allow customers to take advantage of the latest in tooling. Earlier enhanced IMS Java support was provided for enabling JDBC access to IMS DB data from a WebSphere/390 Enterprise Java Bean. Now this environment is enhanced to provide a distributed JDBC access to IMS databases. IMS is also providing enhanced performance for this environment, and providing better integration with the WebSphere development tool set.

IMS is now also providing support and tooling for storing XML data in IMS databases.

New Technology as it evolves with XML and Web Services is also continuing to be exploited to enable new Application Development tooling. IMS is forging a strong alliance with the AD community to provide an integrated tool solution for supporting IMS Java and connectivity to the Internet and to enable COBOL and other language support for this environment.

Additional IMS Data Management tools are also being provided to better integrate and ease use of IMS as an e-business server. As tooling evolves we will continue to take advantage of the latest technologies for our customers to enhance their ability to use our products with these tools.

In addition we continue to provide whatever we can for education and usability of our products. We would also be continuing to enhance the way our users use our information

IMS V9 Line Items

Integration/Openness in Application Development/Connectivity

- Integrated IMS Connect function
- Java/XML tooling enhancements, Distributed JDBC and XML DB
- OTMA/APPC security/serviceability enhancements
- RACF enhancements to replace SMU security
- VTAM Multi-node Persistent Sessions replace of Uservar/3745 for XRF
- >255 Trans Scheduling increased to 999 for enhanced usability

Manageability Ease for Autonomic Computing

- IMS Sysplex Database Commands added to Single Point of Control
- Enhanced Command Environment
- Enhanced Serviceability with new /Diagnose Command and Knowledge Based Log Analysis (KBLA)
- IMS install/system generation reduced time/effort enhancements

Scalability in Performance/Capacity/Availability/Recovery

- Integrated IMS Online Reorganization (OLR) by partition of HALDBs w/concurrent online update/availability
- Additional HALDB usability enhancements
- DBRC Vendor Tools interface, enhanced capacity/usability/integrity
- Fast Path performance/serviceability/usability enhancements
- Enhanced Recoverability with DB2

© IBM Corporation 2004

IMS Version 9 line items provide customer value in simplifying/expanding development and enablement with new technology and ensuring growth. IMS V9 addresses integration/openness in Application Development Connectivity with Integrated IMS Connect function, Java/XML tooling enhancements and other connectivity security, serviceability and usability enhancements across the product.

IMS V9 addresses Manageability ease for Autonomic Computing with enhanced commands and the command environment, enhanced serviceability with Knowledge Based Log Analysis facilities, and reduced time/effort for IMS installation/system generation

IMS V9 also addresses scalability with Integrated Online Reorganization by partition of HALDBs with concurrent online updates for availability, Database Recovery Control (DBRC) application programming interface, enhanced recoverability with DB2, and additional HALDB, DBRC, and Fast Path enhancements

IMS V9 Integration/Openness

- **Integrated Connect Function**
- **OTMA/APPC Enhancements**
- **RACF Enhancements**
- **VTAM MNPS replacement of USERVAR/3745 for XRF**
- **Greater than 255 Transaction Classes, up to a value of 999**
- **IMS Java/XML Enhancements**

f Symbolic Checkpoint/Restart for the Java Batch Region

f COBOL XMI plug-in to parse COBOL copy libs as input to DL/I Model Utility

f XML data in IMS Databases support

f DL/I Model utility enhancements for XML DB and to provide a GUI front-end

f Remote DB Services providing remote data access to IMS DB from a distributed client

Included in IMS V9 for Integration in application development/Connectivity are:

Java and XML Tooling is enhanced

Remote data access to IMS DB from a distributed client, initially from ejbs running on a distributed J2EE application server without requiring additional z/OS application programming

Symbolic Checkpoint/Restart for the Java Batch Region

COBOL XMI plug-in to parse COBOL copy libs as input to the DL/I Model Utility, producing metadata to ease application development

Supports XML document data storage and retrieval into and from IMS Databases

Generates XML schemas from IMS Database information to accelerate application development using the DL/I Model utility

Other items are for enhanced OTMA Security and Serviceability, RACF enhancements to enable migration from SMU security, and the VTAM Multinode Persistent Sessions replacement of USERVAR/3745 for XRF.

You can assign scheduling-class values for a transaction. These values allow you to isolate, organize, or retrieve certain transactions based on the class value. Prior to Version 9, the maximum number of transaction scheduling-class values was 255. The maximum value is now 999

IMS V9 Integrated Connect Function

Provides easy install/use, high volume/performance, secure transparent access to IMS applications and operations from other environments (incl. LINUX)

- f* Provides commands to manage the network and balance workload
 - Better resource utilization.
- f* Reduces design/coding effort for client applications
 - Ease access to IMS applications and operations
 - Improve programmer productivity
- f* Used with IBM WebSphere Application Server and Studio Tools to
 - Quickly transform static web sites into sources of dynamic Web Content to improve marketing effectiveness and enhance customer service
 - Transform IMS Transactions into Web services for Service-Oriented Architectures (SOAs), enabling quick response to new customer requirements, business opportunities and competitive threats.
- f* Used with DB2 and the IMS Control Center for Distributed Operations
 - Improve system availability and operator productivity
- f* Integrates function of separately orderable/installable IMS Connect Tool
 - Simplify administration and reduce costs

© IBM Corporation 2004

A key element of the On Demand environment in IMS V9 is the Integrated IMS Connect function.

Integrated IMS Connect Function provides easy-to-install, easy to use, high performance/high volume and secure transparent access to IMS applications and data from any application environment, including LINUX.

It provides commands to manage the network environment and assist with workload balancing resulting in better resource utilization.

It reduces design/coding effort for client applications and provides easier access to IMS applications and operations, thereby improving programmer productivity

It can be used with IBM WebSphere Application Servers and Studio Tools to quickly transform static web sites into sources of dynamic Web Content improving marketing effectiveness and customer service, and also to transform IMS Transactions into Web services for Service-Oriented Architectures (SOA), enabling quick response to new customer requirements, business opportunities and competitive threats.

It can be used with DB2 and the IMS Control Center to control both IMS and DB2 operations, improving system availability and operator productivity

This integrated function can be used to replace the separately orderable/priced IMS Connect Tool offered for earlier IMS Versions, simplifying administration and reducing cost

IMS V9 Integration with IMS Transactions, Web Services and Service-Oriented Architecture (SOA)

- Web services provides the next step in the evolution of the internet, allowing programmable elements to be placed on sites for distributed web access across platforms
- Enabled as Web services, the unchanged IMS Transactions, including those using MFS, can support a Service-Oriented Architecture (SOA)
 - Leveraging past investments
 - Reducing new programming efforts
 - Aiding business process transformation
 - Aiding application integration with partners, suppliers, and customers.
- IMS C, Cobol and MFS-based Transactions can be enabled as Web services via WebSphere Application Servers (WAS) and Studio Tooling
- Direction: IMS Transactions would also be enabled as Web services via [IMS SOAP Gateway](#)

IMS Transactions can be enabled as Web services, and be supported in a Service Oriented Architecture (SOA).

WebSphere tooling today enables IMS transactions using COBOL, C, and MFS-based applications as Web services. Using IMS Transactions as Web services leverages customers' past investment in application development. It can also eliminate or greatly reduce new programming effort, reduce end-to-end business process transformation, and facilitate application integration with partners, suppliers, and customers.

IMS SOAP Gateway & IMS Connect XML Processor

Sample/demo available at www.ibm.com/ims

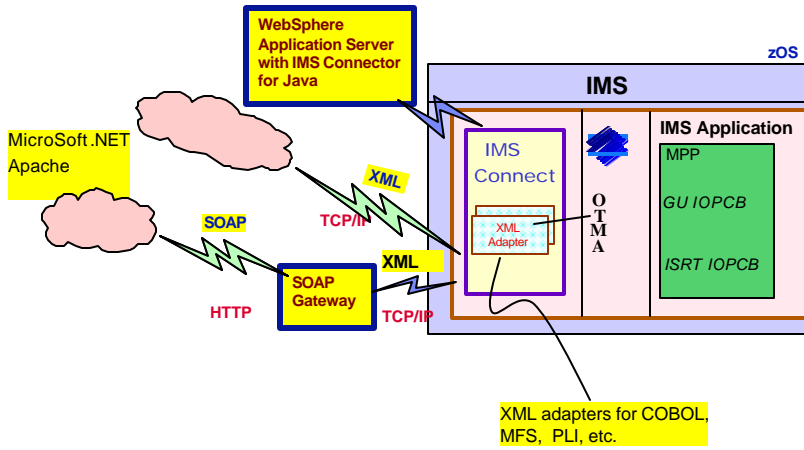

IMS would also use this WSED XML Adapter for COBOL and SOAP support with its IMS SOAP gateway code, a sample/demo of which is currently available at www.ibm.com/ims

IMS V9 XML Database Support Storage and Retrieval

Enables the global standard for on demand solutions, providing universal transparent information interchange among internal business processes, suppliers, partners, customers

- f* Implementation is native IMS
 - Provides efficient utilization of resources
 - Top overall performance
- f* Convert legacy IMS data to XML
 - Facilitates integration with business processes
 - Improves programmer productivity
 - Reduces development lead times
- f* Decomposed XML data for use by non-XML enabled applications
 - Preserve and extend past investment
 - Enhance programmer productivity
- f* Identical data descriptions for distributed and host environments
 - To reduce overhead
 - Improve data consistency and integrity
- f* DL/I Model Utility can generate XML schema at runtime
 - Improves application development time
 - Reduces errors
 - Code in an industry standard interface

© IBM Corporation 2004

Another key element is XML Database support for storage and retrieval of XML data in IMS databases.

The implementation is native IMS, not merely a mapping as must be done with other technologies, providing efficient utilization of resources and top overall performance

Legacy IMS data can be easily converted to XML to facilitate integration with business processes, improve programmer productivity and reduce development lead times

XML data can be decomposed for use by non-XML enabled applications, thereby preserving and extending past investment and enhancing programmer productivity

Data descriptions can be the same for distributed and host environments to reduce overhead and improve data consistency and integrity

DL/I Model Utility Enhancements generate XML schema from existing IMS Database Definitions (DBDs) and Program Status Blocks (PSBs) for XML storage and retrieval at runtime. This improves application development time, reduces errors and makes it possible to consolidate skills by allowing programmers to code in an industry standard interface

IMS V9 Manageability

- **New/Enhanced Commands/Environment**

- f* Expanded Command Environment for simplifying operations
- f* Sysplex-wide Database Commands to expand operations management
- f* New command to ease serviceability
- f* New messages for easing usability
- f* Command Recognition Character Registration

- **Knowledge Based Log Analyzer (KBLA) eases serviceability**

- **Eased Resource Definition by further reducing IMS sysgen time/effort**

- f* Conditional link-edit elimination
- f* Online Change Modules moved from the Nucleus
- f* Dynamic change/addition of Type 4 SVC and resource cleanup module
- f* IVP and Syntax Checker enhancements

© IBM Corporation 2004

A number of additional IMS Manageability Enhancements are requirements for planning the next IMS deliverable. Enhanced Command Environment simplifying the common service layer for use by new and enhanced commands and providing a single point of control without requiring a Resource Manager.

IMS Sysplex Database Commands - The Operations Manager was delivered in IMS V8 and provided an OM API to allow IMS commands to be issued from OM. All existing commands now referred to as 'classic' IMS commands can be issued from OM API. A new command format called the IMSplex commands was introduced. The IMSplex commands are allowed only from OM API and the command responses are encapsulated in XML tags. The output from all IMSs is consolidated and presented back to the SPOC or application that issued the OM API call. In IMS V8, IMSplex commands for transaction resources were added to provide the user better ability to manage the IMSplex and also to provide a single system image. The IMSplex commands for database and area resources would be added to provide the user the ability to better manage the IMSplex and provide a single system image. The following IMSplex commands would be added in IMS V9 to allow the user to query and update databases and to update DEDB areas: QUERY DB, UPDATE AREA, UPDATE DB, and UPDATE DATAGRP.

The new IMSplex database commands are allowed only from OM API and the command response is returned to OM encapsulated in XML tags. In this release, these commands provide the same function as their similar classic commands - the input format and output format is different.

Command Recognition Character Registration is being provided to uniquely register the subsystem so an operator can enter a command from any system in a Sysplex and have it routed to the right subsystem. With it the operating system can detect collisions between subsystems as well as be able to inform operators/systems programmers which prefixes are currently in use, thus easing operations management.

New DFS 41721 Message is being provided as a new WTO message, replacing the earlier WTOR message, so that if the tracker starts before the active, it can wait for the active and continue without awaiting an operator reply message, thus enhancing usability.

Enhanced HALDB Usability easing partition initialization without requiring DBRC commands

New /Diagnose Command easing serviceability

Requirements addressed in V9 are to reduce system generation time/effort by

Removing conditional link edit modules

Remove Online Change modules from the nucleus Linkedit step and places them in their own load module

Removing the ETO install checking

Dynamic Change of Type 4 SVC

Dynamic Add of Resource cleanup module

Providing enhancements to Syntax Checker would continue to dynamically define resources for syntax, validity, an consistency of the IMS Definitions during the Sysgen process

IVP Release support provides general release upgrades for utilities running in the IVP

IMS V9 Scalability items

f *Integrated HALDB Online Reorganization for Improved Availability*

f *Additional HALDB easing Usability*

- to ease partition initialization without requiring DBRC Commands
- partition selection exit customization enhancement

f *Database Recovery Control (DBRC), Log, and Utility Enhancements for Enhanced Recovery*

- DBRC Support for Online Reorganization
- DBRC Interface for Easy Tools access to RECON data
- Command Authorization for /RM
- Move DBRC Modules above the line
- Logger enhancements
- Remove unused code
- Large Tape Block size support
- Fast Database Recovery (FDBR)/DB2 Indoubt notification
- Enhanced capacity and usability items

f *Fast Path Enhancements for Enhanced Availability/Performance*

- Multiple Areas Shared VSO structures
- Provide Parallel TCB Area Open/Close
- Optional EMHQ Structure
- Enhance Serviceability/Usability enhancements

© IBM Corporation 2004

For Scalability IMS HALDB Integrated Online Change provides enhanced availability IMS Database Recovery Control Enhancement requirements include: DBRC support for the new Online Reorganization capability; DBRC Application Program Interface for Vendor tools to interface with DBRC

Command Authorization security, initially provided in V8 for batch commands, would now also be provided for the online /RM command; Move of DBRC Modules above the line providing enhanced capacity; Logger enhancements for taking corrective action where possible and for comparing dual WADS for additional data; Removing some no longer used code for CICS I/O Checking; supporting in the Image Copy and Recovery utilities Large Tape Block sizes >32K to provide customers a performance advantage; Enhancing Fast Database Recovery to inform a user exit of the indoubt DB2 Unit of Work and the final resolution.

Additional items for capacity/usability would also be provided with Multiple Areas Shared Virtual Storage Option (VSO) structures allows Fast Path customers to create VSO structures in the Coupling Facility that house multiple VSO Areas, where currently each VSO area must have its own VSO structure; and Parallel TCB Area Open/Close Enhancements exploits parallel TCBS to open/close areas, thus improving the performance of area open when there are many areas to open.

Reliability would be enhanced by reducing abends that can bring down the IMS Control Region with toleration of the error conditions (E.g. Avoid abending due to errors returned from DBRC) and by making optional the EMHQ structure reduces the allocation of resources when not being used.

A number of additional serviceability and usability customer requirements would also be addressed: Adding Fast Path system event trace and Online Utility trace tables, removal of V5 Sequential Dependent (SDEP) Control Interval (CI) format, and enhancing the SDEP CI Allocation algorithm. Additional items also include: Changing the FP latch wait chains to use separate wait chain (EPSTHNXT); Adding trace entries to the new IMS Fast Path Table Trace; Allowing the activation of the Fast Path Toolkit via an MVS command; Adding the IMS/FP log record dsects in ILOGREC; Adding SDEP statistics information in existing log records for IMSPA. And a number of additional Fast Path changes would also be made for more efficient/serviceable operations.

IMS V9 Integrated HALDB Online Reorganization

IMS Version 9 Integrated HALDB Online Reorganization delivers
Continuous Availability of Business-critical Databases

f Fully integrated online reorganization by partition of IMS High Availability Large Databases (HALDBs)

- Simplifying administration
- Reducing Costs

f Concurrent online update and availability

f Totally non-disruptive

f No outage, minimal additional DASD required

f Adjustable pace to further minimize any online impact

- Multiple partitions can be reorganized in parallel
- Provides greatly enhanced database availability

Providing ultra high availability is the IMS V9 Integrated Online Reorganization (OLR) of High Availability Large Databases support.

High Availability Large DataBase was introduced in IMS Version 7. It greatly increased, by orders of magnitude, the maximum database size permitted in earlier releases. HALDB delivers the first requirement for information management in the unpredictable on demand operating environment: virtually unlimited database capacity.

IMS Version 9 Online Reorganization delivers on the second: continuous availability of business-critical databases. IMS V9 OLR provides a fully integrated online reorganization by partition of HALDBs, with concurrent online update and availability. This is totally non-disruptive. There is no outage, and minimal additional DASD is required during reorganization. Users can adjust the pace of OLR to further minimize any online impact. Multiple partitions can be reorganized in parallel. Coordination is provided through the IMS DBRC facility. This online reorganization function provides for greatly enhanced database availability.

IMS V9 Scalability in Performance/Capacity/Availability/Recovery

Increase in
Bandwidth
Availability

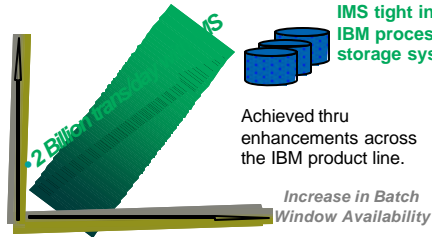

✓ Local systems:

- ƒ z/Architecture 64-bit mode
- ƒ FP Parallel Database Open
- ƒ Greater-than-255 transaction scheduling classes
- ƒ CSA reduction with OLC Mods removed from the nucleus

✓ Parallel Sysplex:

- ƒ IMSplex DB commands
- ƒ Shared VSO multi-area structure support

✓ Increased performance with new IBM T-Rex Processors

- ƒ Over 21,000 trans/sec doing database update on a single Processor
- ƒ 28.5 MB/sec logging bandwidth on M800 .

© IBM Corporation 2004

IMS V9 meets extreme IT needs for e-transaction processing with the ultimate in performance/capacity, availability and systems management and technological leadership in connectivity and new application development.

IMS along with the S/390 and the new zSeries have been delivering on the promise of e-business and continue to do so with new enhancements for e-transaction processing bandwidths capable of supporting the largest web sites and transaction rates through GB ethernet. Fiber connection technology and industry leading web serving with IMS and the IBM WebSphere Application Server, Security and Communications Servers. A balanced system is provided for world class solutions. IMS together with the S/390 and zSeries are delivering more comprehensive security protection, featuring centralized management and a strong suite of end-to-end products. We continue to provide and enhance our leading edge end-to-end transaction integrity and real time data currency with the sharing of data, networks, and messages, utilizing the Sysplex and its coupling facility. Our technology transition from bipolar to CMOS has allowed us to deliver exponentially improving price/performance to our customers. Customers are using this power to take on new e-business related applications.

IMS V9 not only has increased the transaction rate to nearly 2 billion trans/day with database update on a single processor, but has also made a lot of improvements for performance and capacity.

IMS handles scaling to high capacity and for stress. IMS in house testing achieved over 21,000 trans/sec across 4 IMSs in 4-way data sharing and 4-way shared queues environment on ONE processor (T-Rex = 2084). The transactions are UPDATING the databases during the benchmark so it's running this fast with the most costly type of database access! If this was read only then we'd see MUCH higher numbers.

The M800 is the most current Shark DASD model. When we used the T-Rex (2084-B16) and the Shark (2105-M800) we were able to reach up to 28.5 MB/sec logging bandwidth. That shows that IMS scales up to large logging requirements for things like Online Reorg or Multiple Systems Coupling or Shared Queues. And the code holds up well under stress.

IMS Follow-on

Ideal for Driving On Demand Business

- ✓ Integration with Application Development and Connectivity
- ✓ Manageability toward autonomic computing
- ✓ Scalability in Performance, Capacity, Availability, Recovery

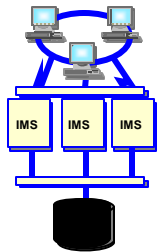

**Strategic Open Access
z/OS Enterprise Servers**

Benefits

- ✓ Enable Customer Growth
- ✓ Enhance Workload Balancing
- ✓ Increase Availability; Ease of Use
- ✓ Preserve Current Application Investment
- ✓ Enable New Applications

Enhancements

- Integration
 - f Enhanced Connectivity
 - f Enh XML data in IMS DBs
 - f Broadened Java/XML Tooling
- Manageability
 - f Simplified Install/Definition Process
 - f Eased Operations
 - f Eased Serviceability/Usability
 - f Enh Systems/Data Mgmt Tools
- Scalability
 - f Parallel Recon
 - f Enhanced Recovery/Control
 - f MSC Bandwidth
 - f Fast Path System Growth

© IBM Corporation 2004

After IMS V9, IMS continues further strengthening its leadership role, helping customers in their e-business enablement and the growth, availability, and systems management that evolving environments and cost measures require. IMS focus thus continues in providing Information Integration with open access and supporting tools for the e-business environment, continually improving, systems management/usability, and system scalability with increased availability, performance and capacity. The goal is to continue to deliver the next stages of this function.

Java and XML continue to be key areas for new application development. IMS Java and XML support and the IMS Connector for Java would be enhanced for the latest in standards and ease of use to allow customers to take advantage of the latest in tooling. IMS continues providing enhanced performance for this environment, and providing better integration with the WebSphere development tool set as it evolves. New Technology as it evolves with XML and Web Services is also continuing to be exploited to enable new Application Development tooling. IMS is forging a strong alliance with the AD community to provide an integrated tool solution for supporting IMS Java and connectivity to the Internet.

IMS has been providing Sysplex support to ensure the highest in availability/performance for Systems growth. IMS would continue to enhance support for this environment and provide support for new capabilities in it.

Systems Management through autonomic computing continues to be a key area with IMS customers in managing their systems. IMS would continue to enhance its single system image with expanded standard user-friendly commands and interfaces accessible across environments. IMS would also continue to ease the installation process, reducing/eliminating the gen requirement. Enhanced security and serviceability for application access and database usage would also be provided.

Additional IMS Tools are also being provided to better integrate and ease use of IMS as an on demand business server. As tooling evolves we will continue to take advantage of the latest technologies for our customers to enhance their ability to use our products with these tools.

IMS is also providing continued enhancements to eliminate bottlenecks and impediments to growth in the IMS systems and in connectivity to the IMS systems. IMS is improving availability, performance, and capacity in the Multiple Systems Coupling (MSC), Fast Path and Database Recovery Control (DBRC) areas of IMS.

In addition we continue to provide whatever we can for education and usability of our products. We also continue to enhance the ways our users can access and use our information.

IMS Connect Internal Structure Provides Connectivity Base for Future

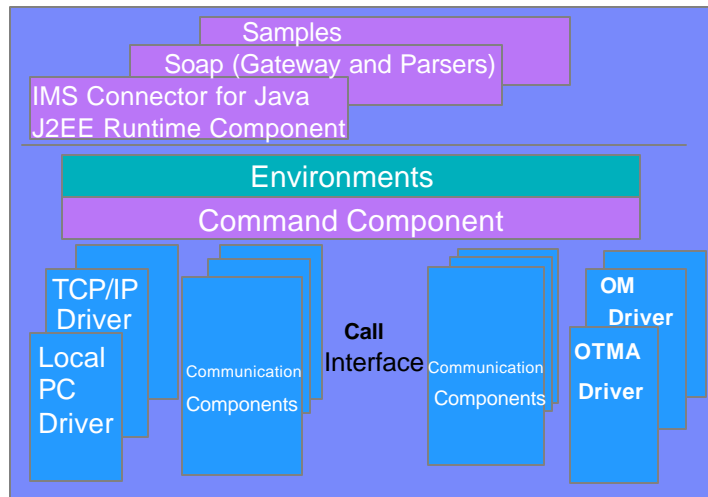

© IBM Corporation 2004

IMS Connect is part of the overall restructure of IMS for the 21st Century and is architected as the base for all future IMS Connectivity. Much of the function of IMS Connect can also be used with IMS V6 so you can start to take advantage of it before migrating your networks/applications/databases to IMS V7. The structure of IMS Connect is designed such that drivers can be interchangeable. That is, alternatives for the TCP/IP front end or OTMA back end interfaces are already being provided. These are allowing IMS to exploit newer, additional, and enhanced protocols and/or interfaces. Along with IMS Connect is provided the IMS Connector for Java for access from Java applications, SOAP Gateway and parsers, and samples for other language access as well.

With IMS Version 8, IMS extended its use of XCF for use by other IBM subsystems, such as IMS Connect, for distributed operations access through the Structured Call Interface to the Operations Manager from the DB2 Version 8 Control Center as a single point of control.

With this structure IMS Connect could evolve to address other connectivity requirements, such as distributed database access to IMS DB.

XML and IMS for Transparent Application Integration

Processing XML Documents in New IMS Applications Today

- Customers can write IMS Java applications using the XML Toolkit for z/OS
- Customers can write IMS Cobol/PL/I applications using parsers in Enterprise COBOL/PL/I z/OS compilers
 - Tran code still must be EBCDIC, rest of data can be XML
 - The IMS program can invoke XML parser to convert to non-tagged data

- Customers can use WSED 5.0 XML Converters for COBOL to generate XML outputs from COBOL applications

Bridging XML and Existing IMS Applications Today

- Using MQSeries Integrator to support IMS COBOL and C applications

Dictionary support for messages
Routing and processing based on message content
US Utility built cost-effective e-business infrastructure to IMS

- Customers can enable IMS applications as Web Services via WAS 5.0 and WSAD-IE 5.0 to support IMS COBOL, C and MFS-based applications

XML and IMS Requirements

- IMS XML DB Support

- Support storing, retrieving, and querying XML in IMS databases (V9)
- Generate XML schema for existing IMS databases (V9)
- Create new IMS XML databases
- Dynamic definition of IMS applications and DB enabling rapid deployment of XML in IMS DB.

- Transform XML for existing IMS applications inside IMS Connect

- Enhanced PL/I support

- Generate XML output from PL/I applications
- Enable IMS PL/I applications as Web Services

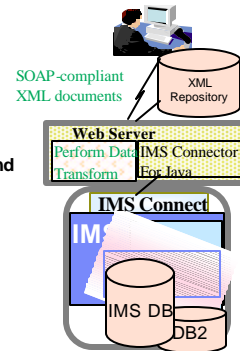

© IBM Corporation 2004

IMS is also taking advantage of XML which is critical for future transparent application integration. Today, IMS documents can be processed in new IMS Java applications using the XML toolkit for z/OS. We are also making available IMS COBOL and PL/I XML Application Capability, using the IBM Enterprise COBOL and PL/I compilers, which allows you to develop new or modify existing IMS applications using XML support for COBOL and PL/I. This can be used to enhance your existing high performance IMS transactions written in COBOL and PL/I in a Business-to-Business environment by receiving and sending XML documents. IMS supports the transmission of XML documents in the data portion of the IMS message. The messages can be placed and retrieved for the IMS messages queue for all messages regions for IMS Message Processing Programs, Fast Path Programs and Batch Message Processing Programs.

You can also enable existing IMS COBOL and C applications as Web Services by connecting SOAP and EJBs to IMS.

Future requirements also offer enhanced support for industry tooling, additional languages, transformation, and the storage of XML in an IMS Data Base.

With the new WebSphere tooling you would be able to generate XML documents for outputs from PL/I applications. You would be able to web enable your MFS applications using XML. You would also be able to transform your MFS based IMS applications into web services. XML transformation processing could eventually be contained within IMS Connect.

IBM's IMS Connectors Team at the Silicon Valley Laboratory developed the Common Application Metamodel (CAM). CAM is an IBM open standard initiative for Enterprise Application Integration (EAI). It was submitted as a proposal to the Object Management Group (OMG). OMG is the world's largest software consortium with a membership of over 800 vendors, developers, and end users. See <http://www.omg.org>.

A good description of CAM is part of a draft document, with diagrams and illustrations, at the web site for the Instituto Tecnologic de Informatica in Spain. Sections 6 (page 13) and 9 (page 79) are of special interest to those who have labored in the Open Transaction Management Access (OTMA) vineyards.

See <http://www.iti.upv.es/iti/i+d/mirrors/ftp.omg.org/pub/docs/ad/00-08-12.pdf>.

CAM defines and publishes a metadata exchange standard for information about accessing enterprise applications such as CICS and IMS. Anyone who has written COBOL COPYBOOK to XML translators or who has tried to make IMS message contents discernible to Java code, as have I, knows there has just got to be a better way. CAM is that better way!

Because CAM provides physical representation of data types and storage mapping to support data transformation in an EAI environment, it enables Web services for enterprise applications.

IBM has indicated CAM in their statement of direction for IMS. I would expect third party software developers to also adopt CAM, especially if and when it is accepted by OMG.

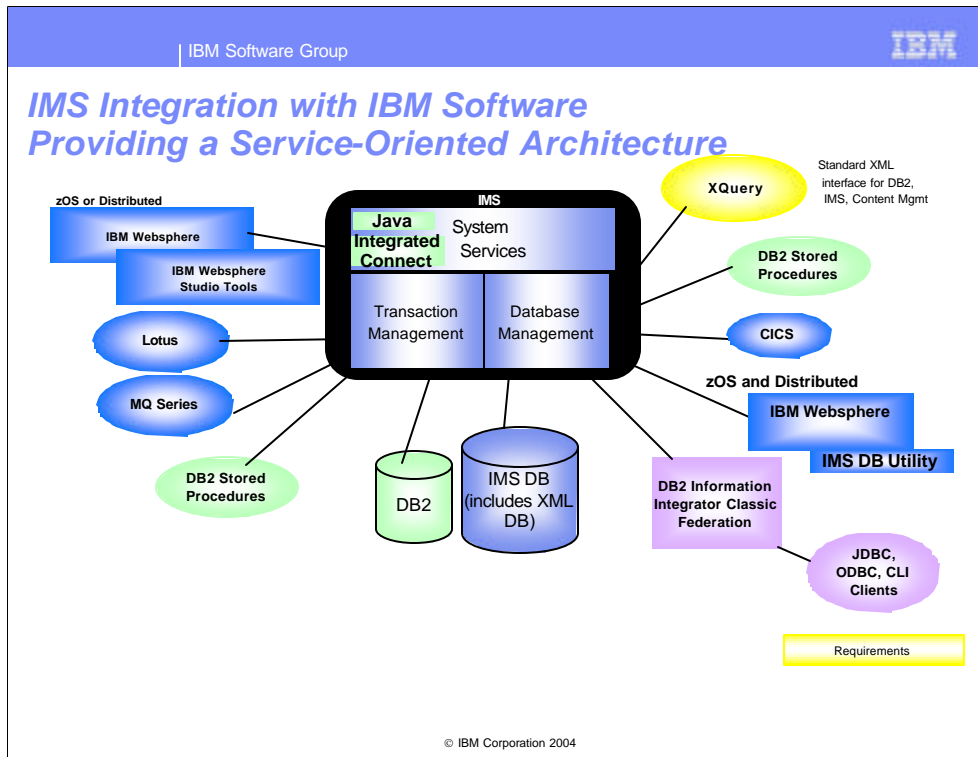

IMS provides integration with other IBM products for common network, application, data and operations access.

For application and information integration, and for operational integration, IMS is exploiting the latest programming technologies for the Internet and Java. With the industry standard, open interfaces of Java, users can transparently download and seamlessly run applications. It is becoming widely used and is platform independent. IMS applications and data can use and be accessible using the latest in standard architectures and interfaces, include the J2EE Connector Architecture (JCA) and standard application programming interfaces, for example, Java Database Connectivity (JDBC) interface, across platforms.

In conjunction with WebSphere studio tools and WebSphere servers, the IMS V9 Integrated Connect/Connector for Java function can be used for new J2EE application development/enabment to access IMS applications. IMS provides Web services for IMS applications using the WebSphere Application Server, IMS Connector for Java, and IMS Connect.

You can transform existing IMS transactions into Web services by using WebSphere Studio tools to create service definitions for IMS transactions. You then deploy these service definitions to WebSphere Application Server (WAS) to make the IMS services available as Enterprise Java Bean (EJB) services or Simple Object Access Protocol (SOAP) services. In this way, customers can enable IMS applications as Web Services to support IMS COBOL, C and MFS-based applications. This Web services support integrates IMS into the Services Oriented Architecture (SOA). SOA is key to interoperability and flexibility for on demand business. SOA supports end-to-end integration across the enterprise and among business partners. This provides a flexible business process model that allows customers to respond quickly to new customer requirements, new business opportunities, and competitive threats.

IMS Java support provides for the development/enabment of Java applications running under the IMS Transaction Manager and also for accessing IMS Databases with JDBC from applications running under other environments, such as WebSphere, CICS, and DB2 Stored procedures, as well. The IMS V9 Java DB utility can help distributed as well as z/OS WebSphere environments access IMS data. Interoperability is also being provided between Java, Cobol and PL/I applications, and between DB2 and IMS databases.

IMS V9 also provides for the storage/retrieval of decomposed or intact XML data in IMS DB databases.

And new support for DB2 Stored procedures can access IMS TM applications as well as IMS DB data.

IBM is also providing JDBC access to IMS Databases with the DB2 Information Integrator Classic Federation product.

IBM is also planning to provide support for IMS Databases with XQuery, the new standard XML interface.

IMS Integration with non-IBM Software

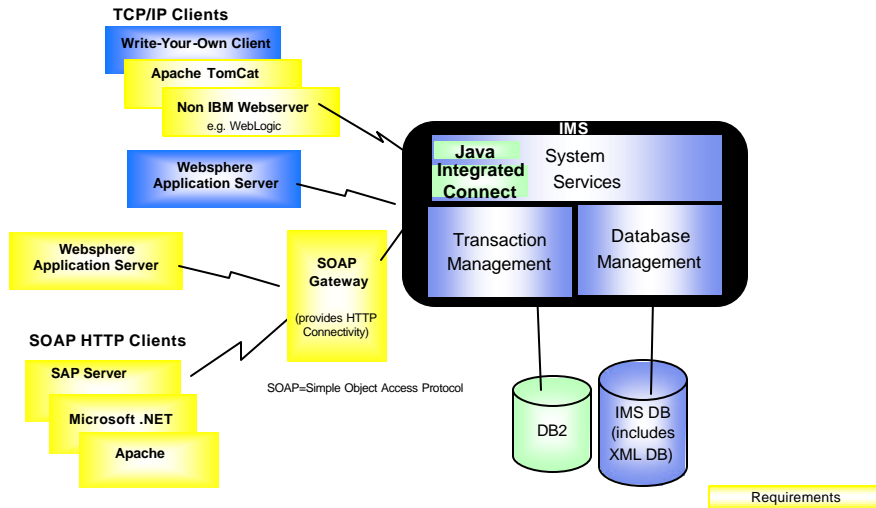

© IBM Corporation 2004

IMS is also providing support for integration with non-IBM products as well.

IMS is also using the WebSphere XML Adapter for COBOL and SOAP support with its IMS SOAP gateway code, a sample/demo of which is currently available at www.ibm.com/ims.

The IMS SOAP Gateway is an XML based connectivity solution that enables existing or new IMS applications to communicate outside of the IMS environment using SOAP to provide and request services independently of platform, environment, application language, or programming model.

The IMS SOAP Gateway enables the seamless exposure of IMS application assets as Web Services. The IMS SOAP Gateway, providing a relatively simple but extensible option, will provide the ability for non-WebSphere customers to re-use existing and to create new IMS-based business logic. One typical usage scenario of providing Web services with the IMS SOAP Gateway is to enable Microsoft .NET client applications or intermediary servers that submit SOAP requests into IMS to drive business logic transactions.

The SOAP for IMS function can assist organizations with Enterprise modernization, Application development, Business integration, and Web Services implementation.

Generated IMS service definitions (that is, Web Services Description Language (WSDL) files) can be published or exposed to a Universal Description, Discovery, Integration (UDDI) directory for businesses to publish their offerings, and for users to discover their needs. You can retrieve IMS WSDL files out of the UDDI directory and fit them into a tool (such as Microsoft .Net tools, or Apache Axis server tools) to generate SOAP messages to be sent to the host to run existing IMS applications. You can also use the standard APIs, such as Java API for XML-based RPC (JAX-RPC), to create both client and server code out of the generated WSDL files.

This gateway could also provide the ability to preserve and enhance IMS value to SAP and other customer applications, as well as to applications running in WebSphere and other Web Server environments.

IMS Dynamic Resource Definition (DRD) Requirements

- **Audience:** All IMS customers with a need to define IMS transactions, programs, routing codes, and databases
- **Objective:** Eliminate system definition process and online change for databases, applications and transactions
- **Solution:** Provide dynamic definition of these resources without system definition and online change
- **Value:** Non-disruptive addition, change and deletion of databases, applications and transactions in IMS

© IBM Corporation 2004

Critical follow-on work to help with installation of new IMS function is the ability for IMS to provide Dynamic Resource Definition. This can help all IMS customers who need to define transactions, programs, routing codes and databases. The objective is to eventually eliminate system definition and online change for databases, applications and transactions by providing a dynamic definition capability for these resources. This would offer a non-disruptive capability to add, change and delete databases, applications and transactions in IMS.

IMS Sysplex Operations Requirements

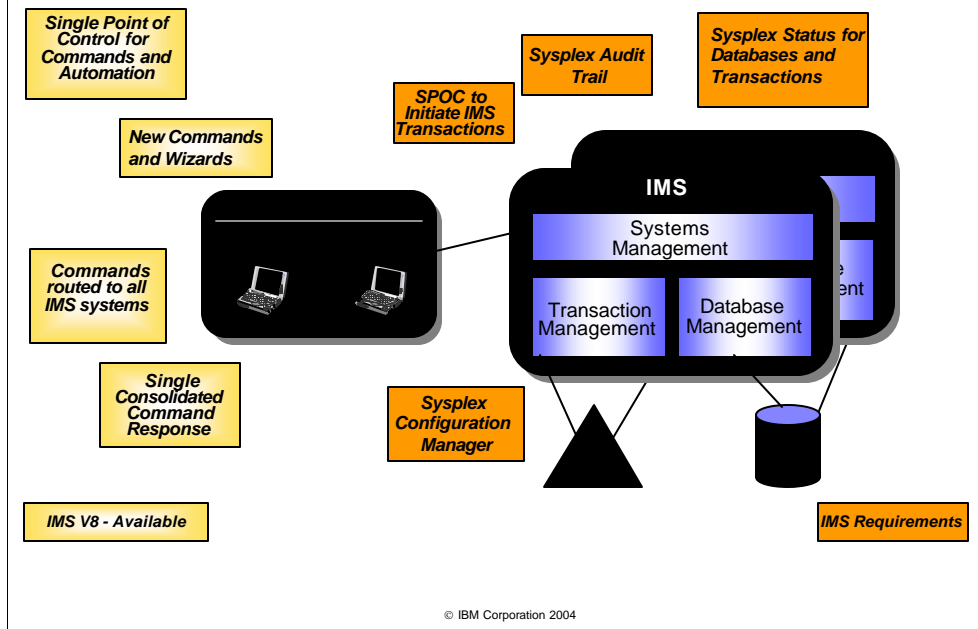

IMS V8 introduced the a Single Point Of Control (SPOC) for a TSO/ISPF application running on zOS and the IMS Control Center, a workstation GUI tool, integrated in the DB2 Control Center and communicating with IMS through the IMS Connect function. A new command syntax was introduced to make it easier to operate IMS in a parallel sysplex. The improved syntax can clearly distinguish between IMS keywords and user defined resource names. New keywords added to commands do not become reserved words, the user can use the keywords as resource names. A single command can be sent to all IMS systems with a single consolidated response returned to the user. Wildcards can be used in the commands for resource names. The command response can be filtered to show only that information that is required, reducing the workload on the operator. The SPOC can sort output. The IMS Control Center provides command wizards to construct IMS commands. IMS V8 facilitates customer automation by providing enhanced commands and by providing a machine readable command response. The important features for automation are the Operations Manager programming APIs, the command response returned in XML which can be parsed by automation, and Netview support.

New QUERY and UPDATE commands allow automation programs to monitor the IMS resources and to alter workload parameters. The command response is in XML which allows automation programs to clearly interpret the response. Vendor and customer automation can be written in assembler programs or in REXX programs. Rexx programs can run under TSO or in Tivoli Netview.

Several enhancements would be provided in the future to simplify management of IMS systems in a parallel sysplex. These include enhancements to Operations Manager, commands and a new Configuration Manager. Additional enhancements would include:

- A new audit trail that can be used by all IMS systems.
- Single Point of Control consoles able to initiate an IMS transaction for audit or diagnostic purposes.
- Ability for IMS to maintain global status for databases and transactions in the IMS Resource Manager Resource Structure, improving resource sharing between the IMS systems.
- A Configuration Manager (CM) function which would maintain a parallel sysplex view of the IMS components in the IMSplex, allowing users to start and stop the IMSplex with a single command while CM understands the dependencies of the components so they are started and stopped in the correct order.
- Automated event scheduling.

IMS Parallel Recovery Control (RECON) Access Requirements

- **Audience:** IMS Data Sharing customers and Single IMS system customers with batch jobs sharing the RECON data set
- **Objectives:** Eliminate performance bottlenecks caused by contention for the RECON
- **Solution:** Exploit DFSMS Transactional VSAM (TVS) to provide record level locking and logging for the RECON data set
- **Value:** Eliminates ATM Timeouts, transaction response time issues, unplanned IMS system quiesces for OLDS switches

© IBM Corporation 2004

IMS would also provide Parallel Recon Access for jobs sharing the RECON dataset. It could eliminate performance bottlenecks caused by contention for the RECON by exploiting DFSMS Transactional VSAM to provide record level locking and logging for the RECON data set. This could eliminate ATM timeouts, transaction response time issues, and unplanned IMS system quiesces for Online Log Dataset (OLDS) switches.

IMS Database Recovery Control (DBRC) Application Program Interface (API) Enhancement Requirements

▪ Audience

- Vendors and customers who access the IMS Recovery Control (Recon) directly via VSAM or decode the LIST.RECON output

• Objectives

- Provide users with a single release-independent interface to Recon
- Provide a Recon Update function for users and programs

▪ Solution

- Provide a standard DBRC API to the Recon data set

▪ Value

- Architected interface to the DBRC Recon data set eases tool workload and V2V migration resulting from individually provided access to Recon information

The IMS DBRC API, provided since V9, would also be enhanced to address additional vendor and customer requirements to access the Recovery Control dataset with a single, standard, release-independent interface, providing the Recon Update function for users and programs. This would ease access by vendor tools and ease version to version migration for customers using tools that interface the Recon.

IMS Multiple Systems Coupling (MSC) Bandwidth Requirements

▪ **Audience**

- Customers with multiple Parallel MSC connections
- Customers using the Workload Router product
- Customers who need a non-SNA alternative to a VTAM link

▪ **Objective**

- Remove long-standing bandwidth problems across the MSC network

▪ **Solution**

- Improve blocking technology for greater bandwidth across MSC links
- Add new MSC link type

▪ **Value**

- Performance improvements in transaction and output message response times

© IBM Corporation 2004

The IMS Multiple Systems Coupling Facility for IMS To IMS connectivity would also be enhanced for broader bandwidth and for support of newer technology links. By using improved blocking technology and new MSC link Types, performance improvements and response times could result for transaction and output messages.

Strategic IMS Architecture

Goals:

- Integration with open interfaces from and between IMS parts
- Manageability with restructured IMS components into independent units
- Scalability through allowing multiples of units
- Mix and Match units to meet business needs
- Fully exploit parallel Sysplex environment

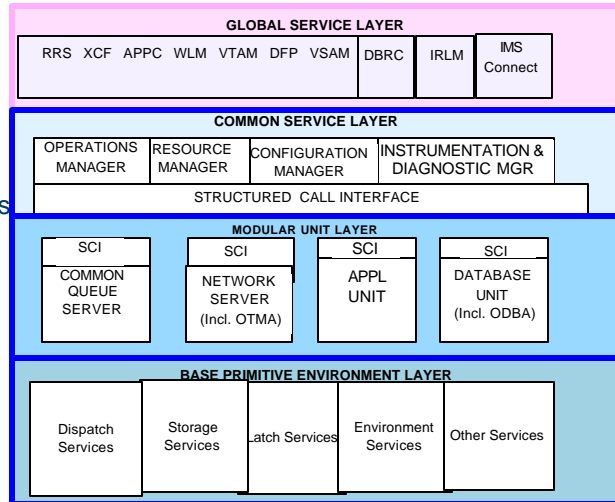

(BPE in V5, CQS in V6, OM, RM, SCI in V8, ...)

© IBM Corporation 2004

IMS is being transformed through restructuring and rebuilding to enable and exploit the latest technological advancements and continue enhancing integration, manageability and scalability for the 21st Century.

The goals for this Architecture are

- Integration with open interfaces from and between IMS parts
- Manageability with Restructured IMS components into independent units
- Scalability through allowing multiples of units (mix and match different multiples of each) in a Sysplex environment.

As we move through time IMS would provide more componentization, rewritten systems services with cleaner interfaces, and extend the layered approach.

The Structured Call Interface (SCI) ties it all together

The BPE (Base Primitives Environment) was first delivered in V5 and is further exploited in V6

Shared Queues (CQS- Common Queue Server) is the "Queue Unit", the first modular unit, delivered in IMS V6

The Common Service Layer will provide single system image and easier systems management

Leveraging IMS Applications and IMS Data for Integration

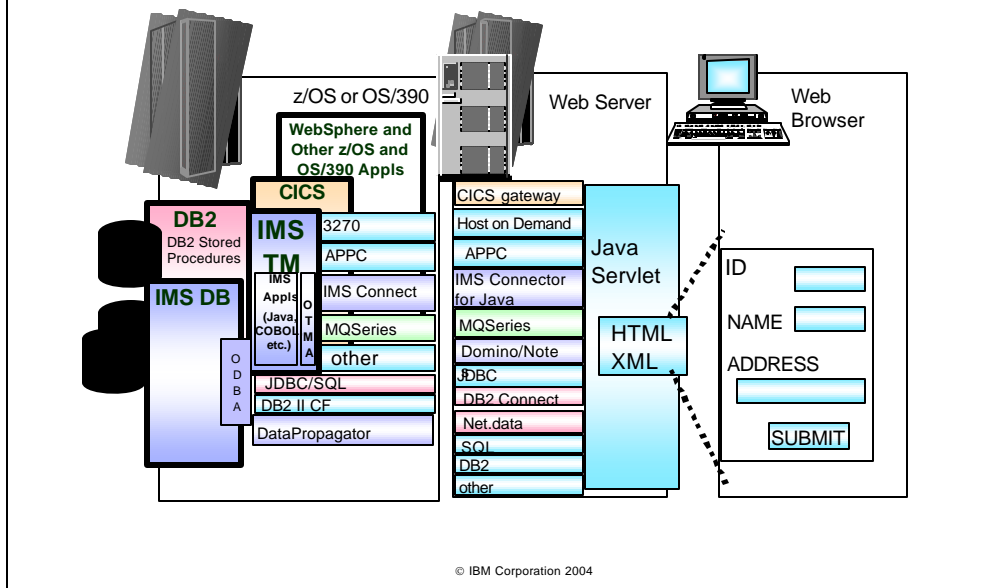

Connectivity has always been a priority with IMS. IMS traditionally has supported a number of communications facilities (e.g., 3270, APPC, TCP/IP, MQSeries, etc.). These solutions can use workstation or z/Series servers to access IMS. Information can be retrieved from the server system in a two-tier environment or in a three-tier environment. IBM and non-IBM Web servers have used connectors for IMS, DB2, CICS, MQ, etc., to communicate with the applications and data, and to generate the formatted screen displayed on the browser. Our strategy here is to ship connectors with their tooling with WebSphere for consistency across platforms and subsystems. And we want people to connect regardless of the tool they are using and regardless of what they want to connect with. IBM's goal is to do the best job of integrating our tools and integrating our solutions with other industry tools as well. Applications can use these tools to display information on the Internet using HTML or XML for data interchange. Mapping activities, as well as enhanced function, can take place in the web server between the web and the existing network protocols and input/output streams.

IMS has taken advantage of the facilities to allow subsystems to communicate more efficiently, with its Open Access facilities. IMS access through IMS Connect, MQSeries, etc., provide more efficient and richer capabilities in accessing existing, unchanged as well as new IMS applications. MQSeries solutions built on the IMS OTMA interface provide e-business access to IMS for other environments such as .Net, VisualAge Interspace to Visual Basic programs, and Lotus Notes/Domino for notes and collaboration.

New IMS application development for e-business can also take place with the IMS Java support and the Java tools being provided.

And IMS's Open Database Access facility, built on the DRA facility for CICS access to IMS DB, now provides a callable interface for easier database access from other subsystems as well. This facility is being used by DB2 Stored procedures to provide access to IMS DB data as well as DB2 data, and through this distributed access can be provided to IMS DB data through DB2 Connectors to the web.

JDBC access has been built on this ODBA facility for IMS DB access from WebSphere ejbs, as well as CICS and DB2. And IMS plans to extend this to more distributed environments as well.

The IMS DataPropagator provides synchronous and asynchronous updates passed between IMS DB and DB2 databases to enable consistency and use in a mixed database environment. The IMS Data Propagator can provide IMS customers with advanced data integration and analysis capabilities, while leveraging their existing IMS data assets. IMS Data Propagator has been enhanced for near real time asynchronous update, Improved user interface, and support for additional environments.

And IMS continues to support and enhance new technology in Integration/Openness for e-business enablement into the foreseeable future.

IMS Information

IMS Information is available at <http://www.ibm.com/ims>

- Presentations/Papers, Newsletters, Redbooks, Fact Sheets, Announce Letters, additional documentation
- Technical Support Info (search on IMS)

IMS Redbooks/Redpieces

- Release Guides, Sysplex Guides, Java guides, etc.

IMS Education at <http://www.ibm.com/services/learning/us>

2H04 IMS Conferences:

- WW IMS Technical Conference, Orlando, Florida, September 2004
- IMS Technical Symposium, Koenigswinter, Germany, October 2004
- Seminars/Roadshows coming to a city near you

IMS Consulting Services

- Migration and skills transfer and customized offerings available at dmservices@us.ibm.com

A wide range of IMS Information is available.

The IMS solutions are generally available along with other IBM products in support of IMS. Additional documentation and information is available from the IMS home page at <http://www.ibm.com/ims>.

The IBM International Technical Support Organization has been producing redbooks and redpieces with additional information, available at <http://www.redbooks.ibm.com>. A number of IMS Technical Conferences are also being provided on an ongoing basis.

The IMS Solutions offer a major step for IMS customers wanting to provide commercial services over the World Wide Web. Commercial services with access to IMS applications and data could include travel reservations, home banking, delivery tracking, service support, etc. Examples today exist in many industries. In a package delivery business, the company's customers track their individual packages from their own Internet access systems. The customer dials a server, asks for a package number, and sends it into the server to run the program to trace their package. A gateway server is provided for communication to the client and access to existing, unchanged IMS applications and data. The customers perceive this Internet access to delivery data as improved service. It also relieves staffing and support costs at the company, providing a good value on both sides. Another example exists in the banking industry. This project is home banking over the Internet. Forms are sent out and received back. Code formats messages and send them to the host S/390 system for processing by IMS. IMS applications accepts input and returns replies. Security is provided on the product server and S/390.

IMS: Providing Leadership in the Marketplace

**Simplifying Information Integration
through Connectivity and New
Application Development**



**Easing Manageability
Reducing the Cost of
Computing**

**Enabling System Scalability
with Availability/Recoverability
Performance/Capacity**

© IBM Corporation 2004

The on demand business cycle focuses on leveraging your existing knowledge and information and transforming your core business processes, managing technology in building new applications, and providing organizational efficiency. In all this you need to be running a high performance, available, scalable, secure environment. You use existing data to sharpen decision making and responsiveness. You prioritize which processes and applications need to be extended. You build new reusable applications integrated with existing ones. And you maximize deployment on secure platforms. And for each of these elements of the cycle, we are providing you the IMS solutions that you will need to help make all this work easily. Built on the power of the S/390, billions of dollars worth of IMS applications have been developed to run your mission-critical work in a safe environment with IMS. If you have money in a bank, feed, house, clothe your family, or protect them with health or insurance services, use educational or government information, etc., most of the information about this is kept securely in IMS databases, accessed through high performance IMS transactions and rapidly being processed across the Internet for wider use. IBM will continue to invest heavily in IMS to enhance IMS to meet the stringent requirements of its customers -- to help them transform their core business processes with emerging technologies using IMS. Exploiting the latest in technologically-advanced hardware and software, IMS will help customers achieve new levels of price-performance and, at the same time, leverage their exiting investment in skills and applications for information access across the Internet.