

E68

IMS V7 Overview: Transaction Manager Enhancements

Suzie Wendler



Anaheim, California

October 23 - 27, 2000



Abstract

- This presentation describes the major Transaction Manager enhancements that are being provided with IMS V7. Included are topics such as the ETO enhancements for autologon and printer support, RACF Passticket support, the new TM and MSC Message Routing and Control User Exit, CQS enhancements including the support for asynchronous APPC and OTMA messages, SLUP cold session termination, IMS monitor enhancements, VGR enhancements and several other serviceability as well as usability enhancements. The presentation also highlights the new Rapid Network Reconnect (RNR) function which implements VTAM persistent session support in IMS, IMS Connect which provides the TCP/IP sockets support for IMS, and IMS Java which allows IMS application programs to be written in the Java programming language.



Transaction Manager Enhancements

▲ Sysplex enhancements

- ▶ Shared Queues enhancements
- ▶ VTAM Generic Resources (VGR) enhancements

▲ Rapid Network Reconnect (RNR)

▲ TM Serviceability

▲ User exits

▲ System execution enhancements

▲ Connectivity

- ▶ OTMA Callable Interface
- ▶ IMS Connect

▲ Application development

- ▶ IMS Java



Shared Queues Environment

▲ Common Queue Server (CQS) enhancements

- Support for multiple clients
- Security checking during CQS registration
- Interface enhancements

▲ APPC/OTMA enhancement

- Capability to process asynchronous messages on a back-end IMS system



CQS Background

▲ Shared Queues were introduced in IMS/ESA V6

- Message queues are stored in CF structures
- Message queues are available to multiple IMS systems
 - ▶ Any IMS system may process a transaction
 - ▶ Provides for dynamic workload balancing

▲ Common Queue Server (CQS)

- Component that manages the shared queue structures on the CF
- Connects to the shared queue structures
- Runs in separate address space connected to IMS
- Acts as server for IMS control region
- V6 - One client (IMS) per CQS

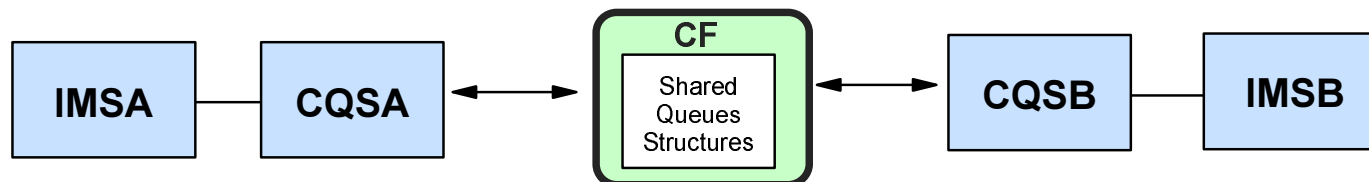



CQS Enhancements

▲ Support for multiple clients

- Achieves better utilization of the CQS address space
- Allows other clients to access shared queues
- Others could include monitoring tools

Usability

Availability

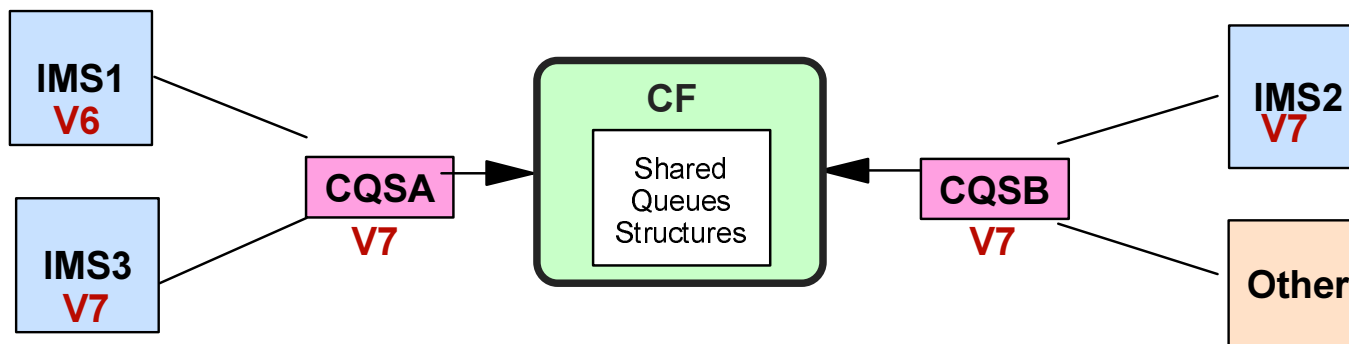

▲ Security checking during CQS registration

- Connector (e.g. IMS) to CQS is checked
- Since multiple users are allowed, we need to check who they are



Asynchronous APPC/OTMA

- Support for *Asynchronous* input message processing on a Shared Queues *back-end system*
- APPC Asynchronous inbound requests (Allocate-Send-Deallocate)
- OTMA Commit-then-Send (commit mode 0)
- Note:
 - ▶ IMS/ESA V6 required all APPC/OTMA input messages to process on the Shared Queues front-end IMS system
 - ▶ Synchronous messages still process on the system in which they are received

Performance

Usability



Asynchronous APPC/OTMA...

▲ *Asynchronous* OTMA/APPC input messages

- May be processed on any IMS in the shared queues group
- APPC/OTMA must be enabled on all back-end systems

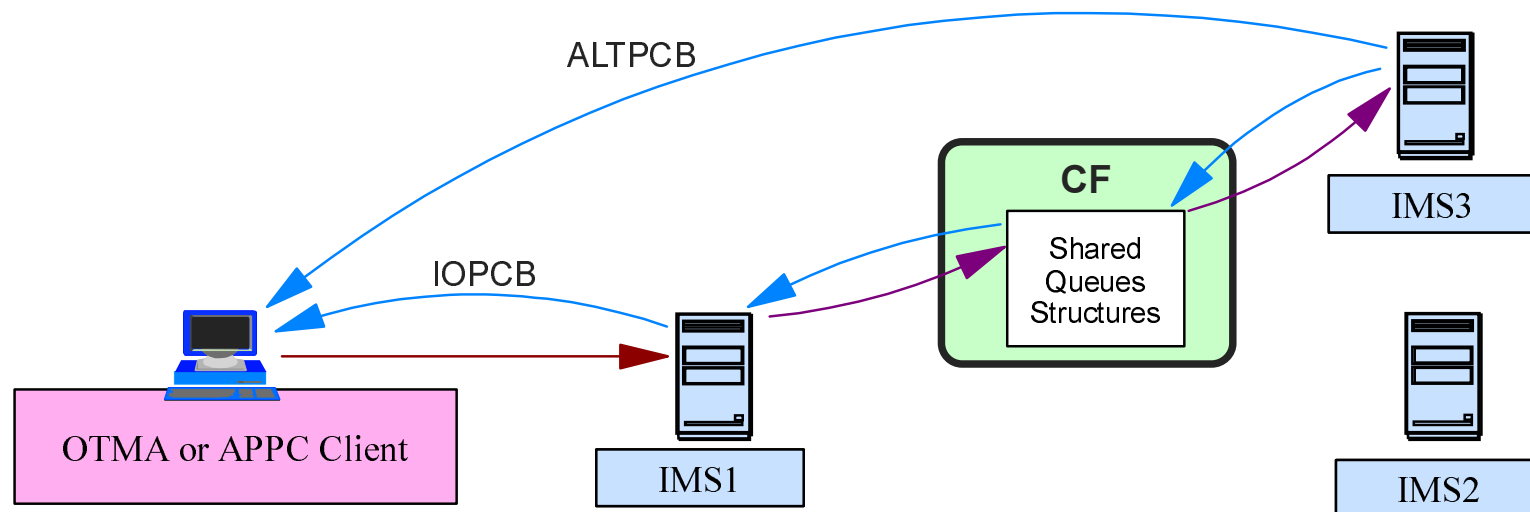



- ▶ IOPCB messages are delivered by the system which receives the input message
- ▶ ALTPCB messages are delivered by the system that processes the transaction



VTAM Generic Resources Enhancements

▲ IMS DFSDCxxx options: GRAFFIN and GRESTAE

Availability

- Delivered via APAR PQ18590 in IMS/ESA V6
- Greater control over access availability to any IMS when failures occur
- **GRAFFIN = IMS | **VTAM**** 
 - ▶ System option that specifies which component is to manage the Generic Resource affinities
- **GRESTAE = Y | **N**** 
 - ▶ System option that defines whether or not IMS should reset affinities (CLSDSTs) during ESTAE processing
 - ▶ Applies to GRAFFIN=IMS

Usability

- NOTE: GRAFFIN=IMS with GRESTAE=Y causes IMS to operate as it did without the APAR

Rapid Network Reconnect



Rapid Network Reconnect (RNR)

- ▲ RNR implements VTAM persistent session support
- ▲ Higher availability and reduced overhead
 - Quickly reestablishes VTAM sessions following system outages (IMS, MVS, CEC or VTAM)
 - Eliminates session cleanup/restart following an outage

Availability



Background - VTAM Persistent Sessions

▲ VTAM Single Node Persistent Session (SNPS)

- Reconnect must be on same CEC as original IMS
- Supports only application (IMS) failure/reconnect

▲ VTAM Multinode Persistent Session (MNPS)

- Reconnect may be on another CEC in a sysplex
- Supports failures/reconnects, including IMS, VTAM, MVS, and CEC failures

▲ Persistent sessions apply to VTAM nodes except MSC

- Persistent session support for APPC is provided by APPC/MVS



Single Node Persistent Sessions

▲ Single Node Persistent Session scenario

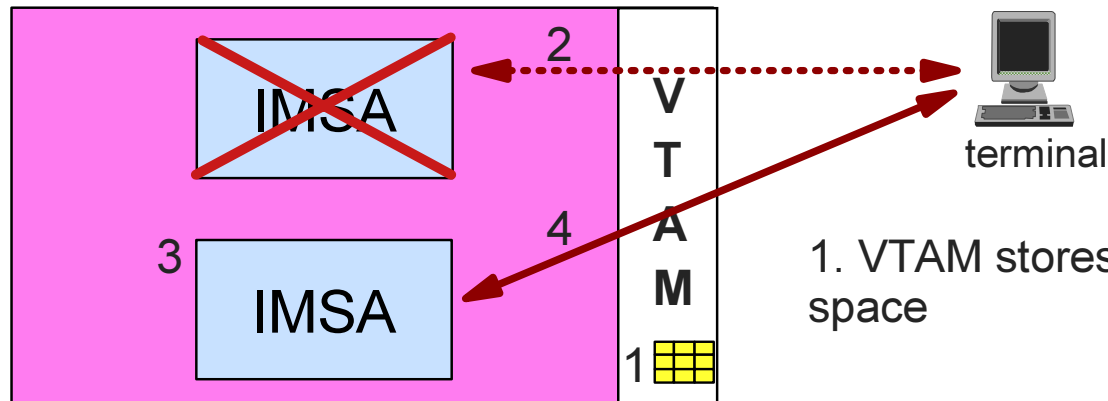

1. VTAM stores session data in addr. space

2. IMSA fails - the session to terminal is pending recovery

3. IMSA restarts

4. Auto reconnect of terminal to restarted IMS

- Terminal is logged on



Multinode Persistent Sessions

▲ Multinode Persistent Session scenario

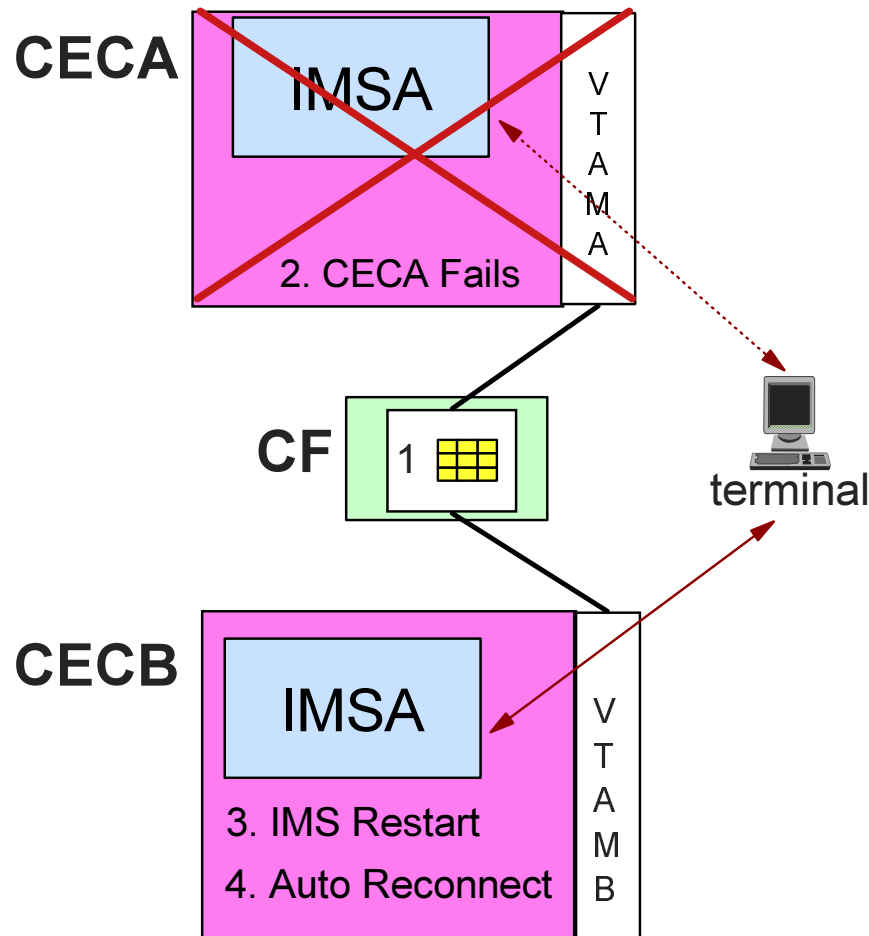

1. VTAM stores session data in the CF
2. CECA fails
 - Another VTAM in the Parallel sysplex detects the error
3. IMSA is restarted on CECB
4. The sessions are restarted using information saved in the CF structure
 - Terminal logged on



Signon Requirements

▲ Signon required after reconnect for:

- SLU1 - non-printer only
- SLU2
- Non-SNA 3270
- NTO

▲ Signon automatically reestablished for:

- SLU0 - FINANCE/3600, SLUP
- LU6.1 - ISC
- SLU1 - printer only



RNR Actions

▲ At session establishment

- Session information is stored by VTAM in address space or CF

▲ At IMS failure

- Nodes cannot logon to another IMS
 - ▶ Terminal users appear to be "hung"
 - Timer may be specified terminate sessions and release terminals

▲ /START DC following IMS restart initiates RNR action

- Sessions reestablished
 - ▶ Logon not required
 - ▶ Signon may be required



RNR Benefits

- ▲ **Session termination and establishment traffic eliminated**
 - Session information is maintained

- ▲ **Terminal service to same IMS is reestablished more quickly**

- ▲ **Value of RNR depends on how quickly IMS is restarted**

Persistent session support for APPC is provided by APPC/MVS

- Specified on LUADD statement
- Sessions are persistent, conversations are not

Exit Routines



New TM and MSC Exit - DFSMSCE0

▲ TM and MSC Message Routing and Control User Exit (DFSMSCE0)

▲ New exit that combines and replaces:

- Terminal Routing Exit (DFSCMTR0)
- Input Message Routing Exit (DFSNPRT0)
- Link Receive Routing Exit routines (DFSCMLR0/DFSCMLR1)
- Program Routing Exit (DFSCMPR0)

Usability

▲ Eases coding by reducing the number of exit routines

▲ Provides a consistent set of routing capabilities for all types of messages

▲ Provides the ability to attach a **user prefix** that follows the message and is passed to each exit interface

- Allows the message to be customized for accounting, security, etc.
- Not available to application programs



Queue Space Notification Exit Enhancement

▲ **Enhancement to allow IMS to pass a stopped status to DFSQSPC0 for conversational destinations**

▲ **Benefit**

- Prevent looping applications from impacting the message queue for stopped conversational destinations
- The exit has been available for many IMS releases and has had the ability to recognize stopped destinations but did not have the ability to provide this interface during conversational transaction processing
 - ▶ Application may receive "A7" status

Availability

System Execution Enhancements



Deferred ACB Open

▲ New system option to delay the opening of the VTAM ACB until IMS is ready to accept logons during /STA DC processing

▲ VACBOPN = INIT | DELAY

- Specified in the DFSDCxxx member of PROCLIB
- INIT - Open ACB is issued during initialization (as before)
- DELAY - Open ACB is delayed until /STA DC

Performance

Availability

▲ Prevents potential queuing of logon requests

- Impacts devices (e.g., ATMs during ERE) that immediately send in logon requests when IMS begins initialization

DFSDCxxx



Security Enhancements

▲ Enhanced PassTicket Support (uses RACF or equivalent)

▲ */SIGN ON userid PassTicket APPL applname*

- New APPL keyword
- Provides greater flexibility for the end-user/program
- Allows the creator of PassTickets to specify the value by which it knows IMS
 - ▶ IMSID (same as before)
 - ▶ IMS application name



▲ New system-wide default SAPPLID=applid in DFSDCxxx

- Enables the use of PassTickets for VGR connections to IMS

▲ USERID Clarification



- An indicator associated with the userid field that defines its content
 - ▶ (U) USERID, (P) PSB name, (L) LTERM name, (O) Other
 - ▶ Added to IOPCB, INQY ENVIRON call, INQY NULL call, Exit parameter lists, e.g., DFSBSEX0 (Build Security Environment) Exit



Spool Enhancements

▲ Internal change to the way EOF markers are written to spool data sets

- Improves spool performance by reducing EOF writes from one per record to one per track

Performance

▲ A new IMSWT = yyyyy parameter in DFSDCxxx

- Identifies the first 5 characters to use when auto scheduling the spool print utility
- Example:
 - ▶ IMSWT=IMSA causes IMS to issue: /STA REGION IMSA000 command to print the first spool line data
 - ▶ If IMSWT= is not coded, IMSWT is used as a default
- Facilitates the use of cloned IMS SYSGENs and PROCLIBs in a Parallel Sysplex environment
 - ▶ Each IMS generates correct spool print JCL

Usability



DFSDCxxx



SLU2 Enhancement

▲ New DFSDCxxx option: **SLU2=EXR/NOEXR**

- Specifies whether or not to suppress the SNA exception response prior to sending a DFS error message during error recovery processing
- Addresses Program check/keyboard lock for SLU2 devices that implement DFT (Distributed Function Terminal) architecture
 - ▶ Applies to static and ETO terminals

Usability



DFSDCxxx



SLUP/Finance Session Cold Termination

▲ Extension to the /CHANGE NODE command for SLUP/Finance

/CHANGE NODE *nodename* | *nodename** | ***ALL COLDSESS***

▲ New keyword COLDSESS

- Resets status to 'COLD'
- Impacts devices that are **not** in session and **are** idle
 - ▶ Applicable to ETO and static terminals
- Allows a forced reset of terminals via command if an unrecoverable STSN sequence number mismatch occurs during system warm start
- Allows applicable ETO control blocks to be cleaned up at next system checkpoint

Availability



ETO Enhancements

▲ Descriptor Limitation (50 records/descriptor) has been removed

▲ Associated Print Support Enhancements

- Allows more timely delivery of output messages for Associated Printers regardless of where the transaction is processed in a Shared Queues environment

▲ Autologon

- Enhancements for Associated Printers, Dynamic terminals activated via /OPNDST
- New keywords in the /CHANGE command
 - ▶ Update autologon information, e.g., Mode
 - ▶ SAVE|NOSAVE across restarts

Usability

▲ LTERM Assignment

- Allows users and LTERMs to be moved between printers more easily
 - ▶ Assignments can persist across session and system restarts

Connectivity Enhancements



OTMA Callable Interface

▲ Introduced in IMS/ESA V6 (PQ17203) - Delivered with IMS V7

▲ A high-level C/C++ API interface for OS/390 applications and subsystems

- Provides access to IMS transactions and commands through OTMA
- Provides a high-level interface for non-authorized and authorized programs to invoke OTMA facilities
 - ▶ Facilitates the coding of an OTMA client
 - ▶ Hides the complexity of XCF and OTMA

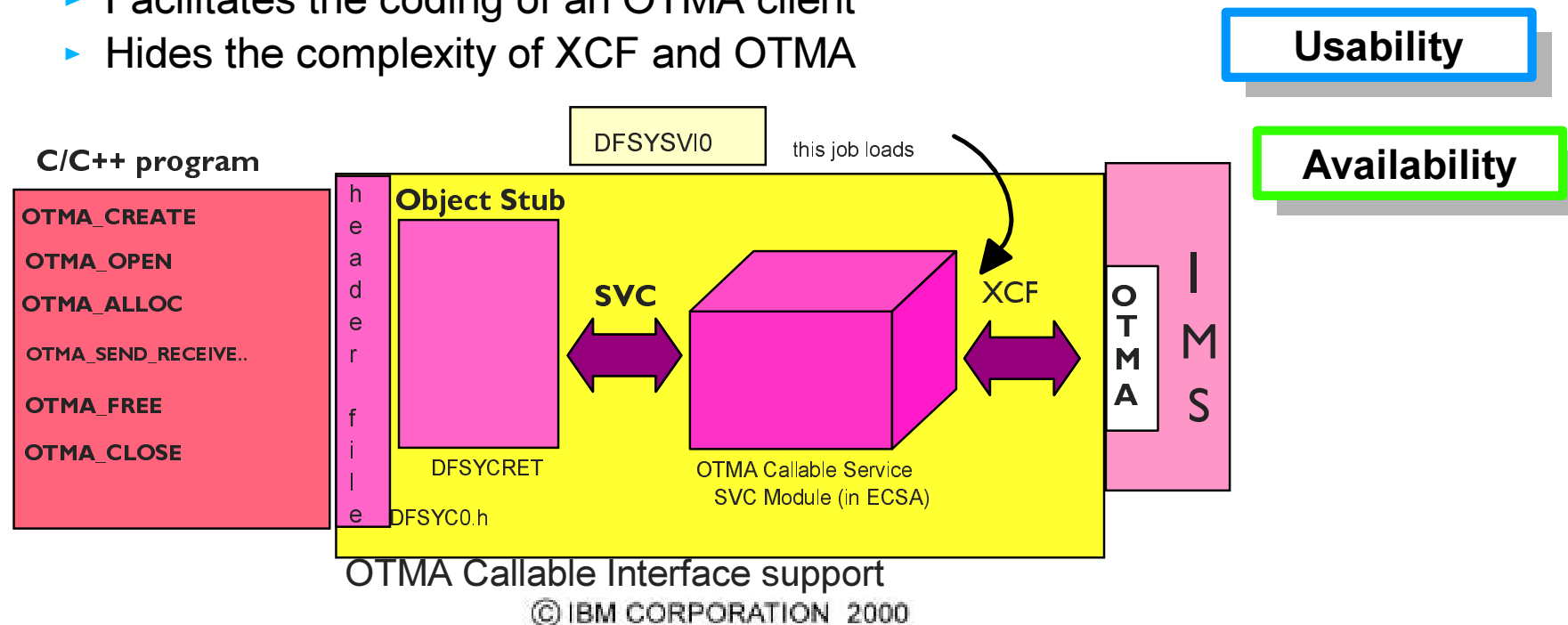



IMS Connect

▲ TCP/IP Sockets function for IMS

▲ Includes the IMS TCP/IP OTMA Connection (IMS TOC) capability

- Plus Enhancements:
 - ▶ SMP Installability
 - ▶ Persistent Sockets
 - ▶ Asynchronous Support
 - ▶ Initialization Exit
 - ▶ Dump Formatting capability

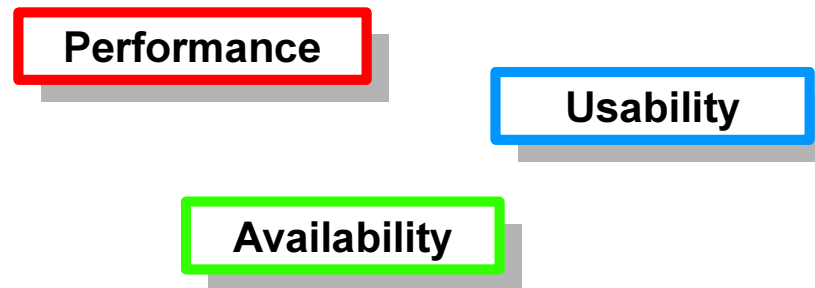

▲ Executes in its own MVS address space

- Functions as a TCP/IP server for communication with external clients
- Uses MVS XCF Services to access IMS OTMA

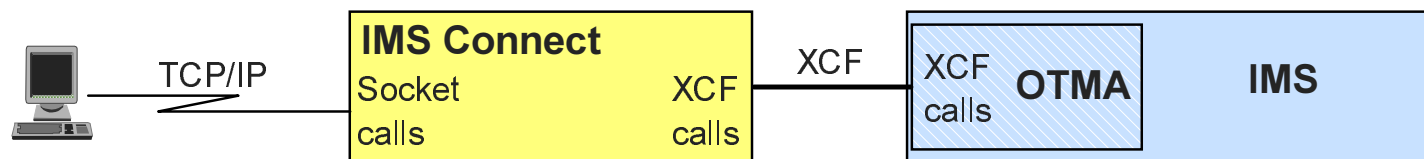



IMS Connect Enhancements

▲ Persistent Sockets

- Capability that allows the socket connection to remain active for multiple transaction iterations
- Only supported for Send-then-commit (Commit mode 1)

Performance

▲ Asynchronous output support

- ISRT's to Alternate TP PCBs (ALTPCB)

Usability

▲ Initialization exit

- User may write routine to route input to available IMS

Availability

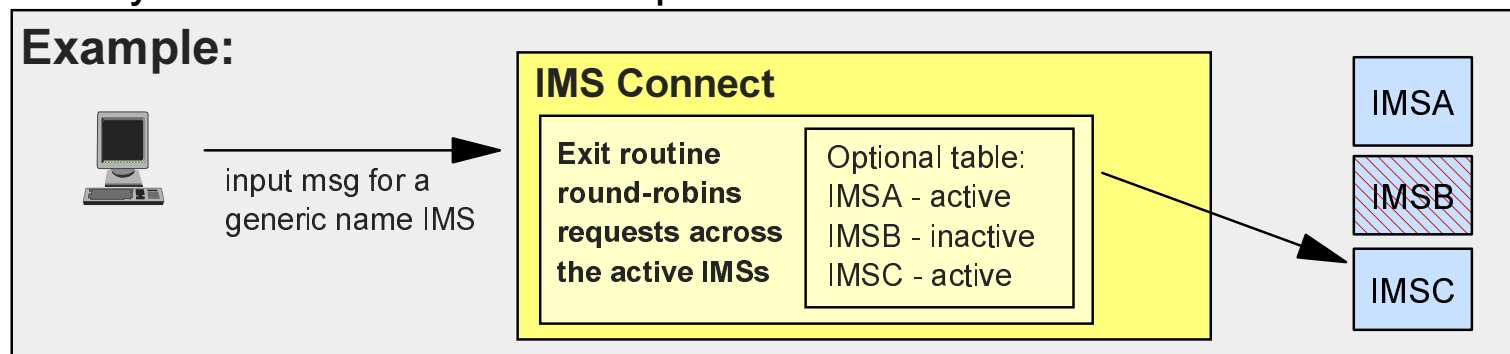

Application Development



IMS Java

▲ New function of IMS V7 TM

▲ Capability to write, compile and run IMS Java programs

- Development environment
 - ▶ Provides a set of packages (groups of classes)
 - Allow access to IMS services
 - Support APIs familiar to Java programmers
 - ▶ Uses the S/390 HPJ (high performance java) compiler
 - Compiles bytecode into high-performance executables/DLLs
- Runtime environment supports
 - ▶ Dependent regions (MPP, IFP, and BMP)

▲ Benefit

- Incorporation of the Java programming model into the IMS environment



Summary

- ▲ **IMS TM continues to be IBM's premier transaction server**
 - **Availability**
 - **Capacity and Performance**
 - **Scalability**