

Sterling Commerce

An IBM Company

Sterling Warehouse Management System: Billing Activity Reporting Engine Guide

Release 8.5

October 2009



Copyright Notice

Copyright © 2005 - 2009

Sterling Commerce, Inc.

ALL RIGHTS RESERVED

STERLING COMMERCE SOFTWARE

TRADE SECRET NOTICE

THE STERLING COMMERCE SOFTWARE DESCRIBED BY THIS DOCUMENTATION ("STERLING COMMERCE SOFTWARE") IS THE CONFIDENTIAL AND TRADE SECRET PROPERTY OF STERLING COMMERCE, INC., ITS AFFILIATED COMPANIES OR ITS OR THEIR LICENSORS, AND IS PROVIDED UNDER THE TERMS OF A LICENSE AGREEMENT. NO DUPLICATION OR DISCLOSURE WITHOUT PRIOR WRITTEN PERMISSION. RESTRICTED RIGHTS.

This documentation, the Sterling Commerce Software it describes, and the information and know-how they contain constitute the proprietary, confidential and valuable trade secret information of Sterling Commerce, Inc., its affiliated companies or its or their licensors, and may not be used for any unauthorized purpose, or disclosed to others without the prior written permission of the applicable Sterling Commerce entity. This documentation and the Sterling Commerce Software that it describes have been provided pursuant to a license agreement that contains prohibitions against and/or restrictions on their copying, modification and use. Duplication, in whole or in part, if and when permitted, shall bear this notice and the Sterling Commerce, Inc. copyright notice.

U.S. GOVERNMENT RESTRICTED RIGHTS. This documentation and the Sterling Commerce Software it describes are "commercial items" as defined in 48 C.F.R. 2.101. As and when provided to any agency or instrumentality of the U.S. Government or to a U.S. Government prime contractor or a subcontractor at any tier ("Government Licensee"), the terms and conditions of the customary Sterling Commerce commercial license agreement are imposed on Government Licensees per 48 C.F.R. 12.212 or 227.7202 through 227.7202-4, as applicable, or through 48 C.F.R. 52.244-6.

These terms of use shall be governed by the laws of the State of Ohio, USA, without regard to its conflict of laws provisions. If you are accessing the Sterling Commerce Software under an executed agreement, then nothing in these terms and conditions supersedes or modifies the executed agreement with respect to the bundled software solution.

Sterling Commerce, Inc.
4600 Lakehurst Court
Dublin, Ohio 43016-2000

Copyright © 2005 - 2009

WARRANTY DISCLAIMER

This Documentation and the Sterling Commerce Software it describes are licensed either "AS IS" or with a limited warranty, as set forth in the Sterling Commerce license agreement. Other than any limited warranties provided, NO OTHER WARRANTY IS EXPRESSED AND NONE SHALL BE IMPLIED, INCLUDING THE WARRANTIES OF MERCHANTABILITY AND FITNESS FOR USE OR FOR A PARTICULAR PURPOSE. Without limitation to the foregoing, Sterling Commerce does not warrant or represent that use of this software will ensure compliance with the U.S. Department of Transportation's (DOT) Hazardous Materials Regulations (HMR) found in Title 49 of the Code of Federal Regulations (49 CFR) or any other legal requirements, and users of this software should consult independent legal counsel and technical support to ensure compliance with the HMR and other legal requirements. The applicable Sterling Commerce entity reserves the right to revise this publication from time to time and to make changes in the content hereof without the obligation to notify any person or entity of such revisions or changes.

These terms of use shall be governed by the laws of the state of Ohio, USA, without regard to its conflict of laws provisions. If you are accessing the Sterling Commerce Software under an executed agreement, then nothing in these terms and conditions supersedes or modifies the executed agreement.

Third-Party Materials

Third-Party Links

The Sterling Commerce Software may include links or references to internet web sites and resources operated or offered by third parties. Such links are provided to facilitate your acquisition of third-party software products or services which may enable or otherwise enhance your use of the Sterling Commerce Software. Sterling Commerce makes no representations, warranties, or other commitments whatsoever about any such web sites or third-party resources. You are solely responsible for any transaction, download, installation and use of any software product or services made available via such third-party web sites or resources, and for compliance with any and all terms applicable to such third-party software products or services. Accordingly, Sterling Commerce is not responsible for the availability of such third-party web sites or resources, and is not responsible for any use of, or reliance on, any such content, products, services, or other materials on, or available through, such web sites or resources.

Third-Party Software

The Sterling Commerce Software may be distributed with or otherwise rely upon other Sterling Commerce software which may be distributed on the same storage media with products, ("Third-Party Software") offered by third parties ("Third-Party Licensors"). Third-Party Software information for such additional components of the Sterling Commerce Software is located at: <INSTALL_DIR>/ReadMe.htm

Contents

Preface

Intended Audience	ix
Structure	ix
Documentation	x
Conventions	xiii

1 Introduction

1.1 Billing Activity Reporting Engine Terminology	2
1.2 Setting Up the Billing Activity Reporting Engine Codes	4
1.3 Billing Activity Reporting Engine Auditing Capabilities	7
1.4 Enabling the Billing Activity Reporting Engine	8
1.5 Billing Activity Reporting Engine Activity Purge	8

2 Billing Activity Reporting Engine Console

2.1 Defining Billing Activity Codes	11
2.1.1 Creating Billing Activity Codes	11
2.1.2 Viewing Billing Activity Codes	12
2.1.3 Modifying a Billing Activity Code	15
2.1.4 Deleting a Billing Activity Code	16
2.2 Defining Billing Activities	17
2.2.1 Manually Recording Billing Activities	17
2.2.2 Viewing Billing Activities	18
2.2.3 Modifying Billing Activities	22
2.3 Activity Status Transitions	24

- 2.3.1 Cancelling Billing Activities..... 24
- 2.4 Viewing Billing Activity Detail Audits..... 25

3 Inbound Billing Activities

- 3.1 Configuring the Billing Activity Reporting Engine 31
 - 3.1.1 Pipeline..... 31
 - 3.1.2 Transactions 32
 - 3.1.2.1 Pickup Statuses..... 32
 - 3.1.2.2 Drop Statuses 32
 - 3.1.3 Agents 33
 - 3.1.4 Services..... 33
 - 3.1.5 Billing Activity Codes for the Inbound Process 33
 - 3.1.5.1 System-Recorded 33
 - 3.1.5.2 User-Recorded 35

4 Outbound Billing Activities

- 4.1 Configuring the Billing Activity Reporting Engine 37
 - 4.1.1 Pipeline..... 37
 - 4.1.2 Transactions 38
 - 4.1.2.1 Pickup Statuses..... 38
 - 4.1.2.2 Drop Statuses 39
 - 4.1.3 Agents 39
 - 4.1.4 Services..... 39
 - 4.1.5 Billing Activity Codes for the Outbound Process 39
 - 4.1.5.1 System-Recorded 39
 - 4.1.5.2 User-Recorded 41

5 Count Billing Activities

- 5.1 Configuring the Billing Activity Reporting Engine 43
- 5.2 Pipeline..... 44
 - 5.2.1 Transactions 44
 - 5.2.1.1 Pickup Statuses..... 44
 - 5.2.1.2 Drop Statuses 45
 - 5.2.2 Agents 45

5.2.3	Services.....	45
5.2.4	Billing Activity Codes for the Count Process.....	45
5.2.4.1	System-Recorded.....	45
5.2.4.2	User-Recorded.....	46

6 Value-Added Services Billing Activities

6.1	Configuring the Billing Activity Reporting Engine.....	49
6.1.1	Pipeline.....	49
6.1.2	Transactions.....	50
6.1.2.1	Pickup Statuses.....	50
6.1.2.2	Drop Statuses.....	51
6.1.3	Agents.....	51
6.1.4	Services.....	51
6.1.5	Billing Activity Codes for the Value-Added Services Process.....	51
6.1.5.1	System-Recorded.....	51
6.1.5.2	User-Recorded.....	52

7 Integrating with External Systems

8 Extending the Billing Activity Reporting Engine Activities

8.1	Shipment Activities.....	59
8.2	Receipt Activities.....	60
8.3	Count Activities.....	61
8.4	Value-Added Service Activities.....	62

A Billing Activity Codes

A.1	Inbound Billing Activities.....	65
A.2	Outbound Billing Activities.....	66
A.3	Count Billing Activities.....	67
A.4	Value-Added Services Billing Activities.....	68

B Billing Activity Units of Measure

Index

Preface

This manual explains the Billing Activity Reporting Engine that records all the billing activities carried out using the Sterling Warehouse Management System.

Intended Audience

This manual provides information for warehouse managers responsible for tracking inventory and inbound, outbound, and other operations in the warehouse using Sterling Warehouse Management System.

Structure

This document contains the following chapters:

Chapter 1, "Introduction"

This chapter introduces the Billing Activity Reporting Engine provided with the Sterling Warehouse Management System.

Chapter 2, "Billing Activity Reporting Engine Console"

This chapter explains the Billing Activity Reporting Engine Console, which enables you to create billing activities and associate them with appropriate billing activity codes, create new billing activity codes, and view billing activities and audits.

Chapter 3, "Inbound Billing Activities"

This chapter explains the inbound billing activities that are recorded using the Billing Activity Reporting Engine.

Chapter 4, "Outbound Billing Activities"

This chapter lists the outbound billing activities that are recorded using the Billing Activity Reporting Engine.

Chapter 5, "Count Billing Activities"

This chapter lists the count billing activities that are recorded using the Billing Activity Reporting Engine.

Chapter 6, "Value-Added Services Billing Activities"

This chapter lists the value-added service billing activities that are recorded using the Billing Activity Reporting Engine.

Chapter 7, "Integrating with External Systems"

This chapter explains how to integrate the Billing Activity Reporting Engine provided with Sterling Warehouse Management System with external systems, such as the Accounts Receivable system.

Chapter 8, "Extending the Billing Activity Reporting Engine Activities"

This chapter explains how to extend the Billing Activity Reporting Engine activities.

Appendix A, "Billing Activity Codes"

This appendix lists the Billing Activity Codes that are recorded using the Billing Activity Reporting Engine.

Appendix B, "Billing Activity Units of Measure"

This appendix lists the Billing Activity Units Of Measure used to charge the billing activities provided with the Sterling Warehouse Management System.

Documentation

For more information about the Sterling Warehouse Management System™ components, see the following manuals:

- *Sterling Warehouse Management System: Release Notes*
- *Sterling Warehouse Management System: Installation Guide*
- *Sterling Warehouse Management System: Overview*
- *Sterling Warehouse Management System: Implementation Guide*

- *Sterling Warehouse Management System: Reports Guide*
- *Sterling Warehouse Management System: Business Intelligence Guide*
- *Sterling Warehouse Management System: Printed Documents Guide*
- *Sterling Warehouse Management System: Billing Activity Reporting Engine Guide*
- *Sterling Warehouse Management System: Upgrade Guide*
- *Sterling Warehouse Management System: Voxware Integration Guide*
- *Sterling Warehouse Management System: Javadocs*

For more information about the Selling and Fulfillment Foundation components, see the following manuals:

- *Selling and Fulfillment Foundation: Release Notes*
- *Selling and Fulfillment Foundation: Installation Guide*
- *Selling and Fulfillment Foundation: Upgrade Guide*
- *Selling and Fulfillment Foundation: Configuration Deployment Tool Guide*
- *Selling and Fulfillment Foundation: Performance Management Guide*
- *Selling and Fulfillment Foundation: High Availability Guide*
- *Selling and Fulfillment Foundation: System Management Guide*
- *Selling and Fulfillment Foundation: Localization Guide*
- *Selling and Fulfillment Foundation: Customization Basics Guide*
- *Selling and Fulfillment Foundation: Customizing APIs Guide*
- *Selling and Fulfillment Foundation: Customizing Console JSP Interface for End User Guide*
- *Selling and Fulfillment Foundation: Customizing the RCP Interface Guide*
- *Selling and Fulfillment Foundation: Customizing User Interfaces for Mobile Devices Guide*
- *Selling and Fulfillment Foundation: Customizing Web UI Framework Guide*

- *Selling and Fulfillment Foundation: Customizing Swing Interface Guide*
- *Selling and Fulfillment Foundation: Extending the Condition Builder Guide*
- *Selling and Fulfillment Foundation: Extending the Database Guide*
- *Selling and Fulfillment Foundation: Extending Transactions Guide*
- *Selling and Fulfillment Foundation: Using Sterling RCP Extensibility Tool Guide*
- *Selling and Fulfillment Foundation: Integration Guide*
- *Selling and Fulfillment Foundation: Product Concepts Guide*
- *Sterling Warehouse Management™ System: Concepts Guide*
- *Selling and Fulfillment Foundation: Application Platform Configuration Guide*
- *Sterling Distributed Order Management™: Configuration Guide*
- *Sterling Supply Collaboration: Configuration Guide*
- *Sterling Global Inventory Visibility™: Configuration Guide*
- *Sterling Catalog Management™: Configuration Guide*
- *Sterling Logistics Management: Configuration Guide*
- *Sterling Reverse Logistics™: Configuration Guide*
- *Sterling Warehouse Management System: Configuration Guide*
- *Selling and Fulfillment Foundation: Application Platform User Guide*
- *Sterling Distributed Order Management: User Guide*
- *Sterling Supply Collaboration: User Guide*
- *Sterling Global Inventory Visibility: User Guide*
- *Sterling Logistics Management: User Guide*
- *Sterling Reverse Logistics: User Guide*
- *Sterling Warehouse Management System: User Guide*
- *Selling and Fulfillment Foundation: Mobile Application User Guide*
- *Selling and Fulfillment Foundation: Business Intelligence Guide*

- *Selling and Fulfillment Foundation: Javadocs*
- *Sterling Selling and Fulfillment Suite: Glossary*
- *Parcel Carrier: Adapter Guide*
- *Selling and Fulfillment Foundation: Multitenant Enterprise Guide*
- *Selling and Fulfillment Foundation: Password Policy Management Guide*
- *Selling and Fulfillment Foundation: Properties Guide*
- *Selling and Fulfillment Foundation: Item Concepts Guide*
- *Selling and Fulfillment Foundation: Pricing Concepts Guide*
- *Business Center: Item Administration Guide*
- *Business Center: Pricing Administration Guide*
- *Business Center: Customization Guide*
- *Business Center: Localization Guide*

Conventions

The following conventions may be used in this manual:

Convention	Meaning
. . .	Ellipsis represents information that has been omitted.
< >	Angle brackets indicate user-supplied input.
mono-spaced text	Mono-spaced text indicates a file name, directory path, attribute name, or an inline code example or command.
/ or \	Slashes and backslashes are file separators for the Windows, UNIX, and LINUX operating systems. The file separator for the Windows operating system is "\" and the file separator for UNIX and Linux systems is "/". The UNIX convention is used unless otherwise mentioned.
<YANTRA_HOME_OLD>	User-supplied location of the installation directory for previously installed releases. This is only applicable for Releases 7.7, 7.9, and 7.11.

Convention	Meaning
<YFS_HOME_OLD>	This is the <YANTRA_HOME>/Runtime directory of previously installed releases. This is only applicable for Releases 7.7, 7.9, and 7.11.
<INSTALL_DIR>	User-supplied location of the Selling and Fulfillment Foundation installation directory. This is applicable for Release 8.0.

Note: The Selling and Fulfillment Foundation documentation set uses the following conventions in the context of the product name:

- Yantra is used for Release 7.7 and earlier.
- Sterling Supply Chain Applications is used for Releases 7.9 and 7.11.
- Sterling Multi-Channel Fulfillment Solution is used for Releases 8.0 and 8.2.
- Selling and Fulfillment Foundation for Release 8.5.

Introduction

Third-Party Logistics (3PL) warehouses bill clients based on the different billing activities performed for the clients at the warehouse.

Billing Activities are units of work performed at the warehouse or fulfillment center of the Third-Party Logistics provider, for a specific client. Each billing activity is associated with a Billing Activity Code that uniquely identifies the billing activity performed. The billing activity is also referenced with the Sales Order number, Purchase Order number, Work Order number, and so forth. These help the client to reference the billing activity back to a specific reason.

The activities billed are generally based on the number of units received, number of units shipped, number of hours spent in inspection or physical count, number of prints, and so forth.

The Billing Activity Reporting Engine records billing activities performed within the fulfillment process. These are recorded at the warehouse level by Sterling Warehouse Management System.

Sterling Warehouse Management System is shipped with a number of system-tracked billable activities. For each billable activity, event handlers are configured, which get triggered when the activity is performed at the warehouse.

You can also use Sterling Warehouse Management System to add, update, or remove billing activities. It provides an audit trail for the changes.

Sterling Warehouse Management System Billing Activity Reporting Engine can be integrated with an external system. Sterling Warehouse Management System provides the external system with the list of all billing activities, along with the associated code, references, and the units of work.

The Billing Activity Report Engine is used to generate Billing Activity Reports based on the activities performed in the warehouse. It is used for billing clients in a Third-Party Logistics environment. For more information about Billing Activity Reports, see the *Sterling Warehouse Management System: Reports Guide*.

1.1 Billing Activity Reporting Engine Terminology

This section introduces the various terms that are used with regard to the Billing Activity Reporting Engine.

Clients

Clients are companies that have outsourced some or all of their logistics requirements to the Third-Party Logistics provider.

Billing Activities

Billing Activities are units of work performed at the warehouse or fulfillment center of the Third-Party Logistics provider, for a specific client.

Billing Activity Code

Billing Activity Codes uniquely identify the billing activities performed. Each billing activity is associated with a Billing Activity Code.

Name

This provides the name or a meaningful description of the billing activity.

Transaction Type

The transaction type indicates the classification to which the activity belongs.

Valid Transaction Types are:

- Ancillary

These transaction types are used to charge activities other than Receiving and Shipping. These Transaction Types are used for Count and VAS activities.

- Receiving
These transaction types are used to charge receipt activities for the Inbound Process.
- Shipping
These transaction types are used to charge shipment activities for the Outbound Process.

Group ID

Group IDs identify the group to which the billing activity group belongs.

Valid Group IDs are:

- Miscellaneous Charges
These Group IDs are used to record miscellaneous charges.
- Storage Charges
These Group IDs are used to record storage charges.
- Transaction Charges
These Group IDs are used to record transaction charges.
- Handling Charges
These Group IDs are used to record handling charges.

Unit Of Measure

The Unit of Measure that is used to charge the billing activity.

Valid Unit Of Measures are: PER_SKU_LINE, PER_ORDER, and so forth.

Track Type

The track type identifies the manner in which the billing activity is tracked.

Valid Track Types are:

- System
The billing activity is recorded by the system.

- Manual

The billing activity is recorded manually by the user.

Ship Via

This indicates the means of transportation.

Ship Via values can include Ground, Air, and so forth.

Transaction Reference

This is the reference for the activity. For example, in the case of shipment activities, the shipment number is the transaction reference.

1.2 Setting Up the Billing Activity Reporting Engine Codes

Billing Activity Reporting Engine codes are used to configure the Billing Activity Reporting Engine.

To view or modify existing Billing Activity Reporting Engine codes:



1. Log in to the application as the system administrator.
2. From the Application Console menu bar, select Configuration > Launch Applications Manager. The Applications Manager opens in a new window.
3. From the Applications Manager menu bar, select Applications > Application Platform.
4. From the tree in the application rules side panel, choose Presentation.
5. Select Custom Common Codes. The Custom Common Codes (DEFAULT) screen displays.
6. In the Custom Common Codes (DEFAULT) screen, select the appropriate Custom Common Code Type and click . The Common Code Values screen displays.
7. To add a new Billing Activity Reporting Engine code:
 - a. In the Common Code Values screen, click . The ARE Unit of Measure Details screen displays.

Table 1–1 Custom Common Codes

Common Code Type	Description
ARE_ACTIVITY_GROUP	<p>The type of activity group of the billing activity.</p> <p>The activity group of the billing activity can be:</p> <p>Miscellaneous Charges: This is used to record miscellaneous charges.</p> <p>Storage Charges: This is used to record storage charges.</p> <p>Transaction Charges: This is used to record transaction charges.</p> <p>Handling Charges: This is used to record handling charges.</p>
ARE_ACTIVITY_STATU S	<p>The type of activity status of the billing activity.</p> <p>The activity status of the billing activity can be:</p> <p>Created: Indicates that the billing activity is created.</p> <p>Modified: ARE Billing Activity Status is set to modified, if the user makes any changes manually in the ARE Activity Record.</p> <p>Error: ARE Billing Activity Status is set to error, if an error is encountered, while uploading the billing activity.</p> <p>Uploaded: ARE Billing Activity Status is set to uploaded, when the billing activity is uploaded to the host system.</p> <p>Cancelled: ARE Billing Activity Status is set to cancelled, when the user manually cancels the billing activity.</p>
ARE_AUDIT_REASON	<p>ARE Audit Reason Code.</p> <p>The audit reason code specifies the reason why the billing activity was modified.</p> <p>The Default Reason Code shipped along with Sterling Warehouse Management System is Default Reason 1.</p>

Table 1–1 Custom Common Codes

Common Code Type	Description
ARE_TRACK_TYPE	The track type of the billing activity. The track type of the billing activity can be: Manual - Billing activities can be tracked manually. System - Billing activities can be tracked by the system.
ARE_TRAN_TYPE	The type of transaction of the billing activity. The type of transaction of the billing activity can be: Ancillary: This transaction types is used to charge activities other than Receiving and Shipping. This transaction type is used for Count and VAS activities. Receiving: This transaction types is used to charge receipt activities for the Inbound Process. Shipping: This transaction types is used to charge shipment activities for the Outbound Process.
ARE_UOM	The type of unit of measure of the billing activity. This indicates the unit of measure in which the billing activity is charged. For more information about the ARE Unit Of Measure, see Appendix B, "Billing Activity Units of Measure" .

1.3 Billing Activity Reporting Engine Auditing Capabilities

The Billing Activity Reporting Engine audits any change in the value of the following fields:

- Service Quantity
- Activity Date
- Transaction Reference
- Ship Via
- Carrier Code
- Reference1

Audits are recorded when you change the entries in the Billing Activity Details screen. For more information about the Billing Activity Details screen, see [Section 2.1.3, "Modifying a Billing Activity Code"](#).

Audits also record and display the Reason Code and Reason Text. For more information about the audit details, see [Section 2.2.2, "Viewing Billing Activities"](#).

1.4 Enabling the Billing Activity Reporting Engine

To enable the Billing Activity Reporting Engine:

1. Open the `<INSTALL_DIR>/properties/customer_override.properties`.
2. Add the new property: `yfs.yfs.enableARE=Y`.
3. Update the Selling and Fulfillment Foundation runtime. For more information about this, see the *Selling and Fulfillment Foundation: Installation Guide*.

Upon adding this property, the system automatically enables the Billing Activity Reporting Engine. Task queue records are inserted for the Inbound, Outbound, VAS, and Count processes. These records are later processed by the system to record the billing activities, as they are performed in the warehouse.

1.5 Billing Activity Reporting Engine Activity Purge

This purge removes the Billing Activity Reporting Engine transaction data from the system. This reduces the load from frequently accessed tables. To be purged, the Billing Activity Reporting Engine activity should be marked as UPLOADED or CANCELED.

Attributes

[Table 1–2](#) illustrates the attributes for the ARE Activity Purge time-triggered transaction.

Table 1–2 ARE Activity Purge Attributes

Common Code Type	Description
Base Transaction ID	PURGE_ARE
Base Document Type	General
Base Process Type	General
Abstract Transaction	No
APIs Called	None
User Exits Called	None

Criteria Parameters

Table 1–3 illustrates the criteria parameters for the ARE Activity Purge transaction.

Table 1–3 ARE Activity Purge Criteria Parameters

Criteria Parameters	Description
Live	Optional Mode in which to run. Valid values are: Y - Default value. Moves qualifying records from the regular tables listed under Tables Purged to the corresponding history tables. N - Test mode. Determines the rows that are moved to history tables without actually moving them.
Purge Code	Required. Purge Code is set to PURGE_ARE. Used for internal calculations, such as determining retention days. Corresponds with the PurgeCode used in the Business Rules Purge Criteria.

Statistics Tracked

Table 1–4 illustrates the statistics tracked for the ARE Activity Purge transaction.

Table 1–4 ARE Activity Purge Statistics

Statistics Name	Description
NumAREActivityPurged	Number of ARE Activity records purged.

Pending Job Count

For the ARE Activity Purge transaction, the pending job count is the number of records that can be purged from the YNW_ARE_ACTIVITY_HEADER table.

Events Raised

None.

Tables Purged

YNW_ARE_ACTIVITY_HEADER

YNW_ARE_ACTIVITY_DETAIL

YNW_ARE_ACTIVITY_AUDIT

Billing Activity Reporting Engine Console

The Sterling Warehouse Management System stores all the billable activities that are performed at the warehouse. The Billing Activity Reporting Engine records billing activities as they are performed within the fulfillment process. These are recorded at the warehouse level and uploaded to Sterling Warehouse Management System.

You can use the Billing Activity Reporting Engine Console to add, update, or remove billing activities and billing activity codes. The Billing Activity Reporting Engine Console also provides an audit trail for the changes.

This chapter explains how to create, view, modify, and delete billing activity codes, create, view, modify, and cancel billing activities, and view billing activity audits using the Billing Activity Reporting Engine Console.

2.1 Defining Billing Activity Codes

Each billing activity is associated with a Billing Activity Code. The billing activity code uniquely identifies the billing activity performed.

This section explains how to create, view, modify, and delete activity codes.

2.1.1 Creating Billing Activity Codes

To create a billing activity code:

1. Log in to the application as the warehouse manager.
2. From the Application Console menu, choose ARE > Create Billing Activity Code. The Create Billing Activity Code screen displays.

Figure 2–1 Create Billing Activity Code

For information about the field values, see [Table 2–1](#).

3. In the Create Billing Activity Code screen, enter the appropriate details.
4. Click Create Billing Activity Code.

Table 2–1 Create Billing Activity Code

Fields	Description
Code	Enter the billing activity code.
Name	Enter the name of the billing activity.
Transaction Type	Select the type of transaction.
Group ID	Select the identifier of the billing activity group.
Unit Of Measure	Select the unit of measure of the billing activity.
Track Type	Select the track type of the billing activity.
Cost	Enter the cost for performing the billing activity.
Currency	Select the currency in which the cost is recorded.

2.1.2 Viewing Billing Activity Codes

The Billing Activity Reporting Engine Console enables you to view a billing activity code.

To view a billing activity code:

1. Log in to the application as the warehouse manager, supervisor, or enterprise user.
2. From the Application Console menu, choose ARE > Billing Activity Code Console. The Billing Activity Code By All Attributes search screen displays.

Figure 2–2 Billing Activity Code By All Attributes

The screenshot shows a search interface titled "Billing Activity Code By All Attributes". It features several input fields for filtering results:

- Code:** A dropdown menu and a text input field.
- Name:** A dropdown menu and a text input field.
- Transaction Type:** A dropdown menu.
- Group ID:** A dropdown menu.
- Unit Of Measure:** A dropdown menu.
- Track Type:** A dropdown menu.
- Max Records:** A text input field containing the value "30".

At the bottom right of the form, there are two buttons: "Search" and "Help".

For more information about the field values, see [Table 2–2](#)

3. In the Billing Activity Code By All Attributes search screen, enter the appropriate search criteria and click Search. The Billing Activity Code List screen displays.

Figure 2–3 Billing Activity Code List

Billing Activity Code List								Retrieved 30 record(s)	Help
<input type="checkbox"/>	Code	Name	Transaction Type	Group ID	Unit Of Measure	Track Type	Cost	Currency	
<input type="checkbox"/>	0040-0300	Order Piece Charge	Shipping	Handling Charges	PER_PIECE	System	0.00		
<input type="checkbox"/>	0040-0200	Order Line Charge	Shipping	Handling Charges	PER_SKU_LINE	System	0.00		
<input type="checkbox"/>	0040-0310	Order Piece/Reference Controlled	Shipping	Handling Charges	PER_CTRL_PIECE	System	0.00		
<input type="checkbox"/>	0010-0001	Monthly Management Fee	Ancillary	Miscellaneous Charges	ONCE_MONTHLY	Manual	0.00		
<input type="checkbox"/>	0010-0002	Monthly Management Fee/Minimum	Ancillary	Miscellaneous Charges	AS_NEEDED	Manual	0.00		
<input type="checkbox"/>	0010-0020	Management Fee/upcharge 24/6	Ancillary	Miscellaneous Charges	AS_NEEDED	Manual	0.00		
<input type="checkbox"/>	0010-0021	Management Fee/Up charge 24/7	Ancillary	Miscellaneous Charges	AS_NEEDED	Manual	0.00		
<input type="checkbox"/>	0020-0100	Storage	Ancillary	Storage Charges	SQ_FT	Manual	0.00		
<input type="checkbox"/>	0020-0101	Additional Storage	Ancillary	Storage Charges	SQ_FT	Manual	0.00		
<input type="checkbox"/>	0020-0200	Storage Pallet	Ancillary	Storage Charges	NUM_PALLET	Manual	0.00		
<input type="checkbox"/>	0020-0210	Storage-Secured Pallet	Ancillary	Storage Charges	NUM_SEC_PALLET	System	0.00		
<input type="checkbox"/>	0020-0300	Storage-Bin	Ancillary	Storage Charges	NUM_BIN	Manual	0.00		
<input type="checkbox"/>	0020-0310	Storage-Secured Bin	Ancillary	Storage Charges	NUM_SEC_BIN	Manual	0.00		
<input type="checkbox"/>	0020-0400	Storage Shelf	Ancillary	Storage Charges	NUM_SHELF	Manual	0.00		
<input type="checkbox"/>	0020-0410	Secured Shelf	Ancillary	Storage Charges	NUM_SHELF	Manual	0.00		
<input type="checkbox"/>	0020-0500	Storage Minimum	Ancillary	Storage Charges	CONTRACT_MIN	Manual	0.00		
<input type="checkbox"/>	0030-0100	Receiving Order Charge	Receiving	Handling Charges	PER_ORDER	System	0.00		
<input type="checkbox"/>	0030-0200	Receiving Line	Receiving	Handling Charges	PER_SKU_LINE	System	0.00		
<input type="checkbox"/>	0030-0310	Receiving Piece/Reference Controlled	Receiving	Handling Charges	PER_CTRL_PIECE	System	0.00		
<input type="checkbox"/>	0030-0330	Receiving Piece/Defective	Receiving	Handling Charges	PER_PIECE	System	0.00		
<input type="checkbox"/>	0030-0340	Receiving Piece/Reference Controlled-Def	Receiving	Handling Charges	PER_PIECE	System	0.00		
<input type="checkbox"/>	0030-0500	Receiving QC	Receiving	Handling Charges	PER_PIECE	System	0.00		
<input type="checkbox"/>	0030-0600	Manual Entry Of ASN	Receiving	Handling Charges	PER_ORDER	System	0.00		
<input type="checkbox"/>	0040-0100	Order Charge	Shipping	Handling Charges	PER_ORDER	System	0.00		
<input type="checkbox"/>	0040-0400	Will Call Order Charge	Shipping	Handling Charges	PER_WC_ORDER	System	0.00		
<input type="checkbox"/>	0040-0410	Will Call Piece	Shipping	Handling Charges	PER_WC_ORDER	System	0.00		
<input type="checkbox"/>	0050-0100	Return Order	Receiving	Handling Charges	PER_ORDER	System	0.00		
<input type="checkbox"/>	0050-0110	Return Piece	Receiving	Handling Charges	PER_PIECE	System	0.00		
<input type="checkbox"/>	0050-0200	Recovery Exchange Order	Receiving	Handling Charges	PER_ORDER	System	0.00		
<input type="checkbox"/>	0050-0210	Recovery Exchange Piece	Receiving	Handling Charges	PER_PALLET	System	0.00		

For information about the field values, see Table 2–3.

Table 2–2 Billing Activity Code By All Attributes Search

Field	Description
Code	Enter the activity code for which you want to generate the billing activity report.
Name	Enter the name of the billing activity code to search.

Table 2–2 Billing Activity Code By All Attributes Search

Field	Description
Transaction Type	Select the type of transaction.
Group ID	Select the billing activity group identifier.
Unit Of Measure	Select the unit of measure of the billing activity.
Track Type	Select the track type of the billing activity.
Max Records	Enter the maximum number of records to be listed as a result of your search.

Table 2–3 Billing Activity Code List

Action	Description
View Details	This action displays the Billing Activity Code Details screen, which enables you to view the detail of the billing activity code.
Delete	This action deletes the selected billing activity code.
Field	Description
Code	Indicates the billing activity code.
Name	Indicates the name of the billing activity.
Transaction Type	Indicates the type of transaction.
Group ID	Indicates the identifier of the billing activity group.
Unit Of Measure	Indicates the unit of measure of the billing activity.
Track Type	Indicates the track type of the billing activity.
Cost	Indicates the cost for performing the billing activity.
Currency	Indicates the currency in which the cost is recorded.

2.1.3 Modifying a Billing Activity Code

The Billing Activity Reporting Engine Console enables you to modify a billing activity code.

To modify a billing activity code:

1. Follow [Step 1](#) to [Step 3](#) in [Section 2.1.2, "Viewing Billing Activity Codes"](#).

- In the Billing Activity Code List screen, select the appropriate billing activity code you want to modify and click View Details. The Billing Activity Code Details screen displays.

Figure 2–4 Billing Activity Code Details

The screenshot shows a web-based form titled "Billing Activity Code Details". The form has a header bar with a "Billing Activity Code" label and a "Save" button. Below the header, there are several input fields arranged in a grid-like fashion. The fields and their values are: Code (0040-0300), Name (Order Piece Charge), Transaction Type (Shipping), Group ID (Handling Charges), Unit Of Measure (PER_PIECE), Track Type (System), Cost (0.00), and Currency (a dropdown menu).

For information about the field values, see [Table 2–4](#).

- In the Billing Activity Code Details screen, enter the appropriate details.
- Click Save.

Table 2–4 Billing Activity Code Details

Fields	Description
Code	Indicates the billing activity code.
Name	Enter the name of the billing activity.
Transaction Type	Select the type of transaction.
Group ID	Select the identifier of the billing activity group.
Unit Of Measure	Select the unit of measure of the billing activity.
Track Type	Select the track type of the billing activity.
Cost	Enter the cost for performing the billing activity.
Currency	Select the currency in which the cost is recorded.

2.1.4 Deleting a Billing Activity Code

The Billing Activity Reporting Engine Console enables you to delete a billing activity code.

To delete a billing activity code:

1. Follow [Step 1](#) to [Step 3](#) in [Section 2.1.2, "Viewing Billing Activity Codes"](#).
2. Select the billing activity code you want to remove and click Delete.

2.2 Defining Billing Activities

Billing activities are units of work performed at the warehouse or fulfillment center of the Third-Party Logistics provider, for a specific client.

This section explains how to record, view, modify, and cancel billing activities.

2.2.1 Manually Recording Billing Activities

The Billing Activity Reporting Engine Console enables you to create billing activities manually.

To manually create billing activities:

1. Log in to the application as the warehouse manager, supervisor, or enterprise user.
2. From the Application Console menu, choose ARE > Record Billing Activity. The Record Activity screen displays.

Figure 2–5 Record Activity

The screenshot shows the 'Record Activity' screen. At the top, there is a title bar with 'Record Activity' and a 'Help' button. Below this is a green header bar with 'Billing Activity' and a close button. The main content area contains several form fields: 'Node' with the value 'DC1', 'Enterprise' with a dropdown menu showing 'E1', 'Transaction Type' with a dropdown menu, 'Group ID' with a dropdown menu, and 'Transaction Reference' with a text input field.

For information about the field values see [Table 2–5](#).

3. In the Record Activity screen, enter the appropriate details.
4. Click Record Activity. The Billing Activity Details screen displays, which enables you to add multiple activities with activity codes.

Table 2–5 Record Activity

Fields	Description
Node	Indicates the node where the activity is performed.
Enterprise	Select the enterprise for which the activity is performed.
Transaction Type	Select the type of transaction.
Group ID	Select the identifier of the billing activity group.
Transaction Reference	Enter the transaction reference that corresponds to the billing activity. For example, for work order billing activities the transaction reference is work order number.

2.2.2 Viewing Billing Activities

The Billing Activity List screen enables you to view billing activities.

To view billing activities:

1. Log in to the application as the warehouse manager, supervisor, or enterprise user.
2. From the Application Console menu, choose ARE > Billing Activity Console. The Billing Activity By All Attributes search screen displays.

Figure 2–6 Billing Activity By All Attributes

The screenshot shows a search interface for 'Billing Activity' with the following fields and options:

- Node:** DC1
- Enterprise:** E1 (dropdown)
- Code:** (dropdown) and (text input)
- Transaction Type:** (dropdown)
- Transaction Reference:** (dropdown) and (text input)
- Group ID:** (dropdown)
- Start Activity Date:** (text input) To (text input) with calendar icons
- Last Activity Date:** (text input) To (text input) with calendar icons
- Activity Status:** (dropdown)
- Max Records:** 30 (text input)

Buttons for **Search** and **Help** are located at the bottom right.

For information about the field values, see [Table 2–6](#).

3. In the Billing Activity By All Attributes search screen, enter the appropriate search criteria and click Search. The Billing Activity List screen displays, which enables you to view the list of billing activities.

Figure 2–7 Billing Activity List

Billing Activity List								Retrieved 28 record(s)	Help
								View Details	
Activity Key	Enterprise	Node	Transaction Type	Start Activity Date	Last Activity Date	Transaction Reference	Activity Status		
<input type="checkbox"/> 200601252006296152	E1	DC1	Ancillary	01/25/2006	01/25/2006	123123	Uploaded		
<input type="checkbox"/> 200601252010426157	E1	DC1	Ancillary	01/25/2006	01/25/2006	234	Uploaded		
<input type="checkbox"/> 2006012715220517282	E1	DC1	Shipping	01/27/2006	01/27/2006	YNWDC1PARCEL26/1	Uploaded		
<input type="checkbox"/> 2006012716150618073	E1	DC1	Receiving	01/27/2006	01/27/2006	SS000054-1	Uploaded		
<input type="checkbox"/> 2006013019175628131	E1	DC1	Receiving	01/30/2006	01/30/2006	123	Uploaded		
<input type="checkbox"/> 2006013117285331364	E1	DC1	Receiving	01/31/2006	01/31/2006	123	Uploaded		
<input type="checkbox"/> 2006020210111235611	E1	DC1	Ancillary	02/02/2006	02/02/2006	123	Uploaded		
<input type="checkbox"/> 2006020218162236394	E1	DC1	Receiving	02/02/2006	02/02/2006	34	Uploaded		
<input type="checkbox"/> 200601251921165964	E1	DC1	Receiving	01/25/2006	01/25/2006	123123	Uploaded		
<input type="checkbox"/> 2006012719303020948	E1	DC1	Receiving	01/27/2006	01/27/2006	100000181-1	Uploaded		
<input type="checkbox"/> 2006012718492220217	E1	DC1	Receiving	01/27/2006	01/27/2006	SHIP1-1	Uploaded		
<input type="checkbox"/> 2006012720014021275	E1	DC1	Receiving	01/27/2006	01/27/2006	123	Uploaded		
<input type="checkbox"/> 2006012721353421629	E1	DC1	Shipping	01/27/2006	01/27/2006	123	Uploaded		
<input type="checkbox"/> 2006012721411221634	E1	DC1	Shipping	01/27/2006	01/27/2006	123	Uploaded		
<input type="checkbox"/> 2006013011503623253	E1	DC1	Ancillary	01/30/2006	01/30/2006	11	Uploaded		
<input type="checkbox"/> 2006013011584123405	E1	DC1	Ancillary	01/30/2006	01/30/2006	21	Uploaded		
<input type="checkbox"/> 2006013012043423485	E1	DC1	Shipping	01/30/2006	01/30/2006	YNWDC1PARCEL36/1	Uploaded		
<input type="checkbox"/> 2006013019375528244	E1	DC1	Receiving	01/30/2006	01/30/2006	100000200-1	Uploaded		
<input type="checkbox"/> 2006013110321129682	E1	DC1	Receiving	01/31/2006	01/31/2006	123	Uploaded		
<input type="checkbox"/> 200601251801445596	E1	DC1	Ancillary	01/25/2006	01/25/2006	123123	Uploaded		
<input type="checkbox"/> 2006012710482614566	E1	DC1	Receiving	01/27/2006	01/27/2006	123	Uploaded		
<input type="checkbox"/> 2006012711352915388	E1	DC1	Receiving	01/27/2006	01/27/2006		Uploaded		

For information about the field values, see [Table 2–7](#).

Table 2–6 Billing Activity By All Attributes Search

Field	Description
Node	Indicates the node where the activity is performed.
Enterprise	Select the enterprise for which you want to generate the billing activity report.
Code	Enter the activity code for which you want to generate the billing activity report.
Transaction Type	Select the type of transaction.
Transaction Reference	Enter the transaction reference of the billing activity detail report.
Group ID	Select the billing activity group identifier.
Start Activity Date	Enter the start date of the specified billing activity audit.

Table 2–6 Billing Activity By All Attributes Search

Field	Description
Last Activity Date	Enter the last date of the specified billing activity audit.
Activity Status	Select the status of the specified billing activity.
Max Records	Enter the maximum number of records to be listed as a result of your search.

Table 2–7 Billing Activity List

Action	Description
View Details	This action button displays the Billing Activity List screen, which enables you to view the details of the selected code.
Field	Description
Activity Key	Indicates the unique key of the billing activity. Click this to view the Billing Activity Details , Billing Activity screen, which enables you to modify the activity.
Enterprise	Indicates the enterprise for which the activity is performed.
Node	Indicates the node where the activity is performed.
Transaction Type	Indicates the type of transaction.
Start Activity Date	Indicates the date when the specified billing activity started.
Last Activity Date	Indicates the date when the specified billing activity was last performed.
Transaction Reference	Indicates the transaction reference that corresponds to the billing activity. For example, for work order billing activities the transaction reference is work order number.
Activity Status	Indicates the status of the specified billing activity.

2.2.3 Modifying Billing Activities

The Billing Activity Reporting Engine Console enables you to modify billing activities.

To modify billing activities:

1. Follow [Step 1](#) to [Step 3](#) in [Section 2.2.2, "Viewing Billing Activities"](#).
2. In the Billing Activity Code List screen, select the appropriate billing activity code you want to modify and click View Details. The Billing Activity Details screen displays.

Figure 2–8 Billing Activity Details

Billing Activity Details											Save	Help
Billing Activity												
Node DC1			Enterprise E1			Activity Status Modified						
Transaction Type Ancillary			Group ID Handling Charges			Transaction Reference 123						
Cost 3.00			Currency EUR									
Billing Activity Detail											Cancel	
<input type="checkbox"/> Code	Service Quantity	UOM	Cost	Currency	Activity Status	Activity Date	Transaction Reference	Ship Via	Carrier Code	Reference1		
<input type="checkbox"/> 0040-0300 / Order Piece Charge	3.00	PER_PIECE	3.00	EUR	Modified	02/23/2006						
1												

For information about the field values see [Table 2–8](#) and [Table 2–9](#).

3. In the Billing Activity Details screen, enter the appropriate details.
4. Click Save.

Table 2–8 Billing Activity Details, Billing Activity

View Icon	Description
	Activity Audits - This icon displays the Billing Activity Detail Audit List screen, which lets you view the billing activity audit list.
Field	Description
Node	Indicates the node where the activity is performed.
Enterprise	Indicates the enterprise for which the activity is performed.
Activity Status	Indicates the status of the specified billing activity.

Table 2–8 Billing Activity Details, Billing Activity

Transaction Type	Indicates the type of transaction.
Group ID	Indicates the identifier of the group.
Transaction Reference	Indicates the transaction reference that corresponds to the billing activity. For example, for work order billing activities the transaction reference is work order number.
Cost	Indicates the cost for performing the billing activity.
Currency	Indicates the currency in which the cost is recorded.

Table 2–9 Billing Activity Details, Billing Activity Detail

Action	Description
Cancel	This action button cancels the selected billing activity.
Field	Description
Code	Indicates the billing activity code.
Service Quantity	Indicates the quantity for the specified billing activity. You can modify the Service Quantity, if needed.
UOM	Indicates the unit of measure of the billing activity.
Cost	Indicates the cost for performing the billing activity.
Currency	Indicates the currency in which the cost is recorded.
Activity Status	Indicates the status of the specified billing activity.
Activity Date	Indicates the date of the specified billing activity. You can modify the Activity Date, if needed.
Transaction Reference	Indicates the transaction reference that corresponds to the billing activity. You can modify the transaction Reference, if needed.
Ship Via	Indicates the mode of transportation for the specified billing activity. You can modify the Ship Via, if needed.

Table 2–9 Billing Activity Details, Billing Activity Detail

Carrier Code	Indicates the carrier code of the specified billing activity. You can modify the Carrier Code, if needed.
Reference1	Indicates the reference number of the specified billing activity. You can modify the Reference1, if needed.

Note: When a new billing activity detail record is added, the Billing Activity Reporting Engine automatically computes the cost for performing the service, based on the service quantity.

However, if the service quantity is modified later, the corresponding cost is not re-computed. In this case, you may change the cost manually.

2.3 Activity Status Transitions

The activity status of the Billing Activity Reporting Engine exhibits different modes of transition.

When the Billing Activity Reporting Engine activity creates an activity, the status of the Billing Activity Reporting Engine is shown as 'Created'. When you manually modify any attribute in the Billing Activity Reporting Engine activity, then the status changes to 'Modified'. If there is any error during the upload, the status of the Billing Activity Reporting Engine activity is changed to 'Error'. You can manually cancel a record from the Billing Activity Reporting Engine activity, then the status of the activity is changed to 'cancelled'. When an activity is uploaded to the host system, the status of the Billing Activity Reporting Engine activity is changed to 'Uploaded'.

2.3.1 Cancelling Billing Activities

The Billing Activity Reporting Engine Console enables you to cancel a billing activity.

To cancel a billing activity code:

1. Follow [Step 1](#) to [Step 3](#) in [Section 2.2.2, "Viewing Billing Activities"](#)
2. In the Billing Activity Code List screen, select the appropriate billing activity code you want to cancel and click View Details. The Billing Activity Details screen displays.
3. In the Billing Activity Details screen, select the billing activity code you want to cancel and click Cancel.

2.4 Viewing Billing Activity Detail Audits

The Billing Activity Audit screen enables you to view the audit of the billing activities.

To view the audit billing activities:

1. Log in to the application as the warehouse manager, supervisor, or enterprise user.
2. From the Application Console menu, choose ARE > Billing Activity Console. The Billing Activity By All Attributes search screen displays.
3. From the Billing Activity entities menu, select Billing Activity Detail Audit. The Billing Activity Detail Audit By All Attributes search screen displays.

Figure 2–9 Billing Activity Detail Audit By All Attributes

The screenshot shows a search interface for 'Billing Activity Detail Audit By All Attributes'. The form contains the following fields and controls:

- Activity Header Key:** A text input field.
- Code:** A dropdown menu followed by a text input field.
- Transaction Reference:** A text input field.
- Ship Via:** A text input field.
- Audit Creator:** A text input field.
- Audit Create Date:** Two date input fields with a 'To' label and calendar icons between them.
- Max Records:** A text input field containing the value '30'.
- Buttons:** 'Search' and 'Help' buttons located at the bottom right of the form.

For information about the field values, see [Table 2–10](#).

4. In the Billing Activity Detail Audit By All Attributes search screen, enter the appropriate search criteria and click Search. The Billing Activity Detail Audit List screen displays.

Figure 2–10 Billing Activity Detail Audit List

Billing Activity Detail Audit List														Retrieved 30 record(s)		Help
Activity Header Key	Code	Audit Creator	Audit Create Program	Audit Create Date	Reason Code	Reason Text	Transaction Reference		Service Quantity		Activity Date		Carrier Code		Ship Via	
							Old Value	New Value	Old Value	New Value	Old Value	New Value	Old Value	New Value	Old Value	New Value
200601251801445596	Work Order Units Charge	dc1mgr	Console	01/25/2006					0.00	0.00	01/27/2006	01/27/2006				
200601251801445596	Work Order Charge	dc1mgr	Console	01/25/2006					0.00	0.00	01/27/2006	01/27/2006				
200601252006296152	Work Order Units Charge	dc1mgr	Console	01/25/2006					0.00	0.00	01/27/2006	01/27/2006				
200601252010426157	Order Piece Charge	dc1mgr	Console	01/25/2006					0.00	0.00	01/27/2006	01/27/2006				
200601252010426157	Work Order Charge	dc1mgr	Console	01/25/2006					0.00	0.00	01/27/2006	01/27/2006				
2006012714194416688	Order Piece Charge	dc1mgr	Console	01/27/2006			50000001-1		1.00	0.00	01/27/2006	01/27/2006				
2006012714194416688	Cycle Counts	dc1mgr	Console	01/27/2006			50000001-1		1.00	0.00	01/27/2006	01/27/2006				
2006012714194416688	Work Order Charge	dc1mgr	Console	01/27/2006			NOR-00001		1.00	0.00	01/27/2006	01/27/2006				
200601271419441668	Work Order Units Charge	dc1mgr	Console	01/27/2006			NOR-00001		100.00	0.00	01/27/2006	01/27/2006				
2006012714194416688	Cycle Counts	dc1mgr	Console	01/27/2006					100.00	0.00	01/27/2006	01/27/2006				
2006012714194416688	Label	dc1mgr	Console	01/27/2006					13.00	0.00	01/27/2006	01/27/2006				
2006012714194416688	Label	dc1mgr	Console	01/27/2006			50000001-1		1.00	0.00	01/27/2006	01/27/2006				
2006012714194416688	Cycle Counts	dc1mgr	Console	01/27/2006			50000001-1		1.00	0.00	01/27/2006	01/27/2006				
2006012714194416688	Order Piece Charge	dc1mgr	Console	01/27/2006			NOR-00001		1.00	0.00	01/27/2006	01/27/2006				
2006012714194416688		dc1mgr	Console	01/27/2006			NOR-00001		100.00	0.00	01/27/2006	01/27/2006				
2006012714194416688		dc1mgr	Console	01/27/2006					100.00	0.00	01/27/2006	01/27/2006				
2006012714194416688	Work Order Charge	dc1mgr	Console	01/27/2006					13.00	0.00	01/27/2006	01/27/2006				
2006012714194416688	Order Piece Charge	dc1mgr	Console	01/27/2006					0.00	0.00	01/27/2006	01/27/2006				
2006012714194416688		dc1mgr	Console	01/27/2006			50000001-1		1.00	0.00	01/27/2006	01/27/2006				
2006012714194416688		dc1mgr	Console	01/27/2006			50000001-1		1.00	0.00	01/27/2006	01/27/2006				
2006012714194416688	Cycle Counts	dc1mgr	Console	01/27/2006			NOR-00001		1.00	0.00	01/27/2006	01/27/2006				
2006012714194416688	Label	dc1mgr	Console	01/27/2006			NOR-00001		100.00	0.00	01/27/2006	01/27/2006				
2006012714194416688	Work Order Charge	dc1mgr	Console	01/27/2006					100.00	0.00	01/27/2006	01/27/2006				
2006012714194416688		dc1mgr	Console	01/27/2006					100.00	1.00	01/27/2006	01/27/2006				
200601251921165964		dc1mgr	Console	01/25/2006					0.00	0.00	01/27/2006	01/27/2006				
200601251921165964	Order Piece Charge	dc1mgr	Console	01/25/2006					0.00	0.00	01/27/2006	01/27/2006				
2006012720014021275		dc1mgr	Console	01/27/2006					123.00	1.00	01/27/2006	01/27/2006				
2006012720014021275		dc1mgr	Console	01/27/2006					234.00	2.00	01/27/2006	01/27/2006				
2006012720014021275	Work Order Charge	dc1mgr	Console	01/27/2006					2.00	3.00	01/27/2006	01/27/2006				
2006012721353421629	Order Piece Charge	dc1mgr	Console	01/27/2006					12.00	2.00	01/27/2006	01/27/2006				

For information about the field values, see [Table 2–11](#).

Table 2–10 Billing Activity Detail Audit By All Attributes Search

Field	Description
Activity Header Key	Enter the activity key for which you want to generate the billing activity report.
Code	Enter the activity code for which you want to generate the billing activity report.
Transaction Reference	Enter the transaction reference that corresponds to the billing activity.
Ship Via	Enter the mode of shipment.
Audit Creator	Enter the name of the person who created the billing activity audit.
Audit Create Date	Enter the date when the audit was created.
Max Records	Enter the maximum number of records to be listed as a result of your search.

Table 2–11 Billing Activity Detail Audit List

Fields	Description
Activity Header Key	Indicates the unique key of the billing activity report.
Code	Indicates the activity code of the billing activity detail report.
Audit Creator	Indicates the person who created the billing activity audit list.
Audit Create Program	Indicates the program that created the audit.
Audit Create Date	Indicates the date when the audit was created.
Reason Code	Indicates the reason code associated with the audit.
Reason Text	Describes the reason associated with the audit.

Table 2–11 Billing Activity Detail Audit List

Fields	Description				
Transaction Reference	<p data-bbox="658 296 1319 348">Indicates the transaction reference that corresponds to the billing activity audit.</p> <table border="1" data-bbox="682 374 1269 574"> <tr> <td data-bbox="689 383 953 470">Old Value</td> <td data-bbox="953 383 1262 470">Indicates the old value of the transaction reference.</td> </tr> <tr> <td data-bbox="689 470 953 565">New Value</td> <td data-bbox="953 470 1262 565">Indicates the new value of the transaction reference.</td> </tr> </table>	Old Value	Indicates the old value of the transaction reference.	New Value	Indicates the new value of the transaction reference.
Old Value	Indicates the old value of the transaction reference.				
New Value	Indicates the new value of the transaction reference.				
Service Quantity	<p data-bbox="658 628 1305 654">Indicates the quantity for the specified billing activity.</p> <table border="1" data-bbox="682 704 1289 852"> <tr> <td data-bbox="689 713 953 774">Old Value</td> <td data-bbox="953 713 1282 774">Indicates the old value of the service quantity.</td> </tr> <tr> <td data-bbox="689 774 953 843">New Value</td> <td data-bbox="953 774 1282 843">Indicates the new value of the service quantity.</td> </tr> </table>	Old Value	Indicates the old value of the service quantity.	New Value	Indicates the new value of the service quantity.
Old Value	Indicates the old value of the service quantity.				
New Value	Indicates the new value of the service quantity.				
Activity Date	<p data-bbox="658 888 1319 914">Indicates the date of the specified billing activity audit.</p> <table border="1" data-bbox="689 965 1296 1112"> <tr> <td data-bbox="696 973 953 1034">Old Value</td> <td data-bbox="953 973 1289 1034">Indicates the old value of the activity date.</td> </tr> <tr> <td data-bbox="696 1034 953 1104">New Value</td> <td data-bbox="953 1034 1289 1104">Indicates the new value of the activity date.</td> </tr> </table>	Old Value	Indicates the old value of the activity date.	New Value	Indicates the new value of the activity date.
Old Value	Indicates the old value of the activity date.				
New Value	Indicates the new value of the activity date.				

Table 2–11 Billing Activity Detail Audit List

Fields	Description				
Carrier Code	<p data-bbox="611 300 1265 331">Indicates the unique carrier code of the billing activity.</p> <table border="1" data-bbox="632 383 1232 527"> <tr> <td data-bbox="632 383 918 453">Old Value</td> <td data-bbox="918 383 1232 453">Indicates the old value of the carrier code.</td> </tr> <tr> <td data-bbox="632 453 918 527">New Value</td> <td data-bbox="918 453 1232 527">Indicates the new value of the carrier code.</td> </tr> </table>	Old Value	Indicates the old value of the carrier code.	New Value	Indicates the new value of the carrier code.
Old Value	Indicates the old value of the carrier code.				
New Value	Indicates the new value of the carrier code.				
Ship Via	<p data-bbox="611 560 1208 614">Indicates the mode of transportation used for the specified billing activity.</p> <table border="1" data-bbox="632 661 1232 857"> <tr> <td data-bbox="632 661 918 760">Old Value</td> <td data-bbox="918 661 1232 760">Indicates the old value of the mode of transportation.</td> </tr> <tr> <td data-bbox="632 760 918 857">New Value</td> <td data-bbox="918 760 1232 857">Indicates the new value of the mode of transportation.</td> </tr> </table>	Old Value	Indicates the old value of the mode of transportation.	New Value	Indicates the new value of the mode of transportation.
Old Value	Indicates the old value of the mode of transportation.				
New Value	Indicates the new value of the mode of transportation.				

Inbound Billing Activities

The Sterling Warehouse Management System enables you to control the Inbound process with information that is available in the warehouse. It also enables you to record the billing activities performed during the Inbound process.

This chapter lists the billing activities that are recorded for the Inbound process, along with their billing activity codes. This chapter also describes the time at which the billing activity is recorded, and the transactions, agents, and services used to record the billing activities.

For the Inbound process, the billing activities are recorded when the shipments are received into the warehouse.

3.1 Configuring the Billing Activity Reporting Engine

This section explains the Billing Activity Reporting Engine configuration for the Inbound process.

3.1.1 Pipeline

If you have enabled the Billing Activity Reporting Engine in your application, the receipt status changes to `Waiting for ARE Process` when the receipt completes. When the status changes to `Waiting for ARE Process`, a record is inserted into the Task Queue and this record is picked up by the `Process Receipt ARE` transaction. This transaction computes the billing activities for the receipt and inserts the billing activities into the `YNW_ARE_Activity_Header` and `YNW_ARE_Activity_Detail` tables. It then changes the receipt status to `ARE Processing Complete`.

Figure 3–1 illustrates the Receiving Pipeline.

Figure 3–1 Receiving Pipeline

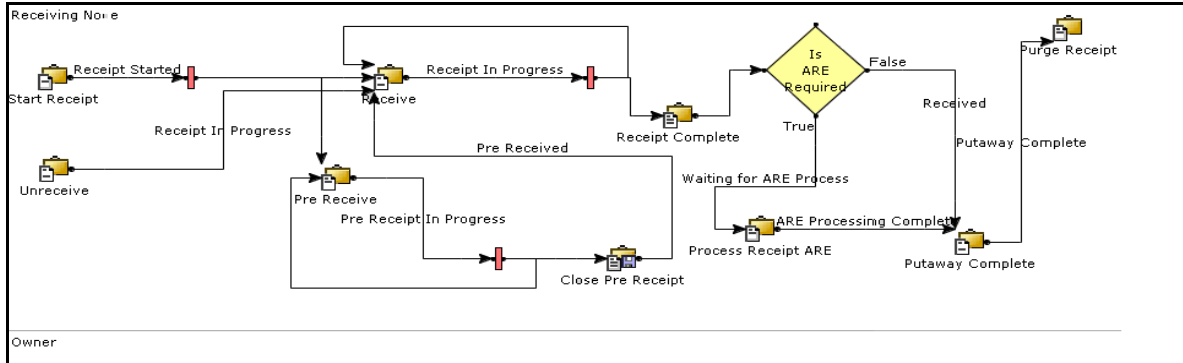

3.1.2 Transactions

When the receipt is completed, the receipt enters the Waiting for ARE Process status. The Process Receipt ARE transaction then picks up these receipts, records the billing activities, and moves them to the ARE Processing Complete status.

3.1.2.1 Pickup Statuses

The Pickup Status for the Process Receipt ARE transaction is Waiting for ARE Process.

The Process Receipt ARE transaction picks up receipts that are in the Waiting for ARE Process status.

3.1.2.2 Drop Statuses

The Drop status for the Process Receipt ARE transaction is ARE Processing Complete.

The Process Receipt ARE transaction picks up receipts that are in the Waiting for ARE Process status, records the billing activities, and moves the receipts to the ARE Processing Complete status.

3.1.3 Agents

The `PROCESS_RECEIPT_ARE` agent invokes the `YNWAREReceipt` service. This service records the billing activities for the Inbound process.

3.1.4 Services

The `YNWAREReceipt` service records the billing activities performed in the Inbound Process.

3.1.5 Billing Activity Codes for the Inbound Process

Every billing activity is associated with a billing activity code. Billing activities can be recorded either manually or automatically by the system.

This section explains the billing activity codes for the Inbound Process.

3.1.5.1 System-Recorded

Billing activities can be recorded automatically by the system. These activities are recorded upon completion of the billing activity.

For the activities recorded, the receipt number is inserted as the value of the `ACTIVITY_GROUP_KEY_DATA` field in the `YNW_ARE_ACTIVITY_HEADER` table. The `ACTIVITY_GROUP_KEY_DATA` field corresponds to the Transaction Reference field in the application console.

Figure 3–2 displays the system-recorded billing activity codes for the Inbound Process.

Figure 3–2 System-Recorded Billing Activity Codes For the Inbound Process

<input type="checkbox"/>	Code	Name	Transaction Type	Group ID	Unit Of Measure	Decimal Qty Allowed	Track Type	Cost	Currency
<input type="checkbox"/>	0030-0100	Receiving Order Charge	Receiving	Handling Charges	PER_ORDER	N	System	0.00	
<input type="checkbox"/>	0030-0200	Receiving Line	Receiving	Handling Charges	PER_SKU_LINE	N	System	0.00	
<input type="checkbox"/>	0030-0310	Receiving Piece/Reference Controlled	Receiving	Handling Charges	PER_CTRL_PIECE	N	System	0.00	
<input type="checkbox"/>	0030-0330	Receiving Piece/Defective	Receiving	Handling Charges	PER_PIECE	N	System	0.00	
<input type="checkbox"/>	0030-0340	Receiving Piece/Reference Controlled-Def	Receiving	Handling Charges	PER_PIECE	N	System	0.00	
<input type="checkbox"/>	0030-0600	Manual Entry Of ASN	Receiving	Handling Charges	PER_ORDER	N	System	0.00	
<input type="checkbox"/>	0030-0300	Receiving Piece	Receiving	Handling Charges	PER_PIECE	N	System	0.00	

Table 3–1 System-Recorded Billing Activities For the Inbound Process

Activity Name	Description	Transaction Reference
Receiving Order Charge (0030-0100)	This activity is recorded for every order received in the warehouse. For every order received, the Service Quantity is one.	Transaction Reference is Receipt No.
Receiving Line (0030-0200)	This activity is recorded for every received item in the warehouse. This includes serial-tracked items. For every received item, the Service Quantity is one.	Transaction Reference is Receipt No.
Receiving Piece/Reference Controlled (0030-0310)	For every serialized item with a disposition code as 'GOOD', a record is inserted into the YNW_ARE_ACTIVITY_DETAIL table. This includes serial-tracked items. For every serialized item, the Service Quantity is one.	Transaction Reference is Serial No.
Receiving Piece/Defective (0030-0330)	This activity is recorded whenever any non-serialized item with disposition code as 'DAMAGED' is received in the warehouse. For every non-serialized item received, the service quantity is equal to the number of units of defective item received.	Transaction Reference is Receipt No.
Receiving Piece/Reference Controlled-Def (0030-0340)	For every serialized defective item with a disposition code as 'DAMAGED', a record is inserted into the ARE Activity Detail. For every serialized defective item received, the Service Quantity is one.	Transaction Reference is Serial No.

Table 3–1 System-Recorded Billing Activities For the Inbound Process

Activity Name	Description	Transaction Reference
Manual Entry of ASN (0030-0600)	This activity is recorded whenever an ASN is entered manually in the warehouse. For every ASN recorded, the service quantity is one.	Transaction Reference is Receipt No.
Receiving Piece (0030-0300)	This activity is recorded whenever any non-serialized item is received in the warehouse. For every non-serialized item received, the service quantity is equal to the number of units of item received.	Transaction Reference is Receipt No.

3.1.5.2 User-Recorded

Sterling Warehouse Management System also enables you to create additional billing activity codes and associate them with billing activities that are recorded as a part of the Inbound process. For more information about how to create billing activity codes manually, see [Section 2.1.1, "Creating Billing Activity Codes"](#).

Sterling Warehouse Management System also enables you to record additional billing activities manually. For more information about how to manually record billing activities, see [Section 2.2.1, "Manually Recording Billing Activities"](#).

[Figure 3–3](#) displays an example of some manually recorded billing activity codes for the Inbound Process.

Figure 3–3 User-Recorded Billing Activity Codes For the Inbound Process

<input type="checkbox"/>	Code	Name	Transaction Type	Group ID	Unit Of Measure	Decimal Qty Allowed	Track Type	Cost	Currency
<input type="checkbox"/>	0030-0500	Receiving QC	Receiving	Handling Charges	PER_PIECE	N	Manual	0.00	
<input type="checkbox"/>	0050-0100	Return Order	Receiving	Handling Charges	PER_ORDER	N	Manual	0.00	
<input type="checkbox"/>	0050-0110	Return Piece	Receiving	Handling Charges	PER_PIECE	N	Manual	0.00	
<input type="checkbox"/>	0050-0200	Recovery Exchange Order	Receiving	Handling Charges	PER_ORDER	N	Manual	0.00	
<input type="checkbox"/>	0050-0210	Recovery Exchange Piece	Receiving	Handling Charges	PER_PALLET	N	Manual	0.00	
<input type="checkbox"/>	0050-0300	Advanced Exchange Order	Receiving	Handling Charges	PER_ORDER	N	Manual	0.00	
<input type="checkbox"/>	0050-0310	Advanced Exchange Piece	Receiving	Handling Charges	PER_PIECE	N	Manual	0.00	
<input type="checkbox"/>	0110-0010	Movements in WorkHouse	Receiving	Handling Charges	PER_UNIT	N	Manual	0.00	

Table 3–2 User-Recorded Billing Activity Codes For the Inbound Process

Activity Name	Description
Receiving QC	This activity is recorded manually whenever any item requires quality checking in the warehouse.
Return Order	This activity is recorded manually whenever any order is returned to the warehouse.
Return Piece	This activity is recorded manually whenever any item is returned to the warehouse.
Recovery Exchange Order	This activity is recorded manually for the exchange order.
Recovery Exchange Piece	This activity is recorded manually for the exchange item.
Advanced Exchange Order	This activity is recorded manually for the advanced exchange order.
Advanced Exchange Piece	This activity is recorded manually for the advanced exchange item.
Movements in WorkHouse	This activity is recorded manually whenever any shipment is moved from one location to other in the warehouse.

Outbound Billing Activities

The Sterling Warehouse Management System enables you to control the Outbound process with the information that is available in the warehouse. It also enables you to record the activities performed during the Outbound process.

This chapter lists the billing activities that are recorded for the Outbound process, along with their billing activity codes. This chapter also describes the time at which the billing activity is recorded, and the transactions, agents, and services used to record the billing activities.

For the Outbound process, the billing activities are recorded when the shipments are shipped from the warehouse.

4.1 Configuring the Billing Activity Reporting Engine

This section explains the Billing Activity Reporting Engine configuration for the Outbound Process.

4.1.1 Pipeline

If you have enabled the Billing Activity Reporting Engine in your application, the shipment status changes to `Waiting for ARE Process` when the shipment completes. When the status changes to `Waiting for ARE Process`, a record is inserted into the Task Queue and this record is picked up by the `Process Shipment ARE` transaction. This transaction computes the billing activities for the shipment and inserts the activities into the `YNW_ARE_Activity_Header` and `YNW_ARE_Activity_Detail` tables. It then changes the shipment status to `ARE Processing Complete`.

Figure 4–1 illustrates the Outbound Shipment Pipeline.

Figure 4–1 Outbound Shipment Pipeline

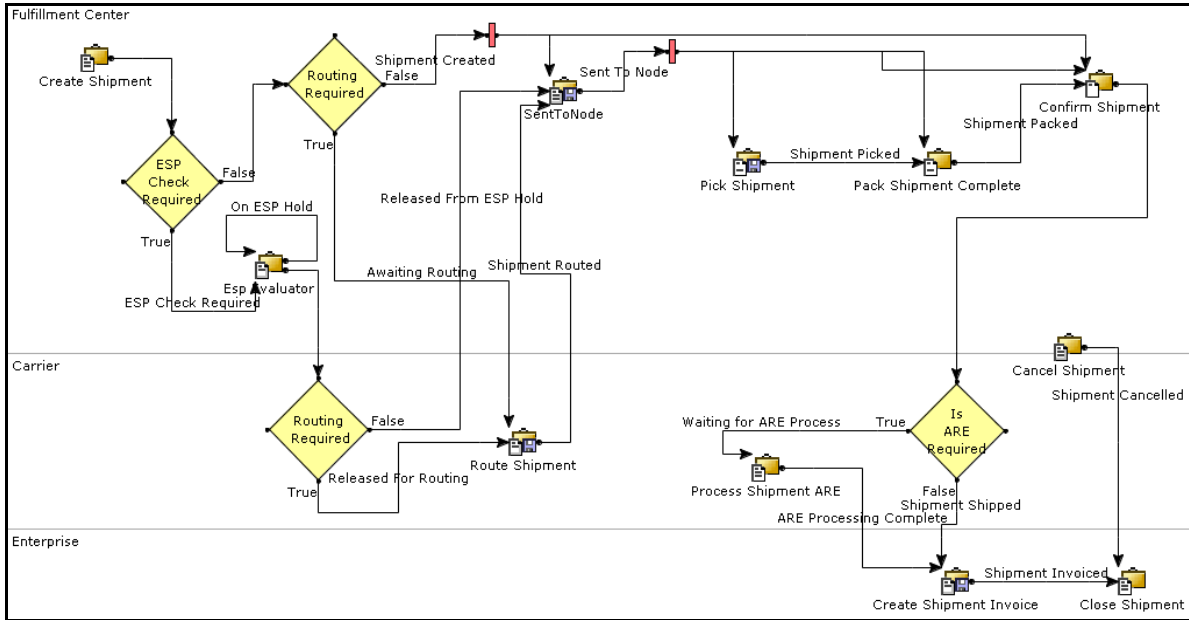

4.1.2 Transactions

When the shipment is completed, the shipment enters the Waiting for ARE Process status. The Process Shipment ARE transaction then picks up these shipments, records the billing activities, and moves them to the ARE Processing Complete status.

4.1.2.1 Pickup Statuses

The Pickup Status for the Process Shipment ARE transaction is Waiting for ARE Process.

The Process Shipment ARE transaction picks up shipments that are in the Waiting for ARE Process status.

4.1.2.2 Drop Statuses

The Drop status for the Process Shipment ARE transaction is ARE Processing Complete.

The Process Shipment ARE transaction picks up shipments that are in the Waiting for ARE Process status, records the billing activities, and moves the shipments to the ARE Processing Complete status.

4.1.3 Agents

The PROCESS_SHIPMENT_ARE agent invokes the YNWAREShipment service. This service records the billing activities for the Outbound process.

4.1.4 Services

The YNWAREShipment service records the billing activities performed in the Outbound Process.

4.1.5 Billing Activity Codes for the Outbound Process

Every billing activity is associated with a billing activity code. Billing activities can be recorded either manually or automatically by the system.

This section explains the billing activity codes for the Outbound Process.

4.1.5.1 System-Recorded

Billing activities can be recorded automatically by the system. These activities are recorded upon completion of the billing activity.

For the activities recorded, the order number or release number is inserted as the value of the ACTIVITY_GROUP_KEY_DATA field in the YNW_ARE_ACTIVITY_HEADER table. The ACTIVITY_GROUP_KEY_DATA field corresponds to the Transaction Reference field in the application console.

Figure 4–2 displays the system-recorded billing activity codes for the Outbound Process.

Figure 4–2 System-Recorded Billing Activity Codes for the Outbound Process

<input type="checkbox"/>	Code	Name	Transaction Type	Group ID	Unit Of Measure	Decimal Qty Allowed	Track Type	Cost	Currency
<input type="checkbox"/>	0040-0300	Order Piece Charge	Shipping	Handling Charges	PER_PIECE	Y	System	0.00	USD
<input type="checkbox"/>	0040-0200	Order Line Charge	Shipping	Handling Charges	PER_SKU_LINE	Y	System	0.00	
<input type="checkbox"/>	0040-0310	Order Piece/Reference Controlled	Shipping	Handling Charges	PER_CTRL_PIECE	Y	System	0.00	
<input type="checkbox"/>	0040-0100	Order Charge	Shipping	Handling Charges	PER_ORDER	N	System	0.00	
<input type="checkbox"/>	0060-0200	Truck Order Charge	Shipping	Handling Charges	PER_ORDER	N	System	0.00	

Table 4–1 System-Recorded Billing Activity Codes For The Outbound Process

Activity Name	Description	Transaction Reference
Order Piece Charge (0040-0300)	This activity is recorded for each non-serialized item shipped from the warehouse. This includes serial-tracked items. For an order shipped, the Service Quantity is equal the number of units of item shipped.	Transaction Reference is Item Id. Reference Field 1, 2 and 3 is Order Name.
Order Line Charge (0040-0200)	This activity is recorded at the shipment line level for all orders shipped from the warehouse. For all orders shipped, the Service Quantity is equal to one.	Transaction Reference is Item Id. Reference Field 1, 2 and 3 is Order Name.
Order Piece/Reference Controlled (0040-0310)	This activity is recorded when a serialized item is shipped from the warehouse. This includes serial-tracked items. For all items shipped, a record is inserted into the YNW_ARE_Activity_Header and YNW_ARE_Activity_Detail tables, with Service Quantity equal to one.	Transaction Reference is Serial No. Reference Field 1, 2 and 3 is Order Name.

Table 4–1 System-Recorded Billing Activity Codes For The Outbound Process

Activity Name	Description	Transaction Reference
Order Charge (0040-0100)	This activity is recorded for every order shipped from the warehouse. For every order shipped, the Service Quantity is equal to one.	Transaction Reference is Shipment No. Reference Field 1, 2 and 3 is Order Name. Reference Quantity 1 is Total Container Weight, Reference Quantity 2 is No of Containers, Reference Quantity 3 is Freight Charge.
Truck Order Charge (0060-0200)	This activity is recorded whenever the shipment is shipped by LTL or TL shipping mode from the warehouse.	Transaction Reference is Shipment No. Reference Field 1, 2 and 3 is Order Name, Reference Quantity 1 is Total Container Weight, Reference Quantity 2 is No of Containers, Reference Quantity 3 is Freight Charge.

4.1.5.2 User-Recorded

Sterling Warehouse Management System also enables you to create additional billing activity codes and associate them with billing activities that are recorded as a part of the Outbound process. For more information about how to create billing activity codes manually, see [Section 2.1.1, "Creating Billing Activity Codes"](#).

Sterling Warehouse Management System also enables you to record additional billing activities manually. For more information about how to

record billing activities manually, see [Section 2.2.1](#), "Manually Recording Billing Activities".

[Figure 4–3](#) displays an example of some manually recorded billing activity codes for the Outbound Process.

Figure 4–3 User-Recorded Billing Activity Codes for the Outbound Process

<input type="checkbox"/>	Code	Name	Transaction Type	Group ID	Unit Of Measure	Decimal Qty Allowed	Track Type	Cost	Currency
<input type="checkbox"/>	0040-0400	Will Call Order Charge	Shipping	Handling Charges	PER_WC_ORDER	N	Manual	0.00	
<input type="checkbox"/>	0040-0410	Will Call Piece	Shipping	Handling Charges	PER_WC_ORDER	N	Manual	0.00	
<input type="checkbox"/>	0060-0100	Next Flight Out(NFO)	Shipping	Handling Charges	PER_OCCURRENCE	N	Manual	0.00	
<input type="checkbox"/>	0060-0110	NFO-Hold At Airport	Shipping	Handling Charges	PER_ORDER	N	Manual	0.00	
<input type="checkbox"/>	0060-0300	Other Air Carrier	Shipping	Handling Charges	PER_ORDER	N	Manual	0.00	

Table 4–2 User-Recorded Billing Activity Codes for the Outbound Process

Activity Name	Description
Will Call Order Charge	This activity is recorded manually for every call order shipped.
Will Call Piece	This activity is recorded manually for every call item shipped.
Next Flight Out (NFO)	This activity is recorded manually for the shipment shipped by Next Flight Out.
NFO-Hold At Airport	This activity is recorded manually for the shipment held at airport.
Other Air Carrier	This activity is recorded manually for the shipment shipped by other modes of air carrier.

5

Count Billing Activities

The Sterling Warehouse Management System enables you to control the Count process with the information that is available in the warehouse. It also enables you to record the billing activities performed during the count process, which can later be used to bill the enterprise.

This chapter lists the billing activities that are recorded for the Count process, along with their billing activity codes. This chapter also describes the time at which the billing activity is recorded, and the transactions, agents, and services used to record the billing activities.

For the Count process, the billing activities are recorded upon completion of the count request.

To complete a Count process, the user must perform the first level of count tasks. The Count process is completed when:

1. No variance is found.
2. Variance is found and
 - Another user performs the variance tasks
 - Variances, are accepted
 - The count process is completed and activities are recorded for the billing activity

5.1 Configuring the Billing Activity Reporting Engine

This section explains the Billing Activity Reporting Engine configuration for the Count Process.

5.2 Pipeline

If you have enabled the Billing Activity Reporting Engine in your application, the count status changes to Count Request Completed - Waiting for ARE when the count completes. When the status changes to Count Request Completed - Waiting for ARE, a record gets inserted into the Task Queue and this record is picked up by the Process Count ARE transaction. This transaction computes the billing activities for the count and inserts the billing activities into the YNW_ARE_Activity_Header and YNW_ARE_Activity_Detail tables. It then changes the count status to ARE Processing Complete.

Figure 5–1 illustrates the Cycle Count Pipeline.

Figure 5–1 Cycle Count Pipeline

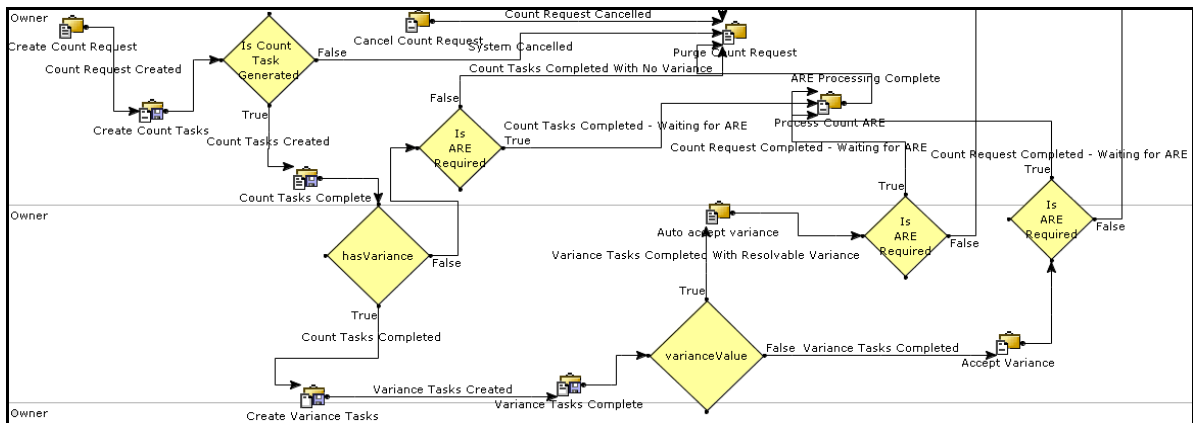

5.2.1 Transactions

When the count is completed, the count enters the Count Request Completed - Waiting for ARE status. The Process Count ARE transaction then picks up these counts, records the billing activities, and moves them to the ARE Processing Complete status.

5.2.1.1 Pickup Statuses

The Pickup Status for the Process Count ARE transaction is Count Request Completed - waiting for ARE.

The `Process Count ARE` transaction picks up counts that are in the `Count Request Completed - Waiting for ARE` status.

5.2.1.2 Drop Statuses

The Drop status for the `Process Count ARE` transaction is `ARE Processing Complete`.

The `Process Count ARE` transaction picks up counts that are in the `Count Request Completed` status, records the billing activities, and moves the count to the `ARE Processing Complete` status.

5.2.2 Agents

The `PROCESS_COUNT_ARE` agent invokes the `YNWARECount` service. This service records the billing activities for the Count process.

5.2.3 Services

The `YNWARECount` service records the billing activities performed in the Count Process.

5.2.4 Billing Activity Codes for the Count Process

Every billing activity is associated with a billing activity code. Billing activities can be recorded either manually or automatically by the system.

This section explains the billing activity codes for the Count Process.

5.2.4.1 System-Recorded

Billing activities can be recorded automatically by the system. These activities are recorded upon completion of the billing activity.

For the activities recorded, the count request number is inserted as the value of the `ACTIVITY_GROUP_KEY_DATA` field in the `YNW_ARE_ACTIVITY_HEADER` table. The `ACTIVITY_GROUP_KEY_DATA` field corresponds to the Transaction Reference field in the application console.

[Figure 5–2](#) displays the system-recorded billing activity codes for the Count Process.

Figure 5–2 System-Recorded Billing Activity Codes for the Count Process

<input type="checkbox"/>	Code	Name	Transaction Type	Group ID	Unit Of Measure	Decimal Qty Allowed	Track Type	Cost	Currency
<input type="checkbox"/>	0070-0100	Cycle Counts	Ancillary	Miscellaneous Charges	PER_PALLET	N	System	0.00	

Table 5–1 System-Recorded Billing Activity Codes for the Count Process

Activity Name	Description	Transaction Reference
Cycle Count (0070-0100)	This activity is recorded for every cycle count performed in the warehouse. For every cycle count, the Service Quantity is equal to one.	If the count is for an Item, the transaction reference is Item Id and Reference Field 2 is Location. If the count is not for an Item, the transaction reference is Location Id, Reference Field 1 is Item Classification 1, Reference Field 2 is Item Classification 2, Reference field 3 is Item Classification 3.

5.2.4.2 User-Recorded

Sterling Warehouse Management System also enables you to create additional billing activity codes and associate them with billing activities that are recorded as a part of the Count process. For more information about how to create billing activity codes manually, see [Section 2.1.1, "Creating Billing Activity Codes"](#).

Sterling Warehouse Management System also enables you to record billing activities manually. For more information about how to record billing activities manually, see [Section 2.2.1, "Manually Recording Billing Activities"](#).

[Figure 5–3](#) displays an example of some manually recorded billing activity codes for the Count Process.

Figure 5–3 User-Recorded Billing Activity Codes for the Count Process

<input type="checkbox"/>	Code	Name	Transaction Type	Group ID	Unit Of Measure	Decimal Qty Allowed	Track Type	Cost	Currency
<input type="checkbox"/>	0010-0002	Monthly Management Fee/Minimum	Ancillary	Miscellaneous Charges	AS_NEEDED	N	Manual	0.00	
<input type="checkbox"/>	0010-0020	Management Fee/upcharge 24/6	Ancillary	Miscellaneous Charges	AS_NEEDED	N	Manual	0.00	
<input type="checkbox"/>	0010-0021	Management Fee/Up charge 24/7	Ancillary	Miscellaneous Charges	AS_NEEDED	N	Manual	0.00	

Table 5–2 Manually Recorded Billing Activity Codes for the Count Process

Activity Name	Description
Monthly Management Fee/Minimum	This activity is recorded manually for the monthly management fee of the activity.
Management Fee/upcharge 24/6	This activity is recorded manually for the monthly management fee of the activity for the 24/6 period.
Management Fee/Up charge 24/7	This activity is recorded manually for the monthly management fee of the activity for the 24/7 period.

6

Value-Added Services Billing Activities

Value-Added Services (VAS) are performed to meet customer demands. These can be activities performed on a product before the product is delivered to the customer or a provided service that is performed at the customer site.

VAS is performed in the warehouse on an ad-hoc basis. The Sterling Warehouse Management System Billing Activity Reporting Engine records kitting activities that are created for the purpose of completing the Order.

The different types of services include Kitting and Compliances services.

Sterling Warehouse Management System enables you to record the billing activities performed during the VAS process.

This chapter lists the billing activities that are recorded for the VAS process, along with their billing activity codes. This chapter also describes the time at which the billing activity is recorded, and the transactions, agents, and services used to record the billing activities.

For VAS, the billing activities are recorded after the work order is confirmed in the warehouse.

6.1 Configuring the Billing Activity Reporting Engine

This section explains the Billing Activity Reporting Engine configuration for the Value-Added Service Process.

6.1.1 Pipeline

If you have enabled the Billing Activity Reporting Engine in your application, when the work order is confirmed the status changes to

Waiting for ARE Process. When the status changes to Waiting for ARE Process, a record is inserted into the Task Queue and this record is picked up by the Process Work Order ARE transaction. This transaction computes the activities for the confirmed work order and inserts the activities into the YNW_ARE_Activity_Header and YNW_ARE_Activity_Detail tables. It then changes the work order status to ARE Processing Complete.

Figure 6–1 illustrates the Work Order Pipeline.

Figure 6–1 Work Order Pipeline

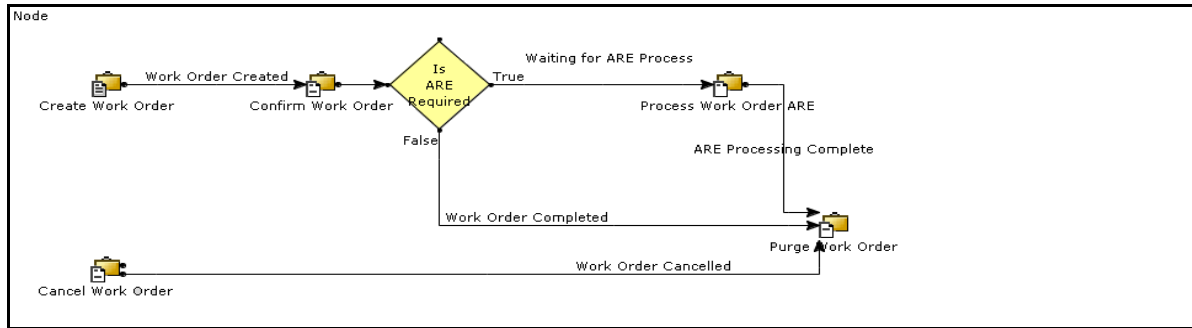

6.1.2 Transactions

When the work order is completed, the work order enters the Waiting for ARE Process status. The Process Work Order ARE transaction then picks up these confirmed work orders, records the activities, and moves them to the ARE Processing Complete status.

6.1.2.1 Pickup Statuses

The Pickup Status for the Process Work Order ARE transaction is Waiting for ARE Process.

The Process Work Order ARE transaction picks up confirmed work orders that are in the Waiting for ARE Process status.

6.1.2.2 Drop Statuses

The Drop status for the Process Work Order ARE transaction is ARE Processing Complete.

The Process Work Order ARE transaction picks up confirmed work orders that are in the Waiting for ARE Process status, records the activities, and moves the confirmed work orders to the ARE Processing Complete status.

6.1.3 Agents

The `PROCESS_WORK_ORDER_ARE` agent invokes the `YNWAREWorkOrder` service. This service records the activities for the Value-Added Services process.

6.1.4 Services

The `YNWAREWorkOrder` service records the activities performed in the Value-Added Services Process.

6.1.5 Billing Activity Codes for the Value-Added Services Process

Every billing activity is associated with a billing activity code. Billing activities can be recorded either manually or automatically by the system.

This section explains the billing activity codes for the Value-Added Services Process.

6.1.5.1 System-Recorded

Billing activities can be recorded automatically by the system. These activities are recorded upon completion of the billing activity.

For the activities recorded, the work order number is inserted as the value of the `ACTIVITY_GROUP_KEY_DATA` field in the `YNW_ARE_ACTIVITY_HEADER` table. The `ACTIVITY_GROUP_KEY_DATA` field corresponds to the Transaction Reference field in the application console.

[Figure 6–2](#) displays the system-recorded billing activity codes for the Value-Added Services Process.

Figure 6–2 System-Recorded Billing Activity Codes for the Value-Added Services Process

<input type="checkbox"/>	Code	Name	Transaction Type	Group ID	Unit Of Measure	Track Type	Cost	Currency
<input type="checkbox"/>	0100-1001	Work Order Charge	Ancillary	Handling Charges	PER_ORDER	System	0.00	
<input type="checkbox"/>	0100-2001	Work Order Units Charge	Ancillary	Handling Charges	NUM_UNIT_WO	System	0.00	

Table 6–1 System-Recorded Billing Activity Codes for the Value-Added Services Process

Activity Name	Description	Transaction Reference
Work Order Charge (0100-1001)	This activity is recorded for a charge work order in the warehouse. For every charge work order, the Service Quantity is equal to one.	Work Order No.
Work Order Units Charge (0100-2001)	This activity is recorded for a charge work order in the warehouse. For every charge work order, the Service Quantity is equal to the number of units completed.	Work Order No.

6.1.5.2 User-Recorded

Sterling Warehouse Management System also enables you to create additional billing activity codes and associate them with billing activities that are recorded as part of the VAS process. For more information about how to create billing activity codes manually, see [Section 2.1.1, "Creating Billing Activity Codes"](#).

Sterling Warehouse Management System also enables you to record additional billing activities manually. For more information about how to record billing activities manually, see [Section 2.2.1, "Manually Recording Billing Activities"](#).

[Figure 6–3](#) displays an example of some manually recorded billing activity codes for the VAS Process.

Figure 6–3 User-Recorded Billing Activity Codes for the Value-Added Services Process

<input type="checkbox"/>	Code	Name	Transaction Type	Group ID	Unit Of Measure	Decimal Qty Allowed	Track Type	Cost	Currency
<input type="checkbox"/>	0010-0002	Monthly Management Fee/Minimum	Ancillary	Miscellaneous Charges	AS_NEEDED	N	Manual	0.00	
<input type="checkbox"/>	0010-0020	Management Fee/upcharge 24/6	Ancillary	Miscellaneous Charges	AS_NEEDED	N	Manual	0.00	
<input type="checkbox"/>	0010-0021	Management Fee/Up charge 24/7	Ancillary	Miscellaneous Charges	AS_NEEDED	N	Manual	0.00	

Table 6–2 User-Recorded Billing Activity Codes for the Value-Added Services Process

Activity Name	Description
Monthly Management Fee/Minimum	This activity is manually recorded for the monthly management fee of the activity.
Management Fee/upcharge 24/6	This activity is manually recorded for the monthly management fee of the activity for a 24/6 period.
Management Fee/upcharge 24/7	This activity is manually recorded for the monthly management fee of the activity for a 24/7 period.

Integrating with External Systems

The Sterling Warehouse Management System Billing Activity Reporting Engine can be integrated with an external system, such as an Accounts Receivable (AR) system. Sterling Warehouse Management System provides the external system with the list of all billing activities, along with the associated code, references, and the units of work. The external system stores the cost of a unit for each billing activity and bills the clients appropriately, at the end of the accounting period. The accounting period may be weekly, fortnightly, or monthly.

To integrate with external systems:

1. Add or Edit the following properties in the `<YANTRA_HOME>/Application/Foundation/resources/yfs.properties` file:
 - a. Set `YNWAREWorkingDir` to the directory that stores temporary files, if any, during the Billing Activity Reporting Engine upload process.
 - b. Set `YNWAREUploadDir` to the directory that stores files uploaded to the Billing Activity Reporting Engine record.
2. Update the Selling and Fulfillment Foundation runtime. For more information about this, see the *Selling and Fulfillment Foundation: Installation Guide*.
3. Run the `UPLOAD_ARE` agent available in the `YNW_UPLOAD_ARE.2001.exe` transaction.

The format of the file generated in the `YNWAREUploadDir` directory is listed in [Table 7-1](#) and [Table 7-2](#).

Table 7–1 Billing Activity Reporting Engine Header Records

Field	Description	Start Position	End Position
Transaction Reference	Transaction Reference	7	46
Ship Node	Ship Node	47	86
Activity Group	Activity Group	87	96
Transaction Type	Transaction Type	97	106
ClientCode	ClientCode	107	116
Status	Status	117	126
Start Date	Start Date	127	136
Last Date	Last Date	137	146
InitTransmitDate	InitTransmitDate	147	156
LastTransmitDate	LastTransmitDate	157	166
Cost	Cost	167	181
Currency	Currency	182	191
CustomerRefNo	CustomerRefNo	192	231
Referencefield1	Referencefield1	232	271
Referencefield2	Referencefield2	272	311
Referencefield3	Referencefield3	312	351

Table 7–2 Billing Activity Reporting Engine Detail Records

Field	Description	Start Position	End position
DetailTransactionReference	DetailTransactionReference	7	46
ActivityCode	ActivityCode	47	56
ActivityDate	ActivityDate	57	66
LineActivityGroup	LineActivityGroup	67	76
LineStatus	LineStatus	77	86
ServiceQty	ServiceQty	87	100

Table 7–2 Billing Activity Reporting Engine Detail Records

Field	Description	Start Position	End position
CarrierCode	CarrierCode	101	140
ShipVia	ShipVia	141	180
RefQty1	RefQty1	181	194
RefQty2	RefQty2	195	208
RefQty3	RefQty3	209	222
LineReferencefield1	LineReferencefield1	223	262
LineReferencefield2	LineReferencefield2	263	302
LineReferencefield3	LineReferencefield3	303	342
Line Cost	Line Cost	343	357
Line Currency	Line Currency	358	367

Extending the Billing Activity Reporting Engine Activities





You can customize the Sterling Warehouse Management System Billing Activity Reporting Engine to record activities other than those shipped with Sterling Warehouse Management System.

For recording the additional activities, you need to customize the services shipped with Sterling Warehouse Management System.

8.1 Shipment Activities

To enable the Billing Activity Reporting Engine to record additional Shipment activities:





1. Log in to the application as the ynwadmin user.
2. From the Application Console menu bar, choose Configuration > Launch Applications Manager. The Applications Manager opens in a new window.
3. From the Applications Manager menu bar, choose Applications > Application Platform.
4. From the tree in the application rules side panel, choose Process Modeling. The Process Modeling screen displays.
5. Select the Outbound Shipment process type. The Outbound Shipment Repository tree displays in the application rules side panel.
6. In the Outbound Shipment Repository, navigate to the Outbound Shipment Services repository.
7. In the Outbound Shipment Services repository:

- a. In the `AREGroup` service group, select `YNWAREShipment`.
 - b. Click . The Save Service As pop-up window displays.
 - c. Enter the new Service Name and click OK.
8. Navigate to the Transactions repository.
 9. In the Transactions repository:
 - a. Select the `Process Shipment ARE` transaction and click . The Transaction Detail:Process Shipment ARE (Outbound Shipment) screen displays.
 - b. Select the Time Triggered tab.
 - c. In the Agent Criteria Definitions area, select the `PROCESS_SHIPMENT_ARE` Criteria ID.
 - d. Click . The Agent Criteria Details pop-up window displays.
 - e. Click the Criteria Parameters tab.
 - f. Select the line where the `ServiceName` is `YNWAREShipment` and click . The Criteria Parameter Details pop-up window displays.
 - g. In Parameter Value, enter the service created in [Step 7](#).
 - h. Click OK.
 - i. In the Agent Criteria Details pop-up window, click .

8.2 Receipt Activities

To enable the Billing Activity Reporting Engine to record additional Receipt activities:





1. Follow [Step 1](#) through [Step 4](#) in [Section 8.1, "Shipment Activities"](#).
2. Select the Purchase Order Receipt Process type. The Purchase Order Receipt Repository tree displays in the application rules side panel.
3. In the Purchase Order Receipt Repository, navigate to the Purchase Order Receipt Services Repository.
4. In the Purchase Order Receipt Services Repository,
 - a. In the `AREGroup` service group, select `YNWAREReceipt`.
 - b. Click . The Save Service As pop-up window displays.

- c. Enter the new Service Name and click OK.
5. Navigate to the Transactions repository.
6. In the Transaction Repository:
 - a. Select the `Process Receipt ARE` transaction and click . The Transaction Detail:Process Receipt ARE (Purchase Order Receipt) screen displays.
 - b. Select the Time Triggered tab.
 - c. In the Agent Criteria Definitions area, select `PROCESS_RECEIPT_ARE` Criteria ID.
 - d. Click . The Agent Criteria Details pop-up window displays.
 - e. Click the Criteria Parameters tab.
 - f. Select the line where the ServiceName is `YNWAREReceipt` and click . The Criteria Parameter Details pop-up window displays.
 - g. In Parameter Value, enter the service created in [Step 4](#).
 - h. Click OK.
 - i. In the Agent Criteria Details pop-up window, click .

8.3 Count Activities



To enable the Billing Activity Reporting Engine to record additional Count activities:



1. Follow [Step 1](#) through [Step 4](#) in [Section 8.1, "Shipment Activities"](#).
2. Select Count Execution Process type. The Count Execution Repository tree displays in the application rules side panel.
3. In the Count Execution Repository, navigate to the Count Execution Services.
4. In the Count Execution Services repository:
 - a. In the `AREGroup` service group, select `YNWARECount`.
 - b. Click . The Save Service As pop-up window displays.
 - c. Enter the new Service Name and click OK.
5. Navigate to the Transactions repository.

6. In the Transaction Repository:
 - a. Select the `Process Count ARE` transaction and click . The Transaction Detail:Process Count ARE (Count Execution) screen displays.
 - b. Select the Time Triggered tab.
 - c. In the Agent Criteria Definitions area, select `PROCESS_COUNT_ARE` Criteria ID.
 - d. Click . The Agent Criteria Details pop-up window displays.
 - e. Click the Criteria Parameters tab.
 - f. Select the line where the ServiceName is `YNWARECount` and click . The Criteria Parameter Details pop-up window displays.
 - g. In Parameter Value, enter the service created in [Step 4](#).
 - h. Click OK.
 - i. In the Agent Criteria Details pop-up window, click .

8.4 Value-Added Service Activities

To customize value-added service:

1. Follow [Step 1](#) through [Step 4](#) in [Section 8.1, "Shipment Activities"](#).
2. Select the VAS Process type. The VAS Process Repository tree displays in the application rules side panel.
3. In the VAS Process Repository, navigate to the VAS Process Services.
4. In the VAS Process Services repository,
 - a. In the `AREGroup` service group, select `YNWAREWorkOrder`.
 - b. Click . The Save Service As pop-up window displays.
 - c. Enter the new Service Name and click OK.
5. Navigate to the Transactions repository.
6. In the Transaction Repository:
 - a. Select the `Process Work Order ARE` transaction and click . The Transaction Detail:Process Work Order ARE (VAS Process) screen displays.

- b. Select the Time Triggered tab.
- c. In the Agent Criteria Definitions area, select `PROCESS_WORK_ORDER_ARE` Criteria ID.
- d. Click . The Agent Criteria Details pop-up window displays.
- e. Click the Criteria Parameters tab.
- f. Select the line where the ServiceName is `YNWAREWorkOrder` and click . The Criteria Parameter Details pop-up window displays.
- g. In Parameter Value, enter the service created in [Step 4](#).
- h. Click OK.
- i. In the Agent Criteria Details pop-up window, click .

A

Billing Activity Codes

This appendix lists the Billing Activity Codes provided with the Sterling Warehouse Management System.

The billing activity codes are grouped into the following classifications:

- [Inbound Billing Activities](#)
- [Outbound Billing Activities](#)
- [Count Billing Activities](#)
- [Value-Added Services Billing Activities](#)

A.1 Inbound Billing Activities

For the Inbound process, the billing activities are recorded when the shipments are received into the warehouse.

Each billing activity is recorded, along with a billing activity code, in the Billing Activity Reporting Engine. The billing activity code identifies the billing activity performed in the warehouse.

[Table 8–1](#) lists the billing activities recorded during the Inbound Process. Billing activities may be recorded either automatically or manually.

Table 8–1 Billing Activities Created for the Inbound Process

Billing Activity Code	Billing Activity Name
0030-0100	Receiving Order Charge
0030-0200	Receiving Line
0030-0310	Receiving Piece/Reference Controlled
0030-0330	Receiving Piece/Defective

Table 8–1 Billing Activities Created for the Inbound Process

Billing Activity Code	Billing Activity Name
0030-0340	Receiving Piece/Reference Controlled-Def
0030-0500	Receiving QC
0030-0600	Manual Entry Of ASN
0050-0100	Return Order
0050-0110	Return Piece
0050-0200	Recovery Exchange Order
0050-0210	Recovery Exchange Piece
0050-0300	Advanced Exchange Order
0050-0310	Advanced Exchange Piece
0110-0010	Movements in WorkHouse
0030-0300	Receiving non-serialized item

A.2 Outbound Billing Activities

For the Outbound process, the billing activities are recorded when the shipments are shipped from the warehouse.

Each billing activity is recorded, along with a billing activity code, in the Billing Activity Reporting Engine. The billing activity code identifies the billing activity performed in the warehouse.

[Table 8–2](#) lists the billing activities recorded during the Outbound Process. Billing activities may be recorded either automatically or manually.

Table 8–2 Billing Activities Created for the Outbound Process

Billing Activity Code	Billing Activity Name
0040-0300	Order Piece Charge
0040-0200	Order Line Charge
0040-0310	Order Piece/Reference Controlled
0040-0100	Order Charge
0040-0400	Will Call Order Charge

Table 8–2 Billing Activities Created for the Outbound Process

Billing Activity Code	Billing Activity Name
0040-0410	Will Call Piece
0060-0100	Next Flight Out (NFO)
0060-0110	NFO-Hold At Airport
0060-0200	Truck Order Charge
0060-0300	Other Air Carrier

A.3 Count Billing Activities

For the Count process, the billing activities are recorded upon completion of the count request.

To complete a Count process, the user must perform the first level of count tasks. The Count process is completed when:

1. No variance is found.
2. A variance is found and:
 - Another user performs the variance tasks.
 - Variances, are accepted.
 - The count process is completed and activities are recorded for the billing activity.

Each billing activity is recorded, along with a billing activity code, in the Billing Activity Reporting Engine. The billing activity code identifies the billing activity performed in the warehouse.

Table 8–3 lists the billing activities recorded during the Count Process. Billing activities may be recorded either automatically or manually.

Table 8–3 Billing Activities for the Count Process

Billing Activity Code	Billing Activity Name
0070-0100	Cycle Count
0010-0002	Monthly Management Fee/Minimum
0010-0020	Management Fee/upcharge 24/6
0010-0021	Management Fee/upcharge 24/7

A.4 Value-Added Services Billing Activities

Value-Added Services are performed in the warehouse on an ad-hoc basis. The different types of services include Kitting and Compliances services.

Each billing activity is recorded, along with a billing activity code, in the Billing Activity Reporting Engine. The billing activity code identifies the billing activity performed in the warehouse.

[Table 8–4](#) lists the billing activities recorded during the VAS Process. Billing activities may be recorded either automatically or manually.

Table 8–4 Billing Activities for the Value-Added Services

Billing Activity Code	Billing Activity Name
0100-1001	Work Order Charge
0100-2001	Work Order Units Charge
0010-0002	Monthly Management Fee/Minimum
0010-0020	Management Fee/upcharge 24/6
0010-0021	Management Fee/Up charge 24/7

B

Billing Activity Units of Measure

Activity Units Of Measure (UOM) are used to charge the billing activities provided with the Sterling Warehouse Management System.

Table 8–5 lists the UOMs used to charge the billing activities.

Table 8–5 Billing Activities Units Of Measure

Unit Of Measure	Description
AS_NEEDED	Charge for each activity as needed.
CONTRACT_MIN	Charge according to contracted in minutes.
COST	Charge at cost.
COST_PLUS_MARKUP	Charge at cost plus the Markup.
EACH	Charge for each activity.
NUM_BIN	Charge according to the number of bin locations.
NUM_PALLET	Charge number of Pallets.
NUM_SEC_BIN	Charge according to the number of secondary bin locations.
NUM_SEC_PALLET	Charge according to the number of secondary pallet.
NUM_SHELF	Charge according to the number of shelves used for storage.
NUM_UNIT_WO	Charge according to the number of work order units.
ONCE_MONTHLY	Charge once per each month.
PER_CALL	Charge per each call.
PER_CARTON	Charge per each carton.
PER_COPY	Charge per each copy.

Table 8–5 Billing Activities Units Of Measure

Unit Of Measure	Description
PER_CTRL_PIECE	Charge per each piece.
PER_FAX	Charge per each fax.
PER_HOUR	Charge per each hour.
PER_LABEL	Charge per each label.
PER_OCCURRENCE	Charge per each occurrence.
PER_ORDER	Charge per each order.
PER_PALLET	Charge per each pallet.
PER_PIECE	Charge per each piece.
PER_QTR_HOUR	Charge per each quarter hour.
PER_SHIPMENT	Charge per each shipment.
PER_SKU_LINE	Charge per each SKU line.
PER_UNIT	Charge per each unit.
PER_WC_ORDER	Charge per each WC order.
SQ_FT	Charge per each square feet.

A

Abstract Transaction field, 9
Accounts Receivable (AR) system, 55
Activity Date field, 23
Activity Group field, 56
Activity Header Key field, 28
Activity Key field, 21
activity name, 2
activity purge, 8
activity references, 1
Activity Status field, 21, 22, 23
ActivityCode field, 56
ActivityDate field, 56
Advanced Exchange Order field, 36
Advanced Exchange Piece field, 36
APIs Called field, 9
ARE activity detail table, 31
ARE Activity Purge transaction, 8
ARE Processing Complete, 32
ARE processing complete status, 45
ARE Processing Complete status, 32
AS_NEEDED unit of measure, 69
Audit Create Date field, 28
Audit Creator field, 28
auditing, 7
auditing capabilities, 7

B

Base Document Type field, 9
Base Process Types field, 9

Base Transaction ID field, 9
billing activities, 1
 defining, 17
 modifying, 22
 recording manually, 17
 viewing, 18
billing activity audits
 viewing, 25
billing activity Code, 1
billing activity code, 2
 Advanced Exchange Order, 66
 Advanced Exchange Piece, 66
 creating, 11
 Cycle Count, 67
 Management Fee/upcharge 24/6, 67
 Management Fee/upcharge 24/7, 67
 Manual Entry Of ASN, 66
 modifying, 15
 Monthly Management Fee/Minimum, 67
 Movements in WorkHouse, 66
 Next Flight Out (NFO), 67
 NFO-Hold At Airport, 67
 Order Charge, 66
 Order Line Charge, 66
 Order Piece Charge, 66
 Order Piece/Reference Controlled, 66
 Other Air Carrier, 67
 Receiving Line, 65
 Receiving Order Charge, 65
 Receiving Piece, 66
 Receiving Piece/Defective, 65
 Receiving Piece/Reference Controlled, 65
 Receiving Piece/Reference Controlled-Def, 66
 Receiving QC, 66

- Recovery Exchange Order, 66
- Recovery Exchange Piece, 66
- Return Order, 66
- Return Piece, 66
- Truck Order Charge, 67
- Will Call Order Charge, 66
- Will Call Piece, 67
- Work Order Charge, 68
- Work Order Units Charge, 68
- billing activity codes
 - count, 67
 - defining, 11
 - deleting, 16
 - inbound, 65
 - outbound, 66
 - VAS, 68
 - viewing, 12
- billing activity reporting engine activity purge, 8
- billing activity reporting engine codes
 - setting up, 4
- billing activity reporting engine terminology, 2
- billing activity UOM
 - charge contract in minutes, 69
 - charge num of bin locations, 69
 - charge num of secondary bin locations, 69
 - charge number of pallets, 69
 - charge number of secondary pallet, 69
 - charge number of shelves used for storage, 69
 - charge number of work order units, 69
 - charge once per month, 69
 - charge per activity as needed, 69
 - charge per call, 69
 - charge per carton, 69
 - charge per copy, 69
 - charge per cost., 69
 - charge per cost plus the markup., 69
 - charge per each activity, 69
 - charge per fax, 70
 - charge per hour, 70
 - charge per label, 70
 - charge per occurrence, 70
 - charge per order, 70
 - charge per pallet, 70
 - charge per piece, 70
 - charge per quarter hour, 70

- charge per shipment, 70
- charge per SKU line, 70
- charge per square feet, 70
- charge per unit, 70
- charge per WC order, 70

C

- Carrier Code field, 24
- CarrierCode field, 57
- ClientCode field, 56
- Clients, 2
- Code field, 12, 28
- common codes setup, 4
- CONTRACT_MIN unit of measure, 69
- Cost field, 12, 23
- COST unit of measure, 69
- COST_PLUS_MARKUP unit of measure, 69
- count billing activity
 - agents, 45
 - billing activity codes
 - manually recorded, 46
 - system-recorded, 45
 - billing activity codes for the count process, 45
 - configuring the billing activity reporting
 - engine, 43
 - pipeline, 44
 - services, 45
 - transactions, 44
- Count Request Completed status, 44
- Currency field, 12, 23
- custom common codes
 - ARE_ACTIVITY_GROUP, 6
 - ARE_ACTIVITY_STATUS, 6
 - ARE_AUDIT_REASON, 6
 - ARE_TRACK_TYPE, 7
 - ARE_TRAN_TYPE, 7
 - ARE_UOM, 7
- CustomerRefNo field, 56
- Cycle Count activity, 46

D

- Delete action, 15
- DetailTransactionReference field, 56

E

EACH unit of measure, 69
enabling, 8
enabling the Billing Activity Reporting Engine, 8
Enterprise field, 18
environment variable
 YANTRA_HOME, xiv
 YANTRA_OLD_HOME, xiii
 YFS_OLD_HOME, xiv
extending billing activity reporting engine activities
 count activities, 61
 receipt activities, 60
 shipment activities, 59

G

group ID, 3
 Handling Charges, 3
 Miscellaneous Charges, 3
 Storage Charges, 3
 Transaction Charges, 3
Group ID field, 12, 15

I

Inbound
 Drop status, 32
 Pickup status, 32, 50
inbound billing activity
 agents, 33
 billing activity codes
 system-recorded, 33
 Billing Activity Reporting Engine activity
 codes, 33
 billing activity reporting engine configuration, 31
 pipeline, 31
 services, 33
 transactions, 32
 user-recorded billing activity codes
 manually recorded, 35
inbound transactions
 drop statuses, 32
 pickup statuses, 32
InitTransmitDate field, 56

L

Last Activity Date field, 21
Last Date field, 56
LastTransmitDate field, 56
Line Cost field, 57
Line Currency field, 57
LineActivityGroup field, 56
LineReferencefield1 field, 57
LineReferencefield2 field, 57
LineReferencefield3 field, 57
LineStatus field, 56
Live field, 9

M

Management Fee/Up charge 24/7 field, 47
Management Fee/upcharge 24/6 activity, 53
Management Fee/upcharge 24/6 field, 47
Management Fee/upcharge 24/7 activity, 53
Manual Entry of ASN activity, 35
Max Records field, 15
Monthly Management Fee/Minimum activity, 47
Movements in WorkHouse field, 36

N

Name field, 12, 14
Next Flight Out (NFO) activity, 42
NFO-Hold At Airport activity, 42
Node field, 18
NUM_BIN unit of measure, 69
NUM_PALLET unit of measure, 69
NUM_SEC_BIN unit of measure, 69
NUM_SEC_PALLET unit of measure, 69
NUM_SHELF unit of measure, 69
NUM_UNIT_WO unit of measure, 69

O

ONCE_MONTHLY unit of measure, 69
Order Charge activity, 41
Order Line Charge activity, 40
Order Piece Charge field, 40

Order Piece/Reference Controlled activity, 40
Other Air Carrier activity, 42
outbound billing activity
 agents, 39
 billing activity codes, 39
 system-recorded, 39
 user-recorded, 41
 billing activity reporting engine configuration, 37
 pipeline, 37
 services, 39
 transactions, 38

P

PER_CALL unit of measure, 69
PER_CARTON unit of measure, 69
PER_COPY unit of measure, 69
PER_CTRL_PIECE unit of measure, 70
PER_FAX unit of measure, 70
PER_HOUR unit of measure, 70
PER_LABEL unit of measure, 70
PER_OCCURRENCE unit of measure, 70
PER_ORDER unit of measure, 70
PER_PALLET unit of measure, 70
PER_PIECE unit of measure, 70
PER_QTR_HOUR unit of measure, 70
PER_SHIPMENT unit of measure, 70
PER_SKU_LINE unit of measure, 70
PER_UNIT unit of measure, 70
PER_WC_ORDER unit of measure, 70
Process Count ARE transaction, 44
process receipt ARE
 transaction, 51
Process Receipt ARE transaction, 32
Process Shipment ARE transaction, 37
Process Work Order ARE transaction, 50
Process Work order ARE transaction, 50
PROCESS_COUNT_ARE
 agent, 45
PROCESS_RECEIPT_ARE agent, 33
PROCESS_SHIPMENT_ARE agent, 39
PROCESS_WORKORDER_ARE
 agent, 51
purchase order number, 1
Purge Code field, 9

R

Received status, 32
Receiving Line field, 34
Receiving Order Charge activity, 34
Receiving Piece activity, 35
Receiving Piece/Defective activity, 34
Receiving Piece/Reference Controlled activity, 34
Receiving Piece/Reference Controlled-Def field, 34
Receiving QC activity, 35
Receiving QC field, 36
Recovery Exchange Order field, 36
Recovery Exchange Piece field, 36
Referencefield1 field, 56
Referencefield2 field, 56
Reference1 field, 24
RefQty1 field, 57
RefQty2 field, 57
RefQty3 field, 57
Return Order field, 36
Return Piece field, 36

S

sales order number, 1
Service Quantity field, 23
Ship Node field, 56
ship via, 4
Ship Via field, 23
Shipment Shipped status, 38
ShipVia field, 57
SQ_FT unit of measure, 70
Start Activity Date field, 20
Start Date field, 56
Status field, 56
system
 manual, 4

T

Third Party Logistics, 1
track type, 3
 system, 3
Track Type field, 15
track type field, 12

transaction reference, 4
Transaction Reference field, 18, 23
transaction type, 2
 Ancillary, 2
 Receiving, 3
 Shipping, 3
Transaction Type field, 12, 15
transactions
 drop statuses, 45
 outbound
 drop statuses, 39
 pickup statuses, 38
 pickup statuses, 44, 50
 vas
 drop statuses, 51
Truck Order Charge activity, 41

U

unit of measure, 3
Unit Of Measure field, 15
unit of measure field, 12
UOM field, 23
User Exits Called field, 9

V

valid group IDs, 3
valid track types, 3
valid transaction types, 2
Value-Added Services (VAS), 49
VAS billing activity
 agents, 51
 billing activity codes, 51
 manually recorded, 52
 system-recorded, 51
 configuring the billing activity reporting, 49
 pipeline, 49
 services, 51
 transactions, 50
View Details action, 15, 21

W

Waiting for ARE Process status, 38
Will Call Order Charge activity, 42
Will Call Piece activity, 42
Work Order Charge activity, 52
Work Order Completed status, 50
work order number, 1
Work Order Units Charge Activity, 52

Y

YANTRA_HOME, xiv
YANTRA_OLD_HOME, xiii
YFS_OLD_HOME, xiv
YNWAREcount service, 45
YNWAREreceipt service, 33
YNWAREshipment service, 39
YNWAREWorkOrder
 service, 51
YNW_ARE_Activity table, 31
YNW_ARE_Activity_Detail, 44
YNW_ARE_Activity_Header table, 44
YNW_UPLOAD_ARE.2001.ex time triggered
 transaction, 55

Z

0010-0002 activity code, 67
0010-0020 activity code, 67
0010-0021 activity code, 67
0030-0100 activity code, 65
0030-0200 activity code, 65
0030-0300 activity code, 66
0030-0310 activity code, 65
0030-0330 activity code, 65
0030-0340 activity code, 66
0030-0500 activity code, 66
0030-0600 activity code, 66
0040-0100 activity code, 66
0040-0200 activity code, 66
0040-0300 activity code, 66
0040-0310 activity code, 66
0040-0400 activity code, 66
0040-0410 activity code, 67

0050-0100 activity code,	66
0050-0110 activity code,	66
0050-0200 activity code,	66
0050-0210 activity code,	66
0050-0300 activity code,	66
0050-0310 activity code,	66
0060-0100 activity code,	67
0060-0110 activity code,	67
0060-0200 activity code,	67
0060-0300 activity code,	67
0070-0100 activity code,	67
0100-1001 activity code,	68
0100-2001 activity code,	68
0110-0010 activity code,	66