

CICS<sup>®</sup> Transaction Server for VSE/ESA<sup>™</sup>



# Enhancements Guide

*Release 1*



CICS<sup>®</sup> Transaction Server for VSE/ESA<sup>™</sup>



# Enhancements Guide

*Release 1*

**Note!**

Before using this information and the product it supports, be sure to read the general information under "Notices" on page 231.

**First Edition (September 2000)**

This edition applies to Release 1 of the IBM licensed program CICS Transaction Server for VSE/ESA, program number 5648-054, and to all subsequent versions, releases, and modifications until otherwise indicated in new editions. Consult the latest edition of the applicable IBM system bibliography for current information on this product.

Order publications through your IBM representative or IBM branch office serving your locality. Publications are not stocked at the address given below.

At the back of the publication is a page entitled "Sending your comments to IBM". If you want to make comments, but the methods described are not available to you, please address them to:

IBM United Kingdom Laboratories,  
Information Development,  
Mail Point 095,  
Hursley Park,  
Winchester,  
Hampshire,  
England,  
SO21 2JN.

When you send information to IBM, you grant IBM a non-exclusive right to use or distribute the information in any way it believes appropriate without incurring any obligation to you.

© Copyright International Business Machines Corporation 1994, 2000. All rights reserved.

US Government Users Restricted Rights – Use, duplication or disclosure restricted by GSA ADP Schedule Contract with IBM Corp.

---

# Contents

<b>Preface</b> . . . . .	vii
What this book is about . . . . .	vii
How to use this book . . . . .	vii
What you need to know to understand this book . . . . .	vii
Notes on terminology . . . . .	vii
<hr/>	
<b>Part 1. Introduction</b> . . . . .	<b>1</b>
<b>Chapter 1. Introduction</b> . . . . .	<b>3</b>
<hr/>	
<b>Part 2. CICS Web support</b> . . . . .	<b>5</b>
<b>Chapter 2. EXEC CICS DOCUMENT</b> . . . . .	<b>7</b>
DOCUMENT CREATE . . . . .	8
DOCUMENT INSERT . . . . .	12
DOCUMENT RETRIEVE . . . . .	15
DOCUMENT SET . . . . .	17
<b>Chapter 3. EXEC CICS START</b> . . . . .	<b>21</b>
START BREXIT . . . . .	22
<b>Chapter 4. EXEC CICS TS</b> . . . . .	<b>25</b>
DELETEQ TS . . . . .	26
READQ TS . . . . .	28
WRITEQ TS . . . . .	31
<b>Chapter 5. EXEC CICS WEB</b> . . . . .	<b>35</b>
WEB ENDBROWSE FORMFIELD . . . . .	36
WEB ENDBROWSE HTTPHEADER . . . . .	37
WEB EXTRACT . . . . .	38
WEB READ FORMFIELD . . . . .	40
WEB READ HTTPHEADER . . . . .	42
WEB READNEXT FORMFIELD . . . . .	43
WEB READNEXT HTTPHEADER . . . . .	45
WEB RECEIVE . . . . .	47
WEB RETRIEVE . . . . .	49
WEB SEND . . . . .	50
WEB STARTBROWSE FORMFIELD . . . . .	52
WEB STARTBROWSE HTTPHEADER . . . . .	53
WEB WRITE . . . . .	54
<b>Chapter 6. EXEC CICS EXTRACT TCPIP</b> . . . . .	<b>55</b>
EXTRACT TCPIP . . . . .	56
<hr/>	
<b>Part 3. Using CICS documents</b> . . . . .	<b>59</b>
<b>Chapter 7. The DOCUMENT application programming interface</b> . . . . .	<b>61</b>
Creating a document . . . . .	61
The BINARY parameter . . . . .	61
The TEXT parameter . . . . .	61
Inserting one document into another . . . . .	61
Using document templates . . . . .	62

<b>Chapter 8. Programming with documents</b> . . . . .	63
Setting symbol values . . . . .	63
Embedded template commands. . . . .	64
Using templates in your application . . . . .	65
The lifespan of a document . . . . .	65
Retrieving the document without control information . . . . .	66
Using multiple calls to construct a document . . . . .	67
Bookmarks and inserting data . . . . .	68
Replacing data in the document . . . . .	69
Codepages and codepage conversion . . . . .	69

---

**Part 4. CICS Resource Definitions Online Changes** . . . . . 71

<b>Chapter 9. DOCTEMPLATE</b> . . . . .	73
<b>Chapter 10. PROFILE</b> . . . . .	75
<b>Chapter 11. TCPIP SERVICE.</b> . . . . .	83

---

**Part 5. CICS Supplied Transactions Changes** . . . . . 87

<b>Chapter 12. CEBR—temporary storage browse</b> . . . . .	89
The HELP panel . . . . .	90
<b>Chapter 13. CEDX — the execution diagnostic facility</b> . . . . .	91
CEDF transaction . . . . .	91
CEDX transaction . . . . .	91
Command syntax . . . . .	91
Command options. . . . .	92
<b>Chapter 14. CEMT INQUIRE commands</b> . . . . .	93
CEMT INQUIRE DOCTEMPLATE . . . . .	94
CEMT INQUIRE TASK . . . . .	96
CEMT INQUIRE TCPIP . . . . .	100
CEMT INQUIRE TCPIP SERVICE . . . . .	101
CEMT INQUIRE TRANSACTION. . . . .	103
CEMT INQUIRE TSQUEUE. . . . .	107

---

**Part 6. CICS System Initialization changes** . . . . . 111

<b>Chapter 15. CICS system initialization parameters</b> . . . . .	113
Specifying system initialization parameters . . . . .	113
Migration considerations . . . . .	114
The DFHSIT macro parameters . . . . .	114
DFHSIT, the default system initialization table . . . . .	117
Creating a system initialization table . . . . .	121
Coding more than one system initialization table . . . . .	122
CICS-supplied system initialization tables. . . . .	122
System initialization tables supplied with VSE/ESA . . . . .	122
Assembling the system initialization table. . . . .	122
Parameters that you cannot code in the DFHSIT macro . . . . .	123
Overriding SIT parameters at system startup . . . . .	123
The CICS parameter manager domain. . . . .	124
System initialization control keywords . . . . .	125
Processing the PARM parameter. . . . .	127

Processing the SYSIPT data set . . . . .	127
Processing the console entries . . . . .	128
Notes on CICS resource table and module keywords . . . . .	129
Selecting versions of CICS programs and tables . . . . .	131
Using a suffix to select the dynamic backout program . . . . .	131
Using an explicit level of function to select programs . . . . .	131
Excluding unwanted programs . . . . .	132
Classes of start and restart . . . . .	133
The global catalog . . . . .	133
The local catalog . . . . .	134
The START system initialization parameter . . . . .	134
CICS startup and the VTAM session . . . . .	137
End of CICS startup . . . . .	138
The system initialization parameter descriptions . . . . .	138

---

**Part 7. Trace entries . . . . . 211**

<b>Chapter 16. Trace entries . . . . .</b>	<b>213</b>
Document handler AP trace points . . . . .	213
Socket domain . . . . .	213
Web domain trace points . . . . .	223
Bridge facility management . . . . .	224
Bridge facility management 2 . . . . .	227

---

**Part 8. Appendixes . . . . . 229**

<b>Notices . . . . .</b>	<b>231</b>
Programming interface information . . . . .	232
Trademarks and service marks . . . . .	232
<b>Bibliography . . . . .</b>	<b>235</b>
CICS Transaction Server for VSE/ESA Release 1 Library . . . . .	235
<b>Books from VSE/ESA 2.5 base program libraries . . . . .</b>	<b>237</b>
VSE/ESA Version 2 Release 5. . . . .	237
High-Level Assembler Language (HLASM) . . . . .	237
Language Environment for VSE/ESA (LE/VSE) . . . . .	238
VSE/ICCF . . . . .	238
VSE/POWER . . . . .	238
VSE/VSAM . . . . .	238
VTAM for VSE/ESA. . . . .	239
<b>Books from VSE/ESA 2.5 optional program libraries . . . . .</b>	<b>241</b>
C for VSE/ESA (C/VSE) . . . . .	241
COBOL for VSE/ESA (COBOL/VSE) . . . . .	241
DB2 Server for VSE . . . . .	242
DL/I VSE . . . . .	242
PL/I for VSE/ESA (PL/I VSE) . . . . .	242
Screen Definition Facility II (SDF II) . . . . .	243
TCP/IP for VSE/ESA . . . . .	243
<b>Information on the World Wide Web . . . . .</b>	<b>245</b>
HTTP/1.0 . . . . .	245
HTML . . . . .	245

<b>Determining if a publication is current . . . . .</b>	<b>247</b>
<b>Index . . . . .</b>	<b>249</b>
<b>Sending your comments to IBM . . . . .</b>	<b>263</b>



---

# Preface

---

## What this book is about

This book provides a brief summary of the changes made in the Application Programming Interface, the CICS® Resource Definitions Online, the CICS System Initialization parameters, Trace Entries and the Web Support since Release 1 of CICS Transaction Server for VSE/ESA®.

---

## How to use this book

This book is intended to show what CICS facilities are available to enable you to use your CICS system as a non-SNA server. Read “Part 1. Introduction” on page 1 for general information, and for guidance about which other parts of the book to consult.

---

## What you need to know to understand this book

**Within this book, reference is made to Release 1. The function described in this book has been added since the release of CICS Transaction Server for VSE/ESA and can be identified within the code as 1.1.1.**

This book assumes that you are familiar with CICS, either as a system administrator or as a system or application programmer. Some parts of the book assume additional knowledge about CICS and other products.

---

## Notes on terminology

When the term “CICS” is used without any qualification in this book, it refers to the CICS element of IBM® CICS Transaction Server for VSE/ESA.

In this release, the CICS Web interface is split into the Listener support for TCP/IP SERVICE, and the protocol support for HTTP. This book now refers to the HTTP protocol support as “**CICS Web support**”. Within the product code, the term “**CICS Web interface**” remains synonymous with “**CICS Web support**”.

In this release, there are two ways of coding Web application programs.

1. **Commarea**-style applications are those that take a communication area containing an HTTP request as input, and build an HTTP response in the communication area.
2. **Web API** applications use the new WEB and DOCUMENT application programming interface to process the inbound HTTP request and build the response



---

# Part 1. Introduction



---

## Chapter 1. Introduction

The CICS for Transaction Server for VSE/ESA Version 1 Enhancements Guide is a new book, intended to document those changes made to CICS TS for VSE/ESA in support of CICS Web support and the 3270 Bridge facility. See the *CICS Internet Guide* for details of the implementation of CICS Web Support and *CICS External Interfaces Guide* for details of the implementation of the 3270 Bridge Support.

This book shows those areas of CICS that have been enhanced, either directly to support these two new functions, or where other changes have been made.



---

## Part 2. CICS Web support

The following Application Programming Interface verbs have been changed or introduced with the new level of CICS Transaction Server for VSE/ESA:

1. EXEC CICS DOCUMENT
2. EXEC CICS START
3. EXEC CICS TS
4. EXEC CICS WEB
5. EXEC CICS EXTRACT TCPIP

Each of the verbs affected is now described:

## CICS Web support



---

## Chapter 2. EXEC CICS DOCUMENT

## DOCUMENT CREATE

# DOCUMENT CREATE

Create a document.

## DOCUMENT CREATE

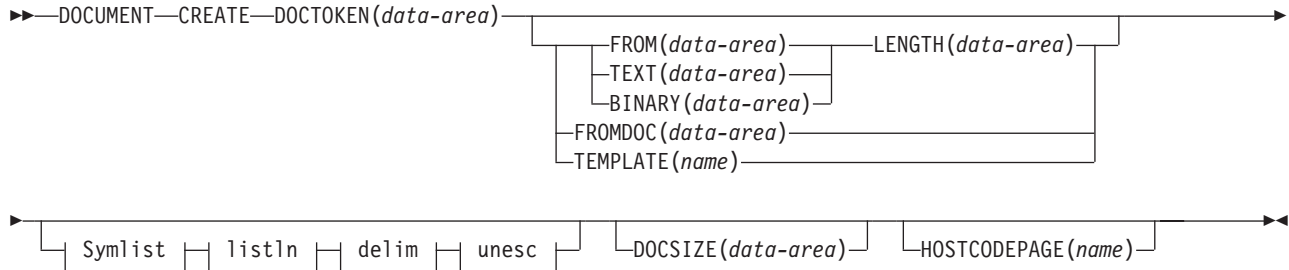

### symlist:

SYMBOLLIST(data-area)

### listln:

LISTLENGTH(data-value)

### delim:

DELIMITER(data-value)

### unesc:

UNESCAPED

**Conditions:** INVREQ, NOTFND, SYMBOLERR, TEMPLATERR

## Description

DOCUMENT CREATE signals the start of the document creation process. The document being created can be an empty document, or it can be based on an existing document, a template, or data contained in an application buffer.

## Options

### **BINARY(data-area)**

specifies a buffer of data which is to be used as the contents of the new document being created. The data is copied unchanged to the document content and no attempt is made to parse the data for symbol substitution. The purpose of the BINARY option is to allow the application to insert blocks of data that must not undergo conversion to a client code page when the data is sent.

**DELIMITER(data-value)**

specifies an optional 1-byte value used to delimit symbol name-value pairs in the SYMBOLLIST buffer. If this option is not specified, the value defaults to an ampersand. There are several disallowed DELIMITER values, all of which cause an INVREQ condition if used. The disallowed values are:

- null (binary X'00')
- shift in (binary X'0E')
- shift out (binary X'0F')
- space (binary X'40')
- plus sign (binary X'4E')
- colon (binary X'7A')
- equals (binary X'7E')
- percent sign (binary X'6C')
- backslash (binary X'E0')

If this option is used, the application must ensure that the DELIMITER does not appear in any symbol value in the SYMBOLLIST buffer. For this reason, the application should not use alphanumeric and other printable characters as the DELIMITER value.

**DOCSIZE(data-area)**

specifies a binary fullword area that will be updated with the current size of the document in bytes. This is the maximum size of the buffer needed to contain a copy of the document when a RETRIEVE command is issued.

**DOCTOKEN(data-area)**

specifies a data area to contain the symbolic name of the document. The area must be 16 bytes in length and will be set to a CICS-generated name by which the document can be referred to in later commands.

**FROM(data-area)**

specifies that data supplied by the application is to be used to create the contents of the new document. The data content could be a template or a document which was created and retrieved. If the data is a template, symbol substitution will take place where the symbols exist in the symbol table. If the data is a previously retrieved document, the conversion and bookmark tags which were inserted during retrieval will be removed from the content and stored in the internal format required by the API commands. Note that symbol substitution will not be attempted on any unresolved symbols contained in a retrieved document.

**FROMDOC(data-area)**

specifies the symbolic name (see the **DOCTOKEN** option) of a document whose contents are to be copied to the new document being created. All bookmark and conversion tags are copied to the new document. The symbol table will be not be copied.

**HOSTCODEPAGE(name)**

specifies the name of the host codepage that the data being added is encoded in. This option applies to the TEXT, SYMBOL and TEMPLATE options only. The name must be eight characters long; if it is shorter than eight characters it must be padded on the right with blanks.

**LENGTH(data-value)**

specifies the length, as a fullword binary value, of the application supplied buffer.

## DOCUMENT CREATE

### **LISTLENGTH(data-value)**

specifies the length, as a fullword binary value, of the symbol list.

### **SYMBOLLIST(data-area)**

specifies a buffer which contains a symbol list. A symbol list is a character string consisting of one or more symbol definitions separated by ampersands. Each symbol definition consists of a name, an equals sign, and a value.

The name is case-sensitive. It can contain only uppercase and lowercase letters, numbers, and underscores ("\_"). Unlike the symbols in the template, the names in the symbol list have neither an ampersand at the beginning, nor a semicolon at the end. For example, the symbol `&mytitle;` in the template corresponds to the name *mytitle* in the symbol list. Symbols in the symbol list are separated by the `&` character. For example:

```
applid=IYCQ&jobname=test
```

The following restrictions apply to the characters allowed in the value in the symbol list:

- A percent sign may be followed by two hexadecimal digits. When the value is put into the symbol table, the percent sign and the two hexadecimal digits following it are interpreted as the EBCDIC equivalent of the single ASCII character denoted by the two digits. If you want a percent sign in the value in the symbol table, you may put `%25` in the symbol list. If the characters following the percent sign are not two valid hexadecimal digits, the percent sign and the following characters are put into the symbol table as they appear in the symbol list. Note that this restriction does not apply if the `UNESCAPED` keyword has been specified.
- An ampersand is not allowed. If you want an ampersand in the value in the symbol table, you must put `%26` in the value in the symbol list. Note that this restriction does not apply if the `DELIMITER` keyword is used to specify a delimiter other than ampersand.
- When the value is put into the symbol table, a plus sign is interpreted as a space. If you want a plus sign in the value in the symbol table, you must put `%2B` in the value in the symbol list. Note that this restriction does not apply if the `UNESCAPED` keyword has been specified.
- If you want a space in the value in the symbol table, the value in your symbol list may contain a space, a plus sign, or `%20`. Note that this restriction does not apply if the `UNESCAPED` keyword has been specified.

### **TEMPLATE(name)**

specifies the 48-byte name of a template. The template must be defined to CICS using RDO. If the name is shorter than 48 bytes, it must be padded on the right with blanks.

### **TEXT(data-area)**

specifies a buffer of data which is to be used as the contents of the new document being created. The data is copied unchanged to the document content and no attempt is made to parse the data for symbol substitution. The data will be marked as requiring conversion to the client code page when the document is sent.

### **UNESCAPED**

prevents CICS from unescaping symbol values contained in the `SYMBOLLIST` buffer. If this option is used, plus signs are not converted to spaces, and sequences such as `%2B` are not converted to single byte values.

## Conditions

### INVREQ

RESP2 values are:

- 1 The retrieved document specified on the FROM option is not in a valid RETRIEVE format.
- 8 The value specified for DELIMITER is not valid.

### NOTFND

RESP2 values:

- 2 The document specified on the FROMDOC option could not be found or was named incorrectly.
- 3 The template specified on the TEMPLATE option could not be found or was named incorrectly.
- 7 The host codepage specified on the HOSTCODEPAGE option could not be found or was named incorrectly.

### SYMBOLERR

a symbol specified in the symbol list does not conform to the naming rules for symbols. RESP2 contains the offset of the symbol in the list.

### TEMPLATERR

an invalid #set, #include or #echo command has been encountered while processing the supplied template data. RESP2 contains the offset of the invalid command. This condition can also occur for unmatched Shift-Out Shift-In pairs.

## DOCUMENT INSERT

# DOCUMENT INSERT

Insert document objects.

## DOCUMENT INSERT

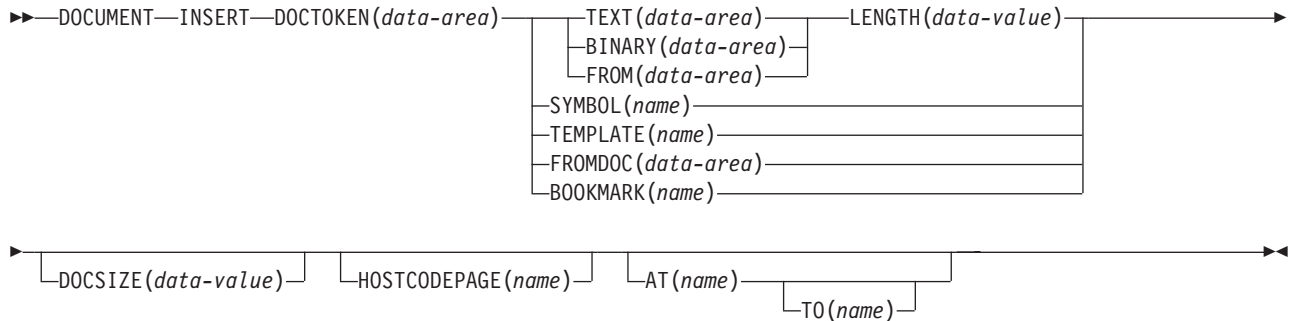

**Conditions:** DUPREC, INVREQ, NOTFND, TEMPLATERR

## Description

DOCUMENT INSERT allows the application to insert document objects at insertion points within the document. The insertion points (bookmarks) define relative positions within the document. Bookmarks must be defined before being referenced. Data is always inserted after the position identified by the bookmark.

## Options

### **AT(*name*)**

specifies the 16-byte symbolic name of a bookmark which identifies the position of the insertion point in the document. Data is inserted after the bookmark, and any data following the bookmark is shifted down. The application can use a combination of the AT and TO options to perform an overlay operation. If the AT operand is not specified, the data is inserted at the end of the document. A pre-defined bookmark of TOP is provided to allow the application to insert data at the beginning of the document.

### **BINARY(*data-area*)**

specifies a buffer of data to be inserted into the document. The data is copied unchanged to the insertion point in the document, and no attempt is made to parse the data for symbol substitution. The BINARY option allows the application to insert blocks of data that must not undergo conversion to a client code page when the data is sent.

### **BOOKMARK(*name*)**

specifies a bookmark to be inserted into the document. A bookmark is a symbolic name which identifies an insertion point in the document. The name can be up to 16 characters in length, and must not contain any imbedded spaces.

### **DOCSIZE(*data-value*)**

specifies a binary fullword area to be updated with the current size of the document in bytes. This is the maximum size of the buffer needed to contain a copy of the document when a RETRIEVE command is issued.

**DOCTOKEN**(*data-area*)

specifies the 16-byte symbolic name of the document into which data is to be inserted.

**FROM**(*data-area*)

specifies that a buffer of data supplied by the application is to be inserted into the document. The data content can be a template or a document that was previously created and retrieved. If the data is a template, symbol substitution takes place where the symbols exist in the symbol table. If the data is a previously retrieved document, the conversion and bookmark tags which were inserted during the retrieval will be removed from the content and stored in the internal form required by the API commands. Note that symbol substitution will not be attempted on any unresolved symbols contained in a retrieved document.

**FROMDOC**(*data-area*)

specifies the symbolic name of a document (see the DOCTOKEN option) whose contents are copied to the insertion point of the target document. All bookmarks and conversion tags are copied to the target document. The symbol table is not copied.

**HOSTCODEPAGE**(*name*)

specifies the symbolic name (see the DOCTOKEN option) of the host codepage that the data being added is encoded in. This option applies to the TEXT, SYMBOL and TEMPLATE options only. The name must be eight characters long; if it is shorter than eight characters, it must be padded on the right with blanks.

**LENGTH**(*data-value*)

specifies the length, as a fullword binary value, of the buffer containing the TEXT, BINARY or FROM data.

When the DOCUMENT INSERT command follows a DOCUMENT RETRIEVE command, without the use of the DATAONLY option, and the retrieved document is being inserted using the FROM option, the LENGTH specified must be equal to the length of the retrieved document.

**SYMBOL**(*name*)

specifies the 32-byte name of a symbol in the symbol table. The data associated with the symbol in the symbol table is inserted, but not the symbol itself.

**TEMPLATE**(*name*)

specifies the 48-byte name of a template. The template must be defined to CICS using RDO. If the name is less than 48 bytes, it must be padded on the right with blanks.

**TEXT**(*data-area*)

specifies a buffer of data to be inserted into the document. The data is copied unchanged to the insertion point in the document, and no attempt is made to parse the data for symbol substitution. When the document is sent, it is marked as requiring conversion to the client code page.

**TO**(*name*)

specifies the symbolic name of a bookmark identifying the end position of an overlay operation. Data between the bookmarks identified by the AT and TO operands is deleted, and new data is inserted in its place. It is possible to delete data between two bookmarks by specifying a null string on the TEXT or BINARY option with a LENGTH of zero.

## DOCUMENT INSERT

### Conditions

#### **DUPREC**

the bookmark has already been defined.

#### **INVREQ**

RESP2 values are:

- 0** The bookmark specified on the TO option appears before the bookmark specified on the AT bookmark.
- 1** The retrieved document specified on the FROM option is not in a valid RETRIEVE format.
- 2** The bookmark name on the BOOKMARK option is invalid.

#### **NOTFND**

one of the following documents or templates could not be found, or its name was incorrect.

RESP2 values:

- 1** The document specified on the DOCUMENT option.
- 2** The document specified on the FROMDOC option.
- 3** The template specified on the TEMPLATE option.
- 4** The document specified on the SYMBOL option.
- 5** The document specified on the AT option.
- 6** The document specified on the TO option.
- 7** The document specified on the HOSTCODEPAGE option.

#### **TEMPLATERR**

an invalid #set, #include or #echo command has been encountered while processing the supplied template data. RESP2 contains either a zero (if the maximum of 32 levels of embedded templates is exceeded), or the offset of the invalid command.



## DOCUMENT RETRIEVE

Copy a document into the application's own buffer.

### DOCUMENT RETRIEVE

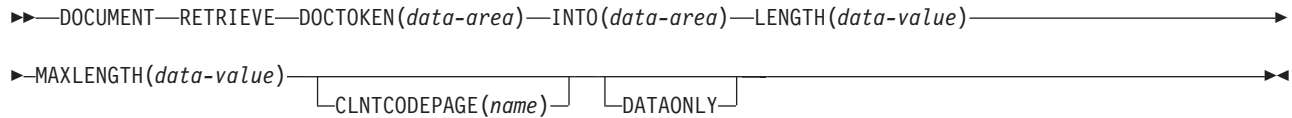

**Conditions:** LENGERR, NOTFND

## Description

DOCUMENT RETRIEVE allows the application to obtain a copy of the document in its own buffer, which it can then manipulate directly. The document is managed by CICS, and the application does not have direct access to the buffer containing the contents of the document. The document exists only for the duration of the current transaction, so the application must retrieve the document and store it if the document is to exist over transaction boundaries. The retrieved document can be used as a basis for a new document by using the FROM option of the DOCUMENT CREATE command.

When the document is retrieved, CICS inserts tags into the document contents to identify the bookmarks and to delimit the blocks that do not require codepage conversion. To request a copy without tags, specify DATAONLY. The extracted document can also be converted into a single client codepage by using the CLNTCODEPAGE option.

## Options

### **CLNTCODEPAGE(*name*)**

specifies the name of the client codepage to which the data should be converted. The name can be up to 40 characters in length; if it is shorter than 40 characters, it must be padded on the right with blanks.

### **DATAONLY**

specifies that the data should be retrieved without any imbedded tags.

### **DOCTOKEN(*data-area*)**

specifies the 16-byte symbolic name of the document to be retrieved.

### **INTO(*data-area*)**

specifies the buffer that is to contain the copy of the document content.

### **LENGTH(*data-value*)**

specifies the length, as a fullword binary value, of the amount of data being returned to the application.

### **MAXLENGTH(*data-value*)**

specifies the length, as a fullword binary value, of the maximum amount of data the buffer can receive.

## DOCUMENT RETRIEVE

### Conditions

#### LENGERR

RESP2 values:

- 1 MAXLENGTH is less than or equal to zero. The document is truncated.
- 2 The length of the receiving buffer is zero, or is too short to contain the document contents. The document is truncated.

#### NOTFND

RESP2 values:

- 1 The document has not been created, or the name is incorrectly specified.
- 7 The specified client codepage can not be found.

## DOCUMENT SET

Add symbols and values to symbol table.

### DOCUMENT SET

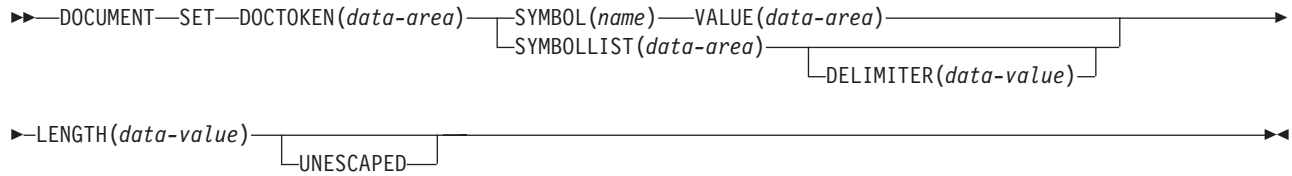

**Conditions:** NOTFND, SYMBOLERR

## Description

DOCUMENT SET allows the application to add symbols and their associated values to the symbol table. If the symbol being added already exists in the table, it is replaced by the new definition.

## Options

### DELIMITER(*data-value*)

specifies an optional 1-byte value used to delimit symbol name-value pairs in the SYMBOLLIST buffer. If this option is not specified, the value defaults to an ampersand. There are several disallowed DELIMITER values, all of which cause an INVREQ condition if used. The disallowed values are:

- null (binary X'00')
- shift in (binary X'0E')
- shift out (binary X'0F')
- space (binary X'40')
- plus sign (binary X'4E')
- colon (binary X'7A')
- equals (binary X'7E')
- percent sign (binary X'6C')
- backslash (binary X'E0')

If this option is used, the application must ensure that the DELIMITER does not appear in any symbol value in the SYMBOLLIST buffer. For this reason, the application should not use alphanumeric and other printable characters as the DELIMITER value.

### DOCTOKEN(*data-area*)

specifies the 16-byte symbolic name of the document that owns the symbol table.

### LENGTH(*data-value*)

specifies the length, as a fullword binary value, of the buffer containing the data value associated with the symbol or the length of the buffer containing the symbol list when the SYMBOLLIST option is used.

## DOCUMENT SET

### **SYMBOL**(*name*)

specifies the name of the symbol that is to be added to the table. The name can be 1 to 32 characters in length with no embedded spaces.

### **SYMBOLLIST**(*data-area*)

specifies a buffer which contains a symbol list. A symbol list is a character string consisting of one or more symbol definitions separated by ampersands. Each symbol definition consists of a name, an equals sign, and a value.

The name is case-sensitive. It can contain only uppercase and lowercase letters, numbers, and underscores (" \_"). Unlike the symbols in the template, the names in the symbol list have neither an ampersand at the beginning, nor a semicolon at the end (for example, the symbol `:&mytitle;` in the template corresponds to the name *mytitle* in the symbol list). Symbols in the symbol list are separated by the & character. For example:

```
applid=IYCQ&jobname=test
```

The following restrictions apply to the characters allowed in the value in the symbol list:

- A percent sign may be followed by two hexadecimal digits. When the value is put into the symbol table, the percent sign and the two hexadecimal digits following it are interpreted as the EBCDIC equivalent of the single ASCII character denoted by the two digits. If you want a percent sign in the value in the symbol table, you may put `%25` in the symbol list. If the characters following the percent sign are not two valid hexadecimal digits, the percent sign and the following characters are put into the symbol table as they appear in the symbol list. Note that this restriction does not apply if the UNESCAPED keyword has been specified.
- An ampersand is not allowed. If you want an ampersand in the value in the symbol table, you must put `%26` in the value in the symbol list. Note that this restriction does not apply if the DELIMITER keyword is used to specify a delimiter other than ampersand.
- When the value is put into the symbol table, a plus sign is interpreted as a space. If you want a plus sign in the value in the symbol table, you must put `%2B` in the value in the symbol list. Note that this restriction does not apply if the UNESCAPED keyword has been specified.
- If you want a space in the value in the symbol table, the value in your symbol list may contain a space, a plus sign, or `%20`. Note that this restriction does not apply if the UNESCAPED keyword has been specified.

### **UNESCAPED**

prevents CICS from unescaping symbol values contained in the SYMBOLLIST buffer. If this option is used, plus signs are not converted to spaces, and sequences such as `%2B` are not converted to single byte values.

### **VALUE**(*data-area*)

specifies an area containing the value to be associated with the SYMBOL.

## Conditions

### **INVREQ**

RESP2 values:

- 8** The value specified for DELIMITER is not valid.

### **NOTFND**

RESP2 values:

- 1** The document has not been created or the name is incorrectly specified.

**SYMBOLERR**

a symbol name is invalid. RESP2 values:

- 0** SYMBOLLIST was not used.

**offset** RESP2 contains the offset of the invalid symbol in the list.

## DOCUMENT SET

---

## Chapter 3. EXEC CICS START

## START BREXIT

---

### START BREXIT

Start a task in the 3270 bridge environment and associate it with the named bridge exit.

#### START BREXIT

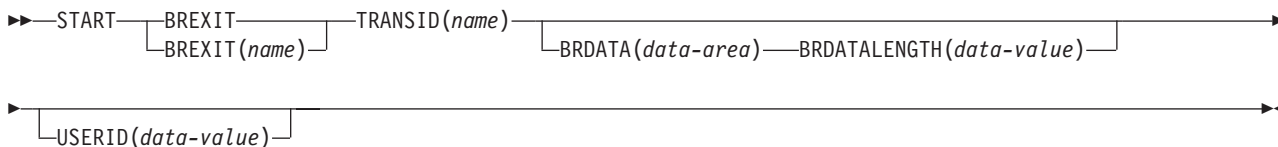

**Conditions:** INVREQ, LENGERR, NOTAUTH, PGMIDERR, TRANSIDERR, USERIDERR

### Description

START BREXIT starts a task immediately in the local CICS region, and initializes the specified transaction (TRANSID) and bridge exit (BREXIT).

In the 3270 bridge environment, all 3270 terminal requests issued by the transaction specified by TRANSID, are intercepted and passed to the user-replaceable program (the bridge exit) specified by BREXIT.

The bridge exit (BREXIT) emulates the 3270 interface by passing the terminal requests to a client application that may be executing inside or outside of CICS.

See the *CICS External Interfaces Guide* for more information about the 3270 bridge and its interfaces.

The attached task cannot be CANCELLED; its STARTCODE is defined by the bridge exit.

#### Passing data to the bridge exit

Data can be passed to the bridge exit using the BRDATA and BRDATALENGTH options.

The following example shows how to start a specified task, in the 3270 bridge environment and pass data to its bridge exit:

```
EXEC CICS START BREXIT('DFH0CBRE')
        TRANSID('TRNL')
        BRDATA(BRSD)
        BRDATALENGTH(72)
        :
```

### Options

#### **BREXIT**(name)

specifies the name (1-8 characters) of the bridge exit to be associated with the started task. If no name is specified, the value of BREXIT on the TRANSACTION resource definition for TRANSID is used.



**BRDATA**(*data-area*)

specifies the data to be passed to the bridge exit specified by BREXIT when the task is started.

**BRDATALENGTH**(*data-value*)

specifies a fullword binary data value that is the length of the BRDATA to be passed to the bridge exit specified by BREXIT when the task is started.

**TRANSID**(*name*)

specifies the symbolic identifier (1–4 characters) of the transaction to be executed by a task started as the result of a START BREXIT command. The transaction will be started in the 3270 bridge environment, and will execute in association with the bridge exit specified in BREXIT.

**USERID**(*data-value*)

Specifies the userid under whose authority the started transaction is to run.

## Conditions

**INVREQ**

RESP2 values:

- 11** An attempt was made to route a START BREXIT request.
- 12** A START BREXIT request has failed..
- 18** A USERID is specified and the CICS external security manager interface is not initialized.

Default action: terminate the task abnormally.

**LENGERR**

occurs if BRDATALENGTH is not greater than zero.

Default action: terminate the task abnormally.

**NOTAUTH**

RESP2 values:

- 7** A resource security check fails on TRANSID (name).
- 9** A surrogate user security check fails on USERID (name).

The security access capabilities of the transaction that issued the command do not allow the command to be performed with the value specified in the USERID option.

Default action: terminate the task abnormally.

**PGMIDERR**

occurs if no name is supplied by the BREXIT option and the transaction definition for TRANSID does not provide a default BREXIT name.

Default action: terminate the task abnormally.

**TRANSIDERR**

occurs if the transaction identifier specified in a START BREXIT command has not been defined to CICS.

Default action: terminate the task abnormally.

**USERIDERR**

RESP2 values:

## START BREXIT

- 8 The specified USERID is not known to the external security manager.
- 10 The external security manager is in a state such that CICS cannot determine whether a specified USERID is valid.

Default action: terminate the task abnormally.

---

## Chapter 4. EXEC CICS TS

## DELETEQ TS

---

## DELETEQ TS

Delete a temporary storage queue.

### DELETEQ TS

```
▶▶—DELETEQ TS—[QUEUE(name)] [QNAME(name)] [SYSID(systemname)]▶▶
```

**Conditions:** INVREQ, ISCVREQ, LOCKED, NOTAUTH, QIDERR, SYSIDERR

#### Note for dynamic transaction routing

Using this command could create inter-transaction affinities that adversely affect the use of dynamic transaction routing. See the *CICS Application Programming Guide* for more information about transaction affinities.

## Description

DELETEQ TS deletes all the temporary data associated with a temporary storage queue. All storage associated with the queue is freed.

You should delete temporary data as soon as possible to avoid using excessive amounts of storage.

When a recoverable temporary storage queue is deleted, you must issue a syncpoint before issuing a subsequent WRITEQ TS for the same queue.

## Options

### QUEUE(*name*)

specifies the symbolic name (1–8 characters) of the queue to be deleted. The name may not consist solely of binary zeros and must be unique within the CICS system.

### QNAME(*name*)

an alternative to QUEUE, QNAME specifies the symbolic name (1–16 characters) of the queue to be deleted. The name may not consist solely of binary zeros and must be unique within the CICS system.

### SYSID(*systemname*)

(remote and shared queues only) specifies the system name (1–4 characters) identifying the remote system or shared queue pool to which the request is directed.

## Conditions

### INVREQ

occurs in either of the following situations:

- the queue was created by CICS internal code.
- the queue name specified consists solely of binary zeroes.

Default action: terminate the task abnormally.

**ISCINVREQ**

occurs when the remote system indicates a failure that does not correspond to a known condition.

Default action: terminate the task abnormally.

**LOCKED**

occurs when the request cannot be performed because use of the queue has been restricted owing to a unit of work failing in-doubt.

Default action: terminate the task abnormally.

**NOTAUTH**

occurs when a resource security check has failed on QUEUE(name).

Default action: terminate the task abnormally.

**QIDERR**

occurs when the specified queue cannot be found in either main or auxiliary storage.

Default action: terminate the task abnormally.

**SYSIDERR**

occurs in any of the following situations:

- When the SYSID option specifies a name that is neither the local system nor a remote system (made known to CICS by defining a CONNECTION)
- When the link to the remote system is closed

Default action: terminate the task abnormally.

## READQ TS

## READQ TS

Read data from temporary storage queue.

### READQ TS

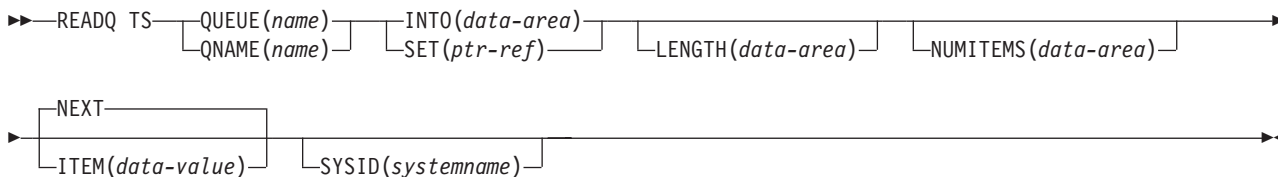

**Conditions:** INVREQ, IOERR, ISCVREQ, ITEMERR, LENGERR, NOTAUTH, QIDERR, SYSIDERR

#### Note for dynamic transaction routing

Using this command could create inter-transaction affinities that adversely affect the use of dynamic transaction routing. See the *CICS Application Programming Guide* for more information about transaction affinities.

## Description

READQ TS retrieves data from a temporary storage queue in main or auxiliary storage.

## Options

### INTO(*data-area*)

specifies the data area into which the data is to be written. The data area can be any variable, array, or structure.

### ITEM(*data-value*)

provides a halfword binary value that specifies the item number of the logical record to be retrieved from the queue.

### LENGTH(*data-area*)

specifies the length, as a halfword binary value, of the record to be read.

If you specify the INTO option, LENGTH need not be specified if the length can be generated by the compiler from the INTO variable.

If you specify INTO, LENGTH defines the maximum length of data that the program accepts. If the value specified is less than zero, zero is assumed. If the length of the data exceeds the value specified, the data is truncated to that value and the LENGERR condition occurs.

On completion of the retrieval operation, the data area is set to the original length of the data record read from the queue.

If you specify the SET option, the LENGTH must be specified.

**NEXT**

specifies retrieval for the next sequential logical record following the last record retrieved (by any task), or the first record if no previous record has been retrieved.

**NUMITEMS**(*data-area*)

specifies a halfword binary field into which CICS stores a number indicating how many items there are in the queue. This only occurs if the command completes normally.

**QUEUE**(*name*)

specifies the symbolic name (1–8 characters) of the queue to be read from.

**QNAME**(*name*)

an alternative to QUEUE, QNAME specifies the symbolic name (1–16 characters) of the queue to be read from.

**SET**(*ptr-ref*)

specifies the pointer reference that is set to the address of the retrieved data. The pointer reference, unless changed by other commands or statements, is valid until the next READQ TS command or the end of task.

If the application program is defined with DATALOCATION(ANY), the address of the data can be above or below the 16MB line. If the application program is defined with DATALOCATION(BELOW), the address of the data is below the 16MB line.

If TASKDATAKEY(USER) is specified for the running task, and storage protection is active, the data returned is in a user-key. If TASKDATAKEY(CICS) is specified and storage protection is active, the data returned is in a CICS-key.

**SYSID**(*systemname*)

(remote and shared queues only) specifies the system name (1–4 characters) identifying the remote system or shared queue pool to which the request is directed.

## Conditions

**INVREQ**

occurs in either of the following situations:

- the queue was created by CICS internal code.
- the queue name specified consists solely of binary zeroes.

Default action: terminate the task abnormally.

**IOERR**

occurs when there is an irrecoverable input/output error.

Default action: terminate the task abnormally.

**ISCINVREQ**

occurs when the remote system indicates a failure that does not correspond to a known condition.

Default action: terminate the task abnormally.

**ITEMERR**

occurs in any of the following situations:

## READQ TS

- The item number specified is invalid (that is, outside the range of item numbers written to the queue).
- An attempt is made to read beyond the end of the queue using the NEXT (default) option.

Default action: terminate the task abnormally.

### LENGERR

occurs when the length of the stored data is greater than the value specified by the LENGTH option.

This condition only applies to the INTO option and cannot occur with SET.

Default action: terminate the task abnormally.

### NOTAUTH

occurs when a resource security check has failed on QUEUE(name).

Default action: terminate the task abnormally.

### QIDERR

occurs when the queue specified cannot be found, either in main or in auxiliary storage.

Default action: terminate the task abnormally.

### SYSIDERR

occurs in any of the following situations:

- When the SYSID option specifies a name that is neither the local system nor a remote system (made known to CICS by defining a CONNECTION).
- When the link to the remote system is closed.

Default action: terminate the task abnormally.

## Examples

The following example shows how to read the first (or only) record from a temporary storage queue into a data area specified in the request; the LENGTH data area is given the value of the length of the record.

```
EXEC CICS READQ TS
      ITEM(1)
      QUEUE(UNIQNAME)
      INTO(DATA)
      LENGTH(LDATA)
```

The following example shows how to read the next record from a temporary storage queue into a data area provided by CICS; the pointer reference specified by the SET option is set to the address of the storage area reserved for the data record, and the LENGTH data area is given the value of the length of the record.

```
EXEC CICS READQ TS
      QUEUE(DESCRQ)
      SET(PREF)
      LENGTH(LENG)
      NEXT
```



## WRITEQ TS

Write data to a temporary storage queue.

### WRITEQ TS

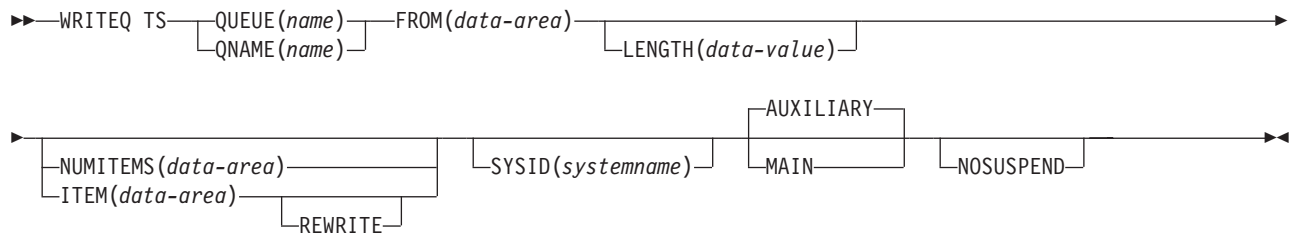

**Conditions:** INVREQ, IOERR, ISCVREQ, ITEMERR, LENGERR, NOSPACE, NOTAUTH, QIDERR, SYSIDERR

#### Note for dynamic transaction routing

Using this command could create inter-transaction affinities that adversely affect the use of dynamic transaction routing. See the *CICS Application Programming Guide* for more information about transaction affinities.

## Description

WRITEQ TS stores temporary data (records) in a temporary storage queue in main or auxiliary storage.

If a queue has been defined as recoverable, the program must not issue a WRITEQ TS if a DELETEQ TS has previously been issued within the same logical unit of work. In other words, following a DELETEQ TS, no WRITEQ TS can be issued until after a syncpoint has occurred.

If there is insufficient space available in the temporary storage data set to satisfy the WRITEQ TS request, the task is suspended until space does become available. (Space may be released by other tasks in the system.) If, however, space is not available in the temporary storage data set, and the NOSUSPEND option has been specified, or there is an active HANDLE CONDITION for NOSPACE, the NOSPACE condition is raised.

## Options

### AUXILIARY

specifies that the temporary storage queue is on a direct access storage device in auxiliary storage. This is the default value for the first write.

This option is ignored for an existing queue.

### FROM(data-area)

specifies the data to be written to temporary storage.

### ITEM(data-area)

specifies, as a halfword binary value, the item number of the logical record to be replaced in the queue (REWRITE option also specified).

## WRITEQ TS

ITEM can be both an input and output field to CICS. As such, programmers should ensure that the ITEM field is not defined within protected storage when issuing a WRITEQ command. If the ITEM value were a literal (for example), command checking (CMDPROT=YES) would result in an AEYD abend occurring.

**Note:** In earlier releases, ITEM on a WRITEQ TS without REWRITE would perform a similar function to NUMITEMS. This function is retained for compatibility.

### **LENGTH**(*data-value*)

specifies the length, as a halfword binary value, of the data to be written.

You must specify this option if you are using SYSID.

The maximum length is 32763.

### **MAIN**

specifies that the temporary storage queue is in main storage.

This option is ignored for an existing queue.:

If you use the MAIN option to write data to a temporary storage queue on a remote system, the data is stored in main storage if the remote system is accessed by the CICS multiregion operation (MRO) facility. If these conditions are not met, the data is stored in auxiliary storage.

If the system is MRO and MAIN is specified, the queue is not recoverable and SYNCPOINT ROLLBACK does not function.

### **NOSUSPEND**

specifies that the application program is not to be suspended if there is insufficient space in the temporary storage data set to satisfy the WRITEQ TS request. Instead, the NOSPACE condition is raised.

Note, however, that if a HANDLE CONDITION for NOSPACE is active when the command is executed, this also overrides the default action, and control is passed to the user label supplied in the HANDLE CONDITION. This takes precedence over the NOSUSPEND option but is, of course, negated by either NOHANDLE or RESP.

This does not apply to temporary storage queues in main storage (MAIN option).

### **NUMITEMS**(*data-area*)

specifies a halfword binary field into which CICS stores a number indicating how many items there are now in the queue, after the WRITEQ TS command is executed.

If the record starts a new queue, the item number assigned is 1; subsequent item numbers follow on sequentially. NUMITEMS is not valid if REWRITE is specified.

### **QUEUE**(*name*)

specifies the symbolic name (1–8 characters) of the queue to be written to. If the queue name appears in the TST, and the entry is marked as remote, the request is shipped to a remote system. The name must be unique within the

CICS system. Do not use X'FA' through X'FF', or \*\*, or \$\$, or DF, as the first character of the name; these characters are reserved for CICS use. The name cannot consist solely of binary zeros.

#### **QNAME**(*name*)

an alternative to QUEUE, QNAME specifies the symbolic name (1–16 characters) of the queue to be written to. If the queue name appears in the TST, and the entry is marked as remote, the request is shipped to a remote system. The name must be unique within the CICS system. Do not use X'FA' through X'FF', or \*\*, or \$\$, or DF, as the first character of the name; these characters are reserved for CICS use. The name cannot consist solely of binary zeros.

#### **REWRITE**

specifies that the existing record in the queue is to be overwritten with the data provided. If the REWRITE option is specified, the ITEM option must also be specified. If the specified queue does not exist, the QIDERR condition occurs. If the correct item within an existing queue cannot be found, the ITEMERR condition occurs and the data is not stored.

#### **SYSID**(*systemname*)

specifies the system name (1–4 characters) identifying the remote system to which the request is directed.

## Conditions

#### **INVREQ**

occurs in any of the following situations:

- A WRITEQ TS command specifies a queue name that consists solely of binary zeros.
- A WRITEQ TS command specifies a queue that is locked and awaiting ISC session recovery.
- The queue was created by CICS internal code.

Default action: terminate the task abnormally.

#### **IOERR**

occurs when there is an irrecoverable input/output error.

Default action: terminate the task abnormally.

#### **ISCINVREQ**

occurs when the remote system indicates a failure that does not correspond to a known condition.

Default action: terminate the task abnormally.

#### **ITEMERR**

occurs in any of the following situations:

- The item number specified in a WRITEQ TS command with the REWRITE option, is not valid (that is, it is outside the range of entry numbers assigned for the queue).
- The maximum number of items (32 767) is exceeded.

Default action: terminate the task abnormally.

#### **LENGERR**

occurs in any of the following situations:

## WRITEQ TS

- The length of the stored data is zero or negative.
- The length of the stored data is greater than 32763.

Default action: terminate the task abnormally.

### **NOSPACE**

occurs when the NOSUSPEND option is specified and there is no space for the data in the auxiliary temporary storage data set.

Also occurs if there is no space and there is an active HANDLE CONDITION for NOSPACE.

Default action: ignore the condition.

### **NOTAUTH**

occurs when a resource security check has failed on QUEUE(name), or QNAME(name).

Default action: terminate the task abnormally.

### **QIDERR**

occurs when the queue specified by a WRITEQ TS command with the REWRITE option cannot be found, either in:

- Main storage
- Auxiliary storage

Default action: terminate the task abnormally.

### **SYSIDERR**

occurs in any of the following situations:

- When the SYSID option specifies a name that is neither the local system nor a remote system (made known to CICS by defining a CONNECTION).
- The link to the remote system is closed.

Default action: terminate the task abnormally.

---

## Chapter 5. EXEC CICS WEB

## WEB ENDBROWSE FORMFIELD

---

### WEB ENDBROWSE FORMFIELD

Signals the end of a FORMFIELD browse.

### WEB ENDBROWSE FORMFIELD

▶▶—WEB—ENDBROWSE—FORMFIELD—◀◀

**Conditions:** INVREQ

### Description

WEB ENDBROWSE FORMFIELD terminates the browse of a set of name-value pairs in an HTML form. The form is part of the body of an HTTP request being processed by the current CICS task. No information is returned on the ENDBROWSE.

### Conditions

#### INVREQ

occurs for the following conditions. RESP2 values are:

- 1 The command is being issued in a non-CICS Web application.
- 3 The command is being issued for a non-HTTP request.
- 4 The command is being issued before a WEB STARTBROWSE command is issued.

---

## WEB ENDBROWSE HTTPHEADER

Signals the end of an HTTP header browse.

### WEB ENDBROWSE HTTPHEADER

▶▶—WEB—ENDBROWSE—HTTPHEADER—◀◀

**Conditions:** INVREQ

## Description

WEB ENDBROWSE HTTPHEADER terminates the browse of HTTP headers. No information is returned on the ENDBROWSE.

## Conditions

### INVREQ

occurs for the following conditions. RESP2 values are:

- 1 The command is being issued in a non-CICS Web interface application.
- 3 The command is being issued for a non-HTTP request.
- 4 The command is being issued before a WEB STARTBROWSE command is issued.

## WEB EXTRACT

## WEB EXTRACT

Obtain information about inbound client request.

### WEB EXTRACT

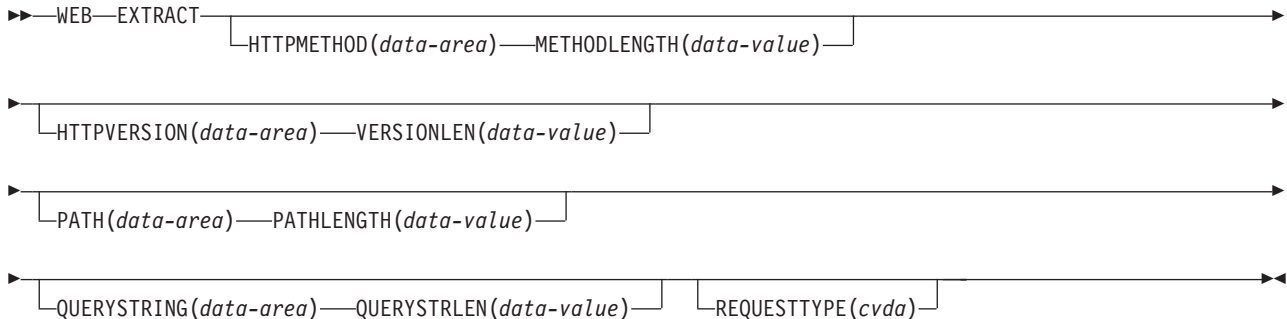

**Conditions:** INVREQ, LENGERR

## Description

WEB EXTRACT allows the application to obtain additional information about the inbound request from the client.

**Note:** This command can also be specified as EXTRACT WEB.

## Options

### HTTPMETHOD(data-area)

specifies a buffer to contain the HTTP method string on the request line of the inbound message.

### HTTPVERSION(data-area)

specifies a buffer to contain the HTTP version string on the request line of the inbound message.

### METHODLENGTH(data-value)

specifies the length of the buffer supplied on the HTTPMETHOD option, and is set to the actual length of the data returned to the application. If the data exceeds the buffer length, a LENGERR condition is raised and the data is truncated. The actual length of the HTTPMETHOD is returned in METHODLENGTH.

### PATH(data-area)

specifies a buffer to contain the PATH specified in the request line of the inbound message.

### PATHLENGTH(data-value)

specifies the length of the buffer supplied on the PATH option, and is set to the actual length of the data returned to the application. If the data exceeds the buffer length, a LENGERR condition is raised and the data is truncated. The actual length of the PATH is returned in PATHLENGTH.

### QUERYSTRING(data-area)

specifies a buffer to contain the query string on the request line of the HTTP request. The query string is the value or values encoded after the question mark (?) delimiting the end of the path on the request line of an HTTP request. The data is passed to the application in its escaped form.



**QUERYSTRLEN(data-value)**

specifies the length of the buffer supplied on the QUERYSTRING option. On returning from CICS, QUERYSTRLEN is set to the actual length of the data returned to the application. If the data exceeds the buffer length, a LENGERR condition is returned and the data is truncated.

**REQUESTTYPE(cvda)**

specifies the type of request received. The request type can be HTTP or NONHTTP.

## Conditions

**INVREQ**

occurs for the following conditions. RESP2 values are:

- 1 The command is being issued in a non-CICS Web interface application.
- 3 The command is being issued for a non-HTTP request (this is set only if one or more of HTTPMETHOD, HTTPVERSION, or PATH is specified and the request is a non-HTTP request).

**LENGERR**

occurs for the following conditions. RESP2 values are:

- 4 The length in METHODLENGTH is less than or equal to zero.
- 5 The length in VERSIONLEN is less than or equal to zero.
- 6 The length in PATHLENGTH is less than or equal to zero.
- 8 The length in QUERYSTRLEN is less than or equal to zero.

## WEB READ FORMFIELD

---

# WEB READ FORMFIELD

Retrieve the value of a field from an HTML form.

## WEB READ FORMFIELD

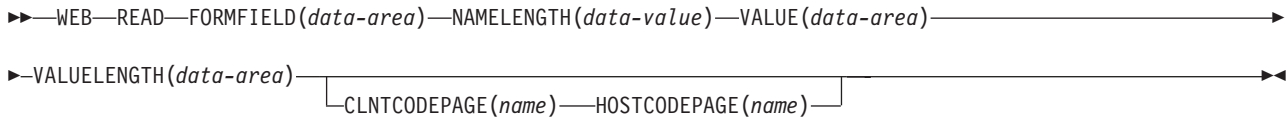

**Conditions:** INVREQ, LENGERR, NOTFND

## Description

WEB READ FORMFIELD retrieves the value of a specific field from an HTML form, the name of which is given on the request in the FORMFIELD parameter. The form is part of the body of an HTTP request being processed by the current CICS task.

## Options

### CLNTCODEPAGE(name)

specifies the 40-character name of the codepage to be used when data is converted from the client codepage. If this is not specified, CICS obtains it from the charset parameter on the Content-Type header of the HTTP request for the current CICS task. If the Content-Type header is not present, CICS uses codepage 819 (ISO-8859-1). If you specify CLNTCODEPAGE you must also specify HOSTCODEPAGE. Valid values for CLNTCODEPAGE are the CICS-supported CLINTCP and SRVERCP values described in *CICS Family: Communicating from CICS on System/390*. Mapping is performed between the IANA Coded Character Set values used in HTTP requests to the CLINTCP values known to CICS; these values are listed in the *CICS Internet Guide*.

### FORMFIELD(data-area)

specifies the name of the form field to extract. It is a string of text containing the name of the requested field. The string of text supplied is not case sensitive.

### HOSTCODEPAGE(name)

specifies the 8-character name of the host codepage to be used when the forms data is converted from the ASCII codepage, it was received in, into the EBCDIC, CICS processes it in. If this is not specified the default (037) is used. If you specify HOSTCODEPAGE you must also specify CLNTCODEPAGE.

### NAMELENGTH(data-value)

specifies the length, as a fullword binary value, of the form field name.

### VALUE(data-area)

specifies the buffer to contain the value of the named form field. CICS unescapes any escaped characters before placing them in the buffer.

### VALUELENGTH(data-area)

specifies the length, as a fullword binary value, of the buffer that is to contain the form field value. If the value exceeds the length of the buffer, it is truncated. If the length of the form field value is less than the size of the buffer, the form field value is placed in the leftmost byte positions. VALUELENGTH contains the actual length of the data returned.

## Conditions

### INVREQ

RESP2 values are:

- 1 The command is being issued in a non-CICS Web application.
- 3 The command is being issued for a non-HTTP request.
- 11 The client codepage cannot be found.
- 12 The server codepage cannot be found.
- 13 No forms data has been supplied in the body of the HTTP request.
- 14 The codepage combination for client and server is invalid.

### LENGERR

RESP2 values are:

- 1 The length in VALUELENGTH is less than or equal to zero.
- 2 The form field value has been truncated during a read operation because the receiving buffer is too small.

### NOTFND

RESP2 values are:

- 1 The form field with the given name cannot be found.

## WEB READ HTTPHEADER

---

## WEB READ HTTPHEADER

Extract HTTP header information.

### WEB READ HTTPHEADER

►►—WEB—READ—HTTPHEADER(*data-area*)—NAMELENGTH(*data-value*)—VALUE(*data-area*)—►  
►—VALUELENGTH(*data-value*)—►◄

**Conditions:** INVREQ, LENGERR, NOTFND

## Description

WEB READ HTTPHEADER extracts HTTP header information.

## Options

### HTTPHEADER(*data-area*)

specifies the name of the HTTP header.

### NAMELENGTH(*data-area*)

specifies the length, as a fullword binary value, of the HTTP header name.

### VALUE(*data-area*)

specifies the buffer to contain the value of the HTTP header being extracted.

### VALUELENGTH(*data-area*)

specifies the length of the buffer supplied on the VALUE option, and is set to the actual length of the data returned to the application. If the data exceeds the buffer length, a LENGERR condition is raised and the data is truncated. The actual length of the VALUE is returned in VALUELENGTH.

## Conditions

### INVREQ

RESP2 values are:

- 1 The command is being issued in a non-CICS Web interface application.
- 3 The command is being issued for a non-HTTP request.

### LENGERR

RESP2 values are:

- 1 The length in VALUELENGTH is less than or equal to zero.
- 2 The header value has been truncated because the receiving buffer is too small.

### NOTFND

RESP2 values are:

- 1 The header with the given name could not be found.

## WEB READNEXT FORMFIELD

Retrieve next name-value pair in an HTML form.

### WEB READNEXT FORMFIELD

```

▶▶—WEB—READNEXT—FORMFIELD(data-area)—NAMELENGTH(data-area)—VALUE(data-area)————▶
▶—VALUELENGTH(data-area)————▶◀

```

**Conditions:** ENDFILE, INVREQ, LENGERR

## Description

WEB READNEXT FORMFIELD retrieves the next name-value pair in an HTML form.

## Options

### FORMFIELD(*data-area*)

specifies the buffer that contains the form field. The case of the name is the same as it is stored in the form.

### NAMELENGTH(*data-area*)

specifies the length, as a fullword binary value, of the form field name. If the length of the form field value is less than the size of the buffer, the form field value is placed in the leftmost byte positions. NAMELENGTH contains the actual length of the data returned.

### VALUE(*data-area*)

specifies the buffer that contains the value corresponding to the name returned in the FORMFIELD data area. CICS unescapes any escaped characters before placing them in the buffer.

### VALUELENGTH(*data-area*)

specifies the length, as a fullword binary value, of the buffer that contains the form field value. If the value exceeds the buffer length, it is truncated. If the length of the form field value is less than the size of the buffer, the form field value is placed in the leftmost byte positions. VALUELENGTH contains the actual length of the data returned.

## Conditions

### ENDFILE

The end of the list of name/value pairs has been reached.

### INVREQ

RESP2 values are:

- 1 The command is being issued in a non-CICS Web application.
- 3 The command is being issued for a non-HTTP request.
- 4 The command is being issued before a WEB STARTBROWSE FORMFIELD has been issued.
- 6 A form field has been found that is not in the expected format.

### LENGERR

RESP2 values are:

## WEB READNEXT FORMFIELD

- 1 NAMELENGTH or VALUELENGTH is less than or equal to zero.
- 4 The form field name has been truncated during a browse operation because the receiving buffer is too small.
- 5 The form field value has been truncated because the receiving buffer is too small.

## WEB READNEXT HTTPHEADER

Retrieve next HTTP header.

### WEB READNEXT HTTPHEADER

```

▶▶—WEB—READNEXT—HTTPHEADER(data-area)—NAMELENGTH(data-value)—VALUE(data-area)————▶
▶—VALUELENGTH(data-value)————▶▶

```

**Conditions:** ENDFILE, INVREQ, LENGERR

## Description

WEB READNEXT HTTPHEADER retrieves the next HTTP header in the list of headers.

## Options

### HTTPHEADER(*data-area*)

specifies the buffer to contain the name of the HTTP header being extracted.

### NAMELENGTH(*data-area*)

specifies the length of the buffer supplied on the HTTPHEADER option, and is set to the actual length of the data returned to the application. If the data exceeds the buffer length, a LENGERR condition is raised and the data is truncated. The actual length of the HTTPHEADER name is returned in NAMELENGTH.

### VALUE(*data-area*)

specifies the buffer to contain the value of the HTTP header being extracted.

### VALUELENGTH(*data-area*)

specifies the length of the buffer supplied on the VALUE option, and is set to the actual length of the data returned to the application. If the data exceeds the buffer length, a LENGERR condition is raised and the data is truncated. The actual length of the VALUE is returned in VALUELENGTH.

## Conditions

### ENDFILE

The end of the list of HTTPHEADERS has been reached.

### INVREQ

RESP2 values are:

- 1 The command is being issued in a non-CICS Web interface application.
- 3 The command is being issued for a non-HTTP request.
- 4 The command is being issued before a WEB STARTBROWSE has been issued.
- 6 A header has been found which is not in the format NAME:VALUE.

### LENGERR

RESP2 values are:

- 1 NAMELENGTH or VALUELENGTH is less than or equal to zero.

## WEB READNEXT HTTPHEADER

- 4 The header name has been truncated during a browse operation because the receiving buffer is too small.
- 5 The header value has been truncated because the receiving buffer is too small.



## WEB RECEIVE

Receive an HTTP request.

### WEB RECEIVE

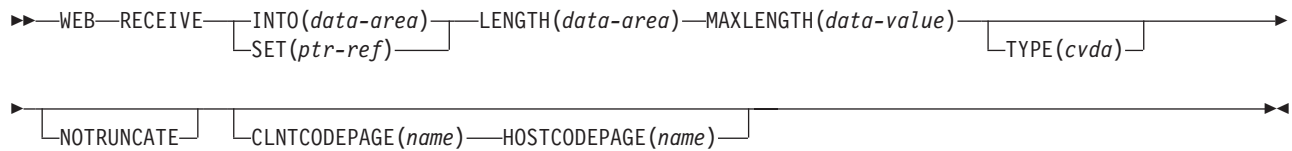

**Conditions:** INVREQ, LENGERR

## Description

WEB RECEIVE receives the body of an HTTP Request from the CICS Web interface or Business Logic Interface into an application-supplied buffer.

## Options

### CLNTCODEPAGE(name)

specifies the 40-character name of the codepage to be used when data is converted from the client codepage. If this is not specified, data is not converted, and is passed to the application in the form in which it was received over the socket connection. If you specify CLNTCODEPAGE you must also specify HOSTCODEPAGE. Valid values for CLNTCODEPAGE are the CICS-supported CLINTCP and SRVERCP values described in *CICS Family: Communicating from CICS on System/390*. Mapping is performed between the IANA Coded Character Set values used in HTTP requests to the CLINTCP values known to CICS; these values are listed in the *CICS Internet Guide*.

### HOSTCODEPAGE(name)

specifies the 8-character name of the host codepage to be used when data is converted from the ASCII codepage in which it was received into the EBCDIC codepage in which CICS will process it. If this is not specified, data is not converted, and is passed to the application in the form in which it was received over the socket connection. If you specify HOSTCODEPAGE you must also specify CLNTCODEPAGE.

### INTO(data-area)

specifies the buffer that is to contain the data being received.

### LENGTH(data-area)

specifies a fullword binary data area which will be set to the length of the data received.

### MAXLENGTH(data-value)

specifies the maximum amount, as a fullword binary value, of data that CICS is to recover, if INTO is specified.

If the length of data exceeds the value specified and the NOTRUNCATE option is not present, the data is truncated to that value and the LENGERR condition occurs. The data area specified in the LENGTH option is set to the original length of data.

## WEB RECEIVE

If the length of data exceeds the value specified and the NOTRUNCATE option is present, CICS retains the remaining data and uses it to satisfy subsequent RECEIVE commands. The data area specified in the LENGTH option is set to the length of data returned.

### **NOTRUNCATE**

specifies that when the data available exceeds the length requested, the remaining data is not to be discarded but is to be retained for retrieval by subsequent RECEIVE commands.

### **SET(ptr-ref)**

specifies a pointer reference that is to be set to the address of data received. The pointer reference is valid until the next receive command or the end of task.

### **TYPE(cvda)**

returns a value of HTTP or NONHTTP to identify whether the data received is an HTTP or non-HTTP message.

## Conditions

### **INVREQ**

RESP2 values:

- 1 the command is issued in a non-CICS Web interface application.

### **LENGERR**

occurs if data is discarded by CICS because its length exceeds the maximum the program accepts. RESP2 values:

- 1 The length is negative.
- 2 The length is positive and exceeds the program's maximum.

---

## WEB RETRIEVE

Retrieve a document token.

### WEB RETRIEVE

►►—WEB—RETRIEVE—DOCTOKEN(*data-area*)—————►►

**Conditions:** INVREQ

## Description

The WEB RETRIEVE command retrieves the DOCTOKEN of the document which was sent using an earlier WEB SEND command.

## Options

### **DOCTOKEN(*data-area*)**

specifies a 16-byte buffer to contain the symbolic name of the document to be retrieved.

## Conditions

### **INVREQ**

RESP2 values:

- 1 The command is issued in a non-CICS Web interface application.
- 2 A WEB SEND command has not been issued.

## WEB SEND

---

## WEB SEND

Select a document for delivery.

### WEB SEND

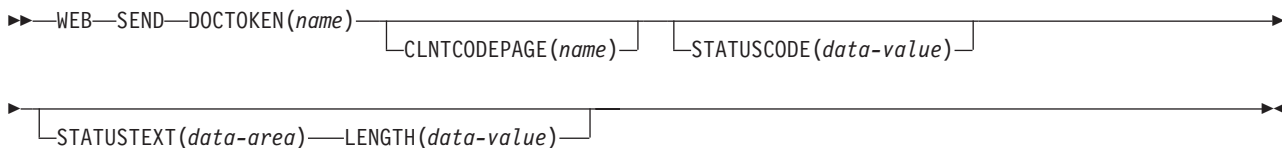

**Conditions:** INVREQ, NOTFND

## Description

WEB SEND selects a document for delivery by the CICS Web interface or the Business Logic Interface.

## Options

### **CLNTCODEPAGE(name)**

specifies the 40-character name of the ASCII codepage in which the data is to be delivered to the browser. If this is not specified, data is not converted, and is sent to the browser in the form in which the application supplied it. Valid values for CLNTCODEPAGE are the CICS-supported CLINTCP and SRVERCP values described in *CICS Family: Communicating from CICS on System/390*. Mapping is performed between the IANA Coded Character Set values used in HTTP requests and the CLINTCP values known to CICS; these values are listed in the *CICS Internet Guide*.

### **DOCTOKEN(name)**

specifies the 16-byte symbolic name of the document to be sent.

### **LENGTH(data-value)**

specifies the length, as a fullword binary value, of the string supplied on the STATUSTEXT option.

### **STATUSCODE(data-value)**

is a binary halfword value to be inserted on the status line. The code is intended to be a HTTP status code and should conform to the rules for HTTP status codes. However, CICS does not validate the code and it is the application's responsibility to ensure that the value is valid.

### **STATUSTEXT(data-area)**

specifies a data-area containing text describing the value of the status code. The status text is intended to be a human-readable value for the status code.

## Conditions

### **INVREQ**

occurs for the following conditions. RESP2 values are:

- 1 The command is being issued in a non-CICS Web interface application.

### **NOTFND**

occurs for the following conditions. RESP2 values are:

## WEB SEND

- 1 The document has not been created or the name is incorrectly specified.
- 7 The specified CLNTCODEPAGE is not recognised or is incorrectly specified.

## WEB STARTBROWSE FORMFIELD

---

# WEB STARTBROWSE FORMFIELD

Signal the start of an HTML form field browse.

## WEB STARTBROWSE FORMFIELD

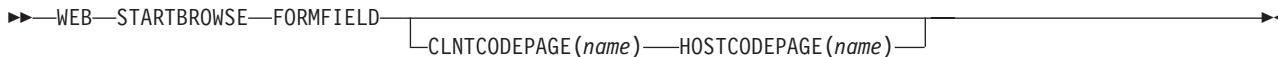

**Conditions:** INVREQ

## Description

WEB STARTBROWSE FORMFIELD signals the start of a browse of a set of name-value pairs in an HTML form that is part of the body of an HTTP request being processed by the current CICS task.

## Options

### CLNTCODEPAGE(name)

specifies the 40-character name of the codepage to be used when data is converted from the client codepage. If this is not specified, CICS obtains it from the charset parameter on the Content-Type header of the HTTP request for the current CICS task. If the Content-Type header is not present, CICS used codepage 819 (ISO-8859-1). If you specify CLNTCODEPAGE you must also specify HOSTCODEPAGE. Valid values for CLNTCODEPAGE are the CICS-supported CLINTCP and SRVERCP values described in *CICS Family: Communicating from CICS on System/390*. Mapping is performed between the IANA Coded Character Set values used in HTTP requests to the CLINTCP values known to CICS; these values are listed in the *CICS Internet Guide*.

### HOSTCODEPAGE(name)

specifies the 8-character name of the host codepage used when data is converted from the ASCII codepage, it was received in, into the EBCDIC, CICS processes it in. If this is not specified the default (037) is used. If you specify HOSTCODEPAGE you must also specify CLNTCODEPAGE.

## Conditions

### INVREQ

occurs for the following conditions. RESP2 values are:

- 1 The command is being issued in a non-CICS Web application.
- 3 The command is being issued for a non-HTTP request.
- 5 There is already a WEB STARTBROWSE in progress.
- 11 The client codepage cannot be found.
- 12 The server codepage cannot be found.
- 13 No forms data has been supplied in the body of the HTTP request.
- 14 The codepage combination for client and server is invalid.

---

## WEB STARTBROWSE HTTPHEADER

Signal the start of an HTTP header browse.

### WEB STARTBROWSE HTTPHEADER

▶▶—WEB—STARTBROWSE—HTTPHEADER—◀◀

**Conditions:** INVREQ

## Description

WEB STARTBROWSE HTTPHEADER signals the start of a browse of the HTTP header information.

## Conditions

### INVREQ

occurs for the following conditions. RESP2 values are:

- 1** The command is being issued in a non-CICS Web interface application.
- 3** The command is being issued for a non-HTTP request.

## WEB WRITE

---

## WEB WRITE

Build HTTP header information.

### WEB WRITE

►►—WEB—WRITE—HTTPHEADER(*data-area*)—NAMELENGTH(*data-value*)—VALUE(*data-area*)—►  
►—VALUELENGTH(*data-value*)—►◄

**Conditions:** INVREQ

## Description

WEB WRITE allows the application to add HTTP header information to the response.

## Options

### **HTTPHEADER(*data-area*)**

specifies the name of the HTTP header to build. It is a string of text containing the name of the header. The name should conform to the standards specified in the current RFC for the HTTP protocol. No validation of the information is done by CICS. If the header already exists, it is replaced with the new information.

### **NAMELENGTH(*data-value*)**

specifies the length, as a fullword binary value, of the HTTP header name.

### **VALUE(*data-area*)**

specifies the value of the HTTP header. It is a text string containing the value of the header.

### **VALUELENGTH(*data-area*)**

specifies the length, as a fullword binary value, of the HTTP header value.

## Conditions

### **INVREQ**

The command is being issued in a non-CICS Web interface environment.



---

## Chapter 6. EXEC CICS EXTRACT TCPIP

## EXTRACT TCPIP

### EXTRACT TCPIP

Obtain information about TCPIP characteristics of the current transaction.

#### EXTRACT TCPIP

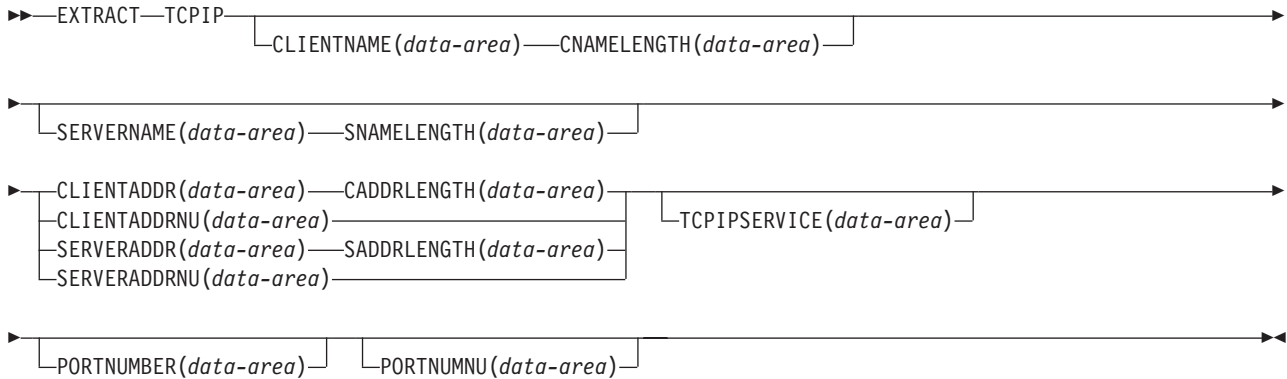

**Conditions:** INVREQ, LENGERR

## Options

### CADDRLENGTH(*data-area*)

specifies the length of the buffer supplied on the CLIENTADDR option, and is set to the actual length of the data returned to the application. If the data exceeds the buffer length, a LENGERR condition is raised and the data is truncated.

### CLIENTADDR(*data-area*)

specifies a buffer to contain the client's TCP/IP address.

### CLIENTADDRNU(*data-area*)

specifies a fullword binary field containing the client's TCP/IP address in binary form.

### CLIENTNAME(*data-area*)

specifies a buffer to contain the client's name as known by the Domain Name Server.

### CNAMELENGTH(*data-area*)

specifies the length of the buffer supplied on the CLIENTNAME option, and is set to the actual length of the data returned to the application. If the data exceeds the buffer length, a LENGERR condition is raised and the data is truncated.

### PORTNUMBER(*data-area*)

Specifies a 5-character field to contain the port number associated with this transaction in character form. This is the port on which the incoming data that initiated this transaction was received.

### PORTNUMNU(*data-area*)

Fullword field to contain the port number associated with this transaction in binary form. This is the port on which the incoming data that initiated this transaction was received.

**SADDRLENGTH(data-area)**

specifies the length of the buffer supplied on the SERVERADDR option, and is set to the actual length of the data returned to the application. If the data exceeds the buffer length, a LENGERR condition is raised and the data is truncated.

**SERVERADDR(data-area)**

specifies a buffer to contain the server's TCP/IP address in dotted decimal character form (nnn.nnn.nnn.nnn).

**SERVERADDRNU(data-area)**

specifies a fullword binary field containing the server's TCP/IP address in binary form.

**SERVERNAME(data-area)**

specifies a buffer to contain the server's name as known by the Domain Name Server.

**SNAMELENGTH(data-area)**

specifies the length of the buffer supplied on the SERVERNAME option, and is set to the actual length of the data returned to the application. If the data exceeds the buffer length, a LENGERR condition is raised and the data is truncated.

**TCPIPSERVICE(data-area)**

An 8-byte field to contain the name of the TCPIPSERVICE associated with this transaction.

## Conditions

**INVREQ**

RESP2 values:

- 2 An invalid socket response was received.
- 5 The command was issued from a non-TCPIP application.

**LENGERR**

RESP2 values:

- 3 CLIENTADDR is too small to contain the string extracted.
- 4 SERVERADDR is too small to contain the string extracted.
- 6 CLIENTNAME is too small to contain the string extracted.
- 7 SERVERNAME is too small to contain the string extracted.

## EXTRACT TCPIP

---

## Part 3. Using CICS documents

This chapter introduces CICS documents. It tells you what you need to consider when writing applications that use documents as a means of formatting information.

The document handler domain allows you to build up formatted data areas, known as documents. Some examples of how these formatted areas, or documents, can be used, are:

- Sending HTML data to be displayed by a Web browser.
- Creating standard formats for printing (for example, using your own letterhead, address, and so on).



---

## Chapter 7. The DOCUMENT application programming interface

This section explains the function and use of the commands in the DOCUMENT application programming interface:

- EXEC CICS DOCUMENT CREATE
- EXEC CICS DOCUMENT INSERT
- EXEC CICS DOCUMENT RETRIEVE
- EXEC CICS DOCUMENT SET

---

### Creating a document

To create an empty document, use the EXEC CICS DOCUMENT CREATE command. This has a mandatory DOCTOKEN parameter requiring a 16-byte data-area. The document handler domain uses the DOCTOKEN operand to return a token, which is used to identify the document on subsequent calls. The following example creates an empty document, and returns the token in the variable MYDOC:

```
EXEC CICS DOCUMENT CREATE
      DOCTOKEN(MYDOC)
```

To create a document with data, use the EXEC CICS DOCUMENT CREATE command in any of the following ways:

- Specify the BINARY parameter
- Specify the TEXT parameter
- Insert one document into another document
- Use document templates

### The BINARY parameter

Use this parameter to add to the document the contents of a data-area that must not undergo conversion to a client code page when the data is sent.

```
EXEC CICS DOCUMENT CREATE
      DOCTOKEN(MYDOC1)
      BINARY(DATA-AREA)
```

### The TEXT parameter

Use this parameter to add the specified contents to the document. For example, if you define a character string variable called DOCTEXT and initialise it to *This is an example of text to be added to a document*, you can use the following command to create a document consisting of this text string:

```
EXEC CICS DOCUMENT CREATE
      DOCTOKEN(MYDOC2)
      TEXT(DOCTEXT)
      LENGTH(53)
```

### Inserting one document into another

To insert an existing document into a new document, you can use the EXEC CICS DOCUMENT CREATE command with the FROMDOC option. The following example does this:

```
EXEC CICS DOCUMENT CREATE
      DOCTOKEN(MYDOC3)
      FROMDOC(MYDOC2)
```

where MYDOC2 and MYDOC3 are 16-character variables. MYDOC2 must contain the token returned by a previous EXEC CICS DOCUMENT CREATE command.

This results in two identical documents, each containing the text *This is an example of text to be added to a document.*

## Using document templates

Portions of the data which make up a document can be created off-line and then inserted directly into the document. These are known as **templates**; they are CICS resources, defined using RDO.

Templates can contain a mixture of static data with symbols embedded in the data, which are substituted at run time when the template is inserted into the document. An example of this is when a programmer creates HTML web pages using an HTML editor. The output from the HTML editor can then be made accessible to CICS Web Interface applications using templates.



---

## Chapter 8. Programming with documents

This section covers the following topics:

- Symbols and symbol lists
- Embedded DOCTEMPLATE commands
- Using DOCTEMPLATES in your application
- The lifespan of a document
- Retrieving the document without control information
- Using multiple calls to construct a document
- Bookmarks and inserting data
- Replacing data in the document
- Codepages and codepage conversion

---

### Setting symbol values

The application program needs to define values for the symbols that will be substituted when the template is used. These values can be defined on the EXEC CICS DOCUMENT CREATE or the EXEC CICS DOCUMENT SET commands. The symbols that are set are associated with a particular document and cannot be used in a different document.

The DOCUMENT CREATE and DOCUMENT SET commands both take a SYMBOLLIST operand which allows several symbols to be defined in a single command. The SYMBOLLIST operand is a character string consisting of one or more definitions with single byte separators. By default, the separator is an ampersand, but you can override this by using the DELIMITER option of the DOCUMENT SET or DOCUMENT CREATE commands. A definition consists of a name, an equals sign, and a value. Here is an example:

```
mytitle=New Authors&auth1=Halliwell Sutcliffe&auth2=Stanley  
Weyman
```

This example defines three symbols. The first symbol called mytitle will have the value 'New Authors'. The second symbol called auth1 will have the value 'Halliwell Sutcliffe' and the last symbol called auth2 will contain the value 'Stanley Weyman'.

The following rules apply when setting symbols using a SYMBOLLIST. The name must contain only uppercase and lowercase letters, numbers and the special characters dollar ('\$'), underscore ('\_'), hyphen ('-'), pound ('#'), period ('.') and at sign ('@'). The name is case-sensitive, so uppercase letters are regarded as different from lowercase letters.

The values in the symbol list can contain any characters except the symbol separator (which defaults to an ampersand, but can be overridden by use of the DELIMITER option). The following restrictions on the use of the percent sign ("%") and the plus sign ("+") apply unless the UNESCAPED option of DOCUMENT CREATE or DOCUMENT SET has been specified.. A percent sign must be followed by two characters that are hexadecimal digits (that is, 0–9, a-f, and A-F). When the value is put into the symbol table, a plus sign is interpreted as a space, a percent sign and the two hexadecimal digits following it are interpreted as the EBCDIC equivalent of the single ASCII character denoted by the two digits, and the remaining characters are left as they are. If you want a plus sign in the value in the symbol table, you must put %2B in the value in the symbol list. If you want a percent sign in the value in the symbol table, you must put in the value %25 in the symbol list. If you want an ampersand in the value in the symbol table, you must

put %26 in the value in the symbol list. If you want a space in the value in the symbol table, the value in your symbol list may contain a space, a plus sign, or a %20.

The DOCUMENT SET command allows you to set individual symbol values with the SYMBOL and VALUE options. Ampersands have no special significance when used in the VALUE option. The restrictions on the use of the plus sign and percent sign for SYMBOLLISTS also apply to the VALUE option unless the UNESCAPED option of the DOCUMENT SET has been specified.

The following example shows you how you can pass symbol values to the document handler containing embedded plus signs, percent signs, and ampersands, none of which are to undergo unescape processing:

```
EXEC CICS DOCUMENT CREATE
      DOCTOKEN(ATOKEN)
      DELIMITER('!')
      SYMBOLLIST('COMPANY=BLOGGS & SON!ORDER=NUTS+BOLTS')
      LISTLENGTH(37)
      UNESCAPED
```

Here the symbol COMPANY has a value of 'BLOGGS & SON', and the symbol ORDER has a value of 'NUTS+BOLTS'. The delimiter used in this example is '!', but it is best to use a non-printable character that does not appear in the symbol value. The use of the UNESCAPED option ensures that the plus sign in 'NUTS+BOLTS' does not get converted to a space.

---

## Embedded template commands

The Document Handler recognises four commands which can be embedded in the template. Three of the commands follow the syntax rules for Server Side Include commands. A Server Side Include command starts with the characters left angle bracket, exclamation mark, hyphen, hyphen, pound followed by the command and it is terminated with the characters hyphen, hyphen, right angle bracket. For example: (e.g. <!--#command -->).

The three commands that are supported are #set, #echo and #include.

The #set command is used to set the values of symbols and is useful for setting up default values for symbols. The #set command in the template will be ignored if the symbol has already been given a value using the EXEC CICS DOCUMENT SET command. If a previous #set command has been used to assign a value to the symbol, the value will be overridden. A symbol which has been assigned a value using the EXEC CICS DOCUMENT SET command can only be changed by issuing another EXEC CICS DOCUMENT SET command.

The #echo command identifies a symbol that must be substituted when the template is inserted into the document. The string containing the #echo command will be completely replaced by the value associated with the symbol. If no symbol has been defined with that name, the #echo command will remain in the output data. An alternative method to using the #echo command is to specify the symbol name, preceding it with an ampersand and terminating it with a semicolon. If we set a symbol called ASYM and give it a value of 'sample', the following two templates will give the same result after substitution.

```
Template 1:
  This is an example template.
  <!--#set var=ASYM value='sample'-->
  This is a &!--#echo var=ASYM--> symbol.
```

```

Template 2:
  This is an example template.
  <!--#set var=ASYM value='sample'-->
  This is a &ASYM; symbol.
Result of substitution:
  This is an example template.
  This is a sample symbol.

```

The #include command allows a template to be embedded within another template. Up to 32 levels of embedding are allowed.

---

## Using templates in your application

If you have created a template and defined it to CICS, the following example shows how you can use the template to create the contents of a document. The following template is created and defined to CICS with the name ASampleTemplate.

```

<!--#set var=ASYM value='DFLTUSER'-->
This is a sample document which has been created by user
<!--#echo var=ASYM-->.

```

In the application program, you can define a 48-byte variable called `TEMPLATENAME` and initialize it to a value of 'ASampleTemplate'. Once again you must define a 16-byte field for the document token (in this example, `ATOKEN`). You can then issue the command to create the document.

```

EXEC CICS DOCUMENT CREATE
      DOCTOKEN(ATOKEN)
      TEMPLATE(TEMPLATENAME)

```

This will result in a document being created with the content “This is a sample document which has been created by user DFLTUSER.”.

To change the symbol to another value, you can issue the `EXEC CICS DOCUMENT CREATE` command with the `SYMBOLLIST` option:

```

EXEC CICS DOCUMENT CREATE
      DOCTOKEN(ATOKEN)
      TEMPLATE(TEMPLATENAME)
      SYMBOLLIST('ASYM=Joe Soap')
      LISTLENGTH(13)

```

This will result in a document being created with the content “This is a sample document which has been created by user Joe Soap.”.

---

## The lifespan of a document

Documents created by an application exist only for the length of the CICS task in which they are created. This means that when the last program in the CICS task returns control to CICS, all documents created during the task’s lifetime are deleted. It is the application’s responsibility to save a document before terminating if the document is going to be used in another task. You can obtain a copy of the document by using the `EXEC CICS DOCUMENT RETRIEVE` command. The application can then save this copy to a location of its choice, such as a temporary storage queue. The copy can then be used to recreate the document.

The following sequence of commands show how a document can be created, retrieved and stored on a temporary storage queue, assuming that the following variables have been defined and initialised in the application program:

- A 16-byte field `ATOKEN` to hold the document token

- A 20-byte buffer DOCBUF to hold the retrieved document
- A fullword binary field called FWORDLEN to hold the length of the data retrieved
- A halfword binary field called HWORDLEN to hold the length for the temporary storage WRITE command.

```
EXEC CICS DOCUMENT CREATE
      DOCTOKEN(ATOKEN)
      TEXT('A sample document.')
      LENGTH(18)

EXEC CICS DOCUMENT RETRIEVE
      DOCTOKEN(ATOKEN)
      INTO(DOCBUF)
      LENGTH(FWORDLEN)
      MAXLENGTH(20)

EXEC CICS WRITEQ TS
      QUEUE('AQUEUE')
      FROM(DOCBUF)
      LENGTH(HWORDLEN)
```

You can now use the following sequence of commands to recreate the document in the same or another application.

```
EXEC CICS READQ TS
      QUEUE('AQUEUE')
      INTO(DOCBUF)
      LENGTH(HWORDLEN)

EXEC CICS DOCUMENT CREATE
      DOCTOKEN(ATOKEN)
      FROM(DOCBUF)
      LENGTH(FWORDLEN)
```

When the document is retrieved, the data that is delivered to the application buffer is stored in a form which contains control information necessary to reconstruct an exact replica of the document. The document that is created from the retrieved copy is therefore identical to the original document. To help the application calculate the size of the buffer needed to hold a retrieved document, each document command which alters the size of the document has a DOCSIZE option. This is a fullword value which gives the maximum size that the buffer must be to contain the document when it is retrieved. This size is calculated to include all the control information and data. The size should not be taken as an accurate size of the document as the actual length delivered to the application can often be slightly smaller than this size. The length delivered will however never exceed the length in the DOCSIZE option.

The above example introduced the use of the FROM option on the DOCUMENT CREATE command. The data passed on the FROM option was the buffer returned to the application when the DOCUMENT RETRIEVE command was issued. It is possible for the application to supply data on the FROM option that did not originate from the DOCUMENT RETRIEVE command. When this happens, the document handler treats the data as a template and parses the data for template commands and symbols.

## Retrieving the document without control information

The document data containing control information is only useful to an application that wishes to recreate a copy of the original document. It is possible to issue a DOCUMENT RETRIEVE command and ask for the control information to be omitted. The following command sequence uses the DATAONLY option on the

DOCUMENT RETRIEVE command to instruct the Document Handler to return only the data. This example assumes that the following variables have been defined and initialised in the application program:

- A 16-byte field ATOKEN to hold the document token
- A 20-byte buffer DOCBUF to hold the retrieved document
- A fullword binary field called FWORDLEN to hold the length of the data retrieved.

```
EXEC CICS DOCUMENT CREATE
      DOCTOKEN(ATOKEN)
      TEXT('A sample document.')
      LENGTH(18)

EXEC CICS DOCUMENT RETRIEVE
      DOCTOKEN(ATOKEN)
      INTO(DOCBUF)
      LENGTH(FWORDLEN)
      MAXLENGTH(20)
      DATALONLY
```

When the commands have executed, the buffer DOCBUF will contain the string “A sample document.”.

## Using multiple calls to construct a document

Once a document has been created, the contents can be extended by issuing one or more EXEC CICS DOCUMENT INSERT commands. The options on the EXEC CICS DOCUMENT INSERT command work in the same way as the equivalent commands on the EXEC CICS DOCUMENT CREATE command. The following sequence of commands shows an empty document being created followed by two INSERT commands:

```
EXEC CICS DOCUMENT CREATE
      DOCTOKEN(ATOKEN)

EXEC CICS DOCUMENT INSERT
      DOCTOKEN(ATOKEN)
      TEXT('Sample line 1. ')
      LENGTH(15)

EXEC CICS DOCUMENT INSERT
      DOCTOKEN(ATOKEN)
      TEXT('Sample line 2. ')
      LENGTH(15)
```

The document resulting from the above commands will contain:

Sample line 1. Sample line 2.

You can use the DOCUMENT RETRIEVE and DOCUMENT INSERT commands to insert a whole document into an existing document. The following variables must first be defined and initialized in the application program:

- A 16-byte field RTOKEN which contains the document token of the document to be retrieved
- A buffer DOCBUF of sufficient length to hold the retrieved document
- A fullword binary field called RETRIEVLLEN to hold the length of the data retrieved
- A fullword binary field called MAXLEN to hold the maximum amount of data the buffer can receive, i.e. the length of DOCBUF
- A 16-byte field ITOKEN which contains the document token of the document that is being inserted into

The following sequence of commands shows a document indicated by RTOKEN being inserted into another document indicated by ITOKEN:

```
EXEC CICS DOCUMENT RETRIEVE
      DOCTOKEN(RTOKEN)
      INTO(DOCBUF)
      LENGTH(RETRIEVLN)
      MAXLENGTH(MAXLEN)
```

```
EXEC CICS DOCUMENT INSERT
      DOCTOKEN(ITOKEN)
      FROM(DOCBUF)
      LENGTH(RETRIEVLN)
```

The retrieved document is inserted at the end of the document specified in the DOCUMENT INSERT command, and all the control information of the retrieved document will be present in the second document. The LENGTH parameter of the DOCUMENT INSERT command must be equal to the value returned from the DOCUMENT RETRIEVE command into the field RETRIEVLN.

The DOCUMENT INSERT command allows an operand called SYMBOL to be used to add blocks of data to the document. SYMBOL must contain the name of a valid symbol whose value has been set. The Document Handler inserts the value that is associated with the symbol into the document.

## Bookmarks and inserting data

The sequence in which an application inserts data into a document might not reflect the desired sequence that the data should appear in the document. Bookmarks allow the application to insert blocks of data in any order yet still control the sequence of the data in the document. A bookmark is a label that the application inserts between blocks of data. Note: a bookmark cannot be inserted in the middle of a block of data.

The following example creates a document with two blocks of text and a bookmark:

```
EXEC CICS DOCUMENT CREATE
      DOCTOKEN(ATOKEN)
      TEXT('Pre-bookmark text. ')
      LENGTH(19)

EXEC CICS DOCUMENT INSERT
      DOCTOKEN(ATOKEN)
      BOOKMARK('ABookmark      ')

EXEC CICS DOCUMENT INSERT
      DOCTOKEN(ATOKEN)
      TEXT('Post-bookmark text. ')
      LENGTH(20)
```

The document will now contain:

```
Pre-bookmark text. <ABookmark>Post-bookmark text.
```

Note that the text <ABookmark> does not appear in the document content but serves merely as a pointer to that position in the document. To add data to this document, you can insert text at the bookmark as follows:

```
EXEC CICS DOCUMENT INSERT
      DOCTOKEN(ATOKEN)
      TEXT('Inserted at a bookmark. ')
      LENGTH(25)
      AT('ABookmark      ')
```

Logically, the data of the document will contain the following (Note that in this instance, only the data is being shown and not the position of the bookmark).

Pre-bookmark text. Inserted at a bookmark. Post-bookmark text.

If the AT option is omitted, the data is always appended to the end of the document. A special bookmark of 'TOP' can be used to insert data at the top of the document, making it unnecessary to define a bookmark which will mark the top of the document.

## Replacing data in the document

The following example shows how data between two bookmarks can be replaced:

```
EXEC CICS DOCUMENT CREATE
      DOCTOKEN(ATOKEN)

EXEC CICS DOCUMENT INSERT
      DOCTOKEN(ATOKEN)
      TEXT('Initial sample text. ')
      LENGTH(21)

EXEC CICS DOCUMENT INSERT
      DOCTOKEN(ATOKEN)
      BOOKMARK('BMark1          ')

EXEC CICS DOCUMENT INSERT
      DOCTOKEN(ATOKEN)
      TEXT('Text to be replaced. ')
      LENGTH(21)

EXEC CICS DOCUMENT INSERT
      DOCTOKEN(ATOKEN)
      BOOKMARK('BMark2          ')

EXEC CICS DOCUMENT INSERT
      DOCTOKEN(ATOKEN)
      TEXT('Final sample text. ')
      LENGTH(19)
```

At this point the logical structure of the document will be as follows:

```
Initial sample text. <BMark1>Text to be replaced. <BMark2>Final
sample text.
```

You can now issue the command to replace the text between the two bookmarks, BMark1 and BMark2:

```
EXEC CICS DOCUMENT INSERT
      DOCTOKEN(ATOKEN)
      TEXT('Replacement Text. ')
      LENGTH(18)
      AT('BMark1          ')
      TO('BMark2          ')

```

The document now has the following logical structure:

```
Initial sample text. <BMark1>Replacement Text. <BMark2>Final
sample text.
```

## Codepages and codepage conversion

The documents that an application creates may be transmitted to systems running on other platforms, especially when applications running under the CICS Web interface use the Document Handler to generate Web pages. To assist the application with the problem of converting data from the codepages used on the host to the codepages used on the target system, the Document Handler allows the application to specify the codepages being used on each system. When the EXEC CICS DOCUMENT CREATE and EXEC CICS DOCUMENT INSERT commands are used, the TEXT, FROM, TEMPLATE and SYMBOL options can have a HOSTCODEPAGE option coded to indicate the codepage for that block of data,

since the data being added with these options is seen as being textual data. Each block can be specified in a different codepage. When the EXEC CICS DOCUMENT RETRIEVE command is issued, the CLNTCODEPAGE option tells the Document Handler to convert all the individual blocks from their respective host codepages into a single client codepage.



---

## Part 4. CICS Resource Definitions Online Changes



---

## Chapter 9. DOCTEMPLATE

---

Use this resource definition to define document templates to CICS. Document templates allow you to perform variable substitution on documents in a manner similar to that done by BMS for 3270 screens.

The template can reside in any one of the following places:

- VSE/ESA sub-library
- CICS temporary storage
- CICS transient data
- CICS load module
- exit program

---

### Defining a DOCTEMPLATE

```
DOctemplate ==>
Group ==>
DEscription ==>
FULL TEMPLATE NAME
TEmlatename ==>
ASSOCIATED CICS RESOURCE
File ==>
TSqueue ==>
TDqueue ==>
Program ==>
Exitpgm ==>
TEMPLATE SUBLIBRARY
Library ==>
Membername ==>
TEMPLATE PROPERTIES
Appendcrlf ==> Yes Yes | No
TType ==> Binary | Ebcdic
```

Figure 1. The DEFINE panel for DOCTEMPLATE

---

### Options

#### **APPENDCRLF**

specifies whether CICS is to delete trailing blanks from and append carriage-return line-feed to each logical record of the template.

#### **LIBRARY**

specifies the library name of the VSE/ESA library containing the template. The library applies only to a template of type VSE/ESA library. If a membername is supplied without a value for library, the default value DFHHTML is used. The template must be in sub-library called DFHDOC.

#### **DESCRIPTION(*text*)**

You can provide a description of the resource you are defining in this field. The DESCRIPTION text can be up to 58 characters in length. There are no restrictions on the characters that you may use. However, if you use parentheses, ensure that for each left parenthesis there is a matching right one. For each single apostrophe in the text, code two apostrophes.

## DOCTEMPLATE

### DOCTEMPLATE

specifies the name of this DOCTEMPLATE definition. The name can be up to eight characters in length. The acceptable characters are: A-Z 0-9 \$ @ # . / - \_ % & ¢ ? ! : | " = ~ , ; < and >.

### EXITPGM

specifies the exit program to be invoked when a request is made for this template. CICS passes a commarea to the exit program which is mapped by the following copybooks:

- DFHDHTXD (Assembler)
- DFHDHTXH (C)
- DFHDHTXL (PL/I)
- DFHDHTXO (COBOL)

### FILE(*filename*)

specifies, for a template of type FILE, the 8-character name of the CICS file definition for the data set containing the template.

### GROUP(*groupname*)

specifies the group name, which can be up to eight characters in length. The characters allowed are A-Z 0-9 @ # and \$. Lowercase characters are treated as uppercase characters. Do not use group names beginning with DFH, because these characters are reserved for use by CICS.

Every resource definition must have a GROUP name. The resource definition becomes a member of the group and is installed in the CICS system when the group is installed. For more information about groups, see *CICS Resource Definition Guide*.

### MEMBER

specifies the name of the member in the PDS containing the template. It applies only to a template of type PDS.

### PROGRAM

specifies the program in which the template data is stored. CICS loads the program and takes all data after the entrypoint to be the template.

### TDQUEUE

specifies the name of the TD queue on which the template is stored.

### TEMPLATENAME

specifies the extended Template-name by which the doctemplate is to be known outside the resource definition function.

### TSQUEUE

specifies the name of the TS queue on which the template is stored.

### TYPE(BINARY|EBCDIC)

specifies the format of the contents of the template.

#### BINARY

When the template is loaded from the template library, no parsing of the template's contents is done.

#### EBCDIC

When the template is loaded from the template library, the contents are parsed as EBCDIC text.

**Note:** The fields EXITPGM, FILE, MEMBER, PROGRAM, TDQUEUE, and TSQUEUE define alternative sources of the template data. Only one of them may be specified on each DOCTEMPLATE definition.

---

## Chapter 10. PROFILE

---

You specify options that control the interactions between transactions and terminals or logical units, as a PROFILE. The PROFILE is a means of standardizing the use of such options as screen size and printer compatibility, and the use of such functions as message journaling and the node error program.

### **MODENAME**

A profile is associated with the communication between a transaction and an LUTYPE6.1 or APPC session to another system. For APPC sessions, you refer on the PROFILE definition to the MODENAME that is also named on the SESSIONS definitions. This MODENAME is the name of the mode set to which the sessions belong. See the *CICS Resource Definition Guide* manual.

When installed in CICS, the information from the PROFILE definition creates an entry in the profile table. This entry is later used by each transaction that references that PROFILE.

There are CICS-supplied PROFILE definitions suitable for most purposes. Each TRANSACTION definition names the PROFILE to be used. If you do not specify a PROFILE, the transaction uses the PROFILE supplied for using a terminal in a standard way.

With CICS intercommunication facilities (for example, function shipping), a PROFILE is needed for the communication between the transaction and the session. The attributes of the CICS-supplied profiles are shown in "PROFILE definitions in group ISC" in the *CICS Resource Definition Guide* manual. The *CICS Intercommunication Guide* gives further information about the CICS-supplied PROFILES, and tells you about defining your own profiles.

## Defining a PROFILE

<b>PROFile</b>	==>	
<b>Group</b>	==>	
Description	==>	
Scrnsize	==> <b>Default</b>	Default   Alternate
Uctran	==> <b>No</b>	No   Yes
MOdename	==>	
Facilitylike	==>	
PRIntercomp	==> <b>No</b>	No   Yes
JOURNALLING		
Journal	==> <b>No</b>	No   1-99
MSGJrn1	==> <b>No</b>	No   INPut   Output   INOut
PROTECTION		
MSGInteg	==> <b>No</b>	No   Yes
Onewte	==> <b>No</b>	No   Yes
PROtect	: <b>No</b>	No   Yes
Chaincontrol	==> <b>No</b>	No   Yes
PROTOCOLS		
DVsuprt	==> <b>All</b>	All   Nonvtam   Vtam
Inbfmh	==> <b>No</b>	No   All   Dip   Eods
RAq	==> <b>No</b>	No   Yes
Logrec	==> <b>No</b>	No   Yes
RECOVERY		
Nepclass	==> <b>000</b>	0-255
RTimout	==> <b>No</b>	No   1-7000

Figure 2. The DEFINE panel for PROFILE

## Options

### CHAINCONTROL({NO|YES})

specifies whether the application program can control the outbound chaining of request units. If you specify CHAINCONTROL(YES), ONEWTE(YES) means one chain and not one terminal control output request.

### DESCRIPTION(*text*)

You can provide a description of the resource you are defining in this field. The DESCRIPTION text can be up to 58 characters in length. There are no restrictions on the characters that you may use. However, if you use parentheses, ensure that for each left parenthesis there is a matching right one. For each single apostrophe in the text, code two apostrophes.

### DVSUPRT({ALL|NONVTAM|VTAM})

specifies the devices (terminals or logical units) that are to be supported. The access method used by a particular terminal or logical unit is specified in its associated TCTTE.

**ALL** The profile can be used with any terminal or logical unit.

#### NONVTAM

The profile can be used only with non-VTAM terminals.

**VTAM** The profile can be used only with logical units.

### FACILITYLIKE(*name*)

This is an optional parameter that specifies the name of an existing (four character) terminal resource definition to be used as a template for the bridge facility. It can be overridden by specifying FACILITYLIKE in the bridge exit.

There is no default value for this parameter.

If you are running in a CICS system started with the VTAM=NO system initialization (SIT) parameter, the resource definition specified by FACILITYLIKE must be defined as a remote terminal.

### **GROUP**(*groupname*)

Every resource definition must have a GROUP name. The resource definition becomes a member of the group and is installed in the CICS system when the group is installed. For more information about groups, see *CICS Resource Definition Guide*.

The GROUP name can be up to eight characters in length. The characters allowed are A-Z 0-9 @ # and \$. Lowercase characters are treated as uppercase characters. Do not use group names beginning with DFH, because these characters are reserved for use by CICS.

### **INBFMH**({NO}ALLIDIPIEODS) (SNA LUs only)

specifies, for profiles used with logical units, whether a function management header (FMH) received from a logical unit is to be passed to the application program.

**ALL** All FMHs (except APPC FMHs and LU6.1 ATTACH and SYNCPOINT FMHs that are processed by CICS) are passed to the application program. This value is required for function shipping transactions such as CSMI, transactions which use distributed transaction processing, and for distributed program link requests.

**DIP** The batch data interchange program (DFHDIP) is to process inbound FMHs. BMS issues a batch data interchange receive request if a BMS receive request has been issued, and a batch data interchange receive request is issued instead of a terminal control receive request.

**EODS** An FMH is passed to the application program only if it indicates end of data set (EODS).

**NO** The FMHs are discarded.

### **JOURNAL**({NO}*number*)

specifies that you want automatic journaling of messages to take place, by giving the identifier of the journal.

**NO** No automatic journaling of messages is to take place.

*number*

The journal identification to be used for automatic journaling. This can be any number in the range 01 through 99. This number is appended to the letters DFHJ to give a journal identification of the form DFHJ*nn*.

### **LOGREC**({NO}IYES)

specifies whether the design of the application requires that each EXEC CICS RECEIVE request is to be satisfied by a logical record. This option allows existing 2770-and 2780-based application programs to be attached to a batch logical unit (for example, 3790 or 8100) without modification to the program.

### **MODENAME**(*name*)

specifies the name that identifies a group of sessions for use on an APPC connection. The name can be up to eight characters in length, and must be the name of a VTAM LOGMODE entry defined to VTAM. It must not be the reserved name SNASVCMG. If you omit the modename, it defaults to blanks. See the *CICS Intercommunication Guide* for more information about VTAM modenames.

## PROFILE

If a transaction that specifies this profile has been started using an EXEC CICS START command, the MODENAME is used for allocation of the principal facility. If a transaction performs an EXEC CICS ALLOCATE command specifying this profile, the MODENAME is used for allocation of the alternate facility.

If you do not specify a MODENAME, CICS selects a session from any one of the mode sets that have been defined.

The CICS-supplied profile DFHCICSA is used, if PROFILE is not specified on an EXEC CICS ALLOCATE command. For function shipping, the profile DFHCICSF is always used. MODENAME is not specified on the definition for either of these profiles, but you can add a MODENAME if you make your own copy. You must then ensure that the mode sets using your MODENAME have been defined in the TERMINAL or SESSIONS definition for all the systems with which communication takes place using APPC.

If a MODENAME is specified and you wish to remove it, delete completely the value previously specified by pressing the ERASE EOF key.

### **MSGINTEG({NOYES}) (SNA LUs only)**

specifies whether a definite response is to be requested with an output request to a logical unit. You cannot specify YES for a pipeline transaction.

### **MSGJRNL({NOINPUTOUTPUTINOUT})**

specifies which messages are to be automatically journaled. If you specify a value other than NO, you must also supply a value for the JOURNAL attribute.

**NO** No message journaling is required.

**INPUT** Journaling is required for input messages.

#### **OUTPUT**

Journaling is to be performed for output messages.

#### **INOUT**

Journaling is to be performed for input and output messages.

### **NEPCLASS({0|value}) (VTAM only)**

specifies the node error program transaction class. This value overrides the value specified on the TYPETERM and SESSION definitions.

**0** This results in a link to the default node error program module for VTAM devices, or is the default value for non-VTAM devices.

*value* The transaction class for the (nondefault) node error program module. The value can be in the range 1 through 255. For programming information on the node error program, see the *CICS Customization Guide*.

### **ONEWTE({NOYES})**

specifies whether the transaction is permitted only one write operation or EXEC CICS SEND during its execution. YES has the effect of forcing the LAST option on the first write of the transaction. Any additional write requests are treated as errors, and the task is made ready for abnormal termination.

You must specify YES for a PIPELINE transaction.

### **PRINTERCOMP({NOYES})**

specifies the level of compatibility required for the generation of data streams to support the printer compatibility option for the BMS SEND TEXT command.



**NO** Each line of output starts with a blank character, so that the format is equivalent to that on a 3270 display where an attribute byte precedes each line.

**YES** No blank character is inserted, so that forms-feed characters included as the first character of your data are honored and the full width of the printer is available for your data.

If you use the BMS forms feed option, specify YES.

**PROFILE(*name*)**

specifies the name of this PROFILE definition. The name can be up to eight characters in length. The acceptable characters are: A-Z 0-9 \$ @ # . / - \_ % & ¢ ? ! : | " = ~ , ; < and >. Do not use profile names beginning with DFH, because these characters are reserved for use by CICS.

**Note:** If you use a comma (,) in a name, you will be unable to use those commands such as

```
CEMT INQUIRE PROFILE(value1,value2)
```

where the comma serves as a list delimiter. See the *CICS Supplied Transactions* manual for information about using lists of resource identifiers.

A profile specifies the options that control the interaction between CICS and a terminal or logical unit. A profile name is specified on the transaction definition to indicate the set of options that control the communication between the transaction and its principal terminal. You can also specify a profile name on an EXEC CICS ALLOCATE command to indicate the options that control communication between the transaction and the allocated session.

CICS supplies a number of profile definitions that are suitable for most purposes. For guidance on the names of the definitions, see the *CICS Operations and Utilities Guide*. Further guidance is also given in the *CICS Intercommunication Guide*.

**PROTECT({NO|YES}) (SNA LUs only)**

This attribute is obsolete from CICS Transaction Server for VSE/ESA, but is retained for compatibility with earlier releases. If you already use PROTECT, you can still access it by using compatibility mode (see *CICS Resource Definition Guide* for information). See *CICS Resource Definition Guide* for a description of PROTECT.

**RAQ({NO|YES}) (SNA terminals only)**

specifies whether the 'read ahead queuing' option is required.

**NO** The transaction obeys SNA protocols and only SEND and RECEIVE when in the correct mode. If it does not follow the protocol, it may be abended with code ATCV.

**YES** The transaction may not obey SNA protocols, and CICS queues incoming data on temporary storage until the data is specifically requested by the transaction. RAQ(YES) is provided only for compatibility with transactions that support both bisynchronous devices and logical units, and its use is not recommended.

**RTIMOUT({NO|*value*})**

specifies the time-out value for the read time-out feature. The task that is timed

## PROFILE

out receives an AKCT or AZCT abend. (Note that if a value is specified and you wish to let it default to NO, you must completely delete the value previously specified.)

RTIMOUT has no effect for MRO or basic (unmapped) APPC connections.

**NO** The read time-out feature is not required.

*value* This is an interval (MMSS for minutes and seconds) after which the task is terminated if no input has been received from the terminal. The maximum value that can be specified is 70 minutes. The value specified in this option is rounded up to units of 16.78 seconds. Thus, the minimum value (after rounding-up) is 16.78 seconds.

### **SCRNSIZE({DEFAULT|ALTERNATE})**

specifies whether the DEFAULT or ALTERNATE buffer size for a 3270 display or printer is to be used. For further information on the choice of screen sizes and buffer sizes, refer to the ALTSCREEN and DEFSCREEN attributes on the TYPETERM definition.

The SCRNSIZE value is ignored if the TYPETERM definition has ALTSCREEN(0,0) and DEFSCREEN(0,0). That is, the screen size is assumed from the related TERMMODEL attribute in the TYPETERM definition; the page size is taken from PAGESIZE, and the ALTPAGE value is ignored. The 3270 erase write (EW) command is inserted for output requests with the ERASE option.

### **ALTERNATE**

If the TYPETERM definition has nonzero ALTSCREEN, the alternate screen size mode is applied, using the erase write alternate (EWA) command. That is, whenever a terminal output request with the ERASE option is issued, the 3270 EWA command is inserted in the data stream. The ALTSCREEN value is assumed as the screen size, and BMS uses the value in ALTPAGE as the page size.

SCRNSIZE(ALTERNATE) may be used for all CICS service transactions (for example, CSMT).

### **DEFAULT**

If the TYPETERM definition has nonzero ALTSCREEN or nonzero DEFSCREEN, the default screen size mode is applied, using the erase write (EW) command. That is, whenever the terminal issues a terminal output request with the ERASE option, the 3270 EW command is inserted in the data stream. The screen size specified in the DEFSCREEN attribute is assumed, and BMS uses the value specified in the PAGESIZE attribute as the page size.

**Note:** Both DEFAULT and ALTERNATE can be overridden by the DEFAULT and ALTERNATE options on the SEND MAP, SEND TEXT, and SEND CONTROL commands. See the *CICS Application Programming Reference* manual for programming information about these commands.

### **UCTRAN({NO}|YES}) (VTAM only)**

specifies whether terminal input is to be translated to uppercase before passing to programs for the transaction using this profile.

You can also request translation to uppercase at the terminal level on the associated TYPETERM definition (see *CICS Resource Definition Guide*) but be aware of the following points:

## PROFILE

- A TYPETERM UCTRAN(YES) definition overrides a PROFILE UCTRAN(NO) definition. So, if you specify TYPETERM UCTRAN(YES), a PROFILE UCTRAN(NO) has no effect.
- A PROFILE UCTRAN(YES) definition overrides a TYPETERM UCTRAN(NO) definition.
- Specifying TYPETERM UCTRAN(TRANID) causes the tranid to be translated to uppercase so that CICS can locate the transaction definition. All other input received by the application is translated according to what is specified for PROFILE UCTRAN.
- UCTRAN(YES) on a profile definition does not cause translation of the input data until an EXEC CICS RECEIVE or CONVERSE is executed. This means that if the transaction is routed through a dynamic routing program, for example DFHDYP, the copy of the input data passed to the routing program is unaffected by the UCTRAN option of the PROFILE definition.

**Note:** In a transaction routing environment where your VTAM terminals have a remote definition on the AOR, and the AOR has a different UCTRAN value from the TOR, the TOR value of UCTRANST (as specified in an EXEC CICS SET TERMINAL command) overrides that on the AOR.

Table 1 shows which portion of the terminal input is translated (transaction id and/or data) according to the setting of the UCTRAN on the PROFILE and TYPETERM resource definitions.

Table 1. The effect of UCTRAN attributes on tranid and data translation

Profile (PROFILE)	Terminal (TYPETERM)		
	UCTRAN (YES)	UCTRAN (NO)	UCTRAN (TRANID)
<b>UCTRAN (YES)</b>	Tranid: Yes Data: yes	Tranid: No Data: Yes	Tranid: Yes Data: Yes
<b>UCTRAN (NO)</b>	Tranid: Yes Data: Yes	Tranid: No Data: No	Tranid: Yes Data: No

## CICS Web support

---

## Chapter 11. TCPIP SERVICE

---

Use this resource definition to define which TCP/IP services are to use CICS internal sockets support. The internal CICS service that can be defined is the CICS Web Interface.

The TCPIP SERVICE definition allows you to manage these internal CICS interfaces, with CICS listening on multiple ports, with different flavors of CICS Web support on different ports.

---

### Defining a TCPIP SERVICE

```
OVERTYPE TO MODIFY
CEDA DEFINE TCpipservice(      )
TCpipservice ==>
Group        ==>
Description  ==>
Urm         ==>
Portnumber   ==> 00000          1-65535
STatus      ==> Open          Open | Closed
TRansaction ==>
Backlog     ==> 00001          0-32767
TSqprefix   ==>
Ippaddress  ==>
Socket Close ==> No           No | 0-240000
```

Figure 3. The DEFINE panel for the TCPIP SERVICE resource definition

---

### Options

#### **BACKLOG**(*number*)

specifies the number of TCP/IP connections for this service which are queued in TCP/IP before TCP/IP starts to reject incoming client requests.

#### **DESCRIPTION**(*text*)

You can provide a description of the resource you are defining in this field. The DESCRIPTION text can be up to 58 characters in length. There are no restrictions on the characters that you may use. However, if you use parentheses, ensure that for each left parenthesis there is a matching right one. For each single apostrophe in the text, code two apostrophes.

#### **GROUP**(*groupname*)

Every resource definition must have a GROUP name. The resource definition becomes a member of the group and is installed in the CICS system when the group is installed. For more information about groups, see *CICS Resource Definition Guide*.

The GROUP name can be up to eight characters in length. The characters allowed are A-Z 0-9 @ # and \$. Lowercase characters are treated as uppercase characters. Do not use group names beginning with DFH, because these characters are reserved for use by CICS.

## TCPIPSERVICE

### IPADDRESS

specifies the dotted decimal IP address on which this TCPIPSERVICE will listen for incoming connections. It must be of the form nnn.nnn.nnn.nnn where nnn is 0 through 255. Possible values are:

**blank** When no IP address is specified, the default is *INADDR\_ANY*

*value* The TCPIPSERVICE accepts connections on this particular address. If the address specified is not known to TCP/IP on the VSE/ESA host, the TCPIPSERVICE will not open. If you enter a specific address here, this definition may not be valid for CICS servers running on other VSE/ESA partitions, and you may not be able to share the definition with those servers.

#### *INADDR\_ANY*

The TCPIPSERVICE listens on any of the addresses known to TCP/IP for the VSE/ESA host. It is possible to have multiple IP addresses defined for a host. Specifying *INADDR\_ANY* also allows for the TCPIPSERVICE definition to be shared among CICS servers.

### PORTNUMBER(*number*)

specifies, in the range 1 through 65535, the decimal number of the port on which CICS is to listen for incoming client requests.

### SOCKETCLOSE(NO|*0-240000*)

specifies if, and for how long, CICS should wait before closing the socket, after issuing a receive for incoming data on that socket.

**No** The socket is left open until data is received. While the socket is open it is unavailable to other tasks, and its associated CICS task is suspended indefinitely.

#### *0-240000*

The period of time (in HHMMSS format) after which CICS is to close the socket. Specifying 000000 closes the socket immediately if data is available

After the TCPIPSERVICE is installed, this value cannot be modified using CEMT; you must set the TCPIPSERVICE out of service, then re-install the TCPIPSERVICE with the modified definition.

CICS ignores the SOCKETCLOSE attribute on the first SOCKET RECEIVE issued after a connection is made. When a connection is accepted by the socket listener, it attaches a task to handle the connection. The first thing this task does is to issue a SOCKET RECEIVE. This first RECEIVE waits indefinitely for data, whatever you have specified on SOCKETCLOSE. This prevents a socket connection being closed as soon as it is initiated, even if no data is immediately available, and so prevents connection reset error at the client.

### TRANSACTION(*name*)

specifies the 4-character ID of the CICS transaction attached to process new requests received for this service. For a Web TCPIPSERVICE definition, specify CWXN or an alias of CWXN. For an IIOP TCPIPSERVICE definition, specify CIOR or an alias of CIOR.

### STATUS({OPEN|CLOSED})

Indicates the initial status of the service after installation. Set it to OPEN if CICS is to begin listening for this service after installation. Set to CLOSE if CICS is not to listen on behalf of this service after installation.

**TCPIPSERVICE**(*name*)

specifies the 8-character name of this service.

**TSQPREFIX**

specifies the 6-character prefix of the temporary storage queue used to store inbound data and Web documents created by applications.

**URM**(*name*)

specifies the name of the user-replaceable module to be invoked by this service. Implementation of this depends on the service being defined; this can be the name of any CICS program.

## CICS Web support



---

## Part 5. CICS Supplied Transactions Changes



## Chapter 12. CEBR—temporary storage browse

Use the CEBR transaction to browse temporary storage queues and to delete them.

You can also use CEBR to transfer a transient data queue to temporary storage in order to look at its contents, and to recreate the transient data queue when you have finished. The CEBR commands that perform these transfers allow you to create and delete transient data queues as well.

Remember that:

- browsing of Temporary Storage queues retrieves the next record, following whichever record has most recently been retrieved by *ANY active task*.  
This can lead to confusion if for example an EXEC CICS READQ NEXT and a CEBR transaction attempt to work with the same Temporary Storage queue at the same time.
- transient data queue reads are destructive. If you read a transient data queue that is being used on an active system by applications, this is likely to cause problems.

You start the CEBR transaction by entering the transaction identifier CEBR, followed by the name of the queue you want to browse. For example, to display the temporary storage queue named CEBRS209, you enter:

```
CEBR CEBRS209
```

CICS responds with a display of the queue, a sample of which is shown in Figure 4:

```
CEBR TSQ AXBYQUEUENAME1  SYSID CIJP REC   1 OF   3   COL   1 OF   5
ENTER COMMAND ==>
***** TOP OF QUEUE *****
00001 HELLO
00002 HELLO
00003 HELLO
***** BOTTOM OF QUEUE *****

PF1 : HELP           PF2 : SWITCH HEX/CHAR   PF3 : TERMINATE BROWSE
PF4 : VIEW TOP       PF5 : VIEW BOTTOM        PF6 : REPEAT LAST FIND
PF7 : SCROLL BACK HALF PF8 : SCROLL FORWARD HALF PF9 : UNDEFINED
PF10: SCROLL BACK FULL PF11: SCROLL FORWARD FULL PF12: UNDEFINED
```

Figure 4. Typical CEBR screen displaying temporary storage queue contents

Alternatively, you can start the CEBR transaction from CEDF. You do this by pressing PF5 from the initial CEDF screen (see *CICS Supplied Transactions*) which takes you to the working-storage screen, and then you press PF2 from that screen to browse temporary storage (that is, you invoke CEBR). CEBR responds by displaying the temporary storage queue whose name consists of the four letters 'CEBR' followed by the four letters of your terminal identifier. (CICS uses this same default queue name if you invoke CEBR directly and do not supply a queue name.) The result of invoking CEBR without a queue name or from an EDF session at terminal S21A is shown in .

If you enter CEBR from CEDF, you will return to the EDF panel when you press PF3 from the CEBR screen.

```

CEBR TSQ AXBYQUEUEAME1  SYSID CIJP REC  1 OF  0 COL  1 OF 1 0
ENTER COMMAND ==>
***** TOP OF QUEUE *****
*
***** BOTTOM OF QUEUE *****

TSQUEUE AXBYQUEUEAME1 DOES NOT EXIST
PF1 : HELP          PF2 : SWITCH HEX/CHAR    PF3 : TERMINATE BROWSE
PF4 : VIEW TOP      PF5 : VIEW BOTTOM        PF6 : REPEAT LAST FIND
PF7 : SCROLL BACK HALF PF8 : SCROLL FORWARD HALF PF9 : UNDEFINED
PF10: SCROLL BACK FULL PF11: SCROLL FORWARD FULL PF12: UNDEFINED

```

**Note:** 1 Header 2 Command line 3 Body 4 Message line 5 Menu of options

Figure 5. Typical CEBR display of default temporary storage queue

For information about the CEBR temporary storage browse transaction and guidance on using it, see the *CICS Application Programming Guide*.

## The HELP panel

If you press the help key (PF1), the following panel is displayed:

```

These commands are available to you (abbreviations in UPPER CASE):
Find /string/                - Keyword optional. Final delimiter optional if
                              string has no blanks. Any other delimiter is OK.

Line line-number
Column column-number
Top
Bottom
TERminal terminal-id        - Browse temp. storage queue for another terminal.
Queue temp-stg-queue       - Browse a named temp. storage queue
                              (name may be in hex - e.g., X'C134')

Sysid shared/remote sysid  - Browse shared or remote temp. storage queue
Put transient-data-queue   - Copy current queue into a transient data queue.
Get transient-data-queue   - Fetch a transient data queue for browsing.
PURGE                      - Destroy the current queue.

```

---

## Chapter 13. CEDX — the execution diagnostic facility

The CICS execution diagnostic facility (EDF) provides two transactions that you can use for testing application programs. These transactions—CEDF and CEDX—enable you to test application programs interactively without having to supply special program testing procedures.

### **CEDF**

Use CEDF to invoke EDF for testing application programs that are associated with user transactions initiated from a terminal.

### **CEDX**

Use CEDX to invoke EDF for testing application programs that are associated with non-terminal transactions.

---

### **CEDF transaction**

The CEDF transaction is fully documented in the *CICS Supplied Transactions* manual and is not further described here.

For information on how to use the CEDF transaction, see the *CICS Application Programming Guide*.

You must ensure that the EDF resource definitions are installed. These resource definitions are provided in the IBM-supplied group, DFHEDF. For information about installing the resource definitions, see the *CICS Resource Definition Guide*.

---

### **CEDX transaction**

Use CEDX to monitor and debug non-terminal transactions. The transaction you specify for debugging can be:

- Initiated without an associated terminal; for example, by an EXEC CICS START command, or by a transient data queue trigger-level.
- Initiated at a terminal, which can be either the EDF terminal or a different terminal.

CICS intercepts the transaction specified on the CEDX *tranid* command, and displays the EDF diagnostic panels at the terminal at which the EDF command is issued.

CEDX provides the same function and diagnostic display panels as CEDF, and the same basic rules for CEDF also apply to CEDX.

### **Command syntax**

#### **CEDX**

►► CEDX—tranid 

,ON
,OFF

 ►►

## Command options

### OFF

specifies that the EDF screen is to be switched OFF. If you specify OFF you must enter the preceding comma, as shown in the following example:

```
CEDX TRNA,OFF
```

### ON

specifies that the EDF screen is to be switched ON. The default is ON. If you specify ON you must enter the preceding comma, as shown in the following example:

```
CEDX TRNB,ON
```

### **tranid**

specifies the identifier of a transaction that you want to test using the execution diagnostic facility. The diagnostic panels are displayed on the terminal at which you issue the CEDX *tranid* command.

The transaction you specify on the CEDX command must run in the local CICS region.

CEDX cannot interrupt transactions that are already running when you issue the CEDX command. It affects only a transaction that starts *after* you issue the command.

The following diagram illustrates the use of CEDX to invoke EDF for a transaction initiated by an EXEC CICS START command:

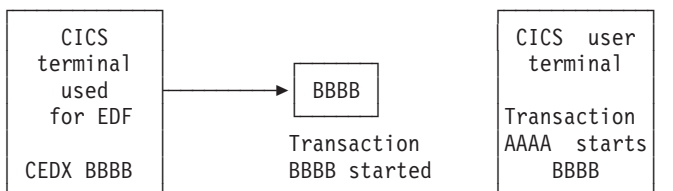

The CEDX command is issued at this terminal, **before** BBBB is started, to invoke EDF services to intercept and debug the specified transaction.

AAAA issues EXEC CICS START command to start BBBB, without a terminal.

## Chapter 14. CEMT INQUIRE commands

Most CEMT requests either inquire about (INQUIRE), or change (SET) the status of one or more named instances of a resource (such as a terminal), a particular subgroup of resources (such as a class of terminals), or all resources of a particular type (such as all terminals).

The INQUIRE command causes the status of the specified resources to be displayed. The SET command makes the changes that you specify, and displays the new status of the resources. No changes are made if there are syntax errors in the SET command.

If, for example, you want to inquire about a resource, enter INQUIRE (or a suitable abbreviation) on the command line. The keywords you can use with CEMT INQUIRE are described in the rest of this section.

If you want to perform those functions that are not concerned with resource status, enter PERFORM (or a suitable abbreviation) on the command line. The keywords you can use with PERFORM are described in *CICS Supplied Transactions*.

And finally, if you want to change the attributes of a resource, enter SET (or a suitable abbreviation) on the command line. The keywords you can use with SET are described in *CICS Supplied Transactions*.

If you enter INQUIRE, you get the following display:

```
INQ                                     ←Command Line
STATUS: ENTER ONE OF THE FOLLOWING OR HIT ENTER FOR DEFAULT ←Status Line

AUTInstmodel FENode      PROGram      TSQueue
AUTOinstall  FEPool      REquestmodel UOW
AUXtrace     FEPropset  RRms        UOWDsnfail
CFdtpool    FETarget    STATistics  UOWLink
COnnecTion  FILE        STReamname  Vtam
DB2Conn     Gtftrace    SYDumpcode  Web
DB2Entry    INttrace    SYSTEM
DB2Tran     IRc        TAsk
DEletshipped JModel     TCLass
D0ctemplate JOurnalname TCPIP
DSAs        Line       TCPIPService
DSName     MODename  TDqueue
DUmpds     MONitor   TERminal
ENQ        Netname   TRAnsaction
ENQModel   PArtner  TRDumpcode
EXci      PROCesstype TSMoDel
FEConnecTion PROFile  TSPool

PF 1 HELP      3 END      5 VAR
SYSID=CICS APPLID=CICSHTC1
9 MSG          ←PF keys
```

Figure 6. Sample of the screen following either the INQUIRE or the SET command

You can inquire about any of the displayed options by typing its keyword after INQUIRE on the command line. For example,

```
INQUIRE PROGRAM
```

gives you the status of all programs, and for each program gives its attributes. Full details are given in *CICS Supplied Transactions*.

# CEMT INQUIRE DOCTEMPLATE

## Function

Retrieves information about a DOCTEMPLATE

## Description

INQUIRE DOCTEMPLATE returns information about any currently installed document template names.

## Input

Press the Clear key to clear the screen, and type CEMT INQUIRE DOCTEMPLATE (the minimum abbreviation is CEMT I D0). You get a display that lists the names and status of any document templates. Note that you cannot change any of the displayed information.

## Sample screen

```

I DOC
STATUS: RESULTS - OVERTYPE TO MODIFY
Doc(test1 ) Tsq Nam(test1 ) App Ebc
  Tem(test1 )

                                SYSID=HA61 APPLID=CICSHA61
RESPONSE: NORMAL                TIME: 15.54.22 DATE: 09.03.98
PF 1 HELP      3 END      5 VAR      7 SBH 8 SFH 9 MSG 10 SB 11 SF

```

Figure 7. CEMT INQUIRE DOCTEMPLATE screen

If you place the cursor against a specific entry in the list and press ENTER, CICS displays an expanded format.

```

i doc
RESULT - OVERTYPE TO MODIFY
Doctemplate(test1)
Templatetype(Tsqueue)
Name(test1)
AppendCrLf(Append)
Type(Ebcdic)
Templatename(test1)
Library()
Dsname()

```

Figure 8. The expanded display of an individual entry

## CEMT INQUIRE DOCTEMPLATE

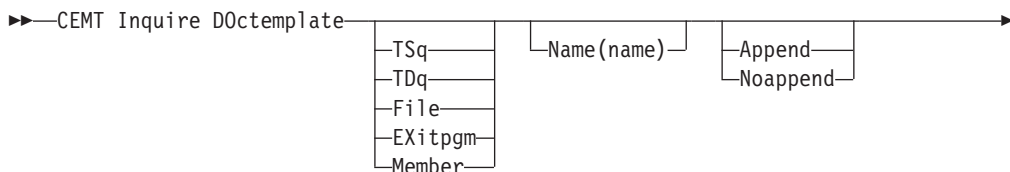



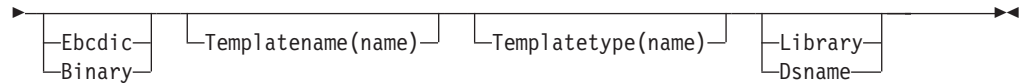

## parameters;

### APPENDCRLF

returns whether CICS is to delete trailing blanks from and append carriage-return line-feed to each logical record of the template.

### LIBRARY

returns the file name of the library containing the template. The library applies only to a template of type Library. If a membername is supplied without a value for LIBRARY, the default value DFHHTML is used.

### DOCTEMPLATE

returns the name of this DOCTEMPLATE definition.

### DSNAME

returns the file-id of the library containing the template. The Dsname applies only to a template of type LIBRARY.

### NAME

returns the name of the location defined in TEMPLATETYPE.

### TEMPLATENAME

returns the extended template name by which the doctemplate is known outside the resource definition function.

### TEMPLATETYPE

returns the type of resource whose name is returned in NAME.

### EXITPGM

an exit program.

**FILE** a CICS file name for a data set.

### MEMBER

a name of the member in the library described in LIBRARY.

### PROGRAM

a name of a program.

### TDQUEUE

a name of a TD queue.

### TSQUEUE

a name of a TS queue.

### TYPE(BINARY|EBCDIC)

returns the format of the template contents.

### BINARY

When the template is loaded from the template library, no parsing of the template's contents is done.

### EBCDIC

When the template is loaded from the template library, the contents are parsed as EBCDIC text.

# CEMT INQUIRE TASK

## Function

Retrieve information about a user task.

## Description

INQUIRE TASK returns information about user tasks. Only information about user tasks can be displayed or changed; information about CICS-generated system tasks or subtasks cannot be displayed or changed. System tasks are those tasks started (and used internally) by CICS, and not as a result of a user transaction.

## Input

Press the Clear key to clear the screen. There are two ways of commencing this transaction:

- Type CEMT INQUIRE TASK (the minimum abbreviation is CEMT I TA). You get a display that lists the current status.
- Type CEMT INQUIRE TASK (CEMT I TA) followed by as many of the other attributes as are necessary to limit the range of information that you require. So, for example, if you enter `cemt i ta i`, the resulting display will show you the details of only those tasks for which the data is not shared with other tasks (isolated).

To change various attributes, you can:

- Overtyping your changes on the INQUIRE screen after tabbing to the appropriate field (see "Overtyping a display" in the CICS Supplied Transaction manual).
- Use the CEMT SET TASK command.

### CEMT INQUIRE TASK

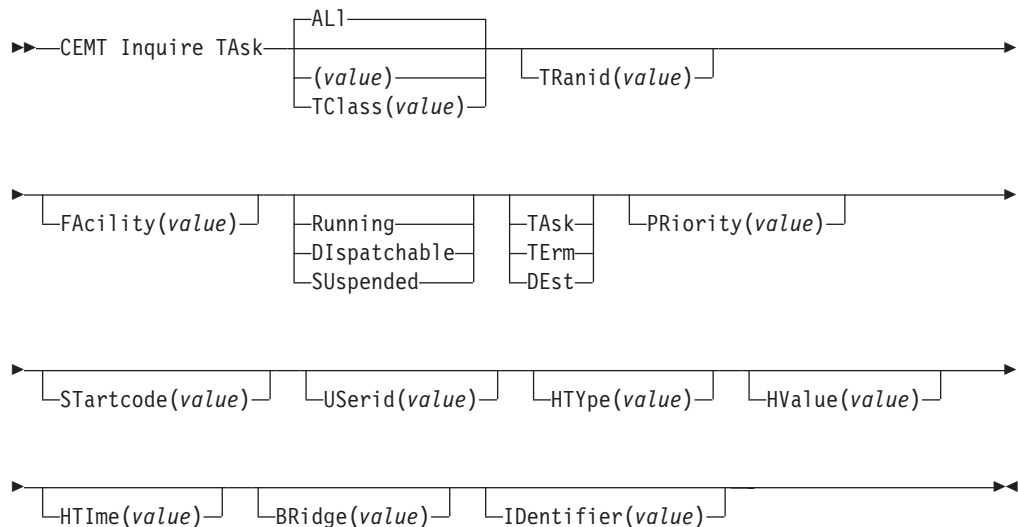

*(value)*  
is the CICS-generated task number, in the range 1–99999.

**ALl**  
is the default.

**TClass(value)**

is the 8-character transaction class name to which the transaction belongs.

You cannot specify a list of identifiers, nor can you use the symbols \* and + to specify a family of tasks.

**Sample screen**

```
IN TASK
STATUS: RESULTS - OVERTYPE TO MODIFY
Tas(0000026) Tra(CEMT) Fac(S262) Sus Ter Pri( 255 )
  Sta(T0) Use(CICSUSER) Rec(X'B0C9D8D111440007') Hty(ZCIOWAIT)
Tas(0000030) Tra(CEMT) Fac(S263) Run Ter Pri( 255 )
  Sta(T0) Use(CICSUSER) Rec(X'B0C9D8E9C3B1FB09')
```

Figure 9. CEMT INQUIRE TASK screen

**Note:** There are blank fields on the screen where a value does not apply or is 'negative'; that is, the value begins with 'No'. To modify these fields, locate them by tabbing (they appear in the same sequence as in the expanded format), and overtype with input valid for that field. You may find it more convenient to use the expanded format when setting one of these values, (negating is easier because you are overtyping a displayed field with its negative causing the result to become non-displayed).

If you place the cursor against a specific entry in the list and press ENTER, CICS displays an expanded format as shown in Figure 10.

```
I TASK
RESULT - OVERTYPE TO MODIFY
Task(0000026)
Tranid(CEMT)
Facility(S262)
Runstatus(Suspended)
Ftype(Term)
Priority( 255 )
Purgetype(          )
Startcode(T0)
Userid(CICSUSER)
Recunitid(X'B4105A1E55031245')
Htype(ZCIOWAIT)
Hvalue(DFHZARQ1)
Htime(000159)
Bridge()
Identifier()

                                SYSID=JOHN APPLID=I
                                TIME: 11.26.40 DATE: 08
PF 1 HELP 2 HEX 3 END          5 VAR          7 SBH 8 SFH          10 SB 11 SF
```

Figure 10. The expanded display of an individual entry

## CEMT INQUIRE TASK

### parameters;

#### **BR**idge(*value*)

Returns the 4-character name of the bridge monitor transaction if the current task is running in a 3270 bridge environment, and was started by a bridge monitor transaction with a START BREXIT TRANSID command. Otherwise, blanks are returned.

#### **FA**cility(*value*)

displays a 4-character string identifying the name of the terminal or queue that initiated the task. If no FACILITY value is displayed, the task was started without a facility.

#### **F**type

displays the type of facility that initiated this task. The values are:

**TA**sk The task was initiated from another task.

**TE**rm The task was initiated from a terminal.

**DE**st The task was initiated by a destination trigger level as defined in the destination control table (DCT).

#### **HT**ime(*value*)

displays the time (in seconds) that the task has been in the current suspended state.

#### **HT**ype(*value*)

displays the reason why the task is suspended. A null value indicates that there is no hold-up, except for the necessity of reaching the head of the queue.

#### **HV**alue(*value*)

displays a 16-character resource name, such as a file name, or a value such as a TCLASS value.

For information on the values that can appear in the HTYPE and HVALUE options, and how they can be used as an aid in problem determination, see the “resource type” and “resource name” details in the *CICS Problem Determination Guide*.

#### **ID**entifier(*value*)

returns a 48-character field containing user data provided by the bridge exit, if the task was initiated in the 3270 bridge environment, or blanks, otherwise. This field is intended to assist in online problem resolution.

For example, it could contain the MQ™ correlator for the MQ bridge, or a Web token.

#### **PR**iority(*value*)

displays the priority of the task, in the range 0–255 where 255 is the highest priority.

**Note:** You can reset this value by overtyping it with a different value.

#### **Pur**getype (*input only field*)

specifies whether a task is to be purged or forcepurged. The values are:

**Purge** The task is to be terminated. Termination occurs only when system and data integrity can be maintained.

#### **Force**purge

The task is to be terminated immediately. System integrity is not guaranteed. In some extreme cases, for example if a task is

## CEMT INQUIRE TASK

forcepurged during backout processing, CICS terminates abnormally. If you want to terminate a task but do not want to terminate CICS, you should use PURGE instead of FORCEPURGE.

In some BTAM situations, further user action is required to complete the purging of the task. If a task is in a terminal read on a BTAM nonlocal terminal and that task is canceled, it can require input from another terminal on the same line before the cancel operation completes.

### **Recunitid**(*value*)

displays a unique identifier of the current unit of recovery. The identifier takes the form of an eight byte clock value and is displayed in hexadecimal format.

### **Runstatus**

displays the status of this task. The values are:

#### **R**unning

The task is running.

#### **D**ispatchable

The task is dispatchable.

#### **S**uspended

The task is suspended.

### **STartcode**(*value*)

displays how this task was started. The values are:

**D** A distributed program link (DPL) request. The program cannot issue I/O requests against its principal facility or any syncpoint requests.

**DS** A distributed program link (DPL) request, as for code D, with the exception that the program can issue syncpoint requests.

**QD** A transient data trigger level was reached.

**S** Start command (no data)

**SD** Start command (with data)

**TO** The operator typed a transaction code at the terminal.

**TP** The transaction was started by presetting the transaction ID for the terminal.

**U** User-attached task.

### **TAsk**(*value*)

indicates that this panel relates to a TASK inquiry and displays a CICS-generated task number in the range 1–999999.

### **TR**anid(*value*)

displays a 4-character string identifying the transaction name associated with the task.

### **U**Serid(*value*)

displays the user currently associated with the task.

---

## CEMT INQUIRE TCPIP

### Function

Inquire about CICS internal TCP/IP support status.

### Description

INQUIRE TCPIP returns information about the current status of CICS internal TCP/IP support.

### Input

Press the Clear key to clear the screen. There are two ways of commencing this transaction:

- Type CEMT INQUIRE TCPIP (the minimum abbreviation is CEMT I TCPIP). You get a display that lists the current status.
- Type CEMT INQUIRE TCPIP (CEMT I TCPIP) followed by as many of the other attribute settings that you wish to view.

To change various attributes, you can:

- Overtyping your changes on the INQUIRE screen after tabbing to the appropriate field (see *CICS Supplied Transactions*).
- Use the CEMT SET TCPIP command.

#### CEMT INQUIRE TCPIP

```
▶▶—INQUIRE TCPIP—┐
                    └─OPENSTATUS(value)—┘▶▶
```

#### OPENSTATUS(value)

displays the status of CICS internal TCP/IP support. The values are:

**OPEN** CICS internal sockets support is open.

#### CLOSED

CICS internal sockets support has not yet been activated, or has been terminated.

#### CLOSING

CICS internal sockets support is in the process of closing.

#### IMMCLOSING

CICS internal sockets support is in the process of immediate termination.

## CEMT INQUIRE TCPIP SERVICE

### Function

Retrieve information about TCP/IP ports on which CICS internal TCP/IP support is currently listening on behalf of other CICS services.

### Description

INQUIRE TCPIP SERVICE returns information about the state of a service using CICS internal TCP/IP support.

### Input

Press the Clear key to clear the screen. There are two ways of commencing this transaction:

- Type CEMT INQUIRE TCPIP SERVICE (the minimum abbreviation is CEMT I TCPIPS). You get a display that lists the current status.
- Type CEMT INQUIRE TCPIP SERVICE (CEMT I TCPIPS) followed by as many of the other attribute settings that you wish to view.

To change various attributes, you can:

- Overtyping your changes on the INQUIRE screen after tabbing to the appropriate field (see *CICS Supplied Transactions*).
- Use the CEMT SET TCPIP SERVICE command.

#### CEMT INQUIRE TCPIP SERVICE

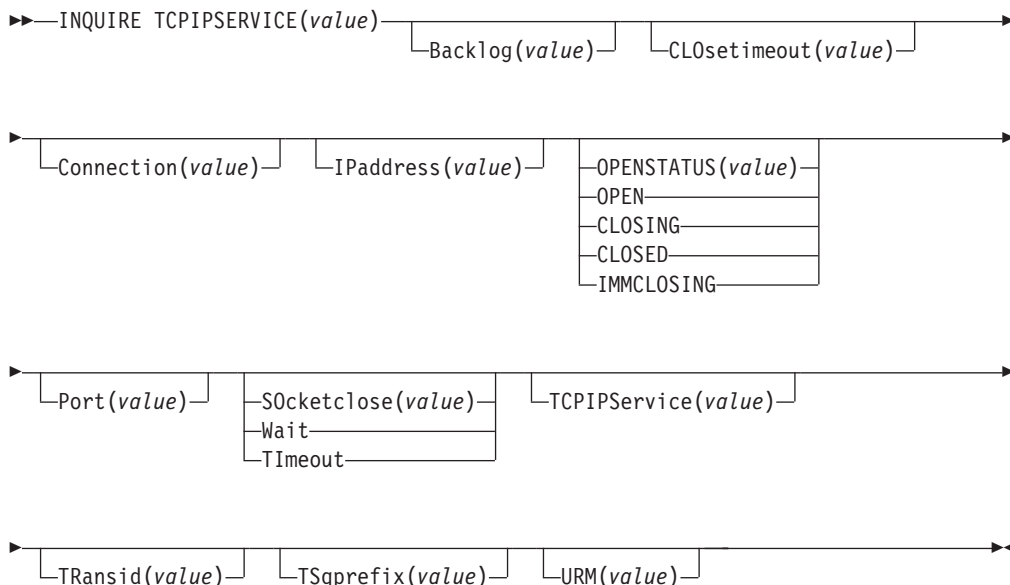

#### Backlog

Change the maximum number of requests which can be queued in TCP/IP waiting to be processed by the service.

#### Closetimeout

returns a fullword value containing the number of seconds specified for the timeout period. This can be 0 through 86400 (24 hours).

## CEMT INQUIRE TCPIP SERVICE

### Connection

The number of current sockets connections for this service

### Ipaddress

returns an IP address. If you specify an IP address in the TCPIP SERVICE definition, that address is returned, otherwise the default IP address is returned. If there is more than one IP address on an OS/390 system, only the default is returned.

### Port

returns the number of the port on which CICS is listening on behalf of this service.

### Service

8-character name identifying this service.

### Socketclose

returns a CVDA value indicating whether a timeout value is in effect for the TCPIP SERVICE. CVDA values are:

#### WAIT

**NO** was specified on the definition. Socket receives will wait for data indefinitely.

#### TIMEOUT

A value was specified for the SOCKETCLOSE parameter on the definition.

### STATUS(cvda)

returns a CVDA value indicating the state of the service. CVDA values are:

**OPEN** CICS internal sockets support is open.

#### CLOSED

CICS internal sockets support has not yet been activated, or has been terminated.

#### CLOSING

CICS internal sockets support is in the process of closing.

#### IMMCLOSING

CICS internal sockets support is in the process of immediate termination.

### Transid

4-character transaction id used on the attach for the task started to process a new request.

### TSQprefix

returns the 6-character prefix used when the service generates TS queue names.

### URM

8 character name of Service URM invoked by attached task.



# CEMT INQUIRE TRANSACTION

## Function

Retrieve information about transactions.

## Description

INQUIRE TRANSACTION returns information about transaction definitions.

## Input

Press the Clear key to clear the screen. There are two ways of commencing this transaction:

- Type CEMT INQUIRE TRANSACTION (the minimum abbreviation is CEMT I TRANS). You get a display that lists the current status.
- Type CEMT INQUIRE TRANSACTION (CEMT I TRANS) followed by as many of the other attributes as are necessary to limit the range of information that you require. So, for example, if you enter `cemt i trans en pu`, the resulting display will show you the details of only those transactions that are enabled and system-purgeable.

To change various attributes, you can:

- Overtyping your changes on the INQUIRE screen after tabbing to the appropriate field (see *CICS Supplied Transactions*).
- Use the CEMT SET TRANSACTION command.

### CEMT INQUIRE TRANSACTION

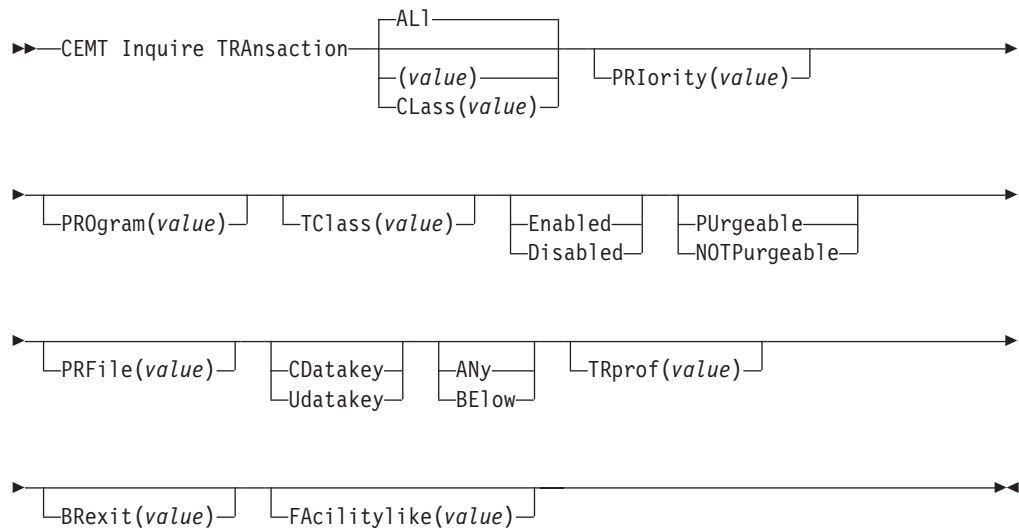

**(value)**  
is a 1–4 character transaction identifier. Only transactions that have been defined in the CICS system definition (CSD) file and installed on the running CICS system are accessible through CEMT.

**ALI**  
is the default.

**CLass(value)**  
is the 2-character suffix of a transaction list table (XLT).

## CEMT INQUIRE TRANSACTION

### Sample screen

```
IN TRAN
STATUS: RESULTS - OVERTYPE TO MODIFY
Tra(AADD) Pri( 001 ) Pro(DFH$AALL) Tc1( DFHTCL00 ) Ena Pur
Prf(DFHCICST) Uda Bel
Tra(ABRW) Pri( 001 ) Pro(DFH$ABRW) Tc1( DFHTCL00 ) Ena Pur
Prf(DFHCICST) Uda Bel
Tra(ADYN) Pri( 001 ) Pro(DFH99 ) Tc1( DFHTCL00 ) Ena Pur
Prf(DFHCICST) Uda Bel
Tra(AINQ) Pri( 001 ) Pro(DFH$AALL) Tc1( DFHTCL00 ) Ena Pur
Prf(DFHCICST) Uda Bel
Tra(AMNU) Pri( 001 ) Pro(DFH$AMNU) Tc1( DFHTCL00 ) Ena Pur
Prf(DFHCICST) Uda Bel
Tra(AORD) Pri( 001 ) Pro(DFH$AREN) Tc1( DFHTCL00 ) Ena Pur
Prf(DFHCICST) Uda Bel
Tra(AORQ) Pri( 001 ) Pro(DFH$ACOM) Tc1( DFHTCL00 ) Ena Pur
Prf(DFHCICST) Uda Bel
Tra(AREP) Pri( 001 ) Pro(DFH$AREP) Tc1( DFHTCL00 ) Ena Pur
Prf(DFHCICST) Uda Bel
+ Tra(AUPD) Pri( 001 ) Pro(DFH$AALL) Tc1( DFHTCL00 ) Ena Pur
Prf(DFHCICST) Uda Bel
```

Figure 11. CEMT INQUIRE TRANSACTION screen

If you place the cursor against a specific entry in the list and press ENTER, CICS displays an expanded format as shown in Figure 12.

```
IN TRAN
RESULT - OVERTYPE TO MODIFY
Transaction(AADD)
Priority( 001 )
Program(DFH$AALL)
Tclass( DFHTCL00 )
Status( Enabled )
Purgeability( Purgeable )
Prfile(DFHCICST)
Taskdatakey(Udatakey)
Taskdataloc(Below)
Trprof()
Brexid
Facilitylike()
```

Figure 12. The expanded display of an individual entry

### parameters;

#### **BRexit**(value)

returns the 8-character name of the bridge exit defined by the BREXIT parameter of the named transaction resource definition.

If BREXIT is not defined, blanks are returned.

#### **FAcilitylike**(value)

returns the 4-character name of the terminal defined by the FACILITYLIKE parameter of the PROFILE associated with the named transaction resource definition.

## CEMT INQUIRE TRANSACTION

### **PRFile**(*value*)

displays the name of the profile definition that defines additional options associated with this transaction.

### **PRI**riority(*value*)

displays a value indicating the priority of a transaction relative to other transactions. When a transaction is running as a CICS task, the priority of a task is the sum of the transaction priority, the terminal priority, and the operator priority.

**Note:** You can reset this value by overtyping it with a different value. The value is in the range 0–255, where 255 is the highest priority.

### **PRO**gram(*value*)

displays an 8-character string identifying the name of the first program to be executed when this transaction is started.

### **Purgeability**

displays whether the transaction is purgeable in system stall conditions. The values are:

#### **PU**rgeable

The transaction is system-purgeable. This value relates to the SPURGE parameter on the transaction resource definition and indicates that CICS can purge the transaction in a deadlock time-out situation. See the *CICS Resource Definition Guide* for information about the SPURGE and DTIMEOUT parameters on a transaction resource definition.

#### **NOTP**urgeable

The transaction cannot be purged.

**Note:** You can reset this value by overtyping it with a different value.

### **Status**

displays whether the transaction is available for use. The values are:

#### **Enabled**

The transaction is available for use.

#### **Disabled**

The transaction is not available for use.

**Note:** If a transaction is disabled, this does not prevent a START command that names this transaction from being shipped to a remote region. When a task is attached for the requested transaction, CICS checks that the transaction is enabled in the remote region.

**Note:** You can reset this value by overtyping it with a different value.

### **Taskdatakey**

displays the storage key in which CICS obtains all storage for use by the transaction. This includes the task life-time storage—the transaction work area (TWA) and the EXEC interface block (EIB)—and the storage that CICS obtains on behalf of programs that run under the transaction.

The values are:

#### **CD**atakey

CICS obtains storage for the transaction from CICS-key storage.

## CEMT INQUIRE TRANSACTION

Application programs that execute in CICS key have read-write access to this storage, but user-key programs have read-only access.

### Udatakey

CICS obtains storage for the transaction from user-key storage. Application programs that execute in any key have read-write access to this storage.

See the description of the TASKDATAKEY parameter on the transaction resource definition in the *CICS Resource Definition Guide*.

### Taskdataloc

displays whether certain CICS control blocks (including EIB and TWA) for a transaction are acquired above or below the 16MB line. The values are:

**ANy** The transaction accepts task-related data anywhere.

### BElow

The transaction requires any task-related data (TWA and EIB plus any internal control blocks) to be located below the 16MB line.

### TClass(*value*)

displays an 8-character string identifying the name of the transaction class to which the transaction belongs. If the transaction does not belong to a class, DFHTCL00 is returned.

**Note:** You can reset this value by overtyping it with a different value.

To remove a transaction from its TCLASS, set this field to DFHTCL00. An added or changed TCLASS **must** be one that has already been defined.

### TRAnSACTION(*value*)

indicates that this panel relates to a TRANSACTION inquiry and displays a 4-character transaction identifier. Only transactions that have been defined in the CICS system definition (CSD) file and installed on the running CICS system are accessible through CEMT.

### TRprof(*value*)

displays the name of the transaction routing profile that defines additional options associated with this transaction if it is defined as a remote transaction.

## CEMT INQUIRE TSQUEUE

### Function

Retrieve information about temporary storage queues.

### Description

The INQUIRE TSQUEUE command returns information about temporary storage queues (TS queues). The INQUIRE TSQUEUE command operates on all the temporary storage queues that exist in the CICS region, including those created internally by CICS for use by CICS itself (for example, queues used by BMS). You can identify the temporary storage queues created by CICS for its own use by queue names that begin with the following character strings:

**\*\*** BMS paging  
**\$\$** BMS route  
 X'fa' to X'ff'  
     CICS  
**CEBR** Default CEBR queue name  
**DF** CICS  
**DFHM** Message cache for message-protected tasks  
**DFxxxx**  
     CICS REQIDS (where x is hexadecimal)

### Input

Press the Clear key to clear the screen. There are two ways of commencing this transaction:

- Type CEMT INQUIRE TSQUEUE (the minimum abbreviation is CEMT I TSQ). You get a display that lists the current status.
- Type CEMT INQUIRE TSQUEUE (CEMT I TSQ) followed by as many of the other attributes as are necessary to limit the range of information that you require. So, for example, if you enter `cemt i tsq main`, the resulting display will show you the details of only those temporary storage queues that are resident in main storage.

To change various attributes, overwrite your changes on the INQUIRE screen after tabbing to the appropriate field (see *CICS Supplied Transactions*).

#### CEMT INQUIRE TSQUEUE

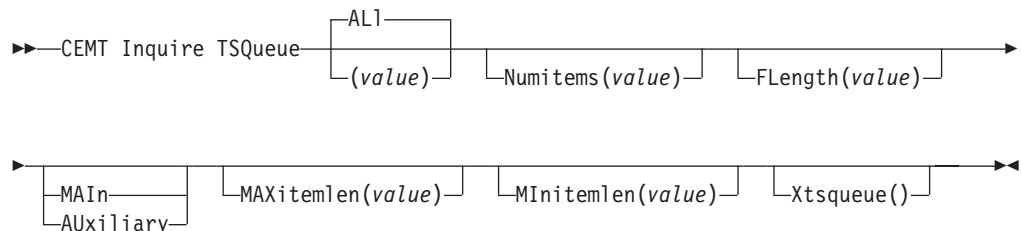

**ALI**  
 is the default.

**(value)**  
 is the name of the temporary storage queue for which information is requested.

## CEMT INQUIRE TSQUEUE

### Sample screen

```
INQ TSQ
STATUS: RESULTS - OVERTYPE TO MODIFY
Tsq(ABCD ) Num(00001) Fle(0000000064) Mai
  Max(00064) Max(00064) Xts(C1D5C4E8840404040)
Tsq(. . . . .) Num(00003) Fle(0000000192) Aux
  Max(00064) Min(00064) Xts(01020304AABBCCDD)
```

Figure 13. CEMT INQUIRE TSQUEUE screen

If you place the cursor against a specific entry in the list and press ENTER, CICS displays an expanded format as shown in Figure 14.

```
INQ TSQ
RESULT - OVERTYPE TO MODIFY
  Tsqueue(AXBYQUEUE1)
  Numitems(00003)
  Flength(0000000192)
  Location(Main)
  Maxitemlen(00064)
  Minitemlen(00064)
  XTsqueue(C1E7C2E8D8E4C5E4)
```

Figure 14. The expanded display of an individual entry

If you place the cursor against a specific entry in the list and type a 'B' (upper or lower case), CICS invokes the CEBR transaction to browse the contents of this TS queue, (see "Chapter 12. CEBR—temporary storage browse" on page 89 for details).

### parameters;

#### **Flength**(value)

displays the total length in bytes of all the items in the temporary storage queue. For information about how CICS calculates the length of items, see the *CICS System Programming Reference*.

#### **Location**(value)

displays where the temporary storage queue resides. The values are:

##### **AU**xiliary

The temporary storage queue is held on the CICS temporary storage VSAM data set DFHTEMP, or in temporary storage pools in the coupling facility.

**MAIn** The temporary storage queue is held in main storage.

#### **MAX**itemlen(value)

displays the length in bytes of the largest item in the temporary storage queue. For information about how CICS calculates the length of items, see the *CICS System Programming Reference*.

**MI**nitelen(*value*)

displays the length in bytes of the smallest item in the temporary storage queue. For information about how CICS calculates the length of items, see the *CICS System Programming Reference*.

**Num**items(*value*)

displays the number of items in the temporary storage queue.

**TS**queue(*value*)

indicates that this panel relates to a TSQUEUE inquiry and displays the 16-character name of a temporary storage queue.

**Note:** Nondisplayable characters appear as periods. You can use PF2 on the expanded panel to see the value in hexadecimal.

## CEMT INQUIRE TSQUEUE



---

## Part 6. CICS System Initialization changes



---

## Chapter 15. CICS system initialization parameters

This chapter describes the CICS system initialization process; describes the DFHSIT macro and its parameters, and tells you how to supply initialization parameters to CICS.

---

### Specifying system initialization parameters

The primary method of providing system initialization parameters is with a system initialization table (SIT). The parameters of the SIT, which you assemble as a load table, supply the system initialization program with most of the information necessary to initialize the system to suit your unique environment. You can generate more than one SIT, and (at the time of system initialization) select the one that is appropriate to your needs.

You can also specify other system initialization parameters, which cannot be coded in the SIT. You specify which SIT you want, and other system initialization parameters (with a few exceptions), using any of the following methods:

1. On the PARM parameter of the EXEC DFHSIP statement
2. In the SYSIPT data set defined in the startup job stream
3. Through the system operator's console

You can also use these methods to override most of the system initialization parameters assembled in the SIT.

The information defined by system initialization parameters can be grouped into three categories:

1. Information used to initialize and control CICS system functions (for example, information such as the dynamic storage area limits and the region exit time interval)
2. Module suffixes used to load the user-specified version of the CICS modules (for example, DFHDBPxx) and tables (for example, DFHJCTxx)
3. Special information used to control the initialization process

The syntax of the various DFHSIT macro parameters is listed in Table 2 on page 114. Except for those parameters marked “**SIT macro only**”, all the system initialization parameters can be provided at run time, although there are restrictions in some cases. The restrictions are explained at the end of the description of the system initialization parameter to which they apply. See the CHKSTRM parameter in the CICS System Definition Guide for an example of such a restriction.

There are some other CICS system initialization parameters (and options of the parameters in Table 2 on page 114) that you cannot define in the DFHSIT macro. (See 141.) The parameters that you cannot define in the DFHSIT macro are shown in “Parameters that you cannot code in the DFHSIT macro” on page 123.

#### **System initialization keywords grouped by function**

For a list of all the system initialization keywords grouped by their functional area, see CICS Resource Definition Guide. This ensures that you do not miss coding an important parameter relating to a particular CICS function. For details of how to code a parameter, you still have to refer to the parameter descriptions that are listed alphabetically in this chapter.

## Migration considerations

If you have existing system initialization tables, you must modify them. Remove all obsolete parameters, and specify the required values for new or changed parameters if you want to run with other than the defaults. When you have made the necessary changes, reassemble the tables using the CICS Transaction Server for VSE/ESA Release 1 macro libraries.

If you have system initialization parameters defined in CICS start-up procedures, you must modify these also.

To avoid generating specific system initialization tables for each CICS system, a simple solution is to let CICS load the default, unsuffixed table (DFHSIT) at start-up, and supply the system initialization parameters for each CICS system in a SYSIPT data set. For more information about the source of the default system initialization table, see “DFHSIT, the default system initialization table” on page 117.

## The DFHSIT macro parameters

Table 2. The DFHSIT macro parameters

DFHSIT	<pre>[TYPE={<b>CSECT</b> DSECT}] [,ADI={<b>30</b> number}] [,AIEEXIT={<b>DFHZATDX</b> DFHZATDY name}] [,AILDELAY={<b>0</b> hhmmss}] [,AIQMAX={<b>100</b> number}] [,AIRDELAY={<b>700</b> hhmmss}] [,AKPFREQ={<b>200</b> number}] [,APPLID={({<b>DBDCCICS</b> name1} ,name2)}]] [,AUTCONN={<b>0</b> hhmmss}] [,AUXTR={<b>OFF</b> ON}] [,AUXTRSW={<b>NO</b> ALL NEXT}] [,BMS={({<b>MINIMUM</b> STANDARD <b>FULL</b>} [,COLD][ [,<b>UNALIGN</b> ALIGN]} [,<b>DDS</b> NODDS]}]] [,CLSDSTP={<b>NOTIFY</b> NONOTIFY}] [,CLT=xx] [,CMDPROT={<b>YES</b> NO}] [,CMDSEC={<b>ASIS</b> ALWAYS}] [,CONFDATA={<b>SHOW</b> HIDETC}] [,CONFTXT={<b>NO</b> YES}] [,CSDACC={<b>READWRITE</b> READONLY}] [,CSDBKUP={<b>STATIC</b> DYNAMIC}] [,CSDBUFND=number] [,CSDBUFNI=number] [,CSDFRLOG=number] [,CSDJID={<b>NO</b> number}] [,CSDLRNO={<b>1</b> number NONE NO}] [,CSDRECOV={<b>NONE</b> ALL BACKOUT ONLY}] [,CSDSTRNO={<b>2</b> number}] [,CWAKEY={<b>USER</b> CICS}] [,DATFORM={<b>MMDDYY</b> DDMMYY YYMMDD}] [,DBP={1\$ 2\$ xx YES}] (Must specify in the SIT macro) [,DBUFSZ={({<b>500</b> number})}] [,DCT={({YES xx <b>NO</b>})}] [,DFLTUSER={<b>CICSUSER</b> userid}] [,DIP={<b>NO</b> YES}] [,DISMACP={<b>YES</b> NO}]</pre>
--------	---

Table 2. The DFHSIT macro parameters (continued)

	<pre> [,{DLIIDL1}={(<b>NO</b> YES REMOTE),[COLD]})] [,{DLIOER}={(<b>ABEND</b> CONTINUE)}] [,{DOCCODEPAGE}={(<b>037</b> codepage)}] [,{DSALIM}={(<b>5M</b> number)}] [,{DSHIPIDL}={(<b>020000</b> hhmmss)}] [,{DSHIPINT}={(<b>120000</b> hhmmss)}] [,{DTRPGM}={(<b>DFHDYP</b> program-name)}] [,{DTRTRAN}={(<b>CRTX</b> name NO)}] [,{DUMP}={ <b>YES</b> NO}] [,{DUMPDS}={(<b>AUTO</b> AIB)}] [,{DUMPSW}={(<b>NO</b> NEXT)}] [,{EDSALIM}={(<b>20M</b> number)}] [,{EODI}={(<b>E0</b> xx)}] [,{ESMEXITS}={(<b>NOINSTLN</b> INSTLN)}] (<i>SIT macro only</i>) [,{FCT}={(<b>YES</b> xx NO)}] [,{FEPI}={(<b>NO</b> YES)}] [,{FLDSEP}={(' '  'xxx')}] [,{FLDSTRT}={(' '  'x')}] [,{FSSTAFF}={(<b>YES</b> NO)}] [,{FTIMEOUT}={(<b>30</b> nn)}] [,{GMTEXT}={('WELCOME TO CICS'  'text')}] [,{GMTRAN}={(<b>CSGM</b> CESN name)}] [,{GNTRAN}={(<b>CESF</b> transaction-id)}] [,{GRPLIST}={(<b>DFHLIST</b> name (name[,name2][,name3][,name4]))}] [,{ICP}=<b>COLD</b>] [,{ICV}={(<b>1000</b> number)}] [,{ICVR}={(<b>5000</b> number)}] [,{ICVTS}={(<b>500</b> number)}] [,{INITPARAM}=(pgmname_1='parmstring_1' [, ... ,pgmname_n='parmstring_n'])] [,{INTTR}={(<b>ON</b> OFF)}] [,{IRCSTRT}={(<b>NO</b> YES)}] [,{ISC}={(<b>NO</b> YES)}] [,{JCT}={(<b>YES</b> xx NO)}] [,{LEVSE}={(<b>YES</b> NO)}] [,{LGNMSG}={(<b>NO</b> YES)}] [,{MCT}={(<b>NO</b> YES xx)}] [,{MN}={(<b>OFF</b> ON)}] [,{MNCONV}={(<b>NO</b> YES)}] [,{MNEXC}={(<b>OFF</b> ON)}] [,{MNFREQ}={(<b>0</b> hhmmss)}] [,{MNPER}={(<b>OFF</b> ON)}] [,{MNSYNC}={(<b>NO</b> YES)}] [,{MNTIME}={(<b>GMT</b> LOCAL)}] [,{MROBTCH}={(<b>1</b> number)}] [,{MROFSE}={ <b>NO</b> YES}] [,{MROLRM}={(<b>NO</b> YES)}] [,{MSGCASE}={(<b>MIXED</b> UPPER)}] [,{MSGLVL}={(<b>1</b> 0)}] [,{MXT}={(<b>5</b> number)}] [,{NATLANG}=(<b>E</b>,x,y,z,...)] [,{OPERTIM}={(<b>120</b> number)}] [,{PARMERR}={(<b>INTERACT</b> IGNORE ABEND)}] [,{PDI}={(<b>30</b> number)}] [,{PGAICTLG}={(<b>MODIFY</b> NONE ALL)}] </pre>
--	---

Table 2. The DFHSIT macro parameters (continued)

	<p>[,PGAEXIT={<b>DFHPGADX</b> name}]</p> <p>[,PGAIPGM={<b>INACTIVE</b> ACTIVE}]</p> <p>[,PGCHAIN=character(s)]</p> <p>[,PGCOPY=character(s)]</p> <p>[,PGPURGE=character(s)]</p> <p>[,PGRET=character(s)]</p> <p>[,PLTPI={<b>NO</b> xx YES}]</p> <p>[,PLTPISEC={<b>NONE</b> CMDSEC RESSECIALL}]</p> <p>[,PLTPIUSR=userid]</p> <p>[,PLTSD={<b>NO</b> xx YES}]</p> <p>[,PRGDLAY={0 hhmm}]</p> <p>[,PRINT={<b>NO</b> YES PA1 PA2 PA3}]</p> <p>[,PRTYAGE={<b>32768</b> number}]</p> <p>[,PSDINT={0 hhmmss}]</p> <p>[,PVDELAY={<b>30</b> number}]</p> <p>[,RAMAX={<b>256</b> number}]</p> <p>[,RAPOOL={ <b>50</b> value1 (value1,value2)]</p> <p>[,RENTPGM={<b>PROTECT</b> NOPROTECT}]</p> <p>[,RESP={<b>FME</b> RRN}]</p> <p>[,RESSEC={<b>ASIS</b> ALWAYS}]</p> <p>[,RMTRAN={({<b>CSGM</b> name1} [, {<b>CSGM</b> name2}])}]</p> <p>[,RUWAPOOL={<b>NO</b> YES}]</p> <p>[,SEC={<b>YES</b> NO}]</p> <p>[,SECPRFX={<b>NO</b> YES}]</p> <p>[,SKRxxxx='page-retrieval-command']</p> <p>[,SNSCOPE={<b>NONE</b> CICS VSE IMAGE}]</p> <p>[,SPCTR={({<b>1,2</b> 1[,2[,3]) ALL OFF}]</p> <p>[,SPOOL={<b>NO</b> YES}]</p> <p>[,SRT={<b>YES</b> xx NO}]</p> <p>[,START={<b>AUTO</b> COLD STANDBY}]</p> <p>[,STARTER={<b>NO</b> YES}] (<i>SIT macro only</i>)</p> <p>[,STATRCD={<b>OFF</b> ON}]</p> <p>[,STGPROT={<b>NO</b> YES}]</p> <p>[,STGRCVY={<b>NO</b> YES}]</p> <p>[,STNTR={1 (1[,2[,3]) ALL OFF}]</p> <p>[,SUFFIX=xx] (<i>SIT macro only</i>)</p> <p>[,SVA={<b>NO</b> YES[]}]</p> <p>[,SYDUMAX={<b>999</b> number}]</p> <p>[,SYSIDNT={<b>CICS</b> name}]</p> <p>[,SYSTR={<b>ON</b> OFF}]</p> <p>[,TAKEOVR={<b>MANUAL</b> AUTO COMMAND}]</p> <p>[,TBEXITS=( [nm1][,nm2][,nm3] [,nm4][,nm5])]</p> <p>[,TCP={<b>YES</b> NO}]</p> <p>[,TCPIP={<b>NO</b> YES}]</p> <p>[,TCSACTN={<b>NONE</b> UNBIND FORCE}]</p> <p>[,TCSWAIT={4 number NO NONE 0}]</p> <p>[,TCT={<b>YES</b> xx NO}]</p> <p>[,TCTUAKEY={<b>USER</b> CICS}]</p> <p>[,TCTUALOC={<b>BELOW</b> ANY}]</p> <p>[,TD={({3 number1}[, {3 number2}])}]</p> <p>[,TRAP={<b>OFF</b> ON}]</p> <p>[,TRDUMAX={<b>999</b> number}]</p> <p>[,TRTABSZ={<b>16</b> number}]</p>
--	---

Table 2. The DFHSIT macro parameters (continued)

	<pre>[,TRTRANSZ={16 number}] [,TRTRANTY={TRAN ALL}] [,TS=([COLD][, {0 3 value-1}][, {3 value-2}])] [,TSMGSET={4 number}] [,TST={NO YES xx}] [,USERTR={ON OFF}] [,USRDELAY={30 number}] [,VTAM={YES NO}] [,VTPREFIX={\character}] [,WEBDELAY={5 time_out,60 keep_time}] [,WRKAREA={512 number}] [,XAPPC={NO YES}] [,XCMD={NO name YES}] [,XDCT={NO name YES}] [,XFCT={NO name YES}] [,XJCT={NO name YES}] [,XLT={NO xx YES}] [,XPCT={NO name YES}] [,XPPT={NO name YES}] [,XPSB={NO name YES}] [,XRF={NO YES}] [,XRFSOFF={NO FORCE FORCE}] [,XRFSTME={5 number}] [,XRFTODI={30 number}] [,XSWITCH=([{0 1-254}][, {?????? progname}][, {,A B}])] [,XTRAN={YES name NO}] [,XTST={NO name YES}] [,XUSER={YES NO}]</pre> <p>You must terminate your macro parameters with the following END statement.</p>
END	DFHSITBA

## DFHSIT, the default system initialization table

The macro source statements used to assemble the default system initialization table are given in Figure 15 on page 118. This default SIT is in PRD1.BASE, and its source, named DFHSIT\$\$, is in PRD1.BASE.

```

*
* SIT parameters (in alphabetical order)
*
SIT      TITLE 'DFHSIT - CICS DEFAULT SYSTEM INITIALIZATION TABLE'
DFHSIT  TYPE=CSECT,
        ADI=30,                XRF(B) - Alternate delay interval
        AIEXIT=DFHZATDX,      Autoinstall user program name
        AILDELAY=0,           Delete delay period for AI terminals
        AIQMAX=100,           Maximum no. of terminals queued for AI*
        AIRDELAY=700,         Restart delay period for AI terminals
        AKPFREQ=200,          Activity keypoint frequency
        APPLID=DBDCCICS,      VTAM APPL identifier
        AUTCONN=0,           Autoconnect delay
        AUXTR=OFF,           Auxiliary trace option
        AUXTRSW=NO,          Auxiliary trace autoswitch facility
        BMS=(FULL,,UNALIGN,DDS), Basic Mapping Support options
        CLSDSTP=NOTIFY,      Notification for ISSUE PASS command
        CLT=,                 The command list table option/suffix
        CMDPROT=YES,         Exec storage command checking
        CMDSEC=ASIS,         API command security checking
        CONFDATA=SHOW,       Show confidential data in dump/trace
        CONFTXT=NO,          Don't prevent VTAM tracing user data
        CSDACC=READWRITE,    CSD access
        CSDBUFND=,           Number of data buffers for the CSD
        CSDBUFNI=,           Number of index buffers for the CSD
        CSDFRLOG=NO,         Journal id. for CSD forward recovery
        CSDJID=NO,           Journal id. for CSD auto. journaling
        CSDLRNO=1,           The VSAM LSR pool number for the CSD
        CSDRECOV=NONE,       CSD recoverable file option
        CSDSTRNO=2,          CSD Number of strings
        CWAKEY=USER,         CWA storage key
        DATFORM=MMDDYY,      CSA date format
        DBP=1$,              REquired version of DBP with DLI=NO
        DBUFSZ=500,          Dynamic backout buffer size
        DCT=YES,             Dest. control table option/suffix
        DFLTUSER=CICSUSER,   Default user
        DIP=NO,              Batch data interchange program
        DISMACP=YES,         Disable macro programs
        DLI=NO,              DL/I option
        DOCCODEPAGE=037      Default host code page
        DSALIM=5M,           Upper limit of DSA below 16Mb line
        DSHIPIDL=020000,     Delete shipped idle time
        DSHIPINT=120000,     Delete shipped interval
        DTRPGM=DFHDYP,       Dynamic routing program
        DTRTRAN=CRTX,        Default dynamic tran routing transid
        DUMP=YES,            Dump option
        DUMPDS=AUTO,         CICS dump data set opening option
        DUMPSW=NO,           Dump data set autoswitch option
        EDSALIM=20M,         Upper limit of DSA above 16MB line
        EODI=E0,             End-of-data indicator for seq. devices*
        ESMEXITS=NOINSTLN,   External security manager exits
        FCT=YES,             File control table option/suffix
        FEPI=NO,             Front-End Programming Interface
        FLDSEP=' ',          End-of-field separator characters
        FLDSTRT=' ',         Field start character for builtin fn
        FSSTAFF=NO,          Function-shipped START affinity option*
        GMTEXT='WELCOME TO CICS', Good-morning message text
        GMTRAN=CSGM,         Initial transaction
        GNTRAN=NO,           Signoff transaction

```

Figure 15. DFHSIT, the pregenerated default system initialization table 1/4



GRPLIST=DFHLIST,	List name of CSD groups for startup	*
ICP=,	Interval control pgm. start option	*
ICV=1000,	Region exit interval (milliseconds)	*
ICVR=5000,	Runaway task interval (milliseconds)	*
ICVTSD=500,	Terminal scan delay interval ( " )	*
INITPARM=,	Initialization parms for programs	*
INTTR=ON,	CICS internal trace option	*
IRCSTRT=NO,	Interregion communication start	*
ISC=NO,	Intersystem communication option	*
LEVSE=YES,	Support for LE	*
LGNMSG=NO,	Extract VTAM logon data	*
MCT=NO,	Monitoring cntl.table option/suffix	*
MN=OFF,	CICS monitoring option	*
MNCONV=NO,	Monitoring converse recording option	*
MNEXC=OFF,	Monitoring exception class option	*
MNFREQ=0,	Monitoring frequency period	*
MNPER=OFF,	Monitoring performance class option	*
MNSYNC=NO,	Monitoring syncpoint recording option	*
MNTIME=GMT,	Monitoring timestamp (GMT/LOCAL)	*
MROBTCH=1,	Number of MRO requests to batch	*
MROFSE=NO,	Extend lifetime of Long-running mirror*	*
MROLRM=NO,	Long-running mirror task option	*
MSGCASE=MIXED,	CICS messages in mixed case	*
MSGLVL=1,	System console MSG level option	*
MXT=5,	Maximum number of tasks in CICS	*
NATLANG=E,	List of national languages	*
OPERTIM=120,	Write to operator timeout (seconds)	*
PARMERR=INTERACT,	System init. parameter errors option	*
PDI=30,	Primary delay interval - XRF active	*
PGAICTLG=MODIFY,	PG autoinstall catalog state	*
PGAEXIT=DFHPGADX,	PG autoinstall exit program	*
PGAIPGM=INACTIVE,	PG autoinstall state	*
PGCHAIN=,	BMS CHAIN command	*
PGCOPY=,	BMS COPY command	*
PGPURGE=,	BMS PURGE command	*
PGRET=,	BMS RETURN command	*
PLTPI=NO,	Program list table PI option/suffix	*
PLTPISEC=NONE,	No PLT security checks on PI programs	*
PLTPIUSR=,	PLT PI userid = CICS region userid	*
PLTSD=NO,	Program list table SD option/suffix	*
PRGDLAY=0,	BMS purge delay interval	*
PRINT=NO,	Print key option	*
PRTYAGE=32768,	Dispatcher priority ageing value	*
PSDINT=0,	Persistent session delay interval	*
PVDELAY=30,	Timeout value for LUIT table	*
RAMAX=256,	Max. I/O area for RECEIVE ANY	*
RAPOOL=50,	Max. RECEIVE ANY request parm.lists	*
RENTPGM=PROTECT,	Reentrant program write protection	*
RESP=FME,	Logical unit response type	*
RESSEC=ASIS,	Resource security check	*
RMTRAN=CSGM,	XRF alternate recovery transaction	*
RST=NO,	Recovery service table (XRF-DBCTL)	*
RUWAPOL=NO,	Allocating storage pool for LE	*
SEC=YES,	External security manager option	*
SECPRFX=NO,	Security prefix	*
SKRPA1=,	SKR PA1 PAGE RETRIEVAL CMD	*
SKRPA2=,	SKR PA2 PAGE RETRIEVAL CMD	*
SKRPA3=,	SKR PA3 PAGE RETRIEVAL CMD	*
SKRPF1=,	SKR PF1 PAGE RETRIEVAL CMD	*
SKRPF2=,	SKR PF2 PAGE RETRIEVAL CMD	*

Figure 16. DFHSIT, the pregenerated default system initialization table 2/4

SKRPF3=,	SKR PF3 PAGE RETRIEVAL CMD	*
SKRPF4=,	SKR PF4 PAGE RETRIEVAL CMD	*
SKRPF5=,	SKR PF5 PAGE RETRIEVAL CMD	*
SKRPF6=,	SKR PF6 PAGE RETRIEVAL CMD	*
SKRPF7=,	SKR PF7 PAGE RETRIEVAL CMD	*
SKRPF8=,	SKR PF8 PAGE RETRIEVAL CMD	*
SKRPF9=,	SKR PF9 PAGE RETRIEVAL CMD	*
SKRPF10=,	SKR PF10 PAGE RETRIEVAL CMD	*
SKRPF11=,	SKR PF11 PAGE RETRIEVAL CMD	*
SKRPF12=,	SKR PF12 PAGE RETRIEVAL CMD	*
SKRPF13=,	SKR PF13 PAGE RETRIEVAL CMD	*
SKRPF14=,	SKR PF14 PAGE RETRIEVAL CMD	*
SKRPF15=,	SKR PF15 PAGE RETRIEVAL CMD	*
SKRPF16=,	SKR PF16 PAGE RETRIEVAL CMD	*
SKRPF17=,	SKR PF17 PAGE RETRIEVAL CMD	*
SKRPF18=,	SKR PF18 PAGE RETRIEVAL CMD	*
SKRPF19=,	SKR PF19 PAGE RETRIEVAL CMD	*
SKRPF20=,	SKR PF20 PAGE RETRIEVAL CMD	*
SKRPF21=,	SKR PF21 PAGE RETRIEVAL CMD	*
SKRPF22=,	SKR PF22 PAGE RETRIEVAL CMD	*
SKRPF23=,	SKR PF23 PAGE RETRIEVAL CMD	*
SKRPF24=,	SKR PF24 PAGE RETRIEVAL CMD	*
SKRPF25=,	SKR PF25 PAGE RETRIEVAL CMD	*
SKRPF26=,	SKR PF26 PAGE RETRIEVAL CMD	*
SKRPF27=,	SKR PF27 PAGE RETRIEVAL CMD	*
SKRPF28=,	SKR PF28 PAGE RETRIEVAL CMD	*
SKRPF29=,	SKR PF29 PAGE RETRIEVAL CMD	*
SKRPF30=,	SKR PF30 PAGE RETRIEVAL CMD	*
SKRPF31=,	SKR PF31 PAGE RETRIEVAL CMD	*
SKRPF32=,	SKR PF32 PAGE RETRIEVAL CMD	*
SKRPF33=,	SKR PF33 PAGE RETRIEVAL CMD	*
SKRPF34=,	SKR PF34 PAGE RETRIEVAL CMD	*
SKRPF35=,	SKR PF35 PAGE RETRIEVAL CMD	*
SKRPF36=,	SKR PF36 PAGE RETRIEVAL CMD	*
SNSCOPE=NONE,	Multiple CICS sessions per userid	*
SPCTR=(1,2),	Level(s) of special tracing required	*
SPOOL=NO,	System spooling interface option	*
SRT=YES,	System recovery table option/suffix	*
START=AUTO,	CICS system initialization option	*
STARTER=YES,	Starter (\$ and #) suffixes option	*
STATRCD=OFF,	statistics recording status	*
STGPROT=NO,	Storage protection facility	*
STGRCVY=NO,	Storage recovery option	*
STNTR=1,	Level of standard tracing required	*
SUFFIX=\$\$,	Suffix of this SIT	*
SVA=NO,	Use SVA option for CICS/user modules	*
SYDUMAX=999,	No of SYSDUMPS to be taken	*
SYSIDNT=CICS,	Local system identifier	*
SYSTR=ON,	Master system trace flag	*
TAKEOVR=MANUAL,	XRF alternate takeover option	*
TBEXITS=,	Backout exit programs	*
TCP=YES,	Terminal control program option/suffix*	*
TCPIP=NO,	TCP/IP support	*
TCSACTN=NONE,	TC Shutdown action	*
TCSWAIT=4,	TC Shutdown wait	*
TCT=YES,	Terminal control table option/suffix	*
TCTUAKEY=USER,	TCT user area storage key	*
TCTUALOC=BELOW,	TCT user area below 16MB	*
TD=(3,3),	Transient data buffers and strings	*
TRAP=OFF,	F.E. global trap exit option	*
TRDUMAX=999,	No of TRANDUMPS to be taken	*
TRTABSZ=16,	Internal trace table size in 1K bytes	*
TRTRANSZ=40,	Transaction dump trace table size	*
TRTRANTY=TRAN,	Transaction dump trace option	*

Figure 17. DFHSIT, the pregenerated default system initialization table 3/4

TS=(,3,3),	Temporary storage buffers and strings *
TSMGSET=4,	# of entries for pointers to TS MSGset*
TST=NO,	Temporary storage table option/suffix *
USERTR=ON,	Master user trace flag *
USRDELAY=30,	Timeout value for User Dir. Entries *
VTAM=YES,	VTAM access method option *
VTPREFIX=\\,	Client virtual terminal prefix *
WEBDELAY=(5,60),	Web timer values *
WRKAREA=512,	Common work area (CWA) size in bytes *
WRKAREA=512,	Common work area (CWA) size in bytes *
XAPPC=NO,	RACF class APPCLU required *
XCMD=NO,	SPI use default name for RACF check *
XDCT=NO,	DCT use default name for RACF check *
XFCT=NO,	FCT use default name for RACF check *
XJCT=NO,	JCT use default name for RACF check *
XLT=NO,	Transaction list table option/suffix *
XPCT=NO,	PCT use default name for RACF check *
XPPT=NO,	PPT use default name for RACF check *
XPSB=NO,	PSB use default name for RACF check *
XRF=NO,	Extended recovery feature (XRF) option*
XRFSOFF=NOFORCE,	XRF - Re-sign on after takeover *
XRFSTME=5,	XRF - sign off timeout value *
XRFTODI=30,	XRF takeover delay interval *
XSWITCH=(0,???????,A),	Pgrmable terminal switching unit *
XTRAN=YES,	Transid use default name, RACF check *
XTST=NO,	TST use default name for RACF check *
XUSER=NO,	Surrogate user checking to be done *
END DFHSITBA	

Figure 18. DFHSIT, the pregenerated default system initialization table 4/4

## Creating a system initialization table

Decide which parameters you want to use. List them, together with the appropriate setting, in a file named DFHSITxx. The suffix xx can be any two characters that you want (apart from the characters reserved solely for use by CICS), and identifies the file as your own SIT. If you do not specify a two-character suffix, CICS uses the default system initialization table, DFHSIT1\$.

See CICS Resource Definition Guide which summarizes the groups of system initialization parameters needed for different CICS functions.

If you specify more than one value for a system initialization parameter, separate the operand values by commas and enclose them all in parentheses. If you do not specify a parameter as a system initialization override, the system uses the value supplied in whichever SIT you specify.

End your system initialization table with an  
END DFHSITBA

statement.

“The system initialization parameter descriptions” on page 138 describes all the system initialization parameters on an individual basis.

There are some parameters that cannot be coded in the DFHSIT macro. These are summarized in “Parameters that you cannot code in the DFHSIT macro” on page 123.

## Coding more than one system initialization table

You can code several SITs, each reflecting different parameter combinations and settings, as long as you remember to give each DFHSITxx a different two-character suffix. CICS uses only one of these tables during initialization. Choose the SIT that best suits your needs at the time, and code its suffix on the SIT system initialization parameter.

Assemble your chosen SIT and link-edit it into one of the sublibraries defined in the LIBDEF statement for your CICS startup job stream.

## CICS-supplied system initialization tables

The VSE/ESA sublibrary, PRD1.BASE, contains the sample system initialization tables, DFHSIT6\$ and DFHSIT\$\$\$. DFHSIT6\$ contains all the SIT values needed for a standard CICS system. DFHSIT\$\$\$ contains all the default values for the system initialization parameters.

## System initialization tables supplied with VSE/ESA

VSE/ESA supplies two sample system initialization tables. DFHSITSP is provided for a standard CICS system, and DFHSITC2 is provided for a second predefined CICS system. There are listings for both these tables in the *VSE/ESA Planning* manual.

## Assembling the system initialization table

When you have defined the parameters you need, add your system initialization table to your working CICS system by assembling the DFHSIT macro. The macro assembly process produces the linkage-editor control statements needed to link-edit your table into your CICS (or private) sublibrary.

When you have assembled your SIT, make it known to CICS using one of the following methods:

- Including your sublibrary in the LIBDEF statement of the CICS startup job stream.
- Coding the suffix of your system initialization table on the SIT system initialization override parameter.
- Including the suffix of chosen system initialization table on the PARM parameter of the EXEC DFHSIP statement. Figure 19 on page 127 gives an example of using the PARM parameter to specify a SIT with the suffix 1ú.

For information about assembling and link-editing CICS control tables, see CICS Resource Definition Guide.

Examples of the syntax notation for describing CICS macros are given in the CICS Resource Definition Guide.

### Assembler errors from duplicated or undefined keywords

If you duplicate a keyword when using VSE/ESA 2.4 and the High Level Assembler, the following error messages are produced:

```
ASMA018S *** ERROR *** DUPLICATE KEYWORD IN MACRO CALL;  
                                LAST VALUE IS USED - DFHSI/keyword
```

If you use an undefined keyword, the following error message is produced:

```
ASMA017W ** WARNING ** UNDEFINED KEYWORD PARAMETER; DEFAULT TO POSITIONAL,  
INCLUDING KEYWORD - DFHSI/keyword
```

However, be aware that because of work space limitations, there is a limit to the number of undefined keyword errors that the assembler can generate. This means that if your SIT contains more undefined keywords than the assembler can generate messages for, the excess errors will not be flagged until a second or even later assembly and, as you correct the currently flagged errors, other (previously unflagged) errors may appear during re-assembly.

---

## Parameters that you cannot code in the DFHSIT macro

There are some CICS system initialization parameters that you cannot define in the DFHSIT macro. These are:

- CDSASZE={0K|number}
- CHKSTRM={CURRENT|NONE}
- CHKSTSK={ALL|CURRENT|NONE}
- ECDSASZE={0K|number}
- ERDSASZE={0K|number}
- ESDSASZE={0K|number}
- EUDSASZE={0K|number}
- JSTATUS=RESET
- NEWSIT={YES|NO}
- PRVMOD={name|(name,name...name)}
- RDSASZE={0K|number}
- SDSASZE={0K|number}
- SIT=xx
- SPCTRxx={{1[,2][,3]}|ALL|OFF}
- START=LOGTERM
- START=(option,ALL)
- STNTRxx={{1[,2][,3]}|ALL|OFF}
- UDSASZE={0K|number}

These parameters can only be supplied at CICS startup time using any of the following methods:

1. The PARM parameter of the EXEC DFHSIP statement
2. The SYSIPT data set defined in the startup job stream
3. Through the system operator's console.

For information about coding system initialization parameters in PARM, SYSIPT or at the console, see "System initialization control keywords" on page 125.

---

## Overriding SIT parameters at system startup

There may be times when you need to change some of the parameters specified in your SIT, but don't want to have to modify your SIT and reassemble it; or you may need to supply parameters that cannot be coded in the DFHSIT macro (as listed in "Parameters that you cannot code in the DFHSIT macro" on page 123). To do this you supply system initialization parameters as **overrides** using the:

- PARM parameter on the EXEC DFHSIP statement
- SYSIPT data set
- Operator console.

You can use one, or a combination of the above methods. However, parameter manager domain processes these three sources in the following strict sequence:

1. The PARM parameter
2. The SYSIPT data set (but only if SYSIPT is coded in the PARM parameter)
3. The console (but only if CONSOLE is coded in either the PARM parameter or in the SYSIPT data set).

**Note:** If you supply duplicate system initialization parameters, either through the same or a different medium, CICS takes the **last** one that it reads. For example, if you specify DCT=1ú in the PARM parameter, DCT=2ú in the SYSIPT data set, and finally enter DCT=3ú through the console, CICS loads DFHDCT3ú.

You complete the override process with the úEND statement.

During startup, CICS uses your chosen system initialization table and any system initialization parameter overrides you have specified to determine the CICS functions you require.

## The CICS parameter manager domain

In addition to loading the system initialization table at the start of initialization, and reading any other parameters from PARM, SYSIPT, or the system console, the parameter manager domain is responsible for the management of the SIT. With the exception of the application domain (AP) which uses the SIT directly, the parameter manager domain passes system initialization parameters to the other CICS domains on request. The domain initialization process is as follows:

### Query the type of startup

With the exception of the trace domain, each domain asks the parameter manager for the type of startup, cold or warm. (For this purpose, the parameter manager domain treats an emergency restart as a warm start.)

### Startup is cold

If startup is cold, domains do not read their domain records from the catalogs. Instead, they request system initialization parameters from the parameter manager domain. Because it is a cold start, the parameter manager domain returns all system initialization parameters from the SIT, modified by any overrides.

### Startup is warm

If startup is warm, domains try to perform a warm start by reading their domain records from the catalogs:

- If they succeed in reading their status records, domains perform a warm start. Where applicable, they also request system initialization parameters from the parameter manager domain. Because it is a warm start, the parameter manager domain returns only those system initialization parameters supplied as overrides via PARM, SYSIPT, or the system console.
- If they fail for any reason to read their status records, domains perform a cold start. They do this either by requesting **all** system initialization parameters from the parameter manager domain, or by using system default values if the domain does not have any system initialization parameters.

### NEWSIT or new suffix

Although a START=AUTO may resolve to a warm start, parameter manager enforces most system initialization parameters if:

- You specify NEWSIT=YES as a system initialization parameter in PARM, SYSIPT, or through the console.
- You specify a different SIT suffix from the previous run of CICS. Parameter manager saves the suffix from each run in the global catalog, and, if it detects a new suffix, it forces the NEWSIT=YES option.

For details of the parameters that are ignored when you specify NEWSIT=YES, see the NEWSIT parameter description on page 172.

**Note:** The trace domain is an exception to the above rules in that it always cold starts. Trace does not save its status at CICS shutdown like the other domains, and regardless of the type of startup, it requests *all* of its system initialization parameters from the parameter manager domain.

## System initialization control keywords

There are three special control keywords that you can use at start up to control how CICS reads in system initialization parameters. These are:

- SYSIN (abbreviated to SI)
- CONSOLE ( abbreviated to CN)
- .END

### The SYSIN (SI) keyword

Code the SYSIN keyword to tell CICS to read system initialization parameters from the SYSIPT data set. You can code SYSIN (or SI) only on the PARM parameter of the EXEC DFHSIP statement. The keyword can appear once only and must be at the end of the PARM parameter. CICS does not read the SYSIPT data stream until it has finished scanning all of the PARM parameter, or until it reaches an úEND keyword before the end of the PARM parameter. An example of coding the SYSIN keyword is:

```
// EXEC DFHSIP,SIZE=DFHSIP,PARM='SI',OS390
```

### The CONSOLE (CN) keyword

Use the CONSOLE (CN) keyword to tell CICS to read initialization parameters from the console. CICS prompts you with message DFHPA1104 when it is ready to read parameters from the console.

You can code the CONSOLE (or CN) keyword in the PARM parameter of the EXEC DFHSIP statement, or in the SYSIPT data stream. The keyword can appear anywhere in the PARM parameter or SYSIPT data stream, but you must code it in one place only.

If you code CONSOLE on the PARM parameter and the PARM parameter also contains the SYSIN keyword CICS does not begin reading parameters from the console until it has finished reading and processing the SYSIPT data stream. Similarly, if you code CONSOLE in the SYSIPT data stream, CICS does not begin reading parameters from the console until it has finished reading and processing the SYSIPT data stream.

In general, after a given CICS system has become the production system, you should perform startup with as little operator intervention as possible (that is, use PARM or SYSIPT, and *not* the console). Better still, use the SIT only, without any overrides. An example of coding the CONSOLE keyword is as follows:

```
// EXEC DFHSIP,SIZE=DFHSIP,PARM='CN',OS390
```

### The .END keyword

The meaning of the .END keyword varies, depending on its context.

Note that \$END is also recognized for compatibility with earlier versions of CICS.

If you are using the PARM parameter, the use of the .END keyword is optional. If you omit it, CICS assumes it to be at the end of the PARM parameter. If you code .END in the PARM parameter it can have one of two meanings:

1. If you also code one, or both, of the other control keywords (CONSOLE and/or SYSIPT) .END denotes the end of the PARM parameter only. For example:



```
// EXEC DFHSIP,SIZE=DFHSIP,PARM='SI,CN,SIT=6$, .END',OS390
```

2. If you code `.END` as the only control keyword in the `PARM` parameter, it denotes the end of all system initialization parameters, and CICS begins the initialization process. For example:

```
// EXEC DFHSIP,SIZE=DFHSIP,PARM='SIT=6$, .END',OS390
```

If `.END` is not the last entry in the `PARM` parameter, CICS truncates the `PARM` parameter and the parameters following the `.END` keyword are ignored.

If you are using the `SYSIPT` data stream, the use of the `.END` keyword is optional. If you omit it, CICS assumes it to be at the end of `SYSIPT`. If you code `.END` in the `SYSIPT` data stream its meaning depends on your use of the `CONSOLE` keyword, as follows:

- If you code the `CONSOLE` control keyword in the `PARM` parameter or in the `SYSIPT` data stream, `.END` denotes the end of the `SYSIPT` data stream only.
- If you do not code the `CONSOLE` control keyword in the `PARM` parameter or in the `SYSIPT` data stream, `.END` denotes the end of all CICS system initialization parameters, and CICS begins the initialization process.

If you code `.END`, and it is not the last entry in the `SYSIPT` data stream, or not at the end of a `SYSIPT` record, CICS initialization parameters following the `.END` are ignored. To avoid accidental loss of initialization parameters, ensure that the `.END` keyword is on the last record in the `SYSIPT` data stream, and that it is the only entry on that line. (However, if you want to remove some system initialization parameters from a particular run of CICS, you could position them after the `.END` statement just for that run.)

The following example shows the use of `.END` in a `SYSIPT` data set:

```
// EXEC DFHSIP,SIZE=DFHSIP,PARM='SI',OS390
* CICS system initialization parameters
SIT=6$,START=COLD,
AUXTR=OFF,CSDLRNO=15
:
:
.END
/*
```

If you are using the `CONSOLE` keyword, the meaning of `.END` through the console depends on whether you are entering new parameters or entering corrections. The two meanings are as follows:

1. If you are keying new parameters in response to message DFHPA1104, `.END` terminates parameter reading, and CICS starts initialization according to the `SIT` it has loaded, but modified by any system initialization parameters you have supplied. Until you enter the `.END` control keyword, CICS continues to prompt you for system initialization parameters.
2. If you have coded `PARMERR=INTERACT`, and CICS detects a parameter error, either in the keyword or in the value that you have assigned to it, CICS prompts you to correct the error with message DFHPA1912 or DFHPA1915. If you enter the correct keyword or value, initialization resumes with CICS continuing to process either the `PARM` parameter, the `SYSIPT` data set, or prompting for more system initialization parameters through the console, depending on where CICS detected the error. If you cannot correct the error, but want CICS to continue with the initialization process, you can enter `.END` to end the error correction phase.



## Processing the PARM parameter

If you omit the PARM parameter from the EXEC DFHSIP statement CICS assumes that there are no SIT override or other initialization parameters, and attempts to load an unsuffixed version of DFHSIT. As a general rule, this is unlikely to be your intention, so the PARM parameter should at least specify the suffix of your system initialization table, using the SIT system initialization parameter.

Alternatively, you can code the special SYSIN keyword as the only PARM parameter, and supply the suffix of your SIT and the other system initialization parameters from the SYSIPT data set.

CICS scans the PARM string looking for a SIT= parameter, any of the special control keywords, or any system initialization parameters, and proceeds as follows:

- If CICS finds a SIT= parameter but no SYSIN keyword, CICS tries to load the SIT as soon as it has finished scanning the PARM parameter. Processing any CICS system initialization parameters that are also present in the PARM parameter takes place only after the SIT has been loaded.
- If CICS finds a SIT= parameter **and** a SYSIN keyword, CICS does not try to load the SIT until it has also finished scanning the SYSIPT data set. In this case, loading the SIT is deferred because there can be other SIT= parameters coded in the SYSIPT data set that override the one in the PARM parameter.

Processing any system initialization parameters that are also present in the PARM parameter takes place only after the SIT has been loaded.

### Rules for coding PARM parameters

The rules for coding the PARM parameter on an EXEC job control statement are described fully in the *VSE/ESA System Control Statements* manual.

Briefly, the maximum number of characters you can code on each PARM parameter is 100, excluding the opening and closing apostrophes. All CICS system initialization parameters must be separated by a comma, and the separating commas are included in the 100 character limit. You can code the PARM parameter up to three times on one EXEC statement. The syntax rules above apply to each PARM parameter separately. Because of this limiting factor, you might prefer to limit the use of the PARM parameter to specify the SYSIN control keyword only.

### Coding the PARM parameter over two lines

If you need to continue your PARM parameter on a second line, indicate the continuation with a nonblank character in column 72, and continue in column 16 on the next line. Do not leave any blank columns between your SIT overrides and the continuation character in column 72; your overrides must be entered up to, and including, column 71.

Figure 19 gives an example of the PARM parameter coded over two lines.

```
0----+----1----+----2----+----3----+----4----+----5----+----6----+----7--
// EXEC DFHSIP,SIZE=DFHSIP,PARM='SIT=1$,DCT=1B,GRPLIST=DFHLIST,TCT=5$,T*
      S=(,0),SPOOL=YES,START=AUTO',OS390
```

Figure 19. Example of a PARM parameter coded over two lines

## Processing the SYSIPT data set

CICS scans the SYSIPT data set looking for a SIT= parameter and any of the special keywords, as well as system initialization parameters.

If CICS finds a SIT= parameter in the SYSIPT data set, it tries to load that SIT, overriding any that was specified in the PARM parameter. If CICS does not find a SIT= parameter in the SYSIPT data set, it tries to load any SIT specified in the PARM parameter.

However, if after scanning the PARM parameter and the SYSIPT data set CICS has not found a SIT= parameter, CICS does one of the following:

1. If you specified CONSOLE in the PARM parameter or in the SYSIPT data set, CICS prompts you with the following message to enter the SIT suffix as the first parameter through the console:

```
DFHPA1921 DBDCCICS PLEASE SPECIFY THE REQUIRED SIT SUFFIX, OR
                SPECIFY 'NONE' (UNSUFFIXED).
```

2. If you did not specify CONSOLE, CICS automatically tries to load an unsuffixed SIT module (DFHSIT). If this load fails, CICS issues message DFHPA1106, requesting a SIT suffix in reply to the message.

**Note:** CICS does not process any system initialization parameters that are coded in the PARM parameter and the SYSIPT data set until after the SIT has been loaded.

### Rules for coding parameters in the SYSIPT data set

There are a few simple rules to observe when coding CICS system initialization parameters in the SYSIPT data set. These are:

- Use a comma to separate parameters that are on the same line. The use of a comma at the end of a SYSIPT record is optional.
- You can use an asterisk in column 1 to code comments, or to remove temporarily an initialization parameter from a particular execution of CICS.
- You can also add comments after the parameters on a SYSIPT line, but they must be preceded by at least one blank character.
- The SYSIPT data set is an 80-byte file. Everything that appears in positions 1 through 80 is treated by CICS as input data.
- You can continue, on another line in SYSIPT, parameters that have multiple operands if you make the split immediately after a comma. CICS concatenates the operands, omitting the intervening blanks.
- As a general rule, you cannot split an individual operand between lines. However, in the case of the GMTEXT parameter, you can enter the operand over more than one line up to the maximum of 246 characters. The format of this parameter is:

```
GMTEXT='User' 's text'
```

You can use apostrophes to punctuate message text, provided that you code *two* successive apostrophes to represent a single apostrophe (as shown in the example above). The apostrophes delimiting the text are mandatory.

- You must take care when coding parameters that use apostrophes, parentheses, or commas as delimiters, because failure to include the correct delimiters is likely to cause unpredictable results.

## Processing the console entries

Generally, CICS does not begin to read from the console until it has loaded the SIT and processed any initialization parameters that are coded in the PARM parameter and the SYSIPT data set. CICS accepts system initialization parameters from the console until you terminate the input with .END.

You can specify a SIT= parameter only as the first parameter through the console when prompted by message DFHPA1921, at which point CICS tries to load the specified SIT. If you try to specify a SIT= parameter after CICS has loaded the SIT it is rejected as an error.

### Rules for coding parameters at the console

When it is ready to read parameters from the console, CICS displays the following message (where nn is the reply ID):

```
nn DFHPA1104 applid - SPECIFY ALTERNATIVE SIT PARAMETERS, IF ANY,
                      AND THEN TYPE '.END'.
```

You can enter as many initialization parameters as you can get on one line of the console, but you must use a comma to separate parameters. CICS continues to prompt for system initialization parameters with displays of message DFHPA1105 until you terminate console input by entering the .END control keyword.

### Entering corrections to parameters at the console

If you have coded PARMERR=INTERACT, and CICS detects a parameter error, either in the keyword or in the value you have assigned to it, CICS prompts you to correct the error with message DFHPA1912 or DFHPA1915:

```
DFHPA1912 applid SIT OVERRIDE 'keyword' IS NOT RECOGNIZED.
                SPECIFY CORRECT SIT OVERRIDE.
```

```
DFHPA1915 applid INVALID DATA HAS BEEN DETECTED FOR SIT OVERRIDE
                'keyword'. RESPECIFY THE OVERRIDE.
```

CICS prompts you to enter corrections to any errors it find in the PARM parameter or the SYSIPT data set *after* it has loaded the SIT, and as each error is detected. This means that if there is an APPLID parameter *following* the parameter that is in error, either in the PARM parameter or in the SYSIPT data set, it is the APPLID coded in the SIT that CICS displays in messages DFHPA1912 and DFHPA1915.

---

## Notes on CICS resource table and module keywords

Table 3 shows the system initialization keywords for those CICS resources that:

- Have a suffix option
- Result in a dummy program or table if you code resource=NO
- You can COLD start individually.

*Table 3. Summary of resources with a suffix, a dummy load module, or a COLD option*

DFHSIT keyword	Default <b>1</b>	Suffix <b>2</b>	Dummy <b>3</b>	COLD start <b>4</b>
BMS	FULL	-	-	COLD
CLT	-	xx	-	-
DBP	-	xx	-	-
DCT	YES	xx	-	COLD
DIP	NO	-	program	-
DL1 or DLI	NO	-	-	COLD
FCT	YES	xx	-	-
ICP	-	-	-	COLD
JCT	YES	xx	program	-
MCT	NO	xx	<b>5</b>	-
PLTPI	NO	xx	-	-
PLTSD	NO	xx	-	-

Table 3. Summary of resources with a suffix, a dummy load module, or a COLD option (continued)

DFHSIT keyword	Default <b>1</b>	Suffix <b>2</b>	Dummy <b>3</b>	COLD start <b>4</b>
SRT	YES	xx	-	-
TCT	YES	xx	table	-
TS	-	-	-	COLD
TST	NO	xx	-	-
XLT	NO	xx	-	-

**Notes for Table 3 on page 129:**

**1** The **Default** column indicates the default value for the keyword in the DFHSIT macro.

If you code YES in the SIT for those keywords with the suffix option, an unsuffixed version of the table or program is loaded. For example, DCT=YES results in a table called DFHDCT being loaded.

You can also select an unsuffixed module or table at CICS startup by specifying **keyword=**, or **keyword=YES**. For example, if you code:

```
DBP=, or DBP=YES
FCT=, or FCT=YES
```

blanks are appended to DFHDBP and DFHFCT respectively, and these unsuffixed names are used during initialization.

The result of specifying **keyword=**, as a system initialization parameter through PARM, SYSIPT, or CONSOLE is not necessarily the same as in the DFHSIT macro. For example, TST=, (or omitted altogether) when coding the DFHSIT macro is taken to mean TST=NO, but TST=, through any of the other three methods is the same as TST=YES.

**2** The **Suffix** column indicates whether you can code a suffix. (xx indicates that a suffix can be coded.)

The DBP keyword is mandatory; you must code either a suffix or YES for DBP. For more information about the DBP system initialization parameter, see page 152.

A suffix can be any 1 or 2 characters, but you must not use DY. You cannot use NO as a suffix.

If you code a suffix, a table or program with that suffix appended to the standard name is loaded. For example, DBP=2\$ causes DFHDBP2\$ dynamic backout program to be included in your CICS region.

When the suffix option is specified with other values, the two values must be enclosed within parentheses: for example, DCT=(xx,COLD).

**3** The **Dummy** column indicates whether a dummy version of the program or table is loaded if you code NO. In some cases, coding NO for the operand associated with the **table** results in a dummy **program**. For more information about the effect of this option, see “Selecting versions of CICS programs and tables” on page 131.

**4** The **COLD start** column indicates whether the resource can be forced to start COLD. (COLD indicates that the resource can be cold started individually).

If COLD is coded, it can be overridden only by coding START=(...,ALL) as a system initialization parameter. For more information about this option, see page 187.

For more information about CICS table and program selection, see “Selecting versions of CICS programs and tables”.

**5** If you code MCT=NO, the CICS monitoring domain builds dynamically a default monitoring control table. This ensures that default monitoring control table entries are always available for use when monitoring is on and a monitoring class is active.

---

## Selecting versions of CICS programs and tables

A CICS program is usually made up from a group of related CICS functional modules, one example of which is the terminal control program. For most CICS programs you can only have one version, which is supplied with CICS. However, for some CICS programs you can create more than one version; for example, with different service levels. To select a particular version of a program, you can include the load library containing that version in the CICS startup JCL. For the following programs, however, you can select from different versions, by specifying the version you require at system initialization:

1. The dynamic backout program (DBP).
2. The basic mapping support (BMS) program suite.

There are two ways of selecting the versions you need:

1. Using a suffix. Use this method for DBP.
2. Explicitly selecting the level of function needed. Use this method for BMS.

You can also specify that a program is **not** needed (see “Excluding unwanted programs” on page 132 for details).

You can use these methods **only** for the programs referred to in this § and in “Excluding unwanted programs” on page 132, by coding system initialization parameters.

### Using a suffix to select the dynamic backout program

Suffixes are used to distinguish different versions of the dynamic backout program (DBP), a CICS management program. Two versions of DBP are supplied with CICS, both in pregenerated format. These two suffixed versions are:

Suffix	Description
1\$	CICS local DL/I is not supported.
2\$	CICS local DL/I is supported.

### Using an explicit level of function to select programs

You use an explicit level of function to select the BMS suite of programs. When you specify your BMS requirement on the BMS system initialization parameter, you can select one of three versions. The BMS level of function is selected by the parameter options MINIMUM, STANDARD, or FULL, from which the system initialization program loads the set of programs you require.

## Excluding unwanted programs

The three ways of excluding programs that are not required are by specifying one of programname=NO, tablename=NO, or function=NO.

### Specifying programname=NO

If you code programname=NO in your system initialization table (for example, DIP=NO), or as a SIT override parameter, you exclude the named management program at CICS system initialization.

The programs that you can exclude by coding programname=NO are:

- Batch data interchange program (DIP)
- Terminal control program (TCP).

**Note:** In the case of DIP, you get a dummy version of the management program, which is supplied on the distribution tape with a suffix of **DY**.

### Specifying tablename=NO for the program's control table

Not all of the CICS programs have a programname parameter in the SIT. The alternative method of excluding them is to code NO against the table name for these programs. This has the same effect as coding NO against a program name parameter, and the associated CICS program is excluded at system initialization, either by loading a dummy program, or by some other technique.

The tables that can be used in this way, and their associated management programs, are shown in Table 4.

Table 4. SIT control tables with a NO option

<b>Control tables</b>	<b>Associated management modules</b>
Journal control table (JCT)	Journal control program (JCP)
System recovery table (SRT)	System recovery program (SRP)

A dummy version of the management program (suffixed **DY**) is supplied for journal control. The dummy program is DFHJCPDY. because you don't need DFHJCP if you specify no journaling.)

#### The dummy TCT, DFHTCTDY

There is a special case where you can also specify tablename=NO, but this does not load a dummy terminal control program. You specify TCT=NO when you are using resource definition online, and all of your terminal resource definitions are in the CSD.

When you specify TCT=NO, CICS loads a dummy TCT named DFHTCTDY. If you specify TCT=NO, a generated table of this name must be available in a sublibrary of the LIBDEF PHASE, SEARCH chain for the CICS job when you start CICS. A pregenerated dummy table, and its source, are provided in the VSE/ESA sublibrary, PRD1.BASE.

The dummy TCT provides **only** the CICS and VTAM control blocks that you need if you are using VTAM terminals and using the CSD for storing terminal definitions. You define your VTAM terminals using the RDO transaction, CEDDA, a user application program using EXEC CICS CREATE TERMINAL commands, or the DEFINE command of the DFHCSDUP utility program.

## Specifying function=NO

If you code function=NO as a system initialization parameter (for example, XRF=NO), you exclude the management program associated with the named function at CICS system initialization.

You can exclude CICS DL/I support, intersystem communication (ISC), the 3270 print-request facility, the system spooling interface, or the extended recovery facility (XRF), in this way.

---

## Classes of start and restart

The type of initialization that CICS performs is not only determined by the START parameter. The CICS local and global catalogs also play a major role in the initialization process, together with any system initialization parameters that you provide, either in the SIT or at run time by one of the three methods described in this chapter.

## The global catalog

CICS uses the global catalog to save all resource definitions that are installed at CICS shutdown. These are:

- Programs
- Transactions and transaction profiles
- Transaction classes
- Terminals, including any which are autoinstalled
- Typeterms
- Connections and sessions
- BMS maps sets and partition sets
- Files.

The resource definitions that CICS saves at its shutdown may have been installed during a cold start (from a list of groups specified by a group list system initialization parameter), or during CICS execution (by CEDA INSTALL or EXEC CICS CREATE commands).

If you run CICS with START=AUTO, and a warm or emergency restart results, CICS restores all the installed resource definitions as they were at normal CICS shutdown, or at the time of system failure. The general rule is that you cannot alter installed resource definitions during a restart except by coding START=COLD.

The CICS domains also use the global catalog to save their domain status between runs. In some cases this information can be overridden during a restart by supplying system initialization parameters. For example, CICS monitoring uses the cataloged status at a restart, but modified by any system initialization parameters you provide. In other cases the domain information saved in the catalog is always used in a restart.

For example, CICS statistics interval time is always restored from the catalog in a warm or emergency restart, because the statistics domain does not have this as a system initialization parameter. To change this you must use CEMT or EXEC CICS commands after control is given to CICS. Alternatively, you can enforce system defaults by performing a cold start.

**Note:** If you need to reinitialize the CICS global catalog for any reason, you must also reinitialize the local catalog.



## The local catalog

The CICS domains use the local catalog to save some of their information between CICS runs. If you delete and redefine the local catalog, you must:

- Initialize the CICS local catalog with an initial set of domain records.
- Use the CICS-supplied utility program, DFHSMUTL, to re-add records to enable the CICS self-tuning mechanism for storage manager domain subpools. For details of how to do this, see the *CICS Operations and Utilities Guide*.
- Delete and reinitialize the CICS global catalog.

For more information about initializing the local catalog, see the CICS System Definition Guide.

Some of the information that is saved in the local catalog can be overridden at CICS system initialization by system initialization parameters, such as CICS transaction dump data set status.

**Note:** If you need to reinitialize the local catalog for any reason, you must also reinitialize the global catalog.

## The START system initialization parameter

You can influence the type of startup that CICS performs, by specifying the START system initialization parameter, as follows:

### START=AUTO

If you code AUTO as the START operand, CICS determines, by inspecting the control record in the global catalog, which of the following three types of start to perform.

#### 1. WARM

If the control record in the global catalog indicates that the previous run of CICS terminated normally with a successful warm keypoint, CICS performs a warm restart. The local catalog must also contain the information saved by the CICS domains during the previous execution for the warm restart to be successful. A warm start restores CICS to the state it was in at the previous shutdown.

If you are using disk journaling, the status of the disk journals is also saved in the global catalog. This information is used by CICS at startup to determine which journal data set is to be opened. You can use the JSTATUS=RESET startup parameter to cause the status in the global catalog to be ignored. During CICS startup, the status of all journal data sets is set to "ready for use". For more information about using JSTATUS=RESET, see the and the description of the JSTATUS parameter on page 167.

You can modify a warm restart by coding the NEWSIT system initialization parameter. This has the effect of enforcing the system initialization parameters coded in the SIT, overriding any cataloged status from the previous CICS shutdown.

The exceptions to this are the system initialization parameters FCT, the CSDxxxx group (for example CSDACC), and GRPLIST, which are always ignored in a warm restart, even if you specify NEWSIT=YES. Specifying NEWSIT=YES causes, in effect, a partial cold start.

#### 2. COLD

If there is no control record in the CICS global catalog, CICS assumes



that the catalog has been newly initialized, and forces a cold start. If you have recreated the global catalog for some reason, you must also reinitialize the local catalog.

### **3. EMERGENCY**

If the control record in the global catalog indicates that the previous run of CICS terminated in an immediate or uncontrolled shutdown, CICS performs an emergency restart.

The emergency restart procedure uses the system log at the time of the failure to return recoverable resources to their committed states.

START=AUTO should be the normal mode of operation, with the choice of start being made by CICS automatically.

### **START=COLD**

If you code COLD as the START operand, CICS initializes using the resource definitions specified by the system initialization parameters, ignoring any previously installed resource definitions saved in a warm keypoint in the global catalog. This includes all the groups of resources specified by the GRPLIST= system initialization parameter, and those resources specified in CICS control tables.

Be aware, however, that a start initiated by START=COLD is not entirely without reference to the previous run of a CICS system using the same global catalog.

For example, CICS checks the 'global catalog' for any dataset name block entries for VSAM data sets for which backout failures have occurred previously.

You can perform a fully cold start of CICS, without reference to any previous execution, only by reinitializing both CICS catalogs. Generally, do this only when you are starting your CICS system for the first time.

There may be times when it is necessary to restart CICS with START=COLD, irrespective of the type of system termination that has been recorded in the global catalog.

### **START=STANDBY**

The STANDBY option is for use only with XRF=YES. START=STANDBY initializes an alternate CICS region. If you code START=STANDBY with XRF=NO, initialization fails with message DFHXA6530, and CICS terminates abnormally with a dump.

CICS initializes as an alternate CICS region by beginning to perform an emergency restart, which is then suspended until it needs to perform a takeover. During the period when initialization is suspended, the alternate CICS region is in standby mode and monitors the active CICS region. When it takes over, the alternate CICS region completes the emergency restart and becomes the active CICS region.

If you have specified a COLD start for other CICS resources, for example, DCT=(xx,COLD), they are cold started when the alternate CICS region (with START=STANDBY specified) takes over. This may cause CICS to lose data on an XRF takeover; for example, coding ICP=COLD results in outstanding STARTs being lost. You are recommended to code START=(STANDBY,ALL) to ensure a full emergency restart during takeover, unless you wish to specifically cold start individual resources.

For information about operating a CICS region with XRF, see the CICS Operations and Utilities Guide.

### START=LOGTERM

The LOGTERM operand on the START parameter is a special restart option. It is for use only when the system log is defined on **disk** data sets, to cater for an abnormal termination of a CICS system that does not close the system log. The LOGTERM option causes a CICS restart to put only an end of file label on the log, and then terminate **before** doing any backout processing. You can use START=LOGTERM, for example, if you need to close the system log to perform offline file recovery, particularly in those cases when you know (or suspect) that emergency restart won't work.

LOGTERM is available only as a system initialization parameter at run time, and cannot be coded in the system initialization table. It is also intended for use only when you are running CICS with XRF=NO.

Table 5. Effect of the START= parameter in conjunction with the catalogs

START= parameter	State of the CICS catalogs	Result at restart
COLD	Local and global catalogs are both newly initialized.	CICS performs a fully cold start. All domains are initialized using system default values, modified by any system initialization parameters. All resources are installed as specified by system initialization parameters.
COLD	The global catalog contains a successful warm keypoint from previous run, and the local catalog contains information saved by the CICS domains.	CICS performs a cold restart, installing the resource definitions specified by system initialization parameters. The domains initialize according to system initialization parameters, or using system default values where there are no parameters (for example the statistics domain). CICS also checks the global catalog for any data set name block entries for VSAM data sets for which backout failures were recorded in the system log.
AUTO	Local and global are both newly initialized.	CICS enforces a fully cold start. All domains are initialized with system default values, modified by any system initialization parameters. All resources are installed as specified by system initialization parameters.
AUTO	The global catalog contains a successful warm keypoint from the previous run. The local catalog is newly initialized.	CICS begins to perform a warm restart, but fails during the initialization process because of absence of expected records in the local catalog.  <b>(Do not reinitialize only one of the catalogs.)</b>
AUTO	The global catalog contains a successful warm keypoint from the previous run, and the local catalog contains information saved by the domains.	CICS performs a warm restart, restoring all of your CICS system except the trace domain to the same status it was in at CICS shutdown. (CICS trace domain does not save the status of the various trace options at CICS shutdown, and always uses the system initialization parameters.) Only those resources that have a COLD option on their system initialization parameter can be cold started (for example, the destination control table or auxiliary temporary storage).

Table 6 shows the effect of the various START options, combined with system initialization parameters where applicable, on the CICS trace, monitoring, statistics, and dump domains:

Table 6. Effect of the START= parameter on the CICS domains at initialization

Domain	State of the CICS catalogs	Result at startup if START=AUTO	Result at startup if START=COLD
Trace	Not relevant	Domain initializes according to the system initialization parameters.	Domain initializes according to the system initialization parameters.
Monitoring	The global catalog is newly initialized.	Domain initializes according to the system initialization parameters.	Domain initializes according to the system initialization parameters.
Monitoring	The global catalog contains status of monitoring at the previous CICS shutdown.	Domain uses monitoring status from the catalog, but modified by any system initialization override parameters.	Domain initializes according to the system initialization parameters.
Statistics	The global catalog is newly initialized.	Domain initializes according to CICS-defined system default values.	Domain initializes according to CICS-defined system default values.
Statistics	The global catalog contains status of statistics at CICS shutdown.	Domain uses statistics status from the catalog.	Domain initializes according to CICS-defined system default values.
Dump	The global catalog is newly initialized.	Domain initializes the dump table according to CICS-defined system default values. Other dump attributes are set by system initialization parameters.	Domain initializes an empty dump table, and takes CICS-defined default action for all dump requests. Other dump attributes are set by system initialization parameters.
Dump	The global catalog contains dump status at CICS shutdown.	Domain reads the dump table and dump status from the catalog, but the dump status is modified by any system initialization parameters.	Domain initializes an empty dump table, and takes CICS-defined default action for all dump requests. Other dump attributes are set by system initialization parameters.

## CICS startup and the VTAM session

In a VTAM network, the session between CICS and VTAM is started automatically if VTAM is started before CICS. If VTAM is not active when you start CICS, you receive the following messages:

```
+DFHSI1589D 'applid' VTAM is not currently active.
+DFHSI1572 'applid' Unable to OPEN VTAM ACB - RC=xxxxxxx, ACB CODE=yy.
```

If you receive messages DFHSI1589D and DFHSI1572, and if the CICS region is not initializing as an alternate CICS region, you can start the CICS-VTAM session manually when VTAM is eventually started, by means of the CEMT SET VTAM OPEN command from any VSE console defined to CICS.

If VTAM is active, but CICS still cannot open the VTAM ACB because VTAM does not recognize the CICS APPLID, you receive the following messages:

```
+DFHSI1592I 'applid' CICS applid not (yet) active to VTAM.  
+DFHSI1572 'applid' Unable to OPEN VTAM ACB - RC=00000008, ACB CODE=5A.
```

This may be caused by an error in the value of APPLID operand, in which case you must correct the error and restart CICS. For information about other causes and actions, see the CICS Messages and Codes manual.

### **Concurrent initialization of VTAM and XRF alternate CICS regions**

An XRF alternate CICS region cannot initialize properly until it has successfully opened the VTAM ACB.

Because VTAM and the alternate CICS region may be initialized concurrently, it is possible that several tries may have to be made to open the VTAM ACB. If VTAM is not active, the following message is written to the system console every 15 seconds:

```
DFHSI1589D 'applid' VTAM is not currently active.
```

If VTAM is active, but CICS cannot open the VTAM ACB, the following messages are written to the system console:

```
+DFHSI1572 'applid' Unable to OPEN VTAM ACB - RC=xxxxxxx, ACB CODE=yy.  
DFHSI1590 'applid' XRF alternate cannot proceed without VTAM.
```

CICS abends with a dump (abend code 1590).

## **End of CICS startup**

Whichever type of startup is performed, when the message:

```
DFHSI1517 'applid' Control is being given to CICS.
```

is displayed on the operating system console, CICS is ready to process terminal requests (*applid* is the value of the specific APPLID system initialization parameter).

When the startup process is completed, users are able to enter transactions from any terminals that are connected to CICS. For information about the CICS-supplied transactions, see the CICS Supplied Transactions manual.

---

## **The system initialization parameter descriptions**

Unless otherwise stated, all of the system initialization parameters described here can be defined to CICS by any of these four ways:

1. In a DFHSIT macro
2. In a PARM parameter on the DFHSIP statement
3. In the SYSIPT data set of the CICS startup job stream
4. Through the system console.

### **Default notation**

Default values are **underscored**; for example, TYPE=CSECT. This notation applies to the SIT macro parameters only.

**TYPE={CSECTIDSECT}**

Indicates the type of SIT to be generated.

**CSECT**

A regular control section that is normally used.

**DSECT**

A dummy control section.

**ADI={30|number}**

Specifies, when you are running CICS with XRF, the alternate delay interval in seconds. The minimum delay that you can specify is 5 seconds. This is the time that must elapse between the (apparent) loss of the surveillance signal in the active CICS system, and any reaction by the alternate CICS system. The corresponding parameter for the active is PDI. ADI and PDI need not have the same value.

**AIEXIT={DFHZATDX|DFHZATDY|name}**

Specifies the name of the autoinstall user-replaceable program that you want CICS to use when autoinstalling local VTAM terminals, APPC connections, and remote terminals. Autoinstall is the process of installing resource definitions automatically, using VTAM logon or BIND data, model definitions, and an autoinstall program.

**Important**

You can specify only one user-replaceable program on the AIEXIT parameter. Which of the CICS-supplied programs (or customized versions thereof) that you choose depends on what combination of resources you need to autoinstall.

For background information about autoinstall, see the CICS Resource Definition Guide.

**DFHZATDX**

A CICS-supplied autoinstall user program. This is the default. It installs definitions for locally-attached VTAM terminals, remote shipped terminals, and remote shipped connections.

**DFHZATDY**

A CICS-supplied autoinstall user program. It installs definitions for both locally-attached VTAM terminals, local APPC connections, remote shipped terminals, and remote shipped connections.

**name**

The name of your own customized autoinstall program, which may be based on one of the supplied sample programs. For programming information about writing your own autoinstall program, see the CICS Customization Guide.

**AILDELAY={0|hhmmss}**

Specifies the delay period that elapses after a session between CICS and an autoinstalled terminal is ended, before the terminal entry is deleted. A session is ended when a terminal logs off or when a transaction disconnects a terminal from CICS.

**hhmmss**

Specify a 1-to 6-digit number. The default is 0, meaning the terminal entry is

deleted as soon as the session is ended. If you leave out the leading zeros, they are supplied (for example, 123 becomes 000123, that is, 1 minute 23 seconds).

**Note:** The AIRDELAY parameter does not apply to autoinstall of APPC connections, because they are not deleted.

**AIQMAX={100|number}**

Specifies the maximum number of VTAM terminals and APPC connections that can be queued concurrently for autoinstall.

**number**

A number in the range 0 through 999. The default is 100.

A zero value disables the autoinstall function.

You should specify a number that is large enough to allow for both APPC connections and terminals.

**Note:** This value does not limit the total number of terminals that can be autoinstalled. If you have a large number of terminals autoinstalled, shutdown can fail due to the MXT system initialization parameter being reached or CICS becoming short on storage. For information about preventing this possible cause of shutdown failure, see the CICS Performance Guide.

**AIRDELAY={700|hhmmss}**

Specifies the delay period that elapses after an emergency restart before autoinstalled terminal entries that are not in session are deleted.

**hhmmss**

Specify a 1-to 6-digit number. If you leave out the leading zeros, they are supplied. The default is 700, meaning a delay of 7 minutes. A value of 0 means that autoinstalled terminal definitions are not written to the global catalog and therefore are not restored at an emergency restart. For guidance about the performance implications of setting different AIRDELAY values, see the CICS Performance Guide.

**Note:** The AIRDELAY parameter does not apply to autoinstall of APPC connections, because they are not cataloged.

**XRF restriction**

If you are running CICS with XRF, set the same value on the AIRDELAY parameter for both the active and the alternate CICS systems. It is particularly important, if you want autoinstall sessions to be reestablished after a takeover, that you avoid coding a zero on this parameter for either the active or the alternate CICS systems.

For background information, see the CICS XRF Guide.

**AKPFREQ={200|number}**

If AKPFREQ is a number other than zero, it specifies the number of consecutive blocks, written by DFHJCP to the system log data set, that triggers the activity keypoint function. The minimum number that should be coded is 200 (the default) and the maximum number is 65535. (The CICS region must support activity keypointing: that is, the CSKP transaction and DFHAKP program must

be defined. For information about supporting activity keypointing, see the CICS Recovery and Restart Guide and the CICS Performance Guide.)

If AKPFREQ=0 is coded, no activity keypoints are taken and a subsequent emergency restart is not possible.

**APPLID={DBDCCICS|applid}**

The VTAM application identifier for this CICS system.

**applid**

This name, 1 through 8 characters, identifies the CICS system in the VTAM network. It must match the name field specified in the APPL statement of the VTAM VBUILD TYPE=APPL definition.

When you define this CICS system to another CICS system, in a CONNECTION definition, you specify the applid as the NETNAME.

If the CICS system uses XRF, the form of the APPLID parameter is:

**APPLID=(generic\_applid,specific\_applid)**

Specifies the generic and specific XRF applids for the CICS system. Both applids must be 1 through 8 characters.

**generic\_applid**

This is the generic applid for both the active and the alternate CICS systems. Therefore, you must specify the same name for *generic\_applid* on the APPLID system initialization parameter for both CICS systems. Because IRC uses *generic\_applid* to identify the CICS systems, there can be no IRC connection for an alternate CICS system until takeover has occurred and the alternate CICS system becomes the active CICS system.

When you define this XRF pair to another CICS system, in a CONNECTION definition, you specify the generic applid as the NETNAME.

**specific\_applid**

This identifies the CICS system in the VTAM network. It must match the label specified in the VTAM VBUILD TYPE=APPL definition. You must specify a different *specific\_applid* on the APPLID system initialization parameter for the active and for the alternate CICS system. Also, *generic\_applid* and *specific\_applid* must be different.

The active and alternate CICS systems use the VTAM MODIFY USERVAR command to set a user application name variable, so end users do not need to know which CICS system is active at any instant. For background information about using this command, see the CICS XRF Guide.

**AUTCONN={0|hhmmss}**

Specify this to delay the reconnection of terminals after an XRF takeover, to allow time for manual switching. The delay is hh hours, mm minutes, ss seconds. The default value of zero means that there is no delay in the attempted reconnection.

The interval specified is the delay before the CXRE transaction runs. CXRE tries to reacquire terminals that were in session at the time of the takeover.



Note that the same delay interval applies to the connection of terminals with AUTOCONNECT(YES) specified in the RDO TYPETERM definition, at a warm or emergency restart, whether or not you have coded XRF=YES.

**AUXTR={OFFION}**

Indicates if the auxiliary trace destination is to be activated at system initialization. This parameter controls whether any of the three types of CICS trace entry are written to the auxiliary trace data set. The three types are: CICS system trace (see the SYSTR parameter), user trace (see the USERTR parameter), and exception trace entries (that are always made and are not controlled by a system initialization parameter).

**OFF**

Do not activate auxiliary trace.

**ON**

Activate auxiliary trace.

For details of internal tracing in main storage, see the INTTR parameter on page 166.

**AUXTRSW={NOIALLINEXT}**

Specifies whether you want the auxiliary trace autoswitch facility.

**NO**

Disables the autoswitch facility.

**NEXT**

Enables the autoswitch facility to switch to the next data set at end of file of the first data set used for auxiliary trace. Coding NEXT permits one switch only, and when the second data set is full, auxiliary trace is switched off.

**ALL**

Enable the autoswitch facility to switch to the inactive data set at every end of file. Coding ALL permits continuous switching between the two auxiliary trace data sets, DFHAUXT and DFHBUXT, and whenever a data set is full, it is closed and the other data set is opened.

**BMS=({MINIMUMISTANDARDIFULL}[ , COLD][ , {UNALIGNIALIGN}][ , {DDSINODDS}])**

Specifies which version of basic mapping support you want to be included. The function included in each version of BMS is shown in Table 7 on page 143. The parameter BMS can be overridden during CICS initialization.

You need full or standard function BMS, if you are using XRF and have specified MESSAGE for RECOVNOTIFY on any of your RDO TYPETERM resource definitions.

**MINIMUM**

The minimum version of BMS is included.

**STANDARD**

The standard version of BMS is included.

**FULL**

The full version of BMS is included. This is the default in the SIT.

**COLD**

CICS deletes delayed messages from temporary storage, and destroys their interval control elements (ICEs).



### **UNALIGN**

Specifies that all BMS maps assembled before CICS/DOS/VS Version 1 Release 6 are unaligned. Results are unpredictable if the stated alignment does not match the actual alignment.

### **ALIGN**

Code this to indicate that all BMS maps assembled before CICS/DOS/VS Version 1 Release 6 are aligned.

### **DDS**

BMS is to load suffixed versions of map sets and partition sets. BMS first tries to load a version that has the alternate suffix (if the transaction uses the alternate screen size). If the load fails, BMS tries to load a version that has the default map suffix. If this fails too, BMS tries to load the unsuffixed version. DDS, which stands for “device dependent suffixing”, is the default.

You need to use map suffixes only if the same transaction is to be run on terminals with different characteristics (in particular, different screen sizes). If you do not use suffixed versions of map sets and partition sets, CICS need not test for them.

### **NODDS**

BMS is not to load suffixed versions of map sets and partition sets. Specifying NODDS avoids the search for suffixed versions, saving processor time.

Table 7. Versions of BMS

<b>BMS version</b>	<b>Devices supported</b>	<b>Function provided</b>
MINIMUM	All 3270 system display units and printers except SNA character string printers, which are defined as DEVICE(SCSPRINT) on the RDO TYPETERM definition or as TRMTYPE=SCSPRT in DFHTCT	SEND MAP command, RECEIVE MAP command, SEND CONTROL command.  Default and alternate screens; extended attributes; map set suffixes; screen coordination with null maps; and block data
STANDARD	All devices are supported by BMS. These are listed in the CICS Application Programming Guide	All function of MINIMUM, <b>plus</b> outboard formats, partitions, controlling a magnetic slot reader, NLEOM mode for 3270 system printers, SEND TEXT command, and Subsystem LDC controls
FULL	All devices supported by BMS. These are listed in the CICS Application Programming Guide	Same as STANDARD, <b>plus</b> terminal operator paging, cumulative mapping, page overflow, cumulative text processing, routing, message switching returning BMS-generated data stream to program before output.

**CDSASZE={0K|number}**

Specifies the size of the CDSA. The default size is 0 indicating that the DSA size can change dynamically. A non-zero value indicates that the DSA size is fixed.

**number**

Specify number as an amount of storage in the range 0 through 16777215 bytes in multiples of 262144 bytes (256KB). If the size specified is not a multiple of 256KB, CICS rounds the value up to the next multiple.

You can specify number in bytes (for example, 4194304), or as a whole number of kilobytes (for example, 4096K), or a whole number of megabytes (for example, 4M).

**Restrictions**

You can code the CDSASZE parameter in PARM, SYSIPT, or CONSOLE only.

**CHKSTRM={CURRENT|NONE}**

Activate, or deactivate, terminal storage-violation checking. The operands have the following meanings:

**CURRENT**

Code CURRENT to check for TIOA storage violations.

**NONE**

Code NONE to deactivate TIOA storage-violation checking.

You can also use the CICS-supplied transaction, CSFE, to switch terminal storage-violation checking on and off.

For information about checking for storage violations, see the CICS Problem Determination Guide.

**Restrictions**

You can code the CHKSTRM parameter in PARM, SYSIPT, or CONSOLE only.

**CHKSTSK={ALL|CURRENT|NONE}**

Activate, or deactivate, task storage-violation checking at startup. The operands have the following meanings:

**ALL**

Code ALL to check all storage areas on the transaction storage chains for all tasks.

**CURRENT**

Code CURRENT to check all storage areas on the transaction storage chain for the current task only.

**NONE**

Code NONE to deactivate task storage-violation checking.

You can also use the CICS-supplied transaction, CSFE, to switch task storage-violation checking on and off.

For information about checking for storage violations, see the CICS Problem Determination Guide.

**Restrictions**

You can code the CHKSTSK parameter in PARM, SYSIPT, or CONSOLE only.

**CLSDSTP={NOTIFY|NONOTIFY}**

Specifies the notification required for an EXEC CICS ISSUE PASS command. This parameter is applicable to both autoinstalled and non-autoinstalled terminals. You can use the notification in a user-written node error program to reestablish the CICS session when a VTAM CLSDST PASS request resulting from an EXEC CICS ISSUE PASS command fails. For more information about the EXEC CICS ISSUE PASS command, see the CICS Application Programming Reference manual.

**NOTIFY**

CICS requests notification from VTAM when the EXEC CICS ISSUE PASS command is executed.

**NONOTIFY**

CICS does not request notification from VTAM.

**CLT=xx**

Specify the suffix for the command list table (CLT), if this SIT is used by an alternate XRF system. The name of the table is DFHCLTxx.

For information about coding the macros for this table, see the CICS Resource Definition Guide.

**CMDPROT={YES|NO}**

Specifies whether to allow, or inhibit, CICS validation of start addresses of storage referenced as output parameters on EXEC CICS commands.

**YES**

If you specify YES, CICS validates the initial byte at the start of any storage that is referenced as an output parameter on EXEC CICS commands to ensure that the application program has write access to the storage. This ensures that CICS does not overwrite storage on behalf of the application program when the program itself cannot do so. If CICS detects that an application program has asked CICS to write into an area to which the application does not have addressability, CICS abends the task with an AEYD abend.

The level of protection against bad addresses depends on the level of storage protection in the CICS environment. The various levels of protection provided when you specify CMDPROT=YES are shown in Table 8 on page 146.

**NO**

If you specify NO, CICS does not perform any validation of addresses of the storage referenced by EXEC CICS commands. This means an application program could cause CICS to overwrite storage to which the application program itself does not have write access.

Table 8. Levels of protection provided by CICS validation of application-supplied addresses

Environment	Execution key of affected programs	Types of storage referenced by applications that cause AEYD abends
Read-only storage (RENTPGM=PROTECT)	CICS-key and user-key	CICS key 0 read-only storage (RDSA and ERDSA).
Subsystem storage protection (STGPROT=YES)	User-key	All CICS-key storage (CDSA and ECDSA)
Base CICS (all storage is CICS key storage) (RENTPGM=NOPROTECT; and STGPROT=NO)	CICS-key and user-key	VSE storage only

### **CMDSEC={ASIS|ALWAYS}**

Specifies whether or not you want CICS to honor the CMDSEC option specified on a transaction's resource definition.

#### **ASIS**

means that CICS honors the CMDSEC option defined in a transaction's resource definition. CICS calls its command security checking routine only when CMDSEC=YES is specified in a RDO TRANSACTION resource definition.

#### **ALWAYS**

means that CICS overrides the CMDSEC option, and always calls its command security checking routine to issue the appropriate call to the System Authorization Facility (SAF) interface.

#### **Notes:**

1. Specify ALWAYS when you want to control the use of the SPI in all your transactions. Be aware that this might incur additional overhead. The additional overhead is caused by CICS issuing the command security calls on every eligible EXEC CICS command, which are *all* the system programming interface (SPI) commands.
2. If you specify ALWAYS, command checking applies to CICS-supplied transactions such as CESN and CESF. You must authorize all users of CICS-supplied transactions to use the internal CICS resources for the transactions, otherwise you will get unexpected results in CICS-supplied transactions.

#### **Restrictions**

You can code the CMDSEC parameter in the SIT, PARM, or SYSIPT only.

### **CONFDATA={SHOW|HIDE|TC}**

Specifies whether CICS is to suppress (hide) user data that might otherwise appear in CICS trace entries or in dumps that contain the VTAM receive any input area (RAIA.). This option applies to initial input data received on a VTAM RECEIVE ANY operation, the initial input data received on an MRO link, and FEPI screens and RPLAREAs.

#### **SHOW**

Data suppression is not in effect. User data is traced regardless of the

CONFDATA option specified in transaction resource definitions. This option overrides the CONFDATA option in RDO TRANSACTION resource definitions.

### **HIDETC**

Specifies that you want CICS to 'hide' user data from CICS trace entries. It also indicates that VTAM RAIAs are to be suppressed from CICS dumps. The action actually taken by CICS is subject to the individual CONFDATA attribute on the RDO TRANSACTION resource definition (see Table 9 on page 148).

If you specify CONFDATA=HIDETC, CICS processes VTAM, MRO, and FEPI user data as follows:

- **VTAM**

CICS clears the VTAM RAIA containing initial input as soon as it has been processed, and before the target transaction has been identified.

The normal trace entries (FC90 and FC91) are created on completion of the RECEIVE ANY operation with the text "SUPPRESSED DUE TO CONFDATA=HIDETC IN SIT" replacing all the user data except the first 4 bytes of normal data, or the first 8 bytes of function management headers (FMHs).

CICS then identifies the target transaction for the data. If the RDO TRANSACTION resource definition specifies CONFDATA(NO), CICS traces the user data that it suppressed from the FC90 trace in the trace entry AP FC92. This trace entry is not created if the transaction is defined with CONFDATA(YES) on the RDO TRANSACTION resource definition.

- **MRO**

CICS does not trace the initial input received on an MRO link.

The normal trace entries (DD16, DD23, and DD25) are created with the text "SUPPRESSED DUE TO CONFDATA=HIDETC IN SIT" replacing all the user data.

CICS then identifies the target transaction for the data. If the transaction definition specifies CONFDATA(NO), CICS traces the user data that it suppressed from DD16 in the trace entry AP FC92. This special trace entry is not created if the transaction is defined with CONFDATA(YES).

- **FEPI**

FEPI screens and RPL data areas (RPLAREAs) areas are suppressed from all FEPI trace points if CONFDATA(YES) is specified in the transaction resource definition. The user data in the FEPI trace points AP 1243, AP 1244, AP 145E, AP 145F, AP 1460, AP 1461, AP 1595, AP 1596, AP 1597, AP 1598, and AP 1599 is replaced with the message "SUPPRESSED DUE TO CONFDATA=HIDETC IN SIT". If the RDO TRANSACTION resource definition specifies CONFDATA(NO), the FEPI trace entries are created with the user data as normal.

### **Mirror transactions**

The CICS-supplied mirror RDO TRANSACTION resource definitions are specified with CONFDATA(YES). This ensures that, when you specify CONFDATA=HIDETC as a system initialization parameter, CICS regions running mirror transactions suppress user data as described for VTAM and MRO data.

## Modified data

By waiting until the transaction has been identified to determine the CONFDATA option, VTAM or MRO data may have been modified (for example, it may have been translated to upper case).

The interaction between the CONFDATA system initialization parameter and the CONFDATA attribute on the RDO TRANSACTION resource definition is shown in Table 9.

Table 9. Effect of CONFDATA system initialization and transaction definition parameters

CONFDATA on RDO TRANSACTION resource definition	CONFDATA system initialization parameter	
	SHOW	HIDETC
NO	Data not suppressed	VTAM RAIAs are cleared. Initial input of VTAM and MRO data is suppressed from the normal FC90, FC91, DD16, DD23, and DD25 trace entries.  For FC90 and DD16 traces only, suppressed user data is traced separately in an FC92 trace entry.  FEPI screens and RPLAREAs are traced as normal.
YES	Data not suppressed	VTAM RAIAs are cleared. All VTAM, MRO, and FEPI user data is suppressed from trace entries.

You cannot modify the CONFDATA option while CICS is running. You must restart CICS to make such a change.

### Restrictions

You can code the CONFDATA parameter in the SIT, PARM, and SYSIPT only.

### CONFTEXT={NO|YES}

Specifies whether CICS is to prevent VTAM from tracing user data.

#### NO

CICS does not prevent VTAM from tracing user data.

#### YES

CICS prevents VTAM from tracing user data.

### Restrictions

You can code the CONFTEXT parameter in the SIT, PARM, and SYSIPT only.

### CSDACC={READWRITE|READONLY}

Specifies the type of access to the CSD to be permitted to this CICS region. Note that this parameter is effective only when you start CICS with a START=COLD parameter. If you code START=AUTO, and CICS performs a warm or emergency restart, the file resource definitions for the CSD are

recovered from the CICS global catalog. However, you can redefine the type of access permitted to the CSD dynamically with a CEMT SET FILE, or an EXEC CICS SET FILE, command.

#### **READWRITE**

Read/write access is allowed, permitting the full range of CEDA, CEDB, and CEDC functions to be used.

#### **READONLY**

Read access only is allowed, limiting the CEDA and CEDB transactions to only those functions that do not require write access.

#### **CSDBUFND=number**

Specifies the number of buffers to be used for CSD data. The minimum you should specify is the number of strings coded on the CSDSTRNO parameter plus 1, up to a maximum of 32768. Note that this parameter is used only if you have also coded CSDLRNO=NONE; if you have coded CSDLRNO=number, CSDBUFND is ignored.

If you specify a value for CSDBUFND that is less than the required minimum (the CSDSTRNO value plus 1), VSAM automatically changes the number of buffers to the number of strings plus 1 when CICS issues the OPEN macro for the CSD.

This parameter is effective only on a CICS cold start. On a warm or emergency restart, file resource definitions for the CSD are recovered from the global catalog.

#### **CSDBUFNI=number**

Specifies the number of buffers to be used for the CSD index. The minimum you should specify is the number of strings coded on the CSDSTRNO parameter, up to a maximum of 32768. This parameter is used only if you have also coded CSDLRNO=NONE; if you have coded CSDLRNO=number, CSDBUFNI is ignored.

If you specify a value for CSDBUFNI that is less than the required minimum (the CSDSTRNO value), VSAM automatically changes the number of buffers to the number of strings when CICS issues the OPEN macro for the CSD.

This parameter is effective only on a CICS cold start. On a warm or emergency restart, file resource definitions for the CSD are recovered from the CICS global catalog.

#### **CSDFRLOG=number**

Specifies a journal identifier to indicate the journal that you want to use for forward recovery of the CSD. This parameter is used only if CSDRECOV=ALL is specified, otherwise it is ignored. If you omit CSDFRLOG, but specify CSDRECOV=ALL, CSDFRLOG defaults to 1, which indicates that the CICS system log is to be used for forward recovery of the CSD.

The CSDRECOV, and CSDFRLOG system initialization parameters interact according to how they are specified. For information about their effects when the SIT is assembled and during CICS override processing, see the CICS System Definition Guide.

This parameter is effective only on a CICS cold start. On a warm or emergency restart, file resource definitions for the CSD are recovered from the global catalog.

**number**

The journal identification of the journal that is to be used for forward recovery. The number must be in the range 1 through 99. The number 1 indicates the CICS system log, and any other number refers to a user journal.

**CSDJID={NO|number}**

Specifies the journal identifier of the journal that you want CICS to use for automatic journaling of file requests against the CSD.

This parameter is effective only on a CICS cold start. On a warm or emergency restart, file resource definitions for the CSD are recovered from the global catalog.

**NO**

Code NO if you do *not* want automatic journaling for the CSD. This is the default.

**number**

A number in the range 1 through 99 to identify the journal that CICS is to use for automatic journaling for the CSD. The number 1 indicates the CICS system log, and any other number refers to another CICS journal.

The automatic journaling options enforced for the CSD when you code CSDJID=number are JNLADD=BEFORE and JNLUPDATE=YES. These options are sufficient to record enough information for a user-written forward recovery utility. No other automatic journaling options are available for the CSD. For information about the options JNLADD=BEFORE and JNLUPDATE=YES, see the CICS Resource Definition Guide.

**CSDLSRNO={1|number|NONE|INO}**

Specifies whether the CSD is to be associated with a local shared resource (LSR) pool.

This parameter is effective only on a CICS cold start. On a warm or emergency restart, file resource definitions for the CSD are recovered from the global catalog. However, you can redefine the LSR pool attribute for the CSD dynamically with an EXEC CICS SET FILE command.

**1** The default LSR pool number is 1.

**number**

The number of the LSR pool the CSD is to be associated with. The number of the pool must be in the range 1 through 15.

**NONE|INO**

Code NONE (or NO) if the CSD is not to be associated with an LSR pool.

**CSDRECOV={NONE|ALL|BACKOUTONLY}**

Specifies whether the CSD is a recoverable file.

The CSDRECOV, and CSDFRLOG system initialization parameters interact according to how they are specified. For information about their effects when the SIT is assembled and during CICS override processing, see the CICS System Definition Guide.

This parameter is effective only on a CICS cold start. On a warm or emergency restart, file resource definitions for the CSD are recovered from the global catalog.



### **NONE**

The default is that the CSD is not recoverable.

### **ALL**

Code ALL to specify that you want both forward recovery and backout for the CSD. If you code ALL, also specify CSDFRLOG with the journal identification of the journal to be used for forward recovery of the CSD. If you do not code the CSDFRLOG parameter, CICS uses the system log for forward recovery.

**Note:** For backout purposes, CICS always uses the system log. (See the BACKOUTONLY option.)

### **BACKOUTONLY**

Code BACKOUTONLY to limit CSD recovery to file backout only. If you specify backout for the CSD, CICS uses the system log to record before images for backout purposes.

### **CSDSTRNO={2|number}**

Specifies the number of concurrent requests that can be processed against the CSD. When the number of requests reaches the STRNO value, CICS automatically queues any additional requests until one of the active requests terminates.

CICS requires two strings per CSD user, and you can increase the CSDSTRNO value, in multiples of two, to allow more than one concurrent CSD user.

See before you code this parameter.

This parameter is effective only on a CICS cold start. On a warm or emergency restart, file resource definitions for the CSD are recovered from the global catalog. However, you can redefine the number of strings for the CSD dynamically with an EXEC CICS SET FILE command.

**2** The minimum number of concurrent requests for the CSD is 2.

### **number**

This number must be a multiple of 2, in the range 2 through 254.

### **CWAKEY={USER|CICS}**

Specifies the storage key for the common work area (CWA) if you are operating CICS with storage protection (STGPROT=YES). (You specify how much storage you want for the CWA on the WRKAREA parameter.) The permitted values are USER (the default), or CICS:

**USER** If you specify USER, or allow this parameter to default, CICS obtains storage for the CWA in user key. This allows a user program executing in any key to modify the CWA.

**CICS** If you specify CICS, CICS obtains storage for the CWA in CICS key. This means that only programs executing in CICS key can modify the CWA, and user-key programs have read-only access.

If CICS is running without storage protection, the CWAKEY parameter is ignored, and the CWA is always allocated from CICS-key storage.

### **DATFORM={MMDDYY|DDMMYY|YYMMDD}**

Specifies the external date display standard that you want to use for CICS date displays. An appropriate indicator setting is made in the CSA. It is examined by CICS supplied system service programs that display a Gregorian date. CICS

maintains the date in the form 0CYDDDD in the CSA (where C=0 for years 19xx, 1 for years 20xx, and so on; YY=year of century; and DDD=day of year), and converts it to the standard you specify for display.

**MMDDYY**

The date is in the form of month-day-year.

**DDMMYY**

The date is in the form of day-month-year.

**YYMMDD**

The date is in the form of year-month-day.

**DBP={1\$|2\$|xx|YES}**

Specifies which version of the dynamic transaction backout program is to be part of the system. This DBP parameter is mandatory, and has no default. (See page 132 for more information about coding this parameter.)

If you are using local DL/I support, specify DBP=2\$. If you have generated a user-defined DFHDBP program for use with local DL/I support, specify either DBP=xx, where xx is the suffix of your program, or DBP=YES if you have defined an unsuffixed version of DFHDBP.

If you are not using local DL/I support, specify DBP=1\$.

For background information about dynamic transaction backout, see the CICS Recovery and Restart Guide.

The dynamic transaction backout program needs a program resource definition entry in the CSD. This entry must be included in your GRPLIST list at CICS initialization. The CICS-supplied programs DFHDBP1\$ and DFHDBP2\$ have resource definition entries in the CSD group DFHBACK, which is included in the default group list DFHLIST. If you use your own dynamic backout program, you must create a RDO PROGRAM resource definition entry for it in the CSD, and include the entry in one of your GRPLIST lists at CICS initialization. You are recommended to code RESIDENT(YES) on your RDO PROGRAM definition. For information about the required program resource definition entry, see the CICS Resource Definition Guide.

**Restrictions**

You must code a DBP parameter in the system initialization table, although you can override that DBP parameter in PARM, SYSIPT, or CONSOLE.

**DBUFSZ={500|number}**

Specifies the maximum size of the dynamic log buffer (needed for dynamic transaction backout) for each transaction. CICS initially allocates for each buffer half the maximum size that you specify, and subsequently uses the value specified to calculate the actual size of the dynamic buffer. The value can be in the range 6 through 32000; the default is 500.

If the resultant dynamic buffer is too small, CICS spills the dynamic log data to a further area of main storage. (CICS allocates all dynamic log storage, including spilled buffers, above the 16MB line.)

For information on the dynamic log, and how you can tune this parameter, see *Dynamic transaction backout statistics* and *Dynamic log buffer size (DBUFSZ)*

in the CICS Performance Guide.

**DCT={YES|xx|NO}[COLD]**

Specifies the destination control table suffix, for more information see page 129. For information about coding the macros for this table, see the CICS Resource Definition Guide.

**DFLTUSER={CICSUSER|userid}**

Specifies the external security manager (ESM) userid with the security attributes to be used for all terminal users who have not explicitly signed on (by the CESN transaction, the EXEC CICS SIGNON command, or by the preset security options of the TERMINAL resource definition).

The specified userid must be defined to your ESM if you are using external security (that is, you have coded SEC=YES).

The specified userid is signed on during CICS initialization. If it cannot be signed on, CICS fails to initialize.

**Restrictions**

You can code the DFLTUSER parameter in the SIT, PARM, or SYSIPT only.

**DIP={NO|YES}**

Code YES to include the batch data interchange program, DFHDIP, which supports the batch controller functions of the IBM 3790 Communication System and the IBM 3770 Data Communication System, for more information see page 129. (Support is provided for the transmit, print, message, user, and dump data sets of the 3790 system.)

**DISMACP={YES|NO}**

DISMACP=YES allows CICS to disable any transaction that terminates abnormally with an ASRD abend (caused by a user program invoking a CICS macro, or referencing the CSA or the TCA).

**Note:** DISMACP=YES has no effect if the ASRD abend is handled by an active abend exit.

**{DLI|DL1}={NO|xx|YES}[COLD]**

Specifies whether DL/I databases are to be accessed during this run of CICS.

This parameter selects only DL/I support that runs within the CICS address space.

**NO**

DL/I is not to be used.

**xx** DL/I is used. xx is the 1- or 2-character suffix of the DL/I application control table (ACT) specified on the DLZACT TYPE=INITIAL macro, which results in the module DLZNUCxx.

**YES**

DL/I is to be used. You must also specify DBP=2ú.

**COLD**

If you code DLI=YES, you can specify the COLD option if you want to cold start the DL/I resources. The default is the start option coded on the START parameter. If you specify COLD, DL/I databases are not backed out in the event of an emergency restart.

**Note:** On initialization of an XRF alternate system, the DLI COLD option is overridden so that DL/I is emergency restarted, and so DL/I databases are backed out.

**DLIOER={ABEND|CONTINUE}**

Code the DLIOER parameter to tell CICS what to do in the event of DL/I detecting an I/O error on a database.

**ABEND**

CICS abends. In an XRF configuration, the alternate system is canceled. Global user exit, XDBDERR, is not invoked.

**CONTINUE**

CICS continues to run. DL/I flags the database as unusable and allows the use of DL/I utilities to perform database recovery and to restart the database.

**DOCCODEPAGE={037|codepage}**

specifies the default host code page to be used by the document domain. The *codepage* is a field of up to 8 characters. If *codepage* value is not specified, the default *doccodepage* is set to 037.

**DSALIM={5M|number}**

Specifies the upper limit of the total amount of storage within which CICS can allocate the individual dynamic storage areas (DSAs) that reside below the 16MB boundary.

**5M**

The default DSA limit is 5MB (5 242 880).

**number**

Specify *number* as an amount of storage in the range 2MB to 16MB (2 097 152 bytes to 16 777 216 bytes) in multiples of 262 144 bytes (256KB). If the size specified is not a multiple of 256KB, CICS rounds the value up to the next multiple.

You can specify *number* in bytes (for example, 4 194 304), or as a whole number of kilobytes (for example, 4096K), or a whole number of megabytes (for example, 4M).

From the storage size that you specify on the DSALIM parameter, CICS allocates the following dynamic storage areas:

**The user DSA (UDSA)**

The user-key storage area for all user-key task-lifetime storage below the 16MB boundary.

**The read-only DSA (RDSA)**

The key-0 storage area for all reentrant programs and tables below the 16MB boundary.

**The shared DSA (SDSA)**

The user-key storage area for any non-reentrant user-key RMODE(24) programs, and also for any storage obtained by programs issuing EXEC CICS GETMAIN commands for storage below the 16MB boundary with the SHARED option.

**The CICS DSA (CDSA)**

The CICS-key storage area for all non-reentrant CICS-key RMODE(24) programs, all CICS-key task-lifetime storage below the 16MB boundary, and for CICS control blocks that reside below the 16MB boundary.

**Note:** CICS allocates the UDSA and the other DSAs below 16MB in multiples of 256KB. The maximum you can specify depends on a number of factors, such as how you have configured your VSE storage (which governs how much private storage remains below the line) and how much private storage you must leave free to satisfy VSE GETVIS requests for storage outside the DSAs.

For information about calculating the amount of storage to specify on the DSALIM parameter, see the CICS Performance Guide.

**DSHIPIDL={020000|hhmmss}**

Specifies the minimum time, in hours, minutes, and seconds, that an *inactive* shipped terminal definition must remain installed in this region. When the timeout delete mechanism is invoked, only those shipped definitions that have been inactive for longer than the specified time are deleted.

You can use this parameter in a transaction routing environment, on the application-owning and intermediate regions, to prevent terminal definitions having to be reshipped because they have been deleted prematurely.

The default minimum idle time is 2 hours.

**hhmmss**

Specify a 1 to 6 digit number in the range 0 995959. Numbers that have fewer than six digits are padded with leading zeros.

**DSHIPINT={120000|0|hhmmss}**

Specifies the interval between invocations of the timeout delete mechanism. The timeout delete mechanism removes any shipped terminal definitions that have not been used for longer than the time specified by the DSHIPIDL parameter.

You can use this parameter in a transaction routing environment, on the application-owning and intermediate regions, to control:

- How often the timeout delete mechanism is invoked.
- The approximate time of day at which a mass delete operation is to take place, relative to CICS startup.

**Note:** For more flexible control over when mass delete operations take place, you can use a CEMT SET DELETSHIPED or EXEC CICS SET DELETSHIPED command to reset the interval. (The revised interval starts *from the time the command is issued*, **not** from the time the remote delete mechanism was last invoked, nor from CICS startup.)

**0** The timeout delete mechanism is not invoked. You might set this value in a terminal-owning region, or if you are not using shipped definitions.

**hhmmss**

Specify a 1 to 6 digit number in the range 1 995959. Numbers that have fewer than six digits are padded with leading zeros.

**DTRTRAN={CRTX|name|NO}**

This is the name of the transaction definition that you want CICS to use for dynamic transaction routing. This is intended primarily for use in a CICS terminal-owning region, although you can also use it in an application-owning region when you want to daisy-chain transaction routing requests. In a dynamic transaction routing environment, the transaction named on DTRTRAN must be installed in the CICS terminal-owning regions if you want to eliminate the need for resource definitions for individual transactions.

### **CRTX**

This is the default dynamic transaction definition. It is the name of the CICS-supplied sample transaction resource definition provided in the CSD group DFHISC.

### **name**

The name of your own dynamic transaction resource definition that you want CICS to use for dynamic transaction routing.

### **NO**

The dynamic transaction routing program is not invoked when a transaction definition cannot be found.

For information about the CICS-supplied sample transaction resource definition, CRTX, and about defining your own dynamic transaction routing definition, see the CICS Resource Definition Guide.

### **DTRPGM={DFHDYP|program-name}**

Specifies the name of the dynamic transaction routing program you want to use for routing transactions that are defined with the DYNAMIC attribute. DFHDYP, the default, is the name of the CICS-supplied version.

### **DUMP={YES|NO}**

Specifies whether the CICS dump domain is to take SDUMPs.

### **YES**

SDUMPs are produced, unless suppressed by the options specified in the CICS system dump table.

### **NO**

SDUMPs are suppressed.

**Note:** This does not prevent the CICS kernel from taking SDUMPs.

For more information about SDUMPs, see the CICS System Definition Guide.

### **DUMPDS={AUTO|AIB}**

Specifies the transaction dump data set that is to be opened during CICS initialization.

### **AUTO**

For all types of start, CICS opens the transaction dump data set that was *not* in use when the previous CICS run terminated. This information is obtained from the CICS local catalog (DFHLCD).

If you specify AUTO, or let it default, code DLBL statements for both of the transaction dump data sets, DFHDMPA and DFHDMPB, in your CICS startup job stream.

**A** CICS opens transaction dump data set DFHDMPA.

**B** CICS opens transaction dump data set DFHDMPB.

### **DUMPSW={NO|NEXT}**

Specifies whether you want CICS to switch automatically to the next dump data set when the first is full.

### **NO**

Disables the CICS autoswitch facility. If the transaction dump data set opened during initialization becomes full, CICS issues a console message

to notify the operator. If you want to switch to the alternate data set, you must do so manually using the CEMT or EXEC CICS SET DUMPDS SWITCH command.

#### **NEXT**

Enables the autoswitch facility to switch to the next data set at end of file of the data set opened during initialization. Coding NEXT permits one switch only. If you want to switch to the alternate data set again, you must do so manually using CEMT or EXEC CICS SET DUMPDS SWITCH command. If you specify NEXT, code DLBL statements for both of the transaction dump data sets, DFHDMPA and DFHDMPB, in your CICS startup job stream.

For more information about transaction dump data sets, see the CICS System Definition Guide

#### **ECDSASZE={0K|number}**

Specifies the size of the ECDSA. The default size is 0 indicating that the DSA size can be changed dynamically. A non-zero value indicates that the DSA size is fixed.

##### **number**

Specify *number* as an amount of storage in the range 0 to 1073741824 bytes in multiples of 1048576 bytes (1MB). If the size specified is not a multiple of 1MB, CICS rounds the value up to the next multiple.

You can specify *number* in bytes (for example, 4194304), or as a whole number of kilobytes (for example, 4096K), or a whole number of megabytes (for example, 4M).

#### **EDSALIM={20M|number}**

Specifies the upper limit of the total amount of storage within which CICS can allocate the individual extended dynamic storage areas (EDSAs) that reside above the 16MB boundary.

##### **20M**

The default EDSA limit is 20MB (20 971 520 bytes).

##### **number**

Specify *number* as a value in the range 10MB to 2047MB, in multiples of 1MB. If the size specified is not a multiple of 1MB, CICS rounds the value up to the next multiple.

You can specify *number* in bytes (for example, 33 554 432), or as a whole number of kilobytes (for example, 32 768K), or a whole number of megabytes (for example, 32M).

The maximum value allowed depends on a number of factors, such as:

- The size of the CICS partition
- How much storage you require for the CICS internal trace table.
- How much private storage you must leave free to satisfy VSE GETVIS requests for storage above the 16MB boundary outside the DSAs.

From the storage value that you specify on the EDSALIM parameter, CICS allocates the following extended dynamic storage areas:

#### **The extended user DSA (EUDSA)**

The user-key storage area for all user-key task-lifetime storage above the 16MB boundary.



**The extended read-only DSA (ERDSA)**

The key-0 storage area for all reentrant programs and tables above the 16MB boundary.

**The extended shared DSA (ESDSA)**

The user-key storage area for any non-reentrant user-key RMODE(ANY) programs, and also for any storage obtained by programs issuing CICS GETMAIN commands for storage above the 16MB boundary with the SHARED option.

**The extended CICS DSA (ECDSA).**

The CICS-key storage area for all non-reentrant CICS-key RMODE(ANY) programs, all CICS-key task-lifetime storage above the 16MB boundary, and CICS control blocks that reside above the 16MB boundary.

CICS allocates all the DSAs above the 16MB boundary in multiples of 1MB.

**Note:** For information about calculating the amount of storage to specify on the EDSALIM parameter, see the CICS Performance Guide. For example, the value that you specify must allow for all temporary storage MAIN requests, for which CICS uses the ECDSA.

**EODI={E0|xx}**

Specifies the end-of-data indicator for input from sequential devices. The characters “xx” represent two hexadecimal digits in the range 01 through FF. The default value is X'E0', which represents the standard EBCDIC backslash symbol (\).

**ERDSASZ={0K|number}**

Specifies the size of the ERDSA. The default size is 0 indicating that the DSA size can change dynamically. A non-zero value indicates that the DSA size is fixed.

**number**

Specify number as an amount of storage in the range 0 to 1073741824 bytes in multiples of 1048576 bytes (1MB). If the size specified is not a multiple of 1MB, CICS rounds the value up to the next multiple.

You can specify number in bytes (for example, 4194304), or as a whole number of kilobytes (for example, 4096K), or a whole number of megabytes (for example, 4MB).

**ESDSASZ={0K|number}**

Specifies the size of the ESDSA. The default size is 0 indicating that the DSA size can change dynamically. A non-zero value indicates that the DSA size is fixed.

**number**

Specify number as an amount of storage in the range 0 to 1073741824 bytes in multiples of 1048576 bytes (1MB). If the size specified is not a multiple of 1MB, CICS rounds the value up to the next multiple.

You can specify number in bytes (for example, 4194304), or as a whole number of kilobytes (for example, 4096K), or a whole number of megabytes (for example, 4M).

**ESMEXITS={NOINSTLNIINSTLN}**

Specifies whether installation data is to be passed via the RACROUTE interface to the external security manager (ESM) for use in exits written for the ESM.



**NOINSTLN**

Specifies that the INSTLN parameter is not used in RACROUTE macros.

**INSTLN**

Specifies that CICS-related and installation-supplied data is passed to the ESM using the INSTLN parameter of the RACROUTE macro. For programming information, including the format of the data passed, see the CICS Customization Guide. This data is intended for use in exits written for the ESM.

**Restrictions**

You can code the ESMEXITS parameter in the SIT only.

**EUDSASZE={0K|number}**

Specifies the size of the EUDSA. The default size is 0 indicating that the DSA size can change dynamically. A non-zero value indicates that the DSA size is fixed.

**number**

Specify number as an amount of storage in the range 0 to 1073741824 bytes in multiples of 1048576 bytes (1MB). If the size specified is not a multiple of 1MB, CICS rounds the value up to the next multiple.

You can specify number in bytes (for example, 4194304), or as a whole number of kilobytes (for example, 4096K), or a whole number of megabytes (for example, 4M).

**FCT={YES|xx|NO}**

Specifies the suffix of the file control table (FCT) to be used.

This parameter is effective only on a CICS cold start. CICS does not load an FCT on a warm or emergency restart, and all file resource definitions are recovered from the CICS global catalog.

For information about coding the macros for this table, see the CICS Resource Definition Guide.

You can use a mixture of macro definitions and RDO definitions for files in your CICS region. However, your FCT should not contain definitions for files that are also defined in an RDO group specified in the group list for the CICS startup, and the converse. In a cold start, CICS first loads the file definitions from the FCT, and adds any files that are defined in RDO groups later (using the groups specified in the GRPLIST parameter). If CICS tries to install a file definition from a group list for a file already defined by an entry from the FCT, the install may fail because of conflicting file attributes. You can avoid this potential conflict by ensuring that you do not have duplicate file entries in the FCT and in your group list.

**FEPI={NO|YES}**

Specifies whether or not you want to use the Front End Programming Interface feature (FEPI).

**NO**

Means that FEPI support is not required. You should specify NO on this parameter (or allow it to default) if you do not have the feature installed, or if you do not require FEPI support.

## YES

Means you require FEPI support, and causes CICS to start the CSZI transaction.

This book does not contain any information about the installation process for the Front End Programming Interface feature. Installation information can be found in the CICS Front End Programming Interface User's Guide.

## FLDSEP={\_'xxxx'

Specifies 1 through 4 field-separator characters, each of which indicates end of field in the terminal input data. The default is four blanks.

The field separator allows you to use transaction identifications of less than four characters followed by one of the separator characters. When less than four characters are coded, the parameter is padded with blanks, so that the blank is then a field separator. None of the specified field separator characters should be part of a transaction identification; in particular, the use of alphabetic characters as field separators is not recommended.

The character specified in the FLDSEP parameter must not be the same as any character specified in the FLDSTRT parameter. This means that it is invalid to allow both parameters to take the default value.

### Restrictions

If you specify FLDSEP in the SIT, the characters must be enclosed in single quotation marks.

If you specify FLDSEP as a PARM, SYSIPT, or CONSOLE parameter, do **not** enclose the characters in quotation marks, and the characters you choose must not include an embedded blank, or any of these characters:  
( ) ' = ,

## FLDSTRT={\_'x'}

Specifies a single character to be the field-name-start character for free-form input for built-in functions. The default is a blank.

The character specified should not be part of a transaction identification; in particular, the use of alphabetic characters is not recommended.

The character specified in the FLDSTRT parameter must not be the same as any character specified in the FLDSEP parameter. This means that it is invalid to allow both parameters to take the default value.

### Restrictions

If you specify FLDSTRT in the SIT, the parameter must be enclosed in single quotation marks.

If you specify FLDSTRT as a PARM, SYSIPT, or CONSOLE parameter, do **not** enclose the character in quotation marks, and the character you choose must not be a blank or any of the following characters:  
( ) ' = ,

## **FSSTAFF={YES|NO}**

specify this parameter in an application-owning region (AOR) to prevent transactions initiated by function-shipped EXEC CICS START requests being started against incorrect terminals.

You may need to code the function-shipped START affinity (FSSTAFF) parameter in an AOR if all of the following are true:

1. The AOR is connected to two or more terminal-owning regions (TORs) that use the same, or a similar, set of terminal identifiers.
2. One or more of the TORs issues EXEC CICS START requests for transactions in the AOR.
3. The START requests are associated with terminals.
4. You are using shippable terminals, rather than statically defining remote terminals in the AOR.

Consider the following scenario:

Terminal-owning region TOR1 issues an EXEC CICS START request for transaction TRAR, which is owned by region AOR1. It is to be run against terminal T001. Meanwhile, terminal T001 on region TOR2 has been transaction routing to AOR1; a definition of T001 has been shipped to AOR1 from TOR2. When the START request arrives at AOR1, it is shipped to TOR2, rather than TOR1, for transaction routing from terminal T001.

To prevent this situation, code YES on the FSSTAFF parameter in the AOR.

**YES** When a START request is received from a terminal-owning region, and a shipped definition for the terminal named on the request is already installed in the AOR, the request is always shipped back to a TOR, for routing, *across the link it was received on*, unless the request supplies a TOR\_NETNAME and a remote terminal with the correct TOR\_NETNAME is located.

If the TOR to which the START request is returned is **not** the one referenced in the installed remote terminal definition, a definition of the terminal is shipped to the AOR, and the autoinstall user program is called. Your autoinstall user program can then allocate an *alias* termid in the AOR, to avoid a conflict with the previously installed remote definition. For information about writing an autoinstall program to control the installation of shipped definitions, see the CICS Customization Guide.

**NO** When a START request is received from a terminal-owning region, and a shipped definition for the named terminal is already installed in the AOR, the request is shipped to the TOR referenced in the definition, for routing.

### **Notes:**

1. FSSTAFF has no effect:
  - On statically-defined (hard-coded) remote terminal definitions in the AOR. If you use these, START requests are always shipped to the TORs referenced in the definitions.
  - On START requests issued in the local region. It affects only START requests shipped from other regions.
  - When coded on intermediate regions in a transaction-routing path. It is effective only when coded on an application-owning region.

- If the AOR contains no remote definition of a terminal named on a shipped START request, the “terminal not known” global user exits, XICTENF and XALTENF, are called. For details of these exits, see the CICS Customization Guide.

**GMTEXT={‘WELCOME TO CICS’|‘text’}**

Specifies whether the default logon message text (WELCOME TO CICS) or your own message text is to be displayed on the screen by the CSGM (good morning) transaction when a terminal is logged on to CICS through VTAM, by the CESN transaction if used to sign on to CICS, or by your own transactions using the EXEC CICS INQUIRE SYSTEM GMMTEXT command.

You can use apostrophes to punctuate your message, in addition to using them as message delimiters. However, you must code *two* successive apostrophes to represent a single apostrophe in your text. For example,

```
GMTEXT='User''s logon message text.'
```

The whole message must still be enclosed by a pair of single delimiting apostrophes.

Your message text can be from 1 through 246 characters (bytes), and can extend over two lines by extending the text to column 80 on the first line, and continuing in column 1 of the second line. For example, the following might be used in the SYSIPT data set:

```
GMTEXT='An Information Development CICS Terminal-Owning Region (TOR) - CICSIDC.
This message is to show the use of continuation lines when creating a GMTEXT par
ameter in the SYSIPT data set'
```

The CSGM transaction displays this as follows (with the time appended to the end of message):

```
An Information Development CICS Terminal-Owning Region (TOR) - CICSIDC. This me
ssage is to show the use of continuation lines when creating a GMTEXT parameter
in the SYSIPT data set 09:56:14
```

The CESN transaction displays this as follows:

```
Signon to CICS                                APPLID CICSHTH1

An Information Development CICS Terminal-Owning Region (TOR) - CICSIDC.
This message is to show the use of continuation lines when creating a GMTEXT
parameter in the SYSIPT data set
```

For any transaction other than CESN that displays the text specified by this parameter, you must use a RDO TYPETERM with LOGONMSG(YES) for all terminals requiring the logon message. For information about using RDO TYPETERM, see the CICS Resource Definition Guide.

**GMTRAN={CSGM|CESN|transaction-id}**

Specifies the name of the transaction that is initiated when terminals are logged on to CICS by VTAM. Do not specify the name of a remote transaction. The transaction must be capable of being automatically initiated (ATI). The default is the transaction CSGM, that displays the text specified in the GMTEXT parameter. Alternatively, you can specify the CICS signon transaction, CESN,

which also displays the text specified in the GMTEXT parameter. The GNTRAN parameter can be used with the LGNMSG parameter to retrieve VTAM logon data.

**GNTRAN={CESF|transaction\_id}**

Specifies the transaction that you want CICS to invoke when a user's terminal-timeout period expires.

**CESF**

The default, CESF, is the basic CICS signoff transaction without any options. This transaction attempts to sign off a terminal, subject to the SIGNOFF attribute of the RDO TYPETERM resource definition for that terminal.

**transaction\_id**

The name of an alternative timeout transaction to signoff the user at the timed-out terminal. Specifying your own transaction allows you to specify functions in addition to, or instead of, signoff. For example, your own transaction could issue a prompt for the terminal user's password, and allow the session to continue if the correct password is entered.

The transaction to be used must have been specially written to handle the GNTRAN commarea that is passed to it. Of the CICS-supplied transactions, only CESF has been written to handle the GNTRAN commarea. For more information about writing your own transactions for GNTRAN, see the CICS Customization Guide.

**Note:** When either the default CESF transaction, or your own transaction, attempts to sign off a terminal, the result is subject to the SIGNOFF attribute of the RDO TYPETERM resource definition for the terminal, as follows:

**SIGNOFF**

**Effect**

**YES** The terminal is signed off, but not logged off.

**NO** The terminal remains signed on and logged on.

**LOGOFF**

The terminal is both signed off and logged off.

**Note:** If GNTRAN fails to attach, and SIGNOFF(LOGOFF) has been specified, the terminal which has reached timeout will be signed off and logged off. GNTRAN will not run and will have no effect.

**GRPLIST={DFHLIST|name1(name[,name2][,name3][,name4])}**

Specifies the names (each 1 through 8 characters) of up to four lists of resource definition groups on the CICS system definition (CSD) file. The resource definitions in all the groups in the specified lists are loaded during initialization when CICS performs a cold start. If a warm or emergency start is performed, the resource definitions are derived from the CICS global catalog, and the GRPLIST parameter is ignored.

Each name can be either a real group list name or a generic group list name that incorporates global filename characters (+ and \*). If you specify more than one group list (either by specifically coding two or more group list names or by coding a group list name with global filename characters), the later group lists are concatenated onto the first group list. Any duplicate resource definitions in later group lists override those in earlier group lists.

Use the CEDA command LOCK to protect the lists of resource groups specified on the GRPLIST parameter.

The default is DFHLIST, the CICS-supplied list that specifies the set of resource definitions needed by CICS. If you create your own group list, either add to it the groups specified in DFHLIST (omitting only those for CICS functions that you know you do not need) or specify the DFHLIST name on the GRPLIST parameter. Do not code GRPLIST=NO unless you have a group list named NO.

**Notes:**

1. Group lists specified by a generic group list name are concatenated in alphabetic then numeric order. For example, the generic list name CICSHT\*, would concatenate the group lists CICSHT#1, CICSHTAP, CICSHTSD, and CICSHT3V in that order. If the order of concatenation is important (for example, to ensure that a particular resource definition overrides another), you should consider coding real group list names.
2. If a group list contains resource definitions that are needed by another group list, the prerequisite group list must be installed first. For example, if list A has TYPETERM definitions needed for TERMINAL definitions in list B, list A must be installed first. This may mean that you have to specifically name the prerequisite group on the GRPLIST parameter.
3. Take care when using generic group list names because, if a group list on your CSD satisfies the generic name, it will be installed. This means that a group list can be installed more than once; for example, if you specify the real group list name and a generic group list name that it satisfies, or if you specify two generic group list names that the group list name satisfies.
4. To override one or more of the group lists specified on the GRPLIST system initialization parameter, you must specify all list names (both real and generic) that you want to use, even if you are not changing the names.

For example, if you want to use the four group lists CICSHT#1, CICSHTAP, CICSHT3V, and CICSHTSD, you could specify either of the following system initialization parameters:

```
GRPLIST=(CICSHT#1,CICSHTAP,CICSHT3V,CICSHTSD)
GRPLIST=(CICSHT*)
```

In the first example GRPLIST, the group lists are loaded in the order specified, and resource definitions installed from the CICSHTSD group list will override any duplicate definitions installed by the other groups.

In the second example GRPLIST, the group lists are loaded in the order CICSHT#1, CICSHTAP, CICSHTSD, then CICSHT3V, and resource definitions installed from the CICSHT3V group list will override any duplicate definitions installed by the other groups.

If your SIT contains the parameter:

```
GRPLIST=(CICSHT#1,CICSAP*,CICSHT3V,CICSHTSD)
```

and you want to replace the list CICSHT3V with the list ANOLST05, you should specify the override:

```
GRPLIST=(CICSHT#1,CICSAP*,ANOLST05,CICSHTSD)
```

In general, any required resource definitions should appear in *one of* the group lists specified on the GRPLIST system initialization parameter.

For information about resource definitions, groups, lists, and the CSD, see the CICS Resource Definition Guide.

**ICP=COLD**

Code this parameter if you want to cold start the interval control program, for more information see page 129.

**ICV={1000|number}**

Code this parameter with the region exit time interval in milliseconds. The ICV system initialization parameter specifies the maximum time in milliseconds that CICS releases control to the operating system when there are no transactions ready to resume processing. This time interval can be any integer in the range 100 through 3600000 milliseconds (specifying an interval up to 60 minutes). A typical range of operation might be 100 through 2000 milliseconds.

A low value interval can enable much of the CICS nucleus to be retained in dynamic storage, and not be paged-out at times of low terminal activity. This reduces the amount of dynamic storage paging necessary for CICS to process terminal transactions (thus representing a potential reduction in response time), sometimes at the expense of concurrent batch region throughput. Large networks with high terminal activity are inclined to run CICS without a need for this value, except to handle the occasional, but unpredictable, period of inactivity. These networks can usually function with a large interval (10000 to 3600000 milliseconds). Once a task has been initiated, its requests for terminal services and the completion of the services are recognized by the system and this maximum delay interval is overridden.

Small systems, or those with low terminal activity, are subject to paging introduced by other jobs running in competition with CICS. By specifying a low value interval, key portions of the CICS nucleus are referenced more frequently, thus reducing the probability of these pages being paged-out. However, the execution of the logic without performing productive work might be considered wasteful. The need to increase the probability of residency by frequent but unproductive referencing must be weighed against the overhead and response time degradation incurred by allowing the paging to occur. By increasing the interval size, less unproductive work is performed at the expense of performance if paging occurs during the periods of CICS activity. For information about the effect of ICV on performance, see the CICS Performance Guide.

**Note:** The region exit time interval process contains a mechanism to ensure that CICS does not constantly set and cancel timers (thus degrading performance) while attempting to meet its objectives for a low region exit time interval. This mechanism can cause CICS to release control to the operating system for up to 0.5 seconds when the interval has been set at less than 250; and up to 0.25 seconds more than the region exit time interval when the interval has been set greater than 250.

**ICVR={500|number}**

Specifies the default runaway task time interval in milliseconds as a decimal number. You can code zero, or a number in the range 500 through 2 700 000, in multiples of 500. CICS rounds down values that are not multiples of 500. This is the RUNAWAY interval used by transactions defined with RUNAWAY(SYSTEM) (see the CICS Resource Definition Guide). CICS may purge a task if it has not given up control after the RUNAWAY interval for the transaction (or ICVR if the transaction definition specified RUNAWAY(SYSTEM)). If you code ICVR=0, runaway task control is inoperative



for transactions specifying RUNAWAY(SYSTEM) in their RDO TRANSACTION definition (that is, tasks do not get purged if they appear to be looping). The ICVR value is independent of the ICV value, and can be less than the ICV value. Note that CICS runaway task detection is based upon task time, that is, the interval is decremented only when the task has control of the processor. For information about commands that reinitialize the ICVR value, see the CICS Problem Determination Guide.

**ICVTSD={500|number}**

The terminal scan delay facility determines how quickly CICS deals with some terminal I/O requests made by applications. The range is 0 through 5000 milliseconds, with a default of ICVTSD=500.

There is an overhead in dealing with such requests. By specifying a nonzero value, the overhead may be spread over several transactions. A value close to zero (for example 200) would be adequate.

**INITPARM=(pgmname\_1='parmstring\_1'[, .... ,pgmname\_n='parmstring\_n'])**

Code this parameter in order to pass parameters to application programs that use the EXEC CICS ASSIGN INITPARM command. For example, you can use INITPARM to pass parameters to PLTPI programs to be executed in the final stages of system initialization. The area giving access to the parameters is specified by the EXEC CICS ASSIGN INITPARM command. For programming information about the EXEC CICS ASSIGN INITPARM command, see the CICS Application Programming Reference manual.

**pgmname**

Code pgmname with the name of a program. This name must be 1 through 8 alphanumeric or national language characters.

**parmstring**

Code parmstring with the parameter string (up to 60 characters enclosed by single quotation marks) to be passed to the associated program. Any quotation marks imbedded in the string must be duplicated. For information on coding INITPARM in the SYSIPT data set, see "Rules for coding parameters at the console" on page 129.

You can specify up to 255 pgmname='parmstring' sets.

**INTTR={ON|OFF}**

Code this parameter to specify whether the internal CICS trace destination is to be activated at system initialization.

This parameter controls whether any of the three types of CICS trace entry are written to the internal trace table. The three types are: CICS system trace (see the SYSTR parameter), user trace (see the USERTR parameter), and exception trace entries (which are always made and not controlled by a system initialization parameter).

**ON**     Activate main storage trace.

**OFF**    Do not activate main storage trace.

**IRCSTRT={NO|YES}**

Code this parameter to indicate whether IRC is started up at system initialization. If IRCSTRT=YES is not coded, IRC can be initialized by issuing a CEMT or EXEC CICS SET IRC OPEN command.



**ISC={NO|YES}**

Code YES to include the CICS programs required for interregion or intersystem communication.

**JCT={YES|xx|NO}**

Code this parameter with the suffix of the journal control table to be used, for more information see page 129. This indicates whether journaling and volume control are to be used. Note that you must have journaling if you code XRF=YES. If you code JCT=NO, a dummy journal control program (DFHJCPDY) is loaded.

For information about coding the macros for this table, see the CICS Resource Definition Guide.

**JSTATUS=RESET**

Code JSTATUS=RESET to reset the journal status of all journal data sets that are defined on disk (JTYPE=DISK1|DISK2), but are *not* specified with JOUROPT=AUTOARCH.

This parameter resets the journal status held in the global catalog to “ready for use”. Before using the JSTATUS option at startup, ensure that any disk journals that contain essential information are archived, either to tape or another disk data set.

**Restrictions**

You can code the JSTATUS parameter in PARM, SYSIPT, or CONSOLE only. It is not applicable if you are using the CICS automatic archiving facility.

**LEVSE={YES|NO}**

Specifies whether you want to initialize the language environment under CICS Transaction Server for VSE/ESA. If you specify NO, you will not be able to execute and PL/I for VSE/ESA, COBOL for VSE/ESA or C for VSE/ESA programs during this execution of CICS.

**LGNSMSG={NO|YES}**

Code this to indicate whether VTAM logon data is made available to an application program.

**NO**

VTAM logon data is not available to an application program.

**YES**

VTAM logon data is available to an application program. The data can be retrieved with an EXEC CICS EXTRACT LOGONMSG command. For programming information about this command, see the CICS Application Programming Reference manual.

You can use this parameter with the GMTRAN parameter to retrieve the VTAM logon data at the time a terminal is logged on to CICS by VTAM.

**MCT={NO|YES|xx}**

Code this parameter to specify the monitoring control table suffix, for more information see page 129.

If you specify MCT=NO, CICS monitoring builds dynamically a default MCT, ensuring that default monitoring control table entries are always available for use when monitoring is on and a monitoring class (or classes) is active.

For information about coding the macros for this table, see the CICS Resource Definition Guide.

### **MN={OFF|ON}**

Code this parameter to indicate whether monitoring is to be switched on or off at initialization, and use the individual monitoring class parameters to control which monitoring classes are to be active. (See the MNEXC, and MNPER parameter descriptions.) The default status is that the CICS monitoring facility is **off**. The monitoring status is recorded in the CICS global catalog for use during warm and emergency restarts.

**OFF** Switch off monitoring.

**ON** Switch on monitoring. However, unless at least one individual class is active, no monitoring records are written. For details of the effect of monitoring status being on or off, in conjunction with the status of the various monitoring classes, see the following notes:

**Note:** If the monitoring status is ON, CICS accumulates monitoring data continuously. For the performance and exception monitoring classes, CICS writes the monitoring data for each class that is active to a CICS Data Management Facility (DMF) data set.

If the monitoring status is OFF, CICS does not accumulate or write any monitoring data, even if any of the monitoring classes are active.

You can change the monitoring status and the monitoring class settings at any time, as follows:

- During a warm restart by coding an MN system initialization parameter in PARM, SYSIPT, or through the system console.
- While CICS is running, by either of:
  - The CEMT SET MONITOR command
  - The EXEC CICS SET MONITOR command.

When you change the status of monitoring, the change takes effect immediately. If you change the monitoring status from OFF to ON, monitoring starts to accumulate data and write monitoring records to DMF for all tasks that start after the status change is made **for all active monitoring classes**.

If the status is changed from ON to OFF, monitoring stops writing records immediately and does not accumulate monitoring data for any tasks that start after the status change is made.

The monitoring status operand can be manipulated independently of the class settings. This means that, even if the monitoring status is OFF, you can change the monitoring class settings and the changes take effect for all tasks that are started after the monitoring status is next set to ON.

For programming information about controlling CICS monitoring, see the CICS System Programming Reference manual.

### **MNCONV={NO|YES}**

Specifies whether or not conversational tasks are to have separate performance class records produced for each pair of terminal control I/O requests.

Any clock (including user-defined) that is active at the time such a performance class record is produced is stopped immediately before the record is written.

After the record is written, such a clock is reset to zero and restarted. Thus a clock whose activity spans more than one recording interval within the conversational task appears in multiple records, each showing part of the time, and the parts adding up to the total time the clock is active. The high-water-mark fields (which record maximum levels of storage used) are reset to their current values. All other fields are set to X'00', except for the key fields (transid, termid). The monitoring converse status is recorded in the CICS global catalog for use during warm and emergency restarts.

**MNEXC={OFF|ON}**

Code this parameter to indicate whether the monitoring exception class is to be made active during initialization. The monitoring exception class status is recorded in the CICS global catalog for use during warm and emergency restarts.

**OFF** Set the exception monitoring class to “not active”.

**ON** Set the exception monitoring class to “active”.

For programming information about exception monitoring records, see the CICS Customization Guide.

**MNFREQ={0|hhmmss}**

Specifies the interval for which CICS automatically produces a transaction performance class record for any long-running transaction. The monitoring frequency value is recorded in the CICS global catalog for use during warm and emergency restarts.

**0** means that no frequency monitoring is active.

**hhmmss**

is the interval for which monitoring produces automatically a transaction performance class record for any long-running transaction. Specify a 1 to 6 digit number in the range 001500–240000. Numbers that are fewer than six digits are padded with leading zeroes.

**MNPER={OFF|ON}**

Code this parameter to indicate whether the monitoring performance class is to be made active during CICS initialization. The monitoring performance class status is recorded in the CICS global catalog for use during warm and emergency restarts.

**OFF** Set the performance monitoring class to “not active”.

**ON** Set the performance monitoring class to “active”.

For programming information about performance monitoring records, see the CICS Customization Guide.

**MNSYNC={NO|YES}**

Specifies whether or not you want CICS to produce a transaction performance class record when a transaction takes an implicit or explicit syncpoint (unit-of-work). No action is taken for syncpoint rollbacks. The monitoring syncpoint status is recorded in the CICS global catalog for use during warm and emergency restarts.

**MNTIME={GMT|LOCAL}**

Specifies whether you want the time stamp fields in the performance class monitoring data to be returned to an application using the EXEC CICS

COLLECT STATISTICS MONITOR(taskno) command in either GMT or local time. The monitoring time value is recorded in the CICS global catalog for use during warm and emergency restarts.

For programming information on the EXEC CICS COLLECT STATISTICS command, see the CICS System Programming Reference.

#### **MROBTCH={1|number}**

Code this parameter to specify the number of events that must occur before CICS is posted for dispatch due to the batching mechanism. The number can be in the range 1 through 255, and the default is 1.

Use this batching mechanism to spread the overhead of dispatching CICS over several tasks. If the value is greater than 1 and CICS is in a system wait, CICS is not posted for dispatch until the specified number of events has occurred. Events include MRO requests from connected systems or DASD I/O. For these events, CICS is dispatched as soon as one of the following occurs:

- The current batch fills up (the number of events equals MROBTCH).
- An ICV interval expires.

Therefore, ensure that the time interval you specify in the ICV parameter is low enough to prevent undue delay to the system.

If CICS is dispatched for another reason, the current batch is dealt with in that dispatch of CICS.

**Note:** During periods of low utilization, a value greater than 1 specified on the MROBTCH parameter may result in increased transaction response times. Transactions issuing file I/O requests may be delayed due to increased FCIOWAIT. For further guidance information about the effect of MROBTCH on performance, see the CICS Performance Guide.

#### **MROFSE={NO|YES}**

specifies whether you want to extend the lifetime of the long-running mirror to keep it allocated until the end of the task rather than after a user syncpoint for Function Shipping applications.

**NO** The lifetime of the MRO long-running mirror is not extended.

**YES** The mirror task remains available to the application until the end of the application's task. This extended long-running mirror saves the overhead of re-attaching the mirror task following a user syncpoint.

This parameter is ignored for DPL requests (that is a DPL causes the session to be freed at the next syncpoint even if it has been kept for a previous sequence of syncpoints).

It should be used with caution. For additional information, see the Long Running Mirror sections of the CICS Intercommunication Guide and the CICS Performance Guide.

#### **MROLRM={NO|YES}**

Code this parameter to specify whether you want to establish an MRO long-running mirror task.

**NO** The MRO long-running mirror task is not required.

**YES** The mirror transaction remains available to the application issuing the remote request. This long-running mirror saves the overhead of

re-establishing communication with the mirror transaction if the application makes more function shipping requests in this unit of work.

For information about long-running mirror tasks, see the CICS Intercommunication Guide.

### **MSGCASE={MIXEDUPPER}**

CICS messages handled by the CICS message domain are in mixed case. Code the MSGCASE parameter to indicate how you want the message domain to display these mixed case messages.

#### **MIXED**

This is the default in the SIT; all messages displayed by the CICS message domain remain in mixed case,

#### **UPPER**

The message domain displays all mixed case messages in uppercase only.

**Note:** Mixed case output is not displayed correctly on Katakana display terminals and printers. Uppercase English characters appear correctly as uppercase English characters, but lowercase appears as Katakana symbols. If you have any Katakana terminals connected to your CICS region, specify MSGCASE=UPPER.

### **MSGVLV={10}**

Code this parameter with the message level that controls the generation of messages to the console.

1 All messages are to be printed.

0 Only critical errors or interactive messages are to be printed.

### **MXT={5number}**

Specifies the maximum number, in the range 1 through 999, of *user* tasks CICS allows to exist at any time. CICS queues requests for tasks above this number but does not action (attach) them until the number of tasks attached drops below the MXT limit.

**Note:** The MXT value does **not** include CICS system tasks.

### **NATLANG=(E,x,y,z,...)**

Specify on this parameter the single-character codes for the languages to be supported in this CICS run. For more information see Figure 3 on page 83.

E Code E for English, which is the *system* default (that is, is provided even if you do not specifically code E).

x,y,z,...

Code the appropriate letters for the other supported languages that you require.

For the codes that you specify on this parameter, you must ensure that a DFHMET1x module (where x is the language code) is in a sublibrary in the LIBDEF PHASE,SEARCH chain for the CICS job.

English language support is provided, even if you do not specifically code E for English.

The first language code specifies the default language for those elements of CICS enabled to receive NLS messages, such as some destinations used for

CICS messages, and the terminals or users not signed-on with an NLS code. The other language codes are provided to specify the language to be used for messages sent to terminals that are defined with the appropriate language support code.

For example, coding NATLANG=(G,C,K) has the same effect as coding NATLANG=(G,C,E,K); that is, in both cases the default NLS language is German (G), and the languages English, Chinese (C), and Kanji (K) are supported.

CICS console messages are available in English and German only.

#### **NEWSIT={YES|NO}**

Specify NEWSIT=YES to cause CICS to load the specified SIT, and enforce the use of all system initialization parameters, modified by any system initialization parameters provided via PARM, SYSIPT, or the system console, even in a warm start. Enforcing the use of system initialization parameters in this way overrides any parameters that may have been stored in a warm keypoint at shutdown.

However, there are some exceptions; the following system initialization parameters are always ignored in a warm start, even if they are supplied via PARM, SYSIPT, or the console:

- CSDACC
- CSDBUFND
- CSDBUFNI
- CSDFRLOG
- CSDJID
- CSDLRNO
- CSDRECOV
- CSDSTRNO
- FCT
- GRPLIST

In a warm restart CICS uses the *installed* resource definitions saved in the CICS global catalog at warm shutdown, and therefore the CSD, FCT, and GRPLIST parameters are ignored. (At CICS startup, you can only modify installed resource definitions, including file control table entries, or change to a new FCT, by performing a cold start of CICS with START=COLD.)

For more information about the use of the NEWSIT parameter, see “Classes of start and restart” on page 133.

#### **Restrictions**

You can code the NEWSIT parameter in PARM, SYSIPT, or CONSOLE only.

#### **OPERTIM={120|number}**

Code this parameter with the write-to-operator timeout value, in the range 0 through 86400 seconds (24 hours). This is the maximum time (in seconds) that CICS waits for a reply before returning control to this transaction. For information about using the write-to-operator timeout value, see the CICS Application Programming Reference manual.

**PARMERR={INTERACT|IGNORE|ABEND}**

Code this parameter to specify what action you want to follow if CICS detects incorrect system initialization parameter overrides during initialization.

**Note:** When specified as an override, this parameter affects only subsequent system initialization parameter overrides. Errors in earlier system initialization parameter overrides are dealt with according to the PARMERR system initialization parameter value in the SIT.

**INTERACT**

Enables the operator to communicate with CICS via the console and correct parameter errors.

**Note:** INTERACT is overridden with IGNORE in the following cases:

- If errors are found in PARM or SYSIPT for system initialization parameter overrides that are not allowed to be entered from the console
- In certain circumstances, in response to invalid data when you have been trying to correct a previous invalid system initialization parameter keyword or value.

**IGNORE**

CICS ignores errors, and tries to complete initialization.

**ABEND**

CICS abends.

**PDI={30|decimal-value}**

Use this parameter in a SIT for an active CICS region. It specifies the XRF primary delay interval, in seconds. The minimum delay that you can specify is 5 seconds. This is the time that must elapse between the (apparent) loss of the surveillance signal in the alternate CICS region, and any reaction by the active CICS region. The corresponding parameter for the alternate CICS region is ADI. PDI and ADI need not have the same value.

**PGAICTLG={MODIFY|NONE|ALL}**

Specifies whether autoinstalled program definitions should be cataloged. While CICS is running, you can set whether autoinstalled programs should be cataloged dynamically, by using either the EXEC CICS SET SYSTEM or CEMT SET SYSTEM command.

**MODIFY**

Autoinstalled program definitions are cataloged only if the program definition is modified by a SET PROGRAM command subsequent to the autoinstall.

**NONE**

Autoinstalled program definitions are not cataloged. This gives a faster CICS restart (warm and emergency) compared with the MODIFY or ALL options, because CICS does not reinstall definitions from the CICS global catalog (DFHGCD). Definitions are autoinstalled on first reference.

**ALL**

Autoinstalled program definitions are written to the global catalog at the time of the autoinstall, and following any subsequent modification.

**PGAIXIT={DFHPGADX|name}**

Specifies the name of the program autoinstall exit program. While CICS is running, you can set the name of the program autoinstall exit program dynamically, by using either the EXEC CICS SET SYSTEM or CEMT SET SYSTEM command.



**PGAIPGM={INACTIVE|ACTIVE}**

Specifies the state of the program autoinstall function at initialization. While CICS is running, you can set the status of program autoinstall dynamically, by using either the EXEC CICS SET SYSTEM or CEMT SET SYSTEM command.

**INACTIVE**

The program autoinstall function is disabled.

**ACTIVE**

The program autoinstall function is enabled.

**PGCHAIN=character(s)**

Code this parameter with the character string that is identified by terminal control as a BMS terminal page-chaining command. It can be 1 through 7 characters. For more information about the character string, see the notes under the PGRET parameter.

**PGCOPY=character(s)**

Code this parameter with the character string that is identified by terminal control as a BMS command to copy output from one terminal to another. It can be 1 through 7 characters. For more information about the character string, see the notes under the PGRET parameter.

**PGPURGE=character(s)**

Code this parameter with the character string that is identified by terminal control as a BMS terminal page-purge command. It can be 1 through 7 characters. For more information about the character string, see the notes under the PGRET parameter.

**PGRET=character(s)**

The character string that is recognized by terminal control as a BMS terminal page-retrieval command. It can be 1 through 7 characters.

**Notes:**

1. Each character string is unique with respect to the leading characters of every other transaction identification defined in the CSD. A command requested by a single character precludes the use of all other transaction identifications starting with this character.
2. In pseudoconversational mode, each character string is unique with respect to the leading characters of any terminal input message.
3. A field-separator or other suitable delimiter may be specified in each character string to separate this command code from the remainder of the paging command when entered by an operator. For example:

```
PGCHAIN=X/  
PGCOPY=C/  
PGPURGE=T/  
PGRET=P/
```

This reduces the risk of creating a nonunique command. (See Note 1.)



**Restrictions**

If you specify PGCHAIN, PGCOPY, PGPURGE, or PGRET in the SIT, the characters you choose must not include any of the following: ( ) ' =

If you specify PGCHAIN, PGCOPY, PGPURGE, or PGRET as a PARM, SYSIPT, or console parameter, do not enclose the characters in quotation marks. The characters you choose must not include an embedded blank or any of the following: ( ) ' =

4. PGCHAIN, PGCOPY, PGPURGE, and PGRET are required only if full function BMS is being used. For information about the BMS page retrieval transaction CSPG, see the CICS Supplied Transactions manual.
5. CICS always processes a paging command entered by the operator before initiating a transaction in response to a macro request, that consists of either DFHBMS or DFHPC with the TRANSID operand coded.

**PLTPI={NO|xx|YES}**

Code this parameter with a program list table that contains a list of programs to be executed in the final stages of system initialization. For more information see page 129.

You can use the system initialization parameter INITPARM to pass parameters to those programs.

For information about coding the macros for this table, see the manual.

**PLTPISEC={NONE|CMDSEC|RESSEC|ALL}**

Specifies whether or not you want CICS to perform command security or resource security checking for PLT programs during CICS initialization. The PLT programs run under the authority of the userid specified on PLTPIUSR, which must be authorized to the appropriate resources defined by PLTPISEC.

**NONE**

Specifies that you do not want any security checking on on PLT initialization programs.

**CMDSEC**

Specifies that you want CICS to perform command security checking only.

**RESSEC**

Specifies that you want CICS to perform resource security checking only.

**ALL**

Specifies that you want CICS to perform both command and resource security checking.

**Restrictions**

You can code the PLTPISEC parameter in the SIT, PARM, or SYSIPT only.

**PLTPIUSR=userid**

Specifies the userid that CICS is to use for security checking for PLT programs that run during CICS initialization. All PLT programs run under the authority of the specified userid, which must be authorized to all the resources referenced by the programs, as defined by the PLTPISEC parameter.

PLT programs are run under the CICS internal transaction, CPLT. Before the CPLT transaction is attached, CICS performs a surrogate user check against the CICS region userid (the userid under which the CICS region is executing). This is to ensure that the CICS region is authorized as a surrogate for the userid specified on the PLTPIUSR parameter. This ensures that you cannot arbitrarily specify any PLT userid in any CICS region—each PLT userid must first be authorized to the appropriate CICS region.

If you do not specify the PLTPIUSR parameter, CICS runs PLTPI programs under the authority of the CICS region userid, in which case CICS does not perform a surrogate user check. However, the CICS region userid must be authorized to all the resources referenced by the PLT programs.

#### **Restrictions**

You can code the PLTPIUSR parameter in the SIT, PARM, or SYSIPT only.

#### **PLTSD={NO|xx|YES}**

Code this parameter with a program list table that contains a list of programs to be executed during system termination. For more information see page 129.

#### **PRGDLAY={0|hhmm}**

Code this parameter with the BMS purge delay time interval that is added to the specified delivery time to determine when a message is to be considered undeliverable and therefore purged. This time interval is coded in the form “hhmm” (where “hh” represents hours from 00 to 99 and “mm” represents minutes from 00 to 59). If PRGDLAY is not coded, or is given a zero value, a message remains eligible for delivery either until it is purged or until temporary storage is reinitialized.

**Note:** If you specify PRGDLAY as a SIT override, you must still specify a 4-character value (for example 0000).

The PRGDLAY facility requires the use of full function BMS. Note also that you must code a PRGDLAY value if you want the ERRTERMIERRTERM(name) parameter on EXEC CICS ROUTE commands to be operative. For programming information about notification of undelivered messages, see the CICS Application Programming Reference manual.

The PRGDLAY value determines the interval between terminal page clean-up operations. A very low value causes the CSPQ transaction to be initiated continuously, and can have a detrimental effect on task-related resources.

A zero value stops CSPQ initiating terminal page clean-up. However, this can cause messages to stay in the system forever, resulting in performance problems with long AID queues or lack of temporary storage. The actual purge delay time interval specified is dependent on individual system requirements.

#### **PRINT={NO|YES|PA1|PA2|PA3}**

Code this parameter with the method of requesting printout of the contents of a 3270 screen.

#### **NO**

Screen copying is not required.

#### **YES**

Screen copying can be requested by terminal control print requests only.

### **PA1, PA2, or PA3**

Screen copying can be requested by terminal control print request, or by using the PA (program attention) key specified.

The PA key specified by this parameter must not be specified by the TASKREQ option of the RDO TRANSACTION definition or be used for 3270 single keystroke retrieval.

When YES, PA1, PA2, or PA3 is specified, transaction CSPP is initiated which invokes program DFHP3270. The transaction and programs are defined in the CSD group DFHHARDC. In the case of 3270 and LUTYPE2 logical units, the resources defined in CSD group DFHVTAMP are required.

The 3270 print-request facility allows either the application program or the terminal operator to request a printout of data currently displayed on the 3270 display.

If CSPP is invoked to print the screen contents at an associated VTAM printer, the screen size of the printer is chosen according to the screen size defined in the profile for the transaction CSPP. The CICS-supplied definitions use the default screen size. Therefore, if you want DFHP3270 to use the alternate screen size of the printer, you must alter the screen size defined in the profile for the transaction CSPP. For information about defining profiles for transactions, see the *CICS Resource Definition Guide*.

For a VTAM 3270 display without the printer-adapter feature, the PRINT request prints the contents of the display on the first available 3270 printer specified by PRINTER and ALTPRINTER options of the RDO TERMINAL definition. For a printer to be considered available, it must be in service and not currently attached to a task. It is not necessary for the printer to be on the same control unit.

In an MRO environment, the printer must be owned by the same system as the VTAM 3270 display.

For the 3275 with the printer-adapter feature, the PRINT request prints the data currently in the 3275 display buffer on the 3284 Model 3 printer attached to the 3275.

The format of the print operation depends on the size of the display buffer. For a 40-character wide display, the print format is a 40-byte line, and for an 80-character wide display the format is an 80-byte line.

For the 3270 compatibility mode logical unit of the 3790 (if the logical unit has the printer-adapter feature specified), the PRINT request prints the contents of the display on the first printer available to the 3790. The allocation of the printer to be used is under the control of the 3790.

For 3274, 3276, and LUTYPE2 logical units with the printer-adapter feature, the PRINT request prints the contents of the display on the first printer available to the 3270 control unit. The printer to be allocated depends on the printer authorization matrix. For information, refer to the *3270 Information Display System Component Description* manual.

For the 3270 compatibility mode logical unit without the printer-adapter feature, see the preceding paragraph on VTAM 3270 displays without the printer-adapter feature.

**PRTYAGE={32768|value}**

Code this parameter with the number of milliseconds to be used in the priority aging algorithm for incrementing the priority of a task. The value can be in the range 0 through 65535, and 32768 is the default.

The priority aging factor is used to increase the effective priority of a task according to the amount of time it is held on a ready queue. The value represents the number of milliseconds that must elapse before the priority of a waiting task can be adjusted upwards by 1. For example, if you code PRTYAGE=3000, a task has its priority raised by 1 for every 3000 milliseconds it is held on the ready queue. Thus a high value for PRTYAGE results in a task being promoted very slowly up the priority increment range, and a low value enables a task to have its priority incremented quickly.

If you specify a value of 0, the priority aging algorithm is not used (task priorities are not modified by age) and tasks on the ready queue are handled according to the user assigned priority.

**PRVMOD={name1(name,name...name)}**

Code the PRVMOD parameter with the name of those modules that are not to be used from the VSE shared virtual area (SVA).

The operand is a list of 1- to 8-character module names. This enables you to use a private version of a CICS nucleus module in the CICS address space, and not a version that might be in the SVA. For more information about preventing modules from being used from the SVA, see the CICS System Definition Guide.

**Restrictions**

You can code the PRVMOD parameter in PARM, SYSIPT, or CONSOLE only.

**PSDINT={0|hhmmss}**

Specifies the persistent session delay interval. This delay interval specifies if, and for how long, VTAM is to hold sessions in a recovery-pending state if CICS fails. The value for hours can be in the range 0 through 23; the minutes and seconds in the range 00 through 59 inclusive.

This value can be overridden during CICS execution (and hence change the action taken by VTAM if CICS fails).

**0** A zero value specifies that, if CICS fails, sessions are terminated. This is the default.

**hhmmss**

Specifies a persistent session delay interval from 1 second up to the maximum of 23 hours 59 minutes and 59 seconds. If CICS fails, VTAM holds sessions in recovery pending state for up to the interval specified on the PSDINT system initialization parameter.

Specify a 1-to-6 digit time in hours, minutes and seconds, up to the maximum time. If you specify less than six digits, CICS pads the value with leading zeros. Thus a value of 500 is taken as five minutes exactly.

The interval you specify must cover the time from when CICS fails to when the VTAM ACB is opened by CICS during the subsequent emergency restart.

VTAM holds all sessions in recovery pending state for up to the interval specified (unless they are unbound through path failure or VTAM operator action, or other-system action in the case of intelligent LUs). The PSDINT value used must take account of the types and numbers of sessions involved.

You must exercise care when specifying large PSDINT values because of the problems they may give in some environments, in particular:

- Dial-up sessions—real costs may be incurred
- LU6.2 sessions to other host systems—such systems may become stressed.

**Notes:**

1. When specifying a PSDINT value, you must consider the number and, more particularly, the nature of the sessions involved. If LU6.2 sessions to other host systems are retained in recovery pending state, the other host systems may experience excessive queuing delays. This point applies to LU6.1 sessions which are retained until restart (when they are unbound).
2. The PSDINT parameter is incompatible with the XRF=YES parameter. If XRF=YES is specified, the PSDINT parameter is ignored.

**PVDELAY={30|number}**

Code this with the persistent verification delay as a value in the range 0 through 10080 minutes (up to 7 days). PVDELAY defines how long entries can remain in the signed-on-from lists for those connections for which persistent verification is specified in a connection resource definition. If you specify PVDELAY=0, entries are deleted immediately after use.

For information about the use of PVDELAY, see the CICS Performance Guide.

**RAMAX={256|value}**

Code this parameter with the size in bytes of the I/O area allocated for each RECEIVE ANY issued by CICS, in the range 0 through 32767 bytes.

**Notes:**

1. If you are using APPC, do not code a value less than 256; otherwise, the results are unpredictable.
2. If you are using pipeline terminals, do not code a value that is less than the RUSIZE (from the CINIT), because pipelines cannot handle data longer than this.

For information about coding this parameter, see the CICS Performance Guide.

**RAPOOL={50|decimal-value}**

Code this parameter to determine the size of the CICS receive any pool. It is the number of fixed request parameter lists (RPLs), receive any control elements (RACEs), and receive any input areas (RAIAs) that are to be generated.

Decimal-value can be in the range 1 through 999, and has a default of 2.

If you omit the RAPOOL parameter altogether, RAPOOL=50 is assumed. CICS maintains n VTAM RECEIVE ANYs, where n is either the RAPOOL “number active” value, or the MXT value minus the number of active tasks, whichever is the smaller. For example:

If RAPOOL=2, MXT=50, active tasks = 45 then RECEIVE ANY = 2  
If RAPOOL=10, MXT=50, active tasks = 45 then RECEIVE ANY = 5  
If RAPOOL=10, MXT=50, active tasks = 35 then RECEIVE ANY = 10

The number of RECEIVE ANYs needed depends on the expected activity of the system, the average transaction lifetime, and the MAXTASK value specified. For information about coding this parameter, see the CICS Performance Guide.

### **RDSASZE={0K|number}**

Code this parameter with the size of the RDSA. The default size is 0 indicating that the DSA size can be changed dynamically. A non-zero value indicates that the DSA size is fixed.

#### **number**

Specify number as an amount of storage in the range 0 to 16,777,215 bytes in multiples of 262,144 bytes (256KB). If the size specified is not a multiple of 256KB, CICS rounds the value up to the next multiple.

You can specify number in bytes (for example, 4,194,304), or as a whole number of kilobytes (for example, 4096K), or a whole number of megabytes (for example, 4M).

#### **Restriction**

You can code the RDSASZE parameter in PARM, SYSIPT or CONSOLE only.

### **RENTPGM={PROTECT|NOPROTECT}**

Code this parameter to specify whether you want CICS to allocate the read-only DSAs, RDSA and ERDSA, from read-only key-0 protected storage. The permitted values are PROTECT (the default), or NOPROTECT:

#### **PROTECT**

CICS obtains the storage for the read-only DSAs from key-0 protected storage.

#### **NOPROTECT**

CICS obtains the storage from CICS-key storage, effectively creating two more CICS DSAs (CDSA and ECDSA). This allows programs eligible for the read-only DSAs to be modified by programs that execute in CICS key.

You are recommended to specify RENTPGM=NOPROTECT for development regions only, and to specify RENTPGM=PROTECT for production CICS regions.

### **RESP={FME|RRN}**

Code this parameter to specify the type of request that CICS terminal control receives from logical units.

**FME** Function management end is the default.

**RRN** Reached recovery node.

### **RESSEC={ASIS|ALWAYS}**

Specifies whether or not you want CICS to honor the RESSEC option specified on a transaction's resource definition.

#### **ASIS**

means that CICS honors the RESSEC option defined in a transaction's

resource definition. CICS calls its resource security checking routine only when RESSEC(YES) is specified in a transaction resource definition. This is normally a sufficient level of control, because often you will need only to control the ability to execute a transaction.

### **ALWAYS**

means that CICS overrides the RESSEC option, and always calls its resource security checking routine to issue the appropriate call to the SAF interface.

Use this option only if you need to control or audit all accesses to CICS resources. You should be aware that using this option can significantly degrade performance.

### **Restrictions**

You can code the RESSEC parameter in the SIT, PARM, or SYSIPT only.

### **RMTRAN={CSGMname1},{CSGMname2}}**

Code this parameter with the name of the transaction you want to initiate when a terminal session is recovered at system restart for a CICS region running with VTAM persistent sessions support.

If you do not specify a name on the RMTRAN parameter, CICS uses the value specified on the GMTRAN system initialization parameter; the CSGM transaction is the default CICS good morning transaction.

#### **name1**

This is the transaction that CICS initiates at terminals that do *not* remain signed-on after system restart (that is, they are still connected to CICS, but are signed off).

#### **name2**

This is the transaction that CICS initiates at terminals that remain signed-on after system restart. If you specify only name1, CICS uses the CSGM transaction as the default for name2.

### **RUWAPool={NOYES}**

specifies the option for allocating a storage pool the first time an LE-conforming program runs in a task.

**NO** CICS disables the option and provides no RUWA storage pool. Every EXEC CICS LINK to an LE-conforming application results in a GETMAIN for RUWA storage.

**YES** CICS creates a pool of storage the first time an LE-conforming program runs in a task. This provides an available storage pool that reduces the need to GETMAIN and FREEMAIN run-unit work areas (RUWAs) for every EXEC CICS LINK request.

### **SDSASZ={0number}**

Code this parameter with the size of the SDSA. The default size is 0 indicating that the DSA size can change dynamically. A non-zero value indicates that the DSA size is fixed.

#### **number**

Specify number as an amount of storage in the range 0 to 16,777,215 bytes in multiples of 262,144 bytes (256KB). If the size specified is not a multiple of 256KB, CICS rounds the value up to the next multiple.



You can specify number in bytes (for example, 4,194,304), or as a whole number of kilobytes (for example, 4096K), or a whole number of megabytes (for example, 4M).

**Restriction**

You can code the SDSASZE parameter in PARM, SYSIPT or CONSOLE only.

**SEC={YES|NO}**

Code this parameter to indicate what level of external security you want CICS to use.

**YES**

Code YES if you want to use full external security. CICS requires the appropriate level of authorization for the access intent: a minimum of READ permission for read intent, and a minimum of UPDATE permission for update intent.

**Note:** You must also ensure that the default userid (CICSUSER or another userid specified on the DFLTUSER system initialization parameter) has been defined to your external security manager (ESM).

If command security checking is defined for EXEC CICS SP-type commands, then specifying SEC=YES means that the appropriate level of authority is checked for; therefore:

- A check for READ authority is made for EXEC CICS INQUIRE and COLLECT commands
- A check for UPDATE authority is made for EXEC CICS SET, PERFORM, and DISCARD commands

For the results of the interaction between the access intent of the user application, and the permission defined to your ESM, see Table 10 on page 183.

- A check for ALTER authority is made for EXEC CICS CREATE commands.

**NO**

Code NO if you do not want CICS to use an ESM. All users have access to all resources, whether determined by attempts to use them or by the QUERY SECURITY command. Users are not allowed to sign on or off.

**Note:** With MRO bind-time security, even if you specify SEC=NO, the CICS region userid is still sent to the secondary CICS region, and bind-time checking is still carried out in the secondary CICS region. For information about MRO bind-time security, see the CICS Security Guide.

Define whether to use your ESM for resource level checking by using the XDCT, XFCT, XJCT, XPCT, XPPT, XPSB, and XTST system initialization parameters. Define whether to use an ESM for transaction-attach security checking by using the XTRAN system initialization parameter. Define whether ESM session security can be used when establishing APPC sessions by using the XAPPC system initialization parameter.

For information on defining command security checking for CICS SP-type commands, and about CICS security in general, see the CICS Security Guide.



For programming information about the use of external security for CICS system commands, see the CICS System Programming Reference manual.

Table 10. Results of ESM authorization requests (with SEC=YES)

Access Permission defined to ESM for CICS user	Access intent in application		
	READ	UPDATE	ALTER
NONE	Refused	Refused	Refused
READ	Permitted	Refused	Refused
UPDATE	Permitted	Permitted	Refused
ALTER	Permitted	Permitted	Permitted

**Restrictions**

You can code the SEC parameter in the SIT, PARM, or SYSIPT only.

**SECPRFX={NOIYES}**

Specifies whether or not CICS prefixes the resource names in any authorization requests to the ESM with a prefix corresponding to the ESM userid for the CICS region. The prefix to be used (the userid for the CICS region) is obtained by the DFHIRP module.

**NO**

CICS does not prefix the resource names in any authorization requests to the ESM.

**YES**

The ESM userid is used as the prefix for CICS resources defined to the ESM. CICS prefixes the resource name in any authorization requests to the ESM with a prefix corresponding to the ESM userid of the CICS region, obtaining the userid as follows:

- If you start CICS as a job, the prefix corresponds to the USER operand coded on the //ID JOB statement of the CICS startup job stream.
- If you start a CICS job without an associated ESM userid, the prefix defaults to CICS.

For information about using the PREFIX option, see the CICS Security Guide.

**Restrictions**

You can code the SECPRFX parameter in the SIT, PARM, or SYSIPT only.

The SECPRFX parameter is effective only if you specify YES for the SEC system initialization parameter.

**SIT=xx**

Code this parameter to specify the suffix, if any, of the system initialization table that you want CICS to load at the start of initialization. If you omit this parameter, CICS loads the unsuffixed table, DFHSIT, which is pregenerated

with all the default values. This default SIT (shown in “DFHSIT, the default system initialization table” on page 117) named DFHSITúú, and its source, is in the VSE/ESA sublibrary, PRD1.BASE.

#### **Restrictions**

You can code the system initialization parameter anywhere in PARM or SYSIPT, or as the *first* parameter entry at the CONSOLE.

#### **SKRxxxx='page-retrieval-command'**

Code this parameter if a single-keystroke-retrieval operation is required. 'xxxx' specifies a key on the 3270 keyboard which, during a page retrieval session, is to be used to represent a page retrieval command. The valid keys are PA1 through PA3, and PF1 through PF36. Thus up to 39 keys can be specified in this way (each by a separate command).

The 'page-retrieval-command' value represents any valid page retrieval command, and must be enclosed in apostrophes. It is concatenated to the character string coded in the PGRET parameter. The combined length must not exceed 16 characters.

**Note:** If full function BMS is used, all PA keys and PF keys are interpreted for page retrieval commands, even if some of these keys are not defined.

#### **SNSCOPE={NONE|CICS|VSEIMAGE}**

Specifies whether or not a userid can be signed on to CICS more than once, within the scope of:

- A single CICS region
- A single VSE image

#### **NONE**

Each userid can be used to sign on for any number of sessions on any CICS region. This is the compatibility option, providing the same signon scope as in releases of CICS before CICS Transaction Server for VSE/ESA Release 1.

#### **CICS**

Each userid can be signed on once only in the same CICS region. A signon request is rejected if the userid is already signed on to the same CICS region. However, the userid can be used to signon to another CICS region in the same, or another, VSE image.

#### **VSEIMAGE**

Each userid can be signed on once only, and to only one of the set of CICS regions in the same VSE image that also specify SNSCOPE=VSEIMAGE. A signon request is rejected if the user is already signed on to another CICS region in the same VSE image.

The signon scope (if specified) applies to all userids signing on by an explicit signon request (for example, by an EXEC CICS SIGNON command or the CESN transaction). SNSCOPE is restricted to users signing on at local terminals, or signing on after using the CRTE transaction to connect to another system.

Signon scope specified by SNSCOPE *does not* apply to:

- Non-terminal users.

- The CICS default userid, specified by the DFLTUSER system initialization parameter.
- Preset userids, specified in the USERID option of the RDO TERMINAL resource definition.
- Userids for remote users, received in attach headers.
- Userids for link security. For information about which userid is used for link security on a specific connection, see the CICS Security Guide.
- The userid specified on the PLTPIUSR system initialization parameter.
- The CICS region userid.

**Restrictions**

You can code the SNSCOPE parameter in the SIT, PARM, or SYSIPT only.

**SPCTR={{(1,2|1[,2][,3)]|ALL|OFF}}**

Code this parameter to set the level of tracing for all CICS components used by a transaction, terminal, or both, selected for special tracing. If you want to set different tracing levels for an individual component of CICS, use the SPCTRxx system initialization parameter. You can select up to three levels of tracing, but some CICS components do not have trace points at all these levels. For a list of all the available trace points and their level numbers, see the CICS User's Handbook. For information about the differences between special and standard CICS tracing, see the CICS Problem Determination Guide.

**number**

Code the level numbers for the level of special tracing you want for all CICS components. The options are: 1, (1,2), or (1,2,3). The default, (1,2), specifies special tracing for levels 1 and 2 for all CICS components.

**ALL** Enables the special tracing facility for all available levels.

**OFF** Disables the special tracing facility.

**SPCTRxx={{(1,2|1[,2][,3)]|ALL|OFF}}**

Code this parameter to set the level of tracing for a particular CICS component used by a transaction, terminal, or both, selected for special tracing. You identify the component by coding a value for xx in the keyword. You code one SPCTRxx keyword for each component you want to define selectively. For a CICS component being specially traced that does not have its trace level set by SPCTRxx, the trace level is that set by SPCTR (which, in turn, defaults to (1,2)). You can select up to three levels of tracing, but some CICS components do not have trace points at all these levels. The CICS component codes that you can code for xx on the SPCTRxx keyword are shown in Table 11:

Table 11. CICS component names and abbreviations

Code	Component name	Code	Component name
AP	Application domain	BF	Built-in function
BM	Basic mapping support	BR	3270 Bridge
CP	Common programming interface	DC	Dump compatability layer
DD	Directory manager domain	DH	Document handler domain
DI	Batch data interchange	DM	Domain manager domain

Table 11. CICS component names and abbreviations (continued)

Code	Component name	Code	Component name
DS	Dispatcher domain	DU	Dump domain
EI	Exec interface	FC	File control
GC	Global catalog domain	IC	Interval control
IS	Inter-system communication	JC	Journal control
KC	Task control	KE	Kernel
LC	Local catalog domain	LD	Loader domain
LM	Lock domain	ME	Message domain
MN	Monitoring domain	PA	Parameter domain
PC	Program control	PG	Program manager domain
RC	Report Controller	SC	Storage control
SM	Storage domain	SO	Sockets domain
SP	Sync point	ST	Statistics domain
SZ	Front end programming interface	TC	Terminal control
TD	Transient data	TI	Timer domain
TR	Trace domain	TS	Temporary storage
UE	User exit interface	US	User domain
WB	Web support	XM	Transaction manager domain
XS	Security manager domain		

**Note:** The component codes BF, BM, BR, CP, DC, DI, EI, FC, IC, IS, JC, KC, PC, RC, SC, SP, SZ, TC, TD, TS, and UE are sub-components of the AP domain. As such, the corresponding trace entries will be produced with a point ID of AP nnnn.

For details of using trace, see the .

**number**

Code the level numbers for the level of special tracing you want for the CICS component indicated by xx. The options are: 1, (1,2), or (1,2,3).

**ALL** Code ALL to indicate that you want all the available levels of special CICS tracing switched on for the specified component.

**OFF** Code OFF to switch off all levels of special CICS tracing for the CICS component indicated by xx.

**Restrictions**

You can code the SPCTRxx parameter in PARM, SYSIPT, or CONSOLE only.

**SPOOL={NO|YES}[,{A|identifier}][,{A|class}{YES|NO}]**

Specifies whether the system spooling interface is required. The identifier and class values are for the report controller.

Use the final YES|NO option to specify whether you want a formfeed (blank page) to precede the first report printed on a non-SCS printer started to the report controller.

The specified identifier is a single character used to identify the printer-owning CICS system to the cross-partition communication (XPCC) component in the device-driving system name (ddsname).

The specified class is the default output class to be used for reports that have no class specified.

**NO**

Specifies that the system spooling interface is not required.

**YES**

Specifies that the system spooling interface is required.

**A** Specifies that the name SYSCICSA is used to identify this CICS system.

**identifier**

Specifies a single character identifier, which is appended to SYSCICS to create a name used to identify this CICS system. This identifier should be unique for each CICS system running with the system spooling interface. If you do not provide a unique identifier, you might receive message DFHRC5301I (indicating that the POWER interface has failed to initialize).

**A** Class A is the default for the output class for reports and printers.

**class**

Specifies a single alpha-numeric character identifier (A to Z, 0-9 only), used as the default output class for reports and printers.

**YES**

Specifies a formfeed (blank page) is to precede the first report printed on a non-SCS printer started to the report controller.

**NO**

Specifies a formfeed (blank page) is not to precede the first report printed on a non-SCS printer started to the report controller. If you code NO, be aware that a report can overwrite the last line of the previous output when the printer is started to the report controller.

**SRT={YES|NO|xx}**

Specifies the system recovery table suffix, for more information see page 129.

For information about coding the macros for this table, see the .

If SRT=NO is coded, the system recovery program (DFHSRP) does not attempt to recover from a program check or from an operating system abend. However, CICS issues VSE ESTAEX macros to intercept program checks to perform clean-up operations before CICS terminates. Therefore, an SRT must be provided if recovery from either program checks or abnormal terminations, or both, is required.

**START=({AUTO|COLD|STANDBY|LOG|TERMI}|,ALL)**

Specifies the type of start for the system initialization program. The value specified for START, or the default of AUTO, becomes the default value for each resource.

**AUTO**

CICS performs either a warm or an emergency restart, according to the status of the control record written to the global catalog by the previous execution of CICS. If the global catalog is newly initialized, it does not contain a control record, and CICS forces a cold start for START=AUTO.

If you code `START=AUTO`, you must provide a restart data set for use in case CICS has to perform an emergency restart, and the system log from the previous execution of CICS must be available. You must also have coded an activity keypoint value (see the `AKPFREQ` parameter on page 140) on the previous execution of CICS for an emergency restart to be successful.

### **COLD**

Specifies a cold start. The status of CICS resource definitions saved in the global catalog at the previous shutdown is ignored, and all resource definitions are reinstalled, either from the CSD or CICS control tables. However, some information saved in the global catalog and local catalog is preserved across cold starts. For information about how CICS uses information saved in the global catalog and local catalog, see the CICS Recovery and Restart Guide.

### **LOGTERM**

`LOGTERM` is a special option for use as an alternative to a full emergency restart when the previous run terminated in an uncontrolled shutdown, and is available only if the CICS system log is defined on disk data sets. If you specify `START=LOGTERM`, CICS initializes up to the point where it writes an end of file on the system log. After it has written the end of file, CICS ends the emergency restart process and shuts down without doing any backout processing.

For background information about this restart process, see the CICS Recovery and Restart Guide.

#### **Restriction**

`START=LOGTERM` is applicable only if `XRF=NO` is coded. You can code `START=LOGTERM` in `PARM`, `SYSIPT`, or `CONSOLE` only.

### **STANDBY**

Coding `START=STANDBY`, but only when you have also specified `XRF=YES`, defines this CICS as the alternate CICS region in an XRF pair. In other words, you *must* specify `START=STANDBY` for the system that starts off as the alternate. (To start an active CICS region, specify `AUTO` or `COLD`, as you would without XRF.)

If you have specified a `COLD` start for other CICS resources, for example, `DCT=(xx,COLD)`, they are cold started when the alternate CICS region (with `START=STANDBY` specified) takes over. This may cause CICS to lose data on an XRF takeover; for example, coding `ICP=COLD` results in outstanding `STARTs` being lost. You are recommended to code `START=(STANDBY,ALL)` to ensure a full emergency restart during takeover, unless you wish to specifically cold start individual resources.

### **(option,ALL)**

Specifies that the `ALL` operand is a special option you can use on the `START` parameter when you supply it as a system initialization parameter at CICS startup; you cannot code it in the `SIT`. If you specify `START=(AUTO,ALL)`, CICS initializes all resources according to the type of startup that it selects (warm, emergency, or cold). The `ALL` option overrides any individual settings in other system initialization parameters (for example, `DCT=(xx,COLD)`).

However, if you do not use the ALL option, you can individually cold start those resources that have a COLD operand. For details of resources that have a COLD option, see Table 3 on page 129.

**Restrictions**

You can code START=(option,ALL) in PARM, SYSIPT, or CONSOLE only.

For more information about the types of CICS startup, see “Classes of start and restart” on page 133.

**STARTER={NOIYES}**

Code YES to indicate that the generation of starter system modules (with ú and # suffixes) is permitted, and various MNOTES are to be suppressed. This parameter should only be used when service is being performed on starter system modules.

**Restrictions**

You can code the STARTER parameter in the SIT only.

**STATRCD=OFFION**

Specifies the interval statistics recording status at CICS initialization. This status is recorded in the CICS global catalog for use during warm and emergency restarts. Statistics collected are written to the DMF data set.

**OFF** Interval statistics are not collected (no action is taken at the end of an interval).

End-of-day, Unsolicited and requested statistics are written to DMF regardless of the STATRCD setting.

**ON** Interval statistics are collected.

On a cold start of a CICS region, interval statistics are recorded by default at three-hourly intervals. All intervals are timed using the end-of-day time (midnight is the default) as a base starting time (*not* CICS startup time). This means that the default settings give collections at 00.00, 03.00, 06.00, 09.00, and so on, regardless of the time that you start CICS.

On a warm or emergency restart the statistics recording status is restored from the CICS global catalog.

You can change the statistics recording status at any time as follows:

- During a warm or emergency restart by coding the STATRCD system initialization parameter.
- While CICS is running by using the CEMT or EXEC CICS SET STATISTICS command.

Whatever the value of the STATRCD system initialization parameter, you can ask for requested statistics and requested reset statistics to be collected. You can get statistics “on demand” for all, or for specified, resource types by using the CEMT or EXEC CICS PERFORM STATISTICS command. The period covered for statistics requested in this way is from the last reset time (that is, from the beginning of the current interval or from when you last issued a CEMT or EXEC CICS statistics command specifying RESETNOW) up to the time that you issue the PERFORM STATISTICS command.



For information about using these CEMT commands, see CICS Supplied Transactions manual. For programming information about the EXEC CICS PERFORM commands, see the CICS System Programming Reference manual.

For information about the statistics utility program DFHSTUP, see CICS Operations and Utilities Guide.

#### **STGPROT={NOYES}**

Specifies whether you want storage protection in the CICS region. The permitted values are NO (the default), or YES:

**NO** If you specify NO, or allow this parameter to default, CICS does not operate any storage protection, and runs in a single storage key as in earlier releases. See the CICS System Definition Guide for a summary of how STGPROT=NO affects the storage allocation for the dynamic storage areas.

**YES** If you specify YES, and if you have the required hardware and software, CICS operates with storage protection, and observes the storage keys and execution keys that you specify in various system and resource definitions. See the CICS System Definition Guide for a summary of how STGPROT=YES affects the storage allocation for the dynamic storage areas.

If you do not have the required hardware and software support, CICS issues an information message during initialization, and operates without storage protection.

#### **STGRCVY={NOYES}**

Specifies whether CICS should try to recover from a storage violation.

**NO** CICS does not try to repair any storage violation that it detects.

**YES** CICS tries to repair any storage violation that it detects.

In both cases, CICS continues unless you have specified in the dump table that CICS should terminate.

In normal operation, CICS sets up four task-lifetime storage subpools for each task. Each element in the subpool starts and ends with a 'check zone' that includes the subpool name. At each freemain, and at end-of-task, CICS checks the check zones and abends the task if either has been overwritten.

Terminal input-output areas (TIOAs) have similar check zones, which are set up with identical values. At each freemain of a TIOA, CICS checks the check zones and abends the task if they are not identical.

If you specify the STGRCVY(YES) system initialization parameter, CICS resets the check zones correctly and the task continues running.

#### **STNTR={1|(1[,2][,3])|ALL|OFF}**

Specifies the level of standard tracing required for CICS as a whole. You can select up to three levels of tracing, but some CICS components do not have trace points at all these levels.

**Note:** Before globally activating tracing levels 3 and ALL for the storage manager (SM) component, read the warning given in the description for the STNTRxx system initialization parameter.



**number**

Code the level number(s) for the level of standard tracing you want for all CICS components. The options are: 1, (1,2), or (1,2,3). The default, 1, specifies standard tracing for level 1 for all CICS components.

**ALL** Enables standard tracing for all levels.

**OFF** Disables standard tracing.

For information about the differences between special and standard CICS tracing, see the CICS Problem Determination Guide.

**STNTRxx={{(1,2)[,2][,3]}|ALL|OFF}**

Specifies the level of standard tracing you require for a particular CICS component. You identify the component by coding a value for xx in the keyword. You code one STNTRxx keyword for each component you want to define selectively. For a CICS component being specially traced that does not have its trace level set by STNTRxx, the trace level is that set by STNTR (which, in turn, defaults to 1). You can select up to three levels of tracing, but some CICS components do not have trace points at all these levels.

The CICS component codes that you can code for xx on this STNTRxx keyword are shown in Table 11 on page 185.

**number**

Code the level number(s) for the level of standard tracing you want for the CICS component indicated by xx. The options are: 1, (1,2), or (1,2,3).

**ALL** Code ALL to indicate that you want all the available levels of standard tracing switched on for the specified component.

**OFF** Code OFF to switch off all levels of standard CICS tracing for the CICS component indicated by xx.

**Attention!**

If you select tracing levels 3 or ALL for the storage manager (SM) component, the performance of your CICS system will be degraded. This is because options 3 and ALL switch on levels of trace that are also used for field engineering purposes. See the CICS Problem Determination Guide for information about the effects of trace levels 3 and ALL.

**Restrictions**

You can code the STNTRxx parameter in PARM, SYSIPT, or CONSOLE only.

**SUFFIX=xx**

Specifies the last two characters of the name of this system initialization table.

The first 6 characters of the name of the SIT are fixed as DFHSIT. You can specify the last two characters of the name, using the SUFFIX parameter. Because the SIT does not have a TYPE=INITIAL macro statement like other CICS resource control tables, you specify its SUFFIX on the TYPE=CSECT macro statement.

The suffix allows you to have more than one version of the SIT. Any one or two characters (other than NO and DY) are valid. You select the version of the table to be loaded into the system during system initialization by coding SIT=xx, either in the PARM parameter or the SYSIPT data set. (You can, in some circumstances, specify the SIT using the system console, but this is not recommended.)

**Restrictions**

You can code the SUFFIX parameter in the SIT only.

**SVA={NO|YES}**

Specifies whether any CICS management modules can be used from the VSE shared virtual area (SVA).

**NO**

No CICS management modules are used from the SVA.

**YES**

CICS management modules installed in the SVA can be used from there, instead of being loaded into the CICS system.

A list of the CICS modules that are read-only, and hence eligible for residence in the SVA, is given in Appendix B of the CICS System Definition Guide.

For details of the CICS system initialization parameter PRVMOD that you can use to override SVA=YES for selected modules, see page 178.

**SYDUMAX={999|number}**

Specifies the limit on the number of system dumps that may be taken per dump table entry. If this number is exceeded, subsequent system dumps for that particular entry will be suppressed.

**number**

Specifies a number in the range 0 through 999. The default, 999, enables an unlimited number of dumps to be taken.

**SYSIDNT={CICS|name}**

Specifies a 1- to 4-character name that is known only to your CICS region. If your CICS region also communicates with other CICS regions, the name you choose for this parameter to identify your local CICS region must not be the same name as an installed RDO CONNECTION resource definition for a remote region.

The value for SYSIDNT, whether specified in the SIT or as an override, can only be updated on a cold start. After a warm start or emergency restart, the value of SYSIDNT is that specified in the last cold start.

For information about the SYSIDNT of a local CICS region, see the CICS Intercommunication Guide.

**SYSTR={ON|OFF}**

Specifies the master system trace flag.

Code ON to obtain trace entries of CICS system activity. Entries are written to all the trace destinations that are active.

## **TAKEOVR={AUTO|MANUAL|COMMAND}**

Code the TAKEOVR parameter in the SIT for an alternate XRF system. It specifies the action to be taken by the alternate CICS, following the (apparent) loss of the surveillance signal in the active CICS system. In doing this, it also specifies the level of operator involvement.

### **AUTO**

No operator approval or intervention is needed for a takeover.

### **MANUAL**

Specifies that the operator is asked to approve a take over if the alternate system cannot detect the surveillance signal of the active system.

Note that the alternate system does not ask the operator for approval if the active system signs off abnormally, nor is there an operator or program command for take over. In these cases, there is no doubt that the alternate system should take over, and manual involvement by the operator would be an unnecessary overhead in the take over process.

For example, you could code MANUAL to ensure manual take over of a master or coordinator region in MRO.

### **COMMAND**

Take over only occurs when a CEBT PERFORM TAKEOVER command is received by the alternate system. It ensures, for example, that a dependent alternate CICS (in MRO) is activated only if it receives the command from the operator, or from a master (coordinator) region.

## **TBEXITS=(*[name1]* [, *name2*] [, *name3*] [, *name4*] [, *name5*])**

Code the names of your transaction backout exit programs. These exits are used for resource backout during emergency restart processing. For programming information about transaction backout exit programs, see the CICS Customization Guide. For background information about transaction backout, see the CICS Recovery and Restart Guide.

The order in which you code the names is critical. If you do not want to use all five exits, code commas in place of the ones you miss out. For example:

```
TBEXITS=(, ,EXITF,EXITV)
```

### **name1**

The name of your initialization/termination exit program.

### **name2**

The name of your input exit program.

### **name3**

The name of your file error exit program.

### **name4**

The name of your open error exit program.

### **name5**

The name of your DL/I error exit program.

If no transaction backout exit programs are required, you can do one of the following:

- Omit the whole parameter from the SIT
- Code TBEXITS=(,,,,) as a SIT parameter
- Code TBEXITS=(,,,,) as a SIT override.

**TCP={YES|NO}**

Code TCP=YES to include the pregenerated non-VTAM terminal control program, DFHTCP.

You must code TCP=YES if you intend using card reader/line printer (sequential) devices.

**TCPIP={NO|YES}**

specifies whether CICS TCPIP services are to be activated at CICS startup. The default is NO, meaning that these services cannot be enabled. If TCPIP is set to YES, the HTTP and IIOPI services can process work.

**Note:** The TCPIP system initialization parameter affects only CICS internal TCP/IP Services defined by TCPIPSERVICE resource definitions. It has nothing to do with the TCP/IP Socket Interface for CICS feature of TCP/IP for MVS.

**TCSACTN={NONE|UNBIND|FORCE}**

Specifies the required action that CICS terminal control should take if the terminal control shutdown wait threshold expires. For details of the wait threshold, see the TCSWAIT system initialization parameter. TCSACTN only takes effect when TCSWAIT is coded with a value in the range 1 through 99. This parameter only applies to VTAM terminals (including LU Type 6.2 single-session APPC terminals), not VTAM intersystem connections (LU Type 6.1 and LU Type 6.2 parallel connections). This is a global default action. On a terminal-by-terminal basis, you can code a DFHZNEP routine to override this action.

**NONE**

No action is taken. This can be overridden by DFHZNEP.

**UNBIND**

CICS terminal control attempts to force-close the session by issuing a VTAM CLSDST and sending an SNA UNBIND command to the hung terminal. This can be overridden by DFHZNEP.

**FORCE**

CICS terminal control attempts to forceclose the CICS VTAM ACB if there are any hung terminals. All CICS VTAM terminals and sessions are released and CICS normal shutdown continues.

**TCSWAIT={4|number|NO|NONE|0}**

Specifies the required CICS terminal control shutdown wait threshold. The wait threshold is the time, during shutdown, that CICS terminal control allows to pass before it considers terminal shutdown to be hung. If all VTAM sessions shutdown and close before the threshold expires then the CICS shutdown process moves on to its next stage, and the terminal control wait threshold then no longer applies. If, however, some of the VTAM session do not complete shutdown and close, then CICS takes special action with these sessions. For details of this special action see the description of the TCSACTN system initialization parameter. The wait threshold only applies to VTAM sessions; that is, VTAM terminals and VTAM intersystem connections. The wait time is specified as a number of minutes, in the range 1 through 99. As a special case, TCSWAIT=NO may be specified to indicate that terminal control shutdown is never to be considered hung, no matter how long the shutdown and close process takes. TCSWAIT=NONE and TCSWAIT=0 are alternative synonyms for TCSWAIT=NO, and all three have the same effect (internally they are held as the one value 0 (zero)).

**TCT={YES|xx|NO}**

Specifies which terminal control table, if any, is to be loaded, for more information see page 129.

For guidance about coding the macros for this table, see the CICS Resource Definition Guide

If you reassemble the TCT after starting CICS, any changes are applied when you next start CICS, even if it is a warm or emergency startup.

If you have VTAM-connected terminals only, you can code TCT=NO. If you do this, note that a dummy TCT, called DFHTCTDY, is loaded during system initialization. For more information about DFHTCTDY, see page 132. (If you code TCT=NO, you must specify a CSD group list in the GRPLIST parameter.)

**TCTUAKEY={USER|CICS}**

Specifies the storage key for the terminal control table user areas (TCTUAs) if you are operating CICS with storage protection (STGPROT=YES). The permitted values are USER (the default), or CICS:

**USER** If you specify USER, or allow this parameter to default, CICS obtains the amount of storage for TCTUAs in user key. This allows a user program executing in any key to modify the TCTUA.

**CICS** If you specify CICS, CICS obtains the amount of storage in CICS key. This means that only programs executing in CICS key can modify the TCTUA, and user-key programs have read-only access.

If CICS is running without storage protection, the TCTUAKEY parameter only designates which DSA (User or CICS) the storage comes from. The TCTUAs are accessed in CICS-key whether they are in the UDSA or CDSA.

See CICS System Definition Guide for more information about TCTUAs.

**TCTUALOC={BELOW|ANY}**

Specifies where terminal user areas (TCTUA) are to be stored.

**BELOW**

Specifies that the TCTUAs are stored below the 16MB line.

**ANY**

Specifies that the TCTUAs are stored anywhere in virtual storage. CICS stores TCTUAs above the 16MB line if possible.

For more information about TCTUAs, see the CICS System Definition Guide.

For details about defining terminals using RDO, see the CICS Resource Definition Guide.

**TD=({3|decimal-value-1}[, {3|decimal-value-2}])**

Specifies the number of VSAM buffers and strings to be used for intrapartition transient data (TD).

**decimal-value-1**

Specifies that the number of buffers to be allocated for the use of intrapartition transient data. The value must be in the range 1 through 32 767. The default value is 3.

CICS obtains, above the 16MB line, storage for the TD buffers in units of the page size (4KB). Because CICS optimizes the use of the storage

obtained, TD may allocate more buffers than you specify, depending on the control interval (CI) size you have defined for the intrapartition data set.

For example, if the CI size is 1536, and you specify 3 buffers (the default number), CICS actually allocates 5 buffers. This is because 2 pages (8192 bytes) are required to obtain sufficient storage for three 1536-byte buffers, a total of only 4608 bytes, which would leave 3584 bytes of spare storage in the second page. In this case, CICS allocates another 2 buffers (3072 bytes) to minimize the amount of unused storage. In this way CICS makes use of storage that would otherwise be unavailable for any other purpose.

#### **decimal-value-2**

Specifies that the number of VSAM strings to be allocated for the use of intrapartition transient data. The value must be in the range 1 through 255, and must not exceed the value specified in decimal-value-1. The default value is 3.

For example, TD=(8,5) specifies 8 buffers and 5 strings.

The operands of the TD parameter are positional. You must code commas to indicate missing operands if others follow. For example, TD=(,2) specifies the number of strings and allows the number of buffers to default.

#### **TRAP={OFF|ON}**

Specifies whether the FE global trap exit is to be activated at system initialization. This exit is for diagnostic use under the guidance of service personnel. For background information about this exit, see the CICS Problem Determination Guide.

#### **TRDUMAX={999|number}**

Specifies the limit on the number of transaction dumps that may be taken per dump table entry. If this number is exceeded, subsequent transaction dumps for that particular entry will be suppressed.

#### **number**

Specifies a number in the range 0 through 999. The default, 999, enables an unlimited number of dumps to be taken.

#### **TRTABSZ={16|number-of-kilobytes}**

Specifies the size in kilobytes of the internal trace table. (1KB = 1024 bytes.) The CICS trace table is allocated in virtual storage above the 16MB line, and it is allocated *before* the extended CICS-key DSA (ECDSA) and the extended user-key DSA (EUDSA). Ensure that there is sufficient virtual storage for the trace table, the ECDSA, and the EUDSA by defining a large enough VSE partition for your CICS job.

**16** 16KB is the default size of the trace table, and also the minimum size.

#### **number**

The number of kilobytes of storage to be allocated for the internal trace table, in the range 16KB through 1048576KB. Subpool 1 is used for the trace table storage, which exists for the duration of the CICS execution. The table is page aligned and occupies a whole number of pages. If the value specified is not a multiple of the page size (4KB), it is rounded up to the next multiple of 4KB.

Trace entries are of variable lengths, but the average length is approximately 100 bytes.

**Note:** To switch on internal tracing, use the INTTR parameter; for a description of INTTR, see page 166.

**TRTRANSZ={40|number-of-kilobytes}**

specifies the size in kilobytes of the transaction dump trace table. (1KB = 1024 bytes.)

When a transaction dump is taken, CICS performs a VSE GETMAIN for storage above the 16MB line for the transaction dump trace table.

**40** 40KB is the default size of the transaction dump trace table. The minimum size is 16KB.

**number**

The number of kilobytes of storage to be allocated for the transaction dump trace table, in the range 16KB through 1048576KB.

**TRTRANTY={TRANIALL}**

specifies which trace entries should be copied from the internal trace table to the transaction dump trace table.

**TRAN** Only the trace entries associated with the transaction that is abending will be copied to the transaction dump trace table.

**ALL** All of the trace entries from the internal trace table will be copied to the transaction dump trace table. If the internal trace table size is larger than the transaction dump trace table size, the transaction dump trace table could wrap. This results in only the most recent trace entries being written to the transaction dump trace table.

**TS=([COLD][,]{0|3|decimal-value-1}[,]{3|decimal-value-2})**

Specifies:

- Whether or not you want to cold start temporary storage
- The number of VSAM buffers to be used for auxiliary temporary storage
- The number of VSAM strings to be used for auxiliary temporary storage.

**COLD**

Specifies that the type of start for the temporary storage program. If you do not want a cold start, code a comma before the second operand.

**Note:** IF ICP is warm-started (that is no ICP=COLD) and TS is cold-started, any ICEs and AIDs with data attached are lost.

**0** No buffers are required; that is, only MAIN temporary storage is required.

**decimal-value-1**

Specifies that the number of buffers to be allocated for the use of auxiliary temporary storage. The value must be in the range 3 through 32 767.

CICS obtains, above the 16MB line, storage for the auxiliary temporary storage buffers in units of the page size (4KB). Because CICS optimizes the use of the storage obtained, TS may allocate more buffers than you specify, depending on the control interval (CI) size you have defined for the auxiliary temporary storage data set.

For example, if the CI size is 2048, and you specify 3 buffers (the default number), CICS actually allocates 4 buffers. This is because 2 pages (8192 bytes) are required to obtain sufficient storage for three 2048-byte buffers, a total of 6144 bytes, which would leave 2048 bytes of spare storage in the second page. In this case, CICS allocates another 2048-byte buffer to use



all of the 8192 bytes obtained. In this way CICS makes use of storage that would otherwise be unavailable for any other purpose.

**decimal-value-2**

Specifies that the number of VSAM strings to be allocated for the use of auxiliary temporary storage. The value must be in the range 1 through 255, and must not exceed the value specified in decimal-value-1. The default value is 3.

For example, TS=(COLD,8,5) specifies 8 buffers and 5 strings.

The operands of the TS parameter are positional. You must code commas to indicate missing operands if others follow. For example, TS=(,8) specifies the number of buffers and allows the other operands to default.

**TSMGSET={4|number}**

Specifies that the number of entries for which dynamic storage is allocated for storing pointers to records put to a temporary storage message set. When the entries are used, space is acquired for the same number of entries as many times as required to accommodate the total number of records in the queue. The range is 4 through 100.

**TST={NO|YES|xx}**

Specifies the temporary storage table suffix, for more information see page 129.

For information about coding the macros for this table, see the CICS Resource Definition Guide

**UDSASZE={0K|number}**

Specifies the size of the UDSA. The default size is 0 indicating that the DSA size can change dynamically. A non-zero value indicates that the DSA size is fixed.

**number**

Specify number as an amount of storage in the range 0 to 16,777,215 bytes in multiples of 262,144 bytes (256KB). If the size specified is not a multiple of 256KB, CICS rounds the value up to the next multiple.

You can specify number in bytes (for example, 4,194,304), or as a whole number of kilobytes (for example, 4096K), or a whole number of megabytes (for example, 4M).

**Restrictions**

You can code the UDSASZE parameter in PARM, SYSIPT and CONSOLE only.

**USERTR={ON|OFF}**

To set the master user trace flag on or off. If the user trace flag is off, the user trace facility is disabled, and EXEC CICS ENTER TRACENUM commands receive an INVREQ condition if EXCEPTION is not specified. If the program does not handle this condition the transaction will abend with an abend code of AEIP.

For programming information about the user trace facility using EXEC CICS ENTER TRACENUM commands, see the manual.

**USRDELAY={30|number}**

Specify the maximum time, in the range 0 through 10080 minutes (up to 7



days), that an eligible userid and its associated attributes are to be retained in the user table if the userid is unused. An entry in the user table for a userid that is retained during the delay period can be reused.

The userids eligible for reuse within the USRDELAY period are any that are:

- Received from remote systems
- Specified on SECURITYNAME in RDO CONNECTION definitions
- Specified on USERID in RDO SESSIONS definitions
- Specified on USERID on DFHDCT TYPE=INTRA definitions
- Specified to be used for non-terminal STARTed transactions.

Within the USRDELAY period, a userid in any one of these categories can be reused in one of the other categories, provided the request for reuse is qualified with the same qualifiers. If a userid is qualified by different group id, APPLID, or terminal id, a retained entry is not reused.

If a userid is unused for more than the USRDELAY limit, it is removed from the system, and the message DFHUS0200 is issued. You can suppress this message in an XMEOUT global user exit program. If you specify USRDELAY=0, all eligible userids are deleted immediately after use, and the message DFHUS0200 is not issued. Do not code USRDELAY=0 if this CICS region communicates with other CICS regions and:

- ATTACHSEC=IDENTIFY is specified on the CONNECTION definitions for the connections used
- The connections used carry high volumes of transaction routing or function shipping activity.

You should specify a value that gives the optimum level of performance for your CICS environment.

**Note:** If a value, other than 0, is specified for USRDELAY, the ability to change the user's attributes or revoke the userid becomes more difficult because the userid and its attributes are retained in the region until the USRDELAY value has expired. For example, if you have specified USRDELAY=30 for a userid, but that userid continues to run transactions every 25 minutes, the USRDELAY value will never expire and any changes made to the userid will never come into effect.

When running a remote transaction, a userid remains signed-on to the remote CICS region (after the conversation associated with the first attach request is complete) until the delay specified by USRDELAY has elapsed since the last transaction associated with the attach request for the userid has completed. When this event occurs, the userid is removed from the remote CICS region.

#### **VTAM={YES|NO}**

Code VTAM=NO only if you do not use the VTAM access method. The default is VTAM=YES.

#### **VTPREFIX={\character}**

Specifies that the first character to be used for the terminal identifiers (termids) of autoinstalled virtual terminals. Virtual terminals are used by the External Presentation Interface (EPI) and terminal emulator functions of the CICS Client products.

Termids generated by CICS for autoinstalled Client terminals consist of a 1-character prefix and a 3-character suffix. The default prefix is '\'. The suffix can have the values 'AAA' through '999'. That is, each character in the suffix

can have the value 'A' through 'Z' or '0' through '9'. The first suffix generated by CICS has the value 'AAA'. This is followed by 'AAB', 'AAC', ... 'AAZ', 'AAO', 'AA1', and so on, up to '999'.

Each time a Client virtual terminal is autoinstalled, CICS generates a 3-character suffix that it has not recorded as being in use.

By specifying a prefix, you can ensure that the termids of Client terminals autoinstalled on this system are unique in your transaction routing network. This prevents the conflicts that could occur if two or more terminal-owning regions (TORs) ship definitions of Client virtual terminals to the same application-owning region (AOR).

If such a naming conflict does occur—that is, if a Client virtual terminal is shipped to an AOR on which a remote terminal of the same name is already installed—the autoinstall user program is invoked in the AOR. Your user program can resolve the conflict by allocating an alias terminal identifier to the shipped definition. (For details of writing an autoinstall user program to install shipped definitions, see the CICS Customization Guide). However, you can avoid potential naming conflicts by specifying a different prefix, reserved for virtual terminals, on each TOR on which Client virtual terminals are to be installed.

You must not use the characters + - \* < > = { } or blank.

**Notes:**

1. The autoinstall user program is not called at install of Client terminals, so cannot be used to specify termids.
2. When specifying a prefix, ensure that termids generated by CICS for Client terminals do not conflict with those generated by your autoinstall user program for user terminals, or with the names of any other terminals or connections.
3. Client terminal definitions are not recovered after a restart. Immediately after a restart, no Client terminals are in use, so when CICS generates suffixes it begins again with 'AAA'. This means that CICS does **not** always generate the same termid for any given Client terminal. This in turn means that server applications should not assume that a particular CICS-generated termid always equates to a particular Client terminal.
4. Clients can override CICS-generated termids.

For further information about Client virtual terminals, see the *CICS Family: Communicating from CICS on System/390* manual.

**WEBDELAY=(5|time\_out,60|keep\_time)**

Specifies two Web delay periods:

1. A time-out period. The maximum time, in minutes, in the range 1-60, that a transaction started through the Web 3270 bridge interface, is allowed to remain in terminal wait state before it is automatically purged by CICS.
2. The terminal keep time. The time, in minutes, in the range 1-6000, during which state data is kept for a CICS Web 3270 bridge transaction, before CICS performs clean-up.

**WRKAREA={512|number}**

Specifies the number of bytes to be allocated to the common work area (CWA).

This area, for use by your installation, is initially set to binary zeros, and is available to all programs. It is not used by CICS. The maximum size for the CWA is 3584 bytes.

**XAPPC={NO|YES}**

Specifies whether ESM security can be used when establishing APPC sessions.

**NO**

ESM session security cannot be used. Only the BINDPASSWORD (defined to CICS for an APPC connection) is checked.

**YES**

ESM session security can be used.

If you specify BINDSECURITY=YES for a particular APPC connection, a request to the ESM is issued to extract the security profile. If the profile exists, it is used to bind the session. If it does not exist, only the BINDPASSWORD (defined to CICS for the connection) is checked.

**Note:** If you specify XAPPC=YES, the external security manager that you use must support the APPCLU general resource class, otherwise CICS fails to initialize.

**Restrictions**

You can code the XAPPC parameter in the SIT, PARM, or SYSIPT only.

**XCMD={NO|name|YES}**

specifies whether you want CICS to perform command security checking, and, optionally, the ESM resource class name in which you have defined the command security profiles. If you specify YES, or an ESM resource class name, CICS calls the ESM to verify that the userid associated with a transaction is authorized to use a CICS command for the specified resource. Such checking is performed every time a transaction tries to use a COLLECT, CREATE, DISABLE, DISCARD, ENABLE, EXTRACT, INQUIRE, PERFORM, RESYNC, or SET command, or any of the FEPI commands, for a resource.

**Note:** The checking is performed only if you have specified YES for the SEC system initialization parameter and specified the CMDSEC(YES) option on the RDO TRANSACTION resource definition.

For information about preparing for and using security with CICS, see the CICS Security Guide.

**NO**

CICS does not perform any command security checks, allowing any user to use commands that would be subject to those checks.

**name**

CICS calls the ESM using the specified resource class name, prefixed by C or V, to verify that the userid associated with a transaction is authorized to use a CICS command for the specified resource. The resource class name is *Cname* and the grouping class name is *Vname*.

The resource class name specified must be 1 through 7 characters.

**YES**

CICS calls the ESM using the default class name of CICS\_CMD, prefixed by C or V, to check whether the userid associated with a transaction is

authorized to use a CICS command for the specified resource. The resource class name is CCICSCMD and the grouping class name is VCICSCMD.

**Restrictions**

You can code the XCMD parameter in the SIT, PARM, or SYSIPT only.

**XDCT={NO|name|YES}**

Specifies whether you want CICS to perform transient data resource security checking. If you specify YES or an ESM resource class name, CICS calls the ESM to verify that the userid associated with a transaction is authorized to access the transient data destination. Such checking is performed every time a transaction tries to access a transient data destination.

**Note:** The checking is performed only if you have specified YES for the SEC system initialization parameter and specified the RESSEC(YES) option on the RDO TRANSACTION resource definition.

For information about preparing for and using security with CICS, see the CICS Security Guide.

**NO**

CICS does not perform any transient data security checks, allowing any user to access any transient data destination.

**name**

CICS calls the ESM using the specified resource class name to check whether the userid associated with the transaction is authorized to access the specified destination. The resource class name is *Dname* and the grouping class name is *Ename*.

The resource class name specified must be 1 through 7 characters.

**YES**

CICS calls the ESM with the default CICS resource class name of CICSXDCT, prefixed by D or E, to verify whether the userid associated with the transaction is authorized to access the specified destination.

The resource class name is DCICXDCT and the grouping class name is ECICXDCT.

**Restrictions**

You can code the XDCT parameter in the SIT, PARM, or SYSIPT only.

**XFCT={NO|name|YES}**

Specifies whether you want CICS to perform file resource security checking, and optionally specifies the ESM resource class name in which you have defined the file resource security profiles. If you specify YES, or an ESM resource class name, CICS calls the ESM to verify that the userid associated with a transaction is authorized to access file control-managed files. Such checking is performed every time a transaction tries to access a file managed by CICS file control.

**Note:** The checking is performed only if you have specified YES for the SEC system initialization parameter and specified the RESSEC(YES) option on the RDO TRANSACTION resource definitions.

For information about preparing for and using security with CICS, see the CICS Security Guide.

**NO**

CICS does not perform any file resource security checks, allowing any user to access any file.

**name**

CICS calls the ESM, using the specified resource class name, to verify that the userid associated with a transaction is authorized to access files referenced by the transaction. The resource class name is *Fname* and the grouping class name is *Hname*.

The resource class name specified must be 1 through 7 characters.

**YES**

CICS calls the ESM, using the default CICS resource class name of CICSFCT prefixed by F or H, to verify that the userid associated with a transaction is authorized to access files reference by the transaction. The resource class name is FCICSFCT and the grouping class name is HCICSFCT.

**Restrictions**

You can code the XFCT parameter in the SIT, PARM, or SYSIPT only.

**XJCT={NO|name|YES}**

Specifies whether you want CICS to perform journal resource security checking. If you specify YES, or an ESM resource class name, CICS calls the ESM to verify that the userid associated with a transaction is authorized to access the referenced journal. Such checking is performed every time a transaction tries to access a CICS journal.

**Note:** The checking is performed only if you have specified YES for the SEC system initialization parameter and specified the RESSEC(YES) option on the RDO TRANSACTION resource definitions.

For information about preparing for and using security with CICS, see the CICS Security Guide.

**NO**

CICS does not perform any journal resource security checks, allowing any user to access any CICS journal.

**name**

CICS calls the ESM, using the specified resource class name prefixed by J or K, to verify that the userid associated with a transaction is authorized to access CICS journals.

The resource class name specified must be 1 through 7 characters.

**YES**

CICS calls the ESM, using the default CICS resource class name of CICSJCT prefixed by a J or K, to check whether the userid associated with

a transaction is authorized to access CICS journals referenced by the transaction. The resource class name is JCICSJCT and the grouping class name is KCICSJCT.

**Restrictions**

You can code the XJCT parameter in the SIT, PARM, or SYSIPT only.

**XLT={NO|xx|YES}**

Specifies a suffix for the transaction list table, for more information see page 129.

The XLT contains a list of transactions that can be attached during the first quiesce stage of system termination.

**NO**

Specifies that a transaction list table is not used.

**xx** Specifies that the transaction list table DFHXLTxx is used.

**YES**

Specifies that the default transaction list table, DFHXLT, is used.

For guidance information about coding the macros for this table, see the CICS Resource Definition Guide

**XPCT={NO|name|YES}**

Specifies whether you want CICS to perform started transaction resource security checking, and optionally specifies the name of the ESM resource class name in which you have defined the started task security profiles. If you specify YES, or an ESM resource class name, CICS calls the ESM to verify that the userid associated with a transaction is authorized to use started transactions and related EXEC CICS commands. Such checking is performed every time a transaction tries to use a started transaction or one of the EXEC CICS commands: COLLECT STATISTICS TRANSACTION, DISCARD TRANSACTION, INQUIRE TRANSACTION, or SET TRANSACTION.

**Note:** The checking is performed only if you have specified YES for the SEC system initialization parameter and specified the RESSEC(YES) option on the RDO TRANSACTION resource definitions.

For information about preparing for and using security with CICS, see the CICS Security Guide.

**NO**

CICS does not perform any started task resource security checks, allowing any user to use started transactions or related EXEC CICS commands.

**name**

CICS calls the ESM using the specified resource class name, to verify that the userid associated with a transaction is authorized to use started transactions or related EXEC CICS commands. The resource class name is ACICSPCT and the grouping class name is BCICSPCT.

The resource class name specified must be 1 through 7 characters.

**YES**

CICS calls the ESM, using the default CICS resource class name CICSPCT

prefixed with A or B, to verify that the userid associated with a transaction is authorized to use started transactions or related EXEC CICS commands.

The resource class name is ACICSPCT and the grouping class name is BCICSPCT.

**Restrictions**

You can code the XPCT parameter in the SIT, PARM, or SYSIPT only.

**XPPT={NO|name|YES}**

Specifies that CICS is to perform application program resource security checks, and optionally specifies the ESM resource class name in which you have defined the program resource security profiles. Such checking is performed every time a transaction tries to invoke another program by using one of the CICS commands: LINK, LOAD, or XCTL.

**Note:** The checking is performed only if you have specified YES for the SEC system initialization parameter and specified the RESSEC(YES) option on the RDO TRANSACTION resource definitions.

For information about preparing for and using security with CICS, see the CICS Security Guide.

**NO**

CICS does not perform any application program authority checks, allowing any user to use LINK, LOAD, or XCTL commands to invoke other programs.

**name**

CICS calls the ESM, with the specified resource class name prefixed by M or N, to verify that the userid associated with a transaction is authorized to use LINK, LOAD, or XCTL commands to invoke other programs. The resource class name is *Mname* and the grouping class name is *Nname*.

The resource class name specified must be 1 through 7 characters.

**YES**

CICS calls the ESM, using the default resource class name prefixed by M or N, to verify that the userid associated with a transaction is authorized to use LINK, LOAD, or XCTL commands to invoke other programs. The resource class name is MCICSPPT and the grouping class name is NCICSPPT.

**Restrictions**

You can code the XPPT parameter in the SIT, PARM, or SYSIPT only.

**XPSB={NO|name|YES}**

Specifies whether you want CICS to perform program specification block (PSB) security checking, and optionally specifies the ESM resource class name in which you have defined the PSB security profiles. If you specify YES, or an ESM resource class name, CICS calls the ESM to check that the userid associated with a transaction is authorized to access PSBs (which describe databases and logical message destinations used by application programs). Such checking is performed every time a transaction tries to access a PSB.



The checking is performed only if you have specified YES for the SEC system initialization parameter and specified the RESSEC(YES) option on the RDO TRANSACTION resource definitions.

For information about preparing for and using security with CICS, see the CICS Security Guide.

#### **NO**

CICS does not perform any PSB resource security checks, allowing any user to access any PSB.

#### **name**

CICS calls the ESM using the specified resource class name prefixed by P or Q, to verify that the userid associated with a transaction is authorized to access PSBs. The resource class name is *Pname* and the grouping class name is *Qname*.

The resource class name specified must be 1 through 7 characters.

#### **YES**

CICS calls the ESM, using the default resource class name CICSPSB prefixed by P or Q, to verify that the userid associated with a transaction is authorized to access PSBs. The resource class name is PCICSPSB and the grouping class name is QCICSPSB.

#### **Restrictions**

You can code the XPSB parameter in the SIT, PARM, or SYSIPT only.

#### **XRF={NO|YES}**

You must specify YES if you want XRF support to be included in the CICS region. If the CICS region is started with the START=STANDBY system initialization parameter specified, the CICS region is the **alternate CICS region**. If the CICS region is started with the START=AUTO or START=COLD system initialization parameter specified, the CICS region is the **active CICS region**. The active CICS region signs on as such to the CICS availability manager. For background information about XRF, see the CICS XRF Guide.

**Note:** You must code JCT=xx|YES, if you are using XRF.

#### **XRFSoFF={NOFORCE|FORCE}**

Specifies whether all users signed-on to the active CICS region are to remain signed-on following a takeover. This parameter is only applicable if you also code XRF=YES as a system initialization parameter.

#### **NOFORCE**

Code NOFORCE to allow CICS to determine sign-off according to the option set in either of:

- The CICS segment of the ESM database
- The RDO TYPETERM resource definition for the user's terminal.

**Note:** For a terminal to remain signed-on after an XRF takeover, NOFORCE must be specified in the SIT, ESM database, and the terminal's RDO TYPETERM resource definition.

#### **FORCE**

Code FORCE if you want **all** terminal users to be signed off in the event of



a takeover by an alternate CICS region, regardless of individual options set in the ESM database or in the terminals' RDO TYPETERM resource definition.

For information about the XRFSOFF option of the RDO TYPETERM resource definition, see the CICS Resource Definition Guide.

**XRFSTME={5|decimal-value}**

Specifies, in minutes, a time-out delay interval for users who are still signed-on when an XRF takeover occurs.

If you have specified NOFORCE in the ESM database, and in the terminals' RDO TYPETERM resource definition, and the takeover takes longer than the time specified in the XRFSTME, all users who are still signed-on after takeover are signed off.

**5** The default value is five minutes.

**decimal-value**

Code a value in the range 0 through 60 for the number of minutes CICS permits users to remain signed on during the takeover period. The takeover period is the time from when the takeover is initiated to the time at which CICS is ready to process user transactions. If the takeover takes longer than the specified period, all users signed-on at the time the takeover was initiated are signed-off.

A value of 0 specifies that there is no time-out delay, and terminals are signed off as soon as takeover commences, which means that XRFSTME=0 has the same effect as coding XRFSOFF=FORCE.

For non-XRF-capable terminals, take into account any AUTCONN delay period when setting the value for XRFSTME. (See the description of the AUTCONN parameter on page 141.) You may need to increase the XRFSTME value to allow for the delay to the start of the CXRE transaction imposed by the AUTCONN parameter; otherwise, terminals may be signed-off too early. For example:

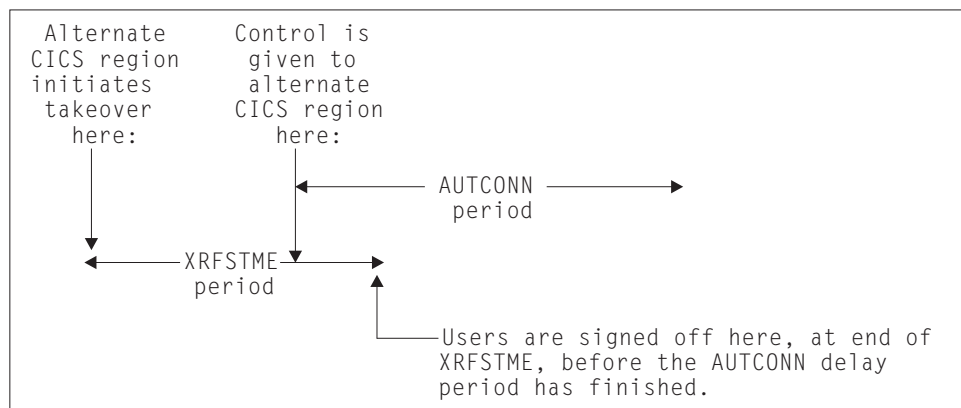

You can avoid this situation by extending the XRFSTME period to exceed the AUTCONN period. For example:

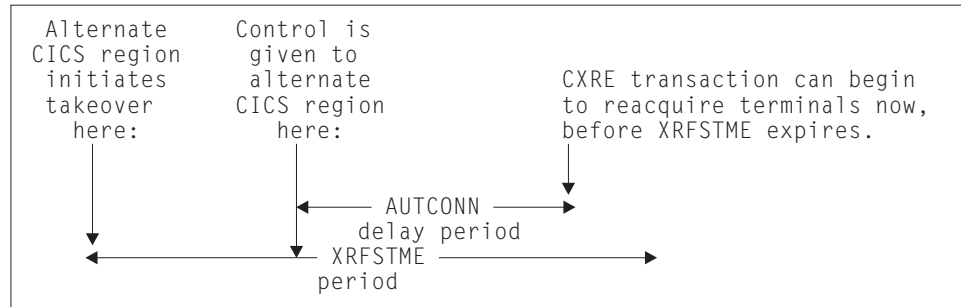

#### **XRFSTME={30|number}**

Use the XRFSTME parameter, in the SIT for an alternate XRF system, to specify, in seconds, the takeover delay interval. The minimum time value is 5 seconds. The alternate system has to ensure that the active system has been canceled before it can take over the resources owned by the active. Because the cancelation process is not fully automatic (for example, the primary CPC fails), the XRFSTME value specifies the interval before the operator becomes involved.

#### **XSWITCH=[({0|1-254|NO}),{???????|programe}],{A|B}}**

Specifies that the XSWITCH parameter defines a programmable terminal switching unit, which may be used with mid-range 2-CPC XRF systems instead of a communication controller. The program defined on the XSWITCH parameter instructs the unit to switch terminal lines to the active system's CPC at start up, and to the alternate system's CPC at take over.

##### **0|1-254**

Specifies that the logical unit to which the switch is assigned. 0 is the default.

##### **???????|programe**

Specifies that the user-written program that issues commands to the switching unit. The program is device-dependent, but has a standard interface that follows normal subroutine conventions.

##### **A|B**

Specifies that the CEC to which the terminal lines are to be directed. A is the active CPC and B is the alternate CPC,

#### **XTRAN={YES|name|NO}**

Specifies whether you want CICS to perform transaction-attach security checking, and optionally specifies the ESM resource class name in which you have defined the transaction security profiles. If you specify YES, or an ESM resource class name, CICS calls the ESM to verify that the userid associated with the transaction is permitted to run the transaction.

**Note:** The checking is performed only if you have specified YES for the SEC system initialization parameter and specified the RESSEC(YES) option on the RDO TRANSACTION resource definitions.

##### **YES**

CICS calls the ESM, using the default CICS resource class name of CICSTRN prefixed by T or G, to verify that the userid associated with the transaction is authorized to run the transaction. The resource class name is TCICSTRN and the grouping class name is GCICSTRN.

**name**

CICS calls the ESM, using the specified resource class name prefixed by T or G, to verify that the userid associated with the transaction is authorized to run the transaction. The resource class name is *Tname* and the corresponding grouping class name is *Gname*.

The name specified must be 1 through 7 characters.

**NO**

CICS does not perform any transaction-attach security checks, allowing any user to run any transaction.

**Note:** The checking is performed only if you have specified YES for the SEC system initialization parameter.

**Restrictions**

You can code the XTRAN parameter in the SIT, PARM, or SYSIPT only.

**XTST={NO|name|YES}**

specifies whether you want CICS to perform temporary storage security checking, and optionally specifies the ESM resource class name in which you have defined the temporary storage security profiles. If you specify YES or an ESM resource class name, CICS calls the ESM to verify that the userid associated with a temporary storage request is authorized to access the referenced temporary storage queue.

**Note:** The checking is performed only if you have specified YES for the SEC system initialization parameter, specified the RESSEC option on the RDO TRANSACTION resource definitions, and specified a DFHTYPE=SECURITY macro for the queue in the temporary storage table (TST).

**NO**

CICS does not perform any temporary storage security checks, allowing any user to access any temporary storage queue.

**name**

CICS calls the ESM, using the specified resource class name prefixed by S or U, to verify that the userid associated with a transaction is authorized to access temporary storage queues.

The name specified must be 1 through 7 characters.

**YES**

CICS calls the ESM, using the default CICS resource class name of CICSTST prefixed by S or U, to verify that the userid associated with the transaction is authorized to access temporary storage queues referenced by the transaction. The resource class name is SCICSTST and the corresponding grouping class name is UCICSTST.

**Restrictions**

You can code the XTST parameter in the SIT, PARM, or SYSIPT only.

**XUSER={NO|YES}**

Specifies whether or not CICS is to perform surrogate user checks.

**NO**

Specifies that CICS is not to perform any surrogate user checking.

**YES**

specifies that CICS is to perform surrogate user checking in all those situations that permit such checks to be made (for example, on EXEC CICS START commands without an associated terminal). For information about the various circumstances in which CICS performs surrogate user checks, see the CICS Security Guide.

**Restrictions**

You can code the XUSER parameter in the SIT, PARM, or SYSIPT only.

---

## Part 7. Trace entries



---

## Chapter 16. Trace entries

---

### Document handler AP trace points

Table 12. document handler

Point ID	Module	Lvl	Type	Data
AP F920	DFHEIDH	AP 2	Entry	1 EIEI parameter list
AP F921	DFHEIDH	AP 2	Exit	1 EIEI parameter list
AP F922	DFHEIDH	Exc	Invalid format	1 EIEI parameter list
AP F923	DFHEIDH	Exc	Invalid function	1 EIEI parameter list
AP F924	DFHEIDH	Exc	Invalid API function	1 EIEI parameter list

### Socket domain

Table 13. Socket domain trace points

Point ID	Module	Lvl	Type	Data
SO 0101	DFHSODM	SO 1	Entry	1 DMDM parameter list
SO 0102	DFHSODM	SO 1	Exit	1 DMDM parameter list
SO 0103	DFHSODM	Exc	Recovery	1 DMDM parameter list 2 Kernel error data
SO 0104	DFHSODM	Exc	Invalid format	1 DMDM parameter list
SO 0105	DFHSODM	Exc	Invalid function	1 DMDM parameter list
SO 0106	DFHSODM	Exc	Exclusive lock error	1 DMDM parameter list 2 LMLM parameter list
SO 0107	DFHSODM	Exc	Exclusive unlock error	1 DMDM parameter list 2 LMLM parameter list
SO 0108	DFHSODM	Exc	Storage error	1 DMDM parameter list
SO 0109	DFHSODM	Exc	Shared lock error	1 DMDM parameter list 2 LMLM parameter list
SO 0110	DFHSODM	Exc	Shared unlock error	1 DMDM parameter list 2 LMLM parameter list
SO 0111	DFHSODM	Exc	Recovery release lock error	1 DMDM parameter list 2 LMLM parameter list
SO 0112	DFHSODM	Exc	Dispatcher error	1 DMDM parameter list
SO 0113	DFHSODM	Exc	Directory manager error	1 DMDM parameter list
SO 0201	DFHSOCK	SO 1	Entry	1 SOCK parameter list 2 Send : sent data

Table 13. Socket domain trace points (continued)

Point ID	Module	Lvl	Type	Data
SO 0202	DFH SOCK	SO 1	Exit	1 SOCK parameter list 2 Receive : received data
SO 0203	DFH SOCK	Exc	Recovery	1 SOCK parameter list 2 Kernel error data
SO 0204	DFH SOCK	Exc	Invalid format	1 SOCK parameter list
SO 0205	DFH SOCK	Exc	Invalid function	1 SOCK parameter list
SO 0206	DFH SOCK	Exc	Exclusive lock error	1 SOCK parameter list 2 LMLM parameter list
SO 0207	DFH SOCK	Exc	Exclusive unlock error	1 SOCK parameter list 2 LMLM parameter list
SO 0208	DFH SOCK	Exc	Getmain error	1 SMGF parameter list
SO 0209	DFH SOCK	SO 2	Before asyncio	1 bpx_interface 2 LTE 3 STE 4 AioCb
SO 0210	DFH SOCK	SO 2	After asyncio	1 bpx_interface 2 LTE 3 STE 4 AioCb
SO 0211	DFH SOCK	Exc	Asyncio error	1 bpx_interface 2 LTE 3 STE 4 AioCb
SO 0212	DFH SOCK	SO 2	Before select	1 bpx_interface 2 LTE 3 Read_List 4 Write_List 5 Exception_List 6 ECB
SO 0213	DFH SOCK	SO 2	After select	1 bpx_interface 2 LTE 3 Read_List 4 Write_List 5 Exception_List 6 ECB
SO 0214	DFH SOCK	Exc	Select error	1 bpx_interface 2 LTE 3 Read_List 4 Write_List 5 Exception_List 6 ECB
SO 0215	DFH SOCK	SO 2	Before socket	1 bpx_interface 2 LTE



Table 13. Socket domain trace points (continued)

Point ID	Module	Lvl	Type	Data
SO 0216	DFH SOCK	SO 2	After socket	1 bpx_interface 2 LTE
SO 0217	DFH SOCK	Exc	Socket error	1 bpx_interface 2 LTE
SO 0218	DFH SOCK	SO 2	Before bind	1 bpx_interface 2 LTE 3 Sockaddr
SO 0219	DFH SOCK	SO 2	After bind	1 bpx_interface 2 LTE 3 Sockaddr
SO 0220	DFH SOCK	Exc	Bind error	1 bpx_interface 2 LTE 3 Sockaddr
SO 0221	DFH SOCK	SO 2	Before listen	1 bpx_interface 2 LTE
SO 0222	DFH SOCK	SO 2	After listen	1 bpx_interface 2 LTE
SO 0223	DFH SOCK	Exc	Listen error	1 bpx_interface 2 LTE
SO 0224	DFH SOCK	SO 2	Before accept	1 bpx_interface 2 LTE 3 STE 4 Sockaddr
SO 0225	DFH SOCK	SO 2	After accept	1 bpx_interface 2 LTE 3 STE 4 Sockaddr
SO 0226	DFH SOCK	Exc	Accept error	1 bpx_interface 2 LTE 3 STE 4 Sockaddr
SO 0227	DFH SOCK	SO 2	Before getclientid	1 bpx_interface 2 LTE 3 Clientid
SO 0228	DFH SOCK	SO 2	After getclientid	1 bpx_interface 2 LTE 3 Clientid
SO 0229	DFH SOCK	Exc	Getclientid error	1 bpx_interface 2 LTE 3 Clientid

Table 13. Socket domain trace points (continued)

Point ID	Module	Lvl	Type	Data
SO 0231	DFH SOCK	SO 2	Before takesocket	1 bpx_interface 2 LTE 3 STE 4 Clientid
SO 0232	DFH SOCK	SO 2	After takesocket	1 bpx_interface 2 LTE 3 STE 4 Clientid
SO 0233	DFH SOCK	Exc	Takesocket error	1 bpx_interface 2 LTE 3 STE 4 Clientid
SO 0234	DFH SOCK	SO 2	Before givesocket	1 bpx_interface 2 LTE 3 STE 4 Clientid
SO 0235	DFH SOCK	SO 2	After givesocket	1 bpx_interface 2 LTE 3 STE 4 Clientid
SO 0236	DFH SOCK	Exc	Givesocket error	1 bpx_interface 2 LTE 3 STE 4 Clientid
SO 0237	DFH SOCK	SO 2	Before close	1 bpx_interface 2 LTE 3 STE
SO 0238	DFH SOCK	SO 2	After close	1 bpx_interface 2 LTE 3 STE
SO 0239	DFH SOCK	Exc	Close error	1 bpx_interface 2 LTE 3 STE
SO 0240	DFH SOCK	SO 2	Before setsockopt	1 bpx_interface 2 LTE 3 option_data
SO 0241	DFH SOCK	SO 2	After setsockopt	1 bpx_interface 2 LTE 3 option_data
SO 0242	DFH SOCK	Exc	Setsockopt error	1 bpx_interface 2 LTE 3 option_data
SO 0243	DFH SOCK	Exc	Socket in use	1 SOCK parameter list

Table 13. Socket domain trace points (continued)

Point ID	Module	Lvl	Type	Data	
SO 0244	DFH SOCK	Exc	Attach error	1	STE
				2	LTE
SO 0245	DFH SOCK	SO 2	IO wait posted for termination	1	STE
SO 0246	DFH SOCK	Exc	Unknown session token	1	SOCK parameter list
SO 0247	DFH SOCK	Exc	IO error	1	SOCK parameter list
SO 0248	DFH SOCK	Exc	DSSR wait error	1	SOCK parameter list
SO 0249	DFH SOCK	SO 2	Immclose requested		
SO 0250	DFH SOCK	SO 2	Register requested		
SO 0251	DFH SOCK	SO 2	Deregister requested		
SO 0252	DFH SOCK	SO 2	Quiesce requested		
SO 0253	DFH SOCK	SO 2	Terminate requested		
SO 0254	DFH SOCK	Exc	Unknown post code	1	bpx_interface
				2	LTE
				3	ECB
SO 0255	DFH SOCK	SO 2	Before gethostname	1	bpx_interface
				2	Name
SO 0256	DFH SOCK	SO 2	After gethostname	1	bpx_interface
				2	Name
SO 0257	DFH SOCK	Exc	Gethostname error	1	bpx_interface
				2	Name
SO 0258	DFH SOCK	SO 2	TCP/IP inactive		
SO 0260	DFH SOCK	SO 2	Listen subroutine entry	1	SOCK parameter list
SO 0261	DFH SOCK	SO 2	Listen subroutine exit	1	SOCK parameter list
SO 0262	DFH SOCK	Exc	EIO received	1	bpx_interface
				2	LTE
				3	Read_List
				4	Write_List
				5	Exception List
				6	ECB
SO 0263	DFH SOCK	Exc	Accept EIO received	1	bpx_interface
				2	LTE
				3	STE
				4	Sockaddr
SO 0270	DFH SOCK	Exc	Shared lock error	1	SOCK parameter list
				2	LMLM parameter list
SO 0271	DFH SOCK	Exc	Shared unlock error	1	SOCK parameter list
				2	LMLM parameter list
SO 0272	DFH SOCK	Exc	Recovery release lock error	1	SOCK parameter list
				2	LMLM parameter list

Table 13. Socket domain trace points (continued)

Point ID	Module	Lvl	Type	Data
SO 0273	DFH SOCK	Exc	Unknown KE error code	1 SOCK parameter list
SO 0274	DFH SOCK	Exc	AsynCIO function error	1 bpx_interface 2 LTE 3 STE 4 AioCb
SO 0275	DFH SOCK	Exc	Getmain for STE failure	
SO 0280	DFH SOCK	SO 2	Before iwmsrsrg	1 iwM_parameters
SO 0281	DFH SOCK	SO 2	After iwmsrsrg	1 iwM_parameters
SO 0282	DFH SOCK	Exc	Iwmsrsrg error	1 iwM_parameters
SO 0283	DFH SOCK	SO 2	Before iwmsrdrs	1 iwM_parameters
SO 0284	DFH SOCK	SO 2	After iwmsrdrs	1 iwM_parameters
SO 0285	DFH SOCK	Exc	Iwmsrdrs error	1 iwM_parameters
SO 0290	DFH SOCK	SO 1	Initialize timer entry	
SO 0291	DFH SOCK	SO 1	Initialize timer exit	
SO 0292	DFH SOCK	SO 1	Timer event	
SO 0293	DFH SOCK	SO 1	Monitor data put entry	
SO 0294	DFH SOCK	SO 1	Monitor data put exit	
SO 0295	DFH SOCK	SO 1	Cancel timer entry	
SO 0296	DFH SOCK	SO 1	Cancel timer exit	
SO 0297	DFH SOCK	SO 2	Connection count increment	1 TcpiPservice name 2 New connection count
SO 0298	DFH SOCK	SO 2	Connection count decrement	1 TcpiPservice name 2 New connection count
SO 0299	DFH SOCK	SO 2	AsynCIO wakeup	1 LTE 2 STE 3 AioRv 4 AioRc 5 AioRsn
SO 029A	DFH SOCK	SO 2	Before sigprocmask	1 bpx_interface 2 How 3 New_signal_mask 4 Old_signal_mask
SO 029B	DFH SOCK	SO 2	After sigprocmask	1 bpx_interface 2 How 3 New_signal_mask 4 Old_signal_mask
SO 029C	DFH SOCK	Exc	Sigprocmask error	1 bpx_interface 2 How 3 New_signal_mask 4 Old_signal_mask
SO 0301	DFH SORD	SO 1	Entry	1 SORD parameter list

Table 13. Socket domain trace points (continued)

Point ID	Module	Lvl	Type	Data	
SO 0302	DFHSORD	SO 1	Exit	1	SORD parameter list
SO 0303	DFHSORD	Exc	Recovery	1 2	SORD parameter list Kernel error data
SO 0304	DFHSORD	Exc	Invalid format	1	SORD parameter list
SO 0305	DFHSORD	Exc	Invalid function	1	SORD parameter list
SO 0306	DFHSORD	Exc	Lock error	1 2	SORD parameter list LMLM parameter list
SO 0307	DFHSORD	Exc	Unlock error	1 2	SORD parameter list LMLM parameter list
SO 0308	DFHSORD	Exc	Storage error	1	SMGF parameter list
SO 0401	DFHSOIS	SO 1	Entry	1	SOIS parameter list
SO 0402	DFHSOIS	SO 1	Exit	1	SOIS parameter list
SO 0403	DFHSOIS	Exc	Recovery	1 2	SOIS parameter list Kernel error data
SO 0404	DFHSOIS	Exc	Invalid format	1	SOIS parameter list
SO 0405	DFHSOIS	Exc	Invalid function	1	SOIS parameter list
SO 0406	DFHSOIS	Exc	Exclusive lock error	1 2	SOIS parameter list LMLM parameter list
SO 0407	DFHSOIS	Exc	Exclusive unlock error	1 2	SOIS parameter list LMLM parameter list
SO 0408	DFHSOIS	Exc	Shared lock error	1 2	SOIS parameter list LMLM parameter list
SO 0409	DFHSOIS	Exc	Shared unlock error	1 2	SOIS parameter list LMLM parameter list
SO 0410	DFHSOIS	Exc	Recovery unlock error	1 2	SOIS parameter list LMLM parameter list
SO 0411	DFHSOIS	Exc	Storage error	1	SMGF parameter list
SO 0412	DFHSOIS	Exc	Unknown KE error code		
SO 0413	DFHSOIS	Exc	CEEPIPI error	1	c_interface
SO 0414	DFHSOIS	Exc	Gethostbyaddr error	1	c_interface
SO 0415	DFHSOIS	Exc	Gethostid error	1	c_interface
SO 0416	DFHSOIS	SO 2	Before CEEPIPI	1 2 3	c_interface pipi_table init_sub_dp : runopts

Table 13. Socket domain trace points (continued)

Point ID	Module	Lvl	Type	Data
SO 0417	DFHSOIS	SO 2	After CEEPIPI	1 c_interface 2 pipi_table 3 init_sub_dp : runopts
SO 0418	DFHSOIS	Exc	Dispatcher error	1 SOIS parameter list
SO 0419	DFHSOIS	Exc	Dub error	1 dub_results
SO 0420	DFHSOIS	SO 2	Before sigprocmask	1 bpx_interface 2 How 3 New_signal_mask 3 Old_signal_mask
SO 0421	DFHSOIS	SO 2	After sigprocmask	1 bpx_interface 2 How 3 New_signal_mask 3 Old_signal_mask
SO 0422	DFHSOIS	Exc	Sigprocmask error	1 bpx_interface 2 How 3 New_signal_mask 3 Old_signal_mask
SO 0501	DFHSOUE	SO 1	Entry	1 SOUE parameter list
SO 0502	DFHSOUE	SO 1	Exit	1 SOUE parameter list
SO 0503	DFHSOUE	Exc	Recovery	1 SOUE parameter list 2 Kernel error data
SO 0504	DFHSOUE	Exc	Invalid function	1 SOUE parameter list
SO 0505	DFHSOUE	Exc	Invalid format	1 SOUE parameter list
SO 0506	DFHSOUE	Exc	Lock error	1 SOUE parameter list 2 LMLM parameter list
SO 0507	DFHSOUE	Exc	Unlock error recovery	1 SOUE parameter list 2 LMLM parameter list
SO 0508	DFHSOUE	Exc	Release lock error	1 SOUE parameter list 2 LMLM parameter list
SO 0509	DFHSOUE	Exc	Recovery release lock error	1 SOUE parameter list 2 LMLM parameter list
SO 050A	DFHSOUE	Exc	Unknown KE error code	
SO 0601	DFHSOAD	SO 1	Entry	1 SOAD parameter list
SO 0602	DFHSOAD	SO 1	Exit	1 SOAD parameter list
SO 0603	DFHSOAD	Exc	Recovery	1 SOAD parameter list 2 Kernel error data
SO 0604	DFHSOAD	Exc	Invalid format	1 SOAD parameter list

Table 13. Socket domain trace points (continued)

Point ID	Module	Lvl	Type	Data	
SO 0605	DFHSOAD	Exc	Invalid function	1	SOAD parameter list
SO 0606	DFHSOAD	Exc	Unlock error recovery	1 2	SOAD parameter list LMLM parameter list
SO 0607	DFHSOAD	Exc	Storage error	1	SMGF parameter list
SO 0701	DFHSOTB	SO 1	Entry	1	SOTB parameter list
SO 0702	DFHSOTB	SO 1	Exit	1	SOTB parameter list
SO 0703	DFHSOTB	Exc	Recovery	1 2	SOTB parameter list Kernel error data
SO 0704	DFHSOTB	Exc	Invalid format	1	SOTB parameter list
SO 0705	DFHSOTB	Exc	Invalid function	1	SOTB parameter list
SO 0706	DFHSOTB	Exc	Unlock error recovery	1 2	SOTB parameter list LMLM parameter list
SO 0707	DFHSOTB	Exc	Storage error	1	SMGF parameter list
SO 0801	DFHSEOSE	SO 1	Entry	1	SOSE parameter list
SO 0802	DFHSEOSE	SO 1	Exit	1	SOSE parameter list
SO 0803	DFHSEOSE	Exc	Recovery	1 2	SOSE parameter list Kernel error data
SO 0804	DFHSEOSE	Exc	Invalid format	1	SOSE parameter list
SO 0805	DFHSEOSE	Exc	Invalid function	1	SOSE parameter list
SO 0806	DFHSEOSE	Exc	Lock error	1 2	SOSE parameter list LMLM parameter list
SO 0807	DFHSEOSE	Exc	Unlock error	1 2	SOSE parameter list LMLM parameter list
SO 0808	DFHSEOSE	Exc	Storage error	1	SMGF parameter list
SO 0809	DFHSEOSE	SO 2	Before CEEPIPI	1	gsk_interface
SO 080A	DFHSEOSE	SO 2	After CEEPIPI	1	gsk_interface
SO 080B	DFHSEOSE	Exc	CEEPIPI error	1	gsk_interface
SO 080C	DFHSEOSE	Exc	GSK error	1	gsk_interface
SO 080D	DFHSEOSE	Exc	Getmain error		
SO 080E	DFHSEOSE	Exc	Repository error		
SO 080F	DFHSEOSE	Exc	Directory error	1	SOSE parameter list
SO 0901	DFHSOXM	SO 1	Entry	1	XMXM parameter list

Table 13. Socket domain trace points (continued)

Point ID	Module	Lvl	Type	Data	
SO 0902	DFHSOXM	SO 1	Exit	1	XXXM parameter list
SO 0903	DFHSOXM	Exc	Invalid function	1	XXXM Parameter list
SO 0904	DFHSOXM	Exc	Invalid format	1	XXXM parameter list
SO 0905	DFHSOXM	Exc	Recovery	1 2	XXXM parameter list Kernel error data
SO 0A01	DFHSOST	SO 1	Entry	1	STST parameter list
SO 0A02	DFHSOST	SO 1	Exit	1	STST parameter list
SO 0A03	DFHSOST	Exc	Recovery	1 2	STST parameter list Kernel error data
SO 0A04	DFHSOST	Exc	Invalid format	1	STST parameter list
SO 0A05	DFHSOST	Exc	Invalid function	1	STST parameter list
SO 0A06	DFHSOST	Exc	Exclusive lock error	1 2	STST parameter list LMLM parameter list
SO 0A07	DFHSOST	Exc	Exclusive unlock error	1 2	STST parameter list LMLM parameter list
SO 0A08	DFHSOST	Exc	Shared lock error	1 2	STST parameter list LMLM parameter list
SO 0A09	DFHSOST	Exc	Shared unlock error	1 2	STST parameter list LMLM parameter list
SO 0A10	DFHSOST	Exc	Recovery release lock error	1 2	STST parameter list LMLM parameter list
SO 0A11	DFHSOST	Exc	Getmain error	1	SMGF parameter list
SO 0A12	DFHSOST	Exc	Unknown kernel error code	1 2	STST parameter list Kernel error data
SO 0A13	DFHSOST	Exc	Invalid parameters	1	STST parameter list
SO 0B01	DFHSOTI	SO 1	Entry	1	SO anchor block
SO 0B02	DFHSOTI	SO 1	Exit	1	SO anchor block
SO 0B03	DFHSOTI	SO 1	Before posting listener		
SO 0B04	DFHSOTI	SO 1	After posting listener		
SO 0B05	DFHSOTI	Exc	Recovery entry	1 2	SO anchor block Kernel error data
SO 0B06	DFHSOTI	Exc	Recovery exit	1 2	SO anchor block Kernel error data



## Web domain trace points

Table 14. Web domain trace points

Point ID	Module	Lvl	Type	Data	
WB 0100	DFHWBDM	WB 1	Entry	1	WBDM parameter list
WB 0101	DFHWBDM	WB 1	Exit	1	WBDM parameter list
WB 0102	DFHWBDM	Exc	Recovery	1	WBDM parameter list
WB 0103	DFHWBDM	Exc	Invalid format	1	DMDM parameter list
WB 0104	DFHWBDM	Exc	Invalid function	1	DMDM parameter list
WB 0105	DFHWBDM	Exc	Release lock error	1 2	DMDM parameter list LMLM parameter list
WB 0107	DFHWBDM	Exc	No storage for anchor block	1	DMDM parameter list
WB 0108	DFHWBDM	Exc	Get parameters failed	1	DMDM parameter list
WB 0200	DFHWBGP	Entry		1	WBGP parameter list
WB 0201	DFHWBGP	Exit		1	WBGP parameter list
WB 0202	DFHWBGP	Exc	Recovery	1	WBGP parameter list
WB 0203	DFHWBGP	Exc	Invalid format	1	WBGP parameter list
WB 0204	DFHWBGP	Exc	Invalid function	1	WBGP parameter list
WB 0300	DFHWBAP	Entry		1 2	WBAP parameter list Client codepage
WB 0301	DFHWBAP	Exit		1 2	WBAP parameter list Client codepage
WB 0302	DFHWBAP	Exc	Recovery	1	WBAP parameter list
WB 0303	DFHWBAP	Exc	Invalid format	1	WBAP parameter list
WB 0304	DFHWBAP	Exc	Invalid function	1	WBAP parameter list
WB 0305	DFHWBAP	Exc	Unlock error recovery	1	WBAP parameter list
WB 0410	DFHWBRQ	Event	Inbound HTTP request	1	HTTP request headers
WB 0411	DFHWBSR	Exc	TSQ put header failed	1	WRB
WB 0412	DFHWBRQ	Exc	TS put request body failed	1	WRB
WB 0413	DFHWBSR	Exc	No repository token returned	1	WRB
WB 0414	DFHWBSR	Event	Before call to Analyzer	1	Analyzer parameter list
WB 0415	DFHWBSR	Event	After call to Analyzer	1	Analyzer parameter list

Table 14. Web domain trace points (continued)

Point ID	Module	Lvl	Type	Data	
WB 0416	DFHWBSR	Data	HTTP request body	1	HTTP request body
WB 0500	DFHWBSR	Entry		1	WBSR parameter list
WB 0501	DFHWBSR	Exit		1	WBSR parameter list
WB 0502	DFHWBSR	Exc	Invalid format	1	WBSR parameter list
WB 0503	DFHWBSR	Exc	Invalid function	1	WBSR invalid function
WB 0600	DFHWBXM	Entry		1	XMAC parameter list
WB 0601	DFHWBXM	Exit		1	XMAC parameter list
WB 0602	DFHWBXM	Exc	Invalid format	1	XMAC parameter list
WB 0603	DFHWBXM	Exc	Invalid function	1	XMAC parameter list
WB 0604	DFHWBXM	Exc	Recovery	1	XMAC parameter list
WB 4109	DFHWBLT	Exc	Trigger partner failed	1	WBST parameter list
WB 4654	DFHWBST	Exc	Directory browse error	1 2	WBST parameter list DDBR parameter list
WB FF60	DFHWBQM	Entry		1	WBQM parameter list
WB FF61	DFHWBQM	Exit		1	WBQM parameter list
WB FF62	DFHWBQM	Exc	Recovery	1	WBQM parameter list
WB FF63	DFHWBQM	Exc	Invalid format	1	WBAP parameter list
WB FF64	DFHWBQM	Exc	Invalid function	1	WBQM parameter list
WB FF65	DFHWBQM	Exc	Invalid parameter	1	WBQM parameter list
WB FF66	DFHWBQM	Exc	TS queue error	1	WBQM parameter list

## Bridge facility management

Table 15. Bridge facility management trace points

Point ID	Module	Lvl	Type	Data	
AP 2140	DFHBRFM	BR 1	Entry	1	BRFM parameter list
AP 2141	DFHBRFM	BR 1	Exit	1	BRFM parameter list
AP 2142	DFHBRFM	Exc	Invalid format	1	BRFM parameter list
AP 2143	DFHBRFM	Exc	Invalid function	1	BRFM parameter list
AP 2144	DFHBRFM	Exc	Invalid token	1	BRFM parameter list

Table 15. Bridge facility management trace points (continued)

Point ID	Module	Lvl	Type	Data	
AP 2145	DFHBRFM	Exc	Invalid template	1	BRFM parameter list
AP 2146	DFHBRFM	Exc	Token not current	1	BRFM parameter list
AP 2147	DFHBRFM	Exc	GETMAIN failed	1	BRFM parameter list
AP 2148	DFHBRFM	Exc	No free name	1	BRFM parameter list
AP 2149	DFHBRFM	Exc	Name create failed	1	BRFM parameter list
AP 214A	DFHBRFM	Exc	Recovery entered	1 2	BRFM parameter list Kernel error data
AP 214B	DFHBRFM	BR 1	Kept BFB expired	1 2 3	BFB name BFB index BFB expiry time
AP 214C	DFHBRFM	BR 1	Kept BFB used	1 2 3	BFB name BFB index BFB expiry time
AP 214D	DFHBRFM	BR 1	BFB added to keep chain	1 2 3	BFB name BFB index BFB expiry time
AP 214E	DFHBRFM	Exc	SNUS signon failed	1	BRFM parameter list
AP 2160	DFHBRMS	BR 1	Entry	1	Exec parameter list
AP 2161	DFHBRMS	BR 1	Exit	1	Exec parameter list
AP 2162	DFHBRMS	Exc	Recovery	1 2	Exec parameter list Kernel error data
AP 2163	DFHBRTC	BR 1	Entry	1	Exec parameter list
AP 2164	DFHBRTC	BR 1	Exit	1	Exec parameter list
AP 2165	DFHBRTC	Exc	Recovery	1 2	Exec parameter list Kernel error data
AP 2166	DFHBRIC	BR 1	Entry	1	Exec parameter list
AP 2167	DFHBRIC	BR 1	Exit	1	Exec parameter list
AP 2168	DFHBRIC	Exc	Recovery	1 2	Exec parameter list Kernel error data
AP 2169	DFHBRxx	Exc	Invalid function	1	Exec parameter list
AP 216A	DFHBRxx	Exc	Invalid group	1	Exec parameter list
AP 216B	DFHBRxx	Exc	Invalid EXEC function	1	Exec parameter list
AP 216C	DFHBRSP	BR 1	Entry	1	Exec parameter list

Table 15. Bridge facility management trace points (continued)

Point ID	Module	Lvl	Type	Data	
AP 216D	DFHBRSP	BR 1	Exit	1	Exec parameter list
AP 216E	DFHBRSP	Exc	Recovery	1 2	Exec parameter list Kernel error data
AP 216F	DFHBRMS	BR 2	Call user exit	1 2	BRXA transaction area BRXA command area
AP 2170	DFHBRMS	BR 2	Return from user exit	1 2	BRXA transaction area BRXA command area
AP 2171	DFHBRTC	BR 2	Call user exit	1 2	BRXA transaction area BRXA command area
AP 2172	DFHBRTC	BR 2	Return from user exit	1 2	BRXA transaction area BRXA command area
AP 2173	DFHBRIC	BR 2	Call user exit	1 2	BRXA transaction area BRXA command area
AP 2174	DFHBRIC	BR 2	Return from user exit	1 2	BRXA transaction area BRXA command area
AP 2175	DFHBRSP	BR 2	Call user exit	1 2	BRXA transaction area BRXA command area
AP 2176	DFHBRSP	BR 2	Return from user exit	1 2	BRXA transaction area BRXA command area
AP 2177	DFHBRSP	Exc	Syncpoint change	1 2 3	BRSP parameter list BRXA transaction area BRXA command area
AP 2178	DFHBRMS	BR 2	Call formatter	1 2	BRXA transaction area BRXA command area
AP 2179	DFHBRMS	BR 2	Formatter return	1 2	BRXA transaction area BRXA command area
AP 217A	DFHBRTC	BR 2	Call formatter	1 2	BRXA transaction area BRXA command area
AP 217B	DFHBRTC	BR 2	Formatter return	1 2	BRXA transaction area BRXA command area
AP 217C	DFHBRIC	BR 2	Call formatter	1 2;	BRXA transaction area BRXA command area
AP 217D	DFHBRIC	BR 2	Call formatter	1 2	BRXA transaction area BRXA command area

## Bridge facility management 2

Table 16. Bridge facility management trace points

Point ID	Module	Lvl	Type	Data	
AP 2800	DFHBRAT	BR 1	Entry	1	BRAT parameter list
AP 2801	DFHBRAT	BR 1	Exit	1	BRAT parameter list
AP 2802	DFHBRAT	Exc	Invalid format	1	BRAT parameter list
AP 2803	DFHBRAT	Exc	Invalid function	1	BRAT parameter list
AP 2804	DFHBRAT	Exc	Recovery	1 2	BRAT parameter list Kernel error data
AP 2805	DFHBRAT	Exc	Xmat sno	1	BRAT parameter list
AP 2806	DFHBRAT	Exc	Xmxd sno	1	BRAT parameter list
AP 2807	DFHBRAT	Exc	Xsrc sno	1	BRAT parameter list
AP 2808	DFHBRAT	Exc	Usad sno	1	BRAT parameter list
AP 2809	DFHBRAT	Exc	Bfrm allocate failed	1	BRAT parameter list
AP 280A	DFHBRAT	Exc	Tm locate failed	1	BRAT parameter list
AP 2820	DFHBRIQ	BR 1	Entry	1	BRIQ parameter list
AP 2821	DFHBRIQ	BR 1	Exit	1	BRIQ parameter list
AP 2822	DFHBRIQ	Exc	Invalid format	1	BRIQ parameter list
AP 2823	DFHBRIQ	Exc	Invalid function	1	BRIQ parameter list
AP 2824	DFHBRIQ	Exc	Recovery	1 2	BRIQ parameter list Kernel error data
AP 2840	DFHBRRM	BR 1	Entry	1	RMRO parameter list
AP 2841	DFHBRRM	BR 1	Exit	1	RMRO parameter list
AP 2842	DFHBRRM	Exc	Recovery	1 2	RMRO parameter list Kernel error data
AP 2847	DFHBRRM	BR 2	Call user exit	1 2	BRXA transaction area BRXA command area
AP 2848	DFHBRRM	BR 2	Return from user exit	1 2	BRXA transaction area BRXA command area
AP 2860	DFHBRXM	BR 1	Entry	1	XMAC parameter list
AP 2861	DFHBRXM	BR 1	Exit	1	XMAC parameter list
AP 2862	DFHBRXM	Exc	Invalid format	1	XMAC parameter list

Table 16. Bridge facility management trace points (continued)

Point ID	Module	Lvl	Type	Data	
AP 2863	DFHBRXM	Exc	Invalid function	1	XMAC parameter list
AP 2864	DFHBRXM	Exc	Recovery	1 2	XMAC parameter list Kernel error data
AP 2865	DFHBRXM	Exc	Smgf sno	1	XMAC parameter list
AP 2866	DFHBRXM	Exc	Xmxd sno	1	XMAC parameter list
AP 2867	DFHBRXM	BR 2	Call user exit	1 2	BRXA transaction area BRXA command area
AP 2868	DFHBRXM	BR 2	Return from user exit	1 2	BRXA transaction area BRXA command area

---

## Part 8. Appendixes





---

## Notices

This information was developed for products and services offered in the U.S.A. IBM may not offer the products, services, or features discussed in this document in other countries. Consult your local IBM representative for information on the products and services currently available in your area. Any reference to an IBM product, program, or service is not intended to state or imply that only that IBM product, program, or service may be used. Any functionally equivalent product, program, or service that does not infringe any IBM intellectual property right may be used instead. However, it is the user's responsibility to evaluate and verify the operation of any non-IBM product, program, or service.

IBM may have patents or pending patent applications covering subject matter described in this document. The furnishing of this document does not give you any license to these patents. You can send license inquiries, in writing, to:

IBM Director of Licensing  
IBM Corporation  
North Castle Drive  
Armonk, NY 10504-1785  
U.S.A.

For license inquiries regarding double-byte (DBCS) information, contact the IBM Intellectual Property Department in your country or send inquiries, in writing, to:

IBM World Trade Asia Corporation  
Licensing  
2-31 Roppongi 3-chome, Minato-ku  
Tokyo 106, Japan

**The following paragraph does not apply to any country where such provisions are inconsistent with local law:** INTERNATIONAL BUSINESS MACHINES CORPORATION PROVIDES THIS PUBLICATION "AS IS" WITHOUT WARRANTY OF ANY KIND, EITHER EXPRESS OR IMPLIED, INCLUDING, BUT NOT LIMITED TO, THE IMPLIED WARRANTIES OF MERCHANTABILITY OR FITNESS FOR A PARTICULAR PURPOSE. Some states do not allow disclaimer of express or implied warranties in certain transactions, therefore this statement may not apply to you.

References in this publication to IBM products, programs, or services do not imply that IBM intends to make these available in all countries in which IBM operates. Any reference to an IBM product, program, or service is not intended to state or imply that only that IBM product, program, or service may be used. Subject to IBM's valid intellectual property or other legally protectable rights, any functionally equivalent product, program, or service may be used instead of the IBM product, program, or service. The evaluation and verification of operation in conjunction with other products, except those expressly designated by IBM, are the responsibility of the user.

Licensees of this program who wish to have information about it for the purpose of enabling: (i) the exchange of information between independently created programs and other programs (including this one) and (ii) the mutual use of the information which has been exchanged, should contact Laboratory Counsel, MP151, IBM United Kingdom Limited, Hursley Park, Winchester, Hampshire, England SO21 2JN.

Such information may be available, subject to appropriate terms and conditions, including in some cases, payment of a fee.

IBM may have patents or pending patent applications covering subject matter in this document. The furnishing of this document does not give you any license to these patents. You can send license inquiries, in writing, to the IBM Director of Licensing, IBM Corporation, 500 Columbus Avenue, Thornwood, New York 10594, U.S.A.

---

## Programming interface information

This book is intended to help you use the external interfaces provided by the CICS Transaction Server for VSE/ESA. This book documents General-use Programming Interface and Associated Guidance Information provided by CICS.

General-use programming interfaces allow the customer to write programs that obtain the services of CICS.

This book also documents Product-sensitive Programming Interface and Associated Guidance Information and Diagnosis, Modification or Tuning Information provided by CICS.

Product-sensitive programming interfaces allow the customer installation to perform tasks such as diagnosing, modifying, monitoring, repairing, tailoring, or tuning of CICS. Use of such interfaces creates dependencies on the detailed design or implementation of the IBM software product. Product-sensitive programming interfaces should be used only for these specialized purposes. Because of their dependencies on detailed design and implementation, it is to be expected that programs written to such interfaces may need to be changed in order to run with new product releases or versions, or as a result of service.

Product-sensitive Programming Interface and Associated Guidance Information is identified, where it occurs, by an introductory statement to a chapter or section.

Diagnosis, Modification, or Tuning Information is provided to help you diagnose problems in your CICS system.

**Note:** Do not use this Diagnosis, Modification, or Tuning Information as a programming interface.

Diagnosis, Modification, or Tuning Information is identified, where it occurs, by an introductory statement to a chapter or section.

---

## Trademarks and service marks

The following terms, used in this publication, are trademarks or service marks of IBM Corporation in the United States or other countries:

BookManager	CICS
CICS/VSE	DB2
DFS	IBM
IMS	Language Environment
OS/2	RACF
RT	SAA
VTAM	

UNIX is a registered trademark in the United States and other countries licensed exclusively through X/Open Company Limited.

Java and all Java-based trademarks and logos are trademarks or registered trademarks of Sun Microsystems, Inc. in the United States and other countries.



---

## Bibliography

---

### CICS Transaction Server for VSE/ESA Release 1 Library

---

Evaluation and planning	
<i>CICS Release Guide</i>	GC33-1645
<i>CICS Migration Guide</i>	GC33-1646
<i>CICS Report Controller Planning Guide</i>	SC33-1941
<i>CICS Enhancements Guide</i>	GC34-5763
General	
<i>CICS Master Index</i>	SC33-1648
<i>CICS Trace Entries Handbook</i>	SC34-5556
<i>CICS User's Handbook</i>	SX33-6101
<i>CICS Glossary</i> (softcopy only)	GC33-1649
Administration	
<i>CICS System Definition Guide</i>	SC33-1651
<i>CICS Customization Guide</i>	SC33-1652
<i>CICS Resource Definition Guide</i>	SC33-1653
<i>CICS Operations and Utilities Guide</i>	SC33-1654
<i>CICS Supplied Transactions</i>	SC33-1655
Programming	
<i>CICS Application Programming Guide</i>	SC33-1657
<i>CICS Application Programming Reference</i>	SC33-1658
<i>CICS 4.1 Sample Applications Guide</i>	SC33-1713
<i>CICS Application Migration Aid Guide</i>	SC33-1943
<i>CICS System Programming Reference</i>	SC33-1659
<i>CICS Distributed Transaction Programming Guide</i>	SC33-1661
<i>CICS Front End Programming Interface User's Guide</i>	SC33-1662
<i>REXX Guide</i>	SC34-5764
<i>CICS Family: Client/Server Programming</i>	SC33-1435
Diagnosis	
<i>CICS Problem Determination Guide</i>	GC33-1663
<i>CICS Messages and Codes</i>	SC33-6799
<i>CICS Diagnosis Reference</i>	LY33-6085
<i>CICS Data Areas</i>	LY33-6086
<i>CICS Supplementary Data Areas</i>	LY33-6087
Communication	
<i>CICS Internet Guide</i>	SC34-5765
<i>CICS Intercommunication Guide</i>	SC33-1665
<i>CICS Family: Interproduct Communication</i>	SC33-0824
<i>CICS Family: Communicating from CICS on System/390</i>	SC33-1697
Special topics	
<i>CICS Recovery and Restart Guide</i>	SC33-1666
<i>CICS Performance Guide</i>	SC33-1667
<i>CICS Shared Data Tables Guide</i>	GC33-1668
<i>CICS Security Guide</i>	SC33-1942
<i>CICS External Interfaces Guide</i>	SC33-1669
<i>CICS XRF Guide</i>	SC33-1671
<i>CICS Report Controller User's Guide</i>	SC34-5688
CICS Clients	
<i>CICS Clients: Administration</i>	SC33-1792
<i>CICS Universal Clients Version 3 for OS/2: Administration</i>	SC34-5450
<i>CICS Universal Clients Version 3 for Windows:</i>	SC34-5449
Administration	

<i>CICS Universal Clients Version 3 for AIX: Administration</i>	SC34-5348
<i>CICS Universal Clients Version 3 for Solaris: Administration</i>	SC34-5451
<i>CICS Family: OO programming in C++ for CICS Clients</i>	SC33-1923
<i>CICS Family: OO programming in BASIC for CICS Clients</i>	SC33-1671
<i>CICS Family: Client/Server Programming</i>	SC33-1435
<i>CICS Transaction Gateway Version 3: Administration</i>	SC34-5448

---

## Books from VSE/ESA 2.5 base program libraries

---

### VSE/ESA Version 2 Release 5

Book title	Order number
Administration	SC33-6705
Diagnosis Tools	SC33-6614
Extended Addressability	SC33-6621
Guide for Solving Problems	SC33-6710
Guide to System Functions	SC33-6711
Installation	SC33-6704
Licensed Program Specification	GC33-6700
Messages and Codes Volume 1	SC33-6796
Messages and Codes Volume 2	SC33-6798
Messages and Codes Volume 3	SC33-6799
Networking Support	SC33-6708
Operation	SC33-6706
Planning	SC33-6703
Programming and Workstation Guide	SC33-6709
System Control Statements	SC33-6713
System Macro Reference	SC33-6716
System Macro User's Guide	SC33-6715
System Upgrade and Service	SC33-6702
System Utilities	SC33-6717
TCP/IP User's Guide	SC33-6601
Turbo Dispatcher Guide and Reference	SC33-6797
Unattended Node Support	SC33-6712
e-business Connectors User's Guide	SC33-6719

---

### High-Level Assembler Language (HLASM)

Book title	Order number
General Information	GC26-8261
Installation and Customization Guide	SC26-8263
Language Reference	SC26-8265
Programmer's Guide	SC26-8264

---

## Language Environment for VSE/ESA (LE/VSE)

Book title	Order number
C Run-Time Library Reference	SC33-6689
C Run-Time Programming Guide	SC33-6688
Concepts Guide	GC33-6680
Debug Tool for VSE/ESA Fact Sheet	GC26-8925
Debug Tool for VSE/ESA Installation and Customization Guide	SC26-8798
Debug Tool for VSE/ESA User's Guide and Reference	SC26-8797
Debugging Guide and Run-Time Messages	SC33-6681
Diagnosis Guide	SC26-8060
Fact Sheet	GC33-6679
Installation and Customization Guide	SC33-6682
LE/VSE Enhancements	SC33-6778
Licensed Program Specification	GC33-6683
Programming Guide	SC33-6684
Programming Reference	SC33-6685
Run-Time Migration Guide	SC33-6687
Writing Interlanguage Communication Applications	SC33-6686

---

## VSE/ICCF

Book title	Order number
Administration and Operations	SC33-6738
User's Guide	SC33-6739

---

## VSE/POWER

Book title	Order number
Administration and Operation	SC33-6733
Application Programming	SC33-6736
Networking Guide	SC33-6735
Remote Job Entry User's Guide	SC33-6734

---

## VSE/VSAM

Book title	Order number
Commands	SC33-6731
User's Guide and Application Programming	SC33-6732



---

## VTAM for VSE/ESA

<b>Book title</b>	<b>Order number</b>
Customization	LY43-0063
Diagnosis	LY43-0065
Data Areas	LY43-0104
Messages and Codes	SC31-6493
Migration Guide	GC31-8072
Network Implementation Guide	SC31-6494
Operation	SC31-6495
Overview	GC31-8114
Programming	SC31-6496
Programming for LU6.2	SC31-6497
Release Guide	GC31-8090
Resource Definition Reference	SC31-6498



---

## Books from VSE/ESA 2.5 optional program libraries

---

### C for VSE/ESA (C/VSE)

Book title	Order number
C Run-Time Library Reference	SC33-6689
C Run-Time Programming Guide	SC33-6688
Diagnosis Guide	GC09-2426
Installation and Customization Guide	GC09-2422
Language Reference	SC09-2425
Licensed Program Specification	GC09-2421
Migration Guide	SC09-2423
User's Guide	SC09-2424

---

### COBOL for VSE/ESA (COBOL/VSE)

Book title	Order number
Debug Tool for VSE/ESA Fact Sheet	GC26-8925
Debug Tool for VSE/ESA Installation and Customization Guide	SC26-8798
Debug Tool for VSE/ESA User's Guide and Reference	SC26-8797
Diagnosis Guide	SC26-8528
General Information	GC26-8068
Installation and Customization Guide	SC26-8071
Language Reference	SC26-8073
Licensed Program Specifications	GC26-8069
Migration Guide	GC26-8070
Migrating VSE Applications To Advanced COBOL	GC26-8349
Programming Guide	SC26-8072

---

## DB2 Server for VSE

Book title	Order number
Application Programming	SC09-2393
Database Administration	GC09-2389
Installation	GC09-2391
Interactive SQL Guide and Reference	SC09-2410
Operation	SC09-2401
Overview	GC08-2386
System Administration	GC09-2406

---

## DL/I VSE

Book title	Order number
Application and Database Design	SH24-5022
Application Programming: CALL and RQDLI Interface	SH12-5411
Application Programming: High-Level Programming Interface	SH24-5009
Database Administration	SH24-5011
Diagnostic Guide	SH24-5002
General Information	GH20-1246
Guide for New Users	SH24-5001
Interactive Resource Definition and Utilities	SH24-5029
Library Guide and Master Index	GH24-5008
Licensed Program Specifications	GH24-5031
Low-level Code and Continuity Check Feature	SH20-9046
Library Guide and Master Index	GH24-5008
Messages and Codes	SH12-5414
Recovery and Restart Guide	SH24-5030
Reference Summary: CALL Program Interface	SX24-5103
Reference Summary: System Programming	SX24-5104
Reference Summary: HLPI Interface	SX24-5120
Release Guide	SC33-6211

---

## PL/I for VSE/ESA (PL/I VSE)

Book title	Order number
Compile Time Messages and Codes	SC26-8059
Debug Tool For VSE/ESA User's Guide and Reference	SC26-8797
Diagnosis Guide	SC26-8058
Installation and Customization Guide	SC26-8057
Language Reference	SC26-8054

Book title	Order number
Licensed Program Specifications	GC26-8055
Migration Guide	SC26-8056
Programming Guide	SC26-8053
Reference Summary	SX26-3836

---

## Screen Definition Facility II (SDF II)

Book title	Order number
VSE Administrator's Guide	SH12-6311
VSE General Introduction	SH12-6315
VSE Primer for CICS/BMS Programs	SH12-6313
VSE Run-Time Services	SH12-6312

---

## TCP/IP for VSE/ESA

Documentation for TCP/IP for VSE/ESA is available by ordering the "TCP/IP for VSE/ESA PDF Product Library" product kit, SK2T-1336. **Not** all the books are separately orderable as they are only available in PDF form. The following titles are available on the product kit at the time of going to press:

Book title	Order number
TCP/IP for VSE/ESA — IBM Program Setup and Supplementary Information	SC33-6601
TCP/IP for VSE/ESA Flyer	G221-9030
TCP/IP for VSE/ESA Performance Considerations	n/a
TCP/IP for VSE/ESA LPS	GC33-6594
The Native TCP/IP forVSE	GC33-6594
TCP/IP Tutorial and Technical Overview	GG24-3376
VSE/ESA as a Web Server	SG24-2040
TCP/IP for VSE 1.4 Installation Guide	n/a
TCP/IP for VSE 1.4 User's Guide	n/a
TCP/IP for VSE 1.4 Commands	n/a
TCP/IP for VSE 1.4 Programmer's Reference	n/a
TCP/IP for VSE 1.4 Messages and Codes	n/a
TCP/IP for VSE 1.4 Optional Products	n/a



---

## Information on the World Wide Web

Information about the hypertext transfer protocol (HTTP) and the hypertext markup language (HTML) is on the World Wide Web. URLs are provided in this book with the caveat that their permanence cannot be guaranteed.

---

### HTTP/1.0

CICS supports HTTP/1.0. Unpredictable results can occur if you use HTTP/1.1-specific headers. For HTTP/1.0 information, consult the following:

- *Overview of HTTP*  
<http://www.w3.org/hypertext/WWW/Protocols/Overview.html>
- *Hypertext Transfer Protocol (HTTP/1.0)*  
<http://ds.internic.net/rfc/rfc1945.txt>

The following references are to information about the ISO 8859-1 (Latin-1) character set:

- *ISO 8859-1 National Character Set FAQ*  
<http://aliga.cesca.es:1025/%7Ezopcgp01/manuals/ISO8859-1.faq>
- *ISO 8859-1:1987 (ordering information)*  
<http://www.iso.ch/cate/d16338.html>
- *ISO 8859-1 (Latin-1) Characters List*  
[http://www.utoronto.ca/webdocs/HTMLdocs/NewHTML/iso\\_table.html](http://www.utoronto.ca/webdocs/HTMLdocs/NewHTML/iso_table.html)
- *Table of Latin-1 character glyphs*  
<http://www.w3.org/pub/WWW/MarkUp/Wilbur/latin1.gif>

---

### HTML

CICS has no dependency on the level of HTML used. There are many reference sites available on the World Wide Web. The most useful starting place for HTML reference material is:

<http://www.w3.org/>





---

## Determining if a publication is current

IBM regularly updates its publications with new and changed information. When first published, both hardcopy and BookManager softcopy versions of a publication are in step, but subsequent updates will probably be available in softcopy before they are available in hardcopy.

For CICS for VSE/ESA books, these softcopy updates appear regularly on the *Transaction Processing and Data Collection Kit* CD-ROM, SK2T-0730-xx and on the

*VSE/ESA Collection Kit* CD-ROM, SK2T-0060-xx. Each reissue of the collection kit is indicated by an updated order number suffix (the -xx part). For example, collection kit SK2T-0730-06 is more up-to-date than SK2T-0730-05. The collection kit is also clearly dated on the cover.

Here's how to determine if you are looking at the most current copy of a publication:

- A publication with a higher suffix number is more recent than one with a lower suffix number. For example, the publication with order number SC33-0667-02 is more recent than the publication with order number SC33-0667-01. (Note that suffix numbers are updated as a product moves from release to release, as well as for hardcopy updates within a given release.)
- When the softcopy version of a publication is updated for a new collection kit the order number it shares with the hardcopy version does not change. Also, the date in the edition notice remains that of the original publication. To compare softcopy with hardcopy, and softcopy with softcopy (on two editions of the collection kit, for example), check the last two characters of the publication's filename. The higher the number, the more recent the publication. For example, DFHPF104 is more recent than DFHPF103. Next to the publication titles in the CD-ROM booklet and the readme files, asterisks indicate publications that are new or changed.
- Updates to the softcopy are clearly marked by revision codes (usually a “#” character) to the left of the changes.



# Index

## Special Characters

.END, PARM keyword 125

### A

abend codes  
    1590 138  
    AEIP 198  
    AEYD 145, 146  
    ASRD 153  
active delay interval for XRF 173  
activity keypoint frequency (AKPFREQ) 140  
ADI, system initialization parameter 139  
AIEXIT, system initialization parameter 139  
AILDELAY, system initialization parameter 139  
AIQMAX, system initialization parameter 140  
AIRDELAY, system initialization parameter 140  
AKPFREQ, system initialization parameter 140  
ALL  
    CEMT INQUIRE TASK 96  
    CEMT INQUIRE TRANSACTION 103  
    CEMT INQUIRE TSQUEUE 107  
ANY  
    CEMT INQUIRE TRANSACTION 106  
APPENDCRLF  
    CEMT INQUIRE DOCTEMPLATE 95  
Appendcrfl attribute  
    DOCTEMPLATE definition 73  
APPL statement, VTAM VBUILD application  
    identifier 141  
APPLID, system initialization parameter 141  
AT option  
    DOCUMENT INSERT command 12  
AUTCONN, system initialization parameter 141  
autoinstall  
    AIEXIT, system initialization parameter 139  
    AILDELAY system initialization parameter 139  
    AIQMAX, system initialization parameter 140  
    PGAICTLG, system initialization parameter 173  
    PGAIXIT, system initialization parameter 173  
    PGAIPGM, system initialization parameter 174  
automatic start 134  
AUXILIARY  
    CEMT INQUIRE TSQUEUE 108  
AUXILIARY option  
    WRITEQ TS command 31  
auxiliary storage trace 142  
AUXTR, system initialization parameter 142  
AUXTRSW, system initialization parameter 142

### B

BACKLOG attribute  
    TCIPSERVICE definition 83  
backout of resources at emergency restart 193  
batching requests 170  
BELOW  
    CEMT INQUIRE TRANSACTION 106

BINARY option  
    DOCUMENT INSERT command 12  
BMS (basic mapping support)  
    BMS system initialization parameter 142  
    DFHBMS, macro 175  
    page-chaining command character string 174  
    page-copying command character string 174  
    page-purging command character string 174  
    page-retrieval command character string 174  
    PGCHAIN, BMS CHAIN command 174  
    PGCOPY, BMS COPY command 174  
    PGPURGE, BMS PURGE command 174  
    PGRET, BMS RETRIEVAL command 174  
    PRGDLAY, BMS PURGE DELAY command 176  
    purge delay time interval 176  
    selecting versions of BMS 131  
    versions of BMS 143  
BMS, system initialization parameter 142  
BOOKMARK option  
    DOCUMENT INSERT command 12  
BRDATA option  
    START BREXIT command 23  
BRDATALENGTH option  
    START BREXIT command 23  
BREXIT  
    CEMT INQUIRE TRANSACTION 104  
BREXIT option  
    START BREXIT command 22  
BRIDGE  
    CEMT INQUIRE TASK 98  
bridge (3270)  
    start a task 22  
buffer size, DTB 152  
buffers and strings, VSAM 195, 197

### C

CADDRLENGTH option  
    EXTRACT TCPIP command 56  
CDATAKEY  
    CEMT INQUIRE TRANSACTION 105  
CDSASZE, system initialization parameter 144  
CEBR transaction 89  
CEDF transaction 91  
CEMT INQUIRE DOCTEMPLATE  
    APPENDCRLF 95  
    DOCTEMPLATE 95  
    DSNAME 95  
    NAME 95  
    TEMPLATENAME 95  
    TEMPLATETYPE 95  
    TYPE 95  
CEMT INQUIRE DOCTEMPLATE definition  
    LIBRARY 95  
CEMT transaction  
    DOCTEMPLATE 94  
    TASK 96  
    TCPIP 100

CEMT transaction (*continued*)

- TCIPSERVICE 101
- TRANSACTION 103
- TSQUEUE 107

CHAINCONTROL attribute

- PROFILE definition 76

CHKSTRM, system initialization parameter 144

CHKSTSK, system initialization parameter 144

CI (control interval)

- for auxiliary temporary storage data set 197
- for intrapartition data set 196

CICS spooler interface

- XPCC, cross-partition communication component 187

CICS Web interface

- WEBDELAY system initialization parameter 200

CICS Web interface (CWI) commands

- WEB RECEIVE 47
- WEB RETRIEVE 49

CICS Web Interface (CWI) commands

- DOCUMENT CREATE 8
- DOCUMENT INSERT 12
- DOCUMENT RETRIEVE 15
- DOCUMENT SET 17
- EXTRACT WEB 38
- WEB ENDBROWSE FORMFIELD 36
- WEB ENDBROWSE HTTPHEADER 37
- WEB EXTRACT 38
- WEB READ FORMFIELD 40
- WEB READ HTTPHEADER 42
- WEB READNEXT FORMFIELD 43
- WEB READNEXT HTTPHEADER 45
- WEB SEND 50
- WEB STARTBROWSE FORMFIELD 52
- WEB STARTBROWSE HTTPHEADER 53
- WEB WRITE 54

CLASS

- CEMT INQUIRE TRANSACTION 103

class, monitoring

- monitoring 168

client requests

- extracting information 38

Client virtual terminals

- system initialization parameter, VTPREFIX 199

CLIENTADDR option

- EXTRACT TCPIP command 56

CLIENTADDRNU option

- EXTRACT TCPIP command 56

CLIENTNAME option

- EXTRACT TCPIP command 56

CLNTCODEPAGE option

- DOCUMENT RETRIEVE command 15
- WEB READ FORMFIELD command 40
- WEB RECEIVE command 47
- WEB SEND command 50
- WEB STARTBROWSE FORMFIELD command 52

CLSDSTP, system initialization parameter 145

CLT (command list table)

- CLT system initialization parameter 145

CMDPROT, system initialization parameter 145

CMDSEC, system initialization parameter 146

CNAMELENGTH option

- EXTRACT TCPIP command 56

COLD option

- system initialization parameter BMS 142
- system initialization parameter DCT 153
- system initialization parameter DLI 153
- system initialization parameter START 188
- system initialization parameter TS 197

commands

- CEMT INQUIRE 93

common work area storage key

- system initialization parameter 151

CONFDATA, system initialization parameter 146

CONFTXT, system initialization parameter 148

CONSOLE (CN), PARM keyword 125

consoles

- entering system initialization parameters 128

cross-partition communication component, XPCC 187

CSD (CICS system definition data set)

- CSDACC, system initialization parameter 148
- CSDBUFND, system initialization parameter 149
- CSDBUFNI, system initialization parameter 149
- CSDFRLOG, system initialization parameter 149
- CSDJID, system initialization parameter 150
- CSDLSRNO, system initialization parameter 150
- CSDRECOV, system initialization parameter 150
- CSDSTRNO, system initialization parameter 151

CSDACC, system initialization parameter 148

CSDBUFND, system initialization parameter 149

CSDBUFNI, system initialization parameter 149

CSDFRLOG, system initialization parameter 149

CSDJID, system initialization parameter 150

CSDLSRNO, system initialization parameter 150

CSDRECOV, system initialization parameter 150

CSDSTRNO, system initialization parameter 151

CSECT operand of system initialization parameter TYPE 139

CWA (common work area)

- WRKAREA, system initialization parameter 200

CWAKEY

- system initialization parameter 151

## D

### D

CEMT INQUIRE TASK 99

data, deleting

- temporary storage queues 26

data sets

- dump 156
- journal data sets 167
- SYSIPT data set 127

DATAONLY option

- DOCUMENT RETRIEVE command 15

date format 151

DATFORM, system initialization parameter 151

DBP (dynamic backout program)

- DBP, system initialization parameter 152
- using suffixes 131

DBP, system initialization parameter 152

DBUFSZ, system initialization parameter 152

DCT (destination control table)  
 DCT, system initialization parameter 153  
 specifying the DCT suffix 153  
 DCT, system initialization parameter 153  
 DDNAME  
 CEMT INQUIRE DOCTEMPLATE 95  
 DDS option of system initialization parameter  
 BMS 143  
 delay, persistent verification 179  
 delay intervals  
 active delay for XRF 173  
 reconnection for XRF 141  
 DELETEQ TS command 26  
 deleting data  
 temporary storage queues 26  
 DESCRIPTION attribute  
 DOCTEMPLATE definition 73  
 PROFILE definition 76  
 DEST  
 CEMT INQUIRE TASK 98  
 DFHDYP, dynamic transaction routing program  
 coding the DTRPGM system initialization  
 parameter 156  
 DFHSIT, system initialization macro  
 .END, PARM keyword 125  
 assembling the SIT 122  
 coding the PARM parameter over two lines 127  
 CONSOLE (CN), PARM keyword 125  
 creating a SIT 121  
 creating more than one SIT 122  
 defining your SIT to CICS at startup 123  
 DFHSIT TYPE=DSECT 139  
 parameters that cannot be coded 123  
 SITs supplied with VSE/ESA 122  
 supplied SITs 122  
 SYSIN (SI), PARM keyword 125  
 DFHSIT keywords and operands  
 DFHSIT keywords and operands 114  
 DFHTCTDY, dummy TCT 132  
 DFLTUSER, system initialization parameter 153  
 DIP, system initialization parameter 153  
 DISABLED  
 CEMT INQUIRE TRANSACTION 105  
 DISMACP, system initialization parameter 153  
 DISPATCHABLE  
 CEMT INQUIRE TASK 99  
 DL/I  
 DLI (DL1), system initialization parameter 153  
 DLIOER, system initialization parameter 154  
 XDBDERR, global user exit 154  
 DLI (DL1), system initialization parameter 153  
 DLIOER, system initialization parameter 154  
 DOCCODEPAGE, system initialization parameter 154  
 DOCSIZE option  
 DOCUMENT INSERT command 12  
 DOCTEMPLATE  
 CEMT INQUIRE DOCTEMPLATE 95  
 CEMT transaction 94  
 DOCTEMPLATE attribute  
 DOCTEMPLATE definition 74  
 DOCTEMPLATE definition  
 AppendCrLf attribute 73  
 DESCRIPTION attribute 73  
 DOCTEMPLATE attribute 74  
 DOCTEMPLATE definition 74  
 EXITPGM attribute 74  
 FILENAME attribute 74  
 GROUP attribute 74  
 Library attribute 73  
 MEMBER attribute 74  
 PROGRAMNAME attribute 74  
 RDO command 73  
 TDQUEUE attribute 74  
 TEMPLATENAME attribute 74  
 TSQUEUE attribute 74  
 TYPE attribute 74  
 DOCTEMPLATE resource 62  
 DOCTOKEN option  
 DOCUMENT RETRIEVE command 15  
 DOCUMENT SET command 17  
 WEB RETRIEVE command 49  
 WEB SEND command 50  
 document  
 adding symbols to symbol table 17  
 creating 8  
 sending documents 50  
 DOCUMENT CREATE command 8  
 DOCUMENT INSERT command 12  
 DOCUMENT option  
 DOCUMENT INSERT command 13  
 DOCUMENT RETRIEVE command 15  
 DOCUMENT SET command 17  
 documents  
 creating 61  
 DOCTEMPLATE 62  
 HTML 59  
 domains  
 document domain 59  
 DS  
 CEMT INQUIRE TASK 99  
 DSA (dynamic storage area)  
 EDSALIM, system initialization parameter 157  
 RENTPGM, system initialization parameter 180  
 STGPROT, system initialization parameter 190  
 DSALIM, system initialization parameter 154  
 DSECT operand of system initialization parameter  
 TYPE 139  
 DSHIPIDL, system initialization parameter 155  
 DSHIPINT, system initialization parameter 155  
 DSNAME  
 CEMT INQUIRE DOCTEMPLATE 95  
 DTB (dynamic transaction backout)  
 dynamic buffer size 152  
 indicating the program version 152  
 DTRPGM, system initialization parameter 156  
 DTRTRAN, system initialization parameter 155  
 DUMP, system initialization parameter 156  
 dump data sets 156  
 dump facilities  
 DUMP, system initialization parameter 156  
 DUMPDS, system initialization parameter 156

dump facilities (*continued*)  
 DUMPSW, system initialization parameter 156  
 effect of START= parameter 137  
 SYDUMAX, system initialization parameter 192  
 TRDUMAX, system initialization parameter 196  
 DUMPDS, system initialization parameter 156  
 DUMPSW, system initialization parameter 156  
 DVSUPRT attribute  
 PROFILE definition 76  
 dynamic buffer size 152  
 dynamic transaction routing  
 DTRPGM, system initialization parameter 156  
 DTRTRAN, system initialization parameter 155

## E

ECDSASZE, system initialization parameter 157  
 EDF (execution diagnostic facility) 91  
 EDSALIM, system initialization parameter 157  
 emergency restart  
 resource backout 193  
 START system initialization parameter 187  
 ENABLED  
 CEMT INQUIRE TRANSACTION 105  
 ENDFILE condition  
 WEB READNEXT FORMFIELD command 43  
 WEB READNEXT HTTPHEADER command 45  
 EODI, system initialization parameter 158  
 ERDSASZE, system initialization parameter 158  
 ESDSASZE, system initialization parameter 158  
 ESMEXITS, system initialization parameter 158  
 EUDSASZE, system initialization parameter 159  
 examples  
 using the READQ TS command 30  
 using the START BREXIT command 22  
 exception class monitoring 169  
 execution diagnostic facility (EDF) 91  
 exit interval, region 165  
 EXITPGM attribute  
 DOCTEMPLATE definition 74  
 exits  
 FE, global trap exit 196  
 XDBDERR, global user exit 154  
 external security interface 182  
 EXTRACT TCPIP command 56  
 EXTRACT WEB command 38

## F

facilities  
 auxiliary trace autoswitch facility 142  
 FACILITY  
 CEMT INQUIRE TASK 98  
 FACILITYLIKE  
 CEMT INQUIRE TRANSACTION 104  
 FACILITYLIKE attribute  
 PROFILE definition 76  
 FCT (file control table)  
 specifying the FCT suffix 159  
 FCT, system initialization parameter 159  
 FE global trap exit 196

field  
 extracting information 40  
 field name start character 160  
 field separator characters 160  
 FLDSEP, system initialization parameter 160  
 FLDSTRT, system initialization parameter 160  
 FORCEPURGE  
 CEMT INQUIRE TASK 98  
 form field  
 extracting information 40  
 FORMFIELD option  
 WEB READ FORMFIELD command 40  
 WEB READNEXT FORMFIELD command 43  
 frequency, activity keypoint 140  
 FROM option  
 WRITEQ TS command 31  
 FROMDOC option  
 DOCUMENT INSERT command 13  
 front end programming interface (FEPI)  
 FEPI, system initialization parameter 159  
 FSSTAFF, system initialization parameter 161  
 FTTYPE  
 CEMT INQUIRE TASK 98  
 FULL option of system initialization parameter  
 BMS 142  
 function shipping  
 FSSTAFF, system initialization parameter 161

## G

generic applid for CICS XRF systems 141  
 global catalog data set (GCD)  
 role in system initialization process 133  
 global trap exit, FE 196  
 GMTEXT, system initialization parameter 162  
 GMTRAN, system initialization parameter 162  
 GNTRAN, system initialization parameter 163  
 good morning message 162  
 good morning transaction 162  
 GOOD MORNING transaction 181  
 GROUP attribute  
 PROFILE definition 77  
 group list, RDO 163  
 GRPLIST, system initialization parameter 163

## H

header  
 browsing 36, 37, 52, 53  
 extracting information 42, 54  
 retrieve next 43, 45  
 HOSTCODEPAGE option  
 WEB READ FORMFIELD command 40  
 WEB RECEIVE command 47  
 WEB STARTBROWSE FORMFIELD command 52  
 HTIME  
 CEMT INQUIRE TASK 98  
 HTTP requests  
 receiving 47, 49  
 HTTPHEADER option  
 WEB READ HTTPHEADER command 42  
 WEB READNEXT HTTPHEADER command 45

HTTPHEADER option *(continued)*  
    WEB WRITE command 54  
HTTPMETHOD option  
    WEB EXTRACT command 38  
HTTPVERSION option  
    WEB EXTRACT command 38  
HTYPE  
    CEMT INQUIRE TASK 98  
HVALUE  
    CEMT INQUIRE TASK 98

## I

ICP, system initialization parameter 165  
ICV, system initialization parameter 165  
ICVR, system initialization parameter 165  
ICVTSD, system initialization parameter 166  
IDENTIFIER  
    CEMT INQUIRE TASK 98  
INBFMH attribute  
    PROFILE definition 77  
INITPARM, system initialization parameter 166  
internal trace, main storage 166  
intervals, activity keypoint 140  
INTO option  
    DOCUMENT RETRIEVE command 15  
    READQ TS command 28  
    WEB RECEIVE command 47  
INTTR, system initialization parameter 166  
INVREQ condition  
    DELETEQ TS command 26  
    EXTRACT TCPIP command 57  
    READQ TS command 29  
    START BREXITcommand 23  
    WEB ENDBROWSE FORMFIELD command 36  
    WEB ENDBROWSE HTTPHEADER command 37  
    WEB EXTRACT command 39  
    WEB READ FORMFIELD command 41  
    WEB READ HTTPHEADER command 42  
    WEB READNEXT FORMFIELD command 43  
    WEB READNEXT HTTPHEADER command 45  
    WEB RECEIVE command 48  
    WEB RETRIEVE command 49  
    WEB SEND command 50  
    WEB STARTBROWSE FORMFIELD command 52  
    WEB STARTBROWSE HTTPHEADER  
        command 53  
    WEB WRITE command 54  
    WRITEQ TS command 33  
IOERR condition  
    READQ TS command 29  
    WRITEQ TS command 33  
IPADDRESS attribute  
    TCPIPSERVICE definition 83  
IRC (interregion communication)  
    IRCSTRT, system initialization parameter 166  
IRCSTRT, system initialization parameter 166  
ISC (intersystem communication)  
    ISC, system initialization parameter 167  
ISC, system initialization parameter 167

ISCINVREQ condition  
    DELETEQ TS command 27  
    READQ TS command 29  
    WRITEQ TS command 33  
ITEM option  
    READQ TS command 28  
    WRITEQ TS command 31  
ITEMERR condition  
    READQ TS command 29  
    WRITEQ TS command 33

## J

JCT, system initialization parameter 167  
journal archiving, automatic  
    CSDJID, system initialization parameter 150  
JOURNAL attribute  
    PROFILE definition 77  
journal control table (JCT)  
    JCT, system initialization parameter 167  
    specifying the JCT suffix 167  
journal data sets  
    JSTATUS, system initialization parameter 167  
journaling  
    JCT, system initialization parameter 167  
    specifying security checking for journal entries 203  
    XJCT, system initialization parameter 203  
JSTATUS, system initialization parameter 167

## K

keypoint frequency 140  
keys for page-retrieval 184

## L

LENGERR condition  
    EXTRACT TCPIP command 57  
    READQ TS command 30  
    START BREXITcommand 23  
    WEB EXTRACT command 39  
    WEB READ FORMFIELD command 41  
    WEB READ HTTPHEADER command 42  
    WEB READNEXT command 45  
    WEB READNEXT FORMFIELD command 43  
    WEB RECEIVE command 48  
    WRITEQ TS command 33  
LENGERR option  
    DOCUMENT RETRIEVE command 16  
LENGTH  
    CEMT INQUIRE TSQUEUE 108  
LENGTH option  
    DOCUMENT RETRIEVE command 15  
    DOCUMENT SET command 17  
    READQ TS command 28  
    WEB RECEIVE command 47  
    WEB SEND command 50  
    WRITEQ TS command 32  
LEVSE (LE support)  
    LEVSE, system initialization parameter 167  
LEVSE, system initialization parameter 167



LGNMSG, system initialization parameter 167  
 Library attribute  
   DOCTEMPLATE definition 73  
 local catalog data set (LCD)  
   role in system initialization process 133  
   use in restart 134  
 LOCATION  
   CEMT INQUIRE TSQUEUE 108  
 LOCKED condition  
   DELETEQ TS command 27  
 logon data, VTAM 167  
 LOGREC attribute  
   PROFILE definition 77

**M**

macros  
   DFHBMS, BMS macro 175  
 MAIN  
   CEMT INQUIRE TSQUEUE 108  
 MAIN option  
   WRITEQ TS command 32  
 MAXITEMLEN  
   CEMT INQUIRE TSQUEUE 108  
 MAXLENGTH option  
   DOCUMENT RETRIEVE command 15  
   WEB RECEIVE command 47  
 MCT, system initialization parameter 167  
 MEMBER attribute  
   DOCTEMPLATE definition 74  
 message, good morning 162  
 message case 171  
 message level 171  
 message set, temporary storage 198  
 messages  
   MSGCASE, system initialization parameter 171  
   MSGLVL, system initialization parameter 171  
 METHODLENGTH option  
   WEB EXTRACT command 38  
 MINIMUM option of system initialization parameter  
   BMS 142  
 MINITEMLEN  
   CEMT INQUIRE TSQUEUE 109  
 MN, system initialization parameter 168  
 MNCONV, system initialization parameter 168  
 MNEXC, system initialization parameter 169  
 MNFREQ, system initialization parameter 169  
 MNPER, system initialization parameter 169  
 MNSYNC, system initialization parameter 169  
 MNTIME, system initialization parameter 169  
 MODENAME attribute  
   PROFILE definition 77  
 monitoring facilities  
   effect of START= parameter 137  
   exception class 169  
   MCT, system initialization parameter 167  
   MN, system initialization parameter 168  
   MNCONV, system initialization parameter 168  
   MNEXC, system initialization parameter 169  
   MNFREQ, system initialization parameter 169  
   MNPER, system initialization parameter 169

monitoring facilities (*continued*)  
   MNSYNC, system initialization parameter 169  
   MNTIME, system initialization parameter 169  
   performance class 169  
 MRO (multiregion operation)  
   batching 170  
   extend lifetime of long-running mirror 170  
   long-running mirror 170  
   MROBTCH, system initialization parameter 170  
   MROFSE, system initialization parameter 170  
   MROLRM, system initialization parameter 170  
 MROBTCH, system initialization parameter 170  
 MROFSE, system initialization parameter 170  
 MROLRM, system initialization parameter 170  
 MSGCASE, system initialization parameter 171  
 MSGINTEG attribute  
   PROFILE definition 78  
 MSGJRNL attribute  
   PROFILE definition 78  
 MSGLVL, system initialization parameter 171  
 MXT, system initialization parameter 171

**N**

NAME  
   CEMT INQUIRE DOCTEMPLATE 95  
 NAMELENGTH option  
   WEB READ FORMFIELD command 40  
   WEB READ HTTPHEADER command 42  
   WEB READNEXT FORMFIELD command 43  
   WEB READNEXT HTTPHEADER command 45  
   WEB WRITE command 54  
 NATLANG, system initialization parameter 171  
 NEPCLASS attribute  
   PROFILE definition 78  
 NEWSIT, system initialization parameter 172  
   effect on warm start 134  
 NEXT option  
   READQ TS command 29  
 NODDS option of system initialization parameter  
   BMS 143  
 NOSPACE condition  
   WRITEQ TS command 34  
 NOSUSPEND option  
   WRITEQ TS command 32  
 NOTAUTH condition  
   DELETEQ TS command 27  
   READQ TS command 30  
   START BREXIT command 23  
   WRITEQ TS command 34  
 NOTFND condition  
   WEB READ FORMFIELD command 41  
   WEB READ HTTPHEADER command 42  
   WEB SEND command 50  
 NOTFND option  
   DOCUMENT RETRIEVE command 16  
 NOTPURGEABLE  
   CEMT INQUIRE TRANSACTION 105  
 NOTRUNCATE option  
   WEB RECEIVE command 48  
 NUMITEMS  
   CEMT INQUIRE TSQUEUE 109



NUMITEMS option  
  READQ TS command 29  
  WRITEQ TS command 32

## O

OFF  
  CEDX 92  
ON  
  CEDX 92  
ONEWTE attribute  
  PROFILE definition 78  
operator communication for initialization  
  parameters 129  
OPERTIM, system initialization parameter 172  
overriding system initialization parameters  
  from the console 128  
  from the SYSIPT data set 127

## P

PA keys for page-retrieval 184  
PA keys for screen copying 176  
page-chaining command character string 174  
page-copying command character string 174  
page-purging command character string 174  
page-retrieval command character string 174  
page-retrieval keys 184  
PARMERR, system initialization parameter 173  
PATH option  
  WEB EXTRACT command 38  
PATHLENGTH option  
  WEB EXTRACT command 38  
PDI, system initialization parameter 173  
performance class monitoring 169  
persistent sessions support  
  PVDELAY, system initialization parameter 179  
persistent verification delay 179  
PF keys for page-retrieval 184  
PGCHAIN, system initialization parameter 174  
PGCOPY, system initialization parameter 174  
PGMIDERR condition  
  START BREXIT command 23  
PGPURGE, system initialization parameter 174  
PGRET, system initialization parameter 174  
PLT (program list table)  
  PLTPI, system initialization parameter 175  
  PLTPISEC, system initialization parameter 175  
  PLTPIUSR, system initialization parameter 175  
  PLTSD, system initialization parameter 176  
PLTPI, system initialization parameter 175  
PLTPISEC, system initialization parameter 175  
PLTPIUSR, system initialization parameter 175  
PLTSD, system initialization parameter 176  
PORTNUMBER option  
  EXTRACT TCPIP command 56  
PORTNUMNU option  
  EXTRACT TCPIP command 56  
PRFILE  
  CEMT INQUIRE TRANSACTION 105  
PRGDLAY, system initialization parameter 176

PRINT, system initialization parameter 176  
PRINTERCOMP attribute  
  PROFILE definition 78  
printing facilities  
  PRINT, system initialization parameter 176  
  screen copying 176  
PRIORITY  
  CEMT INQUIRE TASK 98  
  CEMT INQUIRE TRANSACTION 105  
PROFILE attribute  
  PROFILE definition 79  
PROFILE definition  
  CHAINCONTROL attribute 76  
  DESCRIPTION attribute 76  
  DVSUPRT attribute 76  
  FACILITYLIKE attribute 76  
  GROUP attribute 77  
  INBFMH attribute 77  
  JOURNAL attribute 77  
  LOGREC attribute 77  
  MODENAME attribute 77  
  MSGINTEG attribute 78  
  MSGJRNL attribute 78  
  NEPCLASS attribute 78  
  ONEWTE attribute 78  
  PRINTERCOMP attribute 78  
  PROFILE attribute 79  
  PROTECT attribute 79  
  RAQ attribute 79  
  RDO command 75  
  RTIMOUT attribute 79  
  SCRNSIZE attribute 80  
  UCTRAN attribute 80  
PROGRAM  
  CEMT INQUIRE TRANSACTION 105  
PROGRAMNAME attribute  
  DOCTEMPLATE definition 74  
PROTECT attribute  
  PROFILE definition 79  
PRTYAGE, system initialization parameter 178  
PRVMOD, system initialization parameter 178  
PSDINT, system initialization parameter 116, 178  
PURGE  
  CEMT INQUIRE TASK 98  
purge delay time interval, BMS 176  
PURGEABILITY  
  CEMT INQUIRE TRANSACTION 105  
PURGEABLE  
  CEMT INQUIRE TRANSACTION 105  
PURGETYPE  
  CEMT INQUIRE TASK 98  
PVDELAY, system initialization parameter 179  
**Q**  
QD  
  CEMT INQUIRE TASK 99  
QIDERR condition  
  DELETEQ TS command 27  
  READQ TS command 30  
  WRITEQ TS command 34  
QNAME option  
  DELETEQ TS command 26

QNAME option (*continued*)  
 READQ TS command 29  
 WRITEQ TS command 33  
 QUERYSTRING option  
 WEB EXTRACT command 38  
 QUERYSTRLEN option  
 WEB EXTRACT command 39  
 QUEUE option  
 DELETEQ TS command 26  
 READQ TS command 29  
 WRITEQ TS command 32

## R

RAMAX, system initialization parameter 179  
 RAPOOL, system initialization parameter 179  
 RAQ attribute  
 PROFILE definition 79  
 RDO (resource definition online)  
 group list (GRPLIST) 163  
 RDO command  
 DOCTEMPLATE 73  
 PROFILE 75  
 TCPIP SERVICE 83  
 RDSASIZE, system initialization parameter 180  
 read-only storage  
 system initialization parameter 180  
 reading records  
 from temporary storage queue 28  
 READQ TS command 28  
 RECEIVE ANY (RA) maximum 179  
 RECEIVE ANY (RA) pool size 179  
 reconnection delay interval (XRF) 141  
 reconnection transaction for XRF 181  
 RECUNITID  
 CEMT INQUIRE TASK 99  
 region exit interval (ICV) 165  
 RENTPGM, system initialization parameter 180  
 request parameter list (RPL) 179  
 REQUESTTYPE option  
 WEB EXTRACT command 39  
 resource backout at emergency restart 193  
 RESP, system initialization parameter 180  
 RESSEC, system initialization parameter 180  
 REWRITE option  
 WRITEQ TS command 33  
 RMTRAN, system initialization parameter 181  
 RPL (request parameter list) 179  
 RTIMOUT attribute  
 PROFILE definition 79  
 RUNNING  
 CEMT INQUIRE TASK 99  
 RUNSTATUS  
 CEMT INQUIRE TASK 99  
 RUWAPOL, system initialization parameter 181

## S

S  
 CEMT INQUIRE TASK 99  
 SADDRLENGTH option  
 EXTRACT TCPIP command 57

screen copying 176  
 SCRNSIZE attribute  
 PROFILE definition 80  
 SD  
 CEMT INQUIRE TASK 99  
 SDSASZE, system initialization parameter 181  
 SEC, system initialization parameter 182  
 SECPRFX, system initialization parameter 183  
 security  
 DFLTUSER, system initialization parameter 153  
 ESMEXITS, system initialization parameter 158  
 for transactions 208  
 MRO bind-time security 182  
 of attached entries 208  
 PLTPISEC, system initialization parameter 175  
 PLTPIUSR, system initialization parameter 175  
 resource class names 201  
 RESSEC, system initialization parameter 180  
 SEC, system initialization parameter 182  
 SECPRFX, system initialization parameter 183  
 security checking for EXEC CICS system  
 commands 201  
 security checking for program entries 205  
 security checking for temporary storage entries 209  
 security checking of destination control entries 202  
 security checking of EXEC-started transaction  
 entries 204  
 security checking of file control entries 202  
 security checking of journal entries 203  
 security checking of PSB entries 205  
 specifying a prefix to resource name 183  
 specifying security checking of DCT entries 202  
 using an ESM to establish APPC sessions 182  
 XAPPC, system initialization parameter 201  
 XCMD, system initialization parameter 201  
 XDCT, system initialization parameter 202  
 XFCT, system initialization parameter 202  
 XJCT, system initialization parameter 203  
 XPCT, system initialization parameter 204  
 XPPT, system initialization parameter 205  
 XPSB, system initialization parameter 205  
 XTRAN, system initialization parameter 208  
 XTST, system initialization parameter 209  
 XUSER, system initialization parameter 209  
 SERVADDRNU option  
 EXTRACT TCPIP command 57  
 SERVERADDR option  
 EXTRACT TCPIP command 57  
 SERVERNAME option  
 EXTRACT TCPIP command 57  
 SET option  
 READQ TS command 29  
 WEB RECEIVE command 48  
 single keystroke retrieval (SKR) 184  
 SIT, system initialization parameter 183  
 SKR (single keystroke retrieval) 184  
 SKRxxxx, system initialization parameter 184  
 SNAMELENGTH option  
 EXTRACT TCPIP command 57  
 SNSCOPE, system initialization parameter 184  
 SPCTR, system initialization parameter 185

SPCTRxx, system initialization parameter 185  
 SPOOL, system initialization parameter 186  
 SRT, system initialization parameter 187  
 SRT (system recovery table)  
     SRT, system initialization parameter 187  
 STANDARD option of system initialization parameter  
     BMS 142  
 STANDBY start option 188  
 standby start-up for XRF 188  
 START, system initialization parameter 187  
     (option,ALL) 188  
     START=AUTO 134  
     START=COLD 135  
     START=LOGTERM 136, 188  
     START=STANDBY 135  
 START command 22  
 STARTCODE  
     CEMT INQUIRE TASK 99  
 STARTER, system initialization parameter 189  
 starting CICS  
     ACB at CICS startup 137  
     defining your SIT to CICS at startup 123  
 starting CICS regions  
     specifying the type of startup 133  
     START=AUTO 134, 135  
     START=STANDBY, for an XRF alternate CICS 135  
 statistics  
     effect of START= parameter 137  
     STATRCD, system initialization parameter 189  
 STATRCD, system initialization parameter 189  
 STATUS  
     CEMT INQUIRE TRANSACTION 105  
 STATUSCODE option  
     WEB SEND command 50  
 STATUSTEXT option  
     WEB SEND command 50  
 STGPROT, system initialization parameter 190  
 STGRCVY, system initialization parameter 190  
 STNTR, system initialization parameter 190  
 STNTRxx, system initialization parameter 191  
 storage  
     CHKSTRM system initialization parameter 144  
     CHKSTSK system initialization parameter 144  
     DSALIM, system initialization parameter 154  
     EDSALIM, system initialization parameter 157  
     for the trace table above the 16MB line 196  
     RENTPGM, system initialization parameter 180  
     STGPROT, system initialization parameter 190  
     STGRCVY, system initialization parameter 190  
 storage protection system initialization parameter,  
     STGPROT 190  
 storage trace  
     auxiliary 142  
     main 166  
     trace option in transaction dump 197  
     trace table size in main storage 196  
     trace table size in transaction dump 197  
 strings and buffers, VSAM 195, 197  
 SUFFIX, system initialization parameter 191  
 SUSPENDED  
     CEMT INQUIRE TASK 99  
 SVA (shared virtual area)  
     PRVMOD, system initialization parameter 178  
     SVA system initialization parameter 192  
 SVA, system initialization parameter 192  
 SYDUMAX, system initialization parameter 192  
 SYMBOL option  
     DOCUMENT INSERT command 13  
     DOCUMENT SET command 18  
 SYMBOLERR condition  
     DOCUMENT SET command 19  
 SYMBOLLIST option  
     DOCUMENT CREATE command 10  
     DOCUMENT SET command 18  
 SYSID option  
     DELETEQ TS command 26, 33  
     READQ TS command 29  
 SYSIDERR condition  
     DELETEQ TS command 27  
     READQ TS command 30  
     WRITEQ TS command 34  
 SYSIDNT, system initialization parameter 192  
 SYSIN (SI), PARM keyword 125  
 system identifier, system initialization parameter  
     SYSIDNT 192  
 system initialization  
     for an alternate CICS (XRF=YES)  
         START=STANDBY 135  
     how CICS determines the type of startup 133  
     START=AUTO 134, 135  
 system initialization parameters  
     ADI, alternate delay interval (XRF) 139  
     AIEXIT 139  
     AILDELAY 139  
     AIQMAX 140  
     AIRDELAY 140  
     AKPFREQ 140  
     APPLID 141  
     AUTCONN 141  
     AUXTR 142  
     AUXTRSW 142  
     BMS 142  
     CDSASZE 144  
     CHKSTRM 144  
     CHKSTSK 144  
     CLSDSTP 145  
     CLT 145  
     CMDPROT 145  
     CMDSEC 146  
     CONFDATA 146  
     CONFTXT 148  
     CSDACC 148  
     CSDBUFND 149  
     CSDBUFNI 149  
     CSDFRLOG 149  
     CSDJID 150  
     CSDLSRNO 150  
     CSDRECOV 150  
     CSDSTRNO 151  
     DATFORM 151  
     DBP 152  
     DBUFSZ 152

system initialization parameters *(continued)*

DCT 153  
 DFLTUSER 153  
 DIP 153  
 DISMACP 153  
 DLI (DL1) 153  
 DLIOER 154  
 DOCCODEPAGE 154  
 DSALIM 154  
 DSHIPIDL 155  
 DSHIPINT 155  
 DTRPGM 156  
 DTRTRAN 155  
 DUMP 156  
 DUMPDS 156  
 DUMPSW 156  
 ECDSASZE 157  
 EDSALIM 157  
 entering data at the console 128  
 EODI 158  
 ERDSASZE 158  
 ESDSASZE 158  
 ESMEXITS 158  
 EUDSASZE 159  
 FCT 159  
 FEPI 159  
 FLDSEP 160  
 FLDSTRT 160  
 from operator's console 129  
 FSSTAFF 161  
 GMTEXT 162  
 GMTRAN 162  
 GNTRAN 163  
 GRPLIST 163  
 how to specify 113  
 ICP 165  
 ICV 165  
 ICVR 165  
 ICVTSD 166  
 INITPARM 166  
 INTTR 166  
 IRCSTRT 166  
 ISC 167  
 JCT 167  
 JSTATUS 167  
 LEVSE 167  
 LGNMSG 167  
 MCT 167  
 migration considerations 114  
 MN 168  
 MNCONV 168  
 MNEXC 169  
 MNFREQ 169  
 MNPER 169  
 MNSYNC 169  
 MNTIME 169  
 MROBTCH 170  
 MROFSE 170  
 MROLRM 170  
 MSGCASE 171  
 MSGLVL 171

system initialization parameters *(continued)*

MXT 171  
 NATLANG 171  
 NEWSIT 172  
 OPERTIM 172  
 PARMERR 173  
 PDI 173  
 PGAICTLG 173  
 PGAEXIT 173  
 PGAIPGM 174  
 PGCHAIN 174  
 PGCOPY 174  
 PGPURGE 174  
 PGRET 174  
 PLTPI 175  
 PLTPISEC 175  
 PLTPIUSR 175  
 PLTSD 176  
 PRGDLAY 176  
 PRINT 176  
 PRTYAGE 178  
 PRVMOD 178  
 PSDINT 178  
 PVDELAY 179  
 RAMAX 179  
 RAPOOL 179  
 RDSASZE 180  
 RENTPGM 180  
 RESP 180  
 RESSEC 180  
 RMTRAN 181  
 RUWAPOL 181  
 SDSASZE 181  
 SEC 182  
 SECPRFX 183  
 SIT 183  
 SKRxxxx 184  
 SNSCOPE 184  
 SPCTR 185  
 SPCTRxx 185  
 SPOOL 186  
 SRT 187  
 START 187  
 STARTER 189  
 STATRCD 189  
 STGPROT 190  
 STGRCVY 190  
 STNTR 190  
 STNTRxx 191  
 SUFFIX 191  
 SVA 192  
 SYDUMAX 192  
 SYSIDNT 192  
 SYSTR 192  
 TAKEOVR 193  
 TBEXITS 193  
 TCP 194  
 TCPIP 194  
 TCSACTN 194  
 TCSWAIT 194  
 TCT 195

system initialization parameters *(continued)*

TCTUAKEY 195  
 TCTUALOC 195  
 TD 195  
 TRAP 196  
 TRDUMAX 196  
 TRTABSZ 196  
 TRTRANSZ 197  
 TRTRANTY 197  
 TS 197  
 TSMGSET 198  
 TST 198  
 TYPE 139  
 UDSASZE 198  
 USERTR 198  
 USRDELAY 198  
 VTAM 199  
 VTPREFIX 199  
 WEBDELAY 200  
 WRKAREA 200  
 XAPPC 201  
 XCMD 201  
 XDCT 202  
 XFCT 202  
 XJCT 203  
 XLT 204  
 XPCT 204  
 XPPT 205  
 XPSB 205  
 XRF 206  
 XRFSOFF 206  
 XRFSTME 207  
 XRFTODI 208  
 XSWITCH 208  
 XTRAN 208  
 XTST 209  
 XUSER 209

system initialization programs

INITPARM, system initialization parameter 166  
 PLTP, system initialization parameter 175  
 PLTPISEC, system initialization parameter 175  
 PLTPIUSR, system initialization parameter 175

system initialization table (SIT)

.END, PARM keyword 125  
 assembling the SIT 122  
 coding the PARM parameter over two lines 127  
 CONSOLE (CN), PARM keyword 125  
 creating a SIT 121  
 creating more than one SIT 122  
 defining your SIT to CICS at startup 123  
 DFHSIT TYPE=CSECT 139  
 parameters that cannot be coded in DFHSIT 123  
 PARM parameter, processing 127  
 SIT, system initialization parameter 183  
 SITs supplied with VSE/ESA 122  
 supplied SITs 122  
 SYSIN (SI), PARM keyword 125  
 SYSIPT data set, processing 127

system spooling interface 186

SYSTR, system initialization parameter 192

## T

takeover action for XRF 193  
 TAKEOVR, system initialization parameter 193  
 TASK  
   CEMT INQUIRE TASK 98, 99  
 TASK command  
   CEMT INQUIRE transaction 96  
 TASKDATAKEY  
   CEMT INQUIRE TRANSACTION 105  
 TASKDATALOC  
   CEMT INQUIRE TRANSACTION 106  
 tasks  
   CEMT INQUIRE requests 96  
 TBEXITS, system initialization parameter 193  
 TCLASS  
   CEMT INQUIRE TASK 97  
   CEMT INQUIRE TRANSACTION 106  
 TCP, system initialization parameter 194  
 TCP/IP services, CEMT requests 100, 101  
 TCPIP  
   CEMT INQUIRE transaction 100  
 TCPIP, system initialization parameter 194  
 TCPIPSERVICE  
   CEMT INQUIRE transaction 101  
 TCPIPSERVICE attribute  
   TCPIPSERVICE definition 84  
 TCPIPSERVICE definition  
   BACKLOG attribute 83  
   GROUP attribute 83  
   IPADDRESS attribute 83  
   KEYFILE attribute 84  
   PORTNUMBER attribute 84  
   RDO command 83  
   SOCKETCLOSE attribute 84  
   STATUS attribute 84  
   TCPIPSERVICE attribute 84  
   TCPIPSERVICE definition 83, 84  
   TRANSACTION attribute 84  
   TSQPREFIX attribute 85  
   URM attribute 85  
   USER REPLACEABLE MODULE attribute 85  
 TCPIPSERVICE option  
   EXTRACT TCPIP command 57  
 TCSACTN, system initialization parameter 194  
 TCSWAIT, system initialization parameter 194  
 TCT (terminal control table)  
   TCT, system initialization parameter 195  
 TCTUAKEY, system initialization parameter 195  
 TCTUALOC, system initialization parameter 195  
 TD, system initialization parameter 195  
 TDQUEUE attribute  
   DOCTEMPLATE definition 74  
 TEMPLATE option  
   DOCUMENT INSERT command 13  
 TEMPLATENAME  
   CEMT INQUIRE DOCTEMPLATE 95  
 TEMPLATENAME attribute  
   DOCTEMPLATE definition 74  
 TEMPLATETYPE  
   CEMT INQUIRE DOCTEMPLATE 95



- temporary storage
  - message set, TSMGSET 198
  - TS, system initialization parameter 197
  - TSMGSET, system initialization parameter 198
  - VSAM buffers and strings 197
- temporary storage browse transaction, CEBR 89
- TERM
  - CEMT INQUIRE TASK 98
- terminal control table (TCT)
  - dummy control table, DFHTCTDY 132
  - user area storage key
    - system initialization parameter 195
- terminal scan delay, ICVTSD 166
- terminals
  - CLSDSTP system initialization parameter 145
- TEXT option
  - DOCUMENT INSERT command 13
- time interval, region exit 165
- timeout limit, userid 198
- TO
  - CEMT INQUIRE TASK 99
- TO option
  - DOCUMENT INSERT command 13
- TP
  - CEMT INQUIRE TASK 99
- trace entries, interpretation
  - AP 21xx, bridge facility management 224
  - AP 28xx, bridge facility management 2 227
  - AP F9xx, document handler 213
  - SO xxxx, Socket domain 213
- trace entries, Web domain
  - WB xxxx, Web domain 223
- tracing facilities
  - auxiliary storage trace 142
  - auxiliary trace autoswitch facility 142
  - AUXTR, system initialization parameter 142
  - AUXTRSW, system initialization parameter 142
  - CICS standard tracing, setting levels of 190, 191
  - INTTR, system initialization parameter 166
  - option in transaction dump 197
  - SM component, warning when setting trace level 191
  - SPCTR, system initialization parameter 185
  - SPCTRxx, system initialization parameter 185
  - special tracing, setting levels of 185
  - STNTR, system initialization parameter 190
  - STNTRxx, system initialization parameter 191
  - SYSTR, system initialization parameter 192
  - table size in main storage 196
  - table size in transaction dump 197
  - TRTABSZ, system initialization parameter 196
  - TRTRANSZ, system initialization parameter 197
  - TRTRANTY, system initialization parameter 197
  - USERTR, system initialization parameter 198
- TRANID
  - CEDX 92
  - CEMT INQUIRE TASK 99
- TRANSACTION
  - CEMT INQUIRE transaction 103
  - CEMT INQUIRE TRANSACTION 106
- transaction backout exit programs 193
- transactions
  - CEDF 91
- TRANSID option
  - START BREXIT command 23
- TRANSIDERR condition
  - START BREXIT command 23
- transient data
  - TD, system initialization parameter 195
  - VSAM buffers and strings 195
- TRAP, system initialization parameter 196
- TRDUMAX, system initialization parameter 196
- TRPROF
  - CEMT INQUIRE TRANSACTION 106
- TRTABSZ, system initialization parameter 196
- TRTRANSZ, system initialization parameter 197
- TRTRANTY, system initialization parameter 197
- TS, system initialization parameter 197
- TSMGSET, system initialization parameter 198
- TSQPREFIX attribute
  - TCPIP SERVICE definition 85
- TSQUEUE
  - CEMT INQUIRE transaction 107
  - CEMT INQUIRE TSQUEUE 109
- TSQUEUE attribute
  - DOCTEMPLATE definition 74
- TST, system initialization parameter 198
- TST (temporary storage table)
  - specifying security checking of temporary storage entries 209
  - TST, system initialization parameter 198
- TYPE, system initialization parameter 139
- TYPE attribute
  - CEMT INQUIRE DOCTEMPLATE 95
  - DOCTEMPLATE definition 74
- TYPE=CSECT, DFHSIT 139
- TYPE=DSECT, DFHSIT 139
- TYPE option
  - WEB RECEIVE command 48

## U

- U
  - CEMT INQUIRE TASK 99
- UCTRAN attribute
  - PROFILE definition 80
- UDATAKEY
  - CEMT INQUIRE TRANSACTION 106
- UDSASZE, system initialization parameter 198
- URM attribute
  - TCPIP SERVICE definition 85
- USER REPLACEABLE MODULE attribute
  - TCPIP SERVICE definition 85
- USERID
  - CEMT INQUIRE TASK 99
- USERID option
  - START BREXIT command 23
- userid timeout limit 198
- USERIDERR condition
  - START BREXIT command 23
- USERTR, system initialization parameter 198
- USRDELAY, system initialization parameter 198

## V

### value

- CEMT INQUIRE TASK 96
- CEMT INQUIRE TRANSACTION 103
- CEMT INQUIRE TSQUEUE 107

### VALUE option

- DOCUMENT SET command 18
- WEB READ FORMFIELD command 40
- WEB READ HTTPHEADER command 42
- WEB READNEXT FORMFIELD command 43
- WEB READNEXT HTTPHEADER command 45
- WEB WRITE command 54

### VALUELENGTH option

- WEB READ FORMFIELD command 40
- WEB READ HTTPHEADER command 42
- WEB READNEXT FORMFIELD command 43
- WEB READNEXT HTTPHEADER command 45
- WEB WRITE command 54

### VSAM (virtual storage access method)

- buffers and strings 197
- TS, system initialization parameter 197

### VSAM buffers and strings 195

### VTAM, system initialization parameter 199

### VTAM (virtual telecommunications access method)

- ACB at CICS startup 137
- CONFTXT, system initialization parameter 148
- LGNMSG, system initialization parameter 167
- logon data 167
- PSDINT, system initialization parameter 178
- VBUILD TYPE=APPL statement 141
- VTAM, system initialization parameter 199

### VTPREFIX, system initialization parameter 199

## W

### warm start 187

- WEB ENDBROWSE FORMFIELD command 36
- WEB ENDBROWSE HTTPHEADER command 37
- WEB EXTRACT command 38
- WEB READ FORMFIELD command 40
- WEB READ HTTPHEADER command 42
- WEB READNEXT FORMFIELD command 43
- WEB READNEXT HTTPHEADER command 45
- WEB RECEIVE command 47
- WEB RETRIEVE command 49
- WEB SEND command 50
- WEB STARTBROWSE FORMFIELD command 52
- WEB STARTBROWSE HTTPHEADER command 53
- WEB WRITE command 54
- WEBDELAY, system initialization parameter 200
- welcome (good morning) message 162
- write-to-operator timeout limit 172
- WRITEQ TS command 31
- writing data
  - to temporary storage queue 31
- WRKAREA, system initialization parameter 200

## X

### XAPPC, system initialization parameter 201

### XCMD, system initialization parameter 201

### XDBDERR, global user exit 154

### XDCT, system initialization parameter 202

### XFCT, system initialization parameter 202

### XJCT, system initialization parameter 203

### XLT, system initialization parameter 204

### XPCC, cross-partition communication component 187

### XPCT, system initialization parameter 204

### XPPT, system initialization parameter 205

### XPSB, system initialization parameter 205

### XRF (extended recovery facility)

#### ADI, system initialization parameter 139

#### AIRDELAY parameter (active and alternate CICS) 140

#### APPLID system initialization parameter (active and alternate) 141

#### AUTCONN, system initialization parameter (alternate) 141

#### CLT system initialization parameter (alternate) 145 command list table (CLT) 145

#### DUMP system initialization parameter (active and alternate) 156

#### generic and specific applids 141

#### GOOD MORNING transaction 181

#### PDI, system initialization parameter 173

#### PDI system initialization parameter 173, 181

#### primary delay interval (PDI) 173

#### reconnection delay 141

#### reconnection transaction 181

#### RMTRAN, system initialization parameter 181

#### START=STANDBY (alternate) 188

#### TAKEOVR system initialization parameter (alternate) 193

#### VTAM ACB at startup 137

#### XRF system initialization parameter (active and alternate) 206

#### XRFTODI, system initialization parameter 208

#### XSWITCH, system initialization parameter 208

### XRF, system initialization parameter 206

### XRFSOFF, system initialization parameter 206

### XRFSTME, system initialization parameter 207

### XRFTODI, system initialization parameter 208

### XSWITCH, system initialization parameter 208

### XTRAN, system initialization parameter 208

### XTST, system initialization parameter 209

### XUSER, system initialization parameter 209





---

## Sending your comments to IBM

If you especially like or dislike anything about this book, please use one of the methods listed below to send your comments to IBM.

Feel free to comment on what you regard as specific errors or omissions, and on the accuracy, organization, subject matter, or completeness of this book.

Please limit your comments to the information in this book and the way in which the information is presented.

To request additional publications, or to ask questions or make comments about the functions of IBM products or systems, you should talk to your IBM representative or to your IBM authorized remarketer.

When you send comments to IBM, you grant IBM a nonexclusive right to use or distribute your comments in any way it believes appropriate, without incurring any obligation to you.

You can send your comments to IBM in any of the following ways:

- By mail, to this address:

Information Development Department (MP095)  
IBM United Kingdom Laboratories  
Hursley Park  
WINCHESTER,  
Hampshire  
United Kingdom

- By fax:
  - From outside the U.K., after your international access code use 44-1962-870229
  - From within the U.K., use 01962-870229
- Electronically, use the appropriate network ID:
  - IBM Mail Exchange: GBIBM2Q9 at IBMMAIL
  - IBMLink™ : HURSLEY(IDRCF)
  - Internet: idrcf@hursley.ibm.com

Whichever you use, ensure that you include:

- The publication number and title
- The topic to which your comment applies
- Your name and address/telephone number/fax number/network ID.



Program Number: 5648-054



Printed in the United States of America  
on recycled paper containing 10%  
recovered post-consumer fiber.

GC34-5763-00



Spine information:



CICS TS for VSE/ESA

Enhancements Guide

Release 1