

CICS<sup>®</sup> Transaction Server for OS/390<sup>®</sup>



# CICSplex<sup>®</sup> SM Managing Resource Usage

*Release 3*



CICS<sup>®</sup> Transaction Server for OS/390<sup>®</sup>



# CICSplex<sup>®</sup> SM Managing Resource Usage

*Release 3*

**Note!**

Before using this information and the product it supports, be sure to read the general information under "Notices" on page vii.

**Second Edition, March 1999**

This edition applies to Release 3 of CICS Transaction Server for OS/390, program number 5655-147, and to all subsequent versions, releases, and modifications until otherwise indicated in new editions. Information in this edition was previously contained in SC33-1808-00, which is now obsolete. Make sure you are using the correct edition for the level of the product. The technical changes for this edition are summarized under "Summary of changes," and are indicated by a vertical bar to the left of a change.

Order publications through your IBM representative or the IBM branch office serving your locality. Publications are not stocked at the address given below.

At the back of this publication is a page titled "Sending your comments to IBM". If you want to make comments, but the methods described are not available to you, please address your comments to:

IBM United Kingdom Laboratories, Information Development,  
Mail Point 095, Hursley Park, Winchester, Hampshire, England, SO21 2JN.

When you send information to IBM, you grant IBM a nonexclusive right to use or distribute the information in any way it believes appropriate without incurring any obligation to you.

© Copyright International Business Machines Corporation 1994, 1999. All rights reserved.

US Government Users Restricted Rights – Use, duplication or disclosure restricted by GSA ADP Schedule Contract with IBM Corp.

---

# Contents

## Notices . . . . . vii

Programming interface information . . . . . viii

Trademarks . . . . . viii

## Preface . . . . . ix

Who this book is for . . . . . ix

What you need to know . . . . . ix

Notes on terminology . . . . . ix

Syntax notation and conventions used in this book . . . . . x

CICS system connectivity . . . . . x

## Bibliography . . . . . xiii

CICS Transaction Server for OS/390 . . . . . xiii

    CICS books for CICS Transaction Server for

    OS/390 . . . . . xiii

    CICSplex SM books for CICS Transaction Server

    for OS/390 . . . . . xiv

    Other CICS books . . . . . xiv

Books from related libraries. . . . . xiv

## Summary of changes . . . . . xv

Changes to this book for CICSplex SM for CICS

Transaction Server for OS/390 Release 3. . . . . xv

---

## Part 1. Introduction . . . . . 1

### Chapter 1. Using real-time analysis and resource monitoring views . . . . . 3

Views for creating definitions. . . . . 3

Views for managing definitions . . . . . 6

---

## Part 2. Real-time analysis . . . . . 9

### Chapter 2. Preparing to perform real-time analysis . . . . . 11

Defining real-time analysis attributes . . . . . 11

System availability monitoring . . . . . 12

    Default notification values . . . . . 12

    Activating system availability monitoring . . . . . 15

MAS resource monitoring . . . . . 16

Analysis point monitoring . . . . . 17

Setting intervals and controlling oscillations . . . . . 18

Identifying primary CMASs . . . . . 19

Modifying resources with real-time analysis . . . . . 20

Real-time analysis definitions and their related views . . . . . 20

### Chapter 3. Real-time analysis views . . . . . 25

ACTNDEF (Action definitions) . . . . . 26

    Action commands . . . . . 26

    Hyperlink fields . . . . . 27

    Creating an action definition. . . . . 27

APCMAS (Analysis point specification and CMAS associations) . . . . . 29

    Action commands . . . . . 30

    Hyperlink fields . . . . . 30

APSPEC (Analysis point specifications) . . . . . 30

    Action commands . . . . . 31

    Hyperlink fields . . . . . 32

    Creating an analysis point specification . . . . . 32

    Associating an analysis point specification with a CMAS . . . . . 32

EVALDEF (Evaluation definitions) . . . . . 33

    Action commands . . . . . 34

    Hyperlink fields . . . . . 35

    Creating an evaluation definition . . . . . 35

RTADEF (Analysis definitions) . . . . . 43

    Action commands . . . . . 43

    Hyperlink fields . . . . . 44

    Creating an analysis definition . . . . . 44

    Adding an association to an analysis group. . . . . 46

    Installing an analysis definition. . . . . 47

    Installing an analysis definition into an analysis point specification . . . . . 48

RTAGROUP (Analysis groups) . . . . . 49

    Action commands and overtyping fields . . . . . 49

    Hyperlink fields . . . . . 50

    Creating an analysis group . . . . . 51

    Adding an association to an analysis point specification . . . . . 51

    Adding an association to an analysis specification 52

    Associating a definition with an analysis group 52

    Installing an analysis group . . . . . 53

    Installing an analysis group into an analysis point specification . . . . . 54

RTAINAPS (Analysis groups in analysis point specifications) . . . . . 55

    Action commands . . . . . 56

    Hyperlink fields . . . . . 56

    Adding an analysis group to an analysis point specification . . . . . 56

RTAINGRP (Analysis and status definitions in analysis groups) . . . . . 57

    Action commands . . . . . 58

    Hyperlink fields . . . . . 59

    Adding a definition to an analysis group . . . . . 59

RTAINSPC (Analysis groups in analysis specifications) . . . . . 60

    Action commands . . . . . 60

    Hyperlink fields . . . . . 61

    Adding an analysis group to an analysis specification . . . . . 61

RTASCOPE (Analysis specifications assigned a scope) . . . . . 62

    Action commands and overtyping fields . . . . . 62

    Hyperlink fields . . . . . 63

    Updating scope-to-analysis specification associations . . . . . 63

Removing scope-to-analysis specification associations . . . . .	65
RTASPEC (Analysis specifications). . . . .	65
Action commands . . . . .	66
Hyperlink fields . . . . .	67
Creating an analysis specification . . . . .	67
Adding a scope to an analysis specification. . . . .	68
STATDEF (Status definitions) . . . . .	70
Action commands . . . . .	70
Hyperlink fields . . . . .	71
Creating a status definition . . . . .	71
Adding a status definition to an analysis group . . . . .	72
Installing a status definition . . . . .	73

## Chapter 4. Analysis definitions . . . . . 75

APACTV . . . . .	75
EVENT . . . . .	78
EVENTD . . . . .	79
EVENTDTD . . . . .	80
EVENTDTL . . . . .	80
RTAACTV . . . . .	81

## Chapter 5. Example tasks: real-time analysis . . . . . 85

Switching system availability monitoring (SAM) on for a MAS . . . . .	85
Changing the default actions for system availability monitoring (SAM) . . . . .	87
Monitoring resources temporarily . . . . .	89
Monitoring resources permanently. . . . .	93
Reusing analysis specifications and analysis groups . . . . .	95
Monitoring a resource type in a single CICS system . . . . .	98
Monitoring a resource type throughout the CICSplex . . . . .	101
Monitoring multiple resource types in a CICS system group (1) . . . . .	104
Monitoring multiple resource types in a CICS system group (2) . . . . .	107
Updating analysis and evaluation definitions . . . . .	112
Deactivating an analysis definition . . . . .	112
Using data gathered by the resource monitoring function . . . . .	113
Issuing one notification for multiple conditions (1) . . . . .	116
Issuing one notification for multiple conditions (2) . . . . .	120
Modifying the state of a resource. . . . .	122

## Part 3. Resource monitoring . . . . . 125

### Chapter 6. Preparing to monitor resources . . . . . 127

Defining resource monitoring attributes . . . . .	127
Activating resource monitoring . . . . .	129
Overriding resource monitoring attributes . . . . .	130
Understanding resource monitoring times . . . . .	130
Understanding resource monitoring statistics . . . . .	132
Data retention . . . . .	133
A comparison of CICSplex SM and CICS monitoring . . . . .	133
Using the RODM interface . . . . .	134

Information provided by the RODM interface . . . . .	134
Activating the RODM interface . . . . .	135
Monitoring resources with NGMF . . . . .	135
Monitoring resources with an API program . . . . .	142
Monitoring resources with automation products . . . . .	142
Resource monitoring definitions and their related views . . . . .	142

## Chapter 7. Resource monitoring views 145

MONDEF (Monitor definitions) . . . . .	145
Action commands and overtype fields . . . . .	146
Hyperlink fields . . . . .	147
Creating a monitor definition . . . . .	147
Adding an association to a monitor group. . . . .	150
Installing a monitor definition. . . . .	150
MONGROUP (Monitor groups) . . . . .	152
Action commands and overtype fields . . . . .	152
Hyperlink fields . . . . .	153
Creating a monitor group . . . . .	154
Adding an association to a monitor specification . . . . .	154
Associating a monitor definition with a monitor group . . . . .	155
Installing a monitor group . . . . .	155
MONINGRP (Monitor definitions in monitor groups) . . . . .	156
Action commands and overtype field . . . . .	157
Hyperlink fields . . . . .	158
Adding a monitor definition to a monitor group . . . . .	158
MONINSPC (Monitor groups in monitor specifications) . . . . .	159
Action commands . . . . .	159
Hyperlink fields . . . . .	160
Adding a monitor group to a monitor specification . . . . .	160
MONSCOPE (Monitor specifications assigned a scope) . . . . .	161
Action commands and overtype fields . . . . .	161
Hyperlink fields . . . . .	162
Updating scope-to-monitor specification associations . . . . .	162
Removing scope-to-monitor specification associations . . . . .	164
MONSPEC (Monitor specifications) . . . . .	164
Action commands . . . . .	165
Hyperlink fields . . . . .	166
Creating a monitor specification . . . . .	166
Adding a scope to a monitor specification. . . . .	168

## Chapter 8. Monitor definitions . . . . . 171

MONACTV . . . . .	171
-------------------	-----

## Chapter 9. Example tasks: resource monitoring . . . . . 175

Monitoring transaction response times . . . . .	175
Monitoring programs in multiple CICS systems . . . . .	179
Finding out which resources are being monitored in a CICS system . . . . .	184
Finding out why a CICSplex SM event occurred . . . . .	184

## Part 4. Appendixes . . . . . 187

<b>Appendix A. Customizing programs that monitor status . . . . .</b>	<b>189</b>	CICSplex . . . . .	204
Creating a status program . . . . .	189	CicsSystem . . . . .	205
390 Assembler . . . . .	189	CicsRegion . . . . .	205
OS/2 C . . . . .	189	Connection . . . . .	206
Explanation . . . . .	190	Dataset . . . . .	208
Installing a status program . . . . .	190	FepiConnection. . . . .	209
390 Assembler . . . . .	190	LocalFile . . . . .	210
OS/2 C . . . . .	191	RemoteFile . . . . .	211
Defining a status definition to CICSplex SM . . . . .	191	DataTable . . . . .	213
<b>Appendix B. Generic alert and resolution structures . . . . .</b>	<b>193</b>	Journal . . . . .	214
The generic alert structure . . . . .	193	Program . . . . .	215
The resolution structure . . . . .	194	Terminal . . . . .	216
<b>Appendix C. Information provided by the RODM interface. . . . .</b>	<b>195</b>	LocalTransaction . . . . .	218
NGMF resources . . . . .	195	RemoteTransaction . . . . .	219
Aggregate resources . . . . .	195	ExtraTdqueue . . . . .	220
Real resources . . . . .	196	IntraTdqueue . . . . .	221
MSMODM object fields and values . . . . .	203	RemoteTdqueue . . . . .	222
NonSNADomain . . . . .	203	GlobalExit . . . . .	224
CPSM . . . . .	203	TaskExit . . . . .	225
CMAS. . . . .	204	<b>Glossary . . . . .</b>	<b>227</b>
		<b>Index . . . . .</b>	<b>239</b>
		<b>Sending your comments to IBM . . . . .</b>	<b>243</b>





---

## Notices

This information was developed for products and services offered in the U.S.A. IBM may not offer the products, services, or features discussed in this document in other countries. Consult your local IBM representative for information on the products and services currently available in your area. Any reference to an IBM product, program, or service is not intended to state or imply that only that IBM product, program, or service may be used. Any functionally equivalent product, program, or service that does not infringe any IBM intellectual property right may be used instead. However, it is the user's responsibility to evaluate and verify the operation of any non-IBM product, program, or service.

IBM may have patents or pending patent applications covering subject matter described in this document. The furnishing of this document does not give you any license to these patents. You can send license inquiries, in writing, to:

IBM Director of Licensing  
IBM Corporation  
North Castle Drive  
Armonk, NY 10504-1785  
U.S.A.

For license inquiries regarding double-byte (DBCS) information, contact the IBM Intellectual Property Department in your country or send inquiries, in writing, to:

IBM World Trade Asia Corporation  
Licensing  
2-31 Roppongi 3-chome, Minato-ku  
Tokyo 106, Japan

**The following paragraph does not apply in the United Kingdom or any other country where such provisions are inconsistent with local law:**

INTERNATIONAL BUSINESS MACHINES CORPORATION PROVIDES THIS PUBLICATION "AS IS" WITHOUT WARRANTY OF ANY KIND, EITHER EXPRESS OR IMPLIED, INCLUDING, BUT NOT LIMITED TO, THE IMPLIED WARRANTIES OF NON-INFRINGEMENT, MERCHANTABILITY, OR FITNESS FOR A PARTICULAR PURPOSE. Some states do not allow disclaimer of express or implied warranties in certain transactions, therefore this statement may not apply to you.

This publication could include technical inaccuracies or typographical errors. Changes are periodically made to the information herein; these changes will be incorporated in new editions of the publication. IBM may make improvements and/or changes in the product(s) and/or the program(s) described in this publication at any time without notice.

Licensees of this program who wish to have information about it for the purpose of enabling: (i) the exchange of information between independently created programs and other programs (including this one) and (ii) the mutual use of the information which has been exchanged, should contact IBM United Kingdom Laboratories, MP151, Hursley Park, Winchester, Hampshire, England, SO21 2JN. Such information may be available, subject to appropriate terms and conditions, including in some cases, payment of a fee.

The licensed program described in this document and all licensed material available for it are provided by IBM under terms of the IBM Customer Agreement, IBM International Programming License Agreement, or any equivalent agreement between us.

---

## Programming interface information

This book is intended to help you administer your IBM CICSplex System Manager (CICSplex SM) system.

This book also documents Product-sensitive Programming Interface and Associated Guidance Information provided by CICSplex SM and CICS/ESA.

Product-sensitive programming interfaces allow the customer installation to perform tasks such as diagnosing, modifying, monitoring, repairing, tailoring, or tuning of CICSplex SM and CICS/ESA. Use of such interfaces creates dependencies on the detailed design or implementation of the IBM software product. Product-sensitive programming interfaces should be used only for these specialized purposes. Because of their dependencies on detailed design and implementation, it is to be expected that programs written to such interfaces may need to be changed in order to run with new product releases or versions, or as a result of service.

Product-sensitive Programming Interface and Associated Guidance Information is identified where it occurs, either by an introductory statement to a chapter or section or by the following marking:

Programming Interface and Associated Guidance Information...

---

## Trademarks

The following terms are trademarks of International Business Machines Corporation in the United States, or other countries, or both:

CICS	MVS/ESA
CICS/ESA	NetView
CICS/MVS	OS/2
CICSplex	OS/390
DB2	RACF
IBM	SP
IBMLink	VSE/ESA
MVS	VTAM

Other company, product, and service names may be trademarks or service marks of others.

---

## Preface

This book provides administration information for CICSplex<sup>®</sup> System Manager for CICS<sup>®</sup> Transaction Server for OS/390<sup>®</sup>. It describes how to establish and maintain the CICSplex SM definitions necessary to perform real-time analysis and resource monitoring.

---

## Who this book is for

This book is for the individual responsible for administering the CICS systems in your enterprise.

---

## What you need to know

It is assumed that you have read:

*CICSplex SM User Interface Guide*

For information about using the ISPF user interface to CICSplex SM.

*CICSplex SM Concepts and Planning*

For an introduction to CICSplex SM and the CICSplex SM Starter Set.

**Note:** Many of the views in this book are based on the Starter Set. For useful examples of the definitions and programs described in this book, explore the Starter Set itself. The Starter Set is described in *CICS Transaction Server for OS/390: Planning for Installation*

---

## Notes on terminology

In the text of this book, the term **CICSplex SM** (spelled with an uppercase letter 'P') means the IBM CICSplex System Manager element of CICS TS for OS/390. The term **CICSplex** (spelled with a lowercase letter 'p') means the largest set of CICS systems to be managed by CICSplex SM as a single entity.

Other terms used in this book are:

### **CICS TS for OS/390**

The CICS element of the CICS Transaction Server for OS/390

### **MVS<sup>™</sup>**

MVS/Enterprise Systems Architecture SP<sup>™</sup> (MVS/ESA<sup>™</sup>)

The phrase *issue the command* is used in this book to mean that a command may be either typed in the COMMAND field of an Information Display panel or invoked by pressing the PF key to which it is assigned. When the location of the cursor affects command processing, this phrase also means that you can do one of the following:

- Type the command in the COMMAND field, place the cursor on the appropriate field, and press Enter.
- Move the cursor to the appropriate field and press the PF key to which the command is assigned.

For an explanation of other CICSplex SM terms used in this book, please refer to the Glossary on page 227.

---

## Syntax notation and conventions used in this book

The syntax descriptions of the CICSplex SM commands use the following symbols:

- Braces { } enclose two or more alternatives from which one must be chosen.
- Square brackets [ ] enclose one or more optional alternatives.
- The OR symbol | separates alternatives.

The following conventions also apply to CICSplex SM syntax descriptions:

- Commands and keyword parameters are shown in uppercase characters. If a command or parameter may be abbreviated, the minimum permitted abbreviation is in uppercase characters; the remainder is shown in lowercase characters and may be omitted.
- Variable parameters are shown in lowercase characters. You must replace them with your own information.
- Parameters that are not enclosed by braces { } or brackets [ ] are required.
- A default parameter value is shown like this: KEYWORD. It is the value that is assumed if you do not select one of the optional values.
- Punctuation symbols, uppercase characters, and special characters must be coded exactly as shown.

**Note:** A semicolon ; is shown as the command delimiter in examples using multiple commands. For information about using and changing the command delimiter, see the *CICSplex SM User Interface Guide*.

- The ellipsis ... means that the immediately preceding parameter can be included one or more times.

---

## CICS system connectivity

This release of CICSplex SM may be used to control CICS systems that are directly connected to it, and indirectly connected through a previous release of CICSplex SM.

For this release of CICSplex SM, the directly-connectable CICS systems are:

- CICS Transaction Server for OS/390 1.3
- CICS Transaction Server for OS/390 1.2
- CICS Transaction Server for OS/390 1.1
- CICS for MVS/ESA 4.1
- CICS Transaction Server for VSE/ESA Release 1
- CICS Transaction Server for OS/2 Warp 4.1
- Transaction Server for OS/2 Warp 4.0

CICS systems that are not directly connectable to this release of CICSplex SM are:

- CICS for MVS/ESA 3.3
- CICS for MVS 2.1.2
- CICS for VSE/ESA 2.3
- CICS for VSE/ESA 2.2
- CICS for OS/2 2.0.1

**Note:** IBM Service no longer supports these CICS release levels.

You can use this release of CICSplex SM to control CICS systems that are connected to, and managed by, your previous release of CICSplex SM. However, if you have any directly-connectable release levels of CICS, as listed above, that are connected to a previous release of CICSplex SM, you are strongly recommended to migrate them to the current release of CICSplex SM, to take full advantage of the

enhanced management services. See the *CICS Transaction Server for OS/390 Migration Guide* for information on how to do this.

Table 1 shows which CICS systems may be directly connected to which releases of CICSplex SM.

*Table 1. Directly-connectable CICS systems by CICSplex SM release*

CICS system	CICSplex SM component of CICS TS 1.3	CICSplex SM 1.3	CICSplex SM 1.2
CICS TS 1.3	Yes	No	No
CICS TS 1.2	Yes	Yes	No
CICS TS 1.1	Yes	Yes	Yes
CICS for MVS/ESA 4.1	Yes	Yes	Yes
CICS for MVS/ESA 3.3	No	Yes	Yes
CICS for MVS 2.1.2	No	Yes	Yes
CICS TS for VSE/ESA Rel 1	Yes	No	No
# CICS for VSE/ESA 2.3	No	Yes	Yes
CICS for VSE/ESA 2.2	No	Yes	Yes
CICS TS for OS/2 4.1	Yes	No	No
TS for OS/2 4.0	Yes	Yes	Yes
CICS for OS/2 2.0.1	No	Yes	Yes



---

## Bibliography

---

### CICS Transaction Server for OS/390

<i>CICS Transaction Server for OS/390: Planning for Installation</i>	GC33-1789
<i>CICS Transaction Server for OS/390 Release Guide</i>	GC34-5352
<i>CICS Transaction Server for OS/390 Migration Guide</i>	GC34-5353
<i>CICS Transaction Server for OS/390 Installation Guide</i>	GC33-1681
<i>CICS Transaction Server for OS/390 Program Directory</i>	GI10-2506
<i>CICS Transaction Server for OS/390 Licensed Program Specification</i>	GC33-1707

### CICS books for CICS Transaction Server for OS/390

#### General

<i>CICS Master Index</i>	SC33-1704
<i>CICS User's Handbook</i>	SX33-6104
<i>CICS Transaction Server for OS/390 Glossary (softcopy only)</i>	GC33-1705

#### Administration

<i>CICS System Definition Guide</i>	SC33-1682
<i>CICS Customization Guide</i>	SC33-1683
<i>CICS Resource Definition Guide</i>	SC33-1684
<i>CICS Operations and Utilities Guide</i>	SC33-1685
<i>CICS Supplied Transactions</i>	SC33-1686

#### Programming

<i>CICS Application Programming Guide</i>	SC33-1687
<i>CICS Application Programming Reference</i>	SC33-1688
<i>CICS System Programming Reference</i>	SC33-1689
<i>CICS Front End Programming Interface User's Guide</i>	SC33-1692
<i>CICS C++ OO Class Libraries</i>	SC34-5455
<i>CICS Distributed Transaction Programming Guide</i>	SC33-1691
<i>CICS Business Transaction Services</i>	SC34-5268

#### Diagnosis

<i>CICS Problem Determination Guide</i>	GC33-1693
<i>CICS Messages and Codes</i>	GC33-1694
<i>CICS Diagnosis Reference</i>	LY33-6088
<i>CICS Data Areas</i>	LY33-6089
<i>CICS Trace Entries</i>	SC34-5446
<i>CICS Supplementary Data Areas</i>	LY33-6090

#### Communication

<i>CICS Intercommunication Guide</i>	SC33-1695
<i>CICS Family: Interproduct Communication</i>	SC33-0824
<i>CICS Family: Communicating from CICS on System/390</i>	SC33-1697
<i>CICS External Interfaces Guide</i>	SC33-1944
<i>CICS Internet Guide</i>	SC34-5445

#### Special topics

<i>CICS Recovery and Restart Guide</i>	SC33-1698
<i>CICS Performance Guide</i>	SC33-1699
<i>CICS IMS Database Control Guide</i>	SC33-1700
<i>CICS RACF Security Guide</i>	SC33-1701
<i>CICS Shared Data Tables Guide</i>	SC33-1702
<i>CICS Transaction Affinities Utility Guide</i>	SC33-1777

## CICSplex SM books for CICS Transaction Server for OS/390

### General

<i>CICSplex SM Master Index</i>	SC33-1812
<i>CICSplex SM Concepts and Planning</i>	GC33-0786
<i>CICSplex SM User Interface Guide</i>	SC33-0788
<i>CICSplex SM Web User Interface Guide</i>	SC34-5403
<i>CICSplex SM View Commands Reference Summary</i>	SX33-6099

### Administration and Management

<i>CICSplex SM Administration</i>	SC34-5401
<i>CICSplex SM Operations Views Reference</i>	SC33-0789
<i>CICSplex SM Monitor Views Reference</i>	SC34-5402
<i>CICSplex SM Managing Workloads</i>	SC33-1807
<i>CICSplex SM Managing Resource Usage</i>	SC33-1808
<i>CICSplex SM Managing Business Applications</i>	SC33-1809

### Programming

<i>CICSplex SM Application Programming Guide</i>	SC34-5457
<i>CICSplex SM Application Programming Reference</i>	SC34-5458

### Diagnosis

<i>CICSplex SM Resource Tables Reference</i>	SC33-1220
<i>CICSplex SM Messages and Codes</i>	GC33-0790
<i>CICSplex SM Problem Determination</i>	GC33-0791

## Other CICS books

<i>CICS Application Programming Primer (VS COBOL II)</i>	SC33-0674
<i>CICS Application Migration Aid Guide</i>	SC33-0768
<i>CICS Family: API Structure</i>	SC33-1007
<i>CICS Family: Client/Server Programming</i>	SC33-1435
<i>CICS Family: General Information</i>	GC33-0155
<i>CICS 4.1 Sample Applications Guide</i>	SC33-1173
<i>CICS/ESA 3.3 XRF Guide</i>	SC33-0661

If you have any questions about the CICS Transaction Server for OS/390 library, see *CICS Transaction Server for OS/390: Planning for Installation* which discusses both hardcopy and softcopy books and the ways that the books can be ordered.

---

## Books from related libraries

Books in related libraries that are referenced in this book include:

### NetView Version 2.4

*NetView RODM Programming Guide*, SC31-7095  
*NetView MultiSystem Manager MVS/ESA Version 2 Topology Data Model Reference*, SV40-0093  
*NetView Graphic Monitor Facility User's Guide*, SC31-7089

### Systems Network Architecture (SNA)

*SNA LU6.2 Reference: Peer Protocols*, SC31-6808



---

## Summary of changes

This book is based on the CICSplex SM Release 3 edition, SC33-1808-00.

---

### Changes to this book for CICSplex SM for CICS Transaction Server for OS/390 Release 3

The following changes have been made to this book for CICS Transaction Server for OS/390 Release 3.

- The information on using the end user interface has been removed from this book. For details, see the *CICSplex SM User Interface Guide*.
- The information in “Appendix A. Customizing programs that monitor status” on page 189 has been expanded and clarified.



---

## **Part 1. Introduction**

This part provides an introduction to the real-time analysis and resource monitoring administration tasks described in the remainder of the book.



---

## Chapter 1. Using real-time analysis and resource monitoring views

This chapter identifies the administration views that you can use to establish and maintain the real-time analysis, and resource monitoring activity at your enterprise.

This chapter describes:

- “Views for creating definitions”
- “Views for managing definitions” on page 6

---

### Views for creating definitions

Table 2 on page 4 shows the views you can use to create administration definitions. The views are grouped by CICSplex SM function. It also indicates the information you can display and the actions you can perform using these views.

## using real-time analysis and resource monitoring views

Table 2. Views to create and maintain administration definitions

Task	Display	Actions Supported	View	Page
Real-time analysis	Action definitions	<ul style="list-style-type: none"> <li>• Create, browse, update, and remove an action definition.</li> </ul>	ACTNDEF	26
	Analysis definitions	<ul style="list-style-type: none"> <li>• Create, browse, remove, and update an analysis definition.</li> <li>• Add an association between an analysis definition and an analysis group.</li> <li>• Install an analysis definition in an analysis point specification or in a CICS system or CICS system group.</li> </ul>	RTADEF	43
	Analysis groups	<ul style="list-style-type: none"> <li>• Create or remove an analysis group.</li> <li>• Change the description of an analysis group.</li> <li>• Add an association between an analysis group and an analysis specification.</li> <li>• Install an analysis group in an analysis point specification or in a CICS system or CICS system group.</li> </ul>	RTAGROUP	49
	Analysis groups with their analysis and status definitions	<ul style="list-style-type: none"> <li>• Add or remove the association between an analysis or status definition and an analysis group.</li> </ul>	RTAINGRP	57
	Analysis point specifications	<ul style="list-style-type: none"> <li>• Create and remove an analysis point specification.</li> <li>• Change the description of an analysis point specification.</li> <li>• Add an association between an analysis point specification and a CMAS.</li> </ul>	APSPEC	30
	Analysis point specifications with their CMASs	<ul style="list-style-type: none"> <li>• Remove an analysis point specification and CMAS association.</li> </ul>	APCMAS	29
	Analysis point specifications with their analysis groups	<ul style="list-style-type: none"> <li>• Add or remove an association between an analysis group and an analysis point specification.</li> </ul>	RTAINAPS	55
	Analysis specifications	<ul style="list-style-type: none"> <li>• Create, browse, remove, or update an analysis specification.</li> <li>• Add an association between an analysis specification and a CICS system or CICS system group.</li> </ul>	RTASPEC	65

## using real-time analysis and resource monitoring views

*Table 2. Views to create and maintain administration definitions (continued)*

<b>Task</b>	<b>Display</b>	<b>Actions Supported</b>	<b>View</b>	<b>Page</b>
Real-time analysis (continued)	Analysis specifications with their analysis groups	<ul style="list-style-type: none"> <li>• Add or remove an association between an analysis specification and an analysis group.</li> </ul>	RTAINSPC	60
	CICS systems and CICS system groups associated with a specification	<ul style="list-style-type: none"> <li>• Change or remove the association between an analysis specification and a CICS system or CICS system group.</li> </ul>	RTASCOPE	62
	Evaluation definitions	<ul style="list-style-type: none"> <li>• Create, browse, update, and remove an evaluation definition.</li> </ul>	EVALDEF	33
	Status definitions	<ul style="list-style-type: none"> <li>• Create, browse, remove, or update a status definition.</li> <li>• Add an association between a status definition and an analysis group.</li> <li>• Install a status definition in a CICS system or CICS system group.</li> </ul>	STATDEF	70

## using real-time analysis and resource monitoring views

Table 2. Views to create and maintain administration definitions (continued)

Task	Display	Actions Supported	View	Page
Resource monitoring	Monitor definitions	<ul style="list-style-type: none"> <li>• Create, remove, or change a monitor definition.</li> <li>• Add an association between a monitor definition and a monitor group.</li> <li>• Install a monitor definition into a CICS system or CICS system group.</li> </ul>	MONDEF	145
	Monitor groups	<ul style="list-style-type: none"> <li>• Create or remove a monitor group definition.</li> <li>• Change the description of a monitor group.</li> <li>• Add an association between a monitor group and a monitor specification.</li> <li>• Install monitor definitions associated with the monitor group into a CICS system or CICS system group.</li> <li>• Replace all installed monitor definitions with those associated with a monitor group.</li> </ul>	MONGROUP	152
	Monitor groups with their monitor definitions	<ul style="list-style-type: none"> <li>• Add or remove a monitor definition to monitor group association.</li> <li>• Change the time period associated with a monitor definition.</li> </ul>	MONINGRP	156
	Monitor specifications	<ul style="list-style-type: none"> <li>• Create, browse, remove, or update a monitor specification.</li> <li>• Add an association between a monitor specification and a CICS system or CICS system group.</li> </ul>	MONSPEC	164
	Monitor specifications with their monitor groups	<ul style="list-style-type: none"> <li>• Add and remove a monitor group to monitor specification association.</li> </ul>	MONINSPC	159
	CICS systems and CICS system groups associated with a specification	<ul style="list-style-type: none"> <li>• Update and remove the association between a monitor specification and a CICS system or CICS system group.</li> </ul>	MONSCOPE	161

## Views for managing definitions

When a CICS system is active, you can use the views identified in Table 3 on page 7 to display information about and control their use of real-time analysis and resource monitoring.

For a detailed description of these views, see “Chapter 4. Analysis definitions” on page 75.



## using real-time analysis and resource monitoring views

**Note:** When you discard or deactivate an administration definition, it is removed from the active CICS system. It is not removed from the data repository. Thus, the next time the CICS system starts or the appropriate time period is reached, the definition is available for use.

Table 3. Views to manage administration definitions

Task	View (Command syntax and use)
Real-time analysis	<p>APACTV [apspec [rtadef [ACTIVE PENDING]]]</p> <ul style="list-style-type: none"> <li>• Display information about analysis definitions associated with an analysis point specification.</li> <li>• Deactivate or discard installed analysis definitions.</li> <li>• The defaults are:</li> </ul> <p><b>apspec</b> All analysis point specifications.</p> <p><b>rtadef</b> All analysis definitions for the analysis point specification.</p> <p><b>ACTIVE PENDING</b> All analysis definitions.</p>
	<p>EVENT [event [eventsys [severity [eventtype]]]]</p> <ul style="list-style-type: none"> <li>• Display information about outstanding changes in the status of a CICSplex or one of its CICS systems.</li> <li>• The defaults are:</li> </ul> <p><b>event</b> All events.</p> <p><b>eventsys</b> All CICS systems.</p> <p><b>severity</b> All levels.</p> <p><b>eventtype</b> All types.</p>
	<p>RTAACTV [defname [ACTIVE PENDING].]</p> <ul style="list-style-type: none"> <li>• Display information about the analysis and status definitions associated with active CICS systems.</li> <li>• Deactivate or discard an analysis or status definition.</li> <li>• The defaults are:</li> </ul> <p><b>defname</b> All definitions.</p> <p><b>ACTIVE PENDING</b> All analysis and status definitions, regardless of status.</p>
Resource monitoring	<p>MONACTV [mondef [ACTIVE PENDING]]</p> <ul style="list-style-type: none"> <li>• Display information about monitor definitions installed in CICS systems known to the CICSplex identified as the context.</li> <li>• Deactivate or discard an installed monitor definition.</li> <li>• The defaults are:</li> </ul> <p><b>mondef</b> All monitor definitions.</p> <p><b>ACTIVE PENDING</b> All monitor definitions, regardless of status.</p>

**using real-time analysis and resource monitoring views**

---

## **Part 2. Real-time analysis**

This part describes the CICSplex SM real-time analysis facilities and the views you can use to analyze the activity in a CICSplex. It also includes sample tasks to help you establish real-time analysis at your enterprise.



---

## Chapter 2. Preparing to perform real-time analysis

This chapter describes how you can use CICSplex SM to analyze the status of one or more CICS systems and the resource information gathered about those systems. Based on its analysis, you can have CICSplex SM generate external notifications when a condition occurs that you want to know about. In addition, you can have CICSplex SM modify the attributes of a resource when it is not in the desired state.

The real-time analysis (RTA) component of CICSplex SM performs the following types of monitoring and analysis:

### System availability monitoring (SAM)

You can be notified when a CICS system is not active during its expected hours of operation. While a CICS system is active, you can also be notified if any of a variety of predefined conditions occur that could affect the systems performance.

### MAS resource monitoring (MRM)

You can be notified when CICS resources being monitored at the CICS system level meet the criteria that you establish. You can also request to be notified when the status of a user-written program meets your criteria.

### Analysis point monitoring (APM)

You can be notified when CICS resources being monitored at the CICSplex level meet your criteria.

The notification you receive can be in the form of:

- A record in the CICSplex SM EVENT view.
- An external MVS/ESA WTO message.
- An SNA generic alert transmitted to a NetView® system.

**Note:** You can also use the real-time analysis functions to produce data that will help in the selection of a target region during workload management. See the example tasks in *CICSplex SM Managing Workloads* for more information.

---

## Defining real-time analysis attributes

In order for CICSplex SM to analyze information about CICS systems and the CICS resources being used by those systems, you must create analysis specifications, groups, and definitions.

- An *analysis specification* associates groups of analysis definitions with a CICS system or CICS system group. Analysis specifications are used for MAS resource monitoring. They can also be used to alter the default system availability monitoring values.
- An *analysis point specification* identifies one or more CMASs involved in managing a CICSplex that is to be analyzed. Analysis point specifications are used for analysis point monitoring.
- An *analysis group* identifies the analysis definitions and status definitions that are to be associated with an analysis or analysis point specification.
- An *analysis definition* identifies the associated evaluation and action definitions.
  - *Evaluation definitions* identify the resources to be sampled, the criteria to be used in analyzing them, and, optionally, any modifications to be performed.

## defining real-time analysis attributes

- *Action definitions* identify what is to happen if a notifiable condition occurs.
- A *status definition* identifies user-written programs that are to be evaluated at specific intervals.

**Note:** You can create real-time analysis definitions to be installed in multiple CICSplex SM managed CICS systems regardless of the version of the CICS system. CICSplex SM will determine at installation time whether the resources specified in the definitions are supported by the target system. If not, CICSplex SM issues a warning message indicating that the definition cannot be installed because the resource is not supported. This message does not require any corrective action.

---

## System availability monitoring

With system availability monitoring (SAM), you can be notified if a CICS system is not active at any point during its expected hours of operation. You can also be notified if any of the following conditions should start or stop:

- One or more CICS/ESA dynamic storage areas become short on storage (SOS).
- A CICS/ESA system dump (SYSDUMP) is taken. For CICS/ESA 3.3 or later, this condition indicates that an MVS/ESA SVC dump has been requested.
- A CICS/ESA transaction dump (TRANDUMP) is taken.
- The CICS system has reached the maximum number of tasks (MAXTASK) it is allowed at any one time.
- One or more resources have impacted the processing of a CICS/ESA application (STALL).

A STALL condition occurs when resource contention impacts the processing of application tasks. Parameters you specify in the MAS startup JCL determine when a CICSplex SM STALL message is issued. You can set the parameters conservatively, so that you receive notification while the system is still functioning, even though resource contention is having a serious impact.

Resolution of a STALL condition may prevent a more serious situation (such as an SOS or MAXTASK) from occurring. For example, a lack of temporary storage could prevent a task from completing and trigger a STALL condition.

For more information about the STALL parameters and a list of possible stall conditions, see the discussion of CICSplex SM system parameters in the *CICS Transaction Server for OS/390 Installation Guide* book. For more information about CICS/ESA<sup>®</sup> suspend classes, see the *CICS/ESA Problem Determination Guide*.

If the CICS system becomes unavailable, or if one of the above conditions occurs, a severity level is assigned and the appropriate CICSplex SM messages are issued. These messages, which are prefixed with EYUPN, are described in the *CICSplex SM Messages and Codes* book.

## Default notification values

This section describes the default severity levels and actions associated with each condition for which system availability monitoring produces a notification.

### System unavailable

**Event** Yes

**Event Severity**

VHS (very high severe)

**Event View**

n/a

**Priority**  
 255  
**Event Text**  
 Currently unavailable  
**External Message**  
 Yes  
**Enter Text**  
 Currently unavailable  
**Exit Text**  
 Currently Available  
**Alert** No  
**Enter Text**  
 Currently unavailable  
**Exit Text**  
 Currently Available

**Short on storage (SOS)**

**Event** Yes  
**Event Severity**  
 HS (high severe)  
**Event View**  
 CICSDSA  
**Priority**  
 255  
**Event Text**  
 dsname SOS at hh:mm:ss  
**External Message**  
 Yes  
**Enter Text**  
 dsname SOS at hh:mm:ss  
**Exit Text**  
 dsname SOS at hh:mm:ss  
**Alert** No  
**Enter Text**  
 dsname SOS at hh:mm:ss  
**Exit Text**  
 dsname SOS at hh:mm:ss

**System dumps (SYSDUMP)**

**Event** Yes  
**Event Severity**  
 VHS (very high severe)  
**Event View**  
 SYSDUMP  
**Priority**  
 255  
**Event Text**  
 # ID=dumpid tranid userid termid  
**External Message**  
 Yes  
**Enter Text**  
 # ID=dumpid tranid userid termid  
**Exit Text**  
 # ID=dumpid tranid userid termid  
**Alert** No  
**Enter Text**  
 # ID=dumpid tranid userid termid

## system availability monitoring

```

#           Exit Text
              ID=dumpid tranid userid termid

Transaction dumps (TRANDUMP)
  Event Yes
  Event Severity
              HW (high warning)
  Event View
              TRANDUMP
  Priority
              128
  Event Text
#           ID=dumpid tranid userid termid
  External Message
              Yes
  Enter Text
#           ID=dumpid tranid userid termid
  Exit Text
#           ID=dumpid tranid userid termid
  Alert No
  Enter Text
#           ID=dumpid tranid userid termid
  Exit Text
#           ID=dumpid tranid userid termid

Maximum number of tasks (MAXTASK)
  Event Yes
  Event Severity
              HS (high severe)
  Event View
              TASK
  Priority
              255
  Event Text
              MAXTASK at hh:mm:ss
  External Message
              Yes
  Enter Text
              MAXTASK at hh:mm:ss
  Exit Text
              MAXTASK at hh:mm:ss
  Alert No
  Enter Text
              MAXTASK at hh:mm:ss
  Exit Text
              MAXTASK at hh:mm:ss

System busy (STALL)
  Event Yes
  Event Severity
              VHS (very high severe)
  Event View
              TASK
  Priority
              255
  Event Text
#           type STALLED at hh:mm:ss
```



```

External Message
  Yes
Enter Text
#       type STALLED at hh:mm:ss
Exit Text
#       type STALLED at hh:mm:ss
Alert   No
Enter Text
#       type STALLED at hh:mm:ss
Exit Text
#       type STALLED at hh:mm:ss

```

## Activating system availability monitoring

Depending on the level of system availability monitoring you want to activate, you can perform either or both of the following actions:

- To monitor system activity, use the CICSSYS view to permanently change the CICSplex SM definition of the CICS system. You need to identify:
  - The primary CMAS. This is the CMAS that is assigned the task of monitoring the availability of the CICS system. (For additional information, see “Identifying primary CMASs” on page 19.)
  - The time period definition that identifies the hours during which you expect the CICS system to be running.
- To monitor a CICS system for the predefined conditions, use the CICSSYS or MAS view to set the Analysis Active field on the Analysis Attributes panel to either SAM or YES.

If any of the severity levels or actions shown in “Default notification values” on page 12 is not appropriate for your use, you can change it for a specific CICS system using the CICSSYS or MAS view. If you want the new default to apply to multiple CICS systems, you can, instead, modify the analysis specification with which the CICS systems are associated.

As illustrated in the example shown in Figure 1 on page 16, you can implement system availability monitoring by simply modifying the appropriate CICSplex SM definition of a CICS system.

## system availability monitoring

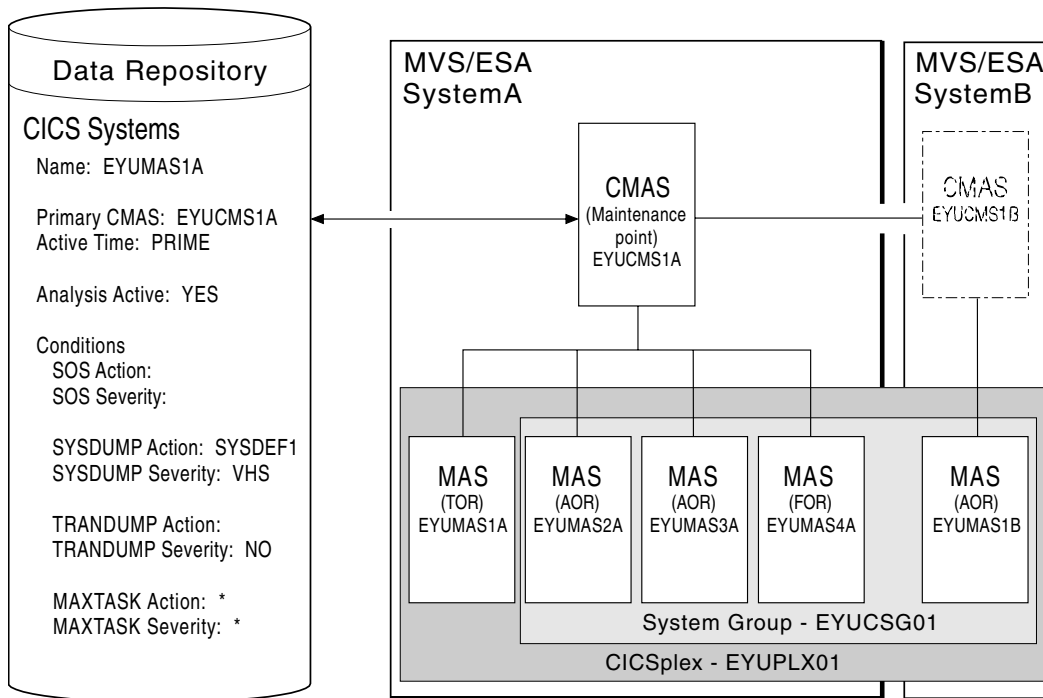

Figure 1. System availability monitoring

In this example, the definition of the CICS system named EYUMAS1A shows that:

- System activity monitoring is to occur because a primary CMAS (EYUCMS1A) and a time period definition (PRIME) are identified.
- Monitoring of predefined conditions is to occur because the Analysis Active field is set to YES.
- If the predefined condition short-on-storage (SOS) occurs, the default action and severity level are to be used.

This example also illustrates how other predefined conditions might be handled:

- For system dumps (SYSDUMP), the severity level is to be set to VHS (very high severe) and an action identified as SYSDEF1 is to be performed.
- For transaction dumps (TRANDUMP), no action is to be taken and no severity level is to be set.

---

## MAS resource monitoring

With MAS resource monitoring (MRM), you can analyze the current status of:

- Resources.

You can use CICSplex SM to sample and evaluate specific resource occurrences against criteria that you define. You can also control the action taken when the criteria is met.

When analyzing a resource occurrence, CICSplex SM resource monitoring does not have to be active. CICSplex SM internally generates any needed monitor definitions based on the sample interval specified in the associated evaluation definitions.

- One or more user-written programs.

You can also use MAS resource monitoring to identify one or more programs in use within your enterprise that are to be called on a regular basis to evaluate specific conditions.

## MAS resource monitoring

These programs must be written to respond to a CICSplex SM status reporting call, where the programs return a value indicating their current status. For more information, see “Appendix A. Customizing programs that monitor status” on page 189.

To use MAS resource monitoring, you need to establish analysis definitions, analysis groups, and analysis specifications.

Figure 2 illustrates the type of definitions you need in order to be notified if a specific condition should occur.

In this illustration, all transactions starting with AB are to be evaluated. If the

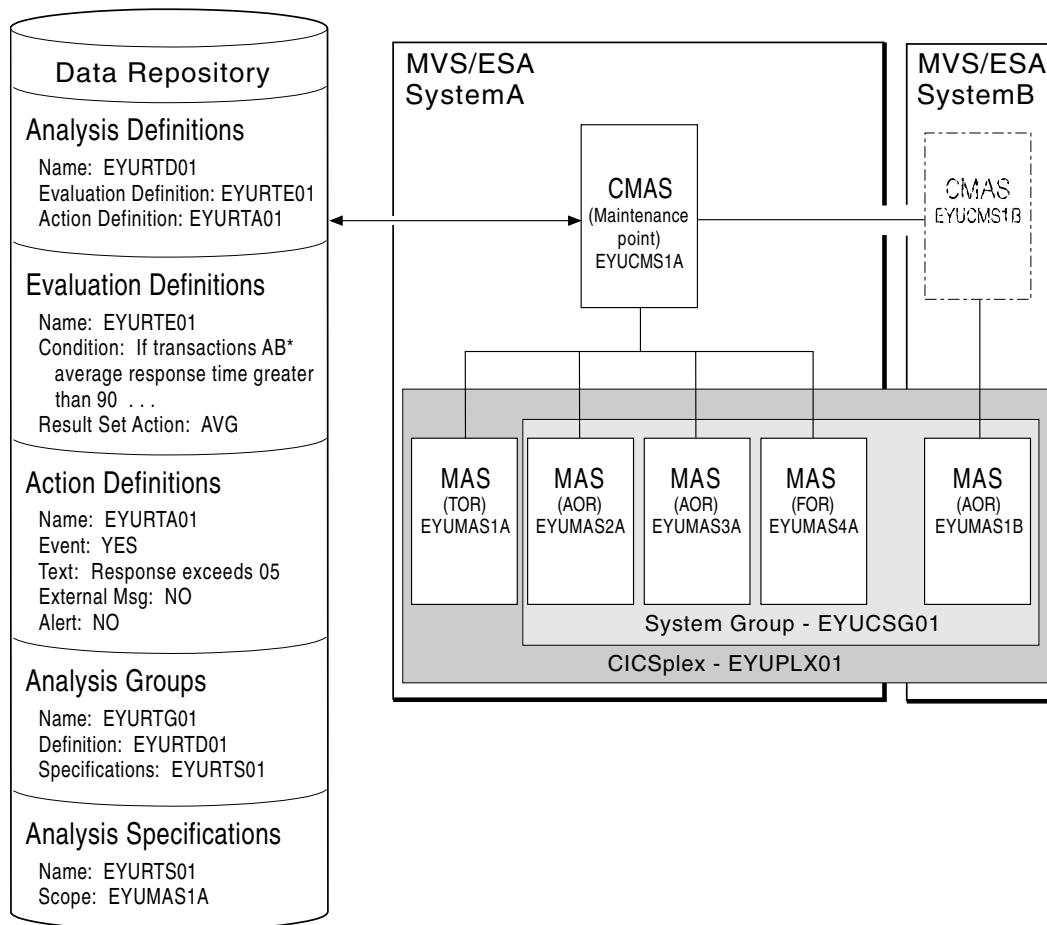

Figure 2. MAS resource monitoring (MRM)

average response time of these transactions should be greater than 90 seconds, a CICSplex SM event is to be generated and a record is added to the EVENT view.

## Analysis point monitoring

When you are using MAS resource monitoring to monitor multiple CICS systems and the same condition occurs in those systems, notification is generated for each system. There may be certain conditions, however, for which you do not want multiple notifications to be generated.

By using analysis point monitoring (APM), you can evaluate the resources being monitored in one or more CICS systems within a CICSplex and be notified when a

## analysis point monitoring

condition meets your specified criteria. Should a condition then occur in multiple systems, a single notification message is generated for the CICSplex.

To use the analysis point monitoring facility, you must define analysis point specifications, analysis groups, and analysis definitions. Note that you can use the same analysis groups and analysis definitions with both analysis point monitoring and MAS resource monitoring.

Although you would probably not use analysis point monitoring and MAS resource monitoring to perform the same type of resource analysis, Figure 3 illustrates that changing the analysis specification to an analysis point specification is all that is required to change the preceding example of MAS resource monitoring to analysis point monitoring.

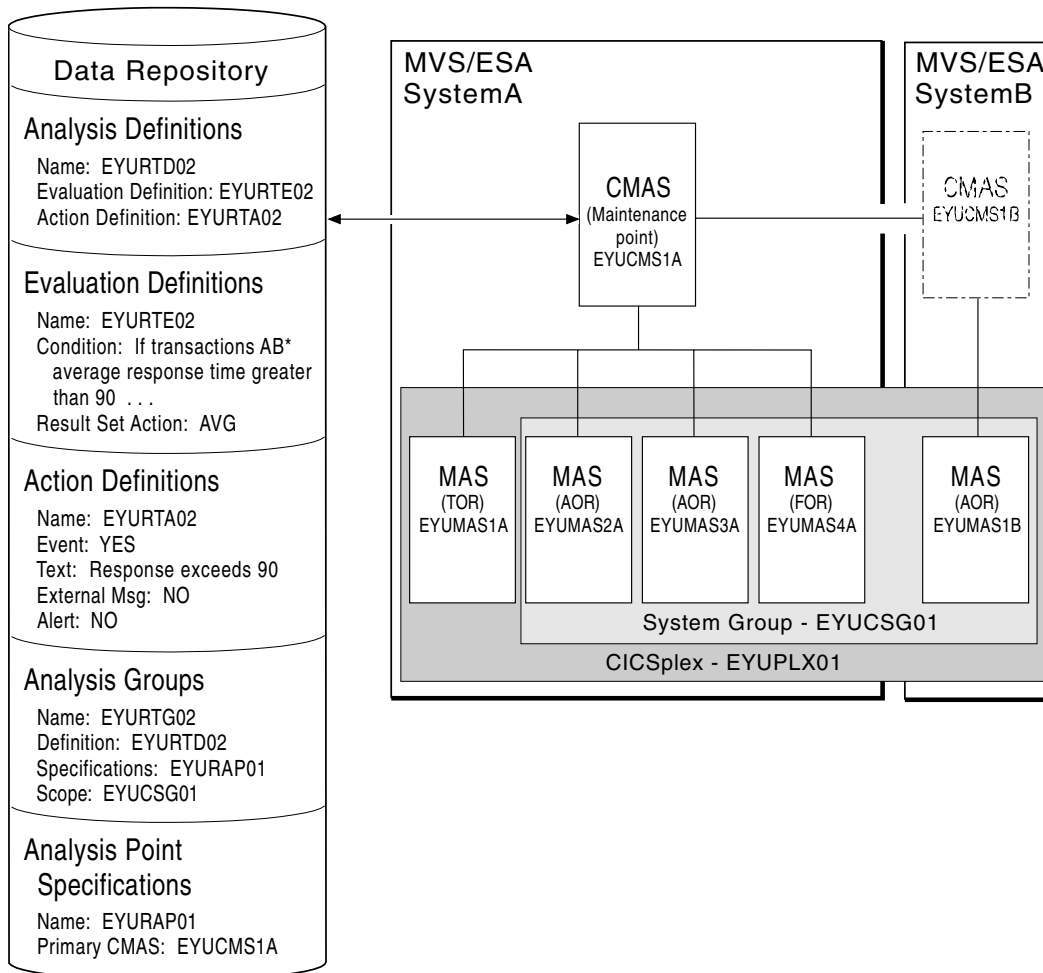

Figure 3. Analysis point monitoring (APM)

## Setting intervals and controlling oscillations

Information about the resources you are analyzing is gathered at specific intervals that are set when you create an evaluation definition.

You can set very short evaluation intervals, frequently updating your picture of the status of a system or program, or longer intervals, smoothing out your picture of the status of the system or program.

## setting intervals and controlling oscillations

Although short intervals might give you a clearer picture of the dynamics of the attributes you are tracking, they consume more processor time than less frequent intervals. Depending on the condition being evaluated, however, you might want to have short intervals to ensure you are notified every time a given condition should occur. For example, you might want to be notified whenever a specific connection is out of service.

In other cases, you may receive an excessive number of notifications about nonrecurring conditions when using a short interval. To prevent this from happening, CICSplex SM uses entry and exit intervals to even out rapid activity oscillations, where:

- Entry intervals define the number of consecutive times a condition must be true before notification occurs. That is, if a condition is not true the specified number of times, no notification is generated.
- Exit intervals define the number of times, following the resolution of a condition, that the condition must be false before the notification is removed. That is, once notification is generated, it remains active until the condition causing the notification has disappeared for a specific number of intervals.

For example, assume that a condition with a severity of HW (high warning) occurs. In order for this condition to cause notification to occur, you decide that the condition must remain true for two consecutive intervals. And the notification must remain in effect until the condition has been false for three consecutive intervals. Notice that the entry and exit intervals need not be the same.

---

## Identifying primary CMASs

You must identify a primary CMAS:

- To enable system availability monitoring.  
To do this, you must change the CICS system definition to identify the CMAS to which the CICS system normally connects. This primary CMAS is used to assist in balancing real-time analysis processing. That is, when the first CMAS involved in managing a CICSplex is started, it monitors all CICS systems comprising the CICSplex. As subsequent CMASs start, they begin monitoring the systems for which they are the primary CMAS. Over time, this helps to balance monitoring across all of the CMASs involved in the CICSplex.
- To enable analysis point monitoring.  
To do this, you can identify a primary CMAS and one or more secondary CMASs.
  - The existence of an analysis point specification causes analysis point processing to be activated when the CMAS identified as its primary CMAS is started.  
When you identify one primary CMAS, all CICSplex-level processing occurs within that CMAS. As an alternative, you can partition the CICSplex at the CMAS level. That is, each CMAS participating in the management of a CICSplex may process one or more analysis point specifications. This mode of operation allows greater flexibility when managing a CICSplex being managed by multiple CMASs. Note that this partitioning does not preclude any CMAS from acting on CICS systems attached to other CMASs.
  - Optionally, you can associate the analysis point specification with one or more secondary CMASs. This identifies the CMAS that is to take over if the primary CMAS becomes unavailable. When the primary CMAS is inactive, the active secondary CMAS with the lowest SYSID will take control of the analysis point specification.

### Modifying resources with real-time analysis

In addition to analyzing and reporting the status of CICS resources, CICSplex SM can also modify the attributes of a resource. You can tell the real-time analysis component what modifications to perform when it determines that a resource is not in the desired state.

To have real-time analysis modify a resource, you must:

1. Define the resource attributes you want to modify and their desired values in an evaluation definition (EVALDEF), as described in “Creating an evaluation definition” on page 35.
2. Tell real-time analysis to perform the modifications when the evaluation condition becomes true in an analysis definition (RTADEF), as described in “Creating an analysis definition” on page 44.

real-time analysis performs any resource modifications that you request in addition to generating the usual external notifications for a condition. So when a notifiable condition occurs, you can have real-time analysis simply tell you about the condition, or tell you and attempt to correct it by modifying the affected resource.

**Note:** Using real-time analysis to modify resources is most effective for evaluations that involve a single operational value, such as ENABLED/DISABLED or OPEN/CLOSED. For evaluations that involve resource thresholds, you cannot specify different modifications for different severity levels.

---

### Real-time analysis definitions and their related views

You can use the real-time analysis administration views to define a variety of real-time analysis attributes. Figure 4 on page 21 provides an overview of the real-time analysis views based on the CICSplex SM object model. In addition to the views shown here, you can use the views described in Table 3 on page 7 to display information about and manage the real-time analysis activity in an active CICS system. You can also display a visual map of your real-time analysis definitions by using the MAP action command, as described in *CICSplex SM User Interface Guide*.

Figure 5 on page 22 illustrates the relationship between system availability monitoring (SAM) and the views used to establish that type of real-time analysis in a CICSplex. In this case, the CICSSYS view is used to change the CICS system definition. The RTASPEC and RTASCOPE views are used to allow multiple CICS systems to use customized action definitions, severity levels, or both.

Figure 6 on page 23 illustrates the relationship between MAS resource monitoring (MRM) and the views used to establish that type of real-time analysis.

Figure 7 on page 24 illustrates the relationship between analysis point monitoring (APM) and the views used to establish that type of real-time analysis.

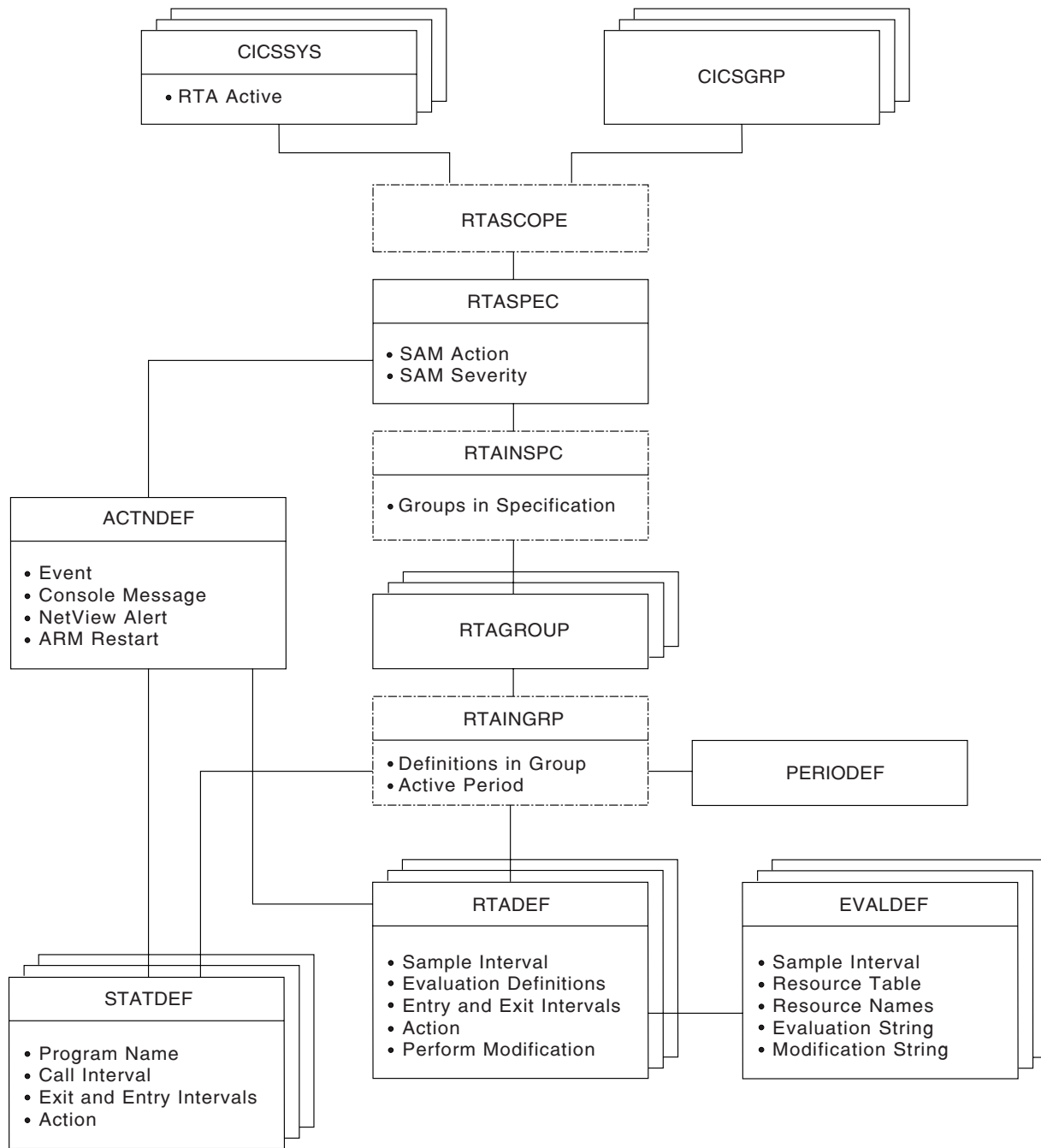

Figure 4. Views for creating real-time analysis objects and associations

## real-time analysis definitions

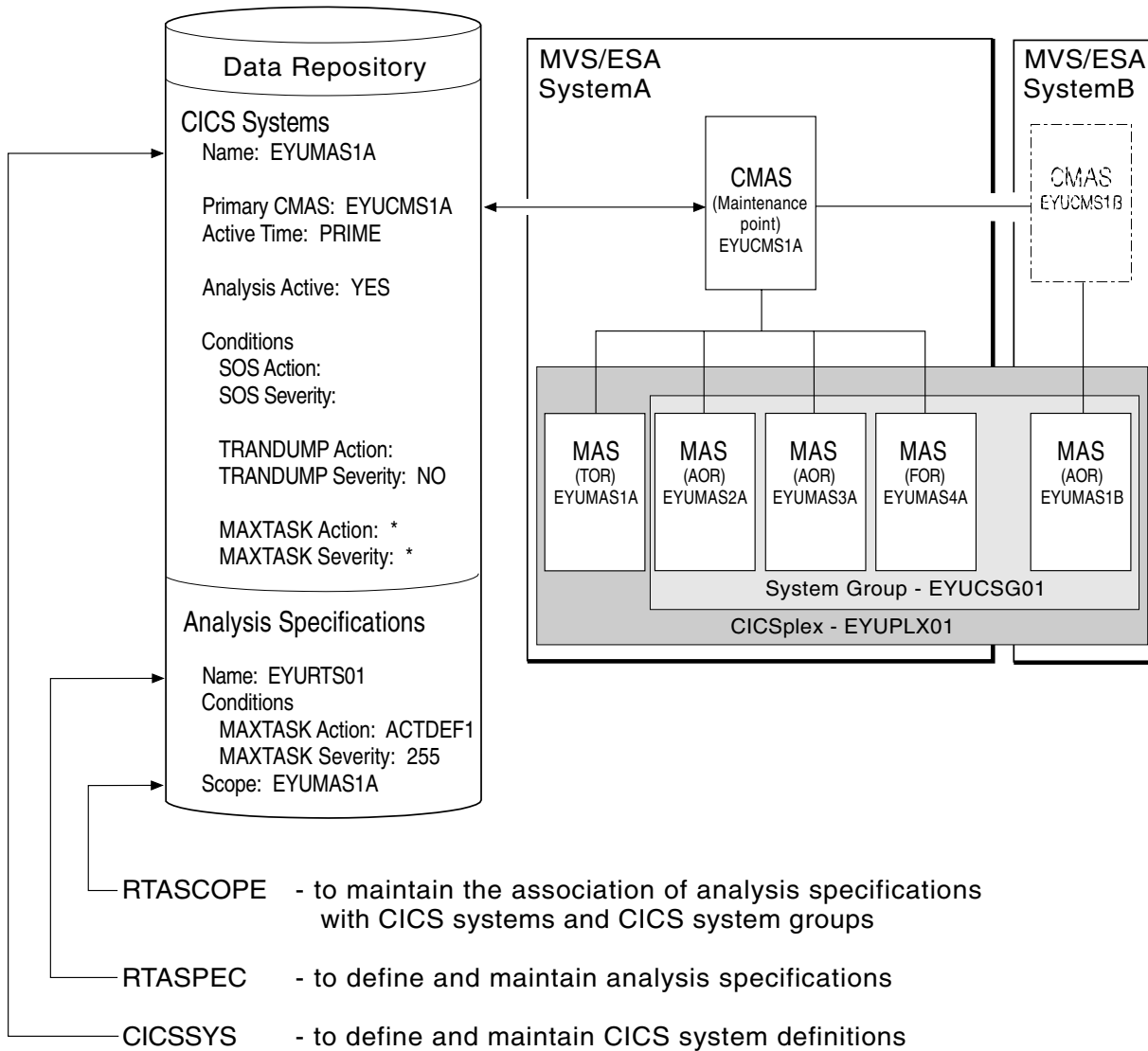

Figure 5. The relationship between SAM, the CICSSYS view, and the real-time analysis views



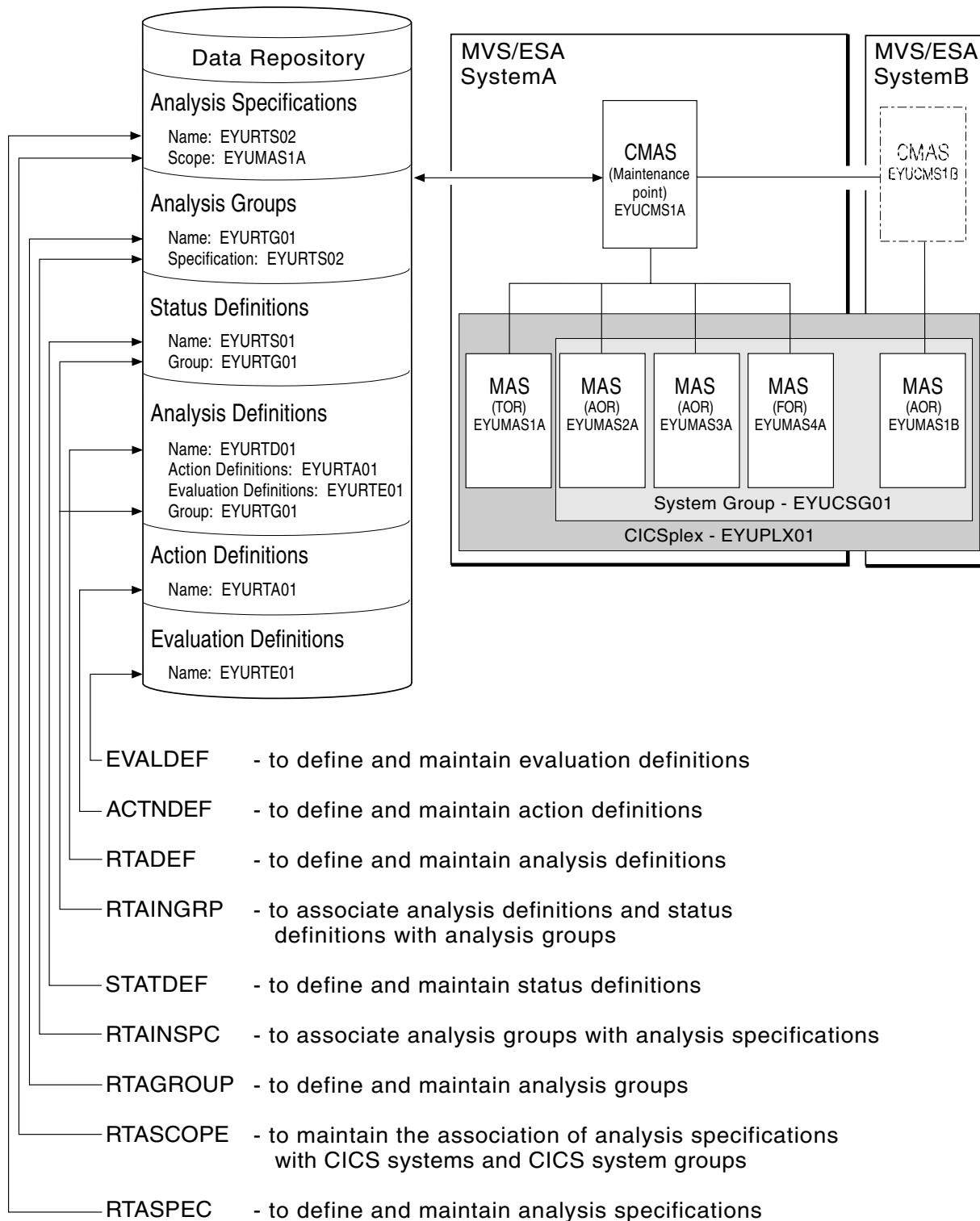

Figure 6. The relationship between MRM and the real-time analysis views

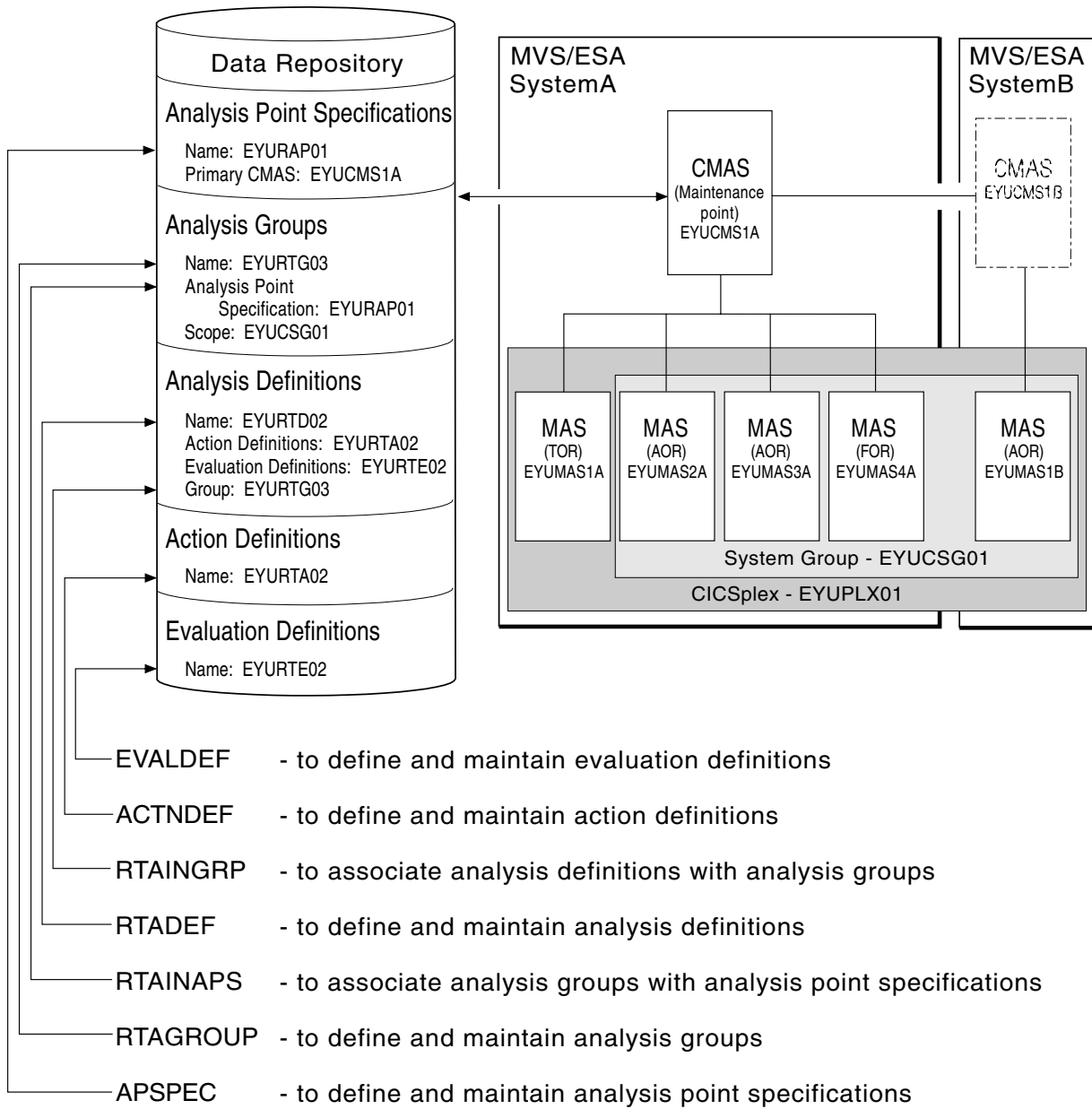

Figure 7. The relationship between APM and the real-time analysis views

---

## Chapter 3. Real-time analysis views

This chapter contains detailed descriptions of the views used to create and maintain real-time analysis definitions.

You can access real-time analysis administration views by:

- Issuing the appropriate real-time analysis view command.
- Issuing one of the following menu commands and selecting a view from the menu:

**MENU ADMSAM**

For system availability monitoring (SAM) views

**MENU ADMMRM**

For MAS resource monitoring (MRM) views

**MENU ADMAPM**

For analysis point monitoring (APM) views

(An example of the ADMMRM menu is shown in Figure 8.)

- Initiating a hyperlink from one view to another by placing the cursor on a hyperlink field and pressing Enter.

For additional information about accessing views, see *CICSplex SM User Interface Guide*.

```
26MAR1999 16:50:48 ----- INFORMATION DISPLAY -----
COMMAND ==>
CURR WIN ==> 1      ALT WIN ==>
W1 =MENU=====EYUPLX01=EYUPLX01=26MAR1999==16:50:48=CPSM=====12===
CMD Name          Description
-----
ADMMRM           RTA MAS Resource Monitoring Administration Views
RTASPEC          Analysis Specifications
RTAGROUP         Analysis Groups
RTADEF           Analysis Definitions
EVALDEF         Evaluation Definitions
STATDEF         User Status Probe Definitions
ACTNDEF         Action Definitions
PERIODEF        Time Period Definitions
=====
RTASCOPE         Members Associated with Analysis Specifications
RTAINSPC        Analysis Groups in Analysis Specifications
RTAINGRP        Analysis and Status Definitions in Groups
```

Figure 8. The ADMMRM menu

**Note:** Unless noted otherwise, only the context setting is recognized when you are creating and maintaining real-time analysis definitions. For information about setting the context, see *CICSplex SM User Interface Guide*.

The remainder of this chapter contains detailed descriptions of the real-time analysis views.

## ACTNDEF (Action definitions)

An action definition designates the type of external notification that is to occur when the condition or conditions identified in an analysis definition are true. Examples of how to use this view can be found in “Chapter 5. Example tasks: real-time analysis” on page 85

To display information about existing action definitions, issue the command:

```
ACTNDEF [actndef]
```

where actndef is the specific or generic name of an action definition. If you omit this parameter, the resulting view, illustrated in Figure 9, includes information about all action definitions for the CICSplex identified as the context.

```

26MAR1999 11:30:30 ----- INFORMATION DISPLAY -----
COMMAND ==>
CURR WIN ==> 1          ALT WIN ==>
W1 =ACTNDEF=====EYUPLX01==EYUCSG01==26MAR1999==11:30:30=CPSM=====2===
CMD Name      Event   View   Msg  Alert  ARM  Description
-----
EYURTA01     YES    CICS   YES  YES    YES  A test action
EYURTA02     YES    LOCF   YES  YES    NO   Another action
    
```

Figure 9. The ACTNDEF view

## Action commands

Table 4 summarizes the action commands you can use with the ACTNDEF view.

Table 4. ACTNDEF view action commands

Primary command	Line command	Description
n/a	BRO	Browse an action definition in the data repository.  The format of the resulting panel is similar to that shown in Figure 10 on page 27. The panel fields are not modifiable.
CREate	CRE	Create an action definition and add it to the data repository, as described on page 27.  When you use the primary command CREate, some fields in the new view may contain values supplied by CICSplex SM; you may change these values. When you enter the line command CRE next to the name of an action definition, fields in the new view contain values to be modelled (from the existing action definition).
n/a	MAP	Display a visual map of real-time analysis definitions using the specified action definition as a starting point.
n/a	REM	Remove an action definition from the data repository.

Table 4. ACTNDEF view action commands (continued)

Primary command	Line command	Description
TEMPMP cmasid	n/a	Change the temporary maintenance point CMAS to a specific CMAS or display a selection list based on a generic CMAS ID.
n/a	UPD	Update an action definition in the data repository.  The format of the resulting panel is similar to the panel shown in Figure 10. You can modify the contents of any field in the panel except Action Name.

## Hyperlink fields

There are no hyperlink fields on the ACTNDEF view.

## Creating an action definition

Figure 10 shows the format of the panel produced when you use the create primary (CREate) or line (CRE) action command from the ACTNDEF view.

```

----- Create Action for EYUPLX01 -----
COMMAND ==>

Action Name ==> EYURTA01
Description ==>

Event ==> YES          Generate Event (Yes/No)
Event View ==> LOCTRAN  View for Event
Priority ==> 255        Event Priority (1 to 255)
Event Text ==> Transaction rate too great

External Msg ==>          Generate External Message (Yes/No)
Enter Msg ==>
Exit Msg ==>

Alert ==>              Generate Alert (Yes/No)
CMAS Name ==>          CMAS to Issue Alert
Enter Text ==>
Exit Text ==>

Restart ==> NO          Cancel for ARM Restart (Yes/No)

Press Enter to create the Action Definition.
Type END or CANCEL to cancel without creating.

```

Figure 10. Creating an action definition

Provide the following information, as appropriate:

### Action Name

Specify a 1- to 8-character name for the action definition. The name can contain alphabetic, numeric, or national characters. However, the first character must be alphabetic,

### Description

(Optional.) Specify a 1- to 30-character description of the definition.

**Event** Specify YES or NO to indicate whether CICSplex SM event messages are to be generated when a notification condition occurs.

## ACTNDEF

If you specify YES, provide the following information, as appropriate:

### Event View

(Optional.) The name of the CICSPlex SM view that is to appear in the View field of the EVENT and EVENTD views when a notification condition occurs. The view should be the one that is most frequently used to obtain information about the condition or to assist in resolving the condition.

### Priority

A value between 1 and 255, inclusive. This value and the severity code associated with the condition, as described on page 38, are used to determine the sort order of events shown in the EVENT view. The higher the priority, the higher in the list an event appears.

### Event Text

A 1- to 30-character description that is to appear in the EVENT and EVENTD views if a notification condition occurs.

If the action definition is for use by a system availability monitoring condition, you can specify \* (asterisk) to use the default event text for that condition. For a list of the system availability monitoring defaults, see "Default notification values" on page 12.

### External Msg

Specify YES or NO to indicate whether external messages are to be generated when a notification condition occurs.

If you specify YES, provide the following information, as appropriate:

### Enter Msg

A 1- to 30-character description that is to be added to the CICSPlex SM message produced when a notifiable condition occurs.

### Exit Msg

A 1- to 30-character description that is to be added to the CICSPlex SM message produced when a notifiable condition ends.

### Notes:

1. If the action definition is for use by a system availability monitoring condition, you can specify \* (asterisk) in one or both of these fields to use the default external message text for that condition. For a list of the system availability monitoring defaults, see "Default notification values" on page 12.
2. The external message text is added to CICSPlex SM messages that are prefixed with EYUPN. For additional information about these messages, see the *CICSPlex SM Messages and Codes* book.

**Alert** Specify YES or NO to indicate whether an SNA generic alert is to be sent to NetView. (For more information about how CICSPlex SM uses SNA generic alerts and resolutions, see "Appendix B. Generic alert and resolution structures" on page 193.)

If you specify YES, provide the following information, as appropriate:

### CMAS Name

The name of the CMAS to which the NetView system is linked.

To specify that generic NetView alerts are to be generated and passed to a CMAS residing in the same MVS image:

- Use the CMAS view, as described in the *CICSplex SM User Interface Guide* book, to display the names of existing CMASs. Decide which of these CMASs is to participate in real-time analysis. That is, which of these CMASs is to record the conditions that are to be transmitted to NetView.
- Then, use the CMASD view, also described in the *CICSplex SM User Interface Guide* book, to display detailed information about each appropriate CMAS. To have generic alerts transmitted to the NetView system that resides in the same MVS image as the CMAS, set the NetView PPI field to YES.

**Enter Text**

A 1- to 30-character message that is to be added to the SNA generic alert when the condition causing the alert starts.

**Exit Text**

A 1- to 30-character message that is to be added to the SNA generic alert when the condition causing the alert ends.

If the action definition is for use by a system availability monitoring condition, you can specify \* (asterisk) in one or both of the text fields to use the default alert text for that condition. For a list of the system availability monitoring defaults, see “Default notification values” on page 12.

**Restart**

Specify YES or NO to indicate whether CICS systems affected by the event are to be immediately cancelled and restarted using the MVS/ESA automatic restart manager (ARM). The default is NO.

For ARM restart to be successful, the CICS system must:

- Be known to CICSplex SM as a local MAS
- Be running in an MVS/ESA image where ARM is active
- Have successfully registered with ARM during initialization
- Be eligible for restart according to current ARM policy

ARM restart is available for CICS/ESA 4.1 and later systems.

Press Enter to add this action definition to the data repository.

---

## **APCMAS (Analysis point specification and CMAS associations)**

During real-time analysis initialization, the association between analysis point specifications and CMASs is used to determine which specification should be installed within the CMAS in which real-time analysis is activated.

To display information about associations between analysis point specifications and CMASs, issue the command:

```
APCMAS
```

The resulting view, illustrated in Figure 11 on page 30, includes information about all analysis point specification and CMAS associations for the CICSplex identified as the context.

```

26MAR1999 16:51:37 ----- INFORMATION DISPLAY -----
COMMAND ==>
CURR WIN ==> 1          ALT WIN ==>          SCROLL ==> PAGE
W1 =APCMAS=====EYUPLX01=EYUPLX01=26MAR1999==16:51:37=CPSM=====2===
CMD Spec      CMAS      Type
--- Name----- Name-----
EYURAPLC EYUCMS1A PRIMARY
EYURAP01 EYUCMS1A PRIMARY
    
```

Figure 11. The APCMAS view

## Action commands

Table 5 summarizes the action commands you can use with the APCMAS view.

Table 5. APCMAS view action commands

Primary command	Line command	Description
n/a	BRO	Browse the association between an analysis point specification and a CMAS.
n/a	MAP	Display a visual map of real-time analysis definitions using the designated specification as a starting point.
n/a	REM	Remove the association between an analysis point specification and a CMAS.
TEMPMP cmasid	n/a	Change the temporary maintenance point CMAS to a specific CMAS or display a selection list based on a generic CMAS ID.

## Hyperlink fields

Table 6 shows the hyperlink field on the APCMAS view.

Table 6. APCMAS view hyperlink field

Hyperlink field	View displayed	Description
AP Spec	APSPEC	Information about the designated analysis point specification.

## APSPEC (Analysis point specifications)

An analysis point specification identifies one or more CMASs that are to be responsible for analyzing CICS systems within the CICSplex identified as the context. An example of how to use this view can be found in “Issuing one notification for multiple conditions (1)” on page 116.

To display information about existing analysis point specifications, issue the command:

```
APSPEC [apspec]
```

where *apspec* is the specific or generic name of an analysis point specification. If you omit this parameter, the resulting view, illustrated in Figure 12 on page 31, includes information about all analysis point specifications for the CICSplex identified as the context.



```

26MAR1999 16:51:44 ----- INFORMATION DISPLAY -----
COMMAND ==>
CURR WIN ==> 1          ALT WIN ==>          SCROLL ==> PAGE
W1 =APSPEC=====EYUPLX01=EYUPLX01=26MAR1999==16:51:44=CPSM=====2===
CMD Spec      Description
--- Name-----
EYURAPLC SSet - License
EYURAP01 SSet - Analysis point 1
    
```

Figure 12. The APSPEC view

## Action commands

Table 7 summarizes the action commands you can use with the APSPEC view. Table 8 identifies the oertype field you can modify when you use the SET action command.

Table 7. APSPEC view action commands

Primary command	Line command	Description
n/a	ADD	Add an association between an analysis point specification and a CMAS, as described on page 32.
n/a	BRO	Browse an analysis point specification in the data repository.  The format of the resulting panel is similar to that shown in Figure 13 on page 32. The panel fields are not modifiable.
CREate	CRE	Create an analysis point specification and add it to the data repository, as described on page 32.
n/a	MAP	Display a visual map of real-time analysis definitions using the designated specification as a starting point.
n/a	REM	Remove an analysis point specification from the data repository.
n/a	SET	Change the description of an analysis point specification using an oertype field (see Table 8). <b>Note:</b> The value you specified in the Require Set field on the CICSplex System Manager entry panel determines whether or not you must use the SET command when you oertype a field.
TEMPMP cmasid	n/a	Change the temporary maintenance point CMAS to a specific CMAS or display a selection list based on a generic CMAS ID.
n/a	UPD	Update an analysis point specification in the data repository.  The format of the resulting panel is similar to that shown in Figure 13. You can change the Description field.

Table 8. APSPEC view oertype field

Field name	Value
Description	1- to 30-character description of the specification.

## Hyperlink fields

Table 9 shows the hyperlink field on the APSPEC view.

Table 9. APSPEC view hyperlink field

Hyperlink field	View displayed	Description
Spec Name	RTAINAPS	Detailed information about the associations that exist between the designated analysis point specification and its analysis groups.

## Creating an analysis point specification

Figure 13 shows the format of the panel produced when you use the create primary (CREate) or line (CRE) action command from the APSPEC view.

```

----- Create Analysis Point Specification for EYUPLX01 -----
COMMAND  ==>>

AP SpecName      ==>>
Description      ==>>

Press Enter to create AP Specification.
Type END or CANCEL to cancel without creating.
    
```

Figure 13. Creating an analysis point specification

Provide the following information, as appropriate:

### AP Spec Name

Specify a 1- to 8-character name for the specification. The name can contain alphabetic, numeric, or national characters. However, the first character must be alphabetic,

### Description

(Optional.) Specify a 1- to 30-character description of the specification.

Press Enter to add the analysis point specification to the data repository.

## Associating an analysis point specification with a CMAS

Figure 14 on page 33 illustrates the panel produced when you use the add (ADD) line action command from the APSPEC view.

```

----- Add APSPEC CMAS Association for EYUPLX01 -----
COMMAND ==>

AP SpecName          EYURAP01
Description

CMAS Name            ==>          CMAS name from CICSplex set or Generic
Type                 ==>          CMAS role (Primary/Secondary)

Press ENTER to add AP Specification to CMAS.
Type END or CANCEL to cancel without adding.
    
```

Figure 14. Adding a CMAS to an analysis point specification

Provide the following information:

**CMAS Name**

Enter the specific or generic name of a CMAS, involved in managing the CICSplex, that is to be associated with this specification. If you specify a generic value, a list of valid CMAS names is displayed.

|  
|  
|

Ensure that the CMASs you specify for the primary and secondary associations are running the highest level of CICSplex SM currently in use in the CICSplex.

**Type** Indicate the type of association that is to be created. Specify:

**PRIMARY**

Control of the analysis definitions associated with the analysis point specification are to be passed to this CMAS when it initializes.

**SECONDARY**

Control of the analysis definitions associated with the analysis point specification are to be passed to this CMAS only when the primary CMAS is unavailable.

Only one primary CMAS can be associated with an analysis point specification. Multiple secondary CMASs can be associated with an analysis point specification.

Press Enter to add the designated CMAS to the analysis point specification definition in the data repository.

To remove the CMAS association, use the REM action command from the APCMAS view, as described on page 29.

---

## EVALDEF (Evaluation definitions)

An evaluation definition identifies the resources in one or more CICS systems that are to be sampled and evaluated. (For more information about these resources, see the *CICSplex SM Resource Tables Reference* book.) When the result of the evaluation is true, an associated analysis definition is used to determine if a notifiable condition has occurred. Examples of how to use this view can be found in “Chapter 5. Example tasks: real-time analysis” on page 85.

To display information about existing evaluation definitions, issue the command:

```
EVALDEF [evaldef]
```

## EVALDEF

where evaldef is the specific or generic name of an evaluation definition. If you omit this parameter, the resulting view, illustrated in Figure 15, includes information about all evaluation definitions for the CICSplex identified as the context.

```

26MAR1999 18:29:18 ----- INFORMATION DISPLAY -----
COMMAND ==>
CURR WIN ==> 1          ALT WIN ==>
W1 =EVALDEF=====EYUPLX01=EYUPLX01=26MAR1999==18:29:18=CPSM=====10===
CMD Name      Table      Column Name  Intvl Description
-----
EYURTELC MAS                60 SSet - Licence
EYURTE01 CONNECT CONNSTATUS 300 SSet - All connections
EYURTE02 LOCFILE ENABLESTATUS 60 SSet - Local File DFHCSD
EYURTE16 LOCFILE EMPTYSTATUS 300 SSet - Empty required on files
EYURTE17 DBCTLSS MAXTHRCNT 300 SSet - DBCTL maxthreads
EYURTE18 CICS RGN DTRPROGRAM 300 SSet - DTR not set correctly
EYURTE19 CICS RGN MONSTAT 300 SSet - MONITORING inactive
EYURTE20 CICS DSA PCTFREE 300 SSet - DSA free space
EYURTE21 EVENT                300 SSet - Outstanding EVENTS
EYURTE22 TRANDUMP TDMP SUPP 300 SSet - Dump suppression
  
```

Figure 15. The EVALDEF view

## Action commands

Table 10 summarizes the action commands you can use with the EVALDEF view.

Table 10. EVALDEF view action commands

Primary command	Line command	Description
n/a	BRO	Browse an evaluation definition in the data repository.
CREate	CRE	Create an evaluation definition and add it to the data repository, as described in Creating an evaluation definition.
n/a	MAP	When you use the primary command CREate, some fields in the new view may contain values supplied by CICSplex SM; you may change these values. When you enter the line command CRE next to the name of an evaluation definition, fields in the new view contain values to be modelled (from the existing evaluation definition). Display a visual map of real-time analysis definitions using the specified definition as a starting point.
n/a	REM	Remove an evaluation definition from the data repository.
TEMPMP cmasid	n/a	Change the temporary maintenance point CMAS to a specific CMAS or display a selection list based on a generic CMAS ID.

Table 10. EVALDEF view action commands (continued)

Primary command	Line command	Description
n/a	UPD	Update an evaluation definition in the data repository.  The format of the resulting panel is similar to the panel shown in Figure 16. You can modify the contents of any field in the panel except Name.

## Hyperlink fields

There are no hyperlink fields on the EVALDEF view.

## Creating an evaluation definition

When you use the create primary (CREate) or line (CRE) action command from the EVALDEF view, a sequence of two panels is produced. The first panel includes all of the fields that are required to create an evaluation definition. The second panel contains optional fields for qualifying the evaluation and defining modifications to be made when the specified condition becomes true.

Figure 16 shows the format of the first panel produced when you are creating an evaluation definition.

```

----- Create Evaluation Definition for EYUPLX01-----
COMMAND ==>

Name           ==> EYURTE01
Description    ==> Evaluate transaction status

Sample Interval ==> 60           Interval between samples in seconds
Table Name     ==> LOCTRAN    Resource Table Name or *
Instance Pattern ==> *       Specific or generic pattern
Result Set Action ==> ANY     Operation (ALL,ANY,SUM,MIN,MAX,AVG,CNT)
Separate Task  ==> NO        Run as a separate task (YES, NO)

Evaluation Column ==> STATUS   Column name to evaluate or *
  either Operator ==> NE      (EQ,NE,LT,GT,LE,GE)
  Value          ==> ENABLED
  Severity       ==> HS      (VLS,LS,LW,HW,HS,VHS)

  or set Thresholds: Provide 3 low and/or 3 high values, N=Normal
VLS      LS      LW  (N)  HW      HS      VHS

View Invoked   ==> LOCTRAN    View invoked for this Evaluation

Type DOWN or UP to view other Evaluation Definition screens.
Press Enter to create Evaluation Definition.
Type END or CANCEL to cancel without creating.

```

Figure 16. Creating an evaluation definition - Page 1

Provide the following information, as appropriate.

**Name** Specify a 1- to 8-character name for the evaluation definition. The name can contain alphabetic, numeric, or national characters. However, the first character must be alphabetic,

### Description

(Optional) Specify a 1- to 30-character description of the definition.

### Sample Interval

Specify how long, in seconds, CICSplex SM is to wait between the collection of sample data. The value must be between 1 and 86400.

If the Table Name field identifies a monitor resource table and monitoring for that resource category is active, this sample interval value is ignored. Instead, the sample interval specified for the appropriate monitor specification is used. To prevent this from occurring, specify the equivalent operations resource table in the Table Name field, rather than the monitor table.

### Table Name

Enter the specific or generic name of a CICSplex SM resource table that identifies the resource category you want to evaluate. If you specify a generic value, a list of valid resource tables is displayed.

When specifying a table name, consider where the evaluation definition and its associated analysis definition will be installed. The definitions may be installed in a variety of CICSplex SM managed CICS systems, however, not all resource tables are supported in all CICS systems. Therefore, when the definitions are installed, CICSplex SM determines whether the target system supports the resource table. For example, resource monitoring and therefore monitor tables are not supported in CICS for OS/2<sup>®</sup>. If you specify a monitor table name in the evaluation definition and attempt to install its associated analysis definition in a CICS for OS/2 system, the installation will fail with a warning message indicating the resource is not supported. This message does not require any corrective action, but can be avoided by specifying a table name that is supported in the target CICS systems.

Refer to the *CICSplex SM Resource Tables Reference* book for a detailed description of each table.

### Instance Pattern

Enter a specific resource name or a pattern for the resource occurrences you want to evaluate. A pattern can include the characters + (plus sign), \* (asterisk), or both.

### Result Set Action

Specify how the information about the resource occurrences is to be evaluated, as:

**ALL** Compare the information against the evaluation criteria. If the result shows all occurrences of the resource within the current sample are true, set a true condition.

This action is not supported when evaluating threshold values.

**ANY** Compare the information against the evaluation criteria. If the result shows any occurrence of the resource within the current sample is true, set a true condition.

This action is not supported when evaluating threshold values.

**AVG** Process the information and compare the resulting average value against the evaluation criteria. If the result for the current sample is true, set the condition true.

This action is available for numeric data only. If you specify this action, you cannot request a modification operation in the Modification String expression field.

**CNT** Compare the number of resource occurrences against the evaluation criteria. If the result for the current sample is true, set the condition true.

If you specify this action, you cannot request a modification operation in the Modification string expression field.

**MAX** Process the information and compare the resulting maximum value against the evaluation criteria. If the result for the current sample is true, set the condition true.

**MIN** Process the information and compare the resulting minimum value against the evaluation criteria. If the result for the current sample is true, set the condition true.

**SUM** Total the information and compare the sum against the evaluation criteria. If the result for the current sample is true, set the condition true.

This action is available for numeric data only. If you specify this action, you cannot request a modification operation in the Modification string expression field.

### Separate Task

Specify YES or NO to indicate whether the evaluation process should run as a separate task.

The default value of NO allows the evaluation process to run under the MAS long running task (LRT). Depending on the type of evaluation and the number of resources involved, running under the LRT may prevent user tasks with the same priority (255) from running.

If you specify YES, a separate task (COIR) is started to process this evaluation definition. The priority of the task is set according to the value of the COIRTASKPRI system parameter.

**Note:** If COIRTASKPRI is set to 0, a separate task is not started for any evaluation definition. For a description of COIRTASKPRI, see the *CICSplex SM Administration* book.

### Evaluation Column

Enter the specific or generic name of a column in the specified resource table that is to be part of the evaluation criteria. If you specify a generic value, a list of the columns in that resource table is displayed.

After identifying the column to be evaluated, you must determine the type of evaluation to be performed. You can specify either an evaluation value and its associated operator and severity, or evaluation threshold values. Note, however, that these two types of evaluation are mutually exclusive.

Use evaluation values when your criteria involves numeric data, keywords (such as ENABLED, OPEN, or YES), or Boolean operators. To use a value as your evaluation criteria, specify the following:

#### Operator

The logical operator to be used in determining if the contents of the evaluation column meet the evaluation criteria. The valid operators are:

## EVALDEF

<b>LT</b>	Less than
<b>LE</b>	Less than or equal to
<b>EQ</b>	Equal to
<b>GE</b>	Greater than or equal to
<b>GT</b>	Greater than
<b>NE</b>	Not equal to

**Value** An alphanumeric value or keyword to be used in determining if the contents of the evaluation column meet the evaluation criteria. This value must be a valid attribute value for the resource table column being evaluated.

### Severity

The severity level to be assigned when the resource occurrence meets the evaluation criteria. The severity levels are:

<b>VLS</b>	Very low severe
<b>LS</b>	Low severe
<b>LW</b>	Low warning
<b>HW</b>	High warning
<b>HS</b>	High severe
<b>VHS</b>	Very high severe

In Figure 16 on page 35, for example, if a local transaction (LOCTRAN) is found to have a status not equal to ENABLED, the evaluation is true and a severity of high severe (HS) is assigned.

Alternatively, you can establish a range of threshold values for the resource occurrence that, if met, result in varying severity levels. To use thresholds as your evaluation criteria, specify the following:

### Thresholds

A threshold value for each severity level. The value type and its format must be valid for the evaluation column you specified. Threshold values are used to assign a severity level to resource occurrences that meet the evaluation criteria.

For severity levels to the left of normal (N), the specified threshold is the upper bound. For severity levels to the right of normal (N), the specified threshold is the lower bound.

For example, if the evaluation thresholds are:

VLS	LS	LW	(N)	HW	HS	VHS
1	3	5		7	9	11

then:

- a value of 4 produces a severity level of LW.
- a value of 6 indicates the resource is within its normal range.
- a value of 8 produces a severity level of HW.

You may specify the values in either ascending or descending numerical order.

Also, it is possible to specify unidirectional thresholds, evaluating for only a high or low condition, but not both. To use only half of the evaluation threshold range, specify threshold values either for VLS, LS, and LW or for VHS, HS, and HW. When you specify values for only half of the threshold range, the fields in the other half must be blank.



**View Invoked**

(Optional) Specify the name of the CICSplex SM view that is to appear in the View field of the EVENTDTL view when a notifiable condition occurs. This field should identify the view associated with the resource table specified in the Table Name field.

If the evaluation definition is complete, press Enter to add it to the data repository. If you want to qualify the evaluation or define modifications to be made, issue the DOWN command.

Figure 17 shows the format of the panel produced when you issue the DOWN command.

```

----- Create Evaluation Definition for EYUPLX01-----
COMMAND ==>

Name                ==> EYURTE01

Filter string expression: (Use FILTER command to list columns)
==> PROGRAM=AB* AND (USECOUNT>0 OR RESTARTCNT>0).
==>
==>
==>
==>
==>
==>
==>
==>
==>

Modification string expression: (Use MODIFY command to list alterable columns)
==> STATUS=ENABLED.
==>
==>
==>

Type DOWN or UP to view other Evaluation Definition screens.
Press Enter to create Evaluation Definition.
Type END or CANCEL to cancel without creating.
    
```

Figure 17. Creating an evaluation definition - Page 2

Provide the following information, as appropriate.

**Filter string expression**

(Optional) Identifies attributes in the specified resource table that are to be used to qualify the condition described in the Evaluation Column fields.

In Figure 17, for example, only those local transactions that have a first program name beginning with AB and either a use count greater than 0 or a restart count greater than 0 are evaluated.

A filter expression can be made up of one or more attribute expressions in the form:

**Filter Expression**

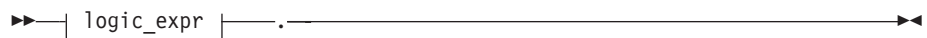

## EVALDEF

### logic\_expr:

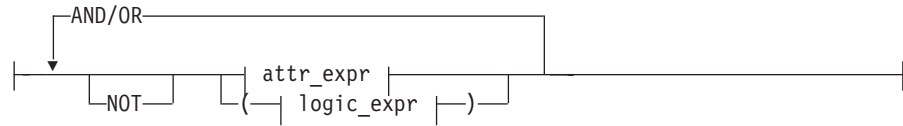

### attr\_expr:



where:

**attr** Is the name of an attribute in the resource table. You can name the same attribute more than once in a filter expression.

**oper** Is one of the following comparison operators:

- < Less than
- <= Less than or equal to
- = Equal to
- >= Greater than or equal to
- > Greater than
- ≠ Not equal to

**value** Is the value for which the attribute is being tested. The value must be a valid one for the attribute.

If the attribute accepts character data, this value can be a generic. Generic values can contain:

- An asterisk (\*), to represent any number of characters, including zero. The asterisk must be the last or only character in the specified value. For example:

```
TRANID=PAY*
```

- A plus sign (+), to represent a single character. A + can appear in one or more positions in the specified value. For example:

```
TRANID=PAY++96
```

If the value contains imbedded blanks or special characters (such as periods, commas, or equal signs), the entire value string must be enclosed in single quotes. For example:

```
TERMID='Z AB'
```

To include a single quote or apostrophe in a value, you must repeat the character, like this:

```
DESCRIPTION='October''s Payroll'
```

### AND/OR

Combines attribute expressions into compound logic expressions using the logical operators AND and OR, like this:

```
attr_expr AND attr_expr.
```

Filter expressions are evaluated from left to right. You can use parentheses to vary the meaning of a filter expression. For example, this expression:

```
attr_expr AND (attr_expr OR attr_expr).
```

has a different meaning than this one:

```
(attr_expr AND attr_expr) OR attr_expr.
```

**NOT** Negates one or more attribute expressions.

You can negate a single attribute expression, like this:

```
NOT attr_expr
```

You can also negate multiple attribute expressions or even a whole filter expression, like this:

```
NOT (attr_expr OR attr_expr).
```

Note that you must place parentheses around the attribute expressions (or the filter expression) to be negated.

To see a list of the attributes in the resource table, type `FILTER` in the `COMMAND` field and press Enter. Figure 18 shows the format of the panel produced when you issue the `FILTER` command. For more information on these attributes, see the *CICSplex SM Resource Tables Reference* book.

```
----- List of CICSplex Resources----- Row 1 of 34
COMMAND ==>                               Scroll ==> PAGE
Available columns in resource table: LOCTRAN

ColumnName  Type  Len  Description
-----
CMDSEC      CVDAS 00004 Command security
DTB         CVDAS 00004 Dynamic Trans Bacout Option
DTIMEOUT    BINARY 00004 Data Timeout
DUMPING     CVDAS 00004 Dumping Option
INDOUBTWAIT CVDAS 00004 Transaction Indoubtwait option
ISOLATEST   CVDAS 00004 Isolation status
LOCALCNT    BINARY 00004 Times run local via DTR
PRIORITY    BINARY 00004 Priority
PROFILE     CHAR 00008 Transaction Profile
PROGRAM     CHAR 00008 First program name
PURGEABILITY CVDAS 00004 Purgability ( SPURGE )
RUNAWAY     BINARY 00004 Runaway time in milliseconds
RUNAWAYTYPE CVDAS 00004 Runaway time type
```

Figure 18. List of attributes in a resource table

### Modification string expression

(Optional) Identifies attributes in the specified resource table that are to be modified if the condition described by this evaluation definition becomes true.

**Note:** CICSplex SM attempts to perform the requested modification only once. If the modification is not successful for any reason (such as the resource is in use or is not available), it is not retried. If the condition generates a CICSplex SM event, the event remains displayed on the `EVENT` view, if the modification cannot be made.

A modification expression can be made up of one or more attribute expressions in the form:

**Modification Expression**



where:

**attr** Is the name of a modifiable attribute in the resource table.

**value** Is the value to which you want the attribute set. The following restrictions apply:

- The value must be a valid one for the attribute.
- If the value contains imbedded blanks or special characters (such as periods, commas, or equal signs), the entire value string must be enclosed in single quotes, like this:

```
DESCRIPTION='Payroll.OCT'
```

- To include a single quote or apostrophe in a value, you must repeat the character, like this:

```
DESCRIPTION='October''s Payroll'
```

To see a list of attributes in the resource table that can be modified, type MODIFY in the COMMAND field and press Enter. Figure 19 shows the format of the panel produced when you issue the MODIFY command. For more information on these attributes, see the *CICSplex SM Resource Tables Reference* book.

```
----- List of CICSplex Resources----- Row 1 of 10
COMMAND ===>                               Scroll ==> PAGE

Available columns in resource table: LOCTRAN

ColumnName  Type  Len  Description
-----
DUMPING     CVDAS 00004 Dumping Option
PRIORITY    BINARY 00004 Priority
PURGEABILITY CVDAS 00004 Purgability ( SPURGE )
RUNAWAY     BINARY 00004 Runaway time in milliseconds
RUNAWAYTYPE CVDAS 00004 Runaway time type
SHUTDOWN    CVDAS 00004 Shutdown run status
STATUS      CVDAS 00004 Enabled Status
TRACING     CVDAS 00004 Tracing option
TRANCLASS   CHAR 00008 Transaction Class
TRANID      CHAR 00008 Name
***** Bottom of Data *****
```

Figure 19. List of modifiable attributes in a resource table

**Note:** You cannot specify a modification expression when:

- The resource table named in the Table Name field is EVENT or any one of the monitor tables (such as, MLOCTRAN).
- The Result Set Action field contains a value of AVG, CNT, or SUM, since the original data is no longer available once these evaluations are performed.

## RTADEF (Analysis definitions)

An analysis definition identifies the evaluations to be performed on a periodic basis and the actions to be taken should a notifiable condition occur. Examples of how to use this view can be found in “Chapter 5. Example tasks: real-time analysis” on page 85.

To display information about existing analysis definitions, issue the command:

```
RTADEF [rtadef]
```

where `rtadef` is the specific or generic name of an analysis definition. If you omit this parameter, the resulting view, illustrated in Figure 20, includes information about all analysis definitions for the CICSplex identified as the context.

```

26MAR1999 21:02:48 ----- INFORMATION DISPLAY -----
COMMAND ==>
CURR WIN ==> 1          ALT WIN ==>
W1 =RTADEF=====EYUPLX01=EYUPLX01=26MAR1999==21:02:48=CPSM=====10===
CMD Name      Intv Action  Description
-----
EYURTDLC      60 EYURTALC SSet - License
EYURTD01      300 EYURTA01 SSet - All connections
EYURTD02      300 EYURTA02 SSet - All DFHCSD files
EYURTD16      300 EYURTA16 SSet - Empty files
EYURTD17      300 EYURTA17 SSet - DBCTL at maxthreads
EYURTD18      300 EYURTA18 SSet - DTR not set correctly
EYURTD19      300 EYURTA19 SSet - Monitoring inactive
EYURTD20      300 EYURTA20 SSet - DSA free space %
EYURTD21      300 EYURTA21 SSet - Outstanding EVENTS
EYURTD22      300 EYURTA22 SSet - Dumps suppressed

```

Figure 20. The RTADEF view

## Action commands

Table 11 summarizes the action commands you can use with the RTADEF view.

Table 11. RTADEF view action commands

Primary command	Line command	Description
n/a	ADD	Add an association between an analysis definition and an analysis group, as described on page 46.
n/a	AIN	Install an analysis definition in an analysis point specification, as described on page 48.
n/a	BRO	Browse an analysis definition in the data repository.

The format of the resulting panel is similar to that shown in Figure 21 on page 45. The panel fields are not modifiable.

## RTADEF

Table 11. RTADEF view action commands (continued)

Primary command	Line command	Description
CREate	CRE	Create an analysis definition and add it to the data repository, as described in <i>Creating an analysis definition</i> .  When you use the primary command CREate, some fields in the new view may contain values supplied by CICSplex SM; you may change these values. When you enter the line command CRE next to the name of an analysis definition, fields in the new view contain values to be modelled (from the existing analysis definition).
n/a	INS	Install an analysis definition in a CICS system or CICS system group, as described on page 47.
n/a	MAP	Display a visual map of real-time analysis definitions using the specified definition as a starting point.
n/a	REM	Remove an analysis definition from the data repository.
TEMPMP cmasid	n/a	Change the temporary maintenance point CMAS to a specific CMAS or display a selection list based on a generic CMAS ID.
n/a	UPD	Update an analysis definition in the data repository.  The format of the resulting panel is similar to the panel shown in Figure 21. You can modify the contents of any field in the panel except Name.

### Hyperlink fields

There are no hyperlink fields on the RTADEF view.

### Creating an analysis definition

Figure 21 on page 45 shows the format of the panel produced when you use the create primary (CREate) or line (CRE) action command from the RTADEF view.

```

----- Create Analysis Definition for EYUPLX01 -----
COMMAND ==>

Name          ==> EYURTD01
Description   ==>
Perform Ops   ==> NO          Perform EVALDEF operations changes (YES, NO)
Sample Interval ==> 60        Interval between samples in seconds (1-86400)
Action Name   ==>           Action definition name or generic

                VLS   LS   LW   HW   HS   VHS
Entry Intervals ==> 5   5   5   5   5   5
Exit Intervals  ==> 2   3   1   1   1   1

Evaluation expression:
==> EYURTE01
==>
==>
==>
==>
==>

Press Enter to create the Analysis Definition.
Type END or CANCEL to cancel without creating.

```

Figure 21. Creating an analysis definition

Provide the following information, as appropriate:

**Name** Specify a 1- to 8-character name for the analysis definition. The name can contain alphabetic, numeric, or national characters. However, the first character must be alphabetic,

**Description**

(Optional.) Specify a 1- to 30-character description of the definition.

**Perform Ops**

Specify YES or NO to indicate whether any resource modifications are to be performed when the condition or conditions being analyzed are true.

Resource modifications are defined as part of the evaluation definitions associated with this analysis definition. If you specify YES, CICSplex SM attempts to perform the modification when the condition described by its evaluation definition is true. If you specify NO, the modification is not performed.

**Notes:**

1. CICSplex SM attempts to perform the requested modification only once. If the modification is not successful for any reason (such as the resource is in use or is not available), it is not retried. If the condition generates a CICSplex SM event, the event remains displayed on the EVENT view, if the modification cannot be made.
2. The actions requested in an action definition (such as events or external messages) are always performed, regardless of whether any resource modification is requested.

**Sample Interval**

Indicate, in seconds, the interval between samples of the specific conditions being evaluated. The definition names specified in the Evaluation Expression field identify the conditions. The value must be between 1 and 86400.

## RTADEF

### Action Name

Enter the specific or generic name of an action definition that is to be associated with this definition. An action definition, as described on page 26, indicates what is to happen when the condition or conditions being analyzed are true. If you specify a generic value, a list of valid action definitions is displayed.

If the action definition cannot be located when this analysis definition is installed in a CICS system and the designated condition or conditions become true, only CICSplex SM event notification will occur.

### Entry Intervals

Indicate the number of consecutive evaluation time periods, for each severity level, during which the designated condition or conditions must be true before any action is taken. The value must be between 1 and 9999.

### Exit Intervals

Indicate the number of consecutive evaluation time periods, for each severity level, during which the designated condition or conditions must be false before any action is taken. The value must be between 1 and 9999.

### Evaluation Expression

Identify one or more evaluation definitions that are to be analyzed.

When you specify multiple definition names, you can indicate how they are to be evaluated by using the operators & (AND) or | (OR). You can also use parentheses to group subsets of evaluation definitions. For example, if you specify:

```
EVALDEF1 | (EVALDEF2 & EVALDEF3)
```

the conditions identified by EVALDEF2 and EVALDEF3 are evaluated first. Then the condition EVALDEF1 is evaluated. If EVALDEF2 and EVALDEF3 are true or if EVALDEF1 is true, the analysis is true.

When you evaluate multiple evaluation definitions and more than one of them returns a true value, the highest severity level assigned to those definitions is used.

Press Enter to add this analysis definition to the data repository.

## Adding an association to an analysis group

Figure 22 illustrates the panel produced when you use the add (ADD) line action command from the RTADEF view.

```
----- Add RTADEF to Analysis Group for EYUPLX01 -----
COMMAND ==>

Name                EYURTD01
Description          Sample definition

Analysis Group      ==> EYURTG01   Analysis Group or Generic
Active Period       ==> PRIME      Period Name or Generic

Press Enter to add RTADEF to Analysis Group.
Type END or CANCEL to cancel without adding.
```

Figure 22. Associating an analysis definition and an analysis group



Provide the following information:

### Analysis Group

Enter the specific or generic name of an existing analysis group. If you specify a generic value, a list of valid analysis groups is displayed.

### Active Period

(Optional) Enter the specific or generic name of a period definition that identifies the range of hours during which the analysis definition is to be active. If you specify a generic value, a list of valid period definitions is displayed.

If the name you specify is not an existing period definition, you can create that period definition later. If you leave this field blank, the analysis definition remains active for as long as the CICS system is running or until you discard it.

Press Enter to add the association to the designated analysis definition and analysis group in the data repository.

If the appropriate analysis group does not currently exist, you must first create the group, as described on page 51. Then you can add the definition to that group, using either this action command or the action command described on page 59.

To remove a definition from an analysis group, see page 58.

## Installing an analysis definition

You can install an analysis definition for one or more active CICS systems that are within the CICSplex identified as the context.

An analysis definition can be automatically installed for a CICS system when that system starts. For this to occur, associate the definition with an analysis group. Then associate that group with an analysis specification that is defined to the CICS system.

Figure 23 illustrates the panel produced when you use the install (INS) line action command from the RTADEF view.

```

----- Install RTADEF for EYUPLX01 -----
COMMAND ==>

Name          EYURTD01
Description   SSet - All connections

Type          RTADEF

Scope         ==>          CICS System, System Group, or Generic
Active Period ==>          Blank, PERIODEF, or Generic

Press Enter to install Analysis Definition.
Type END or CANCEL to cancel without installing.

```

Figure 23. Installing an analysis definition

Provide the following information:

**Scope** Enter the specific or generic name of a CICS system or CICS system group for which the definition is to be installed. The CICS system or CICS system

## RTADEF

group must be within the CICSplex identified as the current context. If you specify a generic value, a list of valid CICS systems and CICS system groups is displayed.

### Active Period

(Optional) Enter the specific or generic name of an existing period definition that identifies the range of hours during which the analysis definition is to be active. If you specify a generic value, a list of valid period definitions is displayed.

Press Enter to install the definition in the designated CICS systems.

For an installation to succeed, the CICS system must be running and real-time analysis must be active. Additionally, associated evaluation definitions must refer to resource tables that are supported in the target CICS system. If CICSplex SM detects otherwise, it issues a message indicating that the definitions are not installed in those systems that do not support the specified resource table.

The analysis definition becomes active either:

- Immediately, if no period definition is associated with it and the CICS system is running
- At the time designated by the associated period definition

The analysis definition remains active as long as the CICS system is running, until you discard it, or until the time designated by an associated period definition is reached.

To discard an analysis definition installed in a CICS system, use the RTAACTV view as described in Table 3 on page 7.

## Installing an analysis definition into an analysis point specification

Figure 24 illustrates the panel produced when you use the install (AIN) line action command from the RTADEF view.

```
----- Install RTADEF for EYUPLX01 -----
COMMAND  ==>>

Name           EYURTD01
Description    SSet - All connections

Type           RTADEF

AP Spec Name   ==>>           Active Analysis Point Spec or Generic
Scope         ==>>           CICS System, System Group, or Generic

Press Enter to install Analysis Definition.
Type END or CANCEL to cancel without installing.
```

Figure 24. Installing an analysis definition into an analysis point specification

Provide the following information:

### AP Spec Name

Enter the specific or generic name of an analysis point specification to which this definition is to be added. If you specify a generic value, a list of valid analysis point specifications is displayed.

**Scope** (Optional.) Enter the specific or generic name of a CICS system or CICS system group that is to be evaluated by the analysis point specification when processing analysis definitions. If you specify a generic value, a list of valid CICS systems and CICS system groups is displayed. If you leave this field blank, all CICS systems in the CICSplex are evaluated.

Press Enter to install the analysis definition into the analysis point specification.

If an analysis definition is associated with an evaluation definition that refers to a resource table that is not supported in the target CICS system, CICSplex SM issues a message indicating that the definitions are not installed because the resource is not supported.

## RTAGROUP (Analysis groups)

An analysis group is used to associate one or more related analysis definitions, status definitions, or both. Examples of how to use this view can be found in:

- “Monitoring resources permanently” on page 93
- “Monitoring multiple resource types in a CICS system group (2)” on page 107
- “Issuing one notification for multiple conditions (1)” on page 116

To display information about existing analysis groups, issue the command:

```
RTAGROUP [rtagroup]
```

where rtagroup is the specific or generic name of an analysis group. If you omit this parameter, the resulting view, illustrated in Figure 25, includes information about all analysis groups for the CICSplex identified as the context.

```

26MAR1999 21:02:56 ----- INFORMATION DISPLAY -----
COMMAND ==>
CURR WIN ==> 1          ALT WIN ==>
W1 =RTAGROUP=====EYUPLX01=EYUPLX01=26MAR1999==21:02:56=CPSM=====4===
CMD Analysis Description
--- Group--- -----
EYURTG01 SSet - License
EYURTG02 SSet - FOR related definitions
EYURTG07 SSet - Plex wide definitions
EYURTG07 SSet - TOR related definitions

```

Figure 25. The RTAGROUP view

## Action commands and overwrite fields

Table 12 summarizes the action commands you can use with the RTAGROUP view. Table 13 on page 50 identifies the overwrite fields you can modify when you use the SET action command.

Table 12. RTAGROUP view action commands

Primary command	Line command	Description
n/a	AAP	Add an association between an analysis group and an analysis point specification, as described on page 51.
n/a	ADD	Add an association between an analysis group and an analysis specification, as described on page 52.

## RTAGROUP

Table 12. RTAGROUP view action commands (continued)

Primary command	Line command	Description
n/a	AIN	Install an analysis group in an active analysis point specification, as described on page 54.
n/a	ASC	Add an association between an analysis or status definition and an analysis group, as described on page 52.
n/a	BRO	Browse an analysis group in the data repository.
CREate	CRE	The format of the resulting panel is similar to that shown in Figure 26 on page 51. The panel fields are not modifiable. Create an analysis group and add it to the data repository, as described in Creating an analysis group.
n/a	INS	Install an analysis group in a CICS system or CICS system group, as described on page 53.
n/a	MAP	Display a visual map of real-time analysis definitions using the specified group as a starting point.
n/a	REM	Remove an analysis group from the data repository.
n/a	SET	Change the description of an analysis group using an overtype field (see Table 13). <b>Note:</b> The value you specified in the Require Set field on the CICSplex System Manager entry panel determines whether or not you must use the SET command when you overtype a field.
TEMPMP cmasid	n/a	Change the temporary maintenance point CMAS to a specific CMAS or display a selection list based on a generic CMAS ID.
n/a	UPD	Update an analysis group in the data repository.  The format of the resulting panel is similar to that shown in Figure 26 on page 51. You can change the Description field.

Table 13. RTAGROUP view overtype fields

Field name	Value
Description	One- to 30-character description of the analysis group.

## Hyperlink fields

Table 14 shows the hyperlink field on the RTAGROUP view.

Table 14. RTAGROUP view hyperlink field

Hyperlink field	View displayed	Description
Analysis Group	RTAINGRP	Detailed information about analysis and status definitions associated with the designated analysis group.

## Creating an analysis group

Figure 26 shows the format of the panel produced when you use the create primary (CREate) or line (CRE) action command from the RTAGROUP view.

```

----- Create Analysis Group for EYUPLX01-----
COMMAND ==>

Group Name          ==> EYURTG02
Description         ==> SSet - Plex wide definitions

Press Enter to create Analysis Group.
Type END or CANCEL to cancel without creating.

```

Figure 26. Creating an analysis group

Provide the following information, as appropriate:

**Name** Specify a 1- to 8-character name for the group. The name can contain alphabetic, numeric, or national characters. However, the first character must be alphabetic,

**Description**

(Optional.) Specify a 1- to 30-character description of the group.

Press Enter to add the analysis group to the data repository.

## Adding an association to an analysis point specification

Figure 27 illustrates the panel produced when you use the add (AAP) line action command from the RTAGROUP view.

```

----- Add Analysis Group to AP Specification for EYUPLX01 -----
COMMAND ==>

Analysis Group          EYURTG01
Description

Analysis Specification Name ==> EYURTS02  Spec Name or Generic

Scope                  ==>                System, Group, or Generic

Press ENTER to add Analysis Group to Specification.
Type END or CANCEL to cancel without adding.

```

Figure 27. Adding an analysis group and analysis point specification association

Provide the following information:

**Analysis Specification Name**

Enter the specific or generic name of an existing analysis point specification. If you specify a generic value, a list of valid analysis point specifications is displayed.

**Scope** (Optional.) Enter the specific or generic name of a CICS system or CICS system group that is to be evaluated by the analysis point when processing

## RTAGROUP

analysis definitions. If you specify a generic value, a list of valid CICS systems and CICS system groups is displayed. If you leave this field blank, all CICS systems in the CICSplex are evaluated.

### Adding an association to an analysis specification

Figure 28 illustrates the panel produced when you use the add (ADD) line action command from the RTAGROUP view.

```
-----Add Analysis Group to Analysis Specification for EYUPLX01 -----
COMMAND ==>

Analysis Group          EYURTG01
Description              SSet - FOR related definitions

Specification Name ==> EYURTS01  Specification Name or Generic

Press Enter to add RTA Group to RTA Specification.
Type END or CANCEL to cancel without adding.
```

Figure 28. Adding an association between an analysis group and specification

Provide the following information:

#### Specification Name

Enter the specific or generic name of an existing analysis specification. If you specify a generic value, a list of valid analysis specifications is displayed.

Press Enter to add the name of the analysis specification to the designated analysis group.

If the appropriate analysis specification does not currently exist, you must first create it, as described on page 67. Then you can add the group to that specification, using either this action command or the action command described on page 61.

To remove a group from an analysis specification, see page 60.

### Associating a definition with an analysis group

Figure 29 illustrates the panel produced when you use the associate (ASC) line action command from the RTAGROUP view.

```

----- Add Analysis Definition to Group for EYUPLX01 -----
COMMAND  ==>

Analysis Group Name      EYUROG01
Description              Sample analysis group

Analysis Definition Name ==> EYUMOD01   Analysis Definition or Generic
Active Period           ==> EYUMOD01   Period Definition or Generic

Press Enter to add Analysis Definition to Group.
Type END or CANCEL to cancel without adding.

```

Figure 29. Associating a definition with an analysis group

Provide the following information, as appropriate:

#### Definition Name

Enter the specific or generic name of an existing analysis or status definition that is to be associated with the analysis group. If you specify a generic value, a list of valid definitions is displayed.

#### Active Period

(Optional) Enter the specific or generic name of a period definition that identifies the range of hours during which the analysis or status definition is to be active. If you specify a generic value, a list of valid period definitions is displayed.

If the name you specify does not belong to an existing period definition you can create that period definition later. If you leave this field blank, the analysis or status definition remains active for as long as the CICS system is running, or until you discard it.

Press Enter to associate the analysis or status definition with the analysis group in the data repository.

## Installing an analysis group

When you install an analysis group, all of the analysis definitions associated with that group are installed in the CICS systems that are using the analysis specification to which the analysis group is associated.

**Note:** The analysis definitions associated with an analysis group can be automatically installed in a CICS system when that system starts. For this to occur, the analysis group must be associated with an analysis specification that is defined to the CICS system.

Figure 23 on page 47 illustrates the panel produced when you use the install (INS) line action command from the RTAGROUP view.

## RTAGROUP

```
----- Install RTAGROUP for EYUPLX01 -----  
COMMAND ===>  
  
Name           EYURTG02  
Description    SSet - Plex wide definitions  
  
Type           RTAGROUP  
  
Scope         ===>           CICS System, System Group, or Generic  
  
Press Enter to install definitions.  
Type END or CANCEL to cancel without installing.
```

Figure 30. Installing an analysis group

Provide the following information:

**Scope** Enter the specific or generic name of an active CICS system or CICS system group into which the analysis definitions associated with this analysis group are to be installed. The CICS system or CICS system group must be within the CICSplex identified as the current context. If you specify a generic value, a list of valid CICS systems and CICS system groups is displayed.

Press Enter to install the analysis definitions associated with the analysis group into the designated CICS system or into all of the CICS systems comprising the designated CICS system group.

For an installation to succeed, the CICS system must be running and real-time analysis must be active. The analysis definition becomes active either:

- Immediately, if no period definition is associated with it and the CICS system is running.
- At the time designated by the associated period definition.

The analysis definition remains active as long as the CICS system is running, until you discard it, or until the time designated by an associated period definition is reached.

To discard an analysis definition installed in a CICS system, use the RTAACTV view as described in Table 3 on page 7.

### Installing an analysis group into an analysis point specification

Figure 31 on page 55 illustrates the panel produced when you use the install (AIN) line action command from the RTAGROUP view.



```

----- Install RTAGROUP for EYUPLX01 -----
COMMAND ==>

Name          EYURTG01
Description    SSet - FOR related definitions

Type          RTAGROUP

AP Spec Name   ==>          Active Analysis Point Spec or Generic
Scope         ==>          CICS System, Group, or Generic

Press Enter to install definitions.
Type END or CANCEL to cancel without installing.

```

Figure 31. Installing an analysis group into an analysis point specification

Provide the following information:

#### AP Spec Name

Enter the specific or generic name of the analysis point specification to which the analysis definitions in this group are to be added. If you specify a generic value, a list of valid analysis point specifications is displayed.

**Scope** (Optional.) Enter the specific or generic name of a CICS system or CICS system group that is to be evaluated by the analysis point specification when processing analysis definitions. If you specify a generic value, a list of valid CICS systems and CICS system groups is displayed. If you leave this field blank, all CICS systems in the CICSplex are evaluated.

Press Enter to install the analysis definitions comprising the analysis group into the designated analysis point specification.

---

## RTAINAPS (Analysis groups in analysis point specifications)

To display the names of analysis groups associated with analysis point specifications, issue the command:

```
RTAINAPS [apspec [rtagroup]]
```

where:

**apspec** Is a specific or generic name of an analysis point specification or \* (asterisk) for all analysis point specifications.

#### **rtagroup**

Is a specific or generic name of an analysis group. If you omit this parameter, the view includes information about all analysis groups associated with the analysis point specifications.

If you do not specify any parameters, the resulting view, illustrated in Figure 32 on page 56, includes information about all analysis point specifications and the analysis groups associated with them.

## RTAINAPS

```

26MAR1999 21:03:16 ----- INFORMATION DISPLAY -----
COMMAND ==>
CURR WIN ==> 1          ALT WIN ==>          SCROLL ==> PAGE
W1 =RTAINAPS=====EYUPLX01=EYUPLX01=26MAR1999==21:03:16=CPSM=====1===
CMD Spec      Group   Scope
--- Name----- Name-----
EYURAP01 EYURTG02 EYUPLX01

```

Figure 32. The RTAINAPS view

### Action commands

Table 15 summarizes the action commands you can use with the RTAINAPS view.

Table 15. RTAINAPS view action commands

Primary command	Line command	Description
n/a	ADD	Add an association between an analysis group and an analysis point specification, as described on page 56.
n/a	BRO	Browse the association between an analysis group and an analysis point specification.  The format of the resulting panel is similar to that shown in Figure 33 on page 57. The panel fields are not modifiable.
n/a	MAP	Display a visual map of real-time analysis definitions using the designated specification as a starting point.
n/a	REM	Remove the association between an analysis group and an analysis point specification.
TEMPMP cmasid	n/a	Change the temporary maintenance point CMAS to a specific CMAS or display a selection list based on a generic CMAS ID.

### Hyperlink fields

Table 16 shows the hyperlink fields on the RTAINAPS view.

Table 16. RTAINAPS view hyperlink field

Hyperlink field	View displayed	Description
Spec Name	APSPEC	Detailed information about the designated analysis point specification.
Group Name	RTAGROUP	Detailed information about the designated analysis group.

### Adding an analysis group to an analysis point specification

Figure 33 on page 57 illustrates the panel produced when you use the add (ADD) line action command from the RTAINAPS view.

```

----- Add Analysis Group to AP Specification for EYUPLX01-----
COMMAND ==>

Analysis group name      ==> EYURTG01  Analysis Group or Generic
Analysis Specification Name ==> EYURTS02  Analysis Spec or Generic
Scope                   ==> EYUCSG01  CICS System, Group or Generic

Press Enter to add Analysis Group to Specification.
Type END or CANCEL to cancel without adding.

```

Figure 33. Adding an analysis group to an analysis point specification

Provide the following information:

**Analysis Group Name**

Enter the specific or generic name of an existing analysis group. If you specify a generic value, a list of valid analysis groups is displayed.

**Analysis Specification Name**

Enter the specific or generic name of an existing analysis point specification to which the analysis group is to be added. If you specify a generic value, a list of valid analysis point specifications is displayed.

**Scope** (Optional) Enter the specific or generic name of CICS system or CICS system group that is to be evaluated by the analysis point specification when processing analysis definitions. If you specify a generic value, a list of valid CICS systems and CICS system groups is displayed. If you leave this field blank, all CICS systems in the CICSplex are evaluated.

Press Enter to add the designated association to the analysis point specification and analysis group definitions in the data repository.

---

## RTAINGRP (Analysis and status definitions in analysis groups)

To display the names of analysis groups and the analysis and status definitions associated with them, issue the command:

```
RTAINGRP [rtagroup [defname [RTADEF|STATDEF]]]
```

where:

**rtagroup**

Is a specific or generic name of an analysis group or \* (asterisk) for all analysis groups.

**defname**

Is a specific or generic name of an analysis definition, status definition, or \* (asterisk) for all definitions associated with designated analysis groups.

**RTADEF|STATDEF**

Limits the view to only analysis or status definitions. If you omit this parameter, the view includes information about both types of definitions that are associated with the designated analysis groups and definitions.

## RTAINGRP

If you do not specify any parameters, the resulting view, illustrated in Figure 34 , includes information about all analysis groups and the analysis and status definitions associated with them.

```

26MAR1999 21:03:32 ----- INFORMATION DISPLAY -----
COMMAND ==>
CURR WIN ==> 1          ALT WIN ==>
W1 =RTAINGRP=====EYUPLX01=EYUPLX01=26MAR1999==21:03:31=CPSM=====6===
CMD Group  Def      Def      Active
--- Name---- Name---- Type---- Period--
EYURTG02  EYURTD01 RTADEF
EYURTG02  EYURTD02 RTADEF  EYUPDF01
EYURTG02  EYURTD19 RTADEF
EYURTG02  EYURTD20 RTADEF
EYURTG02  EYURTD21 RTADEF
EYURTG02  EYURTD22 RTADEF
  
```

Figure 34. The RTAINGRP view

## Action commands

Table 17 summarizes the action commands you can use with the RTAINGRP view. Table 18 on page 59 identifies the overtyp field you can modify when you use the SET action command.

Table 17. RTAINGRP view action commands

Primary command	Line command	Description
n/a	ADD	Add an association between an analysis or status definition and an analysis group, as described on page 59.
n/a	BRO	Browse the association between an analysis or status definition and an analysis group.
n/a	MAP	The format of the resulting panel is similar to that shown in Figure 35 on page 59. The panel fields are not modifiable. Display a visual map of real-time analysis definitions using the specified group as a starting point.
n/a	REM	Remove the association between an analysis or status definition and an analysis group.
n/a	SET	Change the time period associated with the analysis group using an overtyp field (see Table 18). <b>Note:</b> The value you specified in the Require Set field on the CICSplex System Manager entry panel determines whether or not you must use the SET command when you overtyp a field.
TEMPMP cmasid	n/a	Change the temporary maintenance point CMAS to a specific CMAS or display a selection list based on a generic CMAS ID.
n/a	UPD	Update the association between an analysis or status definition and an analysis group.  The format of the resulting panel is similar to that shown in Figure 35 on page 59. You can change the Active Period field.

Table 18. RTAINGRP view overtime field

Field name	Value
Active Period	Name of a new or existing time period definition.

## Hyperlink fields

Table 19 shows the hyperlink fields on the RTAINGRP view.

Table 19. RTAINGRP view hyperlink field

Hyperlink field	View displayed	Description
Group Name	RTAGROUP	Detailed information about the designated analysis group.
Def Name	RTADEF or STATDEF	Detailed information about the designated analysis or status definition.

## Adding a definition to an analysis group

Figure 35 illustrates the panel produced when you use the add (ADD) line action command from the RTAINGRP view.

```

----- Add RTA or Status Definition to Analysis Group for EYUPLX01-----
COMMAND ==>

Analysis Group          ==> EYURTG01    Group Name or Generic
RTA or status definition ==> EYURTD16    RTADEF, STATDEF or Generic
Definition type         ==> RTADEF      (RTADEF/STATDEF)
Active Period           ==> PRIME       Period Name, Generic, or blank

Press ENTER to add Definition to Analysis Group.
Type END or CANCEL to cancel without adding.

```

Figure 35. Adding a definition to an analysis group

Provide the following information:

### Analysis Group

Enter the specific or generic name of an existing analysis group to which you are adding a definition. If you specify a generic value, a list of valid analysis groups is displayed.

### RTA or Status Definition

Enter the specific or generic name of an existing analysis or status definition. If you specify a generic value, a list of valid analysis and status definitions is displayed.

### Definition Type

Specify RTADEF or STATDEF to indicate the type of definition you are associating with the analysis group.

### Active Period

(Optional.) Enter the specific or generic name of a period definition that identifies the range of hours during which the analysis or status definition is to be active. If you specify a generic value, a list of valid period definitions is displayed.

## RTAINGRP

If the name you specify is not an existing period definition, you can create that period definition later. If you leave this field blank, the analysis definition remains active for as long as the CICS system is running or until you discard it.

Press Enter to add the association to the designated analysis group and analysis or status definition in the data repository.

---

## RTAINSPC (Analysis groups in analysis specifications)

To display the names of analysis specifications and the analysis groups associated with them, issue the command:

```
RTAINSPC [rtaspec [rtagroup]]
```

where:

### **rtaspec**

Is the specific or generic name of an analysis specification or \* (asterisk) for all analysis specifications.

### **rtagroup**

Is the specific or generic name of an analysis group. If you omit this parameter, the view includes information about all analysis groups associated with the analysis specifications.

If you do not specify any parameters, the resulting view, illustrated in Figure 36, includes information about all analysis specifications and the analysis groups associated with them.

```
26MAR1999 21:03:49 ----- INFORMATION DISPLAY -----  
COMMAND ==> SCROLL ==> PAGE  
CURR WIN ==> 1 ALT WIN ==>  
W1 =RTAINSPC=====EYUPLX01=EYUPLX01=26MAR1999==21:03:49=CPSM=====1===  
CMD Spec Group  
--- Name---- Name----  
EYURTS01 EYURTG07
```

Figure 36. The RTAINSPC view

## Action commands

Table 20 summarizes the action commands you can use with the RTAINSPC view.

Table 20. RTAINSPC view action commands

Primary command	Line command	Description
n/a	ADD	Add an association between an analysis group and an analysis specification, as described on page 61.
n/a	BRO	Browse the association between an analysis group and an analysis specification.

The format of the resulting panel is similar to that shown in Figure 37 on page 61. The panel fields are not modifiable.

Table 20. RTAINSPC view action commands (continued)

Primary command	Line command	Description
n/a	MAP	Display a visual map of real-time analysis definitions using the designated specification as a starting point.
n/a	REM	Remove the association between an analysis group and an analysis specification.
TEMPMP cmasid	n/a	Change the temporary maintenance point CMAS to a specific CMAS or display a selection list based on a generic CMAS ID.

## Hyperlink fields

Table 21 shows the hyperlink fields on the RTAINSPC view.

Table 21. RTAINSPC view hyperlink field

Hyperlink field	View displayed	Description
Spec Name	RTASPEC	Detailed information about the designated analysis specification.
Group Name	RTAGROUP	Detailed information about the designated analysis group.

## Adding an analysis group to an analysis specification

Figure 37 illustrates the panel produced when you use the add (ADD) line action command from the RTAINSPC view.

```

----- Add Analysis Group to Specification for EYUPLX01-----
COMMAND ==>

Analysis Group Name ==> EYURTG01   RTA Group or Generic

Specification Name ==> EYURTS03   RTA Specification or Generic

Press Enter to add Analysis Group to Specification.
Type END or CANCEL to cancel without adding.

```

Figure 37. Adding an analysis group to an analysis specification

Provide the following information:

### Analysis Group Name

Enter the specific or generic name of an existing analysis group. If you specify a generic value, a list of valid analysis groups is displayed.

### Specification Name

Enter the specific or generic name of an existing analysis specification to which the analysis group is to be added. If you specify a generic value, a list of valid analysis specifications is displayed.

Press Enter to add the designated association to the analysis specification and analysis group definitions in the data repository.

## RTASCOPE (Analysis specifications assigned a scope)

To display information about the CICS systems or CICS system groups that are associated with an analysis specification, issue the command:

```
RTASCOPE [rtaspec]
```

where *rtaspec* is a specific or generic name of an analysis specification. If you omit this parameter, the resulting view, illustrated in Figure 38, includes information about all analysis specifications, and the associated scope information, for the CICSplex identified as the context.

```

26MAR1999 21:03:56 ----- INFORMATION DISPLAY -----
COMMAND ==>
CURR WIN ==> 1          ALT WIN ==>
W1 =RTASCOPE=====EYUPLX01=EYUPLX01=26MAR1999==21:03:56=CPSM=====2===
CMD RTA      Scope  Scope  Scope  Scope  Update
--- Spec---- Name---- Type---- Mode---- Link---- Option--
EYURTS01 EYUMAS1A CICSSYS EXPLICIT
EYURTS03 EYUMAS4A CICSSYS EXPLICIT
    
```

Figure 38. The RTASCOPE view

### Action commands and overtype fields

Table 22 summarizes the action commands you can use with the RTASCOPE view. Table 23 on page 63 identifies the overtype fields you can modify when you use the SET action command.

Table 22. RTASCOPE view action commands

Primary command	Line command	Description
n/a	BRO	Browse the association between a scope and an analysis specification.  The format of the resulting panel is similar to that shown in Figure 39 on page 64. The panel fields are not modifiable.
n/a	MAP	Display a visual map of real-time analysis definitions using the designated specification as a starting point.
n/a	REM	Remove the association between a scope and an analysis specification, as described on page 65.
n/a	SET	Change the association between a scope and an analysis specification using overtype fields (see Table 23 on page 63). <b>Note:</b> The value you specified in the Require Set field on the CICSplex System Manager entry panel determines whether or not you must use the SET command when you overtype a field.
TEMPMP cmasid	n/a	Change the temporary maintenance point CMAS to a specific CMAS or display a selection list based on a generic CMAS ID.
n/a	UPD	Update the association between a scope and an analysis specification, as described in Updating scope-to-analysis specification associations.



When you change or remove the analysis specification associated with a CICS system group, you must indicate how the CICS systems comprising that group are to be affected.

Based on the value you specify, the number of entries shown in the RTASCOPE view may increase or decrease. For example, you might specify a value that causes a CICS system within a CICS system group to be explicitly associated with a specification, rather than inherit it from its CICS system group. When this happens, the resulting RTASCOPE view contains a line identifying the CICS system group and a new line identifying the CICS system that is now explicitly associated with a specification.

Table 23. RTASCOPE view ovrtype fields

Field name	Value
RTA Spec	1- to 8-character name of an existing analysis specification that is to be associated with the CICS system or CICS system group.
Update Option	FORCE   KEEP   NAME   NULL

**Notes:**

1. When the scope of the analysis specification is a CICS system group, you must indicate how the CICS systems comprising the CICS system group are to use the specification by overtyping the contents of the Update Option field.  
If the CICS system group includes other CICS system groups, all of the CICS systems, including those in the subordinate CICS system groups, are affected by the value specified in the Update Option field.
2. If you update the analysis specification for a CICS system that is already active, you must restart real-time analysis, as described in “Updating scope-to-analysis specification associations”.

## Hyperlink fields

Table 24 shows the hyperlink field on the RTASCOPE view.

Table 24. RTASCOPE view hyperlink field

Hyperlink field	View displayed	Description
RTA Spec	RTASPEC	Detailed information about the designated analysis specification.

## Updating scope-to-analysis specification associations

Figure 39 illustrates the panel produced when you use the update (UPD) line action command from the RTASCOPE view.

```

----- Update RTA Specification in Scope for EYUPLX01 -----
COMMAND ==>

Specification Name ==> EYURTS01 Specification name or Generic
Scope              EYUCSG01
Scope Type         SYSGROUP

Option             ==>          FORCE, KEEP, NAME, or NULL
                                   Valid only for SYSGROUP

Press ENTER to update.
Type END or CANCEL to cancel without updating.

```

Figure 39. Updating the association between a scope and an analysis specification

The Option field does not appear on this panel when the scope is a CICS system (CICSSYS).

Change the following information, as appropriate:

#### Specification Name

Enter the specific or generic name of an existing analysis specification. If you specify a generic value, a list of valid analysis specifications is displayed.

#### Option

When the scope of the analysis specification is a CICS system group, you must indicate how the CICS systems comprising the CICS system group are to use the specification. To do this, specify one of the following:

##### FORCE

All CICS systems in the CICS system group are to inherit the new specification.

**KEEP** Any CICS system that inherited a specification from the CICS system group is to be explicitly assigned the old specification; all other CICS systems in the group are to be unaffected.

##### NAME

Any CICS system that inherited a specification from the CICS system group is to be explicitly assigned the new specification; all other CICS systems in the group are to be unaffected.

**NULL** Any CICS system in the CICS system group that is not explicitly associated with a specification is to inherit the new specification; all other CICS systems in the group are to be unaffected.

If the CICS system group includes other CICS system groups, all of the CICS systems, including those in the subordinate CICS system groups, are affected by the value specified in the Option field.

If you update the analysis specification for a CICS system that is already active, the new specification is not immediately available. To reset real-time analysis, you must display the MAS view and use the UPD action command to do one of the following:

- If real-time analysis is not already active (as indicated by NO in the RTA Active field), specify YES in that field and press Enter to turn real-time analysis on.

- If real-time analysis is active (as indicated by YES or SAM in the RTA Active field), first specify NO in that field and press Enter to turn real-time analysis off. Then use the UPD action command again and specify YES in the RTA Active field.

Real-time analysis becomes active using the new analysis specification.

## Removing scope-to-analysis specification associations

Figure 40 illustrates the panel produced when you use the remove (REM) line action command from the RTASCOPE view.

```

----- Confirm Removal of RTA Spec to Scope from EYUPLX01 -----
COMMAND  ==>

Specification Name      EYURTS02
Scope                  EYUCSG01
Scope Type             SYSGROUP

Option                  ==>          KEEP or blank
                               Valid only for SYSGROUP

WARNING:  For this definition type, removal will cascade through
          related associations.

Press Enter to remove.
Type END or CANCEL to cancel without removing.

```

Figure 40. Removing the association between a scope and an analysis specification

The Option field does not appear on this panel when the scope is a CICS system (CICSSYS).

Provide the following information when the scope is a CICS system group:

### Option

Indicate how the CICS systems comprising the CICS system group are to use the analysis specification associated with that CICS system group. Specify:

**KEEP** Those CICS systems that inherited the specification from the CICS system group are explicitly assigned that specification.

**Blank** Those CICS system that inherited the specification from the CICS system group are not to use that specification.

If the CICS system group includes other CICS system groups, all of the CICS systems, including those in the subordinate CICS system groups, are affected by the value specified in this field.

Press Enter to remove the scope from the designated analysis specification definition in the data repository.

---

## RTASPEC (Analysis specifications)

An analysis specification identifies the default control attributes that are used for system availability monitoring and provides an anchor for all analysis definitions and status definitions associated with a CICS system.

Examples of how to use this view can be found in:

## RTASPEC

- “Monitoring resources permanently” on page 93
- “Monitoring multiple resource types in a CICS system group (2)” on page 107

To display information about existing analysis specifications, issue the command:

```
RTASPEC [rtaspec]
```

where `rtaspec` is the specific or generic name of an analysis specification. If you omit this parameter, the resulting view, illustrated in Figure 41, includes information about all analysis specifications for the CICSplex identified as the context.

```

26MAR1999 21:04:03 ----- INFORMATION DISPLAY -----
COMMAND ==>
CURR WIN ==> 1          ALT WIN ==>
W1 =RTASPEC=====EYUPLX01=EYUPLX01=26MAR1999==21:04:02=CPSM=====2===
CMD Spec      Description
--- Name-----
      EYURTS01 SSet - TOR groups
      EYURTS03 SSet - FOR groups
  
```

Figure 41. The RTASPEC view

## Action commands

Table 25 summarizes the action commands you can use with the RTASPEC view.

Table 25. RTASPEC view action commands

Primary command	Line command	Description
n/a	ADD	Add an association between an analysis specification and a CICS system or CICS system group, as described on page 68.
n/a	BRO	Browse an analysis specification definition in the data repository.
CREate	CRE	<p>Create an analysis specification and add it to the data repository, as described on page 67.</p> <p>The format of the resulting panel is similar to that shown in Figure 42 on page 67. The panel fields are not modifiable.</p> <p>When you use the primary command CREate, some fields in the new view may contain values supplied by CICSplex SM; you may change these values. When you enter the line command CRE next to the name of an analysis specification, fields in the new view contain values to be modelled (from the existing analysis specification).</p>
n/a	MAP	Display a visual map of real-time analysis definitions using the designated specification as a starting point.
n/a	REM	Remove an analysis specification from the data repository.
TEMPMP cmasid	n/a	Change the temporary maintenance point CMAS to a specific CMAS or display a selection list based on a generic CMAS ID.

Table 25. RTASPEC view action commands (continued)

Primary command	Line command	Description
n/a	UPD	Update an analysis specification in the data repository.  The format of the resulting panel is similar to the panel shown in Figure 42. You can modify the contents of any field in the panel except RTA Spec Name.

## Hyperlink fields

Table 26 shows the hyperlink field on the RTASPEC view.

Table 26. RTASPEC view hyperlink field

Hyperlink field	View displayed	Description
Spec Name	RTAINSPC	Detailed information about the associations that exist between the designated analysis specification and its analysis groups.

## Creating an analysis specification

Figure 42 shows the format of the panel produced when you use the create primary (CREate) or line (CRE) action command from the RTASPEC view.

```

----- Create Analysis Specification for EYUPLX01 -----
COMMAND ==>

RTA Spec Name    ==> EYURTS03
Description      ==> SSet - FOR groups

System availability management:

          Action or Generic   Severity
SAM              => NOSYSTEM => VHS
SOS              => DSAINSOS => HS
SYSDUMP          => CICS_DUMP => HS
TRANDUMP         => TRANDUMP => HW
MAXTASK          => CICS_MAXT => HS
STALL           => CICS_DEAD => VHS

Press Enter to create the RTA Specification.
Type END or CANCEL to cancel without creating.

```

Figure 42. Creating an analysis specification

Provide the following information, as appropriate:

### RTA Spec Name

Specify a 1- to 8-character name for the analysis specification. The name can contain alphabetic, numeric, or national characters. However, the first character must be alphabetic,

### Description

(Optional.) Specify a 1- to 30-character description of the specification.

### Action

Enter the specific or generic name of an action definition to be used when

a predefined system availability monitoring condition occurs. If you specify a generic value, a list of valid action definitions is displayed. If you leave this field blank, the default action definition is used, as described in “Default notification values” on page 12.

**Severity**

Indicate how the predefined condition is to be handled. Specify:

**severity**

Identify the severity level that is to be associated with the designated condition. The severity codes are:

- VLS** Very low severe
- LS** Low severe
- LW** Low warning
- HW** High warning
- HS** High severe
- VHS** Very high severe

**NO** Exclude this condition from monitoring.

Press Enter to add the analysis specification to the data repository.

**Adding a scope to an analysis specification**

Associating an analysis specification with a scope causes the specification to be automatically installed when a CICS system associated with the scope is started. Any definitions associated with the specification through analysis groups are also automatically installed.

However, if you associate the analysis specification with a CICS system that is already active, the new specification is not immediately available. To reset real-time analysis, you must display the MAS view and use the UPD action command to do one of the following:

- If real-time analysis is not already active (as indicated by NO in the RTA Active field), specify YES in that field and press Enter to turn real-time analysis on.
- If real-time analysis is active (as indicated by YES or SAM in the RTA Active field), first specify NO in that field and press Enter to turn real-time analysis off. Then use the UPD action command again and specify YES in the RTA Active field.

Real-time analysis becomes active using the new analysis specification.

Figure 43 on page 69 illustrates the panel produced when you use the add (ADD) line action command from the RTASPEC view.

```

----- Add Scope for Specification for EYUPLX01 -----
COMMAND ==>

Analysis Spec Name      EYURTS01
Description             SSet - TOR groups

Scope                   ==>          CICS System, Group or Generic
Option                  ==>          FORCE, NULL, or NONE for System Group

Press Enter to add Analysis Specification Scope.
Type END or CANCEL to cancel without adding.

```

Figure 43. Adding a scope to an analysis specification

Provide the following information:

**Scope** Enter the specific or generic name of an existing CICS system or CICS system group that is not associated with any other analysis specification. If you specify a generic value, a list of valid CICS systems and CICS system groups is displayed.

A CICS system or CICS system group can be associated with only one analysis specification at a time. A specification, however, can be associated with any number of CICS systems and CICS system groups.

**Option**

(Required only when the scope is a CICS system group.) Indicate how the CICS systems comprising the CICS system group are to handle analysis specifications. Specify:

**FORCE**

All CICS systems in the CICS system group are to use the analysis specification. (The analysis specification attribute for each CICS system changes to INHERIT, indicating that the CICS system acquired the specification from a CICS system group.)

**NULL** Those CICS systems within the CICS system group that are not associated with an analysis specification are to use this specification. (The analysis specification attribute for those CICS systems changes to INHERIT.)

**NONE**

Only the CICS system group is to be associated with the analysis specification. The CICS systems in the CICS system group are not affected. That is, if there is not association between a CICS system and an analysis specification, none is established; if there is an association, either explicitly established or inherited from another CICS system group, it is unchanged.

When the CICS system group includes other CICS system groups, all of the CICS systems, including those in the subordinate CICS system groups, are affected by the value specified in this field.

Press Enter to add the designated scope to the analysis specification definition in the data repository.

To remove the scope association, see page 65.

## STATDEF (Status definitions)

A status definition identifies a user-program that is to be called by CICSplex SM at specific intervals.

To display information about existing status definitions, issue the command:

```
STATDEF [statdef]
```

where statdef is the specific or generic name of a status definition. If you omit this parameter, the resulting view, illustrated in Figure 44, includes information about all existing status definitions within the current context.

```

26MAR1999 16:17:25 ----- INFORMATION DISPLAY -----
COMMAND ==>
CURR WIN ==> 1          ALT WIN ==>
W1 =STATDEF=====EYUPLX01=EYUPLX01=26MAR1999==16:17:25=CPSM=====
CMD Name      Program  Intvl Action  Description
-----
EYURST06 DB2STATE    60          SSet - Probe for DB2 App1
    
```

Figure 44. The STATDEF view

## Action commands

Table 27 summarizes the action commands you can use with the STATDEF view.

Table 27. STATDEF view action commands

Primary command	Line command	Description
n/a	ADD	Add an association between a status definition and an analysis group, as described on page 72.
n/a	BRO	Browse a status definition in the data repository.
CREate	CRE	<p>The format of the resulting panel is similar to that shown in Figure 45 on page 71. The panel fields are not modifiable.</p> <p>Create a status definition and add it to the data repository, as described on page 71.</p> <p>When you use the primary command CREate, some fields in the new view may contain values supplied by CICSplex SM; you may change these values. When you enter the line command CRE next to the name of a status definition, fields in the new view contain values to be modelled (from the existing status definition).</p>
n/a	INS	Install a status definition in a CICS system or CICS system group, as described on page 73.
n/a	MAP	Display a visual map of real-time analysis definitions using the specified definition as a starting point.
n/a	REM	Remove a status definition from the data repository.
TEMPMP cmasid	n/a	Change the temporary maintenance point CMAS to a specific CMAS or display a selection list based on a generic CMAS ID.



Table 27. STATDEF view action commands (continued)

Primary command	Line command	Description
n/a	UPD	Update a status definition in the data repository.  The format of the resulting panel is similar to the panel shown in Figure 45. You can modify the contents of any field in the panel except Name.

## Hyperlink fields

There are no hyperlink fields on the STATDEF view.

## Creating a status definition

Figure 45 shows the format of the panel produced when you use the create primary (CREate) or line (CRE) action command from the STATDEF view.

```

----- Create Status Definition for EYUPLX01 -----
COMMAND ==>

Name          ==> EYURST06
Description    ==> SSet - Probe for DB2 App1

Program Name   ==> DB2STATE   Name of Status Program
Call Interval  ==> 60         Interval Between Calls in Seconds
Action Name    ==>           Action Definition Name or Generic
User ID       ==>           User ID for Task
Transaction ID ==>           Transaction ID for Task

                VLS   LS   LW   HW   HS   VHS
Entry Intervals ==> 0005 0005 0005 0005 0005 0005
Exit Intervals  ==> 0002 0003 0001 0001 0003 0002

Press Enter to create the Status Definition.
Type END or CANCEL to cancel without creating.

```

Figure 45. Creating a status definition

Provide the following information, as appropriate.

**Name** Specify a 1- to 8-character name for the status definition. The name can contain alphabetic, numeric, or national characters. However, the first character must be alphabetic,

**Description**

(Optional.) Specify a 1- to 30-character description of the definition.

**Program Name**

(Optional.) Specify the name of the user-written program that is to return information to CICSplex SM.

If the program is to return status information about multiple conditions and you can create one status definition for each condition, where:

- Each definition identifies the user program. In this case, a separate task is started for each status definition that names a program.
- Only the first definition identifies the user program. In this case, one task is started for the definition that names the program.

## STATDEF

(For more information about writing programs to monitor status, see “Appendix A. Customizing programs that monitor status” on page 189.)

### Call Interval

Specify the interval, in seconds, between calls to the status program. The value must be between 1 and 86400.

### Action Name

Enter the specific or generic name of an action definition to be used if the STATDEF enters the True state. If you specify a generic value, a list of valid action definitions is displayed.

### User Id

(For CICS/ESA 4.1 only. Optional.) Specify the ID of the user (defined to your external security manager) that is to be associated with the CICS status probe task running in the MAS.

### Transaction Id

(Optional.) Specify the transaction identifier under which the status program is to execute in the target CICS system.

### Entry Intervals

Specify the number of consecutive Call Frequency intervals, within each severity level, that must result in a *true* condition before this definition is considered true.

### Exit Intervals

Specify the number of consecutive Call Frequency intervals, within each severity level, that must result in a *false* condition before this definition is considered false.

Press Enter to add the status definition to the data repository.

## Adding a status definition to an analysis group

Figure 46 illustrates the panel produced when you use the add (ADD) line action command from the STATDEF view.

```
----- Add STATDEF to Analysis Group for EYUPLX01-----
COMMAND ==>

Status Definition      EYURST06
Description            SSet - Probe for DB2 App1

Analysis Group        ==> EYURTG10      Analysis Group or Generic
Active Period         ==> PRIME         Period Name or Generic

Press Enter to add Status Definition to Analysis Group.
Type END or CANCEL to cancel without adding.
```

Figure 46. Adding a status definition to an analysis group

Provide the following information:

### Analysis Group

Enter the specific or generic name of an analysis group with which this definition is to be associated. If you specify a generic value, a list of valid analysis groups is displayed.

### Active Period

(Optional) Enter the specific or generic name of a period definition that

identifies the range of hours during which the status definition is to be active. If you specify a generic value, a list of valid period definitions is displayed.

If the name you specify is not an existing period definition, you can create that period definition later. If you leave this field blank, the status definition remains active for as long as the CICS system is running or until you discard it.

Press Enter to add the status definition to the designated analysis group in the data repository.

## Installing a status definition

You can install a status definition in one or more active CICS systems that are within the CICSplex identified as the context.

### Notes:

1. The RTA status probe program must be available for execution prior to installation of a status definition.
2. A status definition can be automatically installed in a CICS system when that system starts. For this to occur, associate the definition with an analysis group. Then associate that group with an analysis specification that is defined to the CICS system.

Figure 47 illustrates the panel produced when you use the install (INS) line action command from the STATDEF view.

```

----- Install STATDEF for EYUPLX01 -----
COMMAND  ==>

Name      EYURST06
Description  SSet - Probe for DB2 App1

Type      STATDEF

Scope     ==>          CICS System, System Group, or Generic
Active Period  ==>          Blank, PERIODEF, or Generic

Press Enter to install Status Definition.
Type END or CANCEL to cancel without installing.

```

Figure 47. Installing a status definition

Provide the following information:

**Scope** Enter the specific or generic name of a CICS system or CICS system group into which the definition is to be installed. The CICS system or CICS system group must be within the CICSplex identified as the current context. If you specify a generic value, a list of valid CICS systems and CICS system groups is displayed.

### Active Period

(Optional) Enter the specific or generic name of an existing period definition that identifies the range of hours during which the status definition is to be active. If you specify a generic value, a list of valid period definitions is displayed.

Press Enter to install the definition in the designated CICS systems.

## STATDEF

For an installation to succeed, the CICS system must be running and real-time analysis must be active. The status definition becomes active either:

- Immediately, if no period definition is associated with it and the CICS system is running
- At the time designated by the associated period definition

The status definition remains active as long as the CICS system is running, until you discard it, or until the time designated by an associated period definition is reached.

To discard a status definition installed in a CICS system, use the RTAACTV view as described in Table 3 on page 7.

---

## Chapter 4. Analysis definitions

This section describes how you can obtain information about your real-time analysis environment, using the views:

### **APACTV**

Displays information about the current status of analysis definitions associated with an analysis point specification.

### **EVENT**

Displays information about significant outstanding changes in the status of a CICSplex or one of its CICS systems.

### **EVENTD**

Displays information about an outstanding change in the status of a CICSplex or one of its CICS systems.

### **EVENTDTD**

Displays information about the current data for an evaluation definition associated with an analysis definition that has caused an event to be generated.

### **EVENTDTL**

Displays information about evaluation definitions associated with an analysis definition that has caused an event to be generated.

### **RTAACTV**

Displays information about the current status of analysis and status definitions associated with active CICS systems.

---

## **APACTV**

The APACTV view shows information about analysis definitions associated with an analysis point specification.

### **Issue command:**

```
APACTV [apspec [rtadef [ACTIVE|PENDING]]]
```

apspec Is the specific or generic name of an analysis point specification or \* for all analysis point specifications.

rtadef Is the specific or generic name of an analysis definition or \* for all analysis definitions.

ACTIVE|PENDING Limits the view to either active or pending definitions. If you omit this parameter, definitions are included in the view regardless of their status.

If you do not specify any parameters, the resulting view includes information about all analysis definitions associated with analysis point specifications in the current context.

**Select:** APACTV from a menu of ANALYSIS views.

Figure 48 on page 76 is an example of the APACTV view.

## analysis definitions – ARACTV

```

26MAR1999 16:51:29 ----- INFORMATION DISPLAY -----
COMMAND ==>
CURR WIN ==> 1          ALT WIN ==>
W1 =APACTV=====EYUPLX01=EYUPLX01=26MAR1999==16:51:29=CPSM=====7===
CMD APSPEC  CMAS   Type RTADEF  Scope  Status  Active  Rate  Action
--- Name--- Name--- Name----- Period-- -----
EYURAPLC EYUCMS1A PRIM EYURDLC EYUPLX01 ACTIVE          60 EYURTALC
EYURAP01 EYUCMS1A PRIM EYURTD01 EYUPLX01 ACTIVE          300 EYURTA01
EYURAP01 EYUCMS1A PRIM EYURTD02 EYUPLX01 ACTIVE  EYUPDF01  300 EYURTA02
EYURAP01 EYUCMS1A PRIM EYURTD19 EYUPLX01 ACTIVE          300 EYURTA19
EYURAP01 EYUCMS1A PRIM EYURTD20 EYUPLX01 ACTIVE          300 EYURTA20
EYURAP01 EYUCMS1A PRIM EYURTD21 EYUPLX01 ACTIVE          300 EYURTA21
EYURAP01 EYUCMS1A PRIM EYURTD22 EYUPLX01 ACTIVE          300 EYURTA22

```

Figure 48. The ARACTV view

## Action commands

Table 28 shows the action commands you can issue from the ARACTV view.

Table 28. ARACTV view action commands

Primary command	Line command	Description
DEActivate apspec cmasname rtadef plexname	DEA	Deactivates an ACTIVE analysis definition for which a time period is defined; the status of the definition changes to PENDING.
DiSCard apspec cmasname rtadef plexname	DSC	Discards an ACTIVE or PENDING analysis definition from the CICS system in which it is installed.

### Where:

**apspec** Is the specific or generic name of an analysis point specification.

### cmasname

Is the specific or generic name of a CMAS.

### rtadef

Is the specific or generic name of an analysis definition.

### plexname

Is the specific or generic name of a CICSplex.

## Hyperlinks

Table 29 shows the hyperlink fields on the ARACTV view.

Table 29. ARACTV view hyperlink fields

Hyperlink field	View displayed	Description
APSPEC Name	APSPEC	Detailed information about the specified analysis point specifications.
RTADEF Name	RTADEF	Detailed information about the specified analysis definition.
Period	PERIODEF	Detailed information about the specified period definition.
Action	ACTNDEF	Detailed information about the specified action definition.

## Usage

### Deactivating or discarding an analysis definition

When an analysis definition is installed in an analysis point, its status (as illustrated by the Status field in Figure 48 on page 76) is either:

#### ACTIVE

The analysis definition is installed and active.

#### PENDING

The analysis definition is installed and ready to become active.

An analysis definition is active during the time period identified in the Period field. (When this field is blank, the definition is active as long as the analysis point in which it is installed is active.)

To change the status of an installed analysis definition, type either the DEA or DSC action command in the line command field next to the name of the definition.

- Use DEA to deactivate a definition with an ACTIVE status for which a time period is defined. (The definition remains installed; its status is changed to PENDING. The next time the end of the associated time period is reached, the definition will become active again.)
- Use DSC to discard a definition with an ACTIVE or PENDING status and to remove the definition from the analysis point in which it is installed.

Press Enter. A confirmation panel is displayed. Press Enter again to deactivate or discard the analysis definition.

## EVENT

The EVENT view shows information about significant outstanding changes in the status of a CICSplex or one of its CICS systems. An example of how to use this view can be found in *CICSplex SM Operations Views Reference*.

**Issue command:**

```
EVENT [event [eventsys [severity [eventtype]]]]
```

event Is the specific or generic name of an event or \* for all events.

eventsys Is the specific or generic name of a CICS system or CICS system group that was the target of the event, or \* for all CICS systems.

severity Limits the view to events having the specified severity level(s). Specify a severity level or \* for all severity levels. The valid severity levels are:

- VHS** Very high severe
- HS** High severe
- HW** High warning
- LW** Low warning
- LS** Low severe
- VLS** Very low severe

eventtype Limits the view to events of the specified type. Enter one of the following:

- APM** Analysis point monitoring
- MRM** Resource monitoring
- SAM** System availability monitoring

If you omit this parameter, events are included in the view regardless of their type.

If you do not specify any parameters, the resulting view includes information about all events within the CICSplex identified as the context.

**Select:** EVENT from a menu of ANALYSIS views.

Figure 49 is an example of the EVENT view.

```

26MAR1999 18:29:26 ----- INFORMATION DISPLAY -----
COMMAND ==>
CURR WIN ==> 1          ALT WIN ==>
W1 =EVENT=====EYUPLX01=EYUPLX01=26MAR1999==18:29:26=CPSM=====2===
CMD Name   Target   Sev Pri Type Dt1 View   Resource   Key
-----
!!SAMOPS  EYUMAS1A VHS 255 SAM NO
EYURTDLC  EYUPLX01 VHS  1 APM YES CICSGRN CICSGRN  EYUMAS1B
EYURTD01  EYUPLX01 VLS  1 MRM YES PROGRAM PROGRAM  DFHTOR
    
```

Figure 49. The EVENT view

**Notes:**

1. Scroll to the right to see the description associated with each event.
2. Events are sorted for display according to the contents of the following fields:
  - Severity (from VHS to VLS)



- Priority (from 1 to 255)
- Event Name
- Target

## Action commands

None.

## Hyperlinks

Table 30 shows the hyperlink fields on the EVENT view.

Table 30. EVENT view hyperlink fields

Hyperlink field	View displayed	Description
Name	EVENTD	Detailed information about the specified event.
Dtl	EVENTDTL	General information about the evaluation definitions associated with the analysis definition that caused the event to be generated.

**Note:** Dtl can be used as a hyperlink field only when it contains a value of YES.

## EVENTD

The EVENTD view shows information about an outstanding change in the status of a CICSplex or one of its CICS systems.

### Hyperlink from:

the Name field of the EVENT view.

Figure 50 is an example of the EVENTD view.

```

26MAR1999 18:29:49 ----- INFORMATION DISPLAY -----
COMMAND ==>
CURR WIN ==> 1          ALT WIN ==>
W1 =EVENT====EVENTD====EYUPLX01=EYUPLX01=26MAR1999==18:29:26=CPSM=====1===
Event Name..  EYURTD01
Target.....  EYUPLX01 Severity      Defin  Defin  Curr.  Curr.
CMAS Name...  EYUCMS1A Level...          Entry  Exit  Entry  Exit
              VHS
Event Type..  APM      HS           1      1      0      0
Severity....  VHS      HW           1      1      0      0
Priority....  1        LW           1      1      1      0
              LS
Date.....    26MAR1999  VLS          1      1      1      0
Time.....    18:16:58
Eval Rate...  300
Details.....  YES
View.....    CONNECT

Action.....  EYURTA01
Resource.... CONNECTION
Gen Ext Msg.  YES
Gen Alert... NO
NetView CMAS

```

Figure 50. The EVENTD view

## Action commands

None.

## analysis definitions – EVENTD

### Hyperlinks

Table 31 shows the hyperlink field on the EVENTD view.

Table 31. EVENTD view hyperlink field

Hyperlink field	View displayed	Description
Details	EVENTDTL	General information about the evaluation definitions associated with the analysis definition that caused the event to be generated.

**Note:** Details can be used as a hyperlink field only when it contains a value of YES.

---

## EVENTDTD

The EVENTDTD view shows information about an evaluation definition associated with an analysis definition that has caused an event to be generated. An example of how to use this view can be found in “Finding out why a CICSplex SM event occurred” on page 184.

### Hyperlink from:

the EVALDEF field of the EVENTDTL view.

Figure 51 is an example of the EVENTDTD view.

```
26MAR1999 18:30:11 ----- INFORMATION DISPLAY -----
COMMAND ==>
CURR WIN ==> 1      ALT WIN ==>
W1 =EVENTDTL=EVENTDTD=EYUPLX01=EYUPLX01=26MAR1999==18:30:01=CPSM=====1===
Event Name..      EYURTD01      VHS value.
EVALDEF Name     EYURTE01 Table Name...  CONNECT HS value..
Target.....     EYUPLX01 Instance Patt * HW value..
State.....      TRUE Eval Column..  CONNSTATUS LW value..
Severity....     VHS Eval Operator   LS value..
Date.....       26MAR1999      VLS value.
Time.....       18:26:58      Eval Value
Set Action..     ALL      Data Value
Sample Rate.     300      Key.....
View.....       CONNECT
Type.....       VALUE
Resource....    CONNECT
```

Figure 51. The EVENTDTD view

### Action commands

None.

### Hyperlinks

None.

---

## EVENTDTL

The EVENTDTL view shows information about evaluation definitions associated with an analysis definition that has caused an event to be generated. An example of how to use this view can be found in “Finding out why a CICSplex SM event occurred” on page 184.

**Hyperlink from:**

the Dtl field of the EVENT view or the Detail field of the EVENTD view.

Figure 52 is an example of the EVENTDTL view.

```

26MAR1999 18:30:01 ----- INFORMATION DISPLAY -----
COMMAND ==>                                     SCROLL ==> PAGE
CURR WIN ==> 1           ALT WIN ==>
>W1 =EVENTDTL=====EYUPLX01=EYUPLX01=26MAR1999==18:30:01=CPSM=====1===
CMD EVALDEF  Sev Table  Instance Evaluation View  Data Value
----- Column-----
      EYURTE01 VHS CONNECT *          CONNSTATUS  CONNECT  NOTAPPLIC
    
```

Figure 52. The EVENTDTL view

**Note:** CICSplex SM-generated events are not included in this view.

**Action commands**

None.

**Hyperlinks**

Table 32 shows the hyperlink field on the EVENTDTL view.

Table 32. EVENTDTL view hyperlink field

Hyperlink field	View displayed	Description
EVALDEF	EVENTDTD	Detailed information about the specified evaluation definition.

---

**RTAACTV**

The RTAACTV view shows information about analysis and status definitions installed in CICS systems known to the CICSplex identified as the current context.

**Issue command:**

```
RTAACTV [defname [ACTIVE|PENDING]]
```

defname Is the specific or generic name of an analysis or status definition, or \* for all definitions.

ACTIVE|PENDING Limits the view to either active or pending definitions. If you omit this parameter, definitions are included in the view regardless of their status.

If you do not specify any parameters, the resulting view includes information about all analysis and status definitions within the current context.

**Select:** RTAACTV from a menu of ANALYSIS views.

Figure 53 on page 82 is an example of the RTAACTV view.

## analysis definitions – RTAACTV

```

26MAR1999 21:02:41 ----- INFORMATION DISPLAY -----
COMMAND ==>
CURR WIN ==> 1          ALT WIN ==>          SCROLL ==> PAGE
W1 =RTAACTV=====EYUPLX01=EYUPLX01=26MAR1999==21:02:41=CPSM=====3===
CMD Name      System  Status  Active  Rate  Action  Def
-----
EYURTD16  EYUMAS4A  ACTIVE
EYURTD17  EYUMAS4A  ACTIVE
EYURTD18  EYUMAS1A  ACTIVE

```

Figure 53. The RTAACTV view

## Action commands

Table 33 shows the action commands you can issue from the RTAACTV view.

Table 33. RTAACTV view action commands

Primary command	Line command	Description
DEActivate defname sysname	DEA	Deactivates an ACTIVE analysis or status definition for which a time period is defined; the status of the definition changes to PENDING.
DiSCard defname sysname	DSC	Discards an ACTIVE or PENDING analysis or status definition from the CICS system in which it is installed.

**Where:  
defname**

Is the specific or generic name of an analysis definition.

**sysname**

Is the specific or generic name of a CICS system.

## Hyperlinks

Table 34 shows the hyperlink fields on the RTAACTV view.

Table 34. RTAACTV view hyperlink fields

Hyperlink field	View displayed	Description
Name	RTADEF	Detailed information about the specified analysis definition.
Name	STATDEF	Detailed information about the specified status definition.
Active period	PERIODEF	Detailed information about the specified period definition.
Action	ACTION	Detailed information about the specified action definition.

## Usage

### Deactivating or discarding an analysis or status definition

When an analysis or status definition is installed in a CICS system, its status (as illustrated by the Status field in Figure 53) is either:

**ACTIVE**

The definition is installed and active.

**PENDING**

The definition is installed and ready to become active.

An analysis or status definition is active during the time period identified in the Period field. (When this field is blank, the definition is to be active as long as the CICS system in which it is installed is active.)

To change the status of an installed analysis or status definition, type either the DEA or DSC action command in the line command field next to the name of the definition.

- Use DEA to deactivate a definition with an ACTIVE status. (The definition remains installed; its status is changed to PENDING. The next time the associated time period is reached, the definition will become active again.)
- Use DSC to discard a definition with an ACTIVE or PENDING status and to remove the definition from the CICS system in which it is installed.

Press Enter. A confirmation panel is displayed. Press Enter again to deactivate or discard the analysis or status definition.

## analysis definitions – RTAACTV

---

## Chapter 5. Example tasks: real-time analysis

This chapter includes several examples of typical real-time analysis setup tasks.

- The examples “Switching system availability monitoring (SAM) on for a MAS” and “Changing the default actions for system availability monitoring (SAM)” on page 87 demonstrate how easily you can activate system availability monitoring (SAM) and tailor the default actions.
- The examples “Monitoring resources temporarily” on page 89 and “Monitoring resources permanently” on page 93 show how the real-time analysis objects you create for a particular resource vary according to whether the monitoring is to be temporary or permanent.
- The examples “Reusing analysis specifications and analysis groups” on page 95 through “Monitoring multiple resource types in a CICS system group (2)” on page 107 show how a variety of real-time analysis requirements can be expressed in different evaluation definitions, action definitions, and analysis definitions.
- The examples “Updating analysis and evaluation definitions” on page 112 and “Deactivating an analysis definition” on page 112 demonstrate two tasks related to the management of real-time analysis objects.
- “Using data gathered by the resource monitoring function” on page 113 shows how real-time analysis can be used to interpret monitor data and issue appropriate warnings when resources are performing poorly.
- The examples “Issuing one notification for multiple conditions (1)” on page 116 and “Issuing one notification for multiple conditions (2)” on page 120 show how to use analysis point specifications to consolidate multiple real-time analysis notifications into one.
- “Modifying the state of a resource” on page 122 shows how real-time analysis can be used to modify a CICS resource when it is not in the desired state.

---

### Switching system availability monitoring (SAM) on for a MAS

CICSplex SM’s system availability monitoring (SAM) is easy to set up and is extremely useful. When system availability monitoring is activated for a particular CICS system, CICSplex SM warns you if the system becomes unavailable, or if any of these conditions occurs: short on storage (SOS); system dumps (SYSDUMP); transaction dump (TRANDUMP); maximum number of tasks (MAXTASK); system busy (STALL). You activate monitoring of system availability by telling CICSplex SM at which hours of the day you expect the CICS system to be available. You activate monitoring of the SOS, SYSDUMP, TRANDUMP, MAXTASK, and STALL conditions by switching on real-time analysis for the CICS system.

In this example, you’ll see how to tell CICSplex SM that CICS system CICS001, in CICSplex PLXPROD1, should be running problem-free between 09:00 and 17:30 and, if it isn’t, to warn you. You want system availability monitoring to be switched on permanently for CICS001, and to take effect immediately. The time period definition PDFSHFTA, which covers the hours from 09:00 to 17:30, has already been created.

1. If the current context isn’t PLXPROD1, issue the command `CON PLXPROD1` from the current view.
2. Update the CICS system definition.

## example tasks: real-time analysis

Issue the command CICSSYS from the current view. Tab to the entry for CICSPA01 in the CICSSYS view, and issue UPD from the line-command field. The Update System - General Attributes panel is displayed. In the Primary CMAS or Generic field, type in the name of the CMAS to which CICS normally connects. For this task, type CMSSYS1 (as shown here). In the Active Time field, type PDFSHFTA (as shown here), but do not press Enter:

```

----- Update System - General Attributes - for PLXPROD1 -----
COMMAND ==>

System Name      CICSPA01
Description ==>  AOR 1 on System A
Primary CMAS or Generic ==> CMSSYS1      CMAS to which CICS normally connects
Active Time or Generic ==> PDFSHFTA      Hours of operation
APPLID          ==> A700PA01            VTAM application ID

                                SECURITY

CICS Command Checking ==> NO           Simulated CICS Cmd Checks (YES, NO, or *)
CICS Resource Checking ==> NO          Simulated CICS Res Checks (YES, NO, or *)
Exemption Checking   ==> NO           Check for Exempt Users (YES, NO, or *)

                                TIME

Time Zone          ==> U               Time Zone for System (B-Z or *)
Time Zone Offset   ==> 00            Time Zone Offset for System (0-59 or *)
Daylight Savings Time ==> YES        Daylight Savings for System (YES, NO, or *)

Enter DOWN or UP to view other System screens.
Press ENTER to update the System.
Type END or CANCEL to cancel without updating.

```

(If you hit Enter by mistake, the CICS system definition is stored. You can continue by typing UPD against the CICSPA01 entry of the CICSSYS view again.) Next, page forward twice to the Update System - Analysis Attributes panel. In the Analysis active field type YES, as shown here:

```

----- Update System - Analysis Attributes - for PLXPROD1 -----
COMMAND ==>

System Name      CICSPA01
Description      AOR 1 on System A

Analysis active   ==> YES             Activate at startup (YES, NO, SAM, MRM)
Analysis specification ==>          Current RTASPEC
Specification source ==>          Type of link to RTASPEC
System group name ==>          System group if implicit source

System availability management:

Action or Action Severity Severity
Generic Inherit Inherit
SAM ==> ==> NO ==> ==> NO
SOS ==> ==> NO ==> ==> NO
SYSDUMP ==> ==> NO ==> ==> NO
TRANDUMP ==> ==> NO ==> ==> NO
MAXTASK ==> ==> NO ==> ==> NO
STALL ==> ==> NO ==> ==> NO

Type DOWN or UP to view other System Screens.
Press ENTER to Update the System.
Type END or CANCEL to cancel without updating.

```

(If you wanted to activate monitoring of system availability only (and did not want the SOS, SYSDUMP, TRANDUMP, MAXTASK, and STALL conditions to be flagged), you would enter SAM rather than YES in the Analysis active field.)



The System Name and Description fields are prefilled by CICSplex SM, and you can leave the remaining fields blank. Press Enter. The CICSSYS view is redisplayed. The change takes effect immediately.

3. Look at the CICSplex SM event notifications.

Now that system availability monitoring is switched on for CICS system CICSPA01, you can check the system's availability by looking at the EVENT view. (Simply issue the EVENT command from the current view.) If CICSPA01 is not active, or is not problem-free, at a time that falls within the period defined in time-period definition PDFSHFTA, you'll see an entry to that effect in the EVENT view.

If you decide later to switch system availability monitoring off for CICS system CICSPA01, update the CICS system definition again (as described in step 2 on page 85), but overwrite YES in the Analysis active field of the Update System - Analysis Attributes panel with NO. The change takes immediate effect.

---

## Changing the default actions for system availability monitoring (SAM)

If you simply switch system availability monitoring (SAM) on for a particular CICS system, CICSplex SM issues the default notifications when one of the predefined conditions occurs. That is, CICSplex SM generates an external message and an event notification. The default values for these messages are shown in "Default notification values" on page 12. You can customize the external message and the event notification to suit local requirements. For example, you might want to change the message text for a particular condition, or change the severity of a condition, or selectively turn off parts of system availability monitoring.

This example shows you how to modify the default system availability monitoring notifications you requested in the previous example ("Switching system availability monitoring (SAM) on for a MAS" on page 85) for CICS system CICSPA01. The changes you want to make are as follows:

- If CICSPA01 is not available between 09:00 and 17:30, an alert is to be sent to NetView by CMAS CMSSYS1, and an event notification, with a severity of HW, is to be issued. However, no external message is to be generated.
- If the system becomes short on storage (SOS), the default actions should be taken, but the priority of the event should be Very High Severe (VHS).
- No notification of system or transaction dumps is required.

1. If the current context isn't PLXPROD1, issue the command CON PLXPROD1 from the current view.

2. Create an action definition.

Issue the command ACTNDEF from the current view. The ACTNDEF view is displayed, showing any action definitions already created in CICSplex PLXPROD1. To create a new action definition, you can either:

- a. Issue the CRE command from the ACTNDEF view. The Create Action Definition panel, with all fields blank, is displayed.
- b. In the ACTNDEF view, tab to the entry of an existing action definition that you want to use as a template for your own, and issue CRE from the line-command field. The Create Action Definition panel, showing the values of the "template" definition, is displayed. (This could save you some typing.)

Complete the Create Action Definition panel as shown here:

## example tasks: real-time analysis

```

----- Create Action Definition for PLXPROD1 -----
COMMAND ===>

Action Name  ===> RTAPAY01
Description  ===> CICSPA01 unavailable

Event        ===> YES          Generate Event (Yes/No)
Event View   ===>              View for Event
Priority      ===> 255          Event Priority (1 to 255)
Event Text    ===> AOR CICSPA01 is unavailable

External Msg ===> NO          Generate External Message (Yes/No)
Enter Msg    ===>
Exit Msg     ===>

Alert        ===> YES          Generate Alert (Yes/No)
CMAS Name    ===> CMSSYS1      CMAS to Issue Alert
Enter Text   ===> AOR CICSPA01 is unavailable
Exit Text    ===> AOR CICSPA01 is now available

Restart      ===> NO          Cancel for ARM Restart (Yes/No)

Press Enter to create the Action Definition.
Type END or CANCEL to cancel without creating.

```

Press Enter. The ACTNDEF view is redisplayed.

**Note:** For a complete description of the ACTNDEF view, see “ACTNDEF (Action definitions)” on page 26.

3. Change the default system availability monitoring actions for CICSPA01.
  - a. Issue the command CICSSYS from the current view. The CICSSYS view is displayed.
  - b. In the CICSSYS view, tab to the entry for CICSPA01, and issue UPD from the line-command field. The Update System - General Attributes panel is displayed. Page forward twice to the Update System - Analysis Attributes panel. Complete the panel as shown here, and press Enter:

```

----- Update System - Analysis Attributes - for PLXPROD1 -----
COMMAND ===>

System Name      CICSPA01
Description      AOR 1 on System A

Analysis active   ===> YES      Activate at startup (YES, NO, SAM, MRM)
Analysis specification
Specification source
System group name

System availability management:

          Action or Action   Severity   Severity
          Generic  Inherit
SAM      ===> RTAPAY01    ===> NO    ===> HW    ===> NO
SOS      ===>              ===> NO    ===> VHS   ===> NO
SYSDUMP  ===>              ===> NO    ===> NO    ===> NO
TRANDUMP ===>              ===> NO    ===> NO    ===> NO
MAXTASK  ===>              ===> NO    ===>      ===> NO
STALL    ===>              ===> NO    ===>      ===> NO

Type DOWN or UP to view other System Screens.
Press ENTER to Update the System.
Type END or CANCEL to cancel without updating.

```

- To replace the default system availability monitoring notifications with your own, you enter the name of the action definition you created in step 2 on page 87

page 87 (RTAPAY01) in the SAM Action or Generic field. You make the severity of the event notification High Warning by entering HW in the SAM severity field.

- To change the severity of the SOS event to Very High Severe, you enter VHS in the SOS Severity field.
- To switch off notification of system and transaction dumps, you enter NO in the Severity fields of both SYSDUMP and TRANDUMP.

The updated system availability monitoring actions take effect immediately.

## Monitoring resources temporarily

Often, your reasons for monitoring a CICS resource are temporary. For example, a problem might arise with a particular MRO connection that you solve using real-time analysis for a limited period of time. Also, even if you know that you want monitoring of a resource to be regular and permanent, you are recommended to start by monitoring the resource temporarily, so that you can fine-tune the real-time analysis definitions and assess their results.

This example shows you how to create real-time analysis definitions to monitor temporarily the number of DB2<sup>®</sup> thread aborts associated with particular transactions (those whose names begin with the letters AB) in particular CICS systems (CICSPA01 and CICSPA02). An external message and an event notification will be issued when the number of DB2 thread aborts goes above the number you specify.

1. If the current context isn't PLXPROD1, issue the command CON PLXPROD1 from the current view.
2. Create a CICS system group.

From the current view, issue the command CICSGRP. From the CICSGRP view, issue the command CRE. Complete the Create System Group panel as shown here:

```

----- Create System Group for PLXPROD1 -----
COMMAND  ==>

System Group name  ==> CSGAORS1
Description        ==> AORS CICSPA01 and CICSPA02

Press Enter to Create System Group.
Type END or CANCEL to cancel without creating.
    
```

When you press Enter, the CICSGRP view is redisplayed showing an entry for the new group, CSGAORS1. At this point, the group exists, but is empty.

3. Add CICS systems to the CICS system group.

In the CICSGRP view, move the cursor to the CSGAORS1 entry, and issue ADD from the line-command field. The Add Member to System Group panel is displayed, with the System Group Name and Description fields already completed. All you have to do is enter the name of a CICS system (CICSPA01, in this example) in the Member field. You can ignore anything else on the panel. When you press Enter, CICS system CICSPA01 is added to group CSGAORS1.

Repeat this step for CICS system CICSPA02.

## example tasks: real-time analysis

You can check that the CICS systems have been added to the group by looking at the SYSGRPC view. Simply issue the SYSGRPC command, and look at the entries for CICS system group CSGAORS1.

### 4. Create an evaluation definition.

This step, and the two that follow, show which definitions you have to create to tell CICSplex SM about the resource condition you're interested in, and what to do when it occurs. The order in which you create the definitions isn't particularly important, though the order shown here is probably the most logical.

Start with the evaluation definition, which tells CICSplex SM about the resource you're interested in. Then define the action definition, which tells CICSplex SM how to notify you when the condition you've identified occurs. Finish with the analysis definition, which is basically a link between the evaluation definition and the action definition.

From the current view, issue the command EVALDEF. From the EVALDEF view, issue the command CRE. Complete the first Create Evaluation Definition panel as shown here, and press Enter:

```
----- Create Evaluation Definition for PLXPROD1-----
COMMAND  ==>

Name           ==> RTEPAY02
Description    ==> DB2 Thread Aborts (TRANID AB*)

Sample Interval ==> 300           Interval between samples in seconds
TableName      ==> DB2THRD       Resource Table Name or *
Instance Pattern ==> AB*         Specific or generic pattern
Result Set Action ==> MAX         Operation(ALL,ANY,SUM,MIN,MAX,AVG,CNT)
Separate Task   ==> NO           Run as a separate task (YES, NO)

Evaluation Column ==> ABORTCNT    Column name to evaluate or *
  either Operator ==>             (EQ,NE,LT,GT,LE,GE)
  Value          ==>
  Severity       ==>             (VLS,LS,LW,HW,HS,VHS)
  or set Thresholds: Provide 3 low and/or 3 high values, N=Normal

VLS      LS      LW  (N)  HW      HS      VHS
                20      40      80

View           ==> DB2THRD       View invoked for this Evaluation

Type DOWN or UP to view other Evaluation Definition screens.
Press Enter to create Evaluation Definition.
Type END or CANCEL to cancel without creating.
```

- The Sample Interval value is the interval at which CICSplex SM must check the state of the resource. In this example, the number of DB2 thread aborts is to be checked every 300 seconds.
- The evaluation threshold values tell CICSplex SM which severity to apply to the event notification. When the number of DB2 thread aborts reaches 20, the severity value of the event will be HW; when it reaches 40, the severity value of the event will be HS; and when it reaches 80, the severity value of the event will be VHS.

**Note:** This example does not make use of the second Create Evaluation Definition panel. For a complete description of the EVALDEF view and the panels you use to create one, see "EVALDEF (Evaluation definitions)" on page 33.

### 5. Create an action definition.

## example tasks: real-time analysis

From the current view, issue the command ACTNDEF. From the ACTNDEF view, issue the command CRE. Complete the Create Action Definition panel as shown here, and press Enter:

```
----- Create Action Definition for PLXPROD1 -----
COMMAND ==>

Action Name ==> RTAPAY02
Description ==> DB2 Thread Aborts - High

Event ==> YES          Generate Event (Yes/No)
Event View ==> DB2THRD  View for Event
Priority ==> 100        Event Priority (1 to 255)
Event Text ==> DB2 thread aborts too high

External Msg ==> YES    Generate External Message (Yes/No)
Enter Msg ==> DB2 thread aborts too high
Exit Msg ==>

Alert ==> NO           Generate Alert (Yes/No)
CMAS Name ==>          CMAS to Issue Alert
Enter Text ==>
Exit Text ==>

Restart ==> NO        Cancel for ARM Restart (Yes/No)

Press Enter to create the Action Definition.
Type END or CANCEL to cancel without creating.
```

You will see the message “DB2 thread aborts too high” when any of the threshold values you’ve specified is reached. Notice that there is no Exit Msg text. This is because there is no “reverse” condition of a DB2 thread abort.

**Note:** For a complete description of the ACTNDEF view, see “ACTNDEF (Action definitions)” on page 26.

### 6. Create an analysis definition.

From the current view, issue the command RTADEF. From the RTADEF view, issue the command CRE. Complete the Create Analysis Definition panel as shown here, and press Enter:

```
----- Create Analysis Definition for PLXPROD1 -----
COMMAND ==>

Name ==> RTDPAY02
Description ==> DB2 Thread Aborts
Perform Ops ==> NO      Perform EVALDEF operations changes (YES, NO)
Sample Interval ==> 300  Interval between samples in seconds (1-86400)
Action Name ==> RTAPAY02 Action definition name or generic

          VLS  LS  LW  HW  HS  VHS
Entry Intervals ==> 0001 0001 0001 0001 0001 0001
Exit Intervals ==> 0001 0001 0001 0001 0001 0001

Evaluation expression:
==> RTEPAY02
==>
==>
==>
==>
==>

Press Enter to create the Analysis Definition.
Type END or CANCEL to cancel without creating.
```

## example tasks: real-time analysis

The Sample Interval (300 seconds) controls how often CICSplex SM looks at the results of the evaluation definition to determine whether the condition has occurred. This interval should not be smaller than the sample interval you specify in the evaluation definition itself, because there is nothing to be gained by assessing the results of the evaluation more frequently than the evaluation itself occurs. The Entry Intervals and Exit Intervals can be allowed to default to 0001.

When you press Enter, the RTADEF view is redisplayed, showing an entry for RTDPAY02. At this point, the definitions you need have all been created, but they must be activated by installing the analysis definition RTDPAY02 in the CICS system group CSGAORS1.

**Note:** For a complete description of the RTADEF view, see “RTADEF (Analysis definitions)” on page 43.

### 7. Verify that real-time analysis is active.

Before you install the definitions, verify that the CICS systems defined in the CICS system group CSGAORS1 have real-time analysis active. From the current view, issue the command MAS. The MAS view is displayed. Find the entries for CICSPAOR1 and CICSPAOR2. If the RTA Act field specifies YES or MRM, continue with the next step.

If the RTA Act field specifies NO or SAM:

- a. Tab to the entry for CICSPAOR1 and issue the UPD action command. The Control MAS for PLXPROD1 panel is displayed. In the RTA Active field, type YES or MRM. Press Enter to update the MAS attributes. The MAS view is redisplayed with the updated value in the RTA Act field.
- b. From the current view, issue the RTASCOPE command. The RTASCOPE view is displayed. Verify that CICSPAOR1 is listed in the Scope Name field and is associated with an analysis specification.

Repeat this process for CICSPAOR2.

### 8. Install the analysis definition manually.

- a. From the current view, issue the command RTADEF. In the RTADEF view, tab to the entry for RTDPAY02 and issue the INS action command.
- b. In the Scope field of the Install RTADEF panel, enter the name of the CICS system group (CSGAORS1, in this example). The analysis definition takes immediate effect in any of the CICS systems in the group that are currently running.

If you want to check where the analysis definition is currently active, issue the command RTAACTV from the current view. The RTAACTV view lists the analysis definitions that are currently installed in the CICS systems of the current scope.

The analysis definition you’ve just installed will remain active until you deactivate it, or until the CICS systems stop. If you decide, perhaps after some fine-tuning of intervals, that you’re happy with the output you’re getting from this analysis definition, you might want to install it automatically, so that it takes effect at CICS system-startup time and you don’t have to install it manually again. How to do this is described in the next example.

## Monitoring resources permanently

This example is a development of the previous example (“Monitoring resources temporarily” on page 89) in which you saw how to monitor the number of DB2 thread aborts in a CICS system group on a temporary basis. In this example, you will see how to create the real-time analysis definitions required to make this monitoring regular and permanent.

Assume that you want the analysis definition RTDPAY02 to be in effect every day in CICS system group CSGAORS1, but only during prime shift (09:00 through 17:30). You’ve decided this because, outside of prime shift, you have few problems with DB2.

### 1. Create a time period definition.

Issue the command PERIODEF from the current view. From the PERIODEF view, issue the command CRE. Complete the Create Time Period Def panel as shown here, and press Enter:

```

----- Create Time Period Def for PLXPROD1 -----
COMMAND  ==>

Definition Name ==> PDFPRIME
Description    ==> Prime Shift (0900 - 1730)

Time Period Definition:
Start Time     ==> 09:00   (HH:MM)
End Time      ==> 17:30   (HH:MM)
Time Zone     ==> U
Zone Adjustment ==> 0

Press Enter to Create Time Period Definition.
Type END or CANCEL to cancel without creating.

```

You have to give the time period definition a name (PDFPRIME, in this example), say when it starts and when it ends, and specify the time zone. Online help is available for all of these fields. (Position the cursor on the field and issue the command HELP, or press the PF key to which the HELP command has been assigned.) The description isn’t mandatory, but you’ll probably find it useful when you’re looking at a list of period definitions and need to distinguish one from another. You can reuse this definition within the CICSplex any number of times, and for any of the CICSplex SM functions.

### 2. Create an analysis specification.

To get an analysis definition installed in a CICS system automatically, you have to create both an analysis specification and an analysis group. Begin with the analysis specification, though the order isn’t important. Issue the command RTASPEC from the current view. From the RTASPEC view, issue the command CRE. Complete the Create Analysis Specification panel as shown here, and press Enter:

## example tasks: real-time analysis

```
----- Create Analysis Specification for PLXPROD1 -----
COMMAND ===>

RTA Spec Name      ===> RTSPAY02
Description        ===> Install RTDPAY02 in CSGAORS1

System availability management:

          Action or Generic   Severity
SAM              =>          =>
SOS              =>          =>
SYSDUMP          =>          =>
TRANDUMP         =>          =>
MAXTASK          =>          =>
STALL            =>          =>

Press Enter to create the RTA Specification.
Type END or CANCEL to cancel without creating.
```

You can ignore the System availability management fields.

**Note:** For a complete description of the RTASPEC view, see “RTASPEC (Analysis specifications)” on page 65.

3. Set the scope of the analysis specification.

The next step is to identify the CICS systems that are to use this specification.

- a. Tab to the RTSPAY02 entry in the RTASPEC view, and issue ADD from the line-command field.
- b. In the Scope field of the Add Scope for Specification panel, type CSGAORS1 (the name of the CICS system group you created in step 2 on page 89). In the Option field, type FORCE to make all systems in CICS system group CSGAORS1 use this analysis specification. Press Enter.

If you want to check that the analysis specification has been associated with the CICS systems in group CSGAORS1, issue the command RTASCOPE RTSPAY02 from the current view. The RTASCOPE view shows you which CICS systems are associated with analysis specification RTSPAY02.

4. Create an analysis group.

Issue the command RTAGROUP from the current view. Issue the command CRE from the RTAGROUP view. Complete the Create Analysis Group panel as shown here, and press Enter.

```
----- Create Analysis Group for PLXPROD1-----
COMMAND ===>

Group Name          ===> RTGPAY02
Description         ===> Install RTDPAY02

Press Enter to create Analysis Group.
Type END or CANCEL to cancel without creating.
```

**Note:** For a complete description of the RTAGROUP view, see “RTAGROUP (Analysis groups)” on page 49.

5. Associate the analysis group with the analysis specification.

- a. Move the cursor to the RTGPAY02 entry in the RTAGROUP view, and issue ADD from the line-command field.



- b. In the Specification Name field of the Add Analysis Group to Analysis Specification panel, enter RTSPAY02.

If you want to check that the analysis group has been added to the analysis specification, issue the command RTAINSPC from the current view. The RTAINSPC view shows an entry for analysis specification RTSPAY02 with analysis group RTGPAY02.

6. Associate the analysis definition with the analysis group.
  - a. From the current view, issue the command RTADEF.
  - b. In the RTADEF view, tab to the RTDPAY02 entry, and issue ADD from the line-command field.
  - c. In the Analysis Group field of the Add RTADEF to Analysis Group panel, type RTGPAY02. In the Active Period field, type PDFPRIME. Press Enter.

**Note:** For a complete description of the RTADEF view, see “RTADEF (Analysis definitions)” on page 43.

If you want to check that the analysis definition has been successfully added to the analysis group, issue the command RTAINGRP RTGPAY02 from the current view. An entry appears for analysis group RTGPAY02 with analysis definition RTDPAY02 for active period PDFPRIME.

The newly installed analysis definition takes effect in any CICS system that belongs to group CSGAORS1 when that CICS system next starts. (You can also activate a new analysis definition immediately from the MAS view by switching real-time analysis off and back on again.)

---

## Reusing analysis specifications and analysis groups

In this example you’ll see how to use an analysis specification and an analysis group for more than one type of resource checking. This example is an extension of the previous example (“Monitoring resources permanently” on page 93), in which you saw how to monitor the number of DB2 thread aborts in CICS system group CSGAORS1 on a regular basis. In this example, you’ll be monitoring files in the same CICS system group, CGSAORS1. The details are as follows:

- Files PAYFILA1, PAYFILA2, and PAYFILB1 are all used by an application that must be available during prime shift, which starts at 09:00. The application can run in either of the regions CICSPA01 and CICSPA02. The files are owned by region CICSPF01.
 

Files PAYFILA1 and PAYFILA2 are the only remote files with names of the format PAYFILA\* defined to CICSPA01 and CICSPA02. However, a *local* file PAYFILA9 and a remote file PAYFILB9 are also defined in CICSPA02. Because of this, two evaluation definitions will be required:

  - The first evaluation definition will check on remote files whose names begin with the characters PAYFILA. The file PAYFILA9 will not be checked by this definition because it is a local file in CICSPA02, and CICSplex SM distinguishes between local and remote files.
  - The second evaluation definition will check on the single remote file PAYFILB1. A generic name cannot be used in this definition, because the file PAYFILB9, which you do not want to monitor, is also remote.
- To ensure that the application can be used when required, CICSplex SM will check that the files are available in CICSPA01 and CICSPA02 from 08:00, one hour before prime shift starts. The checking will continue for the first 30 minutes of prime shift.

## example tasks: real-time analysis

- An external message and an event notification (severity VHS) are to be issued if any of the files is not ENABLED between 08:00 and 09:30.

### 1. Create a time period definition.

Issue the command PERIODEF from the current view. From the PERIODEF view, issue the command CRE. Complete the Create Time Period Def panel as shown here, and press Enter:

```
----- Create Time Period Def for PLXPROD1 -----
COMMAND ===>

Definition Name ===> PDFCHECK
Description      ===> Prime Shift lead-in

Time Period Definition:
Start Time      ===> 08:00 (HH:MM)
End Time       ===> 09:30 (HH:MM)
Time Zone      ===> U
Zone Adjustment ===> 0

Press Enter to Create Time Period Definition.
Type END or CANCEL to cancel without creating.
```

### 2. Create the first evaluation definition.

From the current view, issue the command EVALDEF. From the EVALDEF view, issue the command CRE. Complete the first Create Evaluation Definition panel as shown here, and press Enter:

```
----- Create Evaluation Definition for PLXPROD1-----
COMMAND ===>

Name              ===> RTEPAY12
Description       ===> REMFILE PAYFILA* enabling

Sample Interval   ===> 60           Interval between samples in seconds
TableName        ===> REMFILE     Resource Table Name or *
Instance Pattern  ===> PAYFILA*    Specific or generic pattern
Result Set Action ===> ANY         Operation(ALL,ANY,SUM,MIN,MAX,AVG,CNT)
Separate Task     ===> NO         Run as a separate task (YES, NO)

Evaluation Column ===> ENABLESTATUS Column name to evaluate or *
  either Operator ===> NE         (EQ,NE,LT,GT,LE,GE)
  Value          ===> ENABLED
  Severity       ===> VHS        (VLS,LS,LW,HW,HS,VHS)
  or set Thresholds: Provide 3 low and/or 3 high values, N=Normal

VLS      LS      LW (N)  HW      HS      VHS

View              ===> REMFILE     View invoked for this Evaluation

Type DOWN or UP to view other Evaluation Definition screens.
Press Enter to create Evaluation Definition.
Type END or CANCEL to cancel without creating.
```

**Note:** This example does not make use of the second Create Evaluation Definition panel. For a complete description of the EVALDEF view and the panels you use to create one, see “EVALDEF (Evaluation definitions)” on page 33.

### 3. Create the second evaluation definition.

In the EVALDEF view, tab to the entry for RTEPAY12, and issue CRE from the line-command field. The first Create Evaluation Definition panel is displayed, showing the values you entered when creating RTEPAY12. Update the Name, Description, and Instance Pattern values as shown here, and press Enter:

```

----- Create Evaluation Definition for PLXPROD1-----
COMMAND  ==>

Name           ==> RTEPAY13
Description    ==> REMFILE PAYFILB1 enabling

Sample Interval ==> 60           Interval between samples in seconds
TableName      ==> REMFILE      Resource Table Name or *
Instance Pattern ==> PAYFILB1   Specific or generic pattern
Result Set Action ==> ANY       Operation (ALL,ANY,SUM,MIN,MAX,AVG,CNT)
Separate Task  ==> NO           Run as a separate task (YES, NO)

Evaluation Column ==> ENABLESTATUS Column name to evaluate or *
  either Operator ==> NE        (EQ,NE,LT,GT,LE,GE)
  Value          ==> ENABLED
  Severity       ==> VHS        (VLS,LS,LW,HW,HS,VHS)
  or set Thresholds: Provide 3 low and/or 3 high values, N=Normal

VLS          LS          LW  (N)  HW          HS          VHS

View          ==> REMFILE      View invoked for this Evaluation

Type DOWN or UP to view other Evaluation Definition screens.
Press Enter to create Evaluation Definition.
Type END or CANCEL to cancel without creating.

```

4. Create the action definition.

From the current view, issue the command ACTNDEF. From the ACTNDEF view, issue the command CRE. Complete the Create Action Definition panel as shown here, and press Enter:

```

----- Create Action Definition for PLXPROD1 -----
COMMAND  ==>

Action Name   ==> RTAPAY12
Description   ==> Prime shift files not ENABLED

Event         ==> YES          Generate Event (Yes/No)
Event View    ==> REMFILE      View for Event
Priority       ==> 255         Event Priority (1 to 255)
Event Text    ==> Prime shift files not ready

External Msg  ==> YES          Generate External Message (Yes/No)
Enter Msg     ==> Prime shift files not ready
Exit Msg      ==> Prime shift files now ENABLED

Alert         ==> NO          Generate Alert (Yes/No)
CMAS Name     ==>             CMAS to Issue Alert
Enter Text    ==>
Exit Text     ==>

Restart      ==> NO          Cancel for ARM Restart (Yes/No)

Press Enter to create the Action Definition.
Type END or CANCEL to cancel without creating.

```

**Note:** For a complete description of the ACTNDEF view, see “ACTNDEF (Action definitions)” on page 26.

5. Create the analysis definition.

From the current view, issue the command RTADEF. From the RTADEF view, issue the command CRE. Complete the Create Analysis Definition panel as shown here, and press Enter:

## example tasks: real-time analysis

```
----- Create Analysis Definition for PLXPROD1 -----
COMMAND ==>

Name           ==> RTDPAY12
Description    ==> Application file check
Perform Ops    ==> NO           Perform EVALDEF operations changes (YES, NO)
Sample Interval ==> 60           Interval between samples in seconds (1-86400)
Action Name    ==> RTAPAY12    Action definition name or generic

                VLS   LS   LW   HW   HS   VHS
Entry Intervals ==> 0001 0001 0001 0001 0001 0001
Exit Intervals  ==> 0001 0001 0001 0001 0001 0001

Evaluation expression:
==> RTEPAY12 | RTEPAY13
==>
==>
==>
==>
==>

Press Enter to create the Analysis Definition.
Type END or CANCEL to cancel without creating.
```

The Evaluation Expression causes CICSplex SM to issue a notification if either evaluation returns a true condition.

**Note:** For a complete description of the RTADEF view, see “RTADEF (Analysis definitions)” on page 43.

6. Associate the new analysis definition with the existing analysis group.

In the RTADEF view, tab to the entry for RTDPAY12, and issue ADD from the line-command field. The Add RTADEF to Analysis Group panel is displayed. Complete the panel as shown here, and press Enter:

```
----- Add RTADEF to Analysis Group for PLXPROD1 -----
COMMAND ==>

Name           RTDPAY12
Description

Analysis Group ==> RTGPAY02    Analysis Group or Generic
Active Period  ==> PDFCHECK     Period Name or Generic

Press Enter to add RTADEF to Analysis Group.
Type END or CANCEL to cancel without adding.
```

The Analysis Group RTGPAY02 already exists (you created it in the previous example) and it has already been associated with the analysis specification RTSPAY02. Therefore, analysis definition RTDPAY12 is installed automatically in the CICS systems in group CSGAORS1 when those systems are next started, for the period of time defined in PDFCHECK.

---

## Monitoring a resource type in a single CICS system

In this example, you’ll see how to get CICSplex SM to monitor the LU 6.2 connections in CICS system CICSPT02, which has recently been experiencing LU 6.2 problems. Both an external message and an event notification are to be issued whenever any connection is found to be in RELEASED status. The monitoring will not be limited to specific hours of the day, but will be continuous.

## example tasks: real-time analysis

The task is fundamentally the same as the one shown in the example “Monitoring resources permanently” on page 93. The interesting differences arise in the creation of the evaluation definition, the action definition, and the analysis definition. Those steps are shown here:

### 1. Create an evaluation definition.

From the current view, issue the EVALDEF command. From the EVALDEF view, issue the CRE command. Complete the first Create Evaluation Definition panel as shown here:

```
----- Create Evaluation Definition for PLXPROD1-----
COMMAND  ==>>

Name      ==>> RTEPAY03
Description ==>> Connections in CICSPT02

Sample Interval ==>> 30          Interval between samples in seconds
TableName      ==>> CONNECT     Resource Table Name or *
Instance Pattern ==>> *         Specific or generic pattern
Result Set Action ==>> ANY      Operation (ALL, ANY, SUM, MIN, MAX, AVG, CNT)
Separate Task   ==>> NO        Run as a separate task (YES, NO)

Evaluation Column ==>> CONNSTATUS Column name to evaluate or *
  either Operator ==>> EQ       (EQ, NE, LT, GT, LE, GE)
  Value           ==>> RELEASED
  Severity        ==>> VHS      (VLS, LS, LW, HW, HS, VHS)
  or set Thresholds: Provide 3 low and/or 3 high values, N=Normal

VLS      LS      LW  (N)  HW      HS      VHS

View      ==>> CONNECT     View invoked for this Evaluation

Type DOWN or UP to view other Evaluation Definition screens.
Press Enter to create Evaluation Definition.
Type END or CANCEL to cancel without creating.
```

In this example:

- The Evaluation values define the type of check to be made.
- The Result Set Action value ensures that, if the condition is true of any single connection that’s being monitored, the evaluation returns a severity of VHS.

Issue the DOWN command and complete the second Create Evaluation Definition panel as shown here:

## example tasks: real-time analysis

```
----- Create Evaluation Definition for EYUPLX01-----
COMMAND  ===>

Name          ===> EYURTE01

Filter string expression: (Type FILTER to list columns)
===> TYPE=LU62.
===>
===>
===>
===>
===>
===>
===>
===>

Modification string expression: (Type MODIFY to list modifiable columns)
===>
===>
===>
===>

Type DOWN or UP to view other Evaluation Definition screens.
Press Enter to create Evaluation Definition.
Type END or CANCEL to cancel without creating.
```

In this example, the filter string limits the checking to LU 6.2 connections.

**Note:** For a complete description of the EVALDEF view, see “EVALDEF (Evaluation definitions)” on page 33.

### 2. Create an action definition.

From the current view, issue the command ACTNDEF. From the ACTNDEF view, issue the command CRE. Complete the Create Action Definition panel as shown here, and press Enter:

```
----- Create Action Definition for PLXPROD1 -----
COMMAND  ===>

Action Name  ===> RTAPAY03
Description  ===> Connections lost in CICSPT02

Event        ===> YES          Generate Event (Yes/No)
Event View   ===> CONNECT      View for Event
Priority      ===> 255          Event Priority (1 to 255)
Event Text   ===> Connections lost in CICSPT02

External Msg ===> YES          Generate External Message (Yes/No)
Enter Msg    ===> Connections lost in CICSPT02
Exit Msg     ===> CICSPT02 connections now OK

Alert        ===> NO          Generate Alert (Yes/No)
CMAS Name    ===>             CMAS to Issue Alert
Enter Text   ===>
Exit Text    ===>

Restart     ===> NO          Cancel for ARM Restart (Yes/No)

Press Enter to create the Action Definition.
Type END or CANCEL to cancel without creating.
```

This action definition tells CICSplex SM that you want both an event notification and an external message to be issued.

**Note:** For a complete description of the ACTNDEF view, see “ACTNDEF (Action definitions)” on page 26.

3. Create an analysis definition.

Issue the command RTADEF from the current view. From the RTADEF view, issue the command CRE. Complete the Create Analysis Definition panel as shown here, and press Enter:

```

----- Create Analysis Definition for PLXPROD1 -----
COMMAND ==>

Name          ==> RTDPAY03
Description   ==> Connections in CICSPT02
Perform Ops   ==> NO          Perform EVALDEF operations changes (YES, NO)
Sample Interval ==> 30          Interval between samples in seconds (1-86400)
Action Name   ==> RTAPAY03   Action definition name or generic

                VLS   LS   LW   HW   HS   VHS
Entry Intervals ==> 0001 0001 0001 0001 0001 0001
Exit Intervals  ==> 0001 0001 0001 0001 0001 0001

Evaluation expression:
==> RTEPAY03
==>
==>
==>
==>
==>

Press Enter to create the Analysis Definition.
Type END or CANCEL to cancel without creating.

```

(You can allow the Entry Intervals and the Exit Intervals to default to 0001.) CICSplex SM will evaluate the results of the evaluation definition (defined in RTEPAY03) every 30 seconds.

You would install the analysis definition in the CICS system CICSPT02 by specifying CICSPT02 as the scope of the analysis specification.

**Note:** For a complete description of the RTADEF view, see “RTADEF (Analysis definitions)” on page 43.

---

## Monitoring a resource type throughout the CICSplex

In this example, you will see how to monitor the availability of all MRO connections throughout CICSplex PLXPROD1. Whenever such a connection goes out of service, an event notification (but no external message) is to be generated, and its severity is to be VHS. Thus, if three connections are lost, three event notifications will be issued. The monitoring is to be continuous. A CICS system group (CSGPLX01), which includes every CICS system in PLXPROD1, has already been created.

As in the previous example, the steps involved in the creation of the evaluation definition, the action definition, and the analysis definition are of most interest:

1. Create an evaluation definition.

From the current view, issue the command EVALDEF. From the EVALDEF view, issue the command CRE. Complete the first Create Evaluation Definition panel as shown here:

## example tasks: real-time analysis

```
----- Create Evaluation Definition for PLXPROD1-----
COMMAND  ==>

Name           ==> RTEPAY04
Description    ==> All MRO connections in PLXPROD1

Sample Interval ==> 30           Interval between samples in seconds
TableName      ==> CONNECT      Resource Table Name or *
Instance Pattern ==> *          Specific or generic pattern
Result Set Action ==> ANY        Operation (ALL,ANY,SUM,MIN,MAX,AVG,CNT)
Separate Task   ==> NO          Run as a separate task (YES, NO)

Evaluation Column ==> SERVSTATUS  Column name to evaluate or *
  either Operator ==> NE          (EQ,NE,LT,GT,LE,GE)
  Value          ==> INSERVICE
  Severity       ==> VHS          (VLS,LS,LW,HW,HS,VHS)
or set Thresholds: Provide 3 low and/or 3 high values, N=Normal

VLS           LS           LW   (N)   HW           HS           VHS

View           ==> CONNECT      View invoked for this Evaluation

Type DOWN or UP to view other Evaluation Definition screens.
Press Enter to create Evaluation Definition.
Type END or CANCEL to cancel without creating.
```

In this example:

- The Evaluation values define the type of check to be made.
- The Result Set Action value ensures that, if the condition is true of any connection that's being monitored, the evaluation returns a severity of VHS.

Issue the DOWN command and complete the second Create Evaluation Definition panel as shown here:

```
----- Create Evaluation Definition for EYUPLX01-----
COMMAND  ==>

Name           ==> EYURTE01

Filter string expression: (Type FILTER to list columns)
==> TYPE=MRO.
==>
==>
==>
==>
==>
==>
==>
==>

Modification string expression: (Type MODIFY to list modifiable columns)
==>
==>
==>

Type DOWN or UP to view other Evaluation Definition screens.
Press Enter to create Evaluation Definition.
Type END or CANCEL to cancel without creating.
```

In this example, the filter string limits the checking to MRO connections.

**Note:** For a complete description of the EVALDEF view, see "EVALDEF (Evaluation definitions)" on page 33.



2. Create an action definition.

From the current view, issue the command ACTNDEF. From the ACTNDEF view, issue the command CRE. Complete the Create Action Definition panel as shown here, and press Enter:

```

----- Create Action Definition for PLXPROD1 -----
COMMAND ==>

Action Name ==> RTAPAY04
Description ==> Connections lost in PLXPROD1

Event ==> YES          Generate Event (Yes/No)
Event View ==> CONNECT  View for Event
Priority ==> 120        Event Priority (1 to 255)
Event Text ==> Connections lost in PLXPROD1

External Msg ==> NO      Generate External Message (Yes/No)
Enter Msg ==>
Exit Msg ==>

Alert ==> NO           Generate Alert (Yes/No)
CMAS Name ==>          CMAS to Issue Alert
Enter Text ==>
Exit Text ==>

Restart ==> NO         Cancel for ARM Restart (Yes/No)

Press Enter to create the Action Definition.
Type END or CANCEL to cancel without creating.

```

The Priority value of 120 means that other VHS events with a priority greater than 120 will appear higher in the EVENT view.

**Note:** For a complete description of the ACTNDEF view, see “ACTNDEF (Action definitions)” on page 26.

3. Create an analysis definition.

From the current view, issue the command RTADEF. From the RTADEF view, issue the command CRE. Complete the Create Analysis Definition panel as shown here, and press Enter:

```

----- Create Analysis Definition for PLXPROD1 -----
COMMAND ==>

Name ==> RTDPAY04
Description ==> MRO connections in PLXPROD1
Perform Ops ==> NO      Perform EVALDEF operations changes (YES, NO)
Sample Interval ==> 30   Interval between samples in seconds (1-86400)
Action Name ==> RTAPAY04 Action definition name or generic

          VLS  LS   LW   HW   HS   VHS
Entry Intervals ==> 0001 0001 0001 0001 0001 0001
Exit Intervals ==> 0001 0001 0001 0001 0001 0001

Evaluation expression:
==> RTEPAY04
==>
==>
==>
==>
==>

Press Enter to create the Analysis Definition.
Type END or CANCEL to cancel without creating.

```

## example tasks: real-time analysis

The Entry Intervals and Exit Intervals can be allowed to default to 0001.

**Note:** For a complete description of the RTADEF view, see “RTADEF (Analysis definitions)” on page 43.

You would install the analysis definition in the CICS system group CSGPLX01 by specifying CSGPLX01 as the scope of the analysis specification.

---

## Monitoring multiple resource types in a CICS system group (1)

This example shows how to monitor both the CDSA and the UDSA free sizes for two CICS systems, CICSPA01 and CICSPA02, which have already been defined as the only members of CICS system group CSGAORS1. When either the CDSA or UDSA free size falls below a specified value, an external message and an event notification are to be issued. The severity of the event notification will increase as the DSA free size reduces.

Because you are monitoring two resources in this example (UDSA and CDSA), two evaluation definitions are required. Here are the relevant steps:

1. Create the first evaluation definition.

From the current view, issue the command EVALDEF. From the EVALDEF view, issue the command CRE. Complete the first Create Evaluation Definition panel as shown here, and press Enter:

```
----- Create Evaluation Definition for PLXPROD1-----
COMMAND  ==>

Name          ==> RTEPAY05
Description   ==> Check CDSA free size

Sample Interval ==> 60           Interval between samples in seconds
TableName     ==> CICSDSA      Resource Table Name or *
Instance Pattern ==> CDSA      Specific or generic pattern
Result Set Action ==> MAX      Operation (ALL,ANY,SUM,MIN,MAX,AVG,CNT)
Separate Task  ==> NO         Run as a separate task (YES, NO)

Evaluation Column ==> STGFSIZE  Column name to evaluate or *
  either Operator ==>          (EQ,NE,LT,GT,LE,GE)
  Value          ==>
  Severity       ==>          (VLS,LS,LW,HW,HS,VHS)
  or set Thresholds: Provide 3 low and/or 3 high values, N=Normal

VLS      LS      LW (N)  HW      HS      VHS
70000    85000   95000

View          ==> CICSDSA      View invoked for this Evaluation

Type DOWN or UP to view other Evaluation Definition screens.
Press Enter to create Evaluation Definition.
Type END or CANCEL to cancel without creating.
```

The Evaluation Threshold values are based on a CDSA cushion size of 64KB. Increasingly severe conditions will be flagged as the free storage drops closer to the cushion value. (An alternative approach would have been to use percentage measurements (PCTFREE) rather than absolute measures (STGFSIZE).) The resource will be sampled once every 60 seconds.

When you press Enter, the EVALDEF view is redisplayed, showing an entry for RTEPAY05.

**Note:** This example does not make use of the second Create Evaluation Definition panel. For a complete description of the EVALDEF view and the panels you use to create one, see “EVALDEF (Evaluation definitions)” on page 33.

2. Create the second evaluation definition.

From the EVALDEF view, tab to the entry for RTEPAY05, and issue CRE from the line-command field. The Create Evaluation Definition panel is displayed, showing the values you entered when you created RTEPA05. Overtyp the Name, Description, Instance Pattern, and Evaluation Threshold values as shown here, and press Enter:

```

----- Create Evaluation Definition for PLXPROD1-----
COMMAND ==>>

Name           ==>> RTEPAY06
Description    ==>> Check UDSA free size

Sample Interval ==>> 60           Interval between samples in seconds
TableName      ==>> CICSDSA      Resource Table Name or *
Instance Pattern ==>> UDSA       Specific or generic pattern
Result Set Action ==>> MAX       Operation(ALL,ANY,SUM,MIN,MAX,AVG,CNT)
Separate Task  ==>> NO          Run as a separate task (YES, NO)

Evaluation Column ==>> STGFSIZE   Column name to evaluate or *
  either Operator ==>>           (EQ,NE,LT,GT,LE,GE)
  Value          ==>>
  Severity       ==>>           (VLS,LS,LW,HW,HS,VHS)
  or set Thresholds: Provide 3 low and/or 3 high values, N=Normal

VLS      LS      LW (N)  HW      HS      VHS
70000    80000   90000

View           ==>> CICSDSA      View invoked for this Evaluation

Type DOWN or UP to view other Evaluation Definition screens.
Press Enter to create Evaluation Definition.
Type END or CANCEL to cancel without creating.
  
```

As for the CDSA evaluation definition, the Evaluation Threshold values are based on a cushion size of 64KB.

3. Create an action definition.

From the current view, issue the command ACTNDEF. From the ACTNDEF view, issue the command CRE. Complete the Create Action Definition panel as shown here, and press Enter:

## example tasks: real-time analysis

```
----- Create Action Definition for PLXPROD1 -----
COMMAND ==>

Action Name ==> RTAPAY05
Description ==> DSA free size low below 16MB

Event ==> YES          Generate Event (Yes/No)
Event View ==> CICSDSA  View for Event
Priority ==> 255       Event Priority (1 to 255)
Event Text ==> Free DSA below 16MB dropping

External Msg ==> YES    Generate External Message (Yes/No)
Enter Msg ==> Free DSA below 16MB dropping
Exit Msg ==> Free DSA below 16MB climbing

Alert ==> NO          Generate Alert (Yes/No)
CMAS Name ==>         CMAS to Issue Alert
Enter Text ==>
Exit Text ==>

Restart ==> NO        Cancel for ARM Restart (Yes/No)

Press Enter to create the Action Definition.
Type END or CANCEL to cancel without creating.
```

**Note:** For a complete description of the ACTNDEF view, see “ACTNDEF (Action definitions)” on page 26.

#### 4. Create an analysis definition.

From the current view, issue the command RTADEF. From the RTADEF view, issue the command CRE. Complete the Create Analysis Definition panel as shown here, and press Enter:

```
----- Create Analysis Definition for PLXPROD1 -----
COMMAND ==>

Name ==> RTDPAY05
Description ==> DSA free below 16MB
Perform Ops ==> NO      Perform EVALDEF operations changes (YES, NO)
Sample Interval ==> 300  Interval between samples in seconds (1-86400)
Action Name ==> RTAPAY05 Action definition name or generic

          VLS  LS  LW  HW  HS  VHS
Entry Intervals ==> 0002 0002 0002 0001 0001 0001
Exit Intervals ==> 0002 0002 0002 0001 0001 0001

Evaluation expression:
==> RTEPAY05|RTEPAY06
==>
==>
==>
==>
==>

Press Enter to create the Analysis Definition.
Type END or CANCEL to cancel without creating.
```

The Entry and Exit intervals are used to smooth out fluctuations in the values being seen. For example, an LW condition is not flagged until a severity of at least LW has been seen for two consecutive samples. Each condition is cleared after two, less severe samples have been seen in succession.

The Evaluation expression value tells CICSplex SM that either of the two evaluation definitions can identify a condition that is to be flagged. The action is the same for both evaluation definitions, and is defined in RTAPAY05.

**Note:** For a complete description of the RTADEF view, see “RTADEF (Analysis definitions)” on page 43.

You would install the analysis definition RTDPAY05 in the CICS system group CSGAORS1 by specifying CSGAORS1 as the scope of the analysis specification.

## Monitoring multiple resource types in a CICS system group (2)

In the previous example (“Monitoring multiple resource types in a CICS system group (1)” on page 104), you saw how to monitor two types of resource (CDSA and UDSA) in a group of CICS systems. You created a single action definition, so that the same notifications were issued, regardless of which of the two types of resource was having problems.

In this example, you will see how to monitor those same resources (CDSA and UDSA), but with these differences:

- The message text of the external message and the event notification will identify whether UDSA or CDSA is having problems. This will require two action definitions rather than one.
- The monitoring will be activated every day, from 10:00 through 11:30 and from 14:00 to 16:00, but not outside those times. This will require two analysis groups to be created, one of which will be installed from 10:00 through 11:00, and one of which will be installed from 14:00 through 16:00.

The CICS system group CSGAORS1, containing CICS systems CICSPA01 and CICSPA02, has already been created, as have the two time-period definitions PDFBUSY1 (for the period 10:00 through 11:30) and PDFBUSY2 (for the period 14:00 through 16:00). You can reuse the two evaluation definitions (RTEPAY05 and RTEPAY06) from the previous example.

### 1. Create the first action definition.

From the current view, issue the command ACTNDEF. From the ACTNDEF view, issue the command CRE. The Create Action Definition panel is displayed. Complete the panel as shown here, and press Enter:

```

----- Create Action Definition for PLXPROD1 -----
COMMAND  ===>

Action Name  ===> RTAPAY07
Description  ===> CDSA free size low below 16MB

Event        ===> YES           Generate Event (Yes/No)
Event View   ===> CICSDSA       View for Event
Priority      ===> 255          Event Priority (1 to 255)
Event Text    ===> Free CDSA below 16MB dropping

External Msg ===> YES           Generate External Message (Yes/No)
Enter Msg    ===> Free CDSA below 16MB dropping
Exit Msg     ===> Free CDSA below 16MB climbing

Alert        ===> NO           Generate Alert (Yes/No)
CMAS Name    ===>              CMAS to Issue Alert
Enter Text   ===>
Exit Text    ===>

Restart      ===> NO           Cancel for ARM Restart (Yes/No)

Press Enter to create the Action Definition.
Type END or CANCEL to cancel without creating.

```

The ACTNDEF view is redisplayed.

## example tasks: real-time analysis

### 2. Create the second action definition.

In the ACTNDEF view, tab to the entry for RTAPAY07, and issue CRE from the line-command field. The Create Action Definition panel is displayed, showing the values you entered while creating RTAPAY07. Update the panel as shown here, and press Enter:

```
----- Create Action Definition for PLXPROD1 -----
COMMAND ==>

Action Name ==> RTAPAY08
Description ==> UDSA free size low below 16MB

Event ==> YES          Generate Event (Yes/No)
Event View ==> CICSDSA  View for Event
Priority ==> 255        Event Priority (1 to 255)
Event Text ==> Free UDSA below 16MB dropping

External Msg ==> YES      Generate External Message (Yes/No)
Enter Msg ==> Free UDSA below 16MB dropping
Exit Msg ==> Free UDSA below 16MB climbing

Alert ==> NO           Generate Alert (Yes/No)
CMAS Name ==>          CMAS to Issue Alert
Enter Text ==>
Exit Text ==>

Restart ==> NO         Cancel for ARM Restart (Yes/No)

Press Enter to create the Action Definition.
Type END or CANCEL to cancel without creating.
```

Notice that the messages generated by action definitions RTAPAY07 and RTAPAY08 differentiate between problems with CDSA and problems with UDSA.

### 3. Create the first analysis definition.

From the current view, issue the command RTADEF. From the RTADEF view, issue the command CRE. Complete the Create Analysis Definition panel as shown here, and press Enter:

```
----- Create Analysis Definition for PLXPROD1 -----
COMMAND ==>

Name ==> RTDPAY07
Description ==> CDSA free size
Perform Ops ==> NO      Perform EVALDEF operations changes (YES, NO)
Sample Interval ==> 60   Interval between samples in seconds (1-86400)
Action Name ==> RTAPAY07 Action definition name or generic

          VLS  LS   LW   HW   HS   VHS
Entry Intervals ==> 0002 0002 0002 0001 0001 0001
Exit Intervals ==> 0002 0002 0002 0001 0001 0001

Evaluation expression:
==> RTEPAY05
==>
==>
==>
==>
==>

Press Enter to create the Analysis Definition.
Type END or CANCEL to cancel without creating.
```

## example tasks: real-time analysis

This analysis definition is basically the same as the one you created in the previous example (“Monitoring multiple resource types in a CICS system group (1)” on page 104), except that it names only one evaluation definition in the Evaluation expression field, has a shorter sample interval, and triggers the CDSA-specific action definition, RTAPAY07.

When you press Enter, the RTADEF view is redisplayed.

### 4. Create the second analysis definition.

In the RTADEF view, tab to the entry for RTDPAY07, and issue CRE from the line command field. The Create Analysis Definition panel is displayed, showing the values you entered when creating RTDPAY07. Update the panel as shown here, and press Enter:

```
----- Create Analysis Definition for PLXPROD1 -----
COMMAND ==>

Name          ==> RTDPAY08
Description   ==> UDSA free size
Perform Ops   ==> NO          Perform EVALDEF operations changes (YES, NO)
Sample Interval ==> 60          Interval between samples in seconds (1-86400)
Action Name   ==> RTAPAY08   Action definition name or generic

          VLS  LS  LW  HW  HS  VHS
Entry Intervals ==> 0002 0002 0002 0001 0001 0001
Exit Intervals  ==> 0002 0002 0002 0001 0001 0001

Evaluation expression:
==> RTEPAY06
==>
==>
==>
==>
==>

Press Enter to create the Analysis Definition.
Type END or CANCEL to cancel without creating.
```

The RTADEF view is redisplayed.

### 5. Create the first analysis group.

From the current view, issue the command RTAGROUP. From the RTAGROUP view, issue the command CRE. Complete the Create Analysis Group panel as shown here, and press Enter:

```
----- Create Analysis Group for PLXPROD1-----
COMMAND ==>

Group Name      ==> RTGPAY07
Description     ==> Peak time DSA health - a.m.

Press Enter to create Analysis Group.
Type END or CANCEL to cancel without creating.
```

**Note:** For a complete description of the RTAGROUP view, see “RTAGROUP (Analysis groups)” on page 49.

### 6. Create the second analysis group.

## example tasks: real-time analysis

In the RTAGROUP view, tab to the entry for RTGPAY07, and issue CRE from the line-command field. The Create Analysis Group panel is displayed, showing the values you entered while creating RTGPAY07. Update the panel as shown here, and press Enter:

```
----- Create Analysis Group for PLXPROD1-----  
COMMAND ===>  
  
Group Name          ===> RTGPAY08  
Description         ===> Peak time DSA health - p.m.  
  
Press Enter to create Analysis Group.  
Type END or CANCEL to cancel without creating.
```

7. Add analysis definitions to analysis group RTGPAY07.
  - a. From the current view, issue the command RTADEF.
  - b. In the RTADEF view, tab to the entry for RTDPAY07, and issue ADD from the line-command field. The Add RTADEF to Analysis Group panel is displayed. Complete the panel as shown here, and press Enter:

```
----- Add RTADEF to Analysis Group for PLXPROD1 -----  
COMMAND ===>  
  
Name                RTDPAY07  
Description  
  
Analysis Group      ===> RTGPAY07      Analysis Group or Generic  
Active Period       ===> PDFBUSY1      Period Name or Generic  
  
Press Enter to add RTADEF to Analysis Group.  
Type END or CANCEL to cancel without adding.
```

When you press Enter, the RTADEF view is redisplayed.

Repeat step 7b to add analysis definition RTDPAY08 to RTGPAY07, specifying Active Period PDFBUSY1.

8. Add analysis definitions to analysis group RTGPAY08.

Repeat step 7 to add analysis definitions RTDPAY07 and RTDPAY08 to analysis group RTGPAY08, but specifying time-period definition PDFBUSY2.  
(To check that analysis definitions have been added successfully to both analysis groups, issue the command RTAINGRP from the current view. The RTAINGRP view is displayed, showing entries for analysis definitions RTDPAY07 and RTDPAY08 in each of the analysis groups RTGPAY07 and RTGPAY08.)
9. Create an analysis specification.

From the current view, issue the command RTASPEC. From the RTASPEC view, issue the command CRE. The Create Analysis Specification panel is displayed. Complete the panel as shown here, and press Enter:



```

----- Create Analysis Specification for PLXPROD1 -----
COMMAND ==>

RTA Spec Name    ==> RTSPAY07
Description      ==> General health checks

System availability management:

          Action or Generic   Severity
SAM              =>          =>
SOS              =>          =>
SYSDUMP          =>          =>
TRANDUMP         =>          =>
MAXTASK          =>          =>
STALL            =>          =>

Press Enter to create the RTA Specification.
Type END or CANCEL to cancel without creating.

```

When you press Enter, the RTASPEC view is redisplayed.

**Note:** For a complete description of the RTASPEC view, see “RTASPEC (Analysis specifications)” on page 65.

10. Set the scope of the analysis specification.

In the RTASPEC view, tab to the entry for RTSPAY07 and issue ADD from the line-command field. The Add Scope for Specification panel is displayed. Complete the panel as shown here, and press Enter:

```

----- Add Scope for Specification for PLXPROD1 -----
COMMAND ==>

Analysis Spec Name    RTSPAY07
Description           General health checks

Scope                ==> CSGAORS1    CICS System, Group or Generic
Option               ==> FORCE       FORCE, NULL, or NONE for System Group

Press Enter to add Analysis Specification Scope.
Type END or CANCEL to cancel without adding.

```

The RTASPEC view is redisplayed.

11. Add the analysis groups to the analysis specification.

- a. From the current view, issue the command RTAGROUP.
- b. In the RTAGROUP view, tab to the entry for RTGPAY07, and issue ADD from the line-command field. The Add Analysis Group to Analysis Specification panel is displayed.
- c. In the Specification Name field of the Add Analysis Group to Analysis Specification panel, type RTSPAY07 and press Enter. The RTAGROUP view is redisplayed.

Repeat this step to add analysis group RTGPAY08 to analysis specification RTSPAY07. The analysis definitions take effect for any CICS system in group CSGAORS1 when that system is next started. If any of the CICS systems in group CSGAORS1 is already active, you can make the analysis definitions take immediate effect as described in “Adding a scope to an analysis specification” on page 68.

## Updating analysis and evaluation definitions

This example shows how to update the evaluation definition and the analysis definition you used for the CDSA resource in the previous example. Assume that you want to reduce the sample intervals in both definitions from 60 seconds to 30 seconds.

1. If the current context isn't PLXPROD1, issue the command CON PLXPROD1 from the current view.
2. Update the evaluation definition RTEPAY05.
  - a. From the current view, issue the command EVALDEF.
  - b. In the EVALDEF view, tab to the entry for RTEPAY05 and issue UPD from the line-command field. The Update Evaluation Definition panel is displayed.
  - c. Overtyping the Sample Interval (currently set to 60) with 30, and press Enter. The EVALDEF view is redisplayed.

**Note:** For a complete description of the EVALDEF view, see "EVALDEF (Evaluation definitions)" on page 33.

3. Update the analysis definition RTDPAY07.
  - a. Issue the command RTADEF from the current view.
  - b. In the RTADEF view, tab to the entry for RTDPAY07, and issue UPD from the line-command field. The Update Analysis Definition panel is displayed.
  - c. Overtyping the Sample Interval (currently set to 60) with 30, and press Enter. The RTADEF view is redisplayed.

**Note:** For a complete description of the RTADEF view, see "RTADEF (Analysis definitions)" on page 43.

Although you have updated the relevant definitions, any active CICS system in which those definitions are installed will not pick up the changes until those systems are next started. If you want to make the changes take effect immediately, you must reinstall the analysis definition "manually".

4. Install the changed analysis definition.
  - a. In the RTADEF view, tab to the entry for RTDPAY07, and issue INS from the line-command field. The Install RTADEF panel is displayed.
  - b. In the Scope field of the Install RTADEF panel, enter CSGAORS1. The RTADEF view is redisplayed.

To check that the updated definition has been installed, issue the command RTAACTV from the current view. The RTAACTV view, showing the current sample interval for installed analysis definitions, is displayed.

---

## Deactivating an analysis definition

This example shows you how to deactivate an analysis definition, installed for a specific period of time, before that time has elapsed. Assume that the analysis definition RTDPAY02 (from the example "Monitoring resources permanently" on page 93) is now being installed automatically from 09:00 through 17:30 every day in CICS systems CICSPA01 and CICSPA02. The time-period definition that controls installation of RTDPAY02 is PDFPRIME. The current time is 14:45, and you want to deactivate the definition in CICSPA02.

1. If the current context isn't PLXPROD1, issue the command CON PLXPROD1 from the current view.

2. Display a list of active analysis definitions.  
Issue the command RTAACTV from the current view. The RTAACTV view is displayed, showing an entry for analysis definition RTDPAY02 in CICS systems CICSPA01 and CICSPA02. The Active Period is PDFPRIME, and the Status is ACTIVE.
3. Deactivate an analysis definition.  
Tab to the entry for RTDPAY02 in CICSPA02, and issue DEA from the line-command field. The RTAACTV view is redisplayed, showing the Status as PENDING. The analysis definition RTDPAY02 will become active again in CICSPA02 when the start of time-period PDFPRIME is next reached.

---

## Using data gathered by the resource monitoring function

This example shows you how the real-time analysis functions of CICSplex SM can interpret data from another CICSplex SM function—resource monitoring—and issue appropriate notifications when problems occur.

Assume that a key transaction (PAY8) is experiencing poor response times, and that the cause is unclear. Transaction PAY8 is initiated from TOR CICSPT02 in CICSplex PLXPROD1. Appropriate monitoring definitions have been created to monitor the response time of transaction PAY8 at 5-minute intervals. (An example of how to do this is provided in “Monitoring transaction response times” on page 175.) CICSplex SM’s real-time analysis function will examine the data gathered by the resource monitoring function, and will issue an event notification and an external message when the response time is poor. The severity of the event notification will increase in line with the degradation in response times.

Analysis of PAY8’s response times is not a permanent requirement, but is necessary only until the problem is solved. Because of this, the analysis definition is installed manually in TOR CICSPT02 on request.

1. If the current context isn’t PLXPROD1, issue the command CON PLXPROD1 from the current view.
2. Create an evaluation definition.  
From the current view, issue the command EVALDEF. From the EVALDEF view, issue the command CRE. Complete the first Create Evaluation Definition panel as shown here, and press Enter:

## example tasks: real-time analysis

```
----- Create Evaluation Definition for PLXPROD1-----
COMMAND ==>

Name           ==> RTPAY09
Description    ==> PAY8 response times check

Sample Interval ==> 300           Interval between samples in seconds
TableName      ==> MREMTRAN      Resource Table Name or *
Instance Pattern ==> PAY8        Specific or generic pattern
Result Set Action ==> MAX        Operation (ALL,ANY,SUM,MIN,MAX,AVG,CNT)
Separate Task   ==> NO          Run as a separate task (YES, NO)

Evaluation Column ==> CURAVGRES    Column name to evaluate or *
  either Operator ==>           (EQ,NE,LT,GT,LE,GE)
  Value          ==>
  Severity       ==>           (VLS,LS,LW,HW,HS,VHS)
  or set Thresholds: Provide 3 low and/or 3 high values, N=Normal

VLS      LS      LW  (N)  HW      HS      VHS
          1.5    3      4

View           ==> MREMTRAN      View invoked for this Evaluation

Type DOWN or UP to view other Evaluation Definition screens.
Press Enter to create Evaluation Definition.
Type END or CANCEL to cancel without creating.
```

The Evaluation Threshold values are response times in seconds. Thus, an average response time of 4 in any one sampling, for example, will be flagged as VHS. (Note that, although a Result Set Action value has been specified, it has no particular effect in this example. It is most useful when multiple resources are being evaluated, rather than one. For example, if you had specified an instance pattern of PAY\* and a Result Set Action value of MAX, the *maximum* average response time of transactions PAY\* would be used by CICSplex SM in determining whether to flag a condition.

**Note:** This example does not make use of the second Create Evaluation Definition panel. For a complete description of the EVALDEF view and the panels you use to create one, see "EVALDEF (Evaluation definitions)" on page 33.

### 3. Create an analysis definition.

From the current view, issue the command RTADEF. From the RTADEF view, issue the command CRE. Complete the Create Analysis Definition panel as shown here, and press Enter:

```

----- Create Analysis Definition for PLXPROD1 -----
COMMAND ==>

Name          ==> RTDPAY09
Description   ==> PAY8 response times high
Perform Ops   ==> NO           Perform EVALDEF operations changes (YES, NO)
Sample Interval ==> 300       Interval between samples in seconds (1-86400)
Action Name   ==> RTAPAY09   Action definition name or generic

                VLS  LS  LW  HW  HS  VHS
Entry Intervals ==> 0001 0001 0001 0001 0001 0001
Exit Intervals  ==> 0001 0001 0001 0001 0001 0001

Evaluation expression:
==> RTEPAY09
==>
==>
==>
==>
==>

Press Enter to create the Analysis Definition.
Type END or CANCEL to cancel without creating.

```

**Note:** For a complete description of the RTADEF view, see “RTADEF (Analysis definitions)” on page 43.

4. Create an action definition.

From the current view, issue the command ACTNDEF. From the ACTNDEF view, issue the command CRE. Complete the Create Action Definition panel as shown here, and press Enter:

```

----- Create Action Definition for PLXPROD1 -----
COMMAND ==>

Action Name   ==> RTAPAY09
Description   ==> PAY8 response times high

Event         ==> YES           Generate Event (Yes/No)
Event View    ==> MREMTRAN      View for Event
Priority       ==> 255          Event Priority (1 to 255)
Event Text    ==> PAY8 response times too high

External Msg  ==> YES           Generate External Message (Yes/No)
Enter Msg     ==> PAY8 response times climbing
Exit Msg      ==> PAY8 response times falling

Alert         ==> NO           Generate Alert (Yes/No)
CMAS Name     ==>              CMAS to Issue Alert
Enter Text    ==>
Exit Text     ==>

Restart      ==> NO           Cancel for ARM Restart (Yes/No)

Press Enter to create the Action Definition.
Type END or CANCEL to cancel without creating.

```

**Note:** For a complete description of the ACTNDEF view, see “ACTNDEF (Action definitions)” on page 26.

5. Explicitly install the analysis definition.

From the current view, issue the command RTADEF. In the RTADEF view, tab to the entry for RTDPAY09, and issue INS from the line-command field. The Install RTADEF panel is displayed. In the Scope field of the Install RTADEF panel type CICST02 and press Enter. The RTADEF view is redisplayed.

## Issuing one notification for multiple conditions (1)

In the real-time analysis examples you've seen so far, CICSplex SM has monitored one or more instances of a resource in one or more CICS systems, and each occurrence of a notifiable condition has caused an external message or an event notification to be issued. So, for example, if the CDSA falls too low in three AORs, you see three sets of notifications. However, there are occasions when a single notification for a group of CICS systems, or even for the entire CICSplex, would be preferable.

To implement this "consolidated" reporting, you create an analysis point specification, in which you identify a single CMAS as the primary CMAS for analysis point monitoring (APM). The primary CMAS consolidates results from all the systems being checked to give a single result.

In this example, you will see how to monitor the number of current tasks throughout the CICSplex PLXPROD1. When the average number of current tasks in PLXPROD1 goes above a specified number, a single event notification will be issued, and an alert will be issued to NetView. The checking will occur from 09:30 through 11:30, for which period a time-period definition (PDFEARLY) has already been created. Also, the CICS system group CSGPLX01, which contains every CICS system in PLXPROD1, has been created.

1. If the current context isn't PLXPROD1, issue the command CON PLXPROD1 from the current view.
2. Create an evaluation definition.

From the current view, issue the command EVALDEF. From the EVALDEF view, issue the command CRE. Complete the first Create Evaluation Definition panel as shown here, and press Enter:

```

----- Create Evaluation Definition for PLXPROD1-----
COMMAND ==>>

Name           ==>> RTEPAY10
Description    ==>> Current tasks in PLXPROD1

Sample Interval ==>> 60           Interval between samples in seconds
TableName      ==>> CICSRGN      Resource Table Name or *
Instance Pattern ==>> *          Specific or generic pattern
Result Set Action ==>> AVG       Operation(ALL,ANY,SUM,MIN,MAX,AVG,CNT)
Separate Task  ==>> NO           Run as a separate task (YES, NO)

Evaluation Column ==>> CURRTASKS Column name to evaluate or *
  either Operator ==>>           (EQ,NE,LT,GT,LE,GE)
  Value          ==>>
  Severity       ==>>           (VLS,LS,LW,HW,HS,VHS)
  or set Thresholds: Provide 3 low and/or 3 high values, N=Normal

VLS          LS          LW  (N)  HW          HS          VHS
                    50          65          70

View          ==>> CICSRGN      View invoked for this Evaluation

Type DOWN or UP to view other Evaluation Definition screens.
Press Enter to create Evaluation Definition.
Type END or CANCEL to cancel without creating.

```

The current number of tasks is to be checked every 60 seconds. An average of 50 or higher will be notified, and the severity of the notification will increase as the average number of current tasks increases.

## example tasks: real-time analysis

**Note:** This example does not make use of the second Create Evaluation Definition panel. For a complete description of the EVALDEF view and the panels you use to create one, see “EVALDEF (Evaluation definitions)” on page 33.

### 3. Create an action definition.

From the current view, issue the command ACTNDEF. From the ACTNDEF view, issue the command CRE. Complete the Create Action Definition panel as shown here, and press Enter:

```
----- Create Action Definition for PLXPROD1 -----
COMMAND ==>

Action Name ==> RTAPAY10
Description ==> High task load in PLXPROD1

Event ==> YES          Generate Event (Yes/No)
Event View ==> CICSRCN  View for Event
Priority ==> 255        Event Priority (1 to 255)
Event Text ==> High task load in PLXPROD1

External Msg ==> NO      Generate External Message (Yes/No)
Enter Msg ==>
Exit Msg ==>

Alert ==> YES          Generate Alert (Yes/No)
CMAS Name ==> CMSSYS1   CMAS to Issue Alert
Enter Text ==> Task load climbing in PLXPROD1
Exit Text ==> Task load falling in PLXPROD1

Restart ==> NO          Cancel for ARM Restart (Yes/No)

Press Enter to create the Action Definition.
Type END or CANCEL to cancel without creating.
```

The ACTNDEF view is redisplayed.

**Note:** For a complete description of the ACTNDEF view, see “ACTNDEF (Action definitions)” on page 26.

### 4. Create an analysis definition.

From the current view, issue the command RTADEF. From the RTADEF view, issue the command CRE. Complete the Create Analysis Definition panel as shown here, and press Enter:

## example tasks: real-time analysis

```
----- Create Analysis Definition for PLXPROD1 -----
COMMAND ==>

Name          ==> RTDPAY10
Description   ==> Average current tasks
Perform Ops   ==> NO           Perform EVALDEF operations changes (YES, NO)
Sample Interval ==> 60           Interval between samples in seconds (1-86400)
Action Name   ==> RTAPAY10     Action definition name or generic

                VLS   LS   LW   HW   HS   VHS
Entry Intervals ==> 0001 0001 0001 0004 0003 0002
Exit Intervals  ==> 0001 0001 0001 0002 0002 0002

Evaluation expression:
==> RTEPAY10
==>
==>
==>
==>
==>
==>

Press Enter to create the Analysis Definition.
Type END or CANCEL to cancel without creating.
```

CICSplex SM will sample the results of its evaluations every 60 seconds. An HW condition will be flagged when a severity of at least HW has been seen in four successive samples. An HS condition will be flagged when a severity of at least HS has been seen in three successive samples. A VHS condition will be flagged when a severity of VHS has been seen in two successive samples. Each of the conditions will be cleared only when two, less severe samples are seen in succession.

**Note:** For a complete description of the RTADEF view, see “RTADEF (Analysis definitions)” on page 43.

### 5. Create an analysis group.

From the current view, issue the command RTAGROUP. From the RTAGROUP view, issue the command CRE. Complete the Create Analysis Group panel as shown here, and press Enter:

```
----- Create Analysis Group for PLXPROD1-----
COMMAND ==>

Group Name     ==> RTGPAY10
Description    ==> AP - CICSplex health checks

Press Enter to create Analysis Group.
Type END or CANCEL to cancel without creating.
```

The RTAGROUP view is redisplayed.

**Note:** For a complete description of the RTAGROUP view, see “RTAGROUP (Analysis groups)” on page 49.

### 6. Add the analysis definition to the analysis group.

From the current view, issue the command RTADEF. In the RTADEF view, tab to the entry for RTDPAY10, and issue ADD from the line-command field. The



## example tasks: real-time analysis

Add RTADEF to Analysis Group panel is displayed. In the Analysis Group field, type RTGPAY10. In the Time Period field, type PDFEARLY. Press Enter. The RTADEF view is redisplayed.

You can check that this step has worked by looking at the RTAINGRP view.

### 7. Create an analysis point specification.

From the current view, issue the command APSPEC. From the APSPEC view, issue the command CRE. Complete the Create Analysis Point Specification panel as shown here, and press Enter:

```
----- Create Analysis Point Specification for PLXPROD1 -----  
COMMAND ==>  
  
AP SpecName      ==> RAPPAY10  
Description      ==> Analysis point for PLXPROD1  
  
Press Enter to create AP Specification.  
Type END or CANCEL to cancel without creating.
```

The APSPEC view is redisplayed.

**Note:** For a complete description of the APSPEC view, see “APSPEC (Analysis point specifications)” on page 30.

### 8. Add the analysis group to the analysis point specification.

From the current view, issue the command RTAGROUP. In the RTAGROUP view, tab to the entry for RTGPAY10, and issue AAP from the line-command field. The Add Analysis Group to AP Specification panel is displayed. In the Specification Name field, type RAPPAY10. In the Scope field, type CSGPLX01. Press Enter. The RTAGROUP view is redisplayed.

You can check that this step has succeeded by looking at the RTAINAPS view.

### 9. Identify the primary CMAS.

From the current view, issue the command APSPEC. In the APSPEC view, tab to the entry for RAPPAY10, and issue ADD from the line-command field. The Add APSPEC CMAS Association panel is displayed. In the CMAS Name field, type CMSSYS1. In the Type field, type PRIMARY and press Enter. The APSPEC view is redisplayed.

When you identify the primary CMAS, the analysis point specification, and any analysis groups and analysis definitions associated with it, are installed automatically. For this reason, you should create the analysis definitions and analysis groups before you identify the primary CMAS.

### 10. Identify a secondary CMAS (optional).

In the APSPEC view, tab to the entry for RAPPAY10 again, and issue ADD from the line-command field. The Add APSPEC CMAS Association panel is displayed. In the CMAS Name field, type CMSSYS2. In the Type field, type SECONDARY and press Enter. The APSPEC view is redisplayed.

When you identify a secondary CMAS (which is optional), that CMAS assumes the role of the primary CMAS if it ever loses contact with the primary CMAS. That is, the secondary CMAS monitors resources in those CICS systems it can communicate with until its contact with the primary CMAS is restored.

You can check that primary and secondary CMASs have been successfully identified by looking at the APCMAS view.

## Issuing one notification for multiple conditions (2)

This example is a variation on the previous example (“Issuing one notification for multiple conditions (1)” on page 116), in which you saw how to obtain a single set of notifications when the average number of current tasks in a CICSplex is high. In this example, you’ll see how to monitor the availability of transactions whose names begin with the letters ETR throughout the CICSplex. (A transaction is not available if its status is DISABLED in any AOR in which it is locally defined.) An event notification and an alert will be issued if any ETR\* transaction is unavailable in one or more AORs.

How to create the evaluation definition, the action definition, and the analysis definition is described here. The remaining steps (such as creating an analysis group and creating the analysis point specification) are as described in step 5 on page 118 through step 9 on page 119 of the previous example.

### 1. Create an evaluation definition.

From the current view, issue the command EVALDEF. From the EVALDEF view, issue the command CRE. Complete the first Create Evaluation Definition panel as shown here, and press Enter:

```

----- Create Evaluation Definition for PLXPROD1-----
COMMAND  ==>

Name      ==> RTEPAY11
Description ==> Key transaction check

Sample Interval ==> 300      Interval between samples in seconds
TableName      ==> LOCTRAN  Resource Table Name or *
Instance Pattern ==> ETR*    Specific or generic pattern
Result Set Action ==> ANY    Operation (ALL,ANY,SUM,MIN,MAX,AVG,CNT)
Separate Task   ==> NO      Run as a separate task (YES, NO)

Evaluation Column ==> STATUS  Column name to evaluate or *
  either Operator ==> EQ      (EQ,NE,LT,GT,LE,GE)
  Value          ==> DISABLED
  Severity       ==> HS      (VLS,LS,LW,HW,HS,VHS)
  or set Thresholds: Provide 3 low and/or 3 high values, N=Normal

VLS      LS      LW  (N)  HW      HS      VHS

View      ==> LOCTRAN      View invoked for this Evaluation

Type DOWN or UP to view other Evaluation Definition screens.
Press Enter to create Evaluation Definition.
Type END or CANCEL to cancel without creating.
    
```

### 2. Create an action definition.

From the current view, issue the command ACTNDEF. From the ACTNDEF view, issue the command CRE. Complete the Create Action Definition panel as shown here, and press Enter:

```

----- Create Action Definition for PLXPROD1 -----
COMMAND ==>

Action Name ==> RTAPAY11
Description ==> Key application unavailable

Event ==> YES          Generate Event (Yes/No)
Event View ==> LOCTRAN  View for Event
Priority ==> 255        Event Priority (1 to 255)
Event Text ==> Key application unavailable

External Msg ==> NO      Generate External Message (Yes/No)
Enter Msg ==>
Exit Msg ==>

Alert ==> YES          Generate Alert (Yes/No)
CMAS Name ==> CMSSYS1   CMAS to Issue Alert
Enter Text ==> Key application unavailable
Exit Text ==> Key application available again

Restart ==> NO         Cancel for ARM Restart (Yes/No)

Press Enter to create the Action Definition.
Type END or CANCEL to cancel without creating.

```

Notice that the Event View value is LOCTRAN. Although the event notification issued in this example is not specific (that is, it doesn't identify the transactions, nor does it tell you in which AORs they are unavailable), you can look at the LOCTRAN view to find out which transactions are DISABLED, and in which AORs they are locally defined.

3. Create an analysis definition.

From the current view, issue the command RTADEF. From the RTADEF view, issue the command CRE. Complete the Create Analysis Definition panel as shown here, and press Enter:

```

----- Create Analysis Definition for PLXPROD1 -----
COMMAND ==>

Name ==> RTDPAY11
Description ==> Key application check
Perform Ops ==> NO      Perform EVALDEF operations changes (YES, NO)
Sample Interval ==> 300  Interval between samples in seconds (1-86400)
Action Name ==> RTAPAY11 Action definition name or generic

          VLS  LS  LW  HW  HS  VHS
Entry Intervals ==> 0001 0001 0001 0001 0001 0001
Exit Intervals ==> 0001 0001 0001 0001 0001 0001

Evaluation expression:
==> RTEPAY11
==>
==>
==>
==>
==>

Press Enter to create the Analysis Definition.
Type END or CANCEL to cancel without creating.

```

## Modifying the state of a resource

In this example you'll see how to use an evaluation definition and an analysis definition to modify a CICS resource when it is not in the desired state. This example is an extension of the example in "Reusing analysis specifications and analysis groups" on page 95, in which you saw how to monitor files in the CICS system group called CGSAORS1. You will be using the Time Period Def (PDFCHECK) and the Action Def (RTAPAY12) from that example.

1. Create the evaluation definition.

From the current view, issue the command EVALDEF. From the EVALDEF view, issue the command CRE. Complete the first Create Evaluation Definition panel as shown here:

```

----- Create Evaluation Definition for PLXPROD1-----
COMMAND  ===>

Name      ===> RTEPAY12
Description  ===> REMFILE PAYFILA* enabling

Sample Interval  ===> 60          Interval between samples in seconds
TableName       ===> REMFILE     Resource Table Name or *
Instance Pattern ===> PAYFILA*   Specific or generic pattern
Result Set Action ===> ANY       Operation (ALL,ANY,SUM,MIN,MAX,AVG,CNT)
Separate Task   ===> NO         Run as a separate task (YES, NO)

Evaluation Column  ===> ENABLESTATUS Column name to evaluate or *
  either Operator  ===> NE       (EQ,NE,LT,GT,LE,GE)
  Value           ===> ENABLED
  Severity        ===> VHS       (VLS,LS,LW,HW,HS,VHS)
  or set Thresholds: Provide 3 low and/or 3 high values, N=Normal

VLS      LS      LW  (N)  HW      HS      VHS

View      ===> REMFILE      View invoked for this Evaluation

Type DOWN or UP to view other Evaluation Definition screens.
Press Enter to create Evaluation Definition.
Type END or CANCEL to cancel without creating.

```

Issue the DOWN command and complete the second Create Evaluation Definition panel as shown here: - Create Evaluation Definition for EYUPLX01----- COMMAND ===> Name ===> EYURTE01 Filter string expression: (Type FILTER to list columns) ===> ===> ===> ===> ===> ===> ===> ===> Modification string expression: (Type MODIFY to list modifiable columns) ===> ENABLESTATUS=ENABLED, OPENSTATUS=OPEN. ===> ===> ===> Type DOWN or UP to view other Evaluation Definition screens. Press Enter to create Evaluation Definition. Type END or CANCEL to cancel without creating.

In this example, the modification string expression modifies the ENABLESTATUS and OPENSTATUS attributes to make the specified files available.

2. Create the analysis definition.

From the current view, issue the command RTADEF. From the RTADEF view, issue the command CRE. Complete the Create Analysis Definition panel as shown here, and press Enter:

```

----- Create Analysis Definition for PLXPROD1 -----
COMMAND ==>

Name          ==> RTDPAY14
Description   ==> Appl file check and modify
Perform Ops   ==> YES          Perform EVALDEF operations changes (YES, NO)
Sample Interval ==> 60          Interval between samples in seconds (1-86400)
Action Name   ==> RTAPAY12    Action definition name or generic

                VLS   LS   LW   HW   HS   VHS
Entry Intervals ==> 0001 0001 0001 0001 0001 0001
Exit Intervals  ==> 0001 0001 0001 0001 0001 0001

Evaluation expression:
==> RTEPAY12
==>
==>
==>
==>
==>

Press Enter to create the Analysis Definition.
Type END or CANCEL to cancel without creating.

```

The Perform Ops field indicates that the resource modification defined in the evaluation definition should be performed when the evaluation condition is true.

**Note:** For a complete description of the RTADEF view, see “RTADEF (Analysis definitions)” on page 43.

3. Associate the new analysis definition with the existing analysis group.

In the RTADEF view, tab to the entry for RTDPAY14, and issue ADD from the line-command field. The Add RTADEF to Analysis Group panel is displayed.

In the Analysis Group field, specify RTGPAY02. In the Active Period field, specify PDFCHECK.

The Analysis Group RTGPAY02 already exists and it has already been associated with the analysis specification RTSPAY02. Therefore, analysis definition RTDPAY14 is installed automatically in the CICS systems in group CSGAORS1 when those systems are next started, for the period of time defined in PDFCHECK.



---

## **Part 3. Resource monitoring**

This part describes the CICSplex SM resource monitoring facilities and the views you can use to monitor the resources in a CICSplex. It also includes sample tasks to help you establish resource monitoring at your enterprise.





---

## Chapter 6. Preparing to monitor resources

This chapter describes how CICSplex SM can be used to monitor the resources in a CICSplex. The primary purpose of these resource monitoring facilities is to provide data to the real-time analysis component. As part of real-time analysis processing, monitor definitions are automatically created to support the types of analysis you request. The data is used by real-time analysis to evaluate the status of a resource. Data can be collected for any or all resource types.

You can request additional monitoring of specific resources in your CICSplex. However, be aware that resource monitoring is implemented by a periodic sampling process that can add significant overhead to your environment.

When resource monitoring is active, either because real-time analysis requires it or you requested it, you can use the MONITOR view commands described in *CICSplex SM User Interface Guide* to display the collected data.

Resource monitoring is also used in the CICSplex SM interface to the NetView Resource Object Data Manager (RODM). By populating the RODM data cache with selected CICS resources, users of the NetView Graphic Monitor Facility (NGMF) can monitor the status of those resources. This status information can also be accessed using the RODM API and MultiSystem Manager Access (MSMACC). To avoid overpopulating the RODM data cache (and cluttering the resulting NGMF views), discretion should be used when identifying resources to RODM.

**Note:** Resource monitoring is not available for CICS for OS/2 2.0.1 and later systems.

---

### Defining resource monitoring attributes

When you define the attributes of resource monitoring, you are telling CICSplex SM exactly which occurrences of one or more resource types are to be monitored and when this monitoring is to occur. The resource monitoring attributes are based on information provided in monitor specifications, monitor definitions, and, optionally, monitor groups.

- A *monitor specification* identifies the types of resources to be monitored and how frequently information about these resources is to be gathered. After you associate a monitor specification with a CICS system, that specification is automatically installed every time the CICS system starts.

If you are using the CICSplex SM interface to RODM, a monitor specification also identifies the CMAS that is responsible for handling RODM requests.

- A *monitor definition* qualifies the resource type identified by a monitor specification. For example, after creating a monitor specification that indicates the program resource type is to be monitored, you might create a monitor definition that causes all programs to be monitored or only those programs with names starting with PAY.

A monitor definition also indicates which resources should be identified to RODM. For example, you might decide to populate the RODM data cache with a specific subset of programs so you can monitor their operational state.

## defining resource monitoring attributes

You can install a monitor definition either manually or automatically. To be automatically installed, a monitor definition must be part of a monitor group. Monitor definitions that are not part of a monitor group must be manually installed.

- A *monitor group* is a collection of monitor definitions that are treated as a single entity. This means that you can install all of the monitor definitions associated with a monitor group either by:
  - Associating the monitor group with a monitor specification. When a CICS system using that specification starts, the specification and all monitor definitions associated with it through the monitor group are automatically installed.
  - Manually installing the monitor group. Monitor definitions installed this way are known to the CICS system as long as the CICS system is running or until you discard the definitions.

You might want to create a monitor group that is not associated with a monitor specification for those resource types that you want to monitor only occasionally.

**Note:** A monitor definition can be installed in variety of CICSplex SM managed CICS systems. However, not all resource types are supported in all of those systems. Therefore, CICSplex SM verifies that the resource to be monitored is supported in the target system prior to installing the definition. If it is not, CICSplex SM issues a message indicating the definition cannot be installed because the resource is not supported. This message is informative in nature and does not require any corrective action.

Figure 54 on page 129 illustrates the attributes of resource monitoring. In this example:

- Monitor specification EYUMOS01 designates that the CICS region, program, and transaction resource types are to be monitored, using the monitor definitions associated with the monitor groups EYUMOG01, EYUMOG02, and EYUMOG03.
- Monitor groups, such as EYUMOG01, activate resource monitoring during the designated range of hours identified by the time period definition.
- Monitor definitions, such as EYUMOD01 and EYUMOD02, qualify the specific resource information to be gathered. That is, the monitor definition EYUMOD01 indicates that only the program named PAYX is to be monitored; while EYUMOD02 indicates that any transaction identifiers starting with PAY are to be monitored.

Monitor definitions such as EYUMOD09 are not associated with any monitor group and must, therefore, be manually installed. These definitions are useful when you have a very specific resource occurrence you want to monitor occasionally.

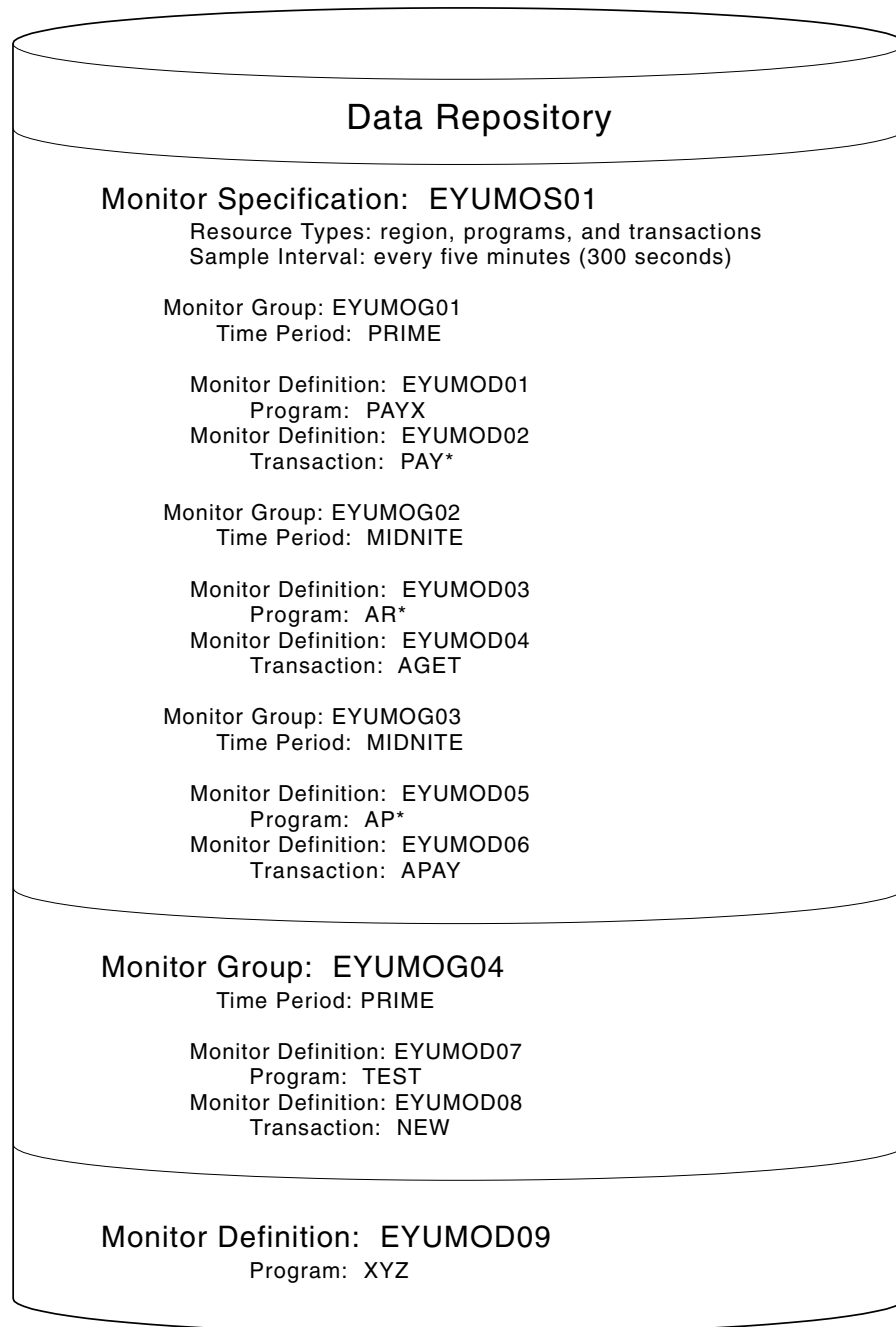

Figure 54. An example of resource monitoring attributes

## Activating resource monitoring

For resource monitoring to occur for a particular CICS system, you must:

1. Associate a monitor specification with the CICS system, using the MONSPEC view, as described on page 168.
2. Activate resource monitoring for the CICS system. You can do this using the views:

### **CICSSYS**

To change the CICS system definition in the data repository.

### **MAS**

To temporarily activate resource monitoring for an active CICS system.

## activating resource monitoring

3. Set the resource sample interval greater than 0. (The sample interval can be set from the associated monitor specification or from the CICS system definition.)

Monitor definitions that are associated with a monitor specification via monitor groups are automatically installed when that CICS system starts. As long as the CICS system remains active, additional monitor definitions can be manually installed in the CICS system.

Installed monitor definitions become active:

- At the time designated by the associated period definition.
- Immediately, when no period definition is associated with the definition, or if the CICS system is activated during the defined time period.

Monitor definitions remain active as long as the CICS system is running, until you discard them, or until the end of the time designated by the period definition is reached. (To determine the current status of installed monitor definitions, you can use the MONACTV view, as indicated in Table 3 on page 7.)

Once resource monitoring is active, any changes you make to monitor definitions are noted in the data repository. To apply these changes to an active CICS system, you must manually install or discard the definitions.

---

## Overriding resource monitoring attributes

The monitor specification associated with a CICS system determines:

- Whether resource monitoring is to be active when the CICS system starts
- How long collected data is to be retained after monitoring stops
- The sample interval to be used for one or more resource types

You can override any of the attributes defined in a monitor specification by changing the definition of the CICS system that is to use that specification. This might occur when, for example, multiple CICS systems are using the same monitor specification and you want the data retention period to be different for one of those systems. To override the monitor specification for a specific CICS system, you can use the views:

### **CICSSYS**

To permanently override part or all of a monitor specification. Values changed via this view are stored in the data repository and used every time the CICS system starts. (For additional information about using this view command, see *CICSplex SM Administration*.)

**MAS** To temporarily override all or part of the monitor specification currently being used by an active CICS system. Values affected by this view remain in effect as long as the CICS system is running or until you change them. (For additional information about this view command, see Table 3 on page 7.)

---

## Understanding resource monitoring times

When you define your resource monitoring attributes, you must identify a monitor interval, period definition, and sample interval, where:

### **Monitor interval**

The number of minutes during which data is to be collected and accumulated. At the end of an interval, the statistics counters are automatically reset.

## understanding resource monitoring times

A monitor interval is associated with a CICSplex and applies to all CICS system and CICS system groups comprising that CICSplex. To create or display the monitor intervals associated with the CICSplex, use the CPLEXDEF view, as described in *CICSplex SM Administration*.

When a CICS system starts, it determines how much of the current interval has elapsed for its CICSplex and begins from there. Thus, the interval for a CICS system may be less than the defined interval. For example, if the monitor interval for a CICSplex is 60 minutes and a CICS system associated with that CICSplex starts at 09:15:00, the first monitor interval for that CICS system is 45 minutes. Subsequent intervals will be 60 minutes in length.

### Period definition

The range of hours during which resource monitoring is to be active for a CICS system.

A time period definition can be associated with a monitor definition when you assign the monitor definition to a monitor group, as illustrated in Figure 54 on page 129. If no time period definition is associated with the monitor group, resource monitoring is active as long as the CICS system using the monitor definitions in that monitor group is active.

When a monitor definition is not associated with a monitor group, no period definition is associated with the monitor definition. In this case, the monitor definition becomes active when you manually install it in a CICS system. It remains active as long as the CICS system is active or until you discard the definition. To display information about existing time period definitions or create new ones, use the PERIODEF view, as described in *CICSplex SM Administration*.

### Sample interval

The number of seconds between the collection of sample data for a resource type; the data is reported in MONITOR views as the current sample.

A sample interval is associated with a resource type via a monitor specification, as illustrated in Figure 54 on page 129.

**Note:** One full sample interval must elapse before information about the resources being monitored is included in a MONITOR view. This ensures that enough time has elapsed for meaningful data to be collected. Depending on when a CICS system starts, more than a full interval may elapse.

Figure 55 on page 132 identifies the monitor-related time periods and illustrates their relationship to each other. In this case, the period during which resource monitoring is to be active is between 09:00:00 and 12:00:00. Resource data is to be collected every 15 minutes (900 seconds). During each monitor interval of 60 minutes, resource data is to be accumulated and reported as an average. After each 60 minute interval, the statistics counters containing the accumulated statistics are to be reset to zero.

## understanding resource monitoring statistics

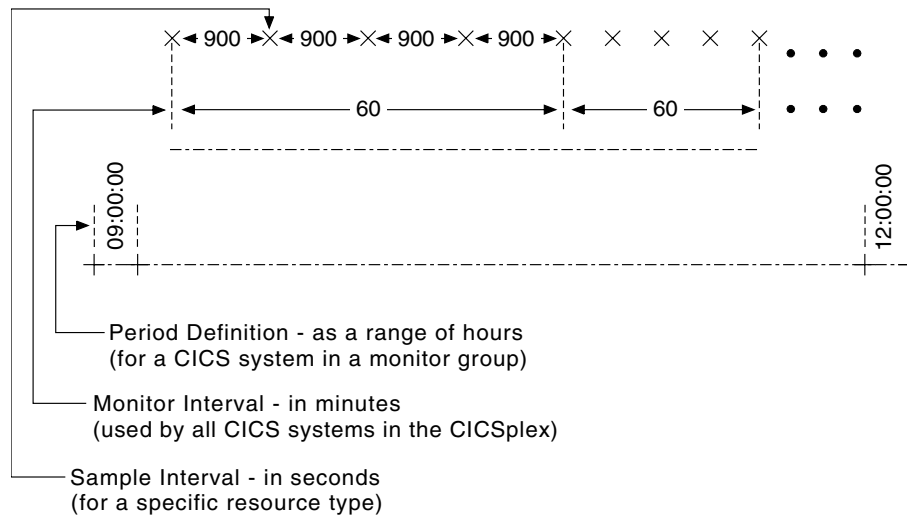

Figure 55. Resource monitoring time periods

---

## Understanding resource monitoring statistics

When resource monitoring is active, CICSplex SM collects data about the specified resources as frequently as indicated by the sample interval. This data reflects:

- The type of information available via the CICS COLLECT STATISTICS command.
- CICSplex SM *derived values*. A derived value is a rate, average, or percentage that results from CICSplex SM processing of CICS statistics.

All of the data collected about the monitored resources is available via the MONITOR views, which are described in *CICSplex SM User Interface Guide*.

**Important**

In order for CICSplex SM to gather the task-related data shown in the views MLOCTRAD, MLOCTRA2, MREMTRAD, and TASKD, the CICS monitoring facility (CMF) must be active and you must be collecting performance class data. For an active system, you can display the CICSRCN2 view and overtype these fields with the specified values:

<b>Field</b>	<b>Value</b>
<b>Monitor Status</b>	ON
<b>Perf Class</b>	PERF

This has the same effect as issuing the following EXEC CICS commands:

- EXEC CICS SET MONITOR STATUS(ON)
- EXEC CICS SET MONITOR PERFCLASS(PERF)

However, these changes remain in effect only while the CICS system is active. To permanently activate CICS performance class data monitoring, use the following CICS SIT parameters:

**For CICS/MVS 2.1.2**  
MONITOR=(PER)

**For CICS/ESA 3.3 or later**  
MN=ON MNPER=ON

You can choose to collect this data for use by CICSplex SM, but not have it written to an SMF data set. For information on suppressing CMF records, see the discussion of system parameters in *CICSplex SM Administration*.

## Data retention

When resource monitoring of a particular resource type is active, data is collected and accumulated until:

- The current monitor interval ends. At that time, the statistics counters are reset.
- The *retention period* has expired. A retention period is associated with a monitor specification. The period indicates the number of minutes accumulated data is to be retained after either the CICS system using that specification stops or you manually stop resource monitoring for that CICS system. At that time, the statistics counters are cleared.
- You explicitly initialize the statistics counters or remove the accumulated data. You can do this using the MONITOR views described in *CICSplex SM User Interface Guide*.

## A comparison of CICSplex SM and CICS monitoring

With CICS, you can collect data about the performance of all user- and CICS-supplied transactions. These records are written to an MVS System Management Facility (SMF) data set as type 110 records. These records can then be used for offline analysis. (If statistics records are also to be written to the SMF data set, you can process the statistics and monitoring records together to obtain resource and system information that complements the transaction data produced by CICS monitoring.)

## understanding resource monitoring statistics

With CICSplex SM, you can collect data about all resource types. That is, you can obtain information about one or more:

- Transactions
- Terminals
- Files
- Transient data queues
- Journals
- Connections
- Programs

You can also get information about CICS systems, dynamic storage areas (DSAs), transaction classes, local shared resource (LSR), and temporary storage.

---

## Using the RODM interface

The primary purpose of the RODM interface is to populate the RODM data cache with information about the current operational state of CICS resources being managed by CICSplex SM. RODM retains this information as objects and collections of objects. These objects are built using the MultiSystem Manager Open Data Model (MSMODM). Once the RODM data cache is populated, this information is available to the:

- NetView Graphic Monitor Facility (NGMF)
- RODM API
- MultiSystem Manager Access (MSMACC)

Non-RODM users can also activate the RODM interface, without populating the RODM data cache, to make this information available to:

- User-written CICSplex SM API programs
- Automation products

While the following sections focus on using the RODM interface in conjunction with RODM, information for non-RODM users is also included.

## Information provided by the RODM interface

The following CICSplex SM resources are identified to RODM as a result of activating the CICSplex SM RODM interface:

- CMASs
- CICSplexes
- CICS systems

You can optionally identify the following managed CICS resources to RODM:

- Connections (LU 6.1, LU 6.2, and MRO)
- Data sets
- Exits
- FEPI connections
- Files
- Journals
- Programs
- Terminals
- Transactions
- Transient data queues

For performance reasons, the RODM data cache is populated with only those resource attributes that are critical in determining the operational state of the resource. For each resource, RODM knows the following information:



#### Resource name attributes

These attributes uniquely identify the resource within its resource class and the CICS system in which it resides.

#### Resource evaluation attributes

These attributes identify values that enable RODM to categorize the state of the resource. The values reported to RODM vary by resource class.

#### Operational state attribute

This attribute describes the state of the resource during the last CICSplex SM resource monitoring sample interval.

If you plan to use the RODM API to access these objects, refer to “Appendix C. Information provided by the RODM interface” on page 195 for detailed information about the object attributes.

## Activating the RODM interface

To establish a connection to RODM, you must:

1. Identify a RODM subsystem to each CMAS that is involved in the interface.

**Note to non-RODM users:** This step is not necessary if you plan to use the CICSplex SM API or automation products. However, the remaining steps are necessary.

2. Identify the CICSplexes that should be reported to RODM.

For more information on updating CMAS and CICSplex definitions, see *CICSplex SM Administration*.

To populate the RODM data cache with specific resources, you must:

1. Identify the resources that are to be reported to RODM in a monitor definition (MONDEF), as described in “Creating a monitor definition” on page 147. (Note that CICS Region and Global resources do not require a monitor definition. They are automatically reported to RODM.)
2. Identify the CMAS that is responsible for handling RODM requests in a monitor specification (MONSPEC), as described in “Creating a monitor specification” on page 166.

You can use the MONACTV view, as described in *CICSplex SM User Interface Guide*, to deactivate an installed monitor definition.

## Monitoring resources with NGMF

Users of the NetView Graphic Monitor Facility (NGMF) can monitor managed CICS resources that have been identified to RODM. The managed resources are displayed in graphical form using a layered approach that represents the structure of the CICSplex SM environment.

This section briefly describes some of the CICSplex SM views available through NGMF. The sample views provided on the following pages are shown with resource name labels displayed for clarity. You can control the information displayed in the views by using **Display labels** on the NGMF **View** pull-down menu. For more information about NGMF, see the *NetView Graphic Monitor Facility User's Guide*.

## using the RODM interface

Figure 56 shows a sample Graphic Monitor view list, in which the CPSM\_World\_view is selected. Note that the name and description of this view can be customized during the RODM interface installation.

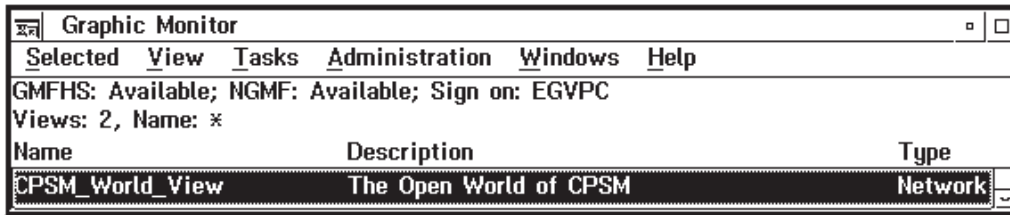

The screenshot shows a window titled "Graphic Monitor" with a menu bar containing "Selected", "View", "Tasks", "Administration", "Windows", and "Help". Below the menu bar, it displays "GMFHS: Available; NGMF: Available; Sign on: EGVPC" and "Views: 2, Name: \*". A table lists the views:

Name	Description	Type
CPSM_World_View	The Open World of CPSM	Network

Figure 56. Graphic Monitor view list

Figure 57 shows the view displayed when the CPSM\_World\_view is opened. The CPSM network object is displayed as an aggregate resource.

As with any NGMF view, you can double-click on a resource, or select the resource and choose **More detail** from the **Resource** pull-down menu to display a more detailed view of the underlying resource(s). If there are no underlying resources to display, a message is issued indicating that the requested view cannot be found.

The standard NGMF system status colors are used to indicate the operational state of a resource (for example, green is satisfactory and red is unsatisfactory). For real resources, the actual CICS status of the resource determines its operational state. Refer to "Appendix C. Information provided by the RODM interface" on page 195 for more information on the operational state of each real resource and its equivalent CICS status.

Assume that a more detailed view of the CPSM network resource is requested.

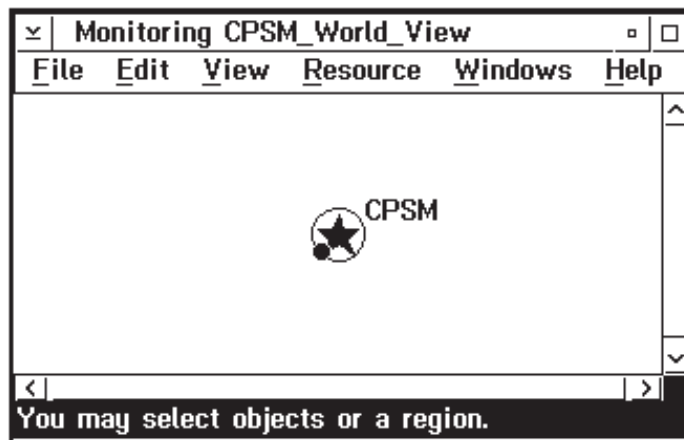

Figure 57. CPSM network object

Figure 58 on page 137 shows the CMAS resource (CMAS1JB), the CICSplex resource managed by the CMAS (PLEX1JB), and the null connector between them. A null connector is used to show which CICSplex is managed by which CMAS.

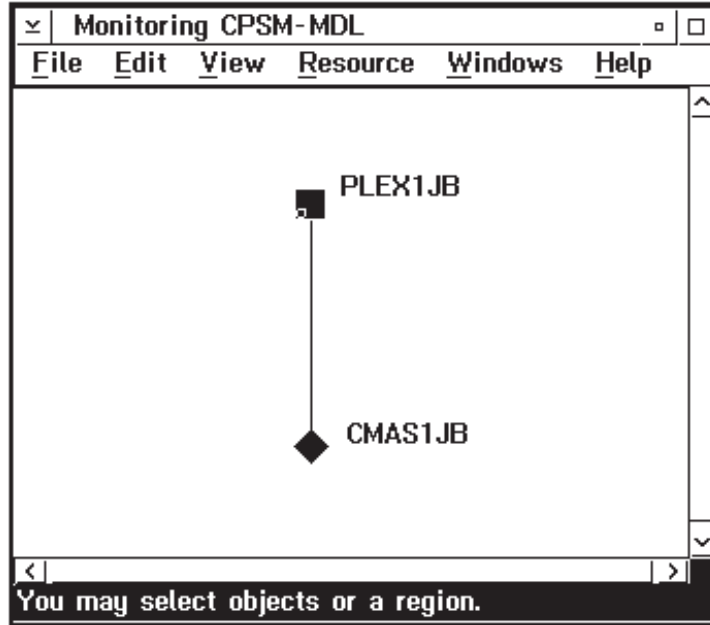

Figure 58. CICSplex and CMAS resources

If more detail is requested for CICSplex PLEX1JB, the view shown in Figure 59 is displayed. All of the CICS systems in the CICSplex are displayed in the view. Any systems that are not managed by CICSplex SM are represented by the UnManagedSystems resource. Note that this resource includes any system to which the CICS system has a connection and may include non-CICS systems. Each CICS system displayed in the view is shown with its ISC/IRC connection to

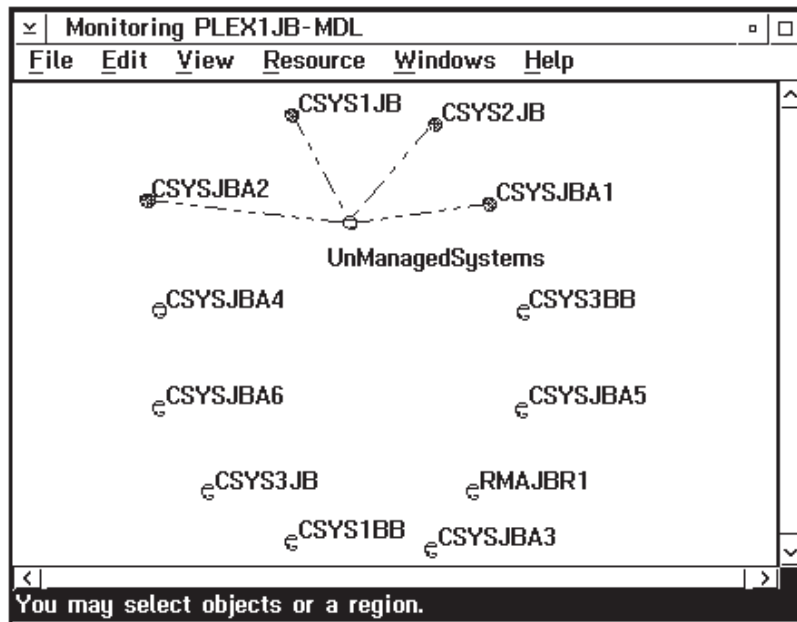

Figure 59. CICSplex topology

other CICS systems. If more detail is requested for the connection between two systems, the view shown in Figure 60 on page 138 is displayed.

## using the RODM interface

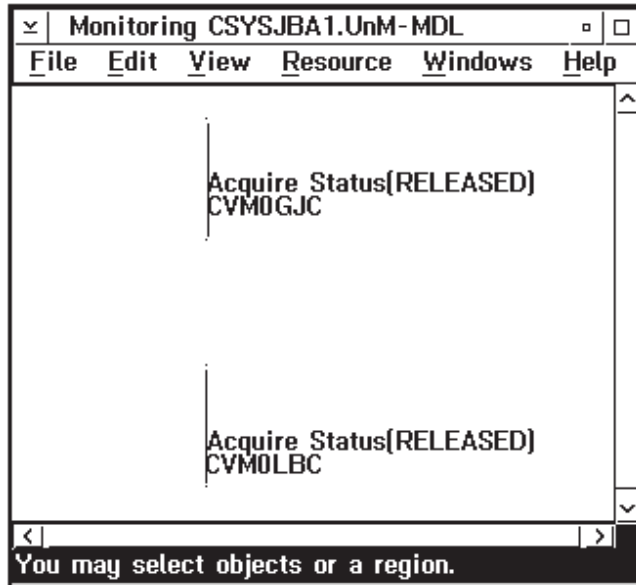

Figure 60. CICS system connection details

This view shows the link objects that represent the endpoints of the connection in each CICS system. If only one of the two CICS systems is active, only one link object is shown. You can determine the operational state of the ISC/IRC connection by requesting resource information on a link object.

If more detail is requested for an ISC/IRC connection to the UnManagedSystems resource, only a single link object is shown for each CICS system, since CICSplex SM has no way of evaluating the operational state of an unmanaged system.

If more detail is requested for CICS system CSYS1JB displayed in Figure 59 on page 137, the view shown in Figure 61 on page 139 is displayed. Only resources for which resource monitoring has been specified (using monitor specifications and monitor definitions) are displayed.

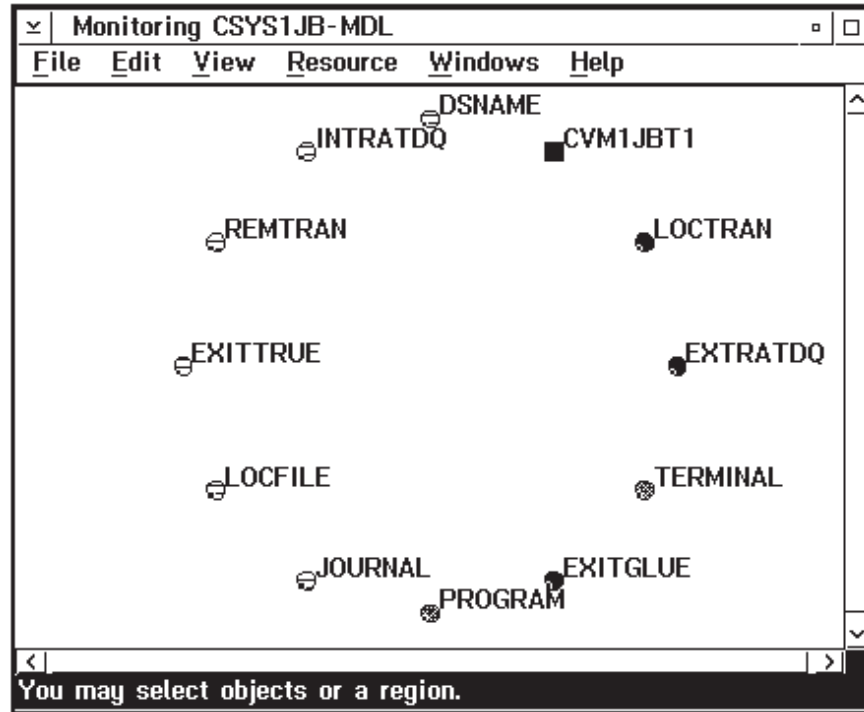

Figure 61. Aggregate resources in CSYS1JB

If all of the resources of a particular type are removed from the CICS system or from resource monitoring, that resource type is dynamically removed from the RODM data cache. Conversely, if resources are added, the RODM data cache is dynamically updated. In either case, the view information line at the bottom of the window will indicate that the view definition has changed. You can then refresh the view to reflect these changes.

If more detail is requested for the EXITGLUE aggregate resource, the view shown in Figure 62 on page 140 is displayed. Each object in the view represents a real resource in the CICS system.

## using the RODM interface

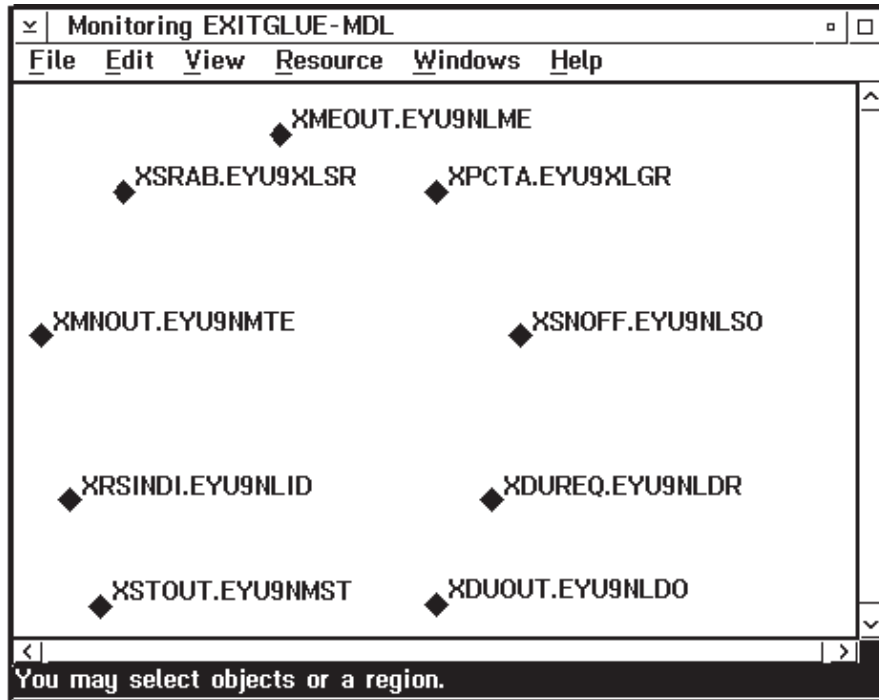

Figure 62. EXITGLUE real resources

You can display information about a resource by selecting the resource and choosing **Information** from the **Resource** pull-down menu. Alternatively, you can select the resource and double-click the right mouse button. The Resource Information window for an EXITGLUE resource is shown in Figure 63 on page 141.

Resource Information	
<b>Name</b>	XSRAB.EYU9XLSR
<b>Other data</b>	None
<b>Type</b>	Utility
<b>Customer data</b>	None
<b>System status</b>	Satisfactory 7:44:47 AM 10-05-95
<b>Operator status</b>	None
<input type="button" value="Status history"/> <input type="button" value="Alert history"/> <input type="button" value="Cancel"/> <input type="button" value="Help"/>	

Figure 63. EXITGLUE real resource information

The fields in the Resource Information window are:

**Name** The name of the resource.

**Other data**

The secondary status attribute of the resource or NONE, if this field is not applicable. Note that this attribute is not dynamically refreshed for real resources until the corresponding aggregate resource object is closed and reopened.

**Type** The type of the resource.

**Customer data**

Additional descriptive information about the resource or NONE, if this field is not applicable.

**System status**

The last known operational state of the resource and the date and time of the last status change.

**Operator status**

The condition set directly by the operator or NONE, if this field is not applicable.

For details on the information available for each resource, refer to "Appendix C. Information provided by the RODM interface" on page 195.

using the RODM interface

## Monitoring resources with an API program

Once the RODM interface is activated, a change in the operational state of a managed CICS resource identified to RODM causes CICSplex SM to issue an event notification.

User-written programs can use the CICSplex SM API LISTEN command to listen for these event notifications by specifying ERESSTAT in the EVENT option. A subsequent RECEIVE command can then be used to retrieve information about the event. For more information on these commands, see *CICSplex SM Application Programming Guide*.

## Monitoring resources with automation products

Once the RODM interface is activated, users of automation products that intercept system console messages can request that CICSplex SM issue an MVS/ESA WTO message whenever a change occurs in the operational state of a managed CICS resource identified to RODM. The WTO message identifier is EYUTS0050I. A sample message is shown here:

```
EYUTS0050I EYUPLX01/EYUMAS1A LocFile : EYUFIL01 state <DISABLED>
```

To request console messages of this nature, the following must be added to the CICSplex SM system parameters for each CMAS identified as a RODM CMAS in a monitor specification (MONSPEC):

```
RESSTATUS(MSG)
```

For more information on updating the CICSplex SM system parameters, see *CICSplex SM Administration*.

---

## Resource monitoring definitions and their related views

You can use the resource monitoring administration views to define a variety of resource monitoring attributes. Figure 64 on page 143 provides an overview of the resource monitoring views based on the CICSplex SM object model.



## resource monitoring definitions and their views

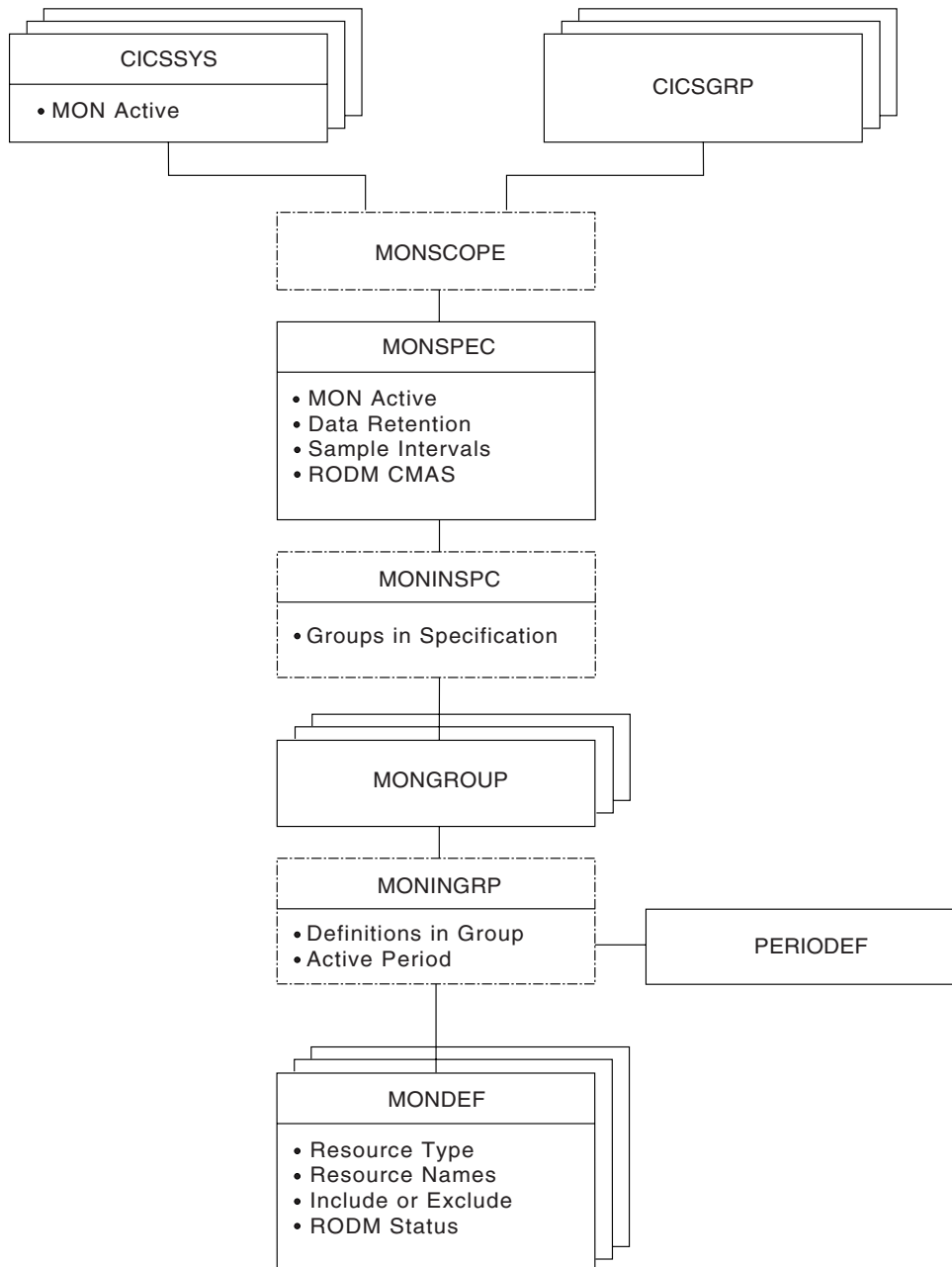

Figure 64. Views for creating resource monitoring objects and associations

In addition to the views shown here, you can use the `MONACTV` view, as described in Table 3 on page 7, to display information about and manage the resource monitoring activity in an active CICS system. You can also display a visual map of your resource monitoring definitions by using the `MAP` action command, as described in *CICSplex SM User Interface Guide*.

Figure 65 on page 144 illustrates the relationship between resource monitoring in a CICSplex and the views used to define resource monitoring attributes.

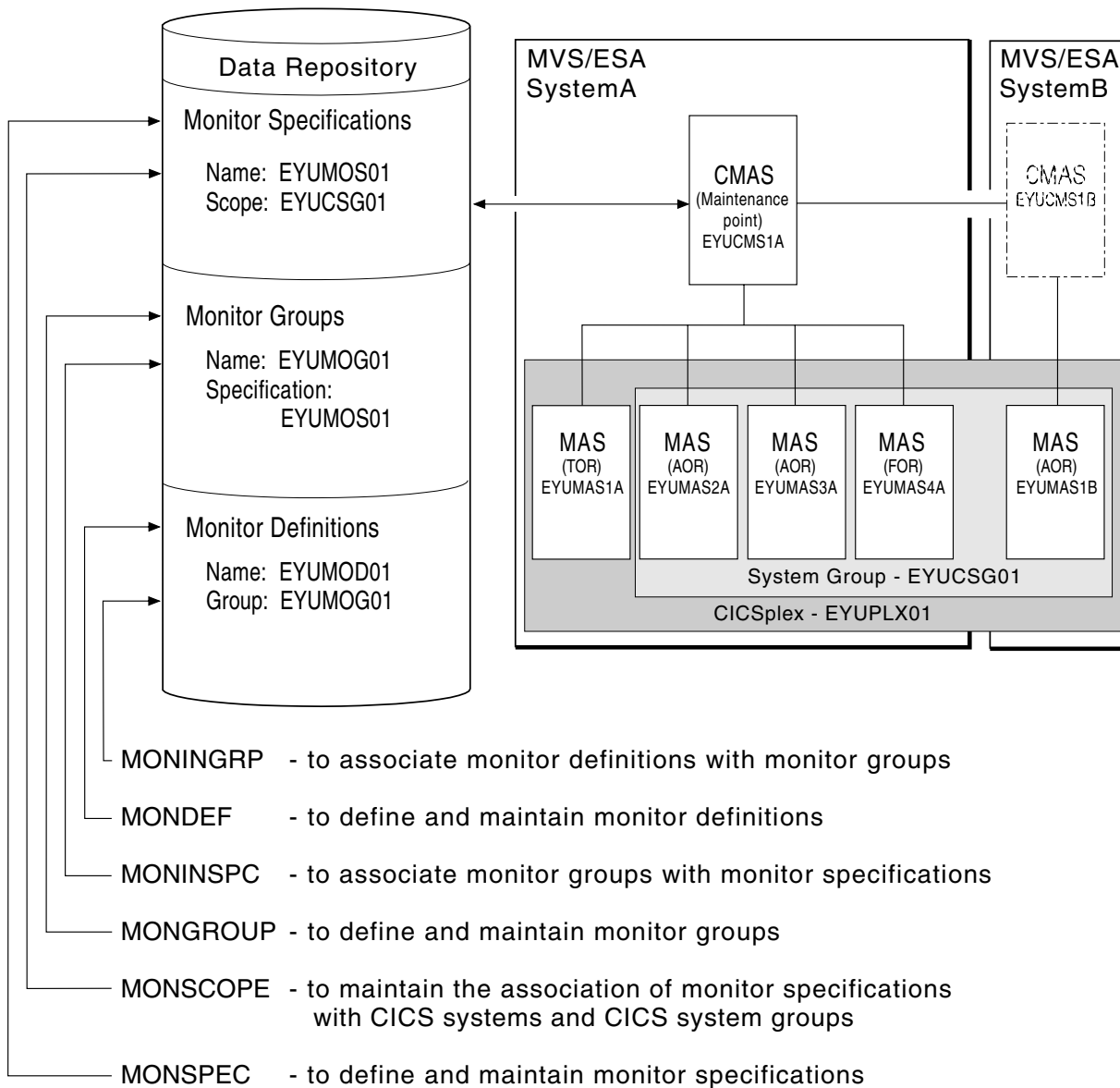

Figure 65. The relationship between resource monitoring definitions and their views

---

## Chapter 7. Resource monitoring views

This chapter contains detailed descriptions of the views used to create and maintain resource monitoring definitions.

You can access resource monitoring administration views by:

- Issuing the appropriate resource monitoring view command.
- Issuing the MENU ADMMON command and selecting a view from the menu. (An example of this menu is shown in Figure 66.)
- Initiating a hyperlink from one view to another by placing the cursor on a hyperlink field and pressing Enter.

```
26MAR1999 16:50:55 ----- INFORMATION DISPLAY -----
COMMAND ==>
CURR WIN ==> 1      ALT WIN ==>
W1 =MENU=====EYUPLX01=EYUPLX01=26MAR1999==16:50:55=CPSM=====9=====
CMD Name          Description
-----
ADMMON           Monitor Administration Views
MONSPEC          Monitor Specifications
MONGROUP         Monitor Groups
MONDEF           Monitor Definitions
PERIODEF         Time Period Definitions
=====
MONSCOPE         Members Associated with Monitor Specifications
MONINSPC         Monitor Groups in Specifications
MONINGRP         Monitor Definitions in Groups
```

Figure 66. The ADMMON menu

For additional information about accessing views, see *CICSplex SM User Interface Guide*.

Unless noted otherwise, only the context setting is recognized when you are creating and maintaining resource monitoring definitions. For information about setting the context, see *CICSplex SM User Interface Guide*.

The remainder of this chapter contains detailed descriptions of the resource monitoring views.

**Note:** Resource monitoring, and therefore the monitor views, are not available for CICS for OS/2 2.0.1 and later systems.

---

### MONDEF (Monitor definitions)

A monitor definition qualifies a resource type identified in a monitor specification by indicating the occurrences of the resource that are to be included in or excluded from monitoring. A monitor definition also identifies which resources are to be reported to RODM when the RODM interface is activated.

Examples of how to use this view can be found in:

## MONDEF

- “Monitoring transaction response times” on page 175
- “Monitoring programs in multiple CICS systems” on page 179

To display information about existing monitor definitions, issue the command:

```
MONDEF [mondef]
```

where `mondef` is a specific or generic monitor definition name. If you omit this parameter, the view, illustrated in Figure 67, includes information about all existing monitor definitions within the current context.

```

26MAR1999 19:33:23 ----- INFORMATION DISPLAY -----
COMMAND ==>                                     SCROLL ==> PAGE
CURR WIN ==> 1          ALT WIN ==>
W1 =MONDEF=====EYUPLX01=EYUPLX01=26MAR1999==19:33:23=CPSM=====11===
CMD Def      Resource Resource Include RODM Monitor Definition
--- Name---- Name---- Type--- Data--- Pop- Description-----
EYUMOD01 *      MCONN  YES    YES  SSet - All Connections
EYUMOD02 CO*    MTRAN  YES    NO   SSet - All CO* Transactions
EYUMOD03 CO*    MTDQS  YES    NO   SSet - TDQs CO*
EYUMOD04 EQ*    MTDQS  NO     YES  SSet - TDQs EQ*
EYUMOD05 DFHCSD MFILE  YES    YES  SSet - DFHCSD Files
EYUMOD06 *      MJRNL  YES    YES  SSet - All Journals
EYUMOD07 SP*    MTERM  YES    YES  SSet - All SP* Terminals
EYUMOD08 CEMT   MTRAN  YES    YES  SSet - CEMT Transaction
EYUMOD09 EYUF*   MFILE  YES    YES  SSet - EYUF* files
EYUMOD10 ET*    MTRAN  YES    YES  SSet - ET* Transactions
EYUMOD11 EYU*    MPROG  YES    YES  SSet - EYU* Programs

```

Figure 67. The MONDEF view

## Action commands and overtype fields

Table 35 summarizes the action commands you can use with the MONDEF view. Table 36 on page 147 identifies the overtype fields you can modify when you use the SET action command.

Table 35. MONDEF view action commands

Primary command	Line command	Description
n/a	ADD	Add an association between a monitor definition and a monitor group, as described on page 150.
n/a	BRO	Browse a monitor definition in the data repository.
CREate	CRE	<p>The format of the resulting panel is similar to that shown in Figure 68 on page 148. The panel fields are not modifiable.</p> <p>Create a monitor definition and add it to the data repository, as described on page 147.</p> <p>When you use the primary command CREate, some fields in the new view may contain values supplied by CICSplex SM; you may change these values. When you enter the line command CRE next to the name of a monitor definition, fields in the new view contain values to be modelled (from the existing monitor definition).</p>
n/a	INS	Install a monitor definition into a CICS system or CICS system group, as described on page 150.

Table 35. MONDEF view action commands (continued)

Primary command	Line command	Description
n/a	MAP	Display a visual map of resource monitoring definitions using the specified definition as a starting point.
n/a	REM	Remove a monitor definition from the data repository.
n/a	SET	Change a monitor definition using overtyping fields (see Table 36). <b>Note:</b> The value you specified in the Require Set field on the CICSplex System Manager entry panel determines whether or not you must use the SET command when you overtype a field.
TEMPMP cmasid	n/a	Change the temporary maintenance point CMAS to a specific CMAS or display a selection list based on a generic CMAS ID.
n/a	UPD	Update a monitor definition in the data repository.  The format of the resulting panel is similar to that shown in Figure 68 on page 148. You can change the contents of any field in the panel except Definition Name.

Table 36. MONDEF view overtyping fields

Field name	Value
Resource Name	Specific or generic name of a resource occurrence.
Resource Type	Type of resource to be monitored.
Include Data	YES NO <b>Note:</b> YES is the default.
RODM Pop	YES NO
Description	1- to 30-character description of the definition.

## Hyperlink fields

There are no hyperlink fields in the MONDEF view.

## Creating a monitor definition

There must be one or more monitor definitions for each resource type identified in a monitor specification. You create the appropriate monitor definitions for all resource types except Region, Global, and DB2/DBCTL. CICSplex SM automatically generates and maintains monitor definitions for the Region, Global, and DB2/DBCTL resource types.

Resource monitoring is not supported for CICS for OS/2 2.0.1 and later systems.

Figure 68 on page 148 shows the format of the panel produced when you use the create primary (CREate) or line (CRE) action command from the MONDEF view.

```

----- Create Monitor Definition for EYUPLX01 -----
COMMAND ==>

Definition Name ==>
Description    ==> Monitor all files

Resource Definition:
Name          ==> *      Resource Name
Type          ==> MFILE MCONN/MFILE/MJRNL/MPROG/MTDQS/MTERM/MTRAN
Include       ==> YES   Include for monitoring (NO, YES)
RODM Status   ==> YES   Operational status for RODM (NO, YES)

Press Enter to create Monitor Definition.
Type END or CANCEL to cancel without creating.
    
```

Figure 68. Creating a monitor definition

Provide the following information, as appropriate.

**Definition Name**

Specify a 1- to 8-character name for the monitor definition. The name can contain alphabetic, numeric, or national characters. However, the first character must be alphabetic,

**Description**

(Optional.) Specify a 1- to 30-character description of the resource occurrence that is to be monitored.

**Name** Indicate the specific or generic name of a resource occurrence.

Table 37 shows the alphabetic, numeric, and special characters that you can use to identify a resource occurrence. In addition to these characters, you may also include the generic characters + (plus sign), \* (asterisk), or both.

Table 37. Resource occurrence naming standards

Resource type	A-Z	0-9	@ # \$	_	. / % & ? ! " = , : < >	~ ¢
MCONN	Yes	Yes	Yes			
MFILE	Yes	Yes	Yes			
MJRNL		Yes				
MPROG	Yes	Yes	Yes			
MTDQS	Yes	Yes	Yes	Yes		
MTERM	Yes	Yes	Yes	Yes	Yes	
MTRAN	Yes	Yes	Yes	Yes	Yes	Yes

**Note:** If the monitor definition is to be installed in a system running the CICS TS, all of these characters are valid in the journal name.

**Type** Specify the type of resource to be monitored, where:

Type	Means
MCONN	Connections and LU 6.2 modenames
MFILE	Files
MJRNL	Journals
MPROG	Programs
MTERM	Terminals
MTRAN	Transactions
MTDQS	Transient data queues

**Note:** When specifying a resource type, consider the CICS systems in which this monitor definition will be installed. Not all resource types are supported in all of the CICSplex SM managed CICS systems. You may specify any resource type in the monitor definition. However, prior to installing the definition, CICSplex SM verifies that the resource type is supported in each target CICS system. For those systems that do not support the resource type, CICSplex SM issues a message indicating that the definition is not installed.

### Include

Specify YES or NO to indicate whether the designated resource is to be included in or excluded from CICSplex SM monitoring.

You can use this field to tailor resource monitoring. For example, to monitor all transactions except those with transaction identifiers starting with PAY, you would define two monitor definitions, where one definition includes all transactions in resource monitoring and the other definition identifies the generic group of transactions to be excluded, as in:

```

Definition ==> DEF1

Name          ==> *
Type          ==> MTRAN
Include       ==> Yes

Definition ==> DEF2

Name          ==> PAY*
Type          ==> MTRAN
Include       ==> No

```

Alphabetic characters take precedence over special characters when CICSplex SM is determining whether the name of a specific resource occurrence matches a monitor definition. Thus, you must be careful when identifying a resource occurrence. For example, suppose you created the following two monitor definitions.

```

Definition ==> DEF3

Name          ==> +++R*
Type          ==> MFILE
Include       ==> No

Definition ==> DEF4

Name          ==> PAY*
Type          ==> MFILE
Include       ==> Yes

```

With these definitions, files containing an R in the fourth position of their names will be excluded from monitoring. However, because alphabetic characters have precedence, any file name starting with PAY, including PAYR, will be included in monitoring. To prevent this from happening, you must create another monitor definition that explicitly excludes file names starting with PAYR.

### RODM Status

Specify YES or NO to indicate whether the designated resource should be identified to the NetView Resource Object Data Manager (RODM). Use discretion when identifying resources to RODM, as overpopulating the RODM data cache can have a negative impact on system performance.

## MONDEF

Press Enter to add the monitor definition to the data repository.

### Adding an association to a monitor group

Figure 69 illustrates the panel produced when you use the add (ADD) line action command from the MONDEF view.

```
----- Add Monitor Definition to Group for EYUPLX01 -----
COMMAND  ==>>

Definition Name      EYUMON01
Description          Programs
Type                MPROG
Resource Name       *
Include             YES
RODM Status         YES

Monitor Group Name ==>>          Monitor Group or Generic
Active Period      ==>>          Period Definition or Generic

Press Enter to add Monitor Definition to Group.
Type END or CANCEL to cancel without adding.
```

Figure 69. Adding an association between a monitor group and a monitor definition

Provide the following information, as appropriate.

#### Monitor Group Name

Enter the specific or generic name of an existing monitor group. If you specify a generic value, a list of valid monitor groups is displayed.

#### Active Period

(Optional) Enter the specific or generic name of a period definition that identifies the range of hours during which the monitor definition is to be active. If you specify a generic value, a list of valid period definitions is displayed.

If the name you specify does not belong to an existing period definition, you can create that period definition later. If you leave this field blank, the monitor definition remains active for as long as the CICS system is running, or until you discard it.

To add the monitor group and interval to the designated monitor definition, press Enter.

You can use the MONINGRP view, as described on page 156, to remove a monitor definition from a monitor group.

If an appropriate monitor group does not currently exist, you must first create the group, as described on page 154. Then you can add the monitor definition to it using either that ADD action command, or the ADD action command described in “Adding a monitor definition to a monitor group” on page 158.

### Installing a monitor definition

You can install a monitor definition into one or more active CICS systems that are within the CICSplex identified as the context. You can do this whether or not the monitor definition is associated with a monitor group that is also associated with a



monitor specification. However, before attempting to install a monitor definition, you should review the requirements described in “Activating resource monitoring” on page 129.

A monitor definition can be automatically installed in a CICS system when that system starts. For this to occur, associate the definition with a monitor group. Then associate that monitor group with a monitor specification that is associated with the CICS system.

Figure 70 illustrates the panel produced when you use the install (INS) line action command from the MONDEF view.

```

----- Install Monitor Definition for EYOPLX01 -----
COMMAND ==>

Definition Name      EYUMON02
Description          Monitor all files
Type                MFILE
Resource Name       *
Include             YES
RODM Status         YES

Scope               ==>          System Group, CICS System, or Generic
Active Period       ==>          Blank, PERIODEF, or Generic

Press Enter to install Monitor Definition.
Type END or CANCEL to cancel without installing.

```

Figure 70. Installing a monitor definition

Provide the following information:

**Scope** Enter the specific or generic name of a CICS system or CICS system group for which the monitor definition is to be installed. The CICS system or CICS system group must be within the CICSplex identified as the current context. If you specify a generic value, a list of valid CICS systems and CICS system groups is displayed.

**Active Period**

(Optional) Enter the name of an existing period definition or a generic name that identifies the range of hours during which the monitor definition is to be active. If you specify a generic value, a list of valid period definitions is displayed.

If you leave this field blank, the monitor definition remains active for as long as the CICS system is running, or until you discard it.

To install the monitor definition into the designated CICS system or into all of the CICS systems associated with the designated CICS system group, press Enter.

When the monitor definition you install:

- Has the same name as a previously installed definition, the new definition replaces the old definition.
- Identifies the same occurrence names and resource types as a previously installed definition, the new definition replaces the old one.
- Specifies a resource type that is not supported in a target CICS system, CICSplex SM issues a message indicating that the definition cannot be installed.

## MONDEF

If you install a monitor definition that specifies a 1- to 8-character journal name (for use in a system running the CICS TS) in a system that does not support such journal names, monitoring does not occur, as the specified journal will not exist.

You can use the MONACTV view, as described in Table 3 on page 7, to deactivate an installed monitor definition.

---

## MONGROUP (Monitor groups)

A monitor group is used to associate one or more related monitor definitions. An example of how to use this view can be found in “Monitoring programs in multiple CICS systems” on page 179.

To display information about existing monitor groups, issue the command:

```
MONGROUP [mongroup]
```

where mongroup is a specific or generic name of a monitor group. If you omit this parameter, the view, illustrated in Figure 71, includes information about all monitor groups within the current context.

```
26MAR1999 19:33:31 ----- INFORMATION DISPLAY -----
COMMAND ==>
CURR WIN ==> 1          ALT WIN ==>
W1 =MONGROUP=====EYUPLX01=EYUPLX01=26MAR1999==19:33:31=CPSM=====6===
CMD Monitor  Monitor Group
--- Group--- Description-----
EYUMOG01 SSet - All Connections
EYUMOG02 SSet - CO* , TDQs, CSD, JRNLs
EYUMOG03 SSet - All SP* term, CEMT tran
EYUMOG04 SSet - EYUF* files
EYUMOG05 SSet - ET* transactions
EYUMOG06 SSet - EYU* programs
```

Figure 71. The MONGROUP view

## Action commands and overtype fields

Table 38 summarizes the action commands you can use with the MONGROUP view. Table 39 on page 153 identifies the overtype field you can modify when you use the SET action command.

Table 38. MONGROUP view action commands

Primary command	Line command	Description
n/a	ADD	Add an association between a monitor group and a monitor specification, as described on page 154.
n/a	ASC	Add an association between a monitor definition and a monitor group, as described on page 155.
n/a	BRO	Browse a monitor group in the data repository.
CREate	CRE	Create a monitor group and add it to the data repository, as described on page 154.

The format of the resulting panel is similar to that shown in Figure 72 on page 154. The panel fields are not modifiable.

Table 38. MONGROUP view action commands (continued)

Primary command	Line command	Description
n/a	INS	Install the monitor definitions associated with a monitor group into a CICS system or CICS system group, as described on page 155.
n/a	MAP	Display a visual map of resource monitoring definitions using the specified group as a starting point.
n/a	REM	Remove a monitor group from the data repository. (Any associations that exist between monitor definitions and that monitor group are also removed.)
n/a	REP	Replace all installed monitor definitions with those associated with a monitor group.  The format of the resulting panel is similar to the one produced by the INS action command, as illustrated in Figure 75 on page 156.  REP causes a two-step operation to be performed. First, all installed monitor definitions are discarded and all accumulated monitoring data relating to those monitor definitions is deleted. Then, CICSplex SM attempts to install the monitor definitions associated with the designated monitor group.
n/a	SET	Change a monitor group description using an overtype field (see Table 39). <b>Note:</b> The value you specified in the Require Set field on the CICSplex System Manager entry panel determines whether or not you must use the SET command when you overtype a field.
TEMPMP cmasid	n/a	Change the temporary maintenance point CMAS to a specific CMAS or display a selection list based on a generic CMAS ID.
n/a	UPD	Update a monitor group in the data repository.  The format of the resulting panel is similar to that shown in Figure 72 on page 154. You can change the Description field.

Table 39. MONGROUP view overtype field

Field name	Value
Monitor Group Description	One- to 30-character description of the monitor group.

## Hyperlink fields

Table 40 shows the hyperlink field on the MONGROUP view.

Table 40. MONGROUP view hyperlink field

Hyperlink field	View displayed	Description
Monitor Group	MONINGRP	Detailed information about the associations that exist between the designated monitor group and monitor definitions.

## MONGROUP

### Creating a monitor group

Figure 72 shows the format of the panel produced when you use the create primary (CREate) or line (CRE) action command from the MONGROUP view.

```
----- Create Monitor Group for EYUPLX01 -----  
COMMAND ==>  
  
Group Name ==>  
Description ==> Test monitor group  
  
Press Enter to create Monitor Group.  
Type END or CANCEL to cancel without creating.
```

Figure 72. Creating a monitor group

Provide the following information, as appropriate:

#### Group Name

Specify a 1- to 8-character name for the monitor group. The name can contain alphabetic, numeric, or national characters. However, the first character must be alphabetic,

#### Description

(Optional) Specify a 1- to 30-character description of the monitor group.

Press Enter to add the monitor group to the data repository.

### Adding an association to a monitor specification

Figure 73 illustrates the panel produced when you use the add (ADD) line action command from the MONGROUP view.

```
----- Add Group to Specification for EYUPLX01 -----  
COMMAND ==>  
  
Monitor Group Name      EYUMOG01  
Description              Sample monitor group  
  
Specification name ==> EYUMOS01      Specification Name or Generic  
  
Press Enter to add Monitor Group to Specification.  
Type END or CANCEL to cancel without adding.
```

Figure 73. Associating a monitor group with a monitor specification

Provide the following information:

#### Specification name

Enter the specific or generic name of an existing monitor specification. If you specify a generic value, a list of valid monitor specifications is displayed.

Press Enter to associate a monitor group with the designated monitor specification in the data repository.

If a monitor specification appropriate for this monitor group does not currently exist, you must first create one, as described on page 166. You can then use the ADD action command described on page 160 to associate the monitor group with that specification.

## Associating a monitor definition with a monitor group

Figure 74 illustrates the panel produced when you use the associate (ASC) line action command from the MONGROUP view.

```

----- Add Monitor Definition to Group for EYUPLX01 -----
COMMAND ==>

Monitor Group Name      EYUMOG01
Description             Sample monitor group

Monitor Definition Name ==> EYUMOD01   Monitor Definition or Generic
Active Period           ==> EYUMOD01   Period Definition or Generic

Press Enter to add Monitor Definition to Group.
Type END or CANCEL to cancel without adding.

```

Figure 74. Associating a monitor definition with a monitor group

Provide the following information, as appropriate:

### Monitor Definition Name

Enter the specific or generic name of an existing monitor definition that is to be associated with the monitor group. If you specify a generic value, a list of valid monitor definitions is displayed.

### Active Period

(Optional.) Enter the specific or generic name of a period definition that identifies the range of hours during which the monitor definition is to be active. If you specify a generic value, a list of valid period definitions is displayed.

If the name you specify does not belong to an existing period definition, you can create that period definition later. If you leave this field blank, the monitor definition remains active for as long as the CICS system is running, or until you discard it.

Press Enter to associate the monitor definition with the monitor group in the data repository.

## Installing a monitor group

When you install a monitor group, all of the monitor definitions associated with that group are installed in the CICS systems that are using the monitor specification to which the monitor group is associated. Before attempting to install a monitor group, you should review the requirements described in “Activating resource monitoring” on page 129.

The monitor definitions associated with a monitor group can be automatically installed in a CICS system when that system starts. For this to occur, the monitor group must be associated with a monitor specification that is defined to the CICS system.

## MONGROUP

Figure 75 illustrates the panel produced when you use the install (INS) line action command from the MONGROUP view.

```
----- Install Monitor Group for EYUPLX01 -----
COMMAND  ===>

Name           EYUMOG01
Description    Sample monitor group

Scope         ===>           CICS System, Group or Generic

Press Enter to install definitions.
Type END or CANCEL to cancel without installing.
```

Figure 75. Installing a monitor group

Provide the following information:

**Scope** Enter the specific or generic name of an active CICS system or CICS system group into which the monitor definitions associated with this monitor group are to be installed. The CICS system or CICS system group must be within the CICSplex identified as the current context. If you specify a generic value, a list of valid CICS systems and CICS system groups is displayed.

Press Enter to install the monitor definitions associated with the monitor group into the designated CICS system or into all of the CICS systems associated with the designated CICS system group.

When one or more monitor definitions associated with the monitor group you install:

- Have the same names as previously installed definitions, the new definitions take the place of the old definitions.
- Identify the same resource occurrence names and resource types as previously installed definitions, the new definitions take the place of the old ones.
- Specify a resource type that is not supported in a target CICS system, CICSplex SM issues a message indicating that the definition cannot be installed because the resource is not supported.

Finally, you can use the MONACTV view, as indicated in Table 3 on page 7, to deactivate an installed monitor definition.

---

## MONINGRP (Monitor definitions in monitor groups)

To display the names of monitor groups, the monitor definitions associated with them, and the time period during which the monitor definitions are to be active, issue the command:

```
MONINGRP [mongroup [mondef]]
```

where:

**mongroup**

Is a specific or generic name of a monitor group, or a blank or an \* (asterisk) for all monitor groups.

**mondef** Is a specific or generic name of a monitor definition. If you omit this

parameter, the view includes information about all monitor definitions associated with the designated monitor group.

If you do not specify any parameters, the view, as illustrated in Figure 76, includes information about all monitor groups and their associated monitor definitions within the current context.

```

26MAR1999 19:33:42 ----- INFORMATION DISPLAY -----
COMMAND ==>
CURR WIN ==> 1          ALT WIN ==>
W1 =MONINGRP=====EYUPLX01=EYUPLX01=26MAR1999==19:33:42=CPSM=====1===
CMD Monitor Def      Active
--- Group-- Name---- Period--
    EYUMOG01 EYUMOD01 EYUPDF01
    
```

Figure 76. The MONINGRP view

### Action commands and overtype field

Table 41 summarizes the action commands you can use with the MONINGRP view. Table 42 on page 158 identifies the overtype field you can modify when you use the SET action command.

Table 41. MONINGRP view action commands

Primary command	Line command	Description
n/a	ADD	Add an association between a monitor definition and a monitor group, as described on page 158.
n/a	BRO	Browse the association between a monitor definition and a monitor group.
n/a	MAP	The format of the resulting panel is similar to that shown in Figure 77 on page 158. The panel fields are not modifiable. Display a visual map of resource monitoring definitions using the specified group as a starting point.
n/a	REM	Remove the association between a monitor definition and a monitor group.
n/a	SET	Change the period definition associated with a monitor definition using an overtype field (see Table 42). <b>Note:</b> The value you specified in the Require Set field on the CICSplex System Manager entry panel determines whether or not you must use the SET command when you overtype a field.
TEMPMP cmasid	n/a	Change the temporary maintenance point CMAS to a specific CMAS or display a selection list based on a generic CMAS ID.
n/a	UPD	Update the association between a monitor definition and a monitor group.

The format of the resulting panel is similar to that shown in Figure 77 on page 158. You can change the Active Period field.

Table 42. MONINGRP view overtyp field

Field name	Value
Period	Name of a period definition or blank. (Setting the field to blanks causes the monitor definition to be active as long as the CICS system using that definition is active.)

## Hyperlink fields

Table 43 shows the hyperlink fields on the MONINGRP view.

Table 43. MONINGRP view hyperlink fields

Hyperlink field	View displayed	Description
Monitor Group	MONGROUP	Detailed information about the designated monitor group.
Def Name	MONDEF	Detailed information about the designated monitor definition.

## Adding a monitor definition to a monitor group

Figure 77 illustrates the panel produced when you use the add (ADD) line action command from the MONINGRP view.

```

----- Add Monitor Definition to Group for EYUPLX01 -----
COMMAND ==>>

Monitor group name ==>> EYUMOG02   Monitor Group or Generic

Definition name     ==>> EYUMOD01   Monitor Definition or Generic
Active Period      ==>> PRIME      Period Definition or Generic

Press Enter to add Definition to Group.
Type END or CANCEL to cancel without adding.
    
```

Figure 77. Adding a monitor definition to a monitor group

Provide the following information, as appropriate:

### Monitor group name

Specify the name of an existing monitor group.

### Definition name

Enter the specific or generic name of an existing monitor definition that is to be associated with the monitor group. If you specify a generic value, a list of valid monitor definitions is displayed.

### Active Period

(Optional.) Enter the specific or generic name of a period definition that identifies the range of hours during which the monitor definition is to be active. If you specify a generic value, a list of valid period definitions is displayed.

If the name you specify does not belong to an existing period definition, you can create that period definition later. If you leave this field blank, the monitor definition remains active for as long as the CICS system is running, or until you discard it.



Press Enter to add the monitor definition to the monitor group in the data repository.

## MONINSPC (Monitor groups in monitor specifications)

To display the names of monitor specifications and the monitor groups associated with them, issue the command:

```
MONINSPC [monspec [mongroup]]
```

where:

**monspec**

Is a specific or generic name of a monitor specification, or a blank or an \* (asterisk) for all monitor specifications.

**mongroup**

Is a specific or generic name of a monitor group. If you omit this parameter, the view includes information about all monitor groups associated with the designated monitor specifications.

If you do not specify any parameters, the view, illustrated in Figure 78, included information about all monitor specifications and their associated monitor groups within the current context.

```

26MAR1999 19:34:01 ----- INFORMATION DISPLAY -----
COMMAND ==>
CURR WIN ==> 1          ALT WIN ==>
W1 =MONINSPC=====EYUPLX01=EYUPLX01=26MAR1999==19:34:01=CPSM=====4===
CMD Spec      Group
--- Name---- Name----
EYUMOS01 EYUMOG01
EYUMOS01 EYUMOG02
EYUMOS01 EYUMOG03
EYUMOS01 EYUMOG05
    
```

Figure 78. The MONINSPC view

## Action commands

Table 44 summarizes the action commands you can use with the MONINSPC view.

Table 44. MONINSPC view action commands

Primary command	Line command	Description
n/a	ADD	Add an association between a monitor group and a monitor specification, as described on page 160.
n/a	BRO	Browse the association between a monitor group and a monitor specification.
n/a	MAP	The format of the resulting panel is similar to that shown in Figure 79 on page 160. The panel fields are not modifiable. Display a visual map of resource monitoring definitions using the designated specification as a starting point.

Table 44. MONINSPC view action commands (continued)

Primary command	Line command	Description
n/a	REM	Remove the association between a monitor group and a monitor specification. (Any associations that exist between the designated monitor group and monitor definitions are also removed when you perform this action.)
TEMPMP cmasid	n/a	Change the temporary maintenance point CMAS to a specific CMAS or display a selection list based on a generic CMAS ID.

## Hyperlink fields

Table 45 shows the hyperlink fields on the MONINSPC view.

Table 45. MONINSPC view hyperlink fields

Hyperlink field	View displayed	Description
Spec Name	MONSPEC	Detailed information about the designated monitor specification.
Group Name	MONGROUP	Detailed information about the designated monitor group.

## Adding a monitor group to a monitor specification

Figure 79 illustrates the panel produced when you use the add (ADD) line action command from the MONINSPC view.

```

----- Add Monitor Group to Specification for EYUPLX01 -----
COMMAND ==>

Specification Name ==> EYUMOS01   Spec Name or Generic
Monitor Group Name ==> EYUMOG01   Group Name or Generic

Press Enter to add Monitor Group to Specification.
Type END or CANCEL to cancel without adding.
    
```

Figure 79. Adding a monitor group to a monitor specification

Provide the following information, as appropriate:

### Specification Name

Enter the specific or generic name of an existing monitor specification. If you specify a generic value, a list of valid monitor specifications is displayed.

### Monitor Group Name

Enter the specific or generic name of an existing monitor group. If you specify a generic value, a list of valid monitor groups is displayed.

Press Enter to add the monitor group to the monitor specification in the data repository.

## MONSCOPE (Monitor specifications assigned a scope)

To display information about the CICS systems or CICS system groups that are associated with a monitor specification, issue the command:

```
MONSCOPE [monspec]
```

where monspec is a specific or generic name of a monitor specification. If you omit this parameter, the view, illustrated in Figure 80, includes information about all monitor specifications, and the associated scope information, for the CICSplex identified as the context.

```

26MAR1999 19:34:15 ----- INFORMATION DISPLAY -----
COMMAND ==>
CURR WIN ==> 1          ALT WIN ==>
W1 =MONSCOPE=====EYUPLX01=EYUPLX01=26MAR1999==19:34:15=CPSM=====8===
CMD Monitor Scope  Scope  Scope  Scope  Update
--- Spec---- Name---- Type---- Link---- Mode---- Option
EYUMOS01 EYUMAS1A CICSSYS          EXPLICIT
EYUMOS02 EYUCSG03 SYSGROUP
EYUMOS02 EYUCSG04 SYSGROUP
EYUMOS02 EYUCSG05 SYSGROUP
EYUMOS02 EYUMAS1B CICSSYS  EYUCSG03 INHERIT
EYUMOS02 EYUMAS2A CICSSYS  EYUCSG04 INHERIT
EYUMOS02 EYUMAS3A CICSSYS  EYUCSG05 INHERIT
EYUMOS03 EYUMAS4A CICSSYS          EXPLICIT

```

Figure 80. The MONSCOPE view

## Action commands and overtyping fields

Table 46 summarizes the action commands you can use with the MONSCOPE view. Table 47 on page 162 identifies the overtyping fields you can modify when you use the SET action command.

Table 46. MONSCOPE view action commands

Primary command	Line command	Description
n/a	BRO	Browse the association between a scope and a monitor specification.  The format of the resulting panel is similar to that shown in Figure 81 on page 163. The panel fields are not modifiable.
n/a	MAP	Display a visual map of resource monitoring definitions using the designated specification as a starting point.
n/a	REM	Remove the association between a scope and a monitor specification, as described on page 164.
n/a	SET	Change the association between a scope and a monitor specification using overtyping fields (see Table 47). <b>Note:</b> The value you specified in the Require Set field on the CICSplex System Manager entry panel determines whether or not you must use the SET command when you overtype a field.
TEMPMP cmasid	n/a	Change the temporary maintenance point CMAS to a specific CMAS or display a selection list based on a generic CMAS ID.

## MONSCOPE

Table 46. MONSCOPE view action commands (continued)

Primary command	Line command	Description
n/a	UPD	Update the association between a scope and a monitor specification, as described on page 162.

When you change or remove the monitor specification associated with a CICS system group, you must indicate how the CICS systems comprising that group are to be affected.

Based on the value you specify, the number of entries shown in the MONSCOPE view may increase or decrease. For example, you might specify a value that causes a CICS system within a CICS system group to be explicitly associated with a specification, rather than inherit it from its CICS system group. When this happens, the resulting MONSCOPE view contains a line identifying the CICS system group and a new line identifying the CICS system that is now explicitly associated with a specification.

Table 47. MONSCOPE view overwrite fields

Field name	Value
Monitor Spec	1- to 8-character name of an existing monitor specification that is to be associated with the CICS system or CICS system group.
Update Option	FORCE   KEEP   NAME   NULL

**Notes:**

1. When the scope of the monitor specification is a CICS system group, you must indicate how the CICS systems comprising the CICS system group are to use the specification by overtyping the contents of the Update Option field.  
If the CICS system group includes other CICS system groups, all of the CICS systems, including those in the subordinate CICS system groups, are affected by the value specified in the Update Option field.
2. If you update the monitor specification for a CICS system that is already active, you must restart resource monitoring, as described in "Updating scope-to-monitor specification associations".

## Hyperlink fields

Table 48 shows the hyperlink field on the MONSCOPE view.

Table 48. MONSCOPE view hyperlink fields

Hyperlink field	View displayed	Description
Monitor Spec	MONSPEC	Detailed information about the designated monitor specification.

## Updating scope-to-monitor specification associations

Figure 81 on page 163 illustrates the panel produced when you use the update (UPD) line action command from the MONSCOPE view.

```

----- Update Monitor Specification to Scope for EYUPLX01 -----
COMMAND ==>

Specification Name ==> EYUMOS01 Specification Name or Generic
Scope              EYUCSG01
Scope Type         SYSGROUP

Option              ==>          FORCE, KEEP, NAME, or NULL

Press ENTER to update Specification Link.
Type END or CANCEL to cancel without updating.

```

Figure 81. Updating the association between a scope and a monitor specification

The Option field does not appear on this panel when the scope is a CICS system (CICSSYS).

Change the following information, as appropriate:

#### Specification Name

Enter the specific or generic name of an existing monitor specification. If you specify a generic value, a list of valid monitor specifications is displayed.

#### Option

When the scope of the monitor specification is a CICS system group, you must indicate how the CICS systems comprising the CICS system group are to use the specification. To do this, specify one of the following:

##### FORCE

All CICS systems in the CICS system group are to inherit the new specification.

**KEEP** Any CICS system that inherited a specification from the CICS system group is to be explicitly assigned the old specification; all other CICS systems in the group are to be unaffected.

##### NAME

Any CICS system that inherited a specification from the CICS system group is to be explicitly assigned the new specification; all other CICS systems in the group are to be unaffected.

**NULL** Any CICS system in the CICS system group that is not explicitly associated with a specification is to inherit the new specification; all other CICS systems in the group are to be unaffected.

If the CICS system group includes other CICS system groups, all of the CICS systems, including those in the subordinate CICS system groups, are affected by the value specified in the Option field.

If you update the monitor specification for a CICS system that is already active, the new specification is not immediately available. To reset resource monitoring, you must display the MAS view and use the UPD action command to do one of the following:

- If resource monitoring is not already active (as indicated by NO in the MON Active field), specify YES in that field and press Enter to turn resource monitoring on.

## MONSCOPE

- If resource monitoring is active (as indicated by YES in the MON Active field), first specify NO in that field and press Enter to turn resource monitoring off. Then use the UPD action command again and specify YES in the MON Active field.

Resource monitoring becomes active using the new monitor specification.

### Removing scope-to-monitor specification associations

Figure 82 illustrates the panel produced when you use the remove (REM) line action command from the MONSCOPE view.

```
----- Confirm Removal of Specification Link from EYUPLX01 -----
COMMAND ==>

Specification Name      EYUMOS01
Scope                  EYUMAS1A
Scope Type             CICSSYS

Option                  ==>          KEEP or blank
                               Valid only for SYSGROUP

WARNING: For this definition type, removal will cascade through
         related associations.

Press Enter to remove Specification Link.
Type END or CANCEL to cancel without removing.
```

Figure 82. Removing the association between a scope and a monitor specification

The Option field does not appear on this panel when the scope is a CICS system (CICSSYS).

Provide the following information when the scope is a CICS system group:

#### Option

Indicate how the CICS systems comprising the CICS system group are to use the monitor specification associated with the CICS system group. Specify:

**KEEP** Those CICS systems that inherited the specification from the CICS system group are explicitly assigned that specification.

**Blank** Those CICS systems that inherited the specification from the CICS system group are not to use that specification.

If the CICS system group identified as the scope includes other CICS system groups, all of the CICS systems, including those in the subordinate system group, are affected by the value specified in the Option field.

Press Enter to remove the scope from the designated monitor specification in the data repository.

---

## MONSPEC (Monitor specifications)

A monitor specification identifies one or more CICS resource types that are to be monitored by CICSplex SM. Examples of how to use this view can be found in:

- “Monitoring transaction response times” on page 175
- “Monitoring programs in multiple CICS systems” on page 179

To display information about existing monitor specifications, issue the command:

```
MONSPEC [monspec]
```

where `monspec` is a specific or generic monitor specification name. If you omit this parameter, the view, illustrated in Figure 83, includes information about all existing monitor specifications within the current context.

```

26MAR1999 19:33:51 ----- INFORMATION DISPLAY -----
COMMAND ==>
CURR WIN ==> 1          ALT WIN ==>
W1 =MONSPEC=====EYUPLX01=EYUPLX01=26MAR1999==19:33:51=CPSM=====3===
CMD Monitor  Monitor Specification      RODM
--- Spec---  Description----- CMAS----
EYUMOS01 SSet - For EYUMAS1A           EYUCMS01
EYUMOS02 SSet - For EYUMAS2A/3A/1B
EYUMOS03 SSet - For EYUMAS4A

```

Figure 83. The MONSPEC view

## Action commands

Table 49 summarizes the action commands you can use with the MONSPEC view.

Table 49. MONSPEC view action commands

Primary command	Line command	Description
n/a	ADD	Add an association between a monitor specification and a scope (CICS system or CICS system group) as described on page 168.
n/a	BRO	Browse a monitor specification in the data repository.
CREate	CRE	Create a monitor specification and add it to the data repository, as described on page 166.
n/a	MAP	Display a visual map of resource monitoring definitions using the designated specification as a starting point.
n/a	REM	Remove a monitor specification from the data repository. (When a monitor specification is removed, associations with monitor groups and the CICS system or CICS system group identified as the scope are lost.)
TEMPMP cmasid	n/a	Change the temporary maintenance point CMAS to a specific CMAS or display a selection list based on a generic CMAS ID.

Table 49. MONSPEC view action commands (continued)

Primary command	Line command	Description
n/a	UPD	Update a monitor specification in the data repository.  The format of the resulting panel is similar to that shown in Figure 84. You may overwrite the contents of any field in the panel except Monitor Spec Name.  Changes to a monitor specification that is currently installed in a CICS system take effect the next time you start the CICS system.

### Hyperlink fields

Table 50 shows the hyperlink field on the MONSPEC view.

Table 50. MONSPEC view hyperlink field

Hyperlink field	View displayed	Description
Monitor Spec	MONINSPC	Detailed information about the associations that exist between the designated monitor specification and its monitor groups.

### Creating a monitor specification

Figure 84 shows the format of the panel displayed when you use the create primary (CREate) or line (CRE) action command from the MONSPEC view.

```

----- Create Monitor Specification for EYUPLX01 -----
COMMAND ==>

Monitor Spec Name  ==> EYUMOS03
Description        ==> SSet - For EYUMAS4A
Monitor Status    ==> ACTIVE      Monitor Status (Active/Inactive)
Retention Period  ==> 5           Minutes to retain data after termination
RODM CMAS        ==> EYUCMS01    CMAS to populate RODM or Generic

Sample Intervals
Resource Name      Interval      Seconds between samples (0 for none)
-----
Region            ==> 300          Transaction ==> 300      MTRAN
Global            ==> 300          Terminal    ==> 0        MTERM
DB2                ==> 300          File        ==> 300      MFILE
                  ==> 300          Transient Data ==> 300      MTDQS
                  ==> 300          Journal     ==> 500      MJRNL
                  ==> 300          Connection  ==> 300      MCONN
                  ==> 300          Program     ==> 0        MPROG

Press ENTER to create Monitor Specification.
Type END or CANCEL to cancel without creating.

```

Figure 84. Creating a monitor specification

Provide the following information, as appropriate.



**Monitor Spec Name**

Specify a 1- to 8-character name for the monitor specification. The name can contain alphabetic, numeric, or national characters. However, the first character must be alphabetic,

**Description**

(Optional) Specify a 1- to 30-character description of the monitor specification.

**Monitor Status**

Specify ACTIVE or INACTIVE to indicate whether resource monitoring is to be in effect when a CICS system associated with this monitor specification is started.

If the comparable field in the definition of the CICS system that will be using this specification contains YES or NO (indicating whether resource monitoring is on or off), the value you specify here will be overridden by that value. If the comparable field contains \* (asterisk), the value specified in *this* field is used.

**Retention Period**

Specify the number of minutes collected data is to be kept after resource monitoring stops. (Resource monitoring stops when the CICS system stops or when the MAS view command is used to stop resource monitoring for the CICS system.) The value must be:

- Between 1 and 1440, when collected data is to be retained.
- 0, when collected data is not to be retained.

**RODM CMAS**

(Optional) Specify the CMAS that is to convey resource topology information to the NetView Resource Object Data Manager (RODM). The specified CMAS must be on the MVS image where NetView is running. If you specify a CMAS name, all of the CICS systems associated with this monitor specification are identified to RODM. You must also update the CMASD view with the name of a RODM subsystem.

If you plan to use the CICSplex SM API or an automation product to access information provided by the RODM interface, you must specify a CMAS in this field. However, you do not need to update the CMASD view with the name of a RODM subsystem.

Refer to “Using the RODM interface” on page 134 for an overview of the RODM interface.

**Sample Intervals**

For each type of resource you want to monitor, specify how long, in seconds, CICSplex SM is to wait between the collection of sample data. You can specify a sample interval for:

- Resource types for which you created a monitor definition (such as connections or files).
- CICS Region, Global, or DB2 resources, which do not require a monitor definition.

These types provide monitoring of the following resources:

**CICS Region**

CICS regions and dynamic storage areas

**Global**

Transient data queue usage, temporary storage queue usage, LSR pools, transaction classes, and FEPI connections

**DB2** DB2 threads

Note that certain CICS Region and Global resources can be reported to RODM. Refer to “Information provided by the RODM interface” on page 134 for a complete list of resources that can be reported to RODM.

The sample interval must be:

- Between 1 and 86400 and evenly divisible into the monitor interval value, when converted to seconds. (If you specify a value that is not evenly divisible, you are prompted for one that is.)

The lower you set the sample interval, the greater the impact on both processor and teleprocessing overhead.

- 0, when no resource monitoring is to occur.

Press Enter to add the monitor specification to the data repository.

## Adding a scope to a monitor specification

Associating a monitor specification with a scope causes the specification to be automatically installed when a CICS system associated with the scope is started. Any monitor definitions associated with the specification through monitor groups are also automatically installed.

However, if you associate the monitor specification with a CICS system that is already active, the new specification is not immediately available. To turn resource monitoring on, you must display the MAS view and use the UPD action command. Specify YES in the MON Active field and press Enter; resource monitoring becomes active using the new monitor specification.

Figure 85 illustrates the panel produced when you use the add (ADD) line action command from the MONSPEC view.

```

----- Add Scope for Specification for EYUPLX01 -----
COMMAND ==>

Monitor Spec Name      EYUMOS01
Description            Test specification 1

Scope                  ==>          CICS System, Group, or Generic
Option                 ==>          FORCE, NULL, or NONE for System Group

Press Enter to add Monitor Specification to Scope.
Type END or CANCEL to cancel without adding.

```

Figure 85. Adding a scope to a monitor specification

Provide the following information, as appropriate.

**Scope** Enter the specific or generic name of an existing CICS system or CICS system group that is not associated with any other monitor specification. If you specify a generic value, a list of valid CICS systems and CICS system groups is displayed.

A CICS system or CICS system group can be associated with only one monitor specification at a time. A specification, however, can be associated with any number of CICS systems and CICS system groups.

**Option**

(Required when the scope is a CICS system group.) Indicate how the CICS systems comprising the CICS system group are to handle monitor specifications. Specify:

**FORCE**

All CICS systems in the CICS system group are to use the monitor specification. (The monitor specification attribute for each CICS system changes to INHERIT, indicating that the CICS system acquired the specification from a CICS system group.)

**NULL** Those CICS systems within the CICS system group that are not associated with a monitor specification are to use this specification. (The monitor specification attribute for those CICS systems changes to INHERIT.)

**NONE**

Only the CICS system group is to be associated with the monitor specification. The CICS systems in the CICS system group are not affected. That is, if there is no association between a CICS system and monitor specification, none is established; if there is an association, either explicitly established or inherited from another CICS system group, it is unchanged.

When the CICS system group includes other CICS system groups, all of the CICS systems, including those in the subordinate CICS system groups, are affected by the value specified in this field.

Press Enter to add the designated scope to the monitor specification in the data repository.



---

## Chapter 8. Monitor definitions

This section describes how you can obtain information about your resource monitoring environment using the MONACTV view.

---

### MONACTV

The MONACTV view shows information about monitor definitions installed in CICS systems known to the CICSplex identified as the current context. An example of how to use this view can be found in “Finding out which resources are being monitored in a CICS system” on page 184.

**Issue command:**

```
MONACTV [mondef [ACTIVE|PENDING]]
```

mondef Is the specific or generic name of a monitor definition or \* for all monitor definitions.

ACTIVE|PENDING Limits the view to either active or pending definitions. If you omit this parameter, monitor definitions are included in the view regardless of their status.

If you do not specify parameters, the view includes information about all monitor definitions within the current context and scope.

**Select:** MONACTV from a menu of MONITOR views.

Figure 86 is an example of the MONACTV view.

```
26MAR1999 19:33:12 ----- INFORMATION DISPLAY -----
COMMAND ==>
CURR WIN ==> 1      ALT WIN ==>
W1 =MONACTV=====EYUPLX01=EYUPLX01=26MAR1999==19:33:12=CPSM=====42===
CMD Def   CICS   Status  Active  Resource Resource Include RODM
--- Name--- System-- ----- Period-- Name---- Type--- ----- Pop-
*0000000 EYUMAS4A ACTIVE          *      MCICS   YES   YES
*0000001 EYUMAS4A ACTIVE          *      MGLBL  YES   YES
*0000002 EYUMAS4A ACTIVE          *      MDBX   YES   NO
*0000003 EYUMAS1A ACTIVE          *      MCICS   YES   YES
*0000004 EYUMAS1A ACTIVE          *      MGLBL  YES   YES
*0000005 EYUMAS2A ACTIVE          *      MCICS   YES   YES
*0000006 EYUMAS2A ACTIVE          *      MGLBL  YES   YES
*0000007 EYUMAS3A ACTIVE          *      MCICS   YES   YES
*0000008 EYUMAS3A ACTIVE          *      MGLBL  YES   YES
EYUMOD01 EYUMAS1A ACTIVE      EYUPDF01 *      MCONN  YES   NO
EYUMOD01 EYUMAS2A ACTIVE      EYUPDF01 *      MCONN  YES   NO
EYUMOD01 EYUMAS3A ACTIVE      EYUPDF01 *      MCONN  YES   NO
EYUMOD02 EYUMAS1A ACTIVE      EYUPDF01 CO*    MTRAN  YES   YES
EYUMOD02 EYUMAS2A ACTIVE      EYUPDF01 CO*    MTRAN  YES   YES
EYUMOD02 EYUMAS3A ACTIVE      EYUPDF01 CO*    MTRAN  YES   YES
EYUMOD02 EYUMAS4A ACTIVE      EYUPDF01 CO*    MTRAN  YES   YES
```

Figure 86. The MONACTV view

**Default monitor definitions**

When you specify a sample rate for the Region, Global, or DB2/DBCTL resource type in a monitor specification, CICSplex SM automatically creates a corresponding monitor definition. The first few monitor definitions shown in Figure 86 on page 171 are examples of these monitor definitions. Notice that:

- The Def Name field contains a unique name that begins with an asterisk (\*) and is followed by seven digits.
- The Period field is blank, which means the monitor definition is to be active as long as the CICS system in which it is installed is active.
- The Resource Name field contains \*, which means all occurrences of this resource type are to be monitored.
- The Resource Type field contains MCICS, MGBL, or MDBX for the resource types of Region, Global and DB2/DBCTL, respectively.
- The Include field contains YES, which means the specified resource occurrences are to be included in monitoring.
- For the Region and Global resource types, the RODM Pop field contains YES, which means the specified resource occurrences are to be monitored by RODM.

Monitor definitions created by CICSplex SM are automatically installed when a CICS system using the associated specification is started. You cannot update or remove these monitor definitions.

**Action commands**

Table 51 shows the action commands you can issue from the MONACTV view.

*Table 51. MONACTV view action commands*

Primary command	Line command	Description
DEActivate mondef sysname	DEA	Deactivates an ACTIVE monitor definition for which a time period is defined; the status of the definition changes to PENDING.
DiSCard mondef sysname	DSC	Discards an ACTIVE or PENDING monitor definition from the CICS system in which it is installed.

**Where:**

**mondef**

Is the specific or generic name of a monitor definition.

**sysname**

Is the specific or generic name of a CICS system.

## Hyperlinks

Table 52 shows the hyperlink field on the MONACTV view.

Table 52. MONACTV view hyperlink field

Hyperlink field	View displayed	Description
Def Name	MONDEF	Detailed description of the specified monitor definition.

**Note:** This hyperlink field is not valid for monitor definitions created by CICSplex SM, which have names beginning with an asterisk (\*); there is no entry for them in the MONDEF view.

## Usage

### Deactivating or discarding a monitor definition

When a monitor definition is installed, its status (as illustrated by the Status field in Figure 86 on page 171) is either:

#### ACTIVE

The definition is installed and active.

#### PENDING

The definition is installed and ready to become active.

The definition is active during the time period identified in the Period field. (When this field is blank, the monitor definition is to be active as long as the CICS system in which it is installed is running.)

To change the status of an installed monitor definition, type either the DEA or DSC action command in the line command field next to the name of the definition.

- Use DEA to deactivate a definition with an ACTIVE status. (The definition remains installed; its status is changed to PENDING. The next time the associated time period is reached, the definition will become active again.)
- Use DSC to discard a definition with an ACTIVE or PENDING status and to remove the definition from the CICS system in which it is installed. (If the definition is associated with a monitor specification, via a monitor group, the definition will be automatically installed the next time the CICS system using the specification starts. If the definition is not associated with a monitor specification, you must manually install the definition in order to use it again.)

Press Enter. A confirmation panel is displayed. Press Enter again to deactivate or discard the monitor definition.

#### Notes:

1. You cannot deactivate or discard a monitor definition created by CICSplex SM. These definitions have names that consist of an asterisk (\*) followed by seven digits.
2. Changes that you make to monitor definitions may be overridden by RTA. If RTA needs a definition that you are attempting to deactivate or had previously deactivated, an error message to that effect is issued and your deactivation is overridden.
3. Deactivating a monitor definition does not remove the data that has been collected and accumulated up to this point in the current monitor interval. The data continues to be displayed in the appropriate monitor views, whether or not the data is being updated. If you know that the data will not be updated

## monitor definitions – MONACTV

by any other active monitor definitions, you can remove it from the view by using the remove (REM) action command, as described in *CICSplex SM User Interface Guide*.

4. If there are multiple monitor definitions, the data for discarded definitions continues to be displayed unless and until all of the definitions are discarded.
5. While DEA and DSC prevent monitoring of the specific resource occurrence identified in the monitor definition, other active monitor definitions may continue to cause information about that resource occurrence to be gathered. To illustrate, suppose the following monitor definitions are active:
  - EYUMOD01, which identifies all file names beginning with PAY
  - EYUMOD02, which identifies all file names beginning with P

Discarding EYUMOD01 has no affect on monitoring since EYUMOD02 includes all file names beginning with P. However, discarding EYUMOD02 means that file names beginning with PAY continue to be monitored.



---

## Chapter 9. Example tasks: resource monitoring

This chapter provides some examples of typical tasks you perform to set up CICSplex SM resource monitoring.

- “Monitoring transaction response times” shows how to monitor temporarily the response times of a single transaction as it is used in a single CICS system.
- “Monitoring programs in multiple CICS systems” on page 179 shows how to monitor, on a permanent basis, the activity of a set of programs in a CICS system group.
- “Finding out which resources are being monitored in a CICS system” on page 184 shows how to retrieve data from CICSplex SM relating to current resource monitoring activity.

---

### Monitoring transaction response times

This example shows what you have to do to monitor the response times of a particular transaction (PAY1), in a single CICS system (CICSPA01), which is a local MAS in CICSplex PLXPROD1. In this example, the monitoring is temporary: that is, it is started in response to a particular problem, and stopped again when enough monitor data has been gathered. The CICS system CICSPA01 is currently running.

1. If the current context isn't PLXPROD1, issue the command CON PLXPROD1 from the current view.
2. Ensure that both CICS monitoring and CICS performance class monitoring are active in CICS system CICSPA01.

CICSplex SM can gather detailed, transaction-related monitor data only if CICS monitoring and performance class monitoring are switched on. You can check whether they are active by issuing the command CICSRRN2 CICSPA01 from the current view. The CICSRRN2 view, showing the current trace, dump, and statistics settings for CICSPA01, is displayed:

```
26MAR1999 17:08:54 ----- INFORMATION DISPLAY -----
COMMAND ==>>
CURR WIN ==>> 1      ALT WIN ==>>
W1 =CICSRGN=CICSRGN2=PLXPROD1=PLXPROD1=26MAR1999==17:07:16=CPSM=====1==
CICS System.  CICSPA01 Shutdn Stat      N/A Init Stat..  N/A
CICS Release  0330 CICS TS lvl.  010200 OS/390 lvl.
Trce Values:      Dump Values      Monitor
Internal....  INTSTART Dumping....  SYSDUMP Status....  ON
Table Size..    2000 Initial Dsn      X Perf Class.  PERF
AUX Status..    AUXSTOP Current Dsn   A Event Clss.  NOEVENT
Cur Aux Dsn.   A Open Status        OPEN Except Clss NOEXCEPT
Aux Swtch St    NOSWITCH Switch Stat SWITCHNEXT Report Clck  N/A
Single Stat.    SINGLEOFF Trandumps..  0 SysEvt Sub   N/A
System Stat.    SYSTEMON Trndmp Sup.   0
User Stat...    USERON Sysdumps...    0 Statistics:
GTF Trace...    GTFSTOP Sysdmps Sup    0 Recording..  OFF
TC Exit Stat    TCEXITNONE Def Userid. N/A Interval... 03:00:00
Perf atSync.    N/A                    Next Time.. 00:00:00
AIn Pgm Stat    N/A                    End of Day. 00:00:00
                                      Last Reset. 09:41:01
```

You are interested in two values in the CICSRRN2 view, the Monitor Status field (which should be set to ON), and the Perf Class field (which should be set to PERF). If either field is showing the wrong value, overwrite it with the

## monitor transaction response times

correct value, and press Enter. (If simple overtyping of values is not supported in your environment, you must also type SET in one of the line-command fields before pressing Enter.)

### 3. Create a monitor definition.

Issue the command MONDEF from the current view. The MONDEF view, showing any monitor definitions already created in CICSplex PLXPROD1, is displayed. To create a new monitor definition, you can either:

- a. Issue the command CRE from the MONDEF view. The Create Monitor Definition panel is displayed. (Some of the fields in the panel might be preset by CICSplex SM, though you can change them.)

or

- b. In the MONDEF view, tab to an entry for an existing monitor definition that you want to use as a template for the new definition, and issue CRE from the line-command field. The Create Monitor Definition panel, showing the values of the “template” definition, is displayed. (This approach might save you a little typing if you’re planning to use some of the values from the template definition.)

Complete the panel as shown here:

```
----- Create Monitor Definition for PLXPROD1 -----
COMMAND  ==>

Definition Name ==> MODPAY01
Description    ==> Transaction PAY1

Resource Definition:
Name          ==> PAY1   Resource Name
Type          ==> MTRAN  MCONN/MFILE/MJRNL/MPROG/MTDQS/MTERM/MTRAN
Include       ==> YES   Include for monitoring (NO, YES)
RODM Status  ==> NO    Operational status for RODM (YES, NO)

Press Enter to Create Monitor Definition.
Type END or CANCEL to cancel without creating.
```

Press Enter. The MONDEF view is redisplayed, showing an entry for the monitor definition MODPAY01.

**Note:** For a complete description of the MONDEF view, see “MONDEF (Monitor definitions)” on page 145.

### 4. Create a monitor specification.

- a. Issue the command MONSPEC from the current view. The MONSPEC view, showing any monitor specifications already created in CICSplex PLXPROD1, is displayed.
- b. Issue the command CRE from the MONSPEC view. (Alternatively, you can tab to the entry for an existing monitor specification, and issue CRE from the line-command field.) The Create Monitor Specification panel is displayed. Complete the panel as shown here, and press Enter:

## monitor transaction response times

```
----- Create Monitor Specification for PLXPROD1 -----
COMMAND ==>

Monitor Spec Name ==> MOSPAY01
Description       ==> Payroll resources
Monitor Status   ==> ACTIVE   Monitor Status (Active/Inactive)
Retention Period ==> 30      Minutes to retain data after termination
RODM CMAS       ==>         CMAS to populate RODM or Generic

Sample Intervals                               Seconds between samples (0 for none)
Resource Name  Interval  Resource Name  Interval  Class Name
-----
Region         ==> 0      Transaction    ==> 120    MTRAN
Global         ==> 0      Terminal       ==> 0      MTERM
DB2            ==> 0      File           ==> 0      MFILE
               ==> 0      Transient Data ==> 0      MTDQS
               ==> 0      Journal        ==> 0      MJRNL
               ==> 0      Connection     ==> 0      MCONN
               ==> 0      Program        ==> 0      MPROG

Press ENTER to create Monitor Specification.
Type END or CANCEL to cancel without creating.
```

Transactions are to be sampled every 120 seconds. The resource sample interval (that is, 120 seconds), when converted to minutes, should be evenly divisible into the monitor interval for the CICSplex. <sup>1</sup>

Press Enter. The MONSPEC view is redisplayed, showing an entry for monitor specification MOSPAY01.

**Note:** For a complete description of the MONSPEC view, see “MONSPEC (Monitor specifications)” on page 164.

### 5. Associate the monitor specification with the CICS system.

In the MONSPEC view, tab to the entry for MOSPAY01, and issue ADD from the line-command field. The ADD Scope for Specification panel is displayed. Enter the CICS system CICSPA01 in the Scope field as shown here:

```
----- Add Scope for Specification for PLXPROD1 -----
COMMAND ==>

Monitor Spec Name      MOSPAY01
Description            Payroll resources

Scope                 ==> CICSPA01   CICS System, Group, or Generic
Option                ==>         FORCE, NULL, or NONE for System Group

Press Enter to add Monitor Specification to Scope.
Type END or CANCEL to cancel without adding.
```

(No Option value is required, because CICSPA01 is not a CICS system group.)

### 6. Check that CICSplex SM monitoring is switched on in the CICS system.

From the current view, issue the command MAS. The MAS view, showing MASs in the current context, is displayed. If the MON Act field for MAS CICSPA01 is set to YES, you need to deactivate and then reactivate monitoring so that the new monitor specification takes effect. If the MON Act field is set to NO, you need activate monitoring. In either case, tab to the entry for

1. You can look at the monitor interval for the CICSplex by issuing the command CPLEXDEF PLXPROD1 from the current view.

## monitor transaction response times

CICSPA01, and issue UPD from the line-command field. The Control MAS panel, looking something like this, is displayed:

```
----- Control MAS for PLXPROD1 -----
COMMAND ==>

MAS      CICSPA01  Description  AOR 1 on System A

      Attributes                                Time
Type     LOCAL      Time Zone      ==> R
CMAS     CMSSYS1    Time Zone Offset ==> 00
Status   ACTIVE     Daylight Savings ==> NO

      Activity                                Security
MON Active ==> NO      Command Check  ==> NO
RTA Active ==> NO      Resource Check ==> NO
WLM Active      NO      Exemption Check ==> NO

Enter DOWN or UP to view other MAS screens.
Press Enter to change the MAS.
Type END or CANCEL to cancel without changing.
```

If the MON Active field is set to YES, change it to NO and press Enter to deactivate monitoring. The MAS view is redisplayed, showing MON Act set to NO. Issue UPD from the line-command field to display the Control MAS panel. Type YES in the MON Active field and press Enter. The MAS view is redisplayed, showing MON Act set to YES.

If the MON Active field is set to NO, change it to YES and press Enter. The MAS view is redisplayed, showing MON Act set to YES.

If you don't set the MON Active value to YES, no monitoring will occur because the CICS system's MON Active value overrides the Monitor Status value in the monitor specification.

### 7. Look at the monitor data.

After a short time has elapsed (for this example, at least two minutes, which is the resource sample interval) you can look at the data that CICSplex SM is gathering by issuing the command MLOCTRAD PAY1 CICSPA01 from the current view. The MLOCTRAD view, showing detailed information (including response times) for transaction PAY1 in CICS system CICSPA01, is displayed. Whenever you press Enter, the MLOCTRAD view is refreshed, though the frequency with which the MLOCTRAD data actually changes is determined by the resource sample interval. The monitor data is also written to an SMF dataset (unless production of CMF records has been suppressed).

### 8. Deactivate monitoring of transaction PAY1.

Monitoring of transaction PAY1 continues until CICSPA01 stops, unless you switch it off before then. If you want to stop monitoring at any time, issue the command MONACTV MODPAY01 from the current view. In the MONACTV view, tab to the MODPAY01 entry, and issue DSC from the line-command field. The monitor definition MODPAY01 is removed from CICS system CICSPA01, though it still exists in the data repository, and can be reinstalled at any time. The data gathered during monitoring of transaction PAY1 in CICSPA01 is kept for 30 minutes after you deactivate MODPAY01. (Remember that 30 minutes is the length of the retention period you specified in the monitor specification MOSPAY01.)

## Monitoring programs in multiple CICS systems

This example shows what you have to do to monitor the activity of a set of programs (programs whose names begin with the letters PAY) as they are used in a group of CICS systems (AORs CICSPA01, CICSPA02, and CICSPA03) in CICSplex PLXPROD1. In this example, the monitoring is to be regular: that is, it will be activated, for each CICS system, from 0800 hours to 1700 hours. CICS systems CICSPA01 and CICSPA03 are running. For none of the three CICS systems is monitoring currently switched on.

1. If the current context isn't PLXPROD1, issue the command CON PLXPROD1 from the current view.
2. Create a CICS system group.
  - a. Issue the command CICSGRP from the current view. The CICSGRP view, showing any CICS system groups that have already been defined for CICSplex PLXPROD1, is displayed.
  - b. Issue the command CRE from the CICSGRP view. The Create System Group panel is displayed. Complete the panel as shown here:

```

----- Create System Group for PLXPROD1 -----
COMMAND ==>

System Group name ==> CSGAORS1
Description       ==> AORs PA01, PA02, PA03

Press Enter to Create System Group.
Type END or CANCEL to cancel without creating.
    
```

When you press Enter, the CICSGRP view is redisplayed, and contains an entry for the group CSGAORS1.

3. Add CICS systems to the CICS system group.
 

In the CICSGRP view, tab to the entry for group CSGAORS1 and issue ADD from the CMD column. The Add Member to System Group panel is displayed. Complete the panel as shown here:

```

----- Add Member to System Group for PLXPROD1 -----
COMMAND ==>

System Group Name  CSGAORS1
Description        AORs PA01, PA02, PA03

Member            ==> CICSPA01      CICS System, Group or Generic

Component Spec    Inherit

Press Enter to add Member to System Group.
Type END or CANCEL to cancel without adding.
    
```

When you press Enter, the CICSGRP view is redisplayed.

You have two more systems (CICSPA02 and CICSPA03) to add to the group, so need to repeat this step twice more.

4. Create a time period definition.
  - a. Issue the command PERIODEF from the current view. The PERIODEF view, showing any time-period definitions already created in this CICSplex, is displayed.

## monitor programs in multiple CICS systems

- b. Issue the command CRE from the PERIODEF view. The Create Time Period Def panel is displayed. Complete the panel as shown here:

```
----- Create Time Period Def for PLXPROD1 -----  
COMMAND ==>  
  
Definition Name ==> PDFPRIME  
Description      ==> Prime shift  
  
Time Period Definition:  
Start Time      ==> 08:00 (HH:MM)  
End Time        ==> 17:00 (HH:MM)  
Time Zone       ==> A  
Zone Adjustment ==> 0  
  
Press Enter to Create Time Period Definition.  
Type END or CANCEL to cancel without creating.
```

Press Enter to create the Time Period Definition PDFPRIME. The PERIODEF view is redisplayed showing an entry for PDFPRIME.

### 5. Create a monitor definition.

Issue the command MONDEF from the current view. The MONDEF view, showing any monitor definitions already created in CICSplex PLXPROD1, is displayed. To create a new monitor definition, you can either:

- a. Issue the command CRE from the MONDEF view. The Create Monitor Definition panel is displayed.

or

- b. In the MONDEF view, tab to an entry for an existing monitor definition that you want to use as a template for the new definition, and issue CRE from the line-command field. The Create Monitor Definition panel, showing the values of the “template” definition, is displayed.

Complete the panel as shown here:

```
----- Create Monitor Definition for PLXPROD1 -----  
COMMAND ==>  
  
Definition Name ==> MODPAY02  
Description      ==> Programs PAY*  
  
Resource Definition:  
Name            ==> PAY*   Resource Name  
Type            ==> MPROG  MCONN/MFILE/MJRNL/MPROG/MTDQS/MTERM/MTRAN  
Include         ==> YES    Include for monitoring (NO, YES)  
RODM Status     ==> NO     Operational status for RODM (YES, NO)  
  
Press Enter to Create Monitor Definition.  
Type END or CANCEL to cancel without creating.
```

The value in the Name field (PAY\*) is a generic name that tells CICSplex SM you’re interested in any program whose name begins with the letters PAY.

Press Enter. The MONDEF view is redisplayed, showing an entry for the monitor definition MODPAY02.

**Note:** For a complete description of the MONDEF view, see “MONDEF (Monitor definitions)” on page 145.

## monitor programs in multiple CICS systems

6. Create a monitor group.
  - a. Issue the command MONGROUP from the current view. The MONGROUP view, showing any monitor groups already created in CICSplex PLXPROD1, is displayed.
  - b. Issue the command CRE from the MONGROUP view. The Create Monitor Group panel is displayed. Complete the panel as shown here:

```
----- Create Monitor Group for PLXPROD1 -----  
COMMAND  ===>  
  
Group Name   ===> MOGPAY01  
Description  ===> Payroll resources  
  
Press Enter to create Monitor Group.  
Type END or CANCEL to cancel without creating.
```

Press Enter. The MONGROUP view is redisplayed, showing an entry for MOGPAY01.

**Note:** For a complete description of the MONGROUP view, see “MONGROUP (Monitor groups)” on page 152.

7. Add the monitor definition to a monitor group.

Because you want the monitor definition MODPAY01 to be installed automatically whenever any of the CICS systems in group CSGAORS1 starts, you must add MODPAY01 to a monitor group.

From the MONDEF view, tab to the entry for MODPAY02 and issue ADD from the line-command field. The Add Monitor Definition to Group panel is displayed. The first five fields of the panel are prefilled by CICSplex SM using data from the monitor definition MODPAY02. Complete the panel as shown here:

```
----- Add Monitor Definition to Group for PLXPROD1 -----  
COMMAND  ===>  
  
Definition Name  ===> MODPAY02  
Description      ===> Programs PAY*  
Type             ===> MPROG  
Resource Name    ===> PAY*  
Include          ===> YES  
  
Monitor Group Name ===> MOGPAY01      Monitor Group or Generic  
Active Period      ===> PDFPRIME      Period Definition or Generic  
  
Press Enter to add Monitor Definition to Group.  
Type END or CANCEL to cancel without adding.
```

In the Monitor Group Name field, type MOGPAY01. In the Active Period field, type the name of the time-period definition you created in step 4 on page 179.

Press Enter to add MODPAY02 to MOGPAY01.

8. Add the monitor group to a monitor specification.

In the MONGROUP view, tab to the entry for MOGPAY01, and issue ADD from the line-command field. The Add Group to Specification panel is displayed. The first two fields are prefilled by CICSplex SM, so all you need to do is enter the monitor specification name, as shown here:

## monitor programs in multiple CICS systems

```

----- Add Group to Specification for PLXPROD1 -----
COMMAND ==>

Monitor Group Name      MOGPAY01
Description             Monitor group 1

Specification name ==> MOSPAY01      Specification Name or Generic

Press Enter to add Monitor Group to Specification.
Type END or CANCEL to cancel without adding.

```

You'll notice that the monitor specification MOSPAY01 is the one you created in the previous example ("Monitoring transaction response times" on page 175). Instead of creating a new monitor specification for this example, you can reuse an existing specification. (This is important, because a CICS system or CICS system group can be associated with only one monitor specification at a time.) However, you still need to update monitor specification MOSPAY01.

9. Update the monitor specification.
  - a. Issue the command MONSPEC MOSPAY01 from the current view. The MONSPEC view, showing an entry for MOSPAY01, is displayed.
  - b. Tab to the entry for MOSPAY01, and issue UPD from the line-command field. The Update Monitor Specification panel is displayed. Update the specification by setting the Programs sample interval to 300 seconds, as shown here:

```

----- Update Monitor Specification for PLXPROD1 -----
COMMAND ==>

Monitor Spec Name      ==> MOSPAY01
Description            ==> Payroll resources
Monitor Status        ==> ACTIVE      Monitor Status (Active/Inactive)
Retention Period      ==> 30          Minutes to retain data after termination
RODM CMAS            ==>              CMAS to populate RODM or Generic

Sample Intervals
Resource Name  Interval      Seconds between samples (0 for none)
Resource Name  Interval      Class Name
-----
Region         ==> 0          Transaction    ==> 120      MTRAN
Global         ==> 0          Terminal       ==> 0         MTERM
DB2            ==> 0          File           ==> 0         MFILE
               ==> 0          Transient Data ==> 0         MTDQS
               ==> 0          Journal        ==> 0         MJRNL
               ==> 0          Connection    ==> 0         MCONN
               ==> 0          Program       ==> 300      MPROG

Press ENTER to update Monitor Specification.
Type END or CANCEL to cancel without updating.

```

Programs are to be sampled every 300 seconds. (You don't have to alter the Transaction sample interval, because it takes effect only when a monitor definition, identifying which transactions are to be monitored, is installed in a CICS system. If no such definition is installed, no monitoring of transactions occurs.)

Press Enter. The MONSPEC view is redisplayed.

**Note:** For a complete description of the MONSPEC view, see "MONSPEC (Monitor specifications)" on page 164.

10. Associate the monitor specification with the CICS system group.



## monitor programs in multiple CICS systems

In the MONSPEC view, tab to the entry for MOSPAY01, and issue ADD from the line-command field. The ADD Scope for Specification panel is displayed. Enter the CICS system group CSGAORS1 in the Scope field as shown here:

```
----- Add Scope for Specification for PLXPROD1 -----
COMMAND ==>

Monitor Spec Name      MOSPAY01
Description            Payroll resources

Scope                 ==> CSGAORS1   CICS System, Group, or Generic
Option                ==> FORCE      FORCE, NULL, or NONE for System Group

Press Enter to add Monitor Specification to Scope.
Type END or CANCEL to cancel without adding.
```

The Option value FORCE means that all CICS systems in the group CSGAORS will use this monitor specification.

### 11. Switch CICSplex SM monitoring on in the CICS systems.

From the current view, issue the command CICSSYS. The CICSSYS view, showing CICS systems in CICSplex PLXPROD1, is displayed. Tab to the entry for CICSPA01, and issue UPD from the line-command field. The Update System panel, looking something like this, is displayed:

```
----- Update System - Monitor Attributes - for PLXPROD1 -----
COMMAND ==>

System name           CICSPA01
Description           AOR 1 on System A

Monitoring active     ==> YES       Activate at startup (YES, NO, or *)
Monitor specification MOSPAY01    Current MONSPEC definition
Specification source  EXPLICIT   Type of link to MONSPEC
System group name     System group if implicit source
Data retention period ==> 30      Data retained after termination

Resource Sample Rates:
CICS Region          ==>          Connections          ==>
Global               ==>          Files                 ==>
DB2/DBCTRL           ==>          Journals             ==>
                                                             Programs            ==> 300
                                                             Terminals           ==>
                                                             Transactions        ==> 120
                                                             TD Queues           ==>

Type DOWN or UP to view other System screens.
Press ENTER to update the System.
Type END or CANCEL to cancel without updating.
```

Type YES in the Monitoring active field, and press Enter. The CICSSYS view is redisplayed. Repeat this step for CICSPA02 and CICSPA03.

Any change you make to the CICS system definitions via the CICSSYS view takes effect when those CICS systems are next started. However, CICS systems CICSPA01 and CICSPA03 are currently running. To switch monitoring on for those systems immediately, you must also update their definitions via the MAS views. (How to do this is shown in the previous example, in step 6 on page 177.) Note that, when you switch monitoring on via the MAS views, it remains on until the CICS system stops or until you switch monitoring off. The time-period definition PDFPRIME has no effect.

### 12. Look at the monitor data.

## monitor programs in multiple CICS systems

You can look at the data that CICSplex SM is gathering by issuing the command MPROGRAM PAY\* from the current view. The MPROGRAM view, showing detailed information (such as usage counts and average fetch times), about programs PAY\* in CICS system group CSGAORS1, is displayed. Whenever you press Enter, the data in the MPROGRAM view is refreshed. (The frequency with which the data changes is dictated by the resource sample interval. In this example, the data changes at most every five minutes.)

---

## Finding out which resources are being monitored in a CICS system

This example shows you how to find out which types of resource are being monitored in CICS system CICSPA01.

1. If the current context isn't PLXPROD1, issue the command CON PLXPROD1 from the current view.
2. Change the scope.

Issue the command SCO CICSPA01 from the current view.

3. Display a list of active monitor definitions in the current scope.

Issue the command MONACTV from the current view. The MONACTV view, showing active monitor definitions in CICS system CICSPA01, is displayed:

```
26MAR1999 19:33:12 ----- INFORMATION DISPLAY -----
COMMAND ==>                                SCROLL ==> PAGE
CURR WIN ==> 1          ALT WIN ==>
W1 =MONACTV=====PLXPROD1=CICSPA01=26MAR1999==19:33:12=CPSM=====2===
CMD Def      CICS   Status   Active   Resource Resource Include RODM
--- Name---- System-- ----- Period-- Name---- Type--- ----- Pop-
MODPAY01    CICSPA01 ACTIVE      PAY1     MTRAN   YES    YES
MODPAY02    CICSPA01 ACTIVE      PDFPRIME PAY*    MPROG   YES    YES
```

---

## Finding out why a CICSplex SM event occurred

This example shows you how to investigate what caused a real-time analysis event notification to be issued.

1. If the current context isn't PLXPROD1, issue the command CON PLXPROD1 from the current view.
2. Display a list of events.

From the current view, issue the command EVENT. The EVENT view, showing outstanding events in the current scope, is displayed:

```
COMMAND ==>                                SCROLL ==> PAGE
CURR WIN ==> 1          ALT WIN ==>
W1 =EVENT=====PLXPROD1=PLXPROD1=26MAR1999==18:29:26=CPSM=====2===
CMD Name      Target  Sev Pri Type Dtl View   Resource  Key
-----
RTDPAY01    CICSP01 VHS   1 MRM  YES CONNECT
RTDPAY02    CICSP01 VHS   1 MRM  YES CONNECT
```

3. Display the details of the event you are interested in.

Suppose that you are interested in event RTDPAY01. Move the cursor to the Dtl column for event RTDPAY01, and press Enter. The EVENTDTL view is displayed:

## why a CICSplex SM event occurred

```
26MAR1999 16:50:35 ----- INFORMATION DISPLAY -----
COMMAND ==>>                                     SCROLL ==>> PAGE
CURR WIN ==>> 1           ALT WIN ==>>
>W1 =EVENTDTL=====PLXPROD1=PLXPROD1=26MAR1999==16:50:35=CPSM=====1===
CMD EVALDEF  Sev Table  Instance Evaluation  View  Data Value
----- Column-----
      RTEPAY01 VHS CONNECT *          CONNSTATUS  CONNECT  RELEASED
```

From the Evaluation Column, you can see that the CONNSTATUS value of this connection has triggered the event, and that its current value is RELEASED. This might tell you all you need to know. If it doesn't, you can investigate further as described in the remaining steps of this example.

4. Look at the associated evaluation definition.

To get more information about the evaluation definition that has triggered this event, move the cursor to the RTEPAY01 entry in the EVALDEF column and press Enter. The EVENTDSTD view is displayed:

```
26MAR1999 17:13:48 ----- INFORMATION DISPLAY -----
COMMAND ==>>                                     SCROLL ==>> PAGE
CURR WIN ==>> 1           ALT WIN ==>>
>W1 =EVENTDTL=EVENTDSTD=PLXPROD1=PLXPROD1=29MAR1999==17:13:46=CPSM=====1===
Event Name..      RTDPAY01                               VHS value..
EVALDEF Name      RTEPAY01 Table Name...   CONNECT HS value..
Target.....      PLXPROD1 Instance Patt   * HW value..
State.....        TRUE Eval Column..   CONNSTATUS LW value..
Severity...       VHS Eval Column..       NE LS value..
Date.....         26MAR1999                               VLS value..
Time.....         17:13:39                               Eval Value
Set Action..      ANY                               Data Value
Sample Rate..     30                               Key.....
View.....         CONNECT
Type.....         VALUE
Resource....      CONNECT
```

From the EVENTDSTD view, you can see that event RTDPAY01 is triggered when the value of the CONNSTATUS column in the CONNECT table is not ACQUIRED. (The Eval Operator value is NE (meaning "not equal to"); the Eval Value is ACQUIRED; and the Eval Column is CONNSTATUS).

Next, you could look at the CONNECT view. However, it's a good idea to open another window first, so that you can see the CONNECT view and the EVENTDSTD view at the same time.

5. Open a second window.

To open a second window, type HS in the COMMAND field, move the cursor approximately halfway down the screen, and press Enter. Window T2 appears, and the current window is now window 2:

## why a CICSplex SM event occurred

```

26MAR1999 17:13:48 ----- INFORMATION DISPLAY -----
COMMAND ==> SCROLL ==> PAGE
CURR WIN ==> 2 ALT WIN ==>
>W1 -EVENTDTL-EVENTDTD-PLXPROD1-PLXPROD1-26MAR1999--17:13:46-CPSM-----1---
Event Name.. RTDPAY01 VHS value.
EVALDEF Name RTEPAY01 Table Name... CONNECT HS value..
Target..... PLXPROD1 Instance Patt * HW value..
State..... TRUE Eval Column.. CONNSTATUS LW value..
Severity... VHS Eval Operator NE LS value..
Date..... 29MAR1999 VLS value.
Time..... 17:13:39 Eval Value
Set Action.. ANY Data Value
Sample Rate. 30 Key.....
View..... CONNECT
Type..... VALUE
Resource.... CONNECT

T2 =====

```

- Set the scope of the second window.

Issue the command `SCO CICSPT01` to set the scope of window 2 to CICS system CICSPT01.

- Display a list of connections for CICS system CICSPT01.

Issue the command `CONNECT *`. The `CONNECT` view, showing all connections defined to CICSPT01, is displayed in window 2:

```

26MAR1999 17:13:48 ----- INFORMATION DISPLAY -----
COMMAND ==> SCROLL ==> PAGE
CURR WIN ==> 2 ALT WIN ==>
>W1 -EVENTDTL-EVENTDTD-PLXPROD1-PLXPROD1-26MAR1999--17:13:46-CPSM-----1---
Event Name.. RTDPAY01 VHS value.
EVALDEF Name RTEPAY01 Table Name... CONNECT HS value..
Target..... PLXPROD1 Instance Patt * HW value..
State..... TRUE Eval Column.. CONNSTATUS LW value..
Severity... VHS Eval Operator NE LS value..
Date..... 26MAR1999 VLS value.
Time..... 17:13:39 Eval Value
Set Action.. ANY Data Value
Sample Rate. 30 Key.....
View..... CONNECT
Type..... VALUE
Resource.... CONNECT

W2 =CONNECT=====PLXPROD1=CICSPT01=26MAR1999==17:27:27=CPSM=====2===
CMD Conn CICS CONN Netname Connect Service Pending
--- ID-- System-- Type ----- Status---- Status---- Status----
AA01 CICSPT01 LU62 CICSIPA01 RELEASED INSERVICE NOTPENDING
AA02 CICSPT01 LU62 CICSIPA02 ACQUIRED INSERVICE NOTPENDING
AA03 CICSPT01 LU62 CICSIPA03 ACQUIRED INSERVICE NOTPENDING

```

From the `CONNECT` view in window 2, you can see that connection AA01 is `RELEASED`, and that this triggered event RTDPAY01.

---

## Part 4. Appendixes



---

## Appendix A. Customizing programs that monitor status

This appendix contains Product-sensitive Programming Interface Information.

User-written programs can be invoked by real-time analysis (RTA) to determine the status of CICS user applications. Status definitions created using the STATDEF view (as described in "STATDEF (Status definitions)" on page 70) establish the interval between calls from CICSplex SM to a status monitoring program. When the user-written program determines that an abnormal condition exists for an application or resource, an RTA event notification can be issued. The user-written program may run in a local or remote MAS on any supported CICS system.

---

### Creating a status program

Once RTA determines (by issuing an EXEC CICS INQ) that your program is available, RTA issues a status call (which uses the CICS/ESA format of DFHCOMMAREA) to the program. When RTA invokes your program, the DFHEICAP field of the DFHEISTG DSECT contains the address of the COMMAREA. The COMMAREA contains data mapped by the CICSplex SM EYURPESC DSECT.

#### 390 Assembler

The EYURPESC DSECT format is as follows:

RTA STATUS CALL DFHCOMMAREA			
PESC_HEADER	DS	CL20	EYURPESC block header
PESC_CONTEXT	DS	CL8	CICSplex name
PESC_SCOPE	DS	CL8	CICS system name
PESC_COUNT	DS	F	Number of NAME/STATUS pairs (between 1 and 64)
PESC_NAME	DS	CL8	Name of status definition (STATDEF)
PESC_STATUS	DS	F	Status token of:
PESC-NORMAL	EQU	0000	Normal
PESC_VLS	EQU	0001	Very low severe
PESC_LS	EQU	0002	Low severe
PESC_LW	EQU	0003	Low warning
PESC_HW	EQU	0004	High warning
PESC_HS	EQU	0005	High severe
PESC_VHS	EQU	0006	Very high severe

#### OS/2 C

The EYURPESC format for OS/2 C is:

```
typedef struct
{
    char    HEADER[20];    /* EYU block header (fixed length) */
    char    CONTEXT[8];    /* CICSplex name (fixed length) */
    char    SCOPE[8];      /* MAS name (fixed length) */
    int     COUNT;         /* Number of elements; 1-64 (32 bit) */
    struct
    {
        char    NAME[8];    /* Name of STATDEF (fixed length) */
        int     STATUS;     /* RTA Status token (32 bit) */
    }
    ELEMENT[64];
} EYURPESC;
```

## creating a status program

```
/* - - Defined values for element STATUS field - - - - - */
#define EYURPESC_STATUS_NORMAL 0 /* Normal */
#define EYURPESC_STATUS_VLS 1 /* Very low severe */
#define EYURPESC_STATUS_LS 2 /* Low severe */
#define EYURPESC_STATUS_LW 3 /* Low warning */
#define EYURPESC_STATUS_HW 4 /* High warning */
#define EYURPESC_STATUS_HS 5 /* High severe */
#define EYURPESC_STATUS_VHS 6 /* Very high severe*/
```

The character arrays within EYURPESC are fixed length strings, filled to the right with spaces. They are not terminated with a null character.

## Explanation

For each status definition for which you wish to return status, your program must enter into the appropriate fields of EYURPESC both the NAME and the associated STATUS value. The value provided in the STATUS field indicates that the condition of the application or resource is normal or, if it is abnormal, it indicates the severity of the condition. The number of status definition entries in EYURPESC can be between 1 and 64; the number must be specified in the COUNT field as a fullword binary integer value.

The name of the status definition which caused the status call is supplied by RTA in the NAME field of the first entry to be returned. Therefore, NAME need not be supplied for the first entry in the table. The associated STATUS must be provided by your program. All subsequent status definition NAMEs (and the STATUS for each) must also be specified by your program.

**Note:** The CICSplex SM API cannot be used from within a program that is invoked through the STATDEF view. Where access to the API is required, you must start another task and invoke the API from the new task.

---

## Installing a status program

### 390 Assembler

To install your status program:

1. Assemble and link edit the status program. Be sure the program resides in a DFHRPL concatenated load library.
2. Define (using either BAS PROGDEF or CEDA DEFINE PROGRAM) a program definition (PPT entry) for your program in each MAS that will contain installed status definitions.

**Note:** (For CICS 3.3 and above.) Be sure the Data location field in the program definition specifies the correct addressing mode for the program. The Exekey field in the program definition must be set to 'CICS'.

3. If a transaction ID other than 'COIE', or blanks, was specified in the Transaction ID field of the RTA status definition, you must define (using either BAS TRANDEF or CEDA DEFINE TRANSACTION) a transaction definition (PCT entry) for the transaction in each MAS that will have this status definition installed. The program name in the transaction definition must be EYU9XLOP.



## installing a status program

**Note:** (For CICS 3.3 and above.) Be sure the TASKDATALOC field in the transaction definition specifies the correct addressing mode for the task. The TASKDATAKEY field must be set to 'CICS'.

4. Use either BAS or the CEDA transaction to install into the active MASs:
  - Your program
  - The transaction specified in the Transaction ID field of the status definition (only if specified)

## OS/2 C

To install your status program:

1. Compile and link edit the status program. Be sure the program resides in a directory in the UserWrk path defined in CICSENV.COMD.
2. If you wish, define a program definition (PPT entry) for your program in the CICS for OS/2 RMAS.
3. If a transaction ID other than 'COIE', or blanks, was specified in the Transaction ID field of the RTA status definition, you must define a transaction definition (PCT entry) for the transaction in each MAS that will have this status definition installed. The program name in the transaction definition must be EYU9XLOP.
4. Install the program and transaction resources by either restarting your CICS for OS/2 system or using dynamic resource installation (if available).

---

## Defining a status definition to CICSplex SM

To define the status definition to CICSplex SM:

1. From CICSplex SM, issue the STATDEF view command. Use the CREATE action command to define an RTA status definition. Specify:
  - The name of a status definition
  - The name of the program to be called
  - A valid transaction ID (Optional)
  - A valid user ID (Optional)
  - The interval at which the user-written program is to be called
  - Entry and exit clock values

### Notes:

- a. If the Transaction ID field is left blank, the user-written program will execute as part of the CICSplex SM COIE transaction.
  - b. For CICS 3.3, the User ID field is not processed by RTA. For CICS 4.1, the User ID field is Optional.
2. Use the INS line action command to install the appropriate status definitions into their respective MASs.
  3. Use the ADD line action command to add the status definition to an RTAGROUP that is associated with a MAS via RTASPEC. This will allow the status definition to be installed automatically during MAS initialization.

## defining a status definition to CICSplex SM

---

## Appendix B. Generic alert and resolution structures

This appendix describes the structure of SNA generic alerts and resolutions as they are used by CICSplex SM. The general structures of SNA alerts and resolutions are defined in the *SNA LU6.2 Reference: Peer Protocols* book, in the section describing SNA/MS Encodings.

---

### The generic alert structure

The CICSplex SM Alert MS major vector contains the following:

#### **“Generic Alert Data” (X'92') MS subvector**

This identifies the Alert Description code as “IMPENDING PROBLEM: THRESHOLD HAS BEEN REACHED” (X'4012').

#### **“Probable Causes” (X'93') MS subvector**

This identifies a single code point specifying “PERFORMANCE DEGRADED” (X'4000').

#### **“Cause Undetermined” (X'97') MS subvector**

This contains:

- A “Recommended Actions” (X'81') common subfield. This identifies one code point specifying “REVIEW” (X'00A1').
- Two “Detailed Data” (X'82') common subfields containing:
  1. Data ID of “THRESHOLD PARAMETER” (X'7111'), with EBCDIC encoding, containing the following characters:

0-2	Creator (SAM   MRM   APM)
3-5	RTA Event Severity (VLS   VLW   LW   HW   HS   VHS)
6-13	RTA Event name (RTADEF name   STATDEF name   !!SAMxxx)
  2. Data ID of “PROBLEM DATA” (X'F511'), with EBCDIC encoding, containing the following characters:

0-29	The text of the “Enter Msg” from the action definition (ACTNDEF)
------	--

#### **“Product Set ID” (X'10') MS common subvector**

a “Product ID” (X'11') common subvector that identifies the product as IBM Software (X'04') and contains:

- A “Product Number” (X'08') Product ID subfield that identifies the product number as 5695081.
- A “Product Common Name” (X'06') Product ID subfield that identifies the common name as CICSplex.SM.
- A “Product Common Level” (X'04') Product ID subfield that identifies the version, release, and modification levels.

#### **“Hierarchy/Resource List” (X'05') MS common subvector**

This contains:

- A “Hierarchy Name List” (X'10') Hierarchy/Resource List subfield, which contains the following list elements:

## generic alert and resolution structures

Element	Resource Type	Resource Name
1	Service point (X'81')	RTA CONTEXT
2	Unspecified device (X'00')	RTA SCOPE
3	Unspecified device (X'00')	RTA RESOURCE TYPE

- An “Associated Resource List” (X'11') subfield, which contains a 16-character EBCDIC resource name that identifies either the event name or the instance key from the associated resource table.

### “Incident Identification” (X'4A') MS common subvector

This contains an “Incident Identification” (X'01') Incident Identification subfield. This uses encoding type X'01'. The fields are as follows:

**Field Contents; Length**

**Netid:** Periods; 8 characters

**Network addressable unit:**

APPLID of the originating CMAS; 8 characters

**Application name:**

CICSplex name; 8 characters

**Unique id:**

CMAS name concatenated with GMT timestamp; 16 characters

---

## The resolution structure

The Resolution (X'0002') MS major vector has the same structure as the Alert MS major vector, except that the second of the two “Detailed Data” common subfields of the “Cause Undetermined” MS subvector contains the text of the “Exit Msg” from the action definition rather than the “Enter Msg” text.

---

## Appendix C. Information provided by the RODM interface

This appendix provides the following information:

- For NGMF users, a list of the CICSplex SM and CICS resources that can be displayed in the NGMF views when the interface to RODM is activated. Refer to “Monitoring resources with NGMF” on page 135 for more information on the NGMF views.
- For MSMACC and RODM API users, a list of the MultiSystem Manager Open Data Model (MSMODM) fields and the values supplied in each field. Refer to the *MultiSystem Manager Topology Data Model Reference* and the *NetView RODM Programming Guide* for more information on the RODM internal field names and data types.

---

### NGMF resources

The NGMF aggregate resources are listed and described in the following section. The NGMF real resources are listed in “Real resources” on page 196, along with the information displayed in the Resource Information window. The resources are listed by class hierarchy starting with the highest level resource. Italicized resource names are replaced in the view with the actual name of the resource. For example, *dsname* is replaced by the actual data set name.

### Aggregate resources

**CPSM** Represents CMASs and CICSplexes. The CPSM resource provides an anchor for all subordinate resources.

***plexname***

Represents CICS systems. The Customer data field of the Resource Information window contains the name of the maintenance point CMAS for this CICSplex, in the form of MP Cmas(mpcmas).

***cicsname***

Represents CICS regions, connections, data sets, FEPI connections, files, journals, programs, terminals, transactions, transient data queues, and exits.

***cics1.cics2***

Represents the underlying connection between two CICS systems. Connections that involve one or more CICS for OS/2 system are not created.

**DSNAME**

Represents underlying data sets.

**FEPICONN**

Represents underlying FEPI connections.

**LOCFILE**

Represents underlying local files.

**REMFILE**

Represents underlying remote files.

**CMDT**

Represents underlying data tables.

## aggregate resources

### JOURNAL

Represents underlying journals.

### PROGRAM

Represents underlying programs.

### TERMINAL

Represents underlying terminals.

### LOCTRAN

Represents underlying local transactions.

### REMTRAN

Represents underlying remote transactions.

### EXTRATDQ

Represents underlying extrapartition transient data queues.

### INTRATDQ

Represents underlying intrapartition transient data queues.

### REMTDQ

Represents underlying remote transient data queues.

### EXITGLUE

Represents underlying global user exits.

### EXITTRUE

Represents underlying task-related user exits.

## Real resources

### *cmasname*

A real CMAS. The Resource Information window provides the following information:

**Name** The name of the CMAS.

#### **Other data**

SNA Address=*vtamdomain.applid*, Agent Application=*cmasname*

**Type** Agent.

#### **Customer data**

None.

#### **System status**

The last operational state of the system as:

#### **Satisfactory**

The CMAS is active.

### *jobname*

A real CICS region. The Resource Information window provides the following information:

**Name** Jobname of the CICS region.

#### **Other data**

The CICS and operating system IDs in the form of Sysidnt(*cics*) OpSysid(*opid*), where *opid* is VSE, OS/2, or for MVS systems, the SMF system ID.

**Type** CICS system.

#### **Customer data**

None.

**System status**

The last operational state of the system as one of the following:

**Satisfactory**

The CICS region is active.

**Intermediate**

The CICS region is starting or terminating.

**Unsatisfactory**

The CICS region has been cancelled.

*cicsapplid*

A real connection between two CICS systems. The Resource Information window provides the following information:

**Name** The name of the connection.

**Other data**

If the Customer data field is set to Type(LU62), the acquired status of the connection is listed in this field as Released, Obtaining, Acquiring, Freeing, or Available.

**Type** Perspective link.

**Customer data**

The type of connection as either LU61, LU62, or MRO.

**System status**

The last operational state of the connection as one of the following:

**Satisfactory**

The connection is in service.

**Intermediate**

The connection is going out of service.

**Unsatisfactory**

The connection is out of service.

*dsname*

A real data set resource. The Resource Information window provides the following information:

**Name** Data set name.

**Other data**

The backout status of the data set as Normal Backout, Failed Backout, Failing Backout or Not Applicable.

**Type** Data set.

**Customer data**

None.

**System status**

The last operational state of a data set as one of the following:

**Satisfactory**

The data set is valid.

**Unsatisfactory**

The data set is invalid.

*fepiconn*

A real FEPI connection. The Resource Information window provides the following information:

**Name** The target of the FEPI connection followed by the node name, in the form of target.node.

## real resources

### Other data

The acquired status of the connection as Released, Releasing, Acquired, or Acquiring.

**Type** 3270 emulation.

### Customer data

None.

### System status

The last operational state of the connection as one of the following:

#### Satisfactory

The FEPI connection is in service.

#### Intermediate

The FEPI connection is going out of service.

#### Unsatisfactory

The FEPI connection is out of service.

*locfile* A real local file. The Resource Information window provides the following information:

**Name** The name of the file.

### Other data

The open status of the file as Open, Opening, Closed, Closing, or Closerequest.

**Type** Local file.

### Customer data

The data set name.

### System status

The last operational state of the file as one of the following:

#### Satisfactory

The file is enabled.

#### Intermediate

The file is being disabled.

#### Unsatisfactory

The file is disabled or unenabled.

*remfile*

A real remote file. The Resource Information window provides the following information:

**Name** The name of the file.

### Other data

The file name in the remote system and the remote CICS system ID.

**Type** Remote file.

### Customer data

None.

### System status

The last operational state of the file as one of the following:

#### Satisfactory

The file is enabled.

#### Intermediate

The file is being disabled.



**Unsatisfactory**

The file is disabled or unenabled.

***data table***

A real data table. The Resource Information window provides the following information:

**Name** The name of the data table file.

**Other data**

The open status of the data table file as Open, Opening, Closed, Closing, or Closerequest.

**Type** Data table.

**Customer data**

Dataset(*data.set.name*) Type (CICSJUSER)

**System status**

The last operational state of the data table file as one of the following:

**Satisfactory**

The data table file is enabled.

**Intermediate**

The data table file is being disabled.

**Unsatisfactory**

The data table file is disabled or unenabled.

***journal***

A real journal. The Resource Information window provides the following information:

**Name** The name of the journal.

**Other data**

None.

**Type** The type of the journal as Disk Journal, Tape Journal, or SMF Journal.

**Customer data**

None.

**System status**

The last operational state of the journal as one of the following:

**Satisfactory**

The journal is open for output.

**Unsatisfactory**

The journal is closed.

***program***

A real program. The Resource Information window provides the following information:

**Name** The name of the program.

**Other data**

None.

**Type** Program.

**Customer data**

None.

## real resources

### **System status**

The last operational state of the program as one of the following:

#### **Satisfactory**

The program is enabled.

#### **Unsatisfactory**

The program is disabled.

### *terminal*

A real terminal. The Resource Information window provides the following information:

**Name** The terminal ID.

#### **Other data**

The acquire status of the terminal as Acquired, Acquiring, or Released.

**Type** Generic terminal.

#### **Customer data**

None.

### **System status**

The last operational state of the terminal as one of the following:

#### **Satisfactory**

The terminal is in service.

#### **Unsatisfactory**

The terminal is out of service.

### *loctran*

A real local transaction. The Resource Information window provides the following information:

**Name** The transaction ID.

#### **Other data**

None.

**Type** Local transaction.

#### **Customer data**

The name of the program associated with this transaction.

### **System status**

The last operational state of the transaction as one of the following:

#### **Satisfactory**

The transaction is enabled.

#### **Unsatisfactory**

The transaction is disabled.

### *remtran*

A real remote transaction. The Resource Information window provides the following information:

**Name** The transaction ID.

#### **Other data**

None.

**Type** Remote transaction.

**Customer data**

The name of the remote transaction ID and the CICS system ID to which it will be routed, in the form of Remote Name(tranid) CICS(cicssysid)

**System status**

The last operational state of the transaction as one of the following:

**Satisfactory**

The transaction is enabled.

**Unsatisfactory**

The transaction is disabled.

*extratdq*

A real extrapartition transient data queue. The Resource Information window provides the following information:

**Name** The name of the transient data queue.

**Other data**

The open status of the transient data queue as Open, Opening, Switching, Closed, or Closing.

**Type** Extrapartition transient data queue.

**Customer data**

None.

**System status**

The last operational state of the transient data queue as one of the following:

**Satisfactory**

The transient data queue is enabled.

**Unsatisfactory**

The transient data queue is disabled.

*intrtdq*

A real intrapartition transient data queue. The Resource Information window provides the following information:

**Name** The name of the transient data queue.

**Other data**

None.

**Type** Intrapartition transient data queue.

**Customer data**

None.

**System status**

The last operational state of the transient data queue as one of the following:

**Satisfactory**

The transient data queue is enabled.

**Unsatisfactory**

The transient data queue is disabled.

*remtdq*

A real remote transient data queue. The Resource Information window provides the following information:

**Name** The name of the transient data queue.

## real resources

### Other data

None.

**Type** Remote transient data queue.

### Customer data

The transient data queue name in the remote system and the remote system ID.

### System status

The last operational state of the transient data queue as one of the following:

#### Satisfactory

The transient data queue is enabled.

#### Unsatisfactory

The transient data queue is disabled.

### *exitglue.program*

A real global user exit. The Resource Information window provides the following information:

**Name** The name of the exit followed by the program name.

### Other data

None.

**Type** Utility.

### Customer data

None.

### System status

The last operational state of the exit as one of the following:

#### Satisfactory

The exit has been started.

#### Unsatisfactory

The exit has been stopped.

### *exittrue*

A real task-related user exit. The Resource Information window provides the following information:

**Name** The name of the exit.

### Other data

None.

**Type** Utility.

### Customer data

None.

### System status

The last operational state of the exit as one of the following:

#### Satisfactory

The exit has been started.

#### Unsatisfactory

The exit has been stopped.

## MSMODM object fields and values

CICSplex SM uses the MultiSystem Manager Open Data Model (MSMODM) to build objects in the RODM data cache. This section provides the MSMODM object fields and their values for users who choose to access these objects using MultiSystem Manager Access (MSMACC), the MultiSystem Manager BLDVIEWS function, or the RODM API.

When using the BLDVIEWS function, the object field names (shown in the following descriptions) must be replaced with their equivalent numeric identifiers. For example, the MyName field for many objects consists of the following five subfields, shown here with their equivalent numeric identifiers:

**systemId**  
2.9.3.2.7.4

**agentName**  
1.3.18.0.0.3519

**graphId**  
1.3.18.0.0.2216

**AggregateNodeName**  
1.3.18.0.0.6463

**functionID**  
1.2.124.360501.1.240

For a complete list of object field names and numeric identifiers, refer to the *MultiSystem Manager Topology Data Model Reference*.

Note that the object field names are not necessarily the same as the internal RODM field names. Refer to the *NetView RODM Programming Guide* for details on the RODM field names.

*Italicized* values are replaced with the actual name of the object. For example, *cmasname* is replaced with the name of the CMAS. UPPERCASE values represent aggregate objects. MixedCase values represent real objects.

### NonSNADomain

This object is an MSMODM Non\_SNA\_Domain\_Class. The object fields and the values for each are as follows.

**MyName**  
*cmasapplid.cmasname*

**ContainsResource**  
CicsRegion, Cmas, DataTable, Dataset, ExtraTdqueue, FepiConnection, GlobalExit, IntraTdqueue, Journal, LocalFile, LocalTransaction, PerspectiveLink, Program, RemoteFile, RemoteTdqueue, RemoteTransaction, TaskExit, Terminal,

**ContainsAggregate**  
AGGREGATELINK, CICSplex, CICSsystem, CMDT, DSNAMES, EXITGLUE, EXITTRUE, EXTRATDQ, FEPICONN, INTRATDQ, JOURNAL, LOCFILE, LOCTRAN, PROGRAM, REMFILE, REMTDQ, REMTRAN, TERMINAL

### CPSM

This object is an MSMODM aggregateGraph. The object fields and the values for each are as follows.

## MSMODM object fields

**MyName**  
systemId=CPSM,agentName=all,graphId=Networks

**graphId**  
Networks

**DisplayResourceType**  
DUIXC\_RTN\_GROUP\_AGG

**DisplayResourceName**  
CPSM

**member**  
CMAS, CICSPLEX

## CMAS

This object is an MSMODM agent. The object fields and the values for each are as follows.

**MyName**  
systemId=*cmasapplid*,agentName=*cmasname*

**DisplayResourceType**  
DUIXC\_RTN\_AGENT

**DisplayResourceName**  
*cmasname*

**DisplayStatus**  
Active = Satisfactory

**MemberOf**  
CPSM

**Manages**  
CICSPLEX

## CICSplex

This object is an MSMODM aggregateGraph. The object fields and the values for each are as follows.

**MyName**  
systemId=*cmasapplid*,agentName=*cmasname*, graphId=*plexname*

**graphId**  
*plexname*

**DisplayResourceType**  
DUIXC\_RTN\_CICSPLEX\_AGG

**DisplayResourceName**  
*plexname*

**DisplayResourceUserData**  
MP CMAS(*cmasname*)

**ManagedBy**  
CMAS

**MemberOf**  
CPSM

**Member**  
CicsSystem

**AggregationParent**  
CPSM

**AggregationChild**  
CICSSYSTEM, AGRREGATELINK

**ParentAccess**  
CPSM

**ChildAccess**  
CICSSYSTEM, AGGREGATELINK

**Domain**  
NonSNADomain

## CicsSystem

This object is an MSMODM aggregateGraph. The object fields and the values for each are as follows.

**MyName**  
*systemId=cmasapplid,agentName=cmasname, graphId=plexname.cicsname*

**graphId**  
*plexname.cicsname*

**DisplayResourceType**  
DUIXC\_RTN\_NETWORK\_AGG

**DisplayResourceName**  
*cicsname*

**memberOf**  
CICSPlex

**member**  
CICSREGION, CMDT, DSNAME, EXITGLUE, EXITTRUE, EXTRATDQ, FEPICONN, INTRATDQ, JOURNAL, LOCFILE, LOCTRAN, PROGRAM, REMFILE, REMTDQ, REMTRAN, TERMINAL

**AggregationParent**  
CICSPlex

**AggregationChild**  
CMDT, DSNAME, EXITGLUE, EXITTRUE, EXTRATDQ, FEPICONN, INTRATDQ, JOURNAL, LOCFILE, LOCTRAN, PROGRAM, REMFILE, REMTDQ, REMTRAN, TERMINAL, CICSREGION

**ParentAccess**  
CICSPlex

**ChildAccess**  
CMDT, DSNAME, EXITGLUE, EXITTRUE, EXTRATDQ, FEPICONN, INTRATDQ, JOURNAL, LOCFILE, LOCTRAN, PROGRAM, REMFILE, REMTDQ, REMTRAN, TERMINAL, CICSREGION

**Domain**  
NonSNADomain

## CicsRegion

This object is an MSMODM realNode. The object fields and the values for each are as follows.

## MSMODM object fields

**MyName**  
systemId=*cmasapplid*,agentName=*cmasname*,  
graphId=*plexname.cicsname*,functionID=*jobname*

**snaNodeName**  
*VTAM Applid*

**functionID**  
*jobname*

**functionType**  
Application

**ProtocolType**  
Systems\_Mgmt

**DisplayResourceType**  
DUIXC\_RTN\_CICS\_SYSTEM

**DisplayResourceName**  
*jobname*

**DisplayResourceUserData**  
Sysidnt(*sysid*) OpSys Id(*opsysid*)

**DisplayStatus**  
Startup = Intermediate Active = Satisfactory Shutdown = Intermediate  
Cancelled = Unsatisfactory

**memberOf**  
CicsSystem

**AggregationParent**  
CicsSystem

**ParentAccess**  
CicsSystem

**Domain**  
NonSNADomain

## Connection

This object is an aggregateLink which contains two perspectiveLinks. The aggregateLinkName is a combination of the names of the CICS systems that are the connecting nodes of the link. Connection objects are not created for connections involving a CICS for OS/2 system. The object fields and the values for each are as follows.

**MyName**  
systemId=*cmasapplid*,agentName=*cmasname*,  
graphId=*plexname*,aggregateLinkName=*cics1.cics2*

**aggregateLinkName**  
*cics1.cics2*

**ProtocolType**  
Systems\_Mgmt

**MemberArcs**  
perspectiveLink

**DisplayResourceType**  
DUIXC\_RTL\_LINK\_AGG



**DisplayResourceName***cics1.cics2***attachedCircuitList***cics1, cics2***memberOf**

CICSPlex

**AggregationParent**

CICSPlex

**AggregationChild**

PerspectiveLink

**ParentAccess**

CICSPlex

**ChildAccess**

PerspectiveLink

**Domain**

NonSNADomain

The aggregateLink object contains two perspectiveLink objects (one for each CicsSystem). The object fields and the values for each ConnectLink perspectiveLink are as follows.

**MyName**

*systemId=cmasapplid,agentName=cmasname, graphId=plexname.cics1.cics2,  
perspectiveLinkName=cicsapplid.sysident*

**perspectiveLinkName***cicsapplid.sysident***ProtocolType**

Systems\_Mgmt

**DisplayResourceType**

DUIXC\_RTL\_PERSPECTIVE\_LINK

**DisplayResourceName**

cicsapplid

**DisplayResourceUserData**Type(*type*)**DisplayResourceOtherData**Acquire Status(*acqstatus*)**memberArcsOf**

AggregateLink

**DisplayStatus**

Inservice = Satisfactory Outservice = Unsatisfactory Goingout =  
Intermediate

**AggregationParent**

AggregateLink

**ParentAccess**

AggregateLink

**Domain**

NonSNADomain

## MSMODM object fields

### Dataset

The dataset object can be either an aggregateNode or a realNode. The aggregateNode object fields and the values for each are as follows.

**MyName**

*systemId=cmasapplid,agentName=cmasname, graphId=plexname.cicsname, AggregateNodeName=DSNAME*

**AggregateNodeName**

DSNAME

**ProtocolType**

Systems\_Mgmt

**DisplayResourceType**

DUIXC\_RTN\_NODE\_AGG

**DisplayResourceName**

DSNAME

**memberOf**

CicsSystem

**member**

Dataset

**AggregationParent**

CicsSystem

**AggregationChild**

Dataset

**ParentAccess**

CicsSystem

**ChildAccess**

Dataset

**Domain**

NonSNADomain

The dataset reaNode object fields and the values for each are as follows.

**MyName**

*systemId=cmasapplid,agentName=cmasname, graphId=plexname.cicsname, AggregateNodeName=DSNAME, functionID=data.set.name*

**functionID**

datasetname

**functionType**

Application

**ProtocolType**

Systems\_Mgmt

**DisplayResourceType**

DUIXC\_RTN\_DATASET

**DisplayResourceName**

datasetname

**DisplayResourceOtherData**

Backout(*backoutstatus*)

**DisplayStatus**

Valid = Satisfactory Invalid = Unsatisfactory

**memberOf**

DSNAME

**AggregationParent**

DSNAME

**ParentAccess**

DSNAME

**Domain**

NonSNADomain

**FepiConnection**

The FepiConnection object can be either an aggregateNode or a realNode. The aggregateNode object fields and the values for each are as follows.

**MyName**

*systemId=cmasapplid,agentName=cmasname, graphId=plexname.cicsname, AggregateNodeName=FEPICONN*

**AggregateNodeName**

FEPICONN

**ProtocolType**

Systems\_Mgmt

**DisplayResourceType**

DUIXC\_RTN\_NODE\_AGG

**DisplayResourceName**

FEPICONN

**memberOf**

CicsSystem

**member**

FepiConnection

**AggregationParent**

CicsSystem

**AggregationChild**

FepiConnection

**ParentAccess**

CicsSystem

**ChildAccess**

FepiConnection

**Domain**

NonSNADomain

The FepiConnection realNode object fields and the values for each are as follows.

**MyName**

*systemId=cmasapplid,agentName=cmasname, graphId=plexname.cicsname, AggregateNodeName=FEPICONN, functionID=fepiname*

**functionID**

fepiname

## MSMODM object fields

**functionType**  
Application

**ProtocolType**  
Systems\_Mgmt

**DisplayResourceType**  
DUIXC\_RTN\_3270\_EMUL

**DisplayResourceName**  
fepiname

**DisplayResourceOtherData**  
Acquired Status(*acqstatus*)

**DisplayStatus**  
Inservice = Satisfactory Outservice = Unsatisfactory Goingout = Intermediate

**memberOf**  
FEPICONN

**AggregationParent**  
FEPICONN

**ParentAccess**  
FEPICONN

**Domain**  
NonSNADomain

## LocalFile

The LocalFile object can be either an aggregateNode or realNode. The aggregateNode object fields and the values for each are as follows:

**MyName**  
systemId=*cmasapplid*,agentName=*cmasname*, graphId=*plexname.cicsname*,  
AggregateNodeName=LOCFILE

**AggregateNodeName**  
LOCFILE

**ProtocolType**  
Systems\_Mgmt

**DisplayResourceType**  
DUIXC\_RTN\_NODE\_AGG

**DisplayResourceName**  
LOCFILE

**memberOf**  
CicsSystem

**member**  
LocalFile

**AggregationParent**  
CicsSystem

**AggregationChild**  
LocalFile

**ParentAccess**  
CicsSystem

**ChildAccess**  
LocalFile

**Domain**  
NonSNADomain

The realNode object fields and the values for each are as follows:

**MyName**  
systemId=*cmasapplid*,agentName=*cmasname*, graphId=*plexname.cicsname*,  
AggregateNodeName=LOCFILE, functionID=*filename*

**functionID**  
filename

**functionType**  
Application

**ProtocolType**  
Systems\_Mgmt

**DisplayResourceType**  
DUIXC\_RTN\_LOCAL\_FILE

**DisplayResourceName**  
filename

**DisplayResourceOtherData**  
Open Status(*openstatus*)

**DisplayResourceUserData**  
Dataset(*data.set.name*)

**DisplayStatus**  
Enabled = Satisfactory Disabled = Unsatisfactory Disabling = Intermediate  
Unenabled = Unsatisfactory

**memberOf**  
LOCFILE

**AggregationParent**  
CicsSystem

**AggregationChild**  
LocalFile

**ParentAccess**  
CicsSystem

**ChildAccess**  
LocalFile

**Domain**  
NonSNADomain

## RemoteFile

The RemoteFile object can be either an aggregateNode or realNode. The aggregateNode object fields and the values for each are as follows:

**MyName**  
systemId=*cmasapplid*,agentName=*cmasname*, graphId=*plexname.cicsname*,  
AggregateNodeName=REMFIL

## MSMODM object fields

**AggregateNodeName**  
REMFIL

**ProtocolType**  
Systems\_Mgmt

**DisplayResourceType**  
DUIXC\_RTN\_NODE\_AGG

**DisplayResourceName**  
REMFIL

**memberOf**  
CicsSystem

**member**  
RemoteFile

**AggregationParent**  
CicsSystem

**AggregationChild**  
RemoteFile

**ParentAccess**  
CicsSystem

**ChildAccess**  
RemoteFile

**Domain**  
NonSNADomain

The RemoteFile realNode object fields and the values for each are as follows:

**MyName**  
*systemId=cmasapplid,agentName=cmasname, graphId=plexname.cicsname, AggregateNodeName=REMFIL, functionID=filename*

**functionID**  
filename

**functionType**  
Application

**ProtocolType**  
Systems\_Mgmt

**DisplayResourceType**  
DUIXC\_RTN\_REMOTE\_FILE

**DisplayResourceName**  
filename

**DisplayResourceOtherData**  
Remote Name(*rmtname*) CICS(*sysid*)

**DisplayStatus**  
Enabled = Satisfactory Disabled = Unsatisfactory Disabling = Intermediate  
Unenabled = Unsatisfactory

**memberOf**  
REMFIL

**AggregationParent**  
REMFIL

**ParentAccess**  
REMFIL

**Domain**  
NonSNADomain

## DataTable

The DataTable objects can be either an aggregateNode or a realNode. The aggregateNode object fields and the values for each are as follows:

**MyName**  
systemId=*cmasapplid*,agentName=*cmasname*, graphId=*plexname.cicsname*,  
AggregateNodeName=CMDT

**AggregateNodeName**  
CMDT

**ProtocolType**  
Systems\_Mgmt

**DisplayResourceType**  
DUIXC\_RTN\_NODE\_AGG

**DisplayResourceName**  
CMDT

**memberOf**  
CicsSystem

**member**  
DataTable

**AggregationParent**  
CicsSystem

**AggregationChild**  
DataTable

**ParentAccess**  
CicsSystem

**ChildAccess**  
DataTable

**Domain**  
NonSNADomain

The DataTable realNode object fields and the values for each are as follows:

**MyName**  
systemId=*cmasapplid*,agentName=*cmasname*, graphId=*plexname.cicsname*,  
AggregateNodeName=CMDT, functionID=*tablename*

**functionID**  
datatable

**functionType**  
Application

**ProtocolType**  
Systems\_Mgmt

**DisplayResourceType**  
DUIXC\_RTN\_DATA\_TABLE

## MSMODM object fields

**DisplayResourceName**

tablename

**DisplayResourceOtherData**

Open Status(*openstatus*)

**DisplayResourceUserData**

Dataset(*data.set.name*) Type(*CICSJUSER*)

**DisplayStatus**

Enabled = Satisfactory Disabled = Unsatisfactory Disabling = Intermediate

Unenabled = Unsatisfactory

**memberOf**

CMDT

**AggregationParent**

CMDT

**ParentAccess**

CMDT

**Domain**

NonSNADomain

## Journal

The Journal object can be either an aggregateNode or realNode. The aggregateNode object fields and the values for each are as follows:

**MyName**

systemId=*cmasapplid*,agentName=*cmasname*, graphId=*plexname.cicsname*,  
AggregateNodeName=JOURNAL

**AggregateNodeName**

JOURNAL

**ProtocolType**

Systems\_Mgmt

**DisplayResourceType**

DUIXC\_RTN\_NODE\_AGG

**DisplayResourceName**

JOURNAL

**memberOf**

CicsSystem

**member**

Journal

**AggregationParent**

CicsSystem

**AggregationChild**

Journal

**ParentAccess**

CicsSystem

**ChildAccess**

Journal

**Domain**

NonSNADomain



## MSMODM object fields

The Journal realNode object fields and the values for each are as follows:

### MyName

*systemId=cmasapplid,agentName=cmasname, graphId=plexname.cicsname,  
AggregateNodeName=JOURNAL, functionID=tablename*

### functionID

journalid

### functionType

Application

### ProtocolType

Systems\_Mgmt

### DisplayResourceType

DUIXC\_RTN\_DISK\_JOURNAL DUIXC\_RTN\_SMF\_JOURNAL  
DUIXC\_RTN\_TAPE\_JOURNAL

### DisplayResourceName

journalid

### DisplayStatus

Openoutput = Satisfactory Closed = Unsatisfactory

### memberOf

JOURNAL

### AggregationParent

JOURNAL

### ParentAccess

JOURNAL

### Domain

NonSNADomain

## Program

The Program object can be either an aggregateNode or realNode. The aggregateNode object fields and the values for each are as follows:

### MyName

*systemId=cmasapplid, agentName=cmasname, graphId=plexname.cicsname,  
AggregateNodeName=PROGRAM*

### AggregateNodeName

PROGRAM

### ProtocolType

Systems\_Mgmt

### DisplayResourceType

DUIXC\_RTN\_NODE\_AGG

### DisplayResourceName

PROGRAM

### memberOf

CicsSystem

### member

Program

### AggregationParent

CicsSystem

## MSMODM object fields

**AggregationChild**  
Program

**ParentAccess**  
CicsSystem

**ChildAccess**  
Program

**Domain**  
NonSNADomain

The Program realNode object fields and the values for each are as follows:

**MyName**  
*systemId=cmasapplid, agentName=cmasname, graphId=plexname.cicsname,  
AggregateNodeName=PROGRAM, functionID=tablename*

**functionID**  
*programname*

**functionType**  
Application

**ProtocolType**  
Systems\_Mgmt

**DisplayResourceType**  
DUIXC\_RTN\_PROGRAM'

**DisplayResourceName**  
programname

**DisplayStatus**  
Enabled = Satisfactory Disabled = Unsatisfactory

**memberOf**  
PROGRAM

**AggregationParent**  
PROGRAM

**ParentAccess**  
PROGRAM

**Domain**  
NonSNADomain

## Terminal

The Terminal object can be either an aggregateNode or realNode. The aggregateNode object fields and the values for each are as follows:

**MyName**  
*systemId=cmasapplid, agentName=cmasname, graphId=plexname.cicsname,  
AggregateNodeName=TERMINAL*

**AggregateNodeName**  
TERMINAL

**ProtocolType**  
Systems\_Mgmt

**DisplayResourceType**  
DUIXC\_RTN\_NODE\_AGG

**DisplayResourceName**  
TERMINAL

**memberOf**  
CicsSystem

**member**  
Terminal

**AggregationParent**  
CicsSystem

**AggregationChild**  
Terminal

**ParentAccess**  
CicsSystem

**ChildAccess**  
Terminal

**Domain**  
NonSNADomain

The Terminal realNode has the following attributes:

**MyName**  
*systemId=cmasapplid, agentName=cmasname, graphId=plexname.cicsname,  
AggregateNodeName=TERMINAL, functionID=termid*

**functionID**  
*termid*

**functionType**  
Application

**ProtocolType**  
Systems\_Mgmt

**snaNodeName**  
VTAM<sup>®</sup> Netname

**DisplayResourceType**  
DUIXC\_RTN\_GENERIC\_TERM

**DisplayResourceName**  
*termid*

**DisplayResourceOtherData**  
*Acquired Status(acqstatus)'*

**DisplayStatus**  
Inservice = Satisfactory Outservice = Unsatisfactory

**memberOf**  
TERMINAL

**AggregationParent**  
TERMINAL

**ParentAccess**  
TERMINAL

**Domain**  
NonSNADomain

## MSMODM object fields

### LocalTransaction

The LocalTransaction object can be either an aggregateNode or a realNode. The aggregateNode object fields and the values for each are as follows.

**MyName**

*systemId=cmasapplid, agentName=cmasname, graphId=plexname.cicsname,  
AggregateNodeName=LOCTRAN*

**AggregateNodeName**

LOCTRAN

**ProtocolType**

Systems\_Mgmt

**DisplayResourceType**

DUIXC\_RTN\_NODE\_AGG

**DisplayResourceName**

LOCTRAN'

**memberOf**

CicsSystem

**member**

LocalTransaction

**AggregationParent**

CicsSystem

**AggregationChild**

LocalTransaction

**ParentAccess**

CicsSystem

**ChildAccess**

LocalTransaction

**Domain**

NonSNADomain

The LocalTransaction realNode object fields and the values for each are as follows:

**MyName**

*systemId=cmasapplid, agentName=cmasname, graphId=plexname.cicsname,  
AggregateNodeName=LOCTRAN, functionID=trandid*

**functionID**

*trandid*

**functionType**

Application

**ProtocolType**

Systems\_Mgmt

**DisplayResourceType**

DUIXC\_RTN\_LOCAL\_TRANS

**DisplayResourceName**

*trandid*

**DisplayResourceUserData**

Program(*programname*)

**DisplayStatus**

Enabled = Satisfactory Disabled = Unsatisfactory

**memberOf**

LOCTRAN

**AggregationParent**

LOCTRAN

**ParentAccess**

LOCTRAN

**Domain**

NonSNADomain

**RemoteTransaction**

The RemoteTransaction object can be either an aggregateNode or realNode. The aggregateNode object fields and the values for each are as follows:

**MyName**

*systemId=cmasapplid, agentName=cmasname, graphId=plexname.cicsname, AggregateNodeName=REMTRAN*

**AggregateNodeName**

REMTRAN

**ProtocolType**

Systems\_Mgmt

**DisplayResourceType**

DUIXC\_RTN\_NODE\_AGG

**DisplayResourceName**

REMTRAN

**memberOf**

CicsSystem

**member**

RemoteTransaction

**AggregationParent**

CicsSystem

**AggregationChild**

RemoteTransaction

**ParentAccess**

CicsSystem

**ChildAccess**

RemoteTransaction

**Domain**

NonSNADomain

The RemoteTransaction realNode object fields and the values for each are as follows:

**MyName**

*systemId=cmasapplid, agentName=cmasname, graphId=plexname.cicsname, AggregateNodeName=REMTRAN, functionID=trandid*

## MSMODM object fields

**functionID**  
*tranid*

**functionType**  
Application

**ProtocolType**  
Systems\_Mgmt

**DisplayResourceType**  
DUIXC\_RTN\_REMOTE\_TRANS

**DisplayResourceName**  
*tranid*

**DisplayResourceUserData**  
Remote Name(*rmtname*) CICS(*sysid*)

**DisplayStatus**  
Enabled = Satisfactory Disabled = Unsatisfactory

**memberOf**  
REMTRAN

**AggregationParent**  
REMTRAN

**ParentAccess**  
REMTRAN

**Domain**  
NonSNADomain

## ExtraTdqueue

The ExtraTdqueue object can be either an aggregateNode or realNode. The aggregateNode object fields and the values for each are as follows:

**MyName**  
systemId=*cmasapplid*,agentName=*cmasname*, graphId=*plexname.cicsname*,  
AggregateNodeName=EXTRATDQ

**AggregateNodeName**  
EXTRATDQ

**ProtocolType**  
Systems\_Mgmt

**DisplayResourceType**  
DUIXC\_RTN\_NODE\_AGG

**DisplayResourceName**  
EXTRATDQ

**memberOf**  
CicsSystem

**member**  
ExtraTdqueue

**AggregationParent**  
CicsSystem

**AggregationChild**  
ExtraTdqueue

**ParentAccess**  
CicsSystem

**ChildAccess**  
ExtraTdqueue

**Domain**  
NonSNADomain

The ExtraTdqueue realNode object fields and the values for each are as follows:

**MyName**  
systemId=*cmasapplid*, agentName=*cmasname*, graphId=*plexname.cicsname*,  
AggregateNodeName=EXTRATDQ, functionID=*quename*

**functionID**  
quename

**functionType**  
Application

**ProtocolType**  
Systems\_Mgmt

**DisplayResourceType**  
DUIXC\_RTN\_EXTRAPART\_TDQ

**DisplayResourceName**  
quename

**DisplayResourceOtherData**  
Open Status(*openstatus*)

**DisplayStatus**  
Enabled = Satisfactory Disabled = Unsatisfactory

**memberOf**  
EXTRATDQ

**AggregationParent**  
EXTRATDQ

**ParentAccess**  
EXTRATDQ

**Domain**  
NonSNADomain

## IntraTdqueue

The IntraTdqueue object can be either an aggregateNode or realNode. The aggregateNode object fields and the values for each are as follows:

**MyName**  
systemId=*cmasapplid*, agentName=*cmasname*, graphId=*plexname.cicsname*,  
AggregateNodeName=INTRATDQ

**AggregateNodeName**  
INTRATDQ

**ProtocolType**  
Systems\_Mgmt

**DisplayResourceType**  
DUIXC\_RTN\_NODE\_AGG

## MSMODM object fields

**DisplayResourceName**  
INTRATDQ

**memberOf**  
CicsSystem

**member**  
IntraTdqueue

**AggregationParent**  
CicsSystem

**AggregationChild**  
IntraTdqueue

**ParentAccess**  
CicsSystem

**ChildAccess**  
IntraTdqueue

**Domain**  
NonSNADomain

The IntraTdqueue realNode object fields and the values for each are as follows:

**MyName**  
*systemId=cmasapplid, agentName=cmasname, graphId=plexname.cicsname,  
AggregateNodeName=INTRATDQ, functionID=quename*

**functionID**  
quename

**functionType**  
Application

**ProtocolType**  
Systems\_Mgmt

**DisplayResourceType**  
DUIXC\_RTN\_INTRAPART\_TDQ

**DisplayResourceName**  
quename

**DisplayStatus**  
Enabled = Satisfactory Disabled = Unsatisfactory

**memberOf**  
INTRATDQ

**AggregationParent**  
INTRATDQ

**ParentAccess**  
INTRATDQ

**Domain**  
NonSNADomain

## RemoteTdqueue

The RemoteTdqueue object can be either an aggregateNode or realNode. The aggregateNode object fields and the values for each are as follows:



## MSMODM object fields

**MyName**  
systemId=*cmasapplid*, agentName=*cmasname*, graphId=*plexname.cicsname*,  
AggregateNodeName=REMTDQ

**AggregateNodeName**  
REMTDQ

**ProtocolType**  
Systems\_Mgmt

**DisplayResourceType**  
DUIXC\_RTN\_NODE\_AGG

**DisplayResourceName**  
REMTDQ

**memberOf**  
CicsSystem

**member**  
RemoteTdqueue

**AggregationParent**  
CicsSystem

**AggregationChild**  
RemoteTdqueue

**ParentAccess**  
CicsSystem

**ChildAccess**  
RemoteTdqueue

**Domain**  
NonSNADomain

The RemoteTdqueue realNode object fields and the values for each are as follows:

**MyName**  
systemId=*cmasapplid*, agentName=*cmasname*, graphId=*plexname.cicsname*,  
AggregateNodeName=REMTDQ, functionID=*quename*

**functionID**  
*quename*

**functionType**  
Application

**ProtocolType**  
Systems\_Mgmt

**DisplayResourceType**  
DUIXC\_RTN\_QUEUE

**DisplayResourceName**  
*quename*

**DisplayResourceUserData**  
RemoteName(*rmtname*) RemoteCICS(*sysid*)

**DisplayStatus**  
Enabled = Satisfactory Disabled = Unsatisfactory

**memberOf**  
REMTDQ

## MSMODM object fields

**AggregationParent**

REMTDQ

**ParentAccess**

REMTDQ

**Domain**

NonSNADomain

## GlobalExit

The GlobalExit object can be either an aggregateNode or realNode. The aggregateNode object fields and the values for each are as follows:

**MyName**

*systemId=cmasapplid, agentName=cmasname, graphId=plexname.cicsname, AggregateNodeName=EXITGLUE*

**AggregateNodeName**

EXITGLUE

**ProtocolType**

Systems\_Mgmt

**DisplayResourceType**

DUIXC\_RTIN\_NODE\_AGG

**DisplayResourceName**

EXITGLUE'

**memberOf**

CicsSystem

**member**

GlobalExit

**AggregationParent**

CicsSystem

**AggregationChild**

GlobalExit

**ParentAccess**

CicsSystem

**ChildAccess**

GlobalExit

**Domain**

NonSNADomain

The GlobalExit realNode object fields and the values for each are as follows:

**MyName**

*systemId=cmasapplid, agentName=cmasname, graphId=plexname.cicsname, AggregateNodeName=EXITGLUE, functionID=exitname.programname*

**functionID**

*exitname.programname*

**functionType**

Application

**ProtocolType**

Systems\_Mgmt

**DisplayResourceType**  
DUIXC\_RTN\_UTILITY

**DisplayResourceName**  
exitname.programname

**DisplayStatus**  
Started = Satisfactory Stopped = Unsatisfactory

**memberOf**  
EXITGLUE

**AggregationParent**  
EXITGLUE

**ParentAccess**  
EXITGLUE

**Domain**  
NonSNADomain

## TaskExit

The TaskExit object can be either an aggregateNode or realNode. The aggregateNode object fields and the values for each are as follows:

**MyName**  
*systemId=cmasapplid, agentName=cmasname, graphId=plexname.cicsname, AggregateNodeName=EXITTRUE*

**AggregateNodeName**  
EXITTRUE

**ProtocolType**  
Systems\_Mgmt

**DisplayResourceType**  
DUIXC\_RTN\_NODE\_AGG

**DisplayResourceName**  
EXITTRUE

**memberOf**  
CicsSystem

**member**  
TaskExit

**AggregationParent**  
CicsSystem

**AggregationChild**  
TaskExit

**ParentAccess**  
CicsSystem

**ChildAccess**  
TaskExit

**Domain**  
NonSNADomain

The TaskExit realNode object fields and the values for each are as follows:

## MSMODM object fields

### **MyName**

*systemId=cmasapplid, agentName=cmasname, graphId=plexname.cicsname,  
AggregateNodeName=EXITTRUE, functionID=entryname.programname*

### **functionID**

*entryname.programname*

### **functionType**

Application

### **ProtocolType**

Systems\_Mgmt

### **DisaveyResourceType**

DUIXC\_RTN\_UTILITY

### **DisplayResourceName**

entryname.programname

### **DisplayStatus**

Started = Satisfactory Stopped = Unsatisfactory

### **memberOf**

EXITTRUE

### **AggregationParent**

EXITTRUE

### **ParentAccess**

EXITTRUE

### **Domain**

NonSNADomain

---

## Glossary

This glossary defines CICSplex SM terms and abbreviations used in this book with other than their everyday meaning. Terms that are defined in the *IBM Dictionary of Computing*, New York: McGraw-Hill, 1994, are not defined here unless CICSplex SM usage is different from the meaning given there.

If you cannot find the definition you need, refer to the *Dictionary of Computing* or the *CICSplex SM Master Index*, SC33-1812.

### A

**action command.** A CICSplex SM command that affects one or more of the resources represented in a view. Action commands can be issued from either the COMMAND field in the control area of the information display panel or the line command field in a displayed view. Valid action commands are listed with the description of each view. See also *overtime field*.

**action definition (ACTNDEF).** In real-time analysis, a definition of the type of external notification that is to be issued when the conditions identified in an analysis definition are true.

**activity.** See *BTS activity*.

**adjacent CMAS.** A CICSplex SM address space (CMAS) that is connected to the local CMAS via a direct CMAS-to-CMAS link. Contrast with *indirect CMAS*. See also *local CMAS*.

**alter expression.** A character string that defines the changes to be made to a resource attribute. An alter expression is made up of one or more attribute expressions.

**alternate window.** A window to which the results of a hyperlink can be directed. By default, the results of a hyperlink are displayed in the same window from which the hyperlink is initiated. Contrast with *current window*.

**alternate window (ALT WIN) field.** In the control area of an information display panel, the field in which you can specify an alternate window to receive the results of a hyperlink.

**analysis definition.** In real-time analysis, a definition of the evaluations to be performed on specified CICS resources, the intervals at which those evaluations are to be performed, and the actions to be taken when a notifiable condition occurs.

**analysis group.** In real-time analysis, a group of one or more analysis definitions, status definitions, or both. Analysis definitions and status definitions must belong to an analysis group if they are to be installed automatically in a CICS system when that system starts.

**analysis point monitoring (APM).** In real-time analysis, resource monitoring across multiple CICS systems within a CICSplex that results in a single notification of a condition, rather than one notification for each system. Contrast with *MAS resource monitoring*.

**analysis point specification.** In real-time analysis, a specification that identifies the CMASs that are to be responsible for analysis point monitoring.

**analysis specification.** In real-time analysis, a specification that establishes system availability monitoring or MAS resource monitoring within a group of CICS systems.

**AOR.** Application-owning region.

**API.** Application programming interface

**APM.** Analysis point monitoring.

**application-owning region (AOR).** In a CICSplex configuration, a CICS region devoted to running applications. For dynamic routing, the terms *requesting region*, *routing region*, and *target region* are used instead of AOR to signify the role of the region in the dynamic routing request.

**ARM.** Automatic restart manager.

**ASU.** Automatic screen update.

**attribute.** See *resource attribute*, *resource table attribute*.

**attribute expression.** A reference to a resource table attribute and, in some cases, its value. Attribute expressions are used to build filter expressions, modification expressions, and order expressions.

**attribute value.** The data currently associated with a resource table attribute. For example, the file attribute OPENSTATUS might have a value of CLOSED.

**automatic restart manager (ARM).** A recovery function of MVS/ESA 5.2 that provides improved availability for batch jobs and started tasks by restarting them automatically if they end unexpectedly. The affected batch job or started task can be restarted on the same system or on a different one, if the system itself has failed.

**automatic screen update (ASU).** A CICSplex SM facility that automatically updates the data in all unlocked windows at user-defined intervals. See also *automatic screen update interval*.

**automatic screen update interval.** The time interval between one automatic screen update and the next. This interval can be set in the CICSplex SM user profile or when the ASU facility is turned on. See also *automatic screen update (ASU)*.

## B

**BAS.** Business Application Services

**batched repository-update facility.** A CICSplex SM facility, invoked from the CICSplex SM end user interface, for the bulk application of CICSplex SM definitions to a CMAS data repository.

**BTS.** CICS business transaction services

**BTS activity.** One part of a process managed by CICS BTS. Typically, an activity is part of a *business transaction*.

**BTS process.** A collection of more than one CICS BTS activities. Typically, a process is an instance of a *business transaction*.

**BTS set.** See CICS system group

**business application.** Any set of CICS resources that represent a meaningful entity to an enterprise or a user (such as, Payroll).

**Business Application Services (BAS).** The component of CICSplex SM that provides the ability to define and manage business applications in terms of their CICS resources and associated CICS systems. BAS provides a central definition repository for CICS systems, complete with installation facilities and the ability to restrict a CICSplex SM request to those resources defined as being part of the business application. See also *business application, scope*.

**business transaction.** A self-contained business function, for example, the booking of an airline ticket.

## C

**CAS.** Coordinating address space.

**CBIPO.** Custom-built installation process offering.

**CBPDO.** Custom-built product delivery offering.

**CEDA.** A CICS transaction that defines resources online. Using CEDA, you can update both the CICS system definition data set (CSD) and the running CICS system.

**CICS Business Transaction Services (BTS).** A CICS domain that supports an application programming interface (API) and services that simplify the development of *business transactions*.

**CICS system.** The entire collection of hardware and software required by CICS. In CICSplex SM topology, a definition referring to a CICS system that is to be managed by CICSplex SM. See also *CICSplex, CICS system group*.

**CICS system group.** A set of CICS systems within a CICSplex that can be managed as a single entity. In CICSplex SM topology, the user-defined name, description, and content information for a CICS system group. A CICS system group can be made up of CICS systems or other CICS system groups. In CICS business transaction services (BTS), a BTS set, that is the set of CICS regions across which BTS processes and activities may execute. See also *CICSplex, CICS system*.

**CICSplex.** A CICS complex. A CICSplex consists of two or more CICS regions that are linked using CICS intercommunication facilities. The links can be either intersystem communication (ISC) or interregion communication (IRC) links, but within a CICSplex are more commonly IRC. Typically, a CICSplex has at least one terminal-owning region (TOR), more than one application-owning region (AOR), and may have one or more regions that own the resources being accessed by the AORs. In CICSplex SM, a management domain. The largest set of CICS regions, or CICS systems, to be manipulated by CICSplex SM as a single entity. CICS systems in a CICSplex being managed by CICSplex SM do not need to be connected to each other. See also *CICS system, CICS system group*.

**CICSplex SM.** IBM CICSplex System Manager.

**CICSplex SM address space (CMAS).** A CICSplex SM component that is responsible for managing CICSplexes. A CMAS provides the single-system image for a CICSplex by serving as the interface to other CICSplexes and external programs. There must be at least one CMAS in each MVS image on which you are running CICSplex SM. A single CMAS can manage CICS systems within one or more CICSplexes. See also *coordinating address space (CAS), managed application system (MAS)*.

**CICSplex SM token.** Unique, 4-byte values that CICSplex SM assigns to various elements in the API environment. Token values are used by CICSplex SM to correlate the results of certain API operations with subsequent requests.

**client program.** In dynamic routing, the application program, running in the *requesting region*, that issues a remote link request.

**CMAS.** CICSplex SM address space.

**CMAS link.** A communications link between one CICSplex SM address space (CMAS) and another CMAS or a remote managed application system (remote MAS). CMAS links are defined when CICSplex SM is configured.

**CODB.** A CICSplex SM transaction for interactive, system-level debugging of CMASs and of CICS/ESA, CICS/MVS, and CICS/VSE MASs. CODB must be used only at the request of customer support personnel.

**COD0.** A CICSplex SM transaction for interactive, method-level debugging of CMASs and of CICS/ESA, CICS/MVS, CICS/VSE, and CICS for OS/2 MASs. COD0 must be used only at the request of customer support personnel.

**COLU.** A CICSplex SM transaction for generating reports about CMAS and local MAS components. COLU must be used only at the request of customer support personnel.

**COMMAND field.** In the control area of an information display panel, the field that accepts CICSplex SM, ISPF, and TSO commands. Contrast with *option field*.

**command-level interface.** A CICSplex SM API interface that uses the CICS translator to translate EXEC CPSM statements into an appropriate sequence of instructions in the source language.

**Common Services.** A component of CICSplex SM that provides commonly requested services (such as GETMAIN, FREEMAIN, POST, and WAIT processing) to other CICSplex SM components.

**communication area (COMMAREA).** A CICS area that is used to pass data between tasks that communicate with a given terminal. The area can also be used to pass data between programs within a task.

**Communications.** A component of CICSplex SM that provides all services for implementing CMAS-to-CMAS and CMAS-to-MAS communication.

**context.** A named part of the CICSplex SM environment that is currently being acted upon by CICSplex SM. For configuration tasks, the context is a CICSplex SM address space (CMAS); for all other tasks, it is a CICSplex. See also *scope*.

**control area.** The top three lines of an information display panel, containing the panel title, the screen update time, the short message area, the COMMAND and SCROLL fields, and the current window (CUR WIN) and alternate window (ALT WIN) fields.

**coordinating address space (CAS).** An MVS subsystem that provides ISPF end-user access to the CICSplex to be accessed. See also *CICSplex SM address space, managed application system (MAS)*.

**coordinating address space subsystem ID.** Identifies the coordinating address space (CAS) which can be up to 4 characters, to be connected to when issuing CICSplex SM requests. The name of the CAS is installation-dependent, and is defined in the CICSplex SM user profile.

**cross-system coupling facility (XCF).** XCF is a component of MVS that provides functions to support cooperation between authorized programs running within a sysplex.

**current window.** The window to which the results of all commands issued in the COMMAND field are directed, unless otherwise requested. Contrast with *alternate window*.

**current window (CUR WIN) field.** In the control area of an information display panel, the field that contains the window number of the current window. You can change the number in this field to establish a new current window.

**custom-built installation process offering (CBIPO).** A product that simplifies the ordering, installation, and service of MVS system control programs and licensed programs by providing them with current updates and corrections to the software that is already integrated.

**custom-built product delivery offering (CBPDO).** A customized package of both products and service, or of service only, for MVS system control programs and licensed programs.

## D

**Data Cache Manager.** A component of CICSplex SM that manages logical cache storage for use by other CICSplex SM components.

**data repository.** In CICSplex SM, the VSAM data set that stores administrative data, such as topology and monitor definitions, for a CICSplex SM address space (CMAS).

**Data Repository.** A component of CICSplex SM that provides methods for creating, accessing, updating, and deleting data in the CICSplex SM data repository. See also *Managed Object Services*.

**Database Control (DBCTL).** An IMS/ESA facility providing an interface between CICS/ESA and IMS/ESA that allows access to IMS DL/I full-function databases and to data-entry databases (DEDBs) from one or more CICS/ESA systems.

**Database 2 (DB2).** An IBM licensed program. DB2 is a full-function relational database management system that presents a data structure as a table consisting of a number of rows (or records) and a number of columns.

**DBCTL.** Database Control.

**DB2.** Database 2.

**derived field.** On a monitor view, a field whose value does not come directly from CICS or CICSplex SM data, but is calculated based on the values in other fields. See also *derived value*.

**derived value.** A rate, average, or percentage that results from CICSplex SM processing of CICS statistics.

**display area.** On an information display panel, the area where windows can be opened to display data. The display area appears below the control area. The bottom two lines of the display area can be used to display the PF key assignments in effect for a CICSplex SM session.

**display attributes.** A CICSplex SM user profile option that controls the appearance of the window information line, field headings, and threshold values in a view.

**display command.** A CICSplex SM command that extends the ISPF interface to create and control a multiwindow environment.

**distributed program link (DPL).** Function of CICS intersystem communication that enables CICS to ship LINK requests between CICS regions.

**distributed routing program (DSRTPGM).** A CICS-supplied user-replaceable program that can be used to dynamically route:

- CICS BTS processes and activities
- Transactions started by non-terminal related EXEC CICS START commands

**DPL.** Distributed program link.

**DTR.** Dynamic transaction routing.

**dynamic routing.** The automatic routing of a transaction or program, at the time it is initiated, from a requesting region to a suitable target region. Routing terminal data to an alternative transaction at the time the transaction is invoked. To do this, CICS allows the dynamic routing program to intercept the terminal data and redirect it to any system and transaction it chooses. See also dynamic routing program (EYU9XLOP)

**dynamic routing program (EYU9XLOP).** A user-replaceable CICS program that selects dynamically both the system to which a routing request is to be sent and the transaction's remote name. The alternative to using this program is to make these selections when a remote transaction is defined to CICS (static routing). See also *static routing*

**dynamic transaction routing (DTR).** The automatic routing of a transaction, at the time it is initiated, from a transaction-owning region (TOR) to a suitable application-owning region (AOR).

## E

**Environment Services System Services (ESSS).** A component of CICSplex SM that implements the formal MVS/ESA subsystem functions required by the product. ESSS provides cross-memory services, data space management, connection services, and lock management. An ESSS system address space is created at CICSplex SM initialization and remains in the MVS image for the life of the IPL.

**ESSS.** Environment Services System Services.

**evaluation definition.** In real-time analysis, a definition of the resources that are to be sampled. When the result of an evaluation is true, an associated analysis definition is used to determine whether a notifiable condition has occurred.

**event.** A significant occurrence within the CICSplex or system for which the user has requested notification. For example, the end of processing, a subsystem failure, or any unusual condition in the system could be defined by a user as an event.

**event notification.** A CICSplex SM notification of a significant occurrence within a CICSplex or CICS system.

**extended diagnostic mode (XDM).** A CICSplex SM online internal diagnostic facility. XDM provides no information about resources managed by CICSplex SM, and should be turned on only at the request of IBM customer support personnel. XDM can be turned on and off in the CICSplex SM user profile.

**external notification.** In RTA, an event notification, generic alert, or operator message issued when a notifiable condition occurs.

## F

**file-owning region.** In a CICSplex configuration, a CICS system devoted to managing CICS file access.

**filter expression.** A character string that consists of logical expressions to be used in filtering resource table records. A filter expression is made up of one or more attribute expressions.

**FOR.** File-owning region.

**form.** The way in which data obtained from a query is presented in a view. See also *query, view*.

## G

**generic alert.** A Systems Network Architecture (SNA) Network Management Vector that enables a product to signal a problem to the network. CICSplex SM uses generic alerts as part of its interface to NetView.



**GMFHS.** Graphic Monitor Facility host subsystem.

**goal algorithm.** In CICSplex SM's workload balancing, an algorithm used to select an AOR to process a dynamic transaction. Using the goal algorithm, CICSplex SM selects the AOR that is the least affected by conditions such as short-on-storage, SYSDUMP, and TRANDUMP; is the least likely to cause the transaction to abend; and is most likely to enable the transaction to meet response-time goals set for it using the Workload Manager component of MVS/ESA SP 5.1. Contrast with *queue algorithm*.

**Graphic Monitor Facility host subsystem.** A NetView feature that manages configuration and status updates for non-SNA resources.

## H

**hyperlink.** A direct connection between the data in one CICSplex SM view and a view containing related information. For example, from a view that lists multiple CICS resources, there may be a hyperlink to a detailed view for one of the resources. To use a hyperlink, place the cursor in the data portion of a hyperlink field and press Enter.

**hyperlink field.** On a CICSplex SM view, a field for which a hyperlink is defined. The headings of hyperlink fields are shown in high intensity or color, depending on the terminal type.

## I

**IBM CICSplex System Manager for MVS/ESA (CICSplex SM).** An IBM CICS system-management product that provides a single-system image and a single point of control for one or more CICSplexes that can be installed on heterogeneous operating systems.

**indirect CMAS.** A CICSplex SM address space (CMAS) that the local CMAS can communicate with via an adjacent CMAS. There is no direct CMAS-to-CMAS link between the local CMAS and an indirect CMAS. Contrast with *adjacent CMAS*. See also *local CMAS*.

**information display panel.** The panel that supports the CICSplex SM window environment. It consists of a control area and a display area. CICSplex SM views are displayed in windows within the display area of this panel.

**information display parameters.** A CICSplex SM user profile option that defines the initial screen configuration, how frequently the screen will be updated by ASU, and how long a window will wait for command processing to complete before timing out.

**installation verification procedure (IVP).** A procedure distributed with a system that tests the newly

generated system to verify that the basic facilities of the system are functioning correctly.

**interregion communication.** Synonym for *multiregion operation*.

**intersystem communication (ISC).** Communication between separate systems by means of SNA networking facilities or by means of the application-to-application facilities of an SNA access method.

**intertransaction affinity.** A relationship between CICS transactions, usually the result of the ways in which information is passed between those transactions, that requires them to execute in the same CICS region. Intertransaction affinity imposes restrictions on the dynamic routing of transactions.

**IRC.** Interregion communication.

**ISC.** Intersystem communication.

**IVP.** Installation verification procedure.

## K

**Kernel Linkage.** A component of CICSplex SM that is responsible for building data structures and managing the interfaces between the other CICSplex SM components. The environment built by Kernel Linkage is known as the method call environment.

## L

**line command field.** In a CICSplex SM view, the 3 character field, to the left of the data, that accepts action commands.

**local CMAS.** The CICSplex SM address space (CMAS) that a user identifies as the current context when performing CMAS configuration tasks.

**local MAS.** A managed application system (MAS) that resides in the same MVS image as the CICSplex SM address space (CMAS) that controls it and that uses the Environment Services System Services (ESSS) to communicate with the CMAS.

**logical scope.** A set of logically related CICS resources that are identified in a CICSplex SM resource description. A logical scope can be used to qualify the context of a CICSplex SM request.

## M

**maintenance point.** A CICSplex SM address space (CMAS) that is responsible for maintaining CICSplex SM definitions in its data repository and distributing them to other CMASs involved in the management of a CICSplex. See also *data repository*.

**Major object descriptor block (MODB).** In CICSplex SM, a control structure built by Kernel Linkage during initialization of a CICSplex SM component that contains a directory of all methods that make up that component. The structure of the MODB is the same for all components.

**Major object environment block (MOEB).** In CICSplex SM, a control structure built by Kernel Linkage during initialization of a CICSplex SM component and pointed to by the MODB. The MOEB stores information critical to a CICSplex SM component and anchors data used by the component. The structure of the MOEB is unique to the component it supports.

**MAL.** Message argument list.

**managed application system (MAS).** A CICS system that is being managed by CICSplex SM. See *local MAS*, *remote MAS*.

**managed object.** A CICSplex SM-managed CICS resource or a CICSplex SM definition represented by a resource table. A view is based on a single managed object.

**Managed Object Services.** A subcomponent of the Data Repository component of CICSplex SM that translates a request for data (from real-time analysis, for example) into the method calls required to obtain the data.

**MAS.** Managed application system.

**MAS agent.** A CICSplex SM component that acts within a CICS system to provide monitoring and data collection for the CICSplex SM address space (CMAS). The level of service provided by a MAS agent depends on the level of CICS the system is running under and whether it is a local or remote MAS. See also *CICSplex SM address space (CMAS)*, *local MAS*, *remote MAS*.

**MAS resource monitoring (MRM).** In real-time analysis, resource monitoring at the CICS system level; it results in one notification of a condition for each system in which it occurs. If the same condition occurs in three CICS systems where MAS resource monitoring is active, three notifications are issued. Contrast with *analysis point monitoring*.

**Message argument list (MAL).** In CICSplex SM, a data structure passed between methods using Kernel Linkage method call services.

**message line.** On an information display panel, the line in the control area where a long message appears when the HELP command is issued in response to a short message. The message line temporarily overlays the CURR WIN and ALT WIN fields.

**Message Services.** A component of CICSplex SM that provides services for building and issuing MVS/ESA console messages to other CICSplex SM components.

**meta-data.** Internal data that describes the structure and characteristics of CICSplex SM managed objects.

**method.** (Action.) An application programming interface (API) instruction that resolves into an EXEC CICS command, issued against one or more resources in one or more CICS systems, within the current context and scope.

**method.** In CICSplex SM, one of the programs that make up a CICSplex SM component. See also *message argument list (MAL)*.

**mirror transaction.** CICS transaction that recreates a request that is function shipped from one system to another, issues the request on the second system, and passes the acquired data back to the first system.

**MODB.** Major object descriptor block.

**modification expression.** A character string that defines the changes to be made to a resource attribute. A modification expression is made up of one or more attribute expressions.

**MOEB.** Major object environment block.

**monitor definition.** A user-defined statement of the specific resource occurrences (such as the program named PAYROLL) to be monitored by CICSplex SM. A monitor definition can either be linked to a monitor specification as part of a monitor group or be installed directly into an active CICS system. See also *monitor group*, *monitor specification*.

**monitor group.** A user-defined set of CICSplex SM monitor definitions that can either be linked to a monitor specification for automatic installation or be installed directly into an active CICS system. See also *monitor definition*, *monitor specification*.

**monitor interval.** The number of minutes that are to elapse before the statistics counters containing accumulated resource monitoring data are automatically reset. This value is part of a CICSplex definition and affects all of the CICS systems and CICS system groups associated with that CICSplex. See also *period definition*, *sample interval*.

**monitor specification.** A user-defined statement of the types of resources (such as programs) to be monitored by CICSplex SM and how often data should be collected. A monitor specification is associated with a CICS system and is automatically installed each time the CICS system starts up. See also *monitor definition*, *monitor group*.

**Monitoring Services.** A component of CICSplex SM that is responsible for monitoring resources within a

CICS system and making the collected data available to other CICSplex SM components.

**MRM.** MAS resource monitoring.

**MRO.** Multiregion operation.

**MSM.** MultiSystem Manager.

**multiregion operation (MRO).** Communication between CICS systems without the use of SNA network facilities. Synonymous with *interregion communication*.

**MultiSystem Manager.** An object-oriented, graphical systems management application that runs under NetView for MVS.

**MVS image.** A single instance of the MVS operating system.

**MVS system.** An MVS image together with its associated hardware.

## N

**NetView.** An IBM network management product that can provide rapid notification of events and automated operations. CICSplex SM can be set up to send generic alerts to NetView as part of its event processing capabilities.

**NetView Graphic Monitor Facility (NGMF).** A function of the NetView program that provides the network operator with a graphic topological presentation of a network controlled by the NetView program and that allows the operator to manage the network interactively.

**NetView program.** An IBM licensed program used to monitor and manage a network and to diagnose network problems.

**NGMF.** NetView Graphic Monitor Facility.

**notification.** A message that is generated asynchronously by a CICSplex SM managed object to describe an event related to the object.

## O

**option field.** On a CICSplex SM menu, the field in which you can specify an option number or letter. Contrast with *command field*.

**order expression.** A character string that defines either the attributes to be used in sorting resource table records, or the attributes to be included in a resource table view. An order expression is made up of one or more attribute expressions.

**override expression.** A character string that defines the changes to be made to a resource attribute. An override expression is made up of one or more attribute expressions.

**overtyping field.** On a CICSplex SM view, a field containing a value that can be changed by typing a new value directly into the field. Values that can be overtyped are shown in high intensity or color, depending on the terminal type. Acceptable values for overtype fields are listed with the description of each view. See also *action command*.

## P

**parameter expression.** A character string that defines the parameters required for an action to complete or a definition to be processed.

**parameter repository.** In CICSplex SM, a data set that stores cross-system communication definitions that allow one coordinating address space (CAS) to communicate with other CASs.

**period definition.** A user-defined range of hours and minutes and the time zone to which that range applies. A period definition is used to indicate when an action, such as resource monitoring, is to occur. See also *monitor interval*, *sample interval*.

**PlexManager.** A service utility that can be used to manage the communication connections between multiple coordinating address spaces (CASs) and between a CAS and its associated CICSplex SM address spaces (CMASs) and CICSplexes.

**process.** See *BTS process*

**processing thread.** A connection between an application program and the CICSplex SM API. A program can establish multiple processing threads, but each one is considered a unique API user; no resources can be shared across the boundary of a thread.

**pseudoconversation.** A CICS application designed to appear to the user as a continuous conversation, but that consists internally of multiple separate tasks.

## Q

**query.** A request for specific data that is generated by a view command. See also *form*, *view*.

**queue algorithm.** In CICSplex SM's workload balancing, an algorithm used to select an AOR to process a dynamic transaction. Using the queue algorithm, CICSplex SM selects the AOR that has the shortest queue of transactions (normalized to MAXTASKs) waiting to be processed; is the least affected by conditions such as short-on-storage,

SYSDUMP, and TRANDUMP; and is the least likely to cause the transaction to abend. Contrast with *goal algorithm*.

**Queue Manager.** A component of CICSplex SM that creates and manages queues of data in a cache that is shared by a CMAS and its local MASs.

## R

**RACF.** Resource Access Control Facility.

**real-time analysis (RTA).** A component of CICSplex SM that is responsible for monitoring the status of a CICS system or resource against its desired status, and issuing one or more external notifications when deviations occur.

**record pointer.** An internal indicator of the next resource table record to be processed in a result set.

**related scope.** A CICS system where resources defined to CICSplex SM as remote should be assigned and, optionally, installed as local resources. See also *target scope*.

**remote MAS.** A managed application system (MAS) that uses MRO or LU 6.2 to communicate with the CICSplex SM address space (CMAS) that controls it. A remote MAS may or may not reside in the same MVS image as the CMAS that controls it.

**requesting region.** The region in which a dynamic routing request originates. For dynamic transaction routing and inbound client dynamic program link requests, this is typically a TOR; for dynamic START requests and peer-to-peer dynamic program link requests, this is typically an AOR.

**resource.** Any physical or logical item in a CICS system, such as a transient data queue, a buffer pool, a file, a program, or a transaction.

**Resource Access Control Facility (RACF).** An IBM licensed program that provides for access control by identifying and verifying the users to the system, authorizing access to protected resources, logging any detected unauthorized attempts to enter the system, and logging the detected accesses to protected resources.

**resource assignment.** A user-defined statement that selects resource definitions to be assigned to CICS systems and, optionally, specifies resource attributes to override those definitions. A resource assignment applies to a single resource type and must be associated with a resource description. See also *resource definition*, *resource description*.

**resource attribute.** A characteristic of a CICS resource, such as the size of a buffer pool.

**resource definition.** In CICSplex SM, a user-defined statement of the physical and operational characteristics of a CICS resource. Resource definitions can be associated with resource descriptions as part of a resource group. See also *resource description*, *resource group*.

**resource description.** A user-defined set of CICSplex SM resource definitions that can be automatically installed in CICS systems and named as a logical scope for CICSplex SM requests. Resource descriptions represent the largest set of CICS resources that can be managed by CICSplex SM as a single entity. A resource description can be associated with one or more resource assignments. See also *logical scope*, *resource assignment*, *resource definition*.

**resource group.** A user-defined set of CICSplex SM resource definitions. A resource group can be associated with resource descriptions either directly or by means of resource assignments. See also *resource assignment*, *resource definition*, *resource description*.

**Resource Object Data Manager (RODM).** A component of the NetView program that operates as a cache manager and that supports automation applications. RODM provides an in-memory cache for maintaining real-time data in an address space that is accessible by multiple applications.

**resource table.** The external representation of a CICSplex SM managed object. A resource table defines all the attributes, or characteristics, of a managed object.

**resource table attribute.** A characteristic of a CICSplex SM managed object, as represented by a field in a resource table.

**resource type.** A group of related resources, such as files.

**result set.** A logical group of resource table records that can be accessed, reviewed, and manipulated by an API program.

**retention period.** For a monitored CICS system, the period of time for which monitor data is retained after the system becomes inactive. If a system is being monitored, becomes inactive, and remains inactive beyond the specified retention period, the monitor data is discarded. If the system becomes active before the retention period expires, the monitor data gathered before the system became inactive is retained, and monitoring continues.

**RODM.** Resource Object Data Manager.

**routing region.** The region in which the decision is made as to which is the most suitable target region for a dynamic routing request. For dynamic transaction routing, dynamic terminal-related START requests, and inbound client dynamic program link requests, this is

typically a TOR; for non-terminal-related START requests, dynamic peer-to-peer program link requests, and CICS BTS activities, this is typically an AOR.

**RTA.** real-time analysis.

**run-time Interface.** A CICSplex SM API interface that accepts commands in the form of text strings and generates the appropriate API calls. The run-time interface supports programs written as REXX EXECs.

## S

**SAM.** System availability monitoring.

**sample interval.** The duration, in seconds, between occurrences of data collection for a specific resource type. See also *monitor interval, period definition, resource type*.

**scope.** A named part of the CICSplex SM environment that qualifies the context of a CICSplex SM request. The scope can be the CICSplex itself, a CICS system, a CICS system group, or any set of CICS resources that are defined as a logical scope in a CICSplex SM resource description. For configuration tasks, where the context is a CICSplex SM address space (CMAS), the scope is ignored. When you are applying security, scope must be a single CICS system or CICSplex. It cannot be a CICS system group or any combination of individual CICSplexes or CICS systems. See also *context, logical scope*.

**screen configuration.** A user-defined, named layout of windows and the context, scope, view, and sort order associated with each. The initial configuration to be displayed when CICSplex SM is accessed can be identified on the user profile.

**screen repository.** In CICSplex SM, a data set that stores screen configuration definitions created by the SAVESCR display command. See also *screen configuration*.

**selection list.** In CICSplex SM, a data set that stores cross-system communication definitions that allow one coordinating address space (CAS) to communicate with other CASs.

**selection list.** A list of named items, such as views or screen configurations, from which one can be selected.

**server program.** In dynamic routing, the application program specified on the link request, and which is executed in the *target region*.

**service point.** One of the combinations of products and contexts that is known to the coordinating address space (CAS) to which you are connected. See also *context*.

**session control parameters.** A CICSplex SM user profile option that sets the coordinating address space

(CAS) subsystem ID used for accessing CICSplex SM views and controls the extended diagnostic mode (XDM).

**short message area.** In the control area of an information display panel, that part of the title line that displays short messages.

**single point of control.** The ability to access and manage all CICS systems and their resources in a CICSplex from a single terminal or user session.

**single system image.** The collection and presentation of data about multiple CICS systems as though they were a single CICS system. In CICSplex SM, the single-system image is provided by the CICSplex SM address space (CMAS).

**specification.** See *analysis specification, monitor specification, workload specification*.

**Starter Set.** A part of CICSplex SM comprising sample CICSplex SM definitions and sample JCL. The Starter Set samples may be used as supplied for educational purposes. They may also be copied and adapted for the customer environment.

**static routing.** Non-dynamic routing. The routing request is routed to a predetermined system. Static transaction routing occurs when NO is specified in the Dynamic field in either the transaction definition or the program definition. In both cases, the request is routed to the system named in the Remote Sysid field.

**status definition.** In real-time analysis, a definition of a user-written program to be invoked at specified intervals to evaluate the status of a non-CICS resource.

**summarized result set.** A special type of result set that is produced by grouping, or summarizing, the resource table records in a result set. See also *result set*.

**summary expression.** A character string that consists of one or more summary options and the resource table attributes to which they apply. See also *summary option*.

**summary option.** A value that indicates how the attribute values in a resource table are to be summarized.

**sysplex.** A set of MVS systems communicating and cooperating with each other through specific multisystem hardware components and software services to process customer workloads.

**system availability monitoring (SAM).** In real-time analysis, the monitoring of CICS systems to determine whether: they are active during their defined hours of operation; they are experiencing a short-on-storage, SYSDUMP, TRANDUMP, MAXTASK, or STALL condition. If a CICS system becomes inactive or one of the specified conditions occurs, an external notification is issued.

**system image.** The representation of a program and its related data as it exists in main storage.

## T

**target region.** The region selected from a set of target regions as the most suitable region in which to execute the work request. For all dynamic routing requests, this is typically an AOR.

**target scope.** A CICS system or CICS system group where resources defined to CICSplex SM should be assigned and, optionally, installed. See also *related scope*.

**temporary maintenance point.** A CICSplex SM address space (CMAS) that serves as the maintenance point when the identified maintenance point is unavailable. See also *maintenance point*.

**terminal-owning region.** In a CICSplex configuration, a CICS region devoted to managing the terminal network. For dynamic routing, the terms *requesting region* and *routing region* are used instead of TOR to signify the role of the region in the dynamic routing request.

**thread.** See *processing thread*.

**time-period definition.** A user-defined range of hours and minutes, and the time zone to which that range applies. A time-period definition is used to indicate when an action, such as resource monitoring, is to occur.

**token.** See *CICSplex SM token, user token*.

**topology.** An inventory of CICS and CICSplex SM resources, and a map of their relationships. CICSplex SM supports the definition of resource and system topology.

**topology definition.** A named subset of CICS and CICSplex SM resources. Topology definitions are user-created and can include CICSplexes, CICS systems, and CICS system groups.

**Topology Services.** A component of CICSplex SM that is responsible for maintaining topology information about CICSplexes and resources, and making it available to other CICSplex SM components.

**TOR.** Terminal-owning region.

**Trace Services.** A component of CICSplex SM that provides other CICSplex SM components with the ability to write trace records to the CICS trace table and trace data sets. Trace Services also writes trace records created by a MAS to the trace table and data set of the managing CMAS.

**transaction group.** A user-defined, named set of transactions that determines the scope of workload balancing and the affinity relationships between transactions.

## U

**user token.** Unique, 1- to 4-byte values that an API user can assign to asynchronous requests. User token values are not used by CICSplex SM; they are simply held until the request is complete and then returned to the user.

## V

**view.** In the CICSplex SM API, a temporary, customized form of a resource table. A view can consist of some or all of the resource table attributes in any order. In the CICSplex SM ISPF end-user interface, a formatted display of selected data about CICS resources or CICSplex SM definitions. The data in a view is obtained from a query and can be presented in one or more forms. The data can be limited to a subset of CICSplex resources or definitions by establishing a context and scope.

**view command.** A CICSplex SM command that displays a view in a window of the display area. The name of the view displayed matches the name of the view command. See also *view*.

## W

**window.** In CICSplex SM, a subdivision of the display area. The results of any CICSplex SM view or display command are directed to a single window, which is the current window by default. Contrast with *view*. See also *current window, alternate window*.

**window identifier.** On a window information line, the field that identifies the window. A window identifier consists of a one-character status code and a number in the range 1 through 20.

**window information line.** The top line of each window in the display area. It includes the window identifier, the name of the view displayed in the window, the context and scope in effect, the date and time when the view was last refreshed, and the product name.

**window number.** A number assigned by CICSplex SM to a window when it is opened. The window number is the second part of the window identifier on the window information line.

**window status code.** A one-character code that indicates whether a window is ready to receive commands, is busy processing commands, is not to be updated, or contains no data. It also indicates when an

error has occurred in a window. The window status code is the first character of the window identifier on the window information line.

**WLM.** Workload Manager.

**workload.** The total number of transactions that a given CICSplex is intended to process in a specific period. For example, a workload could be expressed as a number of transactions per hour, or per day. In CICSplex SM, a named set of transactions and CICS systems, acting as requesting regions, routing regions, and target regions that form a single, dynamic entity.

**workload balancing.** The technique of balancing a workload across multiple target regions that are capable of processing the work.

**workload definition.** A user-defined statement of the transaction groups associated with a CICS system that is an AOR. A workload definition can either be linked to a workload specification as part of a workload group or be installed directly into an active workload. See also *workload group*, *workload specification*.

**workload group.** A user-defined set of CICSplex SM workload definitions that can either be linked to a workload specification for automatic installation or be installed directly into an active workload. See also *workload definition*, *workload specification*.

**Workload Manager (WLM).** A component of CICSplex SM that is responsible for managing the transaction workload in a CICSplex through the use of dynamic transaction routing.

**workload separation.** The technique of separating a workload into discrete parts, and allocating specific transactions to specific AORs.

**workload specification.** A user-defined statement that identifies a workload and a set of CICS systems acting as AORs. A workload specification also provides default management criteria for transactions that are not defined to CICSplex SM. It is associated with a CICS system that is a TOR and is automatically installed each time the CICS system starts up. See also *workload definition*, *workload group*.

## X

**XCF.** Cross-system coupling facility of MVS/ESA.

**XDM.** Extended diagnostic mode





---

# Index

## A

- accessing views
  - for real-time analysis 25
  - for resource monitoring 145
- action command
  - summary by view
    - ACTNDEF 26
    - APCMAS 29
    - APSPEC 30
    - EVALDEF 33
    - MONDEF 146
    - MONGROUP 152
    - MONINGRP 157
    - MONINSPC 159
    - MONSCOPE 161
    - MONSPEC 164
    - RTADEF 43
    - RTAGROUP 49
    - RTAINAPS 55
    - RTAINGRP 57
    - RTAINSPC 60
    - RTASCOPE 62
    - RTASPEC 65
    - STATDEF 70
- action definition
  - creating 27
  - removing 26
  - updating description of 27
- activating real-time analysis 67
- activating resource monitoring 129
- ACTNDEF view 26
- administration menu
  - real-time analysis 25
  - resource monitoring 145
- administration views
  - real-time analysis 25
  - resource monitoring 145
- alerts to NetView
  - requesting 28
  - structure of 193
- analysis and status definitions in analysis groups 57
- analysis definition
  - adding association to an analysis group 46
  - creating 44
  - installing 47
  - installing into an analysis point 48
  - removing 44
  - updating description of 44
- analysis group
  - adding association to analysis point specifications 51
  - adding association to analysis specifications 52
  - creating 51
  - in analysis point specifications 55
  - in analysis specifications 60
  - installing 53
  - installing into an analysis point 54
  - removing 50

- analysis point specification
  - adding association with CMAS 32
  - CMAS association 29
  - creating 32
- analysis specification
  - adding scope 68
  - associated scopes 62
  - creating 67
  - removing 66
  - updating 66
- APACTV view 75
- APCMAS view 29
- APSPEC view 30
- ARM restart, requesting 29
- associating objects
  - analysis definition with analysis group 46
  - analysis group with analysis point specification 51
  - analysis group with analysis specification 52
  - monitor definition with monitor group 150, 158
  - monitor group with monitor specification 154, 160
  - scope
    - to monitor specification 168

## B

- browsing objects
  - action definition 26
  - analysis definition 43
  - analysis specification 66
  - evaluation definition 34
  - monitor specification 165
  - status definition 70

## C

- CICS system
  - resource monitoring association
    - adding 168
    - changing 162
    - displaying 161
    - removing 164
- CICS system group
  - resource monitoring association
    - adding 168
    - changing 162
    - displaying 161
    - removing 164
- CICSplex
  - monitor interval
    - description of 130
    - when retaining data 133
  - monitoring resources 127
- CICSplex SM
  - comparison with CICS monitoring 133

- CICSplex SM (*continued*)
  - statistics collection 132
- collect statistics (CICS command) 132
- creating objects
  - action definition 27
  - analysis definition 44
  - analysis group 51
  - analysis point specification 32
  - analysis specification 67
  - evaluation definition 35
  - monitor definition 147
  - monitor definition to group link 150
  - monitor group 154
  - monitor group to specification link 154
  - monitor specification 166
  - status definition 71

## D

- definition views
  - APACTV 75
  - EVENT 78
  - EVENTD 79
  - EVENTDTD 80
  - EVENTDTL 80
  - MONACTV 171
  - RTAACTV 81
- derived value
  - description of 132
- discarding monitor definitions 173
- displaying objects
  - action definitions 26
  - analysis definitions 43
  - analysis groups 49
    - associated with analysis definitions 57
    - associated with analysis point specifications 55
    - associated with status definitions 57
  - analysis point specifications 30
    - associated with CMAS 29
  - analysis specifications 65
    - associated with analysis groups 60
  - evaluation definitions 33
  - monitor definitions 145
    - associated with monitor groups 156
  - monitor groups 152
    - associated with monitor specifications 159
  - monitor specifications 164
  - scope
    - for analysis specifications 62
    - for monitor specifications 161

## E

- EVALDEF view 33
- evaluation definition
  - creating 35
  - removing 34
  - updating the description of 34
- EVENT view 78
- EVENTD view 79
- EVENTDTD view 80
- EVENTDTL view 80
- example tasks
  - real-time analysis
    - change default actions for SAM 87
    - deactivate an analysis definition 112
  - issue one notification for multiple conditions 116, 120
  - monitor multiple resource types in CICS system group 104, 107
  - monitor resource temporarily 89
  - monitor resource type in single CICS system 98
  - monitor resource type throughout CICSplex 101
  - monitor resources permanently 93
  - reuse analysis specifications and analysis groups 95
  - switch SAM on for a MAS 85
  - update analysis and evaluation definitions 112
  - use data from resource monitoring 113
- resource monitoring
  - monitor programs in multiple CICS systems 179
  - monitor transaction response times 175
  - which resources being monitored in a CICS system 184
- excluding resources from monitoring 149

## G

- generic alert
  - structure used by CICSplex SM 193

## I

- including resources in monitoring 149
- inheriting specifications
  - when adding scope to
    - analysis specification 69
    - monitor specification 169
  - when changing scope for
    - analysis specification 64
    - monitor specification 163
  - when removing scope from
    - analysis specification 65
    - monitor specification 164
- installing objects
  - analysis definition 47
  - analysis definition into analysis point 48

- installing objects (*continued*)
  - analysis group 53
  - analysis group into analysis point 54
  - monitor definition 150
  - monitor group 155
  - status definition 73
- interface to RODM
  - activating 135
  - defining resources (MONDEF) 149
  - displaying resources with NGMF 135
  - identifying RODM CMAS (MONSPEC) 167
  - information provided to RODM 134
  - NGMF resource information 195
  - use with API LISTEN command 142
  - use with automation products 142

## M

- menu, administration
  - real-time analysis 25
  - resource monitoring 145
- MLOCTRAN view requirement 133
- modifying CICS resources 20
- MONACTV view 171
- MONDEF view 146
- MONGROUP view 152
- MONINGRP view 156
- MONINSPC view 159
- monitor definition
  - associating with monitor group 150, 158
  - CICSplex SM created 147, 172
  - creating 147
  - description of 127
  - discarding 173
  - displaying
    - associated with monitor group 156
    - installed 171
    - one or more 145
  - installing
    - directly 150
    - via monitor groups 155
  - period definition
    - changing 158
    - requirement 131
  - removing
    - from data repository 147
    - from monitor group 157
  - replacing all installed 153
  - updating 147
- monitor group
  - adding monitor definitions to 150, 158
  - associating with monitor specification 154, 160
  - changing description of 153
  - creating 154
  - description of 128
  - displaying
    - monitor specification associations 159
    - one or more 152
  - installing monitor definitions comprising 155

- monitor group (*continued*)
  - removing
    - from data repository 153
    - from monitor specification 159
    - monitor definition from 157
  - replacing installed definitions using 153
- monitor interval
  - description of 130
  - when retaining data 133
- monitor specification
  - adding monitor group to 154, 160
  - associating scope with 168
  - browsing 165
  - creating 166
  - description of 127
  - displaying
    - monitor groups associated with 159
    - one or more 164
    - scope association 161
  - inherited by CICS system
    - when adding scope association 169
    - when changing scope association 162
    - when removing scope association 164
  - overriding 130
  - removing
    - from data repository 165
    - monitor group from 159
    - scope from 164
  - updating 165
  - scope for 162
- monitoring resources
  - activating at startup 167
  - comparison to CICS 133
  - defining attributes 127
  - description of 127
  - example tasks
    - monitor programs in multiple CICS systems 179
    - monitor transaction response times 175
    - which resources being monitored in a CICS system 184
- monitor interval
  - description of 130
  - when retaining data 133
- overriding monitor specification 130
- retention period setting
  - description of 133
  - for collected data 133
  - overriding 130
  - when CICSplex active 133
- sample interval setting
  - description of 131
  - overriding 130
  - requirement 130
  - using RODM 134
- MONSCOPE view 161
- MONSPEC view 165

## P

### period definition

- associating with monitor
  - definition 150, 158
- changing for monitor definition 158
- description of 131
- resource monitoring requirement 131

## R

### real-time analysis (RTA)

- activating
  - analysis point monitoring 18
  - MAS resource monitoring 17
  - system availability monitoring 15
- example tasks
  - change default actions for SAM 87
  - deactivate an analysis
    - definition 112
  - issue one notification for multiple conditions 116, 120
  - monitor multiple resource types in CICS system group 104, 107
  - monitor resource type in single CICS system 98
  - monitor resource type throughout CICSplex 101
  - monitor resources
    - permanently 93
    - monitor resources temporarily 89
  - reuse analysis specifications and analysis groups 95
  - switch SAM on for a MAS 85
  - update analysis and evaluation definitions 112
  - use data from resource monitoring 113
- status program
  - creating 189
  - identifying to CICSplex SM 191
  - installing 190, 191

### real-time analysis views

- accessing 25
- ACTNDEF 26
- APACTV 75
- APCMAS 29
- APSPEC 30
- EVALDEF 33
- EVENT 78
- EVENTD 79
- EVENTDTD 80
- EVENTDTL 80
- relationship to definitions 20
- RTAACTV 81
- RTADEF 43
- RTAGROUP 49
- RTAINAPS 55
- RTAINGRP 57
- RTAINSPC 60
- RTASCOPE 62
- RTASPEC 65
- STATDEF 70

### removing objects

- association between
    - analysis definition and analysis group 58
    - analysis point specification and analysis group 56
    - analysis point specification and CMAS 30
    - analysis specification and analysis group 61
    - monitor definition and monitor group 157
    - monitor group and monitor specification 159
    - scope and analysis specification 65
    - scope and monitor specification 161
    - status definition and analysis group 58
  - from data repository
    - action definition 26
    - analysis definition 44
    - analysis group 50
    - analysis point specification 31
    - analysis specification 66
    - evaluation definition 34
    - monitor definition 147
    - monitor group 153
    - monitor specification 165
    - status definition 70
  - replacing monitor definitions 153
  - resource monitoring
    - activating at startup 167
    - comparison to CICS 133
    - defining attributes 127
    - description of 127
    - example tasks
      - monitor programs in multiple CICS systems 179
      - monitor transaction response times 175
      - which resources being monitored in a CICS system 184
  - monitor interval
    - description of 130
    - when retaining data 133
  - overriding monitor specification 130
  - retention period setting
    - description of 133
    - for collected data 133
    - overriding 130
    - when CICSplex active 133
  - sample interval setting
    - description of 131
    - overriding 130
    - requirement 130
  - using RODM 134
- ### resource monitoring views
- accessing 145
  - MONDEF 146
  - MONGROUP 152
  - MONINGRP 156
  - MONINSCP 159
  - MONSCOPE 161
  - MONSPEC 165
  - relationship to definitions 142

### resources, CICS

- identifying to RODM 149
  - including or excluding from monitoring 149
  - modifying the state of 20
- ### retention period
- description of 133
  - for collected data 133
  - overriding 130
  - when creating monitor specification 167
- ### RODM interface
- activating 135
  - defining resources (MONDEF) 149
  - displaying resources with NGMF 135
  - identifying RODM CMAS (MONSPEC) 167
  - information provided to RODM 134
  - NGMF resource information 195
  - use with API LISTEN command 142
  - use with automation products 142
- ### RTA (real-time analysis)
- activating
    - analysis point monitoring 18
    - MAS resource monitoring 17
    - system availability monitoring 15
  - example tasks
    - change default actions for SAM 87
    - deactivate an analysis
      - definition 112
    - issue one notification for multiple conditions 116, 120
    - monitor multiple resource types in CICS system group 104, 107
    - monitor resource type in single CICS system 98
    - monitor resource type throughout CICSplex 101
    - monitor resources
      - permanently 93
      - monitor resources temporarily 89
    - reuse analysis specifications and analysis groups 95
    - switch SAM on for a MAS 85
    - update analysis and evaluation definitions 112
    - use data from resource monitoring 113
  - status program
    - creating 189
    - identifying to CICSplex SM 191
    - installing 190, 191
- ### RTAACTV view 81
- ### RTADEF view 43
- ### RTAGROUP view 49
- ### RTAINAPS view 55
- ### RTAINGRP view 57
- ### RTAINSPC view 60
- ### RTASCOPE view 62
- ### RTASPEC view 65

## S

- ### sample interval
- description of 131
  - overriding 130
  - requirement 130

- sample interval (*continued*)
  - setting when creating CICSplex 167
- scope
  - associating
    - to analysis specification 68
    - to monitor specification 168
  - changing
    - for analysis specification 62
    - for monitor specification 162
  - displaying
    - for analysis specifications 62
    - for monitor specifications 161
  - removing
    - from analysis specification 65
    - from monitor specification 164
- SET MONITOR (CICS command) 133
- STALL condition 12
- STATDEF view 70
- statistics collected 132
- status definition
  - adding to analysis group 72
  - creating 71
  - installing 73
  - removing 70
  - updating description of 70
- status program
  - creating 189
  - identifying to CICSplex SM 191
  - installing 190, 191
- summary of views
  - for creating definitions 3
  - for managing definitions 6

## T

- TASKD view requirement 133
- tasks, example
  - real-time analysis
    - change default actions for SAM 87
    - deactivate an analysis definition 112
    - issue one notification for multiple conditions 116, 120
    - monitor multiple resource types in CICS system group 104, 107
    - monitor resource temporarily 89
    - monitor resource type in single CICS system 98
    - monitor resource type throughout CICSplex 101
    - monitor resources permanently 93
    - reuse analysis specifications and analysis groups 95
    - switch SAM on for a MAS 85
    - update analysis and evaluation definitions 112
    - use data from resource monitoring 113
  - resource monitoring
    - monitor programs in multiple CICS systems 179
    - monitor transaction response times 175
    - which resources being monitored in a CICS system 184

- time-period definition
  - associating with monitor definition 150, 158
  - changing for monitor definition 158
  - description of 131
  - resource monitoring requirement 131

## U

- updating objects
  - action definition 27
  - analysis definition 44
  - analysis group 50
  - analysis point specification 31
  - analysis specification 66
  - evaluation definition 34
  - monitor definition 147
  - monitor group 153
  - monitor specification 165
  - scope association
    - with analysis specification 62
    - with monitor specification 162
  - status definition 70

## V

- view
  - summary of
    - for creating definitions 3
    - for managing definitions 6

---

## Sending your comments to IBM

If you especially like or dislike anything about this book, please use one of the methods listed below to send your comments to IBM.

Feel free to comment on what you regard as specific errors or omissions, and on the accuracy, organization, subject matter, or completeness of this book.

Please limit your comments to the information in this book and the way in which the information is presented.

To request additional publications, or to ask questions or make comments about the functions of IBM products or systems, you should talk to your IBM representative or to your IBM authorized remarketer.

When you send comments to IBM, you grant IBM a nonexclusive right to use or distribute your comments in any way it believes appropriate, without incurring any obligation to you.

You can send your comments to IBM in any of the following ways:

- By mail, to this address:

Information Development Department (MP095)  
IBM United Kingdom Laboratories  
Hursley Park  
WINCHESTER,  
Hampshire  
SO21 2JN  
United Kingdom

- By fax:
  - From outside the U.K., after your international access code use 44-1962-870229
  - From within the U.K., use 01962-870229
- Electronically, use the appropriate network ID:
  - IBM Mail Exchange: GBIBM2Q9 at IBMMAIL
  - IBMLink™ : HURSLEY(IDRCF)
  - Internet: idrcf@hursley.ibm.com

Whichever you use, ensure that you include:

- The publication number and title
- The topic to which your comment applies
- Your name and address/telephone number/fax number/network ID.



Program Number: 5655-147



Printed in the United States of America  
on recycled paper containing 10%  
recovered post-consumer fiber.

SC33-1808-31



Spine information:



CICS Transaction Server for  
OS/390

CICSplex SM Managing Resource Usage

Release 3