

CICS® Transaction Server for OS/390®



CICS Problem Determination Guide

Release 3

CICS® Transaction Server for OS/390®



CICS Problem Determination Guide

Release 3

Note!

Before using this information and the product it supports, be sure to read the general information under "Notices" on page ix.

Third edition (March 1999)

This edition applies to Release 3 of CICS Transaction Server for OS/390, program number 5655-147, and to all subsequent versions, releases, and modifications until otherwise indicated in new editions. Make sure you are using the correct edition for the level of the product.

This edition replaces and makes obsolete the previous edition, GC33-1693-01. The technical changes for this edition are summarized under "Summary of changes" and are indicated by a vertical bar to the left of a change.

Order publications through your IBM representative or the IBM branch office serving your locality. Publications are not stocked at the address given below.

At the back of this publication is a page entitled "Sending your comments to IBM". If you want to make comments, but the methods described are not available to you, please address them to:

IBM United Kingdom Laboratories, Information Development,
Mail Point 095, Hursley Park, Winchester, Hampshire, England, SO21 2JN.

When you send information to IBM, you grant IBM a nonexclusive right to use or distribute the information in any way it believes appropriate without incurring any obligation to you.

© **Copyright International Business Machines Corporation 1979, 1999. All rights reserved.**

Note to U.S. Government Users — Documentation related to restricted rights — Use, duplication or disclosure is subject to restrictions set forth in GSA ADP Schedule Contract with IBM Corp.

Contents

Notices	ix
Trademarks	x
What this book is about	xi
Who this book is for.	xi
What you need to know to understand this book	xi
How to use this book	xi
Notes about terms used in this book	xii
Determining if a publication is current	xii
CICS Transaction Server for OS/390	xv
CICS books for CICS Transaction Server for OS/390	xv
CICSplex SM books for CICS Transaction Server for OS/390	xv
Other CICS books	xvi
Summary of changes.	xvii
Changes for this edition	xvii
Changes for the CICS Transaction Server for OS/390 Release 2 edition	xvii
Changes for the CICS Transaction Server for OS/390 Release 1 edition	xvii
Changes for the CICS for MVS/ESA 4.1 edition	xvii

Part 1. Approach to problem determination 1

Chapter 1. Introduction to problem determination	3
Before you start—preliminary checks	3
What to do next	6
Chapter 2. Classifying the problem	7
Symptom keywords as a basis for classifying problems.	7
Some more ways in which this manual classifies problems	8
Using the symptoms to classify the problem	8
CICS has stopped running	8
CICS is running slowly.	9
A task fails to start	10
A task is running slowly	10
A task stops running at a terminal	10
A transaction has abended	11
You have obtained some incorrect output	11
A storage violation has occurred	12
An XRF error has occurred	12
Distinguishing between waits, loops, and poor performance	12
Waits	13
Loops	13
Poor performance	15
Poor application design	15
What to do next	16
Chapter 3. Sources of information	17
Your own documentation	17
Manuals	17
Source listings and link-edit maps	18
Abend codes and error messages	18
Symptom strings	18

Change log	18
Dumps	19
Statistics	19
Monitoring	19
Transaction inputs and outputs.	20
Terminal data	20
Transient data and temporary storage	20
Passed information	21
Files and databases	21
Traces.	21

Part 2. Dealing with the problem 23

Chapter 4. Dealing with transaction abends	29
Collecting the evidence	29
Symptom string	29
What the abend code can tell you	30
CICS transaction abend codes.	30
AICA abends	30
ASRA abends	30
ASRB abends	31
ASRD abends	31
AEYD abends	31
Finding where a program check occurred.	32
What type of program check occurred?	33
Dealing with arithmetic exceptions	35
Dealing with protection exceptions	35
Causes of protection exceptions	36
Analyzing the problem further	39
Abends when CICS is using the DBCTL interface.	39
Worksheet for transaction abends	39
FEPI abends	41
Chapter 5. Dealing with CICS system abends	43
The documentation you need	43
Interpreting the evidence	44
Looking at the messages.	44
Looking at the exception trace entry.	44
Looking at the symptom string in the dump	45
Looking at the kernel domain storage areas	46
Finding which tasks are associated with the error	46
Finding more information about the error	48
Using the linkage stack to identify the failing module.	51
Using the PSW to find the offset of the failing instruction	53
Finding the PTF level of the module in error.	53
Chapter 6. Dealing with waits	55
Where to look next	55
Techniques for investigating waits	56
Investigating waits—online method	57
Investigating waits—using trace	57
Investigating waits—the formatted CICS system dump	58
How tasks are made to wait.	63
Function ADD_SUSPEND of gate DSSR	64
Function INQUIRE_SUSPEND_TOKEN of gate DSSR	65
Function DELETE_SUSPEND of gate DSSR	65

Function SUSPEND of gate DSSR	66
Function RESUME of gate DSSR.	68
Functions WAIT_MVS, WAIT_OLDW, and WAIT_OLDC of gate DSSR	69
The resources on which tasks in a CICS system can wait.	74
Dispatcher waits	85
Transaction manager waits	85
Lock manager waits.	90
CICS DB2 waits	92
DBCTL waits	93
EDF waits	94
Log manager waits	94
Task control waits	96
Storage waits	98
Temporary storage waits	99
Terminal waits	102
VTAM terminal control waits.	109
Interregion and intersystem communication waits	111
Transient data waits.	112
Loader waits	115
Enqueue waits.	116
File control waits	119
Resolving deadlocks in a sysplex.	135
Interval control waits	136
XRF alternate system waits	141
CICS system task waits	143
FEPI waits	144
Recovery manager waits	144
Resolving in-doubt and resynchronization failures.	145
What to do if CICS has stalled.	145
Chapter 7. Dealing with loops	151
What sort of loop is indicated by the symptoms?	151
Tight loops and non-yielding loops	152
Yielding loops	154
Investigating loops that cause transactions to abend with abend code AICA	156
The documentation you need	156
Looking at the evidence	156
Identifying the loop	157
Finding the reason for the loop	158
Investigating loops that are not detected by CICS.	158
The documentation you need	159
Identifying the loop	159
Finding the reason for the loop	160
What to do if you cannot find the reason for a loop	160
Investigating loops using interactive tools	160
Modifying your program to investigate the loop	160
Chapter 8. Dealing with performance problems	161
Finding the bottleneck	161
Initial attach to the transaction manager	162
Initial attach to the dispatcher	163
Why tasks fail to get attached to the transaction manager.	163
Why tasks fail to get attached to the dispatcher	164
Why tasks fail to get an initial dispatch.	166
Why tasks take a long time to complete	168
A summary of performance bottlenecks, symptoms, and causes	169

Chapter 9. Dealing with incorrect output	171
Trace output is incorrect	171
Tracing has gone to the wrong destination	171
You have captured the wrong trace data	172
Dump output is incorrect	175
The dump you got did not seem to relate to your CICS region	175
You did not get a dump when an abend occurred	176
Some dump IDs were missing from the sequence of dumps	178
You did not get the correct data formatted from a CICS system dump	179
Wrong data has been displayed on a terminal	179
The preliminary information you need to get	179
Specific types of incorrect output, and their possible causes	180
Tools for debugging terminal output in a VTAM environment	185
Incorrect data is present on a VSAM data set	186
An application did not work as expected	186
General points for you to consider	186
Your transaction produced no output at all	187
Are there any messages explaining why there is no output?	187
Can you use the terminal where the transaction should have started?	187
No output—what to do if the task is still in the system	188
No output—what to do if the task is not in the system	188
Did the task run? Techniques for all tasks.	188
Investigating tasks initiated by ATI	191
Your transaction produced some output, but it was wrong	193
The origins of corrupted data	193
Were records in the file incorrect or missing?	194
Was the data mapped correctly into the program?	194
Is the data being corrupted by bad programming logic?	194
Is the data being mapped incorrectly to the terminal?	195
Chapter 10. Dealing with storage violations	197
Avoiding storage violations	197
Two kinds of storage violation	197
CICS has detected a storage violation	198
What happens when CICS detects a storage violation	200
What to do if you cannot find what is overlaying the SAA	201
Storage violations that affect innocent transactions	203
A strategy for storage violations affecting innocent transactions.	204
Procedure for resolving storage violations affecting innocent transactions	204
What to do if you still cannot find the cause of the overlay	205
Programming errors that can cause storage violations	205
Storage recovery	205
Chapter 11. Dealing with external CICS interface (EXCI) problems	207
Chapter 12. Dealing with MRO problems	209
Chapter 13. Dealing with log manager problems	211
Categories of problem	211
Exceeding the capacity of a log stream	212
System log	212
General logs	212
CICS checks for the availability of the MVS logger	213
Diagnosis of problems in the MVS logger	213
Console messages and dumps	213
GRS resource contention.	214

Checking CF structure and couple data set status	215
Checking log stream status	216
SMF and RMF statistics	218
Obtaining MVS logger and coupling facility dumps	218
Restarting the MVS logger address space	220
Dealing with a corrupt system log.	220

Part 3. Using traces and dumps in problem determination 223

Chapter 14. Using traces in problem determination	227
CICS tracing	227
Trace points	228
Trace levels.	228
Specialized trace.	229
CICS exception tracing	229
CICS XRF tracing	230
Program check and abend tracing	232
CICS VTAM exit tracing	232
VTAM buffer tracing.	234
Specifying the CICS tracing you want	234
Selecting tracing by transaction	234
Selecting tracing by component	239
Selecting trace destinations and related options	242
Setting the tracing status	245
Formatting and interpreting trace entries	247
Interpreting extended-format CICS system trace entries	248
Interpreting abbreviated-format CICS system trace entries	252
Interpreting short-format CICS system trace entries	254
Interpreting user trace entries	254
Chapter 15. Using dumps in problem determination.	257
Controlling dump action	257
Setting up the dumping environment	257
Detecting and avoiding duplicate system dumps	258
Events that can cause dumps to be taken	258
CICS dumping in a sysplex	260
Enabling system dumps for some CICS messages	267
System dump actions with messages DFHAP0001 and DFHSR0001.	267
The dump code options you can specify	268
Specifying the areas you want written to a transaction dump.	274
The CSFE ZCQTRACE facility.	274
Where dumps are written.	275
Looking at dumps	276
Formatting transaction dumps	276
Interpreting transaction dumps	276
Locating the last command or statement	280
Last command identification.	281
Last statement identification.	281
Locating program data.	282
Dumps for C/370 programs	282
Location of COBOL dumped areas	282
Formatting system dumps	283
Storage freeze.	295
Dumping a CFDT list structure	295
Formatting a coupling facility data table pool dump	295
Dumping a named counter list structure	296

Formatting a named counter pool dump	297
Using FEPI dump	297
Chapter 16. The global trap/trace exit	299
Establishing the exit.	299
Information passed to the exit	299
Actions the exit can take	300
Program check handling	301
Coding the exit	301

Part 4. Working with IBM to solve your problem 303

Chapter 17. IBM program support	305
When to contact the Support Center.	305
Dealing with the Support Center	305
What the Support Center needs to know	306
What happens next	308
IBM Program Support structure	308
Reporting a FEPI problem to IBM.	309
Chapter 18. APARs, fixes, and PTFs	311
The APAR process	311
Collecting the documentation for the APAR	311
General documentation needed for all problems with CICS	312
Sending the documentation to the change team	312
Packing and mailing the APAR box	313
Applying the fix	313
The APAR becomes a PTF	313

Part 5. Appendixes 315

Appendix A. SDUMP contents and IPCS CICS VERBEXIT keywords	317
Finding the control blocks from the keywords	317
Finding the keywords from the control blocks	327
Appendix B. Summary data for PG and US keywords	335
PG keyword	335
PGA (program manager anchor)	335
System LLE Summary.	336
PGWE Summary.	336
PPTe Summary	336
PTA Summary	338
Task LLE Summary	338
Task PLCB Summary	338
US keyword	339
USXD summary	339
USUD summary	339
Index	341
Sending your comments to IBM	363

Notices

This information was developed for products and services offered in the U.S.A. IBM may not offer the products, services, or features discussed in this document in other countries. Consult your local IBM representative for information on the products and services currently available in your area. Any reference to an IBM product, program, or service is not intended to state or imply that only that IBM product, program, or service may be used. Any functionally equivalent product, program, or service that does not infringe any IBM intellectual property right may be used instead. However, it is the user's responsibility to evaluate and verify the operation of any non-IBM product, program, or service.

IBM may have patents or pending patent applications covering subject matter described in this document. The furnishing of this document does not give you any license to these patents. You can send license inquiries, in writing, to:

IBM Director of Licensing
IBM Corporation
North Castle Drive
Armonk, NY 10504-1785
U.S.A.

For license inquiries regarding double-byte (DBCS) information, contact the IBM Intellectual Property Department in your country or send inquiries, in writing, to:

IBM World Trade Asia Corporation
Licensing
2-31 Roppongi 3-chome, Minato-ku
Tokyo 106, Japan

The following paragraph does not apply in the United Kingdom or any other country where such provisions are inconsistent with local law:

INTERNATIONAL BUSINESS MACHINES CORPORATION PROVIDES THIS PUBLICATION "AS IS" WITHOUT WARRANTY OF ANY KIND, EITHER EXPRESS OR IMPLIED, INCLUDING, BUT NOT LIMITED TO, THE IMPLIED WARRANTIES OF NON-INFRINGEMENT, MERCHANTABILITY, OR FITNESS FOR A PARTICULAR PURPOSE. Some states do not allow disclaimer of express or implied warranties in certain transactions, therefore this statement may not apply to you.

This publication could include technical inaccuracies or typographical errors. Changes are periodically made to the information herein; these changes will be incorporated in new editions of the publication. IBM may make improvements and/or changes in the product(s) and/or the program(s) described in this publication at any time without notice.

Licensees of this program who wish to have information about it for the purpose of enabling: (i) the exchange of information between independently created programs and other programs (including this one) and (ii) the mutual use of the information which has been exchanged, should contact IBM United Kingdom Laboratories, MP151, Hursley Park, Winchester, Hampshire, England, SO21 2JN. Such information may be available, subject to appropriate terms and conditions, including in some cases, payment of a fee.

The licensed program described in this document and all licensed material available for it are provided by IBM under terms of the IBM Customer Agreement, IBM International Programming License Agreement, or any equivalent agreement between us.

Trademarks

The following terms are trademarks of International Business Machines Corporation in the United States, or other countries, or both:

CICS	NetView
CICS/ESA	OS/390
CICS/MVS	RETAIN
C/370	RMF
DB2	SP
IBM	System/390
IMS	VTAM
MVS/ESA	

Other company, product, and service names may be trademarks or service marks of others.

What this book is about

This book is about methods of determining the causes of problems in a system that uses CICS®. It contains information about resolving CICS application and system problems, dealing with the IBM® Support Center, and handling authorized program analysis reports (APARs).

In general, this book does not describe methods of problem determination for the CICS Front End Programming Interface. This information is included in the *CICS Front End Programming Interface User's Guide*.

Note: For problem determination of the ONC/RPC feature, see the *CICS External Interfaces Guide*.

Who this book is for

This book is for those who are responsible for debugging CICS systems and application programs.

What you need to know to understand this book

This book assumes that you have a good knowledge of CICS. If you are using the book to resolve system problems, you need to be familiar with the books that tell you how to install and use a CICS system.

How to use this book

The information in this book is mainly for reference. Use the information to classify your problem and to find a solution to your problem.

Refer to Table 1 to find the section of the book that you need to read.

Table 1. Road map for the CICS Problem Determination Guide

If you want to...	Refer to...
Go through some preliminary checks	"Chapter 1. Introduction to problem determination" on page 3
Classify the problem according to its symptoms	"Chapter 2. Classifying the problem" on page 7
Look for information to help you diagnose and resolve the problem	"Chapter 3. Sources of information" on page 17
Resolve transaction abnormal terminations.	"Chapter 4. Dealing with transaction abends" on page 29
Resolve system abnormal terminations.	"Chapter 5. Dealing with CICS system abends" on page 43
Decide whether the problem is caused by a wait, a loop, or a performance problem.	"Distinguishing between waits, loops, and poor performance" on page 12
Resolve problems caused by waits.	"Chapter 6. Dealing with waits" on page 55
Resolve problems caused by loops.	"Chapter 7. Dealing with loops" on page 151
Resolve problems caused by performance problems.	"Chapter 8. Dealing with performance problems" on page 161
Know what to do if you don't get the output you expected.	"Chapter 9. Dealing with incorrect output" on page 171
Resolve problems caused by storage violations.	"Chapter 10. Dealing with storage violations" on page 197

Table 1. Road map for the CICS Problem Determination Guide (continued)

If you want to...	Refer to...
Resolve problems involving XRF.	<i>CICS/ESA 4.1 Problem Determination Guide</i>
Resolve problems with the external CICS interface.	“Chapter 11. Dealing with external CICS interface (EXCI) problems” on page 207
Resolve problems with MRO.	“Chapter 12. Dealing with MRO problems” on page 209
Resolve problems with log manager.	“Chapter 13. Dealing with log manager problems” on page 211
Use CICS trace.	“Chapter 14. Using traces in problem determination” on page 227
Use CICS dump.	“Chapter 15. Using dumps in problem determination” on page 257
Report the problem to IBM.	“Part 4. Working with IBM to solve your problem” on page 303
Look up a dump exit keyword.	“Appendix A. SDUMP contents and IPCS CICS VERBEXIT keywords” on page 317

Notes about terms used in this book

When the term “CICS” is used without any qualification in this book, it refers to the CICS element of the IBM CICS Transaction Server for OS/390®.

“MVS™” is used for the operating system, which can be either an element of OS/390, or MVS/Enterprise System Architecture System Product (MVS/ESA™ SP™).

Throughout this book, the term *APPC* is used to mean LUTYPE6.2. For example, *APPC* session is used instead of LUTYPE6.2 session.

Determining if a publication is current

IBM regularly updates its publications with new and changed information. When first published, both hardcopy and BookManager softcopy versions of a publication are in step, but subsequent updates will probably be available in softcopy before they are available in hardcopy.

For CICS Transaction Server books, these softcopy updates appear regularly on the *Transaction Processing and Data Collection Kit* CD-ROM, SK2T-0730-xx. Each reissue of the collection kit is indicated by an updated order number suffix (the -xx part). For example, collection kit SK2T-0730-06 is more up-to-date than SK2T-0730-05. The collection kit is also clearly dated on the cover.

Here’s how to determine if you are looking at the most current copy of a publication:

- A publication with a higher suffix number is more recent than one with a lower suffix number. For example, the publication with order number SC33-0667-02 is more recent than the publication with order number SC33-0667-01. (Note that suffix numbers are updated as a product moves from release to release, as well as for hardcopy updates within a given release.)
- When the softcopy version of a publication is updated for a new collection kit the order number it shares with the hardcopy version does not change. Also, the date in the edition notice remains that of the original publication. To compare softcopy with hardcopy, and softcopy with softcopy (on two editions of the

collection kit, for example), check the last two characters of the publication's filename. The higher the number, the more recent the publication. For example, DFHPF104 is more recent than DFHPF103. Next to the publication titles in the CD-ROM booklet and the readme files, asterisks indicate publications that are new or changed.

- Updates to the softcopy are clearly marked by revision codes (usually a “#” character) to the left of the changes.

CICS Transaction Server for OS/390

<i>CICS Transaction Server for OS/390: Planning for Installation</i>	GC33-1789
<i>CICS Transaction Server for OS/390 Release Guide</i>	GC34-5352
<i>CICS Transaction Server for OS/390 Migration Guide</i>	GC34-5353
<i>CICS Transaction Server for OS/390 Installation Guide</i>	GC33-1681
<i>CICS Transaction Server for OS/390 Program Directory</i>	GI10-2506
<i>CICS Transaction Server for OS/390 Licensed Program Specification</i>	GC33-1707

CICS books for CICS Transaction Server for OS/390

General

<i>CICS Master Index</i>	SC33-1704
<i>CICS User's Handbook</i>	SX33-6104
<i>CICS Transaction Server for OS/390 Glossary (softcopy only)</i>	GC33-1705

Administration

<i>CICS System Definition Guide</i>	SC33-1682
<i>CICS Customization Guide</i>	SC33-1683
<i>CICS Resource Definition Guide</i>	SC33-1684
<i>CICS Operations and Utilities Guide</i>	SC33-1685
<i>CICS Supplied Transactions</i>	SC33-1686

Programming

<i>CICS Application Programming Guide</i>	SC33-1687
<i>CICS Application Programming Reference</i>	SC33-1688
<i>CICS System Programming Reference</i>	SC33-1689
<i>CICS Front End Programming Interface User's Guide</i>	SC33-1692
<i>CICS C++ OO Class Libraries</i>	SC34-5455
<i>CICS Distributed Transaction Programming Guide</i>	SC33-1691
<i>CICS Business Transaction Services</i>	SC34-5268

Diagnosis

<i>CICS Problem Determination Guide</i>	GC33-1693
<i>CICS Messages and Codes</i>	GC33-1694
<i>CICS Diagnosis Reference</i>	LY33-6088
<i>CICS Data Areas</i>	LY33-6089
<i>CICS Trace Entries</i>	SC34-5446
<i>CICS Supplementary Data Areas</i>	LY33-6090

Communication

<i>CICS Intercommunication Guide</i>	SC33-1695
<i>CICS Family: Interproduct Communication</i>	SC33-0824
<i>CICS Family: Communicating from CICS on System/390</i>	SC33-1697
<i>CICS External Interfaces Guide</i>	SC33-1944
<i>CICS Internet Guide</i>	SC34-5445

Special topics

<i>CICS Recovery and Restart Guide</i>	SC33-1698
<i>CICS Performance Guide</i>	SC33-1699
<i>CICS IMS Database Control Guide</i>	SC33-1700
<i>CICS RACF Security Guide</i>	SC33-1701
<i>CICS Shared Data Tables Guide</i>	SC33-1702
<i>CICS Transaction Affinities Utility Guide</i>	SC33-1777
<i>CICS DB2 Guide</i>	SC33-1939

CICSplex SM books for CICS Transaction Server for OS/390

General

<i>CICSplex SM Master Index</i>	SC33-1812
<i>CICSplex SM Concepts and Planning</i>	GC33-0786
<i>CICSplex SM User Interface Guide</i>	SC33-0788
<i>CICSplex SM View Commands Reference Summary</i>	SX33-6099
Administration and Management	
<i>CICSplex SM Administration</i>	SC34-5401
<i>CICSplex SM Operations Views Reference</i>	SC33-0789
<i>CICSplex SM Monitor Views Reference</i>	SC34-5402
<i>CICSplex SM Managing Workloads</i>	SC33-1807
<i>CICSplex SM Managing Resource Usage</i>	SC33-1808
<i>CICSplex SM Managing Business Applications</i>	SC33-1809
Programming	
<i>CICSplex SM Application Programming Guide</i>	SC34-5457
<i>CICSplex SM Application Programming Reference</i>	SC34-5458
Diagnosis	
<i>CICSplex SM Resource Tables Reference</i>	SC33-1220
<i>CICSplex SM Messages and Codes</i>	GC33-0790
<i>CICSplex SM Problem Determination</i>	GC33-0791

Other CICS books

<i>CICS Application Programming Primer (VS COBOL II)</i>	SC33-0674
<i>CICS Application Migration Aid Guide</i>	SC33-0768
<i>CICS Family: API Structure</i>	SC33-1007
<i>CICS Family: Client/Server Programming</i>	SC33-1435
<i>CICS Family: General Information</i>	GC33-0155
<i>CICS 4.1 Sample Applications Guide</i>	SC33-1173
<i>CICS/ESA 3.3 XRF Guide</i>	SC33-0661

If you have any questions about the CICS Transaction Server for OS/390 library, see *CICS Transaction Server for OS/390: Planning for Installation* which discusses both hardcopy and softcopy books and the ways that the books can be ordered.

Summary of changes

This edition of the *Problem Determination Guide* is based on the CICS Transaction Server for OS/390 Release 2 edition. Changes from the CICS Transaction Server for OS/390 Release 2 edition are marked by a vertical line to the left of the change.

Changes for this edition

There are a number of small amendments that have been made to this edition. The most significant being the changes in the trace entries.

For problem determination guidance associated with CICS business transactions, see the *CICS Business Transaction Services*.

Changes for the CICS Transaction Server for OS/390 Release 2 edition

The main changes for this edition are as follows:

- “Dealing with a corrupt system log” on page 220 describes the new diagnostic run mechanism for diagnosing problems with the CICS system log.

Changes for the CICS Transaction Server for OS/390 Release 1 edition

The main changes for this edition are as follows:

- New section dealing with problem determination in the log manager area.
- New information in the ‘Dealing with waits’ section detailing waits in the following areas:
 - Log manager
 - EDF
 - Enqueue facility
 - Recovery manager.
- Introduction of the WLM_WAIT_TYPE parameter on DSSR functions.
- Purge status information included for suspended tasks.
- The trace entry interpretation tables have been moved to the *Diagnosis Reference*.

Changes for the CICS for MVS/ESA 4.1 edition

The main changes for this edition are as follows:

- Information added regarding transaction isolation and the data integrity protection that it provides.
- New information in the ‘Dealing with waits’ section to reflect transaction isolation, and other new wait types.
- Discussion of simultaneous dump capture in multiple CICS systems across a sysplex.
- Reference information added to include the new dumped and traced data from the following areas:
 - Transaction isolation

- VTAM® persistent session support
- XCF/MRO
- External CICS interface
- Directory domain
- Program manager domain
- Security manager domain
- Transaction manager domain
- User domain.

Part 1. Approach to problem determination

Chapter 1. Introduction to problem determination	3
Before you start—preliminary checks	3
What to do next	6
Chapter 2. Classifying the problem	7
Symptom keywords as a basis for classifying problems.	7
Some more ways in which this manual classifies problems	8
Using the symptoms to classify the problem	8
CICS has stopped running	8
CICS is running slowly.	9
A task fails to start	10
A task is running slowly	10
A task stops running at a terminal	10
A transaction has abended	11
You have obtained some incorrect output.	11
A storage violation has occurred	12
An XRF error has occurred	12
Distinguishing between waits, loops, and poor performance	12
Waits	13
Loops	13
Poor performance	15
Poor application design	15
What to do next	16
Chapter 3. Sources of information	17
Your own documentation	17
Manuals	17
Source listings and link-edit maps	18
Abend codes and error messages	18
Symptom strings	18
Change log	18
Dumps	19
Statistics	19
Monitoring	19
Transaction inputs and outputs.	20
Terminal data	20
Transient data and temporary storage	20
Passed information	21
Files and databases	21
Traces.	21

Part 1 contains:

Chapter 1. Introduction to problem determination

This book tells you how to find the reasons for problems with your CICS system.

Usually, you start with a symptom, or set of symptoms, and trace them back to their cause. This book describes tools and techniques you can use to find the cause of a problem and suggests action for solving the problem.

Sometimes, you cannot solve the problem yourself if, for example, it is caused by limitations in the hardware or software you are using. If the cause of the problem is CICS code, you need to contact IBM, as described in “Part 4. Working with IBM to solve your problem” on page 303.

Before you start—preliminary checks

Before you go further into looking for the cause of the problem, run through the following preliminary checks. These checks might highlight a simple cause or, at least, narrow the range of possible causes.

As you go through the questions, make a note of anything that might be relevant to the problem. Even if the observations you record do not at first suggest a cause, they could be useful to you later if you need to carry out systematic problem determination.

1. Has the CICS system run successfully before?

If the CICS system has not run successfully before, it is possible that you have not yet set it up correctly. You need to read other books in the CICS library for guidance on doing this.

If you are currently migrating to CICS Transaction Server for OS/390 Release 3, ensure that you are aware of all the changes that have been made for this release. For details of these, see the *CICS Transaction Server for OS/390 Migration Guide*.

2. Are there any messages explaining the failure?

If a transaction abends, and the task terminates abnormally, CICS sends a message reporting the fact to the CSMT log (or your site replacement). If you find a message there, it might immediately suggest a reason for the failure.

Were there any unusual messages associated with CICS start up, or while the system was running before the error occurred? These might indicate some system problem that prevented your transaction from running successfully.

If you see any messages that you do not understand, you can use the CICS messages transaction, CMAC, for online message information. If you do not have access to a CICS system to run the CMAC transaction, look in the *CICS Messages and Codes* manual for an explanation and, perhaps, a suggested course of action that you can take to resolve the problem.

3. Can you reproduce the error?

a. Can you identify any application that is always in the system when the problem occurs?

- Check for application coding errors.
- Check that you have defined sufficient resource for the application, such as VSAM file strings. Typically, if you had not defined sufficient resources, you would find that the problem is related to the number of users of the application.

- b. Are you using exit programming interface (XPI) calls? If so, be sure to observe the XPI protocols and restrictions exactly. For programming information about the XPI, see the *CICS Customization Guide*.

The exit programming interface enables you to invoke a domain and enter its environment directly; using it incorrectly can cause severe CICS system problems. Here are some particular points for your attention:

- Are the input parameters correct? If their format is not valid, they are rejected by the called domain, and an exception trace is made. If their values are acceptable to the domain but inappropriate for the system, they could cause unpredictable effects.
 - Be aware that you cannot use some XPI calls within some of the user exits. If you do, the results can be unpredictable, and can cause CICS to stall or abend. The *CICS Customization Guide* tells you which exits can use X calls and which cannot.
- c. Consider your CICS system definition parameters if the problem is not related to any particular application. Poorly defined parameters may be the cause of problems in your system. You can find guidance about setting up your CICS system in the *CICS System Definition Guide*.
 - d. Does the problem seem to be related to system loading? If so, the system might be running near its maximum capacity, or it might be in need of tuning. For guidance about dealing with this sort of problem, see the *CICS Performance Guide*.

4. Does the failure occur at specific times of day?

If the failure occurs at specific times of day, it could be dependent on system loading. Typically, peak system loading is at mid-morning and mid-afternoon, so those are the times when load-dependent failures are most likely to happen. If your CICS network extends across more than one time zone, peak system loading might seem to you to occur at some other time of day.

5. Is the failure intermittent?

If an error is intermittent, particularly if it does not show the same symptoms, the problem might be more difficult to resolve. An intermittent failure can be caused by a “random” storage overlay. Furthermore, the transaction that caused the error might have been deleted from the system long before the symptoms are seen.

A method you can use to investigate random overlays is described in “Chapter 10. Dealing with storage violations” on page 197.

6. Have any changes been made since the last successful run?

Service

- a. Have you applied a PTF to CICS?
- b. Did it install successfully or did you get an error message during installation? If you installed it successfully, check with IBM for any PTF error.
- c. Have any patches applied to any other program affected the way CICS interfaces with the program?

Hardware

- a. Have you changed your hardware?

Software

- a. Have you changed your software?
- b. If you have installed a new or modified application, check for error messages in the output from the following:

- Translator
- Compiler
- Assembler
- Linkage editor

Administration

- Have you changed your initialization procedure, for example by JCL, CICS system initialization or override parameters, or VTAM CONFIG/LIST?
- Has CICS generated any error messages during initialization?
- Have you installed any resource definitions defined using CEDA?

If the definitions were made but not installed when CICS was last terminated, they might not have been preserved over the termination and subsequent start up. In general, changes made to the CSD but not installed are not visible when the CICS system is *warm* started. However, if the change was in a group in the GRPLIST specified on a *cold* start, it is effectively installed during startup. (Changes which have been installed are not visible after a cold start unless they were made to a group in the GRPLIST.)

If START=AUTO was specified in the system initialization table, or as an override, you need to examine the job log to find out how the CICS system last came up.

For detailed guidance about the ways in which resources can be defined and installed, see the *CICS Resource Definition Guide*.

7. Are specific parts of the network affected by the problem?

- Can you identify specific parts of the network that the problem affects? If you can, look for any explanatory message from the access method. Even if no message has been sent to the console, you might find one in the CSNE log.
- Have you made any network-related changes?
- If the problem affects a single terminal, are your terminal definitions correct? Consider both the TERMINAL definition, and the TYPETERM definition it uses.
- If the problem affects a number of terminals, can you identify a factor that is common to all of them? For example:
 - Do they use the same TYPETERM definition? If so, it is likely that there is an error in that TYPETERM definition.
 - Is the whole network affected? If so, CICS has probably stalled. See “What to do if CICS has stalled” on page 145 for advice about dealing with CICS system stalls.

8. Has the application run successfully before?

- Have any changes been made to the application since it last ran successfully?
Examine the new or modified part of the application.
- Have you used RDO to create or alter a transaction, program, or mapset? You must install these definitions before the resources are available to the running CICS region.
- If you changed any maps, have you created both a new phase (TYPE=MAP) and a new DSECT (TYPE=DSECT), and then recompiled every program using the new DSECT? Use the CEMT commands:

CEMT SET PROGRAM(mapset) NEWCOPY
CEMT SET PROGRAM(all programs) NEWCOPY

(See the *CICS Supplied Transactions* manual for guidance about the CEMT transaction.)

- d. Have all the functions of the application been fully exercised before?

Establish what the program was doing when the error occurred, and check the source code in that part of the program.

If a program has been run successfully on many previous occasions, examine the contents of any records, screen data, and files that were being processed when the error occurred. They may contain some unusual data value that causes a rarely used path in the program to be invoked.

- e. Check that the application successfully retrieved the records that it required at the time of the error.
- f. Check that all fields within the records at the time of the error contain data in a format acceptable to the program. Use CICS dump to do this.

If you can reproduce the problem in a test system, you can use programming language debug tools and the CEDF transaction to check the data and solve the problem.

9. The application has not run successfully before

If your application has not yet run successfully, examine it carefully to see if you can find any errors.

- a. Check the output from the translator, the compiler, and the linkage editor, for any reported errors.

If your application fails to translate, compile or assemble, or link-edit cleanly into the correct phase library, it will also fail to run if you attempt to invoke it.

- b. Check the coding logic of the application. Do the symptoms of the failure indicate the function that is failing and, therefore, the piece of code in error?

- c. The following is a list of some programming errors commonly found in applications:

- CICS areas are addressed incorrectly.
- The rules for quasi-reentrancy are not followed.
- Transient data is managed incorrectly.
- File resources are not released.
- Storage is corrupted by the program.
- Return codes from CICS requests are ignored.

What to do next

Perhaps the preliminary checks have enabled you to find the cause of the problem. If so, you should now be able to resolve it, possibly with the help of other books in the CICS library and in the libraries of other licensed programs.

If you have not yet found the cause, you must start to look at the problem in greater detail. Begin by finding the best category for the problem, using the approach described in “Chapter 2. Classifying the problem” on page 7.

Chapter 2. Classifying the problem

The purpose of this chapter is to help you classify your problem into one of the categories used by the IBM Support Center for its service procedures.

IBM Support Center staff have found that classifying the problem first is a good approach to problem determination.

Symptom keywords as a basis for classifying problems

IBM keeps records of all known problems with its licensed programs on the RETAIN database. IBM Support Center staff continually update the database as new problems are reported, and they regularly search the database to see if problems they are told about are already known.

If you have the IBM INFORMATION/ACCESS licensed program, 5665-266, you can look on the RETAIN database yourself. Each of the problems there has a classification type.

For software problems, the classifications you will see are:

- **ABEND** (for **transaction abends**, see “Chapter 4. Dealing with transaction abends” on page 29; for **system abends**, see “Chapter 5. Dealing with CICS system abends” on page 43)
- **WAIT** (see “Chapter 6. Dealing with waits” on page 55)
- **LOOP** (see “Chapter 7. Dealing with loops” on page 151)
- **POOR PERFORMANCE**, or **PERFM** (see “Chapter 8. Dealing with performance problems” on page 161)
- **INCORRECT OUTPUT**, or **INCORROUT** (see “Chapter 9. Dealing with incorrect output” on page 171)
- **MESSAGE**

All but the last of these, MESSAGE, are considered in this book. If you receive a CICS error message, you can use the CICS message transaction, CMAC, for online message information. If you do not have access to a running CICS system, look in the *CICS Messages and Codes* manual for an explanation. If you get a message from another IBM program, or from the operating system, you need to look in the messages and codes book from the appropriate library for an explanation of what that message means.

The *CICS Messages and Codes* manual might give you enough information to solve the problem quickly, or it might redirect you to this manual for further guidance. If you are unable to deal with the message, you may eventually need to contact the IBM Support Center for help.

One type of problem that might give rise to a number of symptoms, usually ill-defined, is that of poor application design. Checking the design of an application is beyond the scope of this book, but one instance is described in “Poor application design” on page 15, where you will find there an example of how bad design can give rise to an application with poor usability.

Some more ways in which this manual classifies problems

In addition to the RETAIN classifications used by the IBM Support Centers, this manual considers the following types of problem to belong in classes of their own:

- **Storage violations** (see “Chapter 10. Dealing with storage violations” on page 197)
- **XRF errors** (see the *CICS/ESA 4.1 Problem Determination Guide*)
- **EXCI problems** (see “Chapter 11. Dealing with external CICS interface (EXCI) problems” on page 207)
- **MRO problems** (see “Chapter 12. Dealing with MRO problems” on page 209)
- **Log manager problems** (see “Chapter 13. Dealing with log manager problems” on page 211)

Whereas XRF, EXCI, and MRO errors can easily be classified in a straightforward way, confirming that you have a storage violation can be difficult. Unless you get a CICS message stating explicitly that you have a storage violation, you could get almost any symptom, depending on what has been overlaid. You might, therefore, classify it initially as one of the RETAIN symptom types described in “Symptom keywords as a basis for classifying problems” on page 7.

Using the symptoms to classify the problem

The paragraphs that follow are to help you to classify the problem on the basis of the symptoms you observe.

The symptoms might enable you to classify the problem correctly at once, but sometimes classification is not so straightforward. You may need to consider the evidence carefully before making your decision. You might need to make a “best guess”, and then be prepared to reconsider later on the basis of further evidence.

Look for the section heading that most nearly describes the symptoms you have, and then follow the advice given there.

CICS has stopped running

There are three main reasons why CICS might unexpectedly stop running:

1. There could be a CICS system abend.
2. CICS could be in a wait state. In other words, it could have stalled.
3. A program could be in a tight loop.

Consider, too, the possibility that CICS might still be running, but only slowly. Be certain that there is no activity at all before carrying out the checks in this section. If CICS *is* running slowly, you probably have a performance problem. If so, read “CICS is running slowly” on page 9 to confirm this before going on to “Chapter 8. Dealing with performance problems” on page 161 for advice about what to do next.

If CICS *has* stopped running, look for any message that might explain the situation. The message might appear in either of the following places:

- **The MVS console.** Look for any message saying that the CICS job has abnormally terminated. If you find one, it means that a CICS system abend has

occurred and that CICS is no longer running. In such a case, you need to examine the CSMT log (see below) to see which abend message has been written there.

If you do not find any explanatory message on the MVS console, check in the CSMT log to see if anything has been written there.

- **The CSMT log.** CSMT is the transient data destination to which abend messages are written. If you find a message there, use the CMAC transaction or look in the *CICS Messages and Codes* manual to make sure there has been a CICS system abend.

If you see only a *transaction* abend message in the CSMT log, that will not account for CICS itself not running, and you should not classify the problem as an abend. A faulty transaction could hold CICS up, perhaps indefinitely, but CICS would resume work again if the transaction abended.

Here are two examples of messages that might accompany CICS system abends, and which you would find on the CSMT log:

DFHST0001 *applid* An abend (code *aaa/bbbb*) has occurred at offset *X'offset* in module *modname*.

DFHSR0601 Program interrupt occurred with system task *taskid* in control

If you get either of these messages, or any others for which the system action is to terminate CICS, turn to “Chapter 5. Dealing with CICS system abends” on page 43 for advice on what to do next.

If you can find no message saying that CICS has terminated, it is likely that the CICS system is in a wait state, or that some program is in a tight loop and not returning control to CICS. These two possibilities are dealt with in “Chapter 6. Dealing with waits” on page 55 and “Chapter 7. Dealing with loops” on page 151, respectively.

CICS is running slowly

If CICS is running slowly, it is likely that you have a performance problem. It could be because your system is badly tuned, or because it is operating near the limits of its capacity. You will probably notice that the problem is worst at peak system load times, typically at mid-morning and mid-afternoon. If your network extends across more than one time zone, peak system load might seem to you to occur at some other time.

If you find that performance degradation is not dependent on system loading, but happens sometimes when the system is lightly loaded, a poorly designed transaction could be the cause. You might classify the problem initially as “poor performance”, but be prepared to reconsider your classification later.

The following are some individual symptoms that could contribute to your perception that CICS is running slowly:

- Tasks take a long time to start running.
- Some low priority tasks will not run at all.
- Tasks start running, but take a long time to complete.
- Some tasks start running, but do not complete.
- No output is obtained.

- Terminal activity is reduced, or has ceased.

Some of these symptoms do not, in isolation, necessarily mean that you have got a performance problem. They could indicate that some task is in a loop, or is waiting on a resource that is not available. Only you can judge whether what you see should be classified as “poor performance”, in the light of all the evidence you have.

You might be able to gather more detailed evidence by using the tools and techniques that CICS provides for collecting performance data. The following is a summary of what is available:

- **CICS statistics.** You can use these to gather information about the CICS system as a whole, without regard to tasks.
- **CICS monitoring.** You can use this facility to collect information about CICS tasks.
- **CICS tracing.** This is not a specific tool for collecting performance data, but you can use it to gather detailed information about performance problems.

For guidance about using these tools and techniques, and advice about performance and system tuning in general, see the *CICS Performance Guide*.

You can find guidance about identifying specific performance bottlenecks in your CICS system in “Chapter 8. Dealing with performance problems” on page 161.

A task fails to start

If a task fails to start, look first in the CSMT and CSNE logs for any explanatory message. If you do not find one, the task is possibly being prevented from starting because either the system is running at the MXT limit, the transaction is queuing for admittance to a transaction class, or for other performance reasons.

Classify the problem tentatively as “poor performance”, and turn to “Chapter 8. Dealing with performance problems” on page 161 for further guidance.

A task is running slowly

If just one task is running slowly, it is likely that the explanation lies with the task itself. It could be in a loop, or it could periodically be entering a wait state. You need to decide which of these possibilities is the most likely before starting systematic problem determination. The ways that you might distinguish between waits and loops are described in “Distinguishing between waits, loops, and poor performance” on page 12.

Note: Do not overlook the possibility that the task might simply be doing unnecessary work that does not change the final result—for example, starting a skip sequential browse with large gaps between the keys, or failing to finish one because it is holding on to resources.

A task stops running at a terminal

When a task stops running at a terminal, you will notice either or both of these symptoms:

- No output is obtained at the terminal
- The terminal accepts no input

First, make sure that the task is still in the system. Use CEMT INQ TASK to check its status, and make sure that it has not simply ended without writing back to the terminal.

If the terminal has a display unit, check to see whether a special symbol has been displayed in the operator information area that could explain the fault. If the operator information area is clear, next check to see that no message has been sent to any of the transient data destinations used for error messages, for example:

- CDBC, the destination for DBCTL related messages
- CSMT, the destination for terminal error and abend messages
- CSTL, the destination for terminal I/O error messages
- CSNE, the destination for error messages written by DFHZNAC and DFHZNEP

For details of the destinations used by CICS, see the *CICS System Definition Guide*. If you can find no explanation for the problem, the fault is probably associated with the task running at the terminal. These are the possibilities:

- The task is in a wait state.
- The task is in a loop.
- There is a performance problem.

Read “Distinguishing between waits, loops, and poor performance” on page 12 to find out which of these is the most likely explanation. You can then read to the appropriate section for advice about dealing with the problem.

A transaction has abended

If the transaction abended when you ran your application, CICS gives you an error message on your screen as well as a message on the CSMT log.

Use the CMAC transaction or look in the *CICS Messages and Codes* manual for an explanation of the message, and, perhaps, advice about what you should do to solve the problem. If the code is not there, or the explanation or advice given is not sufficient for you to solve the problem, turn to “Chapter 4. Dealing with transaction abends” on page 29.

You have obtained some incorrect output

Incorrect output might be regarded as any sort of output that you were not expecting. However, use the term with care in the context of problem determination, because it might be a secondary effect of some other type of error. For example, looping could be occurring if you get any sort of repetitive output, even though that output is not what you had expected. Also, CICS responds to many errors that it detects by sending messages. You might regard the messages as “incorrect output”, but they are only symptoms of another type of problem.

If you have received an unexpected message, and its meaning is not at first clear, use the CMAC transaction or look in the *CICS Messages and Codes* manual for an explanation. It might suggest a simple response that you can make to the message, or it might redirect you to this manual for further guidance.

These are the types of incorrect output that are dealt with in this manual:

- **Incorrect trace or dump data:**
 - Wrong destination

- Wrong type of data captured
- Correct type of data captured, but the data values were unexpected
- **Wrong data displayed on the terminal.**

You can find advice about investigating the cause of any of these types of incorrect output in “Chapter 9. Dealing with incorrect output” on page 171.

A storage violation has occurred

When CICS detects that storage has been corrupted, this message is sent to the console:

DFHSM0102 *applid* **A storage violation (code X'code') has been detected by module modname.**

If you see this message, or you know (through other means) that a storage violation has occurred, turn to “Chapter 10. Dealing with storage violations” on page 197 for advice about dealing with the problem.

In many cases, storage violations go undetected by CICS, and you only find out that they have occurred when something else goes wrong as a result of the overlay. You could, for example, get a program check because code or data has been overlaid. You might suspect some other type of problem at first, and only after starting your investigation find that a storage violation has occurred.

You can avoid many storage violations by enabling transaction isolation, storage protection, and command protection.

An XRF error has occurred

If an XRF error has occurred, turn to the *CICS/ESA 4.1 Problem Determination Guide* for advice on what to do.

Distinguishing between waits, loops, and poor performance

Waits, loops, and poor performance can be quite difficult to distinguish, and in some cases you need to carry out quite a detailed investigation before deciding which classification is the right one for your problem.

Any of the following symptoms could be caused by a wait, or a loop, or by a badly tuned or overloaded system:

- One or more user tasks in your CICS system fails to start.
- One or more tasks stays suspended.
- One or more tasks fails to complete.
- No output is obtained.
- Terminal activity is reduced, or has ceased.
- The performance of your system is poor.

Because it can be difficult to make a correct classification, consider the evidence carefully before adopting a problem solving strategy.

This section gives you guidance about choosing the best classification. When you have decided on that, read the appropriate section later in this manual for further advice. However, note that in some cases your initial classification could be wrong, and you then need to reappraise the problem.

Waits

For the purpose of problem determination, a wait state is regarded as a state in which the execution of a task has been suspended. That is, the task has started to run, but it has been suspended without completing and has subsequently failed to resume.

The task might typically be waiting for a resource that is unavailable, or it might be waiting for an ECB to be posted. A wait might affect just a single task, or a group of tasks that may be related in some way. If none of the tasks in a CICS region is running, CICS is in a wait state. The way to handle that situation is dealt with in “What to do if CICS has stalled” on page 145.

If you are authorized to use the CEMT transaction, you can find out which user tasks or CICS-supplied transactions are currently suspended in a running CICS system using CEMT INQ TASK. Use the transaction several times, perhaps repeating the sequence after a few minutes, to see if any task stays suspended. If you do find such a task, look at the resource type that it is waiting on (the value shown for the HTYPE option). Is it unreasonable that there should be an extended wait on the resource? Does the resource type suggest possible causes of the problem?

You can use EXEC CICS INQUIRE TASK or EXEC CICS INQUIRE TASK LIST as alternatives to the CEMT transaction. You can execute these commands under CECL, or in a user program.

Use INQUIRE TASK LIST to find the task numbers of all SUSPENDED, READY, and RUNNING user tasks. If you use this command repeatedly, you can see which tasks stay suspended. You may also be able to find some relationship between several suspended tasks, perhaps indicating the cause of the wait.

If it seems fairly certain that your problem is correctly classified as a wait, and the cause is not yet apparent, turn to “Chapter 6. Dealing with waits” on page 55 for guidance about solving the problem.

However, you should allow for the possibility that a task may stay suspended because of an underlying performance problem, or because some other task may be looping.

If you can find no evidence that a task is waiting for a specific resource, you should not regard this as a wait problem. Consider instead whether it is a loop or a performance problem.

Loops

A loop is the repeated execution of some code. If you have not planned the loop, or if you have designed it into your application but for some reason it fails to terminate, you get a set of symptoms that vary depending on what the code is doing. In some

cases, a loop may at first be diagnosed as a wait or a performance problem, because the looping task competes for system resources with other tasks that are not involved in the loop.

The following are some characteristic symptoms of loops:

- **The ‘system busy’ symbol** is permanently displayed in the operator information area of a display unit, or stays displayed for long periods.
- **The transaction abends with abend code AICA.**
- **CPU usage is very high**, perhaps approaching 100%, yet some tasks stay suspended or ready, but not running, for a long time.
You can check what the CPU usage is for any MVS job by using the DISPLAY ACTIVE command at the MVS console to display the active users.
- **There is reduced activity at terminals**, or possibly no activity at all.
- **One or more CICS regions appear to be stalled**, or to be continuing only slowly.
- **No CICS messages are written** to any destination, when they are expected.
- **No new tasks can be started.**
- **Existing tasks remain suspended.**
- **The CEMT transaction cannot be used.**
- **Repetitive output obtained.** Try looking in these areas:
 - Terminals, and the system console.
 - Temporary storage queues. You can use CEBR to browse them online.
 - Data files and CICS journals.
 - Trace tables, but remember that some loops are intentional—some CICS system tasks use them, for example, to see if there is any work to be done.
- **Excessive demand for storage.** If the loop contains a GETMAIN request, storage is acquired each time this point in the loop is passed, as long as sufficient storage to satisfy the request remains available. If storage is not also freed in the loop, CICS eventually goes short on storage (SOS) in one of the DSAs. You then get a message reporting that CICS is under stress in one of these areas.
One further effect is that tasks issuing unconditional GETMAIN requests are suspended more often as the loop continues and storage is progressively used up. Tasks making storage requests do not need to be in the loop to be affected in this way.
- **Statistics show a large number of automatically initiated tasks.**
- **Large numbers of file accesses** are shown for an individual task.

Some loops can be made to give some sort of repetitive output. Waits and performance problems never give repetitive output. If the loop produces no output, a repeating pattern can sometimes be obtained by using trace. A procedure for doing this is described in “Chapter 7. Dealing with loops” on page 151.

If you are able to use the CEMT transaction, try issuing CEMT INQ TASK repeatedly. If the same transaction is shown to be running each time, this is a further indication that the task is looping. However, note that the CEMT transaction is always running when you use it to inquire on tasks.

If different transactions are seen to be running, this could still indicate a loop, but one that involves more than just a single transaction.

If you are unable to use the CEMT transaction, it may be because a task is looping and not allowing CICS to regain control. A procedure for investigating this type of situation is described in “What to do if CICS has stalled” on page 145.

Consider the evidence you have so far. Does it indicate a loop? If so, turn to “Chapter 7. Dealing with loops” on page 151, where there are procedures for defining the limits of the loop.

Poor performance

A performance problem is considered to be one in which system performance is perceptibly degraded, either because tasks fail to start running at all, or because they take a long time to complete once they have started.

In extreme cases, some low-priority tasks may be attached but then fail to be dispatched, or some tasks may be suspended and fail to resume. The problem might then initially be regarded as a wait.

If you get many messages telling you that CICS is under stress, this can indicate that either the system is operating near its maximum capacity, or a task in error has used up a large amount of storage—possibly because it is looping.

You see one of the following messages when CICS is under stress in one of the DSAs:

DFHSM0131 *applid* CICS is under stress (short on storage below 16MB)

DFHSM0133 *applid* CICS is under stress (short on storage above 16MB)

If there is no such indication, see “Chapter 8. Dealing with performance problems” on page 161 for advice on investigating the problem. However, before doing so, be as sure as you can that this is best classified as a performance problem, rather than a wait or a loop.

Poor application design

If you have only a poorly defined set of symptoms that might indicate a loop, or a wait, or possibly a performance problem with an individual transaction, consider the possibility that poor design might be to blame.

This book does not deal with the principles of application design, or how to check whether poor design is responsible for a problem. However, one example is given here, to show how poor design of an application gave rise to symptoms which were at first thought to indicate a loop.

Environment:

CICS and DL/I using secondary indexes. The programmer had made changes to the application to provide better function.

Symptoms:

The transaction ran and completed successfully, but response was erratic and seemed to deteriorate as the month passed. Towards the end of the month, the transaction was suspected of looping and was canceled. No other evidence of looping could be found, except that statistics showed a high number of I/Os.

Explanation:

The programmer had modified the program to allow the user to compare on the last name of a record instead of the personnel number, which it had done in the past. The database was the type that grew through the month as activity was processed against it.

It was discovered that in making the change, the program was no longer comparing on a field that was part of the key for the secondary index. This meant that instead of searching the index for the key and then going directly for the record, every record in the file had to be read and the field compared. The structure of the source program had not changed significantly; the number of database calls from the program was the same, but the number of I/Os grew from a few to many thousands at the end of the month.

Note that these symptoms might equally well have pointed to a performance problem, although performance problems are usually due to poorly tuned or overloaded systems, and affect more than just one transaction. Performance problems tend to have system wide effects.

What to do next

If you have already decided that you should refer the problem to the IBM Support Center, you can find advice about dealing with the Center in “Chapter 17. IBM program support” on page 305.

Chapter 3. Sources of information

You should find some of the following sources of information useful in problem determination.

- “Your own documentation”
- “Manuals”
- “Source listings and link-edit maps” on page 18
- “Abend codes and error messages” on page 18
- “Symptom strings” on page 18
- “Change log” on page 18
- “Dumps” on page 19
- “Statistics” on page 19
- “Monitoring” on page 19
- “Transaction inputs and outputs” on page 20
- “Traces” on page 21.

Your own documentation

“Your own documentation” is the collection of information produced by your organization about what your system and applications do and how they do it. How much of this kind of information you need depends on how familiar you are with the system or application, and could include:

- Program descriptions or functional specifications
- Record layouts and file descriptions
- Flowcharts or other descriptions of the flow of activity in a system
- Statement of inputs and outputs
- Change history of a program
- Change history of your installation
- Auxiliary trace profile for your transaction
- Statistical and monitoring profile showing average inputs, outputs, and response times.

Manuals

“Manuals” means the manuals in the CICS Transaction Server for OS/390 Release 3 library and the libraries for any other products you use with your application.

Make sure that the level of any manual you refer to matches the level of the system you are using. Problems often arise through using either obsolete information or information about a level of the product that is not yet installed.

Source listings and link-edit maps

Include the source listings of any applications written at your installation with your set of documentation. (They often form the largest single element of documentation. Large installations with thousands of programs might prefer to keep such listings on microfiche or CD-ROM.) Make sure you include the relevant linkage-editor output with your source listings to avoid wasting time trying to find your way through a load module with an out-of-date link map. Be sure to include the JCL at the beginning of your listings, to show the libraries that were used and the load library in which the load module was placed.

Abend codes and error messages

Messages are sent to several transient data destinations, for example:

- CSMT for terminal error and abend messages
- CSNE for messages issued by DFHZNAC
- CSTL for terminal I/O error messages
- CDBC for messages concerning DBCTL
- CSFL for file control messages.

For a list of the destinations used by CICS, see the *CICS System Definition Guide*. Use a copy of the appropriate messages and codes manual to look up any messages whose meaning you do not know. Make sure that you also have some documentation of application messages and codes for programs that were written at your installation, as well as a copy of the *CICS Messages and Codes* manual.

Symptom strings

CICS produces symptom strings in CICS system and transaction dumps and in message DFHME0116.

The symptom string provides a number of keywords that can be directly typed in and used to search the RETAIN database. If your installation has access to the IBM INFORMATION/ACCESS licensed program, 5665-266, you can search the RETAIN database yourself. If you report a problem to the IBM Support Center, you are often asked to quote the symptom string.

Although the symptom string is designed to provide keywords for searching the RETAIN database, it can also give you significant information about what was happening at the time the error occurred, and it might suggest an obvious cause or a likely area in which to start your investigation.

Change log

The information in the change log can tell you of changes made in the data processing environment that may have caused problems with your application program. To make your change log most useful, include the data concerning hardware changes, system software (such as MVS and CICS) changes, application changes, and any modifications made to operating procedures.

Dumps

Dumps are an important source of detailed information about problems. Whether they are the result of an abend or a user request, they allow you to see a snapshot of what was happening in CICS at the moment the dump is taken. “Chapter 15. Using dumps in problem determination” on page 257 contains guidance about using dumps to locate problems in your CICS system. However, because they do only provide a “snapshot”, you may need to use them in conjunction with other sources of information relating to a longer period of time, such as logs, traces, and statistics.

Statistics

Statistics are often overlooked as a source of debugging information, but those that relate to an application program can help solve problems. It is useful to have a statistical profile (as mentioned in “Your own documentation” on page 17) to use for problem determination. If you compare the information in the profile with the statistical information produced by CICS, any differences you find may indicate the source of a problem.

Statistics are most often used in system tuning and diagnosis, but they also contain information that can indicate problems with the way your application handles resources. For example, you may notice from these statistics that tables are being loaded, or programs linked, for which there is no known requirement.

You can also use statistics to check terminals, files, queues, and so on for irregularities in their activity. For example, if a terminal has a number of errors recorded for a particular transaction that equal the number of times that transaction was run, this may indicate that an incorrect data stream is being sent to that terminal. See the *CICS Performance Guide* for more information about using statistics.

Monitoring

You can use CICS monitoring to provide information for debugging applications. In addition to the system-defined event monitoring points (EMPs) that already exist within CICS code itself, you can define user event monitoring points in your own application programs by using the EXEC CICS MONITOR POINT command.

At a user EMP, you can add your own data (up to 256 counters, up to 256 clocks, and a single character string of up to 8192 bytes) to fields reserved for you in performance class monitoring data records. You could use these extra EMPs to count how many times a certain event happens, or to time the interval between two events. Your definitions in the Monitoring Control Table (MCT) specify the type and number of fields that are available for your use within each task’s performance record. For further information on the MCT see the *CICS Resource Definition Guide*. See the *CICS Application Programming Reference* manual for programming information on syntax and options of the MONITOR POINT command.

When your monitoring data has been collected, you can read it into a database using, for example, the Service Level Reporter Version 2 (SLR II).

See the *CICS Performance Guide* for guidance about choosing performance tools. See the *CICS Supplied Transactions* manual for information about the transactions needed to invoke them.

Transaction inputs and outputs

Transaction inputs and outputs can be divided into the following areas:

- Terminal data
- Transient data and temporary storage
- Passed information
- Files and databases

Terminal data

Terminal data is very important in solving problems, because it can help you answer the following questions:

- What data did you enter just before the transaction failed?
- Was there any output? If so, what did it look like?

The more you know about the information that was **input** at the terminal on which the transaction failed, the better your chance of duplicating the problem in a test environment. However, this information may not be precise, especially if there are many fields on the input screen. You are recommended to provide a quick and easy way for terminal operators to report problems, so that they can report the error while they can still see the data on the screen (or at least remember more clearly what it was).

The **output** from a transaction is sometimes easier to capture. If you have a locally attached printer, you can make a copy. (The problem may be that the printer output is incorrect.)

The items to look for on the **input** side are:

- Were all necessary input fields entered?
- Were the contents of the input fields correct?
- Which transmit key was used, (that is ENTER, a PF key, or a PA key)?

On the **output** screen, check the following points:

1. Do all the required fields contain data?
2. Is the data correct?
3. Is the screen format as it was designed?
4. Are there any nondisplay fields used to pass data that may not be protected?

Transient data and temporary storage

If the program explicitly uses any transient data or temporary storage queues, inspect them to see if their content is what you expect. You can use the CICS-supplied transaction, CEBR, to inspect temporary storage queues in some detail. See the *CICS Supplied Transactions* for information about this transaction.

Even if the program does not use queues, look at the system queues for CEMT (or your site replacement) and CSTL (and CDBC if you use DBCTL) to see if there are any relevant messages.

The things you might want to look for in the queues are:

1. Are the required entries there?
2. Are the entries in the correct order?
3. Is the queue being *written* the same one that is being *read*?

Passed information

Be particularly careful when you are using the common work area (CWA) because you only have one area for the entire system. A transaction may depend on a certain sequence of transactions and some other program may change that sequence. If you are using the CWA, you must also know if your CICS is split into multiple MRO regions because there is an independent CWA for each MRO region.

Terminal user areas can have problems because the area is associated with a terminal and not a particular transaction.

If you are using tables in the CWA, remember that there is no recovery; if a transaction updates the table and then abends, the transaction is backed out but the change is not.

Files and databases

Files and databases are often the main source of transaction input and output; you should always investigate both these areas whenever a program is having problems.

To do this, you need to use the appropriate utilities and diagnostic tools for the data access methods that you have at your installation.

Check the various indexes in files and databases. If you have more than one method of accessing information, one path may be working well but another path may be causing problems.

When looking through the data in files, pay particular attention to the record layout. The program may be using an out-of-date record description.

Traces

CICS provides a tracing facility that enables you to trace transactions through the CICS components as well as through your own programs. CICS auxiliary trace enables you to write trace records on a sequential device for later analysis.

For information about the tracing facilities provided by CICS, read "Chapter 14. Using traces in problem determination" on page 227.

Part 2. Dealing with the problem

Chapter 4. Dealing with transaction abends	29
Collecting the evidence	29
Symptom string	29
What the abend code can tell you	30
CICS transaction abend codes	30
AICA abends	30
ASRA abends	30
ASRB abends	31
ASRD abends	31
AEYD abends	31
Finding where a program check occurred	32
What type of program check occurred?	33
Dealing with arithmetic exceptions	35
Dealing with protection exceptions	35
Causes of protection exceptions	36
Transaction isolation	36
Command protection	37
Possible causes of protection exceptions referencing CICS DSAs	37
Protection exceptions referencing the read-only DSAs	38
Protection exceptions referencing the UDSA and EUDSA	38
Analyzing the problem further	39
Abends when CICS is using the DBCTL interface	39
Worksheet for transaction abends	39
FEPI abends	41
Chapter 5. Dealing with CICS system abends	43
The documentation you need	43
Interpreting the evidence	44
Looking at the messages	44
Looking at the exception trace entry	44
Looking at the symptom string in the dump	45
Looking at the kernel domain storage areas	46
Finding which tasks are associated with the error	46
Finding more information about the error	48
The error data for the failing task	50
The storage addressed by the registers and PSW	50
Using the linkage stack to identify the failing module	51
Using the PSW to find the offset of the failing instruction	53
Finding the PTF level of the module in error	53
Chapter 6. Dealing with waits	55
Where to look next	55
Techniques for investigating waits	56
Investigating waits—online method	57
Investigating waits—using trace	57
Setting up trace for wait problems	58
Interpreting trace for wait problems	58
Investigating waits—the formatted CICS system dump	58
Interpreting the dump for wait problems	59
Dispatcher task summary fields	59
Parameters and functions setting fields in the dispatcher task summary	62
How tasks are made to wait	63
Function ADD_SUSPEND of gate DSSR	64

Function INQUIRE_SUSPEND_TOKEN of gate DSSR	65
Function DELETE_SUSPEND of gate DSSR	65
Function SUSPEND of gate DSSR	66
Function RESUME of gate DSSR.	68
Functions WAIT_MVS, WAIT_OLDW, and WAIT_OLDC of gate DSSR	69
WAIT_MVS	69
WAIT_OLDW	69
WAIT_OLDC	69
Input and output parameters for WAIT_MVS, WAIT_OLDW, and WAIT_OLDC	70
INTERVAL and DEADLOCK_ACTION parameters	71
The meanings of RESPONSE values returned on DSSR calls	71
The meanings of the WLM_WAIT_TYPE parameter	72
The resources on which tasks in a CICS system can wait.	74
Dispatcher waits	85
Transaction manager waits	85
Maximum task condition waits	85
Transaction summary	86
MXT summary.	89
Transaction class summary	89
A user task is waiting on resource type FOREVER	89
Lock manager waits.	90
Collecting the evidence	90
CICS DB2 waits	92
Resource type CDB2RDYQ	92
Resource type CDB2TBC	92
Resource type DB2	93
Resource type DB2_INIT	93
Resource type DB2CDISC	93
Resource type DB2EDISA	93
DBCTL waits	93
Connection to DBCTL has failed to complete	93
A user task is waiting on resource type DBCTL	94
Disconnection from DBCTL has failed to complete	94
EDF waits	94
Log manager waits	94
Resource type LG_DEFER	95
Resource type LG_FORCE	95
Resource type LGDELALL	95
Resource type LGDELRAN	95
Resource type LGENDBLK	95
Resource type LGENDCRS	95
Resource type LGREDBLK	95
Resource type LGREDCRS	95
Resource type LGSTRBLK	95
Resource type LGSTRCRS	95
Resource type LGWRITE.	96
Task control waits	96
Resource type KCCOMPAT	96
Resource type KC_ENQ	97
Storage waits	98
Was the request for too much storage?	98
Is the storage close to being exhausted?	98
Is fragmentation of free storage causing the GETMAIN request to fail?	99
Temporary storage waits	99
Resource type ENQUEUE	99

Resource type TSAUX	99
Resource type TSBUFFER	101
Resource type TSEXTEND	101
Resource type TSIO	101
Resource type TSPPOOL	101
Resource type TSQUEUE	101
Resource type TSSHARED	102
Resource type TSSTRING	102
Resource type TSWBUFFER	102
Terminal waits	102
Terminal waits—first considerations	103
Terminal waits—a systematic approach	103
VTAM in use—debugging procedures	105
Tools you can use for debugging terminal waits when VTAM is in use	108
Your task is waiting on a physical terminal	108
VTAM terminal control waits	109
Resource type ZC	110
Resource type ZC_ZCGRP	110
Resource type ZC_ZGCH	110
Resource type ZC_ZGIN	110
Resource type ZC_ZGRP, resource name PSINQECB	111
Resource type ZC_ZGRP, resource name PSOP2ECB	111
Resource type ZC_ZGUB	111
Resource type ZCIOWAIT	111
Resource type ZCZGET	111
Resource type ZCZNAC	111
Resource type ZXQOWAIT	111
Resource type ZXSTWAIT	111
Interregion and intersystem communication waits	111
Transient data waits	112
Resource type TD_INIT—waits during initialization processing	112
Resource type TDEPLOCK—waits for transient data extrapartition requests	112
Resource types TDIPLOCK, ENQUEUE, TD_READ, Any_MBCB, Any_MRCB, MBCB_xxx, and MRCB_xxx	113
Loader waits	115
Enqueue waits	116
Using a system dump to resolve enqueue waits	116
EXEC CICS ENQ waits	118
File control waits	119
Resource type CFDTWAIT—wait for CFDT request to complete	121
Resource type CFDTPPOOL - wait for CFDT a request slot	121
Resource type CFDTLRSW - wait for CFDT locking request slot	121
Resource type FCACWAIT & FCCRWAIT—wait for SMSVSAM cleanup	121
Resource type FCBFWAIT—waits for VSAM buffers	122
Resource type FCCAWAIT—waits on the SMSVSAM control ACB	122
Resource type FCCFQR—wait for SMSVSAM server notification	122
Resource type FCCFQS—wait for user task to issue quiesce	123
Resource type FCDWWAIT—wait for VSAM upgrade set activity	123
Resource type FCFSWAIT—wait for file state changes	123
Resource type FCIOWAIT—wait for VSAM I/O (non-RLS).	123
Resource type FCIRWAIT—wait for FC environment to be rebuilt	124
Resource types FCPSWAIT and FCSRSUSP—waits for VSAM strings	124
Resource type FCQUIES—wait for a quiesce request to complete	125
Resource type FCRAWAIT—file control to process non-recoverable requests	125
Resource type FCRBWAIT—file control to process recoverable requests	125

Resource type FCRDWAIT—wait for a drain of the RLS control ACB . . .	125
Resource type FCRPWAIT—wait for file control initialization to complete . . .	126
Resource Type FCRRWAIT—wait for dynamic RLS restart to complete . . .	126
Resource type FCRVWAIT—wait for VSAM I/O (RLS)	126
Resource type FCTISUSP—wait for a VSAM transaction ID	127
Resource type FCXCWAIT—VSAM exclusive control wait.	127
Resource type ENQUEUE—waits for locks on files or data tables	129
Resolving deadlocks in a CICS region	131
Resolving deadlocks in a sysplex.	135
Interval control waits	136
Finding the reason for a DELAY request not completing	137
Using trace to find out why tasks are waiting on interval control	138
XRF alternate system waits	141
XRSTIECB	142
XRSIAECB	142
XRSTCECB	142
XRSRAECB	143
XRSSSECB	143
XRSSTECB.	143
CICS system task waits	143
FEPI waits	144
Recovery manager waits	144
Resource type RMCLIENT	144
Resource type RMUOWOBJ, resource name LOGMOVE	145
Resource type RMUOWOBJ, resource name EXISTENC	145
Resolving in-doubt and resynchronization failures	145
What to do if CICS has stalled.	145
CICS has stalled during initialization.	145
CICS has stalled during a run	146
CICS has stalled during termination	148
Chapter 7. Dealing with loops	151
What sort of loop is indicated by the symptoms?	151
Tight loops and non-yielding loops	152
Yielding loops	154
Investigating loops that cause transactions to abend with abend code AICA	156
The documentation you need	156
Looking at the evidence	156
Identifying the loop	157
Using the trace table	157
Using the transaction dump	157
Finding the reason for the loop	158
Investigating loops that are not detected by CICS.	158
The documentation you need	159
Identifying the loop	159
Finding the reason for the loop	160
What to do if you cannot find the reason for a loop	160
Investigating loops using interactive tools	160
Modifying your program to investigate the loop	160
Chapter 8. Dealing with performance problems	161
Finding the bottleneck	161
Initial attach to the transaction manager	162
Initial attach to the dispatcher	163
Initial dispatch	163
The dispatch, suspend, and resume cycle	163

Why tasks fail to get attached to the transaction manager	163
Why tasks fail to get attached to the dispatcher	164
Is the MXT limit preventing tasks from getting attached?	164
Why tasks fail to get an initial dispatch	166
Priorities of tasks	166
Why tasks take a long time to complete	168
The effect of system loading on performance	168
The effect of task time-out interval on performance	168
The distribution of data sets on DASD volumes	168
A summary of performance bottlenecks, symptoms, and causes	169
Chapter 9. Dealing with incorrect output	171
Trace output is incorrect	171
Tracing has gone to the wrong destination	171
You have captured the wrong trace data	172
You are not getting the correct task tracing	173
You are not getting the correct component tracing	173
The entries you want are missing from the trace table	174
Dump output is incorrect	175
The dump you got did not seem to relate to your CICS region	175
You did not get a dump when an abend occurred	176
How dumping can be suppressed	176
Global suppression of system dumping	176
Suppression of system dumping from a global user exit program	177
Suppression of dumping for individual transactions	177
Suppression of dumping by dump table options	177
Some dump IDs were missing from the sequence of dumps	178
You did not get the correct data formatted from a CICS system dump	179
Wrong data has been displayed on a terminal	179
The preliminary information you need to get	179
Specific types of incorrect output, and their possible causes	180
Tools for debugging terminal output in a VTAM environment	185
Incorrect data is present on a VSAM data set	186
An application did not work as expected	186
General points for you to consider	186
Using traces and dumps	186
Your transaction produced no output at all	187
Are there any messages explaining why there is no output?	187
Can you use the terminal where the transaction should have started?	187
No output—what to do if the task is still in the system	188
No output—what to do if the task is not in the system	188
Did the task run? Techniques for all tasks	188
Using CICS system trace entry points:	188
Using EDF	189
Using CEDX	189
Using statistics	190
Using CEBR	190
Using CECI	191
Disabling the transaction	191
Investigating tasks initiated by ATI	191
The ICE chain	191
The AID chain	192
Your transaction produced some output, but it was wrong	193
The origins of corrupted data	193
Were records in the file incorrect or missing?	194
Was the data mapped correctly into the program?	194

Is the data being corrupted by bad programming logic?	194
Is the data being mapped incorrectly to the terminal?	195
Chapter 10. Dealing with storage violations	197
Avoiding storage violations	197
Two kinds of storage violation	197
CICS has detected a storage violation	198
What happens when CICS detects a storage violation	200
What the transaction abend message can tell you	200
What the CICS system dump can tell you.	200
What to do if you cannot find what is overlaying the SAA	201
How you can force storage chain checking	201
What happens after CICS detects the storage violation?	203
Storage violations that affect innocent transactions	203
A strategy for storage violations affecting innocent transactions.	204
Procedure for resolving storage violations affecting innocent transactions	204
What to do if you still cannot find the cause of the overlay	205
Programming errors that can cause storage violations	205
Storage recovery.	205
Chapter 11. Dealing with external CICS interface (EXCI) problems	207
Chapter 12. Dealing with MRO problems	209
Chapter 13. Dealing with log manager problems	211
Categories of problem	211
Exceeding the capacity of a log stream	212
System log	212
General logs	212
CICS checks for the availability of the MVS logger	213
Diagnosis of problems in the MVS logger	213
Console messages and dumps	213
GRS resource contention.	214
Checking CF structure and couple data set status	215
Checking log stream status	216
SMF and RMF statistics	218
Obtaining MVS logger and coupling facility dumps	218
Setting a SLIP trap	218
Restarting the MVS logger address space	220
Dealing with a corrupt system log.	220
The CICS diagnostic run mechanism	220
Getting dumps of the MVS logger and CF address spaces	221

Part 2 contains:

Chapter 4. Dealing with transaction abends

This section gives guidance about finding the cause of transaction abends.

When a CICS transaction **abends** (ends abnormally), a transaction abend message and an abend code of four alphanumeric characters are sent to CSMT, the CEMT transient data destination (or your site replacement). This is an example of what the message looks like:

```
DFHAC2006 date time applid Transaction tranid program program name abend  
primary abcode at termid.
```

The message contains several vital pieces of information. It identifies the transaction (*tranid*) that failed, and the program (*program name*) that was being executed when the failure was detected. Most importantly, it gives you the abend code (*abcode*), indicating the nature of the error.

The transaction abend can originate from several places, and the method you use for problem determination depends on the source of the abend. The procedures are described in the sections that follow. As you go through them, you might like to use the worksheet that is included at the end of this section to record your findings (“Worksheet for transaction abends” on page 39).

Collecting the evidence

You should find all the evidence you need to investigate the transaction abend in the information sent to the various transient data queues for error messages, and in the transaction dump. If no transaction dump has been produced, it is possible that transaction dumping has been suppressed for the transaction (via the transaction definition), or the dump code entry in the transaction dump code table suppresses dumping. For guidance about changing the dumping options so that you get a transaction dump, see “Chapter 15. Using dumps in problem determination” on page 257.

The transaction abend code and the abend message are recorded in the CSMT log. Make a note, too, of any other messages you find there that might relate to the abend, as they could provide additional valuable evidence.

Check also to see if any relevant messages have been sent to the transient data destinations used by CICS to record messages. For a list of destinations used by CICS, see the *CICS System Definition Guide*. Look in particular for any messages about files, terminals, or printers that you might be attempting to use.

Symptom string

CICS produces a symptom string as part of the transaction dump. The symptom string gives some details about the circumstances of the transaction dump. It might show, for example, that the dump was taken because the transaction abended with the abend code ASRA. If you refer the problem that caused the dump to be taken to the IBM Support Center, they will use the symptom string to search the RETAIN database for problems similar to it. For an introduction to symptom strings and their contents, see “Looking at the symptom string in the dump” on page 45.

What the abend code can tell you

The first thing that the transaction abend code can indicate is whether or not this was a CICS abend. CICS transaction abend codes begin with the letter “A”. A user program or another product might also use abend codes beginning with “A”. However, if the transaction abend code begins with anything other than “A”, it is an abend code belonging to a user program or to some other product. For the sake of convenience, all such non-CICS abend codes are referred to in this section as user abend codes.

For an introduction to the types of transaction abend codes used by CICS and by other IBM products, see the *CICS Messages and Codes* manual.

If you have received a user abend code, it can still be difficult to find out which program is responsible for it unless you have adequate documentation. For this reason, it is good practice for all programmers who issue abends from within their programs to document the codes in a central location at your installation.

As far as vendor products are concerned, the documentation includes, in most cases, a list of abend codes that are issued from the programs making up the products. This list, together with the documentation for your internal applications, should make it possible for you to find what caused the abend. If it is not clear why the user abend was issued, you might need to describe the problem to the owner of the program.

CICS transaction abend codes

Your best source of information on CICS abends is the *CICS Messages and Codes* manual. That book contains a section that lists all transaction abend codes issued by CICS. There is an explanation of why the code was issued, followed by details of system and user actions. The same information is available online, using the CICS-supplied messages and codes transaction, CMAC.

If, after reviewing the material in the *CICS Messages and Codes* manual, you cannot find the cause of the problem, continue with the procedures described here. The abend codes AICA, ASRA, ASRB, ASRD and AEYD are dealt with separately because special procedures apply to them. If your abend code was something other than these, use the procedures in “Last statement identification” on page 281, to find the last command that was executed, and then turn to “Analyzing the problem further” on page 39.

AICA abends

If your transaction terminated with abend code AICA, the transaction is likely to have been in a loop. You can find detailed guidance about dealing with loops in “Chapter 7. Dealing with loops” on page 151.

ASRA abends

CICS issues an ASRA abend code when it detects that a program check has occurred within a transaction. Program checks can occur for a wide variety of reasons, but you can find the nature of the error from the program interrupt code in the program status word (PSW). The PSW is used by the machine hardware to

record the address of the current instruction being executed, the addressing mode, and other control information. The PSW gives you the address at which the program check occurred, and so it represents a record of the circumstances of the failure.

ASRB abends

A transaction can abend with an abend code of ASRB when a program issues the MVS ABEND macro. For example, BDAM issues this ABEND macro when it detects errors, rather than sending a return code to the calling program. CICS is notified when an MVS abend occurs, and in turn issues an ASRB abend code for the transaction.

Use the procedures outlined in “Locating the last command or statement” on page 280 to find the origin of the abend in your program. That information, together with the description and procedures for ASRB abends given in the *CICS Messages and Codes* manual, should be sufficient for you to solve the problem.

ASRD abends

A transaction abends with code ASRD if:

- An application program attempts to invoke CICS macros.
- An application program attempts to access the CSA or TCA.
- An application program issues an EXEC CICS ADDRESS CSA command, and attempts to access storage addressed by the pointer that is returned.
- A COBOL application program attempts to access the CSA via a BLL cell.

Any of the above causes a program check that CICS diagnoses as an ASRD abend, rather than the usual ASRA abend. You can use the information in the PSW to investigate the cause of an ASRD abend.

AEYD abends

If command protection is activated by the CMDPROT(YES) option in the system initialization table (SIT), the AEYD transaction abend can occur. CICS terminates a transaction with this code when an output parameter of an EXEC CICS command addresses storage that the issuing transaction could not itself directly overwrite.

At the time of the abend, register 2 points to the parameter area containing the invalid address. The trace should include an exception trace entry created by DFHEISR. This entry should identify the parameter in error. If the abend is handled, EXEC CICS ASSIGN ASRASTG, ASRAKEY, ASRASPC, and ASRAREGS can give additional information.

To prevent a recurrence of the abend, it is recommended that you correct the program code. Alternatively, changing one or more of the following options may alleviate the problem:

- EXECKEY in the program definition, if storage protection is active
- TASKDATAKEY in the transaction definition
- ISOLATE in the transaction definition, if transaction isolation is enabled

For further information, see “Avoiding storage violations” on page 197.

Finding where a program check occurred

When a transaction abends with code ASRA or ASRD, the first thing you need to do is find out where the program check occurred. CICS will have attempted to establish this for you. A record of the program in error and the offset of the program check within the program load module are contained in the following places:

- Message DFHAP0001 or DFHSR0001, which will have preceded the abend
- The transaction abend control block (TACB) which will have been created to describe the abend
- Exception trace point ID AP 0781 for an ASRA abend or AP 0783 for an ASRD abend.

See “Interpreting transaction dumps” on page 276.

The offset indicates the point in the program at which the program check occurred. Note that the offset is derived from the PSW next sequential instruction address and so may indicate the instruction **after** the one that failed. Unless the offset is X'FFFFFFFF', turn to “What type of program check occurred?” on page 33.

If the offset appears as X'FFFFFFFF', CICS was unable to establish the location of the program check. If this is the case, use the PSW to obtain the next sequential instruction address. The PSW may be found in the following places:

- The TACB for the abend
- At the head of the formatted transaction dump
- Within the kernel error data block traced by exception trace point IDs AP 0781 or AP 0783

Now note down the start and end addresses of the different program areas in the transaction dump. Is the next sequential instruction address from the PSW in any of the programs? If so, then that is the program in which the interrupt occurred. Use the procedure described in “Locating the last command or statement” on page 280 to identify the last command executed.

If the address is *outside* all of the programs, one of two things is likely to have happened.

- The program in which the program check occurred was running on your behalf (for example, VSAM or DL/I), but not under CICS control. This is usually caused by incorrect parameters being passed to the program, or parameters being passed in the wrong sequence. These are usually caught and flagged with an appropriate return code, but certain combinations can cause problems.
- Your program might have taken a “wild” branch into some other piece of storage. If the address from the PSW ends in an odd number, this is probably the case, as valid instructions are always on an even address. The address could be within the CICS address space, or anywhere else in virtual storage.

Often, a wild branch is taken to address zero, because the register that should contain the branch address is set to zero. The PSW usually contains address X'00000004' after such a branch has occurred.

Check the register contents to see whether any of them contains the next sequential instruction address from the PSW, or something close to it. This might help you find out how you got to the wrong address.

If the PSW does point to an instruction in one of your programs, the next thing to consider is the type of program check that occurred. Otherwise, turn directly to “Analyzing the problem further” on page 39.

What type of program check occurred?

Knowing what type of program check occurred can be helpful in finding the cause of the error. This is indicated by the program interrupt code (PIC), which you can find in the PSW at the start of the transaction dump. You can find information about the PSW in ESA/370 from the *IBM Enterprise Systems Architecture/370 Principles of Operation*.

PIC PIC explanation

1 Operation exception—incorrect operation attempted.

Some possible causes

- Overlaid program
- Overlaid register save area, causing incorrect branch
- Resource unavailable, but program logic assumed valid address returned and took inappropriate action
- Incorrect branch to data that contains no instruction known to the machine
- In an assembler-language program, a base register was inadvertently changed

2 Privileged operation—this program is not authorized to execute this instruction.

Some possible causes

- Incorrect branch to this code; may be due to:
 - Overlaid register save area
 - Program overlaid by data that contains the privileged operation code

3 Execution exception—you are not allowed to EXECUTE an EXECUTE instruction.

Some possible causes

- Incorrect branch to this code
- Incorrect register contents; may be due to:
 - Overlaid register save area
 - Program overlaid by data that contains the incorrect instruction
 - Incorrect program logic

4 Protection exception—read or write access violation has occurred.

Some possible causes

- Resource unavailable, and return code not checked. Program logic assumed valid address returned and took inappropriate action.
- Incorrect interface parameters to some other program or subsystem (for example, VSAM or DL/I).
- Overlaid register save area, causing incorrect reference to data.
- In an assembler-language program, incorrect initialization or modification of a register used to address data.

- Attempt to access internal control blocks illegally or use a CICS system or application programming macro call.
- Attempt to write to storage for which the application does not have an adequate key. For example, in a CICS system with storage protection, an application running in USER key attempts to write to the CDSA, the ECDSA or the ERDSA.
- Attempt to write to the ERDSA or RDSA when PROTECT is specified for the RENTPGM parameter.
- Attempt to read or write to another transaction's storage. For example, in a system running with transaction isolation, a program executing in USER key may suffer a protection exception when attempting to access the USER key task-lifetime storage of another transaction.
- Storage, passed to CICS as an output parameter through the EXEC interface, that is not addressable by the application issuing the call. The transaction is abended AEYD, and the PSW shows that a protection exception has occurred.

5 Addressing exception—the address that you referenced is not available or is not valid.

Some possible causes

- Incorrect register contents; may be due to:
 - Overlaid register save area.

6 Specification exception—incorrect format of an instruction or invalid registers.

Some possible causes

- Overlaid program
- Incorrect field lengths used in packed decimal multiply and divide instructions
- Branch to an odd-numbered address, caused by an overlaid register save area

7 Data exception—data invalid in a packed or signed display decimal operation. One, or possibly both, of the operands contain data not suitable for the instruction.

Some possible causes

- Incorrect input data (often because blanks have been used where numeric data is expected)
- Overlaid data
- Overlaid register save area, causing an incorrect branch
- Incorrect program logic, execution of code with uninitialized variables
- Wrong length

8 through F

Arithmetic exceptions, such as divide checks, overflow, and underflow. They differ in the form of arithmetic that was being used—binary, packed decimal, or floating point.

Some possible causes

- Incorrect user data
- Overlaid data areas
- Overlaid register save area, causing incorrect reference to data

10 and above

Program checks associated with system-related interrupts.

Dealing with arithmetic exceptions

If the program check was due to an arithmetic error (interruption codes 7 through F), you need to find the operands used in the last instruction. Use the procedure described in section “Locating program data” on page 282 to locate the fields. You need to know a little about the type of arithmetic being done, so that you can tell if the operands are valid. The interrupt you received tells you what sort of arithmetic the system was doing (binary, packed decimal, or floating point), but you need to determine if that is what you had intended to do. You might need to consult a programming language manual if you have any queries about this.

When you have identified the operands, you need to decide where the problem is. Questions to consider include:

- Has the data been overlaid?
- Has the value been changed by faulty logic?
- Does the data type not match the operation type? For example, if you define the variable as being packed decimal and then you read in binary information, this causes a ‘data exception’ error.

Dealing with protection exceptions

With the storage protection facility, there are further situations in which a protection exception (interrupt code 4) may occur:

- An attempt is made to write to the CDSA, ECDSA, or ERDSA, when storage protection is active and the application is running in user key
- An attempt is made to write to the ERDSA or RDSA when PROTECT is specified for the RENTPGM system initialization parameter.

If transaction isolation (for which storage protection is a prerequisite) is enabled, additional situations can occur:

- A transaction, defined with ISOLATE(YES), is executing a USER key program and attempts to read or write to another transaction’s USER key task-lifetime storage in the UDSA or EUDSA.
- A transaction, defined with ISOLATE(NO), is executing a USER key program and attempts to read or write to another transaction’s USER key task-lifetime storage in the UDSA or EUDSA, but the second transaction is defined with ISOLATE(YES). (For a full description of the transaction isolation facility and its use, see the *CICS Resource Definition Guide*.)

If any of these events occurs, CICS abnormally terminates the transaction with abend code ASRA and issues message DFHSR0622 which identifies the DSA over which the program attempted to write. This information is in the TACB and is traced by exception trace point ID AP 0781. It is also useful to know the execution key of the program at the time of the protection exception and whether the program was executing in a subspace (CDSA, ECDSA, RDSA, ERDSA, UDSA, or EUDSA). This appears in the TACB, exception trace point ID AP 0781 and at the head of the formatted transaction dump.

If the command protection facility is enabled, a protection exception can occur if storage, passed to CICS as an output parameter through the EXEC interface, is not

accessible for READ/WRITE by the program issuing the command. The program is passing to CICS storage that it cannot itself update, but it requires CICS to update the storage. The transaction terminates abnormally with abend code AEYD. CICS creates an exception trace entry AP 0779 and saves relevant data in the TACB that is formatted at the beginning of the transaction dump.

Note

Storage protection, transaction isolation, and command protection are facilities that add data integrity by highlighting application errors. In previous releases, such errors may not have been detected or may have appeared as CICS problems. The use of these facilities greatly reduces the number of abends that appear to be CICS problems.

It is still possible for CICS to abend when the problem is in the application. For example, command protection only checks output parameters and does not prevent the passing of fetch-protected storage as an input parameter to CICS. When CICS attempts to read such storage, an ASRA abend occurs.

Causes of protection exceptions

CICS storage protection is intended to prevent application programs erroneously overwriting CICS programs and control blocks. The occurrence of a protection exception in a new program running in a system with storage protection active probably indicates an error in the application program. However, when existing programs which need to be defined with EXECCKEY(CICS) are first migrated to a system with storage protection active, protection exceptions may well occur.

Any application program causing a protection exception when defined with EXECCKEY(USER) must be examined to determine why it is attempting to modify storage that it is not allowed to modify. Its definition should be changed to EXECCKEY(CICS) only if it is determined that the application program is legitimately accessing CICS key storage, and the exception is not the result of an application error.

Programs might also be incorrectly link-edited as reentrant, and, as a result, loaded by CICS into one of the read-only DSAs (RDSA, ERDSA). When such an incorrectly defined program attempts to modify itself, or another program tries to modify it, a protection exception occurs. The program should be checked to see whether it should be redefined as non-reentrant, or whether the program should be changed to be truly reentrant. The protection exception might indicate that the program uses poor programming techniques that could result in other problems if uncorrected.

Transaction isolation

Transaction isolation protects the data associated with a user transaction from being overwritten by EXECCKEY(USER) programs invoked by other user transactions. If transaction isolation is active, the occurrence of a protection exception in a new transaction indicates a probable error in the transaction or program definition. An interdependency may exist between two or more transactions. In a system running without transaction isolation, a transaction can read or write to the task-lifetime storage of another transaction. The Transaction Affinities Utility helps to identify potential dependencies. Ideally such interdependencies should be removed. If interdependencies cannot be removed, define all affected transactions with

ISOLATE(NO). For further details about defining transactions, see the *CICS Resource Definition Guide*. For more information about the Transaction Affinities Utility, see the *CICS Transaction Affinities Utility Guide*.

When migrating from a CICS 3.3 system to CICS Transaction Server for OS/390 Release 3, it may be helpful to alter all transaction definitions to include the ISOLATE(NO) option. Then gradually change the definitions to use ISOLATE(YES) as interdependencies are removed. This facilitates manageable migration to a system that takes full advantage of the transaction isolation facility.

Command protection

Command protection prevents CICS from updating storage if the storage address is passed as a command output parameter by a transaction that is not authorized to update that storage. The transaction terminates with abend code AEYD. The exception trace entry AP 0779 supplies details of the failing program and command. When migrating to a system with command protection enabled, EXEC commands that pass unauthorized storage are identified and can be corrected.

Possible causes of protection exceptions referencing CICS DSAs

The following is a summary of some of the causes of protection exceptions that can occur in user key programs:

- Issuing an MVS macro request. Most MVS macros and services are not supported in EXECKEY(USER) application programs. Use of unsupported macros and services may cause a failure if these macros or services attempt to reference MVS storage outside the CICS DSAs.
- Referencing storage obtained by an MVS GETMAIN request or another MVS macro. MVS storage obtained by these methods resides outside the CICS DSAs, and is therefore protected from user key programs.
- Using PL/I statements, COBOL verbs or compiler options that are not permitted in CICS application programs (see the *CICS Application Programming Guide* for details of prohibited language statements and compiler options). For example, the use of dynamic link in OS/VS COBOL, CALL with the RES compiler option, or a verb such as INSPECT, may also cause MVS storage outside the CICS DSAs to be obtained or updated (such storage is protected from user-key programs).

In previous releases of CICS, these may have worked, or at least may not have caused the application to fail. However, the use of these statements and options can have other effects on the overall execution of the CICS system, and should be removed where possible.

- Modifying the CWA when CWAKEY=CICS is specified as a system initialization parameter. In a user key program, this is an invalid reference to storage allocated from the CDSA or ECDSA.
- Modifying the TCTUA when TCTUAKEY=CICS is specified as a system initialization parameter. In a user key program this is an invalid reference to storage allocated from the CDSA or ECDSA.
- Issuing EXEC CICS EXTRACT EXIT command and attempting to update an exit program's global work area. In a user key program this is an invalid reference to storage allocated from the CDSA or ECDSA.

Note: If you are using CSP/AD, CSP/AE, or CSP/RS, you must ensure that the definitions for programs DCBINIT, DCBMODS, DCBRINIT and DCBNCOP specify EXECKEY(CICS). These are all examples of programs that modify global work areas set up by global user exit programs.

- If you are using DB2® and you use the DB2 message formatting routine DSNTIAR, which is link-edited with your application programs, you should apply the PTF for DB2 APAR PN12516, and relink-edit the applications using DSNTIAR so that they may run in user key. If the applications are not re-link-edited after this PTF is applied, they will have to run in CICS key. As a first step, until you have applied this PTF, you can define the applications which use DSNTIAR with EXECCKEY(CICS).

Protection exceptions referencing the read-only DSAs

Protection exceptions occurring in programs resident in the ERDSA and RDSA are caused by the program not being truly reentrant. It might be that the program should not be defined as reentrant, or it might be that the program should be reentrant but is using poor coding techniques which should be corrected rather than making the program non-reentrant. For example:

- Using static variables or constants for fields which are set by CICS requests. For example, in assembler coding, if the LENGTH parameter for a retrieval operation such as EXEC CICS READQ TS is specified as a DC elsewhere in the program, a constant is set up in static storage. When CICS attempts to set the actual length into the data area, it causes a protection exception if the program is in the ERDSA or RDSA.

In some cases, for example EXEC CICS READ DATASET INTO () LENGTH() ..., the LENGTH value specifies the maximum length that the application can accept, and is set by CICS to contain the actual length read on completion of the operation. Even if the program does not have RENT specified, using a variable in the program itself for this length could cause problems if the program is being executed concurrently for multiple users. The first transaction may execute correctly, resulting in the actual record length being set in the LENGTH parameter, which is then used as the maximum length for the second transaction.

- Defining a table with the RENT attribute and then attempting to initialize or update the table during CICS execution. Such a table should not be defined as RENT.
- Defining BMS mapsets as RENT can cause a protection exception, if CICS attempts to modify the mapsets. In some cases, CICS needs to modify BMS mapsets during execution. Mapsets should not be link-edited with the RENT attribute. BMS mapsets should be loaded into CICS key storage (because they should not be modified by application programs) which means they must not be link-edited with the RENT attribute. (Partition sets are not modified by CICS and can be link-edited with the RENT attribute.)

Protection exceptions referencing the UDSA and EUDSA

In a system running with transaction isolation enabled, protection exceptions can occur in programs with EXECCKEY(USER). Such an exception is caused by one transaction using a USER-key program to read or write to the USER key task-lifetime storage of another transaction. This may highlight a program error or an interdependency between two transactions. The IBM CICS Transaction Affinities Utility MVS/ESA can help to identify potential transaction interdependencies. Examples of transaction interdependencies are:

- A transaction may use EXEC CICS GETMAIN to obtain storage, and pass the address of the storage to other transactions. Access to this storage by one of these other transactions causes a protection exception if transaction isolation is enabled, unless both affected transactions are defined with ISOLATE(NO).

Storage to be shared in this manner should be acquired by a GETMAIN with the SHARED option. This is preferable to defining the transactions with ISOLATE(NO).

- A transaction may attempt to post an ECB that exists in another transaction's task-lifetime storage. ECBs should be acquired by a GETMAIN from shared storage. Alternatively, the affected transactions should be defined with ISOLATE(NO).

Analyzing the problem further

You should now know the point in the program at which the abend occurred, and what the program was attempting to do.

- If your program uses or calls other programs or systems, examine the interface and the way you pass data to the program. Are you checking the returned information from the other system? Incorrect logic paths based on incorrect assumptions can give unpredictable results.
- Examine the flow of your program using tools like the Execution Diagnostic Facility (CEDF). Check the transient data and temporary storage queues with the CICS browse transaction (CEBR), and use the CICS command-level interpreter and syntax checker transactions (CECI and CECS). If necessary, insert additional statements into the program until you understand the flow.
- Look at any trace output you might have. If you have a "normal" trace output included in the documentation, compare the two for differences.
- Define the current environment, and try to isolate any changes in it since your program last worked. This can be difficult in large installations, because so many people interact with the systems and slight changes can affect things that seem unconnected.

Abends when CICS is using the DBCTL interface

If a transaction terminates abnormally while CICS is using DBCTL, you need to determine whether CICS or IMS™ was in control at the time of the abend. You can do this by examining the time stamps in the CICS and DBCTL traces. For guidance about this, see the *CICS IMS Database Control Guide*.

If tracing was off at the time of the failure, you can find an indicator in the task local work area for DFHDBAT. The indicator is set when CICS passes control to DBCTL, and reset when DBCTL returns control to CICS.

To find the indicator, locate the eye-catcher for the TIE in the dump and then locate the LOCLAREA eye-catcher that follows it. The indicator is at offset X'14' from the start of the LOCLAREA eye-catcher. If the indicator byte is set to X'08', CICS has passed control to DBCTL, and you should examine the IMS part of the transaction. If the byte is set to X'00', DBCTL has returned control to CICS, and you should investigate the CICS part of the transaction.

Worksheet for transaction abends

1. Record the abend code and messages

Find the abend code from the heading of the dump and record any pertinent messages.

2. Is this a CICS or a USER abend code?

For a CICS abend code, go to step 3.

If this is a USER abend code, tell the appropriate person.

3. Look up the abend code

If you need further advice, go to step 4.

4. Is this an AICA abend?

Yes; read "Chapter 7. Dealing with loops" on page 151.

No; go to step 5.

5. Is this an ASRA abend?

Yes; go to step 7.

No; go to step 6.

6. Is this an ASRD abend?

Yes; go to step 7.

No; go to step 14.

7. Record the program areas from the dump.

Begin Address End Address Program Name

Find the program names from the Module Index at the end of the formatted dump.

Begin Address	End Address	Program Name

8. Record the address of the next instruction from the PSW, or the offset established by CICS.

Offset/address of next instruction

9. Did the program check occur in one of the program areas listed above?

Yes; go to step 10.

No; go to step 14.

10. Record what type of program check occurred.

Program Interrupt Code

11. Find the last statement executed.

Last Statement Executed

(See "Locating the last command or statement" on page 280.)

12. Was the PIC one of the arithmetic interrupts (7,8,9,A,B,C,D,E,F)?

No; go to step 15.

Yes; find the contents of the operands of the last instruction.

Contents

(See "Locating program data" on page 282.)

Now go to step 15.

13. Was the PIC a protection exception?

No; go to step 15.

Yes; see "Dealing with protection exceptions" on page 35 and go to step 15.

14. Find the last statement executed.

Last Statement Executed

(See "Locating the last command or statement" on page 280.)

15. Analyze the problem and the data gathered.

For most problems you should now have enough information to solve the problem. If you still cannot find the source, recheck the following:

1. Parameters to or from other programs or systems.
2. Any needed resource that may not be available.
3. The formatted trace, for any unexplained flow.
4. The running environment, for any changes in it.

FEPI abends

For information about FEPI-associated abends in CICS or MVS, see the *CICS Front End Programming Interface User's Guide*.

Chapter 5. Dealing with CICS system abends

The purpose of this section is to give guidance about gathering essential information about CICS system abends. You are likely to be reading it for any of these reasons:

- A message has alerted you that a CICS system abend has occurred.
- You have been directed here from the *CICS Messages and Codes* manual, or the symptom code given in a message has prompted you to look here.
- The symptom string at the head of a system dump gives insufficient information about the cause of a CICS system abend.

If you have not yet done so, use the CMAC transaction or look in the *CICS Messages and Codes* manual for an explanation of any message you may have received, because it could offer a straightforward solution to your problem.

If the abend was clearly caused by a storage violation, turn directly to “Chapter 10. Dealing with storage violations” on page 197. You know when CICS has detected a storage violation, because it issues this message:

DFHSM0102 *applid* **A storage violation (code X'*code*') has been detected by module *modname*.**

On reading this section, you may find that the abend was due to an application error. In this case, you need to look at the application to find out why it caused the abend. However, if you find that a CICS module seems to be in error, you need to contact the IBM Support Center. Before doing so, you must gather this information:

- The name of the failing module, and the module level
- The offset within the module at which the failure occurred
- The instruction at that offset
- The abend type.

This section tells you how to find out all of these things, and contains the following topics:

- “The documentation you need”
- “Interpreting the evidence” on page 44.

The documentation you need

The primary documentation you need for investigating abends is the system dump, taken at the time the error occurred. This usually contains all the evidence needed to find the cause of the problem.

If system dumping is permitted for the dump code, and if system dumping has not otherwise been disabled, a system dump will have been taken when the error was detected. You can find out which dump relates to which message, because the time stamps and the dump IDs are the same.

If a system dump was not taken when the abend occurred, you need to find out why. Use the procedure described in “You did not get a dump when an abend

occurred” on page 176, and follow the advice given there. When you are sure that dumping is enabled for the appropriate system dump code, you need to recreate the system abend.

You can use the interactive problem control system (IPCS) to process dumps and view them online. See “Formatting system dumps” on page 283 for guidance about processing dumps using IPCS VERBEXIT parameters. The kernel domain storage areas (formatting keyword KE) and the internal trace table (formatting keyword TR) are likely to be the most useful at the start of your investigation.

The formatted output for kernel domain (search for the eye-catcher ===KE) contains summary information about the error. The internal trace table (eye-catcher ===TR) contains the exception trace entry (if any) that was made at the time the error was detected.

Later, you might find that storage summaries for the application, transaction manager, program manager, dispatcher, and loader domains (formatting keywords AP, XM, PG, DS, and LD, respectively) are also useful. In each case, level-1 formatting is sufficient in the first instance.

You can format and print the dump offline. Details of how to do this are given in the *CICS Operations and Utilities Guide*.

You may need to copy the dump so that you can leave the system dump data set free for use, or so that you have a more permanent copy for problem reporting.

Whether you look at the dump online or offline, do not purge it from the dump data set until you have either copied it or finished with it—you might need to format other areas later, or the same areas in more detail.

Interpreting the evidence

The first things to look at are any **messages** accompanying the abend, the **exception trace entry** in the internal trace table, and the **symptom string** at the start of the dump.

Looking at the messages

Any messages that accompany a CICS system abend can sometimes point directly to the cause of the failure. For every case, advice about how to react to a message is given in the *CICS Messages and Codes* manual.

Looking at the exception trace entry

When a CICS system abend occurs, an exception trace entry is made to the internal trace table and any other active trace destination. It does not matter whether you have tracing turned on or not—the trace entry is still made.

If the trace table contains more than one exception trace entry, it is likely that the last one is associated with the dump. However, this might not always be the case, and you should make sure that you have found the correct entry. Be aware, too, that dumps can sometimes be requested without a corresponding exception trace entry being made.

The exception trace entry gives information about what was happening when the failure occurred, and data that was being used at the time.

For details of trace entries, see “Chapter 14. Using traces in problem determination” on page 227.

Looking at the symptom string in the dump

The symptom string in a system dump is similar to the short symptom string at the beginning of a CICS transaction dump.

The symptom string:

- Is written to SYS1.LOGREC
- Is issued as part of message DFHME0116
- Appears at the beginning of a CICS system dump.

The symptom string provides a number of keywords that can be directly typed into RETAIN and used to search the RETAIN database. The possible keywords are shown in Table 2. The keywords are used at the IBM Support Center to discover duplicate problems, or problems that have already been reported by other users and for which a solution is available.

If you have the IBM INFORMATION/ACCESS licensed program, 5665-266, you can search the RETAIN database yourself.

If you report a problem to the IBM Support Center, you are often asked to quote the symptom string.

Table 2. Symptom string keywords

Keyword	Meaning
PIDS/	Product ID (CICS product number)
LVLS/	Level indicator (CICS release level)
RIDS/	Module name
PTFS/	Module PTF level
MS/	Message ID reporting error
AB/	Abend code
ADRS/	Address or offset indicator
PRCS/	Return code
PCSS/	CICS jobname
OVS/	Overlaid storage
FLDS/	Name of a field associated with problem
REGS/	Software register associated with problem
VALU/	Value of a named field or register

Although the symptom string is designed to provide keywords for searching the RETAIN database, it can also give you significant information about what was happening at the time the error occurred, and it might suggest an obvious cause or a likely area in which to start your investigation. Amongst other things, it might contain the abend code. If you have not already done so, look in the *CICS Messages and Codes* manual to see what action it suggests for this abend code.

If the system is unable to gather much information about the error, the symptom string is less specific. In such cases, it might not help you much with problem determination, and you need to look at other parts of the dump. The kernel domain storage summary is a good place to start.

Looking at the kernel domain storage areas

The type of information that you can gather from the kernel domain storage areas is as follows:

- A summary of tasks and their status, and whether or not they were in error when the dump was taken.
- An error analysis report for each task currently in error.
- CICS retains information for the previous fifty errors.
- The linkage stack for each task, showing which programs have been called and have not yet returned.

The first thing you need to do is to find out which tasks are associated with the error.

Finding which tasks are associated with the error

You can find out which tasks are associated with the error from the kernel task summary. This tells you which tasks were in the system when the dump was taken, whether or not they were running, and whether they were in error.

The task summary is in the form of a table, each line in the table representing a different task.

The left-hand column of the task summary shows the kernel task number, which is the number used by the kernel domain to identify the task. This is not the same as the normal CICS task number taken from field TCAKCTTA of the TCA.

Figure 1 on page 47 shows an example of a kernel task summary with a task in error.

```

===KE: Kernel Domain KE_TASK Summary
KE_NUM KE_TASK STATUS TCA_ADDR TRAN_# TRANSID DS_TASK KE_KTCB ERROR
0001 06A14928 KTCB Step 00000000 00000000 06A37240
0002 06A145A8 KTCB QR 00000000 06B63000 06A3A090
0003 06A14228 KTCB RO 00000000 06B65000 06A39120
0004 06A23C80 KTCB FO 00000000 06B67000 06A381B0
0005 06A23900 Not Running 00000000 06B69080 06A39120
0006 06A23580 Not Running 06C76080 00022 CSNE 06B69180 06A3A090
0007 06A23200 Not Running 00000000 06B69280 06A3A090
0008 06A30C80 ***RUNNING***00051080 00005 DBRW 06B89880 06A3A090 *YES*
0009 06A30900 Not Running 00051680 00006 CSSY 06B89180 06A3A090
000A 06C3D400 Unused
000D 06C3D780 Unused
000E 06C3DB00 Unused
0011 06CDA080 Unused
0012 06CDA400 Unused
0013 06CDA780 Unused
0014 06CDAB00 Unused
0017 06B5E580 Unused
0018 06B5FC80 Not Running 06C75680 TCP CSTP 06B89A80 06A3A090
001A 06CE7080 Unused

```

Figure 1. Kernel task summary showing a task in error

When you have located the task summary table in the formatted dump, look in the ERROR column. If you find a value of *YES* for a particular task, that task was in error *at the time the dump was taken*.

Note: If the recovery routine that is invoked when the error occurs does not request a system dump, you will not see any tasks flagged in error. In such a case, the system dump is likely to have been requested by a program that is being executed lower down the linkage stack and that received an abnormal response following recovery. The program that received the error has gone from the stack, and so cannot be flagged. However, error data for the failing task was captured in the kernel domain error table (see “Finding more information about the error” on page 48). Error data is also captured in the error table even when no system dump is taken at all.

In Figure 1, you can see that kernel task number 0008 is shown to be in error.

Look next at the STATUS column. For each task you can see one of the following values:

- “***Running***”, meaning that the task was running when the system dump was taken. Most of the time, only one task is shown to be running. If more than one task is shown to be running, the different tasks are attached to separate TCBs.
- “Not Running”, meaning that the task is in the system but is currently not running. It may, for example, be suspended because it is waiting for some resource, or it may be ready to run but waiting for a TCB to become available.
- “KTCB”, referring to CICS control blocks corresponding to the CICS TCBs. These are treated as tasks in the kernel task summary.
- “Unused”, meaning either that the task was in the system but it has now terminated, or that there has not yet been a task in the system with the corresponding task number. Earlier “Unused” tasks are likely to have run and terminated, and later ones are likely never to have represented actual tasks. It is most unlikely that you will ever need to distinguish between the two possibilities.

You are almost certain to find that the task shown to be in error has a status of “***Running***”, as in the example of Figure 1 on page 47. Such a task would have been running at the time the error was detected.

Tasks shown to be “Not Running” are less likely to be associated with the error, but it is possible that one of these could have been flagged with an error. If you find this to be so, the most likely explanation is that the task in error was attempting recovery when, for some reason, it was suspended.

Two of the columns in the kernel task summary are particularly important in solving problems that require the use of traces. They are the TRAN_# and KE_NUM columns. The TRAN_# column for a task can contain:

- A number that matches the task number in the corresponding trace
- “TCP” for the CICS terminal control task
- Other character entries for CICS system tasks (for example, a component identifier like “AP” for a CICS system task in the AP domain).

When you are working with trace output, you can use the number from the TRAN_# column to identify entries associated with a user task up to the point at which that task passes control to CICS. To identify the CICS processing associated with the user task, you need to use the entry in the KE_NUM column of the kernel task summary. This matches the KE_NUM shown in the full trace entries for the task, and enables you to distinguish the CICS processing associated with the task you are interested in from other CICS processing.

Finding more information about the error

More information about the failure is given in the summary information for the task in error. This is given after the kernel task summary. It gives you a storage report for the task, including registers and PSWs, and any data addressed by the registers. The PSW is the program status word that is used by the machine hardware to record the address of the current instruction being executed, the addressing mode, and other control information. An example of such a storage report is shown in Figure 2 on page 49, in this case for a program check.

Look first in the dump for this header, which introduces the error report for the task:

```
==KE: KE DOMAIN ERROR TABLE
```

Next, you will see the kernel error number for the task. Error numbers are assigned consecutively by the kernel, starting from 00000001. You might, for example, see this:

```
=KE: ERROR NUMBER: 00000001
```

The error number tells you the number of program checks and system abends that have occurred for this run of CICS. Not all of them have necessarily resulted in a system dump.

Some kernel error data follows. If you want to find the format of this data (and, in most cases, you will not need to), see the DFHKERRD section of the *CICS Data Areas*. The next thing of interest is the kernel’s interpretation of what went wrong. This includes the error code, the error type, the name of the program that was running, and the offset within the program.

The error code gives you the system and user completion codes issued when the abend occurred.

The error type tells you whether the error was associated with, for example, a program check, a system abend, or an internal request for system recovery.

```

==KE: KE DOMAIN ERROR TABLE
=KE: ERROR NUMBER: 00000001
KERRD 0397B950 KERNEL ERROR DATA
 0000 F0C3F461 C1D2C5C1 018400C4 000022EE C4C6C8E3 E2D74040 04D3FC70 054D0B78 *0C4/AKEA.D.D....DFHTSP .L...(* 0397B950
(Data for offset 0020 to 0100 follows)
ERROR CODE: 0C4/AKEA ERROR TYPE: PROGRAM_CHECK TIMESTAMP: A4D9433F7D330600
DATE (GMT) : 25/08/93 TIME (GMT) : 09:04:49.484592
DATE (LOCAL) : 25/08/93 TIME (LOCAL) : 09:04:49.484592
KE_NUM: 0007 KE_TASK: 03980AD0 TCA_ADDR: 0006A000 DS_TASK: 054D0B78
ERROR HAPPENED IN PROGRAM DFHTSP AT OFFSET 22EE
ERROR HAPPENED UNDER THE CICS RB.
CICS REGISTERS AND PSW FOLLOW.
PSW: 078D1000 84D41F5E INSTRUCTION LENGTH: 4 INTERRUPT CODE: 04 EXCEPTION ADDRESS: 00000000
EXECUTION KEY AT PROGRAM CHECK/ABEND: 8
SPACE AT PROGRAM CHECK/ABEND: BASESPACE
REGISTERS 0-15
0000 F2000518 03AE25CC 00011280 00000002 FFFFFFFF 04D44DB3 84D41DB6 04D42DB5 *2.....M(.DM..M..* 0397B9A0
0020 04D43DB4 03B2F140 039936A0 00000001 0006A000 8003CBB0 84D43A54 04D43A3E *.M....1 .R.....DM..M..* 0397B9C0
DATA AT PSW: 84D41F5E MODULE: DFHTSP OFFSET: 000022EE
0000 5CC4C6C8 E3E2D740 4084D3FC E4F0F3F3 F0C91707 1122C7C2 F6D44040 40401400 **DFHTSP DL.U0330I....GB6M ..* 04D3FC70
(Data for offset 0020 to 2300 follows)
DATA AT REGISTERS
REG 0 F2000518
31-BIT DATA CANNOT BE ACCESSED **
24-BIT DATA FOLLOWS:
-0080 00000000 00000000 00000007 00000000 00000000 00000000 00000000 00FFCF20 *.....* 00000498
(Data for offset -0060 to 0100 follows)
(Similar data for CICS registers 1 to 15 follows)

```

Figure 2. Storage report for a task that has experienced a program check

Next, there is a report of where the system has recorded that the error occurred, and the circumstances of the failure. This is the general format of the information:

```

Error happened in program pppppppp at offset xxxxxxxx
Error happened ...

```

The program name (pppppppp) and offset (xxxxxxx) are determined by searching through the CICS loader's control blocks for a program that owned the abending instruction at the time of the abend. If this search does not find such a program, the following text appears in the report:

```

PROGRAM QQQQQQQ WAS IN CONTROL, BUT THE PSW WAS ELSEWHERE.

```

The program name (qqqqqqqq) reported, is the program that owns the current kernel stack entry for the abending task. If this text appears, it may be possible to locate the failing program using the method described in "Using the linkage stack to identify the failing module" on page 51. The failing program name and offset are also displayed in the section of the report immediately after the contents of the registers have been reported. The format of this information is:

```

DATA AT PSW: AAAAAAAA MODULE: PPPPPPPP OFFSET: XXXXXXXX

```

If the failing program could not be located, the module name and offset are reported as unknown. The possible reasons for the program not being located are:

- The failure occurred in an MVS loaded module
- The failing program had been released by the CICS loader before the dump was taken
- A wild branch in the failing program caused the PSW to point to storage not occupied by a CICS loaded program

Note that the accuracy of the program name and offset reported in a formatted dump that was produced as the result of a program executing a wild branch cannot be guaranteed.

After the kernel's interpretation of the error, you will see one of these diagnostic messages:

Error happened under the CICS RB

This means that the error was detected either when CICS code was executing, or when an access method called by CICS was running (for example, VSAM or QSAM). The CICS RB is the CICS request block, an MVS control block that records the state of the CICS program.

Error did not happen under the CICS RB

This message can be issued in any of these circumstances:

- An error occurs in CICS SVC code.
- An error occurs in a CICS VTAM exit.
- CICS detects a runaway task during the execution of an MVS service request.
- An error occurs during the execution of an SVC request that was made by CICS or an access method invoked by CICS.

After either of these messages, you next get some data that is likely to be related to the problem. The data you get depends on whether or not the error happened under the CICS RB.

The error data for the failing task

If the error happened under the CICS RB, the error data you get in the task storage report is based on values in the **PSW** and the **CICS registers** at the time the error was detected. Figure 2 on page 49 shows the storage report for a task that failed when a program check was detected. It illustrates the error data supplied when an error happens under the CICS RB.

If the error did not happen under the CICS RB, for example when CICS was calling an MVS service, you get data based on two sets of registers and PSWs. The registers and PSW of the CICS RB at the time of the error constitute one set. The registers and PSW of the RB in which the error occurred constitute the other set. This data will relate, very probably, to the execution of an SVC routine called by CICS. The error may have occurred, however, during an IRB interrupt or in an SRB. You can confirm whether this has happened by checking flags `KERNEL_ERROR_IRB` and `KERNEL_ERROR_SRB_MODE`.

The storage addressed by the registers and PSW

Any storage addressed by the registers and PSW is included in the error data for the failing task.

Note that only the values of the registers and PSW, not the storage they address, are guaranteed to be as they were at the time of the error. The storage that is shown is a snapshot taken at the time the internal system dump request was issued. Data might have changed because, for example, a program check has been caused by an incorrect address in a register, or short lifetime storage is addressed by a register.

Also, in general, where error data is given for a series of errors, the older the error, the less likely it is that the storage is as it was at the time of the failure. The most recent error has the highest error number; it might not be the first error shown in the output.

The registers might point to data in the CICS region. If the values they hold can represent 24-bit addresses, you see the data around those addresses. Similarly, if their values can represent 31-bit addresses, you get the data around those addresses.

It could be that the contents of a register might represent both a 24-bit address and a 31-bit address. In that case, you get both sets of addressed data. (Note that a register might contain a 24-bit address with a higher order bit set, making it appear like a 31-bit address; or it could contain a genuine 31-bit address.)

If, for any reason, the register does not address any data, you see either of these messages:

```
24-bit data cannot be accessed  
31-bit data cannot be accessed
```

This means that the addresses cannot be found in the system dump of the CICS region. Note that MVS keeps a record of how CICS uses storage, and any areas not used by CICS are considered to lie outside the CICS address space. Such areas are not dumped in an MVS SDUMP of the region.

It is also possible that the addresses were within the CICS region, but they were not included in the SDUMP. This is because MVS enables you to take SDUMPs selectively, for example “without LPA”. If this were to happen without your knowledge, you might think you had an addressing error when, in fact, the address was a valid one.

The format of the PSW is described in the *IBM Enterprise Systems Architecture/370 Principles of Operation*. The information in the PSW can help you to find the details needed by the IBM Support Center. You can find the address of the failing instruction, and hence its offset within the module, and also the abend type. You find the identity of the failing module itself by examining the kernel linkage stack, as described in “Using the linkage stack to identify the failing module”.

Using the linkage stack to identify the failing module

You can sometimes use the technique described in this section to gather the information that the IBM Support Center needs to resolve the CICS system abend. However, you should normally use the summary information presented in the formatted output for the kernel domain storage areas.

This method is only valid if the abend has occurred in a module or subroutine that has a kernel linkage stack entry. This is the case only where the module or subroutine has been invoked by one of these mechanisms:

- A kernel domain call
- A kernel subroutine call
- A call to an internal procedure identified to the kernel
- A LIFO call

Routines that have been invoked by assembler language BALR instructions do not have kernel linkage stack entries. Having found which task was in error from the kernel's task summary (see "Finding which tasks are associated with the error" on page 46), you need next to find out which module was in error. The module name is one of the things you need to give the IBM Support Center when you report the problem to them.

Find the task number of the task in error from the KE_NUM column, and use this as an index into the linkage stack entries. These are shown in the dump after the task summary.

Figure 3 shows what a typical kernel linkage stack looks like.

KE_NUM	@STACK	LEN	TYPE	ADDRESS	LINK	REG	OFFS	ERROR	NAME
0031	0520A020	0120	Bot	84C00408	84C006D8		02D0		DFHKETA
0031	0520A140	01F0	Dom	84C0F078	84C0F18E		0116		DFHDSKE
0031	0520A330	0370	Dom	84CAA5A8	84CAACC2		071A		DFHXMTA
0031	0520A6A0	0330	Dom	84F25430	84F25CF6		08C6		DFHPGPG
			Int	+00CC	84F254B6		0086		INITIAL_LINK
0031	0520A9D0	03C0	Dom	84F6C230	84E5DC40		0000		DFHAPLI1
			Int	+0EEA	84F6C66E		043E		CICS_INTERFACE
0031	0520AD90	0108	Sub	0230B400	8230B8CA		04CA		DFHEIQSP
0031	0520AE98	0290	Sub	82136D90	82137178		03E8	*YES*	DFHLDLD
	0520B128		Int	+08FC	82136F26		0196		LDLD_INQUIRE
	0520B128		Int	+128E	821376CE		093E		CURRENT_GET_NO_WAIT
0031	0520B128	0F70	Dom	84C6F8E0	84C72EA6		35C6		DFHMEME
			Int	+2CB6	84C6FA4E		016E		SEND
			Int	+1486	84C72684		2DA4		CONTINUE_SEND
			Int	+350E	84C70DE4		1504		TAKE_A_DUMP_FOR_CALLER
0031	0520C098	03D0	Dom	84C52458	84C52F52		0AFA		DFHDUDU
			Int	+08F4	84C5254A		00F2		SYSTEM_DUMP
			Int	+1412	84C53212		0DBA		TAKE_SYSTEM_DUMP

Figure 3. Example of a kernel linkage stack showing a task in error

The TYPE column in the example can contain any of the following entries:

- Bot** This marks the first entry in the stack.
- Dom** This marks a stack entry caused by a domain call.
- Sub** This marks a stack entry caused by a subroutine.
- Lifo** This marks a stack entry caused by a LIFO module.
- Int** This marks a call to an internal procedure identified to the kernel.

A linkage stack for a task represents the sequence in which modules and subroutines have been called during execution of a task. It provides a valuable insight into the sequence of events up until the time of failure, and it also flags any program or subroutine that was executing when the error was detected.

The modules and subroutines are shown in the listing in the order in which they were invoked, so the first module you see is at the bottom of the stack, and the second module is next from bottom. You often see DFHKETA and DFHDSKE, respectively, in these two positions.

The last module or subroutine in the listing is at the top of the stack, and it represents the last call that was made before the dump was taken. Assuming that the system abend caused the dump to be taken, this is likely to be a routine associated with dump domain.

In the example shown, program DFHLDLD is shown to be in error. In this case, DFHLDLD is the module name that you would need to report to the IBM Support Center, together with the other information described in “Using the PSW to find the offset of the failing instruction”.

Note: If module DFHAPLI is flagged in error, consider first whether an application is to blame for the failure. DFHAPLI is the Application Language Interface Program, and it is on the linkage stack whenever an application is being executed. If an application is the cause of the error, it is your responsibility to correct the problem.

Using the PSW to find the offset of the failing instruction

You can calculate the offset of the failing instruction from the PSW, although in practice you seldom need to because the offset is quoted in the storage report for the task. If you are not sure of the format of the PSW, or how to calculate the offset, see the *IBM Enterprise Systems Architecture/370 Principles of Operation* manual.

The Support Center also needs to know the instruction at the offset. Locate the address of the failing instruction in the dump, and find out what instruction is there. It is sufficient to give the hex code for the instruction, but make sure you quote as many bytes as you found from the PSW instruction length field.

Identify also the abend type from the program interruption code, so that you can report that, too. It might, for example, be ‘protection exception’ (interruption code 0004), or ‘data exception’ (interruption code 0007).

Finding the PTF level of the module in error

The IBM Support Center needs to know the PTF level of any module reported to them as being in error. You can find this in the loader domain program storage map summary, which you can get using the dump formatting keyword LD.

Figure 4 shows some entries from a typical program storage map summary.

```

==LD: PROGRAM STORAGE MAP
PGM NAME ENTRY PT CSECT LOAD PT. REL. PTF LVL. LAST COMPILED COPY NO. USERS LOCN TYP ATTRIBUTE R/A MODE APE ADDR
                                OVERRIDE
DFHCSA  80049810 DFHKELCL 00049000 520 UQnnnnn 12/11/96 10.09 1 1 CDSA RPL RESIDENT - - 07F16730
DFHKELRT 00049380 520 UQnnnnn 12/11/96 10.24
DFHCSA  00049608 0520 UQnnnnn I 01/04 14.49
DFHCSAOF 00049AB8 0520 UQnnnnn I 01/04 14.49
DFHKERCD 00049FE0 520 UQnnnnn 11/14/96 18.48
DFHKERER 0004A1B8 520 UQnnnnn 11/14/96 18.49
DFHKERRI 0004ABC0 520 UQnnnnn 02/05/97 08.23
DFHKESFM 0004AF58 520 UQnnnnn 12/11/96 10.25
DFHKESGM 0004B330 510 UQnnnnn 10/21/96 16.30
DFHTCP  8004D020 DFHTCP  0004D000 0520 UQnnnnn I 11/12 10.10 1 1 CDSA RPL RESIDENT - - 07F5C430
DFHTCORS 0004D278 0520 UQnnnnn I 11/12 10.10
DFHTCCOM 0004D538 0520 UQnnnnn I 11/12 10.10
DFHTCCSS 0004D8B0 0520 UQnnnnn I 11/12 10.10
DFHTCTI  0004DA28 0520 UQnnnnn I 11/12 10.10
DFHTCSAM 0004DAB0 0520 UQnnnnn I 11/12 10.10
DFHTCAM  0004DEB8 0520 UQnnnnn I 11/12 10.10
DFHTCTRN 0004ED30 0520 UQnnnnn I 11/12 10.10
DFHTCTDY 0004FA30 DFHTCTDY 0004FA10 0520 UQnnnnn I 04/02 19.16 1 1 CDSA RPL RESIDENT - - 07F5C530

```

Figure 4. Part of the loader domain program storage map summary

Note: Entries made in the R/A MODE OVERRIDE columns are the value of the RMODE and AMODE supplied on the DEFINE_PROGRAM call for that program. If a REQUIRED_RMODE or REQUIRED_AMODE is not specified,

a – (dash) symbol appears in the appropriate column. If AMODE_ANY or RMODE_ANY is specified, 'ANY' appears in the appropriate column. Other values are shown as specified.

Chapter 6. Dealing with waits

This section gives you information about what to do if you are aware that a task is in a wait state, or if CICS has stalled during:

- A run
- Initialization
- Termination
- Restart.

If CICS has stalled, turn directly to “What to do if CICS has stalled” on page 145.

If you have one or more tasks in a wait state, you should have already carried out preliminary checks to make sure that the problem is best classified as a wait, rather than as a loop or as poor performance. If you have not, you can find guidance about how to do this in “Chapter 2. Classifying the problem” on page 7.

You are unlikely to have direct evidence that a CICS system task is in a wait state, except from a detailed examination of trace. You are more likely to have noticed that one of your user tasks, or possibly a CICS user task—that is, an instance of a CICS-supplied transaction—is waiting. In such a case, it is possible that a waiting CICS system task could be the cause of the user task having to wait.

For the purpose of this section a task is considered to be in a wait state if it has been suspended after first starting to run. The task is *not* in a wait state if it has been attached to the transaction manager but has not yet started to run, or if it has been resumed after waiting but cannot, for some reason, start running. These are best regarded as performance problems. Tasks that are ready to run but cannot be dispatched might, for example, have too low a priority, or the CICS system might be at the MXT limit, or the CICS system might be under stress (short on storage). If you think you might have such a problem, read “Chapter 8. Dealing with performance problems” on page 161.

Most tasks are suspended at least once during their execution, for example while they wait for file I/O to take place. This is part of the regular flow of control, and it gives other tasks a chance to run in the meantime. It is only when they stay suspended longer than they should that a problem arises.

There are two stages in resolving most wait problems involving user tasks. The first stage involves finding out what resource the suspended task is waiting for, and the second stage involves finding out why that resource is not available. This section focuses principally on the first of these objectives. However, in some cases there are suggestions of ways in which the constraints on resource availability can be relieved.

If you know that a CICS system task is in a wait state, it does not necessarily indicate an error in CICS. Some system tasks spend long periods in wait states, while they are waiting for work to do. For more information about waiting system tasks, see “CICS system task waits” on page 143.

Where to look next

- If you want information about the ways in which tasks in a CICS system can be made to wait, see “How tasks are made to wait” on page 63.

- If you want guidance about using online or offline techniques to investigate waits, see “Techniques for investigating waits”.
- If you already know the identity of the resource that a task is waiting for, but are not sure what functional area of CICS is involved, see Table 19 on page 74. It shows you where to look for further guidance.
- If you know the functional area with which the wait is associated, turn directly to the appropriate section later in this section:
 - “Lock manager waits” on page 90
 - “DBCTL waits” on page 93
 - “Maximum task condition waits” on page 85
 - “Task control waits” on page 96
 - “Storage waits” on page 98
 - “Temporary storage waits” on page 99
 - “Terminal waits” on page 102
 - “VTAM terminal control waits” on page 109
 - “Interregion and intersystem communication waits” on page 111
 - “Transient data waits” on page 112
 - “Loader waits” on page 115
 - “File control waits” on page 119
 - “Interval control waits” on page 136
 - “XRF alternate system waits” on page 141
 - “CICS system task waits” on page 143
 - “FEPI waits” on page 144.

Note: Throughout this section, the terms “suspension” and “resumption” and “suspended” and “resumed” are used generically. Except where otherwise indicated, they refer to any of the SUSPEND/RESUME and WAIT/POST processes by which tasks can be made to stop running and then be made ready to run again.

Techniques for investigating waits

You can investigate waits in a CICS system by online inquiry, by tracing, or by analysis of the formatted CICS system dump. The last two techniques are, to some extent, complementary.

Online inquiry is the least powerful technique, and it can only tell you what resource a suspended user task is waiting for. This is enough information to locate the failing area, but you often need to do more investigation before you can solve the problem. The advantage of online inquiry is that you can find out about the waiting task as soon as you detect the problem, and so you capture the data early.

Tracing can give you much more detail than online inquiry, but it involves significant processing overhead. It must also be running with the appropriate options selected when the task first enters a wait state, so this usually means you need to reproduce

the problem. However, the information it gives you about system activity in the period leading up to the wait is likely to provide much of the information you need to solve the problem.

A CICS system dump can give you a picture of the state of the CICS system at an instant during the wait. You can request the dump as soon as you notice that a task has entered a wait state, so it gives you early data capture for the problem. However, the dump is unlikely to tell you anything about system activity in the period leading up to the wait, even if you had internal tracing running with the correct selectivity when the task entered the wait. This is because the trace table has probably wrapped before you have had a chance to respond. However, the formatted dump might contain much of the information you need to solve the problem.

If you are able to reproduce the problem, consider using auxiliary tracing and dumping in combination.

Investigating waits—online method

Online, you can use either CEMT INQ TASK or EXEC CICS INQUIRE TASK to find out what resource a user task is waiting on. EXEC CICS INQUIRE TASK can be executed under CECI, or from a user program. Whatever online method you use, you need to supply the task ID of the suspended user task.

If the task *is* suspended, the information that is returned to you includes the resource type and/or the resource name identifying the unavailable resource. CEMT INQ TASK displays the resource type of the unavailable resource in the HTYPE field. The HVALUE field displays the resource name of the unavailable resource. EXEC CICS INQUIRE TASK returns values in the SUSPENDTYPE and SUSPENDVALUE fields which correspond to the resource type and resource name of the unavailable resource.

HTYPE and SUSPENDTYPE, and HVALUE and SUSPENDVALUE correspond to the values in the resource type and resource name fields of the dispatcher task summary.

Table 19 on page 74 gives a list of all the resource types and resource names that user tasks might be suspended on, and references showing where to look next for guidance about solving the wait.

You probably need a system dump of the appropriate CICS region to investigate the wait. If you do not yet have one, you can get one using CEMT PERFORM SNAP or CEMT PERFORM DUMP—but make sure the task is still in a wait state when you take the dump. You subsequently need to format the dump using keywords for the given resource type. Advice on which keywords to use is given, where appropriate, in the individual sections.

Investigating waits—using trace

You can find detailed information about the suspension and resumption of tasks during a run of CICS by studying the trace table. Tracing must, of course, be running when the task in question is suspended or resumed, and the tracing options must be selected correctly.

When you look at the trace table, you can find trace entries relating to a particular task from the task numbers that the entries contain. Each is unique to a task so you can be sure that, for any run of CICS, trace entries having the same task number belong to the same task.

For general guidance about setting tracing options and interpreting trace entries, see “Chapter 14. Using traces in problem determination” on page 227.

Setting up trace for wait problems

Gate DSSR of dispatcher domain provides the major functions associated with the suspension and resumption of tasks. (See “How tasks are made to wait” on page 63.) The level-1 trace points **DS 0004** and **DS 0005** are produced on entry to, and exit from, the gate.

You need, therefore, to select tracing to capture the DS level-1 trace entries to investigate any wait problem. You need to capture trace entries for other components as well, when you know what functional areas are involved. The functional area invoking the task wait might, for example, be terminal control (TC), or file control (FC). Level-1 tracing is often enough for these components. However, there are cases, such as those relating to VSAM I/O errors where level-2 trace is needed to examine the RPL as it is passed to VSAM.

Next, you need to ensure that tracing is done for the task that has the wait problem. At first select special tracing for just that task, and disable tracing for all other tasks by setting the master system trace flag off. Subsequently, you can select special tracing for other tasks as well if it becomes clear that they are implicated in the wait.

Interpreting trace for wait problems

For new-style trace entries, which include those for point IDs DS 0004 and DS 0005, the function being traced is shown explicitly in the interpretation string. The functions in Table 5 on page 64 are all provided by gate DSSR, and you might see any of them traced by these two trace points. The functions that can cause a task to enter a wait state are identified in the table. Look out for these in particular in the trace entries for any waiting task you are investigating.

Each function has its own set of input and output parameters, and these, too, are shown in the interpretation strings of the formatted trace entries. Input parameters are shown in the trace entries made from point ID DS 0004, and output parameters in the trace entries made from point ID DS 0005.

The values of the parameters can provide valuable information about task waits, so pay particular attention to them when you study the trace table.

Investigating waits—the formatted CICS system dump

If you are suitably authorized, you can request a CICS system dump using CEMT PERFORM DUMP, CEMT PERFORM SNAP, or EXEC CICS PERFORM DUMP. Make sure that the task in question is waiting when you take the dump, so that you capture information relevant to the wait.

You need to use the dump formatting keyword DS to format the dispatcher task summary. You probably need to look at other areas of the dump as well, so keep the dump on the dump data set.

Interpreting the dump for wait problems

The dispatcher task summary gives you information like that shown in Figure 5.

```

==DS: DISPATCHER DOMAIN - SUMMARY
KEY FOR SUMMARY
TY = TYPE OF TASK           SY=SYSTEM  NS=NON-SYSTEM
S = STATE OF TASK          DIS=DISPATCHABLE  SUS=SUSPENDED  RUN=RUNNING  REE=RESUMED EARLY
P = PURGEABLE WAIT/SUSPEND Y=YES  N=NO
PS = PURGE STATUS          OK=NO PURGE  PU=PURGED  PP=PURGE  PENDING
TT = TIMEOUT TYPE          IN=INTERVAL  DD=DEADLOCK  DELAYED  DI=DEADLOCK  IMMEDIATE
ST = SUSPEND TYPE          MVS=WAIT_MVS  SUSP=SUSPEND  OLDC=WAIT_OLDC  OLDW=WAIT_OLDW
DTA= DISPATCHER TASK AREA
AD = ATTACHING DOMAIN
MO = TASK MODE
CO=CONCURRENT  QR=QUASI-REENTRANT  RO=RESOURCE OWNING  SZ=FEPI OWNING
RP=ONC/RPC OWNING  FO=FILE OWNING
DS_TOKEN KE_TASK TY S P PS TT RESOURCE RESOURCE ST TIME OF TIMEOUT DTA AD ATTACHER MO SUSPAREA XM_TXN_TOKEN
              TYPE NAME SUSPEND DUE (DSTSK) TOKEN
00000001 06A23900 SY SUS N OK - ENF NOTIFY MVS 17:50:10.056 - 06B69080 DM 06C33640 RO 06C33658
00020003 06A23580 SY SUS N OK - SUSP 17:51:23.515 - 06B69180 XM 06C06690 QR 06B69180 06C066900000022C
00040003 06A23200 SY SUS N OK - TIEXPIRY DS_NUDGE SUSP 17:50:35.325 - 06B69280 TI 003D0003 QR 06B6A530
00820003 06A30900 SY SUS N OK - ICEXPIRY DFHAPTIX SUSP 17:50:35.326 - 06B89180 XM 06C06360 QR 06B89180 06C0636000000006C
00900003 06A30C80 SY SUS N OK - ICMIDNTE DFHAPTIM SUSP 17:50:29.437 - 06B89880 XM 06C06250 QR 06B89880 06C0625000000005C
00940003 06B5FC80 SY SUS N OK - TCP_NORM DFHZDSP OLDW 17:51:46.369 - 06B89A80 XM 06C06470 QR 0004FC10 06C0647000000008C
00980001 06C3D080 SY SUS N OK IN SMSYSTEM SUSP 17:50:10.081 17:55:10.081 06B89C80 SM 00000002 QR 06B6A580
0200000B 07128B00 NS SUS Y OK - ZCLOWAIT DFHZARQ1 SUSP 17:51:39.616 - 06B9C080 XM 06C06580 QR 06B9C080 06C0658000000029C
02020009 07135080 NS RUN - - - - - 06B9C180 XM 06C06140 QR 06C0614000000031C

```

Figure 5. Dispatcher task summary

A brief explanation of the summary information is given in the dump. A more detailed explanation is given in the section that follows.

Dispatcher task summary fields

Detailed descriptions of the fields in the dispatcher task summary are given in Table 3. Some of the fields relate to all tasks known to the dispatcher, and some (identified in the table) relate only to suspended tasks. Values are not provided in fields of the latter type for tasks that are not suspended.

Table 3. Descriptions of fields shown in the dispatcher task summary

Field	Description
AD	The 2-character domain index identifying the domain that attached the task to the dispatcher.
ATTACHER TOKEN	A token provided by the domain that attached the task. This token uniquely identifies the task to the attaching domain.
DS_TOKEN	A token given by the dispatcher to a domain that attaches a task. It identifies the attached task uniquely to the dispatcher.
DTA	An address used internally by the dispatcher.
KE_TASK	A value that uniquely identifies to the kernel a task that has been created.

Table 3. Descriptions of fields shown in the dispatcher task summary (continued)

Field	Description
MO	<p>The dispatching mode for the task. There is an MVS TCB for each mode. All tasks in a given mode are running, or will run next, under the TCB corresponding to the mode. The possible values are:</p> <p>CO—concurrent. FO—file owning. QR—quasi-reentrant. RO—resource owning. RP—ONC RPC SZ—FEPI owning.</p>
P	<p>Whether the suspend call issued by the suspending task specified PURGEABLE(YES) or PURGEABLE(NO). PURGEABLE(NO) inhibits deadlock time-out, CEMT SET TASK PURGE, and EXEC CICS SET TASK PURGE.</p> <p>The possible values are:</p> <p>Y (=YES)—the task is purgeable. N (=NO)—the task is not purgeable.</p>
PS	<p>The purge status of the task. The possible values are:</p> <p>OK—the task has not been purged, and there is no purge pending. PU—the task has been purged, either by the dispatcher or by the operator. PP—there is a purge pending on the task.</p>
RESOURCE NAME (<i>suspended tasks only</i>)	<p>The name of the resource that a suspended task is waiting for. A value is given only if RESOURCE_NAME has been included as an input parameter on the suspend call.</p>
RESOURCE TYPE (<i>suspended tasks only</i>)	<p>The type of the resource that the task is waiting for. A value is given only if RESOURCE_TYPE has been included as an input parameter on the suspend call.</p>
S	<p>The state of the task within the dispatcher. Possible values are:</p> <p>DIS—the task is dispatchable. It is ready to run, and it will be dispatched when a TCB becomes available. RUN—the task is running. SUS—the task has been suspended by any of the functions SUSPEND, WAIT_MVS, WAIT_OLDC, or WAIT_OLDW of gate DSSR. For an explanation of these functions, see “How tasks are made to wait” on page 63. REE—the task has been resumed early, possibly because a RESUME request has arrived before the corresponding SUSPEND request. (The SUSPEND/RESUME interface is asynchronous. For more details, see “Function SUSPEND of gate DSSR” on page 66.)</p>

Table 3. Descriptions of fields shown in the dispatcher task summary (continued)

Field	Description
ST (<i>suspended tasks only</i>)	<p>The type of function that was invoked to suspend a currently suspended task. Possible values include:</p> <ul style="list-style-type: none"> MVS—function WAIT_MVS OLDC—function WAIT_OLDC OLDW—function WAIT_OLDW SUSP—function SUSPEND <p>For a description of the functions, see “How tasks are made to wait” on page 63.</p>
SUSPAREA (<i>suspended tasks only</i>)	<p>Either an address used internally by the dispatcher, or an ECB address, or an ECB list address. These are the cases:</p> <ul style="list-style-type: none"> • Address used internally, if the task was suspended by a SUSPEND call. • ECB address or ECB list address, if the task was suspended by a WAIT_MVS or WAIT_OLDW call. • ECB address, if the task was suspended by a WAIT_OLDC call. <p>Look at the value given in the ST column to see which one of these descriptions applies.</p>
TIME OF SUSPEND (<i>suspended tasks only</i>)	<p>The time when a currently suspended task was suspended.</p> <p>The format is hh:mm:ss.mmm (hours, minutes, seconds, milliseconds), GMT.</p>
TIMEOUT DUE (<i>suspended tasks only</i>)	<p>The time that a suspended task is due to timeout, if a timeout interval has been specified. A suspended task only times out if it is not resumed before this time arrives.</p> <p>The format is hh:mm:ss.mmm (hours, minutes, seconds, milliseconds).</p>
TT (<i>suspended tasks only</i>)	<p>The time-out type for the task. The possible values, where one is given, are:</p> <ul style="list-style-type: none"> IN—a time-out interval has been specified for the task. DD—deadlock action is to be delayed when the time-out interval expires. DI—deadlock action is immediate when the time-out interval expires. <p>See “INTERVAL and DEADLOCK_ACTION parameters” on page 71 for more details of time-out interval and deadlock action.</p>
TY	<p>Whether this is a system task or a non-system task. Possible values are:</p> <ul style="list-style-type: none"> SY—this is a system task. NS—this is a non-system task. <p>A non-system task can be either a user written transaction, or a CICS-supplied transaction.</p>

Parameters and functions setting fields in the dispatcher task summary

Many of the values shown in the dispatcher task summary are provided directly by parameters included on calls to and from the dispatcher. If you are using trace, you can see the values of the parameters in the trace entries, and this can be useful for debugging. For details of how you can use trace to investigate waits, see “Investigating waits—using trace” on page 57.

Table 4 shows the parameters that set task summary fields, the functions that use those parameters, and the domain gates that provide the functions. Task summary fields that are *not* set by parameters are also identified (by *none* in “Related parameter” column).

Table 4. Parameters and functions that set fields shown in the dispatcher task summary

Field	Related parameter	Function	Input or output	Gate
AD	DOMAIN_INDEX	INQUIRE_TASK GET_NEXT	IN OUT	DSBR
DTA	ATTACH_TOKEN	CREATE_TASK	IN	KEDS
DS_TOKEN	TASK_TOKEN	ATTACH CANCEL_TASK PURGE_INHIBIT_QUERY SET_PRIORITY TASK_REPLY GET_NEXT INQUIRE_TASK	OUT IN IN IN IN OUT OUT	DSAT DSBR
KE_TASK	TASK_TOKEN	CREATE_TASK CREATE_TCB PUSH_TASK TASK_REPLY TCB_REPLY	OUT OUT IN IN IN	KEDS
MO	MODE	ATTACH CHANGE_MODE GET_NEXT INQUIRE_TASK	IN IN OUT OUT	DSAT DSBR
P	PURGEABLE	SUSPEND WAIT_MVS WAIT_OLDC WAIT_OLDW	IN IN IN IN	DSSR
PS	<i>none</i>			
RESOURCE NAME	RESOURCE_NAME	ADD_SUSPEND SUSPEND WAIT_MVS WAIT_OLDC WAIT_OLDW GET_NEXT INQUIRE_TASK	IN IN IN IN IN OUT OUT	DSSR DSBR

Table 4. Parameters and functions that set fields shown in the dispatcher task summary (continued)

Field	Related parameter	Function	Input or output	Gate
RESOURCE TYPE	RESOURCE_TYPE	ADD_SUSPEND SUSPEND WAIT_MVS WAIT_OLDC WAIT_OLDW GET_NEXT INQUIRE_TASK	IN IN IN IN IN OUT OUT	DSSR DSBR
S (see note 1)	STATE	GET_NEXT INQUIRE_TASK	OUT OUT	DSBR
SUSPAREA (see note 2)	ECB_ADDRESS or ECB_LIST_ADDRESS (see note 3)	WAIT_MVS WAIT_OLDC WAIT_OLDW	IN IN IN	DSSR
TIME OF SUSPEND	<i>none</i>			
TASKNO	<i>none</i>			
TIMEOUT DUE (see note 4)	<i>none</i>			
TT	INTERVAL and DEADLOCK_ACTION	SUSPEND WAIT_MVS WAIT_OLDW WAIT_OLDC	IN IN IN IN	DSSR
TY	<i>none</i>			
ATTACHER TOKEN	USER_TOKEN	ATTACH PURGE_INHIBIT_QUERY TASK_REPLY GET_NEXT INQUIRE_TASK	OUT OUT	DSAT DSBR
ST	<i>none</i>			

Notes:

1. Field S (for STATE) of the dispatcher task summary has a wider range of values than parameter STATE of DSBR functions GET_NEXT and INQUIRE_TASK. Parameter STATE can only have the values READY, RUNNING, or SUSPENDED. For the possible values of field S, see Table 3 on page 59.
2. Parameters ECB_ADDRESS and ECB_LIST_ADDRESS only relate to SUSPAREA when the task has been suspended by the WAIT_MVS, WAIT_OLDW, or WAIT_OLDC functions of gate DSSR.
3. Parameter ECB_LIST_ADDRESS is only valid for functions WAIT_MVS and WAIT_OLDW, and not for function WAIT_OLDC.
4. If INTERVAL has been specified, the value of TIMEOUT DUE should be equal to INTERVAL + TIME OF SUSPEND.

How tasks are made to wait

The suspension and resumption of tasks in a CICS system are performed by the dispatcher domain, usually on behalf of some other CICS component. If the exit programming interface (XPI) is being used, it can be at the request of user code.

The major functions associated with the suspension and subsequent resumption of tasks are provided by gate DSSR of dispatcher domain. When a task is to be suspended or resumed, the requesting component calls gate DSSR with the appropriate set of parameters. The required function is included in the parameter list sent on the call, and the corresponding routines are executed by the dispatcher. You can use trace to see the functions that are requested, and the values of parameters that are supplied. See “Investigating waits—using trace” on page 57.

Table 5 lists the functions provided by the gate, and gives a brief summary of their effect on the status of tasks in the CICS system.

Table 5. Functions provided by dispatcher gate DSSR

Function	Effect on status of tasks
ADD_SUSPEND	None—this does not cause a task to be suspended.
INQUIRE_SUSPEND_TOKEN	None.
DELETE_SUSPEND	None—this does not cause a task to be resumed.
SUSPEND	This can cause a running task to be suspended.
RESUME	This can cause a suspended task to be resumed.
WAIT_MVS	This can cause a running task to wait.
WAIT_OLDW	This can cause a running task to wait.
WAIT_OLDC	This can cause a running task to wait.

The functions that are significant for problem determination are now described in detail. It is necessary to consider their effects, the protocols that must be used, and the parameters they use. If you are using trace, your approach to the wait problem depends on the features of the function that caused the task to wait, so you must find out early in your investigation how the task was suspended.

Some of the functions are available to users through the exit programming interface (XPI). If you have any applications using these XPI functions, make sure that they follow the rules and protocols exactly. For programming information about the XPI, see the *CICS Customization Guide*.

Function ADD_SUSPEND of gate DSSR

The ADD_SUSPEND function of gate DSSR returns a SUSPEND_TOKEN to the calling component. The function is available to users through the exit programming interface. ADD_SUSPEND does not cause any running task to be suspended.

The ADD_SUSPEND function has only to be called once for any sequence of SUSPEND and RESUME calls for a particular task, because the same token can be used each time.

The input and output parameters for the ADD_SUSPEND function are described in Table 6 and Table 7, respectively.

Table 6. DSSR ADD_SUSPEND input parameters

Parameter	Description
[RESOURCE_NAME] [RESOURCE_TYPE]	Provide default values for SUSPEND calls using this suspend token. The defaults are overridden if values are specified on the SUSPEND call. The parameters are optional, so in some cases you might not see them shown in the formatted DS 0004 and DS 0005 trace entries. A complete list of resource names and types is given in Table 19 on page 74.

Table 7. DSSR ADD_SUSPEND output parameters

Parameter	Description
SUSPEND_TOKEN	The token used to identify a SUSPEND/RESUME pair.
RESPONSE	Possible values are: OK EXCEPTION DISASTER INVALID KERNERROR For the meanings of RESPONSE values, see Table 17 on page 72.
[REASON]	When RESPONSE is 'DISASTER', REASON has this value: INSUFFICIENT_STORAGE

Function INQUIRE_SUSPEND_TOKEN of gate DSSR

INQUIRE_SUSPEND_TOKEN is used by some CICS system tasks to find out the suspend token provided when the task was created.

The output parameters for the DSSR INQUIRE_SUSPEND_TOKEN function are described in Table 8. (There are no input parameters.)

Table 8. DSSR INQUIRE_SUSPEND_TOKEN output parameters

Parameter	Description
SUSPEND_TOKEN	The token that was provided when the task was created.
RESPONSE	Possible values: OK DISASTER For the meanings of RESPONSE values, see Table 17 on page 72.

Function DELETE_SUSPEND of gate DSSR

The DELETE_SUSPEND function of gate DSSR discards a SUSPEND_TOKEN. It does not cause any suspended task to be resumed. The function is available to users through the exit programming interface.

When the SUSPEND_TOKEN has been discarded, it can no longer be used to SUSPEND or RESUME a task. However, note that the dispatcher does not allow a SUSPEND_TOKEN to be discarded while a task is suspended against it, even if the

RESUME request is serviced before the SUSPEND request. (This is an asynchronous interface—see “Function SUSPEND of gate DSSR”.)

The input and output parameters for the DSSR DELETE_SUSPEND function are described in Table 9 and Table 10, respectively.

Table 9. DSSR DELETE_SUSPEND input parameter

Parameter	Description
SUSPEND_TOKEN	The suspend token to be discarded.

Table 10. DSSR DELETE_SUSPEND output parameters

Parameter	Description
RESPONSE	Possible values are: OK EXCEPTION DISASTER INVALID KERNERROR For the meanings of RESPONSE values, see Table 17 on page 72.
[REASON]	When RESPONSE is 'INVALID', REASON can have either of these values: INVALID_SUSPEND_TOKEN—the dispatcher does not recognize the suspend token that has been supplied. SUSPEND_TOKEN_IN_USE—a task is already suspended against the suspend token that has been supplied.

Function SUSPEND of gate DSSR

The SUSPEND function of gate DSSR causes a running task to be suspended. The function is available to users through the exit programming interface, both explicitly (SUSPEND call) and implicitly (GETMAIN SUSPEND(YES) call).

The task to be suspended is identified by a SUSPEND_TOKEN, which might have been obtained by a previous ADD_SUSPEND call. A task suspended by a DSSR SUSPEND call is resumed by a corresponding DSSR RESUME call, if the task is not purged before the RESUME is issued.

It is important to recognize that this is an asynchronous interface: the RESUME call might have been received before the SUSPEND call. This can be significant if you are attempting to match SUSPEND and RESUME call pairs in the trace table, because you might find the RESUME trace entry was made before the corresponding SUSPEND trace entry. However, there can never be more than one outstanding SUSPEND or RESUME against any suspend token.

The input and output parameters for the DSSR SUSPEND function are described in Table 11 and Table 12 on page 67, respectively.

Table 11. DSSR SUSPEND input parameters

Parameter	Description
SUSPEND_TOKEN	The suspend token that the task is to be suspended against.

Table 11. DSSR SUSPEND input parameters (continued)

Parameter	Description
PURGEABLE	The purgeable status of the task. Possible values are: YES NO A task can be purged by the dispatcher when deadlock is detected, or purged by the operator or an application, if PURGEABLE is YES.
[INTERVAL] [DEADLOCK_ACTION]	INTERVAL and DEADLOCK_ACTION are mutually exclusive alternatives. For a discussion of their significance, see "INTERVAL and DEADLOCK_ACTION parameters" on page 71.
[RESOURCE_NAME] [RESOURCE_TYPE]	The name and the type of the resource that the task is to wait for. The parameters are optional, so in some cases you might not see them shown in the formatted DS 0004 and DS 0005 trace entries. A complete list of resource names and types is given in Table 19 on page 74.
[WLM_WAIT_TYPE]	The type of workload manager wait. Possible values are: LOCK IO CONV SESS_LOCALMVS SESS_SYSPLEX SESS_NETWORK TIMER OTHER_PRODUCT MISC For the meanings of WLM_WAIT_TYPE, see Table 18 on page 72.

Table 12. DSSR SUSPEND output parameters

Parameter	Description
[COMPLETION_CODE]	A completion code to be supplied by the issuer of the RESUME.
RESPONSE	Possible values are: OK EXCEPTION DISASTER INVALID KERNERROR PURGED For the meanings of RESPONSE values, see Table 17 on page 72.

Table 12. DSSR SUSPEND output parameters (continued)

Parameter	Description
[REASON]	<p>When RESPONSE is 'PURGED', REASON can have either of these values:</p> <p>TASK_CANCELLED—the task was purged by the operator or an application while it was suspended.</p> <p>TIMED_OUT—the task was automatically resumed because the specified INTERVAL (or the deadlock time-out value specified at task attach) expired.</p> <p>When RESPONSE is 'INVALID', REASON can have any one of these values:</p> <p>INVALID_SUSPEND_TOKEN—the supplied suspend token was not recognized by the dispatcher.</p> <p>ALREADY_SUSPENDED—a SUSPEND call was issued against a suspend token that was already in use.</p> <p>CLEAN_UP_PENDING—the task has automatically been resumed because it has timed out, but resume processing is not yet complete.</p>
[DELAY]	<p>If the RESUME is issued within the time specified by the DELAY value, CICS is not to consider the task for dispatch until either the DELAY interval has expired or there is no other work to do.</p>

Function RESUME of gate DSSR

The RESUME function of gate DSSR causes a suspended task to be resumed. The function is available to users through the exit programming interface.

The task to be resumed is identified by a SUSPEND_TOKEN, which is the same as the one used to SUSPEND the task in the first instance.

It is important to recognize that this is an asynchronous interface: so the RESUME call might have been received before the SUSPEND call. This can be significant if you are attempting to match SUSPEND and RESUME call pairs in the trace table, because you might find the RESUME trace entry was made before the corresponding SUSPEND trace entry. However, there can never be more than one outstanding SUSPEND or RESUME against any suspend token.

The input and output parameters for the DSSR RESUME function are described in Table 13 and Table 14 on page 69, respectively.

Table 13. DSSR RESUME input parameters

Parameter	Description
SUSPEND_TOKEN	The suspend token that the task was suspended against.
[COMPLETION_CODE]	A user-supplied completion code.

Table 14. DSSR RESUME output parameters

Parameter	Description
RESPONSE	<p>Possible values are: OK EXCEPTION DISASTER INVALID KERNERROR PURGED</p> <p>For the meanings of RESPONSE values, see Table 17 on page 72.</p>
[REASON]	<p>When RESPONSE is 'EXCEPTION', REASON can have either of these values:</p> <p>TASK_CANCELLED—the task was purged by the operator or an application while it was suspended.</p> <p>TIMED_OUT—the task was automatically resumed because the specified INTERVAL (or the deadlock time-out value specified at task attach) expired.</p> <p>When RESPONSE is INVALID, REASON can have either of these values:</p> <p>INVALID_SUSPEND_TOKEN—the suspend token was not recognized.</p> <p>ALREADY_RESUMED—the task that was suspended against this suspend token has already been resumed.</p>

Functions WAIT_MVS, WAIT_OLDW, and WAIT_OLDC of gate DSSR

Functions WAIT_MVS, WAIT_OLDW, and WAIT_OLDC of gate DSSR have much in common, and they are considered together. Unlike function SUSPEND of gate DSSR, no corresponding function is provided explicitly by gate DSSR to resume a task suspended by any of these functions. Instead, the task automatically becomes ready to run when an event control block (ECB) is posted. The input and output parameters for the functions are described in Table 15 on page 70 and Table 16 on page 71, respectively.

WAIT_MVS

The WAIT_MVS function of gate DSSR causes a task to wait for an ECB, which might be in a list of ECBs, to be posted by the MVS POST macro. The function is available to users through the exit programming interface. A task made to wait by the WAIT_MVS function becomes eligible to run again when the single ECB, or any ECB in the list, has been posted.

WAIT_OLDW

The WAIT_OLDW function of gate DSSR causes a task to wait on a single ECB, or list of ECBs. The task becomes eligible to run again when the single ECB, or any ECB in the list, has been posted either by an MVS POST macro or by “hand posting”.

WAIT_OLDC

The WAIT_OLDC function of gate DSSR causes a task to wait on a single ECB that must be hand posted. A task made to wait by the WAIT_OLDC function becomes eligible to run again when the ECB has been posted.

Input and output parameters for WAIT_MVS, WAIT_OLDW, and WAIT_OLDC

Table 15. DSSR WAIT_MVS, WAIT_OLDW, and WAIT_OLDC input parameters

Parameter	Description
ECB_ADDRESS ECB_LIST_ADDRESS	<p>These two parameters are mutually exclusive alternatives. ECB_ADDRESS is the address of a single ECB, and ECB_LIST_ADDRESS is the address of a list of addresses.</p> <p>ECB_LIST_ADDRESS is valid only for WAIT_MVS and WAIT_OLDW.</p>
PURGEABLE	<p>The purgeable status of the task. Possible values are: YES NO</p> <p>A task can be purged by the dispatcher when deadlock is detected, or purged by the operator or an application, if PURGEABLE is YES.</p>
[INTERVAL] [DEADLOCK_ACTION]	<p>INTERVAL and DEADLOCK_ACTION are mutually exclusive alternatives. For a discussion of their significance, see "INTERVAL and DEADLOCK_ACTION parameters" on page 71.</p>
[RESOURCE_NAME] [RESOURCE_TYPE]	<p>The name and the type of the resource that the task is to wait for. The parameters are optional, so in some cases you might not see them shown in the formatted DS 0004 and DS 0005 trace entries.</p> <p>A complete list of resource names and types is given in Table 19 on page 74.</p>
[BATCH] (WAIT_MVS only)	<p>Whether the requests can be batched. Possible values are: YES NO</p>
[SPECIAL_TYPE] (WAIT_OLDW only)	<p>Identifies the task as a special type. Its value is always CSTP.</p>
[TIME_UNIT]	<p>The time units used in specifying the INTERVAL value. Can be either seconds or milliseconds.</p>
[DELAY]	<p>If the ECB is posted within the time specified by the DELAY value, CICS is not to consider the task for dispatch until either the DELAY interval has expired or there is no other work to do.</p>
[WLM_WAIT_TYPE]	<p>The type of workload manager wait. Possible values are: LOCK IO CONV SESS_LOCALMVS SESS_SYSPLEX SESS_NETWORK TIMER OTHER_PRODUCT MISC</p> <p>For the meanings of WLM_WAIT_TYPE, see Table 18 on page 72.</p>

Table 16. DSSR WAIT_MVS, WAIT_OLDW, and WAIT_OLDC output parameters

Parameter	Description
RESPONSE	<p>Possible values are: OK EXCEPTION DISASTER INVALID KERNERROR PURGED</p> <p>For the meanings of RESPONSE values, see Table 17 on page 72.</p>
[REASON]	<p>When RESPONSE is 'PURGED', REASON can have either of these values:</p> <ul style="list-style-type: none"> TASK_CANCELLED—the task was purged by the operator or an application while it was waiting for the ECB to be posted. TIMED_OUT—either the INTERVAL or the deadlock time-out interval expired. In the case of the deadlock time-out, PURGEABLE(YES) must be in effect. <p>When RESPONSE is 'INVALID', REASON can have either of these values:</p> <ul style="list-style-type: none"> ALREADY_WAITING—the single ECB specified in ECB_ADDRESS was already being waited on when this WAIT request was received. INVALID_ECB_ADDR—the ECB address that was supplied is not valid.

INTERVAL and DEADLOCK_ACTION parameters

INTERVAL and DEADLOCK_ACTION are mutually exclusive input parameters on the SUSPEND and WAIT calls to gate DSSR of the dispatcher domain.

INTERVAL is a length of time after which a task is to be resumed automatically by the dispatcher, with a RESPONSE value of 'PURGED' and a REASON value of 'TIMED_OUT'.

DEADLOCK_ACTION describes whether or not the suspended task is to be purged if deadlock is detected, and if so, how it should be purged. The action to be taken depends on the anticipated cause of the deadlock, and it can have any one of these values:

- DELAYED. CICS ensures that it does not deadlock purge more than one task specifying DELAYED in a given interval. This is in the hope that purging one task will free the resources required by the others.
- IMMEDIATE. Deadlock purges of tasks specifying IMMEDIATE go ahead regardless of how many tasks are purged in a given interval. This is used, for example, when purging one task will have no effect on other tasks specifying IMMEDIATE.
- INHIBIT. This specifies that there is to be no deadlock time-out. INHIBIT overrides any deadlock time-out interval specified at task attach.

The meanings of RESPONSE values returned on DSSR calls

Table 17 on page 72 explains the meaning of each of the RESPONSE values that can be returned from calls to DSSR functions.

Table 17. Meanings of DSSR function RESPONSE values

RESPONSE	Meaning
OK	When a domain command succeeds, a response of OK is given and the REASON code is not set. The requested function has been completed successfully.
EXCEPTION	Processing of the function could not be completed for the reason specified in the REASON field. If a command fails, the reason for the failure is returned together with an exception response.
DISASTER	The domain could not complete the request because of an unrecoverable system problem.
INVALID	The requested function is not supported by the domain, possibly because the format of the supplied parameters is incorrect.
KERNERROR	The kernel was unable to call the required function gate for the specified REASON.
PURGED	A purge has been requested for the task making the domain call.

The meanings of the WLM_WAIT_TYPE parameter

Table 18 explains the meaning of each of the values that can be specified on the WLM_WAIT_TYPE parameter on DSSR SUSPEND, WAIT_MVS, WAIT_OLDW, and WAIT_OLDC functions. See the *OS/390 MVS Workload Management Services* manual, GC28-1494-01 for further information about this parameter.

Table 18. Meanings of WLM_WAIT_TYPE parameter values

WLM_WAIT_TYPE	Meaning
LOCK	Waiting on a lock. For example, waiting for: <ul style="list-style-type: none"> • A lock on a CICS resource • A record lock on a recoverable VSAM file • A record lock in a BDAM file • An application resource that has been locked by an EXEC CICS ENQ command.
IO	Waiting for an I/O request or I/O related request to complete. For example: <ul style="list-style-type: none"> • File control, transient data, temporary storage, or journal I/O. • Waiting on I/O buffers or VSAM strings.
CONV	Waiting on a conversation between work manager subsystems.
SESS_LOCALMVS	Waiting on the establishment of a session with another CICS region in the same MVS image in the sysplex.
SESS_SYSPLEX	Waiting on establishment of a session with another CICS region in a different MVS image in the sysplex.
SESS_NETWORK	Waiting on the establishment of an ISC session with another CICS region (which may, or may not, be in the same MVS image).

Table 18. Meanings of WLM_WAIT_TYPE parameter values (continued)

WLM_WAIT_TYPE	Meaning
TIMER	Waiting for a timer event or an interval control event to complete. For example, an application has issued an EXEC CICS DELAY or EXEC CICS WAIT EVENT command which has yet to complete.
OTHER_PRODUCT	Waiting on another product to complete its function; for example, when the work request has been passed to a DB2 or DBCTL subsystem.
MISC	Waiting on a resource that does not fall into any of the other categories.

Notes:

1. The MVS workload manager monitoring environment is set to STATE=IDLE when either:
 - A conversational task is waiting for terminal input from its principal facility, or
 - A CICS system task is waiting for work.
2. If the task is waiting on resource type ALLOCATE, the current MVS workload manager monitoring environment is set to STATE=WAITING and either:
 - RESOURCE=SESS_LOCALMVS if the session being waited on is a session with another CICS region in the same local MVS image.
 - RESOURCE=SESS_SYSPLEX if the session being waited on is a session with a CICS region in another MVS image in the same sysplex.
 - RESOURCE=SESS_NETWORK if the session being waited on is an ISC session which may, or may not, be in the same MVS image.
3. If the task is waiting on resource type IRLINK, the current MVS workload manager monitoring environment is set to STATE=WAITING, RESOURCE=CONV. Look at the RMF™ workload activity report to see whether the task continued beyond the current MVS monitoring environment. The SWITCHED column in this report can contain the following values:
 - LOCALMVS - the communicating CICS region is on the same local MVS image.
 - SYSPLEX - the communicating CICS region is on another MVS image in the same sysplex.
4. If the task is waiting on resource type ZCIOWAIT, the current MVS workload manager monitoring environment is set to either:
 - STATE=IDLE for a conversational task, or DTP transaction, that is awaiting input from its principal facility.
 - STATE=WAITING,RESOURCE=CONV for a task awaiting input from its alternate facility. Look at the RMF workload activity report to see whether the task continued beyond the current MVS monitoring environment. The SWITCHED column in this report can contain the following values:
 - LOCALMVS - the communicating CICS region is on the same local MVS image.
 - SYSPLEX - the communicating CICS region is on another MVS image in the same sysplex.
 - NETWORK - the communicating CICS region is in the VTAM network, which may, or may not be, in the same MVS image.

The resources on which tasks in a CICS system can wait

Table 19 shows all the resources on which tasks in a CICS system can wait. Some resources are identified by both a resource name and a resource type, some by a resource name alone, and some by a resource type alone. The resource names and resource types that are shown are the ones that you can see in formatted trace entries and, for some resources, by online inquiry.

User tasks can be made to wait only on some of the resources. For each such resource, you will see a page reference showing you where to look for guidance about dealing with the wait. The values in the column 'Purge status' indicate whether the suspending module permits normal task purging (such as that caused by the API and CEMT purge commands) and purging caused by a deadlock timeout limit being reached. Normal task purging is permitted if there is a 'Y' (standing for 'yes') in the first column. If normal task purging is not permitted, there is an 'N' (standing for 'no') in this column. Deadlock timeout is permitted if there is a 'Y' (standing for 'yes') in the second column. If deadlock timeout is not permitted, there is an 'N' in this column.

The remaining resources are used only by CICS system tasks. If you have evidence that a system task is waiting on such a resource, and it is adversely affecting the operation of your system, you probably need to contact your IBM Support Center. Before doing so, however, read "CICS system task waits" on page 143.

Table 19. Resources on which a suspended task might be waiting

Resource type Purge status	Resource name	Suspending module	DSSR call WLM wait type	Task	Where to look next
(none)	(none)	DFHDUIO	WAIT_MVS IO	System only	"CICS system task waits" on page 143
(none)	(none)	DFHRMSL7	WAIT_MVS TIMER	System only	"CICS system task waits" on page 143
(none)	(none)	DFHZNAC	SUSPEND See note 1 on page 73	System only	"CICS system task waits" on page 143
(none)	DLCNTRL	DFHDBCT	WAIT_MVS See note 1 on page 73	System only	"CICS system task waits" on page 143
(none)	DLCONNECT	DFHDBCON	WAIT_MVS OTHER_ PRODUCT	System only	"CICS system task waits" on page 143
(none)	DMWTQUEU	DFHDMWQ	SUSPEND MISC	System only	"CICS system task waits" on page 143
(none)	LMQUEUE	DFHMLM	SUSPEND LOCK	User	"Lock manager waits" on page 90
N					
ADAPTER	FEPI_RQE	DFHSZATR	WAIT_MVS MISC	User	See note 5 on page 85
N					
ALLOCATE	TCTTETI value	DFHALP	SUSPEND See note 2 on page 73	User	"Interregion and intersystem communication waits" on page 111
Y					

Table 19. Resources on which a suspended task might be waiting (continued)

Resource type Purge status	Resource name	Suspending module	DSSR call WLM wait type	Task	Where to look next
ALP_TERM	(none)	DFHALRC	WAIT_OLDC MISC	System only	"Recovery manager waits" on page 144
Any_MBCB N N	transient data queue name	DFHTDB DFHTDRM	SUSPEND IO	User	"Transient data waits" on page 112
Any_MRCB N N	transient data queue name	DFHTDB DFHTDRM	SUSPEND IO	User	"Transient data waits" on page 112
AP_INIT	ECBTCP	DFHAPSIP	WAIT_OLDC MISC	System only	"CICS system task waits" on page 143
AP_INIT	SIPDMTEC	DFHAPSIP	WAIT_MVS MISC	System only	"CICS system task waits" on page 143
AP_INIT	TCTVCECB	DFHSII1	WAIT_OLDC MISC	System only	"CICS system task waits" on page 143
AP_INIT	ZGRPECB	DFHSII1	WAIT_MVS MISC	System only	"CICS system task waits" on page 143
AP_QUIES	CSASSI2	DFHSTP	WAIT_OLDC MISC	System only	"CICS system task waits" on page 143
AP_QUIES	SHUTECEB	DFHSTP	WAIT_MVS MISC	System only	"CICS system task waits" on page 143
APRDR	INITIAL	DFHAPRDR	SUSPEND MISC	System only	"Recovery manager waits" on page 144
APRDR	RECOVER	DFHAPRC	SUSPEND MISC	System only	"Recovery manager waits" on page 144
AP_TERM	STP_DONE	DFHAPDM	WAIT_MVS LOCK	System only	"CICS system task waits" on page 143
CCSTWAIT	VSMSTRNG	DFHCCCC	WAIT_OLDC IO	System only	"CICS system task waits" on page 143
CCVSAMWT	ASYNRESP	DFHCCCC	WAIT_MVS IO	System only	"CICS system task waits" on page 143
CCVSAMWT	EXCLOGER	DFHCCCC	WAIT_MVS IO	System only	"CICS system task waits" on page 143
CDB2RDYQ N N	name of DB2ENTRY or pool	DFHD2EX1	WAIT_MVS OTHER_ PRODUCT	User	"CICS DB2 waits" on page 92
CDB2TBC N N	(none)	DFHD2EX1	WAIT_MVS OTHER_ PRODUCT	User	"CICS DB2 waits" on page 92
CDSA Y Y	(none)	DFHSMSQ	SUSPEND MISC	User	"Storage waits" on page 98
CFDTWAIT	file name	DFHFCDO DFHFCDR DFHFCDU	WAIT_MVS MISC WAIT_MVS MISC WAIT_MVS MISC	User	"File control waits" on page 119

Table 19. Resources on which a suspended task might be waiting (continued)

Resource type Purge status	Resource name	Suspending module	DSSR call WLM wait type	Task	Where to look next
CFDTPOOL	CFDT pool name	DFHFCDO DFHFCDR DFHFCDU	SUSPEND LOCK SUSPEND LOCK SUSPEND LOCK	User	"File control waits" on page 119
CFDTLRSW	CFDT pool name	DFHFCDR	SUSPEND LOCK	User	"File control waits" on page 119
CSNC	MROQUEUE	DFHCRNP	WAIT_MVS See note 1 on page 73	System only	"CICS system task waits" on page 143
DB2	LOT_ECB	DFHD2EX1	WAIT_MVS OTHER_ PRODUCT	User	"CICS DB2 waits" on page 92
Y					
DB2_INIT	(none)	DFHD2IN1	WAIT_OLDC MISC	User	"CICS DB2 waits" on page 92
Y					
DB2CDISC	name of DB2CONN	DFHD2TM	WAIT_OLDC MISC	User	"CICS DB2 waits" on page 92
Y					
DB2EDISA	name of DB2ENTRY	DFHD2TM	WAIT_OLDC MISC	User	"CICS DB2 waits" on page 92
Y					
DBDXEOT	(none)	DFHDXSTM	WAIT_MVS MISC	System only	"CICS system task waits" on page 143
DBDXINT	(none)	DFHXSTM	WAIT_MVS MISC	System only	"CICS system task waits" on page 143
DBCTL	DLSUSPND	DFHDBSPX	WAIT_MVS OTHER_ PRODUCT	User	"DBCTL waits" on page 93
N					
DFHAIIN	AITM	DFHAIIN1	SUSPEND MISC	System only	"CICS system task waits" on page 143
DFHCPIN	CPI	DFHCPIN1	SUSPEND MISC	System only	"CICS system task waits" on page 143
DFHPRIN	PRM	DFHPRIN1	SUSPEND MISC	System only	"CICS system task waits" on page 143
DFHSIPLT	EARLYPLT	DFHSII1	WAIT_MVS MISC	System only	"CICS system task waits" on page 143
DFHSIPLT	LATE_PLT	DFHSIJ1	WAIT_MVS MISC	System only	"CICS system task waits" on page 143
DISPATCH	OPEN_TCB	DFHDSAT	SUSPEND MISC	User	"Dispatcher waits" on page 85
DMATTACH	QUIESCE	DFHDMDM	WAIT_MVS MISC	System only	"CICS system task waits" on page 143
ECDSA	(none)	DFHSMSQ	SUSPEND MISC	User	"Storage waits" on page 98
Y					

Table 19. Resources on which a suspended task might be waiting (continued)

Resource type Purge status	Resource name	Suspending module	DSSR call WLM wait type	Task	Where to look next
EDF Y N	DBUGUSER	DFHEDFX	SUSPEND MISC	User	"EDF waits" on page 94
EKCWAIT N Y	ATCHMSUB	DFHD2STR	WAIT_OLDW MISC	User	CICS DB2 Guide
EKCWAIT N Y	CEX2TERM	DFHD2STP	WAIT_OLDW MISC	User	CICS DB2 Guide
EKCWAIT N Y	DTCHMSUB	DFHD2STR	WAIT_OLDW MISC	User	CICS DB2 Guide
EKCWAIT N Y	MSBRETRN	DFHD2STP	WAIT_OLDW MISC	User	CICS DB2 Guide
EKCWAIT N N	SINGLE	DFHEKC	WAIT_OLDW MISC	User	"Task control waits" on page 96
ENF	NOTIFY	DFHDMENF	WAIT_MVS See note 1 on page 73	System only	"File control waits" on page 119
ENQUEUE Y Y	EXECADDR	DFHNQED	SUSPEND LOCK	User	"EXEC CICS ENQ waits" on page 118
ENQUEUE Y Y	EXECSTRN	DFHNQED	SUSPEND LOCK	User	"EXEC CICS ENQ waits" on page 118
ENQUEUE Y Y	FCDSSEWR	DFHNQED	SUSPEND LOCK	User	"File control waits" on page 119
ENQUEUE Y Y	FCDSLDM	DFHNQED	SUSPEND LOCK	User	"File control waits" on page 119
ENQUEUE Y Y	FCDSRECD	DFHNQED	SUSPEND LOCK	User	"File control waits" on page 119
ENQUEUE Y Y	FCDSRNGE	DFHNQED	SUSPEND LOCK	User	"File control waits" on page 119
ENQUEUE Y Y	FCFLRECD	DFHNQED	SUSPEND LOCK	User	"File control waits" on page 119
ENQUEUE Y Y	FCFLUMTL	DFHNQED	SUSPEND LOCK	User	"File control waits" on page 119
ENQUEUE Y Y	JOURNALS	DFHNQED	SUSPEND LOCK	User	"Enqueue waits" on page 116
ENQUEUE Y Y	KCADDR	DFHNQED	SUSPEND LOCK	System or user	"Enqueue waits" on page 116
ENQUEUE Y Y	KCSTRNG	DFHNQED	SUSPEND LOCK	System or user	"Enqueue waits" on page 116
ENQUEUE Y Y	LOGSTRMS	DFHNQED	SUSPEND LOCK	User	"Enqueue waits" on page 116

Table 19. Resources on which a suspended task might be waiting (continued)

Resource type Purge status	Resource name	Suspending module	DSSR call WLM wait type	Task	Where to look next
ENQUEUE Y Y	TDNQ	DFHNQED	SUSPEND LOCK	User	"Transient data waits" on page 112
ENQUEUE Y Y	TSNQ	DFHNQED	SUSPEND LOCK	User	"Temporary storage waits" on page 99
ERDSA Y Y	(none)	DFHSMSQ	SUSPEND MISC	User	"Storage waits" on page 98
ESDSA Y Y	(none)	DFHSMSQ	SUSPEND MISC	User	"Storage waits" on page 98
EUDSA Y Y	(none)	DFHSMSQ	SUSPEND MISC	User	"Storage waits" on page 98
FCACWAIT Y Y	*CTLACB*	DFHFCDR	WAIT_OLDC IO	System	"File control waits" on page 119
FCBFWAIT Y Y	file ID	DFHFCVR	WAIT_OLDC IO	User	"File control waits" on page 119
FCCAWAIT N N	*CTLACB*	DFHFCCA	WAIT_MVS OTHER_ PRODUCT	User	"File control waits" on page 119
FCCFQR	(none)	DFHFCQR	WAIT_MVS See note 1 on page 73	System	"File control waits" on page 119
FCCFQS	(none)	DFHFCQS	WAIT_MVS MISC	System	"File control waits" on page 119
FCCRWAIT Y Y	*CTLACB*	DFHFCDR	WAIT_OLDC IO	System	"File control waits" on page 119
FCDWWAIT Y Y	file ID	DFHFCVR	WAIT_OLDC IO	User	"File control waits" on page 119
FCFSWAIT Y Y	file ID	DFHFDFS	WAIT_OLDC IO	User	"File control waits" on page 119
FCINWAIT	STATIC	DFHFCIN1	WAIT_OLDC MISC	System only	"CICS system task waits" on page 143
FCIOWAIT N N	file ID	DFHFCBD DFHFCVR	WAIT_MVS IO WAIT_MVS IO	User	"File control waits" on page 119
FCIRWAIT	RECOV-FC	DFHFCDR DFHFCRR	WAIT_OLDC MISC WAIT_OLDC M ISC	System only	"File control waits" on page 119
FCPSWAIT Y Y	*CTLACB* file ID file ID	DFHFCCA DFHFCDR DFHFCVR	WAIT_OLDC IO WAIT_OLDC IO WAIT_OLDC IO	User	"File control waits" on page 119
FCQUIES Y Y	fcqse_ptr (hexa-decimal)	DFHFCQI	SUSPEND See note 1 on page 73	User	"File control waits" on page 119
FCRAWAIT Y Y	FC_FILE	DFHEIFC	WAIT_OLDC MISC	User	"File control waits" on page 119

Table 19. Resources on which a suspended task might be waiting (continued)

Resource type Purge status	Resource name	Suspending module	DSSR call WLM wait type	Task	Where to look next
FCRBWAIT Y Y	file ID	DFHFCFR	WAIT_OLDC IO	User	"File control waits" on page 119
FCRDWAIT N N	*CTLACB*	DFHFCRC DFHFCRR	WAIT_OLDC MISC WAIT_OLDC MISC	System or user	"File control waits" on page 119
FCRPWAIT	FC-START	DFHFCRR	WAIT_OLDC MISC	System only	"File control waits" on page 119
FCRRWAIT	*DYRRE*	DFHFCRR	WAIT_OLDC MISC	System only	"File control waits" on page 119
FCRVWAIT N N	file ID	DFHFCRV	WAIT_MVS OTHER_ PRODUCT	User	"File control waits" on page 119
FCSRSUSP Y Y	file ID	DFHFCVR	SUSPEND IO	User	"File control waits" on page 119
FCTISUSP Y Y	file ID	DFHFCVR	SUSPEND IO	User	"File control waits" on page 119
FCXCWAIT Y Y	file ID	DFHFCVS	WAIT_OLDC IO	User	"File control waits" on page 119
FEPRM N N	SZRDP	DFHSZRDP	WAIT_MVS MISC	CSZI	See note 5 on page 85
FOREVER N N	DFHXMTA	DFHXMTA	WAIT_MVS MISC	User	"A user task is waiting on resource type FOREVER" on page 89
ICEXPIRY	DFHAPTIX	DFHAPTIX	SUSPEND TIMER	System only	"CICS system task waits" on page 143
ICGTWAIT Y Y	terminal ID	DFHICP	SUSPEND MISC	User	"Interval control waits" on page 136
ICMIDNTE	DFHAPTIM	DFHAPTIM	SUSPEND TIMER	System only	"CICS system task waits" on page 143
ICP_INIT	(none)	DFHICRC	WAIT_OLDC MISC	System only	"Interval control waits" on page 136
ICP_TERM	(none)	DFHICRC	WAIT_OLDC MISC	System only	"Interval control waits" on page 136
ICP_TSWT	(none)	DFHICRC	WAIT_OLDC MISC	System only	"Interval control waits" on page 136
ICWAIT Y N	terminal ID (See note 1 on page 85)	DFHICP	SUSPEND MISC	User	"Interval control waits" on page 136
IRLINK Y N	SYSIDNT concat- enated with session name	DFHZIS2	WAIT_MVS See note 3 on page 73	User	"Terminal waits" on page 102

Table 19. Resources on which a suspended task might be waiting (continued)

Resource type Purge status	Resource name	Suspending module	DSSR call WLM wait type	Task	Where to look next
KCCOMPAT N N	CICS	DFHXCPA	WAIT_OLDC LOCK	User	"Task control waits" on page 96
KCCOMPAT N N	LIST	DFHXCPA	WAIT_OLDW MISC	User	"Task control waits" on page 96
KCCOMPAT N N	SINGLE	DFHXCPA	WAIT_OLDW MISC	User	"Task control waits" on page 96
KCCOMPAT Y N	SUSPEND	DFHXCPA	SUSPEND MISC	User	"Task control waits" on page 96
KCCOMPAT Y N	TERMINAL	DFHXCPA	SUSPEND MISC	User	"Task control waits" on page 96 and "Terminal waits" on page 102
KERNEL N N	DETACH	DFHKETA	SUSPEND LOCK	User	
LATE_PLT	DFHSIPLT	DFHSIPLT	WAIT_MVS MISC	System only	"CICS system task waits" on page 143
LG_DEFER N N	journal name	DFHL2SRC	SUSPEND IDLE	User	"Log manager waits" on page 94
LGDELALL N N	journal name	DFHL2HS4	WAIT_MVS IO	User	"Log manager waits" on page 94
LGDELTRAN N N	journal name	DFHL2HS5	WAIT_MVS IO	User	"Log manager waits" on page 94
LGENDBLK N N	journal name	DFHL2HS9	WAIT_MVS IO	User	"Log manager waits" on page 94
LGENDCRS N N	journal name	DFHL2HSJ	WAIT_MVS IO	User	"Log manager waits" on page 94
LG_FORCE Y N	journal name	DFHL2SRC	SUSPEND MISC	User	"Log manager waits" on page 94
LGHARTBT	LG_MGRST	DFHLGHB	SUSPEND TIMER	System only	"CICS checks for the availability of the MVS logger" on page 213
LGREDBLK N N	journal name	DFHL2HS8	WAIT_MVS IO	User	"Log manager waits" on page 94
LGREDCRS N N	journal name	DFHL2HSG	WAIT_MVS IO	User	"Log manager waits" on page 94
LGSTRBLK N N	journal name	DFHL2HS7	WAIT_MVS IO	User	"Log manager waits" on page 94
LGSTRCRS N N	journal name	DFHL2HS6	WAIT_MVS IO	User	"Log manager waits" on page 94
LGWRITE N N	journal name	DFHL2HSF	WAIT_MVS IO	User	"Log manager waits" on page 94

Table 19. Resources on which a suspended task might be waiting (continued)

Resource type Purge status	Resource name	Suspending module	DSSR call WLM wait type	Task	Where to look next
MBCB_xxx (See note 3 on page 85)	transient data queue name	DFHTDB DFHTDRM	SUSPEND IO	User	"Transient data waits" on page 112
N	N				
MRCB_xxx (See note 3 on page 85)	transient data queue name	DFHTDB DFHTDRM	WAIT_MVS IO	User	"Transient data waits" on page 112
N	N				
MXT	XM_HELD	DFHXMAT	(See note 4 on page 85)	User	"Maximum task condition waits" on page 85
N	N				
PROGRAM	program ID	DFHLDDMI	SUSPEND LOCK	User	"Loader waits" on page 115
Y	Y				
PROGRAM	program ID	DFHPGEX DFHPGIS DFHPGLD DFHPGLE DFHPGLK DFHPGLU DFHPGPG DFHPGRP DFHPGXE	SUSPEND MISC	User	
Y	Y				
RCP_INIT	(none)	DFHAPRC	WAIT_OLDC MISC	System only	"CICS system task waits" on page 143
RDSA	(none)	DFHSMSQ	SUSPEND MISC	User	"Storage waits" on page 98
Y	Y				
RMI	DFHERMRS	DFHERMRS	WAIT_MVS TIMER	System only	"Recovery manager waits" on page 144
RMCLIENT	client name	DFHRMCIC	SUSPEND MISC	User	"Recovery manager waits" on page 144
N	N				
RMUOWOBJ	LOGMOVE EXISTENC	DFHRMUO DFHRMUW DFHRMUWJ DFHRMUWS DFHRMU1U DFHRMUO DFHRMUW DFHRMUWL DFHRMUWP DFHRMUWQ DFHRMU1D DFHRMU1K	SUSPEND LOCK	User	"Recovery manager waits" on page 144
N	N				
SDSA	(none)	DFHSMSQ	SUSPEND MISC	User	"Storage waits" on page 98
Y	Y				
STP_TERM	(none)	DFHAPRC	WAIT_OLDC MISC	System only	"CICS system task waits" on page 143
SMSYSTEM	(none)	DFHSMSY	SUSPEND TIMER	System only	"CICS system task waits" on page 143

Table 19. Resources on which a suspended task might be waiting (continued)

Resource type Purge status	Resource name	Suspending module	DSSR call WLM wait type	Task	Where to look next
SUCNSOLE	WTO	DFHSUWT	WAIT_MVS MISC	System only	"CICS system task waits" on page 143
TCLASS	tclass name	DFHXMAT	(See note 6 on page 85)	User	"Transaction manager waits" on page 85
N					
TCLASS	tclass name	DFHXMCL	SUSPEND LOCK	User	
Y					
TCP_NORM	DFHZDSP	DFHZDSP	WAIT_OLDW See note 1 on page 73	System only	"CICS system task waits" on page 143
TCP_SHUT	DFHZDSP	DFHZDSP	WAIT_OLDW MISC	System only	"CICS system task waits" on page 143
TCTVCECB	ZC_ZGRP	DFHZGRP	WAIT_OLDC MISC	System only	"CICS system task waits" on page 143
TDEPLOCK	transient data queue name	DFHTDA	SUSPEND LOCK	User	"Transient data waits" on page 112
N					
TD_INIT	DCT	DFHTDA	SUSPEND MISC	User	"Transient data waits" on page 112
N					
TDIPLOCK	transient data queue name	DFHTDB	SUSPEND LOCK	User	"Transient data waits" on page 112
N					
TD_READ	transient data queue name	DFHTDB	SUSPEND LOCK	User	"Transient data waits" on page 112
N					
TIEXPIRY	DS_NUDGE	DFHTISR	SUSPEND TIMER	System only	"CICS system task waits" on page 143
TRANDEF	transaction id	DFHXMDD DFHXMQD DFHXMxD	SUSPEND LOCK	User	
Y					
TSAUX	temporary storage queue name	DFHTSWQ	SUSPEND LOCK	User	"Temporary storage waits" on page 99
Y					
TSBUFFER	temporary storage queue name	DFHTSWQ	SUSPEND LOCK	User	"Temporary storage waits" on page 99
Y					
TSEXTEND	temporary storage queue name	DFHTSWQ	SUSPEND LOCK	User	"Temporary storage waits" on page 99
Y					
TSIO	(none)	DFHTSAM	WAIT_MVS IO	User	"Temporary storage waits" on page 99
N					
TSIOWAIT	DFHTEMP	DFHTSDM	WAIT_MVS IO	System only	"Temporary storage waits" on page 99
TSPPOOL	temporary storage queue name	DFHTSWQ	SUSPEND LOCK	User	"Temporary storage waits" on page 99
Y					
TSQUEUE	temporary storage queue name	DFHTSWQ	SUSPEND LOCK	User	"Temporary storage waits" on page 99
Y					

Table 19. Resources on which a suspended task might be waiting (continued)

Resource type Purge status	Resource name	Suspending module	DSSR call WLM wait type	Task	Where to look next
TSSHARED Y Y	temporary storage queue name	DFHTSSH	WAIT_MVS MISC	User	"Temporary storage waits" on page 99
TSSTRING Y Y	temporary storage queue name	DFHTSWQ	SUSPEND LOCK	User	"Temporary storage waits" on page 99
TSWBUFFR Y Y	temporary storage queue name	DFHTSWQ	SUSPEND LOCK	User	"Temporary storage waits" on page 99
UDSA Y Y	(none)	DFHMSMQ	SUSPEND MISC	User	"Storage waits" on page 98
USDOMAIN Y Y	DDB_UPD	DFHUSAD	SUSPEND LOCK	User	—
USERWAIT Y Y or N N	Supplied by application	DFHEIQSK DFHEIQSK	WAIT_MVS MISC WAIT_OLDW MISC	User	—
USERWAIT Y Y	CDB2TIME	DFHD2EX2	WAIT_OLDW MISC	System	<i>CICS DB2 Guide</i>
USERWAIT Y Y	DB2START	DFHD2EX2	WAIT_MVS MISC	System only	<i>CICS DB2 Guide</i>
XRGETMSG	message queue name	DFHWMQG	WAIT_MVS See <i>note 1 on page 73</i>	System only	"CICS system task waits" on page 143
XRPUTMSG Y Y	message queue name	DFHWMQP	WAIT_MVS MISC	User	"XRF alternate system waits" on page 141
ZC Y N	DFHZCRQ1	DFHZCRQ	SUSPEND MISC	User	"VTAM terminal control waits" on page 109
ZC Y N	DFHZEMW1	DFHZEMW	SUSPEND MISC	User	"VTAM terminal control waits" on page 109
ZC Y N	DFHZIS11	DFHZIS1	SUSPEND MISC	User	"VTAM terminal control waits" on page 109
ZC Y N	DFHZRAQ1	DFHZRAQ	SUSPEND MISC	User	"VTAM terminal control waits" on page 109
ZC Y N	DFHZRAR1	DFHZRAR	SUSPEND MISC	User	"VTAM terminal control waits" on page 109
ZC_ZCGRP	ZSLSECB	DFHZCGRP	WAIT_MVS MISC	System only	"VTAM terminal control waits" on page 109
ZC_ZGCH N N	CHANGECEB	DFHZGCH	WAIT_MVS MISC	User	"VTAM terminal control waits" on page 109

Table 19. Resources on which a suspended task might be waiting (continued)

Resource type Purge status	Resource name	Suspending module	DSSR call WLM wait type	Task	Where to look next
ZC_ZGIN N N	INQ_ECB_	DFHZGIN	WAIT_MVS MISC	User	"VTAM terminal control waits" on page 109
ZC_ZGRP	PSINQECB	DFHZGRP	WAIT_MVS MISC	System only	"VTAM terminal control waits" on page 109
ZC_ZGRP	PSOP1ECB	DFHZGRP	WAIT_MVS MISC	System only	"VTAM terminal control waits" on page 109
ZC_ZGRP	PSOP2ECB	DFHZGRP	WAIT_MVS MISC	System only	"VTAM terminal control waits" on page 109
ZC_ZGUB	PSUNBECB	DFHZGUB	WAIT_OLDC MISC	System only	"VTAM terminal control waits" on page 109
ZCIOWAIT Y N	DFHZARQ1	DFHZARQ	SUSPEND See note 4 on page 73	User	"VTAM terminal control waits" on page 109
ZCIOWAIT Y N	DFHZARL1	DFHZARL	SUSPEND See note 4 on page 73	User	"VTAM terminal control waits" on page 109
ZCIOWAIT Y N	DFHZARL4	DFHZARL	SUSPEND See note 4 on page 73	User	"VTAM terminal control waits" on page 109
ZCIOWAIT Y N	DFHZARR1	DFHZARR1	SUSPEND See note 4 on page 73	User	"VTAM terminal control waits" on page 109
ZCIOWAIT Y N	DFHZARER	DFHZARER	SUSPEND MISC	User	"VTAM terminal control waits" on page 109
ZCIOWAIT Y N	DFHZERH1	DFHZERH	SUSPEND CONV	User	"VTAM terminal control waits" on page 109
ZCIOWAIT Y N	DFHZERH2	DFHZERH	SUSPEND CONV	User	"VTAM terminal control waits" on page 109
ZCIOWAIT Y N	DFHZERH3	DFHZERH	SUSPEND CONV	User	"VTAM terminal control waits" on page 109
ZCZGET Y N	DFHZARL2	DFHZARL	SUSPEND MISC	User	"VTAM terminal control waits" on page 109
ZCZNAC Y N	DFHZARL3	DFHZARL	SUSPEND MISC	User	"VTAM terminal control waits" on page 109
ZCZNAC Y N	DFHZERH4	DFHZERH	SUSPEND CONV	User	"VTAM terminal control waits" on page 109

Table 19. Resources on which a suspended task might be waiting (continued)

Resource type Purge status	Resource name	Suspending module	DSSR call WLM wait type	Task	Where to look next
ZXQOWAIT	LIST	DFHZXQO	WAIT_OLDW MISC	System only	“VTAM terminal control waits” on page 109
ZXQOWAIT	LIST	DFHZXST	WAIT_OLDW MISC	System only	“VTAM terminal control waits” on page 109

Notes:

1. If there is a terminal associated with the task.
2. “bbbb” is the block number.
3. “xxx” is literal.
4. The task has not yet started, because the system is at MXT.
5. These waits are used by the CICS/ESA® Front End Programming Interface and are not discussed in this manual.
6. The task has not yet started because it is being held for transaction class purposes.

Dispatcher waits

When a task first needs to make use of an open TCB (for example, a J8 TCB for a JVM transaction), the dispatcher domain attempts to find a free TCB of the correct mode. If there is not a free TCB of the correct mode, CICS:

- Attaches a new TCB if the number of open TCBs in the CICS region is less than MAXOPENTCBS.
- Detaches a free open TCB of a different mode (if there is one available and MAXOPENTCBS limit has been reached) and attaches an open TCB of the correct mode.

However, if neither of these options is available, dispatcher places the requesting task onto a queue and the task is suspended (using suspend token AWAITING_OPEN_TCB_TOKEN in the DS task block). When an open TCB becomes free, or the MAXOPENTCBS limit is raised, the task at the front of the queue is resumed, and the open TCB allocation process is retried.

Transaction manager waits

Formatting a system dump using the keyword XM=1 provides a number of transaction manager summaries that are useful for identifying why tasks have failed to run.

A task may fail to run if the system is at MXT, or if the task is defined in a transaction class that is at its MAXACTIVE limit.

Maximum task condition waits

Tasks can fail to run if either of the following limits is reached:

- MXT (maximum tasks in CICS system)
- MAXACTIVE (maximum tasks in transaction class)

If a task is waiting for entry into the MXT set of transactions, the resource type is MXT, and the resource name is XM_HELD. If a task is waiting for entry into the MAXACTIVE set of transactions for a TCLASS, the resource type is TCLASS, and the resource name is the name of the TCLASS that the task is waiting for.

If a task is shown to be waiting on resource type MXT, it is being held by the transaction manager because the CICS system is at the MXT limit. The task has not yet been attached to the dispatcher.

The limit that has been reached, MXT, is given explicitly as the resource name for the wait. If this type of wait occurs too often, consider changing the MXT limit for your CICS system.

Transaction summary

The transaction summary (Figure 6 on page 88) lists all transactions (user and system) that currently exist. The transactions are listed in order of task number and the summary contains two lines per transaction.

The meanings of the column headings are as follows:

Tran id

The primary transaction id associated with the transaction

Tran num

The unique transaction number assigned to the transaction

Txn Addr

The address of the transaction control block

Txd Addr

The address of the transaction definition instance associated with the transaction

Start Code

The reason the transaction was attached, as follows:

- C** A CICS internal attach
- T** A terminal input attach
- TT** A permanent transaction terminal attach
- QD** A transient data trigger level attach
- S** A START command without any data
- SD** A START command with data
- SZ** A front end programming interface (FEPI) attach
- DF** Start code not yet known—to be set later.

Sys Tran

Indicator (Yes or No) of whether the transaction is attached as a system transaction. System transactions do not contribute towards MXT.

Status

An indicator of how far through attach the transaction has progressed and whether the transaction is abending or not. The first line may take the following values:

- PRE** The transaction is in the early stages of attach.

TCLASS

The transaction is waiting to acquire membership of a tclass.

MXT The transaction is waiting on MXT.

ACT The transaction is active, that is, it has been DS attached.

Depending on the value in the first line, the second line of the status field may further qualify the transaction state. For each first line value, the meaning of the second line is as follows:

PRE No data is displayed in the second line

TCLASS

The second line contains the name of the tclass that the transaction is waiting to join.

MXT or ACT

If applicable, the second line indicates if the transaction is flagged for deferred abend or a deferred message, or if the transaction is already abending, as follows:

DF(yyyy)

indicates that the transaction is scheduled for deferred abend, where yyyy is the abend code.

DM(yy)

indicates that the transaction is scheduled for a deferred message, and yy indicates the message type

AB(yyyy)

indicates that the transaction is already abending with abend code yyyy.

DS token

The token identifying the DS task (if any) assigned to the transaction.

Facility type

Type of the principal facility owned by the transaction.

Facility token

Transaction token for the principal facility owner.

AP token

The AP domain transaction token.

The first word of this token contains the address of the TCA (if any) associated with the transaction.

PG token

The program manager transaction token.

XS token

The security domain transaction token.

US token

The user domain transaction token.

RM token

The recovery manager transaction token.

SM token

The storage manager domain transaction token.

MN token

The monitoring domain transaction token.

Figure 6 shows a transaction summary.

Notes for Figure 6

==XM: TRANSACTION SUMMARY

Tran id	Tran num	TxnAddr TxdAddr	Start code	Sys Tran	Status	DS token	Facility type	Facility token	AP token	PG token	XS token	US token	RM token	SM token
CSTP	00003	10106200 101793C0	C	Yes	ACT	00120003	None	n/a	10164600 01000000	00000000 1017E000	00000000 00000000	00000000 00000000	1016C000 10164600	10089020 00000000
CSNE	00031	10106100 10A34B40	C	Yes	ACT	00000003	None	n/a	10164C00 01000000	00000000 1017E048	00000000 00000000	00000000 00000000	1016C058 10164C00	11542054 00000000
IC06	10056	10E2B200 10AC9300	T	No	ACT	089601C7	Terminal	10E167A0 00000000	1124F600 00000000	00000000 1017E7E0	00000000 00000000	10114023 10E0F6A0	1016C9A0 1124F600	11543610 00000000
IC12	10058	10E34C00 10AC93C0	SD	No	ACT	050601AD	None	n/a	001DE600 00000000	00000000 1017E828	00000000 00000000	10114023 10E31400	1016C9F8 001DE600	11545114 00000000
TA03	93738	10E0E000 10AD3D40	T	No	ACT	088211E3	Terminal	10ED9000 00000000	0024B000 00000000	00000000 1017E090	00000000 00000000	10114023 10117D60	1016C738 0024B000	11543780 00000000
TA03	93920	10AFF200 10AD3D40	T	No	TCL DFHTCL03	00000000	Terminal	11214BD0 00000000	00000000 00000000	00000000 00000000	00000000 00000000	10114023 10117680	00000000 00000000	00000000 00000000
TA03	93960	10E2D200 10AD3D40	T	No	TCL DFHTCL03	00000000	Terminal	10E573F0 00000000	00000000 00000000	00000000 00000000	00000000 00000000	10114023 10E0F6C0	00000000 00000000	00000000 00000000
TA03	93967	10AFEA00 10AD3D40	T	No	TCL DFHTCL03	00000000	Terminal	10ECCBD0 00000000	00000000 00000000	00000000 00000000	00000000 00000000	10114023 10117540	00000000 00000000	00000000 00000000
TA03	94001	10E34800 10AD3D40	T	No	ACT DF(AKCC)	00000000	Terminal	10E2C3F0 00000000	00000000 00000000	00000000 00000000	00000000 00000000	10114023 10E31120	00000000 00000000	00000000 00000000
TA02	95140	10E2D300 10AD3C80	T	No	ACT	0386150D	Terminal	10E2C5E8 00000000	00057000 00000000	00000000 1017E510	00000000 00000000	10114023 10E0F320	1016C790 00057000	11544754 00000000
TA02	95175	10E12C00 10AD3C80	T	No	TCL DFHTCL02	00000000	Terminal	10E937E0 00000000	00000000 00000000	00000000 00000000	00000000 00000000	10114023 10E0F100	00000000 00000000	00000000 00000000
TA02	95187	10E0B000 10AD3C80	T	No	TCL DFHTCL02	00000000	Terminal	10EA95E8 00000000	00000000 00000000	00000000 00000000	00000000 00000000	10114023 10117800	00000000 00000000	00000000 00000000
TA02	95205	10E2D600 10AD3C80	T	No	MXT DF(AKCC)	00000000	Terminal	10E837E0 00000000	00000000 00000000	00000000 00000000	00000000 00000000	10114023 10E0F780	00000000 00000000	00000000 00000000
TA04	96637	10E33000 10AD3E00	T	No	ACT	060408E7	Terminal	10E05BD0 00000000	00057600 00000000	00000000 1017E558	00000000 00000000	10114023 10E31040	1016C7E8 00057600	115457C8 00000000
TA04	96649	10E34000 10AD3E00	T	No	TCL DFHTCL04	00000000	Terminal	10AE89D8 00000000	00000000 00000000	00000000 00000000	00000000 00000000	10114023 10E312C0	00000000 00000000	00000000 00000000
F121	99305	10E2D800 10AD3BC0	T	No	ACT AB(AFCY)	020C1439	Terminal	10EA93F0 00000000	00060000 00000000	00000000 1017E708	00000000 00000000	10114023 10E0F920	1016C898 00060000	115423FC 00000000
TS12	99344	10AFED00 10AD6B40	T	No	MXT	00000000	Terminal	10E499D8 00000000	00000000 00000000	00000000 00000000	00000000 00000000	10114023 101178C0	00000000 00000000	00000000 00000000

Figure 6. Transaction summary

1. Transactions 00003 and 00031 are system transactions.
2. Transactions 93920, 93960, and 93967 are waiting because tclass DFHTCL03 is at its MAXACTIVE limit.
3. Transaction 94001 is scheduled to abend AKCC because it was attached when tclass DFHTCL03 was at its PURGETHRESH limit.
4. Transactions 95175 and 95187 are waiting because tclass DFHTCL02 is at its MAXACTIVE limit.
5. Transaction 95205 was scheduled to abend AKCC because it was attached when tclass DFHTCL02 was at its PURGETHRESH limit. It was subsequently made to queue because CICS is at its MXT limit.
6. Transaction 99305 is abnormally terminating with abend code AFCY.
7. Transaction 99344 is queuing because the system is at its MXT limit.

- Transactions waiting in the transaction manager have no DS token, which is indicated by zeros in the summary.

MXT summary

The MXT summary indicates whether CICS is currently at MXT and shows the current number of queued and active transactions. To check the status of an individual transaction, consult the main transaction summary (Figure 6 on page 88).

==XM: MXT SUMMARY

```

Maximum user tasks (MXT):           7
System currently at MXT:             Yes
Current active user tasks:           7
Current queued user tasks:           2
* Peak active user tasks:            7
* Peak queued user tasks:            2
* Times at MXT limit:                1

```

* NOTE: these values were reset at 18:00:00 (the last statistics interval collection)

Transaction class summary

The transaction class summary lists each transaction class that is currently installed. For each class, the current number of active and queued transactions is shown. A transaction class is at its MAXACTIVE limit if its 'current active' total is greater than or equal to its 'max active' setting. If a transaction class is at its MAXACTIVE limit, a number of transactions may be queueing in that transaction class. The transaction id and number of each queued transaction is listed with its transaction class (for example, transaction classes DFHCTL01, DFHCTL02, and DFHCTL03 in Figure 7).

==XM: TCLASS SUMMARY

Tclass Name	Max Active	Purge Threshld	Current Active	Current Queued	Total Attaches	Queuing TranNum	Queuing Transid	Queuing Start Time
DFHTCL01	1	0	0	0	0			
DFHTCL02	1	3	1	2	7	95175	TA02	18:00:19.677
DFHTCL03	1	4	1	3	29	95187	TA02	18:00:24.624
						93920	TA03	17:55:40.584
						93960	TA03	17:55:42.230
						93967	TA03	17:55:52.253
DFHTCL04	1	0	1	1	23	96649	TA04	18:06:04.348
DFHTCL05	1	0	0	0	0			
DFHTCL06	1	0	0	0	0			
DFHTCL07	1	0	0	0	0			
DFHTCL08	1	0	0	0	0			
DFHTCL09	1	0	0	0	0			
DFHTCL10	1	0	0	0	0			

*** Note that the 'Total Attaches' figures were reset at 18:00:00 (the last statistics interval collection)

Figure 7. Transaction class summary

A user task is waiting on resource type FOREVER

If you have found that a user task is waiting on a resource type of FOREVER, and resource name DFHXMTA, transaction manager has detected a severe error during task initialization or task termination. Transaction manager has suspended the task.

The suspended task is never resumed, and holds its MXT slot until CICS is terminated. **You must cancel CICS to remove this task as you will be unable to quiesce the system.** You cannot purge or forcepurge the task.

This wait is always preceded by one of the following messages: DFHXM0303, DFHXM0304, DFHXM0305, DFHXM0306, DFHXM0307, DFHXM0308, DFHXM0309, DFHXM0310. Transaction manager also takes a dump and message DFHME0116 is produced and contains the symptom string.

Lock manager waits

Read this section if a resource name of LMQUEUE has been shown for a task. It means that the suspended task cannot acquire the lock on a resource it has requested, probably because another task has not released it.

A user task cannot explicitly acquire a lock on a resource, but many of the CICS modules that run on behalf of user tasks do lock resources. If this is a genuine wait, and the system is not just running slowly, this could indicate a CICS system error.

Collecting the evidence

You need to take a system dump, and format it using keywords LM and DS. This formats the storage areas belonging to lock manager domain and dispatcher domain. This section describes the data that you should find there if the resource locks are being managed correctly.

Turn to the lock manager summary information (Figure 8 shows an example of this).

```

LOCK      LOCK      OWNER      MODE      COUNT      # LOCK      # LOCK      -> QUEUE
NAME      TOKEN
-----
SMLOCK    03B051D8
DSITLOCK  03B05208
LD_GBLOK  03B05238  03B0AAD0  EXCL
LD_LBLOK  03B05268
DMLOCKNM  03B05298  03B0B690  EXCL
CCSERLCK  03B052C8
==LM: LOCK WAIT QUEUE
LOCK      ADDRESS  -> NEXT  OWNER      MODE  SUSPEND  STATUS
NAME      -----
-----
LD_GBLOK  03B09378  00000000  03B0B3A0  EXCL  010B0001

```

Figure 8. Lock manager summary information

Table 20 describes each of the fields in the lock manager summary information.

Table 20. Fields in the lock manager summary information

Field	Description
LOCK NAME	The name given to the lock by the domain that originally issued the ADD_LOCK command.
LOCK TOKEN	The token assigned by the lock manager to uniquely identify the lock.
OWNER	A token that uniquely identifies the owner of the lock. It is blank unless a task currently holds the lock, in which case the KE_TAS number of the task is given.

Table 20. Fields in the lock manager summary information (continued)

Field	Description
MODE	The lock mode. It can be: Blank No task currently holds the lock. EXCL The lock is exclusive—only one task can hold the lock at any one time. The lock owner is identified in the OWNER field. SHR The lock is shared—several tasks can hold the lock. In this case, the OWNER field will be blank.
COUNT	Blank unless the lock mode is SHR, when it shows the number of tasks currently holding the shared lock.
# LOCK REQUESTS	The cumulative total of the number of times a lock has been requested—that is, the number of times the LOCK request has been issued for the lock.
# LOCK SUSPENDS	The cumulative total of the number of tasks that have been suspended when requesting this lock because the lock is held by another task.
-> QUEUE	Blank unless tasks are currently suspended, awaiting the lock. If this is the case, this field contains the address of the first such task. Further information about the task is given in the 'LOCK WAIT QUEUE' section of the information.
ADDRESS	The address of the lock manager LOCK_ELEMENT that represents the suspended task.
-> NEXT	The address of the next task in the queue awaiting the lock. If this field is zeros, this is the last task in the queue.
OWNER	The KE_TAS number of the task that is currently suspended, awaiting the lock.
MODE	The lock mode. It can be: EXCL The lock is exclusive—only one task can hold the lock at any one time. The lock requester is identified in the OWNER field. SHR The lock is shared—several tasks can hold the lock.
SUSPEND TOKEN	The dispatcher suspend token for the suspended task.
STATUS	The status of the suspended task. It can be: Blank The task is waiting to acquire the lock. DELETED The suspended task has been deleted from the queue. This occurs only if the lock is deleted. PURGED The task was purged while waiting to acquire the lock.

The first step is to establish which lock the suspended task is waiting on. Obtain the KE_TAS number from the dispatcher domain summary for the suspended task and match this with an OWNER in the 'LOCK WAIT QUEUE' section of the lock manager summary information.

In the example, only one task is suspended and waiting to obtain the LD_GBLOK lock. The owner (KE_TAS identifier) of this task is 03B0B3A0.

You then have to find out which task currently holds the lock that the suspended task is waiting on. You can do this by looking at the lock manager summary for that lock—in this case, LD_GBLOK.

If the mode of the lock is SHR (shared), you will not be able to proceed any further and you will have to contact your IBM Support Center.

If the mode is EXCL (exclusive), the identifier of the task that currently holds the lock is given in the OWNER field. In the example, the task that currently has the lock—LD_GBLOK—is 030B0AAD0. Because the OWNER field is the KE_TAS identifier of the task, you can find out from the dispatcher domain summary the status, dispatcher task number, and TCA address of the task that currently holds the lock.

When you have all this information ready, contact the IBM Support Center and report the problem to them.

ECB “PSTDECB”—DLI code lock, PSB load I/O, or DMB load I/O: If you find that a task is waiting on ECB PSTDECB, it indicates either an error within CICS or IMS code, or some hardware fault preventing a PSB or DMB from being loaded.

If you have no evidence of a hardware fault, contact the IBM Support Center and report the problem to them.

CICS DB2 waits

CICS DB2 uses the WAIT_MVS and WAIT_OLDC functions of the CICS dispatcher to put the running CICS task into a wait.

Resource type CDB2RDYQ

The task is waiting for a thread to become available. The resource name details the DB2ENTRY or pool for which there is a shortage of threads.

You cannot purge the task when it is in this state. Message DFHAP0604 is issued at the console if an attempt to forcepurge the task is made. Forcepurge processing is deferred until a thread is acquired.

You can increase the number of threads available for the DB2ENTRY with a SET DB2ENTRY () THREADLIMIT(*nn*) command. You can increase the number of threads available for the pool with a SET DB2CONN THREADLIMIT(*nn*) command. If you increase the THREADLIMIT value, CICS posts tasks to retry acquisition of a thread.

Resource type CDB2TBC

The task is waiting for a CICS DB2 subtask to become available. This indicates that the TCBLIMIT value has been reached and that all TCBs are in use and running threads.

You cannot purge the task when it is in this state. Message DFHAP0604 is issued at the console if an attempt to forcepurge the task is made. Forcepurge processing is deferred until a TCB has been acquired.

You can increase the number of TCBS permitted with a SET DB2CONN TCBLIMIT command. If you increase the TCBLIMIT value, CICS posts tasks to retry acquisition of a DB2 subtask.

Resource type DB2

The task is waiting for the CICS DB2 subtask to complete a request. If purged or forcepurged in this state, the task abends and backout occurs and the CICS DB2 subtask is detached causing DB2 also to back out.

Resource type DB2_INIT

DFHD2IN1 (CICS DB2 initialization program) issues the wait for DFHD2IN2 to complete.

Resource type DB2CDISC

A SET DB2CONN NOTCONNECTED command has been issued with the WAIT or FORCE option. DFHD2TM waits for the count of tasks using DB2 to reach zero.

Resource type DB2EDISA

A SET DB2ENTRY DISABLED command has been issued with the WAIT or FORCE option. DFHD2TM waits for the count of tasks using the DB2ENTRY to reach zero.

DBCTL waits

Read this section if you have any of the following problems:

- You have attempted to connect to DBCTL using the CICS-supplied transaction CDBC, but the connection process has failed to complete.
- You have a user task in a wait state, and you have found that it is waiting on resource type DBCTL, with resource name DLSUSPND.
- You have attempted to disconnect from DBCTL using the CICS-supplied transaction CDBC, but the disconnection process has failed to complete.

Each of these types of problem is dealt with in turn.

Connection to DBCTL has failed to complete

Connection to DBCTL using the CICS-supplied transaction CDBC takes place in two phases. You can find the current phase using either transaction CDBC, by refreshing the screen display, or transaction CDBI.

In phase 1, CDBC simply passes the request for connection to IMS, and returns. It is very unlikely for a wait to occur during this phase, unless there is an error in CICS code. In such a case, you would see this message displayed whenever you inquired on the connection status using CDBI:

```
DFHDB8291I DBCTL connect phase 1 in progress.
```

In phase 2, IMS processes the request asynchronously, and returns to CICS when connection is complete. Until the connection is complete, you see this status message displayed whenever you inquire with CDBI:

```
DFHDB8292I DBCTL connect phase 2 in progress.
```

If this phase fails to complete, the failure is associated with IMS. See the *IMS Diagnosis Guide and Reference manual* for guidance about debugging the problem.

A user task is waiting on resource type DBCTL

If you have found that a user task is waiting on a resource type of DBCTL, and resource name DLSUSPND, the task has made a DL/I request. It has been suspended by CICS while the request is serviced by DBCTL. If the task has not resumed, the request has not been completed, for some reason.

Disconnection from DBCTL has failed to complete

When you use CDBC to disconnect from DBCTL, it invokes another CICS transaction, CDBT. CDBT makes the disconnection request to DBCTL, and is suspended by CICS while DBCTL services the request asynchronously.

If disconnection fails to complete, you can inquire on CDBT using, for example, CEMT INQ TASK to see how far disconnection has progressed. You will probably find that CDBT is waiting on resource type DBCTL and resource name DLSUSPND, in which case the request is being processed by DBCTL.

- If CDBT *is* waiting on DBCTL, what you do next depends on whether you have requested “orderly” or “immediate” disconnection.
 - If you have requested “orderly” disconnection, it is likely that DBCTL is waiting for conversational tasks to finish. You can override an “orderly” disconnection by requesting “immediate” disconnection, in which case the process should end at once.
 - If you have requested “immediate” disconnection, and this does not happen, there is an unexpected wait within IMS. See the *IMS Diagnosis Guide and Reference manual* for guidance about investigating the problem.
- If CDBT *is not* waiting on DBCTL, this indicates a problem with CICS code. Contact the IBM Support Center for further assistance.

EDF waits

A user task is made to wait on resource type EDF and resource name DBUGUSER when, under the EDF session, CICS has control for EDF processing.

Log manager waits

Read this section if the resource type your task is waiting on starts with the characters LG, indicating log manager. The journal name, given as the resource name, refers to the last element of the MVS log stream name. For example, in the log stream name PAYRO.ACC0001.UJ4321, the journal name, for these purposes, is UJ4321.

If you do encounter any of these waits, look at the MVS console for messages prefixed with ‘IXG’. These are the MVS system logger messages and may provide further information about the cause of the wait. The MVS system console may also reveal evidence of resource contention within MVS, a possible cause of a log manager wait.

If the task is writing to a journal on an SMF log, the journal name is the name of the journal.

Resource type LG_DEFER

The task is the first task to request that the currently active log buffer be flushed. The task waits for 30 milliseconds to allow other tasks to append more records to the buffer.

Resource type LG_FORCE

The task is waiting for the flush of a log buffer to complete. It is resumed by the task that performs the flush operation.

The task may be purged if the log stream is not DFHLOG, the primary system log.

Resource type LGDELALL

During an INITIAL start of CICS, CICS calls the MVS system logger macro IXGDELET ALL. CICS waits until the MVS system logger posts the ECB.

Resource type LGDELTRAN

During keypoint processing, CICS calls the MVS system logger macro IXGDELET RANGE. CICS waits until the MVS system logger posts the ECB.

Resource type LGENDBLK

During an emergency restart of CICS, or transaction backout, CICS calls the MVS system logger macro IXGBRWSE END. CICS waits until the MVS system logger posts the ECB.

Resource type LGENDCRS

During an emergency restart of CICS, CICS calls the MVS system logger macro IXGBRWSE END. CICS waits until the MVS system logger posts the ECB.

Resource type LGREDBLK

During an emergency restart of CICS, or transaction backout, CICS calls the MVS system logger macro IXGBRWSE READBLOCK. CICS waits until the MVS system logger posts the ECB.

Resource type LGREDCRS

During an emergency restart of CICS, CICS calls the MVS system logger macro IXGBRWSE READCURSOR. CICS waits until the MVS system logger posts the ECB.

Resource type LGSTRBLK

During an emergency restart of CICS, or transaction backout, CICS calls the MVS system logger macro IXGBRWSE START. CICS waits until the MVS system logger posts the ECB.

Resource type LGSTRCRS

During an emergency restart of CICS, CICS calls the MVS system logger macro IXGBRWSE START. CICS waits until the MVS system logger posts the ECB.

Resource type LGWRITE

In several situations, CICS calls the MVS system logger macro IXGWRITE. CICS waits until the MVS system logger posts the ECB.

Task control waits

If your task is waiting on a resource type of KCCOMPAT or KC_ENQ, it has been suspended by the transaction manager. If your task is waiting on a resource type of EKCWAIT, it has been suspended by task control.

KC_ENQ indicates that CICS code acting for a task has issued an EXEC CICS ENQ command or a DFHKC TYPE=ENQ macro. If there is an extended wait for no apparent reason, this might indicate an error within CICS. If that turns out to be the case, contact the IBM Support Center.

EKCWAIT indicates that a task has issued an EXEC CICS WAIT EVENT command. If the wait is prolonged, you should identify the event being waited on, and:

- Check that the EXEC CICS WAIT EVENT command specified the correct event.
- Check for problems with the task that should be completing the work for the specified event. It might be waiting or looping, it might have a performance problem, or it might have failed completely.

If the resource type is EKCWAIT and the EXEC CICS WAIT EVENT command included the NAME option, the specified name is the resource name. For programming information about the NAME option of the WAIT EVENT command, see the *CICS Application Programming Reference* manual.

Resource type KCCOMPAT

If you have a resource type of KCCOMPAT, the resource name tells you more about the circumstances of the wait. The meanings of the resource names are described in Table 21.

Table 21. KCCOMPAT waits: meaning of resource names

Resource name	Meaning
CICS	The task has been suspended on a DFHKC TYPE=WAIT,DCI=CICS macro call. CICS has issued the macro. The task is waiting for some internal event, and the ECB should be posted by CICS under another task.
LIST	The task has been suspended on a DFHKC TYPE=WAIT,DCI=LIST macro call issued by CICS code. It is waiting for any ECB in a list of ECBs to be posted, after which it is resumed.
SINGLE	The task has been suspended on a DFHKC TYPE=WAIT,DCI=SINGLE macro call issued by CICS code. It is waiting for a single ECB to be posted, after which it is resumed.
TERMINAL	The task has been suspended on a DFHKC TYPE=WAIT,DCI=TERMINAL macro call. CICS has suspended the task. The task is waiting for terminal I/O to complete, and stays suspended until resumed by CICS.

If the resource name for the wait is SINGLE, CICS, or LIST, look at the entry in the SUSPAREA column of the dispatcher summary in the dump. The type of value it contains depends on the resource name:

- For SINGLE or CICS, it is the address of an ECB

- For LIST, it is the address of a list of ECBs.

(The contents of the SUSPAREA entry are not significant for TERMINAL, because this type of wait is subject to the dispatcher RESUME function. For more information about debugging terminal waits, see “Terminal waits” on page 102.)

Check the contents of the SUSPAREA entry. Does it contain a valid address? That is, is it within the CICS address space, and actually pointing at an ECB, or a list of ECBs?

If you find an invalid address: It is possible that a storage overlay is the cause of the wait problem. If you suspect this to be the case, turn to “Chapter 10. Dealing with storage violations” on page 197 for further advice. However, note that this is likely to be a “random” overlay, and such problems are often very difficult to solve.

From the kernel information in the dump, find out which code issued the DFHKC macro call. If you think that CICS has passed an incorrect address, contact the IBM Support Center, and report the problem to them.

If you find a valid address: Consider what area the ECB is in. Does the position of the ECB, and its environment, suggest that it relates to a resource whose availability you can control? If so, you might be able to solve the problem by redefining the quantity of that resource.

If the ECB does not lie within an area that you can control, refer the problem to the IBM Support Center.

Resource type KC_ENQ

If your task is waiting on resource type KC_ENQ, it is unconditionally enqueued on a single server resource that is currently unavailable. Typically, tasks are made to wait on KC_ENQ when they make certain types of file control request, if the file is already in use. These are the cases:

- The waiting task has attempted to change the state of a file that is in use. Another task has already attempted to change the state of the same file, and is suspended on resource type FCFSWAIT. For more details, see “Resource type FCFSWAIT—wait for file state changes” on page 123.
- The waiting task has attempted to update a record in a recoverable file while another task has the lock on it. The task owning the record lock retains it until it reaches the end of the current logical unit of work (syncpoint or end of task). For more details of record locking for VSAM files, see “Resource type ENQUEUE—waits for locks on files or data tables” on page 129.

If the wait on resource type KC_ENQ is prolonged:

- More than one task might be enqueued on the resource, and the task you are investigating could be some way down the list. Check the programming logic of any of your programs accessing the resource, to see if it can be released more quickly. Consider whether you can include EXEC CICS DEQ commands.
- Another (long-running) task might have used the resource and finished with it, without issuing an EXEC CICS DEQ command or a DFHKC TYPE=DEQ macro call. The resource is made available automatically when the task terminates, but in the meantime, no other tasks are able to use it.
- There might be a CICS system error. If you have considered the other possibilities and you think this is the most likely explanation, refer the problem to the IBM Support Center.

Storage waits

Read this section if you have found that a task is waiting for a long time on any of the resource types CDSA, UDSA, ECDSA, EUDSA, ERDSA, SDSA, ESDSA, or RDSA. Waits on these resources occur when tasks make unconditional storage requests (SUSPEND=YES) that cannot be satisfied. The type is CDSA, UDSA, SDSA, or RDSA for storage requests below the 16MB line, and ECDSA, EUDSA, ESDSA, or ERDSA for storage requests above the line.

Note that, if conditional requests are made (SUSPEND=NO), tasks are not suspended on these resources. Instead, an exception response is returned if the request cannot be satisfied.

CICS automatically takes steps to relieve storage when it is under stress, for example by releasing storage occupied by programs whose current use count is 0.

In addition, your task may be automatically purged if it has waited for storage longer than the deadlock time-out parameter specified in the installed transaction definition. Certain conditions prevent purging of a task, for example, a deadlock time-out value of 0, or a specification of SPURGE(NO). The two most likely explanations for extended waits on storage requests are:

1. The task has issued an unconditional GETMAIN request for an unreasonably large amount of storage.
2. The task has issued an unconditional GETMAIN request for a reasonable amount of storage, but the system has too little available. It could be approaching SOS, or the storage could have become too fragmented for the request to be satisfied.

The first step is to get a CICS system dump, and format it using the formatting keyword SM. The way you interpret the dump to investigate each of the above possibilities is dealt with in the sections that follow.

Was the request for too much storage?

To find out if the suspended task has issued a request for too much storage, look in the SM suspend queue summary. This gives, amongst other things, the number of bytes requested by every task that has been suspended by the storage manager. You can see whether any of them has made a GETMAIN request for an unreasonably large amount of storage. For example, the following is the dump output in the SM suspend queue summary when task 41 requests 10 000 000 bytes:

```
==SM: Suspend queue summary
```

KE Task	Tran #	Susptok	Subpool	DSA	Request
053E5400	0000041	04080011	U0000041	EUDSA	10000016

If the suspended task has made a reasonable GETMAIN request, you next need to see if the system is approaching SOS.

Is the storage close to being exhausted?

It could be that your task has made a reasonable request for storage, but the system is too close to SOS for the request to be satisfied.

To see if this could be the cause of the wait, look at the DSA summary in the formatted dump. This tells you the current free space in each DSA, both in bytes and as a percentage of the total storage. It also tells you the size of the largest free area, that is, the biggest piece of contiguous storage. (“Contiguous storage” in this context means storage not fragmented by other records. It is accepted that records too large to fit in a single CI can be split across two or more CIs that are not necessarily contiguous.)

If the largest free area is smaller than the requested storage, this is likely to be the reason why the task cannot obtain its requested storage.

If the amount of free space is unexpectedly small, look at the task subpool summary. If a task has made an unusually large number of GETMAIN requests, this could indicate that it is looping. A looping task might be issuing GETMAIN requests repetitively, each for a reasonable amount of storage, but collectively for a very large amount. If you find evidence for a looping task, turn to “Chapter 7. Dealing with loops” on page 151.

If your task has made a reasonable request and the system seems to have sufficient free storage, you next need to see if fragmentation of free storage is causing the GETMAIN request to fail.

Is fragmentation of free storage causing the GETMAIN request to fail?

If the DSA summary shows that the current free space is significantly greater than the largest free area, it is likely that the DSA has become fragmented.

Temporary storage waits

Read this section if you have found that a user task is waiting on a resource type starting with TS, showing that it is for temporary storage.

Resource type ENQUEUE

Because enqueues on temporary storage should be held in retained state, no user task should ever wait on a resource type of ENQUEUE with a value of TSNQ (temporary storage enqueue).

For general information about dealing with enqueue waits, see “Enqueue waits” on page 116 .

Resource type TSAUX

A task is forced to wait on TSAUX if it has made an unconditional request for temporary storage, and the request cannot be met because insufficient auxiliary storage is available. The task has issued an EXEC CICS WRITEQ TS command, with or without the REWRITE option, but without specifying NOSUSPEND and without any code to handle the NOSPSPACE condition. If SPURGE(YES) is defined for the task on the CEDA DEFINE TRANSACTION command, and a deadlock time-out interval other than 0 has been specified, the task is purged when that time expires. Otherwise, it is not purged, and is liable to be suspended indefinitely.

A task that makes a conditional temporary storage WRITEQ TS request (NOSUSPEND specified) is not suspended if the request cannot be met. Instead, if the required auxiliary storage is not available, an exception response is returned to

it. (There might still be a suspension for another reason—for example, the temporary storage program itself might become suspended after issuing a GETMAIN, if CICS went short on storage.)

These are the two most likely reasons why a task that has issued an unconditional WRITEQ TS request might be suspended on resource type TSAUX:

1. The task has issued a request requiring too large a piece of temporary storage.
2. The task has issued a request requiring a reasonable amount of temporary storage, but there is too little available.

This could indicate that the amount of auxiliary storage is becoming exhausted. Otherwise, it could be that there is quite a large amount of auxiliary storage left, but the storage is too fragmented for the request to be satisfied.

The first step is to get a CICS system dump, and format it using the formatting keyword TS to show the temporary storage control blocks. Include formatting keywords SM and KE, too, as you might need to refer to the summaries for these two components as well. The way you analyze the dump to investigate the cause of the problem is described in the sections that follow.

Is temporary storage close to being exhausted?: It could be that your task has made a reasonable request for temporary storage, but the amount of unallocated space is close to exhaustion.

To see if this could be the cause of the wait, look at the temporary storage summary in the formatted dump. If the current free space is very small, this is likely to be the reason why the task cannot obtain its requested temporary storage. In such a case, consider defining secondary extents for the data set.

Look also at the trace. If a task has made an unusually large number of WRITEQ TS requests, it could be looping. A looping task might be issuing WRITEQ TS requests repetitively, each for a reasonable amount of storage, but collectively for a very large amount. If you find evidence for a looping task, turn to “Chapter 7. Dealing with loops” on page 151.

If your task has made a reasonable request and the system seems to have sufficient unallocated temporary storage, you next need to see if fragmentation of unallocated storage is causing the WRITEQ TS request to fail.

Is fragmentation of unallocated storage causing the WRITEQ TS request to fail?: You can tell whether fragmentation of unallocated temporary storage is causing the WRITEQ TS request to fail by looking at the temporary storage summary in the dump.

The following fields in the summary are of interest should your task be suspended on resource type TSAUX:

Number of control intervals in data set:
Number of control intervals currently in use:
Available bytes per CI:

For control intervals of 4K, the available bytes per CI figure is 4032.

If your task is attempting to write a record that is smaller than or equal to the available bytes per CI figure (including its record header which is 28 bytes long), this means that no control interval has the required amount of contiguous space to satisfy the request.

If your task is attempting to write a record that is longer than the available bytes per CI figure, CICS splits the record into sections of a length equal to this figure. CICS then attempts to store each section in a completely empty control interval, and any remaining part of the record in a control interval with the contiguous space to accommodate it. If your task is waiting on resource type TSAUX after having attempted to write a record longer than the available bytes per CI figure, either of the following has occurred:

- There are not enough available completely empty control intervals to accommodate all the sections
 $(\text{CIs in data set} - \text{CIs in use}) < (\text{record length} / \text{available bytes per CI})$
- No control interval has enough contiguous space to accommodate the remainder.

Resource type TSBUFFER

Resource type TSBUFFER indicates that the task that is waiting has issued an auxiliary temporary storage request, but the buffers are all in use. If you find that tasks are often made to wait on this resource, consider increasing the number of auxiliary temporary storage buffers (system initialization parameter TS).

Resource type TSEXTEND

Resource type TSEXTEND indicates that the waiting task has issued a request to extend the auxiliary temporary storage data set, but some other task has already made the same request. The wait does not extend beyond the time taken for the extend operation to complete. If you have a task that is waiting for a long time on this resource, it is likely that there is a hardware fault or a problem with VSAM.

Resource type TSIO

Resource type TSIO indicates that the task is being made to wait while physical I/O takes place during an auxiliary temporary storage read or write. If there is an extended wait on this resource, it is likely that there is a hardware fault or a problem with VSAM.

Resource type TSPPOOL

Resource type TSPPOOL indicates that the maximum number of concurrent requests (10) for a temporary storage pool in the coupling facility has been reached. The task resumes when one of the requests completes.

Resource type TSQUEUE

Resource type TSQUEUE indicates that the waiting task has issued a request against a temporary storage queue that is already in use by another task. The latter task is said to have the lock on the queue.

The length of time that a task has the lock on a temporary storage queue depends on whether or not the queue is recoverable. If the queue is recoverable, the task has the lock until the logical unit of work is complete. If it is not recoverable, the task has the lock for the duration of the temporary storage request only.

If tasks in your system are frequently made to wait on temporary storage queues, consider the following:

- Are tasks that are performing operations on the same temporary storage queue intended to do so, or is the ID of the queue unintentionally not unique?

- Is it possible to create more temporary storage queues to reduce the contention between tasks?
- If the queue in question is recoverable, is it possible to make tasks relinquish control of it more quickly? Consider reducing the size of UOWs, or making conversational tasks pseudoconversational.

Resource type TSSHARED

Resource type TSSHARED indicates that the task attempted to write to a shared temporary storage queue on the coupling facility, and there was insufficient space to satisfy the request. The request is retried every half second.

Resource type TSSTRING

Resource type TSSTRING indicates that the task is waiting for an auxiliary temporary storage VSAM string. If you find that tasks frequently wait on this resource, consider increasing the number of temporary storage strings (system initialization parameter TS).

Resource type TSWBUFFR

Resource type TSWBUFFR indicates that the waiting task has issued an auxiliary temporary storage request, but the write buffers are all in use. You have no control over how temporary storage allocates read buffers and write buffers from the buffer pool, but if you find that tasks are often made to wait on this resource, increasing the number of auxiliary temporary storage buffers (system initialization parameter TS) should help solve the problem.

Terminal waits

Read this section if you have any of the following problems:

- A task should have started at a terminal, but has failed to do so.
- A task is waiting on a resource type of KCCOMPAT, with a resource name of TERMINAL.
- A task is waiting on a resource type of IRLINK, with a resource name of SYSIDNT concatenated with the session name.

Note that, if you have one or more unresponsive terminals, that is terminals that are showing no new output and accepting no input, this does not necessarily indicate a *terminal* wait. If you have this problem, use CEMT INQ TERMINAL to find the transaction running at the terminal, and then CEMT INQ TASK to find out what resource that task is waiting on. When you know that, look at Table 19 on page 74 to find where you can get further guidance.

If all the terminals in the network are affected, and CICS has stalled, read “What to do if CICS has stalled” on page 145 for advice about how to investigate the problem.

If yours is a genuine terminal wait, remember when you carry out your investigation that terminals in the CICS environment can have a wide range of characteristics. A terminal is, in fact, anything that can be at the end of a communications line. It could, for example, be a physical device such as a 3270 terminal or a printer, or a batch region, or it could be another CICS region connected by an interregion communication link, or it could be a system that is connected by an LUTYPE6.1 or APPC (LUTYPE6.2) protocol. If LUTYPE6.1 is in use, the other system might be

another CICS region or an IMS region. With APPC (LUTYPE6.2), the range of possibilities is much wider. It could include any of the systems and devices that support this communications protocol. For example, apart from another CICS region, there might be a PC or a DISOSS system at the other end of the link.

If you eventually find that the fault lies with a terminal, or a resource such as DISOSS, the way in which you approach the problem depends on what type it is. In some cases, you probably need to look in appropriate books from other libraries for guidance about problem determination.

Terminal waits—first considerations

Before taking a systematic approach to the problem, here are a few preliminary considerations that could point to a simple solution.

- Is there an obvious physical explanation for the wait? For example, is a terminal operator failing to respond to a request for input? In the case of a printer, has it been powered off, or has it run out of paper?
- Have you checked in the CSTL and CSNE logs to see if there is a message you might have missed? If either DFHTCP or DFHZCP detected an error related to terminal control, a message reporting the problem will have been sent to the CSNE log, and, perhaps, to the console too.

If you do find a message there reporting some terminal error that can be related to the task, it should give you an idea of why the task is waiting. You can find an explanation of the message and a description of the system action in response to the error by using the CMAC transaction, or by looking in the *CICS Messages and Codes* manual.

It is also possible that the CSNE log entry will show that an error was detected, but that no action was taken by TACP or NACP. This could occur if the line or terminal was out of service, or if the error actions had been turned off in the user exits of DFHTEP and DFHNEP. In such a case, the CICS code enabling the waiting task to be resumed would never be executed, and the task would wait indefinitely.

- Have any HANDLE CONDITION routines for terminal errors been coded incorrectly? If an attempt were made to access the terminal having the error in such a routine, the application would be very likely to wait indefinitely.
- If the terminal is installed using autoinstall, has the system failed to load DFHZATA, the autoinstall program, or DFHZCQ which is called by DFHZATA, because of a short on storage condition? If so, you need to deal with the cause of the short on storage condition. Check the delete delay that you have specified—if it is too short, your system may be deleting and reinstalling terminals unnecessarily. If storage fragmentation is preventing DFHZATA or DFHZCQ from being loaded consider defining them as resident. However, be aware that DFHZCQ is a large program, and check your storage requirements before making this change.

If none of these considerations applies, you need to start a systematic investigation into the reason for the wait.

Terminal waits—a systematic approach

You first need to determine the type of terminal involved in the wait, and the type of access method in use for that terminal. Both of these factors influence the way you perform problem determination.

Your strategy must then be to find where in the communication process the fault lies. These are the basic questions that must be answered:

1. Is the problem associated with the access method?
2. If the access method has returned, or has not been involved, is terminal control at fault?
3. If terminal control is working correctly, why is the terminal not responding?

To answer most of these questions, you will need to do some offline dump analysis. Use CEMT PERFORM SNAP to get the dump, and then format it using the formatting keyword TCP. **Do not cancel your task before taking the dump. If you do, the values in the terminal control data areas will not relate to the error.**

What type of terminal is not responding?: You can check the terminal type either online, using a system programming command, or offline, by looking at the appropriate TCTTE in the formatted system dump.

Online method: Use the transaction CECI to execute the system programming command EXEC CICS INQUIRE TERMINAL DEVICE. This returns one of the terminal types identified in the *CICS Resource Definition Guide*.

Offline method: Look at the formatted dump output you have obtained for keyword TCP. First, identify the TCTTE relating to the terminal, from the four-character terminal ID shown in field TCTTETI. Now look in field TCTTETT, and read the 1-byte character that identifies the type of terminal. You can find what terminal type is represented by the value in the field from the description given in the *CICS Data Areas*.

What type of access method is in use?: You can use both an online method and an offline method for finding the type of access method being used by the terminal that is not responding.

Online method: Use the CECI transaction to execute the system programming command EXEC CICS INQUIRE TERMINAL ACCESSMETHOD. This returns the access method in use by the terminal.

Offline method: You can find the access method for the terminal from the TCTTE. Look in field TCTTEAMIB, which is the byte name definition for the access method. The *CICS Data Areas* relates values to access methods.

The most common access method is VTAM, identified by a value of TCTEVTAM. The problem determination procedures outlined below focus exclusively on VTAM. You might also find either of these values, each being of special significance for problem determination:

- TCTEISMM, meaning that the access method is ISMM. This is used for interregion communication, and it shows that the resource that is not responding is a remote CICS region. In such a case, the most likely reason for the wait is that some task in the remote region is also in a wait state. The way you deal with this type of problem is described in “Your task is waiting on a physical terminal” on page 108.
- TCTELU6, meaning that you have intersystem communication (ISC). In this case, the resource that is not responding is a remote system, and the way you deal with the wait depends on what the remote system is. If it is a CICS system, you need to diagnose the problem in the remote system using the techniques given in this book. If the remote system is a non-CICS system, you might need to read a diagnosis book from another library for advice on problem determination.

If you have any other access method, for example TCAM, you need to adapt the guidance given here accordingly.

VTAM in use—debugging procedures

The sections that follow give guidance about debugging terminal waits when the access method is VTAM.

The first step is to look in the CSNE log to see if there is an error message that explains the wait. If it contains an error code, you can find out what it means from the *VTAM Messages and Codes for MVS and VSE* manual.

Look next for any NACP error codes in fields TCTEVR5, TCTEVR6, TCTEVR7, and TCTEVR8 of the terminal table entry, TCTTE. Look also for any SNA sense code in field TCTEVNSS.

Is the problem associated with VTAM?: You can find the VTAM process status with respect to the waiting task from fields TCTEICIP and TCTEIDIP in the TCTTE. The following are the values you might find there, and their interpretations:

TCTEICIP	command request in progress
TCTEDIP	data request in progress

Either of these status values indicates that a VTAM request is in progress, and that the VTAM RPL is active. A response is expected either from VTAM, or from the terminal. You can find the address of the RPL from field TCTERPLA, unless the request was for a RECEIVE on an APPC session, in which case you can find the RPL address from field TCTERPLB.

If a VTAM request is not in progress, the next field of interest is in the VTAM system area of the TCTTE. Find four bytes of VTAM exit IDs, starting at field TCTEEIDA. If any are nonzero, the VTAM request has completed. Nonzero values suggest that VTAM is not involved in the wait. You can find the meanings of the values from the VTAM module ID codes list in the *CICS User's Handbook*.

If you suspect that the problem is associated with VTAM, consider using either CICS VTAM exit tracing or VTAM buffer tracing. Both of these techniques can give you detailed information about the execution of VTAM requests. For guidance about using the techniques, read the appropriate sections in “Chapter 14. Using traces in problem determination” on page 227.

VTAM in use—is terminal control at fault?: The first place to look is field TCTVAA1 in the terminal control table prefix, TCTFX. This contains either the address of the first TCTTE on the active chain, or the value X'FFFFFFFF'. If you see the latter value, it means that terminal control does not recognize that it has work to do. If this conflicts with the INQ TASK report you have received that the task is waiting on some terminal related activity, report the problem to your IBM Support Center.

If field TCTVAA1 points to a TCTTE on the active chain, check that the TCTTE of the terminal your task is waiting for is included in the chain. You can find this out by following the chain using the “next” pointer, field TCTEHACP of the TCTTE. If it does not contain the address of the next TCTTE on the chain, it contains either of these values:

X'FFFFFFFF'	this is the last TCTTE on the chain
X'00000000'	this TCTTE is not on the active chain

If you find a value of X'00000000', report the problem to the IBM Support Center.

VTAM in use—is the terminal at fault?: If you have found that the access method and terminal control are not causing the wait, the terminal itself must be waiting for some reason. You need now to look at some fields in the TCTTE for the terminal to find its status.

CICS system dumps contain an index to the VTAM terminal entries. It appears in the terminal control (TCP) summary section of the dump.

Information about the status and attributes of the VTAM terminals appears in an interpreted form at the end of the control block for each terminal entry. The information shown depends on the attributes of the terminal.

The example in Figure 9 shows the index followed by a terminal entry with its interpreted status and attribute information.

```

===TCP: TERMINAL CONTROL SUMMARY (VTAM TERMINALS)
          TERMINAL          TASK          IN          ERROR          ACTIVE RPL          WORK          ZNAC          INTERVENTION          AUTOINSTALL
TERMINID  TYPE          LOGGED ON  ATTACHED  SERVICE  STATS.  REQUEST  TO DO  QUEUED  REQUIRED  ACTIVITY
R51      C0             NO         NO         YES      00000000  NO      NO      NO      NO      N/A
R52      C0             NO         NO         YES      00000000  NO      NO      NO      NO      N/A
R53      C0             NO         NO         YES      00000000  NO      NO      NO      NO      N/A
R54      C0             NO         NO         YES      00000000  NO      NO      NO      NO      N/A
R55      C0             NO         NO         YES      00000000  NO      NO      NO      NO      N/A
S51      C0             NO         NO         YES      00000000  NO      NO      NO      NO      N/A
S52      C0             NO         NO         YES      00000000  NO      NO      NO      NO      N/A
S53      C0             NO         NO         YES      00000000  NO      NO      NO      NO      N/A
S54      C0             NO         NO         YES      00000000  NO      NO      NO      NO      N/A
S55      C0             NO         NO         YES      00000000  NO      NO      NO      NO      N/A
-AAA     C0             NO         NO         YES      00000001  NO      NO      NO      NO      N/A
-AAB     C0             NO         NO         YES      00000000  NO      NO      NO      NO      N/A
TCTTE.R51 03B5C420 TCT TERMINAL ENTRY
0000     D9F5F140 C0000504 03B5C424 00000000 00000000 00000000 00080000 *R51 .....D.....* 03B5C420
0020     00000000 0C000000 C5D5E400 00008080 00000000 00000000 00000000 *.....ENU.....* 03B5C440
0040     00000000 00000000 00000000 00000000 00000000 01D80000 00000000 03B22030 *.....Q.....* 03B5C460
0060     00000000 00000000 00000000 03B58690 00000000 00000000 03B46390 00000000 *.....f.....* 03B5C480
0080     00000000 00000000 00000000 00000000 03B430F8 00000000 00000000 00000000 *......8.....* 03B5C4A0
00A0     00000000 00000000 00000000 00840000 00000000 00000000 00000000 00000000 *.....d.....* 03B5C4C0
00C0     00000000 80000000 00000000 00000000 00000000 0000003B 01000000 00000000 *.....*.....* 03B5C4E0
00E0     10000000 00000000 00000000 03B5C618 00000000 00000000 00000000 00000000 *.....F.....* 03B5C500
0100     3A008400 00000000 00000000 00000000 00000000 FFFF0000 00000000 00000000 *..d.....* 03B5C520
0120     00000000 00000000 00000000 00000000 00000000 00000000 00000000 00000000 *.....*.....* 03B5C540
0140     10001000 10000000 00000000 00000000 00000000 00000000 00000000 00000000 *.....*.....* 03B5C560
0160     00000000 00000000 00000000 00000000 00000000 00000000 00000000 00000000 *.....*.....* 03B5C580
0180     08090000 00000000 00000000 00000000 00000000 00000000 00000000 03B59421 *.....m.....* 03B5C5A0
01A0     00440000 00001008 D4FD6038 80800014 00000000 00000000 00000000 00000000 *.....M.....* 03B5C5C0
01C0     00000000 00000000 00000000 00000000 00000000 00000000 00000000 *.....*.....* 03B5C5E0
TERMINID = R51          EXIT FOOTPRINTS (HEX) = 00000000
IN SERVICE             TCTTECA (NO TASK ATTACHED)
TCTECCV (STARTED BY TTI) TCTECSM (CA-MODE)
INPUT STATISTICS (DECIMAL) = 00000000  OUTPUT STATISTICS (DECIMAL) = 00000000
ERROR STATISTICS (DECIMAL) = 00000000  TCTEIRY (CICS IS PRIMARY)
TCTELSE (LUC CONTENTION LOSER)  TCTESBIF (SBI/BIS SUPPORTED)

```

Figure 9. Terminal index and terminal entry with interpreted information

The values that are given below for fields in the TCTTE are not the only possibilities, but they show important things about the terminal status. If you find any other values for these fields, look in the *CICS Data Areas* to find out what they mean.

The following are the questions that need to be asked, and some values that could provide the answers.

1. Is the terminal in service? Look at field TCTTETS of the TCTTE, to find the terminal status. The values that indicate why a terminal was failing to respond include:

TCTTESPO = 1 *and* TCTTESOS = 1 terminal out of service
TCTTESOS = 1 *only* terminal in error recovery

Look also at field TCTESEST, to find the session status with respect to automatic transaction initiation (ATI) for the terminal. Some of the values you might see are:

```
TCTESLGI = 0    CREATESESS(NO) in TYPETERM definition
TCTESLGI = 1    CREATESESS(YES) in TYPETERM definition
TCTESLGT = 1    recovering CREATESESS
```

A value of TCTESLGI = 0, with TCTESLGT = 0, too, shows that CREATESESS(NO) has been specified in the TYPETERM definition. This means that EXEC START requests and ATI requests cannot cause a session to be created. The request is either queued or rejected when no session is currently established. This can put a terminal into an indefinite wait state, especially if the terminal is a printer.

A value of TCTESLGI = 1 shows that CREATESESS(YES) has been specified in the TYPETERM definition. This means that CICS is allowed to create sessions for the terminal, so the CREATESESS status is not the cause of the wait.

A value of TCTESLGT = 1 means that the session is in error recovery. This could explain why there is no response from the terminal.

2. Has a task been created for this terminal? Look first at field TCTTECA of the TCTTE.

- If its value is nonzero, there is a task attached to the terminal. You can tell whether the task has been started from a terminal, or by ATI, from field TCTEICCV:

```
TCTECCV = 0    the task has been started by a terminal
TCTECCV = 1    the task has been started by ATI
```

- If its value is zero, look in fields TCTTEIC and TCTECTI. The values you might find there are:

```
TCTTEOIC = 1   ATI is waiting to start
TCTECTI = 1    there is ATI work for ZCP to do
```

3. Is there a task related to the terminal? You can find the task session state with VTAM from field TCTEMOST, and, if bracket protocol is required (from field TCTEIBPE), its conversation state with the terminal from field TCTEINB. The significant values that might provide further clues to the cause of the wait are:

```
TCTECSM = 1    the task is in conversation with the terminal
TCTECSM = 0    terminal control will accept new tasks from
                the terminal
```

Look now at field TCTEIBPE, to see if bracket protocol is required:

```
TCTEBPE = 1    bracket protocol is required
```

If you find that bracket protocol is required, look in field TCTEINB:

```
TCTEINB = 0    a conversation has not been started
TCTEINB = 1    a task is in conversation with the terminal
```

4. Is the terminal logged on to CICS? Look first at the node session status in the TCTTE. The three stages of session creation are represented by three separate bits, in fields TCTEILOS, TCTEIOPD, and TCTEINSD:

```
TCTELOS = 1    the node is logged on
TCTEOPD = 1    VTAM OPNDST macro issued
TCTENSD = 1    Start Data Traffic sent
```

If all three bits are set, so the value of the byte is TCTENIS, the node is in session.

You next need to see if the terminal is logging off, or if it has already been logged off. The fields of interest are TCTEINND, TCTEINBD, and TCTEIPSA. The values to look for are:

TCTENND = 1	the terminal is to be logged off
TCTENBD = 1	the terminal is logging off because of an error
TCTEPSA = 1	the session with the terminal ended abnormally -look for any explanatory message on CSMT

If any of these bits are set, the terminal might not be able to respond to the waiting task.

5. Should the terminal respond to the task? Field TCTEIPRA tells you this:

TCTEIPRA = 1	the terminal should respond
--------------	-----------------------------

If the values you have found in all these fields suggest that the terminal status is normal, the terminal is probably waiting for some activity to complete before it responds. The type of investigation you need to do next depends on the type of terminal involved in the wait. You should already have determined this, for example by using the system programming command EXEC CICS INQUIRE TERMINAL DEVICE.

Tools you can use for debugging terminal waits when VTAM is in use

Amongst your debugging tools, two are likely to be of particular use for investigating terminal waits in a VTAM environment. They are:

- VTAM buffer trace. This is a feature of VTAM itself, and you need to see the appropriate manual in the VTAM library for details of how to use it.
- CICS VTAM exit trace. This is a feature of CICS, and you can control it from the CETR panel.

For a description of the use of these two types of tracing in CICS problem determination, see “Chapter 14. Using traces in problem determination” on page 227.

Your task is waiting on a physical terminal

If your task is waiting on a physical terminal, the terminal should first be checked physically to see why it is not responding. If the terminal is at a remote location, you need to ask someone else to check it for you. Some possibilities are:

- A terminal with a keyboard might be waiting for an operator to enter some data.
- A printer might have been powered off, or it could have run out of paper.

Consider also the possibility of hardware error in the terminal.

Your task is waiting on a physical terminal: If a session has been acquired and it has not failed, your task is likely to be waiting for some response from a task in the other region. This can apply to any of the interregion or intersystem communication activities—function shipping, asynchronous processing, transaction routing, distributed transaction processing, or distributed program link. No matter which of these applies, it is most likely that the other region is not responding because the related task there has been suspended.

You need to identify the related task in the remote region, and find out the resource it is waiting on. When you have done that, see Table 19 on page 74 to find out which part of this section to turn to next.

Investigating the related task in the remote region: The first thing to do is to identify the region that is not responding to your local task.

If the task is using interregion communication (IRC), look first at the name of the resource being waited on, returned together with resource type IRLINK by CEMT INQ TASK. The first four characters give you the SYSIDNT of the remote CICS region.

If the task is using intersystem communication (ISC), you need to look in field TCTTEIST of the TCTTE, which points to the ISC system table entry. The first field in the system table entry is the identity of the remote region.

When you have identified the region, you need to take a system dump of it. You can do that either by using the CEMT PERFORM DUMP command in that region, or by using the MVS DUMP command. Take a system dump of the local region, too.

Format the dumps using the formatting keyword DS to get a summary of the tasks in each region, and TCP to get the TCTTEs.

First find the TCTTE for the task in the local region. The way you find the TCTTE for the task in the remote region depends on whether you are using LUTYPE6.1 sessions (or IRC) or APPC sessions:

- For LUTYPE6.1 sessions and IRC sessions, look in local control block TCTENIB, the TCTTE extension for the NIB descriptor, at field TCTESQP. This gives you the session qualifier pair for the session. It provides the terminal ID associated with the local task, concatenated with the terminal ID associated with the remote task.

Now go to the dump of the remote region, and use the terminal ID to locate its TCTTE. Check in field TCTESQP of TCTENIB to make sure that the session qualifier pair matches that in the local system. It should be made up of the same terminal IDs, but with their order reversed.

- For APPC sessions, look in local control block TCTTELUC, the APPC extension, in field TCTESII. Ignoring the high-order byte, this gives you the session instance identifier of the session.

Now go to the dump of the remote region, and use the session instance identifier you have found for the remote task to locate its TCTTELUC. The TCTTE precedes the TCTTELUC in the dump.

When you have confirmed that you have located the correct TCTTE, look in field TCTTECA. This gives you the TCA address of the task that is not responding.

Using the TCA address as the entry point, you can now investigate the reason why the task has not responded. It is very likely that it has been suspended because some resource is unavailable. Look in the dispatcher and transaction manager summaries. If you can identify your task, you can see what resource it is waiting on.

When you have identified the resource, turn to the appropriate section in this section for guidance about investigating waits on that resource.

VTAM terminal control waits

VTAM terminal control waits are associated with the following resource types:

- ZC
- ZC_ZCGRP

- ZC_ZGCH
- ZC_ZGIN
- ZC_ZGRP
- ZC_ZGUB
- ZCIOWAIT
- ZCZGET
- ZCZNAC
- ZXQOWAIT
- ZXSTWAIT

The implication of waits on any of these VTAM terminal resource types are as follows:

Resource type ZC

If your task is waiting on a resource name of DFHZCRQ1, it is waiting for I/O to complete. The task is attempting to complete one of the following:

- RESETSR
- A send synchronous data flow
- A send asynchronous command
- SESSIONC.

The task waits for the time specified in the RTIMEOUT value of the profile used by the transaction rounded up to the nearest multiple of 16.78 seconds. If the task times out, it receives either an AKCT or AZCT abend.

If your task is waiting on a resource name of DFHZEMW1, the error message writer module, DFHZEMQ, is waiting for the completion of I/O. If a timeout value exists and is exceeded, the suspend expires.

If your task is waiting on a resource name of DFHZRAQ1, this means a READ has been issued. The task is resumed once the I/O operation is complete. If a timeout value exists and is exceeded, the suspend expires.

If your task is waiting on a resource name of DFHZRAR1, this means a READ has been issued. The task is resumed once the I/O operation is complete. If a timeout value exists and is exceeded, the suspend expires.

Resource type ZC_ZGRP

DFHZSLS has to set the TCT prefix VTAM fields from the ACB. This wait is issued to ensure that these fields are set before being used.

Resource type ZC_ZGCH

DFHZGCH is waiting for the VTAM CHANGE ENDAFFIN macro to complete.

Resource type ZC_ZGIN

DFHZGIN issues the VTAM INQUIRE macro and waits until VTAM completes execution of this request.

Resource type ZC_ZGRP, resource name PSINQECB

If the task is waiting on resource name PSINQECB, this means that DFHZGRP has issued the VTAM macro INQUIRE PERSESS during VTAM persistent session restart, or during the reopening of the VTAM ACB, and is waiting for a response from VTAM. The wait expires after 5 minutes if VTAM does not respond.

Resource type ZC_ZGRP, resource name PSOP2ECB

If the task is waiting for resource name PSOP2ECB, this means that DFHZGRP has issued the VTAM macro OPNDST RESTORE during emergency restart, and is waiting for a response from VTAM. The wait expires after 5 minutes if VTAM does not respond.

Resource type ZC_ZGUB

DFHZGUB issues ten VTAM CLSDST or TERMSESS macros during persistent sessions restart. It waits for an RPL to become free for VTAM to post the VTAM exit. The wait expires after 5 minutes if VTAM does not respond.

Resource type ZCIOWAIT

Suspends on resource type ZCIOWAIT occur when the task is waiting for some terminal I/O. Once the expected I/O event occurs, the task is resumed.

Resource type ZCZGET

If your task is waiting on a resource name of DFHZARL2, it is suspended by module DFHZARL which deals with application request logic for LU6.2 devices. The suspend is caused by a GETMAIN call to DFHZGET failing. DFHZGET is continually invoked until the GETMAIN is successful.

Resource type ZCZNAC

Suspends on resource type ZCZNAC are on resource names DFHZARL3 or DFHZERH4. The wait is for DFHZNAC to issue an error message. The error message to be issued depends on the error that led to the suspend. Various actions may be taken by DFHZNAC before control is returned to the suspended task.

Resource type ZXQOWAIT

The XRF queue organizer, DFHZXQO, waits for the posting of TCAICTEC and XQOVECTE which happens when the queue is emptied.

Resource type ZXSTWAIT

The XRF session tracker, DFHZXST, waits for the posting of TCAICTEC and TCTVXPLE which happens when the session tracking queue is emptied.

Interregion and intersystem communication waits

If you have a user task that is waiting for resource type ALLOCATE, it has attempted to get a session with another CICS region, but all the sessions are in use. Consider defining a greater number of sessions, which should solve the problem. For guidance about this, see the *CICS Resource Definition Guide* and the *CICS Intercommunication Guide*.

If you otherwise have a problem that you have identified as an interregion or an intersystem communication wait, investigate it as for terminal waits. This is dealt with in “Terminal waits” on page 102.

The method of debugging is the same in each case. You need to consider the access method, terminal control, and the “terminal” itself.

For interregion and intersystem communication, the remote region or system *is* the terminal. Its status can be found using the same online or offline techniques that you would use to find the status of a physical terminal. The status may lead you to suspect that the task running in the remote region is the cause of the problem, and you then need to investigate why that task is waiting. So you could find that what started as a terminal wait might, after all, be a wait on some other type of resource.

Transient data waits

Tasks issuing requests to read and write to transient data destinations can be made to wait for several different reasons. The reasons depend on the type of request being made, and whether the task is attempting to access an extrapartition or an inrapartition queue.

The resource types that might be associated with the wait are:

- TD_INIT
- TDEPLOCK
- TDIPLOCK
- ENQUEUE
- TD_READ
- Any_MBCB
- Any_MRCB
- MBCB_xxx
- MRCB_xxx

The resource name is the transient data queue name, except in the case of TD_INIT, whose resource name is DCT.

Resource type TD_INIT—waits during initialization processing

A second stage PLT program being executed during system initialization can issue a request for a resource that is not yet available, because the component that services the request has not yet been initialized. If the program issues a transient data request that cannot yet be serviced, it is suspended on a resource type of TD_INIT with a resource name of DCT.

You are unlikely to see any evidence for this type of wait, unless you have trace running during initialization with DS level-1 tracing selected. An error at this stage would be likely to cause CICS to stall (see “CICS has stalled during initialization” on page 145), or to terminate abnormally.

Resource type TDEPLOCK—waits for transient data extrapartition requests

If you have a task suspended on resource type TDEPLOCK, with a resource name corresponding to a transient data queue name, the task has issued a request

against an extrapartition transient data queue. Another task is already accessing the same queue, and the waiting task cannot resume until that activity is complete.

If the wait is prolonged, it could be for either of these reasons:

- It is necessary for a task to change TCB mode to open and close a data set. The task must relinquish control while this happens, and, depending on the system loading, this might take several seconds. This contributes to the wait that the second task, suspended on resource type TDEPLOCK, experiences.
- CICS uses the access method QSAM to write data to extrapartition transient data destinations. QSAM executes synchronously with tasks requesting its services. This means that any task invoking a QSAM service must wait until the QSAM processing is complete. If, for any reason, QSAM enters an extended wait, the requesting task also experiences an extended wait.

The possibility of an extended wait arises whenever QSAM attempts to access an extrapartition data set. QSAM uses the MVS RESERVE volume-locking mechanism to gain exclusive control of volumes while it accesses them, which means that any other region attempting to write to the same volume is forced to wait.

If tasks frequently get suspended on resource type TDEPLOCK, you need to determine which other transactions write data to the same extrapartition destination. You might then consider redefining the extrapartition destinations.

Resource types TDIPLOCK, ENQUEUE, TD_READ, Any_MBCB, Any_MRCB, MBCB_xxx, and MRCB_xxx

If your task is waiting on any of the resource types TDIPLOCK, ENQUEUE, TD_READ, Any_MBCB, Any_MRCB, MBCB_xxx, or MRCB_xxx, it has made a transient data intrapartition request that cannot be serviced at once. In each case, the resource name identifies the intrapartition queue that the request has been issued against.

Resource type TDIPLOCK: If you have a task suspended on resource type TDIPLOCK, with a resource name corresponding to a transient data queue name, the task has issued a request against an intrapartition transient data queue. Another task is already accessing the same queue, and the waiting task cannot resume until that activity is complete.

If tasks frequently get suspended on resource type TDIPLOCK, you need to determine which other transactions use the same intrapartition destination. You might then consider redefining the intrapartition destinations.

You can find further guidance information about the constraints that apply to tasks writing to intrapartition destinations in the *CICS Application Programming Guide*. For more details of the properties of recoverable transient data queues, see the *CICS Resource Definition Guide*.

Resource type ENQUEUE: If a transient data queue has been defined as intrapartition and logically recoverable, there are further restrictions on the use of the queue by more than one task at a time (in addition to those leading to waits on resource type TDIPLOCK).

If you have a task suspended on resource type ENQUEUE, and a value of TDNQ, the task has been suspended while attempting to read, write or delete a logically recoverable queue because a required enqueue is currently held by another task.

Note: For general information about dealing with enqueue waits, see “Enqueue waits” on page 116. Issuing a CEMT INQUIRE UOWENQ command reveals the name of the queue and whether the enqueued read or write is required by the task. If the task is enqueued against the read end of the queue, a qualifier of FROMQ is displayed on the CEMT INQUIRE UOWENQ screen. If the task is enqueued against the write end of the queue, a qualifier of TOQ is displayed on the CEMT INQUIRE UOWENQ screen.

If you want to delete a queue, both the read and the write enqueues must be obtained. No task may, therefore, read or write to a queue while a delete operation is in progress. A delete cannot proceed until any task currently reading has completed its read or any task writing has committed its changes.

In general, a wait on a resource type of ENQUEUE should not last for long unless the task owning the enqueue has been delayed. If the UOW that owns the enqueue has suffered an indoubt failure, the UOW is shunted. If the queue accessed by this UOW is defined as WAIT=YES and WAITACTION=QUEUE, the wait can last for a long period of time. To deduce if an indoubt failure has occurred:

- Issue a CEMT INQUIRE UOWENQ command to display the name of the enqueue owner.
- Issue a CEMT INQUIRE UOW command to see if the UOW is shunted.

Resource type TD_READ: If a queue is defined as logically recoverable, a TD_READ wait may be encountered. A task can read from a queue while another task is writing to the same queue. If this happens, the first task holds the read enqueue and the second task holds the write enqueue on the queue. The task reading the queue can only read data that has already been committed. It cannot read data that is currently being written to the queue until the task holding the write enqueue commits the changes it has made and dequeues from the write end of the queue.

A task is suspended on a resource type of TD_READ if it is trying to read uncommitted data from a logically recoverable queue. The queue name is displayed in a qualifier. The suspended task is forced to wait until the task owning the write enqueue commits the changes it has made..

In most cases, the suspended task will not have to wait long. A lengthy wait can occur if the task owning the write enqueue suffers from an indoubt failure (which causes the associated UOW to be shunted), and the queue is defined with the WAIT=YES and WAITACTION=QUEUE attributes.

If you do not want to wait for data to be committed to the queue, code NOSUSPEND on the READQ TD request. QBUSY is returned to the application and the task does not wait.

Resource type Any_MBCB: If your task is waiting on resource type Any_MBCB, the resource name is the name of an intrapartition queue that it is attempting to access. This type of wait shows that all the transient data I/O buffers are in use, and the task resumes only when one becomes available.

Tasks are only likely to wait in this way in a heavily loaded system.

Resource type Any_MRCB: When a transient data I/O buffer has been acquired for a task, a VSAM string must be obtained. If all the VSAM strings available for

transient data processing are in use, the task is suspended on resource type Any_MRCB, with a resource name equal to the intrapartition queue name.

Waits on Any_MRCB should not be prolonged, except in a heavily loaded system.

Resource type MRCB_xxx: A resource type of MRCB_xxx, with a resource name equal to an intrapartition transient data queue name, shows that the suspended task has successfully obtained a VSAM string, and is now waiting for VSAM I/O to complete. This should not be a long wait, unless operator intervention is required.

Resource type MBCB_xxx: If a task is waiting on resource type MBCB_xxx, with a resource name equal to the intrapartition queue name, this indicates contention for a transient data I/O buffer. It should not be an extended wait, although it is dependent on VSAM I/O taking place on behalf of another task that has issued a transient data request. If that, for any reason, takes a long time, the wait on resource type MBCB_xxx is correspondingly long. (For descriptions of the waits that might occur during transient data VSAM I/O processing, see “Resource type Any_MRCB” on page 114 and “Resource type MRCB_xxx”).

The reason for this type of wait is best illustrated by example, as follows:

1. Task #1 issues a transient data request that requires access to an intrapartition queue. Before the request can be serviced, task #1 must be assigned a transient data I/O buffer that is not currently being used by any other task.
I/O buffers each contain a copy of a control interval (CI) from a data set. Each CI contains records that correspond to elements in an intrapartition queue. A search is made to see if the CI required for task #1 is already in one of the I/O buffers. If it is, that I/O buffer can be used to service the request made by task #1, and no VSAM I/O is involved. If it is not, task #1 is allocated any buffer, so the required CI can be read in. The current contents of the buffer is overwritten. An I/O buffer can have a R/O (read only) status or a R/W (read/write) status. If the buffer that is allocated to task #1 has R/W status, it contains a copy of a CI that has been updated by some other task, but not yet written back to the data set. Before the buffer can be used by task #1, the CI it contains must be preserved by writing it back to the data set.
2. A request now arrives from task #2, and the request requires the CI that is currently being written to the data set. No two buffers can contain the same CI, so task #2 is made to wait on resource type MRCB_xxx until the outcome of the VSAM I/O is known.
If VSAM I/O was successful, task #2 is resumed and assigned some other I/O buffer.
If VSAM I/O was unsuccessful, task #2 can use the I/O buffer that already contains the CI it needs.

Loader waits

A task is suspended by the loader domain if it has requested a program load and another task is already loading that program. Once the load in progress is complete, the suspended task is resumed very quickly and the wait is unlikely to be detected.

Note that the loader *does not* suspend a task while a program is loaded if it is the first one to ask for that program.

If the requested program is not loaded quickly, the reasons for the wait need to be investigated. The possible reasons for the wait, and the ways you should investigate them are:

1. The system could be short on storage (SOS), so only system tasks can be dispatched.

To check if the system is short on storage use the CEMT transaction, submitting CEMT I SYS SOSSTATUS. To see if SOS has been reached too often, examine the job log, check the run statistics, or submit CEMT I DSAS. If SOS has been reached too often, take steps to relieve the storage constraints. For guidance about this, see the *CICS Performance Guide*.

2. There could be an I/O error on a library.

Check for messages that might indicate this. If you find one, investigate the reason why the I/O error occurred.

3. There could be an error within MVS.

Has there been any sort of message to indicate this? If so, it is likely that you need to refer the problem to the IBM Support Center.

Enqueue waits

A task is suspended by the enqueue domain if it requests access to a resource on which another task already holds an enqueue (lock). Do not use the EXEC CICS ENQ command for recoverable resources.

There are two ways in which you can discover the owner of the enqueue that the task is waiting on:

- Use the CEMT INQUIRE UOWENQ command. For an example of how to use this command to discover the owner of an enqueue, see page 132. For definitive information about CEMT INQUIRE UOWENQ, see the *CICS Supplied Transactions* manual.
- Use the NQ section of a system dump. Some types of enqueue wait are not displayed by the CEMT INQUIRE UOWENQ command. In these cases, you can use a system dump to identify the owner of the enqueue (for an example, see “Using a system dump to resolve enqueue waits”). The following resource names identify the enqueue waits that this applies to:

JOURNALS
KCADDR
KCSTRNG
LOGSTRMS

It is possible for an enqueue wait to be caused by a deadlock. For an example of how to resolve a deadlock, see “An example of deadlock diagnosis using CEMT INQUIRE UOWENQ” on page 132.

Using a system dump to resolve enqueue waits

The CEMT INQUIRE UOWENQ (or CEMT INQUIRE ENQ) command does not return information about enqueues on some types of resources. Table 22 on page 117 shows the resources that this applies to.

Table 22. Resources for which INQUIRE UOWENQ does not return information

Resource name	Type of resource
JOURNALS	CICS journal names used during creation, deletion, or use of a journal entry. See "Log manager waits" on page 94 for information to help you diagnose problems with the MVS system logger.
KCADDR	Addresses locked internally by CICS.
KCSTRNG	Strings locked internally by CICS.
LOGSTRMS	MVS logstream names used during connection of streams to the MVS logger. A long wait could indicate a problem with the logger. See "Log manager waits" on page 94 for information to help you diagnose problems with the MVS system logger.

To investigate enqueue waits on these resources, you can use the NQ section of a system dump. (You can use a system dump to investigate enqueue waits on other types of resource, but you may find the INQUIRE UOWENQ command more convenient.)

CICS maintains a separate enqueue pool for each type of resource that can be enqueued upon. To produce a summary of each enqueue pool, specify '1' on the NQ dump formatting keyword (dump formatting keywords are described on page 285). Figure 10 shows an example summary for the transient data enqueue (TDNQ) pool.

==NQ: ENQUEUE POOL SUMMARY - TDNQ

```

Default shunt action:          Retain
*Total enqueue requests:      34
*Total requests that have waited: 8
*Total requests failed busy:  6
*Total requests failed locked: 2
*Total requests timed out:    1
*Total enqueues that were retained: 1
    
```

*NOTE: These values were reset at 15.44.39 (the last statistics interval collection)

Enqueue Name	Len	Sta	NQEA Address	OWNER / WAITER		Local Uowid	Lifetime Uow	Hash Tsk	Indx
				Tran Id	Tran Num				
Q007T0Q	9	Act	052C4580	TDWR	00356	A8EBC70A53A4BC82	1	0	13
Q002FROMQ	9	Act	053D0880	TDRD	00435	A8EBD91A57D9B7D2	2	0	24
		Waiter	: 0540BBC0	TDRD	00467	A8EBDAC692BB7C10	0	1	24
		Waiter	: 0537CE70	TDDL	00512	A8EBDAE6FF0B56F2	1	0	24
Q007FROMQ	9	Act	0540CC80	ENQY	00217	A8EBB7FE23067C44	0	1	51
		Waiter	: 0538F320	ENQY	00265	A8EBBF0846C00FC0	0	1	51
		Waiter	: 0518C5C0	ENQY	00322	A8EBC393B90C66D8	0	1	51
Q002T0Q	9	Ret	0520B260	----	-----	A8EBD82AFDA4CD82	1	0	53
Q009FROMQ	9	Act	0540A140	TDRD	00366	A8EBC84D3FF80250	1	0	62

Figure 10. Example system dump, showing summary information for the TDNQ enqueue pool

In the table at the bottom of Figure 10, each enqueue in the pool appears on a new line. If the enqueue has waiters, they are displayed in order on subsequent lines. Waiters are identified by the string 'Waiter'. The meanings of the table headings are:

Enqueue Name

The string that has been enqueued upon. Normally, up to 30 characters of

the name are displayed; however, the summary reports for file control and address enqueue pools format the enqueue name differently:

- File control uses six enqueue pools for its various types of lock. Each enqueue contains the address of a control block (for example, DSNB, FCTE) in its first four bytes. If the enqueue is a record lock, this is followed by the record identifier.

Depending upon the type of the data set or file, the remainder of the enqueue name could, for example, be an RRN in an RRDS, or a record key in a KSDS data set. In the summary, the remainder of the enqueue name is displayed in both hex and character formats. This takes up two summary lines instead of one.

- The summary reports for the EXECADDR and KCADDR enqueue pools display the enqueue name in hexadecimal format. This is because the enqueue request was made on an address.

Len The length of the enqueue name.

Sta The state that the enqueue is held in. This field contains either:

Act The enqueue is held in active state—that is, other transactions are allowed to wait on the enqueue.

Ret The enqueue is held in retained state—that is, other transactions are not allowed to wait on the enqueue. Typically, this is because the enqueue is owned by a shunted unit of work.

NQEA Address

The address of the NQEA corresponding to the enqueue owner or waiter. The NQEA contains the full enqueue name if it was too large to display fully.

TranId The transaction identifier of the enqueue owner or waiter. If the enqueue is owned by a shunted UOW, this field contains '----'.

TranNum

The task number of the enqueue owner or waiter. If the enqueue is owned by a shunted UOW, this field contains '-----'.

Local Uowid

The local UOW identifier of the enqueue owner or waiter.

Uow Lifetime

For an enqueue owner, the number of times the enqueue is owned with UOW lifetime. For an enqueue waiter, whether the waiter has requested the enqueue for the lifetime of the UOW.

Tsk Lifetime

For an enqueue owner, the number of times the enqueue is owned with task lifetime. For an enqueue waiter, whether the waiter has requested the enqueue for the lifetime of the task.

Hash Indx

An index into the pool's internal hash table.

EXEC CICS ENQ waits

These are a particular type of enqueue wait. They occur when an application issues an EXEC CICS ENQ command to acquire an enqueue on a resource, and another task already holds an enqueue on it.

A resource name of EXECADDR indicates that the LENGTH option of the EXEC CICS ENQ command was omitted—that is, the RESOURCE option supplied the address of the resource to be enqueued upon.

A resource name of EXECSTRN indicates that the LENGTH option of the EXEC CICS region ENQ command was specified—that is, the RESOURCE option supplied the name of the resource to be enqueued upon. (For detailed information about the EXEC CICS ENQ command, see the *CICS Application Programming Reference*.)

A resource name of EXECPLEX indicates that the LENGTH option of the EXEC CICS sysplex ENQ command was specified—that is, the RESOURCE option supplied the name of the resource to be enqueued upon. (For detailed information about the EXEC CICS ENQ command, see the *CICS Application Programming Reference*.)

You can use the CEMT INQUIRE UOWENQ command to discover the owner of the enqueue that the suspended task is waiting on providing the owner is on the same region. This cannot detect owners on other regions. Note that, for EXECADDR-type waits, to display the address of the resource specified on the EXEC CICS ENQ command you need to use the hexadecimal display option of CEMT.

File control waits

Most file control waits are associated with resource types starting with the characters FC. Some are associated with resource type ENQUEUE, but ENQUEUE is not used exclusively for file control waits.

Table 23 lists the identifiable resource types associated with file control waits, with all the possible reasons for waits, and whether they occur for files accessed in RLS mode, non-RLS mode, or both.

Table 23. Resource types for file control waits

Resource	Description	RLS or non-RLS access mode
CFDTPWAIT	The task is waiting for a request to the CFDT server to complete.	N/A. The wait is caused by access to a coupling facility data table.
CFDTPPOOL	The task is waiting for a CFDT “maximum requests” slot to become available.	N/A. The wait is caused by access to a coupling facility data table.
CFDTPPOOL	The task is waiting for a CFDT “locking request” slot to become available.	N/A. The wait is caused by access to a coupling facility data table.
ENQUEUE	The task is waiting for a lock on a file or data table. See “Resource type ENQUEUE—waits for locks on files or data tables” on page 129.	Non-RLS
FCACWAIT	CICS is waiting for the last RLS file to close after an SMSVSAM failure.	RLS
FCBFWAIT	The task is waiting for a VSAM buffer.	Non-RLS
FCCAWAIT	CICS is waiting on a VSAM control ACB request.	RLS

Table 23. Resource types for file control waits (continued)

Resource	Description	RLS or non-RLS access mode
FCCFQR	CICS is waiting for the SMSVSAM server to notify CICS of a new quiesce request	RLS
FCCFQS	CICS is waiting for a user task to issue a new quiesce request.	RLS
FCCRWAIT	CICS is waiting for last RLS control ACB request to complete during cleanup after SMSVSAM failure.	RLS
FCDWWAIT	The task is waiting for VSAM upgrade set activity to complete.	Non-RLS
FCFSWAIT	The task is waiting to change the state of a file.	Both
FCIOWAIT	The task is waiting for I/O on a disk volume.	Non-RLS
FCIRWAIT	The task is waiting for the recoverable file control environment to be rebuilt.	Both
FCPSWAIT	The task is waiting for a private string.	Both
FCQUIES	The task is waiting for a quiesce request to complete.	RLS
FCRAWAIT	The task is waiting for file control to process non-recoverable requests at CICS restart.	Both
FCRBWAIT	The task is waiting for file control to process recoverable requests at CICS restart.	Both
FCRDWAIT	The task is waiting for a drain of the RLS control ACB to complete.	RLS
FCRPWAIT	The task is waiting for file control initialization to complete.	RLS
FCRRWAIT	The task is waiting for a dynamic RLS restart to complete.	RLS
FCRVWAIT	The task is waiting for I/O on a disk volume.	RLS
FCSRSUSP	The task is waiting for a shared resource string.	Non-RLS
FCTISUSP	The task is waiting for a VSAM transaction ID.	Non-RLS
FCXCWAIT	The task is waiting for exclusive control of a VSAM control interval.	Non-RLS

The implications of waits on any of these file control resource types are dealt with in the sections that follow.

Resource type CFDTWAIT—wait for CFDT request to complete

If you have a task waiting on resource type CFDTWAIT, the task is waiting on the coupling facility data table server for a file control request to complete. Requests to the CFDT server are normally processed synchronously. Therefore, this wait could indicate that:

- There is a high level of activity to the CFDT server
- The server is processing a request for a record that is longer than 4K bytes
- The task has issued a request for a record that is currently locked by another task within the sysplex.

Waiting on this resource can occur only for a file defined to access a coupling facility data table.

Resource type CFDTPOOL - wait for CFDT a request slot

If you have a task waiting on resource type CFDTPOOL, the task is waiting for a free slot within the “maximum requests” limit to become available. CICS places a limit on the number of requests that a region can have running simultaneously in a coupling facility data tables server. This limit is known as the “maxreqs” limit, and it avoids overloading the coupling facility. If the number of requests currently running in the server for a CICS region has reached the maxreqs limit, a request waits until one of the other requests completes.

Waiting on this resource can occur only for a file defined to access a coupling facility data table.

Resource type CFDTLRSW - wait for CFDT locking request slot

If you have a task waiting on resource type CFDTLRSW, the task is waiting for a free locking request slot to become available. CICS places a limit on the number of locking requests (that is, requests that might acquire record locks) that a region can have simultaneously running in a coupling facility data table server. This limit is known as the locking request slot (LRS) limit, and it avoids tasks that hold locks from preventing other coupling facility data table accesses. If the number of locking requests currently running in the server for a CICS region has reached the LRS limit, this request waits for one of the locking requests to complete.

Waiting on this resource can occur only for files defined to access a coupling facility data table, and only for record access requests that could potentially require a lock.

Resource type FCACWAIT & FCCRWAIT—wait for SMSVSAM cleanup

The only task that can wait on resource types FCACWAIT and FCCRWAIT is CSFR, the task that performs cleanup after failure of the SMSVSAM server. This is the server that CICS file control uses for any VSAM request it issues in RLS mode.

Cleanup after SMSVSAM failure is in two stages.

1. Wait for VSAM to reject any file requests that were in-flight at the time of the server failure. When all these active file requests have been rejected, CSFR cleans up CICS state by issuing a CLOSE request against every file open in RLS mode. When the last CLOSE request has completed, the first stage of clean up is complete.

If CSFR is waiting for this first stage of cleanup to complete, it is waiting on resource type FCACWAIT.

2. Wait for VSAM to reject any system requests issued against the SMSVSAM control ACB, and then unregister the control ACB.

If CSFR is waiting for this second stage of cleanup to complete, it is waiting on resource type FCCRWAIT.

FCACWAIT and FCCRWAIT are RLS-related waits only.

Resource type FCBFWAIT—waits for VSAM buffers

If your task is waiting on resource type FCBFWAIT, it means that a VSAM buffer is not currently available. You can specify the number of VSAM data buffers and VSAM index buffers in the FILE resource definition using the DATABUFFERS and INDEXBUFFERS parameters, respectively.

Consider increasing the numbers of these buffers if you find that tasks are frequently having to wait on this resource type.

If there are insufficient data and index buffers for a single task, the task is suspended indefinitely. This might happen unexpectedly if you have a base cluster and one or more paths in the upgrade set, and your application references only the base. VSAM upgrades the paths whenever changes are made to the base. There could then be too few buffers defined in the LSRPOOL for both base and paths.

Waiting on this resource can occur only for files accessed in non-RLS mode.

Resource type FCCAWAIT—waits on the SMSVSAM control ACB

If your task is waiting for resource type FCCAWAIT, it means that the task is waiting within VSAM for a request issued against the RLS control ACB to complete. The control ACB is used for requests that are not issued against any specific file: for example, requests to:

- Release locks
- Convert locks to retained status
- Quiesce data sets.

If the request is to quiesce a data set, CICS is waiting for other CICS regions that access the data set to respond to the quiesce request.

In other cases, the request should complete quickly. Failure to complete quickly could indicate a delay within the VSAM lock manager.

Waits on this type of resource can occur only for files accessed in RLS mode.

Resource type FCCFQR—wait for SMSVSAM server notification

The system task CFQR can wait on resource type FCCFQR. This is the normal state for this task and means that the task is waiting on an ECB for more work. New work is created for the task when CICS receives a quiesce request from its SMSVSAM server through the CICS RLS quiesce exit program, DFHFCQX. SMSVSAM drives the CICS RLS quiesce exit, which creates a control block for the request and posts the CFQR task to notify it of the request's arrival.

Resource type FCCFQS—wait for user task to issue quiesce

The system task CFQS can wait on resource type FCCFQS. This is the normal state for this task and means that the task is waiting on an ECB for more work. New work is created for this system task when a user task issues a quiesce request (for example, issues an EXEC CICS SET DSNAME(...) QUIESCED WAIT command). The user request is processed by CICS module DFHFCQI, which creates a control block for the request and posts the CFQS task to notify it of the request's arrival.

Resource type FCDWWAIT—wait for VSAM upgrade set activity

If your task is waiting on resource type FCDWWAIT, it has received a VSAM response which might indicate that your task is trying to read a record via a VSAM path while this record is being updated by another request. This other request is updating the record either via the base or via another path. If VSAM has not yet completed the update, the content of the alternate index currently in use is no longer the same as the content of the base data set.

This is a transient condition. CICS waits for all current update operations for this VSAM data set to complete and retries the request twice. If the error continues after the request is retried, CICS assumes that there is a genuine error and returns a response of ILLOGIC to the application. Since ILLOGIC is a response to all unexpected VSAM errors, CICS also returns the VSAM response and reason codes (X'0890') in bytes 2 and 3 of EIBRCODE. These identify the cause of the ILLOGIC response.

Waiting on this resource can occur only for files accessed in non-RLS mode.

Resource type FCFSWAIT—wait for file state changes

If your task is waiting on resource type FCFSWAIT, it means that it has attempted to change the state of a file—for example, to CLOSE or DISABLE it—but another task is, or other tasks are, still using the file. This can happen, for example, if a long-running transaction, possibly conversational, is using a recoverable file. The file cannot be closed until the updates made by the transaction have been committed; that is, the transaction has issued a syncpoint. In such a case, consider changing the programming logic so that intermediate syncpoints are issued.

Only one task at a time waits on FCFSWAIT. If any other tasks attempt to change the state of the same file, they are suspended on resource type ENQUEUE. See “Task control waits” on page 96.

Waiting on this resource can occur for files accessed in both RLS and non-RLS mode.

Resource type FCIOWAIT—wait for VSAM I/O (non-RLS)

If you have a task waiting on resource type FCIOWAIT, it means that the task is waiting *within* VSAM for I/O to take place. For example, VSAM uses MVS RESERVE volume locking, and it is likely that another job has at present got the lock on the volume. See if there are any messages on the MVS console to explain the error.

A wait on resource type FCIOWAIT occurs when the exclusive control conflict is deferred internally by VSAM and not returned as an error condition to CICS. An

example of this is when a request against an LSR file is made for exclusive control of a control interval (for example, by WRITE or READ UPDATE) and either this task or another task already holds shared control of this control interval (for example, by STARTBR).

Exclusive control waits are discussed further in “Resource type FCXCWAIT—VSAM exclusive control wait” on page 127.

Waiting on this resource can occur only for files accessed in non-RLS mode.

Resource type FCIRWAIT—wait for FC environment to be rebuilt

During CICS initialization, on a warm or emergency restart, file control must wait for the recoverable file control environment to be rebuilt before performing any restart actions for recoverable files. DFHFCIR is the module that rebuilds the recoverable file control environment, and the file control initialization task waits on resource type FCIRWAIT.

Because this wait occurs during CICS initialization, you should not be able to see a task waiting on this resource.

Resource types FCPSWAIT and FCSRSUSP—waits for VSAM strings

If your task is waiting on either of resource types FCPSWAIT or FCSRSUSP, it means that it cannot get a VSAM string. FCPSWAIT shows that the wait is for a private string, and FCSRSUSP shows that the wait is for a shared resource string. You can purge the task from the system, if the task is purgeable.

For non-RLS mode, the number of strings defined for a VSAM data set (STRINGS parameter in the FILE resource definition) determines how many tasks can use the data set concurrently. STRINGS can have a value in the range 1–255. For RLS mode, strings are automatically allocated as needed up to a maximum of 1024. When all the strings are in use, any other task wanting to access the data set must wait until a string has been released.

If tasks are being caused to wait unduly for strings, consider whether you can increase the value of STRINGS, or change the programming logic so that strings are released more quickly.

An example of programming logic that can hold onto strings (and other VSAM resources) for too long is when a conversational transaction issues a STARTBR or READNEXT and then enters a wait for terminal input without issuing an ENDBR. The browse remains active until the ENDBR, and the VSAM strings and buffers are retained over the terminal wait. Also, for an LSR file, the transaction continues to hold shared control of the control interval and causes transactions that attempt to update records in the same control interval to wait.

Similarly, transactions hold VSAM resources for too long if a READ UPDATE or WRITE MASSINSERT is outstanding over a wait for terminal input.

Waiting on this resource can occur for files accessed in both RLS and non-RLS mode.

Resource type FCQUIES—wait for a quiesce request to complete

If your task is waiting on resource type FCQUIES, the task is waiting for the completion of a quiesce command it has issued for a data set (for example, an EXEC CICS SET DSNAME(...) QUIESCED WAIT command). The command generates an FCQSE containing the request and passes this into the CFQS task. The CFQS task posts the user task when the request is completed. The resource name gives the hexadecimal address of the FCQSE control block.

Resource type FCRAWAIT—file control to process non-recoverable requests

A non-recoverable file control request waits on resource type FCRAWAIT if file control has not completed the actions required to allow the processing of non-recoverable work. These actions include the building of FCT entries.

You do not see a task waiting on this resource type, because this wait occurs during CICS initialization.

Waits on this resource type can occur for files accessed in both RLS and non-RLS mode.

Resource type FCRBWAIT—file control to process recoverable requests

A recoverable file control request waits on resource type FCRBWAIT if file control has not completed the actions required to allow the processing of recoverable work. These actions include the rebuilding of non-RLS enqueues and restarting RLS access.

You do not see a task waiting on this resource type, because this wait occurs during CICS initialization.

Waiting on this resource can occur for files accessed in both RLS and non-RLS mode.

Resource type FCRDWAIT—wait for a drain of the RLS control ACB

If a task is waiting on resource type FCRDWAIT, it is waiting for completion of the drain of the RLS control ACB following an SMSVSAM server failure. DFHFCD is the module that performs the drain. When the SMSVSAM server fails, CICS must drain all RLS processing, which involves:

- Disabling further RLS access
- Preventing existing tasks from issuing further RLS requests after the server becomes available again
- Closing all ACBs that are open in RLS mode.

If a system task is waiting on this resource, it means that it is waiting to perform a dynamic RLS restart to re-establish access to a restarted (new) SMSVSAM server. CICS access to the failed server must be drained before CICS can register with the new server.

If a user task is waiting on this resource, it means that it is waiting in backout processing for a drain to complete before checking whether the file being backed out is open, because drain affects the open state of the file.

The drain is carried out by the system task CSFR. This should normally complete without problems, although it may take some time if there is a large number of files to be closed. If a task is waiting on FCRDWAIT for a considerable length of time, you should check whether the CSFR task is itself in a wait and therefore failing to complete.

Resource type FCRPWAIT—wait for file control initialization to complete

If a task is waiting on resource type FCRPWAIT, dynamic RLS restart is waiting for file control initialization to complete. DFHFICRP is the module that performs most of file control initialization processing.

A dynamic RLS restart occurs when a restarted SMSVSAM server becomes available following a failure of the previous server. If this occurs during CICS initialization, dynamic RLS restart must wait for file control initialization to complete.

Because this wait occurs during CICS initialization, you should not be able to see a task waiting on this resource.

Resource Type FCRRWAIT—wait for dynamic RLS restart to complete

If a task is waiting on resource type FCRRWAIT it means that a dynamic RLS restart is waiting for an earlier dynamic RLS restart to complete. DFHFICRR is the module that performs dynamic RLS restart processing.

A dynamic RLS restart occurs when a restarted SMSVSAM server becomes available following a failure of the previous server. If a restarted SMSVSAM server, which has caused one dynamic RLS restart, fails and becomes available again, it causes CICS to perform another dynamic RLS restart. If the first dynamic RLS restart has not finished, the second dynamic RLS restart must wait for the first to complete.

If a task is waiting in FCRRWAIT for a considerable length of time, you should check whether there is any other task performing dynamic RLS restart, which is itself in a wait and therefore failing to complete.

Resource type FCRVWAIT—wait for VSAM I/O (RLS)

If you have a task waiting on resource type FCRVWAIT, it means that the task is waiting *within* VSAM for I/O to take place, or is waiting for a record lock.

A wait on resource type FCRVWAIT occurs when conflicts over shared or exclusive locks are deferred internally by VSAM and not returned as an error condition to CICS. Conflicts that can cause an FCRVWAIT wait are:

- A task issues a file control READ UPDATE request for a record, for which:
 - Another task already holds an exclusive lock
 - One or more tasks hold a shared lock.
- A task issues a file control READ request with CONSISTENT or REPEATABLE integrity for a record, for which:
 - Another task already holds an exclusive lock.
 - Another task is waiting for an exclusive lock because one or more tasks may already have a shared lock, or another task has an exclusive lock.

Waiting on this resource can occur only for files accessed in RLS mode.

A task could be in an FCRVWAIT state because of a deadlock. If VSAM detects an RLS deadlock condition, it returns a deadlock exception condition to CICS, causing CICS file control to abend the transaction with an AFCW abend code. CICS also writes messages and trace entries that identify the members of the deadlock chain.

VSAM cannot detect a cross-resource deadlock (for example, a deadlock arising from use of RLS and DB2 resources) where another resource manager is involved. A cross-resource deadlock is resolved by VSAM when the timeout period expires, as defined by either the DTIMOUT or FTIMEOUT parameters, and the waiting request is timed out. In this situation, VSAM cannot determine whether the timeout is caused by a cross-resource deadlock, or a timeout caused by another transaction acquiring an RLS lock and not releasing it. In the event of a timeout, CICS writes trace entries and messages to identify the holder of the lock for which a timed-out transaction is waiting. Similarly, a task could be made to wait on another task that has an exclusive or shared lock on a record. If this second task was, itself, waiting for an exclusive lock on a resource for which the first task already has a lock, both tasks would be deadlocked.

Resource type FCTISUSP—wait for a VSAM transaction ID

If your task is waiting on resource type FCTISUSP, it means that there are no VSAM transaction IDs available. Transaction IDs are retained by a task for the duration of a MASSINSERT session.

Waits on FCTISUSP should not be prolonged, and if your task stays suspended on this resource type, it could indicate any of the following:

- There could be a system-wide problem. CICS could have stopped running, or it might be running slowly. Turn to “Chapter 2. Classifying the problem” on page 7 for advice if you suspect this.
- There could be a performance problem. Guidance about dealing with performance problems is given in “Chapter 8. Dealing with performance problems” on page 161.
- The logic of your applications might need changing, so that tasks do not retain VSAM transaction IDs for too long. If the task does other processing during the session, perhaps even involving input from an operator, code to release the VSAM transaction ID should be included each time.

Waiting on this resource can occur only for files accessed in non-RLS mode.

Resource type FCXCWAIT—VSAM exclusive control wait

If your task is waiting on resource type FCXCWAIT, it means that it cannot get exclusive control of a VSAM control interval at the present time. Another task already has shared or exclusive control of the control interval, so your task is suspended pending the release of that control interval. An exclusive control wait on resource type FCXCWAIT occurs within CICS, unlike the similar wait on FCIOWAIT, which occurs within VSAM. See page 123.

If you find that exclusive control conflicts occur too often in your system, consider changing the programming logic so that applications are less likely to have exclusive control for long periods.

Waiting on this resource can occur only for files accessed in non-RLS mode.

The possibility that a task is deadlocked, waiting on itself or another task for release of the control interval, is dealt with in the next section.

Exclusive control deadlock: In non-RLS mode, without some means of avoiding it, a task could wait on itself for exclusive control of a VSAM control interval. If this was allowed to happen, the task would be deadlocked, and neither able to release exclusive control or reacquire it.

Similarly, a task could be made to wait on another task that has exclusive or shared control of a VSAM control interval. If this second task was, itself, waiting for exclusive control of a resource of which the first task has exclusive or shared control, then both tasks would be deadlocked.

CICS however, provides a mechanism to avoid exclusive control deadlock. If a task is waiting on resource type FCXCWAIT and causing a task to wait (either itself or another task), causing a deadlock, the task is abended either with abend code AFCE or AFCEG at the time that it makes the request for exclusive control.

A task that is abended with abend code AFCE would have been waiting for exclusive control of a VSAM control interval of which another task has shared or exclusive control.

A task that is abended with abend code AFCEG would have been waiting for exclusive control of a VSAM control interval of which it has shared control.

See the *CICS Messages and Codes* manual for more information about these abend codes.

To resolve the problem, you must determine which program caused the potential deadlock. Find out which programs are associated with the abended task, and attempt to find the one in error. It is likely to be one that provides successive browse and update facilities. When you have found the programs associated with the task, turn to "How tasks can become deadlocked waiting for exclusive control" for guidance about finding how the error might have occurred.

How tasks can become deadlocked waiting for exclusive control: Tasks can become deadlocked waiting for exclusive control of a CI only when they have shared control of the CI and then attempt to get exclusive control without relinquishing shared control first. This can only occur for VSAM shared resource data sets accessed in non-RLS mode.

For the deadlock to occur, a transaction must first issue a VSAM READ SEQUENTIAL request via EXEC CICS STARTBR. This is a VSAM "shared control" operation. It must then issue some VSAM request requiring exclusive control of the CI without first ending the shared control operation.

The requests that require exclusive control of the CI are:

- VSAM READ UPDATE, via EXEC CICS READ UPDATE and, subsequently, EXEC CICS REWRITE.

Exclusive control of the CI is not acquired until after the initial read is complete, but it happens automatically after that and the CI is not released until the record has been rewritten.

- VSAM WRITE DIRECT, via EXEC CICS WRITE.
- VSAM WRITE SEQUENTIAL, via EXEC CICS WRITE MASSINSERT.

VSAM handles requests requiring exclusive control on a data set that is already being used in shared control mode by queueing them internally. VSAM returns control to CICS, but transactions waiting for exclusive control remain suspended.

Example of code causing an exclusive control deadlock: The following sequence of EXEC commands would cause an exclusive control deadlock to occur.

The first command causes shared control to be acquired:

```
EXEC CICS STARTBR
      FILE(myfile)
      RIDFLD(rid-area)
```

This causes no problems. The next command at first acquires shared control while the record is read into “input-area”. When an attempt is subsequently made to get exclusive control, deadlock occurs because the task that wants exclusive control is also the task that is preventing it from being acquired.

```
EXEC CICS READ
      FILE(myfile)
      INTO(input-area)
      RIDFLD(rid-area)
      UPDATE
```

The following sequence of commands would not cause deadlock to occur, because the transaction relinquishes its shared control of the CI by ending the browse before attempting to get exclusive control of it.

The first command causes shared control to be acquired:

```
EXEC CICS STARTBR
      FILE(myfile)
      RIDFLD(rid-area)
```

The next command causes shared control to be relinquished:

```
EXEC CICS ENDBR
      FILE(myfile)
```

The next command initially causes shared control to be acquired. The record is read into “input-area”, and then exclusive control is acquired in place of shared control.

```
EXEC CICS READ
      FILE(myfile)
      INTO(input-area)
      RIDFLD(rid-area)
      UPDATE
```

The transaction now resumes. Exclusive control is relinquished following the next REWRITE or UNLOCK command on file “myfile”.

Resource type ENQUEUE—waits for locks on files or data tables

A resource type of ENQUEUE with a resource name beginning “FC” indicates that the task is waiting for a lock on a file or data table. Table 24 shows the type of lock that each of the “FC” resource names represents.

Table 24. Resource/pool names and lock types

Resource or pool name	Lock type
FCDSRECD	VSAM or CICS-maintained data table record

Table 24. Resource/pool names and lock types (continued)

Resource or pool name	Lock type
FCFLRECD	BDAM or user-maintained data table record
FCDSRNGE	KSDS key range
FCDSLDM	VSAM load mode
FCDSWR	ESDS write
FCFLUMTL	User-maintained data table load

For general information about enqueue waits, see “Enqueue waits” on page 116.

Resource name FCDSRECD: A resource name of FCDSRECD indicates a wait for a record lock in a VSAM file or CICS-maintained data table.

When a transaction updates a record in a VSAM file or CICS-maintained data table, locking occurs at two levels. VSAM locks the CI when the record has been read, and CICS locks the record.

The CI lock is released as soon as the REWRITE (or UNLOCK) request is completed. However, if the file or data table is recoverable, the record is not unlocked by CICS until the updating transaction has reached a syncpoint. This is to ensure that data integrity is maintained if the transaction fails before the syncpoint and the record has to be backed out.

If a transaction attempts to access a record that is locked by another transaction, it is suspended on resource type ENQUEUE until the lock is released. This can be a long wait, because an update might depend on a terminal operator typing in data. Also, the suspended transaction relinquishes its VSAM string and, perhaps, its exclusive control of the CI, and has to wait once more for those resources.

If transactions are commonly made to wait for this reason, you should review the programming logic of your applications to see if the record-locking time can be minimized.

Note that CICS only locks a record for update. Other transactions are allowed to read the record, and this presents a potential read integrity exposure. Thus, a transaction might read a record after an update has been made, but before the updating transaction has reached its syncpoint. If the reading transaction takes action based on the value of the record, the action is incorrect if the record has to be backed out.

There is some more information about read integrity in “Chapter 9. Dealing with incorrect output” on page 171.

Resource name FCFLRECD: A resource name of FCFLRECD indicates a wait for a record lock in a BDAM file or user-maintained data table.

Neither BDAM nor user-maintained data tables use the “control interval” concept. When a task reads a record for update, the record is locked so that concurrent changes cannot be made by two transactions. If the file or data table is recoverable, the lock is released at the end of the current unit of work. If the file or data table is not recoverable, the lock is released on completion of the REWRITE or UNLOCK operation.

If a second task attempts to update the same record while the first has the lock, it is suspended on resource type ENQUEUE.

Resource name FCDSRNGE: A resource name of FCDSRNGE indicates a wait for a range lock in a recoverable KSDS data set.

When a transaction issues a mass-insert WRITE request to a recoverable KSDS data set, CICS obtains exclusive control of a range of key values. This enables CICS to perform an efficient sequential write operation, while maintaining integrity. The range extends to the next higher key in the data set.

If another transaction tries to write a record in the locked key range, or delete the record at the end of the range, it is suspended until the range lock is released. The lock is released when the transaction holding it issues a syncpoint, ends the mass-insert operation by issuing an UNLOCK, or changes to a different range.

Resource name FCDSLMD: A resource name of FCDSLMD indicates a wait for a lock in a VSAM data set that has been opened in load mode.

When a VSAM data set is opened in load mode, only one request can be issued at a time. If a transaction issues a WRITE request while another transaction's WRITE is in progress, it is suspended until the first WRITE completes.

Resource name FCDSWR: A resource name of FCDSWR indicates a wait for an ESDS write lock.

For integrity reasons, WRITE requests to recoverable ESDS data sets must be serialized. When a transaction issues such a request, it holds the ESDS write lock for the time it takes to log the request, obtain a record lock, and write the data set record. If another transaction issues a WRITE request during this period, it is suspended until the ESDS lock is released. The lock is normally released when the WRITE completes, but may be held until syncpoint if the WRITE fails.

Resource name FCFLUMTL: A resource name of FCFLUMTL indicates a wait during loading of a user-maintained data table.

When loading a user-maintained data table from its source data set, this lock is used to serialize loading with application READ requests.

Resolving deadlocks in a CICS region

You can diagnose deadlocks between tasks wanting an exclusive lock on the same resource (such as a record in a non-RLS file, a recoverable transient data queue, or any resource represented by an EXEC CICS ENQUEUE).

Enqueue deadlocks between tasks occur when each of two transactions (say, A and B) needs an exclusive lock on a resource that the other holds already. Transaction A waits for transaction B to release the resource. However, if transaction B cannot release the resource because it, in turn, is enqueued on a resource held by transaction A, the two transactions are deadlocked. Further transactions may then queue, enqueued on the resources held by transactions A and B.

You can use CEMT online to identify deadlocked transactions, and identify the resources they hold.

The CEMT INQUIRE UOWENQ command displays information about the owners of all enqueues held. More importantly, for deadlock diagnosis purposes, it displays information about the tasks waiting for the enqueues. Note that CEMT INQUIRE UOWENQ can be used only for files accessed in non-RLS mode, because files accessed in RLS mode have their locks managed by VSAM, not by CICS. Deadlock and timeout detection for files accessed in RLS mode is also performed by VSAM.

An example of deadlock diagnosis using CEMT INQUIRE UOWENQ: Consider the following example. The user of task 32 complains that his terminal is locked: he cannot enter data and his terminal does not respond to any prompt.

If you enter CEMT INQUIRE TASK at a different terminal at this time, a display similar to the following might appear:

```

INQUIRE TASK
STATUS: RESULTS - OVERTYPE TO MODIFY
Tas(0000025) Tra(CEMT) Fac(T773) Run Ter Pri( 255 )
  Sta(TO) Use(CICSUSER) Uow(AA8E9505458D8C01)
Tas(0000028) Tra(TDUP) Fac(T774) Sus Ter Pri( 001 )
  Sta(TO) Use(CICSUSER) Uow(AA8E9505458D8C01) Hty(ZCIOWAIT) Hva(DFHZARQ1)
Tas(0000032) Tra(FUPD) Fac(T775) Sus Ter Pri( 001 )
  Sta(TO) Use(CICSUSER) Uow(AA8E950545DAC004) Hty(ENQUEUE ) Hva(FCDSRECD)
Tas(0000035) Tra(FUPD) Fac(T784) Sus Ter Pri( 001 )
  Sta(TO) Use(CICSUSER) Uow(AA8E950545DBC357) Hty(ENQUEUE ) Hva(FCDSRECD)
Tas(0000039) Tra(FUPD) Fac(T778) Sus Ter Pri( 001 )
  Sta(TO) Use(CICSUSER) Uow(AA8E97FE9592F403) Hty(ENQUEUE ) Hva(FCDSRECD)
Tas(0000042) Tra(FUP2) Fac(T783) Sus Ter Pri( 001 )
  Sta(TO) Use(CICSUSER) Uow(AA8E97FE9592F403) Hty(ENQUEUE ) Hva(FCDSRECD)

```

Figure 11. CEMT INQUIRE TASK shows task 32 waits on an enqueue

Task 32 is waiting on an enqueue (Hty = ENQUEUE). You can also see that the task is waiting for a lock on a data set record (Hva = FCDSRECD). But, at this stage, you cannot tell which (if any) task has control of this resource.

If you now enter CEMT INQUIRE UOWENQ at the same terminal, you can see the enqueues held in the system - you can see which tasks own which resources and which tasks are waiting for those resources.

A screen similar to the following might be displayed:

```

INQUIRE UOWENQ
STATUS: RESULTS
Uow(AA8E9505458D8C01) Tra(CEMT) Tas(0000025) Act Exe Own
Uow(AA8E9505458D8C01) Tra(TDUP) Tas(0000028) Act Tdq Own
Uow(AA8E950545DAC004) Tra(FUPD) Tas(0000032) Act Dat Own
Uow(AA8E950545DBC357) Tra(FUPD) Tas(0000035) Act Dat Wai
Uow(AA8E97FE9592F403) Tra(FUP2) Tas(0000039) Act Dat Wai
Uow(AA8E9505458D8C01) Tra(TSUP) Tas(0000034) Ret Tsq Own
Uow(AA8E97FE9592F403) Tra(FUP2) Tas(0000039) Act Dat Own
Uow(AA8E950545DAC004) Tra(FUPD) Tas(0000032) Act Dat Wai
Uow(AA8E97FE9592F403) Tra(FUPD) Tas(0000042) Act Dat Own

```

Figure 12. CEMT INQUIRE UOWENQ shows the owners of and waiters on resources

You can see all the enqueue owners and waiters on the same region on this display. Tasks waiting for an enqueue are displayed immediately after the task which owns the enqueue. Owners and waiters on other regions are not displayed.

You can clarify this display in a busy system by displaying only those resources that the task you are interested in owns and waits for. This is called filtering. You add a filter to the end of the INQUIRE UOWENQ command: CEMT INQUIRE UOWENQ TASK(32).

```
INQUIRE UOWENQ TASK(32)
STATUS: RESULTS
Uow(AA8E950545DAC004) Tra(FUPD) Tas(0000032) Act Dat Own
Uow(AA8E950545DAC004) Tra(FUPD) Tas(0000032) Act Dat Wai
```

Figure 13. Information pertinent to task 32

You can now see that task 32 owns one enqueue but is also waiting for another.

This display shows one line of information per item, listing:

- UOW identifier
- Transaction identifier
- Task identifier
- Enqueue state (active, or retained)
- Enqueue type
- Relation (whether owner of the enqueue or waiter).

In order to see more information, press ENTER alongside the item that interests you. If you press ENTER alongside the first entry of the output from CEMT INQUIRE UOWENQ TASK(32), a screen similar to the following might be displayed: This shows you details of the enqueue that task 32 owns.

```
INQUIRE UOWENQ TASK(32)
RESULT
  Uowenq
  Uow(AA8E950545DAC004)
  Transid(FUPD)
  Taskid(0000032)
  State(Active)
  Type(Dataset)
  Relation(Owner)
  Resource(ACCT.CICS530.ACCTFILE)
  Qualifier(SMITH)
  Netuowid(..GBIBMIYA.IYA2T774.n.....)
  Enqfails(00000000)
```

Figure 14. The enqueued owned by task 32

Expanding the second entry shows the enqueue that task 32 is waiting for:

```

INQUIRE UOWENQ TASK(32)
RESULT
  Uowenq
  Uow(AA8E950545DAC004)
  Transid(FUPD)
  Taskid(0000032)
  State(Active)
  Type(Dataset)
  Relation(Waiter)
  Resource(INDX.CICS530.ACIXFILE)
  Qualifier(SMITH)
  Netuowid(..GBIBMIYA.IYA2T774.n.....)
  Enqfails(00000000)

```

Figure 15. The enqueue that task 32 is waiting for

Expanding the one-line display is useful because RESOURCE and QUALIFIER fields are then revealed. These identify the physical resource that is related to the enqueue. You can see, from the first entry in this example, that task 32 owns the enqueue on record identifier “SMITH” in the ACCT.CICS530.ACCTFILE data set. You can also see, from the second expanded entry, that task 32 is waiting on an enqueue - for record identifier “SMITH” in the INDX.CICS530.ACIXFILE data set.

So now you need to investigate why task 32 is waiting on the enqueue detailed in the second expanded entry. You need to find out which task owns this enqueue and why it is holding it for such a long time. You can do this by filtering the CEMT INQUIRE UOWENQ command with the RESOURCE and QUALIFIER options. Enter CEMT INQUIRE UOWENQ RESOURCE(INDX.CICS530.ACIXFILE) QUALIFIER(SMITH) This shows the task that owns the enqueue that is being waited on.

This shows you that another task, task 39, owns the enqueue that task 32 is waiting

```

INQUIRE UOWENQ RESOURCE(INDX.CICS530.ACIXFILE) QUALIFIER(SMITH)
STATUS: RESULTS
  Uow(AA8E97FE9592F403) Tra(FUP2) Tas(0000039) Act Dat Own
  Uow(AA8E950545DAC004) Tra(FUPD) Tas(0000032) Act Dat Wai

```

Figure 16. Task 39 owns the enqueue that task 32 waits on

on. In order to find out why task 39 is holding this enqueue, filter the CEMT command again for task 39. Enter CEMT INQUIRE UOWENQ TASK(39). This shows you that task 39 is also waiting for an enqueue. If you expand the entry

```

INQUIRE UOWENQ TASK(39)
STATUS: RESULTS
  Uow(AA8E97FE9592F403) Tra(FUP2) Tas(0000039) Act Dat Wai
  Uow(AA8E97FE9592F403) Tra(FUP2) Tas(0000039) Act Dat Own

```

Figure 17. Information pertinent to task 39

which indicates the waiting state, you may see a display similar to the following:

```

INQUIRE UOWENQ TASK(39)
RESULT
  Uowenq
  Uow(AA8E97FE9592F403)
  Transid(FUP2)
  Taskid(0000039)
  State(Active)
  Type(Dataset)
  Relation(Waiter)
  Resource(ACCT.CICS530.ACCTFILE)
  Qualifier(SMITH)
  Netuowid(..GBIBMIYA.IYA2T776.p.nk4..)
  Enqfails(00000000)

```

Figure 18. The enqueue that task 39 is waiting on

This shows you that task 39 is waiting for the enqueue on record “SMITH” in the ACCT.CICS530.ACCTFILE data set. This is the enqueue that task 32 owns. You can now see that the deadlock is between tasks 32 and 39.

If you filter by the RESOURCE and QUALIFIER of this enqueue, you can confirm that this is the case. This also shows that task 35 also waits on the enqueue owned by task 32.

You are now in a position of knowing which transaction(s) to cancel and investigate

```

INQUIRE UOWENQ RESOURCE(ACCT.CICS530.ACCTFILE) QUALIFIER(SMITH)
STATUS: RESULTS
  Uow(AA8E950545DAC004) Tra(FUPD) Tas(0000032) Act Dat Own
  Uow(AA8E950545DBC357) Tra(FUPD) Tas(0000035) Act Dat Wai
  Uow(AA8E97FE9592F403) Tra(FUP2) Tas(0000039) Act Dat Wai

```

Figure 19. Task 32 owns the enqueue that task 39 waits on

further.

You can also use the EXEC CICS INQUIRE UOWENQ command or the EXEC CICS INQUIRE ENQ command in your applications. These returns all the information that is available under CEMT INQUIRE UOWENQ. If you wish to automate deadlock detection and resolution, these commands are of great benefit.

Resolving deadlocks in a sysplex

Since sysplex-scope ENQUEUE supports deadlock timeout there should be no possibility of an unresolved deadlock across CICS systems.

If a CICS task fails, the NQ domain releases all MVS ENQs held on behalf of that CICS task

If a CICS system fails, MVS releases all MVS ENQs owned by that CICS region. This applies even if the reason for the CICS system failure was an MVS or CEC failure.

When there is a rogue task with enqueues held, which hangs or spins on the spot (but not subject to runaway), the entire region can halt. CPSM tries to assist in the determination of which task to purge to free-up the system. CPSM allows you to put out an alert when a task’s suspend time is too long. Once this has occurred, you need to find the task causing the problem. To do this:

1. Display the suspended task's details and determine what the suspend reason is (CPSM uses EXEC CICS INQUIRE TASK internally). Note the internal UOW id (the RM UOW).
If the suspend reason is ENQUEUE, you have to find out which enqueue is being waited upon by this task.
2. Display the enqueues held and the one this task is waiting for via the UOWENQ display (which CPSM is building from EXEC CICS INQUIRE UOWENQ(uow) Browse for this UOWid). From this display you can get the enqueue name that this task is waiting for.
3. Display the details of this enqueue (CPSM uses the EXEC CICS INQUIRE UOWENQ RESOURCE(name) browse facility to determine what UOWs are interested in this Enqueue (holder and waiters).
You are now in a position to analyze the problem to determine the cause of the problem.

Interval control waits

Read this section if you have a task that is not running, and interval control seems to be involved. The following is a list of possible cases, and suggestions to consider before you carry out a detailed investigation. If these do not give you enough information in order to solve the problem, turn to "Finding the reason for a DELAY request not completing" on page 137 for further guidance.

If, in the course of your preliminary investigations, you find that the task is waiting because the terminal where it is due to start is unavailable, turn to "Terminal waits" on page 102.

- A terminal task that should have been initiated with an EXEC CICS START command did not start when you expected it to. CEMT INQ TASK does not recognize the task, because it has not yet been attached.
One approach is to identify the terminal where the subject task should have started, and see if that terminal is, for some reason, unavailable. You can use CEMT INQ TERMINAL to find the status of the terminal.
- You have found that a task is waiting on resource type ICGTWAIT. This means that the task has issued an EXEC CICS RETRIEVE WAIT command, and the data to be retrieved is, for some reason, not available. The resource name gives you the name of the terminal running the task in the ICGTWAIT wait and therefore the target TERMID for other tasks issuing EXEC CICS START commands to supply more data. If there are no tasks in the system that would issue START commands for this TERMID, you need to determine whether this is reasonable. If there are such tasks in the system, check to see why they are not issuing the required START commands. They might, for example, be waiting for terminal input.

Look, too, at the deadlock time-out interval (DTIMOUT) and the system purge value (SPURGE) for the task issuing the EXEC CICS RETRIEVE WAIT command. If there is no DTIMOUT value or SPURGE=NO has been specified, the task will wait indefinitely for the data.

Note: The task waiting on resource ICGTWAIT might not be the one that you first set out to investigate. Any AID task scheduled to start at the same terminal cannot do so until the current task has terminated.

- You have found that the task is waiting on resource type ICWAIT. This means that the task issued an EXEC CICS DELAY command that has not yet

completed. Check that the interval or time specified on the request was what you intended. If you believe that the expiry time of the request has passed, that suggests a possible CICS error.

Consider, too, the possibility that the task was the subject of a long DELAY that was due to be canceled by some other task. If the second task failed before it could cancel the delay, the first would not continue until the full interval specified on DELAY had expired.

- A task that issued EXEC CICS POST did not have its ECB posted when you expected it to.

Check to make sure the interval or time you specified was what you intended.

- A task that issued EXEC CICS WAIT EVENT was not resumed when you thought it should have been.

Assuming the WAIT was issued sometime after a POST, first check to make sure that the interval or time specified on the POST was what you intended. If it was, next check to see whether the ECB being waited on was posted. If it was, that indicates a possible CICS error.

If none of the simple checks outlined here help you to solve the problem, read the next section.

Finding the reason for a DELAY request not completing

If your preliminary investigations have not shown the reason for the wait, you need to look in greater detail at the evidence available. Take a system dump, and format it using the keywords CSA, ICP, and AP. These get you the common system area, the interval control program control blocks, and the task control areas, respectively. You might also find information given by the formatting keywords KE (kernel storage areas, including the calling sequence for each task), DS (dispatcher task summary, including details of suspended tasks), and TR (internal trace table) to be useful.

First, locate field CSATODTU in the CSA. Make a note of the value there, which is the current CICS time of day in internal 'timer units'. Now locate the TCA for your task, and read the value of field TCAICEAD. This gives you the address of the interval control element for your task. Use this information to find the ICE (interval control element) for the task, and look at field ICEXTOD. Make a note of the value there.

If ICEXTOD is greater than CSATODTU, the ICE has not yet reached the expiry time. These are the possible explanations:

- Your task either did not make the DELAY request you expected, or the interval specified was longer than intended. This could indicate a user error. Check the code of the transaction issuing the request to make sure it is correct.
- Your task's delay request was not executed correctly. This might indicate an error within CICS code, or a corrupted control block.

If ICEXTOD is equal to CSATODTU (very unlikely), you probably took the system dump just as the interval was about to expire. In such a case, attempt to re-create the problem, take another system dump, and compare the values again.

If ICEXTOD is less than CSATODTU, the ICE has already expired. The associated task should have resumed. This indicates that some area of storage might have been corrupted, or there is an error within CICS code.

Using trace to find out why tasks are waiting on interval control

Before using trace to find out why your task is waiting on interval control, you need to select an appropriate trace destination and set up the right tracing options.

By their nature, interval control waits can be long, so select auxiliary trace as the destination, because you can specify large trace data sets for auxiliary trace. However, the data sets do not have to be large enough to record tracing for the whole interval specified when you first detected the problem. That is because the error is likely to be reproducible when you specify a shorter interval, if it is reproducible at all. For example, if the error was detected when an interval of 20 seconds was specified, try to reproduce it specifying an interval of 1 second.

As far as tracing selectivity is concerned, you need to capture level-2 trace entries made by dispatcher domain, timer domain, and interval control program. Use the CETR transaction to set up the following tracing options:

1. Specify special tracing for the level-2 trace points for components DS (dispatcher domain), TI (timer domain), and IC (interval control program).
2. Select special tracing for the task causing the problem, by specifying special tracing both for the transaction and for the terminal where it is to be run.
3. Set the master system trace flag off, to turn off all standard tracing. This helps minimize the number of trace entries not connected with the problem.
4. Make sure that auxiliary tracing is active, then set the transaction running. When the problem appears, format the auxiliary trace data set and either print it or view it online.

The sort of trace entries that you can expect in normal operation are shown in the figures that follow. They show the flow of data and control following execution of the command EXEC CICS DELAY INTERVAL(000003). A similar set of trace entries would be obtained if TIME had been specified instead of INTERVAL, because TIME values are converted to corresponding INTERVAL values before timer domain is called.

Figure 20 shows the first two entries that you get following execution of the EXEC CICS DELAY INTERVAL(000003) command.

```
AP 00E1 EIP ENTRY DELAY          REQ(0004) FIELD-A( 0034BD70 ....) FIELD-B(08001004 ....)
      TASK-00163 KE_NUM-0007 TCB-009F3338 RET-8413F43E TIME-16:31:58.0431533750 INTERVAL-00.0000166250 =000602=
AP 00F3 ICP ENTRY WAIT          REQ(2003) FIELD-A(0000003C ....) FIELD-B(00000000 ....)
      TASK-00163 KE_NUM-0007 TCB-009F3338 RET-84760B88 TIME-16:31:58.0432681250 INTERVAL-00.0000370000 =000605=
```

Figure 20. Trace entries following EXEC CICS DELAY INTERVAL(000003) invocation

Notes:

1. Trace point **AP 00E1** is on ENTRY to the EIP DELAY routine. The function is stated in the trace header, and the fact that this trace is made on ENTRY can be deduced from the value shown in the request field, REQ(0004).

The rightmost two bytes of FIELD B give the EIBFN value, in this case X'1004'. This shows that this is an interval control DELAY request.

The value shown against TASK is the trace task number, and it is unique to the task while the task is in the system. Its purpose is to show which trace entries relate to which tasks. The task number in this example is 00163. As long as the task is in the system, and either running or suspended, trace entries having this task number always relate to it. Use the task number for your task to identify the trace entries associated with it.

- Trace point **AP 00F3** is on ENTRY to the ICP WAIT routine. The function is given explicitly in the trace header, and both the function and the fact that this represents ENTRY to the routine can be deduced from the request field, REQ(2003).

The value of FIELD A, X'0000003C', is an important one for problem determination. It shows the interval that has been specified, in this case three seconds. Check the value shown here for your own task, to make sure it is what you expect it to be.

Look next for an entry with point ID DS 0004 showing your task being suspended, as in Figure 21. You might see TI domain trace entries preceding it that show entry and exit for FUNCTION(REQUEST_NOTIFY_INTERVAL), but these do not always appear.

There might also be some intervening entries, but they are unlikely to be of relevance to the problem.

```

TI 0100 TISR ENTRY - FUNCTION(REQUEST_NOTIFY_INTERVAL) DOMAIN_TOKEN (00E70000 , 00000000) STCK_INTERVAL
(00000002DC6C1000)
      PERIODIC NOTIFY(NO) NOTIFY_TYPE(TIMER_TASK)
TASK-00163 KE_NUM-0007 TCB-009F3338 RET-8476352A TIME-16:31:58.0442390000 INTERVAL-00.0000155000 =000614=
1-0000 00600000 00000006 00000000 00000000 B3B00000 00000000 01000000 00000000 *.-.....*
0020 00000000 00000000 00000000 00E70000 00000000 00000000 00000000 00000002 *.....X.....*
0040 DC6C1000 00000000 02020000 00000000 00000000 00000000 00000000 00000000 *.%.....*
.....*
TI 0101 TISR EXIT - FUNCTION(REQUEST_NOTIFY_INTERVAL) RESPONSE(OK) TIMER_TOKEN(03B9B058 , 0000001B)
TASK-00163 KE_NUM-0007 TCB-009F3338 RET-8476352A TIME-16:31:58.0738898750 INTERVAL-00.0296188125* =000617=
1-0000 00600000 00000006 00000000 00000000 B3B00000 00000000 01000100 00000000 *.-.....*
0020 00000000 00000000 00000000 00E70000 00000000 03B9B058 0000001B 00000002 *.....X.....*
0040 DC6C1000 00000000 02020000 00000000 00000000 00000000 00000000 00000000 *.%.....*
.....*
DS 0004 DSSR ENTRY - FUNCTION(SUSPEND) SUSPEND_TOKEN(01040034) RESOURCE_NAME(1477) RESOURCE_TYPE(ICWAIT) PURGEABLE(YES)
DEADLOCK ACTION(INHIBIT)
TASK-00163 KE_NUM-0007 TCB-009F3338 RET-847645CE TIME-16:31:58.0739336250 INTERVAL-00.0000437500 =000618=
1-0000 00580000 00000014 00000001 00000000 B7050000 00000000 04000100 00000000 *.....*
0020 00000000 01040034 F1F4F7F7 40404040 C9C3E6C1 C9E34040 0000001B 00000002 *.....1477 ICWAIT .....*
0040 DC6C1000 00000000 02010003 00000000 00000000 00000000 00000000 00000000 *.%.....*
*

```

Figure 21. Trace entries showing interval calculation and task suspension

Notes:

- Trace point **TI 0100**, if shown, is on ENTRY to the REQUEST_NOTIFY_INTERVAL function of timer domain. This is stated explicitly in the trace header.

The value shown in the header for STCK_INTERVAL is derived from the machine store clock value calculated for the DELAY interval specified on the EXEC CICS DELAY command. You can find out how store clock values are related to times in hours, minutes, and seconds from the *ESA/370 Principles of Operation* manual.

If you do the calculation, you find that the value shown is not exactly equal to the interval you specified. An extra microsecond is added, to account for the case where the interval is specified as 0.

In this example, 3 seconds is exactly equal to a store clock interval of X'00000002DC6C0000'. You can see that the actual store clock value is quoted in the trace entry as X'00000002DC6C1000', which is 3 seconds *plus* 1 microsecond.

The TIME field of the trace entry shows the time at which the entry was made, in the format hh:mm:ss. The value in this example (ignoring the fractions of a second) is 16:31:58. It follows that the task is due to be resumed when the time is 16:32:01, because the interval is 3 seconds.

- Trace point **TI 0101**, if shown, is on EXIT from the REQUEST_NOTIFY_INTERVAL function of timer domain.
You can see from RESPONSE(OK) in the header that the function completed normally.
- Trace point **DS 0004** is on ENTRY to the dispatcher task SUSPEND/RESUME interface.
The SUSPEND_TOKEN field in the trace header is significant. It shows the unique suspend token being used for this SUSPEND/RESUME dialog, and it is referred to explicitly again in a later trace entry showing that the task has been resumed. In this example, the suspend token is X'01040034'.
Any subsequent dispatcher trace entry that shows the suspend token for your task is connected with the suspension or resumption of the task.
Field RESOURCE_TYPE(ICWAIT) in the trace header shows that the resource type associated with this suspend is ICWAIT. ICWAIT is the resource type that is returned on CEMT INQ TASK for tasks that are waiting on interval control.

Next, get some trace entries recording system activity during the period when your task is suspended. There are likely to be relatively few at the level of tracing detail you have specified, but you need to look further on in the trace to find the next entries of interest.

Add 3 seconds (or whatever interval you specified) to the time shown on the last trace entry you looked at, and turn forward to the trace entries made at around that time. Now look for an entry made from trace point DS 0004. *This does not show the task number for your task*, but it does show its suspend token. When you have found it, go back one entry. You should find there a trace entry made from trace point AP F322. This and the following two trace entries of interest are shown in Figure 22.

```

AP F322 APTIX RESUMED - SYSTEM TASK APTIX RESUMED
TASK-00006 KE_NUM-0009 TCB-009F3338 RET-84773724 TIME-16:32:01.1016870625 INTERVAL-00.0001065000 =000670=
  1-0000 01000000 D7C5D5C4 D5D6E3D7 01107739 00E70000 00000000 03B9B058 0000001B *....PENDNOTP.....X.....*
    0020 01080002 00D40000 00000000 03B9B000 00000001 01050002 00000000 00000000 *....M.....*
    0040 00000000 00000000 00000000 00000000 00000000 00000000 00000000 00000000 *.....*
    0060 00000000 00000000 00000000 00000000 00000000 00000000 00000000 00000000 *.....*
DS 0004 DSSR ENTRY - FUNCTION(RESUME) SUSPEND_TOKEN(01040034)
TASK-00006 KE_NUM-0009 TCB-009F3338 RET-847646D4 TIME-16:32:01.1019761875 INTERVAL-00.0000278125 =000674=
  1-0000 00580000 00000014 00000001 00000000 B4000000 00000000 05000100 00000000 *.....*
    0020 00000000 01040034 00000000 00E70000 00000000 03B9B058 0000001A 000026EE *.....X.....*
    0040 D9AC1000 00000000 00000000 0001632C 00000000 00000000 *R.....*
DS 0005 DSSR EXIT - FUNCTION(RESUME) RESPONSE(OK)
TASK-00006 KE_NUM-0009 TCB-009F3338 RET-847646D4 TIME-16:32:01.1019959375 INTERVAL-00.0000197500 =000675=
  1-0000 00580000 00000014 00000001 00000000 B4000000 00000000 05000100 00000000 *.....*
    0020 00000000 01040034 00000000 00E70000 00000000 03B9B058 0000001A 000026EE *.....X.....*
    0040 D9AC1000 00000000 00000000 0001632C 00000000 00000000 *R.....*

```

Figure 22. Trace entries showing your task being resumed

Notes:

- Trace point **AP F322** is used to report that system task APTIX has been resumed. APTIX has the job of “waking up” your task on expiration of the specified interval.
The task number for APTIX is, in this case, X'00006', and this value is shown on the trace entry.
- Trace point **DS 0004** is on entry to the dispatcher SUSPEND/RESUME interface. This function is stated explicitly in the header.
TASK-00006 indicates that the trace entry is for system task APTIX.

SUSPEND_TOKEN(01040034) shows that APTIX is requesting dispatcher domain to resume the task that was suspended for the specified interval. You will recall that a suspend token of X'01040034' was given to your task when it was first suspended.

- Trace point **DS 0005** is on exit from the dispatcher SUSPEND/RESUME interface.

The trace entry shows RESPONSE(OK), indicating that the task whose suspend token was X'01040034' has successfully been resumed. However, note that this does not necessarily mean that the task has started to run—it has only been made “dispatchable”. For example, it still needs to wait for a TCB to become available.

Now look forward in the trace, and locate a trace entry made from trace point AP 00F3 and showing your task number. This and the next entry conclude the DELAY request for your task. They are shown in Figure 23.

```

AP 00F3 ICP EXIT NORMAL                                REQ(0005) FIELD-A(01000300 ....) FIELD-B(03BD6EE0
..>.)
TASK-00163 KE_NUM-0007 TCB-009F3338 RET-84760B88 TIME-16:32:01.1023045625 INTERVAL-00.0000154375 =000688=
AP 00E1 EIP EXIT DELAY OK                             REQ(00F4) FIELD-A(00000000 ....) FIELD-B(00001004 ....)
TASK-00163 KE_NUM-0007 TCB-009F3338 RET-8413F43E TIME-16:32:01.1024153750 INTERVAL-00.0000235625 =000691=

```

Figure 23. Trace entries showing satisfactory conclusion of the DELAY request

Notes:

- Trace point **AP 00F3** is on EXIT from interval control program. Field REQ(0005) shows that this is so, and it also shows that the response was normal. Anything other than a normal response would result in a value other than X'00' for the first byte of the REQ field.
- Trace point **AP 00E1** is on EXIT from the EXEC interface program. This is shown by bits 0–3 of the second byte of the REQ value, X'F4'.
The values shown for FIELD A and FIELD B show that no exception condition was detected.

That is the end of the DELAY processing, and the task that was suspended should have been resumed.

When you look at your own trace table, be concerned principally with finding the point at which the processing went wrong. Also, watch for bad parameters. If you do find one, it could mean that an application has a coding error, or some field holding a parameter has been overlaid, or an error has occurred in CICS code.

Checking your application code is the easiest option you have. If you find that it is correct and you suspect a storage violation, see “Chapter 10. Dealing with storage violations” on page 197. If you think the error is in CICS code, contact the IBM Support Center.

XRF alternate system waits

The XRF takeover process involves several operations. Before each operation can be started, one or more events must have completed. For example:

- Terminals with backup sessions can be switched while the active system is running, provided the CICS availability manager (CAVM) has initiated a takeover.

- Passively-shared data sets must not be opened until it is known that the active system has terminated.

Note: This is the only way an alternate system can be sure that no more data will be written by an active system.

- Resource managers, such as transient data, temporary storage, and database recovery control (DBRC), rely on the time-of-day clock providing them with a nondecreasing value to ensure the proper management of their resources. The alternate system must not restart a resource manager until the alternate time-of-day clock has been synchronized with the active time-of-day clock.

A system task that issued a takeover request to CAVM waits on the ECB WCSTCECB in the CAVM static control block (DFHWCGPS) until CAVM has decided to accept or reject the request. The DFHKC TYPE=WAIT and DCI=SINGLE requests are issued in DFHWSRTR. The CAVM TCB posts WCSTCECB in either DFHWSTKV (the normal case) or DFHWSSOF (CAVM failure).

The following ECBs each represent an event. The ECBs are located in the static storage for DFHXRP. The ECBs and the events are:

- XRSTIECB—the CAVM has initiated a takeover.
- XRSIAECB—the alternate system is now the incipient active system.
- XRSTCECB—the active system is known to have terminated.
- XRSSSECB—the time-of-day clock is synchronized with active system sign off.
- XRSSTECB—the time-of-day clock is synchronized with active system termination.

XRSTIECB

This ECB is posted by DFHXRA, following a successful call to the CAVM to initiate takeover. Once the ECB has been posted, DFHXRA attaches a system transaction to initiate the switch of terminals with backup sessions. DFHXRA is called from either the surveillance task (DFHXRSP), or the console communication task (DFHXRCP). No tasks wait for XRSTIECB to be posted.

XRSIAECB

The XRSIAEB ECB is posted by DFHXRA, following notification by the CAVM that an alternate system is now the incipient active system. DFHXRA is called from the surveillance task (DFHXRSP). No tasks wait for XRSIAECB to be posted.

XRSTCECB

The XRSTCECB ECB is posted by DFHXRA, following notification by the CAVM that an active system has terminated. There can be a delay in posting the ECB if:

- An SDUMP is being taken as part of the active system termination process.
- In a 2-CEC environment, the active CEC has failed, and the operator failed to reply to the messages sent to the console.

DFHXRA is called from the surveillance task (DFHXRSP). Only one task, the system initialization task (DFHSII1), waits for XRSTCECB to be posted. When the ECB is posted, DFHSII1 opens the restart data set, for DFHRC use as well as for DFHCC use, and then calls DFHXRA to post the XRSRAECB.

XRSRAECB

The XRSRAECB ECB is posted by DFHXRA once the restart data set has been opened, for DFHRC use as well as for DFHCC use. DFHXRA is called from the system initialization task (DFHSII1). Two tasks wait for XRSRAECB to be posted:

- The transient data recovery task (DFHTDRP) initializes the entry for the CXRF queue before waiting for XRSRAECB to be posted. When the ECB is posted, DFHTDRP resumes emergency restart processing.
- The terminal control recovery task (DFHTCRP) drains its tracking queue before waiting for XRSRAECB to be posted. When the ECB is posted, DFHTCRP resumes emergency restart processing.

XRSSECB

The XRSSECB ECB is posted by DFHXRA following notification by the CAVM that the time-of-day clock is synchronized with active sign off. DFHXRA is called from the surveillance task (DFHXRSP). No tasks wait for XRSSECB to be posted.

XRSSTECB

The XRSSTECB ECB is posted by DFHXRA, following notification by the CAVM that the time-of-day clock is synchronized with respect to active system termination. There may be a delay in posting the ECB if the time indicated by the active system time-of-day clock is significantly ahead of that indicated by the alternate system time-of-day clock. DFHXRA is called from the surveillance task (DFHXRSP).

Only the system initialization task, DFHSII1, waits for XRSSTECB to be posted.

You are only likely to find either of the CICS-supplied transactions CEDA or CESN waiting on a resource type of XRPUTMSG, and only during XRF takeover by the alternate CICS system. It can indicate either of these conditions:

- Data that is required by the transactions is held on a volume subject to MVS RESERVE locking, and another job currently has the lock.
- There is an error in the CICS availability manager.

If it seems clear that MVS RESERVE locking is not implicated, refer the problem to the IBM Support Center.

CICS system task waits

From an analysis of trace, you could have evidence that a CICS system task is in a wait state. You might have seen the task suspended on a SUSPEND call to the dispatcher, but with no corresponding RESUME call. Alternatively, by looking at the dispatcher task summary in a formatted CICS system dump, you might see that a CICS system task is waiting.

Note: You cannot get online information about waiting system tasks from CEMT INQ TASK or EXEC CICS INQUIRE TASK.

If a system task is in a wait state, and there is a system error preventing it from resuming, contact your IBM Support Center. However, do not assume that there is a system error unless you have other evidence that the system is malfunctioning. Other possibilities are:

- Some system tasks are intended to wait for long periods while they wait for work to do. Module DFHSMSY of storage manager domain, for example, can stay

suspended for minutes, or even hours, in normal operation. Its purpose is to clean up storage when significant changes occur in the amount being used, and that might happen only infrequently in a production system running well within its planned capacity.

- System tasks perform many I/O operations, and they are subject to constraints like string availability and volume and data set locking. In the case of tape volumes, the tasks can also be dependent on operator action while new volumes are mounted.

If, in addition to the waiting system task, you think you have enough evidence that shows there is a system error, contact your IBM Support Center.

FEPI waits

This section outlines the CICS waits that FEPI issues. Table 25 shows the points at which FEPI issues CICS waits:

Table 25. FEPI waits

Resource name	Resource type	Wait type	Description
FEPI_RQE	ADAPTER	WAIT_MVS	Issued in the FEPI adapter when a FEPI command is passed to the Resource Manager for processing. Ends when the Resource Manager has processed the request.
SZRDP	FEPRM	WAIT_MVS	Issued in the FEPI Resource Manager when it has no work to do. Ends when work arrives (from either the FEPI adapter or a VTAM exit).

It is possible for a FEPI_RQE wait to be outstanding for a long time—such as when awaiting a flow from the back-end system that is delayed due to network traffic. It is recommended that you do *not* cancel tasks that are waiting at this point; to do so could lead to severe application problems.

An SZRDP wait is generated when the FEPI Resource Manager is idle. Consequently, the SZ TCB is also inactive. On lightly loaded systems, this occurs frequently.

If the Resource Manager abends, then any active CICS FEPI transactions are left waiting on the FEPI_RQE resource. Because the Resource Manager is absent, these waits never get posted, so the transactions suspend. You must issue a CEMT SET TASK FORCEPURGE command to remove these suspended transactions from the system.

Recovery manager waits

This section describes waits associated with the CICS recovery manager (RM).

Resource type RMCLIENT

If a task is suspended with a resource type of RMCLIENT, the recovery manager is trying to call a client which has not yet registered or set its gate. Clients register with the recovery manager and set their gates during CICS initialization, so the suspended task should be resumed by the time CICS initialization is complete.

If such a task does remain suspended for a long time after CICS initialization completes, there is probably an error in CICS—contact your IBM Support Center.

Resource type RMUOWOBJ, resource name LOGMOVE

If a task is suspended with a resource type of RMUOWOBJ and a resource name of LOGMOVE, the recovery manager is trying to log data for a unit of work while an activity keypoint which is moving the UOW's log data is in progress. The suspended task should be resumed when the activity keypoint task completes the move of the UOW's log data.

If a task remains suspended for a long time with a resource type of RMUOWOBJ and a resource name of LOGMOVE, try to discover why the activity keypoint task (CSKP) is not completing.

Resource type RMUOWOBJ, resource name EXISTENC

If a task is suspended with a resource type of RMUOWOBJ and a resource name of EXISTENC, the recovery manager is trying to delete a unit of work while an activity keypoint is in progress. The suspended task should be resumed when the activity keypoint task finishes working with the UOW.

If a task remains suspended for a long time with a resource type of RMUOWOBJ and a resource name of EXISTENC, try to discover why the activity keypoint task (CSKP) is not completing.

Resolving in-doubt and resynchronization failures

For examples of how to resolve in-doubt and resynchronization failures, see the *CICS Intercommunication Guide*.

What to do if CICS has stalled

CICS can stall during initialization, when it is running apparently “normally”, or during termination. These possibilities are dealt with separately in:

- “CICS has stalled during initialization”
- “CICS has stalled during a run” on page 146
- “CICS has stalled during termination” on page 148

If XRF takeover by an alternate CICS system fails to complete satisfactorily, that might also appear to you as a CICS stall. For more information, see the *CICS/ESA 4.1 Problem Determination Guide*.

CICS has stalled during initialization

If CICS stalls during initialization, on an initial, cold, warm, or emergency start, the first place to look is the MVS console log. This tells you how far initialization has progressed.

Note that there might be significant delays at specific stages of initialization, depending on how CICS last terminated.

On cold start, loading the GRPLIST definitions from the CSD data set can take several minutes. For large systems, the delay could be 20 minutes or more while this takes place. You can tell if this stage of initialization has been reached because you get this console message:

```
DFHSI1511 INSTALLING GROUP LIST xxxxxxxx
```

On warm start, there may be a considerable delay while resource definitions are being created from the global catalog.

If you find that unexpected delays occur at other times during CICS initialization, consider the messages that have already been sent to the console and see if they suggest the reason for the wait. For example, a shortage of storage is one of the most common causes of stalling, and is always accompanied by a message. The JCL job log is another useful source of information.

You can find out if this has happened by taking an SDUMP of the CICS region. Format the dump using the keywords KE and DS, to get the kernel and dispatcher task summaries.

Consider, too, whether any first-or second-stage program list table (PLT) program that you have written could be in error. If such a program does not follow the strict protocols that are required, it can cause CICS to stall. For programming information about PLT programs, see the *CICS Customization Guide*.

CICS has stalled during a run

If a CICS region that has been running normally stalls, so that it produces no output and accepts no input, the scope of the problem is potentially system-wide. The problem might be confined exclusively to CICS, or it could be caused by any other task running under MVS.

Look first on your MVS console for any messages. Look particularly for messages indicating that operator intervention is needed, for example to change a tape volume. The action could be required on behalf of a CICS task, or it could be for any other program that CICS interfaces with.

If there is no operator action outstanding, inquire on active users at the MVS console to see what the CPU usage is for CICS. If you find the value is very high, this probably indicates that a task is looping. Read “Chapter 7. Dealing with loops” on page 151 for advice about investigating the problem further.

If the CPU usage is low, CICS is doing very little work. Some of the possible reasons are:

- The system definition parameters are not suitable for your system.
- The system is short on storage, and new tasks cannot be started. This situation is unlikely to last for long unless old tasks cannot, for some reason, be purged.
- The system is at one of the MXT or transaction class limits, and no new tasks can be attached. In such a case, it is likely that existing tasks are deadlocked, and for some reason they cannot be timed out.
- There is an exclusive control conflict for a volume.
- There is a problem with the communications access method.
- There is a CICS system error.

The way you can find out if any of these apply to your system is dealt with in the paragraphs that follow. For some of the investigations, you will need to see a system dump of the CICS region. If you do not already have one, you can request one using the MVS console. Make sure that CICS *is* apparently stalled at the time you take the dump, because otherwise it will not provide the evidence you need. Format the dump using the formatting keywords KE and XM, to get the storage areas for the kernel and the transaction manager.

Are the system definition parameters wrong?: It is possible that the system definition parameters for your system are causing it to stall, possibly at a critical loading. Take a look at what has been specified, paying particular attention to these items:

- The CICS maximum tasks (MXT) and transaction class (MAXACTIVE) limits. If these are too low, new tasks could fail to be attached. If you suspect one of these limits is the cause of the stall, read “Are MXT or transaction class limits causing the stall?” for a way of getting further evidence.
- ICV, the system region exit time. If this is set too high, CICS might relinquish control to the operating system for longer than intended when it has no work to do, perhaps giving the impression of a stall.
- ICVR, the runaway task time interval. If this is set too high, a runaway task could stop other tasks from running for a relatively long time. It can have a value up to 2 700 000 milliseconds, in which case a runaway task would not time out for 45 minutes. CICS could, in the meantime, be stalled. If the ICVR is set to 0, the runaway task does not time out at all.

You should already have an indication if the ICVR is the problem, from the CPU usage (see above).

- ICVTSD, the terminal scan delay interval. The effect differs for VTAM and non-VTAM terminals, but if its value is not appropriate for your system the effect could make you think that CICS is stalled.

For more details about the choice of these and other system definition parameters, see the *CICS Performance Guide*.

Is the system short on storage?: If storage is under stress, storage manager statistics indicate that a storage stress situation has occurred (‘Times went short on storage’). In addition, if the SOS is caused by a suspended GETMAIN or if CICS is unable to alleviate the situation by releasing programs with no current user, and slowing the attachment of new tasks:

- A message is sent to the console saying that CICS is short on storage (DFHSM0131I for storage below the 16 megabyte line, DFHSM0133I for storage above the 16 megabyte line)
- The storage manager statistic ‘Times went short on storage’ is updated.

CICS can go short on storage independently in any DSA. You may see tasks suspended on any of the resource types, CDSA, SDSA, RDSA, UDSA, ECDSA, ESDSA, ERDSA, or EUDSA.

Are MXT or transaction class limits causing the stall?: Before new transactions can be attached for the first time, they must qualify under the MXT and transaction class limits. In a system that is running normally, tasks run and terminate and new transactions are attached, even though these limits are reached occasionally. It is only when tasks can neither complete nor be purged from the system that CICS can stall as a result of one of these limits being reached.

Look first at the transaction manager summary in the formatted system dump.

Investigate the tasks accepted into the MXT set of tasks to see if they are causing the problem. XM dump formatting formats the state of MXT and provides a summary of the TCLASSes and of the transactions waiting for acceptance into each TCLASS.

Now look at the Enqueue Pool Summary in the NQ section of the dump for a summary of task enqueues and resources. This section of the dump lists all enqueues in CICS. Look for any enqueues that have many tasks in a waiting state. If there are any, look for the unit of work (UOW) for which the enqueue state is active. Look to see if this UOW is waiting on a resource.

Is there an exclusive control conflict on a volume?: Some programs use MVS RESERVE to gain exclusive control of a volume, and nothing else can have access to any data set on that volume until it is released. Watch for operations involving database access, because these could indicate an exclusive control conflict on a volume.

Is there a problem with the communications access method?: If you suspect that there is a communication problem, you can inquire on the status of VTAM from the MVS console, but not on the status of TCAM. To do this, use the command `F cicsname,CEMT INQ VTAM`. Substitute the name of the CICS job for “cicsname”. You can only use this command if the MVS console has been defined to CICS as a terminal. The status returned has a value of OPEN or CLOSED.

- If the VTAM status is OPEN, the problem could be associated with processing done in the VTAM part of your system or with processing done in the CICS part of your system. If it appears that there is a communication problem, consider using either CICS VTAM exit tracing or VTAM buffer tracing. For guidance about using these techniques, see “Chapter 14. Using traces in problem determination” on page 227.
- If the VTAM status is CLOSED, CICS cannot use VTAM to perform communication functions.

Is there an MVS system logger error?: If you suspect that there may be a problem with the MVS system logger, see “Log manager waits” on page 94.

Is there a CICS system error?: If you have investigated all the task activity, and all the other possibilities from the list, and you have still not found an explanation for the stall, it is possible that there is a CICS system error. Contact the IBM Support Center with the problem.

CICS has stalled during termination

Waits often occur when CICS is being quiesced because some terminal input or output has not been completed. To test this possibility, try using the CEMT transaction to inquire on the tasks currently in the system. CICS termination takes place in two stages:

1. All transactions are quiesced.
2. All data sets and terminals are closed.

If you find that you cannot use the CEMT transaction, it is likely that the system is already in the second stage of termination. CEMT cannot be used beyond the first stage of termination.

Note: Even if CEMT is not included in the transaction list table (XLT), you can still use it in the first stage of termination.

The action to take next depends on whether you can use the CEMT transaction, and if so, whether or not there are current user tasks.

- **If you can use the CEMT transaction:**

- If there are user tasks currently in the system, check what they are. A task may be performing a prolonged termination routine, or it might be waiting on a resource before it can complete its processing. It is also possible that a task is waiting for operator intervention.

Determine what type of terminal is associated with the task. If the terminal is a 3270 device, some keyboard input might be expected. If it is a printer, it might have been powered off or it might have run out of paper.

- If there are no user tasks in the system, it may be that one or more terminals have not been closed. Use the CEMT transaction to see which terminals are currently INSERVICE, and then use CEMT SET to place them OUTSERVICE.

If these actions fail, proceed as if you were unable to use the CEMT transaction.

- **If you cannot use the CEMT transaction,** go to the MVS console or the NetView® master terminal and display the active sessions. If necessary, close down the network using the VARY NET,INACT,ID=applid command. This should enable CICS to resume its termination sequence. If it does not, you might need to cancel the CICS job. If this does happen, consider whether any PLT program running in the second quiesce stage could be in error. If such a program did not follow the strict protocols that are required, it could cause CICS to stall during termination. For programming information about PLT programs, see the *CICS Customization Guide*.

Chapter 7. Dealing with loops

A loop is a sequence of instructions that is executed repetitively. Loops that are coded into applications must always be guaranteed to terminate, because otherwise you could get any of the symptoms of loops described in “Chapter 2. Classifying the problem” on page 7.

If a loop does not terminate, it could be that the termination condition can never occur, or it might not be tested for, or the conditional branch could erroneously cause the loop to be executed over again when the condition is met.

This section outlines procedures for finding which programs are involved in a loop that does not terminate.

If you find that the looping code is in one of your applications, you need to check through the code to find out which instructions are in error. If it looks as if the error is in CICS code, you probably need to contact the IBM Support Center.

Some CICS domains can detect loops in their own routines, and let you know if one is suspected by sending the following message:

DFHxx0004 *applid* **A possible loop has been detected at offset X'offset' in module modname.**

The two characters “xx” represent the two-character domain index. If, for example, monitoring domain had detected the loop, the message number would be DFHMN0004.

If you see this sort of message repeatedly, contact the IBM Support Center.

What sort of loop is indicated by the symptoms?

Unplanned loops can be divided into those that can be detected by CICS, and those that cannot. Figure 24 shows a hierarchical classification of loops.

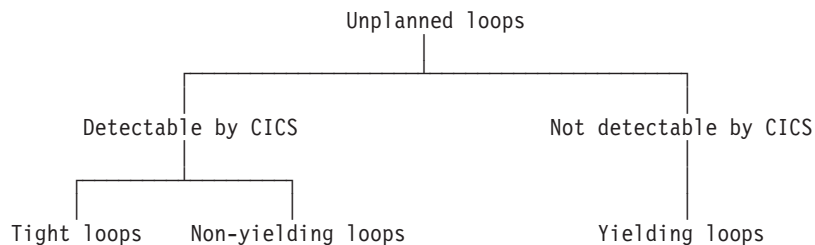

Figure 24. Hierarchical classification of loops

Figure 25 gives a specific example of code containing a simple tight loop.

```

PROCEDURE DIVISION.
  EXEC CICS
    HANDLE CONDITION ERROR(ERROR-EXIT)
    ENDFILE(END-MSG)
  END-EXEC.
ROUTE-FILE.
  EXEC CICS
    ROUTE INTERVAL(0)
    LIST(TERM-ID)
  END-EXEC.
NEW-LINE-ATTRIBUTE.
  GO TO NEW-LINE-ATTRIBUTE.
  MOVE LOW-VALUES TO PRNTAREA.
  MOVE DFHBMPNL TO PRNTAREA.

```

Figure 25. Example of code containing a tight loop

CICS can detect some looping tasks by comparing the length of time the tasks have been running with the runaway time interval, ICVR, that you code in the system initialization table. If a task runs for longer than the interval you specify, CICS regards it as “runaway” and causes it to abend with an abend code of AICA.

However, in some cases, CICS requests that are contained in the looping code can cause the timer to be reset. Not every CICS request can do this; it can only happen if the request can cause the task to be suspended. Thus, if the looping code contains such a request, CICS cannot detect that it is looping.

The properties of the different types of loop, and the ways you can investigate them, are described in the sections that follow.

Tight loops and non-yielding loops

Tight loops and non-yielding loops are both characterized by the fact that the looping task can never be suspended within the limits of the loop. This makes them detectable by CICS, which compares the time they have been running continually with the runaway time interval, ICVR, that you code in the system initialization table. If the tasks run for longer than the interval you specify, CICS regards them as “runaway” and causes them to abend with an abend code of AICA.

Note: If you make the ICVR value equal to 0, runaway task detection is disabled. Runaway tasks can then cause the CICS region to stall, meaning that CICS must be canceled and brought up again. You might choose to set ICVR to zero in test systems, because of the wide variation in response times. However, it is usually more advisable to set ICVR to a large value in test systems.

A tight loop is one involving a single program, where the same instructions are executed repeatedly and control is never returned to CICS.

Figure 26 on page 153 shows a tight loop, with an indefinite number of instructions contained in the loop. None of the instructions returns control to CICS. In the extreme case, there could be a single instruction in the loop, causing a branch to itself.

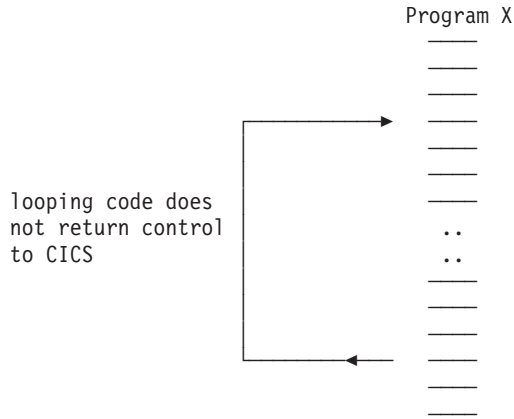

Figure 26. A tight loop

A non-yielding loop is also contained in a single program, but it differs from a tight loop in that control is returned temporarily from the program to CICS. However, the CICS routines that are invoked are ones that can neither suspend the program nor pass control to the dispatcher.¹ There is, therefore, no point at which the task can be suspended, and so the ICVR cannot be reset.

Figure 27 shows a non-yielding loop.

Figure 28 shows an example of code that contains a simple non-yielding loop. In

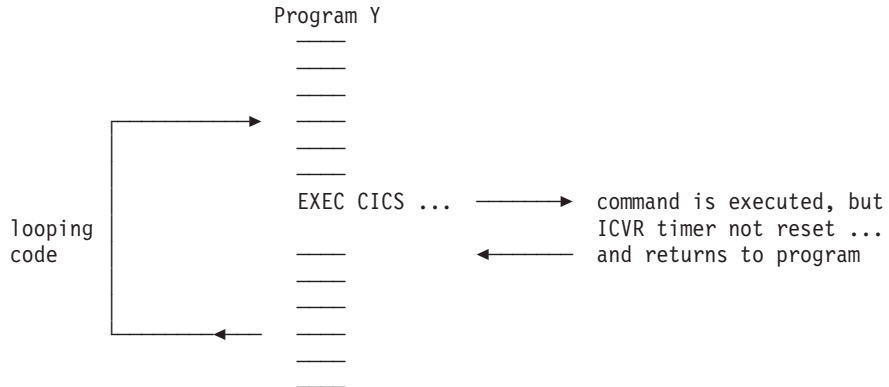

Figure 27. A non-yielding loop

this case, the loop contains only one CICS command, EXEC CICS ASKTIME.

1. The CICS commands that do not cause tasks to wait include (but are not restricted to) ASKTIME, DEQ, ENQ, ENTER TRACENUM, FREEMAIN, HANDLE, RELEASE, TRACE ON/OFF. Whether a command allows the ICVR to be reset might also depend on other factors. For instance, a FREEMAIN might reset the ICVR if the storage lock is held. A READ might also not wait if the desired record is already in a VSAM buffer.

```

PROCEDURE DIVISION.
  EXEC CICS
    HANDLE CONDITION ERROR(ERROR-EXIT)
    ENDFILE(END-MSG)
  END-EXEC.
ROUTE-FILE.
  EXEC CICS
    ROUTE INTERVAL(0)
    LIST(TERM-ID)
  END-EXEC.
NEW-LINE-ATTRIBUTE.
  EXEC CICS
    ASKTIME
  END-EXEC.
GO TO NEW-LINE-ATTRIBUTE.
MOVE LOW-VALUES TO PRNTAREA.
MOVE DFHBMPNL TO PRNTAREA.

```

Figure 28. Example of code containing a non-yielding loop

If you have a transaction that repeatedly abends with an abend code of AICA, first make sure the ICVR value has not been set too low. If the value seems reasonable, read “Investigating loops that cause transactions to abend with abend code AICA” on page 156 for advice on determining the limits of the loop.

If you have a stalled CICS region, diagnose the problem using the techniques in “What to do if CICS has stalled” on page 145. Check if the ICVR value has been set to zero. If it has, change the value and try to cause a transaction to abend with a code of AICA.

Yielding loops

Yielding loops are characterized by returning control at some point to a CICS routine that can suspend the looping task. However, the looping task is eventually resumed, and so the loop continues.

CICS is unable to use the runaway task timer to detect yielding loops, because the timer is reset whenever the task is suspended. Thus, the runaway task time is unlikely ever to be exceeded, and so the loop goes undetected by the system.

Yielding loops typically involve a number of programs. The programs might be linked to and returned from, or control might be transferred from one program to another in the loop. A yielding loop can also be confined to just one program, in which case it must contain at least one wait-enabling CICS command. Figure 29 on page 155 shows a yielding loop involving two programs, A and B. Program A links to program B, and then program B subsequently returns.

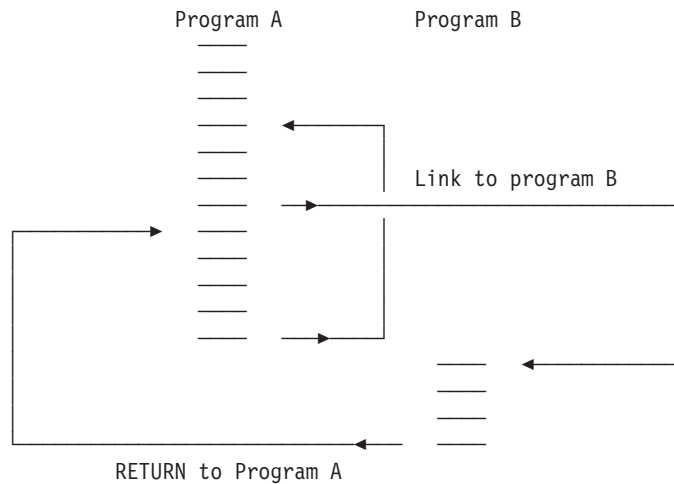

Figure 29. A yielding loop

Figure 30 shows a specific example of a yielding loop within a single program. This code issues the `SUSPEND` command, which is always a yielding type of command. Every time `SUSPEND` is issued, the dispatcher suspends the task issuing the request, and sees if any other task of higher priority can run. If no such task is ready, the program that issued the `SUSPEND` is resumed.

```

PROCEDURE DIVISION.
  EXEC CICS
    HANDLE CONDITION ERROR(ERROR-EXIT)
    ENDFILE(END-MSG)
  END-EXEC.
ROUTE-FILE.
  EXEC CICS
    ROUTE INTERVAL(0)
    LIST(TERM-ID)
  END-EXEC.
NEW-LINE-ATTRIBUTE.
  EXEC CICS
    SUSPEND
  END-EXEC.
  GO TO NEW-LINE-ATTRIBUTE.
  MOVE LOW-VALUES TO PRNTAREA.
  MOVE DFHBMPNL TO PRNTAREA.

```

Figure 30. Example of code containing a yielding loop

You can detect a yielding loop only by circumstantial evidence such as repetitive output, or excessive use of storage. A fuller description of what to look out for is given in “Loops” on page 13.

If you suspect that you have a yielding loop, turn to “Investigating loops that are not detected by CICS” on page 158 for further guidance.

Investigating loops that cause transactions to abend with abend code AICA

If the loop causes a transaction to abend with abend code AICA, it must either be a tight loop or a non-yielding loop. You do not need to find which type you have, although this is likely to be revealed to you when you do your investigation.

Both a tight loop and a non-yielding loop are characterized by being confined to a single user program. You should know the identity of the transaction to which the program belongs, because it is the transaction that abended with code AICA when the runaway task was detected.

The documentation you need

When investigating loops that cause transactions to abend AICA, you need the CICS system dump accompanying the abend. System dumping must be enabled for dump code AICA.

You can use the system dump to find out:

- Whether the loop is in your user code or in CICS code
- If the loop is in your user code, the point at which the loop was entered.

It is also useful to have trace running, as trace can help you to identify the point in your program where looping started. If you have a non-yielding loop, it can probably also show you some instructions in the loop.

A tight loop is unlikely to contain many instructions, and you might be able to capture all the evidence you need from the record of events in the internal trace table. A non-yielding loop may contain more instructions, depending on the EXEC CICS commands it contains, but you might still be able to capture the evidence you need from the record of events in the internal trace table. If you find that it is not big enough, direct tracing to the auxiliary trace destination instead.

You need to trace CICS system activity selectively, to ensure that most of the data you obtain is relevant to the problem. Set up the tracing like this:

1. Select level-1 special tracing for AP domain, and for the EXEC interface program (EI).
2. Select special tracing for just the task that has the loop, and disable tracing for all other tasks by turning the master system trace flag off.

You can find guidance about setting up these tracing options in “Chapter 14. Using traces in problem determination” on page 227.

Now start the task, and wait until it abends AICA. Format the CICS system dump with formatting keywords KE and TR, to get the kernel storage areas and the internal trace table. (See “Formatting system dumps” on page 283.) You now have the documentation you need to find the loop.

Looking at the evidence

Look first at the kernel task summary. The runaway task is flagged “*YES*” in the ERROR column. The status of the task is shown as “***Running***”.

Now use the kernel task number for the looping task to find its linkage stack. If a user task is looping, DFHAPLI, a transaction manager program, should be near the top of the stack. You are likely to find other CICS modules at the top of the stack that have been invoked in response to the abend. For example, those associated with taking the dump. If you find any program or subroutine above DFHAPLI that has not been invoked in response to the error, it is possible that CICS code, or the code of another program, has been looping. If you find that the loop is within CICS code, you need to contact the IBM Support Center. Make sure you keep the dump, because the Support Center staff need it to investigate the problem.

If the kernel linkage stack entries suggest that the loop is in your user program, you next need to identify the loop.

Identifying the loop

There are two approaches to identifying loops in user programs. You can use the trace table, or you can look in the transaction dump.

Using the trace table

Go to the last entry in the internal trace table, and work backward until you get to an entry for point ID AP 1942. The trace entry should have been made when recovery was entered after the transaction abended AICA. Make a note of the task number, so you can check that any other trace entries you read relate to the same abended task.

The entries preceding AP 1942 should have been made either just before the loop was entered (for a tight loop), or within the loop itself (for a non-yielding loop). Watch in particular for trace entries with the point ID AP 00E1. These are made on entry to the EXEC interface program (DFHEIP) whenever your program issues an EXEC CICS command, and again on exit from the EXEC interface program. Field B gives you the value of EIBFN, which identifies the specific command that was issued. (For a list of EIBFN values and their meanings, see the *CICS User's Handbook*.)

For trace entries made on exit from DFHEIP, field A gives you the response code from the request. Look carefully at any response codes—they could provide the clue to the loop. Has the program been designed to deal with every possible response from DFHEIP? Could the response code you see explain the loop?

If you see a repeating pattern of trace points for AP 00E1, you have a non-yielding loop. If you can match the repeating pattern to statements in the source code for your program, you have identified the limits of the loop.

If you see no repeating pattern of trace points for AP 00E1, it is likely that you have a tight loop. The last entry for AP 00E1 (if there is one) should have been made from a point just before the program entered the loop. You might be able to recognize the point in the program where the request was made, by matching trace entries with the source code of the program.

Using the transaction dump

First you need to find the PSW, and see if it points into your program. This is likely to be the case if you have a tight loop, and it should lead you to an instruction within the loop.

If the next instruction address is not within your code, it is of less value for locating the loop. However, you should attempt to identify the module containing the instruction, as it is likely to be one that was called during the execution of a CICS request made within the loop. Use the module index at the end of the formatted dump to find the module name. If the PSW address is not contained in one of these areas, another program was probably executing on behalf of CICS when the runaway task timer expired.

Note: It is possible that the loop was contained entirely within a module owned by CICS or some other product, and your program was not responsible for it at all. If you find that the loop is contained within CICS code, contact the IBM Support Center.

If the PSW does point to a module outside your application program, you need to find the address of the return point in your program from the contents of register 14 in the appropriate register save area. The return address will lie within the loop, if the loop is not confined to system code.

When you have located a point within the loop, work through the source code and try to find the limits of the loop.

Finding the reason for the loop

When you have identified the limits of the loop, you need to find the reason why the loop occurred. Assuming you have the trace, and EI level-1 tracing has been done, ensure that you can explain why each EIP entry is there. Verify that the responses are as expected.

A good place to look for clues to loops is immediately before the loop sequence, the first time it is entered. Occasionally, a request that results in an unexpected return code can trigger a loop. However, you usually can only see the last entry before the loop if you have CICS auxiliary or GTF trace running, because the internal trace table is likely to wrap before the AICA abend occurs.

Investigating loops that are not detected by CICS

You probably suspect that you have a loop through circumstantial evidence, and CICS has failed to detect it. You might, for example, have seen some sort of repetitive output, or statistics might have shown an excessive number of I/O operations or requests for storage. These types of symptom can indicate that you have a yielding loop.

The nature of the symptoms may indicate which transaction is involved, but you probably need to use trace to define the limits of the loop.

Use auxiliary trace to capture the trace entries, to ensure that the entire loop is captured in the trace data. If you use internal trace, there is a danger that wraparound will prevent you from seeing the whole loop.

Use the CETR transaction to set up the following tracing options. You can use the transaction dynamically, on the running CICS system. For guidance about using the CETR transaction, see “Chapter 14. Using traces in problem determination” on page 227.

1. Select level-1 special tracing for every component, using the CETR transaction. You need to capture as much trace information for the task as possible, because you do not yet know what functions are involved in the loop.
2. Set all standard tracing off, by setting the master system trace flag off.
3. Select special tracing for just the task containing the loop.
4. Set the auxiliary tracing status to STARTED, and the auxiliary switch status to ALL. As CETR allows you to control trace dynamically, you do not need to start tracing until the task is running and the symptoms of looping appear.

These steps ensure that you get all level-1 trace points traced for just the task you suspect of looping, the trace entries being sent to the auxiliary trace destination.

When you have captured the trace data, you need to purge the looping task from the system. Use the CEMT INQ TASK command to find the number of the task, and then purge it using either the CEMT SET TASK PURGE or the CEMT SET TASK FORCEPURGE command. This causes the transaction to abend, and to produce a transaction dump of the task storage areas.

Note: The use of FORCEPURGE is, in general, not recommended, because it can cause unpredictable system problems. For example, it causes task storage areas to be released, including I/O areas, without notifying any components that might be accessing them. If the FORCEPURGED task was waiting for input, such an area might be written to after it is released. The storage might even be in use by another task when the input occurs.

The documentation you need

In addition to the auxiliary trace data and the transaction dump, you need source listings of all the programs in the transaction.

The trace data and the program listings should enable you to identify the limits of the loop. You need the transaction dump to examine the user storage for the program. The data you find there could provide the evidence you need to explain why the loop occurred.

Identifying the loop

Examine the trace table, and try to detect the repeating pattern of trace entries. If you cannot do so straightaway, remember that many different programs might be involved, and the loop could be large. Another possibility is that you might not have captured the entire loop in the trace data set. This could be because the loop did not have time to complete one cycle before you purged the transaction, or the trace data sets might have wrapped before the loop was complete.

Consider also the possibility that you might not be dealing with a loop, and the symptoms you saw are due to something else—poor application design, for example.

If you are able to detect a pattern, you should be able to identify the corresponding pattern of statements in your source code.

Note: The PSW is of no value in locating loops that are not detected by CICS. The contents of the PSW are unpredictable, and the PSW is not formatted in the transaction dump for ATCH abends.

Finding the reason for the loop

Look carefully at the statements contained in the loop. Does the logic of the code suggest why the loop occurred? If not, you need to examine the contents of data fields in the task user storage. Look particularly for unexpected response codes, and null values when finite values are expected. Programs can react unpredictably when they encounter these conditions, unless they are tested for and handled accordingly.

What to do if you cannot find the reason for a loop

If you cannot find the reason for a non-yielding or a yielding loop using the techniques outlined above, there are two more approaches that you can adopt:

1. Use the interactive tools that CICS provides
2. Modify the program, and execute it again.

Investigating loops using interactive tools

If you have a non-yielding or a yielding loop, you can use the execution diagnostic facility (CEDF) to look at the various parts of your program and storage at each interaction with CICS. If you suspect that some unexpected return code might have caused the problem, CEDF is a convenient way of investigating the possibility.

CECI and CEBR are also useful for investigating loops. You can, for example, use them to examine the status of files and queues during the execution of your program. Programs can react unpredictably if records and queue entries are not found when these conditions are not tested for and handled accordingly.

Modifying your program to investigate the loop

If the program is extremely complex, or the data path difficult to follow, you may need to insert additional statements into the source code. Even extra ASKTIME commands allow you to use EDF and inspect the program at more points. You can also request dumps from within your program, and insert user trace entries, to help you to find the reason for the loop.

Chapter 8. Dealing with performance problems

When you have a performance problem, you might be able to find that it is characterized by one of the following symptoms, each of which represents a particular processing bottleneck. If so, turn directly to the relevant section:

1. Some tasks fail to get attached to the transaction manager—see “Why tasks fail to get attached to the transaction manager” on page 163.
2. Some tasks fail to get attached to the dispatcher—see “Why tasks fail to get attached to the dispatcher” on page 164.
3. Some tasks get attached to the dispatcher, but fail to get dispatched—see “Why tasks fail to get an initial dispatch” on page 166.
4. Tasks get attached to the dispatcher and then run and complete, but take a long time to do so—see “Why tasks take a long time to complete” on page 168.

If you are only aware that performance is poor, and you have not yet found which of these is relevant to your system, read “Finding the bottleneck”.

There is a quick reference section at the end of this section (“A summary of performance bottlenecks, symptoms, and causes” on page 169) that summarizes bottlenecks, symptoms, and actions that you should take.

Finding the bottleneck

Four potential bottlenecks can be identified for user tasks, and three for CICS system tasks. The bottlenecks are summarized in Figure 31 on page 162.

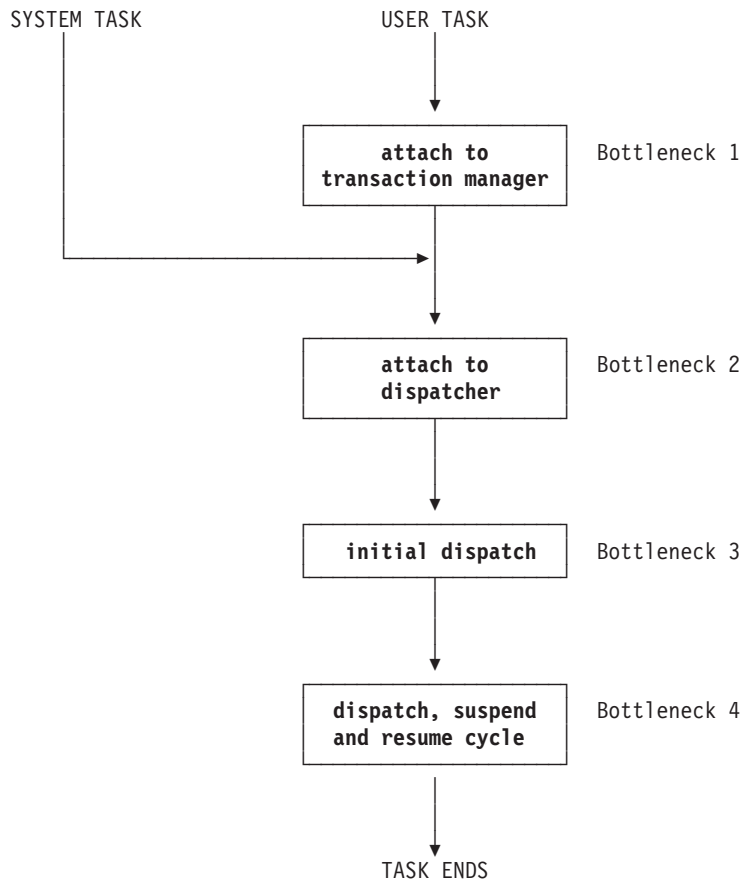

Figure 31. Potential performance bottlenecks in a CICS system

Each bottleneck is affected by a different set of system parameters, and you may find that adjusting the parameters solve the problem. It is useful to determine which bottleneck is causing your performance problem, so you can find out which parameters you need to consider.

If performance is particularly poor for any of the tasks in your system, you might be able to capture useful information about them with CEMT INQ TASK. However, tasks usually run more quickly than you can inquire on them, even though there may be a performance problem. You then need to consider using performance class monitoring or tracing to get the information you need.

Initial attach to the transaction manager

If a task has not been attached to the transaction manager, you cannot get any information about its status online. CEMT INQ TASK returns a response indicating that the task is not known. If the task has not already run and ended, this response means that it has not been attached to the transaction manager.

Guidance about finding out why tasks take a long time to get an initial attach to the transaction manager is given in “Why tasks fail to get attached to the transaction manager” on page 163.

Initial attach to the dispatcher

If a task has been attached to the transaction manager, but has not yet been attached to the dispatcher, CEMT INQ TASK will show it to be 'SUSPENDED' on a resource type of MXT or TCLASS. These are the only valid reasons why a user task, having been attached to the transaction manager, would not be attached to the dispatcher.

If CEMT INQ TASK returns anything other than this, the task is not waiting to be attached to the dispatcher. However, consider whether the MXT limit might be causing the performance problem, even though individual tasks are not being held up long enough for you to use CEMT INQ TASK on them. In such a case, use monitoring and tracing to find just how long tasks are waiting to be attached to the dispatcher.

Guidance about finding whether the MXT limit is to blame for the performance problem is given in "Is the MXT limit preventing tasks from getting attached?" on page 164.

Initial dispatch

A task can be attached to the dispatcher, but then take a long time to get an initial dispatch. In such a case, CEMT INQ TASK returns a status of 'READY' for the task. If you keep getting this response and the task fails to do anything, it is likely that the task you are inquiring on is not getting its first dispatch.

The delay might be too short for you to use CEMT INQ TASK in this way, but still long enough to cause a performance problem. In such a case, you need to use tracing or performance class monitoring for the task, either of which would tell you how long the task had to wait for an initial attachment to the dispatcher.

If you think your performance problem could be due to tasks taking a long time to get a first dispatch, read "Why tasks fail to get an initial dispatch" on page 166.

The dispatch, suspend, and resume cycle

If performance is poor and tasks are getting attached and dispatched, the problem lies with the dispatch, suspend and resume cycle. Tasks run, but the overall performance is poor. If you are able to show that tasks are getting attached and then dispatched, read "Why tasks take a long time to complete" on page 168.

Why tasks fail to get attached to the transaction manager

A task might fail to get attached to the transaction manager for one of the following reasons:

1. The interval specified on an EXEC CICS START command might not have expired, or the time specified might not have been reached, or there might be some error affecting interval control.

Guidance about investigating these possibilities is given in "Interval control waits" on page 136. You need to consider doing this only if INTERVAL or TIME was specified on the START command.

2. The terminal specified on an EXEC CICS START command might not be available. It could be currently OUTSERVICE, or executing some other task. You can check its status using CEMT INQ TERMINAL, and perhaps take some remedial action.

Remember that several tasks might be queued on the terminal, some of which might require operator interaction. In such a case, the transaction to be started might not get attached to the transaction manager for a considerable time.

3. A remote system specified on an EXEC CICS START command might not be available, or an error condition might have been detected in the remote system. In such a case, the error would not be reported back to the local system. You can use CEMT INQ TERMINAL to inquire on the status of the remote system.

Why tasks fail to get attached to the dispatcher

Two valid reasons why a user task might fail to get an initial attach to the dispatcher are² :

- The system is at the MXT limit (see “Is the MXT limit preventing tasks from getting attached?”).
- The task belongs to a transaction class that is at its MAXACTIVE limit.

Is the MXT limit preventing tasks from getting attached?

Before the transaction manager can attach a user task to the dispatcher, the task must first qualify under the MXT (maximum tasks in the system) and transaction class limits. If a task is not getting attached, it is possible that one or both of these values is too small.

You might be able to use CEMT INQ TASK to show that a task is failing to get attached because of the MXT or transaction class limits. If you cannot use CEMT because the task is held up for too short a time, you can look at either the transaction global statistics, transaction class statistics, or the CICS performance-class monitoring records. Another option is to use CICS system tracing.

Using transaction manager statistics: To find out how often the MXT and transaction class limits are reached, look at the transaction global statistics and transaction class statistics. If you compare the number of times these limits are reached with the total number of transactions, you can see whether the values set for the limits are adversely affecting performance.

To gather statistics relating to the number of times that the MXT or transaction class limits are reached, you need to use, at the start of the run, the command CEMT PERFORM STATISTICS RECORD (or your site replacement) with the keywords TRANSACTION and TRANCLASS.

```
CEMT PERFORM STATISTICS RECORD [TRANCLASS TRANSACTION]
```

The statistics are gathered and recorded in the SMF data set. You can format this data set by using the statistics utility program, DFHSTUP. Please read the ‘DFHSTUP’ section in the *CICS Operations and Utilities Guide* for details on how to use this facility.

2. For a system task, there may not be enough storage to build the new task. This sort of problem is more likely to occur near peak system load times.

When formatting the SMF data set using DFHSTUP, you may find the following DFHSTUP control parameters useful:

```
SELECT APPLID=  
COLLECTION TYPE=REQ  
TIME START= ,STOP=  
DATE START= ,STOP=
```

See the 'DFHSTUP' section in the *CICS Operations and Utilities Guide* for details on how to code these parameters. If you correctly code these control parameters, you will avoid the formatting of much information that may well be unnecessary at this point.

If MXT is never reached, or reached only infrequently, it is not affecting performance.

If MXT is reached for 5% of transactions, this might have a noticeable effect on performance. When the ratio reaches 10%, there is likely to be a significant effect on performance, and this could account for some tasks taking a long time to get a first attach.

Consider revising the MXT and transaction class values if the statistics indicate that they are affecting performance. For guidance about the performance considerations when you set these limits, see the *CICS Performance Guide*.

Using CICS monitoring: You can use monitoring information to find out how long an individual task waits to be attached to the Dispatcher. If you want to summarize the monitoring data of particular transactions to assess the impact across many tasks, you can use products such as Service Level Reporter (SLR) or Enterprise Performance Data Manager/MVS (EPDM/MVS).

Monitoring produces performance-class records (if performance-class monitoring is active) for each task that is executing or has executed in the CICS region. Performance-class records contain a breakdown of the delays incurred in dispatching a task, part of which is the impact on a task of the MXT limit and transaction class limits.

For further information on the data produced by CICS monitoring see the *CICS Performance Guide*.

Using trace: You can use trace if you want to find out just how long an individual task waits to be attached to the dispatcher.

If you do not want to do any other tracing, internal trace is probably a suitable destination for trace entries. Because the task you are interested in is almost inactive, very few trace entries are generated.

Select special tracing for the transaction associated with the task, and turn off all standard tracing by setting the master system trace flag off. Define as special trace points the level-1 trace points for transaction manager (XM), and for the CICS task controlling the facility that initiates the task, such as terminal control (TC). Make sure that no other trace points are defined as special. For guidance about setting up these tracing options, see "Chapter 14. Using traces in problem determination" on page 227.

When you have selected the options, start tracing to the internal trace table and attempt to initiate the task. When the task starts, get a system dump with CEMT PERFORM SNAP. Format the dump using the keyword TR, to get the internal trace table.

Look for the trace entry showing terminal control calling the transaction manager with a request to attach the task, and the subsequent trace entry showing the transaction manager calling dispatcher domain with a request to attach the task. The time stamps on the two trace entries tell you the time that elapsed between the two events. That is equal to the time taken for the task to be attached.

Why tasks fail to get an initial dispatch

When a task is past the transaction class and MXT barriers, it can be attached to the dispatcher. It must then wait for its initial dispatch. If tasks are made to wait for a relatively long time for their first dispatch, you will probably notice the degradation in the performance of the system.

You can get evidence that tasks are waiting too long for a first dispatch from performance class monitoring. If you do find this to be the case, you need to investigate the reasons for the delay. To calculate the initial dispatch delay incurred by a task use the following fields from the performance-class monitoring record:

DSPDELAY = First dispatch delay
TCLDELAY = Transaction Class delay
MXTDELAY = MXT delay

Using the above names:

$$\text{Delay in dispatcher} = \text{DSPDELAY} - (\text{TCLDELAY} + \text{MXTDELAY})$$

If 'Delay in Dispatcher' is significantly greater than 0, the dispatcher could not dispatch the task immediately.

The factors that influence the length of time a task must wait before getting its first dispatch are:

- The priority of the task
- Whether the system is becoming short on storage.

Priorities of tasks

Normally, the priorities of tasks determine the order in which they are dispatched. Priorities can have any value in the range 1–255. If your task is getting a first dispatch (and, possibly, subsequent dispatches) too slowly, you might consider changing its priority to a higher value.

You have no control over the priorities of CICS system tasks.

One other factor affecting the priorities of tasks is the priority aging multiplier, PRTYAGE, that you code in the system initialization parameters. This determines the rate at which tasks in the system can have their priorities aged. Altering the value of PRTYAGE affects the rate at which tasks are dispatched, and you probably need to experiment to find the best value for your system.

Storage stress conditions are detailed in the storage manager statistics. CICS attempts to alleviate the situation by releasing programs with no current user, and by not attaching new tasks. If these actions fail to eliminate storage stress or if the SOS condition is caused by a suspended GETMAIN, one or both of these messages is sent to the console:

DFHSM0131 *applid* CICS is under stress (short on storage below 16MB)

DFHSM0133 *applid* CICS is under stress (short on storage above 16MB)

If you don't observe the SOS messages, you can find out how many times CICS has gone SOS from the storage manager statistics ('Times went short on storage'). You can also get this information from the storage manager domain DSA summary in a formatted system dump.

Note: Release of the storage cushion is not the only cause of CICS going SOS. The condition is also raised if a task makes an unconditional request for storage greater than the storage cushion size when the system is approaching SOS. In such a case, the cushion is not released, but the task making the unconditional request is suspended and message DFHSM0131I or DFHSM0133I may be issued. CICS resumes the suspended tasks immediately if storage is made available by CICS releasing unused programs. The short-on-storage condition remains until all the previously suspended tasks have obtained the storage they requested.

Two other conditions are recognized by the dispatcher on the approach to SOS, namely 'storage getting short' and 'storage critical'. The two conditions affect the chance of new tasks getting a first dispatch.

From the 'storage getting short' point, through 'storage critical' and right up to SOS, the priorities of new user tasks are reduced in proportion to the severity of the condition³. At first, you are not likely to notice the effect, but as 'storage critical' is approached, new tasks might typically be delayed by up to a second before they are dispatched for the first time.

It is likely that 'storage getting short' and 'storage critical' occur many times for every occasion SOS is reached. If you want to see how often these points are reached, select level-2 tracing for the dispatcher domain and look out for trace point IDs **DS 0038** ('storage getting short') and **DS 0039** ('storage critical'). Trace point **DS 0040** shows that storage is OK.

A summary of the effects of 'storage getting short', 'storage critical', and SOS is given in Table 26.

Table 26. How storage conditions affect new tasks getting started

State of storage	Effects on user tasks
Storage getting short	Priority of new user tasks reduced a little
Storage critical	Priority of new user tasks reduced considerably

3. This sentence is untrue if the PRTYAGE system initialization parameter is set to 0.

Why tasks take a long time to complete

When a ready task is dispatched, it becomes a running task. It is unlikely to complete without being suspended at least once, and it is likely to go through the 'READY - RUNNING - SUSPENDED' cycle several times during its lifetime in the dispatcher.

The longer the task spends in the non-running state, either 'ready' or 'suspended', the greater your perception of performance degradation. In extreme cases, the task might spend so long in the non-running state that it is apparently waiting indefinitely. It is not likely to remain 'ready' indefinitely without running, but it could spend so long suspended that you would probably classify the problem as a wait.

The purpose of this section is to deal not with waiting tasks, but instead with tasks that complete more slowly than they should.

Here are some factors that can affect how long tasks take to complete:

- System loading
- Time-out interval for tasks
- Distribution of data sets on DASD volumes.

Each of these factors is considered in turn.

The effect of system loading on performance

The most obvious factor affecting the time taken for a task to complete is system loading. For more information, see the *CICS Performance Guide*. Note in particular that there is a critical loading beyond which performance is degraded severely for only a small increase in transaction throughput.

The effect of task time-out interval on performance

The time-out interval is the length of time a task can wait on a resource before it is removed from the suspended state. A transaction that times out is normally abended.

Any task in the system can use resources and not allow other tasks to use them. Normally, a task with a large time-out interval is likely to hold on to resources longer than a task with a short time-out interval. Such a task has a greater chance of preventing other tasks from running. It follows that task time-out intervals should be chosen with care, to optimize the use of resources by all the tasks that need them.

The distribution of data sets on DASD volumes

CICS uses QSAM to write data to extrapartition transient data destinations, and QSAM uses the MVS RESERVE mechanism. If the destination happens to be a DASD volume, any other CICS regions trying to access data sets on the same volume are held up until the TD WRITE is complete.

Other system programs also use the MVS RESERVE mechanism to gain exclusive control of DASD volumes, making the data sets on those volumes inaccessible to other regions.

If you notice in particular that tasks making many file accesses take a long time to complete, check the distribution of the data sets between DASD volumes to see if volume locking could be the cause of the problem.

A summary of performance bottlenecks, symptoms, and causes

Table 27 contains a summary of potential performance bottlenecks, the symptoms you get if they are restricting the performance of your system, and the specific causes of the delays at each point.

Table 27. A summary of performance bottlenecks, symptoms and causes

Bottleneck	Symptoms	Possible causes
Initial attach to transaction manager	CEMT INQ TASK does not know task. Tracing shows long wait for attach to transaction manager.	Interval on EXEC CICS START too long Terminal not available Remote system not available
Initial attach to dispatcher	CEMT INQ TASK shows wait on MXT or transaction class. Tracing shows long wait for attach to dispatcher.	MXT or transaction class limits set too low
First dispatch	Performance class monitoring shows long wait for first dispatch. Storage statistics show CICS has gone SOS.	MXT or transaction class limits set too low Priority of task set too low Insufficient storage System under stress, or near it
SUSPEND / RESUME cycle	Tasks take a long time to complete.	System loading high Task time-out interval too large CICS data sets are on volumes susceptible to MVS RESERVE locking

Chapter 9. Dealing with incorrect output

The term “incorrect output” can be interpreted in many different ways, and its meaning for the purpose of problem determination with this book is explained in “Chapter 2. Classifying the problem” on page 7.

The various categories of incorrect output are dealt with in:

- “Trace output is incorrect”
- “Dump output is incorrect” on page 175
- “Wrong data has been displayed on a terminal” on page 179
- “Incorrect data is present on a VSAM data set” on page 186
- “An application did not work as expected” on page 186
- “Your transaction produced no output at all” on page 187
- “Your transaction produced some output, but it was wrong” on page 193.

Trace output is incorrect

If you have been unable to get the trace output you need, you can find guidance about solving the problem in this section. You can be very selective about the way CICS does tracing, and the options need to be considered carefully to make sure you get the tracing you want.

There are two main types of problem:

- Your tracing might have gone to the wrong destination. This is dealt with in “Tracing has gone to the wrong destination”.
- You might have captured the wrong data. This is dealt with in “You have captured the wrong trace data” on page 172.

Tracing has gone to the wrong destination

In terms of destinations, CICS system trace entries belong to one of three groups:

- CICS trace entries, other than CICS VTAM exit traces and exception traces, go to any of the following trace destinations that are currently active:
 - The internal trace table
 - The current auxiliary trace data set
 - The GTF trace data set.
- CICS VTAM exit traces that are *not* exception traces go only to the GTF trace data set, if GTF tracing is active.
- CICS VTAM exit traces that *are* exception traces go to the internal trace table and, if GTF tracing is active, to the GTF trace data set.
- All other CICS exception traces go to the internal trace table and to any other trace destination that is currently active.

For CICS system tracing other than exception traces and CICS VTAM exit traces, you can inquire on the current destinations and set them to what you want using the CETR transaction.

Figure 44 on page 245 illustrates what you might see on a CETR screen, and indicates how you can change the options by overtyping the fields. From that illustration you can see that, from the options in effect, a normal trace call results in a trace entry being written to the GTF trace destination. If an exceptional condition occurred, the corresponding exception trace entry would be made both to the GTF data set and to the internal trace table, even though the internal trace status is STOPPED.

Note that the master system trace flag value only determines whether standard tracing is to be done for a task (see Figure 42 on page 239). It has no effect on any other tracing status.

Internal tracing goes to the internal trace table in main storage. The internal trace table is used as a buffer in which the trace entries are built no matter what the destination. It, therefore, always contains the most recent trace entries, even if its status is STOPPED—if at least one of the other trace destinations is currently STARTED.

Auxiliary tracing goes to one of two data sets, if the auxiliary tracing status is STARTED. The current data set can be selected from the CETR screen by overtyping the appropriate field with A or B, as required. What happens when the data set becomes full is determined by the auxiliary switch status. Make sure that the switch status is correct for your system, or you might lose the trace entries you want, either because the data set is full or because they are overwritten.

GTF tracing goes to the GTF trace data set. GTF tracing must be started under MVS, using the TRACE=USR option, before the trace entry can be written. Note that if GTF tracing has not been started in this way, the GTF tracing status can be shown as STARTED on the CETR screen and yet no trace entries are made, and no error condition reported.

The way in which trace entries are directed to the required destinations is illustrated in Figure 45 on page 247.

You have captured the wrong trace data

There are several ways in which you might capture the wrong trace data. The following are some sets of symptoms that suggest specific areas for attention:

1. You are not getting the right task tracing, because:
 - Tasks do not trace the right trace points for some components.
 - Transactions are not being traced when they are started from certain terminals.
 - There is no tracing for some terminals that interest you.

If you are aware of symptoms like these, it is likely that you do not have the right task tracing options set up. Turn to “You are not getting the correct task tracing” on page 173 for further guidance.

2. You are getting the wrong amount of data traced, because:
 - Tracing is not being done for all the components you want, so you are getting too little information.
 - Tracing is being done for too many components, so you are getting more information than you want.

- You are not getting the right trace points (level-1 or level-2) traced for some of the components.
- Tasks are not tracing the component trace points you want. This evidence suggests CICS component tracing selectivity is at fault.

If your observations fit any of these descriptions, turn to “You are not getting the correct component tracing” for guidance about fixing the problem.

3. The data you want is missing entirely from the trace table.

If you have this sort of problem, turn to “The entries you want are missing from the trace table” on page 174 for guidance about finding the cause.

It is worth remembering that the more precisely you can define the trace data you need for any sort of problem determination, the more quickly you are likely to get to the cause of the problem.

You are not getting the correct task tracing

If you are not getting the correct task tracing, use the CETR transaction to check the transaction and terminal tracing options, and if necessary change them.

You can define whether you want standard or special CICS tracing for specific transactions, and standard or special tracing for transactions started at specific terminals. You can also suppress tracing for transactions and terminals that do not interest you. The type of task tracing that you get (standard or special) depends on the type of tracing for the corresponding transaction-terminal pair, in the way shown in Figure 40 on page 238.

You can deduce from the table that it is possible to get standard tracing when a transaction is initiated at one terminal, and special tracing when it is initiated from another terminal. This raises the possibility of setting up inappropriate task tracing options, so the trace entries that interest you—for example, when the transaction is initiated from a particular terminal—are not made.

You are not getting the correct component tracing

If you are not getting the correct component tracing, use the CETR transaction to inquire on the current component tracing options and, if necessary, to change them.

First, check that you are only tracing components that interest you. If some other components are being traced, change the options so they are no longer traced for standard tracing or for special tracing, as appropriate.

Next, check that the right tracing levels have been defined for standard tracing and special tracing. Remember that, whenever a task that has standard tracing is running, the trace points that you have defined as standard for a component are traced whenever that component is invoked. Similarly, special trace points are traced whenever special task tracing is being done.

Figure 42 on page 239 illustrates the logic used to determine whether a trace call is to be made from a trace point.

If you are satisfied that the component tracing selectivity is correct but you are still getting too much or too little data, read “You are not getting the correct task tracing”.

The entries you want are missing from the trace table

Read this section if one or more entries you were expecting were missing entirely from the trace table.

These cases are considered:

- The trace data you wanted did not appear at the expected time.
- The earliest trace entry in the table was time-stamped after the activity that interested you took place.
- You could not find the exception trace entry you were expecting.

If the trace entry did not appear at the expected time, consider these possibilities:

- If tracing for some components or some tasks did not appear, you might not have set up the tracing selectivity correctly. For guidance about checking and correcting the options, see the immediately preceding sections You are not getting the correct task tracing and You are not getting the correct component tracing.
- If you were using GTF tracing, it might not have been active at the time the trace entry should have been made. GTF tracing must be started under MVS using the TRACE=USR option.
- If CICS VTAM exit trace entries (point IDs AP FCxx) were missing, remember that they are only ever made to the GTF trace data set.
- If you attempted to format the auxiliary trace data set selectively by transaction or terminal, and trace entries for the transaction or terminal were missing entirely, it could be that you did not capture the corresponding “transaction attach” (point ID AP F004, KC level-1) trace entry.

When you select trace entries by specifying TRANID or TERMID parameters in the DFHTU530 trace control statements, DFHTU530 searches for any transaction attach trace entries that contain the specified TRANID or TERMID. It then formats any associated trace entries, identified by the TASKID found in the transaction attach trace entry data.

It follows that you must have KC level-1 tracing selected for the task in question at the time it is attached if you want to format the auxiliary trace data set selectively by transaction or terminal.

For more details about trace formatting using DFHTU530, see the *CICS Operations and Utilities Guide*.

If the options were correct and tracing was running at the right time, but the trace entries you wanted did not appear, it is likely that the task you were interested in did not run or did not invoke the CICS components you expected. Examine the trace carefully in the region in which you expected the task to appear, and attempt to find why it was not invoked. Remember also that the task tracing options might not, after all, have been appropriate.

If the earliest trace entry was later than the event that interested you, and tracing was running at the right time, it is likely that the trace table wrapped round and earlier entries were overwritten.

Internal trace always wraps when it is full. Try using a bigger trace table, or direct the trace entries to the auxiliary trace or GTF trace destinations.

Note: Changing the size of the internal trace table during a run causes the data that was already there to be destroyed. In such a case, the earliest data would have been recorded after the time when you redefined the table size.

Auxiliary trace switches from one data set to the next when it is full, if the autoswitch status is NEXT or ALL.

If the autoswitch status is NEXT, the two data sets can fill up but earlier data cannot be overwritten. Your missing data might be in the initial data set, or the events you were interested in might have occurred after the data sets were full. In the second case, you can try increasing the size of the auxiliary trace data sets.

If the autoswitch status is ALL, you might have overwritten the data you wanted. The initial data set is reused when the second extent is full. Try increasing the size of the auxiliary trace data sets.

GTF trace always wraps when the data set is full. If this was your trace destination, try increasing the size of the GTF trace data set.

If you cannot find an exception trace entry that you expected, bear in mind that exception tracing is always done to the internal trace table irrespective of the status of any other type of tracing. So, if you missed it in your selected trace destination, try looking in the internal trace table.

Dump output is incorrect

Read this section if you did not get the dump output you were expecting.

The things that can go wrong are:

- The dump you got did not seem to relate to the CICS region in which you were interested.
- You did not get a dump when an abend occurred.
- Some dump IDs were missing from the sequence of dumps in the dump data set.
- You did not get the correct data formatted from a system dump.

The sections that follow give guidance about resolving each of these problems in turn.

The dump you got did not seem to relate to your CICS region

If you have experienced this problem, it is likely that you have dumped the wrong CICS region. It should not occur if you are running a single region.

If you invoked the dump from the MVS console using the MVS MODIFY command, check that you specified the correct job name. It must be the job used to bring up the CICS region in which you are interested. If you invoked the dump from the CICS master terminal using CEMT PERFORM SNAP, check that you were using the master terminal for the correct region. This is more likely to be a problem if you have a VTAM network, because that allows you to switch a single physical VTAM terminal between the different CICS regions.

You did not get a dump when an abend occurred

Read this section if you have experienced any of these problems:

- A transaction abended, but you did not get a transaction dump.
- A transaction abended and you got a transaction dump, but you did not get the system dump you wanted at the same time.
- A system abend occurred, but you did not get a system dump.

There are, in general, two reasons why dumps might not be taken:

- Dumping was suppressed because of the way the dumping requirements for the CICS region were defined. The valid ways that dumping can be suppressed are described in detail in the sections that follow.
- A system error could have prevented a dump from being taken. Some of the possibilities are:
 - No transaction or system dump data sets were available.
 - An I/O error occurred on a transaction or a system dump data set.
 - The system dump data set was being written to by another region, and the DURETRY time was exceeded.
 - There was insufficient space to write the dump in the dump data set. In such a case, you might have obtained a partial dump.

Depending on the areas that are missing from the dump, the dump formatting program might subsequently be able to format the data that is there, or it might not be able to format the data at all.

For each of these system errors, there should be a message explaining what has happened. Use the CMAC transaction or see the *CICS Messages and Codes* manual for guidance about the action to take.

How dumping can be suppressed

If you did not get a dump when an abend occurred, and there was no system error, the dumping that you required must somehow have been suppressed. There are several levels at which dumping can be suppressed:

- System dumps can be globally suppressed.
- System dumps and transaction dumps can be suppressed for specific transactions.
- System dumps can be suppressed for specific dump codes from a dump domain global user exit program.
- System dumps and transaction dumps can be suppressed by dump table options.

You need to find out which of these types of dump suppression apply to your system before you decide what remedial action to take.

Global suppression of system dumping

System dumping can be suppressed globally in two ways:

- By coding a value of NO for the DUMP parameter in the system initialization table.
- By using the system programming command EXEC CICS SET SYSTEM DUMPING, with a CVDA value of NOSYSDUMP.

If system dumping has been suppressed globally by either of these means, any system dumping requirements specified in the transaction dump table and the system dump table are overridden.

You can inquire whether system dumping has been suppressed globally by using the EXEC CICS INQUIRE SYSTEM DUMPING system programming command. If necessary, you can cancel the global suppression of system dumping using EXEC CICS SET SYSTEM DUMPING with a CVDA value of SYSDUMP.

Suppression of system dumping from a global user exit program

System dumping can be suppressed for specific dump codes by an XDUREQ user exit program. For programming information about the XDUREQ global user exit program, see the *CICS Customization Guide*.

If an exit program that suppresses system dumping for a particular dump code is enabled, system dumping is not done for that dump code. This overrides any system dumping requirement specified for the dump code in the dump table.

The exit program can suppress system dumps only while it is enabled. If you want the system dumping suppression to be canceled, you can issue an EXEC CICS DISABLE command for the program. Any system dumping requirements specified in the dump table then take effect.

Suppression of dumping for individual transactions

Transaction dumps taken when a transaction abends can be suppressed for individual transactions by using the EXEC CICS SET TRANSACTION DUMPING system programming command, or by using the DUMP attribute on the RDO definition of the transaction. None of the dumping requirements specified in the transaction dump table would be met if a transaction for which dumping is suppressed were to abend.

You can use EXEC CICS INQUIRE TRANSACTION DUMPING to see whether dumping has been suppressed for a transaction, and then use the corresponding SET command to cancel the suppression if necessary.

Suppression of dumping by dump table options

If transaction dumping and system dumping are *not* suppressed by any of the preceding mechanisms, the dump table options determine whether or not you get a dump for a particular dump code. For details, see “Chapter 15. Using dumps in problem determination” on page 257.

You can inquire on transaction and system dump code attributes using CEMT INQ TRDUMPCODE and CEMT INQ SYDUMPCODE, respectively. You must specify the dump code you are inquiring on.

If you find that the dumping options are not what you want, you can use CEMT SET TRDUMPCODE code or CEMT SET SYDUMPCODE code to change the values of the attributes accordingly.

- **If you had no transaction dump when a transaction abended**, look first to see if attribute TRANDUMP or NOTRANDUMP is specified for this dump code. The attribute needs to be TRANDUMP if a transaction dump is to be taken.

If the attribute is shown to be TRANDUMP, look next at the maximum number of dumps specified for this dump code, and compare it with the current number. The values are probably equal, showing that the maximum number of dumps have already been taken.

- **If you had a transaction dump but no system dump**, use CEMT INQ TRDUMPCODE and check whether there is an attribute of SYSDUMP or NOSYSDUMP for the dump code. You need to have SYSDUMP specified if you are to get a system dump as well as the transaction dump.

Check also that you have not had all the dumps for this dump code, by comparing the maximum and current dump values.

- **If you had no system dump when a system abend occurred**, use CEMT INQ SYDUMPCODE and check whether you have an attribute of SYSDUMP or NOSYSDUMP for the dump code. You need SYSDUMP if you are to get a system dump for this type of abend.

Finally, check the maximum and current dump values. If they are the same, you need to reset the current value to zero.

Some dump IDs were missing from the sequence of dumps

CICS keeps a count of the number of times that dumping is invoked during the current run, and the count is included as part of the dump ID given at the start of the dump.

Note: SDUMPs produced by the kernel do not use the standard dump domain mechanisms, and **always** have a dump ID of 0/0000.

If both a transaction dump and a system dump are taken in response to the event that invoked dumping, the same dump ID is given to both. However, if just a transaction dump or just a system dump is taken, the dump ID is unique to that dump.

The complete range of dump IDs for any run of CICS is, therefore, distributed between the set of system dumps and the set of transaction dumps, but neither set of dumps has them all.

Figure 32 gives an example of the sort of distribution of dump IDs that might occur. Note that each dump ID is prefixed by the run number, in this case 23, and that this is the same for any dump produced during that run. This does not apply to SDUMPs produced by the kernel; these **always** have a dump ID of 0/0000. For further discussion of the way CICS manages transaction and system dumps,

On system dump data set	On transaction dump data set
ID=23/0001	
ID=23/0002	ID=23/0002
	ID=23/0003
ID=23/0004	
	ID=23/0005
ID=23/0006	
ID=23/0007	
	ID=23/0008

Figure 32. Typical distribution of dump IDs between dump data sets

see “Chapter 15. Using dumps in problem determination” on page 257.

You did not get the correct data formatted from a CICS system dump

If you did not get the correct data formatted from a CICS system dump, these are the most likely explanations:

- You did not use the correct dump formatting keywords. If you do not specify any formatting keywords, the whole system dump is formatted. However, if you specify any keywords at all, you must be careful to specify keywords for *all* the functional areas you are interested in.
- You used the correct dump formatting keywords, but the dump formatting program was unable to format the dump correctly because it detected an error. In such a case, you should be able to find a diagnostic error message from the dump formatter.
- A partial dump might have been specified at the MVS level, for example “without LPA”. This requirement would be recorded in the MVS parameter library.

Wrong data has been displayed on a terminal

There are many reasons why you might get the wrong data displayed, some with system-related causes and some with application-related causes. If you think that it is system-related, read this section for some suggestions on likely areas in which to start your investigations.

For the present purpose, a terminal is considered to be any device where data can be displayed. It might be some unit with a screen, or it could be a printer. Many other types of terminals are recognized by CICS, including remote CICS regions, batch regions, IMS regions and so on, but they are not considered in this section on incorrect output.

Broadly, there are two types of incorrect output that you might get on a screen, or on a printer:

- The data information is wrong, so unexpected values appear on the screen or in the hard copy from a printer.
- The layout is incorrect on the screen or in the hard copy. That is, the data is formatted wrongly.

In practice, you may sometimes find it difficult to distinguish between incorrect data information and incorrect formatting. In fact, you seldom need to make this classification when you are debugging this type of problem.

Sometimes, you might find that a transaction runs satisfactorily at one terminal, but fails to give the correct output on another. This is probably due to the different characteristics of the different terminals, and you should find the answer to the problem in the sections that follow.

The preliminary information you need to get

Before you can investigate the reasons why incorrect output is displayed at a terminal, you need to gather some information about the transaction running at the terminal, and the about terminal itself.

The first things you need to know are:

- The identity of the transaction associated with the incorrect output.

- For an autoinstalled terminal, the model number, to ensure that you inquire on the correct TERMTYPE. You can find this from the autoinstall message in the CADL log.

Depending on the symptoms you have experienced, you probably need to examine the PROFILE definitions for the transaction, and the TYPETERM definitions for the affected terminal. The attributes most likely to be of interest are SCRNSIZE for the PROFILE, and ALTSCREEN, ALTPAGE, PAGESIZE, EXTENDEDDES, and QUERY for TYPETERM. Other attributes might also be significant, but the values you find for the attributes named here can often explain why the incorrect output was obtained.

Specific types of incorrect output, and their possible causes

This section contains some suggestions about what to do for specific types of incorrect output, and what might be at fault.

Logon rejection message

If you get a logon rejection message when you attempt to log on to CICS, it could be that the TYPETERM definitions for the terminal are incorrect. A message recording the failure is written to the CSNE log or, in the case of autoinstall, to the CADL log.

You are likely to get a logon rejection if you attempt to specify anything other than QUERY(NO) for a terminal that does not have the structured query field feature. Note that NO is the default value for TYPETERM definitions that you supply, but YES is the value for TYPETERM definitions that are supplied with CICS.

If you have a persistent problem with logon rejection, you can use the VTAM buffer trace to find out more about the reasons for the failure.

Unexpected messages and codes

If the “wrong data” is in the form of a message or code that you do not understand, look in the appropriate manual for an explanation of what it means.

Messages that are prefixed by DFH originate from CICS—use the CMAC transaction or look in the *CICS Messages and Codes* manual for these. For codes that appear in the space at the bottom of the screen where status information is displayed, look in the appropriate guide for the terminal.

The following are examples of common errors that can cause messages or codes to be displayed:

- SCRNSIZE(ALTERNATE) has been specified in a PROFILE, and too many rows have been specified for ALTSCREEN and ALTPAGE in the TYPETERM definition for the terminal.
- An application has sent a spurious hex value corresponding to a control character in a data stream. For example, X'11' is understood as “set buffer address” by a 3270 terminal, and the values that follow are interpreted as the new buffer address. This eventually causes an error code to be displayed.

If you suspect this may be the cause of the problem, check your application code carefully to make sure it cannot send any unintended control characters.

- EXTENDEDDES(YES) has been specified for a device that does not support this feature. In such a case, a message is sent to the screen, and a message might also be written to the CSMT log.

The default value for EXTENDEDDES is NO, but check to make sure that YES has not been specified if you know your terminal is not an extended data stream device.

Unexpected appearance of uppercase or lowercase characters

If the data displayed on your terminal has unexpectedly been translated into uppercase characters, or if you have some lowercase characters when you were expecting uppercase translation, you need to look at the options governing the translation.

These are the significant properties of the various translation options you have:

- The ASIS option for BMS or terminal control specifies that lowercase characters in an input data stream are *not* to be translated to uppercase.
ASIS overrides the UCTRAN attributes for both TYPETERM and PROFILE definitions.
- The UCTRAN attribute of the TYPETERM definition states whether lowercase characters in 3270 input data streams are to be translated to uppercase for terminals with this TYPETERM definition.
The UCTRAN attribute of TYPETERM is overridden by ASIS, but it overrides the UCTRAN attribute of a PROFILE definition.
- The UCTRAN attribute of a PROFILE states whether lowercase characters in the input data stream are to be translated to uppercase for transactions with this PROFILE running on VTAM terminals. The PROFILE UCTRAN value is valid only for VTAM terminals.
The UCTRAN option for a PROFILE is overridden by both the UCTRAN option for a TYPETERM definition and the BMS or terminal control ASIS option.
- If the ASIS option is NOT specified, then if either the PROFILE or the TYPETERM definitions specify UCTRAN(YES), the data presented to the transaction IS translated.

Note: User exit XZCIN can also be used to perform uppercase translation.

The UPPERCASE option in the offline utilities (DFHSTUP, DFHDU530, DFHTU530) specify whether all lowercase characters are to be translated to uppercase characters.

Figure 33 and Figure 34 on page 182 summarize whether or not you get uppercase translation, depending on the values of these options.

ASIS option not specified		TYPETERM	
		UCTRAN(YES)	UCTRAN(NO)
P R O F I L E	UCTRAN(YES)	YES	YES
	UCTRAN(NO)	YES	NO

Figure 33. Uppercase translation truth table—ASIS option not specified

ASIS option is specified		TYPETERM	
		UCTRAN(YES)	UCTRAN(NO)
P R O F I L E	UCTRAN(YES)	NO	NO
	UCTRAN(NO)	NO	NO

Figure 34. Uppercase translation truth table—ASIS option is specified

CRTE and uppercase translation

Initiating a CRTE session

The input required to start a CRTE routing session is of the form:

CRTE SYSID(xxxx),TRPROF(yyyyyyyy)

Translation to uppercase is dictated by the typeterm of the terminal at which CRTE was entered and CRTE's transaction profile definition as shown in Table 28.

Table 28. Uppercase translation on CRTE session initiation

TYPETERM UCTRAN	CRTE PROFILE UCTRAN	INPUT TRANSLATED TO UPPERCASE
YES	YES/NO	ALL OF THE INPUT
NO	NO	NONE OF THE INPUT. See note.

Table 28. Uppercase translation on CRTE session initiation (continued)

TYPETERM UCTRAN	CRTE PROFILE UCTRAN	INPUT TRANSLATED TO UPPERCASE
NO	YES	ALL OF THE INPUT EXCEPT THE TRANSID. See note.
TRANID	YES	ALL OF THE INPUT
TRANID	NO	TRANSID ONLY
Note: Note that if the transid CRTE is not entered in upper case, it will not be recognized (unless there is a lower/mixed case alias), and message DFHAC2001 will be issued.		

Input within the CRTE session

During the CRTE routing session, uppercase translation is dictated by the typeterm of the terminal at which CRTE was initiated and the transaction profile definition of the transaction being initiated (which has to be a valid transaction on the application owning region) as shown in Table 29.

Table 29. Uppercase translation during CRTE session

TYPETERM UCTRAN	TRANSACTION PROFILE (AOR) UCTRAN	INPUT TRANSLATED TO UPPERCASE
YES	YES/NO	ALL OF THE INPUT
NO	NO	NONE OF THE INPUT. See note.
NO	YES	ALL OF THE INPUT EXCEPT THE TRANSID. See note.
TRANID	YES	ALL OF THE INPUT
TRANID	NO	TRANSID ONLY
Note: Note that if the transid CRTE is not entered in upper case, it will not be recognized (unless there is a lower/mixed case alias defined on the AOR) and message DFHAC2001 will be issued.		

During a CRTE routing session, if the first six characters entered at a screen are CANCEL, CICS will recognize this input in upper, lower or mixed case and end the routing session.

For more information on the ALIAS attribute of the transaction definition, see the 'Transaction' section of the *CICS Resource Definition Guide*.

Be aware that when transaction routing from CICS Transaction Server for OS/390 Release 3 to an earlier release of CICS that does not support transaction based uppercase translation, uppercase translation only occurs if it is specified in the typeterm.

EXEC CICS SET TERMINAL and uppercase translation

In a single system, if the EXEC CICS SET TERMINAL command is issued for a terminal while it is running a transaction performing RECEIVE processing, unpredictable results may occur. This is because the command can override the typeterm definition regarding uppercase translation and RECEIVE processing interrogates the uppercase translate status of the terminal in order to establish whether translation is required.

In a transaction routing environment, the system programmer who issues the EXEC CICS SET TERMINAL command should be aware (for VTAM terminals) that the TOR terminal uppercase translate status is copied to the AOR surrogate terminal on every flow across the link from the TOR to the AOR. Consequently:

- The EXEC CICS SET TERMINAL change of uppercase translate status will only take effect on the AOR on the next flow across the link.
- Any AOR typeterm definition used to hard code remote terminal definitions will be overridden with the TOR values for uppercase translate status.
- EXEC CICS INQUIRE TERMINAL issued on the AOR can return misleading uppercase translation status of the terminal, since the correct status on the TOR may not yet have been copied to the AOR.
- The processing of RECEIVE requests on the TOR and AOR can interrogate the uppercase translate status of the terminal. Therefore unpredictable results can also occur if the system programmer issues the EXEC CICS SET TERMINAL command during receive processing.

CICS client virtual terminal

If the codepage sent by a client is incorrect, this can lead to the entire screenful of data being incorrect. You must resolve this problem at the client end of operations.

The entire screenful of data may also be incorrect if the bit TCTSK_VIRTUAL_TERMINAL is not set on in the skeleton for the virtual terminal. The bit might have been overwritten, or not turned on when the virtual terminal was being created during CTIN processing.

Katakana terminals—mixed English and Katakana characters

If you are using a Katakana terminal, you might see some messages containing mixed English and Katakana characters. That is because Katakana terminals cannot display mixed-case output. Uppercase characters in the data stream appear as uppercase English characters, but lowercase characters appear as Katakana characters. If you have any Katakana terminals connected to your CICS system, specify MSGCASE=UPPER in the system initialization table to ensure that messages contain uppercase characters only.

The offline utilities DFHSTUP, DFHDU530, and DFHTU530 have an extra parameter to ensure all output is translated to uppercase. See the *CICS Operations and Utilities Guide* for details on how to use these parameters.

Wrong data values are displayed

If the data values are wrong on the user's part of the screen (the space above the area used to display status information to the operator), or in the hard copy produced by a printer, it is likely that the application is at fault.

Some data is not displayed

If you find that some data is not being displayed, consider these possibilities:

- The SENDSIZE value for the TYPETERM definition could be too large for the device receiving the data. Its receiving buffer could then overflow, with some data being lost.

- SCRNSIZE(ALTERNATE) might be specified in the PROFILE definition for the transaction running at the terminal, while default values for ALTSCREEN and ALTPAGE are allowed in the TYPETERM definition for the terminal.
The default values for ALTSCREEN and ALTPAGE are 0 rows and 0 columns, so no data could then be displayed if SCRNSIZE(ALTERNATE) were specified.
- EXTENDEDDES(YES) is specified for a device that does not support this feature.

Early data is overlaid by later data

Early data can be overlaid by later data, so that data appears in the wrong order, when the SENDSIZE value of the TYPETERM definition is too large for the device receiving the data. This is because the buffer can wrap when it is full, with the surplus data overlaying the first data that was received.

The data is formatted wrongly

Incorrect formatting of data can have a wide range of causes, but here are some suggestions of areas that can sometimes be troublesome:

- BMS maps are incorrect.
- Applications have not been recompiled with the latest maps.
- Different numbers of columns have been specified for ALTSCREEN and ALTPAGE in the TYPETERM definitions for the terminal. This can lead to unpredictable formatting errors. However, you will not see them unless SCRNSIZE(ALTERNATE) has been specified in the PROFILE for the transaction running at the terminal.
- The PAGESIZE values included in the TYPETERM definitions must suit the characteristics of the terminal, or you get formatting errors.

For a screen display, the number of columns specified must be less than or equal to the line width. For a printer, the number of columns specified must be *less than* the line width, or else both BMS (if you are using it) and the printer might provide a new line and you will get extra spacing you do not want.

The default values for PAGESIZE depend on the value you specify for the DEVICE keyword.

- If you get extra line feeds and form feeds on your printer, it could be that an application is sending control characters that are not required because the printer is already providing end of line and end of form operations.

If your application is handling the buffering of output to a printer, make sure that an “end of message” control character is sent at the end of every buffer full of data. Otherwise, the printer might put the next data it receives on a new line.

Tools for debugging terminal output in a VTAM environment

Amongst the debugging tools you have, two are likely to be of particular use for investigating terminal incorrect output errors in a VTAM environment. They are:

- VTAM buffer trace. This is a function of VTAM itself, and you need to read the appropriate manual in the VTAM library to find out how to use it.
- CICS VTAM exit trace. This is a function of CICS, and you can control it from the CETR panel.

For a description of the use of these two types of tracing in CICS problem determination, see “Chapter 14. Using traces in problem determination” on page 227.

Incorrect data is present on a VSAM data set

If READ UPDATE is not used, an error can occur because VSAM allows a record to be read by one transaction while another transaction is updating it.

If the first transaction were to take some action based on the value of the record, the action would probably be erroneous.

For example, in inventory control, a warehouse has 150 items in stock. 100 items are sold to a customer, who is promised delivery within 24 hours. The invoice is prepared, and this causes a transaction to be invoked that is designed to read the inventory record from a VSAM data set and update it accordingly.

In the meantime, a second customer also asks for 100 items. The salesperson uses a terminal to inquire on the number currently in stock. The “inquire” transaction reads the record that has been read for update but not yet rewritten, and returns the information that there are 150 items. This customer, too, is promised delivery within 24 hours.

Errors of this kind are prevented by the use of READ UPDATE.

An application did not work as expected

It is not possible to give specific advice on dealing with this sort of problem, but the points and techniques that follow should help you to find the area where the failure is occurring.

General points for you to consider

1. Make sure you can define exactly what happened, and how this differs from what you expected to happen.
2. Check the commands you are using for accuracy and completeness. For programming information about EXEC CICS commands, see the *CICS Application Programming Reference* manual. Are any default values the ones you really want? Does the description of the effect of each command match your expectations?
3. Can you identify a failing sequence of commands? If so, can it be reproduced using CECI?
4. Consider the resources required by the application. Are they defined as expected?
5. Are the required functions in the failing functional area available in this system?
6. For “input” type requests, does the item exist? You can verify this using offline utilities.
7. For “output” type requests, is the item created? Verify that the before and after images are as expected.

Using traces and dumps

Traces and dumps can give you valuable information about unusual conditions that might be causing your application to work in an unexpected way.

1. If the path through the transaction is indeterminate, insert user trace entries at all the principal points.

2. If you know the point in the code where the failure occurs, insert a CICS system dump request immediately after it.
3. Use CETR to select special tracing for the level-1 trace points for all components. Select special tracing for the failing task only, and disable all standard tracing by setting the master system trace flag off.
4. Run the transaction after setting the trace options, and wait until the system dump request is executed. Format the internal trace table from the dump (formatting keyword TR), and examine the trace entries before the failure. Look in particular for unusual or unexpected conditions, possibly ones that the application is not designed to handle.

Your transaction produced no output at all

If your transaction produced no output at all, you need to carry out some preliminary checks before looking at the problem in detail. You might be able to find a simple explanation for the failure.

Are there any messages explaining why there is no output?

Look carefully in each of the transient data destinations CSMT, CSTL, and CDBC for any messages that might relate to the task. You could find one there that explains why you received no output.

If you can find no such message, the next step is to get some information about the status of the transaction that produced no output, your terminal, and the CICS system.

Can you use the terminal where the transaction should have started?

Go to the terminal where the transaction should have started, and note whether the keyboard is locked. If it is, press RESET. Now try issuing CEMT INQ TASK (or your site replacement) from the terminal.

If you cannot issue CEMT INQ TASK from the terminal, one of these explanations applies:

- The task that produced no output is still attached to the terminal.
- The terminal where you made the inquiry is not in service.
- There is a system-wide problem.
- You are not authorized to use the CEMT transaction. (This may be because you have not signed on to the terminal and the CEMT transaction is not authorized for that terminal. If you **have** signed on to the terminal, you are probably authorized to use CEMT.)

Try to find a terminal where you can issue CEMT INQ TASK. If no terminal seems to work, there is probably a system-wide problem. Otherwise, see if the task you are investigating is shown in the summary.

- If the task is shown, it is probably still attached, and either looping or waiting. Turn to “No output—what to do if the task is still in the system” on page 188 to see what to do next.
- If the task is not shown, there is a problem with the terminal where you first attempted to issue CEMT INQ TASK.

If you are able to issue CEMT INQ TASK from the terminal where the transaction was attached, one of these explanations applies:

- The transaction gave no output because it never started.
- The transaction ran without producing any output, and terminated.
- The transaction started at another terminal, and might still be in the system. If it is still in the system, you can see it in the task summary that you got for CEMT INQ TASK. It is probably looping or waiting. Turn to “No output—what to do if the task is still in the system” for advice about what to do next. If you do not see the task in the summary, turn to “No output—what to do if the task is not in the system”.

No output—what to do if the task is still in the system

If you obtained no output and the task is still in the system, it is either waiting for a resource, or looping. You should get an indication of which of these two conditions is the most likely from the status for the task returned by CEMT INQ TASK.

You have a suspended task, treat this as a “wait” problem. Use the techniques of “Chapter 6. Dealing with waits” on page 55 to investigate it further.

You have a running task, it is likely to be looping. Turn to “Chapter 7. Dealing with loops” on page 151 to find out what to do next.

No output—what to do if the task is not in the system

If you have obtained no output and CEMT INQ TASK shows the task is not in the system, one of two things could have happened:

- Your transaction never started.
- Your transaction ran, but produced no output.

Note: If you’re not getting output on a printer, the reason could be simply that you are not setting on the START PRINTER bit in the write control character. You need to set this bit to get printed output if you have specified the STRFIELD option on a CONVERSE or SEND command, which means that the data area specified in the FROM option contains structured fields. Your application must set up the contents of the structured fields.

Your task might have been initiated by direct request from a terminal, or by automatic task initiation (ATI). Most of the techniques apply to both sorts of task, but there are some extra things to investigate for ATI tasks. Carry out the tests which apply to all tasks first, then go on to the tests for ATI tasks if you need to.

Did the task run? Techniques for all tasks

There are many different techniques for finding out if a transaction started, or if it ran but produced no output. Use the ones that are most convenient at your installation.

Using CICS system trace entry points:

CICS system tracing is probably the most powerful technique for finding out whether a transaction ever started. You might need to direct the trace output to the

auxiliary trace destination, depending on how certain you can be about the time the task is expected to start. Even a large internal trace table might wrap and overlay the data you want to see if you are not too sure about when the task should start.

You need to use the CETR transaction to set up the right tracing options. You may need to see “Chapter 14. Using traces in problem determination” on page 227 for guidance about setting up trace options.

Select special tracing for just your task, and disable tracing for all other tasks by setting the master system trace flag off. Set up special tracing for the level one trace points for the components that are likely to be used during the invocation of the task. The components you choose will depend on how the task is initiated—by direct request from a terminal, or by automatic transaction initialization—but they should include loader domain (LD), program manager (PG), transaction manager (XM), and dispatcher domain (DS). Make sure that special tracing is disabled for all other components, to minimize the amount of trace data that is collected and the tracing overhead.

Now turn tracing on, and attempt to start your task. When you are sure that the time has passed when the output should have appeared, stop tracing, and format the trace data set.

If your transaction ran, you should see the following types of trace entries for your task and the programs associated with it:

1. Loader domain, when it loaded your program, if the program was not already in main storage.
2. Transaction manager, when it attached your task to the dispatcher.
3. Dispatcher domain, when your task got its first dispatch. You might also see subsequent entries showing your task being suspended, and then resumed.
4. Program manager, for any program management functions associated with your task.

If trace entries for any of these processes are missing, that should help you to find where the failure occurred.

Using EDF

If the transaction being tested requires a terminal, you can use EDF. You need two other terminals for input, as well as the one that the transaction requires (“tttt”). Use one of these others to put the transaction terminal under control of EDF, with:

```
CEDF tttt
```

At the remaining terminal, enter whatever transaction or sequence of transactions causes the one under test to be initiated. Wait long enough for it to start. If no output appears at the second terminal, the transaction has not started. If you have not yet done so, consider using trace to get more information about the failure.

Using CEDX

You can use CEDX to debug non-terminal transactions. CICS intercepts the transaction specified on the CEDX tranid command, and displays the EDF diagnostic panels at the terminal at which the EDF command is issued.

CEDX provides the same function and diagnostic display panels as CEDF, and the same basic rules for CEDF also apply to CEDX.

Using statistics

If no one else is using the transaction in question, you can tell from CICS statistics whether the program has been executed or not.

Use the command CEMT PERFORM STATISTICS RECORD (or your site replacement) before you test your transaction, using the TRANSACTION option:

```
CEMT PERFORM STATISTICS RECORD  
[TRANSACTION]
```

This causes statistics on transactions that have been executed to be recorded in the SMF data set.

Now initiate the transaction and wait until it should have been executed. Repeat the CEMT PERFORM STATISTICS RECORD command, to get a new set of statistics written to the SMF data set. Format the data from the SMF data set for the APPLID that interests you, and look at the statistics recorded before and after you attempted to execute the transaction. If the count for your transaction increased by 1, it was executed. If it remained the same, it was not executed.

Alternatively, if no one else is using the transaction, you can tell, using CEMT, whether the program is being executed. Use the command CEMT INQUIRE PROGRAM(xxxxxxx) where xxxxxxx is the program name. The screen presented to you includes a USECOUNT value. This value is the number of times that the program has been executed since the start of the current CICS session.

Now initiate the transaction and wait until it should have been executed. Repeat the CEMT INQUIRE PROGRAM(xxxxxxx) and the USECOUNT value will have been incremented if the program has been executed.

Formatting the SMF data set. The statistics utility program, DFHSTUP, prepares and prints reports offline using the data recorded in the SMF data set. Read the 'DFHSTUP' section in the *CICS Operations and Utilities Guide* for details on how to use this facility.

When you format the SMF data set using DFHSTUP in order to look at the statistics relating to executed transactions and programs, you may find the following DFHSTUP control parameters useful:

```
SELECT APPLID=  
COLLECTION TYPE=REQ  
TIME START= ,STOP=  
DATE START= ,STOP=
```

See the 'DFHSTUP' section in the *CICS Operations and Utilities Guide* for details on how to code these parameters. If you correctly code these control parameters, you avoid the formatting of much information that might be unnecessary at this point.

Using CEBR

You can use CEBR to investigate your transaction if the transaction reads or writes to a transient data queue, or writes to a temporary storage queue. A change in such a queue is strong evidence that the transaction ran, provided that the environment is sufficiently controlled that nothing else could produce the same effect. You need to be sure that no other transaction that might be executed while you are doing your testing does the same thing.

The absence of such a change does not mean that the transaction did not run—it may have run incorrectly, so that the expected change was not made.

Using CECI

If your transaction writes to a file, you can use CECI before and after the transaction to look for evidence of the execution of your transaction. A change in the file means the transaction ran. If no change occurred, that does not necessarily mean that the transaction failed to run—it could have worked incorrectly, so that the changes you were expecting were not made.

Disabling the transaction

If your transaction requires a terminal, you can do the following. Use CEMT to disable the transaction under test, then do whatever causes the transaction to be initiated. You should get this message at the terminal where it is due to run:

```
DFHAC2008 date time applid Transaction tranid has been disabled and cannot be used
```

If you do not get this message, it is likely that your transaction did not start because of a problem with that terminal.

Investigating tasks initiated by ATI

In addition to the general techniques for all tasks described above, there are some additional ones for tasks that should have started by ATI.

Tasks to be started by ATI can be invoked in any of these ways:

- By issuing EXEC CICS START commands, even if no interval is specified
- By BMS ROUTE operations
- By writing to transient data queues with nonzero trigger levels.

There are many reasons why automatically initiated tasks could fail to start. Even when the CICS system is operating normally, an ATI transaction might fail to start for any of the following reasons:

- It might require a resource that is not available. The resource is usually a terminal, although it could be a queue.
- It might not be scheduled to start until some time in the future. START commands and output sent with BMS ROUTE are both subject to this sort of scheduling, but transactions started when transient data trigger levels are reached are not.

CICS maintains two chains for scheduling transactions that have been requested, but not started. They are the interval control element (ICE) chain, and the automatic initiate descriptor (AID) chain. The information contained in one or other of the chains can sometimes indicate why your task has failed to start.

The ICE chain

The ICE chain is used for tasks scheduled to start after some specified interval, for example on an EXEC CICS START command. You can locate it in the formatted system dump by looking at the ICP section. Look in field ICETRNID of each ICE (the 4-character transaction ID) to see if it relates to your task.

If you find an ICE for your task, look in field ICEXTOD. That will show you the expiration time of day. Does it contain the value you expect? If not, either the task which caused this one to be autoinitiated was in error, or there is a system problem.

The AID chain

The AID chain is used for tasks that are due to start immediately. Tasks are moved from the ICE chain to the AID chain as soon as the scheduled time expires, and they are placed there directly if there is no time delay requested. If a task needs a resource, usually a terminal, that is unavailable, the task remains on the AID chain until it can use the resource.

AIDs are hung off system entries with their forward and backward chain pointers at offset '0C' and '10' respectively. AIDs contain the following fields that can be useful in debugging.

AIDTYPE (X'2D')

Type of aid:

Table 30. Contents of AIDTYPE field

Content	Offset	Meaning
AIDBMS	X'80'	BMS AID
AIDPUT	X'50'	Start with data
AIDINT	X'40'	Start with no data
AIDTDP	X'10'	Transient data AID
AIDISC	X'08'	Queued allocate type AID
AIDCRRD	X'04'	Remote delete type AID

AIDSTATI (X'2E')

AID status indicator:

Table 31. Contents of AIDSTATI field

Content	Offset	Meaning
AIDPRIV	X'80'	Privileged allocate
AIDSENT	X'40'	This has been sent to the TOR by CRSR
AIDCANCL	X'20'	Cancel this AID
AIDROUTP	X'10'	Not yet routed to the AOR
AIDSHIPD	X'08'	Prevent duplicate send
AIDREMX	X'04'	AID for a remote transaction
AIDREMT	X'02'	AID for a remote terminal
AIDSTTSK	X'01'	Task already initiated

AID_TOR_NETNAME (X'65')

Netname of the owning region for a specific terminal

AID_TERMINAL_NETNAME (X'5D')

Netname of terminal

AIDDATID (X'34')

TS queue name holding the data.

AID_REROUTED (X'4E')

AID rerouted to a different TOR

You can see the AIDs in the TCP section of the formatted system dump. Look in field AIDTRNID (the 4-character transaction ID) of each AID, to see if it relates to your task.

If you do find an AID that relates to your task, your task is scheduled to start, but cannot do so because the terminal is unavailable. Look in field AIDTRMID to find the symbolic ID of the terminal, and then investigate why the terminal is not available. One possibility is that the terminal is not in ATI status, because ATI(YES) has not been specified for it in the TYPETERM definition.

Your transaction produced some output, but it was wrong

If your transaction produced no output at all, read “Your transaction produced no output at all” on page 187. For other types of wrong terminal output, read this section.

The origins of corrupted data

You get incorrect output to a terminal if data which is the object of the transaction becomes corrupted at some stage.

Figure 35 illustrates how data flows between various CICS resources when a transaction is executed, and shows the points at which the data might become invalid.

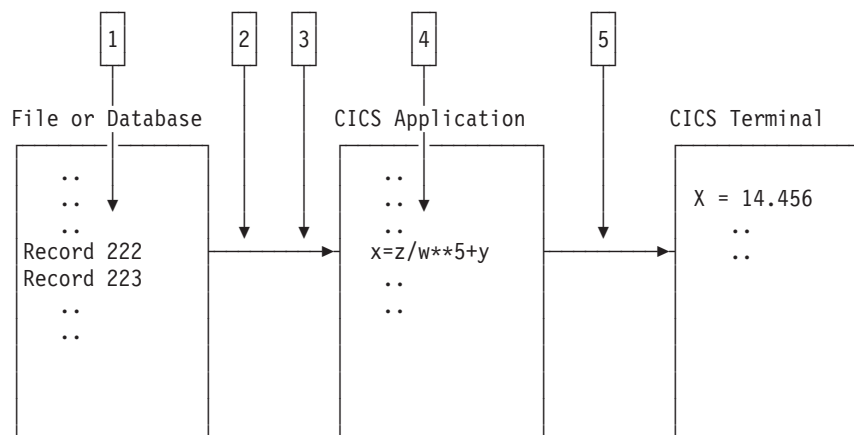

Figure 35. Where data might be corrupted in a transaction

The data might be corrupted at any of points 1 through 5, as it flows from file to terminal.

1. Data records might be incorrect, or they could be missing from the file.
2. Data from the file might be mapped into the program incorrectly.
3. Data input at the terminal might be mapped into the program incorrectly.
4. Bad programming logic might corrupt the data.
5. The data might be mapped incorrectly to the terminal.

Each of these possibilities will be dealt with in turn.

Were records in the file incorrect or missing?

You can check the contents of a file or database either by using CECI or by using a utility program to list off the records in question.

If you find bad data in the file or data set, the error is likely to have been caused by the program that last updated the records containing that data. If the records you expected to see are missing, make sure that your application can deal with a 'record not found' condition.

If the data in the file is valid, it must have been corrupted later on in the processing.

Was the data mapped correctly into the program?

When a program reads data from a file or a database, the data is put into a field described by a symbolic data declaration in the program.

Is the data contained in the record that is read compatible with the data declaration in the program?

Check each field in the data structure receiving the record, making sure in particular that the type of data in the record is the same as that in the declaration, and that the field receiving the record is the right length.

If the program receives input data from the terminal, make sure that the relevant data declarations are correct for that, too.

If there seems to be no error in the way in which the data is mapped from the file or terminal to the program storage areas, the next thing to check is the program logic.

Is the data being corrupted by bad programming logic?

To find out if data is being corrupted by bad programming logic in the application, consider the flow of data through the transaction.

You can determine the flow of data through your transaction by "desk checking", or by using the interactive tools and tracing techniques supplied by CICS.

Desk checking your source code is sometimes best done with the help of another programmer who is not familiar with the program. It is often possible for such a person to see weaknesses in the code which you have overlooked.

Interactive tools allow you to look at the ways in which the data values being manipulated by your program change as the transaction proceeds.

- CEDF is, perhaps, the most powerful interactive tool for checking your programming logic. You can use it to follow the internal flow from one CICS command-level statement to another. If necessary, you can add CICS statements such as ASKTIME at critical points in your program, to see if certain paths are taken, and to check program storage values.
- CECI allows you to simulate CICS command statements. Try to make your test environment match the environment in which the error occurred as closely as possible. If you do not, you might find that your program works with CECI, but not otherwise.

- CEBR enables you to look at temporary storage and transient data queues, and to put data into them. This can be useful when many different programs use the queues to pass data.

Note: When you use CEBR to look at a transient data queue, the records you retrieve are removed from the queue before they are displayed to you. This could alter the flow of control in the program you are testing. You can, however, use CEBR to copy transient data queues to and from temporary storage, as a way of preserving the queues if you need to.

User tracing allows you to trace the flow of control and data through your program, and to record data values at specific points in the execution of the transaction. You could, for example, look at the values of counters, flags, and key variables during the execution of your program. You can include up to 4000 bytes of data on any trace entry, and so this can be a powerful technique for finding where data values are being corrupted.

For programming information about how you can invoke user tracing, see the *CICS Application Programming Reference* manual.

CSFE storage freeze can be used to freeze the storage associated with a terminal or a transaction so that it is not FREEMAINed at the end of processing. This can be a useful tool if, for example, you want to investigate possible storage violations. You need to get a transaction dump to look at the storage after you have run the task with storage freeze on.

For long-running tasks, there is a possibility that a large amount of storage may be consumed because it cannot be FREEMAINed while storage freeze is on. For short-running tasks, however, there should be no significant overhead.

If, after using these techniques, you can find no fault with the logic of the program, the fault either lies with the way data is mapped to the terminal, or you could have missed some important evidence.

Is the data being mapped incorrectly to the terminal?

Incorrect data mapping to a terminal can have both application-related and system-related causes. If you are using BMS mapping, check the items below.

- Examine the symbolic map very carefully to make sure that it agrees with the map in the load module. Check the date and time stamps, and the size of the map.
- Make sure that the attributes of the fields are what they should be. For example:
 - An attribute of DARK on a field can prevent the data in the field from being displayed on the screen.
 - Failing to turn on the modified data tag (MDT) in a field might prevent that field from being transmitted when the screen is read in.

Note: The MDT is turned on automatically if the operator types data in the field. If, however, the operator does not type data there, the application must turn the tag on explicitly if the field is to be read in.

- If your program changes a field attribute byte, or a write control character, look at each bit and check that its value is correct by looking in the appropriate reference manual for the terminal.

Chapter 10. Dealing with storage violations

“Avoiding storage violations” describes the CICS facilities for preventing storage violations. The body of the section describes problem determination techniques for storage violations.

Avoiding storage violations

CICS provides three facilities that help to prevent storage violations.

CICS subsystem storage protection

prevents user application programs from directly overwriting CICS code and control blocks.

Transaction isolation

prevents a user transaction from directly overwriting user application storage of other transactions.

Command protection

prevents CICS, when processing an EXEC CICS command, from overwriting storage that the issuing transaction could not itself directly overwrite.

Even if your system uses all the CICS storage protection facilities, CICS storage violations can occur in certain circumstances in systems using storage protection. For example:

- An application program could contain the necessary instructions to switch to CICS key and modify CICS storage.
- An application program could contain the necessary instructions to switch to the basespace and modify other transactions' storage.
- An application program could be defined with EXECKEY(CICS) and could thus modify CICS storage and other transactions' storage.
- An application could overwrite one or more storage check zones in its own task-lifetime storage.

To gain the full benefit of CICS storage protection, you need to examine the storage needs of individual application programs and control the storage key definitions that are used.

When CICS detects and prevents an attempted storage violation, the name of the abending program and the address of the area it tried to overwrite are passed to the program error program (DFHPEP). For programming information about DFHPEP, see the *CICS Customization Guide*.

If a storage violation occurs in your system, please read the rest of this section.

Two kinds of storage violation

Storage violations can be divided into two classes, namely those detected and reported by CICS, and those not detected by CICS. They require different problem determination techniques.

CICS-detected violations are identified by the following message sent to the console:

DFHSM0102 *applid* A storage violation (code X'code') has been detected by module *modname*.

If you have received this message, turn first to the description of message DFHSM0102 in the *CICS Messages and Codes* manual to see an explanation of the message, and then to the *CICS User's Handbook* to see an explanation of the exception trace point ID, X'code'. This tells you how CICS detected the storage violation. Then return to this section, and read "CICS has detected a storage violation".

Storage violations not detected by CICS are less easy to identify. They can cause almost any sort of symptom. Typically, you may have got a program check with a condition code indicating 'operation exception' or 'data exception', because the program or its data has been overlaid. Otherwise, you might have obtained a message from the dump formatting program saying that it had found a corrupted data area. Whatever the evidence for the storage violation, if it has not been detected by CICS, turn to "Storage violations that affect innocent transactions" on page 203.

CICS has detected a storage violation

CICS can detect storage violations when:

1. The duplicate storage accounting area (SAA) or the initial SAA of a TIOA storage element has become corrupted.
2. The leading storage check zone or the trailing storage check zone of a user-task storage element has become corrupted.

CICS detects storage violations involving TIOAs by checking the SAA chains when it receives a command to FREEMAIN an individual element of TIOA storage, at least as far as the target element. It also checks the chains when it FREEMAINS the storage belonging to a TCTTE after the last output has taken place. CICS detects storage violations involving user-task storage by checking the storage check zones of an element of user-task storage when it receives a command to FREEMAIN that element of storage. It also checks the chains when it FREEMAINS all the storage belonging to a task when the task ends.

The storage violation is detected *not at the time it occurs*, but *only when the SAA chain or the storage check zones are checked*. This is illustrated in Figure 36 on page 199, which shows the sequence of events when CICS detects a violation of a user task storage element. The sequence is the same when CICS detects a violation of a TIOA storage element.

The fact that the SAA or storage check zone is overlaid some time before it is detected does not matter too much for *user* storage where the trailing storage check zone has been overlaid, because the transaction whose storage has been violated is also very likely to be the one responsible for the violation. It is fairly common for transactions to write data beyond the end of the allocated area in a storage element and into the check zone. This is the cause of the violation in Figure 36 on page 199.

The situation could be more serious if the leading check zone has been overlaid, because in that case it could be that some other unrelated transaction was to

blame. However, storage elements belonging to individual tasks are likely to be more or less contiguous, and overwrites could extend beyond the end of one element and into the next.

If the leading storage check zone was only overwritten by chance by some other task, the problem might not be reproducible. On other occasions, other parts of storage might be affected. If you have this sort of problem, you need to investigate it as though CICS had not detected it, using the techniques of "Storage violations that affect innocent transactions" on page 203.

Finding the offending transaction when the duplicate SAA of a TIOA storage element has been overlaid might not be so straightforward. This is because TIOAs tend to have much longer lifetimes than tasks, because they wait on the response of terminal operators. By the time the storage violation is detected, the transaction that caused it is unlikely to still be in the system. However, the techniques for CICS-detected violations still apply.

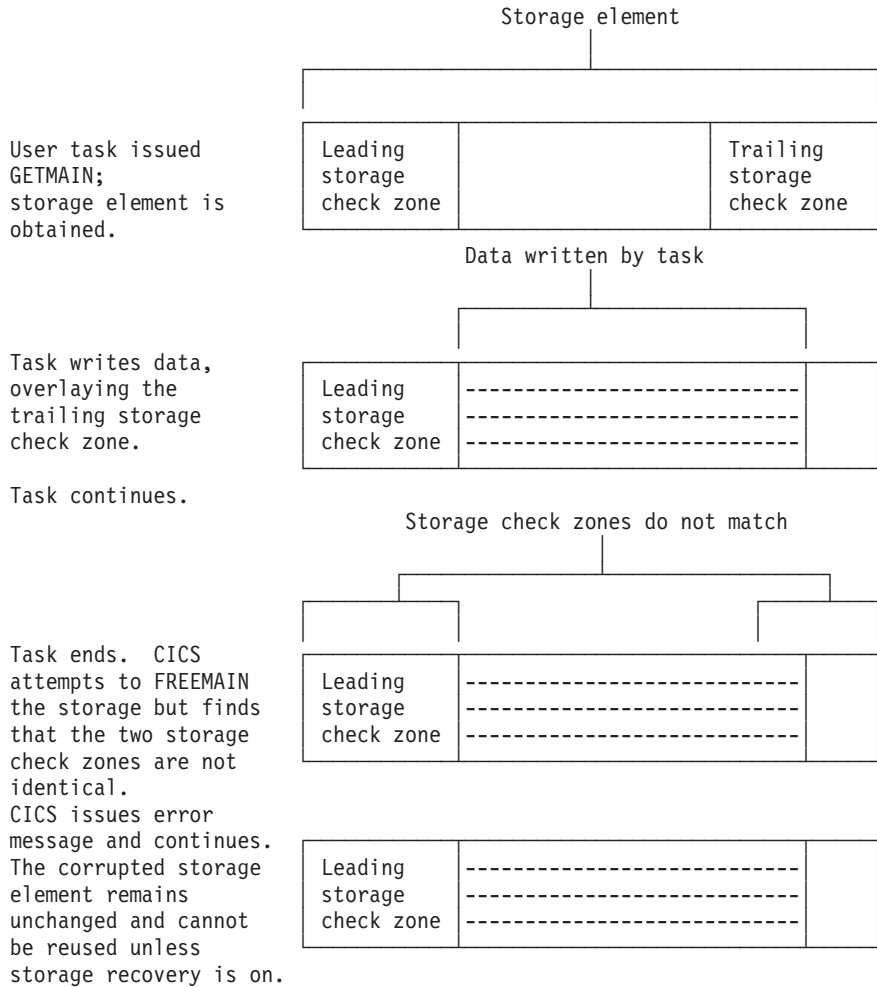

Figure 36. How user-storage violations are committed and detected

Note: For storage elements with SAAs, the address that is returned on the GETMAIN request is that of the leading SAA; for storage elements with storage check zones, the address that is returned is that of the beginning of usable storage.

What happens when CICS detects a storage violation

When CICS detects a storage violation, it makes an exception trace entry in the internal trace table, issues message DFHSM0102 and takes a CICS system dump, unless you have suppressed dumping for system dump code SM0102. If you have suppressed dumping for this dump code, re-enable it and attempt to reproduce the error. The system dump is an important source of information for investigating CICS-detected storage violations.

If storage recovery is on (STGRVCY=YES in the SIT), the corrupted SAAs or check zones are repaired and the transaction continues. See “Storage recovery” on page 205.

If storage recovery is not on, CICS abends the transaction whose storage has been violated (if it is still running). If the transaction is running when the error is detected and if dumping is enabled for the dump code, a transaction dump is taken.

If you received a transaction abend message, read What the transaction abend message can tell you. Otherwise, go on to What the CICS system dump can tell you.

What the transaction abend message can tell you

If you get a transaction abend message, it is very likely that CICS detected the storage violation when it was attempting to satisfy a FREEMAIN request for user storage. Make a note of the information the message contains, including:

- The transaction abend code.
- The identity of the transaction whose storage has been violated.
- The identity of the program running at the time the violation was detected.
- The identity of the terminal at which the task was started.

Because CICS does not detect the overlay at the time it occurs, the program identified in the abend message probably is not the one in error. However, it is likely that it issued the FREEMAIN request on which the error was detected. One of the other programs in the abended transaction might have violated the storage in the first place.

What the CICS system dump can tell you

Before looking at the system dump, you must format it using the appropriate formatting keywords. The ones you need for investigating storage violations are:

- TR, to get you the internal trace table
- TCP, to get you terminal-related areas
- AP, to get you the TCAs and user storage.

The dump formatting program reports the damaged storage check zone or SAA chain when it attempts to format the storage areas, and this can help you with diagnosis by identifying the TCA or TCTTE owning the storage.

When you have formatted the dump, take a look at the data overlaying the SAA or storage check zone to see if its nature suggests which program put it there. There are two places you can see this, one being the exception trace entry in the internal trace table, and the other being the violated area of storage itself. Look first at the exception trace entry in the internal trace table to check that it shows the data

overlaying the SAA or storage check zone. Does the data suggest what program put it there? Remember that the program is likely to be part of the violated transaction in the case of user storage. For terminal storage, you probably have more than one transaction to consider.

As the SAAs and storage check zones are only 8 bytes long, there might not be enough data for you to identify the program. In this case, find the overlaid data in the formatted dump. The area is pointed to in the diagnostic message from the dump formatting program. The data should tell you what program put it there, and, more importantly, what part of the program was being executed when the overlay occurred.

If the investigations you have done so far have enabled you to find the cause of the overlay, you should be able to fix the problem.

What to do if you cannot find what is overlaying the SAA

The technique described in this section enables you to locate the code responsible for the error by narrowing your search to the sequence of instructions executing between the last two successive old-style trace entries in the trace table.

You do this by forcing CICS to check the SAA chain of terminal storage and the storage check zones of user-task storage every time an old-style trace entry is made from AP domain. These types of trace entry have point IDs of the form AP 00xx, “xx” being two hexadecimal digits. Storage chain checking is not done for new-style trace entries from AP domain or any other domain. (For a discussion of old and new-style trace entries, see “Chapter 14. Using traces in problem determination” on page 227.)

The procedure has a significant processing overhead, because it involves a large amount of tracing. You are likely to use it only when you have had no success with other methods.

How you can force storage chain checking

You can force storage chain checking either by using the CSFE DEBUG transaction, or by using the CHKSTSK or CHKSTRM system initialization parameter. Tracing must also be active, or CICS will do no extra checking. The CSFE transaction has the advantage that you need not bring CICS down before you can use it.

Table 32 on page 201 shows the CSFE DEBUG options and their effects. Table 33 shows the startup overrides that have the same effects.

Table 32. Effects of the CSFE DEBUG transaction

CSFE syntax	Effect
CSFE DEBUG, CHKSTSK=CURRENT	This checks storage check zones for all storage areas on the transaction storage chain for the current task only. If a task is overlaying one of the storage check zones of its own user storage, use CSFE DEBUG,CHKSTSK=CURRENT

Table 32. Effects of the CSFE DEBUG transaction (continued)

CSFE syntax	Effect
CSFE DEBUG, CHKSTRM=CURRENT	This checks SAAs for all TIOAs linked off the current TCTTE. Use this if the SAA of a TIOA has been overlaid.
CSFE DEBUG, CHKSTSK=NONE	This turns off storage zone checking for transaction storage areas.
CSFE DEBUG, CHKSTRM=NONE	This turns off SAA checking for TIOAs.

Table 33. Effects of the CHKSTSK and CHKSTRM overrides

Override	Effect
CHKSTSK=CURRENT	As CSFE DEBUG,CHKSTSK=CURRENT
CHKSTRM=CURRENT	As CSFE DEBUG,CHKSTRM=CURRENT
CHKSTSK=NONE	As CSFE DEBUG,CHKSTSK=NONE. This override is the default.
CHKSTRM=NONE	As CSFE DEBUG,CHKSTRM=NONE. This override is the default.

Your strategy should be to have the minimum tracing that will capture the storage violation, to reduce the processing overhead and to give you less trace data to process. Even so, you are likely to get a large volume of trace data, so direct the tracing to the auxiliary trace data sets. For general guidance about using tracing in CICS problem determination, see “Chapter 14. Using traces in problem determination” on page 227.

You need to have only level-1 tracing selected, because no user code is executed between level-2 trace points. However, you do not know which calls to CICS components come before and after the offending code, so you need to trace all CICS components in AP domain. (These are the ones for which the trace point IDs have a domain index of “AP”.) Set level-1 tracing to be special for all such components, so that you get every AP level-1 trace point traced using special task tracing.

If the trailing storage check zone of a user-storage element has been overlaid, select special tracing for the corresponding transaction only. This is because it is very likely to be the one that has caused the overlay.

If the duplicate SAA of a TIOA has been overlaid, you need to select special tracing for all tasks associated with the corresponding terminal, because you are not sure which has overlaid the SAA. It is sufficient to select special tracing for the terminal and standard tracing for every transaction that runs there, because you get special task tracing with that combination. (See Figure 40 on page 238.)

Your choice of terminal tracing depends on where the transaction is likely to be initiated from. If it is only ever started from one terminal, select special tracing for that terminal alone. Otherwise, you need to select special tracing for every such terminal.

When you have set up the tracing options and started auxiliary tracing, you need to wait until the storage violation occurs.

What happens after CICS detects the storage violation?

When the storage violation is detected by the storage violation trap, storage checking is turned off, and an exception trace entry is made. If dumping has not been disabled, a CICS system dump is taken. The following message is sent to the console:

```
DFHSM0103 applid STORAGE VIOLATION (CODE X'code') HAS BEEN  
DETECTED BY THE STORAGE VIOLATION TRAP. TRAP IS NOW INACTIVE.
```

The value of *'code'* is equal to the exception trace point ID, and it identifies the type of storage that was being checked when the error was detected. A description of the exception trace point ID, and the data it contains, is in the *CICS Trace Entries*.

Format the system dump using the formatting keyword TR, to get the internal trace table. Locate the exception trace entry made when the storage violation was detected, near the end of the table. Now scan back through the table, and find the last old-style trace entry (AP 00xx). The code causing the storage violation was being executed between the time that the trace entry was made and the time that the exception trace entry was made.

If you have used the CHKSTSK=CURRENT option, you can locate the occurrence of the storage violation only with reference to the last old-style trace entry for the current task.

You need to identify the section of code that was being executed between the two trace entries from the nature of the trace calls. You then need to study the logic of the code to find out how it caused the storage violation.

For suggestions on programming errors that might have caused your particular problem, look at the list of common ones given in “Programming errors that can cause storage violations” on page 205.

Storage violations that affect innocent transactions

Storage violations that affect innocent transactions—that is, transactions that do not cause the violation—usually go undetected by CICS. However, occasionally CICS detects that the initial SAA of a TIOA element or the storage check zone of a user-storage element has been overlaid by a task that does not own it.

If they are reproducible, storage violations of this type typically occur at specific offsets within structures. For example, the start of an overlay might always be at offset 30 from the start of a field.

The most likely cause of such a violation is a transaction writing data to a part of the DSAs that it does not own, or possibly FREEMAINing such an area. The transaction might previously have GETMAINed the area and then FREEMAINed it

before writing the data, or addressability might otherwise not have been correctly maintained by an application. Another possible reason is that an ECB might have been posted by a transaction after the task that was waiting on it had been canceled.

Storage violations affecting innocent transactions are, in general, more difficult to resolve than those that are detected by CICS. Often, you become aware of them long after they occur, and then you need a long history of system activity to find out what caused them.

A strategy for storage violations affecting innocent transactions

The storage violation has been caused by a program writing to an area it does not own, but you probably have no idea at the outset which program is at fault. Look carefully at the content of the overlay before you do any other investigation, because it could help you to identify the transaction, program, or routine that caused the error. If it does not provide the clue you need, your strategy should be to use CICS tracing to collect a history of all the activities that reference the affected area.

The trace table must go back as far as task attach of the program causing the overlay, because that trace entry relates the transaction's identity to the unit of work number used on subsequent entries. This could mean that a very large trace table is needed. Internal trace is not suitable, because it wraps when it is full and it then overwrites important trace entries.

Auxiliary trace is a suitable destination for recording long periods of system activity, because it is possible to specify very large auxiliary trace data sets, and they do not wrap when they are full.

If you have no idea which transaction is causing the overlay, you need to trace the activities of every transaction. This impacts performance, because of the processing overhead.

Procedure for resolving storage violations affecting innocent transactions

Ensure that level-1 trace points are in the special set for all CICS components. Select special tracing for all user tasks, by setting up special tracing for all user transactions and all terminals, and disable standard tracing by setting the master system trace flag off.

Use the CETR transaction to set up the tracing options, and select auxiliary trace as the trace destination. When you get the symptoms that tell you that the storage violation has occurred, take a system dump—unless the error causes a system dump to be taken.

Format the system dump, and format and print the auxiliary trace data set. If you know which area of storage the violation occurred in, you can use appropriate dump formatting keywords. Otherwise, you need to format the entire system dump. The dump formatting program may report that it has found some incorrect data. If not, you need to find the overlaid area by other means.

The next job is to locate all the entries in the trace table that address the overlaid area. Operations involving GETMAIN and FREEMAIN in particular are likely pointers to the cause of the error.

When you have found a likely trace entry, possibly showing a GETMAIN or FREEMAIN addressing the area, you need to find the ID of the associated transaction by locating the trace entry for TASK ATTACH. Rather than locating this manually, it is probably better to reformat the auxiliary trace data set selectively to show just trace entries corresponding to the task's unit of work.

Having found the identity of the transaction, take a look at all the programs belonging to the transaction. It is likely that one of these caused the overlay, and you need to consider the logic of each to see if it could have caused the error. This is a long job, but it is one of the few ways of resolving a storage violation affecting an innocent transaction.

What to do if you still cannot find the cause of the overlay

If you are unable to identify the cause of the storage violation after carrying out the procedures of the preceding section, contact your IBM Support Center. They may suggest coding a global trap/trace exit to detect the storage violation.

Programming errors that can cause storage violations

The purpose of this section is to outline a number of commonly occurring programming errors that can cause storage violations.

1. Failing to GETMAIN sufficient storage. This is often caused by failure to recompile all the programs for a transaction after a common storage area has been redefined with a changed length.
2. Runaway subscript. Make sure that your tables can only grow to a finite size.
3. Writing data to an area after it has been FREEMAINed.

When a task FREEMAINs an area that it has been addressing, it can no longer write data to the area without the risk of overwriting some other data that might subsequently be there.

4. Hand posting an ECB for a canceled task.

If a task waiting on a CICS ECB is canceled, and then a transaction attempts to hand post the ECB when the resource being waited on becomes available, it may corrupt data belonging to some unrelated activity if the area once occupied by the ECB has been reused.

Storage recovery

The STGRCVY system initialization parameter enables you to vary the action taken by CICS on detection of a storage violation.

In normal operation, CICS sets up four task-lifetime storage subpools for each task. Each element in the subpool starts and ends with a check zone that includes the subpool name. At each FREEMAIN, and at end of task, CICS inspects the check zones and abends the task if either has been overwritten.

Terminal input-output areas (TIOAs) have similar check zones, each of which is set up with the same value. At each FREEMAIN of a TIOA, CICS inspects the check zones and abends the task if they are not identical.

If CICS is initialized with STGRCVY(YES), the overwriting of check zones is treated differently. After the system dump has been taken for the storage violation, CICS resets the check zones to their initial value and the task continues execution.

STGRCVY(NO) is the default.

Chapter 11. Dealing with external CICS interface (EXCI) problems

For detailed problem determination information about the external CICS interface including information about trace, system dumps and MVS abends, see the *CICS External Interfaces Guide*.

The following CICS messages support the external CICS interface:

DFHIR3799

DFHEX0001	DFHEX0012
DFHEX0002	DFHEX0013
DFHEX0003	DFHEX0014
DFHEX0005	DFHEX0015
DFHEX0010	DFHEX0016
DFHEX0011	

Messages DFH5502W and DFH5503E include support for the external CICS interface facility.

This facility is also supported by two translator messages, DFH7004I and DFH7005I.

For full details of all CICS messages, see the *CICS Messages and Codes*.

The external CICS interface outputs trace to two destinations: an internal trace table and an external MVS GTF data set. The internal trace table resides in the non-CICS MVS batch region. Trace data is formatted and included in any dumps produced by the external CICS interface.

Trace entries are issued by the external trace interface destined for the internal trace table and/or an MVS GTF data set. They are listed in the *CICS Trace Entries* manual.

The external CICS interface produces MVS SYSM dumps for some error conditions and MVS SDUMPs for other, more serious conditions. These dumps contain all the external CICS interface control blocks, as well as trace entries. You can use IPCS to format these dumps.

A user-replaceable program, DFHXCTRA, is available for use under the guidance of IBM service personnel. It is the equivalent of DFHTRAP used in CICS. It is invoked every time the external CICS interface writes a trace entry. The actions of the CICS-supplied DFHXCTRA are, on a pipe FREEMAIN error, to:

1. Make a trace entry
2. Take an SDUMP
3. Skip writing the current trace entry
4. Disable itself.

Chapter 12. Dealing with MRO problems

Suppose an error is suspected in communication between System A and System B. The problem can be determined by looking at either system. The following procedure applies to System A, but could equally well apply to System B. The first step is to look at the field CSACRBA in the CSA optional features list in System A. If CSACRBA is zero, the interregion communication routine is not active in that system.

If CSACRBA is not zero, examine the TCTSEs in System A and find the TCTSE for System B. In this TCTSE, TCSEIRCF is the flag byte that indicates the state of communication between the two systems. If bit TCSEIRNC in this byte is on, there is no communication between System A and System B. This is either because System B has not started interregion services, or because System A is out of service with respect to System B, or because System B is out of service with respect to System A.

If bit TCSEIRNC is off, a session should exist. The next step is to inspect the primary and secondary session(s) between the systems. The first primary session is pointed to by field TCSEVC1 in the TCTSE, and the first secondary session is pointed to by TCSEVC2. If System A initiated the session, look at secondary sessions, otherwise look at primary sessions.

Each session is defined by a TCTTE. The field TCTESCCB in TCTTE is zero if the session is not connected to the other system, otherwise it contains the address of the subsystem connection control block (SCCB) that the interregion SVC routine uses to represent that end of the connection.

Assuming the session is connected, TCTTECA is zero if no task is using the session. Otherwise, TCTTECA points to the TCA of the task that uses the session.

The protocol for interregion SVC transfer is similar to that for VTAM SNA data flow control. Field TCTEIRF1 contains information on the state of the session, field TCTESBRS gives the bracket status, field TCTESRHI is the inbound request header, and field TCTESRHO is the outbound request header.

The field TCTENIBA points to the TCTTE extension for the NIB descriptor. Within this TCTTE extension, TCTEPSQ contains the primary name, and TCTESSQ contains the secondary name. Thus a session in System A can be related to a session in System B.

Chapter 13. Dealing with log manager problems

The CICS log manager uses services provided by the MVS logger to support the logging and journaling of data to:

- The CICS system log
- Forward recovery logs
- Autojournals
- User journals.

Categories of problem

The following categories of problem (in order of ascending impact on the user) may be encountered by the CICS log manager:

1. Those problems within the MVS logger that the MVS logger resolves for itself. CICS has no involvement in this category and may only experience the problem as an increase in response times.
2. Where the MVS logger is unable to satisfy the CICS log manager's request immediately. This problem state can be encountered:
 - For a log stream that uses a coupling facility structure, on a 'STRUCTURE FULL' condition, where the coupling facility has reached its capacity before offloading data to DASD. This state may also be encountered during the rebuilding of a coupling facility structure.
 - For a DASD-only log stream, on a 'STAGING DATA SET FULL' condition, where the staging data set has reached its capacity before offloading data to secondary storage.

If either of these conditions occur, CICS issues message DFHLG0771 (for a general log) or DFHLG0777 (for a system log). The CICS log manager retries the request every three seconds until the request is satisfied. Typically, this can take up to a minute.

3. If the MVS logger fails, CICS is abended. If the system log has not been damaged, a subsequent emergency restart of CICS should succeed.
4. If a return code implies that the CICS system log has been damaged, CICS is quiesced, meaning transactions are allowed to run to completion as far as possible, with no further records being written to the system log. To get CICS back into production, you must perform an initial start. However, before doing so you may want to perform a *diagnostic run*, to gather information for problem diagnosis—see “Dealing with a corrupt system log” on page 220.

If a return code implies damage to a forward recovery log or autojournal, all files using the log stream are quiesced and their transactions run to completion. Message DFHFC4800, DFHFC4801, or DFHFC4802 is issued. User transactions writing journal records to the log stream experience a write error. For a forward recovery log, before you can continue to use the log stream, you must:

- a. Take an image copy of **all** data sets referencing the log stream.
- b. Redefine the log stream.
- c. Unquiesce the data sets using the affected logs. You may then explicitly open the files but they open automatically at the first READ or WRITE if they are in a CLOSED ENABLED state after the unquiesce.

For an autojournal, before you can continue to use the log stream, you must:

- a. Try to read and recover data from the damaged autojournal.
- b. Redefine the log stream.

Exceeding the capacity of a log stream

The MVS logger imposes a limit on the number of data sets per log stream. In practice, this is likely to be a problem only if CICS is running in a version of MVS earlier than OS/390 Release 3.

System log

You are strongly recommended to allow the CICS log manager to manage the size of the system log. If you do so, you do not need to worry about the data set limit being exceeded, even if you are using a pre-OS/390 Release 3 version of MVS.

In the unlikely event that you need to retain data beyond the time it would be deleted by CICS, see the *CICS Transaction Server for OS/390 Installation Guide* for advice on how to define the system log.

General logs

If a journal write to a user journal fails because the data set limit is reached, you must delete the tail of the log, or archive it, before you can use the SET JOURNALNAME command to open the journal and make it available for use again. For an example of how to do this, see the *CICS Operations and Utilities Guide*.

Pre-OS/390 Release 3

- The MVS logger imposes a limit of 168 data sets per log stream.
- There is no mechanism for the automatic deletion of records from general log streams. It is your responsibility to delete such data to prevent the 168 data set limit being exceeded.

If you need longer-term data retention, you must copy the data from log stream storage into alternative archive storage.

Although message IXG257I is issued when 90% of the log stream has been filled, this event is not detectable by CICS. You should use your automation software to monitor occurrences of this message.

OS/390 Release 3 and later

- The number of data sets per log stream recognized by the MVS logger is several million. In normal circumstances, you do not need to be concerned about the limit being exceeded.
- You can cause redundant data to be deleted from log streams automatically, after a specified period. To arrange this for general log streams, define the logs to MVS with AUTODELETE(YES) and RETPD(dddd), where dddd is the number of days for which data is to be retained. This causes the MVS logger to delete an entire log data set when all the data in it is older than the retention period (RETPD) specified for the log stream.

Note: Support for the AUTODELETE and RETPD parameters requires the sysplex's LOGR couple data set to have been formatted using OS/390 Release 3 or later. If it has not, refer to the "Pre-OS/390 Release 3" box.

CICS checks for the availability of the MVS logger

CICS itself checks for the availability of the MVS logger. Every ten seconds (or the interval specified in the ICV system initialization parameter if this is greater than ten seconds), CICS initiates a BROWSE START operation on the system log. If this fails, CICS either abends or quiesces depending on the returned MVS logger reason code.

Diagnosis of problems in the MVS logger

Extended waits by the CICS log manager can be caused by problems within the MVS logger or other areas of MVS. You can investigate these by looking at the MVS console messages. Look at the following:

- Console messages and dumps
- Global resource serialization (GRS) resource contention
- Coupling facility status
- SMF and RMF statistics.
- Display Logger command

Console messages and dumps

Look for:

- Outstanding WTOR messages
- IXGxxx messages
- Allocation, catalog and HSM error messages
- IO errors for log stream data sets⁴ and/or LOGR couple data sets
- IXCxxx messages, indicating problems with the coupling facility structure or couple data sets.
- 1C5 abends, and other abends from the IXGLOGR address space.

4. Log stream data sets are of the form IXGLOGR.stream_name.Annnnnnn. The high level qualifier (IXGLOGR) may be different if the HLQ parameter was specified when the log stream was defined.

Explanations of MVS logger reason codes which are shown in CICS and MVS messages and traces are in the IXGCON macro and in the *OS/390 MVS Assembler Services Reference* manual.

GRS resource contention

To check GRS resource contention by displaying GRS enqueues and latch usage on all machines in the sysplex, issue either of the following MVS commands (the R0 *ALL phrase means that the command goes to all systems in the sysplex):

```
R0 *ALL,D GRS,C
R0 *ALL,D GRS,RES=(SYSZLOGR,*)
```

A normal response looks like:

```
D GRS,C

ISG020I 12.06.49 GRS STATUS 647
NO ENQ CONTENTION EXISTS
NO LATCH CONTENTION EXISTS

D GRS,RES=(SYSZLOGR,*)

ISG020I 14.04.28 GRS STATUS 952
NO REQUESTORS FOR RESOURCE SYSZLOGR *
```

A response showing GRS contention looks like this:⁵

```
D GRS,C

ISG020I 12.06.31 GRS STATUS 619
LATCH SET NAME: SYS.IXGLOGGER_LCBVT
CREATOR JOBNAME: IXGLOGR CREATOR ASID: 0202
LATCH NUMBER: 7
  REQUESTOR ASID EXC/SHR OWN/WAIT
  IXGLOGR 0202 EXCLUSIVE OWN
  IXGLOGR 0202 SHARED WAIT

D GRS,RES=(SYSZLOGR,*)

ISG020I 19.58.33 GRS STATUS 374
S=STEP SYSZLOGR 91
SYSNAME JOBNAME ASID TCBADDR EXC/SHR OWN/WAIT
MV26 MSLDELC1 002F 008F6370 EXCLUSIVE OWN
S=STEP SYSZLOGR 93
SYSNAME JOBNAME ASID TCBADDR EXC/SHR OWN/WAIT
MV26 MSLWRTC1 002E 008DED90 EXCLUSIVE OWN
MV26 MSLWRTC1 002E 008DB990 EXCLUSIVE WAIT
MV26 MSLWRTC1 002E 008DB700 EXCLUSIVE WAIT
MV26 MSLWRTC1 002E 008F60C8 EXCLUSIVE WAIT
S=SYSTEMS SYSZLOGR LPAYROL.TESTLOG.TLOG1
SYSNAME JOBNAME ASID TCBADDR EXC/SHR OWN/WAIT
MV27 IXGLOGR 0011 008F7398 EXCLUSIVE OWN
MV26 IXGLOGR 0011 008F7398 EXCLUSIVE WAIT
```

This shows which tasks (that is, MVS TCBs) have exclusive enqueues on the log streams, and which tasks are waiting for them. It is quite normal for enqueues and latches to be obtained, occasionally with contention. They are indications of a problem only if they last for more than a minute or so.

5. You may also see latch set name SYS.IXGLOGGER_MISC

Long term enqueueing on the SYSZLOGR resource can be a sign of problems even if there is no contention.

You can choose to display only those log streams exclusively enqueued on by CICS jobs in the sysplex. Issue the following MVS command:

```
D GRS,RES=(DFHSTRM,*)
```

A typical response to this command looks like this:

```
ISG020I 14.51.28 GRS STATUS 541
S=SYSTEMS DFHSTRM PAYROL.CICSVR.DFHLOG
SYSNAME      JOBNAME      ASID      TCBADDR    EXC/SHR    OWN/WAIT
MV29        PAYROL91      0042      007D9108   SHARE      OWN
MV29        PAYROL93      0044      007D9138   SHARE      OWN
S=SYSTEMS DFHSTRM PAYROL.FWDRECOV.UTL3
SYSNAME      JOBNAME      ASID      TCBADDR    EXC/SHR    OWN/WAIT
MV29        PAYROL91      0042      007D9108   SHARE      OWN
MV29        PAYROL93      0044      007D9138   SHARE      OWN
S=SYSTEMS DFHSTRM PAYROL.IYK8ZET1.DFHJ02
SYSNAME      JOBNAME      ASID      TCBADDR    EXC/SHR    OWN/WAIT
MV29        PAYROL91      0042      007D9108   SHARE      OWN
S=SYSTEMS DFHSTRM PAYROL.IYK8ZET1.DFHLOG
SYSNAME      JOBNAME      ASID      TCBADDR    EXC/SHR    OWN/WAIT
MV29        PAYROL91      0042      007D9108   EXCLUSIVE  OWN
S=SYSTEMS DFHSTRM PAYROL.IYK8ZET1.DFHSHUNT
SYSNAME      JOBNAME      ASID      TCBADDR    EXC/SHR    OWN/WAIT
MV29        PAYROL91      0042      007D9108   EXCLUSIVE  OWN
S=SYSTEMS DFHSTRM PAYROL.IYK8ZET3.DFHJ02
SYSNAME      JOBNAME      ASID      TCBADDR    EXC/SHR    OWN/WAIT
MV29        PAYROL93      0044      007D9138   SHARE      OWN
S=SYSTEMS DFHSTRM PAYROL.IYK8ZET3.DFHLOG
SYSNAME      JOBNAME      ASID      TCBADDR    EXC/SHR    OWN/WAIT
MV29        PAYROL93      0044      007D9138   EXCLUSIVE  OWN
S=SYSTEMS DFHSTRM PAYROL.IYK8ZET3.DFHSHUNT
SYSNAME      JOBNAME      ASID      TCBADDR    EXC/SHR    OWN/WAIT
MV29        PAYROL93      0044      007D9138   EXCLUSIVE  OWN
```

Checking CF structure and couple data set status

To display the MVS logger couple data set status, issue the following MVS command:

```
D XCF,CPL,TYPE=LOGR
```

A normal response looks like this:

```
D XCF,CPL,TYPE=LOGR
IXC358I 14.47.51 DISPLAY XCF 391
LOGR COUPLE DATA SETS
PRIMARY   DSN: SYS1.SYSPLEX2.SEQ26.PLOGR
          VOLSER: P2SS05      DEVN: 230D
          FORMAT TOD          MAXSYSTEM
          12/20/95 09:25:48    8
ALTERNATE DSN: SYS1.SYSPLEX2.SEQ26.ALOGR
          VOLSER: P2SS06      DEVN: 2C10
          FORMAT TOD          MAXSYSTEM
          12/20/95 09:27:45    8
LOGR IN USE BY ALL SYSTEMS
```

If the response shows that LOGR is not in use by all systems, there may be a problem to investigate. Look for IXCxxx messages which might indicate the cause of the problem and issue the following command to attempt reconnection to the couple data set:

```
SETXCF CPL,TYPE=(LOGR),PCOUPLE=(couple_dataset_name)
```

To display all structures with Failed_persistent connections, issue the following MVS command:

```
D XCF,STR,STRNM=*,STATUS=FPCONN
```

The MVS logger should resolve any failed connections.

Checking log stream status

To display information about the status of CICS log streams, a batch job should issue the IXCMIAPU command:

```
LIST LOGSTREAM NAME(streamname) DETAIL(YES)
```

You can use wildcards to select multiple log streams. For example, the following job produces a report on the system log streams for CICS region IYXL4:

```
//IYXLIST JOB NOTIFY=WILLIN,MSGCLASS=A
//LOGLIST EXEC PGM=IXCMIAPU
//SYSPRINT DD SYSOUT=A,DCB=RECFM=FBA
//SYSIN DD *
DATA TYPE(LOGR) REPORT(NO)
LIST LOGSTREAM NAME(WILLIN.IYXL4.DFH*) DETAIL(YES)
```

Figure 37 shows a typical response to this command, with system logs streams for CICS region IYXL4.

```
LOGSTREAM NAME(WILLIN.IYXL4.DFHLOG) STRUCTNAME() LS_DATACLAS()
LS_MGMTCLAS() LS_STORCLAS() HLQ(IXGLOGR) MODEL(NO) LS_SIZE(0)
STG_MGMTCLAS() STG_STORCLAS() STG_DATACLAS() STG_SIZE(0)
LOWOFFLOAD(20) HIGHOFFLOAD(95) STG_DUPLEX(YES) DUPLEXMODE(UNCOND)
RMNAME() DESCRIPTION() RETPD(0) AUTODELETE(NO)
DASDONLY(YES)
MAXBUFSIZE(64000)
```

LOG STREAM ATTRIBUTES:

User Data:

```
0000000000000000000000000000000000000000000000000000000000000000
0000000000000000000000000000000000000000000000000000000000000000
```

LOG STREAM CONNECTION INFO:

SYSTEMS CONNECTED: 1

SYSTEM NAME	STRUCTURE VERSION	CON ID	CONNECTION VERSION	CONNECTION STATE
MV28	0000000000000000	00	00000000	N/A

Figure 37. Example output produced by the LIST LOGSTREAM NAME command (Part 1 of 2)

If you are using coupling facility log streams, the IXCMIAPU LIST STRUCTURE NAME(structname) DETAIL(YES) command is useful in finding the status of CICS log stream structures. For further information about these commands, see the *OS/390 MVS Setting Up a Sysplex* manual.

SMF and RMF statistics

SMF 88 log stream statistics records and RMF coupling facility usage reports are useful for analyzing problems that are affecting performance. Increasing the amount of coupling facility storage allocated to a structure, or the size of a staging data set, may improve both MVS logger performance and CICS performance.

Obtaining MVS logger and coupling facility dumps

If you suspect there is a problem within the MVS logger which is not a result of some other resolvable problem, you may need to collect additional diagnostic information. The dumps generated by CICS often don't contain sufficient information about the MVS logger.

A dump of XCF and MVS logger address spaces from all systems is useful in the diagnosis of such problems. To obtain the dump, issue the following series of MVS commands:

```
DUMP COMM=(meaningful dump title)
R ww,JOBNAME=(IXGLOGR,XCFAS,cics_jobname),DSPNAME=('IXGLOGR'.*,'XCFAS'.*),CONT
R xx,STRLIST=(STRNAME=structure,(LISTNUM=ALL),ACC=NOLIM),CONT
R yy,REMOTE=(SYSLIST=('XCFAS','IXGLOGR'),DSPNAME,SDATA),CONT
R zz,SDATA=(COUPLE,ALLNUC,LPA,LSQA,PSA,RGN,SQA,TRT,CSA,GRSQ,XESDATA),END
```

Use the R xx,STRLIST=(STRNAME=structure,(LISTNUM=ALL),ACC=NOLIM),CONT instruction only where you suspect a problem with the coupling facility structure.

Error records written to the MVS LOGREC data set may also be useful.

Setting a SLIP trap

The procedure described in the previous section produces “snapshots” of the MVS logger address space and coupling facility structure *at the time the commands are issued*. However, it is usually more useful to take a dump *at the time an error occurs*.

If you have applied MVS APAR OW27057, a dump of the MVS logger address space is produced automatically if an MVS IXGBRWSE or IXGDELET request fails because the MVS logger cannot find a specific log stream block identifier. (The MVS logger issues a return code of 8 with a reason code of 804.) To cater for other possible logger errors, or to obtain a dump of the CF structure associated with a failing log stream, you can set an MVS serviceability level indication processing (SLIP) trap. Setting a SLIP trap causes MVS to take a specified set of actions when a specified event occurs. For example, you could specify that MVS is to take a dump of the MVS logger address space if CICS issues a particular message.

Figure 38 on page 219 shows an example SLIP trap that captures a dump of the CICS address space, the MVS logger address space, and the coupling facility structure associated with the failing logstream.

```

SLIP SET,IF,LPAMOD=(IGC0003E,0),DATA=(1R?+
4,EQ,C4C6C8D3,+8,EQ,C7F0F7F7,+C,EQ,F2),A=S      <change the message
VCD,JOBLIST=(cicsjob,IXGLOGR,XCFAS),             <change CICS Job

-->response xx

xx,DSPNAME=('XCFAS'.*, 'IXGLOGR'.*),STRLIST
=(STRNAME=structname,LOCKENTRIES,ACC=NOLIM      <change STRNAME
,(LISTNUM=ALL,

-->response yy

yy,ENTRYDATA=SERIALIZE,ADJUNCT=CAPTURE)),S
DATA=(RGN,XESDATA,ALLNUC,CSA,LSQA,PSA,SQA,
SWA,TRT,COUPLE,WLM,GRSQ,LPA),

-->response zz

zz,ID=LOGR,REMOTE=(JOBLIST,DSPNAME,SDATA),
END

```

Figure 38. An example SLIP trap. The trap is triggered when CICS issues a DFHLG0772 message. It captures dumps of the CICS address space, the MVS logger address space, and the CF structure associated with the failing log stream.

In this example, the SLIP triggers when a specific CICS log manager message—DFHLG0772—is written to the console. This is specified in the EQ parameter of the SLIP:

```

+4,EQ,C4C6C8D3,+8,EQ,C7F0F7F7,+C,EQ,F2)
      D F H L           G 0 7 7           2   <equates to

```

You can also set a more “generic” trap, that is triggered by the occurrence of any one of a range of messages. For example, to cause the SLIP to be triggered by any log manager message in the DFHLG07xx range, alter the value of the EQ parameter to:

```

+4,EQ,C4C6C8D3,+8,EQ,C7F0F7),
      D F H L           G 0 7           <equates to

```

To use the example SLIP, you must:

1. Replace the `cicsjob` value with the name of the CICS job (or jobs) to be dumped.
2. Replace the `xx`, `yy`, and `zz` values with the appropriate operator reply numbers, as each segment is entered.
3. Replace the `structname` value with the name of the coupling facility structure that contains the failing log stream.

For system log failures only, you can get the name of the coupling facility structure (or structures) from the two DFHLG0104 messages that were issued when CICS connected to DFHLOG and DFHSHUNT during the run in which the failure occurred.

For all other log streams, to get the name of the coupling facility structure use the LIST LOGSTREAM NAME command already described. For example:

```

//LOGRRPT EXEC PGM=IXCMIAPU
//SYSPRINT DD SYSOUT=*
//SYSIN DD *
DATA
TYPE(LOGR)
REPORT(YES)
LIST LOGSTREAM NAME(logstream_name) DETAIL(YES)

```

Figure 37 on page 216 shows example output produced by the LIST LOGSTREAM NAME command. Search for the log stream name; the structure name follows it.

Step 3 on page 219 assumes two things:

- That the failing log stream is a CF log stream. If it is a DASD-only log stream, the STRLIST parameter in the example SLIP is not appropriate.
- That the logging problem is repeatable. It is assumed that the log stream has failed at least once before the SLIP is set (the initial failure allowing you to deduce the name of the coupling facility structure to be dumped).

Notes:

1. The example SLIP will just fit into the extended operator command area of MVS Version 5 or later.
2. The example SLIP may result in extra dumps being produced for both CICS and the MVS logger address space.

For definitive information about setting SLIP traps, see the *OS/390 MVS Diagnostics: Tools and Service Aids* manual, SY28-1085-03.

Restarting the MVS logger address space

If the MVS logger address space has failed, it can be restarted by the command S IXGLOGRS

Note the 'S' at the end—IXGLOGRS restarts IXGLOGR as a system address space.

After the MVS logger has restarted, you must restart all CICS regions.

CAUTION:

If you forcibly cancel the MVS logger address space (by issuing a FORCE IXGLOGR,ARM command) or coupling facility structures used by the MVS logger (by issuing a SETXCF FORCE,CON,STRNAME=structname,CONNAME=ALL command), there is a risk of corruption in the CICS system logs. If the system log is corrupted, CICS issues a message telling you that you need to perform an initial start. Data integrity will be compromised because of the loss of log data required for consistency.

Dealing with a corrupt system log

If the system log becomes corrupt, CICS quiesces. After the system log has been corrupted, it cannot be used again; to get CICS back into production, you must perform an initial start. To prevent the problem recurring, you also need to gather diagnosis information that will enable IBM Service to discover why the log was corrupted. Unfortunately, performing an initial start destroys all information from the previous run of CICS.

The CICS diagnostic run mechanism

One way to gather the required diagnosis information is to scan the failed system log, using a utility such as DFHJUP. However, the output produced by DFHJUP in these circumstances is not easy to interpret. To supplement DFHJUP's output, you

should perform a **diagnostic run** of CICS, using the corrupt system log, *before* performing the initial start. On a diagnostic run, CICS:

1. Produces a dump of the CICS system state, retrieved from the failed system log.
2. Terminates. Note that, on a diagnostic run, CICS *performs no recovery work and no new work*.

The output produced by a diagnostic run is usually passed to IBM Service.

Benefits of a diagnostic run: The advantages of performing a diagnostic run are:

- It collects diagnostic information automatically, thus allowing you to get CICS back into production quickly.
- When CICS failed, a system dump may not have been produced. A diagnostic run provides one.
- If the diagnostic run is not able to retrieve all the records from the CICS system log, the last record it retrieves shows the point at which the log became unreadable, and may indicate the cause of the problem.
- A diagnostic run allows you to capture a dump of the MVS logger address space—see “Getting dumps of the MVS logger and CF address spaces”.

How to perform a diagnostic run: For a diagnostic run to take place, AUTO must be specified on the START system initialization parameter. If the system log becomes corrupt, CICS:

- Sets the recovery manager autostart override record in the global catalog so that the next automatic restart of CICS is a diagnostic run (AUTODIAG).
- Issues message DFHRM0152, saying that the next automatic restart will be a diagnostic run, and should be performed before an initial start.

There may be occasions other than when the system log has become unusable when you feel it would be useful to perform a diagnostic run. You can use the recovery manager utility program, DFHRMUTL, to specify a diagnostic run. For information about DFHRMUTL, see the *CICS Operations and Utilities Guide*.

Getting dumps of the MVS logger and CF address spaces

For reliable diagnosis, it is important that you have dumps of the MVS logger address space and (if applicable) the CF structures used by the system log. This means that, before performing the diagnostic run, you will probably need to set a SLIP trap, as described in “Setting a SLIP trap” on page 218. You need to set a SLIP if *any* of the following are true:

- You have not applied MVS APAR OW27057.
- MVS did not produce a dump of the logger address space.
- MVS produced a dump of the logger address space but you have not kept the dump.
- The CICS system log uses CF log streams.

When specifying the SLIP, note the following:

1. Set the trap for the specific DFHLG07xx message that CICS issued when the original failure occurred—see the example SLIP on page Figure 38 on page 219. When the diagnostic run occurs and the failure repeats, the message will drive the SLIP.

Occasionally, the DFHLG07xx message that was issued at the time of the original failure is not repeated during a diagnostic run—instead, a different DFHLG07xx message is issued. Therefore the SLIP is not triggered. If this happens, perform another diagnostic run. This time, however, set the SLIP for the DFHLG07xx message that was issued during the first diagnostic run.

2. You do not need to specify a dump of the CICS system, because one is taken automatically by the diagnostic run mechanism. Change the JOBLIST parameter in the example SLIP to read:

```
JOBLIST=(IXGLOGR,XCFAS),
```

3. Specify a dump of the MVS logger address space—see the example SLIP. (If you have applied MVS APAR OW27057, and the original failure occurred because the MVS logger was unable to find a specific log stream block identifier, an extra dump may be produced.)
4. If the system log uses CF log streams, specify a dump of the coupling facility structure. You can get the name of the structure (or structures) from the two DFHLG0104 messages that were issued when CICS connected to DFHLOG and DFHSHUNT during the run in which the failure occurred.

If DFHLOG and DFHSHUNT use separate coupling facility structures, dump both structures. Specify the names of both structures on the STRLIST parameter.

Part 3. Using traces and dumps in problem determination

Chapter 14. Using traces in problem determination	227
CICS tracing	227
Trace points	228
Trace levels.	228
Specialized trace	229
CICS exception tracing	229
User exception trace entries.	230
CICS XRF tracing	230
Entry types	231
Program check and abend tracing	232
CICS VTAM exit tracing	232
Controlling CICS VTAM exit tracing	233
Interpreting CICS VTAM exit trace entries.	233
VTAM buffer tracing.	234
Specifying the CICS tracing you want	234
Selecting tracing by transaction	234
Tracing for selected tasks	237
The tracing logic used by CICS	239
Selecting tracing by component	239
Component names and abbreviations	240
Selecting trace destinations and related options	242
CICS internal trace	242
CICS auxiliary trace.	243
CICS GTF trace	244
Setting the tracing status	245
Setting the tracing status at system initialization	245
Formatting and interpreting trace entries	247
Interpreting extended-format CICS system trace entries	248
Interpreting abbreviated-format CICS system trace entries	252
Interpreting short-format CICS system trace entries	254
Interpreting user trace entries	254
Chapter 15. Using dumps in problem determination.	257
Controlling dump action	257
Setting up the dumping environment	257
Detecting and avoiding duplicate system dumps	258
Events that can cause dumps to be taken	258
The ways that you can request dumps	258
The occasions when CICS requests a dump	259
CICS dumping in a sysplex	260
Automatic dump data capture from related CICS regions	260
Operator-requested simultaneous dump data capture	261
Requesting dumps to resolve SMSVSAM problems	262
Useful CICS master terminal and MVS console commands in a sysplex	262
Enabling system dumps for some CICS messages	267
System dump actions with messages DFHAP0001 and DFHSR0001.	267
The dump code options you can specify	268
Dump table statistics	269
The transaction dump table	270
The system dump table	272
What happens to a dump request if there is no dump table entry?	272
Specifying the areas you want written to a transaction dump.	274
The CSFE ZCQTRACE facility.	274

Where dumps are written	275
Looking at dumps	276
Formatting transaction dumps	276
Interpreting transaction dumps	276
Job log	277
Symptom string	277
CICS Transaction Server for OS/390 level	277
Transaction environment summary	277
Remote abend indicator	277
PSW	277
Registers at the time of interrupt	277
Execution key	277
Space	278
Registers at last EXEC command	278
Task control area (TCA)	278
Task control area, system area	278
Transaction work area (TWA)	278
EXEC interface structure (EIS)	278
System EXEC interface block (SYSEIB)	278
EXEC interface user structure (EIUS)	278
EXEC interface block (DFHEIB)	278
Kernel stack entries	278
Common system area (CSA)	279
Common system area optional features list (CSAOPFL)	279
Trace table (abbreviated format)	279
Trace table (extended format)	279
Common work area (CWA)	279
Transaction storage	279
Terminal control table terminal entry (TCTTE)	280
Program information for the current transaction	280
Module index	280
Locating the last command or statement	280
Last command identification	281
Last statement identification	281
Locating program data	282
Dumps for C/370 programs	282
Location of COBOL dumped areas	282
The dumped COBOL area	283
BLL cells in a CICS application program	283
Formatting system dumps	283
The DFHIPCSP CICS exit control data	284
A summary of system dump formatting keywords and levels	285
The default SDUMP formatting levels	294
Storage freeze	295
Dumping a CFDT list structure	295
Formatting a coupling facility data table pool dump	295
Dumping a named counter list structure	296
Formatting a named counter pool dump	297
Using FEPI dump	297
Chapter 16. The global trap/trace exit	299
Establishing the exit	299
Information passed to the exit	299
Actions the exit can take	300
Program check handling	301

Coding the exit 301

Part 3 contains:

Chapter 14. Using traces in problem determination

The types of tracing that can be used for CICS systems are:

- CICS tracing - done by the trace domain at predetermined trace points in CICS code during the regular flow of control. This includes user tracing from applications. You get this when you turn on CICS internal tracing, auxiliary tracing, and GTF tracing. You control this type of tracing to suit your needs, except that, when an exception condition is detected by CICS, it always makes an exception trace entry. You cannot turn exception tracing off.
- Tracing from the CICS exit programming interface (XPI), using the TRACE_PUT XPI call from an exit program. You can control this within the exit program, or by enabling and disabling exits.
- CICS XRF tracing, which records CICS XRF-related activities. This is always running if you are operating in a CICS XRF environment.
- Program check and abend tracing, which is used by CICS to record pertinent information when a program check or abend occurs. This is controlled by CICS code.
- CICS VTAM exit tracing. The exits are driven by VTAM when it reaches a particular stage in its asynchronous processing, but the trace points are in CICS code. You can turn CICS VTAM exit tracing on or off.
- VTAM buffer tracing. This is a part of VTAM, but it can be used to record the flow of data between logical units in the CICS environment. You can control this type of tracing to meet your needs.

This section is arranged as follows:

- “CICS tracing”—a description of CICS trace and tracing levels.
- “Specialized trace” on page 229—further details about the various specialized forms of trace that you can use with CICS.
- “Specifying the CICS tracing you want” on page 234—a discussion of the various selection mechanisms available to you to control the extent of CICS tracing carried out in the system.
- “Selecting trace destinations and related options” on page 242—a description of the internal trace table, auxiliary tracing, and CICS GTF trace.
- “Formatting and interpreting trace entries” on page 247—guidance on formatting and interpreting CICS trace, with samples of trace output.

CICS tracing

General CICS tracing is handled by trace domain. It traces the flow of execution through CICS code, and through your applications as well. For programming information about how to make trace calls from within your own programs, see the *CICS Application Programming Reference* manual. You can see what functions are being performed, which parameters are being passed, and the values of important data fields at the time trace calls are made. This type of tracing is also useful in “first failure data capture”, if an exception condition is detected by CICS.

Trace points

Trace points are included at specific points in CICS code; from these points, trace entries can be written to any currently selected trace destination. All CICS trace points are listed in alphanumeric sequence in the *CICS User's Handbook*.

Trace levels

Some trace points are used to make exception traces when exception conditions occur, and some are used to trace the mainline execution of CICS code. Trace points of the latter type each have an associated "level" attribute. The value of this attribute depends on where the trace point is, and the sort of detail it can provide on a trace call.

Trace levels can, in principle, vary in value in the range 1–32, but in practice nearly all mainline trace points have a trace level of 1 or 2.

Level-1 trace points are designed to give you enough diagnostic information to fix "user" errors. The following is a summary of where they are located, and a description of the information they return:

- On entry to, and exit from, every CICS domain. The information includes the domain call parameter list, and data whose address is contained in the parameter list if it is necessary for a high-level understanding of the function to be performed.
- On entry to, and exit from, major internal domain functions. The information includes parameters passed on the call, and any output from the function.
- Before and after calls to other programs, for example, VTAM. The information includes what request is to be made, the input parameters on the request, and the result of the call.
- At many of the points where trace calls were made in CICS/MVS Version 2. The type of information is the same as for that release.

Level-2 trace points are situated between the level-1 trace points, and they provide information that is likely to be more useful for fixing errors within CICS code. You probably will not want to use level-2 trace points yourself, unless you are requested to do so by IBM support staff after you have referred a problem to them.

Level-3 trace points and above are reserved for special cases. Very few components have trace points higher than 2, and they are only likely to be of use by IBM support staff.

You can select how much CICS system tracing is to be done on the basis of the trace level attributes of trace points. You can make your selection independently for each CICS component, and you can also vary the amount of tracing to be done for each task. This gives you control over what system tracing is done.

Note: In the storage manager component (SM), two levels of tracing, level 3 and level 4, are intended for IBM field engineering staff. These trace levels take effect only if specified in system initialization parameters and modify the internal SM operation for CICS subpools as follows:

SM level 3 trace

The quickcell mechanism is deactivated. Every CICS subpool, regardless of quickcelling requirements, will issue domain calls for getmain and freemain services, and these calls will be traced.

SM level 4 trace

Subpool element chaining on every CICS subpool is forced. Every CICS subpool, regardless of element chaining requirements, will use element chaining.

A significant performance overhead is introduced into your CICS system if these storage manager trace levels are selected. Note that specifying SM=ALL activates SM trace levels 1, 2, 3, and 4.

Specialized trace

In addition to the general trace produced by CICS, there is a number of other, more specialized forms of trace that you can use. These are described as follows:

- “CICS exception tracing”
- “CICS XRF tracing” on page 230
- “Program check and abend tracing” on page 232
- “CICS VTAM exit tracing” on page 232
- FEPI trace.

For information about using trace to solve FEPI problems, see the *CICS Front End Programming Interface User's Guide*.

CICS exception tracing

CICS exception tracing is always done by CICS when it detects an exception condition. The sorts of exception that might be detected include bad parameters on a domain call, and any abnormal response from a called routine. The aim is “first failure data capture”, to record data that might be relevant to the exception as soon as possible after it has been detected.

CICS uses a similar mechanism for both exception tracing and “normal” tracing. Exception trace entries are made from specific points in CICS code, and data is taken from areas that might provide information about the cause of the exception. The first data field in the trace entry is usually the parameter list from the last domain call, because this can indicate the reason for the exception.

The exception trace points do not have an associated “level” attribute, and trace calls are only ever made from them when exception conditions occur.

Exception trace entries are always written to the internal trace table, even if no trace destinations at all are currently STARTED. That is why there is always an internal trace table in every CICS region, to make sure there is always somewhere to write exception trace entries. If the other trace destinations are STARTED, the exception trace entries are written there, as well.

You can select tracing options so that exception traces *only* are made to an auxiliary trace data set. This is likely to be useful for production regions, because it enables you to preserve exception traces in auxiliary storage without incurring any general tracing overhead. You need to disable all standard and special task tracing, and enable auxiliary trace:

1. Ensure that special tracing has not been specified for any task.
2. Set the master system trace flag off.

3. Set the auxiliary trace status to `STARTED`, and the auxiliary trace data set and the auxiliary switch status to whatever values you want.

Exception traces are now made to an auxiliary trace data set, but there is no other tracing overhead.

The format of an exception trace entry is almost identical to that of a normal trace entry. However, you can identify it by the eye-catcher `*EXC*` in the header.

Note: Exception conditions that are detected by MVS—for example, operation exception, protection exception, or data exception—do not cause a CICS exception trace entry to be made directly. However, they do cause a CICS recovery routine to be invoked, and that, in turn, causes a “recovery” exception trace entry to be made.

User exception trace entries

The `EXCEPTION` option on the `EXEC CICS ENTER TRACENUM` command enables user programs to write a trace entry to the trace destinations, even when the master user trace flag is off. User exception trace entries are always written to the internal trace table (even if internal tracing is set off), but are written to other destinations only if they are active.

The user exception trace entries CICS writes are identified by the character string `*EXCU` in any formatted trace output produced by CICS utility programs. For example, an application program exception trace entry generated by an `EXEC CICS ENTER TRACENUM() EXCEPTION` command appears in formatted trace output as:

```
USER *EXCU - APPLICATION-PROGRAM-EXCEPTION
```

If you use the exit programming interface (XPI) trace control function to write user trace entries, you can use the `DATA1` block descriptor to indicate whether the entry is an exception trace entry. Enter the literal `'USEREXC'` in the `DATA1` field on the `DFHTRPTX TRACE_PUT` call to identify an exception trace entry. This is interpreted by the trace formatting utility program as follows:

```
USER *EXCU - USER-EXIT-PROGRAM-EXCEPTION
```

See the *CICS Customization Guide* for programming information about XPI trace control function.

CICS XRF tracing

CICS XRF tracing is always active when you are running with XRF. It is used by the CICS availability manager (CAVM), and you cannot turn it off. However, it only makes about 12 entries every 2 seconds, so the overhead is not great. Note that CICS XRF tracing is quite distinct from the “normal” CICS tracing that can originate from the CAVM, which is identified by trace point IDs `AP 00C4` through `AP 00C7`.

The XRF trace entries are 32 bytes long and are written to a trace table in main storage. The table has a fixed size of 64KB, and it wraps around when it is full.

The table starts with 28 bytes of control information, in the format shown in Table 34 on page 231.

Table 34. Control information at the start of the XRF trace table

Bytes	Contents
0–15	'*** XRF TRACE **'
16–19	Address of start of trace entries
20–23	Address of end of trace entries
24–27	Address of end of most recent entry

Trace entries are 32 bytes long, and have the format shown in Table 35.

Table 35. Format of an XRF trace entry

Bytes	Contents
0	Type code
1	Subtype
2–3	Process ID of XRF process that made the entry
4–27	Trace data—the format depends on the type or the subtype
28–31	Clock value when entry was made, same format as “normal” CICS trace entries

Process IDs are assigned in order of process ATTACH starting from 1. Some special values are used for processes which are not known to the dispatcher, but which cause trace entries to be made. These are:

Process ID Function

X'0000' Initial attach
 X'FFFE' ESPIE/ESTAE error handling
 X'FFFF' Dispatcher activities.

Entry types

The entries are as follows:

Table 36. XRF trace entry types

Module	Type	Subtype	Description
DFHWLGET	1	1	Module entry Bytes 4-11 Module name Bytes 12-15 LIFO allocation address
DFHWLFRE	1	2	Module return Bytes 4-11 Module name Bytes 12-15 LIFO allocation address Bytes 16-27 0
DFHWDATT	2	1	XRF process attach Bytes 4- 7 Process entry point Bytes 8-11 Initial data parameter Bytes 12-15 Address of ESPIE routine Bytes 16-19 Address of ESTAE routine Bytes 20-23 Address of attached process XPB Bytes 24-27 Process ID attached process XPB
DFHWDISP	2	2	XRF process detach Bytes 4-27 0
DFHWDISP	2	3	XRF process dispatch Bytes 4- 7 Address of external ECB waited for Bytes 8-11 Address of internal ECB waited for Bytes 12-15 Awaited broadcast events which were posted Bytes 16-19 Broadcast events still posted for this process Bytes 20-23 Address of process XPB Bytes 24-27 Locks held by this process
DFHWDWAT	2	4	XRF process wait (event data) Bytes 4- 7 Address of external ECB to wait for Bytes 8-11 Address of internal ECB to wait for Bytes 12-15 Broadcast events to wait for Bytes 16-19 Events to be broadcast to all processes Bytes 20-23 Events to be reset for this process Bytes 24-27 0

Table 36. XRF trace entry types (continued)

Module	Type	Subtype	Description
DFHWDAT	2	5	XRF process wait (lock data) Bytes 4- 7 Locks to be freed Bytes 8-11 Locks to be acquired Bytes 12-19 0 Bytes 20-23 Locks held by all other processes at time of call Bytes 24-27 Locks held by this process at time of call
DFHWDISP	2	6	Dispatcher termination Bytes 4-27 0
DFHDISP	2	7	Dispatcher issuing OS WAIT Bytes 4-19 0 Bytes 20-23 Address of WAIT list Bytes 24-27 Number of ECBs in WAIT list
DFHWDISP	2	8	Dispatcher resume after OS WAIT Bytes 4-27 0
DFHWMMT	3	1	Message manager issuing VSAM GET Bytes 4- 7 RPL address Bytes 8-11 RBA of CI to be read Bytes 12-27 0
DFHWMMT	3	2	Message manager issuing VSAM PUT Bytes 4- 7 RPL address Bytes 8-11 RBA of CI to be read Bytes 12-27 0
DFHWMMT	3	3	Message manager I/O complete Bytes 4- 7 RPL address Bytes 8-11 RBA of CI to be read Byte 12 0 Bytes 13-15 VSAM feedback information Bytes 16-27 0
DFHWMQH	4	1	Message manager message received Bytes 4- 7 0 Bytes 8-11 Queue name Bytes 12-15 Message sequence number Bytes 16-19 Address of message block (contains message copy) Bytes 20-27 0
DFHWMWR	4	2	Message manager message sent Bytes 4- 7 0 Bytes 8-11 Queue name Bytes 12-15 Message sequence number Bytes 16-19 Message file cycle number(contains message copy) Bytes 20-23 RBA of this message Bytes 24-25 0 Bytes 26-27 Response to PUTMSG request (WMSRESP)

Program check and abend tracing

Program check and abend tracing is carried out by kernel domain. The kernel records information about program checks and abends, including details of the registers and the PSW at the time of failure.

You cannot format the program check and abend trace information directly, but you get a summary of its contents in a formatted CICS system dump when you specify dump formatting keyword KE. The information is provided in the form of a storage report for each task that has had a program check or an abend during the current run of CICS.

An example of such a storage report is given in Figure 2 on page 49.

CICS VTAM exit tracing

CICS VTAM exit tracing gives you a way of tracing VTAM requests made from CICS. You can control it online, using CETR—see Figure 41 on page 238 for an illustration of the screen you need to use.

When CICS issues a VTAM request, VTAM services the request asynchronously and CICS continues executing. When VTAM has finished with the request, it returns control to CICS by driving a CICS VTAM exit. Every such exit contains a trace point, and if CICS VTAM exit tracing is active, a trace entry is written to the GTF trace data set. GTF tracing must be active, but you do not need to start it explicitly from CICS. It is enough to start VTAM exit tracing from the CETR transaction and terminal trace panel.

Note: The GTF trace data set can receive trace entries from a variety of jobs running in different address spaces. You need to identify the trace entries that have been made from the CICS region that interests you. You can do this by looking at the job name that precedes every trace entry in the formatted output.

You can use this type of tracing in any of the cases where you might want to use VTAM buffer tracing, but it has the advantage of being part of CICS and, therefore, controllable from CICS. This means that you do not need a good understanding of VTAM system programming to be able to use it. CICS VTAM exit tracing also has the advantage of tracing some important CICS data areas relating to VTAM requests, which might be useful for diagnosing problems.

Controlling CICS VTAM exit tracing

You can turn CICS VTAM exit tracing on and off using the CETR transaction. You can specify tracing for just a single terminal, or for all the terminals in the VTAM network. However, you cannot select which CICS exits are to be traced. Whenever CICS VTAM exit tracing is running, you get a trace entry every time a CICS exit is driven by VTAM.

If you select “normal” CICS tracing for the affected terminals at the same time as you have CICS VTAM exit tracing running, you can then correlate CICS activities more easily with the asynchronous processing done by VTAM.

If you need to turn on CICS VTAM exit tracing in an application owning region (AOR) while you are signed-on to a terminal in a terminal owning region (TOR), follow these steps:

1. Invoke CETR on the AOR.
2. Press PF5 to call up the CETR transaction and terminal trace screen.
3. Enter the APPLID of the TOR in the NETNAME field.
4. Complete other fields as required.
5. Press Enter.

CICS VTAM trace entries are always written to the GTF trace data set, and you can format them in the usual way—see “Formatting and interpreting trace entries” on page 247. Direct all “normal” CICS tracing to the GTF trace destination as well, so you get the regular trace entries and the CICS VTAM exit trace entries in sequence in a single data set. If you send the normal tracing to another destination, you get only the isolated traces from the exit modules with no idea of related CICS activity.

Interpreting CICS VTAM exit trace entries

CICS VTAM exit trace entries can be identified by their trace point IDs, which are in the range AP FC00 through AP FCFF. Not all the values in the range are used.

The format of the trace entries is similar to that shown in Figure 47 on page 251. The interpretation string contains the netname of the terminal to which the trace entry relates, if the trace entry was made from a terminal-specific trace point. This makes it easy to identify the terminal associated with the VTAM request. The trace entries also contain data from one or more selected CICS data fields, for example from the TCTTE. For guidance on interpreting the data values you might find there, see the *CICS User's Handbook*.

VTAM buffer tracing

VTAM buffer tracing enables you to look at all the data that is passed between logical units on a VTAM communication link.

The trace entries, which include the netname of the terminal to which they relate, are made to the GTF trace data set. If you want to send “normal” CICS trace entries there, you can rationalize the activities of CICS with the asynchronous activities of VTAM. For details of VTAM buffer tracing, see the appropriate manual in the VTAM library.

Specifying the CICS tracing you want

You have a large amount of control over the amount of CICS tracing that is done. You can select tracing by transaction, by CICS component, and by level of detail.

You can select any combination of internal tracing, auxiliary tracing and GTF tracing to be active at the same time. Your choice has no effect on the selectivity with which system tracing is done, but each type of tracing has a set of characteristic properties. These properties are described in “CICS internal trace” on page 242, “CICS auxiliary trace” on page 243, and “CICS GTF trace” on page 244.

Selecting tracing by transaction

For each transaction, you can specify whether *standard* tracing or *special* tracing is to be done, or whether tracing is to be suppressed for that transaction altogether.

For each component, you can specify two sets of trace level attributes. The trace level attributes define the trace point IDs to be traced for that component when standard task tracing is being done and when special task tracing is being done, respectively.

If you are running a test region, you probably have background tracing most of the time. In this case, the default tracing options (standard tracing for all transactions, and level-1 trace points only in the standard set for all components) probably suffice. All you need do is to enable the required trace destinations and set up any related tracing options. Details are given in “Selecting trace destinations and related options” on page 242.

For a production system, background tracing might incur an unacceptable processing overhead. If you find this to be so, you are recommended to set up tracing so that exception traces *only* are recorded on an auxiliary trace data set. There need be no other tracing overhead, and you can be sure that the exception trace will be preserved even when the event invoking the trace does not cause a system dump to be taken. For details, see “CICS exception tracing” on page 229.

When specific problems arise, you can set up special tracing so you can focus on just the relevant tasks and components. A scheme for specifying the tracing you need is outlined in Figure 39 on page 235.

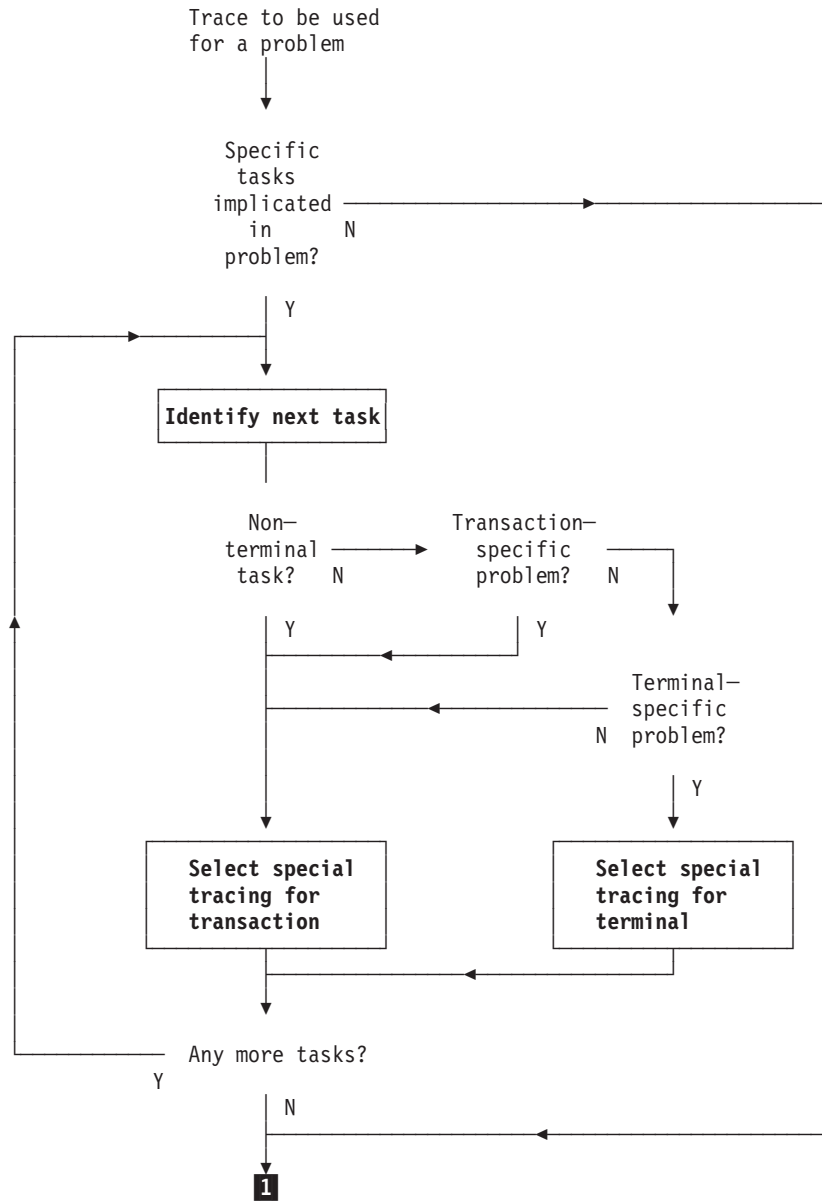

Figure 39. Outline scheme for setting up special tracing for problems (Part 1 of 3)

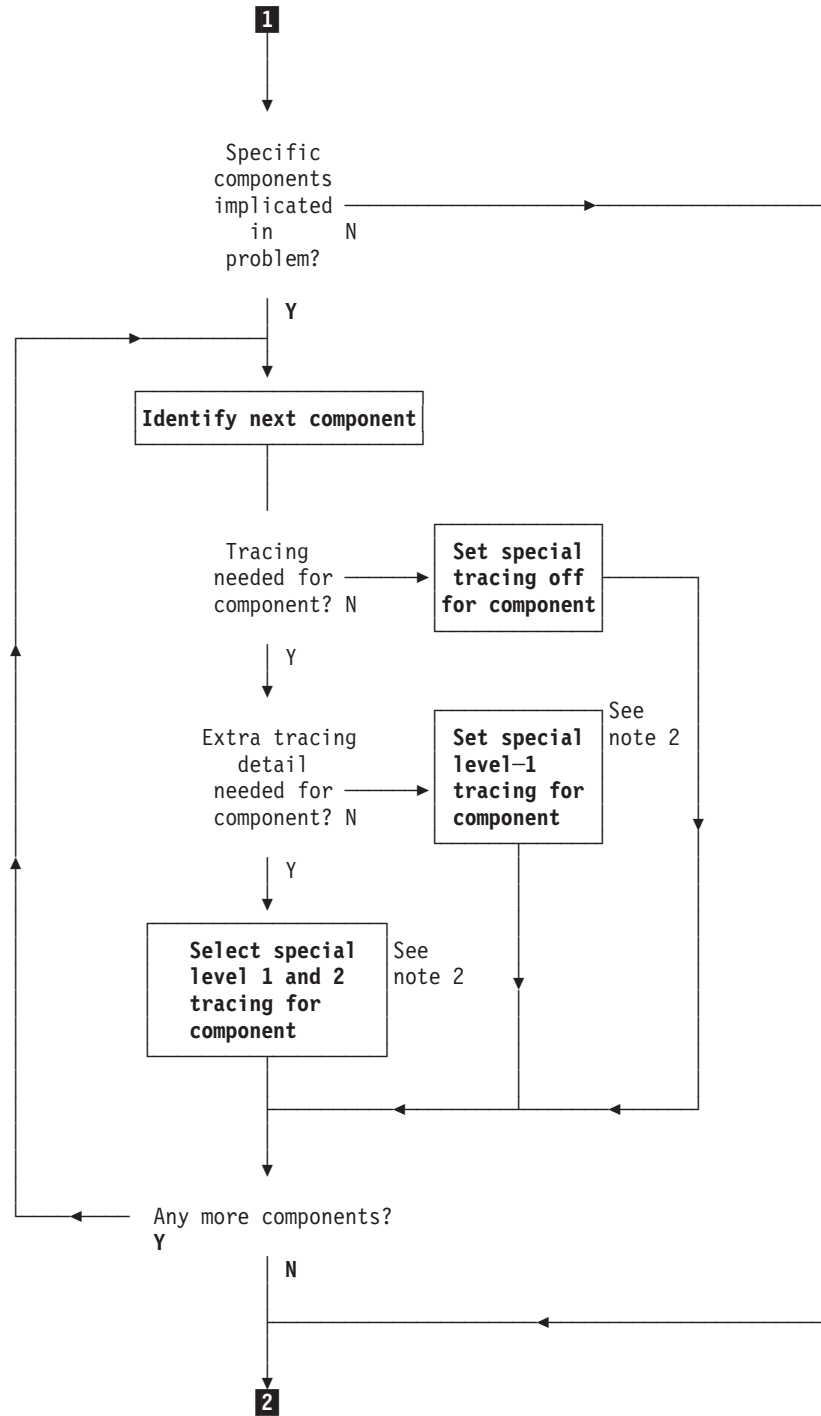

Figure 39. Outline scheme for setting up special tracing for problems (Part 2 of 3)

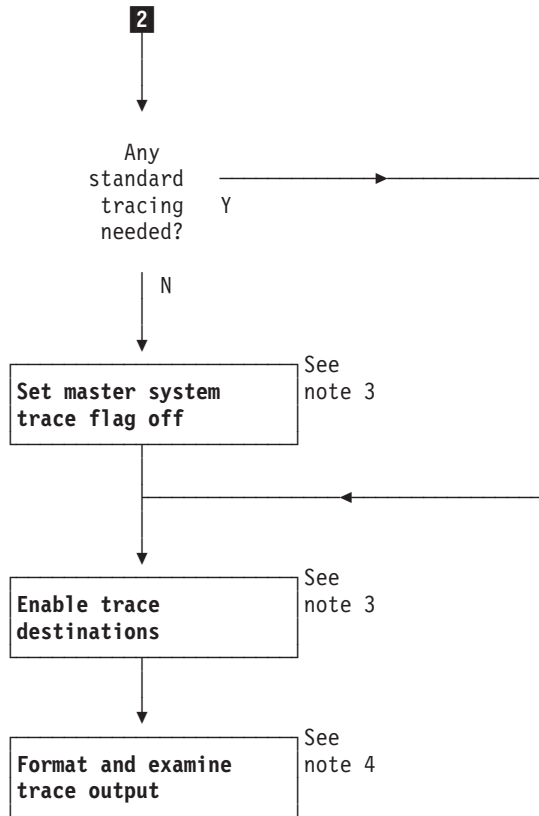

Figure 39. Outline scheme for setting up special tracing for problems (Part 3 of 3)

Notes:

1. See “Tracing for selected tasks”
2. See “Selecting tracing by component” on page 239
3. See “Setting the tracing status” on page 245
4. See “Formatting and interpreting trace entries” on page 247; “Interpreting extended-format CICS system trace entries” on page 248; and “Interpreting abbreviated-format CICS system trace entries” on page 252.

Tracing for selected tasks

You can select which tasks are to have standard tracing, which are to have special tracing, and which are to have tracing suppressed. If you specify standard tracing for a task, trace entries are made at all the trace points in the standard set. If you specify special task tracing, you get trace entries at all the trace points in the special set. If you suppress tracing for a task, you do not get any tracing done (except exception tracing) when that task is running.

For transactions that run at terminals, a task is considered to be an instance of a transaction run at a specific terminal. By defining the type of tracing you want by transaction and terminal, you automatically define what task tracing is to be done.

For non-terminal transactions, a task is just an instance of the transaction. The type of tracing you define for the transaction alone defines the type of task tracing that is to be done.

The type of task tracing you get for the various combinations of transaction tracing and terminal tracing is summarized in the truth table shown in Figure 40. You can set up the task tracing you want using the CETR transaction, with the

OPTION on TRANSACTION	OPTION on TERMINAL	
	standard tracing	special tracing
tracing suppressed	SUPPRESSED	SUPPRESSED
standard tracing	STANDARD	SPECIAL
special tracing	SPECIAL	SPECIAL

Figure 40. The combination of task trace options

screen shown in Figure 41. You need to type in the transaction ID or the terminal ID or the netname for the terminal, together with the appropriate tracing.

The status can be any one of STANDARD, SPECIAL, or SUPPRESSED for the transaction, and either STANDARD or SPECIAL for the terminal.

This screen can also be used to set up certain other terminal tracing options. You can select ZCP tracing for a named terminal (trace point ID AP 00E6), and you can also select CICS VTAM exit tracing for the terminal. For more details about CICS VTAM exit tracing, see "CICS VTAM exit tracing" on page 232.

The CETR transaction can, for example, help you to get standard tracing for a

```

CETR                               Transaction and Terminal Trace
Type in your choices.
Item                               Choice   Possible choices
Transaction ID                      ===>   Any valid 4 character ID
Transaction Status                   ===>   STandard, SPecial, SUPpressed
Terminal ID                          ===>   Any valid Terminal ID
Netname                              ===>   Any valid Netname
Terminal Status                      ===>   STandard, SPecial
Terminal VTAM Exit Trace             ===>   ON, OFF
Terminal ZCP Trace                   ===>   ON, OFF
VTAM Exit override                   ===>   NONE      All, System, None
When finished, press ENTER.
PF1=Help    3=Quit    6=Cancel Exits    9=Error List
  
```

Figure 41. CETR screen for specifying standard and special task tracing

transaction when it is run at one terminal, and special tracing when it is run at a second terminal.

Notes:

1. You can turn standard tracing off for *all* tasks by setting the master system trace flag off. You can do this with the CETR transaction, using the screen shown in

Figure 44 on page 245, or you can code SYSTR=OFF at system initialization. However, any special task tracing will continue—it is not affected by the setting of the system master trace flag.

2. If you run with standard tracing turned off and you specify levels of tracing for the required components under the "Special" heading in the "Components Trace Options" screen shown in Figure 43 on page 242, you can use CETR to trace a single transaction. To do this, specify the transaction ID and a transaction status of SPECIAL, on the screen shown in Figure 41 on page 238.

The tracing logic used by CICS

The logic used by CICS to decide whether a trace call is to be made from a trace point is shown in Figure 42. It is assumed that at least one trace destination is STARTED.

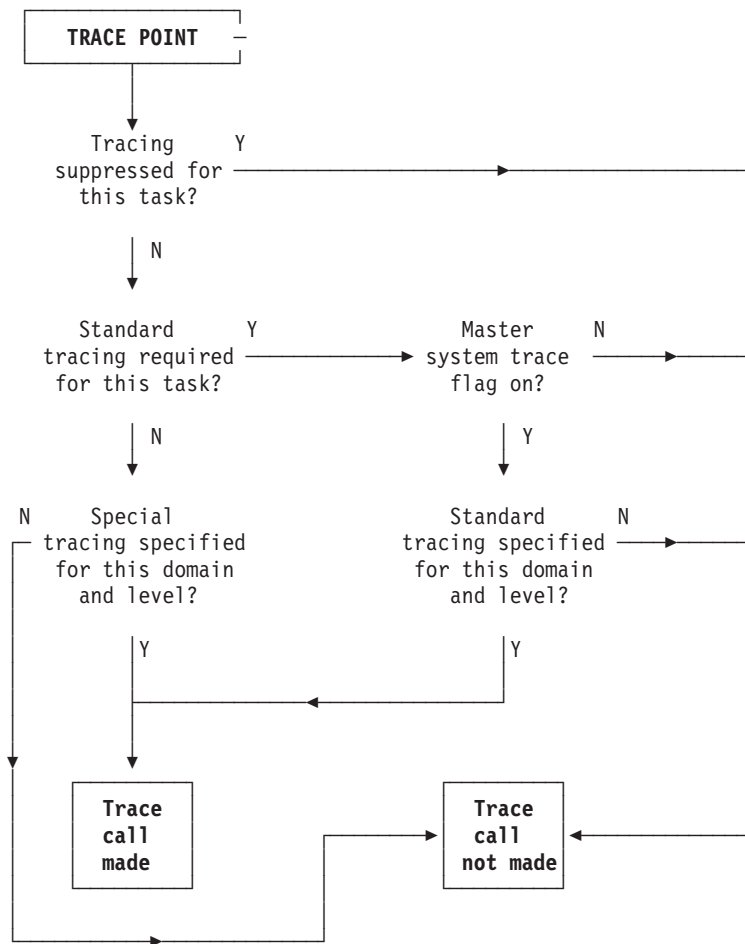

Figure 42. Logic used to determine if a trace call is to be made from a trace point

Selecting tracing by component

"Component names and abbreviations" on page 240 lists the components for which you can select trace levels for standard and special tracing. You can reference this list online through CETR, by pressing PF1 on the component screen (see Figure 43 on page 242).

You need to decide for each component the trace levels to be used for both standard and special tracing. You can define this either during system initialization, or online using the CETR transaction.

Note: The component codes BF, BM, BR, CP, DC, DI, EI, FC, IC, IS, KC, PC, SC, SZ, TC, TD, TS, UE, and WB are subcomponents of the AP domain. The corresponding trace entries are produced with a point ID of AP nnnn.

For example, trace point AP 0471 is a file control level-1 trace point and AP 0472 is a file control level-2 trace point. These trace points are produced only if the trace setting for the FC component is "(1,2)" or "ALL". The component code AP is used for trace points from the AP domain that do not fall into any of the subcomponent areas listed above.

Component names and abbreviations

Code	Component name
AP	Application domain
BA	Business application manager
BF	Built-in function
BM	Basic mapping support
BR	3270 bridge
CP	Common programming interface
DC	Dump compatibility layer
DD	Directory manager domain
DH	Document Handler
DI	Batch data interchange
DM	Domain manager domain
DS	Dispatcher domain
DU	Dump domain
EI	Exec interface
EM	Event manager domain
FC	File control
GC	Global catalog domain
IC	Interval control
IS	ISC or IRC
KC	Task control
KE	Kernel
LC	Local catalog domain
LD	Loader domain
LG	Log manager domain
LM	Lock domain
ME	Message domain
MN	Monitoring domain
NQ	Enqueue domain
PA	Parameter domain

Code	Component name
PC	Program control
PG	Program manager domain
RI	RMI
RM	Recovery manager domain
RX	RRS-coordinated EXCI domain
SC	Storage control
SH	Scheduler services domain
SM	Storage manager domain
SO	Sockets domain
ST	Statistics domain
SZ	Front End Programming Interface
TC	Terminal control
TD	Transient data
TI	Timer domain
TR	Trace domain
TS	Temporary storage domain
UE	User exit interface
US	User domain
WB	Web interface domain
XM	Transaction manager domain
XS	Security manager domain

Defining component tracing at system initialization: You can code any of the following parameters to define component tracing at CICS system initialization time:

- SPCTR, to indicate the level of special tracing required for CICS as a whole.
- SPCTRxx, where xx is one of the two-character component identifiers that specify the level of special tracing you require for a particular CICS component (see “Component names and abbreviations” on page 240).
- STNTR, to indicate the level of standard tracing required for CICS as a whole.
- STNTRxx, where xx is one of the two-character component identifiers that specify the level of standard tracing you require for a particular CICS component (see “Component names and abbreviations” on page 240).

For more information about system initialization parameters, see the *CICS System Definition Guide*.

Defining component tracing when the CICS system is running: You can use the CETR transaction to define component tracing dynamically on the running CICS system.

Figure 43 on page 242 shows you what the CETR Component Trace Options screen looks like. To make changes, you overwrite the settings shown on the screen, and then press ENTER.

Component Trace Options		PAGE 1 OF 3
Component	Standard	Special
AP	1	1-2
BA	1	1-2
BM	1	1
BR	1	1-2
CP	1	1-2
DC	1	1
DD	1	1-2
DH	1	1-2
DM	1	1-2
DS	1	1-2
DU	1	1-2
EI	1	1-2
EM	1	1-2
FC	1	1-2
GC	1	1-2
IC	1	1-2
IS	1	1-2

PF: 1=Help 3=Quit 7=Back 8=Forward 9=Messages ENTER=Change

Figure 43. CETR screen for specifying component trace options

With the settings shown, trace entries are made as follows:

- With standard task tracing in effect, from level-1 trace points of all the components listed.
- With standard task tracing in effect, from level-2 trace points for the 3270 Bridge component.
- With special task tracing in effect:
 - From level-1 trace points only for components DI, EI, IC, and KC
 - From both level-1 and level-2 trace points for components AP, CP, DD, DM, DS, DU, FC, GC, and KE.

No special task tracing is done for components BF, BM, DC, and IS.

Selecting trace destinations and related options

The trace destinations you select and the options you define for the destinations depends on your specific problem determination requirements. You can select any combination of CICS internal tracing, CICS auxiliary tracing, and CICS GTF tracing. Your decision must be based on the characteristics of the various types of CICS tracing, which are described in “CICS internal trace”, “CICS auxiliary trace” on page 243, and “CICS GTF trace” on page 244. You need to decide how much trace data you need to capture, and whether you want to integrate CICS tracing with tracing done by other programs.

You can control the status and certain other attributes of the various types of CICS tracing either dynamically, using the CETR transaction, or during system initialization, by coding the appropriate system initialization parameters.

CICS internal trace

You can select a status of STARTED or STOPPED for internal trace. If you select STARTED, any trace calls that are made cause trace entries to be directed to the internal trace table. This occupies a sequence of pages in virtual storage above the 16MB line, in MVS GETMAIN storage.

The internal trace table has a minimum size of 16KB, and a maximum size of 1 048 576KB. The table is extendable from 16KB in 4KB increments. You can change the size of the table dynamically, while CICS is running, but if you do so you lose all of the trace data that was present in the table at the time of the change. If you want to keep the data *and* change the size of the table, take a system dump before you make the change.

The internal trace table wraps when it is full. When the end of the table is reached, the next entry to be directed to the internal trace entry goes to the start, and overlays the trace entry that was formerly there. In practice, the internal trace table cannot be very big, so it is most useful for background tracing or when you do not need to capture an extensive set of trace entries. If you need to trace CICS system activity over a long period, or if you need many entries over a short period, one of the other trace destinations is likely to be more appropriate.

Note that the internal trace table is always present in virtual storage, whether you have turned internal tracing on or not. The reason is that the internal trace table is used as a destination for trace entries when CICS detects an exception condition. Other trace destinations that are currently selected get the exception trace entry as well, but the entry always goes to the internal trace table even if you have turned tracing off completely. This is so that you get “first failure data capture”.

CICS auxiliary trace

CICS auxiliary trace entries are directed to one or other of two auxiliary trace data sets, DFHAUXT and DFHBUXT. These are CICS-owned BSAM data sets, and they must be created before CICS is started. They cannot be redefined dynamically.

You can use the AUXTR system initialization parameter to turn CICS auxiliary trace on or off in the system initialization table.

You can select a status of STARTED, STOPPED, or PAUSED for CICS auxiliary trace dynamically using the CETR transaction. These statuses reflect both the value of the auxiliary trace flag, and the status of the current auxiliary trace data set, in the way shown in Table 37.

Table 37. The meanings of auxiliary trace status values

Auxiliary tracing status	Auxiliary trace flag	Auxiliary trace data set
STARTED	ON	OPEN
STOPPED	OFF	CLOSED
PAUSED	OFF	OPEN

When you first select STARTED for CICS auxiliary trace, any trace entries are directed to the initial auxiliary trace data set. If CICS terminated normally when auxiliary trace was last active, this is the auxiliary trace data set that was not being used at the time. Otherwise, it is the DFHAUXT data set. If you initialize CICS with auxiliary trace STARTED, DFHAUXT is used as the initial auxiliary trace data set.

What happens when the initial data set is full depends on the status of the auxiliary switch (AUXTRSW). This can have a value of NO, NEXT, or ALL, and you can define it either in the system initialization table, using the AUXTRSW system initialization parameter, or dynamically using the CETR transaction.

NO means that when the initial data set is full, no more auxiliary tracing is done.

NEXT means that when the initial data set is full, then the other data set receives the next trace entries. However, when *that* one is full, no more trace data is written to auxiliary trace.

ALL means that auxiliary trace data is written alternately to each data set, a switch being made from one to the other every time the current one becomes full. This means that trace entries already present in the trace data sets start getting overwritten when both data sets become full for the first time.

The advantage of using auxiliary trace is that you can collect large amounts of trace data, if you initially define large enough trace data sets. For example, you might want to do this to trace system activity over a long period of time, perhaps to solve an unpredictable storage violation problem.

A time stamp is included in the header line of every page of abbreviated auxiliary trace output to help match external events with a particular area of the trace, and thus help you to find the trace entries that are of interest.

CICS GTF trace

CICS GTF trace is an invocation of MVS GTF trace, and the trace entries are directed to a destination defined to MVS. This can be either a trace table in main storage, or a single external GTF trace data set.

You can switch CICS GTF trace on or off by using the GTFTR system initialization parameter.

You can select a status of STARTED or STOPPED for CICS GTF trace dynamically using the CETR transaction. MVS GTF trace must be started with the TRACE=USR option before CICS GTF trace is started, because otherwise no trace entries can be written.

In a multi-system environment, trace entries from CICS Version 3, CICS for MVS/ESA 4.1, CICS Transaction Server for OS/390 Release 2, and CICS Transaction Server for OS/390 Release 3, can be recorded in the GTF trace data set. Entries from all releases are formatted by the CICS-supplied routine, DFHTG530. See the *CICS Operations and Utilities Guide* for details of how to format and print the GTF trace data set.

When the GTF trace data set is full, it wraps. The next trace entries are written at the start of the data set, and the entries that were formerly there are overlaid. Thus, you need to define a data set that is big enough to capture all the trace entries that interest you.

The MVS GTF trace destination can be used not only by CICS, but by other programs as well. This gives you the opportunity of integrating trace entries from CICS with those from other programs. A single GTF trace data set could, for example, contain trace entries made by both CICS and VTAM. You can relate the two types of trace entry using a unique task identifier in the trace header, known to both CICS and VTAM.

Because different products are likely to execute asynchronously, be cautious about using the sequence of trace entries in the GTF trace data set as evidence when you investigate problems.

Setting the tracing status

You can set the system tracing status by coding the appropriate system initialization parameters, and you can also set it dynamically, using the CETR transaction. The CETR transaction enables you to make changes in response to contingencies, as they arise.

Setting the tracing status at system initialization

These are the parameters that you can use to set up tracing status at system initialization:

- AUXTR, to specify whether auxiliary trace is to be activated at system initialization.
- AUXTRSW, to define the auxiliary switch status.
- GTFTR, to enable CICS to use MVS GTF tracing.
- INTTR, to specify whether internal tracing is to be activated at system initialization.
- SYSTR, to set the master system trace flag on or off.
- TRTABSZ, to specify the size of the internal trace table.
- USERTR, to set the master user trace flag on or off. It must be on if user trace calls are to be made from your applications.

For more details of system initialization parameters, see the *CICS System Definition Guide*.

Setting the tracing status using CETR: You can use the CICS/ESA trace control transaction (CETR) to set the tracing status. Figure 44 shows you the CETR screen you can use to set the tracing status dynamically. In this example, internal tracing status is STOPPED, and so regular tracing is not

```

CETR                CICS/ESA Trace Control Facility
Type in your choices.
Item                Choice      Possible choices
Internal Trace Status  ===>  STOPPED    STArted, STOpped
Internal Trace Table Size  ===>  0016 K    16K - 1048576K
Auxiliary Trace Status  ===>  PAUSED    STArted, STOpped, Paused
Auxiliary Trace Dataset  ===>  B         A, B
Auxiliary Switch Status  ===>  ALL       NO, NExt, A11
GTF Trace Status        ===>  STARTED   STArted, STOpped
Master System Trace Flag  ===>  OFF       ON, OFF
Master User Trace Flag   ===>  OFF       ON, OFF
When finished, press ENTER.
PF1=Help    3=Quit    4=Components    5=Ter/Trn    9=Error List
  
```

Figure 44. Tracing options shown on a CETR screen

directed explicitly to the internal trace table. However, note that the internal trace table is used as a buffer for the other trace destinations, so it always contains the most recent trace entry if at least one trace destination is STARTED. The internal trace table is also used as a destination for exception trace entries, which are made whenever CICS detects an exception condition. If such a condition were detected when the options shown in this example were in effect, you would be able to find the exception trace entry in the internal trace table as well as in the GTF trace data set.

The internal trace table size is 16KB, which is the minimum size it can be. If internal trace were STARTED, the trace table would wrap when it became full.

The current auxiliary trace data set is B, meaning that trace entries would be written to DFHBUXT if auxiliary tracing were started. However, its status is shown to be PAUSED, so no tracing is done to that destination. The auxiliary switch status is ALL, so a switch would be made to the other auxiliary trace data set whenever one became full.

The GTF trace status is shown to be STARTED, which means that CICS trace entries are written to the GTF trace data set defined to MVS. Be aware that no error condition is reported if the CICS GTF status is started but GTF tracing has not been started under MVS. If this happens, the trace entries are not written. The master system trace flag is OFF. This means that no standard tracing is done at all, even though standard tracing might be specified for some tasks. However, special task tracing is not affected—the master system trace flag only determines whether standard task tracing is to be done.

You can see the role of the master system trace flag in Figure 42 on page 239.

The master user trace flag is OFF, so no user trace entries can be made from applications. You must set the master user trace flag on before any user trace requests in your programs can be serviced. If it were off, any trace call requests in your programs would be ignored.

The logic used to ensure that trace entries are written to the required destinations is shown in Figure 45 on page 247.

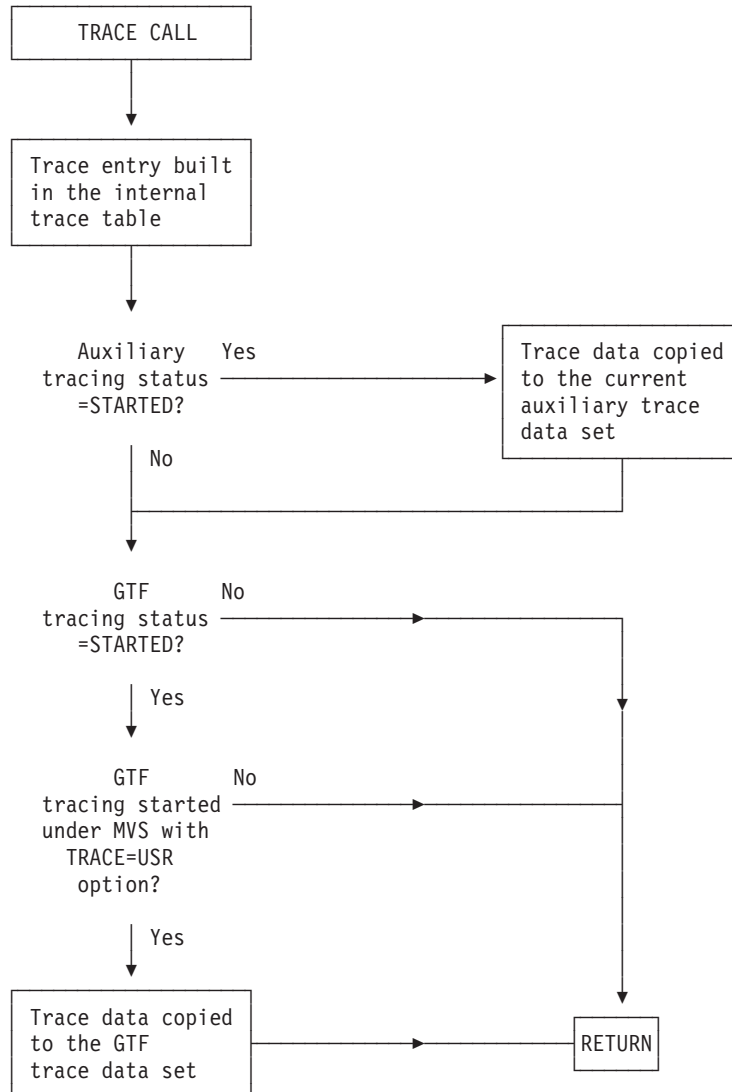

Figure 45. How trace entries are directed to the required destinations

Formatting and interpreting trace entries

Before you can look at the trace entries that have been sent to the various trace destinations, you need to do some formatting. The way you do the formatting varies depending on the destination. For more details of trace utility programs, see the *CICS Operations and Utilities Guide*.

You can specify **abbreviated**, **short**, or **extended** trace formatting, to give you varying levels of information and detail in your output. Typically, abbreviated-format trace gives you one line of trace per entry; short-format provides two lines of trace per entry; extended-format provides many lines of trace per entry. The structures of the different types of trace entry are described in the sections that follow.

Most of the time, the abbreviated trace table is the most useful form of trace formatting, as you can quickly scan many trace entries to locate areas of interest.

However, in error situations, you may require more information than the abbreviated trace can provide. The short trace provides the information that is presented in the abbreviated trace, and, additionally, presents certain items that are presented in the full trace. These are:

- Interpreted parameter list
- Return address
- Time that the trace entry was written
- Time interval between trace entries

These items of information are often very useful in the diagnosis of problems. By selecting the short format, you can gain access to this information without having to bear the processing overhead of formatting a full trace, and without having to deal with the mass of information in a full trace.

There may be occasions, however, when you need to look at extended format trace entries, to understand more fully the information given in the corresponding abbreviated and short entries, and to be aware of the additional data supplied with many extended trace entries.

The internal trace table can be formatted in one of two ways:

1. From a CICS system dump, using the CICS print dump exit, DFHPD530.
2. From a transaction dump, using the CICS dump utility program, DFHDU530.

Auxiliary trace can be formatted using the CICS trace utility program, DFHTU530. You can control the formatting, and you can select trace entries on the basis of task, terminal, transaction, time frame, trace point ID (single or range), dispatcher task reference, and task-owning domain. This complements the usefulness of auxiliary trace for capturing large amounts of trace data.

Note: Trace entries can only be formatted selectively by transaction or terminal if the “transaction attach” entry (point ID XM 1102, XM level-1) for the transaction is included in the trace data set.

GTF trace can be formatted with the same sort of selectivity as auxiliary trace, using a CICS-supplied routine with the MVS interactive problem control system (IPCS).

Interpreting extended-format CICS system trace entries

CICS system trace entries made to the internal trace table, the auxiliary trace data sets, and the GTF trace data set can all be formatted to give the same type of information.

There are two slightly different extended trace entry formats. One (“old-style”) resembles the format used in earlier releases of CICS, and gives FIELD A and FIELD B values. The other (“new-style”) uses a completely new format, described below.

Both types of formatted trace entries always show:

- The **trace point ID**. This is an identifier that indicates where the trace point is in CICS code. In the case of application (AP) domain, the request type field included in the entry is also needed to uniquely identify the trace point. For all other domains, each trace point has a unique trace point ID.

Its format is always a two-character domain index, showing which domain the trace point is in, then a space, then a four-digit (two-byte) hexadecimal number identifying the trace point within the domain.

The following are examples of trace point IDs:

```
AP 00E1      trace point X'00EE' in Application Domain
DS 0005      trace point X'0005' in Dispatcher Domain
TI 0101      trace point X'0101' in Timer Domain
```

- An **interpretation string**, showing:
 - The **module** where the trace point is located
 - The **function** being performed
 - Any **parameters** passed on a call, and any response from a called routine.
- A **standard information string**, showing:
 - The **task number**, which is used to identify a task uniquely for as long as it is in the system. It provides a simple way of locating trace entries associated with specific tasks, as follows:
 - A five-digit decimal number shows that this is a trace entry for a task with a TCA, the value being taken from field TCAKCTTA of the TCA.
 - A three-character non-numeric value in this field shows that the trace entry is for a system task. You could, for example, see “III” (initialization), or “TCP” (terminal control).
 - A two-character domain index in this field shows that the trace entry is for a task without a TCA. The index identifies the domain that attached the task.
 - The **kernel task number** (KE_NUM), which is the number used by the kernel domain to identify the task. The same KE_NUM value for the task is shown in the kernel task summary in the formatted system dump.
 - The **time** when the trace entry was made. (Note that the GTF trace time is GMT time.)
 - The **interval** that elapsed between this and the previous trace entry, in seconds.

The standard information string gives two other pieces of useful information:

- The CICS TCB ID and the address of the **MVS TCB** (field TCB) that is in use for this task. This field can help you in comparing a CICS trace with the corresponding MVS trace.
 - The **return address** (field RET), passed in Register 14 to a called routine. This field helps by showing what invoked the module that is making this trace entry.
- A number of **data fields** containing information relevant to the function being performed.

For old-style trace points, these are shown as fixed length (4-byte) FIELD A and FIELD B values in the same line as the interpretation string. Both the hexadecimal data values and any printable EBCDIC characters that they represent are shown.

For new-style trace points, 1–7 variable-length data fields can be given. They are shown immediately below the standard information line. Any printable EBCDIC characters represented by byte values in the data fields are shown on the right of the trace.

Some of the data fields in the new trace entries contain material intended for use by IBM support personnel and you cannot interpret them directly. However, there is enough information to resolve user errors and for IBM support personnel to resolve most system errors in the interpretation string for the entry. Trace entries

from old-style trace points also include a **request type field (REQ)**, which gives the same information as the two-byte request field in the formatted trace entries of CICS/MVS Version 2.

Some old-style trace entries also have a RESOURCE field. When provided, it is usually the name of a resource associated with the request being traced. For example, for program control requests, it is the program name.

Figure 46 shows a trace entry made from an old-style trace point. Its trace point ID is AP 00E1, corresponding to trace ID X'E1' of CICS/MVS Version 2. If you are migrating from CICS/MVS Version 2, you can probably see the resemblance between this type of format and the one it replaces.

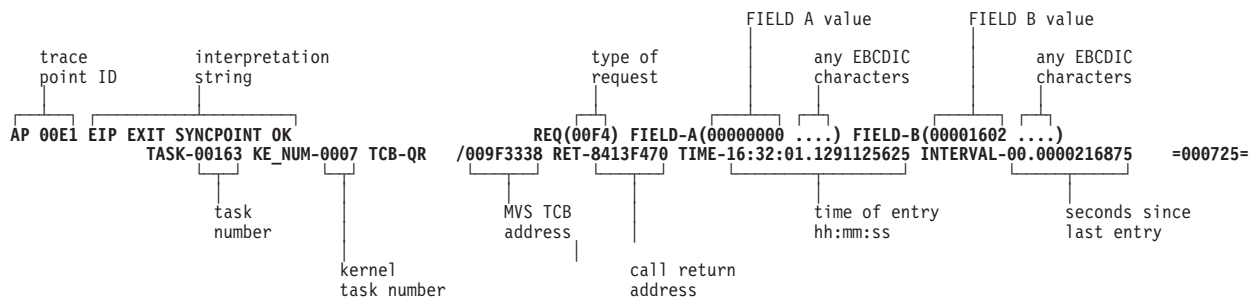

Note: For some trace entries, an 8 character resource field appears to the right of FIELD B.

Figure 46. Example of the extended format for an old-style trace entry

The following is an explanation of the old-style trace entry:

- AP 00E1 shows that this trace entry was made from trace point X'00E1' in the application domain.
Note that although all old-style trace points are in AP domain, not all AP domain trace points are old-style. Some are new trace points, and they have a similar format to that shown in Figure 47 on page 251. In general, old-style trace points have values less than or equal to X'00FF' and new AP-domain trace points have values greater than or equal to X'0200'
- The interpretation string 'EIP EXIT SYNCPOINT OK' gives information about what was going on at the time the trace entry was made.
 - EIP identifies the module where the trace point is located, in this case DFHEIP.
 - EXIT shows that the trace entry was written on completion of processing a request.
 - SYNCPOINT shows the type of function requested.
- REQ(00F4) represents the "request type" of the trace format of CICS/MVS Version 2. In this example, byte 1 bits 0–3 (X'F') show that the trace entry is made on exit from the request.
- FIELD-A and FIELD-B contain the same data as FIELD A and FIELD B in the old-style format.
FIELD-A bytes 0–3 would contain the secondary response, EIBRESP2. FIELD-B bytes 0–1 would contain the condition number, EIBRESP. In this example, both are zero, indicating that no error response has been returned. FIELD-B bytes 2–3 contain the command code, EIBFN. In this example, this is X'1602', showing that the EXEC CICS command was SYNCPOINT.
- The standard information string shows:

- The task number for the currently running task is 00163. Any trace entries having the same task number would have been made while this task was running.
- The kernel task number for the task is 0007. If you were to take a system dump while this task was in the system, you could identify the task in the kernel summary information from this number.
- The time when the trace entry was made was 16:32:01.1291125625.
- The interval that elapsed between this and the preceding trace entry was 00.0000216875 seconds.

Look now at Figure 47, which shows a new-style trace entry.

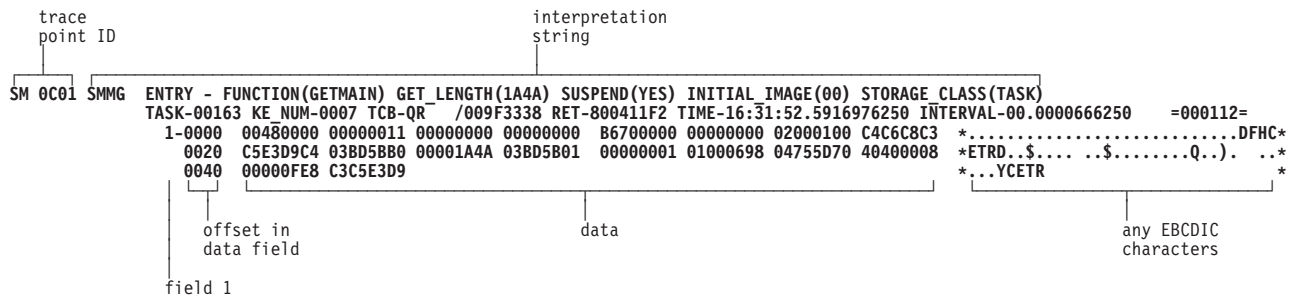

Figure 47. Example of the extended format for a new-style trace entry

The following is an explanation of the new-style trace entry:

- SM 0C01 shows that this trace entry was made from trace point X'0C01' in the storage manager domain.
- The interpretation string provides the following information:
 - SMMG tells you the trace call was made from within module DFHSMMG.
 - ENTRY FUNCTION(GETMAIN) tells you the call was made on entry to the GETMAIN function.
 - GET_LENGTH(1A4A) SUSPEND(YES) INITIAL_IMAGE(00) STORAGE_CLASS(TASK) tells you the parameters associated with the GETMAIN call, as follows:
 - The request is for X'1A4A' bytes of storage.
 - The task is to be suspended if the storage is not immediately available.
 - The storage is to be initialized to X'00'
 - The storage class is TASK.
- The standard information string gives you this information:
 - The task currently running is task number X'00163'.
 - The kernel task number for the task is 0007.
 - The time when the trace entry was made was 16:31:52.5916976250.
 - The time that elapsed between this and the preceding trace entry was 00.0000666250 seconds.
- The data that is displayed below the standard information was taken from only one data area.

The *CICS User's Handbook* contains details of trace point ID SM 0C01. The data area is the SMMG parameter list.

Relevant information is formatted from the data area and appears in the trace entry interpretation string.

Note that information about some data areas is intended for use by IBM support personnel, and this means that details of their format and contents might not be available to you. If you reach a point at which you are certain that you cannot continue the problem determination process because you do not have access to information about a data area, you need to contact your IBM Support Center. They may not necessarily tell you the format and contents, but they investigate the problem in the usual way, as described in “Chapter 17. IBM program support” on page 305.

Interpreting abbreviated-format CICS system trace entries

Abbreviated-format CICS trace entries contain much of the information present in the corresponding extended-format trace entries, and they are often sufficient for debugging purposes. There is a one-to-one correspondence between the trace entry numbers for the abbreviated and extended trace entries, so you can easily identify the trace entry pairs.

Abbreviated trace entries show the CICS TCB-ID of the TCB instead of an MVS TCB address.

Figure 48 gives an example of the abbreviated format for an old-style trace entry.



Note: For some trace entries, an 8-character resource field appears to the right of FIELD B.

Figure 48. Example of the abbreviated format for an old-style trace entry

Abbreviated old-style trace entries are easy to interpret, as you can readily identify the REQ, FIELD A and FIELD B fields. Note that some such trace entries also include a RESOURCE field.

For ZCP trace entries, FIELD B (which contains the TCTTE address) is printed twice on each line. This allows both sides of the output to be scanned for the terminal entries on an 80-column screen without having to scroll left and right.

Figure 49 on page 253 gives an example of the abbreviated format for a new-style trace entry.

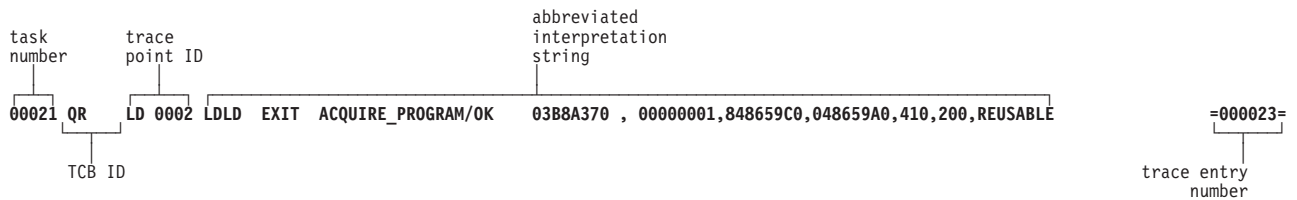

Figure 49. Example of the abbreviated format for a new-style trace entry

Abbreviated-format new-style trace entries are less readily interpreted, because the parameters in the interpretation string are not identified by name. If you are not familiar with the parameters included in the trace entry, you need to look at the corresponding extended-format (or short-format) trace entry to find out what they are. Figure 50 shows the corresponding extended-format trace entry.

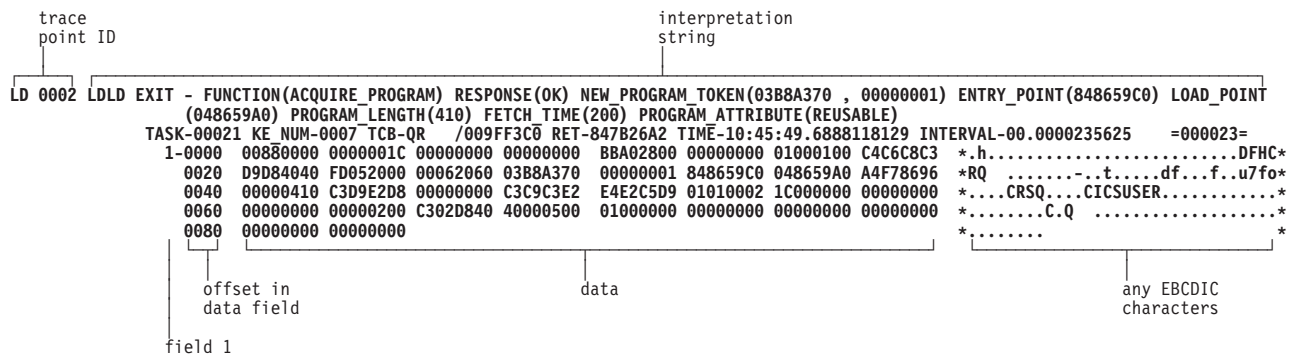

Figure 50. Example of the corresponding extended-format trace entry

LD 0002 shows that this trace entry was made from trace point X'0002' in the loader domain.

The interpretation string provides this information:

- LDLD tells you the trace call was made from within module DFHLDDL.
- EXIT FUNCTION(ACQUIRE_PROGRAM) tells you the call was made on exit from the ACQUIRE_PROGRAM function

The standard information string gives you this information:

- The task currently running has a task number of 00021.
- The kernel task number for the task is 0007.
- The time when the trace entry was made was 10:45:49.6888118129. (Note that the GTF trace time is GMT time.)
- The time that elapsed between this and the preceding trace entry was 00.0000235625 seconds.

The data displayed below the standard information was taken from only one data area. If you look in the *CICS User's Handbook* for details of trace point ID LD 0002, you will see that the data area is the LDLD parameter list.

Interpreting short-format CICS system trace entries

Short-format trace entries contain the information that is presented in the abbreviated-format trace entry and the following items from the interpretation string of the extended-format trace entry:

- Interpreted parameter list, showing keyword and value
- Return address
- Time
- Interval

Figure 51 shows an example of the short-format for an old-style entry.

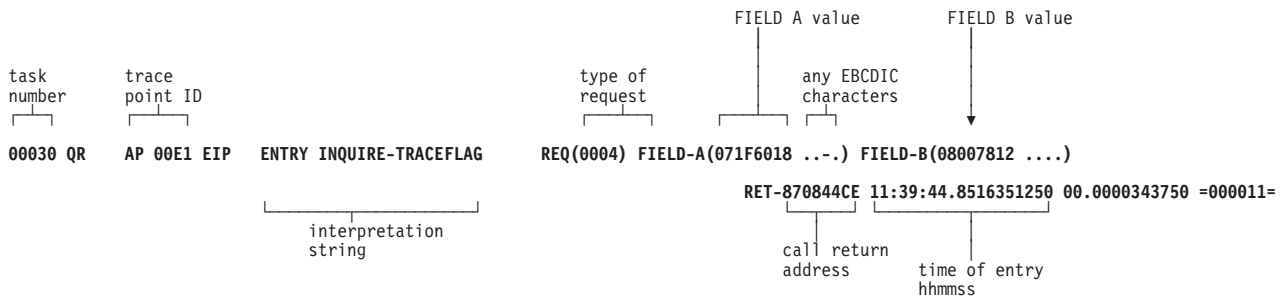

Figure 51. Example of the short-format for an old-style trace entry

Figure 52 shows an example of the short-format for a new-style trace entry.

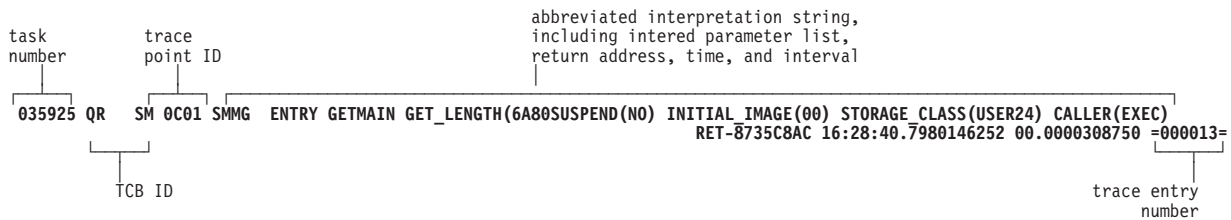

Figure 52. Example of the short-format for a new-style trace entry

Interpreting user trace entries

User trace entries have point IDs in the range AP 0000 through AP 00C2, the numeric part of the point ID being specified in the application.

Extended format user trace entries show a user-defined resource field, and a user-supplied data field that can be up to 4000 bytes in length. A typical extended-format entry is shown in Figure 53 on page 255.

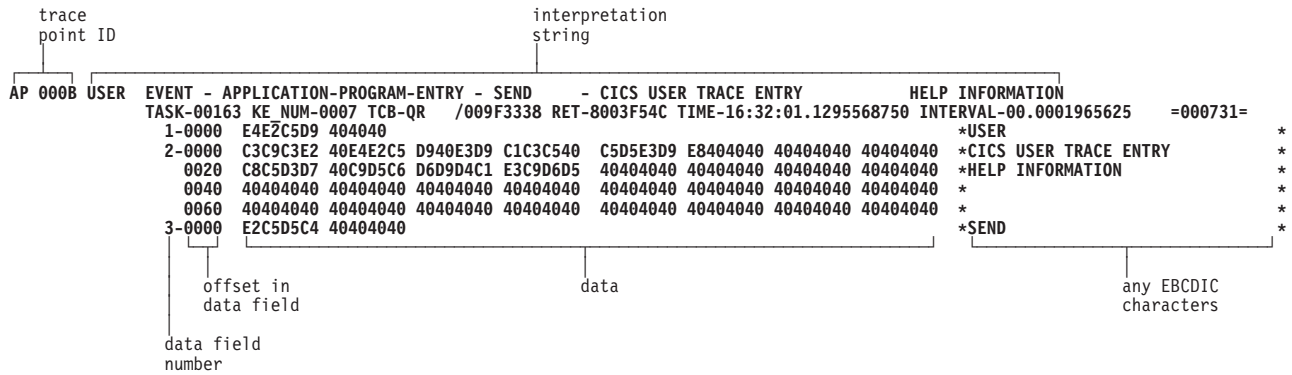

Figure 53. Example of the extended format for a user trace entry

The interpretation string for the entry contains the string “APPLICATION-PROGRAM-ENTRY”, to identify this as a user trace entry, and the resource field.

There are three data fields on an extended-format user trace entry:

1. The character string “USER”.
2. User data from the area identified in the FROM parameter of the trace command.
3. The resource field value identified in the RESOURCE parameter of the trace command.

The abbreviated-trace entry corresponding to the extended trace entry of Figure 53 is shown in Figure 54.

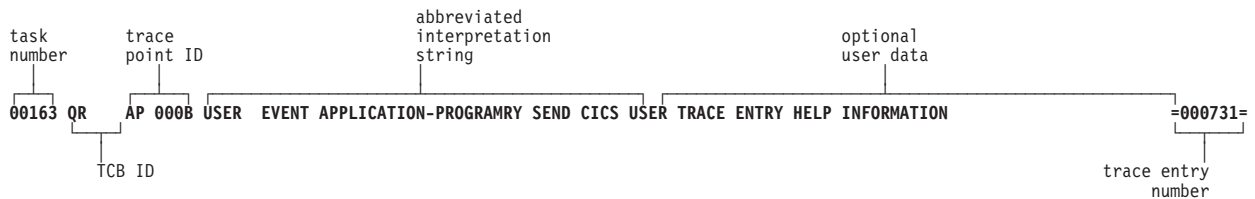

Figure 54. Example of the abbreviated format for a user trace entry

Abbreviated-format trace entries show the user resource field in the interpretation string. There is also an optional user data field that contains as much user-specified data as can be fitted into the line. If successive user trace entries have the same resource field value, but different data field values, you might need to see the corresponding extended trace entries to assess their significance. Figure 55 on page 256 shows an example of the short format for a user trace entry.

task number				interpretation string		time of entry		
00031 QR	AP 000B	USER	EVENT APPLICATION-PROGRAM-E SEND	- CICS USE RET-800820A2		11:42:27.1176805000	00.0000	247500 =00 0815=
	┌───┐							
	trace point ID							
					┌───┐			
					call return address			

Figure 55. Example of the short format for a user trace entry

Chapter 15. Using dumps in problem determination

You have the choice of two different types of CICS dump to help you with problem determination. They are the **transaction dump**, of transaction-related storage areas, and the **CICS system dump**, of the entire CICS region.

The type of dump to use for problem determination depends on the nature of the problem. In practice, the system dump is often more useful, because it contains more information than the transaction dump. You can be reasonably confident that the system dump has captured all the evidence you need to solve your problem, but it is possible that the transaction dump might have missed some important information.

The amount of CICS system dump data that you could get is potentially very large, but that need not be a problem. You can leave the data on the system dump data set, or keep a copy of it, and format it selectively as you require.

You can control the dump actions taken by CICS, and also what information the dump output contains.

Controlling dump action

There are two aspects to controlling dump action:

- Setting up the dumping environment, so that appropriate dump action is taken when circumstances arise that might cause a dump to be taken.
- Causing a dump to be taken. Both users and CICS can issue requests for dumps to be taken.

Setting up the dumping environment

There are several levels at which the dumping environment can be set up:

- System dumps (apart from CICS kernel domain dumps) can be globally suppressed or enabled at system initialization by using the DUMP system initialization parameter.
- System dumps (apart from CICS kernel domain dumps) can be globally suppressed or enabled dynamically through the EXEC CICS SET SYSTEM DUMPING command.
- Transaction dumps can be suppressed or enabled dynamically for individual transactions. This is done by using the EXEC CICS SET TRANSACTION DUMPING system programming command, or the CEMT SET TRDUMPCODE command or by using the DUMP attribute of the RDO definition for the transaction.
- System dumps (apart from CICS kernel domain dumps) can be suppressed for specific dump codes from a dump domain XDUREQ global user exit program.
- System dumps (apart from CICS kernel domain dumps) can be suppressed or enabled, and other dumping requirements specified, by means of dump codes. A dump code defines what action CICS is to take under any of the circumstances in which a dump might be required. Dump codes are kept in one of two **dump tables**, one for “transaction dump codes” and the other for “system dump codes”. For details, see “The dump code options you can specify” on page 268.

- Dumps of the builder parameter set at specific stages in the build process of terminal or connection definition can be enabled. This is done using the CSFE ZCQTRACE facility. For details, see “The CSFE ZCQTRACE facility” on page 274.

Detecting and avoiding duplicate system dumps

When more than one CICS system runs under one instance of the MVS operating system, two CICS systems can take duplicate system dumps.

Each CICS system dump header includes a symptom string. The symptom string will be created only if the system dump code has the DAE option specified in the dump table entry. The default action is that symptom strings are not produced. This can, however, be altered by means of the DAE= system initialization parameter.

The symptom strings provide sufficient information to enable the detection of duplicate dumps. You can take advantage of this in either of two ways:

1. Use MVS Dump Analysis Elimination (DAE) to detect and suppress duplicate dumps. (If the symptom string has been suppressed by the dump table option, DAE will not suppress the system dump.)

You can control DAE with an ADYSETxx parmlib member. For information about DAE, see *OS/390 MVS Diagnosis: Tools and Service Aids*.

2. Manually compare the headers of system dumps, so that you are aware that you have duplicate dumps. Doing it this way, you avoid repeating the same analysis, but still have a separate dump listing for each CICS system.

Events that can cause dumps to be taken

The following are the events that can cause dumps to be taken, if the dumping environment allows dumping under the circumstances:

- Explicit requests for dumps from users
- CICS transaction abends
- CICS system abends.

On most occasions when dumps are requested, CICS references a dump code that is specified either implicitly or explicitly to determine what action should be taken. Dump codes are held in two dump tables, the transaction dump table and the system dump table.

The ways that you can request dumps

You can issue an explicit request for a dump by using the CEMT transaction, by using an EXEC CICS command, or by using an exit programming interface (XPI) call.

- CEMT PERFORM [DUMP|SNAP] enables you to get a CICS system dump from the master terminal, if system dumping has not been globally suppressed. The system dump code that is needed is supplied by CICS, and it has a specific value of “MT0001”.
- You can use EXEC CICS PERFORM DUMP to get a CICS system dump, if system dumping is not globally suppressed. You must specify a system dump code when you use this command and it must be a maximum of 8 characters in length.

- You can use EXEC CICS DUMP TRANSACTION to get a transaction dump. You get a transaction dump even if dumping has been suppressed for the transaction that you identify on the command.

You must specify a transaction dump code when you use this command and it must be a maximum of 4 characters in length. It could, for example, be TD01.

- You can make a TRANSACTION_DUMP or a SYSTEM_DUMP XPI call from an exit program to get a transaction dump or a system dump, respectively. For programming information about these exits, see the *CICS Customization Guide*.

You might use these methods of taking dumps if, for example, you had a task in a wait state, or you suspected that a task was looping. However, these methods are not useful for getting information following a transaction abend or a CICS system abend. This is because the evidence you need is almost certain to disappear before your request for the dump has been processed.

The occasions when CICS requests a dump

In general, CICS requests a dump when a transaction or CICS system abend occurs. The dumping environment determines whether or not a dump is actually taken. CICS does not take a transaction dump if a HANDLE ABEND is active at the current logical level⁶. The NODUMP option on an EXEC CICS ABEND command, an internal call, or the transaction definition, prevents the taking of a transaction dump.

The following are the occasions when CICS requests a dump:

- CICS requests a transaction dump, and perhaps a system dump, after a transaction abend occurs. There are two cases:
 - You can include the command EXEC CICS ABEND in one of your applications, causing it to abend when some condition occurs. You must specify a four-character transaction abend code on this command, and this is used as the transaction dump code. It could, for example, be 'MYAB'.
 - CICS might cause a transaction to abend, for any of the reasons described in the *CICS Messages and Codes* manual. In this case, the four-character CICS transaction abend code is used as the transaction dump code. It might, for example, be ASRA.
- A CICS system dump could be taken following a CICS system abend. In this situation, the system dump code is often equal to the abend message ID, with the leading letters "DFH" stripped off. In the case of message DFHST0001, for example, the system dump code would be "ST0001". However, in some cases the system dump code cannot be directly related to a CICS message, either because it does not closely resemble the message, or because no message accompanies the event causing the dump to be invoked. For details of these system dump codes, see the *CICS Messages and Codes* manual.
- When a transaction dump or system dump is taken, and the dump code includes the RELATED attribute on the DUMPSCOPE option, system dumps are taken of all CICS regions in the sysplex which are related to the CICS region on which this transaction dump or system dump is taken. A related CICS region is one in which the unit of work identifiers, in the form of APPC tokens, of one or more tasks match those in the CICS region that issued the dump request. Typically, these may be regions in a distributed transaction processing environment.

6. To make PL/I on units work, PL/I library routines can issue HANDLE ABEND. This is called an implicit HANDLE ABEND and causes the suppression of transaction dumps.

- A CICS system dump can be requested from within the Node Error Program (NEP) when a terminal error is processed for a terminal with no task attached. For information about using NEPs to handle terminal errors, read the entry for message DFHZC3496 in the *CICS Messages and Codes* manual; also read the programming information on NEPs in the *CICS Customization Guide*.
- A CICS system dump can also be requested from the global trap/trace exit. In this case, the system dump code is TR1003.

CICS dumping in a sysplex

Simultaneous dump capture from multiple CICS regions across a sysplex is possible, considerably aiding problem determination in XCF/MRO environments where many CICS regions are running. Two types of situation, in particular, benefit from this:

- Where a task involves multiple CICS regions in a sysplex, and one region issues a dump, typically in response to an error.
Dump data from all CICS regions related to the region issuing the dump request is usually required in order to fully diagnose and solve the problem. This dump data from related regions would also need to be captured at the same time as the dump taken on the region issuing the dump.
- Where an MVS console operator needs to capture, simultaneously, dump data from multiple CICS regions in the sysplex.

Before CICS for MVS/ESA 4.1, such automatic and simultaneous dump data capture of CICS data was impossible.

You need MVS/ESA 5.1, the MVS workload manager, and the XCF facility in order to collect dump data in this way. The MVS images in the sysplex must be connected via XCF. The CICS regions must be using MRO supported by the CICS Transaction Server for OS/390 Release 3 interregion communication program, DFHIRP.

Automatic dump data capture from related CICS regions

It is possible to collect dump data simultaneously from all related CICS regions in a sysplex. Related CICS regions are those containing one or more tasks which have unit of work identifiers, in the form of APPC tokens, that match the unit of work identifiers in the CICS region which initially issued the dump request.

The CICS regions must be connected via XCF/MRO. Connections using VTAM ISC are not eligible to use the related dump facility.

The function is controlled by the DUMPSCOPE option on each CICS dump table entry. You can set this option to have either of the following values:

- RELATED - take dumps for all related CICS regions across the sysplex.
- LOCAL - take dumps for the requesting CICS region only. This is the default.

The DUMPSCOPE option is available on the following master terminal and system programming commands:

- EXEC CICS INQUIRE SYSDUMPCODE
- EXEC CICS SET SYSDUMPCODE
- EXEC CICS INQUIRE TRANDUMPCODE
- EXEC CICS SET TRANDUMPCODE
- CEMT INQUIRE SYDUMPCODE

- CEMT SET SYDUMPCODE
- CEMT INQUIRE TRDUMPCODE
- CEMT SET TRDUMPCODE

If the DUMPSCOPE option is set to RELATED in the CICS region issuing the dump request, a request for a system dump is sent to all MVS images in the sysplex that run related CICS regions.

The local MVS image running the CICS region that initiated the dump request has two dumps - one of the originating CICS region, the other containing the originating CICS region and up to fourteen additional related CICS regions from the local MVS image.

When a dump is requested, the DUMPSCOPE option is tested only in the CICS region issuing the original dump request. If the requesting CICS region has DUMPSCOPE defined as RELATED for the dump code, then all related CICS regions are dumped even if they have DUMPSCOPE defined as LOCAL for the dump code.

There is a maximum of fifteen address spaces in an SDUMP. If there are more than fifteen related CICS regions on an MVS image, then not all of them will be dumped. Related CICS regions may also fail to be dumped if they are swapped out when the dump request is issued. You should consider whether to make certain CICS regions non-swappable as a result.

Operator-requested simultaneous dump data capture

The MVS console operator may want to issue a dump request simultaneously to several CICS regions in the sysplex. There may be a problem in the sysplex where one or more CICS regions is hanging and, to fully diagnose and solve the problem, dump data captured at the same time is required.

Without this facility, such simultaneous dump data capture across multiple CICS regions in the sysplex is impossible.

Use the following command at the console:

```
DUMP COMM=( )
R x,REMOTE=(SYSLIST=*),PROBDESC=(SYSDCOND,SYSDLOCL,(DFHJOBN,jobnames))
```

where:

- **REMOTE** controls the issuing of dumps on remote systems.
- **SYSLIST=*** means the request is to be routed to all remote systems.
- **PROBDESC** is problem description information, as follows:
 - **SYSDCOND** - an MVS keyword. This specifies that a dump is to be taken on remote MVS images if the IEASDUMP.QUERY exit responds with return code 0. CICS supplies DFHDUMPX as the IEASDUMP.QUERY exit.
 - **SYSDLOCL** - an MVS keyword. This drives the IEASDUMP.QUERY exit on the local and remote MVS images. This allows the CICS regions on the local MVS region to be dumped.
 - **DFHJOBN** - a CICS keyword. The operator should include the generic job name. This is used by DFHDUMPX to determine which address spaces to dump.

See the *MVS System Commands* manual, GC28-1626, for a full description of all command options.

If you adopt a suitable naming convention for your CICS regions, this can be used to define suitable generic jobnames to determine which CICS regions to dump. See the *System/390 MVS Sysplex Application Migration* manual for recommendations on naming conventions. If you follow the recommendation in this manual, the generic job name for all CICS regions in the sysplex would be 'CICS*'.

Requesting dumps to resolve SMSVSAM problems

You may sometimes encounter a CICS problem that involves SMSVSAM. If you need to submit such a problem to IBM, in particular where CICS or a CICS transaction is in a hung state while accessing VSAM data sets in RLS mode, include a dump of the following:

- All the SMSVSAM server address spaces in the sysplex, together with their associated data spaces
- The address space of the CICS region that is hanging
- The GRS address space
- The VSAM CATALOG address space.

You can obtain such a dump by using the following command:

```
/DUMP COMM=(comment to describe the problem)
```

When MVS responds, reply to WTOR number *nn* with the following:

```
/R nn,JOBNAME=(CICS-job-name,SMSVSAM,CATALOG,GRS),DSPNAME='SMSVSAM'.*,  
    REMOTE=(SYSLIST=*( 'SMSVSAM', 'CATALOG', 'GRS' ),DSPNAME,SDATA,  
    END
```

Note: You can use the CONT option to split this command into parts, as follows:

```
/R nn,JOBNAME=(CICS-job-name,SMSVSAM,CATALOG,GRS), CONT  
/R nn,DSPNAME='SMSVSAM'.*,REMOTE=(SYSLIST=*( 'SMSVSAM', CONT  
/R nn,'CATALOG','GRS'),DSPNAME,SDATA, END
```

Useful CICS master terminal and MVS console commands in a sysplex

MVS support for remote SDUMPs is available only for images running MVS/ESA 5.1 or later and which are connected by XCF. Related CICS SDUMPs are produced only for CICS regions which are MRO connected using XCF. DFHIRP must be at CICS Transaction Server for OS/390 Release 3 level. Connections using VTAM ISC are not eligible to use the related dump facility.

If you are unable to produce related system dumps when there are related CICS regions across MVS images, ensure that the regions are MRO connected.

Use CEMT I IRC to ensure that interregion communication is available. If IRC is not available it may be started using the CEMT S IRC OPEN command. Failure to start IRC results in DFHIRxxx messages which may be used to identify the source of the problem.

During IRC start processing, CICS attempts to join XCF group DFHIR000. If this fails, return code yyy is given in the DFHIR3777 message.

The following MVS console commands may be used to monitor activity in the sysplex:

- D XCF - to identify the MVS sysplex and list the name of each MVS image in the sysplex.

An example of a response to this command looks like this:

```

08.14.16 DEV5          d xcf
08.14.16 DEV5          IXC334I 08.14.16 DISPLAY XCF 602
SYSPLEX DEVPLEX5:    DEV5

```

This response tells you that MVS image DEV5 has joined sysplex DEVPLEX5.

- D XCF, GROUP - to list active XCF groups by name and size (note that CICS, group DFHIR000, is missing from the following example response).

```

16.21.36 DEV5          d xcf,group
16.21.36 DEV5          IXC331I 16.21.36 DISPLAY XCF 877
GROUPS(SIZE):         COFVLFNO(1)   SYSDAE(2)   SYSGRS(1)
                     SYSIGW00(1)   SYSIGW01(1) SYSIKJBC(1)
                     SYSMCS(6)     SYSMCS2(3)  SYSWLM(1)
                     WINMVSG(1)

```

- D XCF, COUPLE - to list details about the XCF coupling data set and its definitions. In the following example response, the data set has a MAXGROUP of 10 and a peak of 10. The response to XCF, GROUP indicates there are currently 10 active groups. If CICS now attempts to join XCF group DFHIR000, it will be rejected and the IRC start will fail with message DFHIR3777.

```

16.30.45 DEV5          d xcf,couple
16.30.45 DEV5          IXC357I 16.30.45 DISPLAY XCF 883
SYSTEM DEV5 DATA
  INTERVAL  OPNOTIFY    MAXMSG    CLEANUP    RETRY    CLASSLEN
          42          45          500        60         10         956

  SSUM ACTION    SSUM INTERVAL    WEIGHT
          N/A          N/A          N/A

SYSPLEX COUPLE DATA SETS
PRIMARY   DSN: SYS1.XCFDEV5.PXCF
          VOLSER: SYS001    DEVN: 0F0E
          FORMAT TOD      MAXSYSTEM MAXGROUP(PEAK) MAXMEMBER(PEAK)
          08/16/93 08:05:39      8      10 (10)      87 (6)
ALTERNATE DSN: SYS1.XCFDEV5.AXCF
          VOLSER: SYS001    DEVN: 0F0E
          FORMAT TOD      MAXSYSTEM    MAXGROUP    MAXMEMBER
          08/16/93 08:05:41      8      10      87

```

This example also indicates that the primary and alternate data sets are on the same volume, thereby giving rise to a single point of failure.

Use the CICS master terminal command CEMT I CONNECTION to display the status of the connections. 'XCF' is displayed for every acquired connection using MRO/XCF for communications.

```

I CONNECTION
STATUS: RESULTS - OVERTYPE TO MODIFY
Con(FORD) Net(IYAHZCES)    Ins Acq    Xcf
Con(F100) Net(IYAHZCEC)   Ins Acq    Irc
Con(F150) Net(IYAHZCED)   Ins Acq    Irc
Con(GEO ) Net(IYAHZCEG)   Ins Acq    Xcf
Con(GMC ) Net(IYAHZCEB)   Ins Acq    Xcf
Con(JIM ) Net(IYAHZCEJ)   Ins Acq    Xcf
Con(MARY) Net(IYAHZCEM)   Ins Acq    Xcf
Con(MIKE) Net(IYAHZCEI)   Ins Acq    Xcf
+ Con(RAMB) Net(IYAHZCEE)  Ins Acq    Xcf
                                     SYSID=CHEV APPLID=IYAHZCET
RESPONSE: NORMAL                TIME: 01.28.59 DATE: 06.11.94
PF 1 HELP          3 END                7 SBH 8 SFH 9 MSG 10 SB 11 SF

```

CICS initialization issues an MVS CSVDYNEX request to add DFHDUMPX as an MVS IEASDUMP.QUERY exit. If you need to change the status of the exit, use the MVS console command SETPROG EXIT.

If you have determined that XCF communication is in use, you can verify that the CICS SDUMP exit has been established using the following MVS commands:

```
D PROG,EXIT,MODNAME=DFHDUMPX
  08.16.04 DEV5          CSV463I MODULE DFHDUMPX IS NOT ASSOCIATED ANY EXIT

D PROG,EXIT,EN=IEASDUMP.QUERY
  08.17.44 DEV5          CSV463I NO MODULES ARE ASSOCIATED WITH EXIT IEASDUMP.QUERY
```

This example indicates that the exit has not been established.

The following displays indicate that DFHDUMPX is active as an IEASDUMP exit with one CICS Transaction Server for OS/390 Release 3 region active in one MVS image.

```
D PROG,EXIT,MODNAME=DFHDUMPX
01.19.16 DEV5          CSV461I 01.19.16 PROG,EXIT DISPLAY 993
EXIT          MODULE  STATE MODULE  STATE MODULE  STATE
IEASDUMP.QUERY DFHDUMPX  A

D PROG,EXIT,EN=IEASDUMP.QUERY
01.19.46 DEV5          CSV462I 01.19.46 PROG,EXIT DISPLAY 996
MODULE DFHDUMPX
EXIT(S) IEASDUMP.QUERY
```

You may issue MVS dump commands from the console to verify that remote dumping is available within the MVS image, without an active CICS region.

```
11.29.59 DEV5          dump comm=(NO CICS)
11.29.59 DEV5          *03 IEE094D SPECIFY OPERAND(S) FOR DUMP COMMAND
11.36.49 DEV5          r 03,remote=(syslist=*),probdesc=(sysdcond,
  sysdloc1,(dfhjobn,iyahzcet))
11.36.49 DEV5          IEE600I REPLY TO 03 IS;REMOTE=(SYSLIST=*),
  PROBDESC=(SYSDCOND,SYSDL)
11.36.52 DEV5          IEA794I SVC DUMP HAS CAPTURED:
DUMPID=001 REQUESTED BY JOB (*MASTER*)
DUMP TITLE=NO CICS
```

In the next example, the messages from SDUMP indicate that one dump of the master address space has been taken.

```
*11.37.03 DEV5          *IEA911E COMPLETE DUMP ON SYS1.DUMP03
*DUMPID=001 REQUESTED BY JOB (*MASTER*)
*FOR ASID (0001)
*REMOTE DUMPS REQUESTED
*INCIDENT TOKEN: DEVPLEX5 DEV5      06/28/1994 11:36:49
```

Another test is to issue the dump command specifying the CICS XCF group.

```
11.42.33 DEV5          dump comm=(STILL NO CICS)
11.42.33 DEV5          *05 IEE094D SPECIFY OPERAND(S) FOR DUMP COMMAND
11.43.27 DEV5          r 05,remote=(grplist=dfhir000(*)),
  probdesc=(sysdcond,sysdloc1,(dfhjobn,iyahzcet))
11.43.28 DEV5          IEE600I REPLY TO 05
  IS;REMOTE=(GRPLIST=DFHIR000(*)),PROBDESC=(SYSD
11.43.31 DEV5          IEA794I SVC DUMP HAS CAPTURED:
DUMPID=002 REQUESTED BY JOB (*MASTER*)
DUMP TITLE=STILL NO CICS
```

The messages from SDUMP indicate that one dump of the master address space has been taken.

```
*11.43.42 DEV5          *IEA911E COMPLETE DUMP ON SYS1.DUMP03
*DUMPID=002 REQUESTED BY JOB (*MASTER*)
*FOR ASID (0001)
*REMOTE DUMPS REQUESTED
*INCIDENT TOKEN: DEVPLEX5 DEV5      06/28/1994 11:43:28
```

To verify that the remote dumping function works on the local system, use the following commands:

```

11.45.57 DEV5          dump comm=(TEST REMOTE FUNCTION ON LOCAL SYSTEM
11.45.57 DEV5          *06 IEE094D SPECIFY OPERAND(S) FOR DUMP COMMAND
11.46.57 DEV5          r 06,remote=(grplist=*(*)),probdesc=(sysdloc1)
11.46.59 DEV5          IEE600I REPLY TO 06 IS;REMOTE=(GRPLIST=*(*)),
PROBDESC=(SYSDLOCL)
11.47.00 DEV5          IEA794I SVC DUMP HAS CAPTURED:
DUMPID=003 REQUESTED BY JOB (*MASTER*)
DUMP TITLE=TEST REMOTE FUNCTION ON LOCAL SYSTEM
11.47.17 DEV5          IEA794I SVC DUMP HAS CAPTURED:
DUMPID=004 REQUESTED BY JOB (DUMPSRV )
DUMP TITLE=TEST REMOTE FUNCTION ON LOCAL SYSTEM

```

The messages from SDUMP indicate two dumps were taken, one for the master address space and a second which contains ASIDs 0101, 0012, 0001, 0005, 000B, 000A, 0008, 0007. Note that the same incident token is used for both dumps.

```

*11.47.39 DEV5          *IEA911E COMPLETE DUMP ON SYS1.DUMP03
*DUMPID=003 REQUESTED BY JOB (*MASTER*)
*FOR ASID (0001)
*REMOTE DUMPS REQUESTED
*INCIDENT TOKEN: DEVPLEX5 DEV5      06/28/1994 11:46:57
*11.47.59 DEV5          *IEA911E COMPLETE DUMP ON SYS1.DUMP04
*DUMPID=004 REQUESTED BY JOB (DUMPSRV )
*FOR ASIDS(0101,0012,0005,0001,000A,000B,0008,0007)
*REMOTE DUMP FOR SYSNAME: DEV5
*INCIDENT TOKEN: DEVPLEX5 DEV5      06/28/1994 11:46:57

```

The following example lists the MVS console messages received when the CICS master terminal command CEMT P DUMP is issued from CICS APPLID IYAHZCET executing in ASID 19 on MVS image DEV6. IYAHZCET has at least one related task in the CICS region executing in ASID 1B on MVS DEV6 and ASIDS 001A, 001C, 001B, 001E, 001F, 0020, 001D, 0022, 0024, 0021, 0023, 0028, 0025, 0029, 0026 on MVS image DEV7.

```

- 22.19.16 DEV6 JOB00029 +DFHDU0201 IYAHZCET ABOUT TO TAKE SDUMP. DUMPCODE: MT0001
- 22.19.23 DEV7          DFHDU0214 DFHDUMPX IS ABOUT TO REQUEST A REMOTE SDUMPX.
- 22.19.23 DEV6          DFHDU0214 DFHDUMPX IS ABOUT TO REQUEST A REMOTE SDUMPX.
22.19.27 DEV6 JOB00029 IEA794I SVC DUMP HAS CAPTURED:
DUMPID=001 REQUESTED BY JOB (IYAHZCET)
DUMP TITLE=CICS DUMP: SYSTEM=IYAHZCET CODE=MT0001 ID=1/0001

22.19.43 DEV6 JOB00029 IEA794I SVC DUMP HAS CAPTURED:
DUMPID=002 REQUESTED BY JOB (DUMPSRV )
DUMP TITLE=CICS DUMP: SYSTEM=IYAHZCET CODE=MT0001 ID=1/0001

- 22.19.43 DEV6 JOB00029 +DFHDU0202 IYAHZCET SDUMPX COMPLETE. SDUMPX RETURN CODE X'00'

*22.21.00 DEV6          *IEA911E COMPLETE DUMP ON SYS1.DUMP03
*DUMPID=001 REQUESTED BY JOB (IYAHZCET)
*FOR ASID (0019)
*REMOTE DUMPS REQUESTED
*INCIDENT TOKEN: DEVPLEX1 DEV6      06/10/1994 22:19:16
*ID = DUMP : APPLID IYAHZCET DUMPCODE MT0001 /1/0001

```

The dump in SYS1.DUMP03 on DEV6 was taken as a result of the CEMT request on IYAHZCET.

```

*22.21.15 DEV6          *IEA911E COMPLETE DUMP ON SYS1.DUMP04
*DUMPID=002 REQUESTED BY JOB (DUMPSRV )
*FOR ASIDS(0019,001B)
*REMOTE DUMP FOR SYSNAME: DEV6
*INCIDENT TOKEN: DEVPLEX1 DEV6      06/10/1994 22:19:16
*ID = DUMP : APPLID IYAHZCET DUMPCODE MT0001 /1/0001

```

The dump in SYS1.DUMP04 on DEV6 was taken as a remote dump by MVS dump services as a result of the CEMT request on IYAHZCET. Note that the incident token and ID are the same.

```
22.22.35 DEV7 JOB00088 IEA794I SVC DUMP HAS CAPTURED:
DUMPID=003 REQUESTED BY JOB (DUMPSRV )
DUMP TITLE=CICS DUMP: SYSTEM=IYAHZCET CODE=MT0001 ID=1/0001
```

```
*22.25.58 DEV7 *IEA911E COMPLETE DUMP ON SYS1.DUMP05
*DUMPID=003 REQUESTED BY JOB (DUMPSRV )
*FOR ASIDS(001A,001C,001B,001E,001F,0020,001D,0022,0024,0021,0023,0028,
*0025,0029,0026)
*REMOTE DUMP FOR SYSNAME: DEV6
*INCIDENT TOKEN: DEVPLEX1 DEV6 06/10/1994 22:19:16
*ID = DUMP : APPLID IYAHZCET DUMPCODE MT0001 /1/0001
```

The dump in SYS1.DUMP05 on DEV7 was taken as a remote dump by MVS dump services as a result of the CEMT request on IYAHZCET. Note that the incident token and ID are the same as those for the dumps produced on DEV6, indicating the originating MVS and CICS IDs.

The following example lists the MVS console messages received when transaction abend SCOP is initiated after having first been added to the transaction dump table in CICS IYAHZCES as requiring related dumps. (CEMT S TRD(SCOP) ADD RELATE).

CICS IYAHZCES (ASID 1A in MVS DEV7) has at least one related task in CICS IYAHZCET (ASID 19 in MVS DEV6).

```
23.40.41 DEV7 JOB00088 +DFHDU0201 IYAHZCES ABOUT TO TAKE SDUMP. DUMPCODE: SCOP
23.40.49 DEV7 DFHDU0214 DFHDUMPX IS ABOUT TO REQUEST A REMOTE SDUMPX.
23.40.55 DEV7 JOB00088 IEA794I SVC DUMP HAS CAPTURED:
```

```
DUMPID=012 REQUESTED BY JOB (IYAHZCES)
DUMP TITLE=CICS DUMP: SYSTEM=IYAHZCES CODE=SCOP ID=1/0008
```

```
23.40.49 DEV6 DFHDU0214 DFHDUMPX IS ABOUT TO REQUEST A REMOTE SDUMPX.
23.40.56 DEV6 JOB00029 IEA794I SVC DUMP HAS CAPTURED:
DUMPID=007 REQUESTED BY JOB (DUMPSRV )
DUMP TITLE=CICS DUMP: SYSTEM=IYAHZCES CODE=SCOP ID=1/0008
```

```
23.41.11 DEV7 JOB00088 IEA794I SVC DUMP HAS CAPTURED:
DUMPID=013 REQUESTED BY JOB (DUMPSRV )
DUMP TITLE=CICS DUMP: SYSTEM=IYAHZCES CODE=SCOP ID=1/0008
```

```
23.41.11 DEV7 JOB00088 +DFHDU0202 IYAHZCES SDUMPX COMPLETE. SDUMPX RETURN CODE X'00'
```

```
*23.41.18 DEV6 *IEA911E COMPLETE DUMP ON SYS1.DUMP03
*DUMPID=007 REQUESTED BY JOB (DUMPSRV )
*FOR ASID (0019)
*REMOTE DUMP FOR SYSNAME: DEV7
*INCIDENT TOKEN: DEVPLEX1 DEV7 06/10/1994 23:40:41
*ID = DUMP : APPLID IYAHZCES DUMPCODE SCOP /1/0008
```

The dump in SYS1.DUMP03 on DEV6 was taken upon receipt of the remote dump request issued from IYAHZCES. Note the incident token and ID are the same as those for dumps produced on DEV7.

```
*23.41.28 DEV7 *IEA911E COMPLETE DUMP ON SYS1.DUMP03
*DUMPID=012 REQUESTED BY JOB (IYAHZCES)
*FOR ASID (001A)
*REMOTE DUMPS REQUESTED
*INCIDENT TOKEN: DEVPLEX1 DEV7 06/10/1994 23:40:41
```

```
*ID = DUMP : APPLID IYAHZCES DUMPCODE SCOP /1/0008

*23.41.38 DEV7 *IEA911E COMPLETE DUMP ON SYS1.DUMP04
*DUMPID=013 REQUESTED BY JOB (DUMPSRV )
*FOR ASID (001A)
*REMOTE DUMP FOR SYSNAME: DEV7
*INCIDENT TOKEN: DEVPLEX1 DEV7 06/10/1994 23:40:41
*ID = DUMP : APPLID IYAHZCES DUMPCODE SCOP /1/0008
```

The dump in SYS1.DUMP04 on DEV7 was taken as a remote dump by MVS dump services as a result of the request from IYAHZCES. Note the incident token and ID are the same as those for the dumps produced on DEV6, indicating the originating MVS and CICS IDs. A second dump of ASID 1A is taken because the CICS IEASDUMP does not have information indicating that a dump has already been taken for that address space.

Enabling system dumps for some CICS messages

There are occasions when you might need diagnostic information for an event that causes a message to be sent, but does not normally cause CICS to take a system dump. You can enable system dumping for some CICS messages that do not normally cause CICS to take a system dump. You do this by adding the dump code (constructed by removing the “DFH” prefix from the message number) to the system dump table, and specifying the SYSDUMP option. CICS then causes a system dump to be taken when the message is issued.

To determine which messages you can do this for, look in the *CICS Messages and Codes* manual. If the message you are interested in has a 2-character alphabetic component ID after the “DFH” prefix, and it has **either** XMEOUT global user exit parameters or a destination of “Terminal User”, you can use it to construct a system dump code to add to the dump table.

You cannot enable dumping for messages that do not have these characteristics. For example, some messages that are issued early during initialization cannot be used to cause CICS to take a system dump, because the mechanisms that control dumping might not be initialized at that time. Also, you cannot enable dumping for the message domain’s own messages (they are prefixed by “DFHME”) where they do not normally cause CICS to take a system dump.

System dump actions with messages DFHAP0001 and DFHSR0001

In the event of a program check or MVS abend in the AP domain or in a user application program, CICS may issue either message DFHAP0001 or DFHSR0001. Message DFHSR0001 is issued by CICS only when storage protection is active; that is, the system initialization parameter STGPROT=YES is specified and the hardware and software environment supports the storage protection facility. CICS determines which of these messages to issue depending on whether or not the program check or MVS abend occurs in code running in user key.

If the code had been running in user key at the time of the program check or MVS abend, CICS issues message DFHSR0001 and takes a system dump with dump code SR0001. Only application programs defined with EXECKEY(USER) run in user key.

If the code had not been running in user key at the time of the program check or MVS abend, CICS issues message DFHAP0001 and takes a system dump with dump code AP0001.

So, if CICS storage protection is active, this mechanism enables you to suppress the system dumps caused by errors in application programs, while still allowing dumps caused by errors in CICS code to be taken. To achieve this, use either a CEMT SET SYDUMPCODE or an EXEC CICS SET SYSDUMPCODE command to suppress system dumps for system dumpcode SR0001:

```
CEMT SET SYDUMPCODE(SR0001) ADD NOSYSDUMP
```

If storage protection is not active, the dumps may be suppressed via a suppression of dumpcode AP0001. Note, however, that this suppresses dumps for errors in both application **and** CICS code. The XDUREQ global user exit can be used to distinguish between AP0001 situations in application and nonapplication code.

You cannot control AP0001 and SR0001 system dumps by using the DUMP parameter of the TRANSACTION resource definition. The DUMP parameter of the TRANSACTION resource definition controls only transaction dumps.

Usually, program checks, or MVS abends caused by an application program, are also followed by an ASRA, ASRB or ASRD transaction abend and a transaction dump. If, in some instances, you want the SDUMP for one of these transaction abends but not the other, specify the one you want by using either a CEMT TRDUMPCODE or an EXEC CICS TRANDUMPCODE command. For example, specifying:

```
CEMT SET TRDUMPCODE(ASRB) ADD SYSDUMP
```

adds an entry to the dump table and ensures that SDUMPs are taken for ASRB abends. However, note that the SDUMP in this instance is taken at a later point than the SDUMP normally taken for system dump code AP0001 or SR0001.

The dump code options you can specify

You can specify what dump action is to be taken by CICS for each individual dump code, either by using a CEMT transaction or by using a system programming command. The options you can specify differ slightly, depending on whether you are defining the action for a transaction dump code or for a system dump code.

- For a **transaction dump code**, you can specify:
 - Whether a transaction dump is to be taken.
 - Whether a system dump is to be taken, with or without a transaction dump.
 - Whether a system dump is to be taken on every CICS region in the sysplex related to the CICS region on which the transaction dump is taken. A related CICS region is one on which the unit of work identifiers, in the form of APPC tokens, of one or more tasks match those in the CICS region that takes the transaction dump.
 - Whether CICS is to be terminated.
 - The maximum number of times the transaction dump code action can be taken during the current run of CICS, or before the count is reset.
- For a **system dump code**, you can specify:
 - Whether a system dump is to be taken.
 - Whether a system dump is to be taken on every CICS region in the sysplex related to the CICS region on which the system dump is taken. A related CICS region is one on which the unit of work identifiers, in the form of APPC tokens, of one or more tasks match those in the CICS region that takes the system dump.
 - Whether CICS is to be terminated.

- The maximum number of times the system dump code action can be taken during the current run of CICS, or before the count is reset.
- Whether the system dump is eligible for suppression by DAE.

Notes:

1. Only a *transaction* dump code can cause both a transaction dump and a system dump to be taken.
2. If a severe error is detected, the system can terminate CICS even if you specify that CICS is not to be terminated.
3. Values of 0–998 for “maximum times dump code action can be taken” are literal, but a value of 999 (the default) means there is no limit.
4. You cannot suppress CICS kernel domain dumps.

All the options you specify are recorded in the appropriate dump table, and written in the CICS global catalog. Any dump table entries you have changed or created during a CICS run are preserved when CICS is subsequently shut down. They are available during the next run unless CICS is cold started, when they are deleted from the global catalog.

The only circumstances in which dump table additions and changes are lost are:

- When CICS is cold started.
- When the CICS global catalog is redefined, although this is likely to be done only in exceptional circumstances.
- When CICS creates a temporary dump table entry for you, because you have asked for a dump for which there is no dump code in the dump table.

Dump table statistics

CICS maintains the following statistics for each dump table entry:

- The number of times the dump code action has been taken. This count is referred to as the “dumps taken”. Its value is incremented every time the dump code action is taken, irrespective of what action has been specified in the dump table entry. The current count can be reset to zero by a CEMT transaction, by a system programming command, or by statistical interval expiry.

If system dumping is globally suppressed:

- The dumps-taken count for a system dump code is not incremented by dump requests using that dump code, but the dumps-suppressed count is incremented.
- The dumps-taken count for a transaction dump code specifying a system dump is incremented by dump requests using that dump code. This is so even if the dump code specifies that *only* a system dump is to be taken.
- For a transaction dump code, the number of transaction dumps that have been taken. The number is incremented every time a transaction dump is taken for this dump code. However, it is not incremented if transaction dumping has been suppressed in this table entry.
- For a transaction dump code, the number of transaction dumps that have been suppressed.
- The number of system dumps that have been taken. The number is incremented every time a system dump is taken for this dump code. It is not incremented if system dumping has been suppressed, either explicitly in the dump table entry or because system dumping has been suppressed globally.
- The number of system dumps that have been suppressed, either explicitly for this dump code or because system dumping has been suppressed globally.

Notes:

1. Dump code statistics are all reset when CICS is shut down—unlike dump code attributes, which are not reset.
2. The following dump code statistics are reset at the end of every statistics collecting interval:
 - Number of transaction dumps taken
 - Number of transaction dumps suppressed
 - Number of system dumps taken
 - Number of system dumps suppressed.

The transaction dump table

Table 38 shows some examples of the sort of information that might be maintained in the transaction dump table for different transaction dump codes.

Table 38. Examples of transaction dump table entries

Type of information	Example 1	Example 2	Example 3
Transaction dump code	MYAB	ASRA	AKC3
Take a transaction dump?	YES	NO	NO
Take a system dump?	YES	YES	NO
Take system dumps on related systems?	NO	YES	NO
Shut down CICS?	NO	NO	NO
Maximum times dump code action can be taken	50	30	999
Times dump code action already taken (current count)	0	30	37
Transaction dumps taken	0	0	0
Transaction dumps suppressed	0	30	37
System dumps taken	0	30	0
System dumps suppressed	0	0	37

- **Example 1** shows a transaction dump table entry for transaction dump code MYAB. This is a user-supplied dump code, specified either on an EXEC CICS DUMP TRANSACTION command, or as a transaction abend code on an EXEC CICS ABEND command.

The table entry shows that when this dump code is invoked, both a transaction dump and a system dump are to be taken, and CICS is not to be terminated. System dumps on related systems are not to be taken. The dump code action can be taken a maximum of 50 times, but the action for this dump code has not been taken since CICS was started or since the current count (“times dump action taken”) was reset.

- **Example 2** shows a transaction dump table entry for transaction dump code ASRA. This is a CICS transaction abend code, and this dump table entry is referred to every time a transaction abends ASRA. The entry shows that a system dump only is to be taken for an ASRA abend, and that CICS is not to be terminated. System dumps on related systems are to be taken. It also shows that the action for this abend code has already been taken the maximum number of times, so no action is taken when another ASRA abend occur. However, the

current count could be reset to 0 dynamically using either a CEMT transaction or a system programming command (SET TRANDUMPCODE or SET SYSDUMPCODE). More system dumps would then be taken for subsequent ASRA abends.

- **Example 3** shows a transaction dump table entry for transaction dump code AKC3. This is a CICS transaction abend, and this dump table entry is referenced every time a transaction abends AKC3—that is, whenever the master terminal operator purges a task.

The entry shows that no action at all is to be taken in the event of such an abend. System dumps on related systems are not to be taken. The maximum number of times the dump code action can be taken is given as 999, meaning that there is no limit to the number of times the specified action is taken. The dump code action has been taken 37 times, but each time both the transaction dump and the system dump were suppressed.

Table 39 shows how the transaction dump table entry for transaction dump code MYAB would be updated with and without global suppression of system dumping. Only the updated fields are shown.

Table 39. Effect of global suppression of system dumping on transaction dump table update

Type of information	Before update	System dumping enabled	System dumping suppressed
Transaction dump code	MYAB		
Take a transaction dump?	YES		
Take a system dump?	YES		
Take system dumps on related systems?	NO		
Shut down CICS?	NO		
Maximum times action can be taken	50		
Times action already taken	0	1	1
Transaction dumps taken	0	1	1
Transaction dumps suppressed	0	0	0
System dumps taken	0	1	0
System dumps suppressed	0	0	1

The statistics show that a system dump was taken when system dumping was enabled, but not when system dumping was suppressed.

There is a further effect. CICS maintains a record of the **current dump ID**—the number of the most recent dump to be taken. This is printed at the start of the dump, together with the appropriate dump code. It is concatenated with the CICS run number—that is, the number of times that CICS has been brought up since the global catalog was created—to provide a unique ID for the dump.

Note: This does not apply to SDUMPs taken by the kernel; these always have a dump ID of 0/0000.

For example, for the ninth dump to be taken during the eleventh run of CICS, if the dump code were TD01, this is what you would see:

```
CODE=TD01 ID=11/0009
```

If system dumping is enabled for the dump code, the same dump ID is given to both the transaction dump and the system dump.

The system dump table

Table 40 shows two examples of the sort of information that might be maintained in the system dump table for different system dump codes.

Table 40. Examples of system dump table entries

Type of information	Example 1	Example 2
System dump code	SYDMP001	MT0001
Take a system dump?	YES	YES
Take system dumps on related systems?	YES	NO
Is the dump eligible for DAE?	YES	NO
Shut down CICS?	YES	NO
Maximum times action can be taken	(default)	999
Times action already taken	0	79
System dumps taken	0	79
System dumps suppressed	0	0

The sort of information kept in the system dump table is similar to that kept in the transaction dump table (see Table 38 on page 270).

- **Example 1** shows a system dump table entry for system dump code SYDMP001, a user-supplied system dump code, specified using EXEC CICS PERFORM DUMP. System dumps on related systems are to be taken. Dumps duplicate of this one are to be suppressed by DAE. The table entry shows that no dumps have yet been taken. However, if one were taken, CICS would be shut down. If global suppression of system dumping was in effect, no dump would be taken but CICS would be shut down if this dump code were referenced.
- **Example 2** shows the system dump table entry for system dump code MT0001, the CICS-supplied dump code for system dumps requested from the master terminal, with CEMT PERFORM DUMP or CEMT PERFORM SNAP. CICS is not shut down when a dump is taken for this dump code. Also, the value of 999 for “maximum times action can be taken” shows that an unlimited number of dumps can be taken for this dump code. The current count (“times action already taken”) shows that to date, 79 dumps have been requested using CEMT.

What happens to a dump request if there is no dump table entry?

If a dump is requested, either by CICS or the user, using a dump code that is not in the dump table, CICS makes a temporary dump table entry using default values for the attributes. However, the entry is not written to the CICS global catalog, and it is lost when CICS is shut down.

The **default** value used for the DAEOPTION attribute (for all new system dump codes) is set by means of the DAE= system initialization parameter. The **default** value for the maximum number of times that the dump action can be taken is set by the TRDUMAX system initialization parameter (for new or added transaction dump codes) and the SYDUMAX system initialization parameter (for new or added system dump codes).

You can modify the default values for a transaction dump table entry using the following commands:

- CEMT SET TRDUMPCODE
- EXEC CICS SET TRANDUMPCODE
- EXEC CICS SET TRANSACTION DUMPING (to modify the TRANDUMPING attribute only).

The following table shows the default values for transaction dump table entries and the attributes you can specify to modify them:

Table 41. Default values for transaction dump table entries

Action	Default	Attribute	Permitted value
Take a transaction dump?	YES	TRANDUMPING	TRANDUMP or NOTRANDUMP
Take a system dump?	NO	SYSDUMPING	SYSDUMP or NOSYSDUMP
Take system dumps on related systems?	NO	DUMPSCOPE	LOCAL or RELATED
Shut down CICS?	NO	SHUTOPTION	SHUTDOWN or NOSHUTDOWN
Maximum times dump code action can be taken	999	MAXIMUM	0 through 999

You can modify the default values for a system dump table entry using the following commands:

- CEMT SET SYDUMPCODE
- EXEC CICS SET SYSDUMPCODE
- EXEC CICS SET SYSTEM DUMPING (to modify the SYSDUMPING attribute only).

The following table shows the default values for system dump table entries and the attributes you can specify to modify them:

Table 42. Default values for system dump table entries

Action	Default	Attribute	Permitted value
Take a system dump?	YES	SYSDUMPING	SYSDUMP or NOSYSDUMP
Take system dumps on related systems?	NO	DUMPSCOPE	LOCAL or RELATED
Shut down CICS?	NO	SHUTOPTION	SHUTDOWN or NOSHUTDOWN
Is dump eligible for DAE?	NO	DAEOPTION	DAE or NODAE

Table 42. Default values for system dump table entries (continued)

Action	Default	Attribute	Permitted value
Maximum times dump code action can be taken	999	MAXIMUM	0 through 999

For example, if you issue a command requesting a dump, using the previously undefined dump code SYDMPX01:

```
EXEC CICS PERFORM DUMP DUMPCODE('SYDMPX01')
```

CICS makes a temporary dump table entry for dump code SYDMPX01, and you can browse it, and see that it has the default attributes for a system dump code. You can also see that the current count has been set to 1, as a dump has been taken.

Attempting to add the dump code to the dump table after CICS has made the entry causes the exception response 'DUPREC' to be returned. If you want to make a change to the CICS-generated default table entry, and have that entry preserved across CICS runs, you must delete it and then add a new entry with the options you require.

Specifying the areas you want written to a transaction dump

When you use the EXEC CICS DUMP TRANSACTION command to get a transaction dump, you can specify which areas of storage are to be dumped. You cannot specify in the dump table which areas are to be written to the transaction dump for particular transaction dump codes. You always get a complete transaction dump whenever a transaction abend occurs, if the dump code requires a transaction dump to be taken.

The CSFE ZCQTRACE facility

The CSFE ZCQTRACE facility is used to gather information during the build process of terminal or connection definition. The syntax is as follows:

```
CSFE {ZCQTRACE=termid|ZCQTRACE,AUTOINSTALL|ZCQTRACE,OFF}
```

When CSFE ZCQTRACE is enabled, a dump of the builder parameter set and the appropriate TCTTE is written to the transaction dump data set at specific points in the processing. Table 43 shows the circumstances in which dumps are invoked, the modules that invoke them, and the corresponding dump codes.

Table 43. ZCQTRACE dump codes

Module	Dump code	When invoked
DFHTRZCP	AZCQ	Installing terminal when termid = terminal ID
DFHTRZZP	AZQZ	Merging terminal with TYPETERM when termid = terminal ID
DFHTRZXP	AZQX	Installing connection when termid = connection ID
DFHTRZIP	AZQI	Installing sessions when termid = connection ID
DFHTRZPP	AZQP	When termid = pool terminal ID

Table 43. ZCQTRACE dump codes (continued)

Module	Dump code	When invoked
DFHZCQIQ	AZQQ	Inquiring on resource when termid = resource ID (resource = terminal or connection)
DFHZCQIS	AZQS	Installing a resource when termid = resource ID (resource = terminal or connection), or when ZCQTRACE,AUTOINSTALL is specified.

If a terminal definition is shipped from a terminal owning region (TOR) to an application owning region (AOR) and ZCQTRACE is enabled for that terminal in the TOR, then DFHZCQIQ invokes a dump in the TOR, and DFHZCQIS invokes a dump in the AOR.

Where dumps are written

Transaction dumps and system dumps are written to different destinations.

- **Transaction dumps** go to a pair of CICS BSAM data sets, with DD names DFHDMPA and DFHDMPB. Some of the attributes of these data sets can be set by system initialization parameters, some can be set dynamically using CEMT SET DUMPDS or EXEC CICS SET DUMPDS, and all can be inquired on by using CEMT INQ DUMPDS or EXEC CICS INQUIRE DUMPDS. DFHDMPA and DFHDMPB have the following attributes:

- CURRENTDDS status. This tells you the data set that is currently active, which is the one where transaction dumps are currently written.

You can use the system initialization parameter DUMPDS to specify the transaction dump data set that is to be opened during initialization. You can use the CEMT SET DUMPDS transaction or an EXEC CICS SET command to switch the dump data sets.

- One of the statuses OPEN or CLOSED. A transaction dump data set must be OPEN if it is to be written to.
- The current data set has one of the statuses AUTOSWITCH or NOAUTOSWITCH. You can set the status during system initialization using the DUMPSW system initialization parameter, and you can set it dynamically using the CEMT transaction or an EXEC CICS SET command.

If the status is AUTOSWITCH, a switch is made automatically to the other dump data set when the current one becomes full, and subsequent transaction dumps are written to the new dump data set. The overflowing transaction dump is written in its entirety to the new dump data set.

The dump data set being switched to does not inherit the AUTOSWITCH status, to prevent data in the first dump data set from being overwritten by another switch. You need to reset the AUTOSWITCH status explicitly, if you want it.

If the status is NOAUTOSWITCH, a switch is not made when the current dump data set becomes full, so no more transaction dumps can be written.

- **CICS system dumps** are written to MVS dump data sets. CICS can write only one system dump to any individual dump data set.

If another address space is already taking an SDUMP when CICS issues the SDUMP macro, the request fails but is automatically retried. You can use the DURETRY system initialization parameter to define the total time that CICS is to continue trying to take an SDUMP.

If CICS tries to take an SDUMP when all the dump data sets are full, the dump is lost. Because of this, it is advisable to monitor the number of full data sets, and to take copies of dumps before processing them, so that you can free the dump data sets for reuse.

Looking at dumps

CICS system dumps and transaction dumps are written unformatted to the appropriate dump data set. In other words, they are memory dumps of all or part of the CICS address space.

Unformatted dumps are not easy to interpret, and you are recommended not to use them for debugging. CICS provides utilities for formatting transaction dumps and CICS system dumps, and you should always use them before you attempt to read any dump. You can quickly locate areas of storage that interest you in a formatted dump, either by browsing it online, or by printing it and looking at the hard copy.

The formatting options that are available for transaction dumps and system dumps are described in Formatting transaction dumps and “Formatting system dumps” on page 283, respectively.

Formatting transaction dumps

You can format transaction dumps offline using the CICS dump utility program, DFHDU530. Individual transaction dumps must be formatted in their entirety, but you can control which dumps are formatted from the dump data set. You can select dumps to be formatted as follows:

- Those taken in a specific period of time
- Those associated with a specific transaction identifier
- Those taken for a specific transaction dump code
- Those having specific dump IDs—that is, those for specific CICS runs and dump count values.

You can also use the SCAN option with the dump utility program, to get a list of the transaction dumps recorded on the specified dump data set.

For information about using DFHDU530 to format transaction dumps, see the *CICS Operations and Utilities Guide*.

Interpreting transaction dumps

This section describes the contents of a transaction dump, and gives guidance on locating information that is useful for debugging transactions. The different parts of the transaction dump are dealt with in the order in which they appear, but be aware that only those parts that users should be using for problem determination are described. Some control blocks which do appear in the transaction dump are intended for the problem determination purposes of IBM Service and, as such, are not described in this section.

Job log

The job log for the dump utility program, DFHDU530, is sometimes shown at the start of the transaction dump, depending on how the job was invoked. You can ignore it, because it does not contain any information that can be used for debugging.

Symptom string

The symptom string tells you something about the circumstances of the transaction dump. It might show, for example, that the dump was taken because the transaction abended with abend code ASRA.

If you refer the problem that caused the dump to be taken to the IBM Support Center, they can use the symptom string to search the RETAIN database for problems that resemble it.

CICS Transaction Server for OS/390 level

The CICS Transaction Server for OS/390 level shows you what level of CICS Transaction Server for OS/390 was being executed when the transaction dump was taken.

Transaction environment summary

The transaction environment summary is a formatted summary of the transaction environment at the time the dump is taken.

Remote abend indicator

If the transaction abended remotely (the abend originally occurred in a remote distributed program link (DPL) server program), and the abend is being re-issued on the local system, a message indicates this. The message contains the SYSID of the system that passed the abend to the local system. This information is taken from the transaction abend control block (see "Transaction storage" on page 279).

PSW

If the transaction dump was taken in response to a local abend with abend code AICA, ASRA, ASRB, or ASRD, a PSW is formatted from the dump data set. It belongs to the program that was being executed when the abend occurred. It is taken from the transaction abend control block (see "Transaction storage" on page 279).

Registers at the time of interrupt

If the transaction abended locally with abend code AICA, ASRA, ASRB, or ASRD, you see a set of registers that belong to the program that was executing when the error was detected. They are taken from the transaction abend control block (see "Transaction storage" on page 279).

Execution key

If the transaction abended locally with abend code ASRA or ASRB, the execution key that is in force at the time of the abend is formatted. It is taken from the transaction abend control block (see "Transaction storage" on page 279).

Space

If the transaction abended locally with an ASRA or ASRB abend code, CICS formats the space, basespace or subspace, in which the program was executing. If transaction isolation is not enabled, the program always executes in the basespace.

Registers at last EXEC command

If the transaction has issued any EXEC commands, then a set of registers is displayed. These are the registers from the last EXEC command that was issued.

Task control area (TCA)

The next thing in the transaction dump is the entire TCA. This contains information about the transaction to which the dump relates. Note that the user area precedes the system area.

Task control area, system area

The system area of the task control area is formatted separately, because it can be addressed separately by CICS. It contains system information relating to the task and can often be a valuable source of debugging information.

Transaction work area (TWA)

Any transaction work area relating to the transaction is formatted, if present.

EXEC interface structure (EIS)

The EIS contains information about the transaction and program specific to the execution interface component of CICS.

System EXEC interface block (SYSEIB)

This is used solely by programs using the SYSEIB option. See the *CICS Application Programming Guide* for more details.

EXEC interface user structure (EIUS)

The EIUS contains execution interface component information that must reside in user key storage.

EXEC interface block (DFHEIB)

DFHEIB contains information relating to the passing of EXEC requests from the program to CICS, and the passing of data between the program and CICS. Field EIBFN is of particular interest, because it shows the type of the last EXEC command to be issued by the program. For programming information about the values that EIBFN can contain, see the *CICS Application Programming Reference manual* or the *CICS User's Handbook*.

Kernel stack entries

The kernel stack entries contain information that has been saved by the kernel on behalf of programs and subroutines on the kernel linkage stack. If you refer the problem to the IBM Support Center, they might need to use the stack entries to find the cause of the failure.

Common system area (CSA)

The CSA is one of the main control areas used by CICS. It contains information relating to the system as a whole, and to the task that was running when the transaction dump was invoked. It can be very useful for debugging both application problems and system problems. You cannot access fields in the CSA in your programs. Attempting to do so causes your transaction to terminate abnormally with abend code ASRD.

Common system area optional features list (CSAOPFL)

The common system area optional features list, an extension of the CSA, contains the addresses of CICS optional features.

Trace table (abbreviated format)

The abbreviated-format trace table is formatted by default. You can suppress it by specifying the NOABBREV parameter in the DFHDU530 job. A “one entry per line” summary of the trace entries, copied from the internal trace table, is formatted.

Provided that you had EI level-1 and PC level-1 tracing selected for your task, you can identify the last CICS command issued by your task quite easily. The procedure is outlined in “Locating the last command or statement” on page 280.

Trace table (extended format)

Following the abbreviated-format trace table is the corresponding extended-format trace table. This is formatted by default. You can suppress it by specifying the NOFULL parameter in the DFHDU530 job. It contains more detail, but you can probably get all the information you need using the abbreviated trace.

Common work area (CWA)

The CWA is the installation-defined work area for use by all programs and is formatted if it exists.

Transaction storage

“Transaction storage” is storage that might have been obtained by CICS to store information about a transaction, or it might have been explicitly GETMAINed by the transaction for its own purposes. You are likely to find several such areas in the dump, each introduced by a header describing it as transaction storage of a particular class, for example:

```
USER24
USER31
CICS24
CICS31
```

Transaction storage class CICS31 contains, among other things, the transaction abend control block (TACB). To find it, look for the eye-catcher **DFHTACB**. DFHTACB contains valuable information relating to the abend. It contains:

- The PSW and general purpose registers of the program executing at the time of the abend (for local AICA, ASRA, ASRB and ASRD abends only. However, for some AICA abends, only the “next sequential instruction” part of the PSW and the registers are present.) Registers 12 and 13 contain the addresses of the TCA

and CSA respectively in all abends except for ASRA and ASRB abends, when these registers contain data as at the time of the abend.

- The name of the failing program.
- The offset within the failing program at which the abend occurred (for local ASRA, ASRB and ASRD abends only).
- The execution key at the time of the abend (for local ASRA and ASRB abends only).
- Whether the abend was caused by an attempt to overwrite a protected CICS DSA (local ASRA abends only).
- Whether the program is executing in a subspace or the basespace.
- The subspace STOKEN.
- The subspace's associated ALET.

Note that if the abend originally occurred in a remote DPL server program, an eye-catcher ***REMOTE*** is present. If this is the case, the registers and PSW are not present.

Terminal control table terminal entry (TCTTE)

The TCTTE contains information about the terminal that is the principal facility of the transaction. You usually find one TCTTE for the transaction if the transaction is terminal oriented. For "daisy chained" transactions, you may find more than one.

To look at the TIOA for the task, find the address in field TCTTEDA of the TCTTE.

Program information for the current transaction

This shows summary information for all linked programs for the transaction that have not yet returned, including load point, entry point, and length. This is followed by the program storage for each of these programs. This is where you can find the instructions addressed by register 14 and by the PSW, and hence the point of failure in your program. For details of how you do this, see "Locating the last command or statement".

Other program manager control blocks are shown too, including PPT entries for active programs, and load list elements and program storage for any programs loaded by this transaction but not yet released.

Module index

The final item that you find in the transaction dump is the module index. This shows you all the modules that were in storage when the error was detected, and their addresses.

Locating the last command or statement

The easiest way of locating the last command issued by your application before the abend is to use the internal trace table. You must have had internal trace running, and you need to have captured entries from the EI level-1 and PC level-1 trace points for your task. The way you can find the last command using trace is described in "Last command identification" on page 281.

If you did not have trace running, you need to rely on values in registers belonging to your programs, and try to relate these to your source statements. That might lead

you to an EXEC CICS command, or to another type of statement in your program. The procedure is outlined in “Last statement identification”.

Last command identification

This process for identifying the last command applies to system dumps, in which it is necessary to identify the abending task. Item 2 is relevant to transaction dumps.

1. If the abend was a local AICA, ASRA, ASRB, or ASRD, find the last entry in the table and work back until you find an entry for trace point ID AP 1942. If you cannot find AP 1942, then search for any one of the following: AP 0790, AP 0791, or AP 0792. The trace entry for AP 1942 is made on entry to APLI's recovery routine. The entries for AP 0790, AP 0791, and AP 0792 are made by DFHSRP, the AP domain recovery routine that deals with program checks, operating system abends, and runaway task conditions. The task number for your task is shown in the entry.

If the abend was none of those mentioned above, find the last entry in the table and work back until you find an entry for trace point ID AP 00F2 (PCP abend) that references the abend code. The task number of your task is shown in the entry.

2. Now go back until you find the last trace entry showing your task number that was made from trace point ID AP 00E1. The trace entry is located in the EXEC interface program, DFHEIP. The data in the trace entry includes the value of EIBFN, which tells you the specific command your program issued before the abend. For programming information about the possible values that EIBFN can take, and their meanings, see the *CICS Application Programming Reference* manual, or the *CICS User's Handbook*.
3. You might now be able to identify the program that was being run when the abend occurred, from knowing the structure of the application. If not, you can identify the program by using the information in the “program information for the current transaction” section of the dump. The failing program is the one most recently linked to (the first program printed in this section). The summary information includes the name of the program, and its load point, entry point, and length.
4. You should by now have found the program containing the last EXEC command that was issued before the abend. You next need to locate the EXEC command in that program. If you cannot do it by inspection, use the techniques described in the next section.

Last statement identification

1. Locate the “transaction storage –CICS31” areas of the transaction dump. These areas are maintained by CICS, and they relate to the transaction that was running when the abend occurred. You should be able to see the eye-catcher **DFHTACB** in at least one of the areas. This signifies the start of the transaction abend control block, and it contains the registers and PSW belonging to the program being executed when the abend occurred. If there is more than one area containing this eye-catcher, it means that two or more successive abends occurred. You need to find the first occurrence, because that relates to the abend that started the sequence.
2. Locate the PSW for the program in the TACB, and make a note of the next sequential instruction address. The PSW for the program is present if the abend is AICA, ASRA, ASRB or ASRD. Alternatively, obtain the offset of the abend

within the failing program load module from the TACB. The offset is present if the abend is ASRA, ASRB or ASRD and is valid if not X'FFFFFFFF'. Note the value of register 14, too.

3. Use the “program information for the current transaction” section of the dump to obtain the name and entry point of the failing program. Alternatively, obtain the name of the failing program from the TACB.
4. The offset or PSW should point to an instruction in the program. If it does not, register 14 should show a return address into your program. Either way, you need to correlate the address with a statement in the source code for the program.

If the source language is **assembler**, the instruction where the abend occurred is apparent from the program storage in the dump. If the source language is **COBOL**, **PL/I**, or **C/370™**, you need to refer to a compiler output mapping source statements onto the object code.

Locating program data

You might want to look at the data that your application program has in its storage areas. CICS maintains a pointer to the chain of dynamic storage that the program uses, in field TCAPCDSA of the system area of the TCA.

- For **PL/I programs**, TCAPCDSA addresses the chain of PL/I DSAs.
- For **COBOL programs**, TCAPCDSA addresses the task global table (TGT) and working storage.
- For **assembler programs**, TCAPCDSA addresses the DFHEISTG storage.

You need to look in the appropriate programming language manual for details of the structure of the program’s acquired storage.

Dumps for C/370 programs

If DUMP(YES) is coded on the transaction definition, CICS system and transaction dumps are produced for failing C/370 programs. The use of the relevant C/370 registers is as follows:

Register	Use
3	In most circumstances, is the base register
12	Holds the address of the CICS TCA for the C/370 program
13	Holds the address of the register save area

Location of COBOL dumped areas

The dumped COBOL program can be found in the “program information for the current transaction” section of the dump, and is addressed by the LOAD_POINT parameter on the appropriate LDLD ACQUIRE_PROGRAM exit trace entry. The register save area INI1+X'48' (covering registers 0 through 14) should have register 12 pointing to the program global table (PGT), register 13 pointing to the task global table (TGT), and some others to locations in the data area and compiled code of the program storage. If not, a CICS error is indicated.

For each invocation of the COBOL program, CICS copies the **static** TGT from program storage into CICS **dynamic** storage (the COBOL area) and uses the dynamic copy instead of the static one. CICS also copies working storage from

program storage to the COBOL area, above the TGT. Task-related COBOL areas thus enable the single copy of a COBOL program to multithread as if it were truly reentrant.

The dumped COBOL area

The COBOL area is addressed by TCAPCDSA (alias TCAPCCA) in the system part of the TCA (and forms part of the transaction storage chain). The COBOL area contains:

- The COBOL working storage for the task
- A copy of the TGT.

The TGT is addressed by TCAPCHS in the system part of the TCA.

The TGT is used to hold intermediate values set at various stages during program execution. The first 18 words of the TGT constitute a standard save area, in which the program's current registers are stored on any request for CICS service.

The TGT also holds the base locator for linkage (BLL) cells, which contain the addresses of all areas defined in the linkage section of the COBOL program. You can use the memory map from the COBOL compiler listing for your application to find the offset of the BLL cells in the TGT.

BLL cells in a CICS application program

To investigate a problem connected with BLL cells, you should examine the COBOL compiler listing for your application to determine the use you have made of the BLL cells.

The **first** BLL cell that is used points to the EXEC interface block (an area that follows the literal string 'DFHEIB').

The **second** BLL cell that is used points to the first (or only) 4096-byte block of CICS COMMAREA as supplied with an EXEC CICS LINK, XCTL, or RETURN with a TRANSID. If the COMMAREA is greater than 4096 bytes, the **third** BLL cell that is used points to the next 4096-byte block of COMMAREA; further 4096-byte COMMAREAs are pointed to by succeeding BLL cells.

The next BLL cell always points to itself; the remaining BLL cells are set by the application program. Thus, for example, if the COMMAREA size is 10KB, it is the **fifth** BLL cell used that points to itself.

Note that an ASRD abend will occur if an attempt is made to access storage via the BLL cell immediately after the one that points to itself, if it has not yet been set by the application program.

Formatting system dumps

You can process system dumps from the dump data set using an invocation of the interactive problem control system (IPCS).

In prior releases, the CICS formatting routine for use under the MVS interactive problem control system (IPCS) is supplied as DFHPDX. This standard name is not suitable for those users running more than one release of CICS, because the dump formatting process in each version of DFHPDX is release-specific, and you must use the correct version for the system dump you are formatting. The module is

named with the release identifier as part of the name - DFHPD530 is the formatting routine you must define to IPCS when formatting CICS Transaction Server for OS/390 Release 3 system dumps.

The DFHIPCSP CICS exit control data

IPCS provides an exit control table with imbed statements to enable other products to supply exit control information. The IPCS default table, BLSCECT, normally in SYS1.PARMLIB, has the following entry for CICS:

```
IMBED MEMBER(DFHIPCSP) ENVIRONMENT(ALL) /*CICS */
```

Ensure that the CICS-supplied DFHIPCSP member can be found by your IPCS job. You can either copy DFHIPCSP into SYS1.PARMLIB (so that it is in the same default library as BLSCECT) or provide an IPCSPARM DD statement to specify the library containing the IPCS control tables. For example:

```
//IPCSPARM DD DSN=SYS1.PARMLIB,DISP=SHR          For BLSCECT
//          DD DSN=CICSTS13.CICS.SDFHPARM,DISP=SHR  For DFHIPCSP
```

Figure 56 shows the release-specific entries specified in DFHIPCSP.

```
/* ===== */
EXIT EP(DFHPD212) VERB(CICS212) ABSTRACT(+
  'CICS Version 2 Release 1.2 analysis')
EXIT EP(DFHPD321) VERB(CICS321) ABSTRACT(+
  'CICS Version 3 Release 2.1 analysis')
EXIT EP(DFHPD330) VERB(CICS330) ABSTRACT(+
  'CICS Version 3 Release 3 analysis')
EXIT EP(DFHPD410) VERB(CICS410) ABSTRACT(+
  'CICS Version 4 Release 1 analysis')
EXIT EP(DFHPD510) VERB(CICS510) ABSTRACT(+
  'CICS Transaction Server for OS/390 Release 1 analysis')
EXIT EP(DFHPD520) VERB(CICS520) ABSTRACT(+
  'CICS Transaction Server for OS/390 Release 2 analysis')
EXIT EP(DFHPD530) VERB(CICS530) ABSTRACT(+
  'CICS Transaction Server for OS/390 Release 3 analysis') /* =====
```

Figure 56. Release-specific entries in DFHIPCSP for DFHPDnnn routines

To use the DFHIPCSP member as it is, rename the CICS-supplied version of DFHPDX for earlier releases to the names shown in the table.

- The IPCS dump analysis subcommands enable you to format and analyze CICS-produced SDUMPs, which you can either view at a terminal or print. You can:
 - Examine the data in a dump
 - Locate and verify control blocks associated with certain functions or system components
 - Trace and verify chains of control blocks
 - Perform contention analysis on key MVS resources
 - Locate modules and unit control blocks
 - Execute user-written exits for certain control blocks
 - Keep a list of names and locations of control blocks and areas of the dump that you consider important.
- The CICSnnn dump exit (where nnn is the CICS release identifier) enables you to format a dump selectively by specifying one or more CICS component

identifiers as parameters to the exit. Thus, the CICS530 dump exit enables you to process a CICS Transaction Server for OS/390 Release 3 dump selectively. You can:

- Specify which job in the dump data set is to be formatted (**JOB** parameter).
- Specify which component storage areas are to be formatted, and at what level of detail, by using formatting keywords and level numbers (**keyword** parameter). You do this using the IPCS command: VERBEXIT CICS530 'keyword,...'.
- Specify the default level of detail for components that are not explicitly identified by keyword (**DEF** parameter).
- Specify whether the output is to be printed in uppercase characters (**UPPERCASE** parameter).

The use of formatting keywords enables you to format those parts of the dump that interest you at any particular time, at specific levels of detail. You have the option of formatting other parts later for further investigation by you or by the IBM service organizations. It is advisable to copy your dumps so that you can save the copy and free the dump data set for subsequent use.

For guidance about using the formatting keywords and levels, see the *CICS Operations and Utilities Guide*.

A summary of system dump formatting keywords and levels

The component keywords specify which areas of CICS you want the CICS530 exit to format dump data for, and the level number operand specifies the amount of data you want formatted.

If you omit all of the component keywords, and you do not specify DEF=0, the CICS dump exit formats dump data for all components.

The CICS dump component keywords, and the levels you can specify for each of them, are as follows:

AI [= {0|2}]

Autoinstall model manager.

AI=0 Suppress formatting of AI control blocks.

AI=2 Format AI control blocks.

AP [= {0|1|2|3}]

Application domain.

AP=0 Suppress formatting of AP control blocks.

AP=1 Format a summary of addresses of the AP control blocks for each active transaction.

AP=2 Format the contents of the AP control blocks for each active transaction.

AP=3 Format level-1 and level-2 data.

AU [= {0|2}]

CICS affinities utility.

AU=0 Suppress formatting of AU control blocks.

AU=2 Format the affinities utility control blocks (the GWA, and the internal trace table).

BA [= {0|1|2|3}]

Business application manager domain.

BA=0 Suppress formatting of business application manager domain control blocks.

BA=1 Format the BA unit of work context (BAUW) and BA activity (BAACT) summaries.

BA=2 Format the anchor block (BADMANC), BA unit of work context (BAUW), and BA activities (BAACT).

BA=3 Format level-1 and level-2 data.

BR [= {0|1|2|3}]

The 3270 bridge

BR=0 Suppress formatting of bridge control blocks.

BR=1 Format bridge facility summary information.

BR=2 Format the bridge exit interface block, the bridge facility block, the bridge facility bitmap and keep chain, and the TXN_CS.

BR=3 Format level-1 and level-2 data.

CC [= {0|2}]

The CICS catalog domain.

CC=0 Suppress formatting of CC control blocks.

CC=2 Format the CC control blocks.

CP [= {0|2}]

The common programming interface.

CP=0 Suppress formatting of CP control blocks.

CP=2 Format the CPI static storage.

CSA [= {0|2}]

The CICS common system area.

CSA=0

Suppress formatting of the CSA.

CSA=2

Format the CSA and its extension, the optional features list (CSAOPFL).

DB2 [= {0|1|2|3}]

The CICS DB2 interface.

DB2=0

Suppress formatting of DB2 control blocks.

DB2=1

Format the summary of tasks currently using the CICS DB2 interface.

DB2=2

Format the control blocks.

DB2=3

Format level-1 and level-2 data.

DD [= {0|1|2|3}]

The directory manager domain.

- DD=0** Suppress formatting of DD control blocks.
- DD=1** Format the directory manager summary.
- DD=2** Format the directory manager control blocks, including the anchor block, directory headers, and AVL tree headers.
- DD=3** Format level-1 and level-2 data.

DH[={0|1|2|3}]

The document handler domain.

- DH=0** Suppress formatting of DH control blocks.
- DH=1** Format document handler summary information.
- DH=2** Format the domain anchor block, document anchor block, document control record, document data block and document bookmark block.
- DH=3** Format level-1 and level-2 data.

DLI[={0|2}]

CICS DL/I interface.

- DLI=0** Suppress formatting of DLI control blocks.
- DLI=2** Format DLI control blocks.

DM[={0|1|2|3}]

The domain manager.

- DM=0** Suppress formatting of DM control blocks.
- DM=1** Format the wait queue.
- DM=2** Format the anchor block.
- DM=3** Format level-1 and level-2 data.

DS[={0|1|2|3}]

The dispatcher domain.

- DS=0** Suppress formatting of DS control blocks.
- DS=1** Format the dispatcher dump summary.
- DS=2** Format the anchor block.
- DS=3** Format level-1 and level-2 data.

DU[={0|2}]

The dump domain.

- DU=0** Suppress formatting of DU control blocks.
- DU=2** Format the DU anchor block.

EM[={0|1|2}]

The event manager.

- EM=0** Suppress formatting of EM control blocks.
- EM=1** Format a summary of the active event pools.
- EM=2** Format the content of the EM control blocks.

FCP[={0|2}]

The file control program.

- FCP=0** Suppress formatting of the file control table.

FCP=2

Format the file control table.

FT[={0|1|2|3}]

The feature domain.

FT=0 Suppress formatting of the feature table.

FT=1 Provide a system dump summary.

FT=2 Provide a dump for the feature table.

FT=3 Provide a summary and dump for the feature table.

ICP[={0|2}]

The interval control program.

ICP=0 Suppress formatting of the interval control elements (ICEs).

ICP=2 Format the ICEs.

IND[={0|1|2|3}]

The page number indexes for the formatted output.

IND=0 Suppress formatting of the page number indexes.

IND=1 Provide a control block index sorted by address.

IND=2 Provide a control block index sorted by block name.

IND=3 Format level-1 and level-2 data.

Note: IPCS does not produce page numbers if formatting directly to the terminal.

JCP [={0|2}]

The journal control area.

JCP=0

Suppress formatting of the JCA.

JCP=2

Format the JCA.

KE[={0|1|2|3}]

The CICS kernel.

KE=0 Suppress formatting of the kernel control blocks.

KE=1 Format the stack and a summary of tasks.

KE=2 Format the anchor block.

KE=3 Format level-1 and level-2 data.

LD[={0|1|2|3}]

The loader domain.

LD=0 Suppress formatting of loader domain control blocks.

LD=1 Format a program status and module summary.

LD=2 Format the anchor block, the current program elements (CPEs), and the active program elements (APEs)

LD=3 Format level-1 and level-2 data.

LG[={0|1|2|3}]

The log manager domain.

LG=0 Suppress formatting of log manager domain control blocks.

LG=1 Format the log manager summary.

LG=2 Format all log manager control blocks.

LG=3 Format level-1 and level-2 data.

LM[={0|1|2|3}]

The lock manager domain.

LM=0 Suppress formatting of lock manager domain control blocks.

LM=1 Format the lock status and allocated locks summary.

LM=2 Format the anchor block and quickcells.

LM=3 Format level-1 and level-2 data.

ME[={0|2}]

The message domain.

ME=0 Suppress formatting of the ME anchor block.

ME=2 Format the anchor block.

MN[={0|1|2|3}]

The monitoring domain.

MN=0 Suppress formatting of monitoring domain control blocks.

MN=1 Format the monitoring status and monitoring dictionary summary.

MN=2 Format the anchor block and monitoring control table.

MN=3 Format level-1 and level-2 data.

MRO[={0|2}]

CICS multiregion operation.

MRO=0

Suppress formatting of all MRO control blocks.

MRO=2

Format MRO control blocks, APPC URDs, and any associated DWE chains.

NQ [={0|2}]

The enqueue manager domain.

NQ=0 Suppress formatting of NQ control blocks.

NQ=2 Format NQ control blocks.

PA[={0|2}]

The parameter manager domain.

PA=0 Suppress formatting of the PA anchor block.

PA=2 Format the PA anchor block.

PCT[={0|2}]

The program control table.

PCT=0

Suppress formatting of the transaction definitions.

PCT=2

Format the transaction definitions.

PG[={0|1|2|3}]

The program manager domain.

PG=0 Suppress formatting of program manager domain control blocks.

PG=1 Format the program manager summary.

PG=2 Format the program manager control blocks, including the anchor block, the LLEs, the PGWEs, the PPTEs, the PLCBs, and the HTBs.

PG=3 Format level-1 and level-2 data.

PR [={0|2}]

Partner resource management.

PR=0 Suppress formatting of PR areas.

PR=2 Format the PR static storage and the partner resource table.

RD [={0|2}]

Resource definition.

RD=0 Suppress formatting of RD areas.

RD=2 Format the RD recovery and locking blocks.

RM [={0|2}]

The recovery manager domain.

RM=0 Suppress formatting of RM control blocks.

RM=2 Format RM control blocks.

RX [={0|2|3}]

The recoverable resource management services (RRMS) domain.

RX=0 Suppress formatting of RRMS control blocks.

RX=1 Format summary of unit-of-recovery information.

RX=2 Format all RRMS domain storage.

RX=3 Format level-1 and level-2 data.

SH [={0|1|2|3}]

The scheduler services manager domain.

SH=0 Suppress formatting of the scheduler services manager domain control blocks.

SH=1 Format the SH unit of work pending queue (SHPQUEUE), the bound, pending and committed SH request (SHREQUES) summaries.

SH=2 Format the anchor block (SHDMANC), SH unit of work pending queue, (SHPQUEUE), the bound, pending and committed SH requests (SHREQUES).

SH=3 Format level-1 and level-2 data.

SM[={0|1|2|3}]

The storage manager domain.

SM=0 Suppress formatting of storage manager domain control blocks.

SM=1 Format the dynamic storage areas (DSAs), task and domain storage subpools, transaction areas (SMXs), suspend queue, and subspace area (SUA) summaries.

SM=2 Format the anchor block (SMA), subpool control areas (SCAs),

pagepool areas (PPAs), pagepool extent areas (PPXs), storage manager transaction areas (SMXs), subspace areas (SUAs), suspend queue elements (SQEs), page allocation maps (PAMs), DSA extent descriptors (DXEs), and DSA extent getmain descriptors (DXGs).

SM=3 Format level-1 and level-2 data.

SSA[={0|2}]

The static storage areas.

SSA=0

Suppress formatting of the static storage areas address list.

SSA=2

Format the static storage areas address list.

SO[={0|1|2|3}]

The socket domain.

SO=0 Suppress formatting of the socket domain control blocks.

SO=1 Format a summary of the socket domain control blocks.

SO=2 Format the contents of the socket domain control blocks in full.

SO=3 Format both the level-1 and level-2 data. Specifying SO is the same as SO=3.

ST[={0|1|2|3}]

The statistics domain.

ST=0 Suppress formatting of statistics domain control blocks.

ST=1 Format statistics collection details.

ST=2 Format the anchor block.

ST=3 Format level-1 and level-2 data.

SZ[={0|1}]

Front end programming interface (FEPI).

SZ=0 Suppress formatting of the FEPI static area.

SZ=1 Format the FEPI static area. Nothing is printed unless you have installed FEPI. See the *CICS Front End Programming Interface User's Guide* for further information on this feature.

TCP[={0|1|2|3}]

The terminal control program.

TCP=0

Suppress formatting of TCP control blocks.

TCP=1

Format the terminal control summary.

TCP=2

Format the terminal control table, the terminal input/output areas, and the AIDs.

TCP=3

Format level-1 and level-2 data.

TDP[={0|1|2|3}]

The transient data program.

TDP=0
Suppress formatting of transient data control blocks.

TDP=1
Format the summary of transient data destinations.

TDP=2
Format the transient data static storage areas and the multiple strings control blocks (MRCBs).

TDP=3
Format level-1 and level-2 data.

TI[={0|1|2|3}]
The timer domain.

TI=0 Suppress formatting of timer domain control blocks.

TI=1 Format outstanding request details.

TI=2 Format the anchor block.

TI=3 Format level-1 and level-2 data.

TMP[={0|2}]
The table manager program.

TMP=0
Suppress formatting of table manager static storage and control blocks.

TMP=2
Format table manager static storage and control blocks.

TR[={0|1|2|3}]
The trace domain.

TR=0 Suppress formatting of trace.

TR=1 Format abbreviated trace.

TR=2 Format full trace.

TR=3 Format level-1 and level-2 data.

TRS[=<trace selectivity parameter(s)>]
Trace entry selectivity.

This keyword is effective only if the TR keyword value is 1, 2, or 3.

The TRS component keyword allows you to exercise much the same selectivity over the formatting and printing of trace entries written in a trace internal to a system dump, as you may exercise over the formatting and printing of trace entries in an auxiliary trace.

The trace selectivity parameter may be any valid trace selectivity parameter available to DFHTU530 for the formatting of CICS auxiliary trace entries except the parameters PAGESIZE, ABBREV, and FULL. You may, as with DFHTU530, select any number of parameters from those available.

Note, however, that you must use angled brackets around the parameter, or sequence of parameters, that you specify. The format and default values of parameters used to select trace entries from an internal SDUMP trace, are the same as those that apply when you use DFHTU530 to format auxiliary trace entries.

TS[={0|1|2|3}]

Temporary storage domain.

- TS=0** Suppress formatting of temporary storage control blocks.
- TS=1** Format a summary of temporary storage control blocks and temporary storage control block checking.
- TS=2** Format temporary storage control blocks.
- TS=3** Format level-1 and level-2 data.

UEH[={0|2}]

The user exit handler.

- UEH=0**
Suppress formatting of control blocks.
- UEH=2**
Format control blocks.

US[={0|1|2|3}]

The user domain.

- US=0** Suppress formatting of user domain control blocks.
- US=1** Format the user domain summary.
- US=2** Format the control blocks.
- US=3** Format level-1 and level-2 data.

WB[={0|1|2}]

The web interface.

- WB=0** Suppress formatting of web interface control blocks.
- WB=1** Format the web interface summary. This displays the current state of the CICS web interface, followed by a summary of the state blocks controlled by the state manager.
- WB=2** Format the control blocks. This displays the current state of the CICS web interface, followed by the web anchor block, the global work area and associated control blocks, and the web state manager control blocks.

XM[={0|1|2|3}]

The transaction manager.

- XM=0** Suppress formatting of transaction manager control blocks.
- XM=1** Format the domain summary, global state summary, transaction summary, transaction class summary, and MXT summary.
- XM=2** Format the control blocks including the transaction domain anchor block, transactions (TXn), and transaction class control blocks (TCL).
- XM=3** Format level-1 and level-2 data.

XRF[={0|2}]

The extended recovery facility.

- XRF=0**
Suppress formatting of control blocks.
- XRF=2**
Format control blocks.

XS[={0|1}]

The security domain.

XS=0 Suppress formatting of anchor block and supervisor storage.

XS=1 Format anchor block and supervisor storage.

For a more detailed list of the contents of SDUMPs for each of the VERBEXIT keywords, see “Appendix A. SDUMP contents and IPCS CICS VERBEXIT keywords” on page 317.

The default SDUMP formatting levels

The **DEF** dump exit parameter specifies the default level of formatting you want for data from the dump data set. Note that the DEF parameter is only effective for components that are not included in a list of component keywords.

The levels that you can specify are as follows:

Level Meaning

- | | |
|----------|--|
| 0 | For those components not included in a specified list of keywords, suppress all component formatting. Note that if you specify DEF=0, but do not specify any component keywords, you still get the dump summary and, if appropriate, the error message index. |
| 1 | For those components not included in a specified list of keywords, and where applicable, format the summary information only. (A summary is not available for all components; see the level numbers available for the individual keywords for those for which a summary of dump information is available.) |
| 2 | For those components not included in a specified list of keywords, format the control block information only. |
| 3 | For those components not included in a specified list of keywords, format the control block information and also (where applicable) the summary information. |

Effects of omitting the DEF parameter:

- If you omit the DEF parameter and *do not* specify any component keywords, the result is as if you specified DEF=3.
- If you omit the DEF parameter *and* specify one or more component keywords, the result is as if you specified DEF=0.

Exceptions to the scope of the DEF parameter: There are two parts of a CICS system dump that are not governed by component keywords, and are therefore outside the scope of the DEF parameter. These are:

1. The dump summary
2. The error message index.

These parts of a CICS system dump are always formatted, even if you specify DEF=0 and no component keywords.

Storage freeze

Certain classes of CICS storage that are normally freed during the processing of a transaction can, optionally, be kept intact and freed only at the end of the transaction. Then, in the event of an abend, the dump contains a record of the storage that would otherwise have been lost, including the storage used by CICS service modules. The classes of storage that can be frozen in this way are those in the teleprocessing and task subpools, and in terminal-related storage (TIOAs).

The storage freeze function is invoked by the CSFE transaction. For information about using CSFE, see the *CICS Supplied Transactions* manual.

Dumping a CFDT list structure

You can use the MVS DUMP command to obtain a dump of the coupling facility list structure for a coupling facility data table pool. For example, enter the following command at the console:

```
DUMP COMM=(cfdt_poolname)
```

In response to the DUMP command, the system prompts you with a reply number for the dump options you want to specify. When prompted for dump parameters in response to the DUMP COMM command, enter the reply:

```
REPLY nn,STRLIST=(STRNAME=DFHCFLS_poolname,ACCESSTIME=NOLIMIT,  
(LISTNUM=ALL,ADJUNCT=DIRECTIO,ENTRYDATA=UNSERIALIZE)),END
```

Using abbreviations for the keywords, this reply can be entered as:

```
R nn,STL=(STRNAME=DFHCFLS_poolname,ACC=NOLIM,  
(LNUM=ALL,ADJ=DIO,EDATA=UNSER)),END
```

The parameter ACCESSTIME=NOLIMIT allows XES to override server access time limits, to obtain serialization to take the dump. Without this parameter, no dump is taken if any server is active.

The parameters ADJUNCT=DIRECTIO and ENTRYDATA=UNSERIALIZE notify XES not to keep the serialization while dumping adjunct areas and entry data. If servers are currently active but it is considered important to obtain a serialized dump, to show the structure at a moment in time, replace these parameters with ADJUNCT=CAPTURE and ENTRYDATA=SERIALIZE. Note that this will lock out server access to the structure until the dump is complete.

For more information about the MVS DUMP command, see *OS/390 MVS System Commands*, GC28-1781 .

Formatting a coupling facility data table pool dump

To format a coupling facility data table structure dump, use the IPCS STRDATA subcommand. To display the table index list, use the STRDATA subcommand as follows:

```
STRDATA DETAIL LISTNUM(2) ENTRYPOS(ALL)
```

The key of each entry in this list is the table name, and the first word of the adjunct area is the corresponding data list number. If the table is open, entry data is present containing a list of information about the current table users (regions that have the table open). Each one is identified by its MVS system name and CICS APPLID. The

number of users is at +X'14' in the adjunct area. After any valid table user elements, the rest of the data area is uninitialized and can contain residual data up to the next 256-byte boundary.

You can display the table data by converting the data list number to decimal and specifying it on another STRDATA subcommand. For example, if the first word of the adjunct area is X'00000027', the command to display the table data is as follows:

```
STRDATA DETAIL LISTNUM(39) ENTRYPOS(ALL)
```

In the data list, the key of each entry is the record key, and the data portion contains the user data with a 2-byte length prefix (or a 1-byte X'80' prefix if the data length is 32767 bytes). The rest of any data area is uninitialized and can contain residual data up to the next 256-byte boundary. The entry version contains the time stamp at the time the record was last modified or created.

The adjunct area contains information for locking and recovery. It contains null values (binary zeros) if the record is not locked. When the record is locked, the lock owner APPLID and UOWID appear in this area.

If a record has a recoverable rewrite pending, there are two entries with the same key, where the second entry is the before-image.

For information about the STRDATA subcommand and its options, see *OS/390 MVS IPCS Commands*, GC28-1754 .

Dumping a named counter list structure

You can use the MVS DUMP command to obtain a dump of the coupling facility list structure for a named counter pool. For example, enter the following command at the console:

```
DUMP COMM=(named_counter_poolname)
```

In response to the DUMP command, the system prompts you with a reply number for the dump options you want to specify. When prompted for dump parameters in response to the DUMP COMM command, enter the reply:

```
REPLY nn,STRLIST=(STRNAME=DFHNCLS_poolname,ACCESSTIME=NOLIMIT,  
(LISTNUM=ALL,ADJUNCT=DIRECTIO)),END
```

Using abbreviations for the keywords, this reply can be entered as:

```
R nn,STL=(STRNAME=DFHNCLS_poolname,ACC=NOLIM,(LNUM=ALL,ADJ=DIO)),END
```

The parameter ACCESSTIME=NOLIMIT allows XES to override server access time limits, to obtain serialization to take the dump. Without this parameter, no dump is taken if any server is active.

The parameter ADJUNCT=DIRECTIO notifies XES not to keep the serialization while dumping adjunct areas. If servers are currently active but it is considered important to obtain a serialized dump, to show the structure at a moment in time, replace this parameter with ADJUNCT=CAPTURE. Note that this will lock out server access to the structure until the dump is complete.

For more information about the MVS DUMP command, see *OS/390 MVS System Commands*, GC28-1781 .

Formatting a named counter pool dump

To format a named counter structure dump, use the IPCS STRDATA subcommand as follows:

```
STRDATA DETAIL LISTNUM(0) ENTRYPOS(ALL)
```

The key of each entry in this list is the counter name. The version field contains the counter value minus its maximum value minus 3 (in twos complement form) which has the effect that all counters have a value of -2 when they have reached their limit (and the value of -1, equal to all high values, never occurs). The start of the adjunct area contains the 8-byte minimum and maximum limit values that apply to the counter.

For information about the STRDATA subcommand and its options, see *OS/390 MVS IPCS Commands*, GC28-1754 .

Using FEPI dump

For information about using dumps to solve FEPI problems, see the *CICS Front End Programming Interface User's Guide*.

Chapter 16. The global trap/trace exit

The global trap/trace exit (DFHTRAP) is intended to be used only under the guidance of IBM Service personnel. It is designed so that a detailed diagnosis of a problem can be made without having to stop and then restart CICS.

Typically, the global trap/trace exit is used to detect errors that cannot be diagnosed by other methods. These might cause intermittent problems that are difficult to reproduce, the error perhaps occurring some time before the effects are noticed. For example, a field might be changed to a bad value, or some structure in storage might be overlaid at a specific offset.

DFHTRAP is an assembler language program that can be invoked whenever the trace (TR) domain is called to make a trace entry. The trap must be activated before it is used, either dynamically or at CICS initialization.

A skeleton version of DFHTRAP is supplied in both source and load-module forms. The source of DFHTRAP is cataloged in the CICS530.SDFHMAC library. The source of the skeleton DFHTRAP contains comments explaining its use of registers and DSECTs, and the coding you need to do if you need to use the exit.

The code in DFHTRAP must **not** make use of any CICS services, cause the current task to lose control, or change the status of the CICS system.

Establishing the exit

DFHTRAP can be installed as part of the RDO group DFHFE. You can install it either with the GRPLIST system initialization parameter, or dynamically using the CEDA transaction.

When CICS is running, activation and deactivation of the trap exit routine can be requested using the TRAP operand of the CSFE DEBUG command:

```
CSFE DEBUG,TRAP={ON|OFF}
```

The trap exit can also be activated at CICS initialization by specifying TRAP=ON, either in DFHSIT or as a startup override. If you want to **replace** a trap exit routine while CICS is running, use the CSFE DEBUG commands in conjunction with the CEMT NEWCOPY command. The following sequence of commands causes the currently active version of DFHTRAP to be refreshed:

```
CSFE DEBUG,TRAP=OFF  
CEMT SET PROGRAM(DFHTRAP) NEWCOPY  
CSFE DEBUG,TRAP=ON
```

Information passed to the exit

To assist in the diagnosis of faults in a CICS system, the trace domain passes information to the exit in a parameter list addressed by register 1. A DSECT (DFHTRADS) is supplied for this list, which contains the addresses of:

- The return-action flag byte
- The trace entry that has just been added to the table
- Up to three areas to be included in a further trace entry
- An 80-byte work area for the sole use of the trap exit

- The CSA (which may be zero during early initialization)
- The TCA, if there is one
- A register save area.

The DSECT also contains EQU statements for use in setting the return-action flag byte.

The exit can look at data from the current trace entry to determine whether or not the problem under investigation has appeared. It can also look at the TCA of the current task, and the CSA. The DSECTs for these areas are included in the skeleton source.

The CSA address is zero for invocations of DFHTRAP early in initialization, before the CSA is acquired.

Actions the exit can take

The return-action flag byte can be set by the exit to tell the trace domain what action is required on return from the exit. The following list gives the possible choices:

- Do nothing.
- Make a further trace entry.
- Take a CICS system dump using dump code TR1003.
- Terminate CICS without a dump after message DFHTR1000. (If you require a dump, the system dump return-action flag must also be set.)
- Disable the trap exit, so that it is not invoked again until reactivated by the CSFE transaction.

Any combination of these actions can be chosen and all actions are honored on return to the trace domain.

To reactivate the trap exit when it has been disabled, use CSFE `DEBUG,TRAP=ON`, unless the exit routine is to be replaced. In this case the sequence of commands given above applies.

The skeleton program shows how to make a further trace entry. When DFHTRAP detects a TS GET request, it asks for a further trace entry to be made by entering the data required in the area supplied for this purpose, and by setting the appropriate bit in the return-action flag byte.

The trace domain then makes a trace entry with trace point ID TR 0103, incorporating the information supplied by the exit.

Trace entries created in this way are written to any currently active trace destination. This could be the internal trace table, the auxiliary trace data set, or the GTF trace data set.

The skeleton DFHTRAP also shows how to detect the trace entry made by the storage manager (SM) domain for a GETMAIN request for a particular subpool. This is provided as an example of how to look at the data fields within the entry.

Program check handling

The occurrence of a program check in the trap exit is detected by the recovery routine in DFHTRPT. This then:

1. Marks the exit as unusable
2. Issues the message DFHTR1001 to the system console
3. Takes a CICS system dump with dump code TR1001, showing the PSW and registers at the time of the interrupt
4. Continues (ignoring the exit on future invocations of the trace domain).

To recover from this situation, execute the commands given above for replacing the current version of the exit routine.

Coding the exit

When using the trap exit, note the following points:

- A skeleton version of DFHTRAP is supplied in both source and load-module forms. Make sure that the library search sequence in the CICS startup JCL finds the correct version of the load module.
- DFHTRAP must save and restore the trace domain's registers. The supplied skeleton version contains the code necessary to do this. You are strongly advised not to change this code.
- The 80-byte work area provided for the sole use of the exit is in working storage acquired by the trace domain using an MVS GETMAIN. It is acquired and initialized to binary zeros when the trap is activated. It then exists until the trap is deactivated (CSFE DEBUG,TRAP=OFF). In a CICS transaction dump, the DFHTRAP working storage can be found soon after the CSA optional features list. The 80-byte work area is at the end of the DFHTRAP working storage and is immediately preceded by a 16-byte eye-catcher (**DFHTRAP_WORKAREA**), so that the work area can be located even if it has not been formatted. In a CICS system dump, the DFHTRAP working storage is in the trace domain (TR) section. See "Formatting system dumps" on page 283 for details of how to use the TR keyword to format the trace domain information in the dump.
- DFHTRAP must always run with AMODE(31) and RMODE(ANY) specified. In particular, it must always return control to the trace domain in 31-bit mode.

Part 4. Working with IBM to solve your problem

Chapter 17. IBM program support	305
When to contact the Support Center.	305
Dealing with the Support Center	305
What the Support Center needs to know	306
What happens next	308
IBM Program Support structure	308
Reporting a FEPI problem to IBM.	309
Chapter 18. APARs, fixes, and PTFs	311
The APAR process	311
Collecting the documentation for the APAR	311
General documentation needed for all problems with CICS	312
Sending the documentation to the change team	312
Packing and mailing the APAR box	313
Applying the fix	313
The APAR becomes a PTF	313

Part 4 contains:

Chapter 17. IBM program support

The IBM Customer Engineering Program Support structure exists to help you resolve problems with IBM products, and to ensure that you can make the best use of your IBM computing systems. Program support is available to all licensed users of IBM licensed programs, and you can get assistance by telephoning your local Support Center.

This section helps you decide when to contact the Support Center, and what information you need to collect before contacting the Center. The section also gives you an understanding of the way in which IBM Program Support works.

When to contact the Support Center

Before contacting the Support Center, try to ensure that the problem belongs with the Center. Do not worry if you cannot be sure that the problem is due to CICS itself. How sure you are depends on the complexity of your installation, the experience and skill levels of your systems staff, and the symptoms that you have been getting.

In practice, many errors reported to Program Support turn out to be user errors, or they cannot be reproduced, or they need to be dealt with by other parts of IBM Service. This indicates just how difficult it can be to determine the precise cause of a problem. User errors are mainly caused by faults in application programs and errors in setting up systems. TCT parameters, in particular, have been found to cause difficulty in this respect.

Dealing with the Support Center

Your first contact with the Support Center is the call receipt operator, who takes initial details and routes your call to the correct support group.

The Support Center needs to know as much as possible about your problem, and you should have the information ready before making your first call. It is a good idea to put the information down on a problem reporting sheet, such as the one shown in Figure 57 on page 306.

PROBLEM REPORTING SHEET		
Date	Severity	Problem No. Incident No.
Problem/Enquiry		
Abend/Prog CK	Incorrout	MVS Re1
Wait	Module	MVS Lv1
Loop	Message	CICS Re1
Performance	Other	CICS Lv1
Documentation available		
Abend	System dump	Program output
Message	Transaction dump	Other
Trace	Translator output	
Symptom string	Compiler output	
Actions		
Date	Name	Activity
Resolution		
APAR	PTF	Other

Figure 57. Sample problem reporting sheet

There are two advantages of using a problem reporting sheet:

1. You will be communicating with the IBM Support Center by telephone. So, with all your findings before you on a sheet of paper, you are prepared to respond to the questions that you may be asked.
2. You should maintain your own in-house tracking system to record all problems. This information can then be used for planning, organizing, communicating, and establishing priorities for controlling and solving these problems.

What the Support Center needs to know

When you contact the Support Center, you need to give the operator the name of your organization and your access code. Your access code is a unique code authorizing you to use IBM Software Services, and you provide it every time you contact the Center. Using this information, the operator accesses your customer

profile, which contains details of your address, relevant contact names, telephone numbers, and details of the IBM products at your installation.

The Support Center operator asks you if this is a new problem, or a further call on an existing one. If it is new, you are assigned a unique incident number. A problem management record (PMR) is opened on the RETAIN® system, where all activity associated with your problem is recorded. The problem remains “open” until it is solved.

Make a note of the incident number on your own problem reporting sheet. The Center expects you to quote the incident number in all future calls connected with this problem.

If the problem is new to you, the operator asks you for the source of the problem within your system software—that is, the program that seems to be the cause of the problem. As you are reading this book, it is likely that you have already identified CICS as the problem source. You also need to give the version and release number, for example Version 4 Release 1.

You need to give a severity level for the problem. Severity levels can be 1, 2, or 3. They have the following meanings:

- Severity level 1 indicates that you are unable to use a program, resulting in a critical condition that needs immediate attention.
- Severity level 2 indicates that you are able to use the program, but that operation is severely restricted.
- Severity level 3 indicates that you are able to use the program, with limited functions, but the problem is not critical to your overall operation.

When deciding the severity of the problem, take care neither to understate it nor to overstate it. The Support Center procedures depend on the severity level so that the most appropriate use can be made of the Center’s skills and resources. Your problem is normally dealt with immediately if it is severity level 1.

Finally, the call receipt operator offers you a selection of specific component areas within CICS (for example, terminal control, file control) and asks you to choose the area where your problem appears to lie. Based on this selection, the operator can route your call to a specialist in the chosen area.

The keywords are subsequently used as search arguments on the RETAIN database, to see if your problem is a known one that has already been the subject of an authorized program analysis report (APAR).

You are not asked for any more information at this stage. However, you need to keep all the information relevant to the problem, and any available documentation such as dumps, traces, and translator, compiler, and program output.

How your problem is subsequently progressed depends on its nature. The representative who handles the problem gives you guidance about what is required from you. The possibilities are described in the next section.

What happens next

Details of your call are passed using the RETAIN problem management system to the appropriate support group. Your problem, assuming it is one associated with CICS, is put on the CICS queue. The problems are dealt with in order of severity level.

At first, a support center representative uses the keywords that you have provided to search the RETAIN database. If your problem is found to be one already known to IBM, and a fix has been devised for it, a Program Temporary Fix (PTF) can quickly be dispatched to you.

Let the representative know if any of the following events occurred before the problem appeared:

- Changes in level of MVS or licensed programs
- Regeneration of any product
- PTFs applied
- Additional features used
- Application programs changed
- Unusual operator action.

You might be asked to give values from a formatted dump or trace table. You might also be asked to carry out some special activity, for example to set a trap, or to use trace with a certain type of selectivity, and then to report on the results.

It might be necessary to have several follow-up telephone calls, depending on the complexity of the symptoms and your system environment. In every case, the actions taken by you and the Support Center are entered in the PMR. The representative can then be acquainted with the full history of the problem before any follow-up call.

The result of the investigations determines whether your problem is a new one, or one that is already known. If it is already known, and a fix has been developed, the fix is sent to you.

If the problem is new, an APAR may be submitted. This is dealt with by the CICS change team. See "Chapter 18. APARs, fixes, and PTFs" on page 311.

IBM Program Support structure

Figure 58 on page 309 attempts to show the relationships between the customer, the staff at the IBM Support Center, and the change team. The role of each member of the IBM support staff is outlined in the preceding parts of this section.

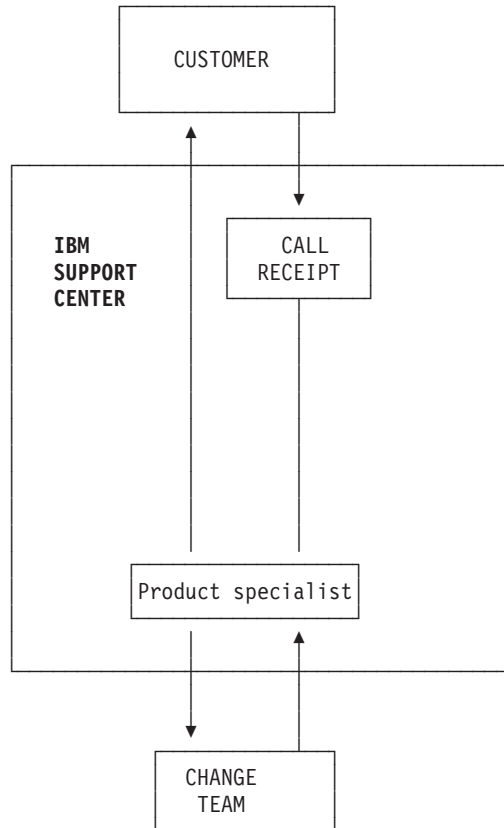

Figure 58. Structure of IBM Program Support

Reporting a FEPI problem to IBM

For information specifically about reporting a FEPI problem, see the *CICS Front End Programming Interface User's Guide*.

Chapter 18. APARs, fixes, and PTFs

An APAR is an “authorized program analysis report”. An APAR is your means of informing the appropriate change team of a problem you have found with an IBM program.

When the change team solves the problem, they produce a fix enabling you to get your system running properly again. Finally, a PTF is produced to replace the module in error, and the APAR is closed.

The APAR process

The first step in the APAR process is that a support center representative enters your APAR into the RETAIN system. The APAR text contains a description of your problem. If you have found a means of getting round the problem, details of this are entered as well. Your name is also entered, so that the Support Center knows who to contact if the change team need to ask anything further about the APAR documentation.

When the APAR is entered, you are given an APAR number. You must write this number on all the documentation you submit to the change team. This number is always associated with the APAR and its resolution and, if a code change is required, it is associated with the fix as well.

The next stage in the APAR process, getting relevant documentation to the change team, is up to you.

The following is a summary of the things you need to do:

1. You must collect all of the documentation that is required for the APAR. You are given guidance by the support center on precisely what you need to send. The documentation that is required varies, depending on the problem area, but “Collecting the documentation for the APAR” gives you an idea of the material that you should supply.
2. You need to package all the documentation and send it to the change team. The procedure for this is given in “Sending the documentation to the change team” on page 312.
3. Lastly, you need to apply the PTF resulting from the APAR, possibly after testing the fix on your system. This is described in “Applying the fix” on page 313.

Collecting the documentation for the APAR

As a general rule, the documentation you need to submit for an APAR includes all the material you need yourself to perform problem determination. Some of the documentation is common to all CICS problems, and some is specific to particular types of problem.

Make sure the problem you have described can be seen in the documentation you send. If the problem has ambiguous symptoms, you need to reveal the sequence of events leading up to the failure. Tracing is valuable in this respect, but you might be able to provide details that trace cannot give. You are encouraged to annotate your documentation, if your annotation is legible and if it does not cover up vital

information. You can highlight data in any hard copy you send, using transparent highlighting markers. You can also write notes in the margins, preferably using a red pen so that the notes are not overlooked.

Finally, note that if you send too little documentation, or if it is unreadable, the change team will return the APAR marked “insufficient documentation”. It is, therefore, worthwhile preparing your documentation carefully and sending everything relevant to the problem.

The general documentation is described in “General documentation needed for all problems with CICS”. However, these are only guidelines—you must find out from the support center precisely what documentation you need to send for your specific problem.

General documentation needed for all problems with CICS

The following is a list of the general documentation you might be asked to submit for an APAR:

- Any hard or soft copy illustrating the symptoms of the problem.
- A system dump of the CICS address space. Format the whole system dump if you plan to submit hard copy. Otherwise, you can just send the system dump data set on tape.
- A CICS trace. Auxiliary trace and GTF trace are best, but internal trace will do if you do not have either of these. If internal trace has been running, it is in the system dump in any case.
- Listings of CICS management modules, such as DFHKCP, that are not supplied as object code only. **These should be unnecessary if preassembled modules are used.**
- Relevant CICS tables. Again, these should be unnecessary if preassembled versions are used.
- Listings of relevant application programs.
- Console logs.
- CICS logs (for example, the CSMT log) wherever possible. These contain information that is often overlooked. They are particularly useful when VTAM is in use.
- JCL listings. These may appear on dumps, and need not be sent twice.
- A list of PTFs and APARs applied. The System Modification Program (SMP) CICS control data set (CDS) provides this information and should be sent.
- Details of any user modifications.

Sending the documentation to the change team

Follow the directions in APAR II02709 when gathering documentation to send to the change team. If you do not have access to the RETAIN database, ask your IBM representative to obtain a copy of APAR II02709 for you. The documentation you submit for the problem is best shipped in an APAR box, which you can obtain from your local IBM branch. APAR boxes are clearly marked as such, and they have a panel where tracking information such as the APAR number can be written.

Packing and mailing the APAR box

Place all your documentation and notes in one or more APAR boxes, making sure that the boxes are marked, for example, "1 of 2", and so on, if you need to use more than one.

If you include any magnetic tapes, write this clearly on the outside of the box. This lessens the chance of their being stored in magnetic fields strong enough to damage the data.

To make sure the documentation reaches the correct destination, that is, the CICS change team, write the following on the box:

```
SHIP TO CODE 5U6
```

You also need a mailing label with the address of the CICS change team on it.

When the change team receives the package, this is noted in your APAR record on the RETAIN system. The team then investigates the problem. Occasionally, they need to ask the Support Center to contact you for more documentation, perhaps specifying some trap you must apply before getting it.

When the problem is solved, a code is entered on RETAIN to close the APAR, and you are provided with a fix.

You can enquire any time at your Support Center on how your APAR is progressing, particularly if it is a problem of high severity.

Applying the fix

When the change team have found a fix for your problem, they might want you to test it on your system. If they do ask you to test the fix, you are normally given two weeks to do it and to provide them with the results. However, you can ask for an extension if you are unable to complete the testing in that time.

When the team is confident that the fix is satisfactory, the APAR is certified by the CICS development team and the APAR is closed. You receive notification when this happens.

The APAR becomes a PTF

If the solution involves a change to code in a CICS module that you can assemble, you are sent the code change right away. The change is later distributed as a PTF.

If you cannot assemble the module yourself, because it involves a part of CICS that is object serviced, you might be supplied with a ZAP or a TOTEST PTF.

If you want a PTF to resolve a specific problem, you can order it explicitly by its PTF number through the IBM Support Center. Otherwise, you can wait for the PTF to be sent out on the standard distribution tape.

Part 5. Appendixes

Appendix A. SDUMP contents and IPCS CICS VERBEXIT keywords

The following two tables provide a cross-reference between the CICS control blocks contained in an SDUMP and their associated IPCS CICS VERBEXIT keyword.

The first table provides a list of IPCS CICS VERBEXIT keywords and the CICS control blocks that they display.

The second table provides a list of all CICS control blocks in an SDUMP, alphabetically, with their associated IPCS CICS VERBEXIT keyword.

Finding the control blocks from the keywords

AI keyword

- AITMTE (AITM entry)
- AITMSSA (AITM static storage)

AP keyword

- CICS24 (task storage—below 16MB, CICS key)
- CICS31 (task storage—above 16MB, CICS key)
- DWE (user DWE storage)
- EIB (EXEC interface block)
- EIS (EXEC interface structure)
- EIUS (EXEC interface user structure)
- FILE (user file storage)
- JCA (journal control area)
- MAPCOPY (user BMS MAP storage)
- SYSEIB (system EXEC interface block)
- SYS_TCA (task control area—system area only)
- TD (user transient data)
- TS (user temporary storage)
- TCA (task control area—user)
- USER24 (task storage—below 16MB, user key)
- USER31 (task storage—above 16MB, user key)

AU keyword

- GWA
- Local (anchor block)
 - CCBUFFER (local catalog buffers—one each thread)
 - CC_ACB (local catalog ACB)
 - CC_RPL (local catalog RPLs—one each thread)
- Global (anchor block)
 - GCBUFFER (global catalog buffers—one each thread)
 - GC_ACB (global catalog ACB)
 - GC_RPL (global catalog RPLs—one each thread)

BR keyword

- BRXA (bridge exit interface)

- bridge facility bitmap
- bridge facility keep chain
- TXN_CS
- bridge facility block

CP keyword

- CPSTATIC (common programming interface static storage)

CSA keyword

- CSA (common system area)
- CSAOPFL (CSA optional features list)
- CWA (common work area)

DB2 keyword

- D2CSB (CICS DB2 subtask block)
- D2ENT (CICS DB2entry control block)
- D2GLB (CICS DB2 global block)
- D2LOT (CICS DB2 life of task block)
- D2SS (CICS DB2 static storage)
- D2TRN (CICS DB2tran control block)

DD keyword

- ANCHOR (directory manager anchor block)
- DIR_HEAD (directory header)
- AVL_HEAD (AVL tree header)
- BRWS_VAL (browse value)
- HASH_TBL (hash table)
- HASHELEM (collision list element)

DH keyword

- DHA (document handler domain anchor block)
- DOA (document anchor block)
- DCR (document control record)
- DDB (document data block)
- DBB (document bookmark block)

DLI keyword

- CWE (CICS-DBCTL control work element)
- DFHDLP (CICS-DLI interface parameter list)
- DGB (CICS-DBCTL global block)
- DGBCTA (DBCTL transaction area)
- DSB (CICS-DBCTL scheduling block)
- DXPS (CICS-DL/I-XRF anchor block)
- PAPL (DL/I-DRA architected parameter list)
- RSB (remote scheduling block)
- SYS_TCA (TCA system area only)
- TCA (task control area)

DM keyword

- DMANCHOR (domain manager anchor block)

- WQP (domain wait queue)

DS keyword

- DSANC (dispatcher anchor block)
- DS_TCB (TCB block)
- DTA (dispatcher task area)
- SUSPAREA (unformatted SUSPEND_AREAS/TOKENS)
- TASK (unformatted DTAs)

DU keyword

- DUA (dump domain anchor block)
- DUBUFFER (transaction dump data set buffer)
- OPENBLOK (transaction dump Open block)
- SDTE (system dump table elements)
- TDTE (transaction dump table elements)

EM keyword

- EVA (event pool anchor)
- EMA (EM anchor block)
- EVB (event pool block)

FCP keyword

- ACB (VSAM ACBs)
- AFCTE (application file control table element)
- DCB (data control block)
- DSNB (data set name block)
- DFHDTABLE (data table base area)
- DFHDTFILE (data table path area)
- DFHDHEADER (data table global area)
- DTRGLOBL (data table remote global area)
- FBWA (data table browse area)
- FCSTATIC (FCP static storage—anchor block)
- FCTE (file control table element)
- FLAB (file lasting access block)
- FRAB (file request anchor block)
- FRTE (file request thread element)
- SHRCTL (shared LSRPOOLS)
- VSWA (VSAM work area)

ICP keyword

- ICE (interval control elements/AIDs)

KE keyword

- AFCB (CICS AFCB)
- AFCS (CICS AFCS)
- AFT (CICS AFT)
- AUTOSTCK (automatic storage stack entry)
- KCB (kernel anchor block)
- KERNSTCK (kernel linkage storage stack entry)
- KERRD (kernel error data)

- KTCB (KTCB table entry)
- DOH (domain table header)
- DOM (domain table entry)
- TAH (task table header)
- TAS (task table entry—TASENTRY)
- TCH (KTCB table header)

LD keyword

- APE (active program element)
- CPE (current program element)
- CSECTL (program CSECT List)
- LD_GLBL (loader domain global storage—anchor block)
- LDBE (loader domain browse element)
- LDWE (loader domain wait element)
- LLA (load list area)

LG keyword

- LGA (log domain anchor)
- LGGL (general log data)
- LGSD (stream data)
- LGJI (journal information)
- LGJMC (journalmodel content)
- LGBR (stream/journal/journalmodel browse)
- LGUOW (log manager unit of work token)
- STATSBUF (log manager statistics)
- Block class data
- Block instance data
- BrowseableStream class data
- BrowseableStream instance data
- Chain class data
- Chain instance data
- HardStream instance data
- L2 anchor block
- Stream class data
- Stream instance data
- SuspendQueue elements
- SystemLog class data

LM keyword

- FREECHAI (LM domain freechain 1)
- FREECHAI (LM domain freechain 2)
- FREECHAI (LM domain freechain 3)
- LMANCHOR (lock manager domain anchor block)
- LMQUICK1 (LM domain quickcell 1)
- LMQUICK2 (LM domain quickcell 2)
- LMQUICK3 (LM domain quickcell 3)
- LOCK_ELE (LM domain lock element)

ME keyword

- MEA (message domain anchor block)

MN keyword

- MCT (monitoring control table)
- MNA (monitoring domain global storage—anchor block)
- MNAFB (monitor authorization facility parameter block)
- MNCONNS (monitor field connectors)
- MNDICT (monitor dictionary)
- MNEVE (SYSEVENT record buffer)
- MNEXC (exception record buffer)
- MNEXLIST (user EMP address list)
- MNFLDMAP (excluded/included CICS field map)
- MNPER (performance data buffer)
- MNSMF (SMF record buffer)
- MNTMA (transaction monitoring area)
- MNWLMPB (MVS WLM performance blocks)

MRO keyword

- CCB (connection control block)
- CRB (CICS region block)
- CSB (connection status block)
- LACB (logon address control block)
- LCB (logon control block)
- LXA (LX array)
- SCACB (subsystem connection address control block)
- SCCB (subsystem connection control block)
- SCTE (subsystem control table extension)
- SLCB (subsystem logon control block)
- SUDB (subsystem user definition block)
- UCA (use count array)

NQ Keyword

- NQAN (NQ domain anchor block)
- NQPL (enqueue pool control block)
- NQEA (queue element area control block)
- NQBR (enqueue browse element)
- NQOX (enqueue owner extension block)
- NQWX (enqueue waiter extension block)

PA keyword

- DFHSIT (system initialization table)
- OVERSTOR (override parameter temporary work area)
- PAA (parameter manager domain anchor block)
- PARMSAVE (SIT override parameters)
- PRVMODS (SIT PRVMOD list)
- SITDLI (SIT DL/I extension)

PCP keyword

- PPTTE (program processing table entries)

PCT keyword

- PCTTE (program control table entries)

PG keyword

- PGA (program manager anchor)
- LLE (load list element)—can be system LLE or task LLE
- PGWE (program manager wait element)
- PPTTE (program processing table element)
- PTA (program transaction area)
- PLCB (program manager program level control block)
- HTB (handle table)

For an explanation of PG summary data in a level-1 dump, see “Appendix B. Summary data for PG and US keywords” on page 335.

RM keyword

- RMUW (recovery manager unit of work)
- RMLK (recovery manager link)
- RMCD (recovery manager client directory)
- RMCI (recovery manager client identity)
- RMDM (recovery manager domain anchor)
- RMLI (recovery manager loggable identity)
- RMNM (recovery manager logname)
- RMRO (recovery manager resource owner)
- RMSL (recovery manager system log)

RX keyword

- Active Unit of Recovery data (CICS key)
- In-resync Unit of Recovery data (CICS key)
- Active Unit of Recovery data (Key 0)
- In-resync Unit of Recovery data (Key 0)
- RX domain anchor block (CICS key)
- DFHRXSVC dynamic storage area
- RX domain anchor block (Key 0)

SM keyword

- CTN (cartesian tree node)
- DXE (DSA extent list element)
- DXG (DSA extent getmain description)
- DXH (DSA extent list header)
- MCA (SM macro-compatibility control area)
- PAM (page allocation map)
- PPA (page pool control area)
- PPX (page pool extent control area)
- QPF (quickcell page free element)
- QPH (quickcell page header)
- SAE (storage access table entry)

- SAT (storage access table)
- SCA (subpool control area)
- SCE (storage element descriptor)
- SCF (free storage descriptor)
- SMA (storage manager domain anchor block)
- SMSVCTRT (DFHSM SVC trace table)
- SMX (transaction storage area)
- SQE (suspend queue element)
- STAB (storage manager statistics buffer)
- SUA (subspace area)

SO keyword

- SOA (SO domain anchor block)
- LTE (Listener table entry)
- STE (Session table entry)
- TDA (Tcpi service anchor block)
- TDB (Tcpi service control block)
- TBR (Tcpi service browse block)

SSA keyword

- SSAL (static storage address list)
- SSA (static storage areas)

ST keyword

- STANCHOR (statistics domain anchor block)
- STSAFPB (statistics authorization facility parameter block)
- STSMF (statistics SMF record)
- STSTATS (statistics domain statistics record)

SZ keyword

- SZSDS (FEPI static area)

TCP keyword

- ACB (VTAM access method control block)
- AID (automatic initiation descriptor)
- AWE (autoinstall work element)
- BIND (bind image)
- BITMAPn (one of several resource naming BITMAPs)
- CCIN (CICS client CCIN parameters)
- CTIN (CICS client CTIN parameters)
- DCB (BSAM data control block)
- DIB (data interchange block)
- DUMTCTTE (dummy TCTTE)
- EXLST (VTAM ACB exit list)
- ISORM (indirect system object resolution map)
- LOGDS (extracted logon or CLSDST Pass data)
- LUI TE (local userid table element)
- NIB (node initialization block)
- NIBLIST (persistent sessions INQUIRE PERSESS list of NIBs)

- PRSS (persistent sessions CV29, FMH5, BIS, and BID data)
- PS_BID (persistent sessions OPNDST RESTORE BID)
- PS_BIND (persistent sessions INQUIRE PERSESS BIND)
- PS_BIS (persistent sessions OPNDST RESTORE BIS)
- PS_CV29 (persistent sessions OPNDST RESTORE control vector 29)
- PS_FMH5 (persistent sessions OPNDST RESTORE FMH5)
- PS_MODN (persistent sessions INQUIRE PERSESS modename)
- PS_NIB (persistent sessions INQUIRE PERSESS NIB)
- PS_PLST (persistent sessions INQUIRE PERSESS parameter list)
- PS_POOL (persistent sessions RPL pool header)
- PS_RPL (persistent sessions RPL)
- PS_SESS (persistent sessions INQUIRE PERSESS session ID)
- PWE (postponed work element)
- RACE (receive-any control elements)
- RAI (VTAM receive-any Input area)
- RPL (VTAM request parameter list—receive-any RPLs)
- SNEX (TCTTE signon extension)
- TACLE (terminal abnormal condition line entry)
- TCTENIB (NIB descriptor)
- TCTESBA (APPC send/receive buffer)
- TCTFX (TCT prefix)
- TCTLE (TCT line entries)
- TCTTELUC (TCTTE APPC extension)
- TCTME (TCT mode entry)
- TCTSE (TCT system entries)
- TCTSK (TCT skeleton entries)
- TCTTE (TCT terminal entries)
- TCTTECCE (console control element)
- TCTTETTE (TCTTE extension)
- TCTTEUA (TCTTE user area)
- TIOA (terminal I/O area)
- WAITLST (wait list)
- ZEPD (TC module entry list)

TDP keyword

- ACB (TD VSAM ACB)
- BUFFER (TD I/O buffer)
- DCTE (transient data queue definitions)
- MBCA (TD buffer control area)
- MBCB (TD buffer control block)
- MQCB (TD queue control block)
- MRCA (TD string control area)
- MRCB (TD string control block)
- MRSD (TD CI state map—segment descriptor)
- MWCB (TD wait control block)
- RPL (TD VSAM RPL)

- SDSCI (TD SCSCI)
- TDCUB (TD CI update block)
- TDST (TD static storage)
- TDQUB (TD queue update block)
- TDUA (TD UOW anchor block)
- VEMA (TD VSAM error message area)

TI keyword

- TIA (Timer domain anchor block)
- TRE (Timer request elements)

TMP keyword

- TMSTATIC (table manager static storage)
- SKT (scatter tables)
- DIRSEG (directory segments)
- TM_LOCKS (read lock blocks)

TR keyword

- TRA (trace domain anchor block)
- TRDCB (auxiliary trace data set DCB)
- TRDECB (auxiliary trace data set DECB)

TS keyword

- ACA (TS auxiliary control area)
- BCA (TS buffer control area)
- BMH (TS byte map header)
- BMP (TS byte map)
- BRB (TS browse block)
- DTN (TS digital tree node)
- ICE (interval control element)
- PCA (TS pool control area)
- QAB (TS queue anchor block)
- QOB (TS queue ownership block)
- QUB (TS queue update block)
- SBB (TS shared browse block)
- STE (TS sysid table entry)
- TSA (TS anchor block)
- TSBUFFER (TS I/O buffer)
- TSI (TS item descriptor)
- TSM (TS main item header)
- TSHANCH (TS shared class anchor)
- TSMNANCH (TS main class anchor)
- TSMODEL (TS model class anchor)
- TSNANCH (TS name class anchor)
- TSOANCH (TS ownership lock class anchor)
- TSQ (TS queue control block)
- TSQANCH (TS queue class anchor)
- TSS (TS aux section descriptor)

- TST (TS table header)
- TSTTE (TS table entry)
- TSW (TS wait element)
- TSX (TS aux item descriptor)
- VCA (TS VSWA control area)
- VSWA (TS VSAM work area)
- XRH (TS aux record header)

UEH keyword

- EPB (exit program blocks)
- GWA (EPB global work area)
- TIE (task interface element)
- UET (user exit table)

US keyword

- USA (user domain anchor block)
- USXD (user domain transaction data)
- USUD (user domain user data), one or more of the following:
 - Principal
 - Session
 - EDF

For an explanation of US summary data in a level-1 dump, see “Appendix B. Summary data for PG and US keywords” on page 335.

WB keyword

- Web anchor block
- Global work area
- Web state manager blocks

XM keyword

- XMA (XM domain anchor block)
- TXN (XM domain transaction))
- TCL (XM domain tclass)
- XM_XB (XM domain browse element)
- MXT (XM domain MXT tclass)

XRF keyword

- XRPSTAT (XRP static storage)
- XRP_ACTS (XRP active status area)
- XRP_ALTS (XRP alternate status area)
- XRP_HLTH (XRP health area)
- XRP_XRSA (XRP anchor area)
- CAVM_STA (CAVM static storage)

XS keyword

- XSA (security domain anchor block)
- XSSS (security supervisor storage)

Finding the keywords from the control blocks

CICS Control Block		VERBEXIT Keyword
ACA	TS auxiliary control area	TS
ACB	VSAM ACBs	FCP
ACB	VTAM access method control block	TCP
ACB	TD VSAM ACB	TDP
AFCB	CICS AFCB	KE
AFCS	CICS AFCS	KE
AFCTE	application file control table element	FCP
AFT	CICS AFT	KE
AID	automatic initiation descriptor	TCP
AITM	static storage	AI
AITMTE	autoinstall terminal models	AI
ANCHOR	directory manager anchor block	DD
APE	active program element	LD
AUTOSTCK	automatic storage stack entry	KE
AVL_HEAD	AVL tree header	DD
AWE	autoinstall work element	TCP
BCA	TS buffer control area	TS
BIND	bind image	TCP
BITMAPn	instance of resource naming BITMAP	TCP
BMH	TS byte map header	TS
BMP	TS byte map	TS
BRB	TS browse block	TS
BRWS_VAL	browse value	DD
BRXA	bridge exit interface	BR
	bridge facility bitmap	BR
	bridge facility keep chain	BR
	bridge facility block	BR
	TXN_CS	BR
BUFFER	TD I/O buffer	TDP
CAVM_STA	CAVM static storage	XRF
CC_ACB	local catalog ACB	CC
CC_RPL	local catalog RPLs, one each thread	CC
CCB	connection control block	MRO
CCBUFFER	local catalog buffers, one each thread	CC
CCIN	CICS client CCIN parameters	TCP
CTIN	CICS client CTIN parameters	TCP
CICS24	task storage - below 16MB, CICS key	AP
CICS31	task storage - above 16MB, CICS key	AP
CPE	current program element	LD
CPSTATIC	common program interface storage	CP
CRB	CICS region block	MRO
CSA	common system area	CSA
CTN	cartesian tree node	SM
CSAOPFL	CSA optional features list	CSA
CSB	connection status block	MRO
CSECTL	program CSECT list	LD
CWA	common work area	CSA
CWE	CICS/DBCTL control work element	DLI

CICS Control Block		VERBEXIT Keyword
D2CSB	CICS DB2 subtask block	DB2
D2ENT	CICS DB2entry control block	DB2
D2GLB	CICS DB2 global block	DB2
D2LOT	CICS DB2 life of task block	DB2
D2SS	CICS DB2 static storage	DB2
D2TRN	CICS DB2tran control block	DB2
DCB	data control block	FCP
DCB	BSAM data control block	TCP
DCTE	transient data queue definitions	TDP
DFHDLP	CICS/DLI interface parameter list	DLI
DFHSIT	system initialization table	PA
DGB	CICS/DBCTL global block	DLI
DGBCTA	DBCTL transaction area	DLI
DIB	data interchange block	TCP
DIR_HEAD	directory header	DD
DIRSEG	directory segments	TMP
DMANCHOR	domain manager anchor block	DM
DOH	domain table header	KE
DOM	domain table entry	KE
DS_TCB	TCB block	DS
DSANC	dispatcher anchor block	DS
DSB	CICS/DBCTL scheduling block	DLI
DSNB	data set name block	FCP
DFHDTTABLE	data table base area	FCP
DFHDTFILE	data table path area	FCP
DFHDTHEADER	data table global area	FCP
DTA	dispatcher task area	DS
DTN	TS digital tree node	TS
DTRGLOBL	data table remote global area	FCP
DUA	dump domain anchor block	DU
DUBUFFER	transaction dump-data set buffer	DU
DUMTCTTE	dummy TCTTE	TCP
DWE	user DWE storage	AP
DXE	DSA extent list element	SM
DXG	DSA extent getmain descriptor	SM
DXH	DSA extent list header	SM
DXPS	CICS-DL/I-XRF anchor block	DLI
EIB	EXEC interface block	AP
EIS	EXEC interface structure	AP
EIUS	EXEC interface user structure	AP
EPB	exit program blocks	UEH
EXLST	VTAM ACB exit list	TCP
FBWA	data table browse area	FCP
FCSTATIC	FCP static storage - anchor block	FCP
FCTE	file control table element	FCP
FILE	user file storage	AP
FLAB	file lasting access block	FCP
FRAB	file request anchor block	FCP
FREECHAI	LM domain freechain 1	LM
FREECHAI	LM domain freechain 2	LM
FREECHAI	LM domain freechain 3	LM

CICS Control Block		VERBEXIT Keyword
FRTE	file request thread element	FCP
GC_ACB	global catalog ACB	CC
GC_RPL	global catalog RPLs, one each thread	CC
GCBUFFER	global catalog buffers, one each thread	CC
GWA	EPB global work area	UEH
GWA	affinities utility global work area	AU
GWA	web global work area	WB
HASH_TBL	hash table	DD
HASHELEM	collision list element	DD
HTB	handle table	PG
ICE	interval control elements/AIDs	ICP
ICE	TS interval control element	TS
ISORM	indirect system object resolution map	TCP
JCA	journal control area	AP
KCB	kernel anchor block	KE
KERNSTCK	kernel linkage storage stack entry	KE
KERRD	kernel error data	KE
KTCB	KTCB table entry)	KE
LACB	logon address control block)	MRO
LCB	logon control block)	MRO
LD_GLBL	loader domain global storage - anchor block	LD
LDBE	loader domain browse element	LD
LDWE	loader domain wait element	LD
LGA	log domain anchor block	LG
LGGL	general log data	LG
LGSD	stream data	LG
LGJI	journal information	LG
LGJMC	journalmodel content	LG
LGBR	stream/journal/journalmodel content	LG
LGUOW	log manager unit of work token	LG
	Block class data	LG
	Block instance data	LG
	BrowseableStream class data	LG
	BrowseableStream instance data	LG
	Chain class data	LG
	Chain instance data	LG
	HardStream instance data	LG
	L2 anchor block	LG
	Stream class data	LG
	Stream instance data	LG
	SuspendQueue elements	LG
	SystemLog class data	LG
LLE	load list element	PG
LMANCHOR	lock manager domain anchor block	LM
LMQUICK1	LM domain quickcell 1	LM
LMQUICK2	LM domain quickcell 2	LM
LMQUICK3	LM domain quickcell 3	LM

CICS Control Block		VERBEXIT Keyword
LOCK_ELE	LM domain lock element	LM
LOGDS	extracted logon or CLSDST pass data	TCP
LUIITE	local userid table element	TCP
LXA	LX array	MRO
MAPCOPY	user BMS MAP storage	AP
MBCA	TD buffer control area	TDP
MBCB	TD buffer control block	TDP
MCA	SM macro-compatibility control area	SM
MCT	monitoring control table	MN
MEA	message domain anchor block	ME
MNA	monitor domain global storage - anchor block	MN
MNAFB	monitor authorization facility parameter block	MN
MNCONNS	monitor field connectors	MN
MNDICT	monitor dictionary	MN
MNEVE	SYSEVENT record buffer	MN
MNEXC	exception record buffer	MN
MNEXLIST	user EMP address list	MN
MNFLDMAP	excluded/included CICS field map	MN
MNPER	performance data buffer	MN
MNSMF	SMF record buffer	MN
MNTMA	transaction monitoring area	MN
MNWLMPB	MVS WLM performance blocks	MN
MQCB	TD queue control block	TDP
MRCA	TD string control area	TDP
MRCB	TD string control block	TDP
MRSD	TD CI state map - segment descriptor	TDP
MWCB	TD wait control block	TDP
MXT	XM domain MXT tclass	XM
NIB	node initialization block	TCP
NIBLIST	persistent session INQUIRE PERSESS NIBs	TCP
OPENBLOK	transaction dump open block	DU
OVERSTOR	override parameter temporary work area	PA
PAA	parameter manager domain anchor block	PA
PAM	page allocation map	SM
PAPL	DLI/DRA architected parameter list	DLI
PARMSAVE	SIT override parameters	PA
PCA	TS pool control area	TS
PCTTE	program control table entries	PCT
PGA	program management anchor	PG
PGWE	program management wait element	PG
PLCB	program management program control blk	PG
PPA	pagepool control area	SM
PPTTE	program processing table element	PG
PPTTE	program processing table entries	PCP
PPX	pagepool extent control area	SM
PRSS	persistent sessions CV29, FMH5, BIS, and BID data	TCP
PRSTATIC	partner resource static area	PR
PRTE	partner resource table entries	PR
PRVMODS	SIT PRVMOD list	PA

CICS Control Block		VERBEXIT Keyword
PS_BID	persistent sessions OPNDST RESTORE BID	TCP
PS_BIND	persistent sessions INQUIRE PERSESS BIND	TCP
PS_BIS	persistent sessions OPNDST RESTORE BIS	TCP
PS_CV29	persistent sessions OPNDST RESTORE control vector 29	TCP
PS_FMH5	persistent sessions OPNDST RESTORE FMH5	TCP
PS_MODN	persistent sessions INQUIRE PERSESS modename	TCP
PS_NIB	persistent sessions INQUIRE PERSESS NIB	TCP
PS_PLST	persistent sessions INQUIRE PERSESS parameter list	TCP
PS_POOL	persistent sessions RPL pool header	TCP
PS_RPL	persistent sessions RPL	TCP
PS_SESS	persistent sessions INQUIRE PERSESS session ID	TCP
PTA	program transaction area	PG
PWE	postponed work element	TCP
QAB	TS queue anchor block	TS
QOB	TS queue ownership block	TS
QPH	quickcell page header	SM
QPK	quickcell page free element	SM
QUB	TS queue update block	TS
RACE	receive-any control elements	TCP
RAIA	VTAM receive-any input area	TCP
RMCBS	recovery manager control blocks	RM
RPL	VTAM request parameter list - receive-any RPLs	TCP
RPL	TD VSAM RPL	TDP
RSB	remote scheduling block	DLI
SAE	storage access table entry	SM
SAT	storage access table	SM
SBB	TS shared browse block	TS
SCA	subpool control areas	SM
SCACB	subsystem connection address control block	MRO
SCCB	subsystem connection control block	MRO
SCE	storage element descriptor	SM
SCF	free storage descriptor	SM
SCTE	subsystem control table extension	MRO
SDSCI	TD SCSCI	TDP
SDTE	system dump table elements	DU
SHRCTL	shared LSRPOOLS	FCP
SITDLI	SIT DL/I extension	PA
SKT	scatter tables	TMP
SLCB	subsystem logon control block	MRO
SMA	storage manager domain anchor block	SM
SMX	transaction storage area	SM
SNEX	TCTTE signon extension	TCP
SQE	suspend queue element	SM
SSA	static storage areas	SSA
SSAL	static storage address list	SSA
STANCHOR	statistics domain anchor block	ST
STATSBUF	log manager statistics	LG
STE	TS sysid table entry	TS
STSAFPB	statistics authorization facility parameter block	ST
STSMF	statistics SMF record	ST

CICS Control Block		VERBEXIT Keyword
STSTATS	statistics domain statistics record	ST
SUA	subspace area	SM
SUDB	subsystem user definition block	MRO
SUSPAREA	unformatted SUSPEND_AREAS/TOKENS	DS
SYS_TCA	TCA - system	DLI,AP
SZSDS	FEPI static area	SZ
TACLE	terminal abnormal condition line entry	TCP
TAH	task table header	KE
TAS	task table entry - TASENTRY	KE
TASK	unformatted DTAs	DS
TCA	task control area	DLI,AP
TCH	KTCB table header	KE
TCL	XM domain tclass	XM
TCTENIB	NIB descriptor	TCP
TCTESBA	LU6.2 send/receive buffer	TCP
TCTFX	TCT prefix	TCP
TCTLE	TCT line entries	TCP
TCTME	TCT mode entry	TCP
TCTSE	TCT system entries	TCP
TCTSK	TCT skeleton entries	TCP
TCTTE	TCT terminal entries	TCP
TCTTECCE	console control element	TCP
TCTTELUC	TCTTE LU6.2 extension	TCP
TCTTETTE	TCTTE extension	TCP
TCTTEUA	TCTTE user area	TCP
TD	user transient data	AP
TDCUB	TD CI update block	TDP
TDQUB	TD queue update block	TDP
TDST	TD static storage	TDP
TDTE	transaction dump table elements	DU
TDUA	TD UOW anchor block	TDP
TIA	timer domain anchor block	TI
TIE	task interface element	UEH
TIOA	terminal I/O area	TCP
TM_LOCKS	read lock blocks	TMP
TMSTATIC	table manager static storage	TMP
TRA	trace domain anchor block	TR
TRDCB	auxiliary trace data set DCB	TR
TRDECB	auxiliary trace data set DECB	TR
TRE	timer request elements	TI
TS	user temporary storage	AP
TSA	TS anchor block	TS
TSBUFFER	TS I/O buffer	TS
TSHANCH	TS shared class anchor	TS
TSI	TS item descriptor	TS
TSM	TS main item header	TS
TSMNANCH	TS main class anchor	TS
TSMODEL	TS model class anchor	TS
TSNANCH	TS name class anchor	TS
TSOANCH	TS ownership lock class anchor	TS
TSQ	TS queue control block	TS
TSQANCH	TS queue class anchor	TS

CICS Control Block		VERBEXIT Keyword
TSS	TS aux section descriptor	TS
TST	TS table header	TS
TSTTE	TS table entry	TS
TSW	TS wait element	TS
TSX	TS aux item descriptor	TS
TXN	XM domain transaction	XM
UCA	use count array	MRO
UET	user exit table	UEH
USER24	task storage - below 16MB, user key	AP
USER31	task storage - above 16MB, user key	AP
VCA	TS VSWA control area	TS
VEMA	TD VSAM error message area	TDP
VSWA	VSAM work area	FCP
VSWA	TS VSAM work area	TS
WAITLST	wait list	TCP
WBABC	Web anchor block	WB
WBSTC	Web state manager block	WB
WQP	domain wait queue	DM
XMA	XM domain anchor block	XM
XM_XB	XM domain browse element	XM
XRH	TS aux record header	TS
XRP_ACTS	XRP active status area	XRF
XRP_ALTS	XRP alternate status area	XRF
XRP_HLTH	XRP health area	XRF
XRP_XRSA	XRP anchor area	XRF
XRPSTAT	XRP static storage	XRF
ZEPD	TC module entry list	TCP

Appendix B. Summary data for PG and US keywords

This section lists the elements of the control block summaries in a level-1 IPCS dump for the PG and US keywords.

PG keyword

The summaries appear below in the sequence in which they appear in a dump. This is broadly the sequence in which the control blocks are listed in "Appendix A. SDUMP contents and IPCS CICS VERBEXIT keywords" on page 317 form=numonly, but note:

- The system LLE summary, if present, follows the PGA summary, but the task LLE summary, if present, follows the PTA summary.
- The HTB does not appear in a summary.

PGA (program manager anchor)

PG Domain Status

One of the following:

- Initializing
- Initialized
- Quiescing
- Quiesced
- Terminating
- Terminated.

Autoinstall status

Either active or inactive.

Autoinstall catlg status

Autoinstall catalog status, one of the following:

- All
- Modify
- None.

Autoinstall exit name

Autoinstall exit name.

Attempted autoinstalls

Number of attempted autoinstalls in decimal.

Failed autoinstalls

Number of failed autoinstalls in decimal.

Rejected autoinstalls

Number of rejected autoinstalls in decimal.

XRSINDI active

Status of user exit, either Y or N.

Exec calls allowed

Either Y or N.

System LLE chain head

Address of system LLE chain head, zero if no chain exists.

PGWE chain head

Address of PGWE chain head, or zero if no chain exists.

Stats last - 1st word

Statistics last reset time using GMT (on two lines).

Reset time - 2nd word

Second part of last reset time.

SM access token

SM access token value.

SM isolation token

SM isolation token value.

Storage protect

Either Y or N.

Cold start

Either Y or N.

Recovery complete

Either Y or N.

System LLE Summary

LLE-ADDR

LLE address.

PROGRAM

Program name.

PPTE-ADD

PPTE address.

PGWE Summary

PGWE-ADD

Address of suspended program.

PROGRAM

Name of suspended program.

SUS-TOKN

Suspend token.

PPTE-ADD

Program PPTE address.

PPTE Summary

PPTE ADDRESS

Address of PPTE block.

PROGRAM NAME

The tables are indexed using the program name.

MOD TYPE

Module type, one of the following:

- PG - Program
- MP - Mapset
- PT - Partitionset.

LANG DEF

Language defined, one of the following:

- NDF - Not defined
- ASS - Assembler (or Ada)
- C - C370
- COB - Cobol
- CO2 - Cobol 2
- LE3 - Le370
- PLI - PL/I.

LANG DED

Language deduced, one of the following:

- NDD - Not deduced
- ASS - Assembler (or Ada)
- C - C370
- COB - Cobol
- CO2 - Cobol 2
- LE3 - Le370
- PLI - PL/I.

INST TYPE

PPTE installation type, one of the following:

- R - Built from RDO
- C - Built from catalog constant
- G - Built from grouplist
- A - Autoinstall
- S - System autoinstall
- M - Manual.

CEDF STAT

CEDF status, either CED(CEDF allowed) or NOC(CEDF not allowed).

AVAL STAT

Program availability status, either E(enabled) or DI(disabled).

DATA LOC

Data location, either A (any location) or B(below 16M).

EXEC KEY

Execution key, either C (CICS) or U (user).

DPL SUBS

DPL subset, either DP (DPLsubset) or F (full API).

RE LOAD

Indicator of whether this is a reload program, either Y or N.

LOAD STAT

Load status, one of the following:

- L - Loaded
- NL - Not loadable
- ND - Not loaded.

HOLD STAT

CICS hold status, either C (loaded for CICS lifetime) or T (task lifetime).

USE COUNT

Use count in decimal, blank if 0.

LOCK OWNER

Transaction number of locking program.

PGWE CHAIN

Indicator of presence of any PGWEs, either Y or N.

REMOTE PRGID

Remote program name.

REMOTE SYSID

Remote system name.

REMOTE TRNID

Remote transaction name.

PTA Summary

TRAN NUM

Transaction number.

PTA ADDRESS

Address of PTA.

LOG-LVL

Logical level count in decimal.

SYS-LVL

System level count in decimal.

TASK-LLE

Address of task LLE head, zero if no task LLE exists.

PLCB Address of PLCB head, or zero if no PLCB exists.

Task LLE Summary

LLE-ADDR

LLE address.

PROGRAM

Program name.

PPTE-ADD

PPTE address.

Task PLCB Summary

PLCB-ADD

PLCB address.

PROGRAM

Program name.

LOG-LVL

Logical level of program.

LOAD Program load point.

ENTRY

Program entry point.

LENGTH

Program length.

CA-CURR

Current commarea address.

CLEN Current commarea length.

INVK-PRG

Name of invoking program.

STG Commarea storage class. Can be one of five:

- Blank - No commarea for this level.
- C - CICS
- C24 - CICS 24 bit
- U - User
- U24 - User 24 bit.

EXIT-NME

Exit name derived from user exit number, if applicable.

ENV Environment type, one of the following:

- EXEC - Command level application
- GLUE - Global user exit
- PLT - PLT program
- SYS - CICS system program
- TRUE - Task-related user exit
- URM - User-replaceable program.

PPTE-ADD

Program PPTTE address.

US keyword

A level-1 dump summarizes only the user domain data (USUD). The fields displayed are the same for each type of USUD (principal, session, or EDF).

USXD summary

TRAN NUM

Transaction number.

PRINCIPAL TOKEN

Principal token, if any.

SESSION TOKEN

Session token, if any.

EDF TOKEN

EDF token, if any.

USUD summary

TOKEN

User token.

USERID

User identifier.

GROUPID

Group identifier.

ADDCOUNT

Adduser use count.

TRNCOUNT

Transaction use count.

OPID Operator identifier.

CLASSES

A bitmap expressing the operator classes in order 24 to 1.

PRTY Operator priority.

TIMEOUT

Timeout interval in hours and minutes (hh:mm).

ACEE Address of ACEE.

XRFSOFF

XRF user signon. Can be NOFORCE or FORCE.

USERNAME

User name.

Index

A

- abbreviated-format trace 252
- abend codes
 - transaction 29
 - AICA 30
 - ASRA 30
 - ASRB 31
 - CICS 30
 - destination 29
 - documentation 30
 - interpretation 30
 - product other than CICS 30
 - user 30
- ABEND symptom keyword 7
- abends
 - AICA 152
 - DBCTL interface 39
 - dump not made when expected 176
 - exception trace entry 44
 - investigating 43
 - the documentation you need 43
 - looking at the symptom string 45
 - symptom keyword 7
 - transaction 29
 - AICA 30
 - ASRA 30
 - ASRB 31
 - worksheet 39
- access method
 - determining the type in use 104
 - intersystem communication 104
 - ISMM 104
 - possible reason for stalled system 148
 - TCAM 105
 - VTAM
 - terminal control waits 109
 - terminal waits 105
- ADD_SUSPEND function 64
 - input parameters 65
 - output parameters 65
- addressing exception 34
- AEYD
 - causes 31
- AICA abend
 - probable cause 30
 - PSW 277
 - registers 277
- AICA abends 152
- AID chain
 - investigating tasks that have not started 191
 - locating in the formatted system dump 192
- AIDTRMID (symbolic ID of terminal) 193
- AIDTRNID (transaction ID) 193
- AITM resource name 76
- ALLOCATE resource type 74, 111
- alternate system waits 141
- ALTPAGE attribute 180, 184, 185
- ALTSCREEN attribute, 180, 184, 185
- Any_MBCB resource type 75
- Any_MRCB resource type 75
- AP_INIT resource type 75
- AP_QUIES resource type 75
- AP_TERM resource type 75
- APAR (authorized program analysis report)
 - authorization 311
 - closing 313
 - documentation needed 311
 - process 311
 - submitting 312
- APPC (LUTYPE6.2), range of devices 102
- application programs
 - dynamic storage 282
 - storage areas 282
- arithmetic exceptions 34, 35
 - investigating 35
- ASIS option 181
- ASRA abend
 - causes 30
 - execution key 277
 - PSW 277
 - registers 277
- ASRB abend
 - causes 31
 - execution key 277
 - PSW 277
 - registers 277
- ASRD abend
 - causes 31
 - PSW 277
 - registers 277
- assembler programs
 - locating the DFHEISTG storage 282
- assemblers
 - errors in output 6
- asynchronous processing 108
- ASYNRESP resource name 75
- ATCHMSUB, resource name 77
- ATI (automatic transaction initiation) 107
- autoinitiated tasks
 - excessive numbers shown in statistics 14
- automatic initiate descriptor (AID)
 - identifying the related task 193
 - identifying the terminal 193
 - investigating tasks that have not started 191
- automatic transaction initiation (ATI)
 - task produced no output 188, 191
 - looking at the AID chain 191
 - looking at the ICE chain 191
 - resource not available 191
 - task not yet scheduled to start 191
- automatic transaction initiation session status 107
- auxiliary trace 254
 - abbreviated-format 252
 - advantages 244
 - characteristics 243

- auxiliary trace 252 *(continued)*
 - controlling 252
 - data sets 243
 - destination 243
 - DFHAUXT 243
 - DFHBUXT 243
 - extended-format 248
 - formatting 248
 - selectivity 248
 - interpreting 248, 252
 - loss of trace data 172
 - short-format 254
 - status 243, 246
 - switch status 243
 - trace entries missing 174
- AUXTR, system initialization parameter 245
- AUXTRSW, system initialization parameter 245

B

- BATCH
 - WAIT_MVS input parameter 70
- BDAM
 - cause of ASRB abends 31
 - record locking 130
- BLL (base locator linkage (COBOL))
 - in COBOL dump 283
- BMS (basic mapping support)
 - applications not compiled with latest maps 185
 - ASIS option 181
 - attributes of fields 195
 - DARK field attribute 195
 - incorrect output to terminal 195
 - attributes of fields 195
 - DARK field attribute 195
 - MDT 195
 - modified data tag 195
 - symbolic map 195
 - maps incorrect 185
 - MDT 195
 - modified data tag 195
 - symbolic map 195
- bottlenecks 161, 169
 - dispatch, suspend and resume cycle 163
 - initial attach to the dispatcher 163
 - initial attach to the transaction manager 162
 - initial dispatch 163
- builder parameter set (BPS)
 - CSFE ZCQTRACE facility 274

C

- CAVM (CICS availability manager) 230
- CCSTWAIT resource type 75
- CCVSAMWT resource type 75
- CDB2RDYQ resource type 75
- CDB2TBC resource type 75
- CDB2TIME, resource name 83
- CDBC transaction
 - DBCTL connection fails 93
 - DBCTL disconnection fails 94
- CDBT transaction 94

- CDSA resource type 75
- CEBR transaction
 - checking programming logic 194
 - investigating loops 160
 - use in investigating no task output 190
- CECI transaction
 - checking for bad data in a file 194
 - checking programming logic 194
 - investigating loops 160
 - use in investigating no task output 191
- CEDA in a wait state 143
- CEDF transaction
 - checking programming logic 194
 - investigating loops 160
- CEDX
 - use in investigating no task output 189
- CEMT INQUIRE TASK
 - HTYPE field 57
 - HVALUE field 57
- CEMT INQUIRE UOWENQ command
 - deadlock diagnosis 132
- CEMT transaction
 - SET PROGRAM NEWCOPY 5
 - use during CICS termination 148
- CESN in a wait state 143
- CETR transaction
 - controlling CICS VTAM exit tracing 233
 - example screen 241, 245
 - master system trace flag 238
 - selecting components to be traced 240
 - setting special trace levels 240
 - setting standard trace levels 240
 - suppressing standard tracing 238
 - task tracing options 238
 - terminal tracing options 238
 - transaction tracing options 238
- CEX2TERM, resource name 77
- CFDTLSW resource type 76
- CFDTPPOOL resource type 76
- CFDTPWAIT resource type 75
- CHANGECEB resource name 83
- CHKSTRM option, startup override 201
- CHKSTSK option, startup override 201
- CICS, resource name 80
- CICS availability manager (CAVM) 230
 - trace table 230
- CICS GTF trace 254
 - abbreviated-format 252
 - characteristics 244
 - common destination 244
 - controlling 245
 - destination 244
 - extended-format 248
 - formatting 248
 - selectivity 248
 - interpreting 248, 252
 - no CICS trace entries made 172
 - short-format 254
 - status 244, 246
 - trace data set 244
 - trace entries missing 174

- CICS GTF trace 252 (*continued*)
 - wrapping 252
- CICS running slowly 9
- CICS stalled
 - caused by SOS condition 147
 - during a run 146, 152
 - during initialization 145
 - during quiesce 148
 - during termination 148
 - effect of ICV parameter 147
 - effect of ICVR parameter 147
 - effect of ICVTSD parameter 147
 - effect of MXT parameter 147
 - exclusive control of volume conflict 148
 - investigating the reason for the stall 8
 - messages 8
 - on cold start 145
 - on emergency restart 145
 - on initial start 145
 - on warm start 145
 - PLT initialization programs 146
 - PLT shutdown programs 149
 - possible causes 8
 - specific regions 14
 - system definition parameters wrong 147
- CICS system abends
 - action of global trap/trace exit 300
 - CICS system dump following 259
 - CSMT log messages 9
 - exception trace entry 44
 - information needed by the Support Center 43
 - investigating 43
 - looking at the symptom string 45
 - messages 9
 - the documentation you need 43
- CICS system dumps
 - data not formatted correctly 179
 - destination 275
 - dispatcher domain storage areas 90
 - dump not made on CICS system abend 176
 - following CICS system abend 259
 - following transaction abend 259
 - formatting 283
 - selectivity 283
 - formatting keywords 285
 - formatting levels 285
 - from global trap/trace exit 300
 - global suppression 176, 257
 - in problem determination 257
 - interactive problem control system (IPCS) 283
 - internal trace table 44
 - investigating CICS system abends 43
 - investigating waits 56, 58
 - kernel domain storage areas
 - CICS system abends 44
 - error code 49
 - error data 50
 - error type 49
 - failing program 49
 - information provided 46
 - kernel error number 48
- CICS system dumps (*continued*)
 - kernel domain storage areas (*continued*)
 - point of failure 44
 - PSW at time of error 50
 - registers at time of error 50
 - task error information 48
 - task summary 46
 - tasks in error 47
 - waits for resource locks 90
 - locating the AID chain 192
 - locating the ICE chain 191
 - lock manager domain storage areas 90
 - looking at the symptom string 45
 - of remote CICS regions 109
 - precautions using dump formatting keywords 179
 - statistics 269
 - storage manager domain storage areas 98
 - storage violation 200, 204
 - suppression by user exit program 177
 - suppression for individual transactions 177, 257
 - suppression for specific dump codes 257
 - system dump code option 268
 - system dump codes 257
 - temporary storage control blocks 100
 - terminal control storage areas 104
- CICS530 dump exit
 - DEF parameter 285
 - JOB parameter 285
 - keyword parameter 285
- classification of problems 7
- COBOL programs
 - BLL (base locator linkage) 283
 - task global table 282
 - working storage 282
- common system area (CSA)
 - in transaction dump 279
 - locating the AID chain 192
 - optional features list 279
- compilers
 - errors in output 6
- COMPLETION_CODE
 - RESUME input parameter 68
 - SUSPEND output parameter 67
- component tracing
 - identifying codes 239
 - precautions when selecting 173
 - setting special trace levels 240
 - setting standard trace levels 240
- control interval (CI)
 - exclusive control deadlock 128
 - exclusive control waits 127
- CONV value of WLM_WAIT_TYPE input parameter 72
- CPI resource name 76
- CRTE and uppercase translation 182
- CSAOPFL 279
- CSASSI2 resource name 75
- CSATODTU 137
- CSFE DEBUG transaction
 - global trap/trace exit 299
 - storage checking 201
 - TRAP operand 299

- CSFE transaction
 - checking the programming logic 195
 - storage freeze option 195
- CSFE ZCQTRACE transaction
 - dumps of builder parameter set 274
- CSMT log
 - abend messages 3, 9, 11
 - terminal error messages 11, 103
- CSNC resource type 76
- CURRENTDDS, transaction dump data set status 275
- CWA (common work area) 279

D

- data corruption
 - bad programming logic 194
 - incorrect mapping to program 194
 - incorrect mapping to terminal 195
 - attributes of fields 195
 - DARK field attribute 195
 - MDT 195
 - modified data tag 195
 - symbolic map 195
 - incorrect records in file 194
 - missing records in file 194
 - possible causes 193
- data exception 33
- DATABUFFERS parameter of FILE resource
 - definition 122
- DB2_INIT resource type 76
- DB2 migration considerations
 - DSNTIAR 38
- DB2 resource type 76
- DB2CDISC resource type 76
- DB2EDISA resource type 76
- DB2START, resource name 83
- DBCTL (database control)
 - abends 39
 - connection fails 93
 - disconnection fails 94
 - immediate disconnection 94
 - orderly disconnection 94
 - waits 93
- DBCTL resource type 76, 94
- DBDXEOT resource type 76
- DBDXINT resource type 76
- DEBUGUSER resource name 77
- DCT resource name 82
- DEADLOCK_ACTION
 - description of parameter 71
 - SUSPEND input parameter 66
 - WAIT_MVS input parameter 70
 - WAIT_OLDC input parameter 70
 - WAIT_OLDW input parameter 70
- deadlock time-out interval
 - description 71
 - EXEC CICS WRITEQ TS command 99
 - interval control waits 136
 - task storage waits 98
- deadlocks
 - resolving 131
 - resolving in a sysplex 135

- debugging
 - IRC problems 209
 - multiregion operation problems 209
- DEF parameter of CICS510 dump exit 285
- DELETE_SUSPEND function of gate DSSR 65
 - input parameters 66
 - output parameters 66
- destination control table (DCT)
 - extrapartition transient data destination 113
 - logically recoverable queues 113
- DETACH resource name 80
- DFHAIIN resource type 76
- DFHAUXT 243
- DFHBUXT 243
- DFHCPIN resource type 76
- DFHDMPA dump data set 275
- DFHDMPB dump data set 275
- DFHDU520 job log 277
- DFHEIB 278
 - EIBFN 278
- DFHEISTG 282
- DFHKC TYPE=DEQ macro 97
- DFHKC TYPE=ENQ macro 96
- DFHKC TYPE=WAIT macro 96
 - DCI=CICS option 96
 - DCI=LIST option 96
 - DCI=SINGLE option 96
 - DCI=TERMINAL option 96
- DFHPRIN resource type 76
- DFHSIPLT resource name 80
- DFHSIPLT resource type 76
- DFHTACB 279, 281
 - PSW 279
 - registers 279
- DFHTEMP resource name 82
- DFHTRADS DSECT 299
- DFHZARER resource name 84
- DFHZARL1 resource name 84
- DFHZARL2 resource name 84
- DFHZARL3 resource name 84
- DFHZARL4 resource name 84
- DFHZARQ1 resource name 84
- DFHZARR1 resource name 84
- DFHZCRQ1 resource name 83
- DFHZDSP resource name 82
- DFHZEMW1 resource name 83
- DFHZERH1 resource name 84
- DFHZERH2 resource name 84
- DFHZERH3 resource name 84
- DFHZERH4 resource name 84
- DFHZIS11 resource name 83
- DFHZRAQ1 resource name 83
- DFHZRAR1 resource name 83
- diagnostic run, of CICS 220
- DISASTER value of dispatcher RESPONSE output parameter 71
- DISOSS, communication with CICS 103
- DISPATCH resource type 76
- dispatcher
 - ADD_SUSPEND function 64
 - DELETE_SUSPEND function 65

- dispatcher (*continued*)
 - dispatch, suspend and resume cycle 64, 168
 - failure of tasks to get attached 163, 164
 - failure of tasks to get initial dispatch 163, 166
 - functions of gate DSSR 64
 - INQUIRE_SUSPEND_TOKEN function 65
 - RESUME function 68
 - SUSPEND function 66
 - suspension and resumption of tasks 63
 - tracing the suspension and resumption of tasks 58
 - WAIT_MVS function 69
 - WAIT_OLDC function 69
 - WAIT_OLDW function 69
- dispatcher wait
 - OPEN_TCB 85
- distributed transaction processing (DTP) 108
- DLCNTRL resource name 74
- DLCONNECT resource name 74
- DLSUSPND resource name 76
- DMATTACH resource type 76
- DMB (data management block)
 - load I/O 92
- DMWTQUEU resource name 74
- domain identifying codes 239
- DS_NUDGE resource name 82
- DSA (dynamic storage area)
 - current free space 99
 - storage fragmentation 99
- DSNTIAR 38
- DSSR gate of dispatcher domain
 - ADD_SUSPEND function 64
 - DELETE_SUSPEND function 65
 - INQUIRE_SUSPEND_TOKEN function 65
 - RESUME function 68
 - SUSPEND function 66
 - tracing the functions 58
 - interpreting the trace table 58
 - tracing the input and output parameters 58
 - WAIT_MVS function 69
 - WAIT_OLDC function 69
 - WAIT_OLDW function 69
- DTCHMSUB, resource name 77
- DUMP, system initialization parameter 176, 257
- dump codes
 - checking the attributes 177
 - DUMPSCOPE option 259, 260
 - RELATED attribute 259, 260
 - storage violation 200
 - suppression of system dumps 257
 - suppression of transaction dumps 257
 - system 177, 257
 - CICS termination option 268
 - maximum dumps option 268
 - NOSYSDUMP attribute 178
 - options 268
 - RELATED dumping option 268
 - SYSDUMP attribute 178
 - system dumping option 268
 - transaction 177, 257
 - CICS termination option 268
 - format 259
- dump codes (*continued*)
 - transaction 177, 257 (*continued*)
 - maximum dumps option 268
 - NOTRANDUMP attribute 177
 - options 268
 - RELATED dumping option 268
 - system dumping option 268
 - TRANDUMP attribute 177
 - transaction dumping option 268
- dump data sets
 - attributes 275
 - AUTOSWITCH status 275
 - CLOSED status 275
 - current status 275
 - DFHDMPA 275
 - DFHDMPB 275
 - inquiring on 275
 - NOAUTOSWITCH status 275
 - OPEN status 275
 - setting 275
 - switch status 275
- dump domain
 - XDUREQ global user exit 177
- dump table
 - examples 270, 272
 - options 177, 269
 - loss of additions and changes 269
 - preservation of additions and changes 269
 - statistics 269
 - current count 269
 - reset 270
 - system dumps suppressed 269
 - system dumps taken 269
 - times dump code action taken 269
 - transaction dumps suppressed 269
 - transaction dumps taken 269
 - suppression of dumping 177
 - system 272
 - temporary entries 269, 272
 - transaction 270
- DUMPDS, system initialization parameter 275
- dumping in a sysplex 260
- dumps
 - CFDT list structure dump 295
 - controlling
 - CEMT transaction 258
 - dump codes 257
 - dump tables 257
 - examples 270, 272
 - EXEC CICS commands 258
 - selective dumping of storage 274
 - specifying dump options 268
 - using an undefined dump code 272
 - controlling dump action 257
 - current dump ID 271
 - dump output is incorrect
 - data not formatted correctly 179
 - dump not made on abend 176
 - investigating 175
 - some dump IDs missing from the sequence of dumps 178

dumps (*continued*)
 wrong CICS region 295
 dumps 19
 events that can cause dumps 258
 formatting a CFDT pool dump 295
 formatting a named counter pool dump 297
 formatting keywords 285
 formatting levels 285
 IDs missing from the sequence of dumps 178
 in a sysplex 260
 in problem determination 257
 looking at the symptom string 45
 named counter list structure dump 296
 options 268
 requesting dumps 258
 setting the dumping environment 257
 suppressing 176, 258
 DUMPSCOPE dump code option 259, 260
 DUMPSW, system initialization parameter 275
 DURETRY, system initialization parameter 275

E

EARLYPLT resource name 76
 ECB (event control block)
 EXEC CICS POST command 137
 finding the address. 96
 function WAIT_MVS of gate DSSR 69
 function WAIT_OLDC of gate DSSR 69
 function WAIT_OLDW of gate DSSR 69
 invalid address, task control waits 97
 posting after task is canceled 204
 PSTDECB 92
 storage violations 204
 valid address, task control waits 97
 ECB_ADDRESS
 WAIT_MVS input parameter 70
 WAIT_OLDC input parameter 70
 WAIT_OLDW input parameter 70
 ECB_LIST_ADDRESS
 WAIT_MVS input parameter 70
 WAIT_OLDW input parameter 70
 ECBTCP resource name 75
 ECDSA resource type 76
 EDF (execution diagnostic facility)
 investigating loops 160
 use in investigating no task output 189
 waits 94
 EDF resource type 77
 EDSA (extended dynamic storage area)
 current free space 99
 storage fragmentation 99
 EIBFN 278
 in last command identification 281
 EKCWAIT resource type 77
 EMP (event monitoring point) 19
 ENF resource type 77
 ENQUEUE on single server resource 97
 ENQUEUE resource type 77, 78, 96, 97, 123
 BDAM record locking 130
 ESDS write lock 131
 KSDS range lock 131
 ENQUEUE resource type 131, 78, 96, 97, 123
 (*continued*)
 VSAM load mode lock 130
 VSAM record locking 130
 enqueue waits 116
 ERDSA resource type 78
 error code 49
 error data 50
 error number 48
 error type 49
 ESDSA resource type 78
 EUDSA resource type 78
 event monitoring point (EMP) 19
 exceeding the capacity of a log stream 212
 exception trace
 characteristics 229
 CICS system abends 44
 destination 229
 format 230
 missing trace entries 175
 purpose 229
 storage violation 200, 203
 user 230
 EXCEPTION value of dispatcher RESPONSE output
 parameter 71
 EXCLOGER resource name 75
 exclusive control of volume conflict 148
 EXEC CICS ABEND command 259
 EXEC CICS DELAY command 136
 EXEC CICS DUMP TRANSACTION command 259,
 274
 EXEC CICS ENTER TRACENUM command 230
 EXEC CICS INQUIRE TASK
 SUSPENDTYPE field 57
 SUSPENDVALUE field 57
 EXEC CICS PERFORM DUMP command 258
 EXEC CICS POST 137
 EXEC CICS READ UPDATE command 128
 EXEC CICS RETRIEVE WAIT command 136
 EXEC CICS REWRITE command 128
 EXEC CICS START command 136, 163, 164
 EXEC CICS STARTBR command 128
 EXEC CICS WAIT EVENT command 137
 EXEC CICS WRITE command 128
 EXEC CICS WRITE MASSINSERT command 128
 EXEC CICS WRITEQ TS command 99
 NOSUSPEND 99
 REWRITE option 99
 EXEC interface block (EIB)
 EIBFN 278
 EXECADDR resource name 77
 EXECSTRN resource name 77
 execution diagnostic facility (EDF)
 investigating loops 160
 execution exception 33
 Execution key 277
 exit programming interface (XPI)
 ADD_SUSPEND function 64
 correctness of input parameters 4
 DELETE_SUSPEND function of dispatcher 65
 need to observe protocols and restrictions 4

- exit programming interface (XPI) *(continued)*
 - problems using 64
 - restrictions in user exits 4
 - RESUME function of dispatcher 68
 - SUSPEND function of dispatcher 66
 - suspension and resumption of tasks 63
 - SYSTEM_DUMP call 259
 - TRANSACTION_DUMP call 259
 - WAIT_MVS function of dispatcher 69
- extended-format trace 248
- EXTENDEDDES attribute, TYPETERM 180, 185
- extrapartition transient data waits 112

F

- FCACWAIT resource type 78
- FCBFWAIT resource type 78, 122
- FCCAWAIT resource type 78, 122
- FCCFQR resource type 78, 122
- FCCFQS resource type 78, 123
- FCCRWAIT resource type 78
- FCDSSEWR resource name 77
- FCDSLDM resource name 77
- FCDSRECD resource name 77
- FCDSRNGE resource name 77
- FCDWWAIT resource type 78, 123
- FCFLRECD resource name 77
- FCFLUMTL resource name 77
- FCFSWAIT resource type 78, 123
- FCINWAIT resource type 78
- FCIOWAIT resource type 78, 123
- FCIRWAIT resource type 78, 124
- FCPSWAIT resource type 78, 124
- FCQUIES resource type 78, 125
- FCRAWAIT resource type 78, 125
- FCRBWAIT resource type 79, 125
- FCRDWAIT resource type 79, 125
- FCRPWAIT resource type 79, 126
- FCRRWAIT resource type 79, 126
- FCRVWAIT resource type 79, 126
- FCSRSUSP resource type 79, 124
- FCTISUSP resource type 79, 127
- FCXCWAIT resource type 79, 127
- file accesses, excessive 14
- file control waits 119
 - BDAM record locking 130
 - drain of RLS control ACB 125
 - ESDS write lock 131
 - exclusive control conflict 127
 - exclusive control deadlock 128
 - FC environment rebuild 124
 - file state changes 123
 - KSDS range lock 131
 - process non-recoverable requests 125
 - process recoverable requests 125
 - RLS control ACB access 122
 - VSAM buffer unavailable 122
 - VSAM I/O 123, 126
 - VSAM I/O waits (RLS) 126
 - VSAM load mode lock 131
 - VSAM record locking by CICS 130
 - VSAM string unavailable 124

- file control waits 127 *(continued)*
 - VSAM transaction IDs 130
 - VSAM upgrade set activity 122, 123, 125
 - wait for dynamic RLS restart 126
 - wait for FC initialization 126
- files
 - no task output 191
- first failure data capture 229, 243
- FOREVER resource type 79
- formatting CICS system dumps 283
 - keywords 285
- front end programming interface (FEPI)
 - dump control option 291
 - FEPI waits 144
- function shipping 108

G

- global catalog data set (GCD)
 - dump table options 269
 - effect of redefinition on dump table 269
- global ENQUEUE 135
- global trap/trace exit 205, 299
 - actions the exit can take 300
 - activating and deactivating the exit 299
 - coding 301
 - establishing the exit 299
 - information passed to the exit 299
 - program check handling 301
 - replacing a trap exit 299
 - uses 299
 - work area 301
- GTFTTR, system initialization parameter 245

H

- HTYPE field 57
- HVALUE field 57

I

- I/O buffers, transient data
 - all in use 114, 115
- IBM Support Center
 - call receipt 305
 - Call Receipt 306
 - dealing with the Center 305
 - problem reporting 305
 - structure 308
 - use of RETAIN database 7, 307
 - when to contact 305
- ICE (interval control element) 191
- ICE expiration 137
- ICETRNID transaction ID 191
- ICEXPIRY resource type 79
- ICEXTOD expiration time 192
- ICEXTOD value 137
- ICGTWAIT resource type 79, 102, 136
- ICMIDNTE resource type 79
- ICV, system initialization parameter
 - possible cause of CICS stall 147

- ICVR, system initialization parameter
 - non-yielding loops 152
 - possible cause of CICS stall 147
 - tight loops 152
- ICVTSD, system initialization parameter
 - possible cause of CICS stall 147
- ICWAIT resource type 79, 102, 136
- incorrect output
 - abend codes 18
 - application did not work as expected 186
 - BMS mapping 195
 - attributes of fields 195
 - DARK field attribute 195
 - MDT 195
 - modified data tag 195
 - symbolic map 195
 - change log 18
 - checking for bad data in a file 194
 - checking the mapping from file to program 194
 - checking the programming logic 194
 - desk checking 194
 - using CEBR 194
 - using CECI 194
 - using CEDF 194
 - using interactive tools 194
 - databases 21
 - error messages 18
 - files 21
 - incorrect output read from VSAM data set 186
 - investigating 171
 - link-edit maps 18
 - manuals 17
 - monitoring 19
 - no output obtained 187
 - ATI tasks 188, 191
 - disabling the transaction 191
 - explanatory messages 187
 - finding if the task ran 188
 - looking at files 191
 - looking at temporary storage queues 190
 - looking at transient data queues 190
 - possible causes 187
 - START PRINTER bit on write control
 - character 188
 - task not in system 188
 - task still in system 188
 - testing the terminal status 187
 - using CECI 191
 - using execution diagnostic facility 189
 - using statistics 190
 - using trace 188
 - passed information 21
 - printed output wrong 179
 - source listings 18
 - statistics 19
 - symptom keyword 7
 - symptoms 11
 - temporary storage 20
 - terminal data 20
 - terminal output wrong 179
 - trace 21
- incorrect output (*continued*)
 - trace data wrong 18
 - trace destination wrong 171
 - trace entries missing 174
 - trace output wrong 171
 - transaction inputs and outputs 20
 - transient data 20
 - unexpected messages 11
 - user documentation 17
 - wrong CICS components being traced 173
 - wrong output obtained 193
 - possible causes 193
 - wrong tasks being traced 173
- INCORROUT symptom keyword 7
- INDEXBUFFERS parameter of FILE resource
 - definition 122
- INFORMATION/ACCESS licensed program 7
- information sources 17
- INITIAL resource name 75
- initialization stall 145
- INQUIRE_ resource name 84
- INQUIRE_SUSPEND_TOKEN function of gate
 - DSSR 65
 - output parameters 65
- INQUIRE UOWENQ command
 - deadlock diagnosis 135
- interactive problem control system (IPCS)
 - analyzing CICS system dumps 283
 - CICS system abends 44
 - CICS530 dump exit 284
- internal trace 254
 - abbreviated-format 252
 - characteristics 242
 - controlling 245
 - destination 242
 - exception trace destination 243
 - extended-format 248
 - formatting 248
 - interpreting 248, 252
 - short-format 254
 - status 242, 245
 - trace entries missing 174
 - trace table size 243
 - changing the size dynamically 243
 - wrapping 243
- intersystem communication (ISC)
 - poor performance 164
 - waits 108, 111
- INTERVAL
 - description of parameter 71
 - SUSPEND input parameter 66
 - WAIT_MVS input parameter 70
 - WAIT_OLDC input parameter 70
 - WAIT_OLDW input parameter 70
- interval control
 - element 137
 - performance considerations 163
 - waits 136
 - deadlock time-out interval 136
 - systematic investigation 137
 - using trace 138

interval control element (ICE) 191
INTTR, system initialization parameter 245
INVALID value of dispatcher RESPONSE output parameter 71
IO value of WLM_WAIT_TYPE input parameter 72
IRC (interregion communication) 209
 poor performance 164
 waits 108, 111
IRLINK resource type 79, 102, 109
ISMM access method 104

J

JOB parameter of CICS530 dump exit 285
JOURNALS resource name 77

K

Katakana terminals 184
 mixed English and Katakana characters 184
KCADDR resource name 77
KCCOMPAT resource type 80, 96
 resource names 96
 CICS 96
 LIST 96
 SINGLE 96
 SUSPEND 96
 TERMINAL 96, 102
KCSTRNG resource name 77
kernel domain
 information given in dump 46
 error code 49
 error data 50
 error table 48
 error type 49
 failing program 49, 52
 kernel error number 48
 point of failure 49
 PSW at time of error 50
 registers at time of error 50
 storage addressed by PSW 50
 storage addressed by registers 50
 task error information 48
 task summary 46
 tasks in error 47, 48
 linkage stack 51
 identifying the task in error 51
 stack entries 278
 storage areas 46
KERNEL resource type 80
KERNERROR value of dispatcher RESPONSE output parameter 71
keyword parameter of CICS530 dump exit 285

L

last command identification 280
last statement identification 281
LATE_PLT resource name 76
LATE_PLT resource type 80
level-1 trace points 228

level-2 trace points 228
level-3 trace points 228
LG_DEFER resource type 80
LG_FORCE resource type 80
LG_MGRST resource name 80
LGDELALL resource type 80
LGDELTRAN resource type 80
LGENDBLK resource type 80
LGENDCRS resource type 80
LGHARTBT resource type 80
LGREDBLK resource type 80
LGREDCRS resource type 80
LGSTRBLK resource type 80
LGSTRCRS resource type 80
LGWRITE resource type 80
link editor
 errors in output 6
LIST resource name 80, 85
LMQUEUE resource name 74, 90
loader domain (LD)
 program storage map 53
 waits 115
lock manager domain (LM)
 involvement in waits 90
 identifying the lock owning task 90
 investigating 90
LOCK value of WLM_WAIT_TYPE input parameter 72
log manager problems
 categories of 211
 corrupt system log 220
 diagnostic run, of CICS 220
 exceeding the capacity of a log stream 212
 problems in the MVS logger 213
logon rejection 180
LOGSTRMS resource name 77
LOOP symptom keyword 7
loops
 CICS detected 151
 debugging with interactive tools 160
 identifying the point of entry 157
 in CICS code 151
 in system code 158
 investigating 151
 looking at the evidence 156
 techniques 156, 158
 investigating by modifying your program 160
 looking at the transaction dump 157
 non-yielding 151
 characteristics 152
 finding the cause 158
 investigating 156
 possible causes 158
 possible causes 151
 potential consumption of storage 99
 potential consumption of temporary storage 100
 symptom keyword 7
 symptoms 12, 13, 151
 CICS region stalled 14
 CPU usage high 14
 reduced activity at terminals 14
 repetitive output 14

- loops *(continued)*
 - short on storage 151
 - system busy symbol 14
- tight 151
 - characteristics 152
 - finding the cause 158
 - identifying an instruction in the loop 157
 - investigating 156
 - possible causes 158
- types 151
- using CEBR 160
- using CECI 160
- using CEDF 160
- using the CEMT transaction 14
- using trace 156, 158
- yielding 151
 - characteristics 154
 - finding the cause 160
 - investigating 158
 - possible causes 160
 - useful documentation 159
- LOT_ECB resource name 76
- lowercase characters 181
- LUTYPE6.1, range of devices 102

M

- MBCB_xxx resource type 81
- MESSAGE symptom keyword 7
- messages
 - absence of, when expected 14
 - CICS under stress 15
 - destination
 - CDBC 11
 - CSMT 9, 11
 - CSTL 11
 - DFHAC2008 191
 - DFHSM0131 15, 167
 - DFHSM0133 15, 167
 - DFHSR0601 9
 - DFHST0001 9
 - dump formatting error 200
 - preliminary checks 3
 - short on storage 167
 - sources 4
 - storage violation 197, 200
 - symptom keyword 7
 - terminal errors 103
 - transaction abend 29
 - transaction disabled 191
 - unexpected 11, 180
- MISC value of WLM_WAIT_TYPE input parameter 72
- missing trace entries 174
- module index
 - in transaction dump 280
- MONITOR POINT command 19
- monitoring point 19
- MRCB_xxx resource type 81
- MRO waits 108, 111
- MROQUEUE resource name 76
- MSBRETRN, resource name 77
- multiregion operation using IRC 209

- multiregion operation waits 108, 111
- MVS ABEND macro 31
- MVS console
 - CICS termination message 8
- MVS RESERVE locking
 - CEDA in a wait state 143
 - CESN in a wait state 143
 - CICS system stalls 148
 - effect on CICS performance 168
 - transient data extrapartition waits 113
 - VSAM I/O waits 123
 - waits during XRF takeover 143
 - waits on resource type XRPUTMSG 143
- MXT (maximum tasks value)
 - effect on performance 164
 - kernel task summary 47
 - possible cause of CICS stall 147
 - reason for task failing to start 10
 - waits 85
 - XM_HELD resource type 86
- MXT resource type 81

N

- NetView 149
- networks
 - messages 103
 - preliminary checks 5
- NOSYSDDUMP, system dump code attribute 178
- NOTRANDUMP, transaction dump code attribute 177

O

- OK value of dispatcher RESPONSE output
 - parameter 71
- ONC/RPC 7
- OPEN_TCB resource name 76
- operation exceptions 33
- OTHER_PRODUCT value of WLM_WAIT_TYPE input
 - parameter 72
- output
 - absence when it is expected 12
 - none obtained 187
 - ATI tasks 188, 191
 - disabling the transaction 191
 - explanatory messages 187
 - finding if the task ran 188
 - looking at files 191
 - looking at temporary storage queues 190
 - looking at transient data queues 190
 - possible causes 187
 - START PRINTER bit on write control
 - character 188
 - task not in system 188
 - task still in system 188
 - testing the terminal status 187
 - using CECI 191
 - using execution diagnostic facility 189
 - using statistics 190
 - using trace 188
 - repetitive 14
 - wrong 193

output (*continued*)
possible causes 12

P

PAGESIZE attribute, TYPETERM 185

PC, communication with CICS 103

PERFM symptom keyword 7

performance

bottlenecks 161, 169

dispatch, suspend and resume cycle 163

initial attach to the dispatcher 163

initial attach to the transaction manager 162

initial dispatch 163

dispatch, suspend and resume cycle 168

extrapartition transient data 168

initial attach to the dispatcher 164

initial attach to the transaction manager 163

initial dispatch to the dispatcher 166

interval control delays 163

MXT limit 164

performance class monitoring 166

poor

at peak system load times 9

finding the bottleneck 161

investigating 161

lightly loaded system 9

possible causes 9

symptom keyword 7

symptoms 9, 12, 15, 161

remote system status 164

system loading 168

task control statistics 164

task priority 166

task time-out interval 168

terminal status 163

use of MVS RESERVE 168

using trace 165

performance class monitoring 166

PL/I application programs

locating the DSA chain 282

PMR (problem management record) 307

preliminary checks

all functions fully exercised 6

any changes to the application 5

any previous success 3, 5

changes since last success 4

hardware modification 4

initialization procedure 5

modified application 4

new application 4

PTF (program temporary fix) 4

resource definitions 5

common programming errors 6

failure at specific times of day 4

intermittent failures 4

interval control waits 136

messages 3

network related errors 5

many terminals 5

single terminal 5

preliminary checks (*continued*)

no previous success 6

output from assembler 6

output from compiler 6

output from link editor 6

output from translator 6

reproducible problems 3

caused by poor system definition 4

related to applications 3

related to system loading 4

terminal waits 103

printers

no output 188

printed output wrong 179, 184

unexpected line feeds and form feeds 185

write control character 188

privileged operation 33

PRM resource name 76

problem classification 7

problem determination

FEPI waits 144

problem management record (PMR) 307

problem reporting

documentation needed 307

IBM Program Support 305

information needed 306

report sheet 305

problems in the MVS logger 213

processors

usage high 14

PROFILE definition

SCRNSIZE attribute 180, 184, 185

UCTRAN attribute 181

program check

addressing exception 34

arithmetic exceptions 34, 35

investigating 35

cause of ASRA abends 30

data exception 33

execution exception 33

investigating 32

next sequential instruction 32

operation exception 33

outside of CICS 33

possible types 33

privileged operation 33

protection exception 33

specification exception 34

system interrupts 35

wild branch 32

program check and abend tracing 232

program control waits 115

program interrupt code (PIC)

addressing exception 34

arithmetic exceptions 34

data exception 33

execution exception 33

interpretation 33

operation exception 33

privileged operation 33

protection exception 33

- program interrupt code (PIC) *(continued)*
 - specification exception 34
 - system interrupts 35
- program list table (PLT)
 - programs executing during CICS quiesce 149
 - transient data waits 112, 146
- PROGRAM resource type 81
- program status word (PSW) 30
- programming errors
 - preliminary checks 6
- programs
 - information for current transaction 280
 - loops 151
 - problems with loading 115
 - representation in linkage stack 51
 - storage 280
- protection exception 33
 - dealing with 35
 - possible causes 36
- PSB (program specification block)
 - load I/O 92
- PSINQECB resource name 84
- PSOP1ECB resource name 84
- PSOP2ECB resource name 84
- PSTDECB 92
- PSUNBECB resource name 84
- PSW (program status word)
 - at time of error 50
 - CICS system abends 50
 - description 30
 - finding the offset of a failing instruction 53
 - format 53
 - in transaction abend control block 279
 - in transaction dump 277
- PTF 313
- PTF level 53
- PURGEABLE operand
 - SUSPEND input parameter 66
 - WAIT_MVS input parameter 70
 - WAIT_OLDC input parameter 70
 - WAIT_OLDW input parameter 70
- PURGED value of dispatcher RESPONSE output parameter 71

Q

- QSAM 113, 168
- QUIESCE resource name 76
- quiesce stall 148

R

- RCP_INIT resource type 81
- RDSA resource type 81
- REASON
 - ADD_SUSPEND output parameter 65
 - DELETE_SUSPEND output parameter 66
 - RESUME output parameter 69
 - SUSPEND output parameter 67
 - WAIT_MVS output parameter 71
 - WAIT_OLDC output parameter 71
 - WAIT_OLDW output parameter 71

- record locking
 - BDAM data sets 130
 - VSAM data sets 130
- registers
 - at time of error 50
 - CICS system abends 50
 - data addressed at the time of error 50
 - in transaction abend control block 279
 - in transaction dump 277
- registers at last EXEC command 278
- RELATED dump code attribute 259, 260
- Remote abend indicator 277
- resource definition online (RDO)
 - ALTER mapset 5
 - ALTER program 5
 - ALTER transaction 5
 - DEFINE mapset 5
 - DEFINE program 5
 - DEFINE transaction 5
 - INSTALL option 5
- RESOURCE_NAME
 - ADD_SUSPEND input parameter 65
 - SUSPEND input parameter 66
 - WAIT_MVS input parameter 70
 - WAIT_OLDC input parameter 70
 - WAIT_OLDW input parameter 70
- resource names
 - *CTLACB* 78
 - AITM 76
 - ASYNRESP 75
 - ATCHMSUB 77
 - CDB2TIME 83
 - CEX2TERM 77
 - CHANGECEB 83, 110
 - CICS 80
 - CPI 76
 - CSASSI2 75
 - DB2START 83
 - DEBUGUSER 77
 - DCT 82, 112
 - DETACH 80
 - DFHSIPLT 80
 - DFHTEMP 82
 - DFHXMTA 79
 - DFHZARER 84
 - DFHZARL1 84
 - DFHZARL2 84, 111
 - DFHZARL3 84, 111
 - DFHZARL4 84
 - DFHZARQ1 84
 - DFHZARR1 84
 - DFHZCRQ1 83, 110
 - DFHZDSP 82
 - DFHZEMW1 83, 110
 - DFHZERH1 84
 - DFHZERH2 84
 - DFHZERH3 84
 - DFHZERH4 84, 111
 - DFHZIS11 83
 - DFHZRAQ1 83, 110
 - DFHZRAR1 83, 110

resource names *(continued)*

DLCNTRL 78
 DLCONECT 74
 DLSUSPND 76
 DMWTQUEUE 74
 DS_NUDGE 82
 DTCHMSUB 77
 EARLYPLT 76
 ECBTCP 75
 EXCLOGER 75
 EXECADDR 77
 EXECSTRN 77
 FCDSSEWR 77
 FCDSLDM 77
 FCDSRECD 77
 FCDSRNGE 77
 FCFLRECD 77
 FCFLUMTL 77
 file ID 77, 78, 79
 HVALUE 57
 INITIAL 75
 INQ_ECB 84
 INQUIRE 110
 inquiring during task waits 57
 JOURNALS 77
 KCADDR 77
 KCSTRNG 77
 LATE_PLT 76
 LG_MGRST 80
 LIST 80, 85
 LMQUEUE 74, 90
 LOGSTRMS 77
 LOT_ECB 76
 message queue ID 83
 module name 79
 MROQUEUE 76
 MSBRETRN 77
 OPEN_TCB 76
 PRM 76
 program ID 81
 PSINQECB 84, 111
 PSOP1ECB 84
 PSOP2ECB 84, 111
 PSUNBECB 84, 111
 QUIESCE 76
 SHUTECEB 75
 SINGLE 77, 80
 SIPDMTEC 75
 SMSYSTEM 81
 STATIC 78
 STP_DONE 75
 summary of possible values 74
 SUSPEND 80
 SUSPENDVALUE 57
 SYSIDNT/session ID 79
 TCLASS 82
 TCTTETI value 74
 TCTVCECB 75
 TDNQ 78
 TERMINAL 80
 terminal ID 79

resource names *(continued)*

transient data queue name 78, 81, 82, 112, 113,
 114, 115
 TSBUFFER 82
 TSEXTEND 82
 TSIO 82
 TSNQ 78
 TSQUEUE 82
 TSSTRING 83
 TSWBUFFER 83
 VSMSTRNG 75
 WTO 82
 XM_HELD 81
 ZC_ZGRP 82
 ZGRPECB 75
 ZSLSECB 83, 110
 RESOURCE_TYPE
 ADD_SUSPEND input parameter 65
 SUSPEND input parameter 66
 WAIT_MVS input parameter 70
 WAIT_OLDC input parameter 70
 WAIT_OLDW input parameter 70
 resource types
 ALLOCATE 74, 111
 Any_MBCB 75, 114
 Any_MRCB 75, 114
 AP_INIT 75
 AP QUIES 75
 AP_TERM 75
 CCSTWAIT 75
 CCVSAMWT 75
 CDB2RDYQ 75, 92
 CDB2TBC 75, 92
 CDSA 75, 98
 CFDTLRSW 76
 CFDTPPOOL 76
 CFDTWAIT 75
 CSNC 76
 DB2 76, 93
 DB2_INIT 76, 93
 DB2CDISC 76, 93
 DB2EDISA 76, 93
 DBCTL 76, 94
 DBDXEOT 76
 DBDXINT 76
 DFHAIIN 76
 DFHCPIN 76
 DFHPRIN 76
 DFHSIPLT 76
 DISPATCH 76
 DMATTACH 76
 ECDSA 76, 98
 EDF 77, 94
 EKCWAIT 77, 96
 ENF 77
 ENQUEUE 77, 78, 113
 ERDSA 78, 98
 ESDSA 78
 EUDSA 78, 98
 FCACWAIT 78
 FCBFWAIT 78, 122

resource types *(continued)*

FCCAWAIT 74, 122
FCCFQR 78, 122
FCCFQS 78, 123
FCCRWAIT 78
FCDWWAIT 78, 123
FCFSWAIT 78, 123
FCINWAIT 78
FCIOWAIT 78, 123
FCIRWAIT 78, 124
FCPSWAIT 78, 124
FCQUIES 78, 125
FCRAWAIT 78, 125
FCRBWAIT 79, 125
FCRDWAIT 79, 125
FCRPWAIT 79, 126
FCRRWAIT 79, 126
FCRVWAIT 79, 126
FCSRSUSP 79, 124
FCTISUSP 79, 127
FCXCWAIT 79, 127
FOREVER 79
HTYPE 57
ICEXPIRY 79
ICGTWAIT 79, 136
ICMIDNTE 79
ICWAIT 79, 136
inquiring during task waits 57
IRLINK 79, 102, 109
KC_ENQ 96, 97, 123
KCCOMPAT 80, 96, 102
KERNEL 80
LATE_PLT 80
LG_DEFER 80, 95
LG_FORCE 80, 95
LGDELALL 80, 95
LGDELTRAN 80, 95
LGENDBLK 80, 95
LGENDCRS 80, 95
LGHARTBT 80
LGREDBLK 80, 95
LGREDCRS 80, 95
LGSTRBLK 80, 95
LGSTRCRS 80, 95
LGWRITE 80, 96
MBCB_xxx 81, 115
MRCB_xxx 81, 115
MXT 81
PROGRAM 81
RCP_INIT 81
RDSA 81
SDSA 81
STP_TERM 81
SUCNSOLE 82
summary of possible values 74
SUSPENDTYPE 57
TCP_NORM 82
TCP_SHUT 82
TCTVCECB 82
TD_INIT 82, 112
TD_READ 82, 114

resource types *(continued)*

TDEPLOCK 74, 112
TDIPLOCK 82, 113
TIEXPYRY 82
TRANDEF 82
TSAUX 82, 99
TSBUFFER 101
TSEXTEND 101
TSIO 101
TSIOWAIT 82
TSPOOL 82, 101
TSQUEUE 101
TSSHARED 83, 102
TSSTRING 102
TSWBUFFR 102
UDSA 83, 98
USDOMAIN 83
USERWAIT 83
XRGETMSG 83
XRPUTMSG 143
ZC 83, 110
ZC_ZGRP 83, 110
ZC_ZGCH 83, 110
ZC_ZGIN 84, 110
ZC_ZGRP 84, 111
ZC_ZGUB 84, 111
ZCIOWAIT 84, 111
ZCZGET 84, 111
ZCZNAC 84, 111
ZXQOWAIT 85, 111
ZXSTWAIT 85

resources

DBCTL 93
definition errors 5
inquiring during task waits 57
locks 90
 investigating waits 90
log manager 94
names 74
storage manager 98
task control 96
temporary storage 99
types 74

RESPONSE

ADD_SUSPEND output parameter 65
DELETE_SUSPEND output parameter 66
INQUIRE_SUSPEND_TOKEN output parameter 65
meanings of possible values 71
RESUME output parameter 69
SUSPEND output parameter 67
WAIT_MVS output parameter 71
WAIT_OLDC output parameter 71
WAIT_OLDW output parameter 71

RESUME function 68

input parameters 68

RETAIN problem management system

APARs 311
data base 7, 308
problem management record 307
symptom keywords 7
using INFORMATION/ACCESS 7

RLS (record-level sharing)
taking SMSVSAM dumps 262

S

SAA (storage accounting area)
chains 198
overlays 198, 200, 203
SCRNSIZE attribute, PROFILE 180, 184, 185
SDSA resource type 81
SDUMP macro 275
failure 275
retry on failure 275
SENDSIZE attribute, TYPETERM 184, 185
SESS_LOCALMVS value of WLM_WAIT_TYPE input parameter 72
SESS_NETWORK value of WLM_WAIT_TYPE input parameter 72
SESS_SYSPLEX value of WLM_WAIT_TYPE input parameter 72
short-format trace 254
SHUTECEB resource name 75
SINGLE, resource name 77
SINGLE resource name 80
SIPDMTEC resource name 75
SLIP trap, MVS 218
SMSVSAM problems
taking RLS-related dumps 262
SMSYSTEM resource name 81
SOS (short on storage)
caused by looping code 14
potential cause of waits 98
SPCTR, system initialization parameter 241
SPCTRxx, system initialization parameter 241
SPECIAL_TYPE
SUSPEND input parameter 66
WAIT_OLDW input parameter 70
specification exception 34
START PRINTER bit on write control character 188
statistics
autoinitiated tasks 14
file accesses 14
task control
number of times at MXT 164
use in investigating no task output 190
STGRVCVY system initialization parameter 205
STNTR, system initialization parameter 241
STNTRxx, system initialization parameter 241
storage
consumption by looping tasks 99
fragmentation 99
task subpool summary 99
waits 98
fragmentation of free storage 99
too little free storage 98
storage chain checking
by CICS 198
forcing 201
storage freeze 295
storage manager domain (SM)
conditional storage requests 98
storage manager domain (SM) (*continued*)
request for too much storage 98
suspend queue summary 98
trace levels 3 and 4 228
unconditional storage requests 98
waits 98
likely causes 98
storage recovery 205
storage violations
CHKSTRM option 201
CHKSTSK option 201
CICS detected 197, 198
CICS system dump 200
exception trace entry 200, 203
forcing storage chain checking 201
investigating 197
looking at the overlaying data 200
possible causes 205
programming errors 205
reason for invalid ECB address 97
symptoms 197
TIOA 198
undetected 197, 203
possible causes 203
user task storage element 198
using CSFE DEBUG 201
using trace 201, 204
STP_DONE resource name 75
STP_TERM resource type 81
STRFIELD option
CONVERSE command 188
SEND command 188
STRINGS parameter of FILE resource definition 124
structured fields 188
SUCNSOLE resource type 82
suppressing dumps
CICS dump table options 176
MVS Dump Analysis Elimination (DAE) 258
SUSPEND function of gate DSSR 66
input parameters 66
SUSPEND resource name 80
SUSPEND_TOKEN
ADD_SUSPEND output parameter 65
DELETE_SUSPEND input parameter 66
INQUIRE_SUSPEND_TOKEN output parameter 65
RESUME input parameter 68
SUSPEND input parameter 66
SUSPENDTYPE field 57
SUSPENDVALUE field 57
symbolic maps 195
symptom strings
in transaction dump 277
problem determination 45
RETAIN database search 277
RETAIN search keywords 45
symptoms
CICS has stopped running 8
CICS running slowly 9
incorrect output 11
keywords 7, 307
loops 12, 13

- symptoms (*continued*)
 - low priority tasks will not start 8
 - no output is obtained 9
 - poor performance 9, 12, 15, 161
 - tasks do not complete 9
 - tasks in a wait state 13
 - tasks take a long time to complete 9
 - tasks take a long time to start 9
 - terminal activity is reduced 9
 - use in classifying problems 8
 - waits 12
- SYS1.DUMP data set 275
- SYSDUMP, system dump code attribute 178
- SYSIDNT/session ID resource name 79
- sysplex
 - MVS console commands 262
 - problem determination 260
 - resolving deadlocks 135
- system busy symbol 14
- SYSTEM_DUMP, exit programming interface call 259
- system initialization
 - AUXTR parameter 245
 - AUXTRSW parameter 245
 - defining component tracing requirements 241
 - defining the tracing status 245
 - DUMP parameter 176, 257
 - DUMPDS parameter 275
 - DUMPSW parameter 275
 - DURETRY parameter 275
 - global suppression of CICS system dumps 257
 - GTFTR parameter 245
 - INTTR parameter 245
 - setting transaction dump data set attributes 275
 - SPCTR parameter 241
 - SPCTRxx parameter 241
 - STNTR parameter 241
 - STNTRxx parameter 241
 - suppressing standard tracing 238
 - SYSTR parameter 238
 - TRTABSZ parameter 245
 - USERTR parameter 245
- system loading, effect on performance 168
- system task waits 74, 143
 - intentional 143
- SYSTR, system initialization parameter 238

T

- task control
 - waits 96
 - causes 96, 97
 - failure of task to DEQUEUE on resource 97
 - invalid ECB address 97
 - resource type KCCOMPAT 96
 - unconditional ENQUEUE on single server resource 97
 - valid ECB address 97
- task control area (TCA)
 - in transaction dump 278
 - system area 278
 - user area 278
- task global table (TGT) 282

- task termination
 - abnormal 3
- task tracing
 - precautions when choosing options 173
 - special 237
 - standard 237
 - suppressed 237
- tasks
 - abnormal termination 3
 - ATI, no output produced 188, 191
 - looking at the AID chain 191
 - looking at the ICE chain 191
 - conversation state with terminal 107
 - dispatch, suspend and resume cycle 163, 168
 - dispatching priority 166
 - error data 50
 - exclusive control deadlock 128
 - failure during MVS service call 50
 - failure to complete 9, 10, 12
 - failure to get attached to the dispatcher 163, 164
 - failure to get attached to the transaction manager 162, 163
 - failure to get initial dispatch 163, 166
 - failure to start 9, 10, 12
 - failure under the CICS RB 50
 - identifying, in remote region 109
 - identifying the AID 193
 - identifying the ICE 191
 - in a wait state 13
 - in error 47
 - identified in linkage stack 51
 - information in kernel domain storage areas 48
 - lock owning
 - identifying a lock being waited on 90
 - looping 151
 - consumption of storage 99, 100
 - identifying the limits 159
 - MXT limit 164
 - PSW at time of error 50
 - reason for remaining on the AID chain 192
 - registers at time of error 50
 - runaway
 - detection by MVS 50
 - non-yielding loops 152
 - storage report 48
 - tight loops 152
 - session state with VTAM 107
 - slow running 10, 168
 - subpool summary 99
 - summary in kernel storage 46
 - suspended 12
 - inquiring on 13
 - investigating 56
 - task error information 48
 - time-out interval 168
 - tracing 173, 237
 - transfer from ICE to AID chain 192
 - waits 55
 - CICS DB2 92
 - DBCTL 93
 - definition of wait state 55

- tasks *(continued)*
 - EDF 3
 - log manager 94
 - maximum task conditions 85
 - on locked resources 90
 - online investigation 56
 - stages in resolving wait problems 55
 - storage manager 98
 - suspension and resumption of tasks 63
 - system 74
 - task control 96
 - techniques for investigating 56
 - temporary storage 99
 - user 74
 - using the formatted CICS system dump 56
 - using trace 56
- TCAM 105
- TCAPCDSA field 282
- TCLASS resource type 82
- TCP_NORM resource type 82
- TCP_SHUT resource type 82
- TCSESUSF 192
- TCTTE (terminal control table terminal entry)
 - in transaction dump 280
- TCTTE chain, in terminal waits 105
- TCTVCECB resource name 75
- TCTVCECB resource type 82
- TD_INIT resource type 82
- TD_READ resource type 82
- TDEPLOCK resource type 82
- TDIPLOCK resource type 82
- TDNQ resource name 78
- temporary storage
 - conditional requests for auxiliary storage 99
 - consumption by looping tasks 100
 - current free space 100
 - no task output 190
 - repetitive records 14
 - summary 100
 - unconditional requests for auxiliary storage 99
 - waits 99
 - unallocated space close to exhaustion 100
- terminal control program (TCP) 105
- TERMINAL resource name 80
- terminal tracing
 - precautions when choosing options 173
 - special 238
 - standard 238
 - suppressed 238
- terminal waits
 - autoinstall program not loaded 103
 - CREATESESS(NO) in TYPETERM definition 107
 - error action by TACP or NACP turned off 103
 - finding the access method 104
 - finding the type of terminal 104
 - HANDLE CONDITION coded incorrectly 103
 - interregion communication 108
 - intersystem communication 104, 108
 - ISMM access method 104
 - multiregion operation 108
 - identifying tasks in remote regions 109
- terminal waits *(continued)*
 - multiregion operation 103 *(continued)*
 - identifying the remote region 109
 - operator failing to respond 103
 - preliminary considerations 103
 - printer powered off 103
 - printer run out of paper 103
 - TCAM access method 105
 - terminal control waits 109
 - VTAM access method in use 105
 - automatic transaction initiation session status 107
 - NACP error codes 105
 - node session status 107
 - SNA sense codes 105
 - task conversation state with terminal 107
 - task session state with VTAM 107
 - task status 107
 - TCTTE chain 105
 - terminal control status 105
 - terminal status 106
 - VTAM exit ids 105
 - VTAM process status 105
 - VTAM terminal control 109
- terminals
 - ATI status 193
 - control characters in data stream 180
 - conversation state with task 107
 - error messages 103
 - incorrect mapping of data 195
 - attributes of fields 195
 - DARK field attribute 195
 - MDT 195
 - modified data tag 195
 - symbolic map 195
 - incorrect output displayed
 - data formatted wrongly 185
 - debugging tools 185
 - early data overlaid by later data 185
 - investigating 179
 - logon rejection message 180
 - mixed English and Katakana characters 184
 - some data not displayed 184
 - unexpected messages and codes 180
 - unexpected uppercase or lowercase characters 181
 - wrong data values displayed 184
 - no input accepted 10
 - no output 9, 10
 - range of characteristics 102
 - reduced activity 9, 12, 14
 - repetitive output 14
 - status 106
 - effect on performance 163
 - terminal control program 105
 - unresponsive 102
- termination
 - abnormal 3
 - system dump code option 268
 - transaction dump code option 268
- termination stall 148

- TIEXPIRY resource type 82
- TIMER value of WLM_WAIT_TYPE input parameter 72
- trace
 - abbreviated format 279
 - abbreviated-format 252
 - calls to other programs 228
 - CICS VTAM exit
 - advantages 233
 - controlling 233
 - description 232
 - destination 232
 - destinations 171
 - identifying the terminal 233
 - interpretation 233
 - terminal waits 108
 - CICS XRF trace
 - description 230
 - destination 230
 - origin 230
 - controlling
 - auxiliary trace 245
 - CICS GTF trace 245
 - internal trace 245
 - special task tracing 237
 - special trace levels 240
 - standard task tracing 237
 - standard trace levels 240
 - suppressing standard tracing 238
 - suppressing task tracing 237
 - data provided on call 228
 - exception trace 229
 - destinations 171
 - domain entry 228
 - domain exit 228
 - DSSR functions 58
 - input and output parameters 58
 - interpreting the trace table 58
 - entries from AP domain 248, 250
 - entries missing 174
 - example of formatted entry 250, 251
 - extended-format 248, 279
 - formatted entry
 - data fields 249
 - interpretation string 249
 - interval 249
 - kernel task number 249
 - standard information string 249
 - task number 249
 - time of entry 249
 - trace point id 248
 - formatting 247
 - from global trap/trace exit 300
 - global trap/trace exit 299
 - in problem determination
 - loops 156, 158
 - poor performance 165
 - selecting destinations 242
 - storage violations 201, 204
 - incorrect output from
 - investigating 171

- trace (*continued*)
 - incorrect output from (*continued*)
 - trace entries missing 171
 - wrong CICS components being traced 173
 - wrong data captured 172
 - wrong destination 171
 - wrong tasks being traced 173
 - internal domain functions 228
 - interpreting 248, 252
 - user entries 254
 - interpreting user entries 254
 - investigating waits 56, 57
 - setting the tracing options 58
 - last command identification 281
 - last statement identification 281
 - level-1 228
 - level-2 228
 - level-3 228
 - levels 228, 229
 - logic of selectivity 239
 - master system trace flag 172, 238, 246
 - master user trace flag 246
 - MVS GTF 244
 - common destination 244
 - overview of different types 227
 - point id 248
 - points 228
 - location 228
 - program check and abend 232
 - repetitive output 14
 - storage manager trace levels 228
 - suspension and resumption of tasks 58
 - interpreting the trace table 58
 - use in investigating no task output 188
 - user 195
 - checking programming logic 195
 - user exception trace entries 230
 - VTAM buffer
 - description 234
 - destination 234
 - investigating logon rejection 180
 - terminal waits 108
- TRANDEF resource type 82
- TRANDUMP, transaction dump code attribute 177
- transaction abends
 - abend code 29
 - documentation 30
 - interpretation 30
 - action of global trap/trace exit 300
 - AICA 30, 152
 - ASRA 30
 - ASRB 31
 - collecting the evidence 29
 - CSMT log messages 9
 - dump not made when expected 176
 - getting a transaction dump 29
 - investigating 29
 - last command identification 280
 - last statement identification 281
 - message 29
 - messages 3, 11

- transaction abends (*continued*)
 - storage violation 29
 - system dump following 259
 - transaction dump following 259
 - worksheet 39
- transaction deadlocks
 - in a sysplex 135
 - resolving 131
- TRANSACTION_DUMP, exit programming interface
 - call 259
- transaction dumps
 - abbreviated-format trace table 279
 - accompanying transaction abends 29
 - common system area 279
 - CSA 279
 - CSAOPFL 279
 - CWA 279
 - destination 275
 - DFHTACB 279, 281
 - dump not made on transaction abend 176
 - exec interface structure 278
 - EXEC interface user structure 278
 - execution key 277
 - extended-format trace table 279
 - following transaction abend 259
 - formatting 276
 - selectivity 276
 - in problem determination 257
 - interpretation 276
 - job log for DFHDU520 277
 - kernel stack entries 278
 - last command identification 280
 - last statement identification 281
 - locating program data 282
 - assembler program DFHEISTG storage 282
 - chain of PL/I DSAs 282
 - COBOL working storage 282
 - task global table 282
 - module index 280
 - optional features list 279
 - program information 280
 - program storage 280
 - PSW 277
 - registers 277
 - registers at last EXEC command 278
 - remote abend indicator 277
 - selective dumping of storage 274
 - statistics 269
 - storage violation 200
 - suppression for individual transactions 177, 257
 - symptom string 277
 - system EXEC interface block 278
 - task control area, system area 278
 - task control area, user area 278
 - TCTTE 280
 - transaction abend control block 279, 281
 - transaction dump code options 268
 - transaction dump codes 257
 - transaction storage 279
 - transaction work area 278
- transaction list table (XLT) 148
- transaction manager
 - failure of tasks to get initial attach 163
- transaction routing 108
- transaction storage
 - in transaction dump 279
- transaction tracing
 - precautions when choosing options 173
 - special 238
 - standard 238
 - suppressed 238
- transactions
 - disabling 191
 - evidence that it ran 188
 - program control 189
 - program load 189
 - task attach 189
 - task dispatch 189
 - no output produced 187
 - ATI tasks 188, 191
 - disabling the transaction 191
 - explanatory messages 187
 - finding if the task ran 188
 - investigating 187
 - looking at files 191
 - looking at temporary storage queues 190
 - looking at transient data queues 190
 - possible causes 187
 - START PRINTER bit on write control character 188
 - task not in system 188
 - task still in system 188
 - testing the terminal status 187
 - using CECI 191
 - using execution diagnostic facility 189
 - using statistics 190
 - using trace 188
 - wrong output produced 193
 - investigating 193
 - possible causes 193
- transient data
 - extrapartition destinations 112
 - performance considerations 168
 - I/O buffers 114, 115
 - intrapartition destinations 113
 - no task output 190
 - recoverable queues 113
 - VSAM I/O 115
 - VSAM strings 114
 - waits 112
 - during initialization 112
 - extrapartition 112
 - I/O buffer contention 115
 - I/O buffers all in use 114
 - intrapartition 113
 - resource names 112
 - resource types 112
 - VSAM I/O 115
 - VSAM strings all in use 114
- translator
 - errors in output 6
- traps 299

TRTABSZ, system initialization parameter 245
 TSAUX resource type 82, 99
 TSBUFFER resource name 82, 101
 TSEXTEND resource name 82, 101
 TSIO resource name 82, 101
 TSIOWAIT resource type 82
 TSNQ resource name 78
 TSPPOOL resource type 82, 101
 TSQUEUE resource name 82, 101
 TSSHARED resource type 83, 102
 TSSTRING resource name 83, 102
 TSWBUFFR resource name 83, 102
 TYPETERM definition
 ALTPAGE attribute 180, 184, 185
 ALTSCREEN attribute 180, 184, 185
 ATI status 193
 CREATESESS(NO), cause of terminal waits 107
 EXTENDEDDES attribute 180, 185
 PAGESIZE attribute 185
 SENDSIZE attribute 184, 185
 UCTRAN attribute 181

U

UCTRAN attribute 182
 PROFILE definition 181
 TYPETERM definition 181
 UDSA resource type 83
 uppercase characters 181
 USDOMAIN resource type 83
 user task waits 74
 user tracing
 checking programming logic 195
 exception trace entries 230
 interpretation 254
 USERTR, system initialization parameter 245
 USERWAIT resource type 83

V

VARY NET,INACT command 149
 VSAM
 data buffers 122
 exclusive control deadlock 128
 exclusive control of control interval 127
 I/O waits 123, 126
 incorrect data read from file 186
 index buffers 122
 strings 124
 transaction ID waits 127
 waits
 exclusive control deadlock 128
 file state changes 123
 for exclusive control of control interval 127
 for VSAM transaction ID 127
 I/O 123
 record locking by CICS 130
 VSAM buffer unavailable 122
 VSAM string unavailable 124
 VSAM READ SEQUENTIAL 128
 VSAM READ UPDATE 128
 VSAM WRITE DIRECT 128

VSAM WRITE SEQUENTIAL 128
 VSMSTRNG resource name 75
 VTAM
 process status 105
 session state with task 107

W

WAIT_MVS function 69
 input parameters 70
 WAIT_OLDC function 69
 input parameters 70
 WAIT_OLDW function 69
 input parameters 70
 WAIT symptom keyword 7
 waits
 alternate system 141
 CICS DB2 92
 DBCTL 93
 deadlock time-out interval 136
 definition 13, 55
 EDF 94
 enqueue 116
 FEPI 144
 file control 119
 interregion communication 108, 111
 intersystem communication 108, 111
 interval control 136
 investigating 55
 lock manager 90
 log manager 94
 maximum task conditions 85
 online investigation 56
 finding the resource 57
 program control 115
 stages in resolving 55
 storage manager 98
 suspension and resumption of tasks 63
 symptom keyword 7
 symptoms 12, 13
 task control 96
 techniques for investigating 56
 temporary storage 99
 terminal 102
 transient data 112
 during initialization 112
 extrapartition 112
 I/O buffer contention 115
 I/O buffers all in use 114
 intrapartition 113
 VSAM I/O 115
 VSAM strings all in use 114
 using the formatted CICS system dump 56, 58
 using trace 56, 57
 setting the tracing options 58
 VTAM terminal control 109
 WCC (write control character) 188
 WLM_WAIT_TYPE parameter 72
 working storage, COBOL programs 282
 workload manager wait type parameter 72
 write control character (WCC) 188

WTO resource name 82

X

XDUREQ, dump domain global user exit 177

XDUREQ global user exit 257

XLT (transaction list table) 148

XM_HELD resource type 86

XRF errors

failure of CAVM 143

XRF takeover

CEDA in a wait state 143

CESN in a wait state 143

wait on resource type XRPUTMSG 143

XRGETMSG resource type 83

XRPUTMSG resource type 83, 143

Z

ZC resource type 83

ZC_ZCGRP resource type 83

ZC_ZGCH resource type 83

ZC_ZGIN resource type 84

ZC_ZGRP resource name 82

ZC_ZGRP resource type 84

ZC_ZGUB resource type 84

ZCIOWAIT 84

ZCZGET resource type 84

ZCZNAC resource type 84

ZGRPECB resource name 75

ZSLSECB resource name 83

ZXQOWAIT resource type 85

ZXSTWAIT resource type 85

Sending your comments to IBM

If you especially like or dislike anything about this book, please use one of the methods listed below to send your comments to IBM.

Feel free to comment on what you regard as specific errors or omissions, and on the accuracy, organization, subject matter, or completeness of this book.

Please limit your comments to the information in this book and the way in which the information is presented.

To request additional publications, or to ask questions or make comments about the functions of IBM products or systems, you should talk to your IBM representative or to your IBM authorized remarketer.

When you send comments to IBM, you grant IBM a nonexclusive right to use or distribute your comments in any way it believes appropriate, without incurring any obligation to you.

You can send your comments to IBM in any of the following ways:

- By mail, to this address:
Information Development Department (MP095)
IBM United Kingdom Laboratories
Hursley Park
WINCHESTER,
Hampshire
United Kingdom
- By fax:
 - From outside the U.K., after your international access code use 44-1962-870229
 - From within the U.K., use 01962-870229
- Electronically, use the appropriate network ID:
 - IBM Mail Exchange: GBIBM2Q9 at IBMMAIL
 - IBMLink™: HURSLEY(IDRCF)
 - Internet: idrcf@hursley.ibm.com

Whichever you use, ensure that you include:

- The publication number and title
- The topic to which your comment applies
- Your name and address/telephone number/fax number/network ID.



Program Number: 5655-147



Printed in the United States of America
on recycled paper containing 10%
recovered post-consumer fiber.

GC33-1693-02



Spine information:



CICS TS for OS/390

CICS Problem Determination Guide

Release 3