

CICS<sup>®</sup> Transaction Server for OS/390<sup>®</sup>



# CICS Front End Programming Interface User's Guide

*Release 3*



CICS<sup>®</sup> Transaction Server for OS/390<sup>®</sup>



# CICS Front End Programming Interface User's Guide

*Release 3*

**Note!**

Before using this information and the product it supports, be sure to read the general information under "Notices" on page xi.

**Third edition (June 1999)**

This edition applies to Release 3 of CICS Transaction Server for OS/390, program number 5655-147, and to all subsequent versions, releases, and modifications until otherwise indicated in new editions. Make sure you are using the correct edition for the level of the product.

This edition replaces and makes obsolete the previous edition, SC33-1692-01. The technical changes for this edition are summarized under "Summary of changes" and are indicated by a vertical bar to the left of a change.

Order publications through your IBM representative or the IBM branch office serving your locality. Publications are not stocked at the address given below.

At the back of this publication is a page entitled "Sending your comments to IBM". If you want to make comments, but the methods described are not available to you, please address them to:

IBM United Kingdom Laboratories, Information Development,  
Mail Point 095, Hursley Park, Winchester, Hampshire, England, SO21 2JN.

When you send information to IBM, you grant IBM a nonexclusive right to use or distribute the information in any way it believes appropriate without incurring any obligation to you.

© **Copyright International Business Machines Corporation 1992, 1999. All rights reserved.**

US Government Users Restricted Rights – Use, duplication or disclosure restricted by GSA ADP Schedule Contract with IBM Corp.

---

# Contents

<b>Notices</b> . . . . .	xi
Programming interface information . . . . .	xii
Trademarks . . . . .	xii
<b>About this book</b> . . . . .	xiii
Who this book is for . . . . .	xiii
What you need to know to understand this book . . . . .	xiii
How to use this book . . . . .	xiii
Determining if a publication is current . . . . .	xiii
Notes on terminology . . . . .	xiv
CICS syntax notation used in this book . . . . .	xv
<b>CICS Transaction Server for OS/390</b> . . . . .	xvii
CICS books for CICS Transaction Server for OS/390 . . . . .	xvii
CICSplex SM books for CICS Transaction Server for OS/390 . . . . .	xviii
Other CICS books . . . . .	xviii
<b>Summary of changes</b> . . . . .	xix
Changes for this edition . . . . .	xix
Changes for the CICS Transaction Server for OS/390 Release 2 edition. . . . .	xix
Changes for the CICS Transaction Server for OS/390 Release 1 edition. . . . .	xix
Changes for the CICS/ESA 4.1 edition . . . . .	xix

---

## Part 1. Concepts and facilities . . . . . 1

<b>Chapter 1. Introducing FEPI</b> . . . . .	3
Problems FEPI can solve . . . . .	3
Advantages over alternative solutions . . . . .	4
How FEPI fits into your system . . . . .	4
Planning for FEPI . . . . .	5
Hardware and software requirements . . . . .	6
System integrity . . . . .	6
Storage . . . . .	6
Installation . . . . .	6
Configuration . . . . .	7
<b>Chapter 2. Functions and services</b> . . . . .	9
Introducing FEPI functions . . . . .	9
Samples . . . . .	10
Programming commands . . . . .	10
High-level FEPI commands . . . . .	10
Data-stream-level commands. . . . .	11
Specialized-level commands . . . . .	11
List of commands . . . . .	11
Setup and resources. . . . .	12
FEPI resources. . . . .	12
CICS FEPI application programs . . . . .	13
Terminals supported . . . . .	14
Security . . . . .	14
Signon security . . . . .	14
Command security . . . . .	15
Problem determination, customization, and performance. . . . .	15
Problem determination . . . . .	15

Customization . . . . .	15
Performance . . . . .	15

---

**Part 2. Installation and administration. . . . . 17**

<b>Chapter 3. Planning for FEPI . . . . .</b>	<b>19</b>
Analysis and planning . . . . .	19
Back-end applications and systems . . . . .	19
Names of nodes and targets . . . . .	19
Operator control requirements . . . . .	20
Journaling requirements . . . . .	20
Signon and signoff procedures . . . . .	20
Special event handling . . . . .	20
Using pools for control reasons . . . . .	20
Using pools for functional reasons . . . . .	21
Number of nodes . . . . .	21
Setup program organization . . . . .	21
Organizing your pools and property sets . . . . .	21
Organizing pools . . . . .	22
Organizing property sets . . . . .	22
Workload balancing in a sysplex . . . . .	23
Planning FEPI storage . . . . .	24
<b>Chapter 4. Getting started . . . . .</b>	<b>27</b>
The installation process. . . . .	27
A note about loading FEPI modules into the LPA . . . . .	27
Updating CICS definitions . . . . .	27
Installing FEPI resource definitions . . . . .	28
Starting CICS . . . . .	28
<b>Chapter 5. Configuring FEPI . . . . .</b>	<b>29</b>
CICS configuration . . . . .	29
Setup-initialization program in PLT . . . . .	29
VTAM configuration . . . . .	30
Defining FEPI nodes to VTAM . . . . .	30
Availability of network resources . . . . .	30
Selection of FEPI session parameters . . . . .	31
Pacing of FEPI sessions . . . . .	32
Back-end system configuration . . . . .	32
CICS . . . . .	32
IMS . . . . .	33
FEPI configuration . . . . .	33
Writing configuration programs . . . . .	33
Writing setup programs . . . . .	35
Running setup programs . . . . .	35
Varying the resources installed by the setup program . . . . .	36
Sample FEPI configuration . . . . .	37
Writing monitoring programs . . . . .	41
Handling unexpected events . . . . .	41
Handling CLSDST(PASS) . . . . .	43
Writing operator transactions . . . . .	45
Other functions . . . . .	45
Global user exit programs . . . . .	45
<b>Chapter 6. FEPI operation . . . . .</b>	<b>47</b>
Controlling FEPI resources . . . . .	47

SERVSTATUS . . . . .	47
ACQSTATUS . . . . .	47
LASTACQCODE . . . . .	49
INSTLSTATUS . . . . .	49
WAITCONVNUM . . . . .	49
STATE . . . . .	49
Performance . . . . .	49
Using CICS monitoring and statistics . . . . .	50
Shutdown . . . . .	51
Normal shutdown . . . . .	51
Immediate shutdown . . . . .	52
Forced shutdown . . . . .	52
Using FEPI with XRF . . . . .	52
XRF and VTAM. . . . .	52
FEPI resource definition and XRF . . . . .	53
XRF takeover of front-end system . . . . .	53
XRF takeover of back-end system . . . . .	54
Using FEPI with VTAM persistent sessions . . . . .	55
Restart of front-end system using persistent sessions. . . . .	55
Restart of back-end system using persistent sessions . . . . .	55
<b>Chapter 7. Operator control . . . . .</b>	<b>59</b>
CEMT—master terminal transaction . . . . .	59
CEMT DISCARD . . . . .	60
CEMT INQUIRE FECONNECTION . . . . .	61
CEMT INQUIRE FENODE. . . . .	65
CEMT INQUIRE FEPOOL. . . . .	67
CEMT INQUIRE FEPROPSET . . . . .	69
CEMT INQUIRE FETARGET . . . . .	70
CEMT SET FECONNECTION . . . . .	72
CEMT SET FENODE . . . . .	74
CEMT SET FEPOOL . . . . .	75
CEMT SET FETARGET . . . . .	76
CETR—trace control transaction . . . . .	77
VTAM commands . . . . .	77
<b>Chapter 8. Customizing FEPI . . . . .</b>	<b>79</b>
Global user exits . . . . .	79
XSZBRQ . . . . .	79
XSZARQ . . . . .	82
The UEPSZACT and UEPSZACN exit-specific parameters . . . . .	82
Using XMEOUT to control message output . . . . .	83
Journaling. . . . .	83
FEPI journal operation . . . . .	84
Printing FEPI journal records. . . . .	84
<b>Chapter 9. System programming reference . . . . .</b>	<b>87</b>
The FEPI SPI commands . . . . .	87
Command format . . . . .	88
Arguments and data types. . . . .	88
Errors and exception conditions. . . . .	88
Syntax notation. . . . .	89
Translator options . . . . .	89
INQUIRE and SET commands . . . . .	89
Other points . . . . .	89
FEPI ADD POOL . . . . .	90

Function . . . . .	90
Syntax . . . . .	90
Options. . . . .	90
Conditions . . . . .	91
FEPI DELETE POOL . . . . .	91
Function . . . . .	91
Syntax . . . . .	91
Options. . . . .	92
Conditions . . . . .	92
FEPI DISCARD NODELIST . . . . .	92
Function . . . . .	92
Syntax . . . . .	92
Options. . . . .	93
Conditions . . . . .	93
FEPI DISCARD POOL . . . . .	93
Function . . . . .	93
Syntax . . . . .	93
Options. . . . .	93
Conditions . . . . .	93
FEPI DISCARD PROPERTYSET . . . . .	94
Function . . . . .	94
Syntax . . . . .	94
Options. . . . .	94
Conditions . . . . .	94
FEPI DISCARD TARGETLIST . . . . .	94
Function . . . . .	94
Syntax . . . . .	94
Options. . . . .	95
Conditions . . . . .	95
FEPI INQUIRE CONNECTION . . . . .	95
Function . . . . .	95
Syntax . . . . .	95
Options. . . . .	96
Conditions . . . . .	98
FEPI INQUIRE NODE . . . . .	98
Function . . . . .	98
Syntax . . . . .	99
Options. . . . .	99
Conditions . . . . .	100
FEPI INQUIRE POOL . . . . .	100
Function . . . . .	100
Syntax . . . . .	100
Options . . . . .	101
Conditions . . . . .	104
FEPI INQUIRE PROPERTYSET . . . . .	104
Function . . . . .	104
Syntax . . . . .	104
Options . . . . .	105
Conditions . . . . .	107
FEPI INQUIRE TARGET . . . . .	107
Function . . . . .	107
Syntax . . . . .	107
Options . . . . .	107
Conditions . . . . .	108
FEPI INSTALL NODELIST . . . . .	108
Function . . . . .	108



Syntax . . . . .	108
Options . . . . .	109
Conditions . . . . .	109
FEPI INSTALL POOL . . . . .	109
Function . . . . .	109
Syntax . . . . .	110
Options . . . . .	110
Conditions . . . . .	111
FEPI INSTALL PROPERTYSET . . . . .	111
Function . . . . .	111
Syntax . . . . .	111
Options . . . . .	112
Conditions . . . . .	114
FEPI INSTALL TARGETLIST . . . . .	115
Function . . . . .	115
Syntax . . . . .	115
Options . . . . .	115
Conditions . . . . .	116
FEPI SET CONNECTION . . . . .	116
Function . . . . .	116
Syntax . . . . .	116
Options . . . . .	117
Conditions . . . . .	118
FEPI SET NODE . . . . .	118
Function . . . . .	118
Syntax . . . . .	118
Options . . . . .	119
Conditions . . . . .	119
FEPI SET POOL . . . . .	120
Function . . . . .	120
Syntax . . . . .	120
Options . . . . .	120
Conditions . . . . .	121
FEPI SET TARGET . . . . .	121
Function . . . . .	121
Syntax . . . . .	121
Options . . . . .	121
Conditions . . . . .	122
FEPI SP NOOP . . . . .	122
Function . . . . .	122
Syntax . . . . .	122
Options . . . . .	122
Conditions . . . . .	122
Transient data queue records . . . . .	122
Fields . . . . .	123
<b>Chapter 10. Problem determination . . . . .</b>	<b>125</b>
Debugging FEPI applications . . . . .	125
FEPI dump . . . . .	125
Using CICS dump facilities to investigate FEPI problems . . . . .	127
FEPI trace . . . . .	128
Taking trace entries . . . . .	128
Interpreting FEPI trace entries . . . . .	129
FEPI messages . . . . .	129
FEPI abends . . . . .	129
Restart . . . . .	130

Message DFHSZ4099E . . . . .	130
Message DFHSZ4155I . . . . .	131
Reporting a FEPI problem to IBM . . . . .	131

---

**Part 3. Application programming . . . . . 133**

<b>Chapter 11. Basics of FEPI programming . . . . .</b>	<b>135</b>
Communication and conversations . . . . .	135
Structure and design . . . . .	136
Programming . . . . .	137
<b>Chapter 12. Key stroke and screen-image applications . . . . .</b>	<b>139</b>
General sequence of commands . . . . .	139
Sending key stroke data . . . . .	140
Errors . . . . .	141
Receiving field-by-field . . . . .	142
Command completion . . . . .	142
Errors . . . . .	143
Multiple attentions . . . . .	143
Sending screen-image data . . . . .	144
Errors . . . . .	145
Receiving screen-image data . . . . .	145
Command completion and errors . . . . .	145
Extracting field data. . . . .	146
CONVERSE . . . . .	146
Errors . . . . .	146
<b>Chapter 13. Data stream applications . . . . .</b>	<b>147</b>
When to use the data stream interface. . . . .	147
General sequence of commands . . . . .	148
Receiving . . . . .	148
Command completion . . . . .	149
Errors . . . . .	150
Sending . . . . .	151
Errors . . . . .	151
CONVERSE . . . . .	151
SLU2 mode considerations . . . . .	151
SLU P mode considerations . . . . .	152
<b>Chapter 14. Application design . . . . .</b>	<b>153</b>
Programs . . . . .	153
Access program . . . . .	153
Begin-session handler . . . . .	154
Unsolicited-data handler . . . . .	154
End-session handler . . . . .	155
Application organization . . . . .	155
Application style . . . . .	155
Started tasks . . . . .	156
Conversations. . . . .	157
Signon security . . . . .	159
How to use PassTickets . . . . .	159
Benefits . . . . .	160
Requirements . . . . .	160
Error handling. . . . .	161
Time-outs . . . . .	161
Lost session . . . . .	162

Previous SEND failed . . . . .	162
Communication errors . . . . .	162
Bypass by user exit . . . . .	162
Unknown conversation ID . . . . .	162
Operator/system action . . . . .	162
Shutdown . . . . .	163
System considerations . . . . .	163
IMS considerations . . . . .	163
Performance . . . . .	166
<b>Chapter 15. Specialized functions.</b> . . . . .	167
Set and test sequence number (STSN) . . . . .	167
DRx responses . . . . .	167
SNA commands . . . . .	168
<b>Chapter 16. Application programming reference</b> . . . . .	169
The FEPI API commands . . . . .	169
Command format . . . . .	169
Arguments and data types . . . . .	170
Errors and exception conditions . . . . .	170
Syntax notation . . . . .	171
Translator options . . . . .	171
Other points . . . . .	171
Start data . . . . .	211
Fields . . . . .	211
Data formats . . . . .	212
Outbound data . . . . .	212
Inbound data . . . . .	214
Ending status . . . . .	214

---

**Part 4. Appendixes** . . . . . 217

<b>Appendix A. Sample programs</b> . . . . .	219
What you get . . . . .	219
COBOL II Sample Restrictions. . . . .	221
Installing the samples . . . . .	221
The CICS front-end samples . . . . .	221
The CICS and IMS back-end samples . . . . .	221
Using the samples . . . . .	222
The back-end CICS program . . . . .	222
The back-end IMS program . . . . .	223
Description of the samples . . . . .	224
Setup . . . . .	224
Monitor and unsolicited data-handler . . . . .	225
Begin session . . . . .	226
Key stroke CONVERSE . . . . .	228
Screen image SEND and START. . . . .	229
Screen image RECEIVE and EXTRACT FIELD . . . . .	230
3270 data stream pass-through . . . . .	231
End-session handler . . . . .	232
SLU P one-out one-in . . . . .	233
SLU P pseudoconversational . . . . .	234
STSN handler. . . . .	235
<b>Appendix B. CVDA and RESP2 values</b> . . . . .	237
CVDAs and numeric values in alphabetic sequence . . . . .	237

CVDAs and numeric values in numeric sequence. . . . .	239
RESP2 values . . . . .	241
<b>Glossary</b> . . . . .	245
<b>Index</b> . . . . .	251

---

## Notices

This information was developed for products and services offered in the U.S.A. IBM may not offer the products, services, or features discussed in this document in other countries. Consult your local IBM representative for information on the products and services currently available in your area. Any reference to an IBM product, program, or service is not intended to state or imply that only that IBM product, program, or service may be used. Any functionally equivalent product, program, or service that does not infringe any IBM intellectual property right may be used instead. However, it is the user's responsibility to evaluate and verify the operation of any non-IBM product, program, or service.

IBM may have patents or pending patent applications covering subject matter described in this document. The furnishing of this document does not give you any license to these patents. You can send license inquiries, in writing, to:

IBM Director of Licensing  
IBM Corporation  
North Castle Drive  
Armonk, NY 10504-1785  
U.S.A.

For license inquiries regarding double-byte (DBCS) information, contact the IBM Intellectual Property Department in your country or send inquiries, in writing, to:

IBM World Trade Asia Corporation  
Licensing  
2-31 Roppongi 3-chome, Minato-ku  
Tokyo 106, Japan

**The following paragraph does not apply in the United Kingdom or any other country where such provisions are inconsistent with local law:**

INTERNATIONAL BUSINESS MACHINES CORPORATION PROVIDES THIS PUBLICATION "AS IS" WITHOUT WARRANTY OF ANY KIND, EITHER EXPRESS OR IMPLIED, INCLUDING, BUT NOT LIMITED TO, THE IMPLIED WARRANTIES OF NON-INFRINGEMENT, MERCHANTABILITY, OR FITNESS FOR A PARTICULAR PURPOSE. Some states do not allow disclaimer of express or implied warranties in certain transactions, therefore this statement may not apply to you.

This publication could include technical inaccuracies or typographical errors. Changes are periodically made to the information herein; these changes will be incorporated in new editions of the publication. IBM may make improvements and/or changes in the product(s) and/or the program(s) described in this publication at any time without notice.

Licensees of this program who wish to have information about it for the purpose of enabling: (i) the exchange of information between independently created programs and other programs (including this one) and (ii) the mutual use of the information which has been exchanged, should contact IBM United Kingdom Laboratories, MP151, Hursley Park, Winchester, Hampshire, England, SO21 2JN. Such information may be available, subject to appropriate terms and conditions, including in some cases, payment of a fee.

The licensed program described in this document and all licensed material available for it are provided by IBM under terms of the IBM Customer Agreement, IBM International Programming License Agreement, or any equivalent agreement between us.

---

## Programming interface information

This book is intended to help you use the CICS Front End Programming Interface. This book primarily documents General-use Programming Interface and Associated Guidance Information provided by CICS.

General-use programming interfaces allow the customer to write programs that obtain the services of CICS.

However, this book also documents Product-sensitive Programming Interface and Associated Guidance Information and Diagnosis, Modification or Tuning Information provided by CICS.

Product-sensitive programming interfaces allow the customer installation to perform tasks such as diagnosing, modifying, monitoring, repairing, tailoring, or tuning of CICS. Use of such interfaces creates dependencies on the detailed design or implementation of the IBM software product. Product-sensitive programming interfaces should be used only for these specialized purposes. Because of their dependencies on detailed design and implementation, it is to be expected that programs written to such interfaces may need to be changed in order to run with new product releases or versions, or as a result of service.

Product-sensitive Programming Interface and Associated Guidance Information is identified where it occurs, by an introductory statement to a chapter or section.

Diagnosis, Modification or Tuning Information is provided to help you diagnose problems with CICS.

**Attention:** Do not use this Diagnosis, Modification or Tuning Information as a programming interface.

Diagnosis, Modification or Tuning Information is identified where it occurs, by an introductory statement to a chapter or section.

---

## Trademarks

The following terms are trademarks of International Business Machines Corporation in the United States, or other countries, or both:

ACF/VTAM	CICS/ESA	MVS/ESA
BookManager	CICS/MVS	OS/390
IBM	RACF	C/370
IMS	CICS	IMS/ESA
VTAM		

Other company, product, and service names may be trademarks or service marks of others.

---

## About this book

This book describes the Front End Programming Interface (FEPI) of CICS Transaction Server for OS/390 Release 3.

---

## Who this book is for

This book is intended primarily for CICS® system programmers and administrators responsible for installing and configuring FEPI, and for application programmers responsible for writing FEPI “front-end” application programs.

---

## What you need to know to understand this book

To configure FEPI, you need to be familiar with all aspects of CICS administration (such as system definition, resource definition, customization, and operations) and the programming interface to CICS. Information about CICS system definition is in the *CICS System Definition Guide*. Information about defining resources to CICS is in the *CICS Resource Definition Guide*. Programming information about customizing CICS is in the *CICS Customization Guide*. Programming information about EXEC CICS commands is in the *CICS Application Programming Reference* and the *CICS System Programming Reference*. You should also be familiar with the IBM® ACF/VTAM® telecommunication access method and, if you are accessing IMS™ back-end systems, with IBM IMS/VS or IBM IMS/ESA® administration.

To write FEPI “front-end” applications, you need to know how to write programs in at least one of the programming languages that CICS supports. More importantly, you also need knowledge of data communication and protocols. And, if you will be accessing IMS back-end systems, you must also be familiar with using IMS and writing IMS applications.

---

## How to use this book

Read “Part 1. Concepts and facilities”, as an introduction to FEPI. Other parts and chapters are self-contained. Use an individual part or chapter when performing the task described in it.

---

## Determining if a publication is current

IBM regularly updates its publications with new and changed information. When first published, both hardcopy and BookManager softcopy versions of a publication are usually in step. However, due to the time required to print and distribute hardcopy books, the BookManager version is more likely to have had last-minute changes made to it before publication.

Subsequent updates will probably be available in softcopy before they are available in hardcopy. This means that at any time from the availability of a release, softcopy versions should be regarded as the most up-to-date.

For CICS Transaction Server books, these softcopy updates appear regularly on the *Transaction Processing and Data Collection Kit* CD-ROM, SK2T-0730-xx. Each reissue of the collection kit is indicated by an updated order number suffix (the -xx part). For example, collection kit SK2T-0730-06 is more up-to-date than SK2T-0730-05. The collection kit is also clearly dated on the cover.

Updates to the softcopy are clearly marked by revision codes (usually a “#” character) to the left of the changes.

---

## Notes on terminology

In this book, VTAM® refers to ACF/VTAM and IMS refers to IMS/VS and IMS/ESA. The term “CICS”, without any qualification, refers to the CICS element of IBM CICS Transaction Server for OS/390.

CICS Transaction Server for OS/390 Release 3 supports CICS applications written in:

- Assembler language
- C/370™
- OS/VS COBOL
- VS COBOL II
- PL/I.

In this book, the phrase “the languages supported by CICS” refers to the above languages.

KB equals 1024 bytes; MB equals 1024KB.

The following terms have different meanings for FEPI, CICS, IMS, and VTAM:

### **application**

FEPI uses application in the normal sense of a program or suite of programs that do work. VTAM uses application for programs that communicate directly using VTAM; in a FEPI environment, this means the back-end systems on one hand, and FEPI on the other.

### **conversation**

A FEPI conversation is not the same as an IMS conversation, although they would normally coincide, and it is not related to CICS conversational mode. It is analogous to a CICS APPC conversation.

### **inbound, input**

In FEPI and CICS usage, these describe data received by a program from elsewhere. From the point-of-view of the back-end system, this data is outbound or output to a terminal.

### **message**

VTAM and IMS use message to refer to any data transmission, and not just to data displayed for a user’s attention.

**node** In VTAM and IMS, a node is a named point in a network. In FEPI, nodes are those points (VTAM nodes) that are the secondary LU terminals simulated by FEPI.

### **outbound, output**

In FEPI and CICS usage, these describe data sent by a program to somewhere else. From the point-of-view of the back-end system, this data is inbound or input from a terminal.

### **secondary**

In VTAM, secondary describes one of the partners of an LU-LU pair; the terminals simulated by FEPI are secondary LUs. This is not the same as the CICS usage of secondary.



---

## CICS syntax notation used in this book

Throughout this book, the syntax of CICS commands is presented in a standard way.

The “EXEC CICS” that always precedes each command’s keyword is not included; nor is the “END\_EXEC” statement used in COBOL or the semicolon (;) used in PL/I and C/370 that you must code at the end of each CICS command. In the C/370 language, a null character can be used as an end-of-string marker, but CICS does not recognize this; you must never, therefore, have a comma or period followed by a space (X'40') in the middle of a coding line.

You interpret the syntax by following the arrows from left to right. The conventions are:

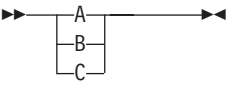
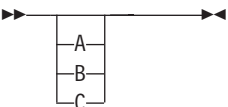
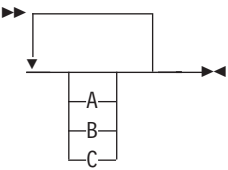
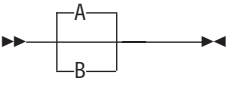
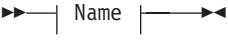
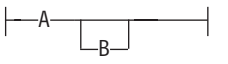
Symbol	Action
	A set of alternatives—one of which you <b>must</b> code.
	A set of alternatives—one of which you <b>may</b> code.
	A set of alternatives—any of which you may code.
	Alternatives where <b>A</b> is the default.
 <p data-bbox="164 1203 248 1234"><b>Name:</b></p> 	Use with the named section in place of its name.
Punctuation and uppercase characters	Code exactly as shown.
Lowercase characters	Code your own text, as appropriate (for example, name).

---

## CICS Transaction Server for OS/390

<i>CICS Transaction Server for OS/390: Planning for Installation</i>	GC33-1789
<i>CICS Transaction Server for OS/390 Release Guide</i>	GC34-5352
<i>CICS Transaction Server for OS/390 Migration Guide</i>	GC34-5353
<i>CICS Transaction Server for OS/390 Installation Guide</i>	GC33-1681
<i>CICS Transaction Server for OS/390 Program Directory</i>	GI10-2506
<i>CICS Transaction Server for OS/390 Licensed Program Specification</i>	GC33-1707

---

## CICS books for CICS Transaction Server for OS/390

### General

<i>CICS Master Index</i>	SC33-1704
<i>CICS User's Handbook</i>	SX33-6104
<i>CICS Transaction Server for OS/390 Glossary (softcopy only)</i>	GC33-1705

### Administration

<i>CICS System Definition Guide</i>	SC33-1682
<i>CICS Customization Guide</i>	SC33-1683
<i>CICS Resource Definition Guide</i>	SC33-1684
<i>CICS Operations and Utilities Guide</i>	SC33-1685
<i>CICS Supplied Transactions</i>	SC33-1686

### Programming

<i>CICS Application Programming Guide</i>	SC33-1687
<i>CICS Application Programming Reference</i>	SC33-1688
<i>CICS System Programming Reference</i>	SC33-1689
<i>CICS Front End Programming Interface User's Guide</i>	SC33-1692
<i>CICS C++ OO Class Libraries</i>	SC34-5455
<i>CICS Distributed Transaction Programming Guide</i>	SC33-1691
<i>CICS Business Transaction Services</i>	SC34-5268

### Diagnosis

<i>CICS Problem Determination Guide</i>	GC33-1693
<i>CICS Messages and Codes</i>	GC33-1694
<i>CICS Diagnosis Reference</i>	LY33-6088
<i>CICS Data Areas</i>	LY33-6089
<i>CICS Trace Entries</i>	SC34-5446
<i>CICS Supplementary Data Areas</i>	LY33-6090

### Communication

<i>CICS Intercommunication Guide</i>	SC33-1695
<i>CICS Family: Interproduct Communication</i>	SC33-0824
<i>CICS Family: Communicating from CICS on System/390</i>	SC33-1697
<i>CICS External Interfaces Guide</i>	SC33-1944
<i>CICS Internet Guide</i>	SC34-5445

### Special topics

<i>CICS Recovery and Restart Guide</i>	SC33-1698
<i>CICS Performance Guide</i>	SC33-1699
<i>CICS IMS Database Control Guide</i>	SC33-1700
<i>CICS RACF Security Guide</i>	SC33-1701
<i>CICS Shared Data Tables Guide</i>	SC33-1702
<i>CICS Transaction Affinities Utility Guide</i>	SC33-1777
<i>CICS DB2 Guide</i>	SC33-1939

---

## CICSplex SM books for CICS Transaction Server for OS/390

### General

<i>CICSplex SM Master Index</i>	SC33-1812
<i>CICSplex SM Concepts and Planning</i>	GC33-0786
<i>CICSplex SM User Interface Guide</i>	SC33-0788
<i>CICSplex SM Web User Interface Guide</i>	SC34-5403
<i>CICSplex SM View Commands Reference Summary</i>	SX33-6099

### Administration and Management

<i>CICSplex SM Administration</i>	SC34-5401
<i>CICSplex SM Operations Views Reference</i>	SC33-0789
<i>CICSplex SM Monitor Views Reference</i>	SC34-5402
<i>CICSplex SM Managing Workloads</i>	SC33-1807
<i>CICSplex SM Managing Resource Usage</i>	SC33-1808
<i>CICSplex SM Managing Business Applications</i>	SC33-1809

### Programming

<i>CICSplex SM Application Programming Guide</i>	SC34-5457
<i>CICSplex SM Application Programming Reference</i>	SC34-5458

### Diagnosis

<i>CICSplex SM Resource Tables Reference</i>	SC33-1220
<i>CICSplex SM Messages and Codes</i>	GC33-0790
<i>CICSplex SM Problem Determination</i>	GC33-0791

---

## Other CICS books

<i>CICS Application Programming Primer (VS COBOL II)</i>	SC33-0674
<i>CICS Application Migration Aid Guide</i>	SC33-0768
<i>CICS Family: API Structure</i>	SC33-1007
<i>CICS Family: Client/Server Programming</i>	SC33-1435
<i>CICS Family: General Information</i>	GC33-0155
<i>CICS 4.1 Sample Applications Guide</i>	SC33-1173
<i>CICS/ESA 3.3 XRF Guide</i>	SC33-0661

If you have any questions about the CICS Transaction Server for OS/390 library, see *CICS Transaction Server for OS/390: Planning for Installation* which discusses both hardcopy and softcopy books and the ways that the books can be ordered.

---

## Summary of changes

This edition of the *CICS Front End Programming Interface User's Guide* is based on the *Front End Programming Interface User's Guide* for CICS Transaction Server for OS/390 Release 2, SC33-1692-01.

---

### Changes for this edition

There are no significant changes for this edition. Any differences between this book and the last edition are indicated by a vertical bar to the left of the text.

---

### Changes for the CICS Transaction Server for OS/390 Release 2 edition

There were no significant changes for this edition.

---

### Changes for the CICS Transaction Server for OS/390 Release 1 edition

The main changes for this edition were:

- The information in “Updating CICS definitions” on page 27 about defining transient data queues for FEPI was modified, because transient data queues are now defined using RDO, rather than macro instructions.
- “Printing FEPI journal records” on page 84 was rewritten, because the format of FEPI journal records changed.

---

### Changes for the CICS/ESA 4.1 edition

The major changes for this edition were:

- Information about signon security was added to “Chapter 2. Functions and services” on page 9 and “Chapter 14. Application design” on page 153.
- Information about using FEPI with VTAM persistent sessions was added to “Chapter 6. FEPI operation” on page 47.
- “Using CICS monitoring and statistics” on page 50 described how to use the FEPI-related fields in CICS monitoring and statistics records for performance-tuning purposes.
- “Chapter 4. Getting started” on page 27 was modified to reflect the fact that, in CICS/ESA 4.1 and later releases, FEPI is part of the base CICS product.
- “Chapter 7. Operator control” on page 59 was reorganized; the CEMT INQUIRE commands are now described separately from their CEMT SET counterparts, and the distinction between input and output fields was made clearer.
- “Chapter 10. Problem determination” on page 125 contains information that was previously in the *CICS Diagnosis Reference* manual.
- Throughout the book, the syntax of programming and operator commands was translated into “railroad diagrams”. The chapters mainly affected were “Chapter 7. Operator control” on page 59 “Chapter 9. System programming reference” on page 87, and “Chapter 16. Application programming reference” on page 169.
- Descriptions of the FEPI messages and codes (Appendix B in the CICS/ESA 3.3 book) were transferred to the *CICS Messages and Codes* manual.
- Descriptions of the FEPI trace entries (Appendix C in the CICS/ESA 3.3 book) have been transferred to the *CICS Diagnosis Reference*.



---

## Part 1. Concepts and facilities

This part of the book gives an overview of FEPI, and some general information about functions, services, and implementing applications.

- “Chapter 1. Introducing FEPI” on page 3 explains what FEPI is and what problems it solves; it also describes some planning considerations.
- “Chapter 2. Functions and services” on page 9 describes the various types of FEPI commands and introduces the concepts and functions used by FEPI applications.





---

## Chapter 1. Introducing FEPI

This chapter explains what the CICS Front End Programming Interface (FEPI) is, what problems it solves, what it does, and how it can help you; it also describes some planning considerations.

The Front End Programming Interface is an integral part of CICS. The function is called a front-end programming interface because it enables you to write CICS application programs that access other CICS or IMS programs. In other words, it provides a front end to those programs. The interface simulates the terminals that the other programs use.

The chapter contains the following topics:

- “Problems FEPI can solve”
- “How FEPI fits into your system” on page 4
- “Planning for FEPI” on page 5.

---

### Problems FEPI can solve

Many users have CICS and IMS applications that they want to use differently; for example, to extend their use by incorporating them into other applications. But they cannot change the way the applications are used because they cannot change the application programs.

FEPI allows existing CICS and IMS application programs to be used in different ways, in different combinations, in different environments, and on different systems, *without changing* them, because it provides a simple integrated interface to these programs.

FEPI also lets you write new programs that add function to old programs.

There are many reasons why existing application programs can't be changed. Perhaps the application was bought in a package, so that you don't have the source. Perhaps someone else owns the application; perhaps it runs on someone else's system. Perhaps the source has been lost, and there's no one around who knows the program well enough. Perhaps the program logic is so complex that any changes are considered too dangerous.

Or perhaps it is an application that was written for one specific environment, such as IBM 3270 information display systems, and you want to use it for another, or you want to extend its function. You don't want to change the application, because it must still work with the 3270s.

To get around this, you can run the existing application unchanged and provide a front-end program to interface to it. Using FEPI, a front-end program can simulate a terminal. This means the program can gain access to applications written to support that terminal. That program can then use the existing applications, and the existing application is unaware that anything has changed.

Therefore, the existing application can be used differently without being changed in any way. The changes are in the simulating program. For example, newly written applications can collect data from several existing applications. The existing applications can be on the same system as the simulating program, or on a different system.

## Introducing FEPI

### Advantages over alternative solutions

There are other ways of accessing existing programs differently, but they all have their drawbacks.

**Can CICS multiregion operation (MRO) or intersystem communication (ISC) be used to access remote applications?**

Yes, but using MRO or ISC often requires some changes to the existing application—for example, to change the type of terminal supported or to provide an interface that uses a communication area.

**Can VTAM program-to-program support be used?**

Yes, if your programmers can write an access program to issue the appropriate VTAM calls. But these VTAM calls cannot be part of a CICS application program.

---

### How FEPI fits into your system

Figure 1 on page 5 shows the relationship between FEPI and other components of your system. Note, particularly, the unchanged applications in the lower part of the figure, and the new CICS FEPI application near the top. To an existing application, the front-end application looks like a terminal.

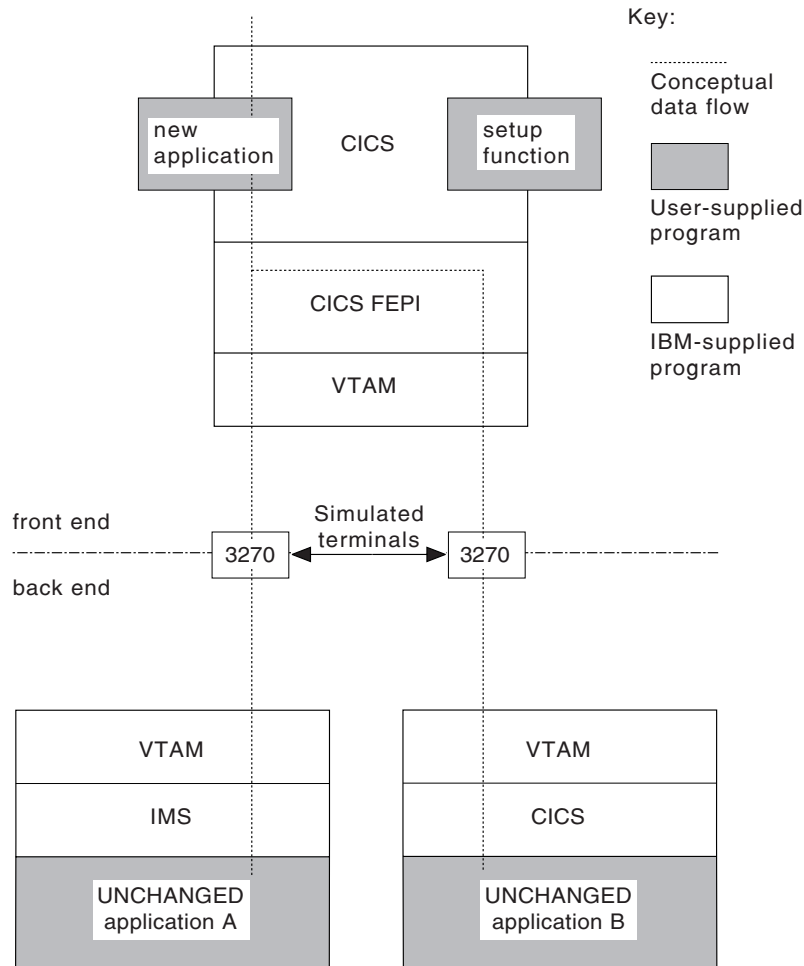

Figure 1. Structure of FEPI and application programs

Now some definitions: the *front end* is the system on which the CICS FEPI application runs, and the *back end* is the system on which the existing application runs. (They may be the same system.)

FEPI allows CICS front-end application programs to communicate with *unchanged* back-end applications running on CICS or IMS systems that are local or remote. The back-end applications continue to work just as if they are being accessed from the type of terminal they were originally written for.

A *CICS FEPI application* is a CICS application that is designed to use FEPI to communicate with existing back-end applications. It is also known as a terminal front-end program.

## Planning for FEPI

This section explains what hardware and software you need to use the CICS/ESA® Front End Programming Interface (FEPI), what MVS system integrity is involved, what resources you need, and what to consider when installing FEPI and customizing your system.

## Introducing FEPI

### Hardware and software requirements

There are different requirements for the front-end and the back-end.

#### Front-end

For front-end systems, FEPI is an integral part of CICS Transaction Server for OS/390 (and of all CICS/ESA releases after Version 3 Release 3).

Other hardware and software requirements are the same as for CICS Transaction Server for OS/390.

Extra 37x5 controllers and network control programs (NCPs) may be needed to provide the necessary intersystem connections.

#### Back-end

Applications running on the following, and subsequent compatible releases, are supported:

- CICS/MVS Version 2 Release 1 Modification 2
- CICS/ESA Version 3 Release 2 Modification 1
- CICS/ESA Version 3 Release 3
- CICS/ESA Version 4
- CICS Transaction Server for OS/390
- IMS/VS Version 2 Release 2
- IMS/ESA Version 3
- IMS/ESA Version 4
- IMS/ESA Version 5

FEPI provides simulation for two very common classes of terminals on these systems:

- 3270-types for CICS and IMS applications (using LU 2 protocol)
- A family of programmable terminals, including the 4700, accessed through an LU 0 protocol (called SLU P), for IMS applications.

### System integrity

All application programs that use FEPI run in problem-program mode in user-key storage. No part of FEPI needs to be authorized to run.

IBM accepts authorized program analysis reports (APARs) where the installation of the FEPI function introduces an exposure to the system integrity of MVS. Refer to the *MVS Integrity Programming Announcement* dated 21 October 1981.

### Storage

Some storage below the 16MB line is required, but the bulk resides above the 16MB line in storage managed by CICS. For details, see "Planning FEPI storage" on page 24.

There are no inherent resource limits in FEPI. It is limited only by what is configured and the available system storage.

### Installation

FEPI is distributed through normal IBM Program Library channels. It is a part of CICS and cannot be ordered separately. CICS FEPI is supplied in System Modification Program/Extended (SMP/E) format on:

- 9/6250 magnetic tape
- 3480 data cartridge.

All necessary instructions and guidance for installation are included in the *CICS Transaction Server for OS/390 Program Directory*. The function modification identifier (FMID) is JCI3329. See “Chapter 4. Getting started” on page 27 for more information.

## Configuration

You need to configure your system specifically for CICS FEPI, for new application programs, and possibly for existing applications. See “Chapter 3. Planning for FEPI” on page 19 and “Chapter 5. Configuring FEPI” on page 29 for more information.

### **For the CICS FEPI function itself**

You may need to adapt your VTAM setup, your CICS system, and CICS FEPI to use the interface effectively.

The CICS system initialization parameter and override, FEPI=YES|NO (default NO), controls whether FEPI is available or not. If it is, it runs as a system transaction that is started automatically when CICS starts; it does not need to be started (or stopped) independently.

FEPI itself is configured with the resources that it can use, by issuing commands from a front-end application program; FEPI does not use a configuration file or CICS RDO. The system programmer should provide a setup program to configure FEPI using these requests; the program can get the configuration data from a file or from whatever source it identifies.

### **For CICS FEPI applications**

CICS FEPI applications must be defined to CICS in the normal way.

### **For back-end systems**

It may be necessary to define simulated terminals for FEPI to use.



---

## Chapter 2. Functions and services

This chapter contains the following topics:

- “Introducing FEPI functions”
- “Programming commands” on page 10
- “Setup and resources” on page 12
- “CICS FEPI application programs” on page 13
- “Terminals supported” on page 14
- “Security” on page 14
- “Problem determination, customization, and performance” on page 15.

---

### Introducing FEPI functions

The CICS/ESA Front End Programming Interface (FEPI) function provides access, by means of simulated terminals, to CICS and IMS applications available through a communication network. An application program using FEPI can provide a front end to other CICS or IMS applications. Because this is done by simulating a terminal in session with the non-FEPI application, that application does not have to be changed in any way.

Thus you can write FEPI applications that provide a single integrated interface to previously disparate applications. The scope and usability of your CICS and IMS applications can be extended by using them in combination, in different environments, or on different systems.

Because a FEPI application communicates with other applications that may run in different systems, it is necessary to distinguish between systems and identify the direction of data flows. The convention is:

#### **Front-end**

The front-end system is the one in which the FEPI application runs.

#### **Back-end**

Back-end identifies the system in which the other CICS or IMS applications run. (This is equivalent to “partner” system, used elsewhere by CICS.)

#### **Outbound**

Identifies data *sent* by the FEPI application *to* the back-end application.

#### **Inbound**

Identifies data *received* by the FEPI application *from* the back-end application.

FEPI provides a programming interface. Its functions can be invoked only through that interface, which is an extension to the EXEC CICS programming interface. All FEPI requests are made by issuing EXEC CICS FEPI commands; all the commands have the qualifier FEPI. The languages supported by the EXEC CICS programming interface (Assembler, VS COBOL II, C/370, PL/I) can be used. For educational and initial development purposes, you could simply use CECL, rather than formally writing a program.

All functions are available in the normal way to all applications, except that some functions are intended for system programmers, and their use can be restricted. All the other facilities that you can use with CICS applications, such as the execution diagnostic facility (EDF) and the command interpreter transaction, CECL, are available.

## Functions and services

### Samples

To help you develop your own CICS FEPI applications, and to show you what FEPI can do, FEPI includes detailed samples. They form an integrated set, and include a program that sets up the FEPI configuration needed to run the other samples. The samples are supplied in source format. Their names have the form *DFH0xZyy*. *Z* shows that the sample is a FEPI sample and *x* identifies the source language of the sample (*A* for Assembler language, *C* for C, *P* for PL/I, and *V* for VS COBOL II), and *yy* identifies the specific program. See “Appendix A. Sample programs” on page 219.

---

## Programming commands

EXEC CICS FEPI commands provide several ways of developing CICS FEPI applications. The commands are at three logical levels:

**High-level:**

a straightforward interface for normal 3270 applications

**Data stream-level:**

for use with IMS SLU P applications and more complicated 3270 applications

**Specialized-level:**

for access to complex VTAM communication functions and events, designed for use by vendors and experienced CICS FEPI application developers.

## High-level FEPI commands

The high-level front-end programming interface consists of two interfaces for everyday use: *key stroke* and *screen-image*, collectively known as *formatted* data. They allow programmers to build their own CICS FEPI applications in a straightforward manner. However, the programmer must understand data communication and protocols.

See “Chapter 12. Key stroke and screen-image applications” on page 139 for details.

**The key stroke interface**

The key stroke interface allows programmers writing in any of the CICS-supported languages, to specify the keys that an operator might press while using an existing application. The key strokes are specified using easily coded mnemonics; no hexadecimal values are required.

**The screen-image interface**

The screen-image interface allows programmers writing in any language supported by CICS, to define the contents of a 3270 screen, using a data structure appropriate to the programming language. It uses a buffer with one byte for each screen position (for example, 1920 bytes for a 24 × 80 character screen). This buffer can be defined in any way that suits the application program and the programming language. It is passed as a complete screen buffer to the back-end application.

In both cases, key stroke and screen-image, the data received from the back-end application is presented as a screen image.



## Data-stream-level commands

For many applications, the key stroke and screen-image interfaces should be quite adequate. However, where they are not, FEPI data-stream-level commands give an application complete control of the 3270 data stream. These commands are also needed for SLU P applications, which can use only this interface. FEPI does not buffer or interpret the data stream; it is presented as it arrives from the back-end application, and the front-end application must be prepared to handle whatever is presented. Similarly, data sent by the front-end application is transmitted without verification.

A detailed knowledge of data communication and protocols and of data stream format is required.

See “Chapter 13. Data stream applications” on page 147 for details.

## Specialized-level commands

These are some of the specialized functions that can be accessed through FEPI:

### STSN for SLU P applications:

Set and test sequence number (STSN) is a communication protocol used to check and control transmissions. FEPI normally handles all necessary STSN processing automatically. However, FEPI also provides access to STSN information for those applications that need to control sequence number data.

### Application access to definite responses:

When a flow is received, the receiving LU can choose what response to return to the sending LU. FEPI normally handles this automatically, but also provides facilities for applications to determine this flow.

### Other VTAM facilities:

Some applications use a VTAM facility known as CLSDST(PASS); this can be used in more sophisticated CICS FEPI application programming.

See “Chapter 15. Specialized functions” on page 167 for details.

## List of commands

All the logical levels use more or less the same set of commands, though the options used may vary. The EXEC CICS FEPI application programming commands are:

### ALLOCATE

Establishes communication with a back-end application

**FREE** Frees communication with a back-end application

**SEND** Sends data from a CICS FEPI application to a back-end application

### RECEIVE

Receives data into a CICS FEPI application from a back-end application

### CONVERSE

Sends data to and receives data from a back-end application

**ISSUE** Sends control data to a back-end application

### EXTRACT

Gets field data and attributes, set-and-test-sequence-number (STSN) data, or conversation status

### START

Schedules a CICS transaction to handle inbound data.

## Setup and resources

Besides the application programming functions that communicate with back-end applications, FEPI also provides system programming functions that define and inquire about *FEPI resources* and perform control functions. Defining and configuring FEPI resources is called *setup program*. The EXEC CICS FEPI commands that provide these functions are:

**INSTALL, ADD**

Sets up communication resources

**DISCARD, DELETE**

Discards communication resources

**INQUIRE**

Queries FEPI resource status

**SET** Controls FEPI resources.

The setup functions are usually performed by a customer-written transaction that is started from a second-phase program list table post initialization (PLTPI) program. See “FEPI configuration” on page 33.

FEPI resources can be controlled, like other CICS resources, using the CEMT SET and INQUIRE functions. CECI can also be used. See “Chapter 7. Operator control” on page 59.

## FEPI resources

There are four types of FEPI resource—*pool*, *property set*, *target*, and *node*. The relationship between them is illustrated below. The resources are further explained in “Chapter 5. Configuring FEPI” on page 29 and the more complex relationships possible between them are illustrated in “Sample FEPI configuration” on page 37.

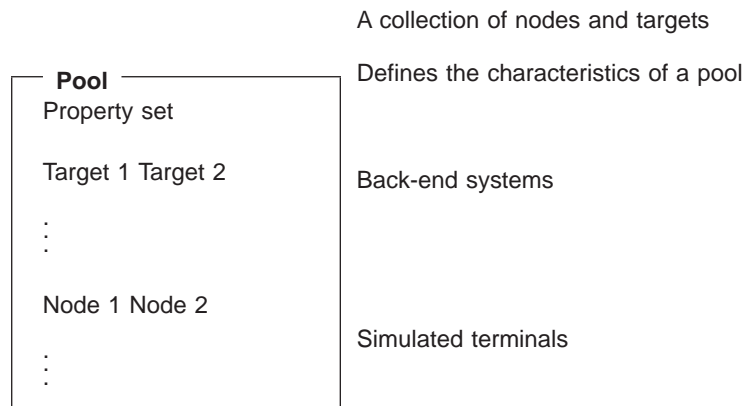

A FEPI pool can have one or more nodes and one or more targets. The same nodes and targets can be in any number of pools, except that the same node-target pair (a *connection*) cannot occur in more than one pool.

A CICS FEPI application can reach a target only by specifying a pool, which defines the set of nodes that can be used to make the connection, and the characteristics of the communication.

A target and an open node in the same pool are 'connected'; when bound, they are 'in session'. To *bind* means to establish a *session* on a *connection*, to make it ready to allow communication.

The process of communicating with a back-end system is called a *conversation*; it is the fundamental entity that a FEPI application deals with. Only one conversation can use a connection at one time, although any number can do so consecutively. For efficiency, the session on the connection is kept bound between conversations, unless you choose otherwise. Furthermore, a conversation is owned by the task that establishes it; no other task can use it.

**Note:** The use of the term conversation does not mean that the back-end or front-end application has to be conversational, in the CICS meaning of the term.

---

## CICS FEPI application programs

A CICS FEPI application comprises several distinct logical functions:

**Access programs:**

Communicate with the back-end applications

**Begin-session handler:**

Handles begin-session processing

**End-session handler:**

Handles end-session processing

**STSN handler:**

Assists message synchronization

**Unsolicited-data handler:**

Handles unsolicited inbound data

**Monitor:**

Handles unexpected events such as the loss of a session or errors in setup.

These functions can be in separate programs, or contained in one program. The need for each function depends on the requirements of the application; in many cases default processing is all that you need. You might need several styles of each function, again depending on the requirements of your application.

The application programmer always writes the access programs. The system programmer usually writes the monitors to handle the unexpected events that FEPI reports to transient data queues such as CSZX. As for the other functions, sometimes the system programmer writes them providing, perhaps, just one instance of each, so that they are common to everyone. (This approach has the advantage that adherence to standard procedures—for such things as signon and signoff—is enforced.) In other installations, the application programmers provide them.

In many cases, writing a CICS FEPI application is straightforward. However, some applications need more sophisticated programming. The programmer not only has to understand all the displays and protocols of the back-end application and system (CICS or IMS), but must also understand the detailed data-stream protocols. For further information, see "Chapter 14. Application design" on page 153.

### Terminals supported

To access back-end applications, FEPI has VTAM secondary logical unit (SLU) support, so that CICS FEPI applications can simulate certain logical unit (LU) types. FEPI uses VTAM program-to-program support to provide this function, and to communicate between front-end and back-end applications.

**Note:** FEPI cannot send VTAM logon data.

FEPI provides simulation support for two families of terminals. The names **SLU2** and **SLU P** are used to identify the two types of support:

**SLU2** for the 3270 family of terminals, used in many CICS and IMS applications. See the *3270 Data Stream Programmer's Reference*.

**SLU P** for a family of programmable terminals, including the 4700, accessed through an LU 0 protocol, for IMS applications. This protocol is defined in *IMS/VS Programming Guide for Remote SNA Systems* (for IMS/VS Version 2) or *IMS/ESA Customization Guide* (for IMS/ESA Version 3 and later).

Data-stream-level and specialized-level commands can be used with both families of terminals, but the high-level commands, which use formatted data, are only for SLU2.

The mode of a conversation must be either SLU2 or SLU P; it cannot be mixed. For SLU2 conversations, formatted data or data stream data can be used, but cannot be mixed in the same conversation. The mode and data type are controlled by the pool used, which is set up by the system programmer.

These terminals are supported only when they are used to communicate with CICS or IMS systems.

---

## Security

This section introduces FEPI security.

### Signon security

Because FEPI is a terminal emulator, the back-end system “sees” the front-end as a terminal rather than a system; it cannot differentiate between FEPI emulation and a real device. Thus, CICS bind, link, and attach-time security are not applicable to FEPI connections. If security is enabled in the back-end system, in order for your FEPI application to access protected resources the emulated terminal must be signed on to the back-end. The alternative is that you do not use CICS security with FEPI—that is, you make all the back-end transactions accessed by FEPI available to the CICS default user. This option is clearly unacceptable; it means that you must either run a security risk or deprive your FEPI applications of access to sensitive data.

When signing on to a back-end system, FEPI applications can ask the external security manager (ESM) to supply a password substitute, or *PassTicket*. Using PassTickets to sign on means that FEPI applications do not need to store user passwords (which is risky), or ask users to reenter them (which is irritating). For information about implementing signon security, see page 159.

## Command security

You can restrict access to the FEPI system programming commands by defining operator profiles to your ESM. For details of how to do this, see “Command-level security” on page 28. All application programming commands are generally available.

---

## Problem determination, customization, and performance

### Problem determination

Determining the source of an error involves the use of debugging tools, trace, dump routines, and messages. These topics are described in “Chapter 10. Problem determination” on page 125.

### Customization

Two CICS global user exits are available. They are described in “Global user exits” on page 79.

Data that flows to and from CICS FEPI applications can be journaled for audit trails. For details, see “Journaling” on page 83.

### Performance

You can use CICS monitoring and statistics data to help you tune FEPI applications, and to control the resources that they use. For details, see “Using CICS monitoring and statistics” on page 50.



---

## Part 2. Installation and administration

This part of the book is intended for system programmers and administrators responsible for installing and configuring FEPI. It contains the following topics:

- “Chapter 3. Planning for FEPI” on page 19 lists the things you need to consider when organizing your FEPI nodes, pools, and property sets.
- “Chapter 4. Getting started” on page 27 describes how to install FEPI.
- “Chapter 5. Configuring FEPI” on page 29 describes the tasks required to implement your planned FEPI system.
- “Chapter 6. FEPI operation” on page 47 describes how FEPI operates.
- “Chapter 7. Operator control” on page 59 describes the CICS-supplied transactions and VTAM commands that operators can use to control FEPI resources.
- “Chapter 8. Customizing FEPI” on page 79 describes how to use the FEPI global user exits and journaling function.
- “Chapter 9. System programming reference” on page 87 describes the FEPI system programming commands that are used to control FEPI resources.
- “Chapter 10. Problem determination” on page 125 describes how to identify the source of errors that affect your FEPI applications.





---

## Chapter 3. Planning for FEPI

This chapter is about planning your system and FEPI configuration. To understand it, you need to be familiar with the basic FEPI concepts and terminology described in “Part 1. Concepts and facilities” on page 1. You must also be familiar with all aspects of CICS administration and operations; if you plan to use IMS, you also need to be familiar with IMS administration and operations.

The chapter contains the following topics:

- “Analysis and planning”
- “Organizing your pools and property sets” on page 21
- “Workload balancing in a sysplex” on page 23
- “Planning FEPI storage” on page 24.

---

### Analysis and planning

First, you need to consider the following:

- Details of the back-end applications and systems
- Names of nodes and targets
- Operator control requirements
- Journaling requirements
- Signon and signoff procedures
- Special event handling
- Pools required for control reasons
- Pools required for functional reasons
- Number of nodes
- Setup program organization.

Then you can decide how to organize your pools, their properties, and the connections.

These are now discussed in turn.

### Back-end applications and systems

You need to know whether the back-end systems are CICS or IMS, the terminal types they use, and the timing and volume of transactions expected. Also, are there any restrictions on the use of the terminals? For example:

- Is a specific terminal required, or can any terminal be used?
- Is a specific LU or terminal type defined in the target application—for example, a 3278 model 3?

### Names of nodes and targets

#### Nodes

Decide which VTAM node names are available for use by FEPI as simulated terminals. (Remember that FEPI nodes are VTAM APPL definitions, not logical units (LUs).) Do not use names starting with “DFH”.

#### Targets

The back-end system already has defined VTAM primary PLU names (applids) which you must use. However, you can define your own local target names to associate with these applids. This means that FEPI applications are not affected if an applid is changed; you simply associate the local name with the new back-end target name. Do not use names starting with “DFH”.

## Planning

### Operator control requirements

The CEMT INQUIRE and SET master terminal transactions can be used to view and amend the state of FEPI resources. CEMT DISCARD can be used to remove resources from FEPI. This is described in “Chapter 7. Operator control” on page 59. If you decide you need extra functions for operators, you will need to write appropriate programs.

### Journaling requirements

Journaling is available if you need it. Among the reasons for using FEPI journaling are:

- To create audit trails
- To monitor performance
- To control message security.

For further information, see “Journaling” on page 83.

### Signon and signoff procedures

You need to know if there are any specific requirements for signon and signoff to back-end systems. Central control may be required, or applications may perform signon and signoff individually.

### Special event handling

In addition to signon and signoff, you need to consider what should be done in the following circumstances, and whether they are to be handled by central functions or by applications individually:

- The receipt of unsolicited data
- Unexpected events
- Beginning a session
- Ending a conversation or session
- Shutdown of the front-end CICS system.

If some sort of enforcement is required, or you want central provision for convenience, commonality, or the upholding of conventions and standards, you must supply a set of standard handlers. Otherwise, the application programs must handle each event. If you need special back-end processing when CICS shuts down, you need an end-session handler.

Unexpected events (including errors in setup) are reported to a transient data (TD) queue, so that a monitoring transaction can be triggered to handle them; they also send a message to the FEPI message log CSZL. You must decide how to handle these events, and which queues to use.

For more detailed information about the design and structure of applications, including information about using the various event handlers, see “Chapter 14. Application design” on page 153.

If you want central control over the range of FEPI commands that applications are permitted to issue, you can use the XSZBRQ global user exit, which is described in “Global user exits” on page 79.

### Using pools for control reasons

You can use pools for a number of control purposes. For example, you could define them so as to:

- Restrict users and applications to particular targets or nodes, or restrict access to some targets to particular times of day.
- Force specific begin-session and end-session effects.
- Split resources among different types of back-end requests, according to (for example) priority, or to the department issuing the request. By doing this, you can ensure that there is always a set of connections to a target for time-sensitive requests, while other connections handle long-running requests that are not time-sensitive.
- Ration the use of connections, especially for long-running requests, so that each set of users has access to only a limited number of connections.
- Ease signon considerations.

### Using pools for functional reasons

Pools determine the data format and special event handlers used by your FEPI applications. These attributes may be specified by the application programmer, or they may be imposed by the system programmer for central control, especially of signon and signoff.

If you need several types of special event handling, you might need to define your own pool-specific transient data queues, as well as the default queues.

### Number of nodes

The number of nodes required depends on:

- How the pools are structured
- How much storage is available
- How many concurrent sessions are required to a particular target.

The number of concurrent sessions to a particular target may depend on the volumes of data to be transmitted and the speed of the network.

Although a node can have only one session with a particular target at a time, it can communicate with several different targets concurrently, and several nodes can communicate with the same target concurrently.

### Setup program organization

You must decide:

- How many programs you need—for example, should your setup program consist of a single module, or a set of related modules?
- Whether your programs should take replaceable parameters, or fixed values. (You might use mainly fixed programs, with a flexible program for one-off changes.)
- When programs are to be run—started from a second-phase PLTPI program, under operator control, or at set times of the day.
- Where the definitions required by the setup program are to be obtained—from panel entry, from a file, or by other means.

---

### Organizing your pools and property sets

When you have done the analysis work described in the previous section, you can decide how to organize your pools, their properties, and the connections between nodes and targets.

## Planning

### Organizing pools

There are several ways of organizing your pools:

- If possible, restrict each pool to a single target, but specify as many nodes as you believe you need to satisfy *concurrent* access to the target. The reasons for taking this approach are:
  - It avoids the need for the front-end application to specify a target.
  - It makes it easier to avoid duplicate connection definitions.
  - Because a connection is created for every node-target combination within a pool, having large numbers of both nodes and targets within the same pool may generate more resources than are actually required.
  - The overhead associated with a pool is very small. Therefore there is no reason not to define many pools.
  - The expected concurrent usage of each target may be different. If you have more than one target in the pool, it becomes difficult to estimate the number of nodes required.
- You can define a pool containing only one node and one target. This lets a FEPI application allocate a specific session, which is necessary if the target system associates any special qualities with a particular terminal ID. You can use the XSZBRQ global user exit to control access to the pool.
- You can define pools that use different nodes to reference the same target. By making each pool available to a different group of users, you can eliminate competition for resources. Alternatively, you could use each pool to support a different set of properties, according to application requirements.
- If you plan to use the VTAM CLSDST(PASS) command, other considerations might apply. See “Handling CLSDST(PASS)” on page 43.

Do not use names starting with “DFH” for pools.

### Organizing property sets

Property sets allow you to define the properties of pools (such as the data format and special functions they use) separately from the definition of the pool itself. You can use a single property set to define any number of pools. You must define as many property sets as you need to satisfy every unique pool requirement. Because the overhead associated with a property set is very small, there is no reason why you should not define a large number of them.

The properties are:

#### Device attributes

This specifies which family the simulated terminal belongs to, SLU2 or SLU P. For SLU2, it also determines the presentation size of the display (24 x 80, 32 x 80, and so on), and whether it supports extended attributes such as color.

Many back-end applications can be run with any terminal type, so you can use the default device type (SLU2, 3278 model 2). But if you have applications that demand particular terminal types, you need to define pools with the appropriate device types.

#### Data handling

This specifies which command level to use (high-level with formatted data, or data stream), how much data can be handled, and how contention is to be handled.

High-level is simpler to use and suits many front-end applications; applications that require sophisticated functions or use SLU P, and those performing a simple pass-through, need the more complex data-stream-level. In most cases the default data size of 4096 is adequate; increase it only if you know there are large amounts of data to send and receive in a single command. Set contention handling so that the front end wins—as for a real terminal—unless you have some particular reason for not doing so.

### Session management

This specifies whether begin-session and end-session are to be handled by special transactions, and whether initial inbound data is expected. For SLU P, it also includes whether message resynchronization (“set and test sequence number” (STSN)) is to be handled.

The use of event handlers was introduced on page 20; it is generally preferable to use specially written transactions for session management, rather than to leave it to be handled individually by applications.

If a back-end system sends initial data (a “good morning” message) you must specify this as a property of the pool, so that FEPI waits for the data to arrive and ensures that the front-end application receives it; otherwise the results will be unpredictable. For SLU2, IMS always sends initial data; CICS might or might not do so, depending on your system definition.

FEPI does all the necessary STSN handling automatically, but you can specify a transaction to handle it yourself.

### Unexpected events

This specifies how unsolicited data and other unexpected events (including setup errors) are to be handled.

General considerations of the need for transactions and queues have been discussed earlier in this chapter. If you choose not to handle unsolicited data in your own transaction, you can tell FEPI how to handle it for you—positively or negatively; if the back-end system is IMS, you must specify that FEPI should respond positively. All unexpected events are logged in the FEPI message log (CSZL), even if you specify no unexpected event queue.

### Journaling

This specifies what sort of data journaling is required, and which journal to use.

Do not use names starting with “DFH” for property sets.

---

## Workload balancing in a sysplex

In an MVS/ESA™ sysplex, you can create a CICSplex consisting of sets of functionally-equivalent CICS terminal-owning regions (TORs) and application-owning regions (AORs). If the FEPI back-end system is a TOR in such a CICSplex, you can use the VTAM generic resource function to perform workload balancing across the available TORs.

A VTAM application program such as CICS can be known to VTAM by a generic resource name, as well as by the specific network name defined on its VTAM APPL definition statement. A number of CICS regions can use the same generic resource name.

## Planning

A FEPI application, wishing to start a session with a CICSplex that has several terminal-owning regions, names a target that you have defined as the generic resource name of the TORs. Using the generic resource name, VTAM is able to select one of the CICS TORs to be the target for that session. For this mechanism to operate, the TORs must all register to VTAM under the same generic resource name. VTAM is able to perform dynamic workload balancing of the terminal sessions across the available terminal-owning regions.

For information about defining FEPI targets as VTAM generic resource names, see the APPLIST option of the FEPI INSTALL TARGETLIST system programming command. For further information about VTAM generic resources, see the *CICS Intercommunication Guide* and the *VTAM Version 4 Release 2 Release Guide*.

---

## Planning FEPI storage

FEPI does not require any additional MVS storage beyond that recommended for basic CICS. As for dynamic storage, the storage used by FEPI is allocated exclusively from CDSA and ECDSA; CDSA usage is only that required to support VTAM processing. The following information allows you to estimate the storage requirements of a particular FEPI configuration.

*Table 1. Dynamic storage requirements (in bytes)*

Item	ECDSA	CDSA
Basic	80K	
For each node	288	180
For each node that is currently available for communication	192	
For each target	236	
For each pool	272 + 64 x (number of nodes in pool) + 64 x (number of targets in pool)	
For each property set	176	
For each connection (note 1)	432 if using data stream data 688 if using formatted data	
For each connection that is currently available for communication	384 + additional value from Table 2 if using formatted data	
For each current conversation	128	
For each command in progress	2.5K + size of user data (Note 2)	
<b>Notes:</b>		
1. The number of connections is (number of nodes in pool) x (number of targets in pool) for each pool.		
2. This is the data that is to be sent and received, or used for defining resources. If global user exits are used, twice the data size is needed; similarly if journaling is used.		

For each connection that is currently available for communication and that uses formatted data, additional ECDSA storage is required; the amount depends on the device type and capabilities defined, as shown in Table 2.

*Table 2. Connection storage requirements (in bytes) by device type and function*

Device type	Basic	Additional for color support	Additional for extended data stream support	Maximum
327x model 2	3840	1920	5760	11520

*Table 2. Connection storage requirements (in bytes) by device type and function (continued)*

<b>Device type</b>	<b>Basic</b>	<b>Additional for color support</b>	<b>Additional for extended data stream support</b>	<b>Maximum</b>
327x model 3	5120	2560	7680	15360
327x model 4	6880	3440	10320	20640
327x model 5	7128	3564	10692	21384

You should add some contingency (say 10%) to your final estimate.





---

## Chapter 4. Getting started

FEPI is installed automatically when you install CICS. However, to make it operative you need to install some additional resources.

---

### The installation process

The process comprises the following tasks:

- Updating CICS resource definitions
- Installing FEPI resource definitions
- Starting CICS.

### A note about loading FEPI modules into the LPA

Any of the FEPI modules can be loaded in the MVS Link Pack Area (LPA). However, as with CICS modules in general, it is not recommended that you do so. (For information about installing modules in the LPA, see the *CICS Transaction Server for OS/390 Installation Guide*.)

### Updating CICS definitions

The RDO group DFHFEPI, which is on the product tape, contains definitions of the following resources:

- The FEPI programs (identified by the prefix DFHSZ)
- The FEPI transaction CSZI.

DFHFEPI is included in the default startup group list, DFHLIST.

You must use the CEDA transaction:

- To define your FEPI application programs
- If you have installed FEPI modules in the LPA, to modify the definitions of the modules in the CICS system definition file (the CSD), so that they specify USELPACOPY(YES).

#### Transient data queues

Sample definitions for the transient data (TD) queues required by FEPI are supplied in group DFHDCTG. You can use the sample definitions, or create your own, together with any extra queues that you need. The required queues are:

**CSZL** The FEPI message log. You can define CSZL as an intrapartition, extrapartition, or indirect queue. Note that CSZL must be defined as non-recoverable.

It is recommended that you define CSZL as an indirect queue, pointing to CSSL.

**CSZX** The queue for information about unexpected events (including setup errors) that do not relate to specific pools. You can define CSZX as an intrapartition, extrapartition, or indirect queue. Note, however, that it must be defined as non-recoverable.

It is recommended that you define CSZX as an intrapartition queue, with a trigger level of 1, so that each event is processed immediately it is reported. (You must also, of course, write and install the event-handling transaction that is to be triggered.)

#### Any pool-specific TD queues that you require

Such queues receive information about events that affect specific pools.

## Getting started

They can be defined as intrapartition, extrapartition, or indirect queues. Note, however, that they must be defined as non-recoverable.

It is recommended that you define pool-specific queues as intrapartition queues with trigger levels of 1, so that each event is processed immediately it is reported.

For information about defining transient data queues, see the *CICS Resource Definition Guide*.

### **System initialization parameter, FEPI=YES|NO**

Code FEPI=YES, to specify that FEPI is available. (The default is FEPI=NO.) For information about setting system initialization parameters, see the *CICS System Definition Guide*.

### **Command-level security**

If your installation uses CICS command-level security, you can restrict access to the EXEC CICS FEPI system programming commands (and to the equivalent commands that you can issue with the CEMT master terminal transaction) by defining access authorizations to your external security manager (ESM). The commands you can protect in this way are those listed in “Chapter 9. System programming reference” on page 87 and in the CEMT section of “Chapter 7. Operator control” on page 59. You cannot restrict access to the FEPI application programming commands (as listed in “Chapter 16. Application programming reference” on page 169).

To protect the FEPI system programming commands, use the resource identifier ‘FEPIRESOURCE’ when defining resource profiles to the ESM. Note that, if you use command security, you must ensure that authorized users of CEMT are also authorized to use the FEPI commands.

For RACF<sup>®</sup> users, details of how to define resource profiles to the ESM are in the *OS/390 Security Server (RACF) Security Administrator's Guide*. For information about using RACF with CICS, see the *CICS RACF Security Guide*. Users of other security managers must refer to the documentation for their own product.

## Installing FEPI resource definitions

Ensure that the RDO group DFHFEPI is in your startup group list. (DFHFEPI is in the DFHLIST startup group list, so this should have been done automatically when you installed CICS.)

## Starting CICS

Start your CICS region. This is described in the *CICS System Definition Guide*.

---

## Chapter 5. Configuring FEPI

Having done the planning work described in “Chapter 3. Planning for FEPI” on page 19, you can now carry out the configuration tasks. These are:

- Defining your FEPI applications to CICS
- Defining nodes to VTAM
- Defining simulated terminals to back-end systems
- Writing the following for FEPI itself:
  - A setup program, to install your FEPI resources
  - A monitoring program, to handle unexpected events
  - If required:
    - Global user exit programs
    - Common functions
    - Transactions for operator control and administration.

To configure FEPI, you need to be familiar with all aspects of CICS administration (such as system definition, customization, resource definition, and operations) and the programming interface to CICS. Programming information is in the *CICS Application Programming Reference* and the *CICS System Programming Reference*. You should also be familiar with VTAM and, if you are accessing IMS back-end systems, with IMS administration.

The chapter contains the following topics:

- “CICS configuration”
- “VTAM configuration” on page 30
- “Back-end system configuration” on page 32
- “FEPI configuration” on page 33.

---

### CICS configuration

“Chapter 4. Getting started” on page 27 covers everything that FEPI itself requires: the RDO group DFHFEP1 in the startup group list; definitions of the transient data queues CSZL and CSZX; and any required security access controls.

Now you have to define your FEPI applications to CICS in the usual way. This includes the setup programs, any common functions, and any additional transient data queues that you need for handling pool-specific events.

Define transactions that are to be started by FEPI (the event handlers and pseudoconversational access programs) as CICS started tasks, with SPURGE=NO and TPURGE=NO to prevent them from being accidentally canceled by CICS. See page 27 for details about the queues. Before starting, you should ensure that your CICS system has enough storage available to support your FEPI configuration: for details see “Planning FEPI storage” on page 24.

Note that, in an intercommunication environment, FEPI itself must be run in the application-owning region (AOR) and all transactions that FEPI may start must run locally. This is because FEPI commands cannot be function shipped.

### Setup-initialization program in PLT

The setup transaction that installs your FEPI nodes, targets, and pools is typically started by a program list table (PLT) program. This process is described in “Running setup programs” on page 35. If you use this method, you need to include your PLT program in the second part of the program list table post initialization (PLTPI) list.

## Configuration

For information about coding entries in the PLTPI list, see the *CICS Resource Definition Guide*.

---

## VTAM configuration

For FEPI to communicate with the network, some information must be defined to VTAM. This is described here. For information about configuring VTAM, see the *VTAM Network Implementation Guide* and the *VTAM Resource Definition Reference*.

### Defining FEPI nodes to VTAM

Each FEPI node (simulated secondary LU terminal) must have a VTAM application minor node definition. The name of this minor node must be the same as the node name specified on the FEPI INSTALL NODELIST command.

For example, the FEPI node called 'FEPI0001' would require the following application minor node definition in VTAM:

```
DG4FEPI1  APPL ACBNAME=FEPI0001
```

The important points to note are:

- If your network uses a naming convention to manage network resources, you can allow a network-independent name to be used by specifying it on the ACBNAME keyword of the VTAM APPL statement. If this is not the case, you can simplify the definition of the VTAM application minor node by omitting the ACBNAME keyword (which means that the margin-name—DG4FEPI1 in the example—must be the same as the FEPI node name).
- FEPI does not impose any additional restrictions on the naming of nodes, other than that the names should not begin with "DFH"; apart from this, any values acceptable to VTAM are acceptable to FEPI.

If you require password protection of the minor nodes, you can use the PRTCT keyword of the VTAM APPL statement to specify a password of 1–8 characters. The password must then be specified on the corresponding FEPI INSTALL NODELIST command.

VTAM application minor node definition statements are stored collectively as one or more members of an MVS partitioned data set (usually SYS1.VTAMLST), accessed by VTAM via the VTAMLST data-definition statement in the VTAM startup JCL. If you are defining multiple FEPI nodes, you may choose to place them all in a single member (also known as a VTAM application major node) or in several members. They may also be added to an existing VTAM application major node. How you choose to organize the VTAM definitions may depend on how your installation manages its network resources, or how you plan to manage the FEPI configuration.

### Availability of network resources

For FEPI to communicate with the network using a node, both the application minor node and the defining major node must be active, and the minor node must be in a connectable condition.

If FEPI is initialized before VTAM, and is instructed to acquire this node, it retries the VTAM OPEN request several times. Similarly, if a target application is unavailable, FEPI makes another attempt at session initiation. After this, the operator will need to intervene to establish connectivity.

## Selection of FEPI session parameters

When FEPI establishes a session with a back-end system, it searches the VTAM LOGON mode (logmode) table for an entry that corresponds to the simulated device type specified on the FEPI INSTALL PROPERTYSET command used to define the pool to which the node-target connection belongs. If it finds such an entry, it uses it to set the parameters for the session. Suitable mode table entries for FEPI are in the LOGON mode table ISTINCLM. Table 3 shows how entries in ISTINCLM correspond to FEPI device types.

Table 3. Relation of FEPI device-types to ISTINCLM mode table entries

DEVICE CVDA on FEPI INSTALL PROPERTYSET	Mode table entry in ISTINCLM	Session parameters
T3278M2	D4A32782	LU2 3278 model 2
T3278M3	D4A32783	LU2 3278 model 3
T3278M4	D4A32784	LU2 3278 model 4
T3278M5	D4A32785	LU2 3278 model 5
T3279M2	SNX32702	LU2 3279 model 2
T3279M3	SNX32703	LU2 3279 model 3
T3279M4	SNX32704	LU2 3279 model 4
T3279M5	SNX32705	LU2 3279 model 5
TPS55M2	SNX32702	LU2 PS/55, 24 lines
TPS55M3	SNX32703	LU2 PS/55, 32 lines
TPS55M4	SNX32703	LU2 PS/55, 43 lines
LUP	IBM3600	Secondary LU P (IMS protocol LU 0)
<b>Note:</b> The mode entries are fixed by FEPI; you cannot use any other entries.		

If *ISTINCLM* is defined as your default LOGON mode table, no additional definitions are required, and FEPI sessions use the characteristics that these entries specify. If you have defined a different default table, which does not contain the supplied entries, or if you want to associate a different set of characteristics with the names listed above (for example, class-of-service or pacing specifications), then you must provide the required entries in a customized mode table. This must be associated with the node via the *MODETAB* keyword of the VTAM APPL statement used to define the node to VTAM. For example:

```
DG4FEPI1 APPL ACBNAME=FEPI0001,MODETAB=mode-table-name
```

### Notes:

1. If you choose to define your own mode table, it needs to contain only those entries that differ from the set supplied in the default mode table (for example, *ISTINCLM*). If VTAM cannot find a given entry in the node-specific mode table, it automatically searches the system default table for an entry of the same name.
2. FEPI establishes the presentation space size of a terminal, based on the session parameters received in response to the session request, *not* on any fixed dimension implied by the device type specified for the pool (although the device type does establish a default value when a default *BIND* is received).
3. An externally initiated session (one started by the primary LU or by the operator through the *VARY LOGON* command) can specify any entry name in the mode table. If you expect to make use of external session initiation, it is advisable to

## VTAM configuration

specify the DLOGMOD keyword on the APPL statement used to define the node in question. This keyword identifies the mode table entry to be used in those cases where the session initiation request did not specify session parameters. It can be specified regardless of whether the MODETAB keyword is used. For example:

```
DG4FEPI1 APPL ACBNAME=FEPI0001,  
        MODETAB=mode-table-name,DLOGMOD=mode-table-entry-name
```

4. If you define your own mode entries, ensure that all the parameters in an entry are appropriate. These logmode entries should be explicitly named in the APPL statements as described in note 3 on page 31.

## Pacing of FEPI sessions

The pacing values used for FEPI sessions should be consistent with whatever installation standards are in effect for other LU2 and SLU P sessions in the network.

---

## Back-end system configuration

No special configuration is needed for back-end systems, except that you must provide and manage LUs (simulated terminals) for FEPI use. These terminals are defined to the back-end CICS or IMS system just like real terminals. They can be explicitly defined or autoinstalled as required. They do not need to be defined to VTAM in the back-end system, to which they appear as real terminals on that system. VTAM uses the various network definitions to determine how and where to route data; it can be routed locally, cross-domain, or cross-network. The LU name corresponds to the front-end node name. (Similarly, the VTAM applid of the back-end system corresponds to the applid in the FEPI target definition.) The diagram of the sample configuration in Figure 2 on page 38 illustrates these relationships.

If your back-end systems use the extended recovery facility (XRF), you must use their *generic* applids, rather than specific ones, in your FEPI target definitions. See “Using FEPI with XRF” on page 52.

## CICS

For CICS back-end systems, acceptable terminal definitions (TYPETERMs) are:

- DFHLU2E2
- DFHLU2E3
- DFHLU2E4
- DFHLU2E5
- DFHLU2M2
- DFHLU2M3
- DFHLU2M4
- DFHLU2M5

These definitions match the VTAM mode table entries shown in Table 3 on page 31. You must create your own TYPETERMs for 3279 model 5 and PS/55 devices, if required, because no such definitions are supplied by CICS. If the back-end system is using CICS/MVS® Version 2, you must create all your own TYPETERMs or copy them from the front-end system. For information about defining terminals to CICS, see the *CICS Resource Definition Guide*.

## IMS

For terminals to be used by FEPI, the following settings are **required** on the TYPE or TERMINAL system definition macros:

- NAME must match the NODE name specified to and used by FEPI.
- MODETBL must specify the correct LOGMODE.

The following non-default settings are **recommended**. (FEPI will support the default settings as well.)

- Specify OPTIONS=OPTACK for more efficient communication.
- Specify OPTIONS=FORCRESP so transactions are run in response mode. (If you let this default, you might get non-response mode regardless of how the transactions are defined.)
- Specify OPTIONS=NORELRQ to make IMS ignore external requests for the node.
- Specify OPTIONS=BID to indicate that the VTAM BID command should always precede output messages that occur while between brackets.
- Specify OUTBUF=*nnn* to set a bigger output buffer than the default of 256 bytes.

The following example defines some IMS terminals for use by FEPI. You may need to customize it for use in your own IMS environment.

```

                TYPE UNITYPE=SLUTYPEP,MODETBL=IBM3600,                x
        OPTIONS=(OPTACK,FORCRESP,NORELRQ,BID),OUTBUF=512                TERMINAL
NAME=IMSLUP01                NAME IMSLUP01                TERMINAL NAME=IMSLUP02
                NAME IMSLUP02                TERMINAL NAME=IMSLUP03
        NAME IMSLUP03                TERMINAL NAME=IMSLUP04
        NAME IMSLUP04

```

For further information, see “IMS considerations” on page 163.

---

## FEPI configuration

You **must** write:

- A setup program to define your FEPI nodes, targets, property sets, and pools.

You **may** also need to write:

- A monitoring program to handle unexpected events (including setup errors)
- Any common functions not provided by individual FEPI applications
- One or more global user exit programs
- Some specialized operator transactions, to simplify the control of FEPI resources.

See “Appendix A. Sample programs” on page 219 for details of the samples that are provided.

## Writing configuration programs

FEPI programs are CICS applications, and so all aspects of CICS programming apply. For guidance about writing CICS application programs, see the *CICS Application Programming Guide*. For programming information, (including command formats, argument values, details on the translation of programs, and language considerations), see the *CICS Application Programming Reference*. Particularly relevant are the chapters in the *CICS Application Programming Guide* about designing efficient applications and dealing with exception conditions.

## FEPI configuration

The FEPI system programming commands are an extension of the EXEC CICS commands. They have similar names and similar functions. The FEPI commands also have similar keywords, but they are distinguished by having “FEPI” as a prefix. For system programming, the commands are:

Definition:

**EXEC CICS FEPI INSTALL**

Define communication resources

**EXEC CICS FEPI ADD**

Add resources to a pool

**EXEC CICS FEPI DELETE**

Remove targets or nodes from a pool

**EXEC CICS FEPI DISCARD**

Remove communication resources completely from FEPI.

Operations:

**EXEC CICS FEPI INQUIRE**

Query FEPI status and resources

**EXEC CICS FEPI SET**

Control FEPI resources.

Note that, when translating your programs, you must specify the FEPI option, which instructs the translator to process FEPI commands, but you do not need the SP option.

Your FEPI configuration programs can be AMODE(24) or AMODE(31)—that is, they can issue FEPI commands in either 24- or 31-bit addressing mode, and reside above or below the 16MB line.

### Exception conditions

As with all CICS commands, FEPI commands may produce exception conditions that you can check using the RESP option, or capture using HANDLE CONDITION. Most FEPI command errors return INVREQ. The particular error in each case is uniquely identified by the RESP2 value. All the FEPI exception conditions and RESP2 values are listed in “Chapter 9. System programming reference” on page 87. There are copy books that contain declarations for the RESP2 values:

- DFHSZAPA for Assembler language
- DFHSZAPO for COBOL
- DFHSZAPP for PL/I
- DFHSZAPC for C/370.

For the system programming commands, errors are reported as unexpected events to the CSZX or other transient data queue, and to the FEPI message log CSZL, as well as by exception conditions on the command.

If there is an error, the command does nothing, and output values are not changed. Some commands operate on a list of resources; an error in one resource does not prevent the command from operating on the other resources in the list.

You can use EDF and CECI to debug FEPI programs. Because FEPI commands can be quite long, you will probably find the NAME field of CECI useful.

All resource names used by FEPI are a fixed length of 8 characters; they must be padded with blanks if necessary. For commands that use lists, make sure that the



list field is a multiple of 8 characters long and that the number option is set correctly; neither the translator nor CECI checks these and unpredictable results could occur if they are wrong.

## Writing setup programs

There are many considerations in designing setup programs, and so there is no single recommended way of writing them. On the distribution tape, there is:

- An Assembler language sample setup program with filename DFH0AZXS
- A COBOL sample setup program with filename DFH0VZXS
- A C/370 sample setup program with filename DFH0CZXS.

These programs install resources to make FEPI function with the other sample programs. They show you one way of writing setup programs. See “Setup” on page 224.

Your setup programs must:

- Install all node names that are available for FEPI.
- Install all targets that FEPI is permitted to access.
- Install properties. See “Organizing property sets” on page 22 for guidance on what choices to make. In defining the properties of connections in pools, the following options must be set:

**Device attributes**

DEVICE

**Data handling**

FORMAT, MAXLENGTH, CONTENTION

**Session management**

BEGINSESSION, ENDSSESSION, INITIALDATA, STSN

**Unexpected events**

EXCEPTIONQ, UNSOLDATA, UNSOLDATAACK

**Journaling**

MSGJRNL, FJOURNALNUM, FJOURNALNAME

- Install pools
- Associate nodes and targets with the pools to define connections.

Note that, by default, FEPI resources are available for use as soon as they are installed or associated with a pool. For control, performance, or other reasons, you might want to override this; if so, you must provide a further program (or operations procedure) to bring the resources into service when you require them.

Many of the FEPI commands used by your setup program can use lists; using lists helps to improve performance. If some items in a list fail, errors (both programming errors and resource problems) are reported to your monitoring program, *not* to the setup program. If you want to track the errors in the setup program itself, without using the monitoring program, restrict your lists to a single item. Errors are then reported on the command itself.

In addition to a setup program, you may need a corresponding program to deal with deleting and discarding resources.

## Running setup programs

The setup program is typically initiated by a program list table (PLT) program. Using this method, the setup program is run automatically at every CICS startup, including an XRF takeover. Follow this procedure:

1. Write your setup program.

## FEPI configuration

2. Define it to CICS, using RDO, and associate it with a transaction.

**Note:** You can define your setup program statically, or allow it to be installed automatically (autoinstalled) when it is invoked. For details of the CICS autoinstall facility for programs, see the *CICS Resource Definition Guide*.

3. Write a PLT program containing the command

```
EXEC CICS START TRANSID(tranid) INTERVAL(1)
```

where `tranid` is the ID of your setup transaction. (For programming information about writing PLT programs, see the *CICS Customization Guide*.)

4. Define your PLT program to CICS, and include it in the second part of the program list table post initialization (PLTPI) list. (For information about coding entries in the PLTPI list, see the *CICS Resource Definition Guide*.)

There may be a good reason for you to decide not to use the PLT to start the setup transaction. For example, you may want to have several, time-sensitive, setup programs, each having a corresponding discard program. If you decide not to use the PLT, you must arrange to start the setup transactions manually.

You should restrict access to the setup programs, because they are of a sensitive nature.

## Varying the resources installed by the setup program

Unless your setup program contains some conditional logic, you always get the same set of FEPI resources installed. This may be exactly what you require, but if not, here are a few techniques that might prove useful.

### Checking startup type

Your setup program can determine how the CICS system started by issuing an EXEC CICS INQUIRE SYSTEM STARTUP command. It could use this to install different sets of FEPI resources for warm and cold starts.

### Recording the status of resources

If you install all your FEPI resources at CICS startup, and then alter their accessibility, consider writing a non-terminal transaction that runs frequently and uses the FEPI INQUIRE commands to determine the status of each FEPI resource. Write these to a *recoverable* temporary storage file. (You could, for example, use an XSZARQ global user exit program to log changes to FEPI resources.) At restart time, your setup program can read the file to determine the required access settings.

### Using timed actions

You could take advantage of CICS automatic transaction initiation (ATI) at specified times to control FEPI resources. If you want to terminate FEPI access to another system at a specific time each day, schedule a transaction to run at the required time. When this transaction runs it can either make the required FEPI resources unavailable for access, or discard them. Because FEPI resources remain available for use by current tasks in this circumstance, this has no effect on existing FEPI users.

You could use timed initiation in a similar way to make FEPI resources available.

### Using event handlers

Another way of controlling FEPI resources is to use the begin-session and end-session event handlers. (See “Other functions” on page 45.)

## FEPI configuration

These handlers are invoked when a conversation starts and ends. Although they are primarily designed to handle signon and signoff to the back-end systems, you can take advantage of the fact that all FEPI functions are available to them. So you can use them to control access to back-end systems by either installing or discarding FEPI resources.

For example, suppose you want to ensure that no FEPI application is waiting for a connection to a back-end system. In the handlers, issue FEPI INQUIRE POOL commands, and look at the WAITCONVNUM option, which returns the number of FEPI applications waiting for a connection. If this option exceeds a certain trigger value, issue FEPI commands to increase the number of connections (that is, add nodes, define new pools, and so on).

This technique can be extended to provide tuning of FEPI access to back-end systems.

### Sample FEPI configuration

A sample configuration is given in Table 4 on page 39. Next, the target lists and node lists used in the sample are given. Then there are the definitions used to achieve the sample configuration. Figure 2 on page 38 is a diagrammatic representation of the sample configuration.

# FEPI configuration

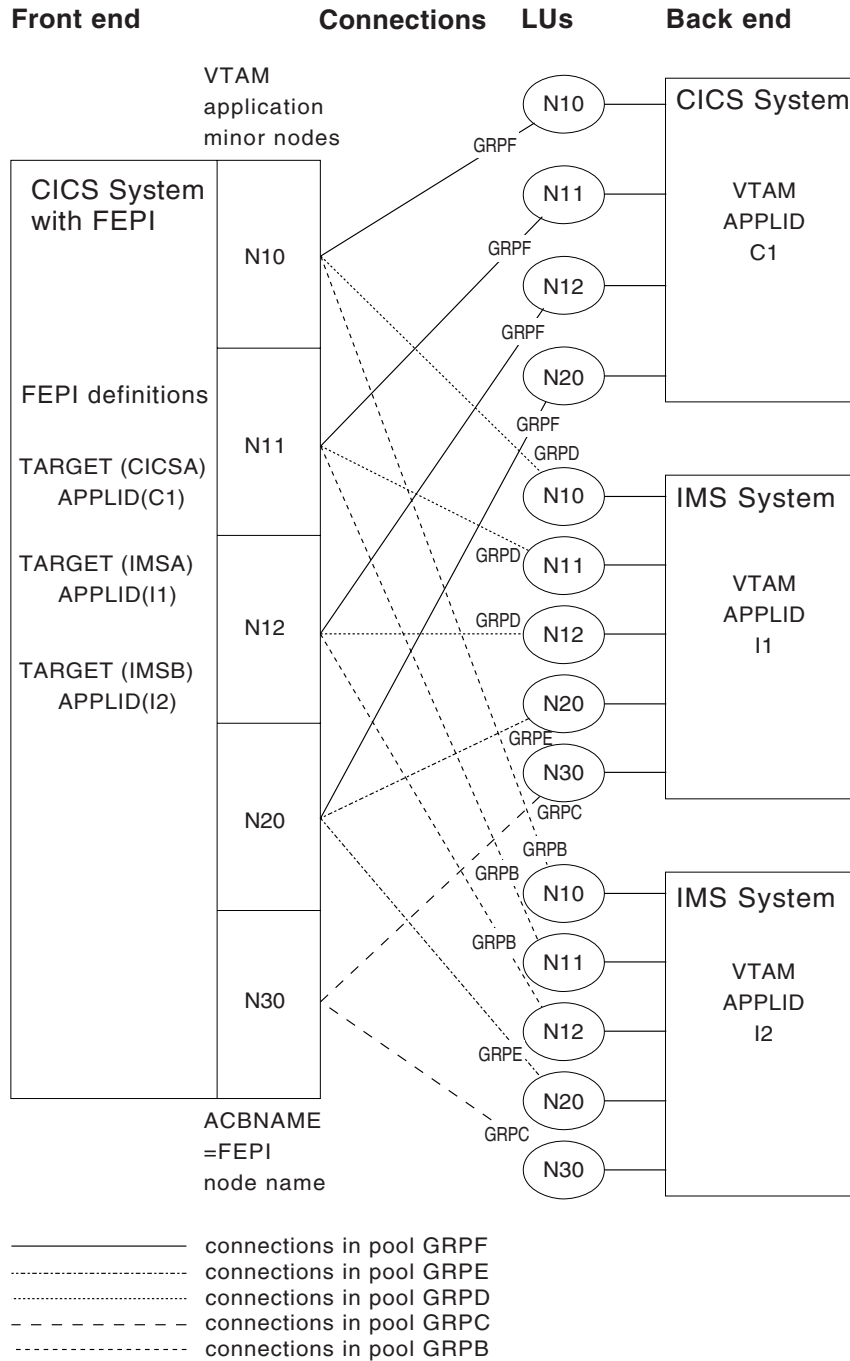

Figure 2. The sample FEPI configuration—a diagrammatic representation

Note that this is not the configuration the sample programs use; it illustrates as many aspects of configuration as possible.

Table 4. A sample FEPI configuration

Pool name	GRPB	GRPC	GRPD	GRPE	GRPF
Property set	SLUP	SLU2M3I	SLU2M3I	SLU2M2I	SLU2M2C
Target names	IMSB	IMSA IMSB	IMSA	IMSA IMSB	CICSA
Node names	N10 N11 N12	N30	N10 N11 N12	N20	N10 N11 N12 N20
Device type	LUP	T3278M3	T3278M3	T3278M2	T3278M2
Logmode name	IBM3600	D4A32783	D4A32783	D4A32782	D4A32782
Exceptional events queue name	IEXEPTP	IEXEPT2	IEXEPT2	IEXEPT2	CEXEPT2
Unsolicited-data transaction name or response	IUP	IU2	IU2	IU2	Negative
Begin-session transaction name	ISIP	ISI2	ISI2	ISI2	CSI2
End-session transaction name	none	IXI2	IXI2	IXI2	CXI2
STSN transaction name	ISTP	n/a	n/a	n/a	n/a
Initial inbound data	No	Yes	Yes	Yes	Yes

**Sample lists**

Here are the target lists and node lists used in the sample configuration, padded to eight bytes per item.

```

TLIST      'CICSA  IMSA  IMSB  '
TLISTA    'IMSA  '
TLISTB    'CICSA  '
TLISTC    'IMSA  IMSB  '
TLISTD    'IMSB  '
NLIST     'N10   N11   N12   N20   N30   '
NLISTA    'N10   N11   N12   '
NLISTB    'N20   '
NLISTC    'N30   '
NLISTD    'N10   N11   N12   N20   '
    
```

The following is the list of VTAM application names of the back-end CICS and IMS systems with which FEPI applications will communicate.

```

PLIST 'C1    I1    I2    '
    
```

**Sample definitions**

The following definitions illustrate the various possibilities when defining FEPI resources.

**Define the back-end subsystems you want FEPI to access:** This defines the logical names (targets) that FEPI uses to refer to back-end systems (in this case CICSA, IMSA, and IMSB as given in TLIST), and relates them to their VTAM names (C1, I1, and I2 as given in PLIST).

## FEPI configuration

```
EXEC CICS FEPI INSTALL TARGETLIST(TLIST) TARGETNUM(3)
      APPLLIST(PLIST)
```

**Define the VTAM minor nodes available to FEPI:** The names are N10, N11, N12, N20, and N30, as given in NLIST.

```
EXEC CICS FEPI INSTALL NODELIST(NLIST) NODENUM(5)
```

**Define properties:** This defines the characteristics of the connections.

*SLU P connections:*

```
EXEC CICS FEPI INSTALL PROPERTYSET(SLUP)
      LUP /* Device type (SLU P) */
      BEGINSSESSION(ISIP) /* Begin session handler */
      STSN(ISTP) /* STSN transaction */
      EXCEPTIONQ(IEXEPT) /* Exception report TD queue */
      UNSOLDATA(IUP) /* Unsolicited-data transaction */
      NOTINBOUND /* No "good morning" message */
```

*SLU2 24 x 80 connections to IMS:*

```
EXEC CICS FEPI INSTALL PROPERTYSET(SLU2M2I)
      T3278M2 /* Device type (3278 model 2, 24 x 80) */
      BEGINSSESSION(ISI2) /* Begin session handler */
      EXCEPTIONQ(IEXEPT2) /* Exception report TD queue */
      UNSOLDATA(IU2) /* Unsolicited-data transaction */
      INBOUND /* Initial data */
      ENDSSESSION(IXI2) /* End session handler */
```

*SLU2 32 x 80 connections to IMS:*

```
EXEC CICS FEPI INSTALL PROPERTYSET(SLU2M3I)
      T3278M3 /* Device type (3278 model 3, 32 x 80) */
      BEGINSSESSION(ISI2) /* Begin session handler */
      EXCEPTIONQ(IEXEPT2) /* Exception report TD queue */
      UNSOLDATA(IU2) /* Unsolicited-data transaction */
      INBOUND /* Initial data */
      ENDSSESSION(IXI2) /* End session handler */
```

*SLU2 24 x 80 connections to CICS:*

```
EXEC CICS FEPI INSTALL PROPERTYSET(SLU2M2C)
      T3278M2 /* Device type (3278 model 2, 24 x 80) */
      BEGINSSESSION(CSI2) /* Begin session handler */
      EXCEPTIONQ(CEXEPT2) /* Exception report TD queue */
      NEGATIVE /* Response to unsolicited data */
      INBOUND /* "Good morning" message */
      ENDSSESSION(CXI2) /* End session handler */
```

**Define the pools of connections:** The pools define connections between targets and nodes; they specify which nodes can be used to access which target, and what properties the connection has.

```
EXEC CICS FEPI INSTALL POOL(GRPB) PROPERTYSET(SLUP)
      TARGETLIST(TLISTD) TARGETNUM(1)
      NODELIST(NLISTA) NODENUM(3)
EXEC CICS FEPI INSTALL POOL(GRPC) PROPERTYSET(SLU2M3I)
      TARGETLIST(TLISTC) TARGETNUM(2)
      NODELIST(NLISTC) NODENUM(1)
EXEC CICS FEPI INSTALL POOL(GRPD) PROPERTYSET(SLU2M3I)
      TARGETLIST(TLISTA) TARGETNUM(1)
      NODELIST(NLISTA) NODENUM(3)
EXEC CICS FEPI INSTALL POOL(GRPE) PROPERTYSET(SLU2M2I)
      TARGETLIST(TLISTC) TARGETNUM(2)
```

```

NODELIST(NLISTB) NODENUM(1)
EXEC CICS FEPI INSTALL POOL(GRPF) PROPERTYSET(SLU2M2C)
      TARGETLIST(TLISTB) TARGETNUM(1)
NODELIST(NLISTD) NODENUM(4)

```

## Writing monitoring programs

You need a monitoring program to handle:

- Unexpected events reported by FEPI
- Errors in FEPI system programming commands.

FEPI reports these events by writing a record to a transient data (TD) queue. You can define pool-specific TD queues for FEPI, where information about events that relate to specific pools is reported. (There is also a common FEPI TD queue, CSZX, where events that do not relate to specific pools are reported.) Note that, if a pool-specific event occurs, and you have not defined a corresponding queue, information about the event is lost. Also, FEPI TD queues must be defined as NONRECOVERABLE; if a queue is 'recoverable', FEPI does not write to it, and discards any information about unexpected events.

Typically, you would arrange for the monitoring program to be triggered whenever an item is placed in a TD queue. (Define the queue with a trigger level of 1.) A single monitoring program can service several queues, by using EXEC CICS ASSIGN QNAME to check which queue triggered it. According to the nature of the event, the monitoring program might simply write a message, log the event, or embark on a full conversation.

For example, using this method, whenever a session is lost, the monitoring program is invoked. The TD queue data provides information about what happened. Your monitoring program can obtain this in the usual way with EXEC CICS READQ TD. The following copy books describe the structure of the data:

- DFHSZAPA for Assembler language
- DFHSZAPO for COBOL
- DFHSZAPP for PL/I
- DFHSZAPC for C/370.

Your program may then choose to reestablish the lost session, to reinitialize, and so on. It may also set indicators for the application programs if contact with a target has been lost altogether.

Monitoring programs are written using the techniques and commands discussed in "Part 3. Application programming" on page 133. See also the overview of the sample monitoring program in "Monitor and unsolicited data-handler" on page 225.

## Handling unexpected events

This section suggests some actions your monitoring program could take after various types of unexpected event. The type of event is indicated by the EVENTTYPE area in the TD queue record. In most cases, the EVENTVALUE area gives specific details of the failure; the values are the same as the RESP2 values listed in "RESP2 values" on page 241.

### Events in CSZX TD queue records

#### INSTALLFAIL

A FEPI resource has failed to be installed. This is probably because you are trying to install a duplicate name. This may indicate either a logic error or a possible security violation.

## FEPI configuration

**Recommended action:** Report possible application logic error, for investigation.

### DISCARDFAIL

A FEPI resource has not been discarded. This is probably because you are trying to discard a nonexistent object. This may indicate a logic error.

**Recommended action:** Report possible application logic error, for investigation.

### SETFAIL

A FEPI resource has rejected a SET request. This is probably because you are trying to manipulate a resource that does not exist. However, there is also the possibility of rejection due to VTAM considerations. So SETFAIL may indicate either a logic error or a network failure.

**Recommended action:** Schedule a transaction to repeat the operation (if not a logic error).

### ACQFAIL

A FEPI resource has failed to be acquired. This is probably because of a network failure, and so FEPI automatically retries the acquire request several times at intervals; the count in EVENTDATA shows whether there will be any more retries. However, there is also the possibility of an error in either the VTAM definition or the back-end system definition of the object.

**Recommended action:** After FEPI stops retrying, suggest investigating the condition of the resource from a VTAM viewpoint. The VTAM sense code describing the problem is in EVENTDATA. See the appropriate VTAM manual for more information. For nodes, this is the *VTAM Programming* manual; for connections, *VTAM Messages and Codes*. Further information is in the *SNA Formats* manual.

### SESSION

An unsolicited bind was received, probably because of a CLSDST(PASS). See "Handling CLSDST(PASS)" on page 43.

## Events in pool-specific TD queue records

### SESSIONLOST

An active connection has failed. This is probably due to the back-end system failing. However, this error is also generated if an operator cancels an active connection.

**Recommended action:** Suggest that the operator:

- Investigate the condition of the connection from a VTAM viewpoint. The VTAM sense code that describes the problem is in EVENTDATA. See the *VTAM Messages and Codes* and *SNA Formats* manuals for more details.
- See whether the back-end system is still running.
- Check that the back-end system has not "closed" the FEPI simulated terminal.

### SESSIONFAIL

A connection has failed to start. This is probably due to a setup inconsistency or to a failure of the back-end system, and so FEPI automatically retries the acquire request several times at intervals; the count in EVENTDATA shows whether there will be any more retries. However, this failure is also generated if an operator has canceled the connection.

**Recommended action:** After FEPI stops retrying, suggest the operator:



- Investigate the condition of the connection from a VTAM viewpoint. The VTAM sense code that describes the problem is in EVENTDATA. See the *VTAM Messages and Codes* and *SNA Formats* manuals for more details.
- See whether the back-end system is still running.
- Check that the back-end system has not “closed” the FEPI simulated terminal.
- Check that the terminal type definition in the back-end matches the FEPI device type.

### ADDFAIL

An attempt to add a target or node to a pool has failed. The probable cause of this error is an attempt to add a resource that is already in the pool. This indicates a possible logic error.

**Recommended action:** Report possible application logic error, for investigation.

### DELETFAIL

An attempt to delete a target or node from a pool has failed. This is probably caused by an attempt to delete a resource that is not in the pool, indicating a possible logic error.

**Recommended action:** Report possible application logic error, for investigation.

## Handling CLSDST(PASS)

A back-end system can end a network session with a VTAM CLSDST(PASS) request. This indicates that the back-end will reestablish a session with the front-end using a different PLU name (a *third-party* PLU). The front-end system detects reestablishment of the session by receiving an unsolicited bind request; so when the back-end system ends a session, it is important for it to indicate that an unsolicited bind is to be expected.

**Note:** To determine whether a lost session was caused by a CLSDST(PASS) request, a FEPI application can issue a FEPI INQUIRE CONNECTION command. If the value of LASTACQCODE is X'32020000', the back-end system issued a CLSDST(PASS) to unbind the session.

The three most likely scenarios are described in the following sections.

### Unsolicited bind not expected

FEPI unconditionally rejects the bind request.

### Third-party PLU name known and unsolicited bind expected

The prospective PLU names must be defined to FEPI as targets. You might need to restrict access to the pools that include these targets to make sure the connection is not already in use when the CLSDST(PASS) takes place. The simplest way to configure this is to define a pool containing the node and all the targets it can be placed in session with. Install all connections except the initial one with an ACQSTATUS of RELEASED so the back-end system can successfully acquire the session. No other special processing is required and no TD queue record is written in this case.

### Third-party PLU name not known and unsolicited bind expected

The necessary resource definitions must be managed dynamically.

## FEPI configuration

**Note:** Managing the resource definitions dynamically (described under “Conversation in progress”) is the only method that allows the conversation to persist across the CLSDST(PASS).

When FEPI receives the unsolicited bind, it writes a record to the CSZX TD queue, with an EVENTTYPE of SESSION, and with the third-party PLU name in the TARGET area. At this point, the bind has not been accepted or rejected. A VTAM display for either the back-end or the front-end system would show the connection to be in a PSESST/B state. You are responsible for managing these TD queue records and making the necessary FEPI configuration updates so that processing can continue. If no action is taken, the session remains in this state until a VTAM VARY NET,TERM command is issued to terminate the session request.

There are two cases, according to whether or not there is a conversation in progress on the connection when the CLSDST(PASS) occurs. (This can be determined from the STATE option of the FEPI INQUIRE CONNECTION command.) In both cases, you need to determine which pool has the connection that the CLSDST(PASS) applies to, because the TD queue record does not report either the pool or the old target name. If the node is used in only one pool, the old target name can be found easily by browsing connections using FEPI INQUIRE CONNECTION; if not, use some other technique, such as the USERDATA option of the FEPI SET commands.

**Conversation in progress:** Nodes for which this kind of processing is required should be defined in pools containing only the node and the initial target, because of the nature of the processing involved.

The monitor program should:

1. Install a new pool with the same properties as the current one.
2. Install a new target whose PLU name is the third-party PLU name given in the TARGET area of the TD queue record.
3. Add the target to the new pool. This should be the only target in that pool.
4. Delete the node identified in the TD queue record from the pool in which it currently exists. If necessary, to ensure continuity, the monitor program can add another node to the pool before deleting the old node.
5. Add the node to the newly created pool. The new connection is now established.

When the session ends, the connection reverts to a RELEASED state. If necessary, use an end-session handler to perform any necessary cleanup, such as reversing the process described above.

The front-end application must also anticipate CLSDST(PASS) processing. See “Lost session” on page 162 for more details.

**Conversation not in progress:** The CLSDST(PASS) occurred as a result of trying to acquire a connection. The monitor program should:

1. Install a new target whose PLU name is the third-party PLU name given in the TARGET area of the TD queue record.
2. Add the target to the pool, specifying a desired connection acquire status of ACQUIRED. The new connection is now established.

If necessary, use an end-session handler to cleanup the dynamically defined targets. These connections always become RELEASED when the session ends and can be left for reuse, if required.

### Writing operator transactions

You might find it useful to write some specialized operator transactions of your own to control FEPI resources. For more information, see “Controlling FEPI resources” on page 47.

### Other functions

The other functions you might need to write for FEPI itself are the begin-session, end-session, and unsolicited-data handlers. These are extensions of the FEPI application programs, and are described in “Part 3. Application programming” on page 133. If you write them as common functions, you need to know what the application programs do. Alternatively, the application programmer may write them.

### Global user exit programs

Two CICS global user exits are provided:

#### **XSZBRQ**

Invoked before a FEPI command is executed

#### **XSZARQ**

Invoked after a FEPI command is executed.

XSZBRQ is passed the parameters input to the command, and can be used to monitor commands, to bypass commands that violate installation conventions, or to change the parameters of a command, subject to the rules applying to global user exits. XSZARQ is passed the parameters output from the command.

For details of the FEPI global user exits, see “Global user exits” on page 79. For programming information about writing and using global user exit programs, see the *CICS Customization Guide*.



---

## Chapter 6. FEPI operation

This chapter describes how FEPI operates. It includes information on controlling FEPI resources, performance, and shutdown. It also describes using FEPI with XRF and VTAM persistent sessions.

The chapter contains the following topics:

- “Controlling FEPI resources”
- “Performance” on page 49
- “Shutdown” on page 51
- “Using FEPI with XRF” on page 52
- “Using FEPI with VTAM persistent sessions” on page 55.

---

### Controlling FEPI resources

The FEPI INQUIRE and SET functions can be carried out by a program, or by using the master terminal transaction, CEMT. You may find it useful to write some specialized operator transactions of your own.

The FEPI INQUIRE command (and its CEMT equivalent) tells you what resources are defined and their statuses. The only thing you cannot do directly is determine which nodes and targets are in a particular pool. Do this using CEMT to inquire about the connections in a particular pool:

```
CEMT I FECONNECTION POOL(poolname)
```

To do this from an application program, browse all connections and select those in the pool you want.

Here are the resource statuses of most interest:

### SERVSTATUS

SERVSTATUS is used with connections, nodes, pools, and targets. It specifies the service status of the resource—that is, whether it can be used for a conversation. The service status can be set to `INSERVICE` to allow usage, or to `OUTSERVICE` to stop usage for any *new* conversation. Note that setting `OUTSERVICE` does not end any existing conversations that are using the resource; the status is `GOINGOUT` until the existing conversations end.

### ACQSTATUS

ACQSTATUS is used with connections and nodes. It specifies the “acquire status” of the resource. For a connection, this means whether it should have a session established (bound) or ended (unbound). For a node, it means whether the VTAM ACB for the node should be opened or closed. The acquire status can be set to `ACQUIRED` (a status of `ACQUIRING` indicates that the acquisition has not yet been completed), or to `RELEASED`.

Setting `RELEASED` does not end any existing conversations that are using the resource; the acquire status is `RELEASING` until the existing conversations end. However, for connections, a conversation that is unowned and in a “pending” state (see “STATE” on page 49) is ended immediately if the acquire state is set to `RELEASED`; this means that connections being used by a failed application can be recovered.

## Controlling FEPI

ACQUIRING and RELEASING are shown as BEING ACQUIRED and BEING RELEASED by CEMT.

Network and other problems can cause connections to become stuck in a RELEASING or ACQUIRING state, in which case the operator might need to intervene using VTAM operator commands.

If a FEPI connection remains in a RELEASING state for longer than expected, try the following:

1. Note the node and target associated with the connection; use CEMT INQUIRE FETARGET to find the VTAM application name that the target represents.

2. Issue the VTAM command

```
D NET,E,ID=nodename
```

to find out the state of network session associated with the connection.

3. Note the session status. See the *VTAM Programming* manual for an explanation of the status. If no session exists and a subsequent INQUIRE of the connection status using CEMT shows the state still as BEING RELEASED, there has been a system failure; you should collect diagnostic information.

4. If the session is in 'session takedown processing', you can use the VTAM command

```
D NET,SESSION
```

to find out what signals are needed to complete processing.

5. If you can resolve the problem using commands on the back-end system, attempt to do so.

6. If there is no other way to resolve the session status, you can use the VTAM command

```
V NET,TERM
```

to end the network procedure in progress. FEPI will then be able to complete processing.

It is not so easy to find out when an ACQUIRING state has persisted for too long. However, if you cannot determine why the session has not been established, follow the procedure described above. If no session is active for the connection, FEPI is currently waiting for the retry interval to expire. The system log should contain VTAM messages explaining why the session cannot be established. The LACQCODE option of CEMT INQUIRE FECONNECTION gives the reason code VTAM provided for the last session failure.

Also be sure to check that the node on which the connection depends is properly acquired; if not, resolve whatever problem is indicated by the LACQCODE option for the node.

Note that, under normal circumstances, after a FEPI FREE RELEASE command has been issued the session does not remain in RELEASED state, because FEPI automatically tries to reacquire the session. However, if a FEPI SET CONNECTION ACQSTATUS(RELEASED) command is issued before the FREE RELEASE, the session remains in RELEASED state.

## LASTACQCODE

The INQUIRE CONNECTION or INQUIRE NODE commands can use the option LASTACQCODE (LACQCODE in CEMT), which returns the result of the last acquire request. This is the sense code from the last VTAM operation, where zero indicates success. For a full explanation of VTAM sense codes, see the appropriate VTAM manual: for nodes, this is *VTAM Programming*; for connections, *VTAM Messages and Codes*. Further information is in the *SNA Formats* manual.

## INSTLSTATUS

INSTLSTATUS is used with connections, nodes, pools, and targets. It specifies whether the resource is installed, or is in the process of being discarded, waiting for the conversations that are using it to end.

## WAITCONVNUM

WAITCONVNUM shows how many conversations are currently waiting to start using a connection or pool. If WAITCONVNUM is nonzero for significant periods of time, it might mean that you need to allocate extra resources to meet the demand. Or it might mean that applications are holding on to resources for too long.

## STATE

STATE is used with connections. It shows the state of the conversation that is using a connection. See page 63 for the values that STATE can have.

If any of the “pending” states (PENDSTSN, PENDBEGIN, PENDDATA, PENDSTART, PENDFREE, PENDRELEASE, PENDUNSOL, or PENDPASS) is shown, it indicates that the conversation is unowned, pending the event or task shown. If a “pending” state persists, it is likely that the application has failed in some way; you should consider resetting the connection by issuing a FEPI SET CONNECTION RELEASED command.

---

## Performance

You cannot tune FEPI itself—it is already optimized for speed of response. However, you can influence the performance of FEPI application programs.

FEPI runs under a separate CICS task control block (TCB) and CICS permits only *one* application program to issue a FEPI command at a time. This is a major influence on FEPI performance. Although many application programs can have FEPI commands being processed at any time, only one application can *issue* a FEPI command.

In a lightly loaded system, this means that CICS does not run FEPI until a command is issued. Thus, performance is impacted by the overhead of starting up the TCB so that the FEPI command can be processed. In a heavily loaded system, this overhead is not present, because the TCB is already active processing earlier FEPI commands. This is in contrast to a traditional CICS system, where a lightly loaded system may perform better than a heavily loaded one.

FEPI tries to minimize this overhead by issuing timer requests that ensure that the TCB is not inactive for more than one second.

There are three main principles that should be used in FEPI applications to provide the best performance:

## Performance

1. Each FEPI command generates a CICS WAIT even if no network transmission is involved, and so the number of commands issued should be minimized.
2. Data transmission should be kept to a minimum.
3. Session disconnection should be avoided.

Techniques to use in application programs in support of these principles are given in “Performance” on page 166.

As to FEPI system programming, command usage can be reduced by using lists of resources on a command where possible. However, when a command using a list results in a VTAM operation, you could:

- “Flood” VTAM by requesting too many operations at once
- “Flood” the back-end system with requests for session initiation
- “Flood” the front-end system with started begin- or end-session transactions.

So you must carefully evaluate the benefits of using lists.

## Using CICS monitoring and statistics

CICS monitoring and statistics data can help with performance tuning and resource planning for applications that use FEPI.

### Monitoring data

By default, CICS performance class monitoring records include the following data about the user task:

- The number and type of requests made to FEPI
- The time spent waiting for requests to FEPI to complete
- The number of requests to FEPI that are timed out.

For detailed information about the FEPI-related fields in performance class monitoring records, see the *CICS Performance Guide*. For information about using the DFHMCT TYPE=RECORD macro to control which FEPI fields are monitored, see the *CICS Resource Definition Guide*.

### Statistics data

The standard CICS statistics reports contain data about usage of:

- FEPI pools
- FEPI connections
- FEPI targets.

To obtain the current statistics for a FEPI pool, connection, or target, a utility program can issue an EXEC CICS COLLECT STATISTICS command. For example, the command EXEC CICS COLLECT STATISTICS SET(pointer) POOL(GRPD) returns the current statistics for the 'GRPD' pool. To map the returned statistics, your utility program should include the appropriate CICS-supplied copybook:

#### **DFHA22DS**

FEPI pool statistics

#### **DFHA23DS**

FEPI connection statistics

#### **DFHA24DS**

FEPI target statistics.

The copybooks are supplied in COBOL, PL/I, and assembler language.

To cause all FEPI statistics to be written immediately to the SMF statistics data set, you can use either the EXEC CICS or the CEMT version of the PERFORM STATISTICS RECORD FEPI command.



For details of the CEMT COLLECT STATISTICS and PERFORM STATISTICS RECORD commands, see the *CICS Supplied Transactions*; for programming information about the equivalent EXEC CICS commands, see the *CICS System Programming Reference*.

To format and print FEPI-related statistics in the DFHSTATS data set, you can use the CICS-supplied utility program, DFHSTUP. To print only the FEPI statistics, specify the command parameter SELECT TYPE=FEPI. For information about how to use the DFHSTUP program, see the *CICS Operations and Utilities Guide*. For detailed information about fields in the FEPI statistics records, see the *CICS Performance Guide*.

---

## Shutdown

FEPI shutdown is triggered as part of CICS shutdown—you cannot shut down FEPI alone. There are three forms of shutdown:

- Normal
- Immediate
- Forced.

### Normal shutdown

A normal shutdown of CICS causes FEPI to shut down normally—active transactions are allowed to terminate. When all active conversations have ended, and all FEPI resources have been discarded, FEPI shuts down. While FEPI is shutting down, no *new* conversations can be started, but existing owned conversations continue. However, these cannot use the FEPI START or FEPI FREE PASS commands. Existing unowned conversations are ended immediately. Any FEPI transactions that you want to be able to start during CICS shutdown must be defined in the transaction list table (XLT).

If an end-session handler is invoked at the end of conversations, it is told that the session is to be ended because of CICS shutdown. The handler can choose to perform additional back-end operations that might be needed because of the shutdown. If you require this function, make sure the end-session handler transaction is defined in the transaction list table (XLT), and that it does not adversely affect the performance of CICS shutdown. (For details of how to define entries in the XLT, see the *CICS Resource Definition Guide*.)

CICS normal shutdown waits until FEPI shutdown has completed before continuing processing. So if you know when CICS shutdown is to occur, you should initiate FEPI DISCARD operations before starting CICS termination. Removing FEPI resources as they become inactive allows existing FEPI conversations to continue, but prevents new ones from starting. You could achieve the same effect by setting the status of FEPI resources to OUTSERVICE,RELEASED.

If shutdown is not proceeding, then before you force it to continue, consider carefully whether the problem is due to:

- A back-end system taking a long time to respond. In this case, do not attempt to speed things up—you may generate integrity errors in the back-end system.
- A FEPI failure. In this case, issue the following commands, pausing after each step to see whether CICS is still waiting:
  1. CEMT DISCARD FExxxx(\*), to remove all FEPI resources
  2. CEMT SET FECONNECTION(\*) OUTSERVICE RELEASED, to end any waiting conversations

## Shutdown

3. CEMT SET TASK(nnn) FORCE, to end any running FEPI transactions
4. Attempt to issue VTAM VARY NET,INACT,FORCE commands from the system console to terminate connections.

If CICS shutdown still does not proceed, you cannot perform a warm shutdown. Try issuing a CEMT P SHUT IMMEDIATE command. If this fails, you must cancel CICS.

## Immediate shutdown

An immediate shutdown of CICS immediately terminates FEPI. There is nothing you can do to influence this process.

## Forced shutdown

A forced shutdown of CICS immediately terminates FEPI. There is nothing you can do to influence this process.

---

## Using FEPI with XRF

This section discusses FEPI in a CICS extended recovery facility (XRF) environment. To understand it, you need to have read the *CICS/ESA 3.3 XRF Guide*, and to be familiar with CICS XRF VTAM USERVAR processing—the *VTAM Programming* manual contains relevant material.

The effect of an XRF takeover of a CICS back-end system with which FEPI is in communication is described. Although IMS XRF processing is not discussed here, the same considerations apply.

## XRF and VTAM

FEPI uses VTAM secondary LU support for communication and the simulated terminals defined to the back-end CICS system behave in a different way to real devices.

In an XRF environment, the simulated terminals in the back-end system cannot behave as VTAM class 1 terminals because there is no 3745/3725/3720 controller acting as the boundary network node (BNN). They behave like VTAM class 2 terminals, which is the default setting for CICS and IMS terminal definitions. Consequently, simulated terminals do not support VTAM XRF, and CICS XRF facilities are provided by tracking mechanisms that are explained in the *CICS/ESA 3.3 XRF Guide*.

When a FEPI connection is acquired, the back-end CICS generates a TCTTE (if one is not present already) using autoinstall. At this point, in a CICS XRF environment, the active CICS informs the alternate that a terminal has been defined. If the active is then taken over, the alternate knows which terminals are defined, and can take actions to recover the links.

As part of takeover processing, a VTAM BIND is issued to reestablish the session with each simulated terminal. However, FEPI also has detected that the connection has ended, and attempts to contact the (new active) back-end system by issuing a similar bind. This results in a **bind race**. The outcome of this bind race depends on the circumstances of the exchange. However, the bind issued by the new active CICS will probably be rejected, and the FEPI bind accepted. This results in DFHZCxxxx messages being produced during the takeover (see “Connections with a conversation—with data flow” on page 55). If FEPI reestablishes the connection, these messages can be ignored. You can remove these bind races by defining the

back-end CICS terminal so it behaves as a VTAM class 3 terminal (no XRF support). To define the simulated terminals as class 3, specify RECOVOPTION=NONE in CICS, or BACKUP=NO in IMS.

## FEPI resource definition and XRF

In an XRF environment, the applid specified on the FEPI INSTALL TARGETLIST command must be the *generic* applid of the back-end system. Specifying either the primary or secondary applid of the target results in processing errors. If you use the generic applid, FEPI is able to cater for the back-end system undergoing an XRF takeover.

However, you can define a pool that contains the specific applids of both the active and alternate systems. In this case, the alternate targets cannot be contacted until an XRF takeover has been performed. Similarly, the active targets cannot be contacted after takeover. If you define pools in this way (perhaps to provide backup support without XRF), you should manage the ACQUIRED-RELEASED status yourself, to minimize FEPI retry processing.

## XRF takeover of front-end system

This section describes what happens when the CICS system running FEPI undergoes an XRF takeover.

### Effect on back-end transactions

Each back-end transaction is abended, due to the loss of the simulated terminal—which is usually the principal facility for the task. Consequently, the ATNI (or equivalent) abend processing is unable to send the usual message indicating a transaction abend to the principal facility.

Transactions that attempt to handle terminal control errors should already be written to cope with this circumstance, and you should not need to alter them.

### Effect on back-end terminals

FEPI is acting as the “terminal”, so an XRF takeover of the FEPI system results in the loss of the “terminal” in the back-end system. CICS takes the usual actions for the loss of a (real) terminal. There are three cases to consider:

**“Terminals” without a conversation:** If you are using autoinstall, the TCTTEs representing these “terminals” are deleted after a delay; if the delay is long enough, the alternate front-end CICS may reestablish the sessions before the TCTTEs are deleted.

**“Terminals” with a conversation—no data flow:** If you are using autoinstall, the TCTTEs representing these “terminals” are deleted after a delay; if the delay is long enough, the alternate front-end CICS may reestablish the sessions before the TCTTEs are deleted.

**“Terminals” with a conversation—with data flow:** These “terminals” are usually running a transaction when the “terminal” is lost. This results in the transaction being abended with the normal CICS abend code for a terminal failure (usually ‘ATNI’). The abend is usually accompanied by a DFHZCxxxx message indicating that the “terminal” has suffered an unrecoverable failure.

You may have to modify your node error program to prevent retry loops, but normally the default action (not to retry) is taken. When node error processing ends, if autoinstall is used, the “terminal” is deleted.

## Using FEPI with XRF

### Effect on the alternate FEPI CICS system

The alternate FEPI CICS takes over operation of the failed CICS in the normal fashion. However, FEPI resources are not recovered automatically after an XRF takeover.

FEPI restarts at a late stage of takeover, after all RDO resources have been reinstalled. Nevertheless, when the second phase of the PLTPI list is entered, FEPI is ready to receive commands. Therefore, if you follow the recommendation to start your FEPI setup transaction from a PLTPI program, FEPI resources are reinstalled as part of the takeover. If you do *not* run your setup transaction in this way, then after a takeover you must arrange for it to be run manually, so that your FEPI resources are reinstalled.

However you handle resource definition in an XRF-environment, you must be prepared to cope with the possibility that FEPI resources have been manipulated in the failed CICS, so that the environment after takeover is not the same as that immediately before takeover. For example, resources may have been installed or deleted, or SERVSTATUS or ACQSTATUS values altered, after your setup transaction was run in the failed CICS.

## XRF takeover of back-end system

This section describes what happens when the CICS back-end system with which FEPI is communicating undergoes an XRF takeover.

### Effect on FEPI application programs

FEPI application programs are unable to distinguish between a loss of session due to an XRF takeover of the back-end system, and one due to a FEPI failure. In both cases, a typical RESP2 value of '215' ('Session lost') is returned on the next FEPI command issued after the takeover has started. Alternatively, the application may get an indication of a state error, meaning that the command cannot be issued because the connection is not active. The application should *immediately* issue a FEPI FREE command to free the conversation.

If an end-session handler is active, it gets invoked, even though the conversation has ended.

If the application program believes that the back-end is undergoing an XRF takeover, it should reissue a FEPI ALLOCATE command for the back-end. When the takeover is complete, and FEPI has reestablished contact, the FEPI ALLOCATE completes successfully (together with any specified begin-session processing). If the TIMEOUT option is used, consider its setting in relation to how long you expect the alternate back-end system to take to complete takeover.

It is the responsibility of the application program to perform any processing in the new active back-end system necessitated by the XRF takeover.

### Effect on FEPI connections

In general, FEPI successfully copes with the XRF takeover of a back-end system with which it is communicating. However, when the new active back-end system attempts to establish its terminal sessions, communication with FEPI may result in some strange terminal control messages. You should ignore these until FEPI has had time to contact the back-end system.

While FEPI is attempting to reestablish contact with the back-end system:

- Connections are in ACQUIRING state, with a last acquire code of (probably) X'320C0000'.

- Message DFHSZ4155I may be produced, with reason codes (typically X'320C0000' or X'81062900') showing that FEPI is attempting to reestablish contact with the back-end system.

There are three cases to consider:

**Connections without a conversation:** These connections reestablish contact with the new active back-end when the back-end's ACB is opened.

**Connections with a conversation—no data flow:** These connections reestablish contact with the new active back-end when the back-end's ACB is opened. You may get some messages in the back-end system indicating that the TCTTE was deleted and reinstalled.

**Connections with a conversation—with data flow:** These connections generate errors in the back-end system when it attempts to reestablish contact with the "terminal". You may see messages DFHZC3492E, DFHZC2411E, DFHZC3422E, DFHZC3437I, or DFHZC3462I being generated—all of which say that the standby back-end could not reestablish contact with the "terminal". However, as long as the conversation that was running on the connection has been freed, FEPI subsequently reestablishes contact and reinstalls the "terminal".

---

## Using FEPI with VTAM persistent sessions

When creating FEPI applications, you need to be aware of the possible effects of the use of VTAM persistent sessions in the front- or back-end systems. For information about support for VTAM persistent session in CICS Transaction Server for OS/390 Release 3, see the *CICS Recovery and Restart Guide*.

### Restart of front-end system using persistent sessions

Using persistent sessions in the front-end does not give FEPI any additional recoverability benefits. FEPI is always cold started; thus, to FEPI, the effect of restarting a front-end system for which persistent sessions support is enabled is indistinguishable from a cold start of CICS.

### Restart of back-end system using persistent sessions

In the back-end system, there are terminal definitions that are used when the FEPI simulated terminals establish sessions with the target. These definitions may be hard-coded, or may be autoinstall model definitions. If the terminal definitions have been set up to use persistent session support, and the back-end system is restarted within the persistent session delay interval, the terminal sessions are recovered.

#### Effect on FEPI application programs

It is likely that FEPI application programmers have little say in the way that persistent session support is used in the back-end system. They therefore need to be aware of the different ways in which terminal sessions can be recovered, so that their applications cater for all possibilities. If the back-end (target) is a CICS Transaction Server for OS/390 Release 3 system, the way in which a session is recovered depends on the setting of the RECOVOPTION and RECOVNOTIFY options of the TYPETERM definition.

#### RECOVOPTION(SYSDEFAULT)

On restart within the persistent session delay interval, CICS selects the optimum procedure to recover a session.

## Using FEPI with XRF

For LU2, if the session is busy and CICS is in send mode, CICS sends an end bracket. If the session is busy and CICS is not in send mode, CICS sends an SNA CLEAR request to reset the conversation state.

If a FEPI conversation is in progress when the target system terminates, your application could see one of the following:

- A timeout on a RECEIVE, CONVERSE, or START command, while it waits for the target to restart.  
Deal with this in the normal way for a timeout.
- A FEPI RECEIVE or CONVERSE command completes as a result of the end bracket sent by CICS. The RU on this data flow may be empty or may contain a user-defined message, depending on the value of the RECOVNOTIFY option.  
Your application may need to perform some backout processing.
- An INVREQ response with a RESP2 value of 230 on a FEPI SEND, RECEIVE, CONVERSE, ISSUE, or START command, indicating that an SNA CLEAR was received.  
Your application may need to perform some backout processing.

You must also consider the value specified for RECOVNOTIFY:

### **RECOVNOTIFY(MESSAGE)**

A message (defined in the BMS maps DFHXRC3 and DFHXRC4) is sent to the "terminal". Your FEPI application must contain logic to deal with this data flow.

If there is no active conversation at the time of restart, the flow is received as unsolicited data at the FEPI front-end.

### **RECOVNOTIFY(TRANSACTION)**

A transaction is initiated in the target. The default is the Good Morning transaction. Your application must contain logic to deal with this data flow.

If there is no active conversation at the time of restart, the flow is received as unsolicited data at the FEPI front-end.

### **RECOVNOTIFY(NONE)**

The "terminal" is not notified that a restart has occurred. Your application need take no special action.

### **RECOVOPTION(CLEARCONV)**

On restart within the persistent session delay interval, CICS sends an SNA CLEAR request to reset the conversation states. The CLEAR is sent only if the session was busy at the time of system restart. If a FEPI conversation is in progress when the target system terminates, your application could see one of the following:

- A timeout on a RECEIVE, CONVERSE, or START command, while it waits for the target to restart.  
Deal with this in the normal way for a timeout.
- An INVREQ response with a RESP2 value of 230 on a FEPI SEND, RECEIVE, CONVERSE, ISSUE, or START command, indicating that an SNA CLEAR was received.  
Your application may need to perform some backout processing.

You must also consider the value specified for RECOVNOTIFY. The possible values are as described above, for RECOVOPTION(SYSDEFAULT).

### **RECOVOPTION(RELEASESESS)**

On restart within the persistent session delay interval, CICS sends an UNBIND request to release an active session. The request is sent only if the session was busy at the time of system restart.

If a FEPI conversation is in progress when the target system terminates, your application could see one of the following:

- A timeout on a RECEIVE, CONVERSE, or START command, while it waits for the target CICS to restart.

Deal with this in the normal way for a timeout.

- An INVREQ response with a RESP2 value of 215 on any FEPI command, indicating a 'session lost' condition.

Deal with this in the normal way for a session loss.

### **RECOVOPTION(UNCONDREL)**

On restart within the persistent session delay interval, CICS sends an UNBIND request to release an active session. The request is sent whether or not the session was busy at the time of system restart.

If a FEPI conversation is in progress when the target system terminates, your application could see either of the symptoms described for RECOVOPTION(RELEASESESS).

### **RECOVOPTION(NONE)**

Even if the system is restarted within the persistent session delay interval, the session is not recovered—it has no persistent session support.

Deal with this in the normal way for a session loss.

## Using FEPI with XRF



---

## Chapter 7. Operator control

Two CICS-supplied transactions, CEMT and CETR, provide operator control of FEPI: you can use the CEMT INQUIRE, SET, and DISCARD commands to control FEPI resources such as nodes, targets, and pools; and the CETR transaction to control FEPI trace. You can also use VTAM commands to manage communication with target systems.

FEPI application programs, and the CICS resources they use, are controlled just like other CICS applications and resources.

The chapter contains the following topics:

- “CEMT—master terminal transaction”
- “CETR—trace control transaction” on page 77
- “VTAM commands” on page 77.

---

### CEMT—master terminal transaction

The CEMT transaction has a range of commands that support FEPI. These commands, which are described below, work exactly like the CEMT commands described in the *CICS Supplied Transactions* manual—for example, in supporting resource selection by families (AB\*, for example), lists (AB,CD,EF, for example), and by subdefining groups. Note that 4-character option names are used in the display.

See “Controlling FEPI resources” on page 47 for more information.

## CEMT DISCARD

---

## CEMT DISCARD

### Function

DISCARD removes targets, nodes, pools, or property sets completely from FEPI.

### Syntax

Press the Clear key to clear the screen. Type CEMT DISCARD (the minimum abbreviation is CEMT DISC), followed by any one of:

FENODE(*nodename*)  
FEPOOL(*poolname*)  
FEPROPSET(*propsetname*)  
FETARGET(*targetname*).

For example, `cemt disc fen(feptide1)` removes the node *feptide1* from FEPI.

Typing ? at the beginning of either the first or second line gives a syntax prompt.

### CEMT DISCARD

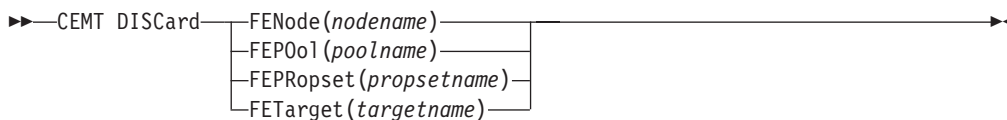

### Options

#### **FENode(*nodename*)**

The name of the FEPI node to be discarded.

#### **FEPOol(*poolname*)**

The name of the FEPI pool to be discarded.

#### **FEPRopset(*propsetname*)**

The name of the FEPI property set to be discarded.

#### **FETarget(*targetname*)**

The name of the FEPI target to be discarded.

## CEMT INQUIRE FECONNECTION

### Function

Display information about FEPI connections.

### Description

INQUIRE FECONNECTION displays information about the state of FEPI connections. A connection is identified by specifying the target and node. The results are given in order of target within the node. Family selection can be used for TARGET and NODE, but list selection cannot be used.

### Input

Press the Clear key to clear the screen. There are two ways of commencing this transaction:

- Type CEMT INQUIRE FECONNECTION (the minimum abbreviation is CEMT I FEC). You get a display that lists the current status.
- Type CEMT INQUIRE FECONNECTION (CEMT I FEC) followed by as many of the other attributes as are necessary to limit the range of information that you require. For example, if you enter `cemt i fec p(pool15) acq`, the resulting display will show you the details of all FEPI connections in *pool15* on which sessions are bound.

You can tab to the highlighted fields and overwrite them with new values.

#### CEMT INQUIRE FECONNECTION

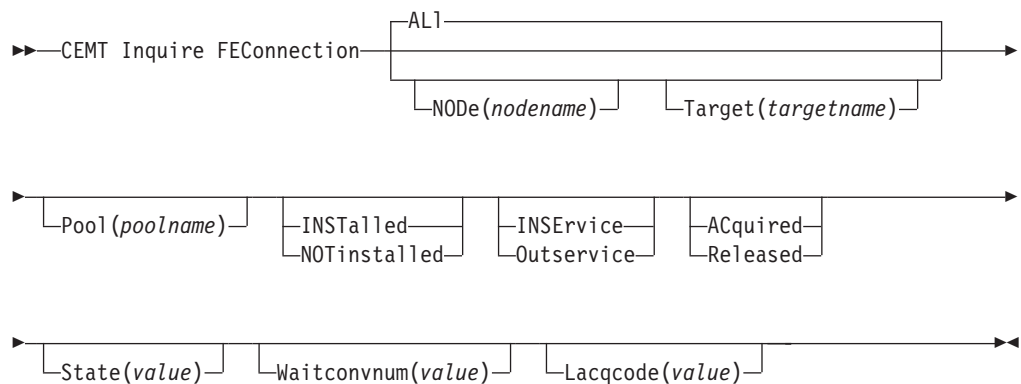

#### ALI

is the default. Information about all connections is given, unless you specify a selection.

#### NODE(nodename)

is the 8-character name of a node. Information is restricted to connections of which this node forms part.

#### Target(targetname)

is the 8-character name of a target. Information is restricted to connections of which this target forms part.

## CEMT INQUIRE FECONNECTION

### Sample screen

```
CEMT IN FEC
STATUS: RESULTS - OVERTYPE TO MODIFY
Node(NODE1 ) Targ(TARGETA ) Pool(POOL5 ) Inst Inse Rele
Stat(NOCONV ) Wait(00000) Lacq(X'08570002')
Node(NODE1 ) Targ(TARGETB ) Pool(POOL5 ) Inst Inse Rele
Stat(NOCONV ) Wait(00000) Lacq(X'08570002')
Node(NODE1 ) Targ(TARGET3 ) Pool(POOL3 ) Inst Inse Rele
Stat(NOCONV ) Wait(00000) Lacq(X'08570002')
```

Figure 3. CEMT INQUIRE FECONNECTION screen

### Displayed fields

#### **Node(value)**

displays the 8-character name of a node identifying a connection.

#### **Target(value)**

displays the 8-character name of a target identifying a connection.

#### **Pool(poolname)**

displays the 8-character name of a pool of connections.

#### **Installed|Notinstalled**

displays a value identifying the install state of the connection. The values are:

##### **Installed**

The connection is in a pool that has been defined by INSTALL and is available for use.

##### **Notinstalled**

The connection is in a pool, or involves a node or target that is being discarded, but is still in use.

#### **Inservice|Outservice**

displays a value identifying the service state of the connection. The values are:

##### **Inservice**

The connection is in service and can be used in a conversation. If OUTSERVICE state has been requested but has not yet completed, a 'GOING OUT' message is shown.

##### **Outservice**

The connection is out of service and cannot be used for any conversation.

#### **Acquired|Released**

displays a value identifying whether a session on the connection is bound. The values are:

##### **Acquired**

A session is bound on the connection. If RELEASED state has been requested but has not yet completed, a 'BEING RELEASED' message is shown. If this persists, you might need to use VTAM commands to recover the connection.

##### **Released**

Sessions involving the connection have been unbound. If ACQUIRED state has been requested but has not yet completed, a 'BEING

## CEMT INQUIRE FECONNECTION

ACQUIRED' message is shown. If this persists, you might need to use VTAM commands to recover the connection.

### **State(value)**

displays a 12-character value identifying the state of the conversation using the connection. The values are:

#### **APPLICATION**

A normal application task owns the conversation

#### **BEGINSESSION**

A begin-session handling task owns the conversation

**FREE** An end-session handling task owns the conversation, following a FEPI FREE command

#### **NOCONV**

No conversation is active on the connection

#### **PENDBEGIN**

A begin-session handling task has been scheduled

#### **PENDDATA**

FEPI is waiting for inbound data, following a FEPI START command

#### **PENDFREE**

An end-session handling task has been scheduled, following a FEPI FREE command

#### **PENDPASS**

The conversation is unowned, following a FEPI FREE PASS command

#### **PENDRELEASE**

An end-session handling task has been scheduled, following an unbind request

#### **PENDSTART**

Inbound data having arrived, a task specified by FEPI START has been scheduled

#### **PENDSTSN**

An STSN-handling task has been scheduled

#### **PENDUNSOL**

An unsolicited-data handling task has been scheduled

#### **RELEASE**

An end-session handling task owns the conversation, following an unbind request

**STSN** An STSN-handling task owns the conversation

#### **UNSOLDATA**

An unsolicited-data handling task owns the conversation.

The "pending" states indicate the conversation is unowned, pending the event or task indicated. If a "pending" state persists, it is likely that the application has failed in some way; you should consider resetting the connection by issuing a CEMT SET FECONNECTION RELEASED command.

### **Waitconvnum(value)**

displays a value identifying the number of conversations that are waiting to start using a connection. (If a conversation could use any one of several connections, it is counted as waiting on each one.)

## CEMT INQUIRE FECONNECTION

### **Lacqcode(value)**

displays a hexadecimal value indicating the result of the last acquire request for the node; that is, the sense code from the last VTAM REQSESS, a zero indicating success. For information about VTAM sense codes, see either the *VTAM Messages and Codes* or the *SNA Formats* manual.

# CEMT INQUIRE FENODE

## Function

Display information about a FEPI node.

## Input

Press the Clear key to clear the screen. There are two ways of commencing this transaction:

- Type CEMT INQUIRE FENODE (the minimum abbreviation is CEMT I FEN). You get a display that lists the current status.
- Type CEMT INQUIRE FENODE (CEMT I FEN) followed by as many of the other attributes as are necessary to limit the range of information that you require. For example, if you enter `cemt i fen inst`, the resulting display will show you the details of all FEPI nodes that have been installed and are ready for use.

You can tab to the highlighted fields and overwrite them with new values.

### CEMT INQUIRE FENODE

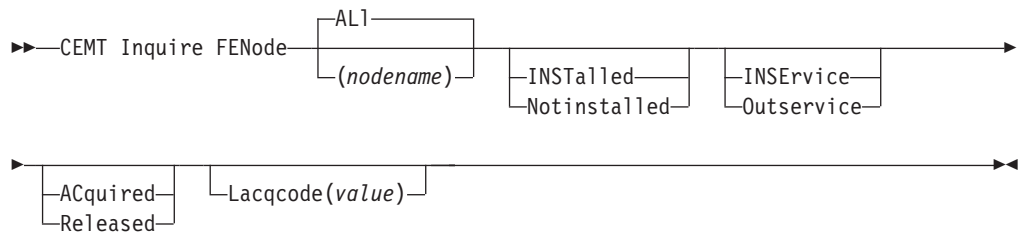

### ALI

is the default. Information about all nodes is given, unless you specify a node.

### nodename

is the 8-character name of the node to be queried.

## Sample screen

```

CEMT IN FEN
STATUS: RESULTS - OVERTYPE TO MODIFY
Feno(NODE1 ) Inst Inse Acqu Lacq(X'00000000')
Feno(NODE2 ) Inst Inse Acqu Lacq(X'00000000')
Feno(NODE3 ) Inst Inse Acqu Lacq(X'00000000')
Feno(NODE4 ) Inst Inse Acqu Lacq(X'00000000')
    
```

Figure 4. CEMT INQUIRE FENODE screen

## Displayed fields

### Feno

indicates that this panel relates to an FENODE inquiry.

## CEMT INQUIRE FENODE

### **(value)**

displays the 8-character name of a node.

### **Installed|Notinstalled**

displays a value identifying the install state of the node. The values are:

#### **Installed**

The node has been defined by INSTALL and is available for use.

#### **Notinstalled**

The node is being discarded, but is still in use.

### **Inservice|Outservice**

displays a value identifying the service state of the node. The values are:

#### **Inservice**

The node is in service and can be used in a conversation. If OUTSERVICE state has been requested but has not yet completed, a 'GOING OUT' message is shown.

#### **Outservice**

The node is out of service and cannot be used for any conversation.

### **Acquired|Released**

displays a value identifying whether the state of the VTAM ACB for the node. The values are:

#### **Acquired**

The VTAM ACB for the node is open and the VTAM 'set logon start' command has completed. If RELEASED state has been requested but has not yet completed, a 'BEING RELEASED' message is shown. If this persists, you might need to use VTAM commands to recover the node.

#### **Released**

The VTAM ACB is closed. If ACQUIRED state has been requested but has not yet completed, a 'BEING ACQUIRED' message is shown. If this persists, you might need to use VTAM commands to recover the node.

### **Lacqcode(value)**

displays a hexadecimal value indicating the result of the last acquire request for the node; that is, the sense code from the last VTAM OPEN ACB, a zero indicating success. For information about VTAM sense codes, see either the *VTAM Messages and Codes* or the *SNA Formats* manual.



## CEMT INQUIRE FEPOOL

### Function

Display information about the state of FEPI pools of connections.

### Input

Press the Clear key to clear the screen. There are two ways of commencing this transaction:

- Type CEMT INQUIRE FEPOOL (the minimum abbreviation is CEMT I FEPO). You get a display that lists the current status.
- Type CEMT INQUIRE FEPOOL (CEMT I FEPO) followed by as many of the other attributes as are necessary to limit the range of information that you require. For example, if you enter `cemt i fepo inse`, the resulting display will show you the details of all FEPI pools that are in service and can be used by conversations.

You can tab to the highlighted 'service state' field and overwrite it with a new value.

#### CEMT Inquire FEPOol

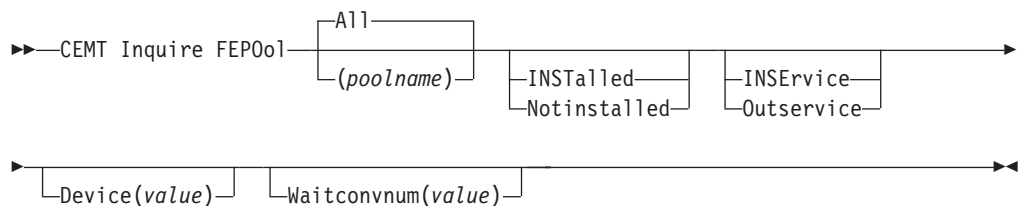

#### All

is the default. Information about all pools is given, unless you specify a pool to be queried.

#### poolname

specifies the name of a pool of connections.

### Sample screen

```
CEMT IN FEPO
STATUS: RESULTS - OVERTYPE TO MODIFY
Fepo(P00L3 ) Inst Inse Devi(T3278M4 ) Wait(00000)
Fepo(P00L5 ) Inst Inse Devi(T3278M2 ) Wait(00000)
```

Figure 5. CEMT INQUIRE FEPOOL screen

### Displayed fields

#### Fepo

indicates that this panel relates to an FEPOOL inquiry.

## CEMT INQUIRE FEPOOL

### **(value)**

displays the 8-character name of a pool of connections.

### **Installed|Notinstalled**

displays a value identifying the install state of the pool. The values are:

#### **Installed**

The pool has been defined by INSTALL and is available for use.

#### **Notinstalled**

The pool is being discarded, but is still in use.

### **Inservice|Outservice**

displays a value identifying the service state of the pool. The values are:

#### **Inservice**

The pool is in service and can be used in a conversation. If OUTSERVICE state has been requested but has not yet completed, a 'GOING OUT' message is shown.

#### **Outservice**

The pool is out of service and cannot be used for any conversation.

### **Device(value)**

displays a value identifying the mode of conversation and the type of device. The values are:

<b>T3278M2</b>	SLU2 mode, 3278 Model 2
<b>T3278M3</b>	SLU2 mode, 3278 Model 3
<b>T3278M4</b>	SLU2 mode, 3278 Model 4
<b>T3278M5</b>	SLU2 mode, 3278 Model 5
<b>T3279M2</b>	SLU2 mode, 3279 Model 2B
<b>T3279M3</b>	SLU2 mode, 3279 Model 3B
<b>T3279M4</b>	SLU2 mode, 3279 Model 4B
<b>T3279M5</b>	SLU2 mode, 3279 Model 5B
<b>TPS55M2</b>	SLU2 mode, PS/55, 24 lines
<b>TPS55M3</b>	SLU2 mode, PS/55, 32 lines
<b>TPS55M4</b>	SLU2 mode, PS/55, 43 lines
<b>LUP</b>	SLU P mode, all cases

### **Waitconvnum(value)**

displays a value identifying the number of conversations that are waiting to start using a connection in the pool.

## CEMT INQUIRE FEPROPSET

### Function

Display information about a set of FEPI properties.

### Input

Press the Clear key to clear the screen. There are two ways of commencing this transaction:

- Type CEMT INQUIRE FEPROPSET (the minimum abbreviation is CEMT I FEPR). You get a display that lists all FEPI property sets that are currently installed.
- Type CEMT INQUIRE FEPROPSET (CEMT I FEPR) followed by the name of a particular property set. For example, if you enter `cent i fepr (feprop1)`, the resulting display will show you whether or not the FEPI property set *feprop1* is installed. (If it is not installed, you get a 'NOT FOUND' response.)

#### CEMT INQUIRE FEPROPSET

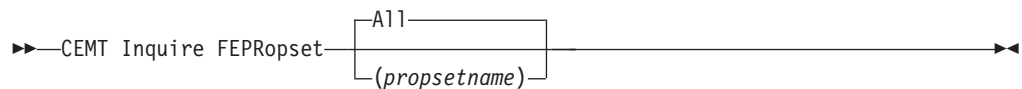

#### All

is the default. Information about all property sets is given, unless you specify a particular one.

#### propsetname

is the name of the property set to be queried.

### Sample screen

```
CEMT IN FEPR
STATUS: RESULTS
Fepr(PROP1 )
Fepr(PROP2 )
Fepr(PROP3 )
Fepr(PROP4 )
```

Figure 6. CEMT INQUIRE FEPROPSET screen

### Displayed fields

#### Fepr

indicates that this panel relates to an FEPROPSET inquiry.

#### (value)

displays the 8-character name identifying a property set.

# CEMT INQUIRE FETARGET

## Function

Display information about the state of FEPI targets.

## Input

Press the Clear key to clear the screen. There are two ways of commencing this transaction:

- Type CEMT INQUIRE FETARGET (the minimum abbreviation is CEMT I FET). You get a display that lists the current status.
- Type CEMT INQUIRE FETARGET (CEMT I FET) followed by as many of the other attributes as are necessary to limit the range of information that you require. For example, if you enter `cemt i fet inse`, the resulting display will show you the details of all FEPI targets that are in service.

You can tab to the highlighted 'service state' field and overtype it with a new value.

### CEMT INQUIRE FETARGET

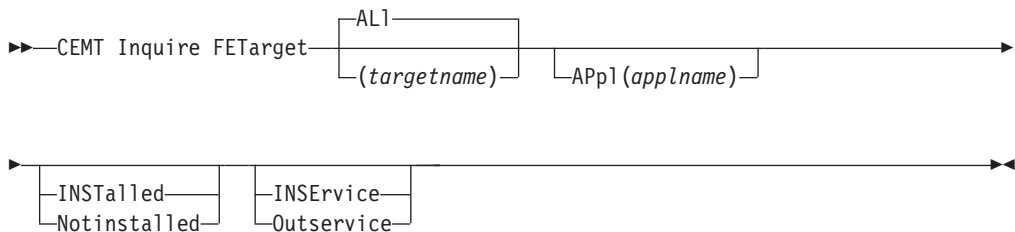

#### ALI

is the default. Information about all targets is given, unless you specify the target to be queried.

#### targetname

is the name of the target to be queried.

## Sample screen

```

CEMT IN FET
STATUS: RESULTS - OVERTYPE TO MODIFY
Feta(TARGETA ) App1(APPL5 ) Inst Inse
Feta(TARGETB ) App1(APPL6 ) Inst Inse
Feta(TARGET1 ) App1(APPL1 ) Inst Inse
Feta(TARGET2 ) App1(APPL2 ) Inst Inse
Feta(TARGET3 ) App1(APPL3 ) Inst Inse
Feta(TARGET4 ) App1(APPL4 ) Inst Inse
    
```

Figure 7. CEMT INQUIRE FETARGET screen

## Displayed fields

#### Feta

indicates that this panel relates to an FETARGET inquiry.

**(value)**

displays the 8-character name identifying a target.

**Appl(applname)**

displays the 8-character VTAM application name of the back-end system that the target represents.

**Installed|Notinstalled**

displays a value identifying the install state of the target. The values are:

**Installed**

The target has been defined by INSTALL and is available for use.

**Notinstalled**

The target is being discarded, but is still in use.

**Inservice|Outservice**

displays a value identifying the service state of the target. The values are:

**Inservice**

The target is in service and can be used in a conversation. If OUTSERVICE state has been requested but has not yet completed, a 'GOING OUT' message is shown.

**Outservice**

The target is out of service and cannot be used for any conversation.

## CEMT SET FECONNECTION

### Function

Change the state of FEPI connections. Family selection can be used for TARGET and NODE, but list selection cannot be used.

### Syntax

Press the Clear key to clear the screen. There are two ways of commencing this transaction:

- Type CEMT SET FECONNECTION (the minimum abbreviation is CEMT S FEC) with either TARGET(*targetname*) NODE(*nodename*) or ALL. You get a display that lists the current status, similar to that obtained by CEMT INQUIRE FECONNECTION. You can tab to the highlighted fields and overtype them with new values.
- Type CEMT SET FECONNECTION (CEMT S FEC) with either TARGET(*targetname*) NODE(*nodename*) or ALL, followed by one or more attribute settings that you want to change. For example, `cemt s fec all ac` causes sessions to be bound for all FEPI connections.

Typing ? at the beginning of either the first or second line gives a syntax prompt. Resetting the values takes effect immediately.

#### CEMT SET FECONNECTION

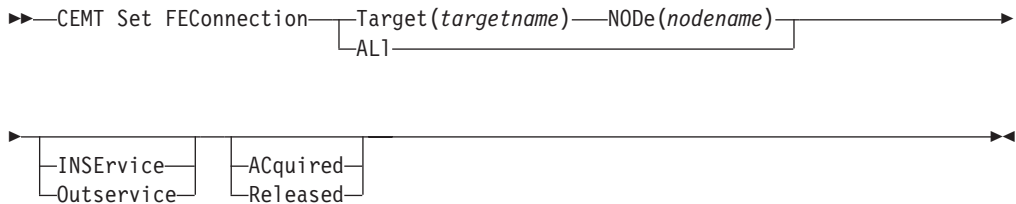

### Options

#### ACquired

specifies that the connection is to have a session established (that is, 'bound'). The state is ACQUIRING until this is completed.

#### ALI

specifies that any change you request is made to all connections that you are authorized to access.

#### INService

specifies that the connection is to be put in service and can be used in a conversation.

#### NODE(nodename)

specifies the 8-character name of the node identifying a connection.

#### Outservice

specifies that the connection is to be put out of service and not to be used for any new conversations, though existing conversations are unaffected. The service state is GOINGOUT until these conversations end.

#### Released

specifies that the connection is to have its session ended (that is, 'unbound'),

## CEMT SET FECONNECTION

when usage of the connection by all owned conversations ends. (An unowned conversation on the connection is ended immediately.) The state is RELEASING until this is completed.

**Target(targetname)**

specifies the 8-character name of the target identifying a connection.

## CEMT SET FENODE

### Function

Change the state of FEPI nodes.

### Syntax

Press the Clear key to clear the screen. There are two ways of commencing this transaction:

- Type CEMT SET FENODE (the minimum abbreviation is CEMT S FEN) with either a *nodename* or ALL. You get a display that lists the current status, similar to that obtained by CEMT INQUIRE FENODE. You can tab to the highlighted fields and overtype them with new values.
- Type CEMT SET FENODE (CEMT S FEN) with either a *nodename* or ALL, followed by one or more attribute settings that you want to change. For example, `cemt s fen al ac` causes the VTAM ACBs for all FEPI nodes to be opened, and 'set logon start' to be done.

Typing ? at the beginning of either the first or second line gives a syntax prompt. Resetting the values takes effect immediately.

#### CEMT Set FENode

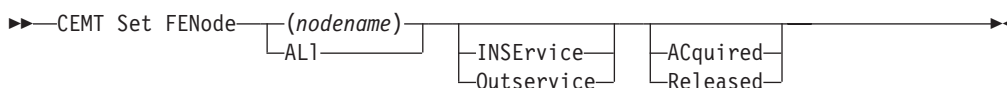

### Options

#### ACquired

specifies that the VTAM ACB for the node should be opened, and 'set logon start' is to be done. The state is ACQUIRING until this is completed.

#### ALI

specifies that any change you request is made to all nodes that you are authorized to access.

#### INService

specifies that the node is in service and can be used in a conversation.

#### (nodename)

specifies the 8-character name of the node whose state is to be changed.

#### Outservice

specifies that the node is to be put out of service and not to be used for any new conversations, though existing conversations are unaffected. The service state is GOINGOUT until these conversations end.

#### Released

specifies that the VTAM ACB for the node is to be closed, when usage of the node by any conversation ends. The state is RELEASING until this is completed.



## CEMT SET FEPOOL

### Function

Change the state of FEPI pools of connections.

### Syntax

Press the Clear key to clear the screen. There are two ways of commencing this transaction:

- Type CEMT SET FEPOOL (the minimum abbreviation is CEMT S FEPO) with either a *poolname* or ALL. You get a display that lists the current status, similar to that obtained by CEMT INQUIRE FEPOOL. You can tab to the highlighted 'service state' field and overtype it with a new value.
- Type CEMT SET FEPOOL (CEMT S FEPO) with either a *poolname* or ALL, followed by a service state setting. For example, `cemt s fepo fepool1 i` specifies that the *fepool1* pool is in service and available for use by a conversation.

Typing ? at the beginning of either the first or second line gives a syntax prompt. Resetting the values takes effect immediately.

#### CEMT SET FEPOOL

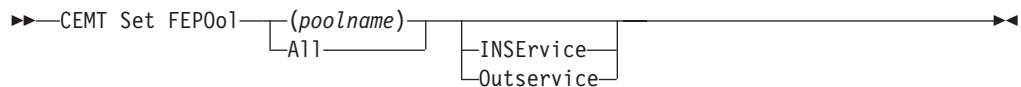

### Options

#### All

specifies that any change you request is made to all pools that you are authorized to access.

#### INService

specifies that the pool is in service and can be used in a conversation.

#### Outservice

specifies that the pool is to be put out of service and not be used for any new conversations, though existing conversations are unaffected. The service state is GOINGOUT until these conversations end.

#### (poolname)

specifies the pool of connections to be changed.

---

## CEMT SET FETARGET

### Function

Change the state of FEPI targets.

### Syntax

Press the Clear key to clear the screen. There are two ways of commencing this transaction:

- Type CEMT SET FETARGET (the minimum abbreviation is CEMT S FET) with either a *targetname* or ALL. You get a display that lists the current status, similar to that obtained by CEMT INQUIRE FETARGET. You can tab to the highlighted 'service state' field and overwrite it with a new value.
- Type CEMT SET FETARGET (CEMT S FET) with either a *targetname* or ALL, followed by a service state setting. For example, `cemt s fet fetarg1 i` specifies that the *fetarg1* target is in service and available for use by a conversation.

Typing ? at the beginning of either the first or second line gives a syntax prompt. Resetting the values takes effect immediately.

#### CEMT Set FETarget

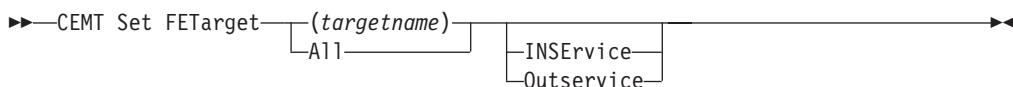

### Options

#### All

specifies that any change you request is made to all targets that you are authorized to access.

#### INService

specifies that the target is in service and can be used in a conversation.

#### Outservice

specifies that the target is out of service and cannot be used for any new conversations, though existing conversations are unaffected. The service state is GOINGOUT until these conversations end.

#### (targetname)

specifies the 8-character name of the target to be changed.

---

## CETR—trace control transaction

You use the CETR transaction to control FEPI trace. The FEPI component code (on the CETR “Component Trace Options” panel) is ‘SZ’. Specify ‘SZ 1’ to turn on FEPI tracing.

For detailed information about the syntax of the CETR transaction, see the *CICS Supplied Transactions* manual. For information about using CETR in problem determination, see the *CICS Problem Determination Guide*.

---

## VTAM commands

In addition to the resource control facilities provided by FEPI, you can use specific VTAM commands to manage communication with target systems. They are particularly useful where there are problems in acquiring or releasing sessions; see “ACQSTATUS” on page 47.

These commands are fully described in the *VTAM Operations* manual, but are summarized here. You can:

- Use the VTAM DISPLAY command to inquire about the status of the FEPI nodes (acting as SLUs) and the target systems. It should normally be necessary to use this command only when you experience problems in communicating with a particular target. Note that to understand the displays you require some knowledge of how VTAM operates. VTAM messages are explained in the *VTAM Messages and Codes* manual.
- Use the VTAM VARY command to control the availability of resources within the network. In the case of FEPI, you can use it to force the closure of a node regardless of whether it is being used in an active conversation. This is achieved by making the VTAM node inactive. However, any pending request to change to a state of RELEASED or OUTSERVICE is able to complete. A subsequent VARY ACTIVE command makes the node available for use again (if its state is still INSERVICE).
- Use the VTAM VARY TERM command to terminate individual connections—that is, to end the session between a particular PLU (target) and SLU (FEPI) pair.
- Use the VTAM DISPLAY SESSIONS command to diagnose problems in establishing sessions. To use this command, you require an understanding of VTAM session processing.

## VTAM commands

---

## Chapter 8. Customizing FEPI

This chapter outlines the customization features of FEPI. It contains:

- “Global user exits”
- “Journaling” on page 83.

It assumes that you are aware of the customization features of CICS Transaction Server for OS/390 Release 3 (programming information about these is in the *CICS Customization Guide* and the *CICS System Programming Reference*).

This chapter contains Product-sensitive Programming Interface information.

---

### Global user exits

This section describes the two FEPI global user exits, **XSZBRQ** and **XSZARQ**. These exits behave in exactly the same manner as standard CICS global user exits.

#### **XSZBRQ**

Invoked before a FEPI command is executed (but after the syntax of the command has been validated, and therefore after EDF processing).

#### **XSZARQ**

Invoked immediately after a FEPI command has completed (before EDF processing).

Note that both the FEPI application programming *and* system programming commands cause XSZBRQ and XSZARQ to be invoked, but the latter do not provide the exit programs with any meaningful information.

You cannot use exit programming interface (XPI) calls or EXEC CICS commands in programs invoked from these exits.

The exits allow you to monitor the FEPI commands and data being processed; you can inhibit commands, and modify specific command options. You could use them for:

- Monitoring the issue of FEPI commands
- Load balancing
- External security on application programming commands.

### **XSZBRQ**

XSZBRQ is invoked before a FEPI command is executed; the input parameters for the command are passed to the exit program. The majority of the information passed is read-only, but specific parameters can be updated. In addition, your exit program can decide whether the request is to be processed or bypassed. You could use XSZBRQ, for example, to log commands, to bypass commands that violate the conventions of your installation, or to reroute commands by changing their specified targets or pools.

#### **XSZBRQ parameters you can modify**

Your exit program can modify the settings of some of the parameters passed to it. However, if it does so, FEPI does not check the validity of the new value. The following parameters can be modified; no others can.

## Exit XSZBRQ

### **UEPSZSTT**

The ID of the transaction that is to continue a FEPI conversation (as supplied on the FEPI START command).

### **UEPSZSTM**

The ID of the terminal that is to continue a FEPI conversation (as supplied on the FEPI START command). (Set UEPSZSTM=X'00000000' to run non-terminal.)

### **UEPSZTIM**

The TIMEOUT value for FEPI ALLOCATE, RECEIVE, CONVERSE, and START commands.

### **UEPSZALP**

The POOL name supplied on the FEPI ALLOCATE or FEPI CONVERSE command.

### **UEPSZALT**

The TARGET name supplied on the FEPI ALLOCATE or FEPI CONVERSE command.

Together, UEPSZALP and UEPSZALT contain the information necessary to initiate a conversation.

*Table 5. Exit XSZBRQ*

Invoked by FEPI before a FEPI command is executed (but after syntax and semantic checking).
---

Table 5. Exit XSZBRQ (continued)

<b>Exit-specific parameters</b>	<p><b>UEPSZACT</b> A 2-byte field that identifies the command. The values are given in Table 7 on page 82.</p> <p><b>UEPSZCNV</b> An 8-character field containing the conversation ID (CONVID) for the command. Applicable on FEPI ALLOCATE, SEND, RECEIVE, CONVERSE, EXTRACT, ISSUE, START, and FREE commands.  For an EXEC CICS FEPI ALLOCATE command without PASSCONVID, this field is set to nulls; if PASSCONVID is used, it contains the CONVID.</p> <p><b>UEPSZALP</b> An 8-character field containing the name of the pool (POOL). Modifiable and applicable on FEPI ALLOCATE and CONVERSE commands.</p> <p><b>UEPSZALT</b> An 8-character field containing the name of the target (TARGET). Modifiable and applicable on FEPI ALLOCATE and CONVERSE commands.</p> <p><b>UEPSZTIM</b> Fullword binary field containing the time-out value (TIMEOUT). Modifiable and applicable on FEPI ALLOCATE, RECEIVE, CONVERSE, and START commands.</p> <p><b>UEPSZSND</b> Address of the 'send' data-area (FROM). Applicable on FEPI CONVERSE and SEND commands.</p> <p><b>UEPSZSNL</b> Fullword binary field containing the length of the 'send' data (FROMLENGTH, FLENGTH). Applicable on FEPI CONVERSE and SEND commands.</p> <p><b>UEPSZSTT</b> A 4-character field containing the transaction ID (TRANSID). Modifiable and applicable on FEPI START commands.</p> <p><b>UEPSZSTM</b> A 4-character field containing the terminal ID (TERMIN). Modifiable and applicable on FEPI START commands.</p> <p><b>UEPSZSNK</b> A 1-bit flag field indicating whether data is in key stroke format (KEYSTROKE). Applicable on FEPI CONVERSE FORMATTED and SEND FORMATTED commands. It can contain the following values: <b>UEPSZSNK_OFF</b> Not key stroke format. <b>UEPSZSNK_ON</b> Key stroke format.</p> <p><b>UEPSZSNE</b> A 1-character field containing the key stroke escape character (ESCAPE). Applicable on FEPI CONVERSE FORMATTED and SEND FORMATTED commands.</p>
<b>Return codes</b>	<p><b>UERCNORM</b> Continue processing.</p> <p><b>UERCBYP</b> Do not process the request; return INVREQ to the application. <b>Note:</b> Your exit program cannot bypass <b>events</b> (like CICS shutdown or end-of-task).</p>
<b>XPI calls</b>	<b>Do not use any XPI calls.</b>

## Exit XSZARQ

### XSZARQ

XSZARQ is invoked immediately after a FEPI command has been executed; the exit program is passed the parameters that are output from the command. All of the information passed is read-only.

Table 6. Exit XSZARQ

<b>Exit-specific parameters</b>	<p>Invoked by FEPI immediately after a FEPI command has been processed.</p> <p><b>UEPSZACN</b> A 2-byte field that identifies the command. The values are given in Table 7.</p> <p><b>UEPSZCON</b> An 8-character field containing the conversation ID (CONVID) for the command. Applicable on FEPI ALLOCATE, SEND, RECEIVE, CONVERSE, EXTRACT, ISSUE, START, and FREE commands.</p> <p><b>UEPSZRP2</b> Fullword containing the response code for the command (RESP2).</p> <p><b>UEPSZRVD</b> Address of the 'receive' data-area (INTO). Applicable on FEPI RECEIVE, CONVERSE, and EXTRACT FIELD commands.</p> <p><b>UEPSZRVL</b> Fullword binary data field containing the length of the receive data (FLENGTH, TOFLENGTH). Applicable on FEPI RECEIVE, CONVERSE, and EXTRACT FIELD commands.</p>
<b>Return code</b>	<p><b>UERCNORM</b> Continue processing.</p>
<b>XPI calls</b>	<p><b>Do not use any XPI calls.</b></p>

## The UEPSZACT and UEPSZACN exit-specific parameters

Both XSZBRQ and XSZARQ are passed a parameter (**UEPSZACT** for XSZBRQ, and **UEPSZACN** for XSZARQ) indicating the command or event being processed. Table 7. relates the hexadecimal values passed in UEPSZACT and UEPSZACN to the FEPI commands they represent.

Table 7. Settings of UEPSZACT for exit XSZBRQ and UEPSZACN for exit XSZARQ

Name	Setting (hex)	FEPI command or event
UEPSZNOA	820E	AP NOOP
UEPSZOAL	8210	ALLOCATE
UEPSZOCF	8212	CONVERSE FORMATTED
UEPSZOCD	8214	CONVERSE DATASTREAM
UEPSZOXC	8216	EXTRACT CONV
UEPSZOXF	8218	EXTRACT FIELD
UEPSZOXS	821A	EXTRACT STSN
UEPSZOFR	821C	FREE
UEPSZOSU	821E	ISSUE
UEPSZORF	8220	RECEIVE FORMATTED
UEPSZORD	8222	RECEIVE DATASTREAM
UEPSZOSF	8224	SEND FORMATTED
UEPSZOSD	8226	SEND DATASTREAM



## UEPSZACT and UEPSZACN parameters

Table 7. Settings of UEPSZACT for exit XSZBRQ and UEPSZACN for exit XSZARQ (continued)

Name	Setting (hex)	FEPI command or event
UEPSZOST	8228	START
UEPSZSDN	8402	CICS normal shutdown <b>1</b>
UEPSZSDI	8404	CICS immediate shutdown <b>1</b>
UEPSZSDF	8406	CICS forced shutdown <b>1</b>
UEPSZEOT	8408	CICS end-of-task <b>1</b>
UEPSZNOS	840E	SP NOOP
UEPSZOQY	8422	INQUIRE PROPERTYSET
UEPSZOIY	8428	INSTALL PROPERTYSET
UEPSZODY	8430	DISCARD PROPERTYSET
UEPSZOQN	8442	INQUIRE NODE
UEPSZOTN	8444	SET NODE
UEPSZOIN	8448	INSTALL NODELIST
UEPSZOAD	844A	ADD POOL
UEPSZODE	844C	DELETE POOL
UEPSZODN	8450	DISCARD NODELIST
UEPSZOQP	8462	INQUIRE POOL
UEPSZOTP	8464	SET POOL
UEPSZOIP	8468	INSTALL POOL
UEPSZODP	8470	DISCARD POOL
UEPSZOQT	8482	INQUIRE TARGET
UEPSZOTT	8484	SET TARGET
UEPSZOIT	8488	INSTALL TARGETLIST
UEPSZODT	8490	DISCARD TARGETLIST
UEPSZOQC	84A2	INQUIRE CONNECTION
UEPSZOTC	84A4	SET CONNECTION

**Note:**

**1** These events are generated internally by CICS; you cannot bypass them.

## Using XMEOUT to control message output

You can use the XMEOUT global user exit, in the CICS message domain, to suppress or reroute FEPI messages. Note, however, that error conditions that generate a message also generate a transient data queue record. It is more efficient to handle such events using a monitoring program, through the TD queue, than by duplicating a message and then acting on it. See “Writing monitoring programs” on page 41.

For programming information about the XMEOUT exit, see the *CICS Customization Guide*.

## Journaling

This section describes the format of FEPI journal records, and how to print them. For background information about CICS journaling, you should refer to the *CICS Operations and Utilities Guide*; for programming information, see the *CICS Customization Guide*.

## Journaling

### FEPI journal operation

You can request FEPI to write inbound, outbound, or both inbound and outbound data to a specified CICS user journal; you cannot write to the system log. This is done using the **MSGJRNL**, **FJOURNALNUM**, and **FJOURNALNAME** options in your property set definitions.

Of the various reasons for using CICS journaling, the following are particularly relevant to FEPI processing:

- Creating audit trails
- Monitoring performance
- Controlling message security.

Table 8 shows the types of FEPI data that can be journaled.

Table 8. FEPI journaled data

FEPI command	Data flow	Type
SEND	Outbound	Data stream Formatted, screen image Formatted, key stroke
RECEIVE	Inbound	Data stream Formatted, screen image
CONVERSE	Outbound	Data stream Formatted, screen image Formatted, key stroke
CONVERSE	Inbound	Data stream Formatted, screen image
EXTRACT FIELD	Inbound	Extract field data

The records journaled by FEPI are identified in the usual way by module and function identifiers. These are listed in Table 9.

Table 9. FEPI journal record identifiers

Identifier-type	Name	Value	Type of data
Module identifier	MODIDFEP	X'5D'	Identifies FEPI records in the journal
Function identifiers	FIDFEPIN FIDFEPOU	X'F0' X'F1'	Identifies FEPI inbound data Identifies FEPI outbound data

In order to identify the conversation for which the data was journaled, FEPI provides a prefix area in the journal record.

### Printing FEPI journal records

You can select FEPI journal records in any of the ways described in the *CICS Operations and Utilities Guide*; programming information about this is in the *CICS Customization Guide*.

Each FEPI journal record contains a prefix area which contains FEPI-related information. See the *CICS Customization Guide* for details on the structure of journal records. The FEPI prefix area lies within the API user header, as shown in the following diagram.

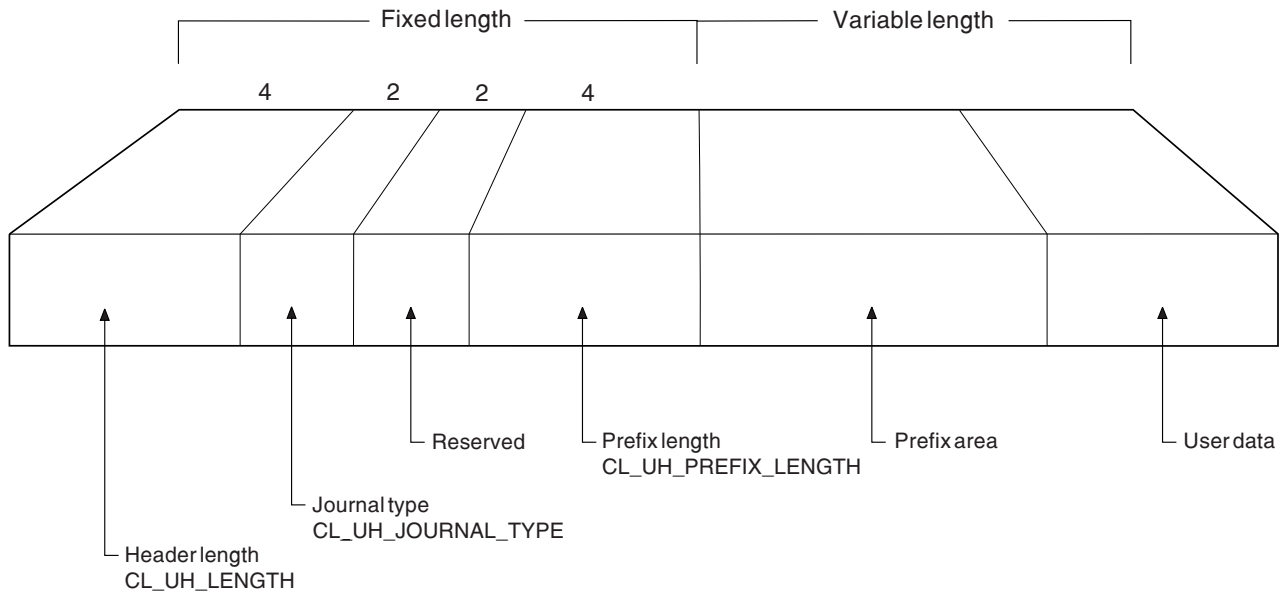

Figure 8. Format of the API user header, showing the position of the prefix area

The exact format of this FEPI prefix area is shown in the following diagram.

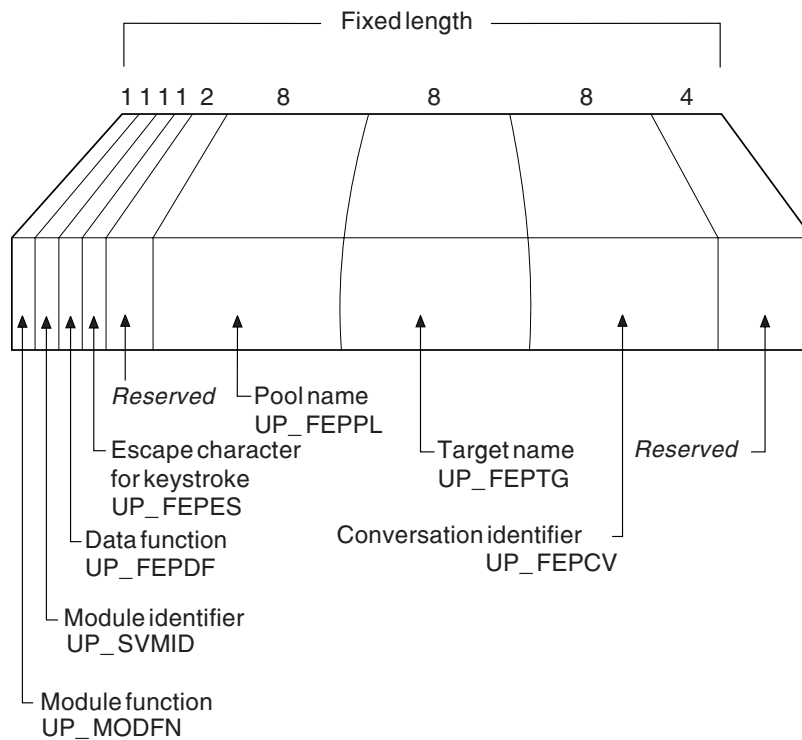

Figure 9. Format of the FEPI prefix area

Field UP\_FEPDF can take any of the following values:

Table 10. Values of UP\_FEPDF

Field name	Value	Meaning
UP_FEPDD	1	Datastream

## Journaling

Table 10. Values of UP\_FEPDF (continued)

Field name	Value	Meaning
UP_FEPDS	2	Formatted, screen image
UP_FEPDK	3	Formatted, keystroke
UP_FEPDE	4	Extract field data

See the *CICS Operations and Utilities Guide* for examples of ways in which you can use the CICS-supplied utility program, DFHJUP, to select FEPI records for printing.

---

## Chapter 9. System programming reference

This chapter describes the FEPI system programming commands that you use for FEPI configuration and operation. (Application programming commands such as ALLOCATE, CONVERSE, and EXTRACT are described in “Chapter 16. Application programming reference” on page 169.)

The chapter contains the following topics:

- “The FEPI SPI commands”
- “Transient data queue records” on page 122.

---

### The FEPI SPI commands

The FEPI system programming commands are:

ADD POOL  
DELETE POOL  
DISCARD NODELIST  
DISCARD POOL  
DISCARD PROPERTYSET  
DISCARD TARGETLIST  
INQUIRE CONNECTION  
INQUIRE NODE  
INQUIRE POOL  
INQUIRE PROPERTYSET  
INQUIRE TARGET  
INSTALL NODELIST  
INSTALL POOL  
INSTALL PROPERTYSET  
INSTALL TARGETLIST  
SET CONNECTION  
SET NODE  
SET POOL  
SET TARGET  
SP NOOP

These commands are

an addition to the system programming group of EXEC CICS commands (programming information about these is in the *CICS System Programming Reference*) and have the same features and properties. To use these commands, you should be familiar with:

- The format of EXEC CICS commands
- Input and output values, and CVDAs
- The use of the RESP, RESP2, and NOHANDLE options
- Security checking
- The use of INQUIRE and SET commands
- Browsing.

Brief notes on some of these topics are included here. For programming information about system programming commands, see the *CICS System Programming Reference*.

## System programming reference

### Command format

The general format of a command is:

```
EXEC CICS FEPI command option(argument)...
```

where:

**command**

Is the command name (for example, ADD)

**option**

Is an option name (for example, POOL)

**argument**

Is the source or destination for data, as required for the specified option, that is passed to or returned from the command.

The way that you terminate the command is determined by the programming language that you use—COBOL, for example, requires an END-EXEC statement.

### Arguments and data types

The text used to identify arguments in this book indicates the type of data represented by the argument and whether it is a value used by the command, or an area in which the command returns data. For example:

POOL(8-character data-value) indicates that the argument is, or identifies, a string of eight characters, and that the string is passed to the command as an input value.

ACQNUM(fullword binary data-area) indicates that the argument is a user-defined fullword data area in which the command can return a binary number as an output value.

Exceptionally, arguments that are lists have to be data areas, even though they are input values.

### Errors and exception conditions

All FEPI commands support the RESP and RESP2 options to signal successful completion or an exception condition. Alternatively, you can use HANDLE CONDITION to trap errors.

Most FEPI command errors give the 'INVREQ' exception condition. The particular error in each case is uniquely identified by the RESP2 value.

Both RESP and RESP2 take, as an argument, the name of a user-defined fullword binary data area. Possible values of the RESP2 option are given in the description of each of the commands and a full list is given in "RESP2 values" on page 241. The following copy books provide declarations for the RESP2 values:

- DFHSZAPA for assembler language
- DFHSZAPO for COBOL
- DFHSZAPP for PL/I
- DFHSZAPC for C/370.

The following conditions and RESP2 values can occur for any system programming command:

Condition	RESP2	Meaning
INVREQ	10	Command bypassed by user exit.
INVREQ	11	FEPI not installed, or not active.
INVREQ	12	CICS shutting down, command not allowed.

Condition	RESP2	Meaning
INVREQ	13	FEPI unavailable.
INVREQ	14	FEPI busy or cannot get storage.
INVREQ	15	Unknown command.
INVREQ	16	Internal error.
INVREQ	17	FEPI cannot get storage for user exit.
INVREQ	18	Command failed through operator or system action.
NOTAUTH	100	Not authorized for this command.

If there is an error, the command does nothing, and the output arguments are not changed.

By their nature, some commands (for example, FEPI SET NODE INSERVICE) initiate a function and return before the function has completed. Errors in the execution of the function cannot be reported as an exception condition on the command. Such errors are reported by writing a record to a transient data (TD) queue and a message to the message log CSZL. See “Transient data queue records” on page 122 for details.

### List processing

Commands that operate on a list of resources can fail for some of the resources in the list, but succeed for others. If this happens, a ‘list error’ is returned on the command. A record is written to a TD queue for each of the resources for which the command failed.

Even if the command fails for *all* of the resources in the list, it may still be partially successful if other parameters are valid. For example, a FEPI INSTALL POOL command installs a valid pool even if the array of node names specified on the NODELIST parameter does not exist.

## Syntax notation

The notation used in this book to show the syntax of FEPI commands is the same as that used in the *CICS System Programming Reference*. See “CICS syntax notation used in this book” on page xv for details.

## Translator options

Unlike other CICS system programming commands, the FEPI system programming commands do not need the ‘SP’ translator option. However, you do need to specify the ‘FEPI’ translator option.

## INQUIRE and SET commands

The FEPI INQUIRE and SET commands work in the same way as other CICS INQUIRE and SET commands. They allow you to look at named FEPI resource definitions, browse sets of related definitions, and modify some of the defined values.

## Other points

- FEPI commands can be issued in either 24-bit or 31-bit addressing mode, by programs that reside either above or below the 16MB line.
- No information is passed through the EXEC interface block (EIB) except that, as for all CICS commands, the EIBRESP, EIBRESP2, EIBFN, and EIBRCODE fields are set.

## FEPI ADD POOL

### Function

FEPI ADD POOL adds targets or nodes, or both, to an existing pool, thereby creating new connections in the pool. The targets or nodes must not be in the pool already. You can specify initial service and acquire states for these new connections. The command completes when the resources have been added to the pool but without waiting for the requested states to be achieved.

### Syntax

#### FEPI ADD POOL

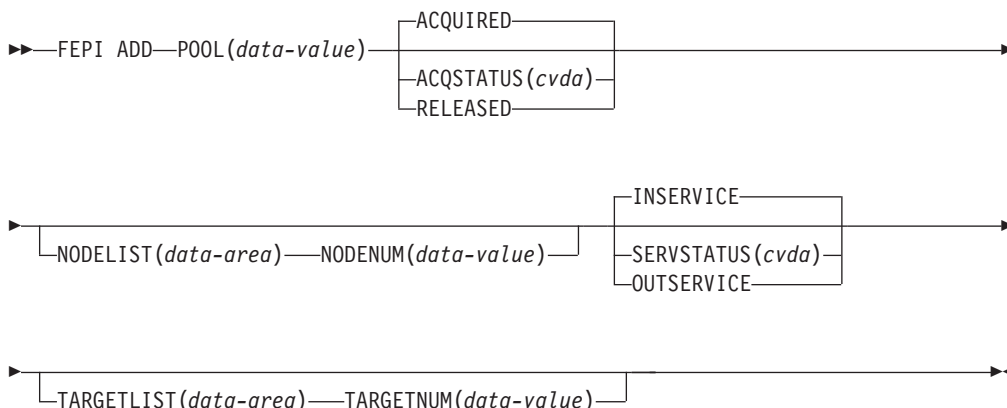

#### Notes:

- 1 INVREQ, NOTAUTH

### Options

#### ACQSTATUS(cvda)

specifies the initial acquire state of the connections being created. All the new connections have the same state. The relevant CVDA values are:

##### ACQUIRED

The connections are to have sessions established (that is, be 'bound').

##### RELEASED

The connections are not to have sessions established (that is, be left 'unbound').

#### NODELIST(data-area)

specifies a contiguous array of 8-character node names to be added to the pool. They must already be defined by FEPI INSTALL NODELIST, but can have any service state.

#### NODENUM(fullword binary data-value)

specifies the number of names in the NODELIST, in the range 0–256.

#### POOL(8-character data-value)

specifies the name of the pool to which the targets or nodes, or both, are being added.



**SERVSTATUS(cvda)**

specifies the initial service state of the connections being created. All the new connections have the same state. The relevant CVDA values are:

**INSERVICE**

The connections are to be in service, and so can be used in a conversation.

**OUTSERVICE**

The connections are to be out of service and cannot be used for any conversation.

**TARGETLIST(data-area)**

specifies a contiguous array of 8-character target names to be added to the pool. They must already be defined by FEPI INSTALL TARGETLIST, but can be in any service state.

**TARGETNUM(fullword binary data-value)**

specifies the number of names in TARGETLIST, in the range 0–256.

**Conditions**

Condition	RESP2	Meaning
INVREQ	110	SERVSTATUS value not valid.
INVREQ	111	ACQSTATUS value not valid.
INVREQ	115	POOL name unknown.
INVREQ	116	TARGET name unknown.
INVREQ	117	NODE name unknown.
INVREQ	119	The command failed for one or more items in the list.
INVREQ	130	TARGETNUM value is out of range.
INVREQ	131	NODENUM value is out of range.
INVREQ	173	NODE name already exists in the specified pool.
INVREQ	174	TARGET name already exists in the specified pool.
INVREQ	175	Connection already exists.

---

**FEPI DELETE POOL**

**Function**

FEPI DELETE POOL removes targets or nodes, or both, from a specified pool, thereby removing connections from the pool. The targets or nodes must be in the pool already. The command completes immediately, without waiting for the necessary deletions to be achieved. When the connections are deleted, they are no longer defined to FEPI.

**Syntax**

**FEPI DELETE POOL**

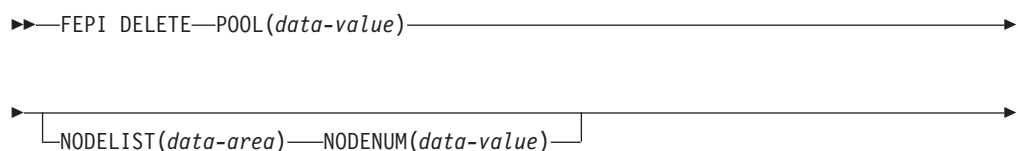

## FEPI DELETE POOL

▶ TARGETLIST(*data-area*)—TARGETNUM(*data-value*)—▶

### Notes:

- 1 INVREQ, NOTAUTH

## Options

### NODELIST(*data-area*)

specifies a contiguous array of 8-character node names that are to be deleted from the pool.

### NODENUM(*fullword binary data-value*)

specifies the number of names in the NODELIST, in the range 0–256.

### POOL(*8-character data-value*)

specifies the name of the pool from which targets or nodes are to be removed.

### TARGETLIST(*data-area*)

specifies a contiguous array of 8-character target names that are to be deleted from the pool.

### TARGETNUM(*fullword binary data-value*)

specifies the number of names in TARGETLIST, in the range 0–256.

## Conditions

Condition	RESP2	Meaning
INVREQ	115	POOL name unknown.
INVREQ	116	TARGET name unknown.
INVREQ	117	NODE name unknown.
INVREQ	119	The command failed for one or more items in the list.
INVREQ	130	TARGETNUM value out of range.
INVREQ	131	NODENUM value out of range.

---

## FEPI DISCARD NODELIST

### Function

FEPI DISCARD NODELIST removes nodes completely from FEPI. The state of each node to be discarded is set to OUTSERVICE RELEASED (see “FEPI SET NODE” on page 118). When this state is achieved, the node is deleted from any pool that it is in. The nodes are then discarded so that they are no longer defined to FEPI. The command completes immediately without waiting for the necessary service and acquire states to be achieved.

### Syntax

#### FEPI DISCARD NODELIST

▶▶ FEPI DISCARD—NODELIST(*data-area*)—NODENUM(*data-value*)—▶▶

**Notes:**

- 1 INVREQ, NOTAUTH

**Options**

**NODELIST(data-area)**

specifies a contiguous array of 8-character node names that are to be discarded.

**NODENUM(fullword binary data-value)**

specifies the number of names in NODELIST, in the range 1–256.

**Conditions**

Condition	RESP2	Meaning
INVREQ	117	NODE name unknown.
INVREQ	119	The command failed for one or more items in the list.
INVREQ	131	NODENUM value out of range.

**FEPI DISCARD POOL**

**Function**

FEPI DISCARD POOL removes a pool of connections completely from FEPI. The state of the connections in the pool is set to OUTSERVICE RELEASED (see “FEPI SET CONNECTION” on page 116), and the state of the pool is set to OUTSERVICE (see “FEPI SET POOL” on page 120). When these states have been achieved, the pool and its connections are discarded, so that they are no longer defined to FEPI. The command completes immediately, without waiting for the necessary service and acquire states to be achieved.

**Syntax**

**FEPI DISCARD POOL**

►►—FEPI DISCARD—POOL(*data-value*)—◄◄

**Notes:**

- 1 INVREQ, NOTAUTH

**Options**

**POOL(8-character data-value)**

specifies the name of the pool to be discarded.

**Conditions**

Condition	RESP2	Meaning
INVREQ	115	POOL name unknown.

---

## FEPI DISCARD PROPERTYSET

### Function

FEPI DISCARD PROPERTYSET removes a set of properties. The properties are discarded immediately so that they are no longer defined to FEPI, but any pool that was installed using the properties is not affected.

### Syntax

#### FEPI DISCARD PROPERTYSET

►►—FEPI DISCARD—PROPERTYSET(*data-value*)—►►

#### Notes:

1 INVREQ, NOTAUTH

### Options

#### PROPERTYSET(8-character *data-value*)

specifies the name of the set of properties to be discarded.

### Conditions

Condition	RESP2	Meaning
INVREQ	171	PROPERTYSET name unknown.

---

## FEPI DISCARD TARGETLIST

### Function

FEPI DISCARD TARGETLIST removes targets completely from FEPI. The state of the targets to be discarded is set to OUTSERVICE (see “FEPI SET TARGET” on page 121). When this state has been achieved, the targets are deleted from any pool they are in, and are then discarded, so that they are no longer defined to FEPI. The command completes immediately, without waiting for the necessary service and acquire states to be achieved.

### Syntax

#### FEPI DISCARD TARGETLIST

►►—FEPI DISCARD—TARGETLIST(*data-area*)—TARGETNUM(*data-value*)—►►

#### Notes:

1 INVREQ, NOTAUTH

## Options

**TARGETLIST(data-area)**

specifies a contiguous array of 8-character target names that are to be discarded.

**TARGETNUM(fullword binary data-value)**

specifies the number of names in TARGETLIST, in the range 1–256.

## Conditions

Condition	RESP2	Meaning
INVREQ	116	TARGET name unknown.
INVREQ	119	The command failed for one or more items in the list.
INVREQ	130	TARGETNUM value out of range.

---

## FEPI INQUIRE CONNECTION

### Function

FEPI INQUIRE CONNECTION returns information about a FEPI connection. A connection is identified by specifying its target and node.

### Syntax

**FEPI INQUIRE CONNECTION**

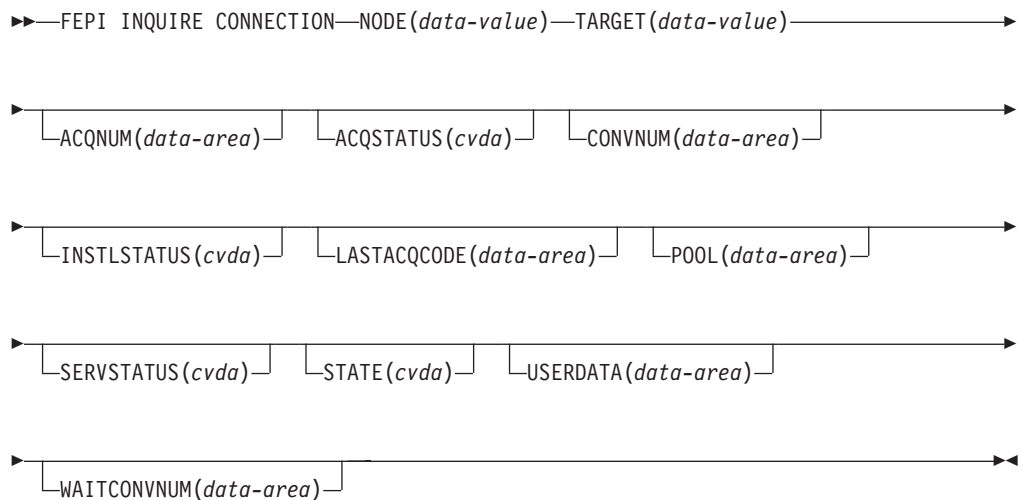

**Notes:**

- 1 END, ILLOGIC, INVREQ, NOTAUTH

The following commands allow you to browse all FEPI connections. Read the information about browsing earlier in this book before using the browsing commands.

## FEPI INQUIRE CONNECTION

### FEPI Browse CONNECTION

```
FEPI INQUIRE CONNECTION START
FEPI INQUIRE CONNECTION NEXTNODE|NEXTTARGET
NODE(8-character data-area)
TARGET(8-character data-area)
[The options are as for FEPI INQUIRE CONNECTION]
FEPI INQUIRE CONNECTION END
```

**Conditions:** INVREQ, NOTAUTH

The next connection for which information is returned depends on whether NEXTNODE or NEXTTARGET is specified. If NEXTNODE is specified, the information returned is for:

- The next node connected to the current target
- If there are no more nodes connected to the current target, then the first node connected to the next target.

If NEXTTARGET is specified, the information returned is for:

- The next target connected to the current node
- If there are no more targets connected to the current node, then the first target connected to the next node.

## Options

### ACQNUM(fullword binary data-area)

returns the number of times that the connection has been acquired.

### ACQSTATUS(cvda)

returns the acquire state; that is, whether a session on the connection is bound or not. The relevant CVDA values are:

#### ACQUIRED

The session is bound.

#### ACQUIRING

A state of ACQUIRED has been requested but binding a session has not yet been completed.

#### RELEASED

No session is bound.

#### RELEASING

A state of RELEASED has been requested but unbinding the session has not yet been completed.

If ACQUIRING or RELEASING persist, the operator might need to intervene using VTAM commands to recover the connection.

### CONVNUM(fullword binary data-area)

returns the number of conversations that have used the connection.

### INSTLSTATUS(cvda)

returns the install state of the connection. The relevant CVDA values are:

#### INSTALLED

The connection is in a pool defined by INSTALL and is available for use.

### NOTINSTALLED

The connection is in a pool, or involves a node or target that is being discarded but is still in use.

### LASTACQCODE(fullword binary data-area)

returns the result of the last acquire request for the connection; that is, the sense code from the last VTAM REQSESS, zero indicating success.

**Note:** CLSDST(PASS)—X'32020000'—can be returned in this field. This is the unbind flow received by CICS during CLSDST(PASS) processing.

For details of VTAM sense codes, see the *VTAM Messages and Codes* manual, or *SNA Formats* manual.

### NODE(8-character data-value/8-character data-area)

is the node identifying the connection.

### POOL(8-character data-area)

returns the name of the pool that defines the connection.

### SERVSTATUS(cvda)

returns the service state of the connection. The relevant CVDA values are:

#### INSERVICE

The connection is in service and can be used in a conversation.

#### OUTSERVICE

The connection is out of service and cannot be used for any new conversation, but a conversation using the connection is unaffected. The service state is GOINGOUT until any such conversation ends.

#### GOINGOUT

A state of OUTSERVICE has been requested but the connection is still being used by some conversation.

### STATE(cvda)

returns the state of the conversation using the connection. The relevant CVDA values are:

#### NOCONV

No conversation is active on the connection.

#### PENDSTSN

An STSN-handling task has been scheduled.

**STSN** An STSN-handling task owns the conversation.

#### PENDBEGIN

A begin-session handling task has been scheduled.

#### BEGINSESSION

A begin-session handling task owns the conversation.

#### APPLICATION

A normal application task owns the conversation.

#### PENDDATA

FEPI is waiting for inbound data, following a FEPI START command.

#### PENDSTART

Inbound data having arrived, a task specified by FEPI START has been scheduled.

## FEPI INQUIRE CONNECTION

### PENDFREE

An end-session handling task has been scheduled, following a FEPI FREE command.

**FREE** An end-session handling task owns the conversation, following a FEPI FREE command.

### PENDRELEASE

An end-session handling task has been scheduled, following an unbind request.

### RELEASE

An end-session handling task owns the conversation, following an unbind request.

### PENDUNSOL

An unsolicited-data handling task has been scheduled.

### UNSOLDATA

An unsolicited-data handling task owns the conversation.

### PENDPASS

The conversation is unowned, following a FEPI FREE PASS command.

The 'pending' states indicate that the conversation is unowned, pending the event or task indicated; the state ceases to be pending when a task issues a FEPI ALLOCATE PASSCONVID command. If a 'pending' state persists, it is likely that the application has failed in some way; you should consider resetting the connection by issuing FEPI SET CONNECTION RELEASED.

### TARGET(8-character data-value/8-character data-area)

is the target identifying the connection.

### USERDATA(64-character data-area)

returns the user data for the connection. If no user data has been set, nulls are returned.

### WAITCONVNUM(fullword binary data-area)

returns the number of conversations that are waiting to start using the connection. Note that, if a conversation could use any one of several connections, it is counted as waiting on each one.

## Conditions

Condition	RESP2	Meaning
ILLOGIC	1	For START: browse of this resource type is already in progress. For NEXT or INQUIRE: END was not issued.
END	2	For NEXT: all resource definitions have been retrieved.
INVREQ	116	TARGET name unknown.
INVREQ	117	NODE name unknown.
INVREQ	118	Connection unknown (TARGET and NODE names known, but not in a common pool).

---

## FEPI INQUIRE NODE

### Function

FEPI INQUIRE NODE returns information about a FEPI node.



## Syntax

### FEPI INQUIRE NODE

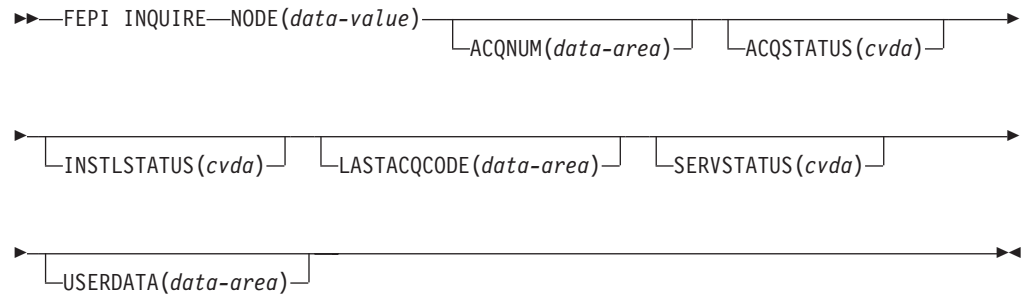

### Notes:

1 END, ILLOGIC, INVREQ, NOTAUTH

The following commands allow you to browse all FEPI NODE definitions. Read the information on browsing earlier in this book before using the browsing commands.

#### FEPI Browse NODE

```

FEPI INQUIRE NODE START
FEPI INQUIRE NODE(8-character data-area) NEXT
[The options are as for FEPI INQUIRE NODE]
FEPI INQUIRE NODE END
  
```

## Options

### ACQNUM(fullword binary data-area)

returns the number of times that the node has been acquired.

### ACQSTATUS(cvda)

returns the acquire state—that is, whether the VTAM ACB is opened or closed. The relevant CVDA values are:

#### ACQUIRED

The VTAM ACB for the node is open and 'set logon start' has completed.

#### ACQUIRING

A state of ACQUIRED has been requested but opening the VTAM ACB for the node and issuing 'set logon start' has not yet been completed.

#### RELEASED

Sessions on any connections involving the node have been unbound and the VTAM ACB has been closed.

#### RELEASING

A state of RELEASED has been requested but closing the VTAM ACB for the node has not yet been completed.

If ACQUIRING or RELEASING persist, the operator might need to intervene using VTAM commands to recover the node.

## FEPI INQUIRE NODE

### INSTLSTATUS(*cvda*)

returns the install state of the node. The relevant CVDA values are:

#### INSTALLED

The node has been defined by INSTALL and is available for use.

#### NOTINSTALLED

The node is being discarded, but is still in use.

### LASTACQCODE(**fullword binary data-area**)

returns the result of the last acquire request for the node; that is, the return code from the last VTAM OPEN ACB, zero indicating success. For details of VTAM return codes, see the *VTAM Programming* manual.

### NODE(**8-character data-value/8-character data-area**)

is the name of the node.

### SERVSTATUS(*cvda*)

returns the service state of the node. The relevant CVDA values are:

#### INSERVICE

The node is in service and can be used in a conversation.

#### OUTSERVICE

The node is out of service and cannot be used for any conversation.

#### GOINGOUT

A state of OUTSERVICE has been requested but the node is still being used by a conversation.

### USERDATA(**64-character data-area**)

returns the user data for the node. If no user data has been set, nulls are returned.

## Conditions

Condition	RESP2	Meaning
ILLOGIC	1	For START: browse of this resource type is already in progress. For NEXT or END: START was not issued.
END	2	For NEXT: all resource definitions have been retrieved.
INVREQ	117	NODE name unknown.

---

## FEPI INQUIRE POOL

### Function

FEPI INQUIRE POOL returns information about a FEPI pool of connections.

### Syntax

#### FEPI INQUIRE POOL

►►—FEPI INQUIRE—POOL(*data-value*)—┐  
└—BEGINSESSION(*data-area*)—┘

## FEPI INQUIRE POOL

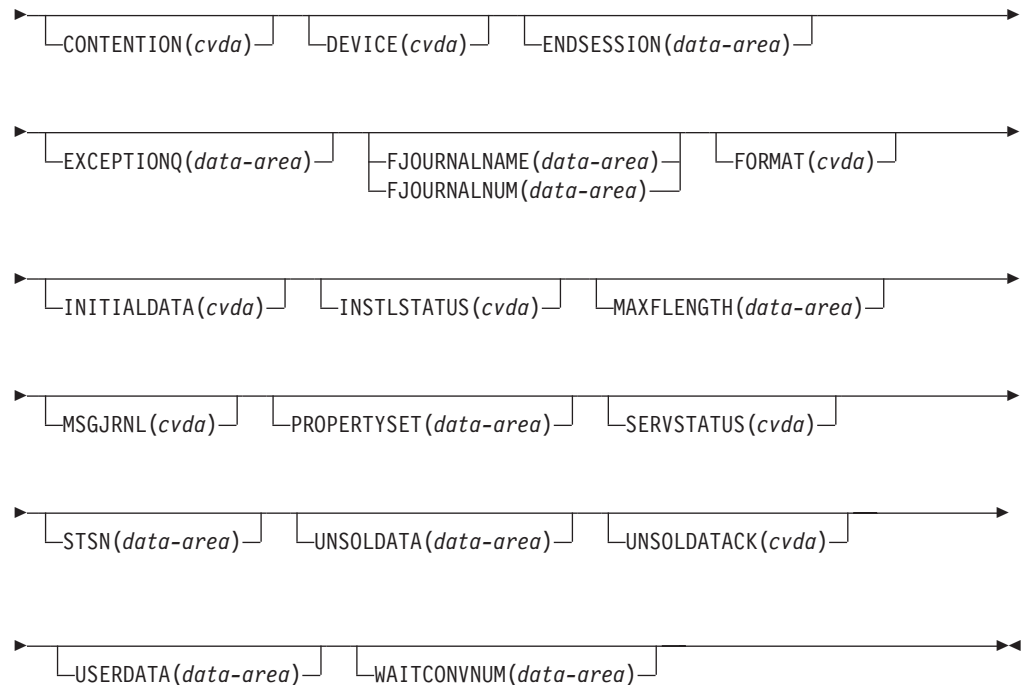

### Notes:

- 1 END, ILLOGIC, INVREQ, NOTAUTH

The following commands allow you to browse all FEPI POOL definitions. You should read the information on browsing earlier in this book before using the browsing commands.

### FEPI Browse POOL

```
FEPI INQUIRE POOL START
FEPI INQUIRE POOL(8-character data-area) NEXT
[The options are as for FEPI INQUIRE POOL]
FEPI INQUIRE POOL END
```

## Options

### BEGINSESSION(4-character data-area)

returns the name of the transaction performing begin-session processing, or blanks if no transaction was specified.

### CONTENTION(cvda)

returns a value that specifies what happens when a FEPI SEND command is issued and there is inbound data with 'begin bracket'. The relevant CVDA values are:

**LOSE** FEPI SEND command fails; a FEPI RECEIVE must be issued to get the inbound data.

**WIN** FEPI SEND command succeeds; inbound data is rejected with a negative response.

## FEPI INQUIRE POOL

### DEVICE(cvda)

returns a value that identifies the mode of conversation and the type of device.  
Defined values are:

<b>T3278M2</b>	SLU2 mode, 3278 Model 2
<b>T3278M3</b>	SLU2 mode, 3278 Model 3
<b>T3278M4</b>	SLU2 mode, 3278 Model 4
<b>T3278M5</b>	SLU2 mode, 3278 Model 5
<b>T3279M2</b>	SLU2 mode, 3279 Model 2B
<b>T3279M3</b>	SLU2 mode, 3279 Model 3B
<b>T3279M4</b>	SLU2 mode, 3279 Model 4B
<b>T3279M5</b>	SLU2 mode, 3279 Model 5B
<b>TPS55M2</b>	SLU2 mode, PS/55, 24 lines
<b>TPS55M3</b>	SLU2 mode, PS/55, 32 lines
<b>TPS55M4</b>	SLU2 mode, PS/55, 43 lines
<b>LUP</b>	SLU P mode, all cases.

### ENDSESSION(4-character data-area)

returns the name of the transaction performing end-session processing, or blanks if no transaction was specified.

### EXCEPTIONQ(4-character data-area)

returns the name of the TD queue to which exceptional events are notified, or blanks if no queue was specified.

### FJOURNALNAME(8-character data-area)

returns the 1- to 8-character name of the journal where data is to be logged.

### FJOURNALNUM(fullword binary data-area)

returns the number of the journal where data is to be logged.

### FORMAT(cvda)

returns a value that identifies the data format. The relevant CVDA values are:

**FORMATTED** Formatted operation

**DATASTREAM**  
Data stream operation

**NOTAPPLIC** Option is not applicable for the specified pool.

### INITIALDATA(cvda)

returns a value indicating whether initial inbound data is expected when a session is started. The relevant CVDA values are:

**NOTINBOUND** No inbound data expected

**INBOUND** Inbound data expected.

### INSTLSTATUS(cvda)

returns the install state of the pool. The relevant CVDA values are:

**INSTALLED** The pool has been defined by INSTALL and is available for use.

**NOTINSTALLED** The pool is being discarded, but is still in use.

**MAXLENGTH(fullword binary data-area)**

returns the maximum length of data that can be returned on any FEPI RECEIVE, CONVERSE, or EXTRACT FIELD command for a conversation, or that can be sent by any FEPI SEND or CONVERSE command for a conversation.

**MSGJRNL(cvda)**

returns a value indicating whether journaling is performed for inbound and outbound data. The relevant CVDA values are:

**NOMSGJRNL** No journaling is to be performed.

**INPUT** Inbound data is journaled.

**OUTPUT** Outbound data is journaled.

**INOUT** Inbound and outbound data are journaled.

**POOL(8-character data-value/8-character data-area)**

is the name of the pool.

**PROPERTYSET(8-character data-area)**

returns the name of the set of properties with which the pool was installed.

**SERVSTATUS(cvda)**

returns the service state of the pool. The relevant CVDA values are:

**INSERVICE**

The pool is in service and can be used in a conversation.

**OUTSERVICE**

The pool is out of service and cannot be used for any conversation.

**GOINGOUT**

A state of OUTSERVICE has been requested but the pool is still being used by some conversation.

**STSN(4-character data-area)**

returns the name of the transaction handling STSN data, or blanks if no transaction was specified.

**UNSOLDATA(4-character data-area)**

returns the name of the transaction handling unsolicited data (data received outside a conversation), or blanks if no transaction was specified.

**UNSOLDATAACK(cvda)**

if there is no unsolicited data processing, this indicates what acknowledgment FEPI gives to a BID. The relevant CVDA values are:

**NEGATIVE**

Negative response X'0813', BID not accepted

**POSITIVE**

Positive response, BID accepted and subsequent data is accepted and discarded

**NOTAPPLIC**

Option is not applicable for the specified pool.

**USERDATA(64-character data-area)**

returns the user data for the pool. If no user data has been set, nulls are returned.

## FEPI INQUIRE POOL

### WAITCONVNUM(fullword binary data-area)

returns the number of conversations that are waiting to start using a connection in the pool.

## Conditions

Condition	RESP2	Meaning
ILLOGIC	1	For START: browse of this resource type is already in progress. For NEXT or END: START was not issued.
END	2	For NEXT: all resource definitions have been retrieved.
INVREQ	115	POOL name unknown.

---

## FEPI INQUIRE PROPERTYSET

### Function

FEPI INQUIRE PROPERTYSET returns information about a FEPI property set.

### Syntax

#### FEPI INQUIRE PROPERTYSET

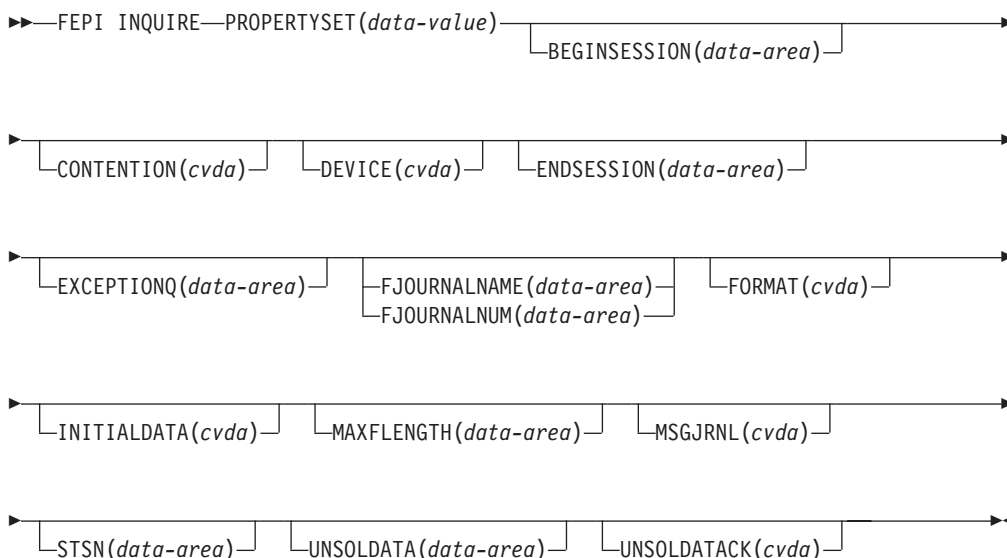

#### Notes:

- 1 END, ILLOGIC, INVREQ, NOTAUTH

The following commands allow you to browse all FEPI PROPERTYSET definitions. You should read the information on browsing earlier in this book before using the browsing commands.

**FEPI Browse PROPERTYSET**

```
FEPI INQUIRE PROPERTYSET START
FEPI INQUIRE PROPERTYSET(8-character data-area) NEXT
[The options are as for FEPI INQUIRE PROPERTYSET]
FEPI INQUIRE PROPERTYSET END
```

**Options****BEGINSESSION(4-character data-area)**

returns the name of the transaction performing begin-session processing, or blanks if no transaction was specified.

**CONTENTION(cvda)**

returns a value that specifies what happens when a FEPI SEND command is issued and there is inbound data with 'begin bracket'. The relevant CVDA values are:

**LOSE** FEPI SEND command fails; a FEPI RECEIVE must be issued to get the inbound data.

**WIN** FEPI SEND command succeeds; inbound data is rejected with a negative response.

**DEVICE(cvda)**

returns a value that identifies the mode of conversation and the type of device. Defined values are:

**T3278M2** SLU2 mode, 3278 Model 2

**T3278M3** SLU2 mode, 3278 Model 3

**T3278M4** SLU2 mode, 3278 Model 4

**T3278M5** SLU2 mode, 3278 Model 5

**T3279M2** SLU2 mode, 3279 Model 2B

**T3279M3** SLU2 mode, 3279 Model 3B

**T3279M4** SLU2 mode, 3279 Model 4B

**T3279M5** SLU2 mode, 3279 Model 5B

**TPS55M2** SLU2 mode, PS/55, 24 lines

**TPS55M3** SLU2 mode, PS/55, 32 lines

**TPS55M4** SLU2 mode, PS/55, 43 lines

**LUP** SLU P mode, all cases.

**ENDSESSION(4-character data-area)**

returns the name of the transaction performing end-session processing, or blanks if no transaction was specified.

**EXCEPTIONQ(4-character data-area)**

returns the name of the TD queue to which exceptional events are notified, or blanks if no queue was specified.

**FJOURNALNAME(8-character data-area)**

returns the 1- to 8-character name of the journal where data is to be logged.

**FJOURNALNUM(fullword binary data-area)**

returns the number of the journal where data is to be logged.

## FEPI INQUIRE PROPERTYSET

### **FORMAT(cvda)**

returns a value that identifies the data format. The relevant CVDA values are:

#### **FORMATTED**

Formatted operation

#### **DATASTREAM**

Data stream operation

#### **NOTAPPLIC**

Option is not applicable for the specified pool.

### **INITIALDATA(cvda)**

returns a value indicating whether initial inbound data is expected when a session is started. The relevant CVDA values are:

#### **NOTINBOUND**

No inbound data expected

#### **INBOUND**

Inbound data expected.

### **MAXLENGTH(fullword binary data-area)**

returns the maximum length of data that can be returned on any FEPI RECEIVE, CONVERSE, or EXTRACT FIELD command for a conversation, or that can be sent by any FEPI SEND or CONVERSE command for a conversation.

### **MSGJRNL(cvda)**

returns a value indicating whether journaling is performed for inbound and outbound data. The relevant CVDA values are:

#### **NOMSGJRNL**

No journaling is to be performed.

**INPUT** Inbound data is journaled.

#### **OUTPUT**

Outbound data is journaled.

#### **INOUT**

Inbound and outbound data are journaled.

### **PROPERTYSET(8-character data-value/8-character data-area)**

is the name of the set of properties.

### **STSN(4-character data-area)**

returns the name of the transaction handling STSN data (SLU P mode only), or blanks if no transaction was specified.

### **UNSOLDATA(4-character data-area)**

returns the name of the transaction handling unsolicited data (data received outside a conversation), or blanks if no transaction was specified.

### **UNSOLDATAACK(cvda)**

indicates what acknowledgment FEPI gives to a BID, if there is no unsolicited-data processing. The relevant CVDA values are:

#### **NEGATIVE**

Negative response X'0813', BID not accepted

#### **POSITIVE**

Positive response, BID accepted and subsequent data is accepted and discarded



**NOTAPPLIC**

Option is not applicable for the specified pool.

**Conditions**

Condition	RESP2	Meaning
ILLOGIC	1	For START: browse of this resource type is already in progress. For NEXT or END: START was not issued.
END	2	For NEXT: all resource definitions have been retrieved.
INVREQ	171	PROPERTYSET name unknown.

**FEPI INQUIRE TARGET**

**Function**

FEPI INQUIRE TARGET returns information about a FEPI target.

**Syntax**

**FEPI INQUIRE TARGET**

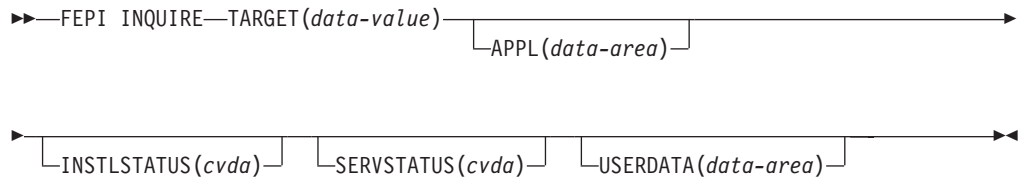

**Notes:**

- 1 END, ILLOGIC, INVREQ, NOTAUTH

The following commands allow you to browse all FEPI TARGET definitions. Read the information on browsing earlier in this book before using the browsing commands.

**FEPI Browse TARGET**

```
FEPI INQUIRE TARGET START
FEPI INQUIRE TARGET(8-character data-area) NEXT
[The options are as for FEPI INQUIRE TARGET]
FEPI INQUIRE TARGET END
```

**Options**

**APPL(8-character data-area)**

returns the VTAM application name of the back-end system that the target system represents.

**INSTLSTATUS(cvda)**

returns the install state of the target. The relevant CVDA values are:

**INSTALLED**

The target has been defined by INSTALL and is available for use.

## FEPI INQUIRE TARGET

**NOTINSTALLED** The target is being discarded but is still in use.

**SERVSTATUS(*cvda*)**  
returns the service state of the target. The relevant CVDA values are:

**INSERVICE**  
The target is in service and can be used in a conversation.

**OUTSERVICE**  
The target is out of service and cannot be used for any conversation.

**GOINGOUT**  
A state of OUTSERVICE has been requested but the target is still being used by some conversation.

**TARGET(8-character data-value/8-character data-area)**  
is the name of the target.

**USERDATA(64-character data-area)**  
returns the user data for the target. If no user data has been set, nulls are returned.

## Conditions

Condition	RESP2	Meaning
ILLOGIC	1	For START: browse of this resource type is already in progress. For NEXT or END: START was not issued.
END	2	For NEXT: all resource definitions have been retrieved.
INVREQ	116	TARGET name unknown.

---

## FEPI INSTALL NODELIST

### Function

FEPI INSTALL NODELIST defines new nodes to FEPI. You may specify initial service and acquire states for these new nodes. A node cannot be used for a conversation until it has been acquired, put in service, and added to a pool so that it is connected to a target. The command completes when the nodes have been defined without waiting for the requested states to be achieved.

### Syntax

#### FEPI INSTALL NODELIST

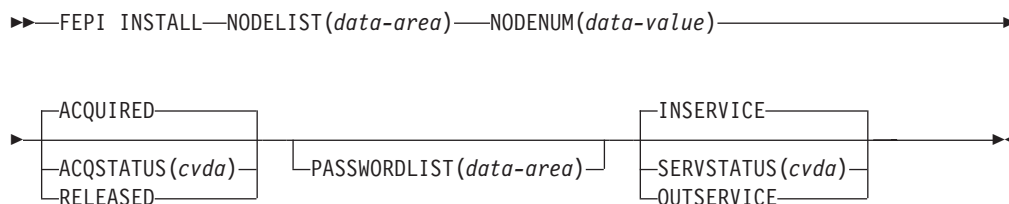

#### Notes:

- 1 INVREQ, NOTAUTH

## Options

### **ACQSTATUS(cvda)**

specifies the initial acquire state of the nodes being defined. All nodes in the list have the same state. The relevant CVDA values are:

#### **ACQUIRED**

The VTAM ACB for the node is to be opened and 'set logon start' is to be done.

#### **RELEASED**

The VTAM ACB for the node is not to be opened.

### **NODELIST(data-area)**

specifies a contiguous array of 8-character node names (that is, VTAM application minor node names in the front-end) to be defined. Names must not contain null characters (X'00'), leading blanks, or embedded blanks.

### **NODENUM(fullword binary data-value)**

specifies the number of names in NODELIST, in the range 1–256.

### **PASSWORDLIST(data-value)**

specifies a contiguous array of 8-character passwords. They correspond one-to-one with the node names in NODELIST. The passwords are those that VTAM requires to access the application minor nodes. They are not required if passwords are not used. You can use a value of 8 null characters (X'00') to indicate 'no password'.

### **SERVSTATUS(cvda)**

specifies the initial service state of the nodes being defined. All nodes in the list have the same state. The relevant CVDA values are:

#### **INSERVICE**

The nodes are in service and can be used in a conversation.

#### **OUTSERVICE**

The nodes are out of service and cannot be used for any conversation.

## Conditions

<b>Condition</b>	<b>RESP2</b>	<b>Meaning</b>
INVREQ	110	SERVSTATUS value not valid.
INVREQ	111	ACQSTATUS value not valid.
INVREQ	119	The command failed for one or more items in the list.
INVREQ	131	NODENUM value out of range.
INVREQ	163	NODE name not valid.
INVREQ	173	NODE name already exists.
INVREQ	176	The VTAM OPEN ACB failed.

---

## FEPI INSTALL POOL

### Function

FEPI INSTALL POOL defines a new pool of connections to FEPI. Any targets and nodes specified in the command are added to it, thereby creating new connections in the pool. You may specify an initial service state for the pool, and initial service and acquire states for any new connections. A pool cannot be used for a

## FEPI INSTALL POOL

conversation until it has been put in service. The command completes when the pool has been created and any resources added; it does not wait for the requested states to be achieved.

## Syntax

### FEPI INSTALL POOL

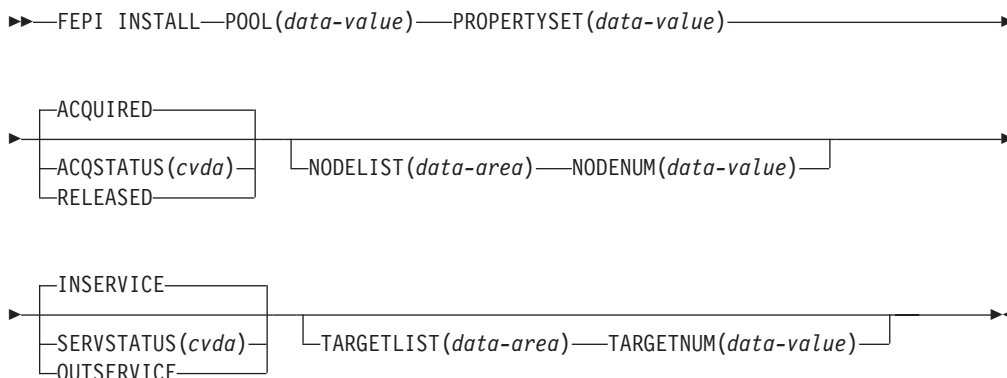

### Notes:

- 1 INVREQ, NOTAUTH

## Options

### ACQSTATUS(cvda)

specifies the initial acquire state of the connections being created. All the new connections have the same state. The relevant CVDA values are:

#### **ACQUIRED**

The connections are to have sessions established (that is, 'bound').

#### **RELEASED**

The connections are not to have sessions established (that is, left 'unbound').

### NODELIST(data-area)

specifies a contiguous array of 8-character node names. They must already be defined by FEPI INSTALL NODELIST.

### NODENUM(fullword binary data-value)

specifies the number of names in NODELIST, in the range 0–256.

### POOL(8-character data-value)

specifies the name of the pool to be defined. The name must not contain null characters (X'00'), leading blanks, or embedded blanks.

### PROPERTYSET(8-character data-value)

specifies the name of the set of properties for the pool, which must have been installed already.

### SERVSTATUS(cvda)

specifies the initial service state of the pool being defined and of the connections being created. All the new connections have the same state. The relevant CVDA values are:

**INSERVICE**

The pool and any connections are in service and can be used in a conversation.

**OUTSERVICE**

The pool and any connections are out of service and cannot be used for any conversation.

**TARGETLIST(data-area)**

specifies a contiguous array of 8-character target names. They must already be defined by FEPI INSTALL TARGETLIST.

**TARGETNUM(fullword binary data-value)**

specifies the number of names in TARGETLIST, in the range 0–256.

**Conditions**

Condition	RESP2	Meaning
INVREQ	110	SERVSTATUS value not valid.
INVREQ	111	ACQSTATUS value not valid.
INVREQ	116	TARGET name unknown.
INVREQ	117	NODE name unknown.
INVREQ	119	The command failed for one or more items in the list.
INVREQ	130	TARGETNUM value out of range.
INVREQ	131	NODENUM value out of range.
INVREQ	162	POOL name not valid.
INVREQ	171	PROPERTYSET name unknown.
INVREQ	172	POOL name already exists.
INVREQ	175	The connection already exists.

---

**FEPI INSTALL PROPERTYSET**

**Function**

FEPI INSTALL PROPERTYSET defines a new set of properties to FEPI, which can be applied to any subsequently defined pool.

**Syntax**

**FEPI INSTALL PROPERTYSET**

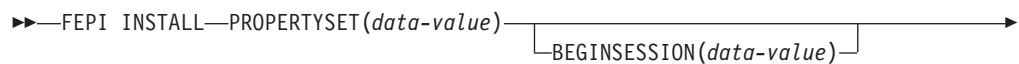

## FEPI INSTALL PROPERTYSET

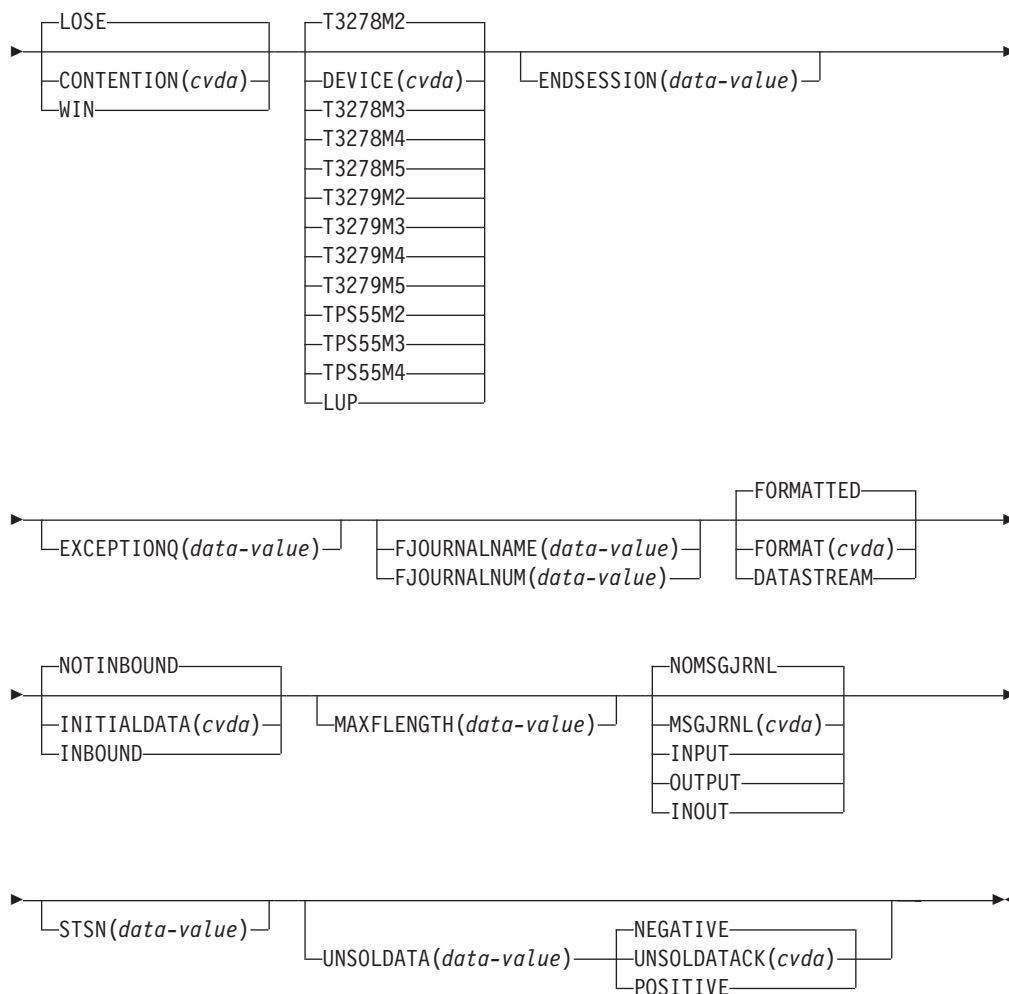

### Notes:

- 1 INVREQ, NOTAUTH

## Options

**Note:** Specifying a blank value for BEGINSESSION, ENDESESSION, EXCEPTIONQ, STSN, or UNSOLDATA has the same effect as omitting the option.

### **BEGINSESSION(4-character data-value)**

specifies the name of the transaction to perform begin-session processing, immediately after a session has been established ('bound'). If omitted, there is to be no user-supplied begin-session processing.

### **CONTENTION(cvda)**

specifies what happens when a FEPI SEND command is issued and there is inbound data with begin-bracket. The relevant CVDA values are:

**LOSE** The FEPI SEND command fails; a FEPI RECEIVE must be issued to get the inbound data.

**WIN** The FEPI SEND command succeeds; inbound data is rejected with a negative response.

**DEVICE(cvda)**

specifies the LU mode and device type that is to be simulated. The relevant CVDA values are:

<b>T3278M2</b>	SLU2 mode, 3278 Model 2
<b>T3278M3</b>	SLU2 mode, 3278 Model 3
<b>T3278M4</b>	SLU2 mode, 3278 Model 4
<b>T3278M5</b>	SLU2 mode, 3278 Model 5
<b>T3279M2</b>	SLU2 mode, 3279 Model 2B
<b>T3279M3</b>	SLU2 mode, 3279 Model 3B
<b>T3279M4</b>	SLU2 mode, 3279 Model 4B
<b>T3279M5</b>	SLU2 mode, 3279 Model 5B
<b>TPS55M2</b>	SLU2 mode, PS/55, 24 lines
<b>TPS55M3</b>	SLU2 mode, PS/55, 32 lines
<b>TPS55M4</b>	SLU2 mode, PS/55, 43 lines
<b>LUP</b>	SLU P mode, all cases.

**ENDSESSION(4-character data-value)**

specifies the name of the transaction to perform end-session processing, when a conversation is ended (by a FEPI FREE command) or when a session is to be ended ('unbound'). If omitted, there is to be no user-supplied end-session processing.

**EXCEPTIONQ(4-character data-value)**

specifies the name of the TD queue to which pool-specific exceptional events are to be notified. If EXCEPTIONQ is omitted, there is to be no user-supplied exceptional event processing.

**FJOURNALNAME(8-character data-value)**

specifies the 1- to 8-character name of the journal where data is to be logged. You are not permitted to specify DFHLOG or DFHSHUNT, the primary and secondary system logs. If the value is zero or omitted, no journaling is done.

**FJOURNALNUM(fullword binary data-value)**

specifies the number of the journal where data is to be logged, in the range 1 through 99. Specifying a value here implies the journal name 'DFHJnn', where nn is the journal number. If the value is zero or omitted, no journaling is done.

**FORMAT(cvda)**

specifies, for SLU2 mode, the data mode to be used. The relevant CVDA values are:

**FORMATTED**

Formatted operation. Character attributes are not supported on outbound data and ignored on inbound data.

**DATASTREAM**

Data stream operation.

This option is not valid for SLU P operation.

**INITIALDATA(cvda)**

specifies whether initial inbound data is expected when a session is started. The relevant CVDA values are:

## FEPI INSTALL PROPERTYSET

### NOTINBOUND

No inbound data is expected.

### **INBOUND**

Inbound data is expected.

If the target is a back-end IMS system, you should specify INBOUND. See page 154.

### **MAXLENGTH(fullword binary data-value)**

specifies the maximum length of data that can be returned on any FEPI RECEIVE, CONVERSE, or EXTRACT FIELD command for a conversation, or that can be sent by any FEPI SEND or CONVERSE command for a conversation. This value helps FEPI use storage more efficiently, so should be set no larger than is necessary. It must be in the range 128–1 048 576. If MAXLENGTH is not specified, 4096 is used.

### **MSGJRNL(cvda)**

specifies the required journaling of data to and from the back-end system. The relevant CVDA values are:

#### NOMSGJRNL

No journaling

**INPUT** Journal inbound data

#### **OUTPUT**

Journal outbound data

#### **INOUT**

Journal inbound and outbound data.

### **PROPERTYSET(8-character data-value)**

specifies the name of the set of properties to be defined. The name must not contain null characters (X'00'), leading blanks, or embedded blanks.

### **STSN(4-character data-value)**

specifies the name of the transaction to be started to handle 'set and test sequence number' (STSN), for SLU P mode only. If omitted, there is to be no user-supplied STSN-handling; FEPI handles STSN automatically.

### **UNSOLDATA(4-character data-value)**

specifies the name of the transaction to handle unsolicited data (data received outside a conversation). If omitted, there is to be no user-supplied unsolicited-data processing; FEPI treats unsolicited data as specified by UNSOLDATAACK.

### **UNSOLDATAACK(cvda)**

if there is to be no unsolicited-data processing, this specifies what acknowledgment FEPI is to give to a BID. The relevant CVDA values are:

#### NEGATIVE

Negative response X'0813', BID not accepted

#### **POSITIVE**

Positive response, BID accepted and subsequent data is accepted and discarded.

## Conditions

Condition	RESP2	Meaning
INVREQ	140	DEVICE value not valid.



Condition	RESP2	Meaning
INVREQ	141	CONTENTION value not valid.
INVREQ	142	INITIALDATA value not valid.
INVREQ	143	UNSOLDATAACK value not valid.
INVREQ	144	MSGJRNL value not valid.
INVREQ	150	FORMAT value not valid or is unsuitable for the LU mode and device type specified by the DEVICE value.
INVREQ	153	STSN name not valid or STSN is not allowed for the LU mode and device type specified by the DEVICE value.
INVREQ	154	BEGINSESSION name not valid.
INVREQ	155	UNSOLDATA name not valid.
INVREQ	156	EXCEPTIONQ name not valid.
INVREQ	157	FJOURNALNUM value not valid.
INVREQ	158	MAXFLENGTH value not valid.
INVREQ	159	ENDSESSION name not valid.
INVREQ	160	PROPERTYSET name not valid.
INVREQ	170	PROPERTYSET name already exists.
INVREQ	178	FJOURNALNAME value not valid.

## FEPI INSTALL TARGETLIST

### Function

FEPI INSTALL TARGETLIST defines new targets to FEPI. You can specify an initial service state for these new targets. A target cannot be used for a conversation until it has been put in service, and has been added to a pool so that it is connected to a node. The command completes when the targets have been installed without waiting for the requested states to be achieved.

### Syntax

#### FEPI INSTALL TARGETLIST

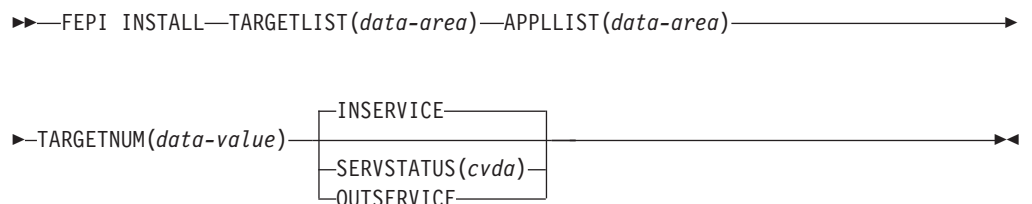

#### Notes:

- 1 INVREQ, NOTAUTH

### Options

#### APPLIST(*data-area*)

specifies a contiguous array of 8-character primary logical unit (PLU) names. These are the VTAM application names (APPLID) of the back-end CICS or IMS systems with which FEPI applications are to communicate; they correspond one-to-one with the target names in TARGETLIST. The names must not contain

## FEPI INSTALL TARGETLIST

null characters (X'00'), leading blanks, or embedded blanks. Each name must be unique within the list; duplicate names result in an INVREQ condition being returned.

If a target specified in TARGETLIST is a CICS terminal-owning region that is a member of a VTAM generic resource group, you can specify in APPLIST its generic resource name. This enables you to use the VTAM generic resource function to balance sessions across the available TORs. See "Workload balancing in a sysplex" on page 23.

### **SERVSTATUS(cvda)**

specifies the initial service state of the targets being defined. All the targets in the list have the same state. The relevant CVDA values are:

#### **INSERVICE**

The target is in service and can be used in a conversation.

#### **OUTSERVICE**

The target is out of service and cannot be used for any conversation.

### **TARGETLIST(data-area)**

specifies a contiguous array of 8-character target names to be defined. A target name is the logical FEPI front-end name of a back-end system. The names must not contain null characters (X'00'), leading blanks, or embedded blanks. Each name must be unique within the list; duplicate names result in an INVREQ condition being returned.

### **TARGETNUM(fullword binary data-value)**

specifies the number of names in TARGETLIST, in the range 1–256.

## Conditions

<b>Condition</b>	<b>RESP2</b>	<b>Meaning</b>
INVREQ	110	SERVSTATUS value not valid.
INVREQ	119	The command failed for one or more items in the list.
INVREQ	130	TARGETNUM value out of range.
INVREQ	164	TARGET name not valid.
INVREQ	167	Application name not valid.
INVREQ	174	TARGET name already exists.
INVREQ	177	Application name already exists.

---

## FEPI SET CONNECTION

### Function

FEPI SET CONNECTION controls the use of FEPI connections. Lists may be used to set more than one connection at a time; all connections in the list are set to the same state. The command completes immediately, although the requested settings may not be achieved until later.

### Syntax

#### **FEPI SET CONNECTION**

►► FEPI SET CONNECTION — [ NODE(*data-value*) — NODELIST(*data-area*) — NODENUM(*data-value*) ] —►

## FEPI SET CONNECTION

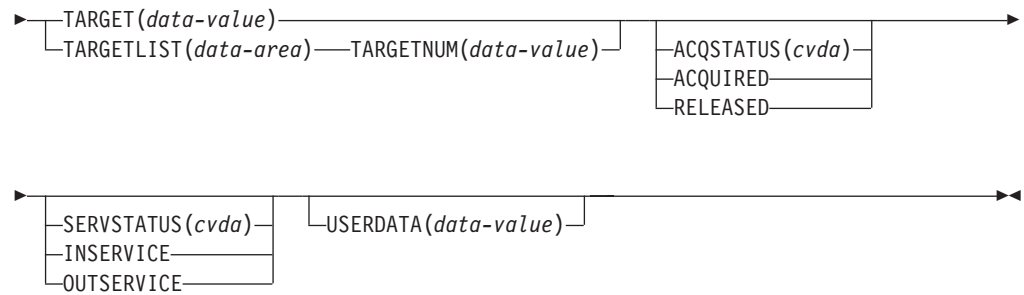

### Notes:

- 1 INVREQ, NOTAUTH

## Options

### ACQSTATUS(cvda)

specifies the acquire state of the connection; that is, whether a session should be established ('bound') or not ('unbound'). The relevant CVDA values are:

#### ACQUIRED

The connection is to have a session established (that is, 'bound'). The state is ACQUIRING until this is completed.

#### RELEASED

The connection is to have its session ended (that is, 'unbound'), when usage of the connection by all owned conversations ends. However, if ownership of a conversation is relinquished by a FREE PASS command, a subsequent FREE RELEASE command must be issued before the session can be 'unbound' as a result of a SET CONNECTION RELEASED command. (An unowned conversation on the connection is ended immediately. See the STATE option of FEPI INQUIRE CONNECTION on page 97.) The state is RELEASING until this is completed.

#  
#  
#  
#  
#  
#  
#  
#  
#  
#

If this option is not coded, the acquire state is not changed.

### NODE(8-character data-value)

specifies the node name that identifies a connection.

### NODELIST(data-area)

specifies a contiguous array of 8-character node names identifying connections.

### NODENUM(fullword binary data-value)

specifies the number of node names in NODELIST, in the range 1–256.

### SERVSTATUS(cvda)

specifies the service state of the connection; that is, whether the connection can be used for a conversation or not. The relevant CVDA values are:

#### INSERVICE

Allows usage of the connection in a conversation.

#### OUTSERVICE

Stops usage of a connection for any new conversation, although existing conversations are unaffected. The service state is GOINGOUT until these conversations end.

If this option is not coded, the service state is not changed.

## FEPI SET CONNECTION

### TARGET(8-character data-value)

Specifies the target name that identifies a connection.

### TARGETLIST(data-area)

specifies a contiguous array of 8-character target names identifying a connection or connections.

### TARGETNUM(fullword binary data-value)

specifies the number of target names in TARGETLIST, in the 1–256.

### USERDATA(64-character data-value)

Specifies optional user data relating to the connections; it is not used by FEPI. It replaces any previous user data that was set.

## Conditions

Condition	RESP2	Meaning
INVREQ	110	SERVSTATUS value not valid.
INVREQ	111	ACQSTATUS value not valid.
INVREQ	116	TARGET name unknown.
INVREQ	117	NODE name unknown.
INVREQ	118	Unknown connection (TARGET and NODE names are known but not connected in any pool).
INVREQ	119	The command failed for one or more items in the list.
INVREQ	130	TARGETNUM value out of range.
INVREQ	131	NODENUM value out of range.

---

## FEPI SET NODE

### Function

FEPI SET NODE controls the use of FEPI nodes. Lists may be used to set more than one node at a time; all nodes in the list are set to the same state. The function completes immediately, although the requested settings may not be achieved until later.

### Syntax

#### FEPI SET NODE

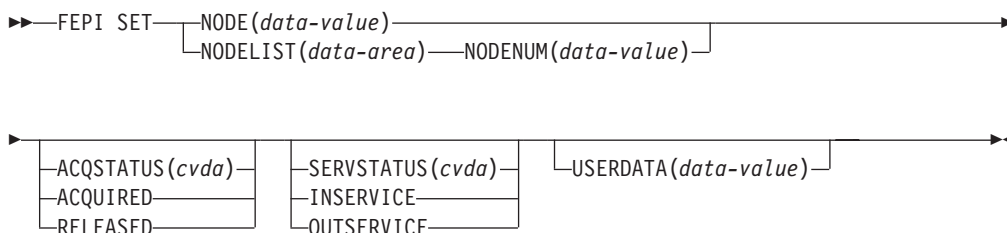

#### Notes:

- 1 INVREQ, NOTAUTH

## Options

### **ACQSTATUS(cvda)**

specifies the acquire state of the node; that is, whether its VTAM ACB should be opened or closed. The relevant CVDA values are:

#### **ACQUIRED**

The VTAM ACB for the node is to be opened and 'set logon start' is to be done. The state is ACQUIRING until this is completed.

#### **RELEASED**

The VTAM ACB for the node is to be closed when usage of the node by any conversation ends. The state is RELEASING until this is completed.

If this option is not coded, the acquire state is not changed.

### **NODE(8-character data-value)**

specifies the node to be set.

### **NODELIST(data-area)**

specifies a contiguous array of 8-character node names to be set.

### **NODENUM(fullword binary data-value)**

specifies the number of node names in NODELIST, in the range 1–256.

### **SERVSTATUS(cvda)**

specifies the service state of the node; that is, whether the node can be used for a conversation or not. The relevant CVDA values are:

#### **INSERVICE**

Allows usage of the node in a conversation.

#### **OUTSERVICE**

Stops usage of a node for any new conversation, although existing conversations are unaffected. The service state is GOINGOUT until these conversations end.

If this option is not coded, the service state is not changed.

### **USERDATA(64-character data-value)**

Specifies optional user data relating to the nodes; it is not used by FEPI. It replaces any previous user data that was set.

## Conditions

<b>Condition</b>	<b>RESP2</b>	<b>Meaning</b>
INVREQ	110	SERVSTATUS value not valid.
INVREQ	111	ACQSTATUS value not valid.
INVREQ	117	NODE name unknown.
INVREQ	119	The command failed for one or more items in the list.
INVREQ	131	NODENUM value is out of range.
INVREQ	174	The VTAM OPEN ACB failed.

## FEPI SET POOL

### Function

FEPI SET POOL controls the use of FEPI pools. Lists may be used to set more than one pool at a time; all pools in the list are set to the same state. The function completes immediately, although the requested settings may not be achieved until later.

### Syntax

#### FEPI SET POOL

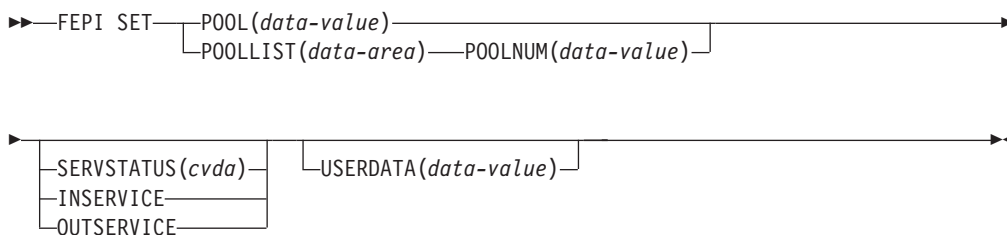

#### Notes:

- 1 INVREQ, NOTAUTH

### Options

#### POOL(8-character data-value)

specifies the pool to be set.

#### POOLLIST(data-area)

specifies a contiguous array of 8-character pool names to be set.

#### POOLNUM(fullword binary data value)

specifies the number of pool names in POOLLIST, in the range 1–256.

#### SERVSTATUS(cvda)

specifies the service state of the pool; that is, whether the pool can be used for a conversation or not. The relevant CVDA values are:

##### INSERVICE

Allows usage of the pool in a conversation.

##### OUTSERVICE

Stops usage of a pool for any new conversation, although existing conversations are unaffected. The service state is GOINGOUT until these conversations end.

If this option is not coded, the service state is not changed.

#### USERDATA(64-character data-value)

Specifies optional user data relating to the pools; it is not used by FEPI. It replaces any previous user data that was set.

## Conditions

Condition	RESP2	Meaning
INVREQ	110	SERVSTATUS value not valid.
INVREQ	115	POOL name unknown.
INVREQ	119	The command failed for one or more items in the list.
INVREQ	132	POOLNUM value is out of range.

---

## FEPI SET TARGET

### Function

FEPI SET TARGET controls the use of FEPI targets. Lists may be used to set more than one target at a time; all targets in the list are set to the same state. The function completes immediately, although the requested settings may not be achieved until later.

### Syntax

#### FEPI SET TARGET

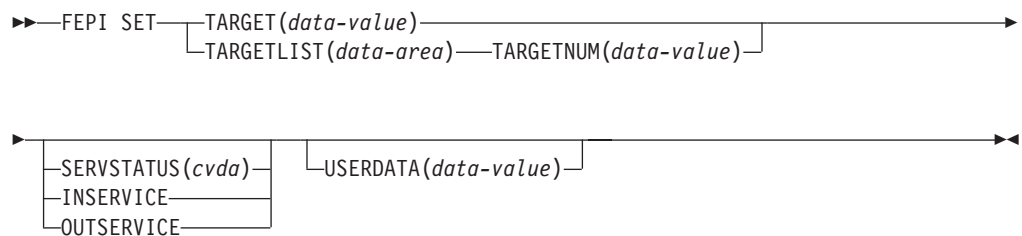

#### Notes:

- 1 INVREQ, NOTAUTH

### Options

#### SERVSTATUS(cvda)

specifies the service state of the target; that is, whether the target can be used for a conversation or not. The relevant CVDA values are:

#### INSERVICE

Allows usage of the target in a conversation.

#### OUTSERVICE

Stops usage of a target for any new conversation, although existing conversations are unaffected. The service state is GOINGOUT until these conversations end.

If this option is not coded, the service state is not changed.

#### TARGET(8-character data-value)

specifies the name of the target to be set.

#### TARGETLIST(data-area)

specifies a contiguous array of 8-character target names to be set.

## FEPI SET TARGET

### TARGETNUM(fullword binary data-value)

specifies the number of target names in TARGETLIST, in the 1–256.

### USERDATA(64-character data-value)

Specifies optional user data relating to the targets; it is not used by FEPI. It replaces any previous user data that was set.

## Conditions

Condition	RESP2	Meaning
INVREQ	110	SERVSTATUS value not valid.
INVREQ	116	TARGET name unknown.
INVREQ	119	The command failed for one or more items in the list.
INVREQ	130	TARGETNUM value is out of range.

---

## FEPI SP NOOP

### Function

FEPI SP NOOP has no effect.

### Syntax

#### FEPI SP NOOP

▶▶—FEPI SP NOOP—▶▶

#### Notes:

- 1 INVREQ, NOTAUTH

### Options

None.

### Conditions

None specific to this command.

---

## Transient data queue records

In response to various unexpected events, FEPI writes a record, describing the event and its circumstances, to a transient data (TD) queue. Such events include:

- Errors in functions initiated by a system programming command
- Errors for items in a list on a system programming command
- Events unrelated to any command.

If the event relates to a specific pool, the record is written to the queue specified by EXCEPTIONQ for that pool; if EXCEPTIONQ was not specified, no record is written. If the event does not relate to a specific pool, the record is written to queue CSZX. In all cases, if the appropriate TD queue does not exist or if it is not defined as non-recoverable, the record is lost.



The format of the record is as follows. The copy books DFHSZAPA, DFHSZAPO, DFHSZAPC, and DFHSZAPP (according to your programming language) provide declarations for this record structure.

DATATYPE	Fullword binary data-area
EVENTTYPE	CVDA
EVENTVALUE	Fullword binary data-area
EVENTDATA	8-character data-area
Reserved	4-character data-area
POOL	8-character data-area
TARGET	8-character data-area
NODE	8-character data-area
CONVID	8-character data-area
DEVICE	CVDA
FORMAT	CVDA
Reserved	8-character data-area.

## Fields

### CONVID(8-character data-area)

the conversation ID for which the event occurred; null if not applicable.

### DATATYPE(fullword binary data-area)

identifies the type and structure of the data. A value of 2 indicates FEPI TD queue data.

### DEVICE(cvda)

the device type of the conversation for which the event occurred (the values are as for FEPI INQUIRE POOL); zero if not applicable.

### EVENTDATA(8-character data-area)

contains data about the event:

Event	Data
ACQFAIL	2 fullword binary numbers: <ul style="list-style-type: none"> <li>• VTAM reason code</li> <li>• Count</li> </ul>
SESSIONFAIL	2 fullword binary numbers: <ul style="list-style-type: none"> <li>• VTAM reason code</li> <li>• Count</li> </ul>
SESSIONLOST	2 fullword binary numbers: <ul style="list-style-type: none"> <li>• VTAM reason code</li> <li>• Count</li> </ul>
Others	Nulls

If the count is nonzero, it indicates the number of times the node acquire or session start has failed; it will be tried again. A zero count indicates that several failures have occurred and that there will be no further attempts to acquire the node or start the session.

### EVENTTYPE(cvda)

indicates what the event was.

Exceptional events queued to common TD queue CSZX:

ACQFAIL	A node could not be acquired (its VTAM ACB could not be opened).
---------	--

## TD queue records

DISCARDFAIL	A resource in a list could not be discarded by FEPI DISCARD.
INSTALLFAIL	A resource in a list could not be installed by FEPI INSTALL.
SESSION	An unsolicited bind was received.
SETFAIL	A connection or resource in a list could not be set by FEPI SET or FEPI INSTALL.

Exceptional events queued to pool-specific TD queue:

ADDFAIL	A connection in a list could not be added to the pool by FEPI ADD.
DELETEFAIL	A connection in a list could not be deleted from the pool by FEPI DELETE.
SESSIONFAIL	Session could not be started.
SESSIONLOST	Active session was lost.

### EVENTVALUE(fullword binary data area)

provides further information about the event. Values are:

Event	Value
ACQFAIL	0
ADDFAIL	The RESP2 value describing the failure, as given in the description of the FEPI ADD command
DELETEFAIL	The RESP2 value describing the failure, as given in the description of the FEPI DELETE command
DISCARDFAIL	The RESP2 value describing the failure, as given in the description of the FEPI DISCARD command
INSTALLFAIL	The RESP2 value describing the failure, as given in the description of the FEPI INSTALL command
SESSION	0
SESSIONFAIL	The RESP2 value describing the communication failure; it can be any of the RESP2 values in the range 182–199.
SESSIONLOST	The RESP2 value describing the communication failure; it can be any of the RESP2 values in the range 182–199.
SETFAIL	The RESP2 value describing the failure, as given in the description of the FEPI SET command

### FORMAT(cvda)

the data format of the conversation for which the event occurred (the values being as for FEPI INQUIRE POOL); zero if not applicable.

### NODE(8-character data-area)

the name of the node for which the event occurred; nulls if not applicable.

### POOL(8-character data-area)

the name of the pool for which the event occurred; nulls if not applicable.

### TARGET(8-character data-area)

the name of the target for which the event occurred; nulls if not applicable. For the SESSION event, it is the VTAM application name of the back-end system, rather than the FEPI target name.

### Reserved

nulls.

---

## Chapter 10. Problem determination

This chapter contains guidance information to help you identify the source of errors that affect your FEPI applications. For information about using CICS debugging tools, trace, and dump, see the *CICS Problem Determination Guide*.

This chapter contains Diagnosis, Modification or Tuning information. It contains the following topics:

- “Debugging FEPI applications”
- “FEPI dump”
- “FEPI trace” on page 128
- “FEPI messages” on page 129
- “FEPI abends” on page 129
- “Reporting a FEPI problem to IBM” on page 131.

---

### Debugging FEPI applications

The CICS execution diagnostic facility (EDF) helps users of the EXEC CICS interface to step through the EXEC CICS commands of an application program. EDF can be used in just the same way to debug programs that use the EXEC CICS FEPI commands.

---

### FEPI dump

CICS dump routines are available for FEPI. These routines are under the control of the usual CICS selection mechanisms.

You generate interpretation of the FEPI areas of a CICS dump by specifying the SZ keyword from within the interactive problem control system (IPCS). SZ can take the following values:

<b>SZ value</b>	<b>What is printed</b>
<b>0</b>	No FEPI areas are interpreted.
<b>1</b>	All FEPI areas are interpreted, excluding the stacks.
<b>2</b>	All FEPI areas are interpreted, including the stacks.

If you are looking at a FEPI problem, first ensure the SZ TCB is active, and the FEPI Resource Manager is running. Look at the kernel and dispatcher prints to verify their presence.

If the SZ TCB is present, and the FEPI Resource Manager is running, the problem is probably caused by a wait or an abend. In the case of a wait, the dispatcher and kernel prints should show where it is located.

After looking at any FEPI trace entries, you should direct your attention to the output from the ‘SZ=2’ dump formatting keyword. This displays all known FEPI control blocks. If you think a storage violation has occurred, use the dump storage manager options to display the contents of the FEPI storage subpools.

Here are some things that might help you identify a problem when you read the dump:

- Were any errors reported during interpretation? If so, this may indicate a corrupt address pointer or a broken chain.

## Problem determination

- Follow all the pointers to associated control blocks (such as the conversation pointed to by the connection). Is this pointer correct? If not, this probably indicates corruption.
- Are there the expected numbers of nodes, targets, property sets, and pools? If not, this can indicate a broken chain or an unauthorized deletion.
- Does each pool contain the expected number of connections (that is, the number of nodes multiplied by the number of targets)? If not, this may indicate the failure of a FEPI ADD command.
- Has each node been successfully acquired? If not, there is the possibility of VTAM definition errors. The ACB and RPL may contain VTAM sense information—perhaps a VTAM major node is inactive.
- Is there successful communication with a target? If not, have APPLID and PASSWORD been correctly specified? If they are correct, is the back-end system running?
- Are there any queued ALLOCATE commands? If so, this indicates that there are not enough connections for the pool to process FEPI conversations without queuing. This may be acceptable, or not, depending on your configuration.
- Are the event handlers being run? If not, have they been correctly defined to CICS using RDO?
- Are the event handlers being recursively invoked? If so, this indicates a problem with a FEPI FREE command, a storage violation, or an internal logic error.
- Is information being correctly sent to the specified transient data queues? If not, are the queues defined as unrecoverable? Investigation of the DCT may help here.
- Are transactions being triggered from the TDQs? If not, are the transactions correctly defined to CICS?
- Is there a current conversation? If so, this conversation may be causing the error. Is the data correct? Is there any VTAM sense information in the RPL?
- Are the surrogate terminals correct? If not, the links between the nodes, pools, and targets may have become corrupted.
- Are FEPI SEND or FEPI RECEIVE commands failing due to state errors? If so, look at the conversation and see if the states are correct. If they are not, the conversation has become out of step with the VTAM flow.
- Is unexpected data being sent or received in formatted conversations? If so, there may be corrupt FEPI data. Look at FEPI's internal terminal character buffer.
- Look at the queues. Are there any requests that look as if they have got stuck? If so, the FEPI work chains may be corrupt. However, it may be simply that the flow to satisfy the requests has not yet happened. If you think it should have happened, there may be communication problems.
- Look at the FREE queue. The last VTAM event may be shown. If so, does it correspond with what you expected?
- Is the behavior of a pool correct? If not, it is possible that the property set used to define the pool is incorrect. However, if the property set is shown, it could have been re-created since the pool was defined—treat property set definitions with care.
- Are there any outstanding timer events that should have run? If so, this may indicate a chaining failure.
- Has a timer-dependent action been delayed? If so, this could indicate that the TIMEOUT parameter on the command was incorrect.
- Are you receiving all the data you expect? If not, have you set the correct end-of-flow condition on the FEPI RECEIVE (or CONVERSE) command?

- Are there many transactions waiting on FEPI? If so, either back-end systems are not responding, or the FEPI Resource Manager has failed.
- Has a VTAM dump been taken? If so, this may indicate a failure in one of the VTAM exits.

## Using CICS dump facilities to investigate FEPI problems

This section describes how FEPI relates to the rest of CICS, and how its presence is revealed by the other CICS dump formatting commands.

The problem determination process for FEPI is driven from the usual CICS dump interpretation routines. The following sections describe what to look for in the major CICS areas.

### Dispatcher

You should see a task (CSZI) running under the SZ task control block. (However, note that CSZI can run under the QR TCB while executing certain CICS functions, such as starting transactions and writing to transient data queues.) If CSZI is not present, then either FEPI is not in the system, or the FEPI Resource Manager has failed.

Application programs waiting for responses from the FEPI Resource Manager are shown as waiting on FEPI. (For details of FEPI waits, see the *CICS Problem Determination Guide*.)

### Interval control

Any transactions that have been started by the FEPI Resource Manager, but not yet run, appear in the interval control section.

### Kernel

In the kernel, you should find a running task named KETCB SZ representing the SZ TCB that FEPI uses. If KETCB SZ is not present, then either FEPI is not in the system, or the TCB has abended.

You should find the CSZI task either running or waiting. If CSZI is not present, then either FEPI is not in the system, or the FEPI Resource Manager has failed.

If an abend has occurred, the usual information is available. The location of the abend is indicated by the failing module, as follows:

#### DFHESZ

The application programming EXEC stub

#### DFHEIQSZ

The system programming EXEC stub

#### DFHSZATR

The FEPI adapter

#### DFHSZRMP

The FEPI Resource Manager.

### Storage manager

Table 11 on page 128 lists the CICS storage subpools used by FEPI. You can use the storage manager dump facilities to display the contents of these subpools. If you suspect a storage violation, a comparison of the contents of these subpools with the areas interpreted by a FEPI dump may show where the corruption has occurred.

## Problem determination

Table 11. FEPI storage subpools

Name	Type	Chained	Above or below 16MB line?	Usage
SZSPFCAC	Fixed	Yes	Below	ACBs
SZSPFCCD	Fixed	Yes	Any	Connections
SZSPFCCM	Fixed	Yes	Any	Common area
SZSPFCCV	Fixed	Yes	Any	Conversations
SZSPVUDA	VAR	Yes	Any	Various data areas
SZSPFCDS	Fixed	Yes	Any	Device support extensions
SZSPFCDT	Fixed	Yes	Any	Device-type control areas
SZSPFCNB	Fixed	Yes	Any	NIBs
SZSPFCND	Fixed	Yes	Any	Nodes
SZSPFCPD	Fixed	Yes	Any	Pools
SZSPFCPS	Fixed	Yes	Any	Property sets
SZSPFCRP	Fixed	Yes	Any	RPLs
SZSPFCRQ	Fixed	Yes	Any	Requests
SZSPFCSR	Fixed	Yes	Any	Surrogates
SZSPFCTD	Fixed	Yes	Any	Targets
SZSPFCWE	Fixed	Yes	Any	DQEs

---

## FEPI trace

There are appropriate trace entries in the CICS trace table which are under the control of the usual CICS mechanisms. FEPI trace entries are listed in the *CICS User's Handbook*.

FEPI generates exception and event trace entries—the latter under control of the 'SZ' component code. Points AP 1200 through AP 16FF are reserved for use by FEPI, although not all of these are used.

## Taking trace entries

You control the taking of FEPI trace entries with the CETR SZ transaction, or the SET TRACETYPE SZ command. FEPI supports only one level of tracing—either all or nothing. At CICS initialization, you can specify the default levels of standard and special tracing by means of the STNTR, SPCTR, STNTRSZ, and SPCTRSZ system initialization parameters, which are described in the *CICS System Definition Guide*. Exception trace entries are always taken.

You can use the selection features of the CETR transaction to limit tracing to specific transactions. This is described in the *CICS Supplied Transactions* manual. If you do this, you can control the tracing of application programs, but the FEPI Resource Manager, running as the CSZI transaction, is unaffected, because trace selection is applied only at transaction start.

If you are using DFHTRAP under the guidance of IBM support, note that the FEPI Resource Manager runs under the SZ TCB. Therefore, do not do anything that could force an MVS task switch to any other TCB.

### Interpreting FEPI trace entries

The first thing to consider is whether there are any exception trace entries. Their presence indicates that a problem has been detected, and (perhaps) that the appropriate action has been taken. Exception trace entries are either initialization errors or storage management errors.

Initialization errors result from checks made when CSZI starts, to prevent a second instance of the FEPI Resource Manager. Storage errors result from GETMAIN or FREEMAIN errors, and are usually caused by a lack of CICS storage.

The other trace entries are the usual module entry and exit traces, together with a few points indicating that important processing events have occurred (such as the FEPI Resource Manager becoming idle).

---

### FEPI messages

Messages produced by FEPI have exactly the same format (DFHSZ...) as other CICS messages. They are all sent to the FEPI message log (the CSZL transient data queue); some are also sent to the operator.

FEPI messages are documented in the *CICS Messages and Codes* manual, and are also available through the CMAC transaction.

---

### FEPI abends

FEPI does not (deliberately) issue either CICS transaction abends or MVS abends. However, an unexpected failure can occur in the following places:

- In a FEPI application program when INVREQ is returned
- In the EXEC stubs
- In the FEPI adapter
- In the FEPI Resource Manager transaction (CSZI) code
- In a VTAM exit routine.

## Problem determination

These abends have different results, as shown in Table 12.

Table 12. Types of abend issued by FEPI

Point of failure	Result
Application	The usual transaction abend for the error condition.
EXEC stubs	The usual transaction abend for a failure within CICS management modules. An example of this is an 'operation' program check, which generates a CICS AKEA abend, which in turn generates an ASRA abend.
FEPI adapter	The usual transaction abend for a failure within CICS management modules. An example of this is an 'operation' program check, which generates a CICS AKEA abend, which in turn generates an ASRA abend.
FEPI Resource Manager	No direct effect on the application program, because the abend occurs under the CSZI Resource Manager task. This probably results in a DFHSZ4099E message (see "Message DFHSZ4099E"), and the failure of the Resource Manager. An example of this is an 'operation' program check, which generates a CICS AKEA abend, which in turn generates an ASRA abend. Any CICS FEPI transactions are left waiting on the FEPI_RQE resource (for details of FEPI waits, see the <i>CICS Problem Determination Guide</i> ).
VTAM exit	A VTAM abend; a VTAM dump is taken. Because the exit lies within the FEPI Resource Manager, the CICS abend handling routines are activated to process a "normal" failure in the Resource Manager.

## Restart

An abend in an application program, an EXEC stub, or the FEPI adapter affects only the active CICS task that issued the FEPI command; other FEPI programs continue as normal.

If an abend affects the SZ TCB, CICS makes that TCB unavailable for use, while keeping the other CICS TCBs active and accessible. This means that FEPI functions can be restored only by restarting the CICS system.

## Message DFHSZ4099E

This message indicates that the abend exit routine within the FEPI adapter has trapped an abend within the FEPI Resource Manager.

As soon as an abend within the Resource Manager is detected, the FEPI state (in the FEPI static area) is set to 'Failed'. If possible, message DFHSZ4099E is issued, together with a SNAP dump, to indicate that FEPI has failed. However, in some circumstances it is not possible to issue DFHSZ4099E, and a system dump is generated instead.

Any FEPI transactions are left waiting on the FEPI\_RQE resource (for details of FEPI waits, see the *CICS Problem Determination Guide*). These waits never get posted, so the transactions suspend. You must issue a CEMT FORCEPURGE command to remove these suspended transactions from the system.

**Attention:** It is strongly recommended that the CSZI transaction is initiated only as part of CICS system initialization. *Do not attempt to restart the CSZI transaction after a failure, other than by restarting CICS.*



## Message DFHSZ4155I

This message indicates that a connection has ended, and gives a reason code taken from the VTAM control blocks. The reason code may be returned in the LASTACQCODE option of a CEMT or FEPI INQUIRE command, depending on the operation which generated DFHSZ4155I.

DFHSZ4155I does not always indicate a problem; if you took positive action to end the connection, DFHSZ4155I merely confirms that VTAM did as you requested. However, if the connection ended unexpectedly, the reason code tells you why.

To determine what the reason code means, refer to the *VTAM Programming* manual.

---

## Reporting a FEPI problem to IBM

When reporting a problem to IBM Support, you need the following details of the CICS system in which FEPI is installed:

- All listings from the CICS job, including the CICS job log and JCL
- A print of all reports sent to the CSZL transient data queue
- A full system dump (including the CSA and LSQA)
- Any relevant transaction dumps
- All trace entries (you may need to recreate the problem with SZ trace active)
- A listing of the application program that detected the problem
- Listings of the programs used to configure your FEPI system
- Listings of any active CICS global user exit programs (not only the FEPI ones)
- Prints of user journals, if FEPI journaling was active when the problem occurred.

The following materials might also be required:

- A VTAM trace showing the data flows
- A trace of the back-end system showing what data streams were received from FEPI application programs
- A VTAM status display showing the status of FEPI connections
- Any dumps or logs produced by the back-end system.

## Problem determination

---

## Part 3. Application programming

This part of the book is primarily for application programmers and includes reference information for FEPI application programming commands.

- “Chapter 11. Basics of FEPI programming” on page 135 introduces FEPI programming and the commands that are used.
- “Chapter 12. Key stroke and screen-image applications” on page 139 discusses the high-level interface for FEPI applications.
- “Chapter 13. Data stream applications” on page 147 describes the low-level interface for FEPI applications.
- “Chapter 14. Application design” on page 153 describes the programs comprising a FEPI application and various design aspects such as conversation ownership, handling errors, and specific requirements for CICS and IMS back-end systems.
- “Chapter 15. Specialized functions” on page 167 describes control functions, normally handled by FEPI, that can be taken over by FEPI applications.
- “Chapter 16. Application programming reference” on page 169 contains reference information for the FEPI commands that are used in application programs.



---

## Chapter 11. Basics of FEPI programming

This chapter introduces FEPI programming and the FEPI commands that you can use. Before reading this chapter you should be familiar with the FEPI concepts and facilities described in “Chapter 1. Introducing FEPI” on page 3 and “Chapter 2. Functions and services” on page 9.

To write FEPI front-end applications, you need to know how to write programs in at least one of the programming languages that CICS supports. More importantly, you also need knowledge of data communication and protocols. And, if you will be accessing IMS back-end systems, you must also be familiar with using IMS and writing IMS applications.

The applications that you write using FEPI are normal CICS transactions with the familiar EXEC CICS commands. These FEPI applications use the FEPI subset of EXEC CICS application programming commands to:

- Allocate a connection from a pool
- Communicate with a back-end application using this connection
- Free the connection when finished.

The chapter contains the following topics:

- “Communication and conversations”
- “Structure and design” on page 136.

---

### Communication and conversations

**Note:** The highlighted terms in this section are defined in “Chapter 2. Functions and services” on page 9.

A FEPI application runs in a **front-end** CICS system and accesses applications in a **back-end** CICS or IMS system. FEPI lets it do this by simulating a terminal connected to the back-end system; this means that it has to act just like a real terminal and terminal operator.

The back-end systems are known as **targets** and the **connections** to them are arranged in **pools** that define the properties controlling communication. Targets, pools, and properties are defined by your system programmer, who can tell you which targets and pools to use and what properties they have.

When a connection has been established, on successful completion of a bind, the connection is **in session** and it can be allocated by FEPI for a **conversation** with the back-end system.

Conversations are the basis of all FEPI applications and, depending upon the needs of your application, may be used in several ways (see “Chapter 14. Application design” on page 153):

- A single conversation for all transactions on a back-end system
- A different conversation for each transaction or associated series of transactions
- A special conversation to handle unusual events.

The task that started the conversation owns it and other tasks cannot issue commands for it; however, the owning task can transfer ownership to another task. You can have as many conversations as you like at a time with various targets: they can be consecutive or, much more usefully, interleaved.

## Basics

FEPI simulates a 3270-type terminal (SLU2 mode) for both CICS and IMS systems; it also supports the SLU P mode that is used by IMS for programmable terminals such as the 4700 family. The mode to be used, SLU2 or SLU P, is a property of the pool being used. Your application cannot change the mode of a conversation.

The data that you send and receive can be **formatted** or **data stream** and, as with mode, the data type is a property of the pool being used:

### Formatted

A high-level data interface for SLU2 mode. The data sent by the FEPI application can be either **key stroke** format or **screen-image** format; data received by the application is in screen-image format.

### Data stream

A low-level data interface for more sophisticated SLU2 mode applications and for use with SLU P mode. The data sent and received by the FEPI application is the data stream; applications using this format have access to some very specialized VTAM communication functions.

The same basic set of FEPI commands is used for all modes and data types and protocols, but the command options and keywords are generally different.

---

## Structure and design

In addition to your main access program that handles communication with the back-end system, you may need to provide programs for other functions:

### Begin session

Handle begin-session processing.

### Unsolicited data

Handle unsolicited inbound data that arrives when there is no conversation.

### End session

Handle end of conversation and end of session processing.

These functions could be combined in one program or implemented in separate programs with individual transaction names. There may be any number of each function, again according to your requirements and preferences. Suggestions about the various possibilities are given later.

As the application programmer, you will always write the main access programs. Sometimes the system programmer provides any special functions that are required; otherwise you would be responsible for these. Even if you are writing only the main access program, you need to be aware of what these special functions do and how they affect how you communicate with the back-end system. Because the use of these special functions is controlled by the pools that you use, you need to liaise with the system programmers or administrators who set them up.

Several different styles of access program are possible:

### One-out one-in conversational

One program performs the complete conversation with the target and each conversation has a single transmission to and from the back-end system.

### Conversational

One program performs the complete conversation with the target with multiple transmissions to and from the back-end system, waiting each time for the inbound data.

**Pseudoconversational**

Here, one program sends data to the target and requests CICS to start another program when the inbound data arrives.

The section beginning with “Chapter 12. Key stroke and screen-image applications” on page 139 and ending with “Chapter 15. Specialized functions” on page 167 describes the various features of writing application programs. A set of sample programs is available to help you to get started; these are supplied as source code on the distribution tape. For details, see “Appendix A. Sample programs” on page 219.

**Programming**

FEPI programs are CICS applications, so all aspects of CICS programming apply. For general information about writing CICS application programs, see the *CICS Application Programming Guide*. For programming information (including command formats, argument values, details on the translation of programs, and language considerations), see the *CICS Application Programming Reference*. Particularly relevant are the chapters in the *CICS Application Programming Guide* about designing efficient applications and dealing with exception conditions.

The FEPI application programming commands are an extension of the EXEC CICS commands. They have similar names and similar functions. The FEPI commands also have similar keywords, but they are distinguished by having FEPI as a prefix. For application programming the commands are:

**EXEC CICS FEPI ALLOCATE**

Starts a conversation with a back-end system.

**EXEC CICS FEPI FREE**

Ends the conversation with a back-end system.

**EXEC CICS FEPI REQUEST PASSTICKET**

Requests the external security manager to supply a password substitute.

**EXEC CICS FEPI SEND**

Sends data to the back-end system.

**EXEC CICS FEPI RECEIVE**

Receives data from the back-end system.

**EXEC CICS FEPI CONVERSE**

Sends data to and receives data from the back-end system.

**EXEC CICS FEPI ISSUE**

Sends control data to the back-end system.

**EXEC CICS FEPI EXTRACT**

Gets field data and attributes, set-and-test sequence number (STSN) data, or information about a conversation.

**EXEC CICS FEPI START**

Schedules a CICS transaction to handle inbound data.

Note that, when translating your programs, you must specify the FEPI option; this instructs the translator to process FEPI commands.

Your FEPI application programs can be AMODE(24) or AMODE(31)—that is, they can issue FEPI commands in either 24- or 31-bit addressing mode, and reside above or below the 16MB line.

### Exception conditions

As with all CICS commands, FEPI commands may produce exception conditions that you can check using the RESP option, or capture using HANDLE CONDITION. Most FEPI command errors return INVREQ. The particular error in each case is uniquely identified by the RESP2 value. All the FEPI exception conditions and RESP2 values are listed in “Chapter 16. Application programming reference” on page 169. There are copy books that contain declarations for the RESP2 values:

- DFHSZAPA for Assembler language
- DFHSZAPO for COBOL
- DFHSZAPP for PL/I
- DFHSZAPC for C/370.

If there is an error, the command does nothing, and output values are not changed. Note, however, that commands such as FEPI SEND may have transferred data before the condition is recognized.

You can use EDF and CECI to debug FEPI programs. Because FEPI commands can be quite long, you will probably find the NAME field of CECI useful.



---

## Chapter 12. Key stroke and screen-image applications

This chapter discusses the key stroke and screen-image data interfaces for FEPI applications. The examples given in this chapter are confined to simple conversational applications. However, you can use this data interface whatever the application structure. See “Chapter 14. Application design” on page 153 for further possibilities together with full details of conversations, error handling, and system considerations.

The key stroke and screen-image data interface is suitable for a wide range of applications, and is simpler to use than the alternative data stream interface. However, there are certain types of application for which you cannot use screen-image data. For more details, see “Chapter 13. Data stream applications” on page 147.

You can send both key stroke and screen-image data in the same conversation. The inbound data format is the same for both: a screen-image, that you can also access field-by-field.

You must have general knowledge of data communication and protocols.

The chapter contains the following topics:

- “General sequence of commands”
- “Sending key stroke data” on page 140
- “Receiving field-by-field” on page 142
- “Multiple attentions” on page 143
- “Sending screen-image data” on page 144
- “Receiving screen-image data” on page 145
- “Extracting field data” on page 146
- “CONVERSE” on page 146.

---

### General sequence of commands

The following diagram illustrates the general sequence of FEPI commands that you use with key stroke and screen-image data. That is, a FEPI SEND, multiple FEPI RECEIVES that complete when all the data has been received, followed by another FEPI SEND.

## Key stroke and screen-image

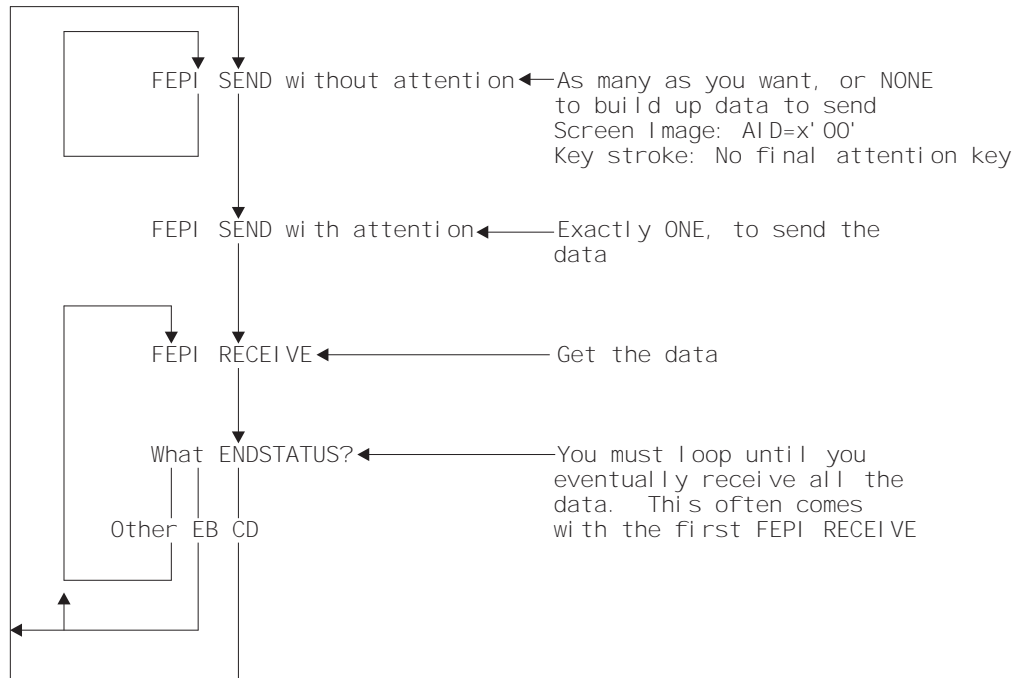

**Note:** The diagram does not show any processing of the data, nor where you might enter, or leave, the loop. This information is explained more fully in “Chapter 14. Application design” on page 153.

---

## Sending key stroke data

Sending key strokes is the easiest way of sending data.

Your program acts in the same way as the keyboard operator, with FEPI letting the program “press keys” just as the operator does.

A sample program illustrates the techniques used; see “Key stroke CONVERSE” on page 228.

The data can contain any combination of data characters together with manipulative, special, and attention key values representing almost every keyboard key. Data characters are represented as themselves. Manipulative, special, and attention key values are represented by *escape* sequences, comprising an escape character followed by a 2-character code. For example, using '&' for the escape character, you might send the following sequence to insert AB in one field, type IJKL into another field, and press PF7 to complete the input operation:

```
&H0&T2&R1&INAB&RS&N4IJKL&EF&07
```

```
Home
  Tab, twice
    Cursor right
      Insert
        AB
          Reset
            Newline, 4 times
              IJKL
                Erase—EOF
                  PF7
```

## Key stroke and screen-image

If the sequence were in a character string named KEY-SCRIPT, you would send it with:

```
EXEC CICS FEPI SEND FORMATTED
      CONVID(....)
      KEYSTROKES
      FROM(KEY-SCRIPT)
      FLENGTH(30)
```

In full, the escape sequences are:

<i>Manipulative keys</i>	<i>Special keys</i>	<i>Attention keys</i>
<b>&amp;HO</b> home	<b>&amp;IN</b> insert	<b>&amp;AT</b> attention
<b>&amp;Ln</b> cursor left, n times	<b>&amp;DL</b> delete	<b>&amp;An</b> PAn (n = 1–3)
<b>&amp;Rn</b> cursor right, n times	<b>&amp;RS</b> reset	<b>&amp;nn</b> PFnn (nn = 01–24, any leading 0 must be specified)
<b>&amp;Un</b> cursor up, n times	<b>&amp;EF</b> erase to end of field	<b>&amp;CL</b> clear
<b>&amp;Dn</b> cursor down, n times	<b>&amp;EI</b> erase input	<b>&amp;CS</b> cursor select (light pen)
<b>&amp;Tn</b> tab, n times	<b>&amp;FM</b> field mark	<b>&amp;EN</b> enter
<b>&amp;Bn</b> backtab, n times	<b>&amp;DU</b> DUP	<b>&amp;ME</b> end secure MSR
<b>&amp;Nn</b> newline, n times (n = 1–9)	<b>&amp;ES</b> escape character	
	<b>&amp;SO</b> shift out	
	<b>&amp;SI</b> shift in	
	<b>&amp;MS</b> start secure MSR	

You can choose an alternative escape character.

Data characters must have values  $\geq X'40'$ , so nulls (X'00') are not supported as such, although they can be generated using the erase or delete keys. Key strokes following an attempt to type into a protected field are ignored until RESET is keyed.

For magnetic stripe reader support, the sequence &MS...data...&ME represents passing a secure magnetic stripe card through the reader. Nonsecure cards have to be simulated by entering the data in the normal way.

The cursor position is set by your key strokes, rather than specifying where the cursor is placed. If your first key stroke is always the HOME key (&HO), you will have the cursor in a known starting position.

You can choose to send all the data with one command, or to use several commands to build up the data. The last (or only) command should have an attention key as its final key stroke, to actually send the data. There should be no other attention keys.

Alternatively, if you are not interested in the received data, you can ignore it by sending key strokes with multiple attention keys, as described in “Multiple attentions” on page 143.

## Errors

Apart from communication errors caused externally, there are two likely sorts of error that you might get:

- Bad command sequencing; that is, you have issued a FEPI SEND when one was not expected. A FEPI SEND must **not** follow a FEPI SEND with a final attention key, or a FEPI RECEIVE that did not indicate ‘change direction’.
- Incorrect data; that is, your key strokes are improper. You may have:
  - Sent data, characters, or escape sequences that are not valid.
  - Got into an ‘input inhibited’ situation and not reset it.

## Key stroke and screen-image

- Broken the rules for double-byte character set (DBCS) data.
- Failed a validation test, if there are fields with one of the validation attributes.

Many of these data errors cannot be detected until the data is actually processed, because they depend on the previous data. This means that any key strokes preceding the error will already have taken effect—they cannot be removed by FEPI.

The FEPI SEND can also fail if, following end bracket, the back-end sends BID to send more data and your pool has CONTENTION(LOSE). You must then receive the new back-end data first.

---

## Receiving field-by-field

Receiving data field-by-field is the easiest way of receiving data.

In the simplest case you would issue a FEPI RECEIVE command without specifying an INTO data area. FEPI gets the data from the back-end system and builds the resulting screen image internally. The cursor position is returned by the CURSOR option. Information about the number of lines, columns, and fields in the screen image is returned by the LINES, COLUMNS, and FIELDS options.

To get the data, you issue the FEPI EXTRACT FIELD command for each individual field that you want. As well as the data, you can find out the attribute settings for the field, and its length and position. The attribute values are defined in the DFHBMSCA copy book, as is used with BMS. You can issue as many FEPI EXTRACT FIELD commands as you need, for whichever fields you want. You can issue more than one for each field, for example, if you want to get the data and attributes separately. It is generally preferable to use the FIELDLOC option rather than FIELDNUM. There may be spurious attributes between each displayed field which make determining field numbers difficult.

A sample program illustrates the techniques used; see “Screen image RECEIVE and EXTRACT FIELD” on page 230.

## Command completion

The FEPI RECEIVE command completes on ‘end of chain’. This normally coincides with ‘change direction’ or ‘end bracket’, meaning that all data has been received. In some cases, however, back-end applications may send data to you in several sections (chains), each causing a screen update, so you must keep on receiving data until ‘change direction’ or ‘end bracket’ is indicated.

In all cases, the ENDSTATUS option is set to indicate what the completion conditions were. Where several conditions occur together, ENDSTATUS shows the most significant one. The values of ENDSTATUS and their associated meanings are shown in Table 13.

Table 13. ENDSTATUS values and associated meanings for formatted data

ENDSTATUS	Conditions			Next command expected
	End bracket	Change direction	End of chain	
EB	Y	-	Y	Any
CD	-	Y	Y	FEPI SEND or CONVERSE

Table 13. ENDSTATUS values and associated meanings for formatted data (continued)

ENDSTATUS	Conditions			Next command expected
	End bracket	Change direction	End of chain	
LIC	-	-	Y	FEPI RECEIVE
<b>Note:</b> Y=Condition indicated.				

When 'end bracket' is received, the session is in *contention state*, and either end may try to transmit data next. Some back-end systems use 'end bracket' in the middle of a series of transmissions to allow the terminal to break in if it wants, and they may use 'end bracket' instead of 'change direction' at the end of the flow. This is particularly true of IMS. CICS usually sends 'change direction' eventually, although it may send 'end bracket' indicators intermediately.

Using your knowledge of the back-end application and system, you must check the data that you have already received, to determine whether more data is to be expected or the transmission is complete. If more data is expected, you should issue another FEPI RECEIVE command; if the transmission is complete, it is the front-end application's turn to send data.

You should always use the TIMEOUT option on a FEPI RECEIVE command; see "Time-outs" on page 161.

## Errors

Apart from communication errors caused externally, the most likely error you may get is due to bad command sequencing. That is, you have issued a FEPI RECEIVE when a FEPI SEND is expected. A FEPI RECEIVE must **not** follow a FEPI SEND without attention, or a FEPI RECEIVE that indicated 'change direction'.

Another likely error is 'previous SEND failed'. This may be an external communication error, or it may be that the back-end system has responded negatively—as IMS does, for example, if you try to run an unknown transaction. The sense data which you can get using FEPI EXTRACT CONV tells you which error it is, and, where the back-end system has responded negatively, you simply issue another FEPI RECEIVE to get the data.

---

## Multiple attentions

In certain circumstances you might not have any interest in the immediate result of the data you send, but only in a later result, after you have sent more data. If this is the case, you can construct a single key stroke sequence, comprising all the sets of data to send, each with its own attention key, and then send the whole lot in one operation.

At each attention key, FEPI sends your data to the back-end system and receives the results internally, until 'change direction' or 'end bracket' is indicated. Then FEPI sends the next set of key strokes. Using multiple attentions improves performance but, if the intermediate results are not what you expect, FEPI has no way of knowing this and carries on sending your key strokes. This can lead to unexpected effects, or to the failure of the command with a data error. In the latter case, all the key strokes and back-end system interactions preceding the error have already taken effect and you may find it difficult to determine the state of the back-end

## Key stroke and screen-image

system. Further, no time-out can be specified for the intermediate receives, and so, if there is a communication problem, your application may be suspended indefinitely.

If the last set of key strokes ends with an attention key, you **must** issue a FEPI RECEIVE command to get the final result. If the last set of key strokes does not end with an attention key, you can issue another FEPI SEND command, with yet more key strokes.

---

## Sending screen-image data

Sending screen-image data is an alternative to sending key stroke data. In general, this would be the screen image that you received modified to reflect the changes that would be the result of an operator action. A sample COBOL program, DFH0VZTS, illustrates the techniques used; see “Screen image SEND and START” on page 229.

The data is exactly what you would expect: an image of the screen that you want to send. That is, 24 rows of 80 bytes (or whatever your screen size is) of data, corresponding byte-for-byte with the screen. For example, in a COBOL program containing this data description:

```
01 SCREEN-IMAGE PIC X(1920).
01 SCREEN-FIELDS REDEFINES SCREEN-IMAGE.
   05 LINE-1 PIC X(80).
   05 FILLER REDEFINES LINE-1.
     10 FILLER PIC X(20).
     10 CUST-NO PIC X(12).
     10 FILLER PIC X(48).
   05 LINE-2 PIC X(80).
   05 LINE-3 PIC X(80).
   05 LINE-4 PIC X(80).
   05 FILLER REDEFINES LINE-4.
     10 FILLER PIC X(12).
     10 CUST-NAME PIC X(32).
     10 FILLER PIC X(36).
```

you would put the required data into the fields and send the screen image using:

```
EXEC CICS FEPI SEND FORMATTED
      CONVID(...)
      FROM(SCREEN-IMAGE) FLENGTH(1920)
      AID(PF2)
```

where AID specifies which attention key was pressed on the simulated terminal.

Data bytes are represented as themselves; you must set any nulls (X'00') that are needed to fill a field. In a protected field, the data bytes must be the same as in the current, simulated terminal buffer that FEPI holds. In the case of attribute bytes, it does not matter what values you put, because you have no control over their positions or settings, any more than a terminal operator does. However, if the value is X'01', FEPI sets the modified data tag (MDT) for the field, even if its data has not changed. (If the data has changed, FEPI sets the MDT automatically.)

You do not have to send a complete screen image. If your changes are confined to the first few lines, you need only send those few lines. The data you send is taken as starting from the top left position of the screen.

**Note:** If you are using the C/370 programming language, remember that a screen image probably contains null characters. Take care if you are handling the screen image as a string.

The cursor position can be set using the CURSOR option.

You can choose to send all the data with one command, or to use several commands to build up the data. The last (or only) command must have an attention identifier (AID) specified, using the AID option, to send the data. The other commands must have an AID value of X'00'. Definitions for the AID values are in the DFHAID copy book, as is used with BMS.

**Note:** The COBOL and assembler versions of the DFHAID copybook are different. Therefore, you cannot simply copy unmodified SEND commands from the DFH0VZTS sample program, which is supplied in COBOL only, to a user-written assembler program.

## Errors

The errors you can get are similar to those for key stroke data. Your screen-image data has other ways of being incorrect. In place of escape sequences not being valid, or 'input inhibited', you might have cursor or AID settings not valid, or changed data in a protected field. Many of these data errors cannot be detected until the data is actually processed. This means that some of the changes will have taken effect already—they cannot be removed by FEPI.

---

## Receiving screen-image data

If you specify an INTO data area on a FEPI RECEIVE command, the data you receive is the screen image; 24 rows of 80 bytes (or whatever your screen size is) corresponding byte-for-byte with the screen. Data bytes are represented as themselves. In positions corresponding to attribute bytes, X'FF' appears.

You need only get the first few lines of the screen if that is all that you are interested in.

After you have processed the data, you will probably use the same screen image, modified as required, on a subsequent screen-image send.

Even though you got a screen image, you can use the FEPI EXTRACT FIELD command as well if you want, for any particular fields that you require, just as described in "Receiving field-by-field" on page 142. In particular, the FEPI EXTRACT FIELD command is the only way you can determine the value of the field attributes.

A sample program illustrates the techniques you can use; see "Key stroke CONVERSE" on page 228.

**Note:** If you are using the C/370 programming language, remember that a screen image probably contains null characters. Take care if you are handling the screen image as a string.

## Command completion and errors

As far as completion and errors are concerned, a FEPI RECEIVE command with an INTO data area is just like one without. So, if you do not get 'change direction' or

## Key stroke and screen-image

'end bracket', you have to issue another FEPI RECEIVE command before you can send your screen image back, and even 'end bracket' might require further FEPI RECEIVE commands.

---

## Extracting field data

It is not only after a FEPI RECEIVE command that you can issue a FEPI EXTRACT FIELD command. You can issue this command anywhere in the conversation to find out about the current screen image that FEPI holds for the simulated terminal.

This can be particularly useful where a FEPI SEND command has failed or given unexpected results, to discover what happened.

---

## CONVERSE

FEPI CONVERSE can be used instead of a FEPI SEND with attention and the first (or only) FEPI RECEIVE. It is more efficient than issuing two separate commands and is allowed anywhere that FEPI SEND is allowed. The effects are exactly as if the two commands had been issued.

The ending conditions are identical to those for FEPI RECEIVE, unless you use the POOL option to get a temporary conversation. In this case, it ends on the first to occur of:

- 'Change direction' indicated
- 'End bracket' indicated,

and does not end at 'end of chain' alone.

## Errors

You need to take into consideration which command is expected next:

- If the receive part of the FEPI CONVERSE command fails, the send will have already been done, and so a FEPI RECEIVE command is expected next.
- If the send part fails, the receive is not done, and, if the initial send was expected, a FEPI SEND or CONVERSE command is expected next.



---

## Chapter 13. Data stream applications

This chapter discusses the low-level data stream interface for FEPI applications. The examples it contains are confined to simple conversational applications. However, you can use this data interface whatever the application structure; see “Chapter 14. Application design” on page 153 for all the possibilities, together with details of conversations, error handling, and system considerations.

The chapter contains the following topics:

- “When to use the data stream interface”
- “General sequence of commands” on page 148
- “Receiving” on page 148
- “Sending” on page 151
- “CONVERSE” on page 151
- “SLU2 mode considerations” on page 151
- “SLU P mode considerations” on page 152.

---

### When to use the data stream interface

You need, or should use the data stream interface for the following types of applications:

- With pass-through; that is where the application passes data through, usually to the user’s terminal, without doing anything to it.
- With SLU P.
- Where the formatted interface does not provide the detailed function that you need.
- For handling non-3270 LU2 devices.
- With non-response mode IMS transactions.

The 3270 data stream interface is especially useful when creating FEPI applications that require to do little or no manipulation of the inbound (screen) data, because it is already in a form suitable for sending to a real terminal. If interpretation or reformatting of the inbound data is required, however, it can be significantly more difficult to operate on a 3270 data stream.

An example of an application suited to the 3270 data stream interface is a pass-through program, as illustrated by the sample program “3270 data stream pass-through” on page 231. Such programs can also be used to determine the flows and screen layouts of back-end systems when you are developing FEPI applications that, for example, drive signon or menu selection sequences and manipulate screens or dialogs.

You **must** be fully conversant with the data stream and data stream protocols as detailed in the books in the following list, and with how the back-end system uses them:

- *3270 Data Stream Programming Reference*
- *3274 Functional Description*
- *SNA Formats*
- *VTAM Programming*
- *IMS/ESA Programming Guide for Remote SNA Systems*
- *IMS/VS Version 2 Programming Guide for Remote SNA Systems.*

## Data stream applications

The application program is entirely responsible for the integrity of the data stream that uses this interface. FEPI performs no checking or interpretation on the data stream that is sent to or received from the back-end system, and makes no attempt to manipulate data into RU sizes that the sender or receiver can handle; the application program must be prepared to handle whatever data is presented to it. For example, with SLU2 mode, it must be prepared to handle READ commands, and WRITE STRUCTURED FIELD commands, in addition to the normal WRITE commands.

---

## General sequence of commands

The following diagram illustrates the general sequence of FEPI commands that you use with data stream. That is, a FEPI SEND, multiple FEPI RECEIVE commands that complete when all the data has been received, followed by another FEPI SEND.

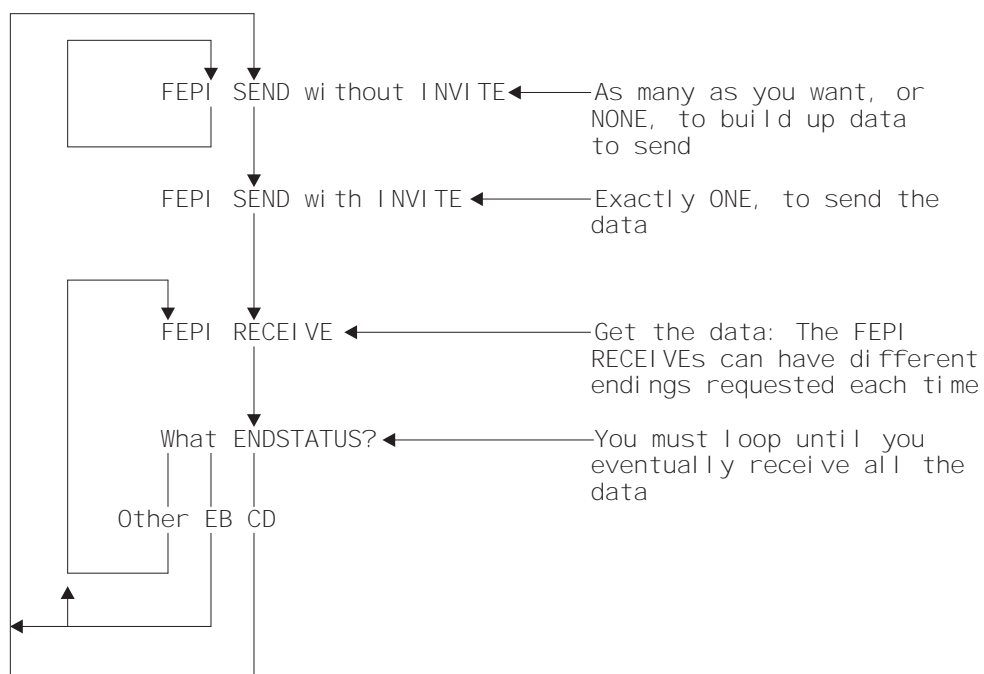

**Note:** The diagram does not show any processing of the data, nor where you might enter, or leave, the loop. This information is explained more fully in "Chapter 14. Application design" on page 153.

---

## Receiving

You can choose whether to process data in small segments or all at once. Your choice depends upon various factors including:

- Processing convenience
- The amount of data that you expect
- The size of the data area that you can use
- What you are doing with the data
- How the back-end application operates
- Whether you want to handle responses (see "Chapter 15. Specialized functions" on page 167 for this feature).

The data is a standard inbound data stream, exactly as is sent to the simulated terminal from VTAM. It is quite possible that there will be occasions on which you will receive no data; for example, when the back-end system needs to set a protocol indicator.

## Command completion

FEPI RECEIVE can be specified, or defaulted, to end in one of the following ways:

**RU** On the first to occur of:

- INTO data area full
- End of request unit.

**CHAIN**

On the first to occur of:

- INTO data area full
- End of chain.

**UNTILCDEB**

On the first to occur of:

- INTO data area full
- End of chain with definite response request
- 'Change direction' indicated
- 'End bracket' indicated.

**Note:** Using UNTILCDEB is not recommended, because you may have the difficult task of splitting data back into its constituent chains in order to process it.

In all cases, the ENDSTATUS option is set to indicate what the completion conditions were. Where several conditions occur together, ENDSTATUS shows the most significant one. The values of ENDSTATUS and their associated meanings are shown in Table 14.

Table 14. ENDSTATUS values and associated meanings for data stream

ENDSTATUS	Command options	Conditions					Next command expected
		End bracket	Change direction	End chain	End RU	INTO area full	
EB	RU, CHAIN, UNTILCDEB	Y	-	Y	Y	-	Any
CD	RU, CHAIN, UNTILCDEB	-	Y	Y	Y	-	FEPI SEND or CONVERSE
LIC	RU, CHAIN, UNTILCDEB	-	-	Y	Y	-	FEPI RECEIVE
RU	RU	-	-	-	Y	-	FEPI RECEIVE
MORE	RU, CHAIN, UNTILCDEB	-	-	-	-	Y	FEPI RECEIVE

**Note:** Y=Condition indicated.

FEPI RECEIVE commands must continue to be issued until 'change direction' or 'end bracket' is indicated. You cannot start sending data until all inbound data has been received. If an ENDSTATUS of MORE is indicated, the data stream is not necessarily self-contained and should not be processed until the remainder of the information is received. The value returned for REMFLENGTH *may* indicate how much more information is to come.

## Data stream applications

When 'end bracket' is received, the session is in *contention state*, and either end may try to transmit data next. Some back-end systems use 'end bracket' in the middle of a series of transmissions to allow the terminal to break in if it wants, and they may use 'end bracket' instead of 'change direction' at the end of the flow. This is particularly true of IMS. CICS usually sends 'change direction' eventually, although it may send 'end bracket' indicators intermediately.

Using your knowledge of the back-end application and system, you must check the data that you have already received, to find out whether more data is to be expected or the transmission is complete. If more data is expected, you should issue another FEPI RECEIVE command; if the transmission is complete, it is the front-end application's turn to send data.

A problem arises where the application is the pass-through type, because it does not look at the received data. There are various ways of handling this:

1. Request data conditionally from both ends—which cannot generally be done, and particularly not in the most typical case where the pass-through is directly to a front-end terminal.
2. Wait for data from both ends at once. This can be done where the pass-through is directly to a front-end terminal and the transaction is pseudoconversational for both CICS and FEPI. See “Started tasks” on page 156.
3. Ask each end at intervals if there is data waiting (for the back-end system by using FEPI RECEIVE with TIMEOUT); this is often not possible, as in the case where the pass-through is directly to a front-end terminal.
4. Forego a strict pass-through technique and check the data.
5. Assume that a transmission with 'end bracket' and no data means that more data is to come.
6. Issue another FEPI RECEIVE with TIMEOUT in case more data is to come, which has the disadvantage of introducing a delay.

**Note:** The last two cases involve an element of risk because the wrong assumptions can be made.

You should always use the TIMEOUT option on a FEPI RECEIVE command; see “Time-outs” on page 161.

---

## Errors

Apart from VTAM and back-end communication errors caused externally or, more probably, by errors in the outbound data stream that you sent previously, the most likely cause of an error condition is an incorrect sequence of commands. That is, you have issued a FEPI RECEIVE when a FEPI SEND is expected. A FEPI RECEIVE must **not** follow a FEPI SEND without INVITE, or a FEPI RECEIVE that indicated 'change direction'.

Another likely error is 'previous SEND failed'. This may be an external communication error, or it may be that the back-end system has responded negatively—as IMS does, for example, if you try to run an unknown transaction. The sense data which you can get using FEPI EXTRACT CONV tells you which error it is, and in the latter case you simply issue another FEPI RECEIVE to get the data.

See “3270 data stream pass-through” on page 231 and “SLU P pseudoconversational” on page 234 for sample programs illustrating some of the programming techniques.

---

## Sending

You can choose to send an entire stream of data, or you can break it up into smaller units, finishing with a FEPI SEND with INVITE. INVITE indicates that this is the last data to send, and that inbound data should be expected next. The data is sent with 'last in chain' and 'change direction'. Otherwise, further FEPI SENDS are to be expected. It is the application program's responsibility to ensure that the amount of data sent on a request does not exceed the capacity of the receiving LU.

## Errors

Apart from VTAM errors caused, most probably, by errors in the outbound data stream that you sent previously, the most likely cause of an error condition is an incorrect sequence of commands. That is, you have issued a FEPI SEND when one was not expected. A FEPI SEND must not follow a FEPI SEND with INVITE, or a FEPI RECEIVE that did not indicate 'change direction'.

The FEPI SEND can also fail if, following 'end bracket', the back-end system sends BID to send more data and your pool has CONTENTION(LOSE). You must then receive the new back-end data first.

See "3270 data stream pass-through" on page 231 and "SLU P pseudoconversational" on page 234 for sample programs illustrating some of the programming techniques.

---

## CONVERSE

FEPI CONVERSE can be used instead of a FEPI SEND with INVITE and the first (or only) FEPI RECEIVE. It is more efficient than issuing two separate commands and is allowed anywhere that FEPI SEND is allowed. The effects are exactly as if the two commands had been issued.

The ending conditions are identical to those for FEPI RECEIVE, unless you use the POOL option to get a temporary conversation. In this case, it ends on the first to occur of:

- INTO data area full
- 'Change direction' indicated
- 'End bracket' indicated,

and **not** at 'end of chain' alone. Further, if there is any residual data to receive, it is lost.

With regard to errors, you need to take into consideration which command is expected next:

- If the receive part of the FEPI CONVERSE command fails, the send will have already been done, and so a FEPI RECEIVE command is expected next.
- If the send part fails, the receive is not done, and, if the initial send was expected, a FEPI SEND or CONVERSE command is expected next.

---

## SLU2 mode considerations

It is necessary, when sending outbound 3270 data streams, to ensure that a three-byte prefix containing the attention identifier (AID) and cursor address is inserted at the front of the data. Similarly, the first two bytes of inbound data typically contain the 3270 command code and write control character (WCC). The

## Data stream applications

lengths supplied or returned on the FEPI SEND, RECEIVE, or CONVERSE DATASTREAM commands include the length of the prefix.

AID values are the same as the CICS values and, in pass-through applications, can be taken from EIBAID. The cursor address however is a buffer address and **cannot** be taken from EIBCPOSN. 3270 buffer addresses can be 12-, 14-, or 16-bit addresses depending on the device. Twelve-bit addressing is the most difficult to convert to or from, but it is very common; an address conversion table and an algorithm are contained in the *3270 Information Display System 3274 Control Unit Reference Summary*.

The inbound 3270 command is most likely to be a WRITE or ERASE WRITE and is, therefore, followed by a WCC then orders and data. However, this is not guaranteed and the inbound command should be inspected to determine what it is, what, if anything, should follow it, and how it should be handled. For example, the application may choose to perform an EXEC CICS SEND TEXT from the inbound data and may, therefore, require to know whether to append the ERASE keyword. The various READ commands (such as READ BUFFER and READ MODIFIED) and all the WRITE STRUCTURED FIELD commands (a common one being READ PARTITION with QUERY) need special handling.

If you receive more than one chain (using the UNTILCDEB option), you have to find each inbound command yourself, so this is not recommended unless you know that the back-end system only sends a single chain.

For further information, refer to the *3270 Information Display System Data Stream Programmer's Reference*.

---

## SLU P mode considerations

Two sample programs illustrate some of the programming techniques for SLU P mode. For details, see "SLU P pseudoconversational" on page 234 and "SLU P one-out one-in" on page 233.

---

## Chapter 14. Application design

This chapter describes the programs comprising a FEPI application and the basic design aspects. It also discusses signon security, error handling, and system considerations, including performance.

The chapter contains the following topics:

- “Programs”
- “Application organization” on page 155
- “Signon security” on page 159
- “Error handling” on page 161
- “System considerations” on page 163.

---

### Programs

The programs comprising a FEPI application are:

- Access
- Begin-session handler
- Unsolicited-data handler
- End-session handler.

### Access program

The main purpose of an access program is to:

- Start a conversation, using FEPI ALLOCATE
- Communicate with the back-end application using FEPI SEND and RECEIVE or FEPI CONVERSE
- End the conversation using FEPI FREE.

It must also be able to handle exception cases such as edit errors, transactions that are not valid, or security violations, and it may need to manage signon/signoff sequences. It may also need to handle begin-session and end-session requirements, if special handlers are not provided. The SESSNSTATUS option of FEPI ALLOCATE tells you if a new session has been started, or if you are reusing an existing session.

For many FEPI applications, particularly where formatted data is used, the access program is not complex. However, you do need to be fully conversant with everything that the back-end application might do. Your application **must** behave just like the real terminal and operator, and you **must** send and receive data in the correct sequence. Within a conversation, any data received is passed to the application that owns the conversation; FEPI cannot determine whether it is the data or screen image that was expected or, for example, a message reporting an abnormal end. Although the FEPI application needs to handle these cases, the access program need not test for all possibilities. The suggested method is to test only for the expected data or screen image and use a special error-handling program if the test fails.

Other applications may require more sophisticated programming. In some cases, you not only have to understand all the displays and protocols of the back-end application, but must also be conversant with the detailed data stream protocols. Applications may have to be custom-written for each device and type of target that is to be supported.

## Application design

Syncpoints are not needed and not applicable in FEPI because communication environments do not provide any recoverable units of work. It is up to you to provide the syncpoints and any recovery of data that you need. For particularly critical operations with the back-end applications, you may find that using “definite responses” is helpful; see “DRx responses” on page 167.

## Begin-session handler

The begin-session handler transaction is started by FEPI when a connection is acquired. This transaction handles any functions that are required to initialize the session. Typical tasks are:

- Handling device queries.
- Handling any initial inbound data, or “good morning” message, following the bind.
- Signing on to the back-end system.

Device queries are sent by the back-end system (particularly CICS) if the terminal definitions so demand. You would normally reply ‘null’ (as illustrated by the begin-session sample program), or with some particular terminal properties that you want. Note, if you want to match the terminal properties to those of the real front-end terminal that an application is using, you cannot use a begin-session handler; each application will have to do its own begin-session handling.

When a back-end system sends a message after a successful bind, the connection should be in a pool where the INITIALDATA property is set to INBOUND. For SLU2, IMS always sends such a message; CICS may or may not do so depending on the way your system is defined. This extends the process of acquiring a connection to include receiving the data. Note that, if INBOUND is specified, the begin-session handler (or each application program, if there is no begin session handler) must issue a FEPI RECEIVE command to get the data and then send a suitable reply to the back-end system.

Remember that handling this initial data is just like handling any other back-end data: you must cope with whatever the back-end system may send, and handle and reply to it accordingly.

Security requirements in the back-end system might make it more appropriate for sign-on to be part of the access program. (Information about implementing signon security is on page 159.)

There is a sample begin-session handler program; see “Begin session” on page 226.

## Unsolicited-data handler

The unsolicited-data handler transaction is started by FEPI if inbound data arrives on a connection for which there is no current conversation.

Unsolicited data can occur when:

- A target sends more data than the application expected.
- The access program times out, or the conversation is ended, before the data arrives.
- Asynchronous IMS output such as:
  - Message from previous input that could not be processed at the time of receipt by IMS
  - Reassignment of a logical terminal that has a message queued.



With IMS, this type of unsolicited data does not usually occur in SLU2 mode because IMS only sends messages in reply to explicit requests from the terminal.

- Asynchronous CICS output such as that sent by ATI.

The unsolicited data should all be received by the handler, even if it is only to be discarded. Otherwise, although FEPI eventually discards the data, it also ends and restarts the session, which is inefficient.

There is a sample unsolicited-data handler program; see “Monitor and unsolicited data-handler” on page 225.

## End-session handler

The end-session handler transaction is started by FEPI when a conversation ends or a session is to be unbound. This could be used as follows:

- To set the session to a known state, perhaps by signing off from the back-end system, ready for the next conversation.
- When the conversation ends, to force (or prevent) unbind and the subsequent starting of a new session (overriding what the access program specified).
- To perform special action on CICS shutdown in the front-end system.

There is a sample end-session handler program; see “End-session handler” on page 232.

**Note:** The end-session handler transaction runs under the CICS region userid.

---

## Application organization

This section discusses application styles, started tasks, and conversations.

The three application styles can be mixed as desired. If there are enough connections available, you can have as many conversations as you like at a time with various targets: they can be consecutive or, much more usefully, interleaved. For example, if you need data from four different applications, you could overlap the processing by sending all four requests for data before you start waiting for a response.

## Application style

### One-out one-in conversational

One transaction performs the complete conversation with the back-end application in a single send and receive operation. This is the simplest style, if the required data can be obtained from the back-end application in this way. The transaction can be reduced to a single FEPI CONVERSE command using a temporary conversation.

By freeing the connection between transmissions, the capacity of the connection is increased. However, this style only works where no setup is needed to run the back-end transaction and it does not depend on any prior communication. This is because, unless you have a very strict pool regime, you cannot generally guarantee which simulated terminal FEPI will use—it may not be the same one as in a previous conversation—or that you were the last user of the terminal. Further, if you receive unexpected results from the back-end transaction, you may not be able to recover. Therefore, you should only use this style where it does not matter if the back-end

## Application design

transaction runs or not, for example, for a simple inquiry. A one-out one-in conversational program is unlikely to be suitable for accessing CICS transactions or IMS conversational transactions.

See the sample program “SLU P one-out one-in” on page 233.

### **Conversational**

One transaction performs the complete conversation with the back-end application using multiple send and receive operations and waiting for the inbound data to arrive. This style is used for a back-end application that requires several transmissions or complex setup. This style is simple, and if the network performance is good, the time spent waiting for inbound data may not be a problem.

See the sample program “Key stroke CONVERSE” on page 228.

### **Pseudoconversational**

One transaction sends data to the back-end application, identifies another transaction that is to be started when the inbound data arrives, and ends. When inbound data arrives, FEPI starts the specified transaction which then receives the data. A typical technique is to have a transaction that, when started to receive inbound data, receives the data, sends the next piece of outbound data, issues FEPI START to start itself, and then ends.

The pseudoconversational style (use of FEPI START commands) results in significant CPU overheads in the front-end region. Further, since the use of FEPI START generates additional flows to and from the real terminal, response times are also significantly increased. As a consequence, FEPI START should be used sparingly when, for example, the receipt of the data from the back-end application takes a long time.

See the sample programs “Screen image SEND and START” on page 229 and “Screen image RECEIVE and EXTRACT FIELD” on page 230.

## Started tasks

In the pseudoconversational case, the ‘receive’ program is started by FEPI as a CICS started task, with a start code of 'SZ' (for FEPI) which can be checked using EXEC CICS ASSIGN STARTCODE.

FEPI supplies **start data** that identifies the reason for starting the task and gives information about the FEPI resources, such as the node-target connection, the data mode and format, and the conversation ID involved. The program that processes the transaction issues EXEC CICS RETRIEVE to get this data (the CICS rules relating to transactions and start data apply; in particular, you must retrieve all of the start data to prevent multiple initiations). Copy books DFHSZAPA, DFHSZAPO, DFHSZAPC, and DFHSZAPP contain declarations of the start data structure. You can provide your own data to be included in the start data, so that your programs can communicate with each other about their processing state and so on.

The first thing such a program must do is get ownership of the conversation using the conversation ID from the start data; it should then use FEPI RECEIVE to get the actual data from the back-end. Then it can do whatever it likes: end the conversation, send more data to the back-end system (and start itself or a new task to receive the reply), and so on.

In addition to inbound data arriving, anything else that would cause a FEPI RECEIVE command to complete causes the 'receive program' to be started. This includes a 'previous SEND failed' error, and a response from the back-end system without any data. The FEPI RECEIVE that you issue shows these cases, as if FEPI START had not been used.

The program is also started if the time limit set by the FEPI START command expires, or if the session is lost. These cases are indicated by the value of EVENTTYPE, in the start data, being TIMEOUT or SESSIONLOST rather than DATA. They should be handled as if a FEPI RECEIVE command had caused the error.

If your 'send' program is associated with a front-end terminal, your FEPI START command would normally specify that the 'receive' program uses the same terminal. You should be aware that it is not possible for FEPI to guarantee that another transaction will not use the terminal while the inbound data is awaited. In the majority of cases, this does not happen or does not matter. If it does happen and it is critical (perhaps for security reasons), you can prevent user input at the terminal by issuing an EXEC CICS SET TERMINAL command specifying NEXTTRANSID(itran) before issuing FEPI START; remember to reset NEXTTRANSID to blank in the started task. *itran* is the name of a transaction that you provide which simply rejects any user input, and sets NEXTTRANSID(itran) again. If this is unacceptable, you must avoid using pseudoconversational applications.

The handlers mentioned on pages 154, 154 and 155 —begin-session, unsolicited data, end-session—are also CICS started tasks. Again, the start data (obtained with EXEC CICS RETRIEVE) tells you why the task was started and the identity of the conversation. The started task must get ownership of the conversation so that it can continue the conversation and so that FEPI knows that the event is being handled.

## Conversations

Your entire communication with a particular back-end transaction should be contained in a single FEPI conversation. This means that you remain in control of the communication; no other program can break in and you keep using the same simulated terminal. Only the task that started the conversation with FEPI ALLOCATE can use the conversation. It "owns" it and no other task can issue any command for it, not even FEPI EXTRACT CONV.

### Conversational applications

In the simplest case, an access program starts a conversation with a FEPI ALLOCATE command specifying the pool of connections that is to be used. The command returns an identifier, the conversation ID, that is used to refer to the conversation subsequently. The program then issues a series of FEPI SEND, RECEIVE (and possibly other) commands for the conversation, each specifying the identifier, so that FEPI knows which conversation—and therefore which connection and target—the command is for. Finally, it ends the conversation with a FEPI FREE command. If it does not, the conversation is ended by FEPI when the task ends.

The FEPI FREE command should normally specify the HOLD option, so that the connection remains ready for use by another conversation. If the RELEASE option is used, or you leave the conversation to be freed by FEPI at the end of task, the session is ended, and a new one must be started for the next conversation; this is inefficient and, therefore, not recommended.

## Application design

### Started tasks

If the access program is pseudoconversational, after sending data it issues a FEPI START command to name the transaction that FEPI is to start when inbound data arrives. At this point the conversation becomes “unowned” and the first task can no longer use it. However, the conversation does not end; when data arrives, the conversation ID is passed to the started task and that task issues FEPI ALLOCATE with the PASSCONVID option to get ownership of the conversation. Only then can the started task use the conversation to receive the inbound data.

While the conversation is unowned, it can be acquired by any task that knows the conversation ID. Acquiring the connection cancels the pending start request, and the task that acquired ownership has to continue the conversation as if no FEPI START had been issued. This technique is useful in a pass-through application to a front-end terminal to handle contention between inbound data and terminal input. The application issues a FEPI START command, specifying the front-end terminal, and then returns to CICS specifying a ‘next’ transaction. Inbound data arriving first causes FEPI to start the transaction on the front-end terminal, which causes CICS to cancel its wait for terminal input; if terminal input arrives first, the application, after using EXEC CICS ASSIGN STARTCODE to determine why it was started, issues FEPI ALLOCATE with PASSCONVID which cancels the FEPI START request.

Getting ownership also applies to the tasks started by the various handlers. The conversation may have been started by some access program (end-session), or by FEPI itself (begin-session, unsolicited-data). Either way, you must still issue a FEPI ALLOCATE command with PASSCONVID, quoting the conversation ID, to get ownership and continue the conversation.

When a handler has finished processing, it must tell FEPI by issuing a FEPI FREE command for the conversation. For the begin-session handler, this should specify the HOLD option to indicate that the session is ready to be used; if RELEASE is used, the session is ended. The end-session and unsolicited-data handlers can use any of the options according to requirements.

### Passing conversations

Besides using FEPI START to have a task for receiving data, any program or handler can explicitly give up ownership of its conversations so that another task can use them. You do this with the FEPI FREE command and the PASS option. Any task can then get ownership by using FEPI ALLOCATE with PASSCONVID and, if it maintains the command sequence, continue the conversation (for example, if the first task has issued a FEPI SEND with INVITE, the second task would have to issue a FEPI RECEIVE or, perhaps, a FEPI START). It is up to the two tasks to communicate between themselves, using the standard CICS methods (TS queue, COMMAREA, and so on), about the state of the conversation and its ID. FEPI does not offer any application programming facilities for this except that the new task can use FEPI EXTRACT CONV to determine details such as the data format.

If you do not employ a method of passing and saving the conversation across invocations of a pseudoconversational front-end transaction, and instead issue the default FREE command, you lose your connection to the back-end transaction, making it possible for another program to start a conversation and effectively “break into” the active transaction. This can cause the back-end application to abnormally end.

The only other method that can be used to ensure a unique relationship between front-end and back-end transactions, is to have FEPI pools containing a single FEPI

node for each user. This ensures that you always get connected to the back-end transaction on the same terminal (FEPI node) to continue your conversation. However, this method can cause administrative problems where there are a large number of end users.

### Temporary conversations

In a one-out one-in conversational application you can use a single FEPI CONVERSE command that combines an ALLOCATE–SEND–RECEIVE–FREE command sequence. This combination is selected by using the POOL option of FEPI CONVERSE rather than the CONVID option. In this case, the conversation is a *temporary* conversation that lasts only for the duration of the FEPI CONVERSE command. No conversation ID is returned by FEPI and no other commands can be issued for the conversation; you cannot even use FEPI EXTRACT FIELD to process the returned data.

As with all one-out one-in conversational applications, temporary conversations should be used with care. If more data is received than can be returned on the FEPI CONVERSE command (because, for example, the data is not what you expect), the excess is discarded and cannot be retrieved by the application. Data may be lost if the command fails and, because you cannot receive any more data or guarantee that your next conversation will use the same simulated terminal, it may be difficult to determine the state of the back-end system.

#### Notes:

1. Every conversation started with FEPI ALLOCATE has a unique conversation ID, as does every conversation started for a handler, except in the case of end-session when started after a FEPI FREE. In this case, the ID is the same as in the task issuing the FEPI FREE.  
A task started when inbound data arrives gets the same conversation ID as the task that issued the FEPI START command.
2. The state of a conversation (whether, for example, it is owned by an access program, in a begin-session handler, waiting for inbound data, or being passed) is shown by the STATE option of the CEMT INQUIRE FECONNECTION command ( page 63) or the FEPI INQUIRE CONNECTION command ( page 95). This may be useful when you are debugging applications.
3. If your programs are written in C/370, do not handle conversation identifiers as strings; they may contain null characters.

---

## Signon security

When signing on to a back-end system, FEPI applications can ask the external security manager (ESM) to supply a password substitute, or *PassTicket*. (For an explanation of why PassTickets are necessary, see page 14.)

### How to use PassTickets

This section is an overview of how PassTickets work, and describes what you need to do to use them. For detailed information about PassTickets, see the *OS/390 Security Server (RACF) Security Administrator's Guide*.

1. To process PassTickets, the ESM uses keys, known as Secure Signon keys, that are shared by the front- and back-end systems. You must define a Secure Signon key for each target system with which FEPI communicates. For information about how to do this, RACF users should refer to the *OS/390 Security Server (RACF) System Programmer's Guide*. Users of other ESMs should refer to the documentation for their product.
2. The end-user is verified by signing on to the front-end CICS in the usual way.

## Application design

3. When he or she runs a transaction that uses FEPI, your application issues a FEPI REQUEST PASSTICKET command to obtain a PassTicket<sup>1</sup>. A PassTicket is a secure representation of a password that can be used to sign on to the back-end system. It is valid for one use only, and is time-stamped. The userid for which the PassTicket is generated is that of the currently signed-on user. Your FEPI application can use an EXEC CICS ASSIGN command to check the userid of the currently signed-on user.
4. Your FEPI application uses the PassTicket and userid to perform a sign-on in the back-end system, just as if it were sending a password and userid. For example:

```
EXEC CICS FEPI SEND FORMATTED
                        CONVID(convid) FROM(CESN userid PassTicket)
                        FROMLENGTH(length_of_data)
```

It is the application's responsibility to provide the signon processing, because CICS cannot know either the type of back-end (CICS or IMS) or the back-end program being used for signon processing.

5. The back-end system uses an unchanged interface to perform the sign-on. Thus, a CICS system receiving a userid and a PassTicket can use its existing procedures to sign on the userid. RACF takes care of the fact that a PassTicket, rather than a password, is passed to it.

**Note:** If the PassTicket times out (because, for example, of a session failure), your application should generate another and try to sign on again. If signon continues to fail and the front- and back-ends are in different MVS systems, check that the TOD clocks are suitably synchronized. Too many failed signon attempts could result in the userid being revoked.

For information about using RACF with CICS, see the *CICS RACF Security Guide*.

## Benefits

The advantages of using PassTickets are that:

- They provide a secure way of signing on to back-end systems. This is because:
  - They are valid for one use only and are timestamped—therefore, the potential damage caused by their being intercepted is minimal.
  - Passwords are not transmitted across the network.
- FEPI applications do not have to store passwords (or ask users to reenter them) in order to sign on to back-end systems.
- No changes are required in the CICS or IMS back-end systems.
- System clocks in the front- and back-end systems do not need to be precisely synchronized (RACF compensates for variations up to plus or minus 5 minutes).

## Requirements

- The front-end must be a CICS/ESA 4.1 or later system. The back-end can be an earlier-level CICS or IMS system.
- RACF Version 2 Release 1 or later, or a functionally-equivalent external security manager, on both the front- and back-end systems.
- End-users must use the same userid in the back-end systems as in the front-end system.

---

1. If EDF is being used the PassTicket is not displayed.

---

## Error handling

This section gives some general guidance on how to handle various error conditions, for example:

- Time-outs
- Session loss
- Previous send failed
- Communication errors
- Bypass by user exit
- Unknown conversation ID
- Operator/system action
- CICS shutdown.

FEPI does not recover any user data when an error condition is raised—data recovery, if needed, must be performed by the application program. In addition, the output option values on a command are not set if the command fails; your program should not be using these values in such cases.

The recommended way is that errors raised by FEPI commands should be handled by your application rather than letting CICS terminate the transaction abnormally. Errors and exceptions can be detected by using the RESP and RESP2 command options, or trapped using HANDLE CONDITION.

## Time-outs

You should use time-outs with FEPI commands. If there is a problem with the connection to the back-end application, a program without time-outs may wait for ever, you may stop other applications running, and operator intervention may be needed.

Time-outs can be used with FEPI ALLOCATE, RECEIVE, START, and CONVERSE commands. In all cases, the timing applies only to the period that FEPI waits for a reply from the back-end system. As soon as anything is received from the back-end, FEPI stops the timer, and then waits for as long as is necessary to receive all the data that is required to complete the command. You **cannot** specify a time-out for FEPI SEND, because the command always completes immediately, without waiting for any data to be transmitted. Any delay or other problem is handled by the following FEPI RECEIVE command. The action to take on a time-out depends on the command that was used:

- For FEPI ALLOCATE, you could retry the initial command and then retry using a different pool or target before going into your error-handling routine.
- For FEPI RECEIVE, you can retry the command and, if that fails, handle the error as if the session with the back-end application had been lost.
- For FEPI START, the time-out is reported to the started task, and not as an error on the command. In other respects, however, it is the same as a FEPI RECEIVE time-out.
- For FEPI CONVERSE with a previously allocated conversation, it is exactly as if a FEPI SEND command and then a FEPI RECEIVE command were issued. That is, the time-out that you specify applies only to the 'receive' part of the command, and is treated and handled just like that for a FEPI RECEIVE.

For a temporary conversation, it is as if the command were preceded by a FEPI ALLOCATE and followed by a FEPI FREE, so in this case the time-out is applied to both the 'allocate' and 'receive' parts of the command. In this situation, if a time-out occurs, there is no indication as to which part caused it.

## Application design

### Lost session

If a FEPI application loses the session with the back-end application, it should free the conversation. Having done that, the application can take whatever action is required. A typical action would be to recover any data and restore the initial state before retrying the conversation or sending a message to the user.

The loss of a session can also occur because of CLSDST(PASS) processing (as discussed in "Handling CLSDST(PASS)" on page 43). If this is the case, you can find out when the session has been reestablished using the FEPI EXTRACT CONV command. You can then continue processing as required.

### Previous SEND failed

This occurs on a FEPI RECEIVE and is indicated by RESP2=216. It may be an external communication error, or it may be that the back-end system has responded negatively (as IMS does, for example, if you try to run an unknown transaction). Use the FEPI EXTRACT CONV command to get the sense data describing the failure. If this indicates a negative response, you should reissue the FEPI RECEIVE to get the data. If it was not a negative response, it is equivalent to a lost session and the session cannot be recovered.

### Communication errors

It is simplest to treat communication and network errors as a lost session, which avoids the need for detailed SNA error protocol handling. However, sophisticated applications may want to handle certain recoverable conditions, for example, SNA CLEAR received (RESP2=230).

### Bypass by user exit

A command can be rejected by the FEPI global user exits (RESP2=10). Typically this would be because it violates the rules imposed by your system programmer. Check the rules with your system programmer.

### Unknown conversation ID

Besides specifying the ID incorrectly, this is probably caused by the task that issued the command not owning the conversation, because:

- The conversation has been ended
- The conversation has been passed to another task
- FEPI ALLOCATE with PASSCONVID has not been issued.

If the error occurs on a FEPI ALLOCATE command with PASSCONVID, the conversation was probably not "unowned". Where the CONVID was obtained from FEPI start data, it is possible that between FEPI scheduling the task and it actually starting, a resource used by the conversation has been discarded, or CICS has started shutdown.

### Operator/system action

An operator/system error occurs when the operator tries to cancel a FEPI transaction. If, as is likely, it is waiting for a FEPI command to be processed, it is the 'wait' for FEPI processing that is canceled, not the transaction.

When a FEPI command fails with an 'operator action' error (RESP2=18), first end all the active conversations and then end the transaction as soon as possible.



## Shutdown

A normal CICS shutdown waits for currently active tasks to end, but does not allow new tasks to start. FEPI allows existing conversations to continue within a task but does not allow them to be passed to another task (because that task would never be started), nor does it allow new conversations to be started. Conversations that are “unowned” are ended immediately, because the tasks that would subsequently handle them would never be started. Therefore, FEPI START or FREE PASS commands issued during shutdown fail (RESP2=214); in this case the error-handling routine, after doing whatever housekeeping is required, should issue FEPI FREE to end the conversation. FEPI ALLOCATE commands issued during shutdown fail with RESP2=12.

You might need to take special action on the back-end system, for example, signing off, when the front-end application is going to shut down. For this reason, when conversations end during shutdown, the end-session handler is invoked with SHUTDOWN indicated in the EVENTVALUE field of the start data, so that the back-end system can be restored to a known state before FEPI ends; the FEPI FREE issued by the handler is treated as if RELEASE is specified. If you require this function, make sure the end-session handler is defined in the transaction list table (XLT), so that it can be started, and so that it does not adversely affect the performance of CICS shutdown. (The XLT is described in the *CICS Resource Definition Guide*.) Using an end-session handler is the only way to perform special processing on shutdown, because no notification of shutdown is given to normal active transactions and conversations.

An immediate CICS shutdown ends all conversations immediately, and commands in progress fail. No further FEPI commands can be issued, and no end-session handlers are started.

---

## System considerations

You can think of FEPI as a “pipe” through which users access back-end transactions; any peculiarities that exist in the back-end system have to be allowed for in the FEPI application. IMS has special considerations and these are explained in the following text.

This section concludes with some notes about performance.

## IMS considerations

It is essential that you are familiar with using IMS and writing IMS applications.

When designing access programs that have IMS as a target back-end system, careful consideration must be given to the differences between CICS and IMS under certain circumstances:

- Message protocols
- Use of response mode
- Beginning and end of session
- Effects of IMS restart and recovery features in a FEPI environment. (Because IMS is almost totally recoverable, this can present problems in the design of the FEPI application and some event handlers.)

### Message protocols

- In SLU2 mode, IMS sends messages only in reply to explicit requests from the terminal. Therefore, unsolicited data will not usually occur; rather it will be available for the next FEPI conversation to receive. At the start of a FEPI

## Application design

conversation, you should first dequeue all such messages. However, unsolicited data can occur when requested data arrives after a FEPI conversation has been ended by, for example, a time-out.

- Take care if you use the IMS /SET command to preset a destination or put the transaction ID in the SPA to specify which IMS transaction to use next.
- If you are using Message Format Services (MFS), consider the following:
  - Physical paging or operator logical paging:
    - Whether paged output is deleted automatically by an input message or not.
    - for SLU2 mode, sending PA1 to request additional pages of paged output, and sending PA2 to remove paged output from the queue.
  - Unlocking the keyboard after MFS bypass.

### Response mode

You are strongly recommended to run all your back-end IMS transactions in response mode where messages to IMS from the (simulated) terminal are handled synchronously; that is, each message from the terminal is processed by IMS and the reply is queued before a further message from the terminal is allowed. This lets your front-end application be much simpler because data received will be the reply to the data just sent, and because the data stream flows from IMS are more straightforward; further, a separate FEPI conversation can be used for each IMS transaction and this allows much better use of the network (of course, you must use the same FEPI conversation throughout an IMS conversational transaction).

If you use non-response mode, the data stream flows may be more complex. If you send multiple messages to IMS, the application has to handle asynchronous messages from IMS and, to keep the same simulated terminal, has to use the same FEPI conversation all the time.

Check with your system programmer that the transactions to be used by FEPI are defined to run in response mode. This requires the terminals for FEPI to be defined either to force response mode or to use the setting for the transaction (which in turn should be defined as response mode).

### Beginning of session

For SLU2, there is always initial data. You should:

- Dequeue all output messages by sending CLEAR and PA1 after each FEPI RECEIVE, until there are no more messages (there may be 'unsolicited' data as well as the initial data).
- If there is an IMS error message, end the session using FEPI FREE with the RELEASE option.

### End of session

Application programs must be designed such that when a session is ended:

- An IMS conversation is not left active.
- An IMS /RCLSDST command is issued if appropriate.
- An IMS MFS bypass application is not left in bypass mode.
- Any preset destination has been reset.
- Any used test mode has been ended.
- No paged output message is left on the IMS message queue.
- All messages have been received.

Physically paged messages are removed from the queue automatically when the last page has been sent and, if they are recoverable, acknowledged. Operator logically-paged messages are not removed and require a PA2 (for SLU2 mode) or a NEXTMSG/NEXTMSGP control function (for SLU P mode) to be sent to IMS to remove the message from the queue if no input message is due.

## IMS recovery

After a system failure, IMS recovers following a restart from the last checkpoint it took. This means that, if the failure occurs when IMS has committed a message to the input queue then, on restart, IMS requeues that message and schedules a transaction to process it. Similarly, IMS will requeue all output messages that it has committed to its output queues and not successfully sent.

When IMS fails, all sessions between FEPI and IMS are ended. This is reported to the FEPI application as a command error ('session lost'). A FEPI application should check this so that it can tidy up before ending and take the appropriate action (such as informing the operator).

FEPI attempts to regain lost connections and, therefore, when IMS restarts, any previously acquired connections are reestablished. If IMS has committed an input or output message, eventually there is going to be an output message to send. With the connection reacquired, IMS attempts to recover its position and ultimately to send any queued output messages to the FEPI node that carried the original FEPI conversation. The process of recovery in this situation is different for each of the two modes:

- **SLU P recovery** When IMS tries to recover SLU P connections, it uses 'set and test sequence numbers' (STSN) in an attempt to resynchronize failed conversations. The STSN flow from IMS carries its version of the sequence numbers for the node being resynchronized. If there is an STSN handler specified, it is started. If not, FEPI responds POSITIVE, which effectively tells IMS that FEPI is satisfied with the sequence numbers sent. On receiving this, IMS sends all messages queued for the node. FEPI receives the messages, discards them and responds to IMS, completing the resynchronization.
- **SLU2 recovery** The queued message is sent by IMS until there is a request from a front-end application, that application will receive the message as unexpected data interleaved with the data that it expects to receive. This problem can be handled in either of two ways:
  1. By the application issuing a FEPI RECEIVE, with TIMEOUT, before starting its intended task or by dequeuing all output messages using CLEAR and PA1.
  2. By the begin-session handler.

This situation becomes more complex if the back-end transaction is IMS conversational, because the front-end transaction has no way of knowing this, and the IMS conversation will still be active in the back-end system awaiting input.

The potential therefore exists for a front-end FEPI application to allocate a FEPI conversation on a node where an IMS conversation still exists on the back-end system. Any data flowing on this FEPI conversation is viewed by the front-end application as an exchange with a new back-end transaction, but it is viewed by IMS as the next input message to the existing conversation. To prevent this situation occurring, you can use the begin-session handler to issue the IMS /EXIT command, which has the effect of ending an active IMS conversation.

Where the possibility exists of a number of nodes with active IMS conversations following a restart, it is possible to use FEPI to obtain a connection to IMS and control the cleanup operation, from a single point. You do this by issuing, again from the appropriate handler:

- An IMS /DISPLAY command to display all active conversations
- The IMS /EXIT command to end all those attached to FEPI nodes.

## Application design

In the event of a failure that unbinds all the FEPI connections to IMS, the recovery procedure is identical to that described here.

## Performance

Use the following techniques to get the best performance from your FEPI applications; the main principles are to minimize the number of commands issued and the amount of data transmitted. Remember, however, that some of these techniques have drawbacks (as have been explained elsewhere), and some conflict with each other; you must choose the best balance to meet your needs.

### General

- Use data area sizes that allow a send or receive to be completed with a single FEPI command.
- Use FEPI CONVERSE where possible. But remember that the send part of CONVERSE can fail for various reasons, so be sure to write your program so that it can issue a subsequent FEPI RECEIVE if necessary.
- The pseudoconversational style (use of FEPI START commands) results in significant CPU overheads in the front-end region. Further, since the use of FEPI START generates additional flows to and from the real terminal, response times are also significantly increased. As a consequence, FEPI START should be used sparingly when, for example, the receipt of the data from the back-end application takes a long time.
- Avoid ending sessions unnecessarily. Use the begin-session and end-session handlers to manage usage of the connections.
- Try to avoid operator dependency in exchanges with a back-end system.

### Formatted data

- Unformatted screens (where the terminal character buffer contains no field attributes) require more processing than formatted screens. Where possible use formatted screens from the back-end systems.
- Not clearing a screen results in unnecessary data being transmitted to the back-end system.
- If, when data is received, only a small portion of the resultant screen is of interest, use FEPI EXTRACT FIELD to minimize the amount of data that needs to be transferred to the application.
- When using key stroke data, avoid issuing a FEPI CONVERSE, SEND, or RECEIVE for each attention operation; combine all the operations into one long string.
- When using key stroke data with an unformatted screen, use the HOME and ERASE-EOF keys to clear the screen rather than CLEAR, because the latter requires a network transmission.
- Use key stroke rather than screen-image data where possible, because much less data needs transferring from the application.

---

## Chapter 15. Specialized functions

This chapter describes specialized control functions that are handled by FEPI but can be taken over by a FEPI application. It contains the following topics:

- “Set and test sequence number (STSN)”
- “DRx responses”
- “SNA commands” on page 168.

---

### Set and test sequence number (STSN)

In SLU P mode, message sequence numbers are available in the data stream to allow message resynchronization. This can be demanded by a ‘Set and Test Sequence Number’ (STSN) request when a session is started.

The response that IMS requires, and that FEPI supplies if the system programmer has not defined a transaction to handle the STSN request, depends upon whether the STSN request showed ‘SET’ or ‘TEST and SET’:

For ‘SET’, the response is always ‘TEST POSITIVE’.

For ‘TEST and SET’, the response is ‘TEST POSITIVE’ or ‘TEST NEGATIVE’.

Any other response to STSN will cause the session to be unbound.

If an STSN handler is defined, it is started when session resynchronization is requested by the back-end system through an SNA STSN or SDT command. The back-end system sends an SNA STSN command indicating whether the last inbound message was in doubt or not; that is, whether a message had been sent by the back-end system but it had not logged the receipt of a response. The back-end system does not send an SNA STSN command if no traffic has been on the session since the latest cold start of the back-end system, but sends an SNA SDT command directly.

Like other handlers, the STSN handler is a CICS started task that uses EXEC CICS RETRIEVE to get the start data and FEPI ALLOCATE with PASSCONVID to get ownership of the conversation identified in that data. The STSN handler, which can use the FEPI EXTRACT STSN command to determine what response is needed, must use the FEPI ISSUE command to respond to the STSN.

FEPI normally does all the necessary STSN handling automatically, so an STSN handler is required only where you need to handle the sequence number information yourself. The FEPI SEND, FEPI RECEIVE, and FEPI CONVERSE commands return the current sequence numbers for you.

A sample program illustrates the techniques used. See “STSN handler” on page 235.

---

### DRx responses

In all cases except those mentioned in the next paragraph, FEPI automatically gives a positive DRx response when the inbound data indicates that a response is required. This response flows on the next FEPI command (SEND, RECEIVE, CONVERSE, FREE, or START).

The automatic response is not issued if the next command for a conversation is a FEPI ISSUE CONTROL or a FEPI FREE PASS. Thus, if you want to send your own

## Specialized functions

response, perhaps for added certainty or confirmation of particularly sensitive changes, you would do so using FEPI ISSUE CONTROL. The response type that is required can be determined from the RESPSTATUS option of FEPI RECEIVE and FEPI CONVERSE.

You can send your own responses with either formatted data or data stream. But do not use the following because they can cause FEPI to send responses automatically:

- Key stroke formatted data containing an attention key that is not the final key stroke
- FEPI CONVERSE with the POOL option to use a temporary conversation.

If you respond negatively a back-end CICS system will discard the data but an IMS system will resend it.

---

## SNA commands

The FEPI ISSUE command allows you to send various other SNA commands yourself. You should do this only if you have a particular requirement.

---

## Chapter 16. Application programming reference

This chapter defines the FEPI application programming commands. (System programming commands such as INSTALL, INQUIRE, and SET are defined in “Chapter 9. System programming reference” on page 87.) The chapter contains the following topics:

- “The FEPI API commands”
- “Start data” on page 211
- “Data formats” on page 212
- “Ending status” on page 214.

---

### The FEPI API commands

The FEPI application programming commands are:

ALLOCATE  
AP NOOP  
CONVERSE  
EXTRACT  
FREE  
ISSUE  
RECEIVE  
REQUEST PASSTICKET  
SEND  
START

The FEPI application programming commands are additions to the set of EXEC CICS commands that are available to application programmers, and they have the same features and properties as those commands. Some brief notes of these features and properties appear below; for details, refer to the programming information on the following subjects in the *CICS Application Programming Reference* manual:

- Command format
- Argument values, including programming-language considerations, and CVDA values
- RESP, RESP2, and NOHANDLE options
- LENGTH options.

### Command format

The general format of a command is:

**EXEC CICS FEPI command option(argument)...**

where:

**command**

Is the command name (for example, ALLOCATE).

**option**

Is an option name (for example, POOL).

**argument**

Is the source or destination for data, as required for the specified option, that is passed to or returned from the command.

## Application programming reference

The way that you end the command is determined by the programming language that you are using: COBOL, for example, requires an END-EXEC statement.

## Arguments and data types

The text used to identify arguments in this book indicates the type of data represented by the argument and whether it is a value used by the command, or an area in which the command returns data. For example:

P00L(8-character data-value) says that the argument is, or identifies, a string of eight characters and that the string is passed to the command as an input value.

SIZE(fullword binary data-area) says that the argument is a user-defined fullword data area in which the command can return a binary number as an output value.

## Errors and exception conditions

All FEPI commands support the RESP and RESP2 options to signal successful completion or an exception condition. Alternatively, you can use HANDLE CONDITION to trap errors.

Most FEPI command errors give the 'INVREQ' exception condition. The particular error in each case is uniquely identified by the RESP2 value.

If there is an error, the command does nothing and the output arguments are not changed. Note, however, that commands such as FEPI SEND may have transferred data before the condition is recognized.

Both RESP and RESP2 take, as an argument, the name of a user-defined fullword binary data area. Possible values of the RESP2 option are given in the description of each of the commands and a full list is given in "RESP2 values" on page 241. The following copy books provide declarations for the RESP2 values:

- DFHSZAPA for Assembler language
- DFHSZAPO for COBOL
- DFHSZAPP for PL/I
- DFHSZAPC for C/370.

The INVREQ condition and the following RESP2 values can occur for any application programming command:

<b>RESP2</b>	<b>Meaning</b>
10	Command bypassed by user exit.
11	FEPI not installed, or not active..
12	CICS shutting down, command not allowed.
13	FEPI unavailable.
14	FEPI busy or cannot get storage..
15	Unknown command..
16	Internal error.
17	FEPI cannot get storage for user exit..
18	Command failed through operator or system action..



## Syntax notation

The notation used in this book to show the syntax of FEPI commands is the same as that used in the *CICS System Programming Reference*. See “CICS syntax notation used in this book” on page xv for details.

## Translator options

You must specify the ‘FEPI’ translator option when you use FEPI commands.

## Other points

- FEPI commands can be issued in either 24-bit or 31-bit addressing mode, by programs that reside either above or below the 16MB line.
- No information is passed through the EXEC interface block (EIB) except that, as for all CICS commands, the EIBRESP, EIBRESP2, EIBFN, and EIBRCODE fields are set.

## FEPI ALLOCATE PASSCONVID

### FEPI ALLOCATE PASSCONVID

**Function:** FEPI ALLOCATE PASSCONVID acquires ownership of an existing unowned conversation.

**Syntax:**

### FEPI ALLOCATE PASSCONVID

►►—FEPI ALLOCATE—PASSCONVID(*data-value*)—◀◀

#### Notes:

1 INVREQ

#### Options:

**PASSCONVID(8-character data-value)**  
specifies the ID of the conversation.

#### Conditions:

RESP2	Meaning
216	Error occurred on previous FEPI SEND.
240	Unknown conversation ID.

## FEPI ALLOCATE POOL

**Function:** FEPI ALLOCATE POOL establishes a new FEPI conversation with a target application, acquiring a session from the named pool to use for the conversation. The conversation has the properties, particularly the mode (SLU2 or SLU P) and data format (data stream or formatted), specified for the pool that is used: some of the properties can be queried using FEPI EXTRACT CONV.

The command completes immediately if, in the named POOL, a suitable session has been established and is not in use. Otherwise the request waits for a session to become available. A time limit can be set for this wait.

### Syntax:

#### FEPI ALLOCATE POOL

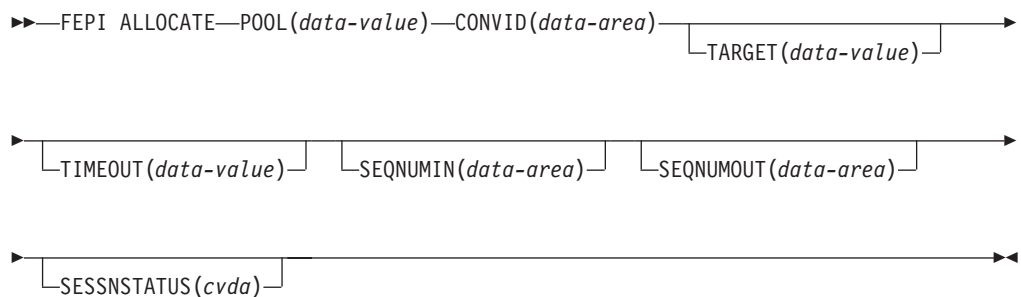

### Notes:

1 INVREQ

### Options:

#### CONVID(8-character data-area)

returns a unique identifier for the new conversation; this is the ID that must be quoted on all subsequent commands for the conversation.

#### POOL(8-character data-value)

specifies the name of the pool containing the target for the conversation.

#### SEQNUMIN(fullword binary data-area)

in SLU P mode, returns the current sequence number for inbound data. (SEQNUMIN has no significance in SLU2 mode.)

#### SEQNUMOUT(fullword binary data-area)

in SLU P mode, returns the current sequence number for outbound data. (SEQNUMOUT has no significance in SLU2 mode.)

#### SESSNSTATUS(cvda)

returns a value that indicates whether the session being used for the conversation was newly-bound or not. The relevant CVDA values are:

NEWSESSION  
OLDESSION

#### TARGET(8-character data-value)

specifies the name of the target. TARGET can be omitted if there is only one target in the pool or if all targets are suitable for the desired conversation.

#### TIMEOUT(fullword binary data-value)

specifies the maximum time in seconds that the command is to wait for a

## FEPI ALLOCATE POOL

suitable session to become available. If TIMEOUT is not specified or the specified time is zero, the command is not timed out.

**Conditions:** If an INVREQ condition is returned, it can have the following RESP2 values:

<b>RESP2</b>	<b>Meaning</b>
30	Pool name unknown.
31	Pool name out of service.
32	Target name unknown..
33	Target name out of service..
34	Target name required but not specified.
36	No suitable session available and in service.
213	Command timed out.
241	TIMEOUT value negative or not valid.

**FEPI AP NOOP**

**Function:** FEPI AP NOOP has no effect.

**Syntax:**

**FEPI AP NOOP**

▶▶—FEPI AP NOOP—▶▶

**Notes:**

1 INVREQ

**Options:** None

**Conditions:** None specific to this command.

## FEPI CONVERSE DATASTREAM

### FEPI CONVERSE DATASTREAM

**Function:** FEPI CONVERSE DATASTREAM sends application data to and receives a reply from a target. The data supplied by the application must be a currently valid data stream appropriate to the mode of the conversation (SLU2 or SLU P); the data received into the application's data area is also data stream. Full details about the data are given in "Data formats" on page 212.

The conversation with the target can be one of two types:

#### Previously allocated

The conversation is specified by the CONVID option; it must be one that uses data-stream-type data. By default, the command completes when a whole chain of data has been received, although other ending conditions can be requested.

#### Temporary

The conversation is allocated from the pool specified by the POOL option and exists only for the duration of the command. The pool must be one that uses data-stream-type data.

The command first waits for a suitable session to become available (if there is not already one); then, after sending the data, it completes when 'change direction' or 'end bracket' is received.

A time limit can be set for this command. For more details of ending conditions, see "Ending status" on page 214.

**Syntax:** The syntax for each type of conversation is shown separately.

*Previously allocated conversation:*

### FEPI CONVERSE DATASTREAM

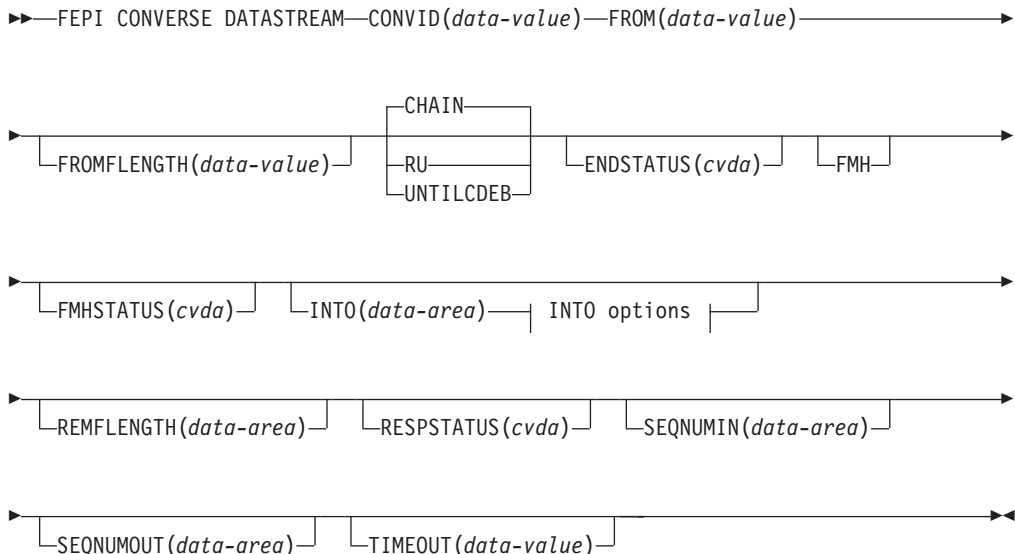

## FEPI CONVERSE DATASTREAM

### INTO options:



### Notes:

#### 1 INVREQ

*Temporary conversation:*

## FEPI CONVERSE DATASTREAM

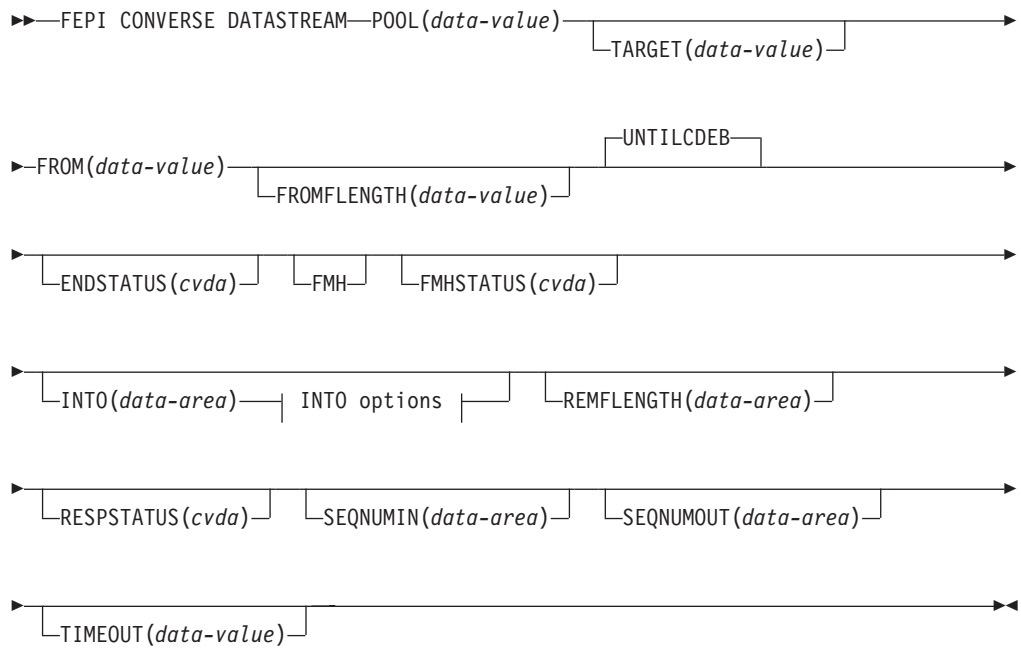

### INTO options:



### Notes:

#### 1 INVREQ

### Options:

#### CHAIN

specifies that the command should complete when a whole chain has been received. CHAIN is not allowed if the POOL option is specified.

#### CONVID(8-character data-value)

specifies the ID of the conversation to use. The conversation must be owned by the task issuing the command.

## FEPI CONVERSE DATASTREAM

### **ENDSTATUS(cvda)**

returns a value that indicates the ending status for the received data. The relevant CVDA values are:

#### **Value Meaning**

**CD** 'Change direction' received.

**EB** 'End bracket' received.

**LIC** 'Last in chain' received.

**RU** RU received.

**MORE** The data area identified by the INTO option was too small to receive all the requested data.

For more details of ending status and how additional data is handled, see "Ending status" on page 214.

### **FMH**

indicates that the data to send includes a function management header.

### **FMHSTATUS(cvda)**

returns a value that indicates whether the received data contains a function management header. The relevant CVDA values are:

FMH

NOFMH

### **FROM(data-value)**

specifies the data to send to the back-end application. Its length is specified by the FROMLENGTH option.

### **FROMLENGTH(fullword binary data-value)**

specifies the length of the data to send; that is, the length of the data area identified by the FROM option. It must not be zero or more than the maximum length allowed for the pool.

### **INTO(data-area)**

specifies the data area in which the received data is to be returned. The length of the area is specified by the MAXLENGTH option, and the actual length of data written into the area is returned by the TOLENGTH option.

### **MAXLENGTH(fullword binary data-value)**

specifies the maximum amount of data that can be returned; that is, the length of the data area identified by the INTO option. It must not be more than the maximum length allowed for the pool.

### **POOL(8-character data-value)**

specifies the name of the pool containing the target for the conversation. Specifying POOL means that the conversation is a temporary one, that exists only for the duration of the FEPI CONVERSE. The CHAIN and RU options are not allowed, and the command completes when 'change direction' or 'end bracket' is received. If there is more data to receive than fits into the data area identified by the INTO option, the additional data is discarded.

### **REMLENGTH(fullword binary data-area)**

returns the length, if known, of data remaining after filling the data area identified by the INTO option.

### **RESPSTATUS(cvda)**

returns a value that indicates the type of response that is required at the back-end system. The relevant CVDA values are:



Value	Meaning
DEFRESP1	Definite response 1 required.
DEFRESP2	Definite response 2 required.
DEFRESP3	Definite response 1 and definite response 2 required.
NONE	No response required.

**RU**

specifies that the command should complete when a request unit has been received. RU is not allowed if the POOL option is specified.

**SEQNUMIN(fullword binary data-area)**

in SLU P mode, returns the current sequence number for inbound data, as at the completion of the command. (SEQNUMIN has no significance in SLU2 mode.)

**SEQNUMOUT(fullword binary data-area)**

in SLU P mode, returns the current sequence number for outbound data, as at the completion of the command. (SEQNUMOUT has no significance in SLU2 mode.)

**TARGET(8-character data-value)**

specifies the name of the target. TARGET can be omitted if there is only one target in the pool or if all targets are suitable for the desired conversation.

**TIMEOUT(fullword binary data-value)**

specifies the maximum time in seconds that the command is to wait for the requested data to begin to arrive. If TIMEOUT is not specified or the specified time is zero, the command is not timed out.

**TOFLENGTH(fullword binary data-area)**

returns the actual length of data received in the data area identified by the INTO option.

**UNTILCDEB**

specifies that the command should complete when 'change direction' or 'end bracket' is received.

**Conditions:** The INVREQ condition can have the following RESP2 values:

RESP2	Meaning
30	Pool name unknown.
31	Pool name out of service.
32	Target name unknown.
33	Target name out of service.
34	Target name required but not specified.
35	POOL name is unsuitable for temporary conversations. It has CONTENTION(LOSE) or it has INITIALDATA(INBOUND) and no begin-session handler.
36	No suitable session available and in service.
40	FROMLENGTH value negative, zero, or more than the maximum allowed for the current pool.
50	Inbound data with 'begin bracket' to be received.
58	VTAM SEND failed.

## FEPI CONVERSE DATASTREAM

60	MAXLENGTH value negative, zero, or more than the maximum allowed for the current pool.
71	VTAM RECEIVE failed.
212	Conversation has wrong data format.
213	Command timed out.
215	Session lost.
216	Error occurred on previous FEPI SEND.
220	FEPI CONVERSE not allowed at this point in the conversation.
224	Only FEPI ISSUE or FEPI FREE commands allowed at this point in the conversation.
230	SNA CLEAR command received. <sup>3</sup>
231	SNA CANCEL command received. <sup>3</sup>
232	SNA CHASE command received. <sup>3</sup>
233	Exception response received.
234	Exception request received.
240	Conversation ID not owned by this task.
241	TIMEOUT value negative or not valid.

**FEPI CONVERSE FORMATTED**

**Function:** *The command is for SLU2 mode only.*

FEPI CONVERSE FORMATTED sends application data to and receives a reply from a target. The data supplied by the application must be formatted data, as key strokes (with a final attention character) or a screen image; the data received into the application’s data area is a screen image. Full details about the data are given in “Data formats” on page 212.

The conversation with the target can be one of two types:

**Previously allocated**

The conversation is specified by the CONVID option; it must be one that uses formatted data. The command completes when ‘last in chain’, ‘end bracket’, or ‘change direction’ is received.

**Temporary**

The conversation is allocated from the pool specified by the POOL option and exists only for the duration of the command. The pool must be one that uses formatted data. In addition, the data must be sent in key stroke format.

The command first waits for a suitable session to become available (if there is not already one); it does not complete until ‘end bracket’ or ‘change direction’ is indicated.

A time limit can be set for this command. For more details of ending conditions, see “Ending status” on page 214.

**Syntax:** The syntax for each type of conversation is shown separately.

*Previously allocated conversation:*

**FEPI CONVERSE FORMATTED**

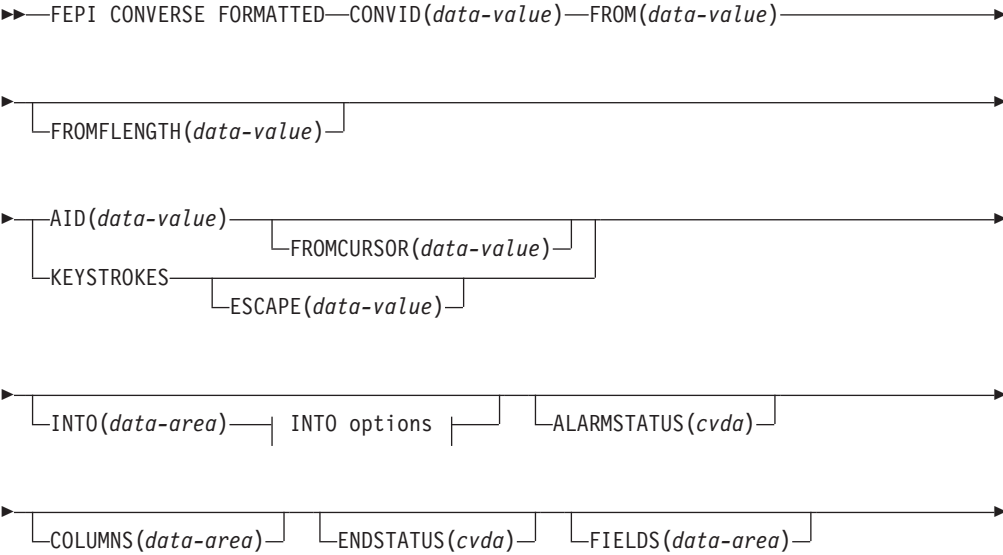

## FEPI CONVERSE FORMATTED

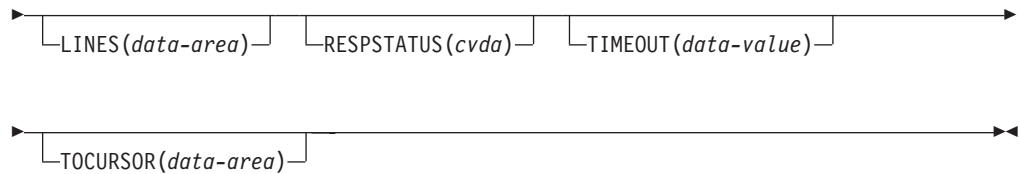

### INTO options:



### Notes:

#### 1 INVREQ

*Temporary conversation:*

## FEPI CONVERSE FORMATTED

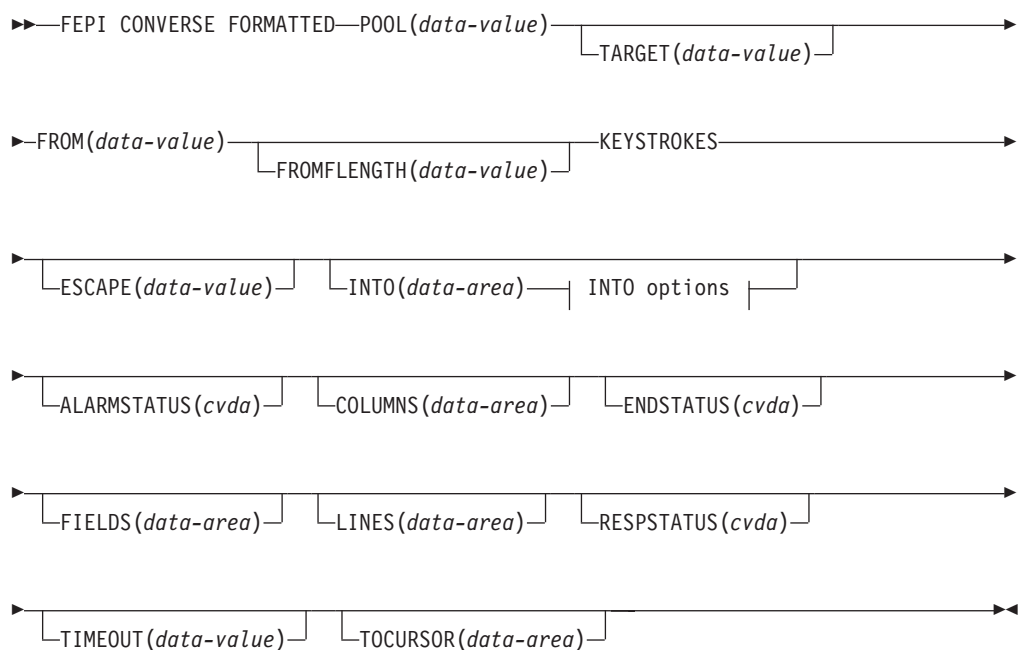

### INTO options:



### Notes:

#### 1 INVREQ

*Options:*

**AID(1-character data-value)**

specifies the attention identifier value to send with the data. Specifying AID also indicates that the data to send is in screen-image format, as described in “Data formats” on page 212. The value must not be null (X'00'). AID, and therefore screen-image format data, is not allowed if POOL is specified.

Symbolic names for the AID values are available for the supported languages in the language-specific DFHAID copybooks.

**ALARMSTATUS(cvda)**

returns a value that indicates whether the received data sounded the alarm. The relevant CVDA values are:

- ALARM
- NOALARM

**COLUMNS(fullword binary data-area)**

returns the number of columns in the screen image.

**CONVID(8-character data-value)**

specifies the ID of the conversation to use. The conversation must be owned by the task issuing the command.

**ENDSTATUS(cvda)**

returns a value that indicates the ending status for the received data. The relevant CVDA values are:

Value	Meaning
CD	'Change direction' received.
EB	'End bracket' received.
LIC	'Last in chain' received.

For more details of ending status and how additional data is handled, see “Ending status” on page 214.

**ESCAPE(1-character data-value)**

for send data in key stroke format, specifies the escape character used to indicate character combinations representing special keys. You can use any value in the range X'40' through X'FE'. The default escape character is & (X'50').

**FIELDS(fullword binary data-area)**

returns the number of fields in the screen image.

**FROM(data-value)**

specifies the data to send to the back-end application. Its length is specified by the FROMLENGTH option. For send data in screen-image format, if the length is more than the screen image, the additional data is ignored; if it is less, the data is the first part of the screen image, and the last part of the screen image is not changed.

**FROMCURSOR(fullword binary data-value)**

for send data in screen-image format, specifies the position of the cursor, expressed as an offset from the start of the screen image; offset zero is the top left-hand corner of the screen. If FROMCURSOR is not specified, the cursor remains where it was positioned by the last inbound data.

## FEPI CONVERSE FORMATTED

### **FROMLENGTH(fullword binary data-value)**

specifies the length of the data to send; that is, the length of the data area identified by the FROM option. It must not be zero or more than the maximum length allowed for the pool.

### **INTO(data-area)**

specifies the data area in which the received data is to be returned. The length of the area is specified by the MAXLENGTH option, and the actual length of data written into the area is returned by the TOLENGTH option.

### **KEYSTROKES**

specifies that the data to send is a sequence of key strokes (see "Data formats" on page 212).

### **LINES(fullword binary data-area)**

returns the number of lines in the screen image.

### **MAXLENGTH(fullword binary data-value)**

specifies the maximum amount of data that can be returned; that is, the length of the data area identified by the INTO option. It must not be more than the maximum length allowed for the pool.

### **POOL(8-character data-value)**

specifies the name of the pool containing the target for the conversation. Specifying POOL means that the conversation is a temporary one, that exists only for the duration of the FEPI CONVERSE. You must also specify the KEYSTROKES option. If the length of the data area identified by the INTO option is less than the size of the screen image, the additional data is discarded.

### **RESPSTATUS(cvda)**

returns a value that indicates the type of response that is required at the back-end system. The relevant CVDA values are:

<b>Value</b>	<b>Meaning</b>
<b>DEFRESP1</b>	Definite response 1 required.
<b>DEFRESP2</b>	Definite response 2 required.
<b>DEFRESP3</b>	Definite response 1 and definite response 2 required.
<b>NONE</b>	No response required.

### **TARGET(8-character data-value)**

specifies the name of the target. TARGET can be omitted if there is only one target in the pool or if all targets are suitable for the desired conversation.

### **TIMEOUT(fullword binary data-value)**

specifies the maximum time in seconds that the command is to wait for the requested data to begin to arrive. If TIMEOUT is not specified or the specified time is zero, the command is not timed out.

### **TOCURSOR(fullword binary data-area)**

returns the position of the cursor in the received screen image, expressed as an offset from the start of the screen image; offset zero is the top left-hand corner of the screen.

### **TOLENGTH(fullword binary data-area)**

returns the actual length of data received in the data area identified by the INTO option.

## FEPI CONVERSE FORMATTED

**Note:** On a FEPI CONVERSE FORMATTED command, if MAXLENGTH is less than the presentation space size, TOLENGTH returns the value defined in MAXLENGTH. If MAXLENGTH is greater than the presentation space size, TOLENGTH returns the presentation space size.

**Conditions:** The INVREQ condition can have the following RESP2 values:

<b>RESP2</b>	<b>Meaning</b>
30	Pool name unknown.
31	Pool name out of service.
32	TARGET name unknown.
33	TARGET name out of service.
34	TARGET name required but not specified.
35	POOL name is unsuitable for temporary conversations. It has CONTENTION(LOSE) or it has INITIALDATA(INBOUND) and no begin-session handler.
36	No suitable session available and in service.
40	FROMLENGTH value negative, zero, or more than the maximum allowed for the current pool.
41	ESCAPE value not valid.
50	Inbound data with 'begin bracket' to be received.
51	AID value not valid.
52	Cursor position not valid.
53	Character values in send data not valid.
54	Attribute positions or values in send data not valid.
55	Key stroke escape sequence in send data is not valid.
56	Field validation (mandatory fill, mandatory enter, trigger) failed.
57	Input inhibited.
58	VTAM SEND failed.
59	DBCS data rules violated.
60	MAXLENGTH value negative, zero, or more than the maximum allowed for the current pool.
71	VTAM RECEIVE failed.
72	RECEIVE FORMATTED processing found invalid, or unexpected data while interpreting the 3270 data stream for a WRITE, ERASE/WRITE ALTERNATE, or WRITE STRUCTURED FIELD command code.
210	Command not allowed for SLU P mode.
212	Conversation has wrong data format.
213	Command timed out.

---

2. For an explanation of this SNA command, see the *SNA Formats* manual, GA27-3136.

## FEPI CONVERSE FORMATTED

215	Session lost.
216	Error occurred on previous FEPI SEND.
220	FEPI CONVERSE not allowed at this point in the conversation.
221	Data cannot be received because no AID or final attention key stroke specified.
224	Only FEPI ISSUE or FEPI FREE commands allowed at this point in the conversation.
230	SNA CLEAR command received. <sup>3</sup>
231	SNA CANCEL command received. <sup>3</sup>
232	SNA CHASE command received. <sup>3</sup>
233	Exception response received.
234	Exception request received.
240	Conversation ID not owned by this task.
241	TIMEOUT value negative or not valid.

---

3. For an explanation of this SNA command, see the *SNA Formats* manual, GA27-3136.



## FEPI EXTRACT CONV

**Function:** FEPI EXTRACT CONV gets general information about a conversation.

**Syntax:**

### FEPI EXTRACT CONV

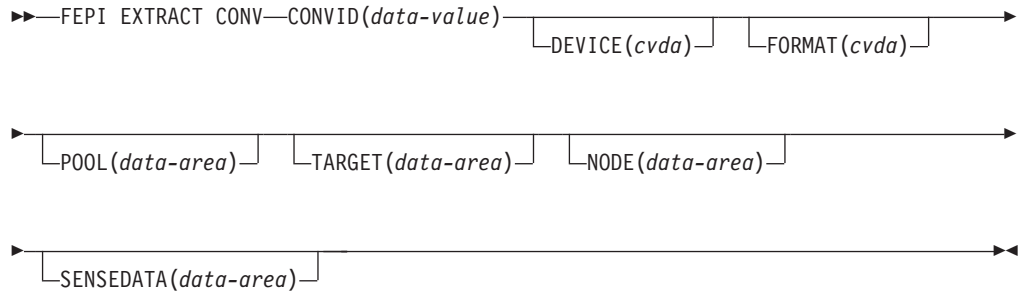

#### Notes:

1 INVREQ

#### Options:

##### CONVID(8-character data-value)

specifies the ID of the conversation for which information is wanted. The conversation must be owned by the task issuing the command.

##### DEVICE(cvda)

returns a value that identifies the mode of conversation and the type of device. The relevant CVDA values are:

Value	Meaning
<b>T3278M2</b>	SLU2 mode, 3278 Model 2
<b>T3278M3</b>	SLU2 mode, 3278 Model 3
<b>T3278M4</b>	SLU2 mode, 3278 Model 4
<b>T3278M5</b>	SLU2 mode, 3278 Model 5
<b>T3279M2</b>	SLU2 mode, 3279 Model 2B
<b>T3279M3</b>	SLU2 mode, 3279 Model 3B
<b>T3279M4</b>	SLU2 mode, 3279 Model 4B
<b>T3279M5</b>	SLU2 mode, 3279 Model 5B
<b>TPS55M2</b>	SLU2 mode, PS/55, 24 lines
<b>TPS55M3</b>	SLU2 mode, PS/55, 32 lines
<b>TPS55M4</b>	SLU2 mode, PS/55, 43 lines
<b>LUP</b>	SLU P mode, all cases.

##### FORMAT(cvda)

in SLU2 mode, returns a value that identifies the data mode. The relevant CVDA values are:

DATASTREAM  
FORMATTED

## FEPI EXTRACT CONV

**NODE(8-character data-area)**

returns the node name.

**POOL(8-character data-area)**

returns the pool name.

**SENSEDATA(fullword binary data-area)**

returns the sense data associated with the last FEPI SEND, FEPI RECEIVE, or FEPI CONVERSE command for the conversation. If there is no sense data, zero is returned.

**TARGET(8-character data-area)**

returns the target name.

**Conditions:** The INVREQ condition can have the following RESP2 values:

<b>RESP2</b>	<b>Meaning</b>
215	Session lost.
240	Conversation ID not owned by this task.

## FEPI EXTRACT FIELD

**Function:** *The command is for SLU2 mode only, and for formatted data only.*

FEPI EXTRACT FIELD gets information about a field in the current character buffer of the simulated terminal. It can be issued at any point in the conversation. More than one FEPI EXTRACT FIELD command can be issued for a given field.

For information about field attributes and their values see *3270 Data Stream Programmer's Reference*. Symbolic names for the various attribute values are available in the DFHBMSCA copybook.

### Syntax:

#### FEPI EXTRACT FIELD

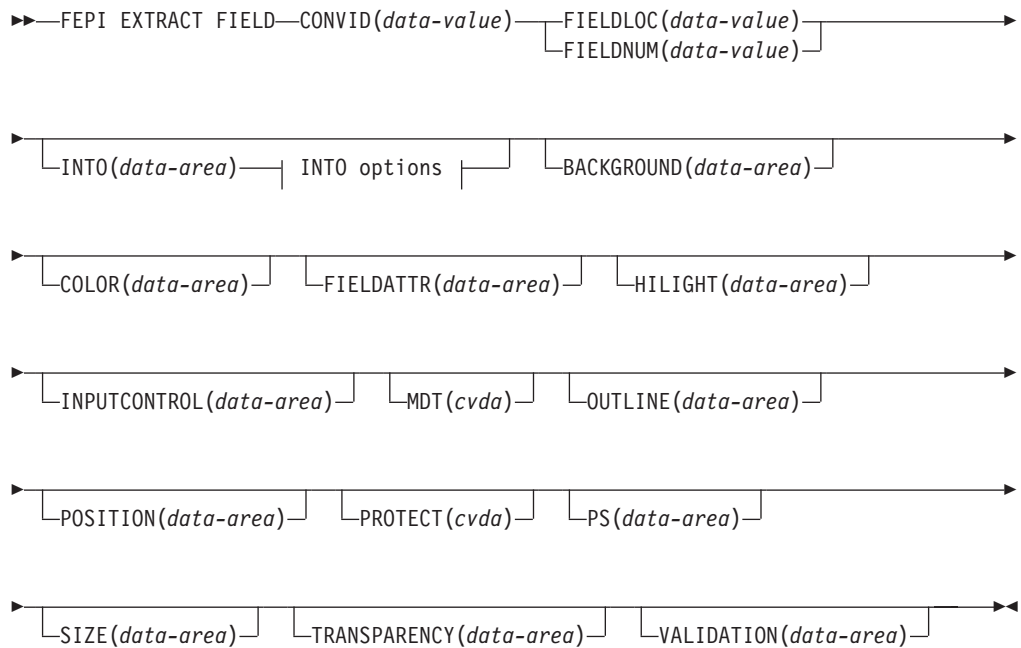

#### INTO options:

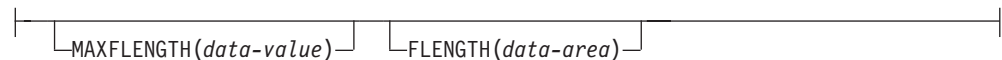

#### Notes:

- 1 INVREQ

#### Options:

##### **BACKGROUND(1-character data-area)**

returns the background color attribute of the field.

##### **COLOR(1-character data-area)**

returns the foreground color attribute of the field.

## FEPI EXTRACT FIELD

### **CONVID(8-character data-value)**

specifies the ID of the conversation for which information is wanted. The conversation must be owned by the task issuing the command.

### **FIELDATTR(1-character data-area)**

returns the 3270 field attribute of the field.

### **FIELDLOC(fullword binary data-value)**

specifies the location of the required field expressed as an offset from the start of the screen image; offset zero is the top left-hand corner of the screen. The location can refer to any character position in the field, including its attribute byte.

### **FIELDNUM(fullword binary data-value)**

specifies the location of the required field expressed as a field number counting from the top left-hand corner of the screen. The first field is number 1, and starts at the top-left hand corner of the screen, whether or not there is an attribute in that position. The last field ends at the bottom right-hand corner of the screen, and does not wrap back to the top.

### **FLENGTH(fullword binary data-area)**

returns the actual length of data received in the data area identified by the INTO option.

### **HIGHLIGHT(1-character data-area)**

returns the extended highlighting attribute of the field.

### **INPUTCONTROL(1-character data-area)**

returns the DBCS input control attribute of the field.

### **INTO(data-area)**

specifies the data area in which the data in the field is to be returned. The length of the area is specified by the MAXFLENGTH option, and the actual length of data written into the area is returned by the FLENGTH option.

### **MAXFLENGTH(fullword binary data-value)**

specifies the maximum amount of data that can be returned; that is, the length of the data area identified by the INTO option. It must not be more than the maximum length allowed for the pool.

### **MDT(cvda)**

returns a value that identifies the state of the modified data tag for the field. The relevant CVDA values are:

NOMDT  
MDT

### **OUTLINE(1-character data-area)**

returns the field outlining attribute of the field.

### **POSITION(fullword binary data-area)**

returns the position of the field expressed as the offset of the first data byte from the start of the screen image; offset zero is the top left-hand corner of the screen.

### **PROTECT(cvda)**

returns a value that indicates whether or not the field is protected. The relevant CVDA values are:

UNPROTECTED  
PROTECTED

### **PS(1-character data-area)**

returns the character set attribute of the field.

**SIZE(fullword binary data-area)**

returns the size of the field on the screen, excluding the field attribute byte, expressed as a number of bytes.

**TRANSPARENCY(1-character data-area)**

returns the transparency attribute of the field.

**VALIDATION(1-character data-area)**

returns the field validation attribute of the field.

**Conditions:** The INVREQ condition can have the following RESP2 values:

<b>RESP2</b>	<b>Meaning</b>
<b>60</b>	MAXFLENGTH value negative, zero, or more than the maximum allowed for the current pool.
<b>70</b>	FIELDLOC or FIELDNUM value negative or not valid.
<b>210</b>	Command not allowed for SLU P mode.
<b>212</b>	Conversation has wrong data format.
<b>224</b>	Only FEPI ISSUE or FEPI FREE commands allowed at this point in the conversation.
<b>240</b>	Conversation ID not owned by this task.

## FEPI EXTRACT STSN

### FEPI EXTRACT STSN

**Function:** *The command is for SLU P mode only.*

FEPI EXTRACT STSN gets sequence number status information for a conversation.

**Syntax:**

### FEPI EXTRACT STSN

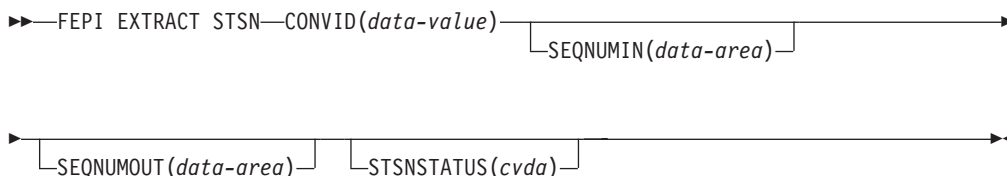

### Notes:

1 INVREQ

### Options:

#### CONVID(8-character data-value)

specifies the ID of the conversation for which information is wanted. The conversation must be owned by the task issuing the command.

#### SEQNUMIN(fullword binary data-area)

returns the current sequence number for inbound data.

#### SEQNUMOUT(fullword binary data-area)

returns the current sequence number for outbound data.

#### STSNSTATUS(cvda)

returns the current sequence-number set and test status. The relevant CVDA values are:

Value	Meaning
NOSTSN	No 'set' or 'test and set' issued.
STSNSET	'Set' sequence number issued.
STSNTEST	'Test and set' sequence number issued.

**Conditions:** The INVREQ condition can have the following RESP2 values:

RESP2	Meaning
211	Command not allowed for SLU2 mode.
240	Conversation ID not owned by this task.

## FEPI FREE

**Function:** FEPI FREE ends a task's use and ownership of a conversation. The conversation may be ended completely, or may be passed to another task. The action depends on the processing state of the conversation:

- Begin session handler
- STSN handler
- Access program
- End session handler
- Unsolicited-data handler.

### Syntax:

#### FEPI FREE

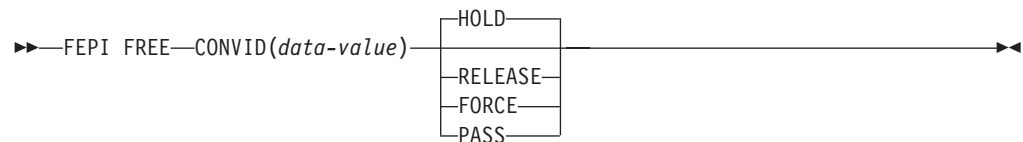

### Notes:

1 INVREQ

### Options:

#### CONVID(8-character data-value)

specifies the ID of the conversation to free. The conversation must be owned by the task issuing the command.

#### FORCE

tells FEPI what action to take. For all processing states of the conversation, FORCE instructs FEPI to end the conversation unconditionally, and to take the connection that it was using out of service immediately and, if possible, reset it.

#### HOLD

tells FEPI what action to take.

For the access program and the unsolicited-data handler, HOLD instructs FEPI to end the conversation and to retain the session for use by another conversation. However, this is subject to any end-session processing.

For the begin-session handler and the STSN handler, HOLD tells FEPI that begin-session or STSN processing has ended, and that the conversation is ready for the next processing state.

For the end-session handler, HOLD tells FEPI that end-session processing has ended, and instructs FEPI to end the conversation and to retain the session for use by another conversation. (If CICS shutdown is in progress, HOLD is the same as RELEASE.)

#### PASS

# tells FEPI what action to take. For all the processing states of the conversation,  
 # PASS specifies that the task is relinquishing ownership of the conversation so  
 # that another task can acquire it. FEPI regards this connection as still being used  
 # until such time as another task frees the connection without using the PASS  
 # parameter. (PASS is not allowed if CICS shutdown is in progress.)

## FEPI FREE

### RELEASE

tells FEPI what action to take.

For the access program and the unsolicited-data handler, RELEASE instructs FEPI to end the conversation, and to release and unbind the session that it was using, thereby forcing a new session to be started next time the connection is used. However, this is subject to any end-session processing.

For the begin-session handler and the STSN handler, RELEASE tells FEPI that begin-session or STSN processing has ended, and instructs FEPI to end the conversation without proceeding to the next processing state, and to release and unbind the session that it was using, thereby forcing a new session to be started next time the connection is used. However, this is subject to any end-session processing.

For the end-session handler, RELEASE tells FEPI that end-session processing has ended, and instructs FEPI to end the conversation, and to release and unbind the session that it was using, thereby forcing a new session to be started next time the connection is used.

Note that, under normal circumstances, after a FEPI FREE RELEASE command has been issued the session does not remain in RELEASED state, because FEPI automatically tries to reacquire the session. However, if a FEPI SET CONNECTION ACQSTATUS(RELEASED) command is issued before the FREE RELEASE, the session remains in RELEASED state.

**Conditions:** The INVREQ condition can have the following RESP2 values:

RESP2	Meaning
214	CICS shutting down, conversation should be ended.
240	Conversation ID not owned by this task.



## FEPI ISSUE

**Function:** FEPI ISSUE sends control data, such as standard responses and sense data, to the target system.

The command completes as soon as the corresponding VTAM SEND has been accepted.

**Syntax:**

### FEPI ISSUE

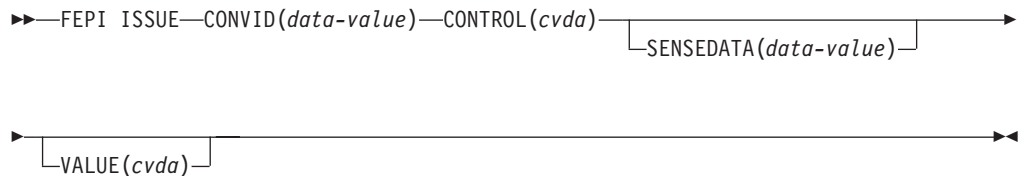

**Notes:**

- 1 INVREQ

**Options:**

**CONTROL(cvda)**

specifies what type of control data to send. The relevant CVDA values depend upon the data type and the mode of the conversation:

**For all modes:**

Value	Meaning
<b>NORMALRESP</b>	Send a normal response, as specified by the VALUE option.
<b>EXCEPTRESP</b>	Send an exception response, as specified by the VALUE option, and with the sense data specified by the SENSEDATA option.
<b>ATTENTION</b>	Send an attention (SNA 'signal' command X'00010000').
<b>LUSTAT</b>	Send an SNA 'LUSTAT' command with the sense data specified by the SENSEDATA option.

**For data stream only:**

Value	Meaning
<b>CANCEL</b>	Send an SNA 'cancel' command.

**For SLU P mode only:**

Value	Meaning
<b>STSN</b>	Send an SNA 'set and test sequence number' command.

## FEPI ISSUE

**RTR** Send an SNA 'ready to receive' command.

**CONVID(8-character data-value)**

specifies the ID of the conversation to use. The conversation must be owned by the task issuing the command.

**SENSEDATA(fullword binary data-value)**

specifies sense data to send to the target when the CONTROL is LUSTAT or EXCEPTRESP.

**VALUE(cvda)**

specifies the response type associated with the control data. The relevant CVDA values are determined by what is specified for the CONTROL option:

**For EXCEPTRESP and NORMALRESP:**

Value	Meaning
<u>DEFRESP1OR2</u>	Send definite response 1 or 2 as required.
DEFRESP1	Send definite response 1.
DEFRESP2	Send definite response 2.
DEFRESP3	Send definite response 1 and definite response 2.

**For STSN:**

Value	Meaning
<u>POSITIVE</u>	Send STSN positive response.
NEGATIVE	Send STSN negative response.
INVALID	Send STSN response not valid (this unbinds the session).
RESET	Send STSN reset response (this unbinds the session).
DEFRESP2	Send definite response 2.
DEFRESP3	Send definite response 1 and definite response 2.

**For other controls:**

None; the VALUE option is not used with the other controls.

**Conditions:** The INVREQ condition can have the following RESP2 values:

RESP2	Meaning
80	CONTROL value not valid.
81	VALUE value not valid: omitted when required, specified when not required, or unsuitable for the specified CONTROL value.
82	SENSEDATA value omitted when required or specified when not required.
90	Definite response type did not match what was required.
91	Only NORMALRESP or EXCEPTRESP are allowed at this point in the conversation.

<b>92</b>	Response to STSN SET was not positive.
<b>93</b>	Only FEPI ISSUE CONTROL(STSN) allowed at this point in the conversation.
<b>94</b>	Only FEPI ISSUE CONTROL(STSN) or FEPI ISSUE CONTROL(NORMALRESP) allowed at this point in the conversation.
<b>95</b>	CONTROL value not allowed at this point in the conversation.
<b>211</b>	Option not allowed for SLU2 mode.
<b>215</b>	Session lost.
<b>216</b>	Error occurred on previous FEPI SEND.
<b>230</b>	SNA CLEAR command received.
<b>231</b>	SNA CANCEL command received.
<b>232</b>	SNA CHASE command received.
<b>233</b>	Exception response received.
<b>234</b>	Exception request received.
<b>240</b>	Conversation ID not owned by this task.

## FEPI RECEIVE DATASTREAM

### FEPI RECEIVE DATASTREAM

**Function:** FEPI RECEIVE DATASTREAM receives data from a target and places the received data stream into the application's data area. Full details about the data are given in "Data formats" on page 212.

By default, FEPI RECEIVE DATASTREAM completes when a whole chain of data has been received. A time limit can be set for this command. For more details of ending conditions, see "Ending status" on page 214.

#### Syntax:

### FEPI RECEIVE DATASTREAM

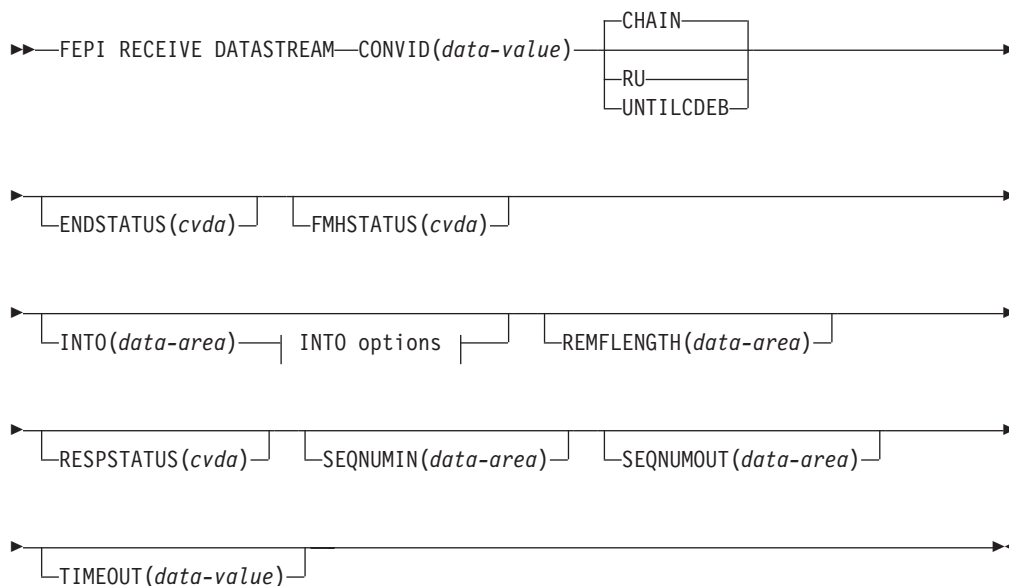

#### INTO options:

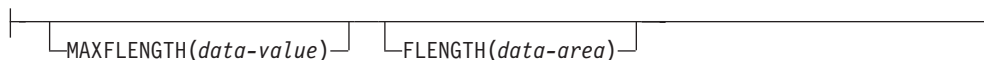

#### Notes:

1 INVREQ

#### Options:

##### CHAIN

specifies that the command should complete when a whole chain has been received.

##### CONVID(8-character data-value)

specifies the ID of the conversation to use. The conversation must be owned by the task issuing the command.

##### ENDSTATUS(*cvda*)

returns a value that indicates the ending status for the received data. The relevant CVDA values are:

**Value    Meaning**

**CD**    'Change direction' received.

**EB**    'End bracket' received.

**LIC**   'Last in chain' received.

**RU**    RU received.

**MORE** The data area identified by the INTO option was too small to receive all the requested data.

For more details of ending status and how additional data is handled, see "Ending status" on page 214.

**FLENGTH(fullword binary data-area)**

returns the actual length of data received in the data area identified by the INTO option.

**FMHSTATUS(cvda)**

returns a value that indicates whether the received data contains a function management header. The relevant CVDA values are:

- FMH
- NOFMH

**INTO(data-area)**

specifies the data area in which the received data is to be returned. The length of the area is specified by the MAXFLENGTH option, and the actual length of data written into the area is returned by the FLENGTH option.

**MAXFLENGTH(fullword binary data-value)**

specifies the maximum amount of data that can be returned; that is, the length of the data area identified by the INTO option. It must not be more than the maximum length allowed for the pool.

**REMFLENGTH(fullword binary data-area)**

returns the length, if known, of data remaining after filling the data area identified by the INTO option.

**RESPSTATUS(cvda)**

returns a value that indicates the type of response that is required at the back-end system. The relevant CVDA values are:

**Value            Meaning**

**DEFRESP1**    Definite response 1 required.

**DEFRESP2**    Definite response 2 required.

**DEFRESP3**    Definite response 1 and definite response 2 required.

**NONE**        No response required.

**RU**

specifies that the command should complete when a request unit has been received.

**SEQNUMIN(fullword binary data-area)**

in SLU P mode, returns the current sequence number for inbound data, as at the completion of the command. (SEQNUMIN has no significance in SLU2 mode.)

## FEPI RECEIVE DATASTREAM

### **SEQNUMOUT(fullword binary data-area)**

in SLU P mode, returns the current sequence number for outbound data, as at the completion of the command. (SEQNUMOUT has no significance in SLU2 mode.)

### **TIMEOUT(fullword binary data-value)**

specifies the maximum time in seconds that the command is to wait for the requested data to begin to arrive. If TIMEOUT is not specified or the specified time is zero, the command is not timed out.

### **UNTILCDEB**

specifies that the command should complete when 'change direction' or 'end bracket' is received.

**Conditions:** The INVREQ condition can have the following RESP2 values:

<b>RESP2</b>	<b>Meaning</b>
<b>60</b>	MAXFLENGTH value negative or more than maximum allowed for the current pool.
<b>71</b>	VTAM RECEIVE failed.
<b>212</b>	Conversation has wrong data format.
<b>215</b>	Session lost.
<b>216</b>	Error occurred on previous FEPI SEND.
<b>221</b>	FEPI RECEIVE not allowed at this point in the conversation.
<b>224</b>	Only FEPI ISSUE or FEPI FREE commands allowed at this point in the conversation.
<b>230</b>	SNA CLEAR command received.
<b>231</b>	SNA CANCEL command received.
<b>232</b>	SNA CHASE command received.
<b>233</b>	Exception response received.
<b>234</b>	Exception request received.
<b>240</b>	Conversation ID not owned by this task.
<b>241</b>	TIMEOUT value negative or not valid.

## FEPI RECEIVE FORMATTED

**Function:** *This command is for SLU2 mode only.*

FEPI RECEIVE FORMATTED receives data from a target. The data received into the application's data area is a screen image. Full details about the data are given in "Data formats" on page 212.

FEPI RECEIVE FORMATTED completes after receiving the inbound data with 'last in chain', 'end bracket' or 'change direction' indicated. A time limit can be set for this command. For more details of ending conditions, see "Ending status" on page 214.

**Syntax:**

### FEPI RECEIVE FORMATTED

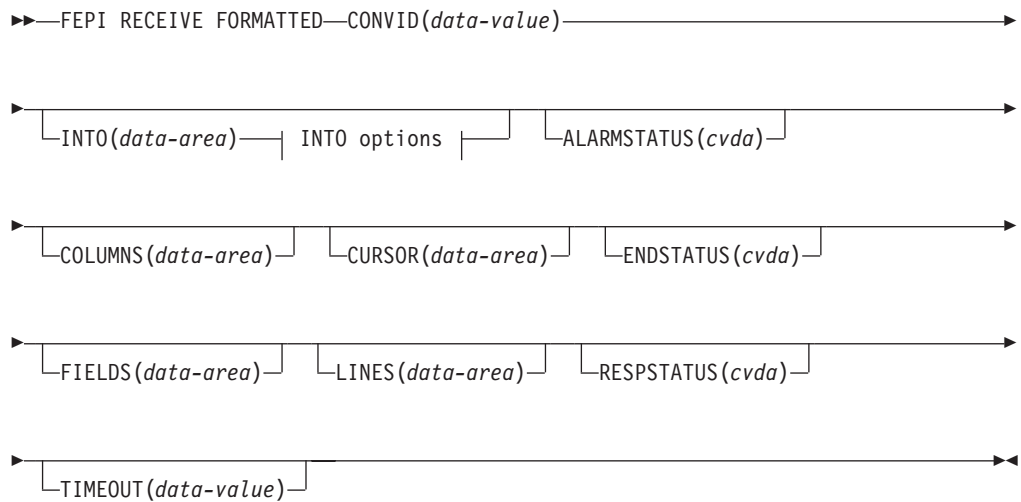

**INTO options:**

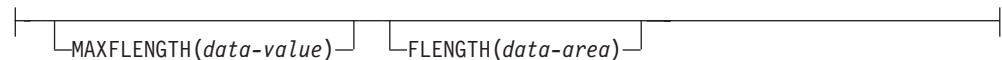

**Notes:**

- 1 INVREQ

**Options:**

#### ALARMSTATUS(cvda)

returns a value that indicates whether the received data sounded the alarm.

The relevant CVDA values are:

- ALARM
- NOALARM

#### COLUMNS(fullword binary data-area)

returns the number of columns in the screen image.

#### CONVID(8-character data-value)

specifies the ID of the conversation to use. The conversation must be owned by the task issuing the command.

## FEPI RECEIVE FORMATTED

### **CURSOR(fullword binary data-area)**

returns the position of the cursor in the received screen image, expressed as an offset from the start of the screen image; offset zero is the top left-hand corner of the screen.

### **ENDSTATUS(cvda)**

returns a value that indicates the ending status for the received data. The relevant CVDA values are:

<b>Value</b>	<b>Meaning</b>
--------------	----------------

<b>CD</b>	'Change direction' received.
-----------	------------------------------

<b>EB</b>	'End bracket' received.
-----------	-------------------------

<b>LIC</b>	'Last in chain' received.
------------	---------------------------

For more details of ending status and how additional data is handled, see "Ending status" on page 214.

### **FIELDS(fullword binary data-area)**

returns the number of fields in the screen image.

### **FLENGTH(fullword binary data-area)**

returns the actual length of data received in the data area identified by the INTO option.

### **INTO(data-area)**

specifies the data area in which the received data is to be returned. The length of the area is specified by the MAXFLENGTH option, and the actual length of data written into the area is returned by the FLENGTH option.

### **LINES(fullword binary data-area)**

returns the number of lines in the screen image.

### **MAXFLENGTH(fullword binary data-value)**

specifies the maximum amount of data that can be returned; that is, the length of the data area identified by the INTO option. It must not be more than the maximum length allowed for the pool.

### **RESPSTATUS(cvda)**

returns a value that indicates the type of response that is required at the back-end system. The relevant CVDA values are:

<b>Value</b>	<b>Meaning</b>
--------------	----------------

<b>DEFRESP1</b>	Definite response 1 required.
-----------------	-------------------------------

<b>DEFRESP2</b>	Definite response 2 required.
-----------------	-------------------------------

<b>DEFRESP3</b>	Definite response 1 and definite response 2 required.
-----------------	---

<b>NONE</b>	No response required.
-------------	-----------------------

### **TIMEOUT(fullword binary data-value)**

specifies the maximum time in seconds that the command is to wait for the requested data to begin to arrive. If TIMEOUT is not specified or the specified time is zero, the command is not timed out.

**Conditions:** The INVREQ condition can have the following RESP2 values:

<b>RESP2</b>	<b>Meaning</b>
--------------	----------------

<b>60</b>	MAXFLENGTH value negative or more than maximum allowed for the current pool.
-----------	--



## FEPI RECEIVE FORMATTED

71	VTAM RECEIVE failed.
72	RECEIVE FORMATTED processing found invalid, or unexpected data while interpreting the 3270 data stream for a WRITE, ERASE/WRITE, ERASE/WRITE ALTERNATE, or WRITE STRUCTURED FIELD command code.
210	Command not allowed for SLU P mode.
212	Conversation has wrong data format.
213	Command timed out.
215	Session lost.
216	Error occurred on previous FEPI SEND.
221	FEPI RECEIVE not allowed at this point in the conversation.
224	Only FEPI ISSUE or FEPI FREE commands allowed at this point in the conversation.
230	SNA CLEAR command received.
231	SNA CANCEL command received.
232	SNA CHASE command received.
233	Exception response received.
234	Exception request received.
240	Conversation ID not owned by this task.
241	TIMEOUT value negative or not valid.

## FEPI REQUEST PASSTICKET

### FEPI REQUEST PASSTICKET

**Function:** FEPI REQUEST PASSTICKET requests an external security manager (ESM) such as RACF to build a *PassTicket*. The PassTicket is a password substitute that your application can use to sign on to the back-end system associated with the conversation. For an explanation of how to use PassTickets to make your FEPI applications more secure, see “How to use PassTickets” on page 159.

**Syntax:**

#### FEPI REQUEST PASSTICKET

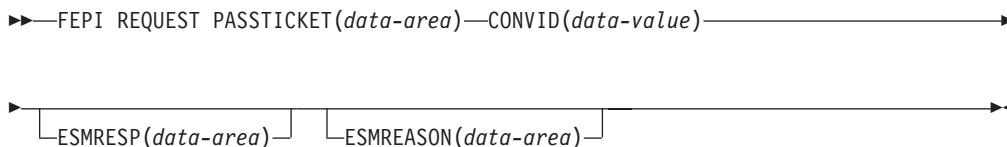

**Notes:**

1 INVREQ

**Options:**

**CONVID(8-character data-value)**

specifies the ID of the conversation with the back-end system for which a PassTicket is required.

**ESMREASON(fullword binary data-area)**

returns the reason code from the ESM.

**ESMRESP(fullword binary data-area)**

returns the response code from the ESM. For an explanation of the response and reason codes returned by RACF, see the *OS/390 Security Server (RACF) Messages and Codes* manual.

**PASSTICKET(8-character data-area)**

returns the PassTicket generated by the ESM.

**Conditions:** The INVREQ condition can have the following RESP2 values:

RESP2	Meaning
240	Conversation ID not owned by this task.
250	Passticket not built successfully.
251	CICS ESM interface not initialized.
252	Unknown return code in ESMRESP from the ESM.
253	Unrecognized response from CICS security modules.
254	Function unavailable.

## FEPI SEND DATASTREAM

**Function:** FEPI SEND DATASTREAM sends application data to a target. The data supplied by the application must be currently valid data stream appropriate to the mode of the conversation (SLU2 or SLU P). Full details about the data are given in “Data formats” on page 212.

The command completes as soon as the (first) VTAM SEND has been accepted.

### Syntax:

#### FEPI SEND DATASTREAM

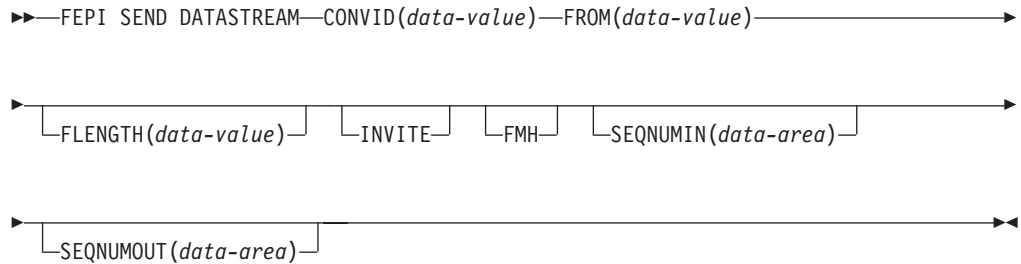

### Notes:

1 INVREQ

### Options:

#### CONVID(8-character data-value)

specifies the ID of the conversation to use. The conversation must be owned by the task issuing the command.

#### FMH

indicates that the data to send includes a function management header.

#### FLENGTH(fullword binary data-value)

specifies the length of the data to send; that is, the length of the data area identified by the FROM option. It must not be zero or more than the maximum length allowed for the pool.

#### FROM(data-value)

specifies the data to send to the back-end application. Its length is specified by the FLENGTH option.

#### INVITE

requests FEPI to send ‘last in chain’ and ‘change direction’ at the end of the data. This indicates that the data is complete, and that inbound data is expected next.

#### SEQNUMIN(fullword binary data-area)

in SLU P mode, returns the current sequence number for inbound data, as at the completion of the command. (SEQNUMIN has no significance in SLU2 mode.)

#### SEQNUMOUT(fullword binary data-area)

in SLU P mode, returns the current sequence number for outbound data, as at the completion of the command. (SEQNUMOUT has no significance in SLU2 mode.)

## FEPI SEND DATASTREAM

**Conditions:** The INVREQ condition can have the following RESP2 values:

<b>RESP2</b>	<b>Meaning</b>
40	FLENGTH value negative or more than maximum allowed for the current pool.
50	Inbound data with 'begin bracket' to be received.
58	VTAM SEND failed.
212	Conversation has wrong data format.
215	Session lost.
216	Error occurred on previous FEPI SEND.
220	FEPI SEND not allowed at this point in the conversation.
224	Only FEPI ISSUE or FEPI FREE commands allowed at this point in the conversation.
230	SNA CLEAR command received.
231	SNA CANCEL command received.
232	SNA CHASE command received.
233	Exception response received.
234	Exception request received.
240	Conversation ID not owned by this task.

**FEPI SEND FORMATTED**

**Function:** *This command is for SLU2 mode only.*

FEPI SEND FORMATTED sends application data to a target. The data supplied by the application must be formatted data, as key strokes or as a screen image. Full details about the data are given in “Data formats” on page 212.

The command completes as soon as the (first) VTAM SEND has been accepted.

**Syntax:**

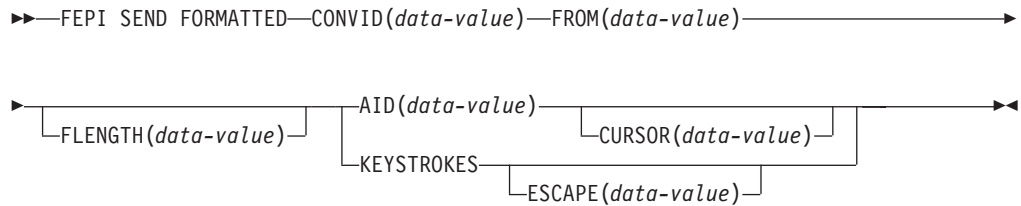
**FEPI SEND FORMATTED**

**Notes:**

1 INVREQ

**Options:**

**AID(1-character data-value)**

specifies the attention identifier value to send with the data. Specifying AID also indicates that the data to send is in screen-image format, as described in “Data formats” on page 212. A value of null (X'00') may be specified to indicate that no attention is to be sent, and that a further FEPI SEND is to follow.

Symbolic names for the AID values are available for the supported languages in the language-specific DFHAID copybooks.

**CONVID(8-character data-value)**

specifies the ID of the conversation to use. The conversation must be owned by the task issuing the command.

**CURSOR(fullword binary data-value)**

for send data in screen-image format, specifies the position of the cursor, expressed as an offset from the start of the screen image; offset zero is the top left-hand corner of the screen. If CURSOR is not specified, the cursor remains where it was positioned by the last inbound data.

**ESCAPE(1-character data-value)**

for send data in key stroke format, specifies the escape character used to indicate character combinations representing special keys. You can use any value in the range X'40' through X'FE'. The default escape character is & (X'50').

**FLENGTH(fullword binary data-value)**

specifies the length of the data to send; that is, the length of the data area identified by the FROM option. It must not be zero or more than the maximum length allowed for the pool.

## FEPI SEND FORMATTED

### **FROM(data-value)**

specifies the data to send to the back-end application. Its length is specified by the FLENGTH option. For send data in screen-image format, if the length is more than the screen image, the additional data is ignored; if it is less, the data is the first part of the screen image, and the last part of the screen image is not changed.

### **KEYSTROKES**

specifies that the data to send is in key stroke format, a sequence of key strokes, as described in "Data formats" on page 212.

**Conditions:** The INVREQ condition can have the following RESP2 values:

<b>RESP2</b>	<b>Meaning</b>
40	FLENGTH value negative or more than maximum allowed for the current pool.
41	ESCAPE value not valid.
50	Inbound data with 'begin bracket' to be received.
51	AID value not valid.
52	Cursor position not valid.
53	Character values in send data not valid.
54	Attribute positions or values in send data not valid.
55	Key stroke escape sequence in send data not valid.
56	Field validation (mandatory fill, mandatory error, trigger) failed.
57	Input inhibited.
58	VTAM SEND failed.
59	DBCS data rules violated.
210	Command not allowed for SLU P mode.
212	Conversation has wrong data format.
215	Session lost.
220	FEPI SEND not allowed at this point in the conversation.
224	Only FEPI ISSUE or FEPI FREE commands allowed at this point in the conversation.
230	SNA CLEAR command received.
231	SNA CANCEL command received.
232	SNA CHASE command received.
233	Exception response received.
234	Exception request received.
240	Conversation ID not owned by this task.

## FEPI START

**Function:** FEPI START is used to relinquish control of a conversation and to specify a new transaction to be started when the next inbound data arrives. Up to 128 characters of user data can be passed to the transaction as part of the start data, as described in “Start data” on page 211 below.

### Syntax:

#### FEPI START

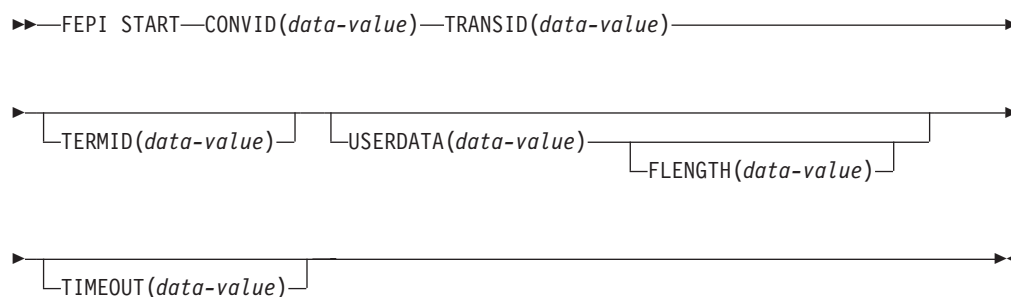

### Notes:

- 1 INVREQ

### Options:

#### CONVID(8-character data-value)

specifies the ID of the conversation to suspend. The conversation must be owned by the task issuing the command.

#### FLENGTH(fullword binary data-value)

specifies the length of the optional user data to pass to the transaction that is started; that is, the length of the data area identified by the USERDATA option. The FLENGTH value must not be greater than 128.

#### TERMID(4-character data-value)

specifies the name of the terminal, if any, to be associated with the transaction that is started.

#### TIMEOUT(fullword binary data-value)

specifies the maximum time in seconds that FEPI is to wait for inbound data to begin to arrive before starting the transaction. If TIMEOUT is not specified or the specified time is zero, the command is not timed out.

#### TRANSID(4-character data-value)

specifies the name of the transaction that is to be started when the next inbound data arrives.

#### USERDATA(data-value)

specifies optional user data to pass to the transaction that is started, in addition to control information passed by FEPI. Its length is specified by the FLENGTH option.

**Conditions:** The INVREQ condition can have the following RESP2 values:

RESP2	Meaning
61	FLENGTH value negative or too large.

## FEPI START

62	TRANSID name not valid.
63	TERMID name not valid.
214	CICS shutting down, conversation should be ended.
215	Session lost.
216	Error occurred on previous FEPI SEND.
223	FEPI START not allowed at this point in the conversation.
224	Only FEPI ISSUE or FEPI FREE commands allowed at this point in the conversation.
230	SNA CLEAR command received.
231	SNA CANCEL command received.
232	SNA CHASE command received.
233	Exception response received.
234	Exception request received.
240	Conversation ID not owned by this task.
241	TIMEOUT value negative or not valid.



## Start data

For various events, FEPI invokes a transaction, as a CICS started task, to handle the event. This may be in response to FEPI START, or to handle STSN, begin-session, end-session, or unsolicited-data. The transactions have a start code of 'SZ', as can be determined with the EXEC CICS ASSIGN command. FEPI provides start data which describes the event, and the conversation which is to be used to handle it. All of this data must be retrieved by the transaction using EXEC CICS RETRIEVE. The transaction can then gain access to the conversation identified in the data by using FEPI ALLOCATE PASSCONVID.

The structure for start data is shown below; the copy books DFHSZAPA, DFHSZAPO, DFHSZAPC, and DFHSZAPP (according to your programming language) provide declarations for this structure.

DATATYPE	Fullword binary data-area
EVENTTYPE	CVDA
EVENTVALUE	CVDA
EVENTDATA	8-character data-area
*spare*	4-character data-area
POOL	8-character data-area
TARGET	8-character data-area
NODE	8-character data-area
CONVID	8-character data-area
DEVICE	CVDA
FORMAT	CVDA
*spare*	8-character data-area
FLENGTH	Fullword binary data-area
USERDATA	128-character data area.

## Fields

### CONVID(8-character data-area)

the ID of the conversation for which the event occurred (this is the CONVID that should be used in FEPI ALLOCATE PASSCONVID).

### DATATYPE(fullword binary data-area)

Type and structure of data. Value is 1 for FEPI start data.

### DEVICE(cvda)

the device type of conversation for which the event occurred, values being as for FEPI EXTRACT CONV.

### EVENTDATA(8-character data-area)

always nulls.

### EVENTTYPE(cvda)

Indicates why the transaction was started. Values are:

Value	Event
BEGINSESSION	Begin-session to be handled
DATA	Inbound data arrived, following a FEPI START command
FREE	End-session transaction started to handle end of conversation as a result of a FEPI FREE request
SESSIONLOST	Active session lost while waiting for inbound data to arrive following a FEPI START command
STSN	Set and test sequence number (STSN) to be handled

## start data

<b>Value</b>	<b>Event</b>
TIMEOUT	Timed out waiting for inbound data to arrive following a FEPI START command
UNSOLDATA	Inbound data arrived outside a conversation.

### **EVENTVALUE(cvda)**

A CVDA giving further information about event types FREE and RELEASE.

Values for FREE:

FORCE	A FEPI FREE FORCE command was issued.
HOLD	A FEPI FREE HOLD command was issued.
RELEASE	A FEPI FREE RELEASE command was issued.
SHUTDOWN	CICS is shutting down.
TASK	Conversation being freed by end-of-task.

The EVENTVALUE value is zero for all other event types.

### **FLENGTH(fullword binary data-area)**

the length of the data in USERDATA.

### **FORMAT(cvda)**

the data format of conversation for which the event occurred, values being as for FEPI EXTRACT CONV.

### **NODE(8-character data-area)**

the name of the node for which the event occurred.

### **POOL(8-character data-area)**

the name of the pool for which the event occurred.

### **TARGET(8-character data-area)**

the name of the target for which the event occurred.

### **USERDATA(128-character data-area)**

user data as specified on the FEPI START command.

### **\*spare\***

nulls.

---

## Data formats

### Outbound data

#### **Data stream**

The data is a standard outbound data stream, exactly as would be sent from the simulated terminal to VTAM.

#### **Screen-image format, SLU2 mode**

The data replaces, byte for byte, the data in the character buffer of the simulated terminal. Any data value is allowed. Data that goes into positions within a protected field must be identical to that in the field; data for positions occupied by an attribute byte is ignored. MDTs can be set forcibly for fields by setting the value in the attribute position to X'01'. (FEPI will set MDT automatically if data has changed.)

#### **Key stroke format, SLU2 mode**

The data can contain any combination of data characters together with

manipulative, special, and attention key values. Data characters are represented by their EBCDIC code values in the range X'40'–X'FE', or by their DBCS code values of pairs of bytes in the range X'41'–X'FE', plus X'4040'. Manipulative, special, and attention key values are represented by *escape* sequences, comprising the escape character specified by the ESCAPE option and a 2-character code. Using '&' for the escape character, the escape sequences are:

#### Manipulative keys

- &HO** home
- &Ln** cursor left, n times
- &Rn** cursor right, n times
- &Un** cursor up, n times
- &Dn** cursor down, n times
- &Tn** tab, n times
- &Bn** backtab, n times
- &Nn** newline, n times (where n = 1–9)

#### Special keys

- &IN** insert
- &DL** delete
- &RS** reset
- &EF** erase to end of field
- &EI** erase input
- &FM** field mark
- &DU** DUP
- &ES** escape character
- &MS** start secure MSR
- &SO** shift out
- &SI** shift in

#### Attention keys

- &AT** attention
- &An** PAn (n = 1–3)
- &nn** PFnn (where nn = 01–24, leading 0 must be specified)
- &CL** clear
- &CS** cursor select (light pen)
- &EN** enter
- &ME** end secure MSR

## data formats

Keys not listed and data characters below X'40' are not supported. Thus, nulls (X'00') are excluded—nulls can be generated by use of the erase or delete keys. Key strokes following an attempt to enter into a protected field are ignored until 'reset' is keyed.

For magnetic stripe reader support, the sequence &MS...data...&ME represents passing a secure magnetic stripe card through the reader. Nonsecure cards have to be simulated by using the corresponding key strokes.

Zero, one, or more than one, attention keys may be used. If an attention key is followed by data characters, FEPI does an implicit receive operation for each one until the back-end application unlocks the keyboard and sends 'change direction' or 'end bracket' (and FEPI responds positively to any definite response requests); then the subsequent key strokes are sent.

## Inbound data

### Data stream

The data is a standard inbound data stream, exactly as would be sent to the simulated terminal from VTAM. Note that the received data is not complete if the command that received the data returned an ENDSTATUS of MORE.

### Formatted, SLU2 mode

The data is the contents of the simulated terminal character buffer that FEPI holds. Data characters are represented by their EBCDIC or DBCS code values; positions corresponding to field attributes contain X'FF'.

---

## Ending status

This describes in detail the conditions under which FEPI CONVERSE and FEPI RECEIVE commands complete, and how the completion condition is reported to the application.

The completion conditions for each command are:

### FEPI CONVERSE DATASTREAM using a temporary conversation

On the first to occur of:

- INTO data area full
- 'change direction' indicated
- 'end bracket' indicated.

It does not end at 'end of chain' alone; if a definite response request is indicated on a chain, FEPI responds positively and continues receiving data.

### FEPI CONVERSE DATASTREAM using a previously allocated conversation

As for FEPI RECEIVE DATASTREAM.

### FEPI CONVERSE FORMATTED using a temporary conversation

on the first to occur of:

- 'change direction' indicated
- 'end bracket' indicated.

It does not end at 'end of chain' alone; if a definite response request is indicated on a chain, FEPI responds positively and continues receiving data.

### FEPI CONVERSE FORMATTED using a previously allocated conversation

As for FEPI RECEIVE FORMATTED.

**FEPI RECEIVE DATASTREAM**

This can be specified or defaulted to end in one of the following ways:

**RU** on the first to occur of:

- INTO data area full
- end of request unit.

**CHAIN**

on the first to occur of:

- INTO data area full
- 'end of chain'.

**UNTILCDEB**

on the first to occur of:

- INTO data area full
- 'end of chain' with definite response request
- 'change direction' indicated
- 'end bracket' indicated.

**FEPI RECEIVE FORMATTED**

At end of chain.

In all cases, ENDSTATUS is set to indicate the completion conditions and RESPSTATUS is set to indicate whether a response is required and, if so, the type of response. Where several conditions occur together, ENDSTATUS shows the most significant. The values and their meanings are shown in Table 15.

Table 15. ENDSTATUS values and associated meanings

ENDSTATUS	Commands						Conditions					Next command expected (except after CONVERSE with POOL)
	RECEIVE		CONVERSE without POOL		CONVERSE with POOL		End bracket	Change direction	End chain	End RU	INTO area full	
	DS	FM	DS	FM	DS	FM						
EB	X	X	X	X	X	X	Y	-	Y	Y	-	Any
CD	X	X	X	X	X	X	-	Y	Y	Y	-	FEPI SEND or CONVERSE
LIC	X	X	X	X	-	-	-	-	Y	Y	-	FEPI RECEIVE
RU	R	-	R	-	-	-	-	-	-	Y	-	FEPI RECEIVE
MORE	X	-	X	-	X	-	-	-	-	-	Y	FEPI RECEIVE
<b>Note:</b> DS=Datastream FM=Formatted X=Possible with command R=Possible with RU option of command Y=Condition indicated.												



---

## Part 4. Appendixes





## Appendix A. Sample programs

The SDFHSAMP library contains a set of sample programs (in source form), including two back-end application programs, that show many of the principles and techniques discussed in this book. Although the samples are copyrighted, you may use and copy them freely for educational purposes to help you write FEPI applications. This appendix gives an overview of these programs. It contains the following topics:

- What you get
- “COBOL II Sample Restrictions” on page 221
- “Installing the samples” on page 221
- “Using the samples” on page 222
- “Description of the samples” on page 224.

### What you get

A subset of the sample programs is available in each of the supported programming languages. The programs and their names are given in Table 16.

Table 16. Sample programs and their names

Description	Transaction name	COBOL	Assembler	PL/I	C/370
<b>Programs:</b>					
Setup	CZXS	DFH0VZXS	DFH0AZXS		DFH0CZXS
Monitor and unsolicited data handler	CZUX	DFH0VZUX			
Begin-session handler	CZUC	DFH0VZUC			
3270 data stream pass-through	CZTD	DFH0VZTD	DFH0AZTD		
Key stroke CONVERSE	CZTK	DFH0VZTK		DFH0PZTK	DFH0CZTK
Screen image SEND and START	CZTS	DFH0VZTS			
Screen image RECEIVE and EXTRACT	CZTR	DFH0VZTR			
End-session handler	CZUU	DFH0VZUU			
SLU P, one-out, one-in	CZPS	DFH0VZPS	DFH0AZPS		
SLU P, pseudoconversational	CZPA	DFH0VZPA	DFH0AZPA		
STSN handler	CZQS	DFH0VZQS	DFH0AZQS		
Back-end CICS	CZBC		DFH0AZBC		
Back-end IMS	CZBI		DFH0AZBI		
<b>Copy books:</b>					
Customization data		DFH0BZCO	DFH0BZCA	DFH0BZCP	DFH0BZCC
Messages and other text		DFH0BZMO	DFH0BZMA	DFH0BZMP	DFH0BZMC
Key stroke map		DFH0BZ1O		DFH0BZ7P	DFH0BZ6C
Send/receive map		DFH0BZ2O			
Back-end CICS map			DFH0BZ3A		
SLU P, one-out, one-in map		DFH0BZ4O	DFH0BZ8A		
SLU P, pseudoconversational map		DFH0BZ5O	DFH0BZ9A		

## Sample programs

Table 16. Sample programs and their names (continued)

Description	Transaction name	COBOL	Assembler	PL/I	C/370
<b>Maps:</b>					
Key stroke		DFH0MZ1		DFH0MZ7	DFH0MZ6
Send/receive		DFH0MZ2			
SLU P, one-out, one-in		DFH0MZ4	DFH0MZ8		
SLU P, pseudoconversational		DFH0MZ5	DFH0MZ9		
Back-end CICS			DFH0MZ3		

There are also some sample resource definitions:

Front-end CICS	DFH0IZRD
Back-end CICS	DFH0IZRC
Back-end IMS	DFH0IZRI
CICS TD queues	DFH0IZRQ

Table 17 shows you which samples illustrate which functions.

Table 17. Functional cross-reference for sample programs

Functions	Samples (Last two letters of sample program name. See notes.)										
	TD	TK	TS	TR	PA	PS	QS	UC	UU	UX	XS
SLU2	X	X	X	X	X	X	X				
SLU P	X	X	X	X	X	X					
Data stream	X	X	X	X	X	X					
Screen-image	X	X	X	X							
Key stroke	X	X									
ALLOCATE	X	X	X	X							
ALLOCATE with PASSCONVID	X	X	X	X	X	X	X				
EXTRACT STSN	X										
EXTRACT FIELD	X	X									
SEND	X	X									
START	X	X									
RECEIVE	X	X	X	X							
CONVERSE	X	X	X								
CONVERSE with POOL	X										
ISSUE	X										
FREE	X	X	X	X	X	X	X	X			
FREE with PASS	X	X									
INSTALL	X										
ADD	X										
Start data	X	X	X	X	X						
TD queue data	X										
One-out one-in	X										
Conversational	X	X									
Pseudo- conversational	X	X	X								
Assembler language	X	X	X	X	X						
COBOL	X	X	X	X	X	X	X	X	X	X	X
C/370	X	X									
PL/I	X										

Table 17. Functional cross-reference for sample programs (continued)

Functions	Samples (Last two letters of sample program name. See notes.)										
	TD	TK	TS	TR	PA	PS	QS	UC	UU	UX	XS
<b>Notes:</b>											
<b>TD</b>	Data stream										
<b>TK</b>	Key stroke										
<b>TS</b>	Screen image send/start										
<b>TR</b>	Screen image receive										
<b>PA</b>	SLU P pseudoconversational										
<b>PS</b>	SLU P one-out, one-in										
<b>QS</b>	STSN										
<b>UC</b>	Begin session										
<b>UU</b>	End session										
<b>UX</b>	Monitor, unsolicited data										
<b>XS</b>	Setup										
FEPI EXTRACT CONV, SET/INQUIRE/browse, and DELETE/DISCARD commands are not illustrated in the sample programs.											

---

## COBOL II Sample Restrictions

The following COBOL II samples can only be compiled using the release 3 and later versions of the COBOL II compiler:

- DFH0VZUC
- DFH0VZUX
- DFH0VZPS
- DFH0VZPA

---

## Installing the samples

### The CICS front-end samples

All you have to do to get the samples running is customize them for your system. This means that you need to change at most three things:

- The customization data copy book, DFH0BZCx
- The setup program, DFH0xZXS
- The resource definitions, DFH0IZRx.

Then compile or assemble and link-edit all the samples (and their maps) that you want, as you would do for any CICS application program. Define them to your front-end system, using the examples in DFH0IZRD for the resource definitions that are needed; they are in the form required as input to the DFHCSDUP utility. Note that there is a separate resource group for each language because the transaction names used are the same for each programming language. You should have defined the necessary transient data (TD) queues when you installed FEPI itself. Sample definitions are provided in group, DFHDCTG.

### The CICS and IMS back-end samples

You need to assemble, link-edit, define, and install the appropriate back-end program and maps on your back-end system. For CICS, sample resource definitions are in DFH0IZRC. For IMS, sample resource definitions are in DFH0IZRI.

**Note:** When using the IMS back-end samples, ensure that you link-edit the back-end program with the IMS version of ASMTDLI (or the appropriate language module), and that you specify RMODE and AMODE as 24. (If you use the CICS version of ASMTDLI, the program will abend when executed in the IMS environment.)

### Using the samples

The samples form an integrated set. The setup program provides the FEPI resource definitions that the other samples use. The monitor and the various handlers support and complement the access programs, to form a complete FEPI communication package, just as you need to provide. Remember, however, that these are samples designed for illustration purposes. Although they give a great deal of help, and include suggestions about writing FEPI programs, for any particular circumstance you must consider exactly what your requirements are.

The two back-end programs (one for CICS and one for IMS) provide applications for the front-end programs to access. The back-end CICS program is for access by the front-end SLU2 mode programs, and the back-end IMS program is for access by the front-end SLU P mode programs; no SLU2 mode access to IMS is provided. Although the back-end programs are supplied in source form, it is not necessary for you to understand the internal logic—only the external operations, as is the case for a “real” existing back-end application.

The FEPI sample front-end and back-end transactions assume that the datastream sent from the back-end application is received unaltered by the front-end application. For example, FEPI samples may perform unexpectedly if the datastreams are compressed after having been sent from the back-end application.

### The back-end CICS program

This program is the CICS back-end application used by the FEPI sample programs.

Module name: DFH0AZBC

Transaction name: CZBC

Abend code: USZA

Map name: DFH0MZ3

#### Screen

```
CZBC                      Customer Inquiry
Please type a customer number in the range 1 to 9999, then Enter.
Customer Number . . . . .
          Name . . . . . :
          Balance. . . . . :
          Address. . . . . :
Last Transaction Date . . :
          F3=EXIT to CICS
```

*Figure 10. CZBC transaction: customer inquiry*

#### Overview

On the first invocation of the transaction, a map is sent to the terminal.

When there is input from the terminal, CICS invokes the transaction again. The customer data for the customer number from the input is found and sent to the terminal, and further input is awaited. PF3 or CLEAR ends the transaction.

Certain customer numbers cause special processing such as abends and delays, to show how a front-end application could manage such events. The valid customer numbers are:

**0001-0005**

Normal

**0006** Delayed response

**0007** Abend before send

**0008** Abend after send.

### Program logic

```

Main procedure:
  Set up exception condition handling:
    Map error - SEND_NEW_MAP
    CLEAR/PF3 - END_PROG
  Test COMMAREA
  If transaction not previously invoked
    Call SEND_NEW_MAP
  RECEIVE map
  If customer number not valid
    SEND message
    RETURN
  If customer type is 'ABEND before MAP'
    ABEND
  Build map with customer data
  If customer type is 'LONG DELAY'
    DELAY
  SEND map
  If customer type is 'ABEND after MAP'
    ABEND
  RETURN
SEND_NEW_MAP routine:
  SEND new map
  RETURN
END_PROG routine:
  Clear terminal
  RETURN

```

## The back-end IMS program

This program is the IMS back-end application used by the FEPI sample programs.

Module name: DFH0AZBI

Transaction name: CZBI

### Overview

This is a simple IMS back-end response mode program that is driven by input from a front-end FEPI application. It modifies the time stamp in the input message and returns the message to the front-end application.

IMS schedules this transaction when an input message is queued for it. It addresses the I/O PCB, DLI call function, and I/O area to build the parameter list for the GU call to retrieve the queued input message.

The time field of the input message is updated and the program then issues an ISRT call to place the message on the output queue. IMS then sends the output message to the front-end FEPI application.

Output messages from this program are all prefixed with a 5-byte function management header.

## Sample programs

If any errors occur, the program ends with a nonzero return code.

### Program logic

```
GETMAIN storage areas for reentrancy
Address PCB
Issue GU call to get input message
Use TIME to obtain system time
Update I/O area
Issue ISRT call to send output message
RETURN
```

---

## Description of the samples

### Setup

This program installs the resources—property sets, nodes, targets, and pools—that are used by the FEPI sample programs.

Module names: DFH0VZXS, DFH0AZXS, DFH0CZXS

Transaction name: CZXS

### Overview

The definitions of each of these resources are organized so that they can easily be changed. They are kept separate from the processing that does the installation, and there is no hard-coding of values in the CICS commands. There are four main tables, holding details of each resource type. This enables the resources to be changed by repeating sets of definitions which are in an easy-to-understand form. If desired, the program could be changed to obtain the resource definitions from a file.

The resources defined are:

Pool	Property set	Nodes	Targets
P00L1	PROPSET1	NODE1 NODE2 NODE3 NODE4 NODE5	TARGET1
P00L2	PROPSET2	NODE6 NODE7 NODE8 NODE9 NODE10	TARGET1
P00L3	PROPSET3	NODE1 NODE2 NODE3 NODE4 NODE5	TARGET2

You must customize these definitions to match the requirements of your system. If you do, you may also need to change the definitions in the sample customization constants copy book DFH0BZCx. You do not need to change any other samples—you need simply recompile them.

Each table is processed in turn. Nodes and targets are organized into lists for reasons of efficiency. Details of resource installation are written to the CICS log automatically by FEPI.

On completion, a message is sent. The setup program would typically be started by a PLT program, in which case the message goes to the CICS log. It can, however, be invoked from a terminal and, in this case, the message is sent to the terminal.

For clarity, error checking is minimal. In particular, the FEPI INSTALL commands do not check errors at all, because FEPI reports any errors that occur to the FEPI transient data queue, and they are then recorded by the sample monitor program.

## Program logic

```

For each property set in table
  FEPI INSTALL PROPERTYSET
For each node in table
  Add node to list
FEPI INSTALL NODELIST
For each target in table
  Add target to list
FEPI INSTALL TARGETLIST
For each pool in table
  Start new lists of nodes and targets
  For each entry within pool definition
    If node, add details to node list
    If target, add details to target list
  FEPI INSTALL POOL with NODELIST and TARGETLIST
Send completion message
RETURN

```

## Monitor and unsolicited data-handler

This program monitors unexpected events and handles unsolicited data for the FEPI sample programs.

Module name: DFHOVZUX

Transaction name: CZUX

TS queue name: MONITOR

### Overview

This transaction handles:

- Unexpected events that are reported by FEPI to a TD queue, which triggers this transaction
- Unsolicited data from a back-end system, for which FEPI starts this transaction.

Because the event descriptions provided by FEPI and the processing required is basically the same for both cases, this common program is used.

ASSIGN STARTCODE is used to determine how the transaction was started, and ASSIGN QNAME to determine what TD queue triggered it. Details of the event are in the start data or the TD queue record as the case may be.

For illustrative purposes, all events are handled similarly by simply reporting their details to a TS queue named MONITOR, which can be browsed using CEBR. In practice, for any of the events you can do whatever extra or different processing you require, or (except for unsolicited data) you can ignore the event.

For unsolicited data, the conversation started by FEPI *must* be accessed so that FEPI knows that the data is being handled. The data itself should be received, or else FEPI ends and restarts the session. For illustration purposes, this program simply discards the data; in practice, you will probably want to process the data in some way.

However, if you did simply want to discard such data, you should specify no unsolicited-data handling and use the UNSOLDATAACK property to tell FEPI what action to take, as is done for SLU P mode by these samples.

The general format of the TS queue records is:

## Sample programs

```
date time CZUX description
          Event type..ACQFAIL      Pool.....POOLNAME
          Target.....TGTNAME       Node.....NODENAME
          Device.....T3278M2       Event data..X'00000000'
          Format.....0              Event value.176
```

The actual details for each event vary. Events with similar details are grouped together for processing. The groups are:

- Unknown event—an event that is not recognized
- Unsolicited data
- Session lost
- Standard events—all other events.

The groups also determine any additional processing needed. Only unsolicited data needs any processing.

If any errors occur, they are reported to the TS queue.

### Program logic

Main procedure:

Determine how transaction was started using ASSIGN

If started with data by FEPI

RETRIEVE start data

If triggered by TD queue

READ the queue record

Otherwise

Report start code

RETURN

TD-LOOP:

Locate event type

Locate device type

Build description of event: event type, device type,  
format, event value, date/time, transaction

Call UNKNOWN-EVENT, UNSOLDATA, STANDARD-EVENT, or  
SESSION-LOST according to event group

If triggered by TD queue

READ the next queue record

If one exists, loop to TD-LOOP

RETURN

UNKNOWN-EVENT routine:

Write event details to TS queue: description and  
event value

UNSOLDATA routine:

Write event details to TS queue: description, event  
type, pool, target, and node

Access conversation using FEPI ALLOCATE with PASSCONVID

FEPI RECEIVE unsolicited data

Free conversation

Handle data as required

STANDARD-EVENT routine:

Write event details to TS queue: description, event  
type, pool, target, node, device, event data,  
format, and event value

SESSION-LOST routine:

Write event details to TS queue: description, event  
type, pool, target, node, device, and format

## Begin session

This program prepares sessions for use by the FEPI sample application programs.

Module name: DFH0VZUC



Transaction name: CZUC

TS queue name: SESSION

### Overview

This transaction is started by FEPI when it begins a new session.

The conversation started by FEPI *must* be accessed so that FEPI knows that the event is being handled. The processing required depends on the data mode and type that the session uses (this is obtained from the start data), and whether the back-end system is IMS or CICS.

For SLU P mode (necessarily IMS), processing depends entirely on local requirements, and is typically used for handling security applications. For illustration purposes, this program simply gets and discards the initial data. Note that the setup for these samples does not specify a begin-session transaction for SLU P mode.

For SLU2 mode with CICS using formatted data, there is a CICS “good morning” message waiting. The message is received, and the back-end screen is cleared and left ready for a transaction ID to be entered.

For SLU2 mode with CICS using data stream, there may be a “read partition” request waiting which requires a reply—for example, if your pool has device T3279Mx or TPS55Mx specified, or if the logon mode table being used has “extended data stream” specified). Then there is a CICS “good morning” message to be received. A reply is sent to any “read partition” query request, the “good morning” message is received, and the back-end screen is cleared and left ready for a transaction ID to be entered.

For SLU2 mode with IMS, no processing is illustrated.

After the processing, the conversation is freed with the HOLD option, which leaves it ready for use by applications. A report is written to a TS queue named SESSION, which can be browsed using CEBR. The format of the TS queue records is:

```
date time CZUC Begin session completed
      RESP.....0          RESP2.....0
      Target.....TGTNAME   Node.....NODENAME
      Pool.....POOLNAME
```

If any errors occur, a report is written to the TS queue, and the conversation is freed with the RELEASE option, so that the session is ended.

### Program logic

Main procedure:

```
RETRIEVE start data
Access conversation using FEPI ALLOCATE with PASSCONVID
Call PROCESS-LUP, PROCESS-FORMATTED, or
PROCESS-DATASTREAM according to data mode and type
Free conversation, keeping session
Write event details to TS queue
RETURN
```

PROCESS-LUP routine:

```
FEPI RECEIVE initial data
Handle data as required
```

PROCESS-FORMATTED routine:

```
FEPI RECEIVE initial data
Clear back-end screen and make ready for transaction ID
to be entered, using FEPI CONVERSE
```

PROCESS-DATASTREAM routine:

## Sample programs

```
FEPI RECEIVE
If 'read partition' query
    FEPI CONVERSE query reply and get acknowledgement
    FEPI RECEIVE initial data
Clear back-end screen and make ready for transaction ID
to be entered, using FEPI CONVERSE
```

## Key stroke CONVERSE

This sample program demonstrates using FEPI to obtain information from a back-end transaction using the key stroke data format.

Module names: DFH0VZTK, DFH0PZTK, DFH0CZTK

Transaction name: CZTK

Map names: DFH0MZ1, DFH0MZ6, DFH0MZ7

### Screen

```
CZTK                Customer Name and Address Inquiry
Please type a customer number in the range 1 through 9999, then Enter.
Customer Number . . . . .
Name . . . . . :
Address. . . . . :
F3=EXIT to CICS
```

Figure 11. CZTK transaction: customer name and address inquiry

### Overview

On the first invocation of the transaction, a map is sent to the front-end terminal.

When there is input from the front-end terminal, CICS invokes the transaction again. The customer number from the input is built into a key stroke sequence which runs a transaction at the back-end. The key strokes are sent and the results received using a FEPI ALLOCATE-CONVERSE-FREE command sequence. Information is extracted from the results and sent to the front-end terminal. Further input is then awaited.

When PF3 or CLEAR is received from the front-end terminal, the transaction ends. If there is an error, the front-end map is reset. These situations are detected using HANDLE CONDITION.

If the back-end sends a CICS message, it is sent on to the front-end terminal, and the transaction ends.

For clarity, error checking is minimal except for the FEPI commands. Note that the key stroke sequence used involves several attention keys, so that if the intermediate responses are not what is expected, the effects are unpredictable. According to your requirements, it may be advisable to send each attention sequence individually and to check each time that the results are as expected.

### Program logic

```
MAIN procedure:
  Test COMMAREA
  If transaction not previously invoked
    Call SEND-NEW-MAP
  Set up exception condition handling:
```

```

Map error - SEND-NEW-MAP
CLEAR/PF3 - END-PROG
RECEIVE MAP from front-end terminal
Build key stroke sequence to:
  clear back-end screen
  type transaction ID
  ENTER
  type the customer number
  ENTER
FEPI ALLOCATE conversation with back-end
FEPI CONVERSE to send key strokes to back-end and get
  the resulting screen image
FEPI FREE      conversation with back-end
If CICS message received from back-end
  SEND message to front-end terminal
  RETURN
Get customer information from back-end screen image
Build data for front-end terminal map
SEND map data to front-end terminal
RETURN TRANSID(CZTK) with COMMAREA
SEND-NEW-MAP routine:
  SEND new map to front-end terminal
  RETURN TRANSID(CZTK) with COMMAREA
END-PROG routine:
  Clear front-end terminal
  RETURN

```

## Screen image SEND and START

This sample program demonstrates using FEPI to send formatted data to a back-end transaction, and requesting a transaction to be started when the reply to the data arrives.

Module name: DFH0VZTS

Transaction name: CZTS

Map name: DFH0MZ2

### Screen

```

CZTS                      Customer Name and Balance Inquiry
Please type a customer number in the range 1 through 9999, then Enter.
Customer number . . . . .
Name . . . . . :
Balance. . . . . :
F3=EXIT to CICS

```

Figure 12. CZTS transaction: customer name and balance inquiry

### Overview

This program is the SEND part of a SEND-RECEIVE pair of programs, the RECEIVE part being DFH0VZTR.

On the first invocation of this send transaction, a map is sent to the front-end terminal.

When there is input from the front-end terminal, CICS invokes this send transaction again. The customer number is extracted from the input. Using FEPI ALLOCATE a conversation is started with the back-end system. Then FEPI SEND with screen

## Sample programs

image data is used to start a back-end transaction. FEPI START is issued to specify that the receive transaction is to be started when the back-end system replies.

In due course, the receive transaction is started and XCTLs to this send transaction. The customer number can now be sent to the back-end using FEPI SEND with screen image data. FEPI START is again issued.

The receive transaction gets the results from the back-end transaction and sends them on to the front-end terminal.

When there is more input from the front-end terminal, CICS invokes this transaction again. FEPI ALLOCATE with PASSCONVID is issued to gain ownership of the conversation and the customer number is sent to the back-end as before. The cycle continues until PF3 or CLEAR is received. These are passed on to the receive transaction (using the FEPI START user data) and to the back-end transaction to indicate that it is to end.

### Program logic

```
MAIN procedure:
  Test COMMAREA
  If transaction not previously invoked
    Call SEND-MAP
  If first customer number to process
    Call CONTINUE-CONVERSATION
  Set up exception condition handling:
    Map error - SEND-MAP
    PF3/CLEAR - CONTINUE-CONVERSATION
  RECEIVE MAP from front-end terminal
  If conversation not started
    Call INITIATE-CONVERSATION
  Else
    Call CONTINUE-CONVERSATION
SEND-MAP routine:
  SEND new map to front-end terminal
  RETURN TRANSID(CZTS) with COMMAREA
INITIATE-CONVERSATION routine:
  FEPI ALLOCATE conversation with back-end
  Build screen image to invoke back-end transaction
  FEPI SEND screen image to back-end
  FEPI START the receive transaction
  RETURN
CONTINUE-CONVERSATION routine:
  Unless first customer number
    Reaccess conversation with FEPI ALLOCATE PASSCONVID
  Build screen image to send customer number
  FEPI SEND screen image to back-end
  FEPI START the receive transaction
  RETURN
```

## Screen image RECEIVE and EXTRACT FIELD

This sample program demonstrates using FEPI to get formatted data from a back-end transaction.

Module name: DFH0VZTR

Transaction name: CZTR

Map name: DFH0MZ2

### Screen

See Figure 12 on page 229.

**Overview**

This program is the RECEIVE part of a SEND-RECEIVE pair of programs, the SEND part being DFH0VZTS.

This transaction is started by CICS either when data is received from the back-end transaction or if no data is received in the time set in the send transaction, as is determined from the start data obtained with RETRIEVE. The user data in the start data indicates whether the conversation is starting, continuing, or finishing.

A FEPI RECEIVE obtains the screen image from the back-end transaction and FEPI EXTRACT FIELD is used to obtain specific fields.

If the conversation is starting, control is passed to the send transaction using XCTL to allow an inquiry to be sent to the back-end transaction.

If the conversation is continuing, the results from the back-end are sent on to the front-end terminal. Access to the conversation is relinquished, and control is returned to CICS specifying that the send transaction is to be invoked when there is next user input.

If the conversation has finished, a message to that effect is sent to the front-end terminal. The conversation is freed and the transaction ends.

**Program logic**

```

MAIN procedure:
  RETRIEVE start data
  Reaccess conversation with FEPI ALLOCATE PASSCONVID
  If time out
    Call REPORT-PROBLEM
  FEPI RECEIVE back-end screen image
  If conversation ending (PF3 or CLEAR indicated)
    Call REPORT-PROBLEM
  If back-end problem
    (CICS message or back-end transaction message)
    Call REPORT-PROBLEM
  If conversation starting (user data has customer number)
    XCTL to program DFH0VZTS
  If conversation continuing
    Get interesting fields from back-end data using
      FEPI EXTRACT FIELD
    Build and send map to front-end terminal
    Release conversation using FEPI FREE PASS
    RETURN TRANSID(CZTS) with COMMAREA
REPORT-PROBLEM routine:
  SEND message to front-end terminal
  FEPI FREE conversation
  RETURN

```

**3270 data stream pass-through**

This sample program demonstrates using FEPI to pass-through 3270 data stream between a back-end application and a front-end terminal.

Module names: DFH0VZTD, DFH0AZTD

Transaction name: CZTD

**Overview**

On the first invocation of the transaction, a request is sent to the back-end system to start a transaction there. The response is sent on to the front-end terminal.

## Sample programs

When there is input from the front-end terminal, CICS reinvoles the transaction. This input is sent on to the back-end system, using the FEPI CONVERSE command, and the resulting response is returned to the front-end terminal.

If there is an error, or the back-end system sends a CICS message, or PF3 is received from the front-end terminal, the transaction ends.

### Program logic

```
Test COMMAREA
If transaction not previously invoked
  Build data stream request to start back-end transaction
  FEPI ALLOCATE conversation with back-end system
  FEPI CONVERSE data stream to and from back-end system
  SEND returned data stream to the front-end terminal
Else
  RECEIVE data stream from the front-end terminal
  Prepare data stream to send on to back-end system
  Reaccess conversation with FEPI ALLOCATE PASSCONVID
  FEPI CONVERSE data stream to and from back-end system
  SEND data stream to the front-end terminal
If error during processing
  SEND explanatory message
If continuing
  Release conversation using FEPI FREE PASS
  RETURN TRANSID(CZTD) with COMMAREA
Else (error, CICS message, or PF3)
  FEPI FREE conversation
  RETURN
```

## End-session handler

This program cleans up sessions after use by FEPI sample application programs.

Module name: DFH0VZUU

Transaction name: CZUU

TS queue name: SESSION

### Overview

This transaction is started by FEPI when an application ends a conversation or when a session is released.

The conversation passed by FEPI must be accessed so that FEPI knows that the event is being handled. The processing required depends entirely on local requirements. For illustration purposes, this program simply keeps the session for use by another conversation or lets it end, depending on the event type.

For end of conversation (EVENTTYPE=FREE in start data), processing could typically involve setting the session back to a known state (such as a clear back-end screen ready to accept a new transaction name), or handling security, or overriding the type of FREE used. Such processing would depend on the data mode and type that the session uses (which is obtained from the start data), whether the back-end system is CICS or IMS, and the type of FREE used (also obtained from the start data).

For end of session (EVENTTYPE=FREE and EVENTVALUE=RELEASE in start data), processing could typically involve handling security.

For both cases, there could be an indication (in EVENTVALUE in the start data) that CICS is shutting down, which might require alternative special processing. This transaction would have to be in the XLT to allow it to be started during shutdown.

After the processing, a report is written to a TS queue named SESSION, which can be browsed using CEBR. The format of the TS queue records is:

```
date time CZUU End-session handling completed
          RESP.....0          RESP2.....0
          Target.....TGTNAME    Node.....NODENAME
          Pool.....POOLNAME
```

### Program logic

```
Main procedure:
  RETRIEVE start data
  Access conversation using FEPI ALLOCATE with PASSCONVID
  Call PROCESS-RELEASE or PROCESS-FREE as appropriate
  Write event details to TS queue
  RETURN
PROCESS-RELEASE routine:
  Handle as required
  Free conversation, ending session
PROCESS-FREE routine:
  Handle as required
  Free conversation, keeping session
```

## SLU P one-out one-in

This sample program demonstrates using FEPI to obtain information from a back-end IMS system, using SLU P mode and the FEPI CONVERSE command with the POOL option.

Module names: DFH0VZPS, DFH0AZPS

Transaction name: CZPS

Map names: DFH0MZ4, DFH0MZ8

### Screen

```
CZPS          SLU P Sample Program.
IMS SLU P conversational sample program
This transaction will process a FEPI CONVERSE command to obtain time
and date from a back-end IMS system.
DATE   : 02/04/92
TIME   : 10:57:10
STATE  : Not started
F3=EXIT to CICS  ENTER=obtain time and date stamp from IMS
```

Figure 13. CZPS transaction: SLU P sample program

### Overview

On the first invocation of the program, a map is sent to the front-end terminal.

When there is input from the front-end terminal, CICS reinvokes the program. A simple inquiry is made to the back-end system—for illustration purposes, it asks the time—and the answer is displayed on the front-end terminal. Because the inquiry requires only a one-out one-in exchange with the back-end system, a temporary conversation can be used, so the FEPI CONVERSE command with the POOL option is used.

## Sample programs

When PF3 or CLEAR is received from the front-end terminal, the transaction ends. If there is an error, the front-end map is reset. These situations are detected using HANDLE CONDITION.

If the back-end system sends an IMS message, it is sent on to the front-end terminal and the transaction ends.

For clarity, error checking is minimal except for the FEPI commands.

### Program logic

```
MAIN procedure:
  Test COMMAREA
  If transaction not previously invoked
    Call SEND-NEW-MAP
  Set up exception condition handling:
    Map error - SEND-NEW-MAP
    CLEAR/PF3 - END-PROG
  RECEIVE MAP from front-end terminal
  Build SLU P data stream to request time from back-end IMS
  system
  FEPI CONVERSE to send data stream to the back-end and get
  the message containing the time
  If IMS message received from back-end system
    SEND message to front-end terminal
    RETURN
  Build data for front-end terminal map
  SEND map data to front-end terminal
  RETURN TRANSID(CZPS) with COMMAREA
SEND-NEW-MAP routine:
  SEND new map
  RETURN TRANSID(CZPS) with COMMAREA
END-PROG routine:
  Clear front-end terminal
  RETURN
```

## SLU P pseudoconversational

This sample program demonstrates using FEPI to obtain data from an IMS back-end transaction. It is in pseudoconversational style, using the FEPI START command to schedule itself when the results arrive.

Module names: DFH0VZPA, DFH0AZPA

Transaction name: CZPA

Map names: DFH0MZ5, DFH0MZ9

### Screen

```
CZPA          SLUP Sample Program.
IMS SLUP Pseudoconversational sample program
This transaction will process SEND/START/RECEIVE requests with MFS
              specified, to a back-end IMS system.
              DATE   : 02/04/92
              TIME   : 10:58:50
              STATE  : Not Started
F3=EXIT to CICS  ENTER=obtain time and date stamp from IMS
```

Figure 14. CZPA transaction: SLU P pseudoconversational sample program



## Overview

On the first invocation of the program, a map is sent to the front-end terminal.

When there is input from the front-end terminal, CICS invokes the program again. After establishing a conversation, an inquiry is sent to the back-end system. FEPI START is issued to start this program again when the results arrive. Meanwhile it returns to CICS, so releasing resources.

When the results arrive, FEPI starts the program again. The results are obtained using FEPI RECEIVE, and sent on to the front-end terminal. The conversation is freed and the program returns to CICS to await more input. If the back-end system sends an IMS message, it is sent on to the front-end terminal and the transaction ends.

When PF3 or CLEAR is received from the front-end terminal, the transaction ends. If there is an error, the front-end map is reset. These situations are detected using HANDLE CONDITION.

For clarity, error checking is minimal except for the FEPI commands.

## Program logic

```

MAIN procedure:
  If started from terminal
    Test COMMAREA
    If transaction not previously invoked
      Call SEND-NEW-MAP
    Set up exception condition handling:
      Map error - SEND-NEW-MAP
      CLEAR/PF3 - END-PROG
    RECEIVE map from front-end terminal
    FEPI ALLOCATE conversation with back-end system
    Build SLU P data stream to request time
    FEPI SEND data stream to back-end system
    FEPI START transaction
    RETURN
  If started by FEPI
    RETRIEVE start data
    Reaccess conversation using FEPI ALLOCATE PASSCONVID
    If EVENTTYPE = data received
      FEPI RECEIVE data stream from back-end system
      FEPI FREE conversation
      If IMS message received
        SEND message to front-end terminal
        RETURN
      Build data for front-end terminal map
      SEND map to front-end terminal
      RETURN TRANSID(CZPA) with COMMAREA
    Otherwise (timeout or session loss)
      SEND map with message to front-end terminal
      RETURN (freeing conversation implicitly)
SEND-NEW-MAP routine:
  SEND new map
  RETURN TRANSID(CZPA) with COMMAREA
END-PROG routine:
  Clear front-end terminal
  RETURN

```

## STSN handler

This program handles STSN processing for the FEPI sample application programs.

Module name: DFH0AZQS

## Sample programs

Transaction name: CZQS

TS queue name: SESSION

### Overview

This transaction is started by FEPI when a request for message resynchronization ('set and test sequence number', STSN) or a 'start data traffic' indication is received from a back-end IMS system.

The conversation passed by FEPI must be accessed so that FEPI knows that the event is being handled. The processing required depends on the STSN status, which is obtained using FEPI EXTRACT STSN.

For STSNSTATUS=NOSTSN, the transaction was started because 'start data traffic' arrived. A DR1 normal response must be sent.

For STSNSTATUS=STSNSET, a positive STSN response must be sent.

For STSNSTATUS=STSNTEST, processing would typically involve comparing saved sequence numbers with those received from the back-end IMS system to determine what response to send. The *IMS Customization Guide* gives advice on the appropriate action.

After the processing, the response is sent using FEPI ISSUE. A report is written to a TS queue named SESSION, which can be browsed using CEBR. The general format of the TS queue records is:

```
date time CZQS STSN processing completed
      Target.....TGTNAME      Node.....NODENAME
      Seqnumin...nnnn          Seqnumout...nnnn
      STSN status.XXXXXXX      Response...XXXXXXX
```

### Program logic

Main procedure:

```
RETRIEVE start data
Access conversation using FEPI ALLOCATE with PASSCONVID
Get STSN status using FEPI EXTRACT STSN
Call NOSTSN, STSNSET, or STSNTEST
    according to STSN status
Send response using FEPI ISSUE CONTROL
Write event details to TS queue
Free conversation, keeping session
RETURN
```

NOSTSN routine:

```
Build DR1 normal response
```

STSNSET routine:

```
Build STSN positive response
```

STSNTEST routine:

```
Handle as required
```

```
Build required response
```

---

## Appendix B. CVDA and RESP2 values

This appendix lists the CVDA and RESP2 values returned by FEPI commands. It contains:

- “CVDA and numeric values in alphabetic sequence”
- “CVDA and numeric values in numeric sequence” on page 239
- “RESP2 values” on page 241.

---

### CVDA and numeric values in alphabetic sequence

The following table lists the CVDA values used or returned by the FEPI commands. (See Table 19 on page 239 for the same values in numeric sequence.) For programming information about other CICS Transaction Server for OS/390 CVDA values, see the *CICS System Programming Reference* manual.

Table 18. CVDA values in alphabetic sequence

ACQFAIL	515
ACQUIRED	69
ACQUIRING	71
ADDFAIL	519
ALARM	501
APPLICATION	559
ATTENTION	524
BEGINSESSION	510
CANCEL	526
CD	491
DATA	508
DATASTREAM	543
DEFRESP1	497
DEFRESP1OR2	528
DEFRESP2	498
DEFRESP3	499
DELETEDFAIL	520
DISCARDFAIL	513
EB	490
EXCEPTRESP	523
FMH	502
FORCE	342
FORMATTED	542
FREE	85
GOINGOUT	172
HOLD	163
INBOUND	547
INOUT	532
INPUT	226
INSERVICE	73
INSTALLED	550
INSTALLFAIL	512
INVALID	359
LIC	493
LOSE	544
LUP	541
LUSTAT	525
MDT	506
MORE	492

## CVDA values

Table 18. CVDA values in alphabetic sequence (continued)

NEGATIVE	530
NEWSSESSION	485
NOALARM	500
NOCONV	556
NOFMH	503
NOMDT	507
NOMSGJRNL	531
NONE	496
NORMALRESP	522
NOSTSN	487
NOTINBOUND	546
NOTINSTALLED	551
OLDSESSION	486
OUTPUT	227
OUTSERVICE	74
PENDBEGIN	558
PENDDATA	560
PENDFREE	86
PENDPASS	565
PENDRELEASE	562
PENDSTART	561
PENDSTSN	557
PENDUNSOL	564
POSITIVE	529
PROTECTED	504
RELEASE	563
RELEASED	70
RELEASING	549
RESET	290
RTR	527
RU	494
SESSION	372
SESSIONFAIL	517
SESSIONLOST	516
SETFAIL	514
SHUTDOWN	288
STSN	509
STSNSET	488
STSNTEST	489
TASK	233
TIMEOUT	511
TPS55M2	552
TPS55M3	553
TPS55M4	554
T3278M2	533
T3278M3	534
T3278M4	535
T3278M5	536
T3279M2	537
T3279M3	538
T3279M4	539
T3279M5	540
UNPROTECTED	505

Table 18. CVDA values in alphabetic sequence (continued)

UNSOLDATA	521
WIN	545

## CVDAs and numeric values in numeric sequence

The following table lists the CVDA values used or returned by the FEPI commands. (See Table 18 on page 237 for the same values in alphabetic sequence.) For programming information about other CVDA values, see the *CICS System Programming Reference* manual.

Table 19. CVDA values in numeric sequence

69	ACQUIRED
70	RELEASED
71	ACQUIRING
73	INSERVICE
74	OUTSERVICE
85	FREE
86	PENDFREE
163	HOLD
172	GOINGOUT
226	INPUT
227	OUTPUT
233	TASK
288	SHUTDOWN
290	RESET
342	FORCE
359	INVALID
372	SESSION
485	NEWSESSION
486	OLDSESSION
487	NOSTSN
488	STSNSET
489	STSNTEST
490	EB
491	CD
492	MORE
493	LIC
494	RU
496	NONE
497	DEFRESP1
498	DEFRESP2
499	DEFRESP3
500	NOALARM
501	ALARM
502	FMH
503	NOFMH
504	PROTECTED
505	UNPROTECTED
506	MDT
507	NOMDT
508	DATA
509	STSN

## CVDA values

Table 19. CVDA values in numeric sequence (continued)

510	BEGINSESSION
511	TIMEOUT
512	INSTALLFAIL
513	DISCARDFAIL
514	SETFAIL
515	ACQFAIL
516	SESSIONLOST
517	SESSIONFAIL
519	ADDFAIL
520	DELETEFAIL
521	UNSOLDATA
522	NORMALRESP
523	EXCEPTRESP
524	ATTENTION
525	LUSTAT
526	CANCEL
527	RTR
528	DEFRESP1OR2
529	POSITIVE
530	NEGATIVE
531	NOMSGJRNL
532	INOUT
533	T3278M2
534	T3278M3
535	T3278M4
536	T3278M5
537	T3279M2
538	T3279M3
539	T3279M4
540	T3279M5
541	LUP
542	FORMATTED
543	DATASTREAM
544	LOSE
545	WIN
546	NOTINBOUND
547	INBOUND
549	RELEASING
550	INSTALLED
551	NOTINSTALLED
552	TPS55M2
553	TPS55M3
554	TPS55M4
556	NOCONV
557	PENDSTSN
558	PENDBEGIN
559	APPLICATION
560	PENDDATA
561	PENDSTART
562	PENDRELEASE
563	RELEASE
564	PENDUNSOL

Table 19. CVDA values in numeric sequence (continued)

565	PENDPASS
-----	----------

## RESP2 values

Table 20 gives, in general terms, the meaning of the RESP2 values used by FEPI. These values are used in the EVENTVALUE area of FEPI transient data queue records and returned by the RESP2 option of FEPI commands. For details of the error conditions and related RESP2 values for each FEPI command, see the FEPI command definitions in Chapter 9. System programming reference and Chapter 16. Application programming reference.

Declarations for the RESP2 values are provided in the following copy books:

- DFHSZAPA for Assembler language
- DFHSZAPO for COBOL
- DFHSZAPP for PL/I
- DFHSZAPC for C/370.

Table 20. RESP2 values

1	INQUIRE START, NEXT, or END command not valid here: <b>START</b> Browse of this resource type already in progress <b>NEXT</b> INQUIRE START not issued <b>END</b> INQUIRE START not issued.
2	All resource definitions have been retrieved.
10	Command bypassed by user exit.
11	FEPI not installed or not active.
12	CICS shutting down, command not allowed.
13	FEPI not available.
14	FEPI busy or cannot get storage.
15	Unknown command.
16	Internal problem.
17	FEPI cannot get storage for user exit parameters.
18	Command failed because of operator or system action.
30	POOL name not known.
31	POOL name out of service.
32	TARGET name not known.
33	TARGET name out of service.
34	TARGET name required but not specified.
35	Pool name is unsuitable for temporary conversations. It has CONTENTION(LOSE) or INITIALDATA(INBOUND) but no begin-session handler.
36	No suitable session available and in service.
40	[FROM]FLENGTH value is negative, zero, or more than MAXFLENGTH value for pool.
41	ESCAPE value not valid.
50	Inbound data with 'begin bracket' to be received.
51	Attention identifier (AID) not valid.
52	Cursor position not valid.
53	Code points in formatted data not valid.
54	Attribute positions or values in send data not valid.
55	Key stroke escape sequence in send data not valid.
56	Field validation (mandatory fill, mandatory enter, trigger) failed.
57	Input is inhibited.

## RESP2 values

Table 20. RESP2 values (continued)

58	VTAM SEND failed.
59	DBCS data rules violated.
60	MAXLENGTH value negative, or greater than MAXLENGTH value for pool.
61	FLENGTH value negative or greater than 128.
62	TRANSID name not valid.
63	TERMID name not valid.
70	FIELDLOC or FIELDNUM value negative or not valid.
71	VTAM RECEIVE failed.
72	RECEIVE FORMATTED processing found invalid, or unexpected data while interpreting the 3270 data stream for a WRITE, ERASE/WRITE, ERASE/WRITE ALTERNATE, or WRITE STRUCTURED FIELD command code.
80	CONTROL value not valid.
81	VALUE not valid: omitted when required; included when not required; or unsuitable for specified CONTROL.
82	SENSEDATA option omitted when required, or specified when not required.
90	Definite response type did not match what was required.
91	Only NORMALRESP or EXCEPTRESP allowed at this point in conversation.
92	Response to STSN SET was not positive.
93	Only STSN allowed at this point in conversation.
94	Only STSN or NORMALRESP allowed at this point in conversation.
95	CONTROL value not allowed at this point in conversation.
100	Not authorized to issue command.
110	SERVSTATUS value not valid.
111	ACQSTATUS value not valid.
115	POOL name not known.
116	TARGET name not known.
117	NODE name not known.
118	Unknown connection (TARGET and NODE names known, but not in a common POOL).
119	Request failed for one or more items in list. Detailed errors reported to TD queue for monitor to handle.
130	TARGETNUM value negative, zero, or not valid.
131	NODENUM value negative, zero, or not valid.
132	POOLNUM value negative, zero, or not valid.
140	DEVICE value not valid.
141	CONTENTION value not valid.
142	INITIALDATA value not valid.
143	UNSOLDATAACK value not valid.
144	MSGJRNL value not valid.
150	FORMAT value not valid or unsuitable for specified device.
153	STSN name not valid or STSN unsuitable for specified device.
154	BEGINSESSION value not valid.
155	UNSOLDATA value not valid.
156	EXCEPTIONQ value not valid.
157	FJOURNALNUM value not valid.
158	MAXLENGTH value not valid.
159	ENDSESSION name not valid.
160	PROPERTYSET name not valid.
162	POOL name not valid.
163	NODE name not valid.
164	TARGET name not valid.
167	APPL name not valid.
170	PROPERTYSET name already exists.
171	PROPERTYSET name not known.



Table 20. RESP2 values (continued)

172	POOL name already exists.
173	NODE name already exists.
174	TARGET name already exists.
175	Connection already exists.
176	VTAM OPEN NODE failed.
177	VTAM APPLID already known.
178	FJOURNALNAME value not valid.
182	Session unbound, unrecoverable.
183	Session unbound, recoverable.
184	Session unbound, error.
185	Session unbound, bind coming.
186	Session unbound.
187	Lost terminal.
188	CLEANUP, abnormal.
189	CLEANUP.
190	UNBIND error.
191	SETUP error.
192	SSCP error.
193	SLU error.
194	PLU error.
195	BIND error.
196	CINIT error.
197	REQSESS error.
198	REQSESS inhibited.
199	REQSESS not available.
210	Option not valid for SLU P.
211	Option not valid for SLU2.
212	Wrong data format for conversation.
213	Command has timed out.
214	CICS shutting down, conversation should be ended.
215	Session lost.
216	Error occurred on previous SEND command.
220	SEND or CONVERSE command not allowed at this point in conversation.
221	RECEIVE command not allowed at this point in conversation.
223	START command not allowed at this point in conversation.
224	Only ISSUE or FREE allowed at this point in conversation.
230	SNA CLEAR command received.
231	SNA CANCEL command received.
232	SNA CHASE command received.
233	Exception response received.
234	Exception request received.
240	Conversation ID unknown or not owned by task.
241	TIMEOUT value negative or not valid.
250	Passticket not built successfully.
251	CICS ESM interface not initialized.
252	Unknown return code in ESMRESP from the ESM.
253	Unrecognized response from CICS security modules.
254	Function unavailable.
259	No signed-on user.

## RESP2 values

---

# Glossary

This glossary describes terms and abbreviations used in this book and words used with other than their everyday meaning. In some cases, a definition may not be the only one applicable to a term, but it gives the particular sense in which the word is used in this book.

This glossary includes only the most common 3270 and SNA terms. For other 3270 terms, refer to the glossary in *3270 Data Stream Programmer's Reference*. For other SNA terms, refer to the glossary in *SNA Technical Overview*.

This glossary includes terms and definitions from the *IBM Dictionary of Computing*, published by McGraw-Hill. If you do not find the term you are looking for, refer to the index or the *Dictionary of Computing*.

## A

**ACB.** In VTAM, an access method control block that links an application to VTAM.

**access program .** A user-provided part of a FEPI application that handles the main communications with application programs in CICS or IMS systems.

**AID.** Attention identifier. In CICS, automatic initiate descriptor.

**APAR .** Authorized program analysis report.

**application.** A program or suite of programs that do work. If an application uses FEPI, it is a FEPI application (also known as a terminal front-end program). In VTAM, *application* means programs that communicate directly using VTAM; in a FEPI environment, this means the back-end systems on one hand, and FEPI on the other.

**application programming interface .** The set of commands by which an application accesses CICS services.

**attention identifier (AID).** A code in the inbound data stream that identifies the source or type of data that follows. A character in a data stream indicating that the user has pressed a key, such as ENTER, that requests an action by the system.

**ATI .** Automatic transaction initiation.

**authorized program analysis report (APAR).** A report of a problem caused by a suspected defect in a current, unaltered release of a program.

**automatic transaction initiation (ATI).** The initiation of a CICS transaction by an internally generated request, for example, the issue of an EXEC CICS START command or the reaching of a transient data trigger level. See the *CICS Application Programming Guide* manual.

## B

**back-end (system).** The CICS or IMS system in which existing applications run. Equivalent to **partner** system. (See also **front-end (system)**.)

**begin-session handler.** A user-provided part of a FEPI application that handles begin-session processing.

**begin bracket.** See **bracket**.

**between brackets.** See **bracket** and **contention mode**.

**bind.** In SNA, to activate a session between logical units.

**bind race.** In SNA, a situation where two or more logical units (LUs) send bind requests to each other at the same time.

**bracket.** In SNA, one or more chains of request units (RUs) and their responses, which are exchanged between two LU-LU half-sessions and represent a transaction between them. A bracket must be completed before another bracket can start. Examples of brackets are data base inquiries and replies, update transactions, and remote job entry output sequences to work stations.

The duration of a bracket is shown by the begin-bracket and end-bracket indicators in the request headers of the first and last requests in the bracket. When a bracket is not in progress, the session is between brackets and is in **contention mode**.

**buffer address.** In 3270 data stream, the address of a location in the character buffer (screen image).

## C

**CECI.** Command-level interpreter.

**CEMT.** A CICS-supplied transaction that invokes all the master terminal functions. These functions include inquiring and changing the value of parameters used by CICS, altering the status of system resources, terminating tasks, and shutting down CICS. See the *CICS Supplied Transactions* manual.

**chain.** In SNA, a group of one or more logically linked records (request units) that are transferred over a communication line. The ends of the chain are shown

by the first-in-chain and last-in-chain indicators in the request headers of the first and last requests in the chain.

**change direction protocol.** In SNA, a data flow control protocol in which the sending logical unit (LU) stops sending normal-flow requests, signals this fact to the receiving LU using the change-direction indicator (in the request header of the last request of the last chain), and prepares to receive requests.

**CICS.** Customer Information Control System.

**command-level interpreter (CECI CECS).** Enables CICS commands to be entered, syntax-checked, and executed interactively at a 3270 screen. See the *CICS Application Programming Guide* manual.

**connection.** A target-node pair in the same pool, between which a session can be established (bound), and which can then be used for communication.

**contention mode.** In data communication, a mode of transmission in which any station may transmit whenever the line is available. This occurs when a session is between brackets. If stations transmit simultaneously, protocols determine who wins the contention.

**conversation.** In FEPI, a sequence of related data transmissions between a FEPI application and a particular back-end system. This is analogous to a CICS APPC conversation, but it is not the same as an IMS conversation, and it is not related to CICS conversational mode. In distributed transaction processing, a sequence of exchanges over a session, delimited by SNA brackets. A dialog between two programs in which each program alternately sends and receives data. A dialog between CICS and a terminal user in which CICS alternately accepts input and responds.

**Customer Information Control System (CICS).** An IBM licensed program that enables transactions entered at remote terminals to be processed concurrently by user-written application programs. It includes facilities for building, using, and maintaining databases.

## D

**data stream.** A continuous stream of data elements being transmitted, or intended for transmission, in character or binary-digit form, using a defined format.

**DBCS.** Double-byte character set.

**DCT.** Destination control table.

**definite response.** In SNA, a value on the form-of-response-requested field of the request header.

The value directs the receiver of the request to return a response unconditionally, whether positive or negative, to that request.

**double-byte character set (DBCS).** A set of characters in which each character is represented by two bytes. Languages, such as Japanese, which contain more symbols than can be represented by 256 code points require DBCS.

**DRx response.** Same as **definite response**.

## E

**EDF.** Execution diagnostic facility.

**end bracket.** See **bracket**.

**end session handler.** A user-provided part of a FEPI application that handles end of conversation and end of session processing.

**ESM.** External security manager.

**execution diagnostic facility (EDF).** A CICS facility used for testing application programs interactively online, without making any modifications to the source program or to the program preparation procedure.

**Extended Recovery Facility (XRF).** A facility that increases the availability of CICS transaction processing, as seen by the end users. Availability is improved by having a second CICS system (the alternate system) ready to continue processing the workload, if and when particular failures that disrupt user services occur on the first system (the active system).

**external security manager (ESM).** A program, such as RACF, that performs security checking for CICS users and resources.

## F

**FEPI.** Front End Programming Interface.

**FMH.** Function management header.

**formatted data interface.** In FEPI, a collective name for the keystroke and screen-image interfaces.

**front-end (system).** The CICS system in which the Front End Programming Interface (FEPI) runs to provide access to applications running on other systems. (See also **back-end (system)**.)

**Front End Programming Interface (FEPI).** An interface that enables you to write CICS application programs that access other CICS or IMS programs, providing a front end to those programs. The interface simulates the terminals that the other programs use.

**function management header (FMH).** In SNA, one or more headers, optionally present in the leading request units (RUs) of a chain, that contain control information.

## G

**global user exit.** An event in CICS at which CICS can pass control to a user-supplied program and then resume control after the user program finishes. The exit is invoked on every occurrence of the event in CICS.

## H

**handler.** In the CICS/ESA Front End Programming Interface (FEPI), a transaction initiated to handle specified events.

## I

**Information Management System (IMS).** A data base/data communication system capable of managing complex data bases and terminal networks.

**inbound.** In FEPI and CICS, data received by a program from elsewhere. From the point-of-view of the back-end system, this data is outbound or output to a terminal.

**initial data.** A type of inbound data that arrives when a new session is bound. This is commonly called a “good morning” message.

**ISC.** CICS intersystem communication.

## K

**key stroke interface.** The part of the Front End Programming Interface that allows a front-end application to specify a sequence of key stroke-like commands, used to define input to a back-end application.

## L

**last in chain.** See **chain**.

**LIC.** Last in chain. See **chain**.

**logical unit (LU).** In SNA, a port through which an end user accesses the SNA network in order to communicate with another end user and through which the end user accesses the functions provided by system services control points.

**LU.** See **Logical unit (LU)**.

## M

**modified data tag (MDT).** An indicator, associated with each input or output/input field in a displayed record, that is set ON when data is keyed into the field. The modified data tag is maintained by the display device and can be used by the program using the field. In 3270, a bit in each input field that, when set, causes that field to be transferred to the host system.

**monitor.** A user-provided program that handles unexpected events reported by FEPI.

**MRO.** CICS multiregion operation.

## N

**node.** In VTAM, a named point in a network. In FEPI, a point (VTAM node) that is a secondary LU terminal simulated by FEPI. In other words, a node in FEPI is a simulated terminal.

**non-response mode.** In IMS, a mode of terminal operation that allows asynchronous operations between the terminal operator and the application program. Contrast with **response mode**.

**no response.** In SNA, a value in the form-of-response-requested field of the request header (RH) indicating that no response is to be returned to the request, whether or not the request is received and processed successfully.

## O

**outbound.** In FEPI and CICS, data sent by a program to somewhere else. From the point-of-view of the back-end system, this data is inbound or input from a terminal.

## P

**partner.** In CICS intercommunication, a transaction communicating with a remote transaction or system. In FEPI, this is equivalent to **back-end system**.

**PLT.** In CICS, the program list table.

**PLTPI.** In CICS, program list table post initialization.

**PLU.** Primary logical unit.

**pool.** In the CICS/ESA Front End Programming Interface (FEPI), a collection of **nodes** and **targets**.

**presentation space.** A portion of the device's buffer storage, allocated to a partition, that contains only display data that CICS sends to that partition.

**primary logical unit (PLU).** In SNA, the logical unit that contains the primary half-session. In a FEPI environment, the back-end systems are the PLUs.

**program list table.** In CICS, a list of programs to be executed at a specific phase of system initialization or termination.

**Program Temporary Fix (PTF).** A temporary solution or bypass of a problem diagnosed by IBM field engineering as the result of a defect in a current, unaltered release of the program. See authorized program analysis report (APAR).

**property set.** In the CICS/ESA Front End Programming Interface (FEPI), the definition of the characteristics of a **pool**.

**PTF.** Program temporary fix.

## R

**RACF.** Resource Access Control Facility.

**RDO.** In CICS, resource definition online.

**request header (RH).** In SNA, control information preceding a request unit.

**request unit (RU).** In SNA, a message unit that contains control information such as a request code, or function management headers (FMHs), end-user data, or both. Synonymous with request. Each request unit belongs to a chain.

**Resource Access Control Facility (RACF).** A licensed program, provided by IBM, that provides for access control by identifying and by verifying the users to the system, authorizing access to protected resources, logging the detected unauthorized attempts to enter the system, and logging the detected accesses to protected resources.

**resource definition online (RDO).** A method of defining resources to CICS, in which resource definitions are created interactively with the CEDA transaction, or by using the CICS utility DFHCSDUP.

**response.** In SNA, a message that acknowledges receipt of a request.

**response mode.** A mode in which a system can communicate with an end-user. In IMS, a mode of terminal operation that synchronizes operations between the terminal operator and the application program. Contrast with **non-response mode**.

**RU.** Request unit.

## S

**screen-image interface.** The part of the Front End Programming Interface that has a buffer with one byte for each screen position.

**secondary logical unit (SLU).** In SNA, the logical unit that contains the secondary half-session. In a FEPI environment, the FEPI system is the SLU, and the back-end CICS or IMS system is the PLU.

**session.** In SNA, that period during which programs or devices can communicate with each other.

**set and test sequence number (STSN).** In SNA, a communication protocol whereby transmissions can be checked.

**setup program.** A user-provided program that defines and inquires about FEPI resources, and performs housekeeping for the sessions.

**SIT.** System initialization table.

**SLU.** Secondary logical unit.

**SLU P.** An LU0 protocol defined by IMS as a protocol to communicate between a programmable workstation, such as a 4700, and IMS. IMS is the Primary Logical Unit (PLU) and the workstation is the Secondary Logical Unit (SLU) in the connection.

**SLU2.** An SLU using LU2 protocols, that is, the 3270 datastream protocol.

**SMP/E.** System Modification Program/Extended.

**SNA.** Systems Network Architecture.

**STSN.** Set and test sequence number.

**STSN handler.** A user-provided part of a FEPI application that handles STSN requests.

**system initialization table (SIT).** A CICS table that contains information to initialize and control system functions, module suffixes for selection of user-specified versions of CICS modules and tables, and information used to control the initialization process. You can generate several SITs, using the resource definition macro DFHSIT, and then use the SIT system initialization parameter to select the one that best meets your current requirements at initialization time.

**System Modification Program/Extended (SMP/E).** An IBM licensed program use to install software (for example, CICS/ESA) and software changes on MVS/ESA.

**system programming interface.** A subset of the CICS application programming interface that accesses special system-oriented CICS services.

## T

**target.** In the CICS/ESA Front End Programming Interface (FEPI), the back-end CICS or IMS system to which FEPI appears as a secondary logical unit.

**TCTTE.** terminal control table terminal entry.

**TD.** Transient data.

**temporary conversation.** A FEPI conversation allocated from the pool specified by the POOL option that exists only for the duration of a FEPI CONVERSE command.

**terminal control table terminal entry (TCTTE).** In the CICS terminal control table (TCT), an entry for each terminal known to CICS.

**terminal front-end program (FEPI application).** A CICS application designed to use the front end programming interface (FEPI) to communicate with existing back-end applications.

**transaction list table (XLT).** CICS control table containing a list of transaction identifications. Depending on a system initialization specification that can be changed during system termination, the transactions in a particular XLT can be initiated from terminals during the first quiesce stage of system termination. During CICS execution the suffix of an XLT can be entered at the master terminal; the transactions in that XLT can then be enabled or disabled as a group.

**transient data (TD).** A CICS facility for temporarily saving data in the form of queues, called destinations. A TD destination is held either as a queue in a VSAM data set managed by CICS (intrapartition TD), or as a QSAM data set outside the CICS region.

## U

**unbind.** In SNA, to deactivate a session between logical units.

**unsolicited data.** A type of inbound data that arrives on a connection where no FEPI conversation is active.

**unsolicited-data handler.** A user-provided part of a FEPI application that handles unsolicited inbound data.

## V

**Virtual Telecommunications Access Method (VTAM).** A set of programs that maintain control of the communication between terminals and application programs.

## W

**write control character (WCC).** A control character that follows a write command in the 3270 data stream and provides control information for executing display and printer functions. A character used with a write-type command to specify that a particular operation, or combination of operations, is to be performed at a display station or printer.

## X

**XLT.** Transaction list table.

**XRF.** Extended Recovery Facility.

## Numeric

**3270 data stream.** The commands, control codes, orders, attributes, and data or structured fields for 3270 devices that are transmitted between an application program and a terminal. Data being transferred from or to an allocated primary or tertiary device, or to the host system, as a continuous stream of data and 3270 Information Display System control elements in character form.





---

# Index

## Numerics

- 16MB line, AMODE setting for FEPI 34
- 3270 data stream
  - data formats 151
  - data-stream-level commands 11
  - glossary entry 249
  - pass-through sample program 231
- 3278 device type 102
- 3279 device type 102

## A

- abends 129
- access program 13, 153
  - glossary entry 245
- ACQFAIL event 42
- ACQNUM option
  - FEPI INQUIRE CONNECTION 96
  - FEPI INQUIRE NODE 99
- ACQSTATUS, resource status 47
- ACQSTATUS option
  - FEPI ADD 90
  - FEPI INQUIRE CONNECTION 96
  - FEPI INQUIRE NODE 99
  - FEPI INSTALL NODELIST 109
  - FEPI INSTALL POOL 110
  - FEPI SET CONNECTION 117
  - FEPI SET NODE 119
- Acquired
  - CEMT INQUIRE FECONNECTION 62
  - CEMT INQUIRE FENODE 66
- ACQUIRED option
  - CEMT SET FECONNECTION 72
  - CEMT SET FENODE 74
- ACQUIRED resource status 47
- ACQUIRING, resource status 47
- ADD POOL command 90
- ADDFAIL event 43
- addressing mode 34, 137
- AID (attention identifier), screen-image data 145
- ALARMSTATUS option
  - FEPI CONVERSE FORMATTED 183
  - FEPI RECEIVE FORMATTED 201
- ALL option
  - CEMT SET FECONNECTION 72
  - CEMT SET FENODE 74
  - CEMT SET FEPOOL 75
  - CEMT SET FETARGET 76
- ALLOCATE command 172
  - conversation 157
  - PASSCONVID 172
  - POOL 173
- ALLOCATE POOL 173
- AMODE setting
  - application programs 137
  - system programs 34
- analysis and planning 19
- AP NOOP 175

- APAR (authorized program analysis report) 6
- APAR (Authorized Program Analysis Report)
  - glossary entry 245
- Appl
  - CEMT INQUIRE FETARGET 71
- APPL option
  - FEPI INQUIRE TARGET 107
- application minor nodes, VTAM 30
- application programming 133
  - commands 10, 169
  - components of FEPI programs 13, 153
  - conversational 156, 157
  - CVDA values 237, 239
  - data stream integrity 148
  - design 153
  - general sequence of commands 139
  - IMS considerations 163
  - IMS response mode 164
  - interface, glossary entry 245
  - one-out one-in conversational 155
  - performance considerations 49, 166
  - pseudoconversational 156
  - RESP2 values 241
  - writing FEPI programs 137
- APPLLIST option
  - FEPI INSTALL TARGETLIST 115
- Assembler language
  - copybook 34, 170
  - sample programs 219
- ATI (automatic transaction initiation)
  - controlling FEPI resources 36
  - glossary entry 245
  - unsolicited data 155
- attention
  - general sequence of commands 139
  - keys 141, 213
  - multiple attentions 143
  - sending screen-image data 144
- availability
  - of network resources 30

## B

- back-end system 5
  - CICS sample program 222
  - configuration of 32
  - glossary entry 245
  - hardware and software requirements 6
  - IMS considerations 163
  - IMS sample programs 223
  - in a CICSplex 23
  - initial data 154
  - message sent after a bind 154
  - planning 19
  - sample configuration 39
  - XRF takeover 54
- BACKGROUND option
  - FEPI EXTRACT FIELD 189

- begin-session handler 13
    - application design 154
    - defining to FEPI 23, 36
    - glossary entry 245
    - IMS considerations 164
    - sample program 226
  - BEGINSESSION option
    - FEPI INQUIRE POOL 101
    - FEPI INQUIRE PROPERTYSET 105
    - FEPI INSTALL PROPERTYSET 112
  - BEING ACQUIRED status 48
  - BEING RELEASED status 48
  - bind
    - back-end system message after a bind 154
    - communication and conversations 135
    - device query 154
    - glossary entry 245
    - handling unsolicited binds with CLSDST(PASS) 42, 43
    - introduction to FEPI resources 12
    - removing bind races 52
    - selection of FEPI session parameters 31
    - XRF takeover 52
  - bind race, glossary entry 245
  - bracket
    - glossary entry 245
  - bypass
    - handling in application 162
    - using in user exit 45
- ## C
- C/370 language
    - copybook 34, 170
    - nulls in screen image 145
    - sample programs 219
  - card reader, sending key stroke data 141
  - CDSA storage requirements 24
  - CECI transaction
    - debugging FEPI programs 34, 138
    - glossary entry 245
  - CEMT transaction 59
    - after FEPI failure 51
    - DISCARD 60
    - glossary entry 245
    - INQUIRE FECONNECTION 61
    - INQUIRE FENODE 65
    - INQUIRE FEPOOL 67
    - INQUIRE FEPROPSET 69
    - INQUIRE FETARGET 70
    - SET FECONNECTION 72
    - SET FENODE 74
    - SET FEPOOL 75
    - SET FETARGET 76
  - CETR transaction 77, 128
  - chain, receiving a 152
  - CHAIN option
    - FEPI CONVERSE DATASTREAM 177
    - FEPI RECEIVE DATASTREAM 198
  - CICS (Customer Information Control System) 246
    - CICS (Customer Information Control System) 246
    - (continued)
      - back-end
        - sample program 222
        - terminal definitions 32
      - CICS-supplied transactions 59
      - default startup group list, DFHLIST 27, 28
      - EXEC CICS command format 88, 169
      - front-end, configuration of 29
      - ISC and MRO considerations 4
      - RDO group DFHFPEPI 27
      - shutdown 51
      - startup procedure 28
      - TYPETERMs for CICS/MVS Version 2 32
      - updating definitions 27, 29
    - CICSplex
      - back-end systems in 23
    - CLSDST(PASS) 43
    - COBOL language
      - copybook 34, 170
      - example of sending screen-image data 144
      - sample programs 219
    - COLLECT STATISTICS command 50
    - COLOR option
      - FEPI EXTRACT FIELD 189
    - color support
      - device attributes 22
      - getting colors 189
      - storage requirements 24
      - VTAM configuration 30
    - COLUMNS option
      - FEPI CONVERSE FORMATTED 183
      - FEPI RECEIVE FORMATTED 201
    - command-level security 15, 28
    - commands
      - application programming reference section 169
      - CEMT DISCARD 60
      - copy books for RESP2 values 34, 170
      - CVDA values 237, 239
      - data-stream-level 11, 147
      - errors and exception conditions 34, 138
      - format 88, 169
      - formatted data 10
      - general sequence 139, 148
      - high-level FEPI 10
      - introduction to FEPI commands 10
      - key stroke interface 10, 139
      - list of FEPI commands 11
      - performance considerations 49
      - RESP2 values 241
      - screen-image interface 10, 139
      - SNA 168
      - specialized-level 11, 167
      - storage requirements 24
      - system programming 33, 87
      - VTAM-level 11
    - communication
      - error handling 162
      - general considerations 135
      - resources 135

- conditions
  - error and exception 88, 170
- configuration
  - 16MB line 34
  - AMODE setting 34
  - example of 37
  - of back-end CICS and IMS systems 32, 33
  - of CICS 29
  - of FEPI
    - coding of programs 33
    - global user exits 45
    - monitoring program 41
    - sample 37
    - setup program 35
    - writing operator transactions 47
  - of VTAM
    - application minor nodes 30
    - ISTINCLM mode table 31
    - session pacing values 32
    - session parameters 31
  - planning 19
  - programs, design of 33
  - sample programs 37, 224
- connection 12
  - acquiring and releasing 47
  - controlling waits with event handlers 37
  - determining contents of a pool 47
  - glossary entry 246
  - INQUIRE CONNECTION command 95
  - sample configuration 40
  - SET CONNECTION command 116
  - storage requirements 24
  - waiting in RELEASING state 48
- contention mode 143, 150
  - glossary entry 246
- CONTENTION option
  - FEPI INQUIRE POOL 101
  - FEPI INQUIRE PROPERTYSET 105
  - FEPI INSTALL PROPERTYSET 112
- CONTROL option
  - FEPI ISSUE 195
- conventions used by FEPI
  - node names 30
  - pool names 22
  - property set names 23
  - systems and data flow 9
- conversation ID 157
- conversation identifier 157
- conversations 135, 157
  - design of conversational applications 156
  - glossary entry 246
  - ownership of 158
  - passing conversations 158
  - previously allocated 176, 181
  - state of 49
  - storage requirements 24
  - temporary 159, 176, 181
  - unknown conversation ID, error handling 162
- CONVERSE
  - data stream applications 151
  - DATASTREAM 176
  - CONVERSE (*continued*)
    - FORMATTED 181
    - key stroke and screen image applications 146
- CONVID field
  - start data 211
  - TDQ record 123
- CONVID option
  - FEPI ALLOCATE POOL 173
  - FEPI CONVERSE DATASTREAM 177
  - FEPI CONVERSE FORMATTED 183
  - FEPI EXTRACT CONV 187
  - FEPI EXTRACT FIELD 189
  - FEPI EXTRACT STSN 192
  - FEPI FREE 193
  - FEPI ISSUE 196
  - FEPI RECEIVE DATASTREAM 198
  - FEPI RECEIVE FORMATTED 201
  - FEPI REQUEST PASSTICKET 204
  - FEPI SEND DATASTREAM 205
  - FEPI SEND FORMATTED 207
  - FEPI START 209
- CONVNUM option
  - FEPI INQUIRE CONNECTION 96
- CSZL transient data queue
  - command errors 34, 89
  - defining 27
- CSZX transient data queue
  - command errors 34, 123
  - defining 27
  - record format 122
  - reporting unexpected events 41
- CURSOR option
  - FEPI RECEIVE FORMATTED 201
  - FEPI SEND FORMATTED 207
- cursor setting 141, 145
- customization
  - global user exits 79
  - journaling 83
- CVDA values 237
- CZBC transaction 222
- CZBI transaction 223
- CZPA transaction 234
- CZPS transaction 233
- CZQS transaction 235
- CZTD transaction 231
- CZTK transaction 228
- CZTR transaction 230
- CZTS transaction 229
- CZUC transaction 226
- CZUU transaction 232
- CZUX transaction 225
- CZXS transaction 224

## D

- data formats
  - inbound data 214
  - journaling 83
  - start data 211
  - TD queue records 122
- data handling, using property set for 22, 35
- data stream applications 11

- data stream applications 11 (*continued*)
    - 3270 pass-through sample program 231
    - converse 151
    - data formats 212
    - data stream integrity 148
    - FEPI commands 10, 11
    - glossary entry 246
    - receiving 148
    - sending 151
    - SLU P mode 152
    - SLU2 mode 151
    - writing 147
  - DATATYPE field
    - start data 211
    - TDQ record 123
  - DBCS (double-byte character set)
    - errors sending key stroke data 142
    - formatted, SLU2 mode 214
    - glossary entry 246
    - key stroke format 212
  - DCT (destination control table)
    - glossary entry 246
  - debugging 34, 125
  - default CICS startup group list, DFHLIST 27, 28
  - defining transient data queues 27
  - definite responses 154, 167
  - definitions
    - for sample programs 220
    - sample 39
    - updating CICS 27
  - DELETE POOL command 91
  - DELETFAIL event 43
  - design
    - access program 153
    - application organization 155
    - begin-session handler 154
    - end-session handler 155
    - programs 153
    - unsolicited-data handler 154
  - Device
    - CEMT INQUIRE FEPOOL 68
  - device attributes, using property set for 22, 35
  - DEVICE field
    - start data 211
    - TDQ record 123
  - DEVICE option
    - FEPI EXTRACT CONV 187
    - FEPI INQUIRE POOL 102
    - FEPI INQUIRE PROPERTYSET 105
    - FEPI INSTALL PROPERTYSET 113
  - device query 154
  - device-type, VTAM logon mode table entries 31
  - DFHFPEPI, RDO group 27, 28
  - DFHLIST, default CICS startup group list 27, 28
  - DFHSZ4099E message 130
  - DFHSZ4155I message 131
  - DFHSZAPA, copy book 34, 170
  - DFHSZAPC, copy book 34, 170
  - DFHSZAPO, copy book 34, 170
  - DFHSZAPP, copy book 34, 170
  - DISCARD command
    - NODELIST 92
    - POOL 93
    - PROPERTYSET 94
    - TARGETLIST 94
  - DISCARDFAIL event 42
  - distributed program link, shipping FEPI applications 29
  - distribution tape 6
  - DRx responses 154, 167
  - dumps
    - FEPI 125
- ## E
- ECDSA storage requirements 24
  - EDF (Execution Diagnostic Facility)
    - debugging FEPI programs 34, 138
    - FEPI problem determination aids 125
    - glossary entry 246
  - EIB (EXEC interface block) 89, 171
  - end-session handler 13
    - application design 155
    - defining to FEPI 23, 36
    - glossary entry 246
    - IMS considerations 164
    - sample program 232
  - ENDSESSION option
    - FEPI INQUIRE POOL 102
    - FEPI INQUIRE PROPERTYSET 105
    - FEPI INSTALL PROPERTYSET 113
  - ENDSTATUS option
    - data stream 149
    - FEPI CONVERSE DATASTREAM 177
    - FEPI CONVERSE FORMATTED 183
    - FEPI RECEIVE DATASTREAM 198
    - FEPI RECEIVE FORMATTED 202
    - formatted data 142
  - environmental requirements 6
  - error handling 161
    - application programming commands 170
    - bad command sequencing 151
    - bypass by user exit 162
    - CONVERSE 146
    - general guidance 161
    - list of resources 35, 89
    - operator/system action 162
    - receiving data 143
    - receiving screen-image data 145
    - SEND failure 162
    - sending data
      - key stroke data 141
      - screen-image data 145
    - session loss 162
    - shutdown 163
    - system programming commands 89
    - time-outs 161
    - unknown conversation ID 162
  - ESCAPE option
    - FEPI CONVERSE FORMATTED 183
    - FEPI SEND FORMATTED 207
  - escape sequences 140, 213

- ESM (external security manager) 28
  - glossary entry 246
  - PassTickets 14, 159
- ESMREASON option
  - FEPI REQUEST PASSTICKET 204
- ESMRESP option
  - FEPI REQUEST PASSTICKET 204
- EVENTDATA field
  - start data 211
  - TDQ record 123
- EVENTTYPE field
  - start data 211
  - TDQ record 123
- EVENTVALUE field
  - start data 212
  - TDQ record 124
- example of FEPI configuration 37
- exception conditions
  - application programs 138, 170
  - configuration programs 34
  - general considerations 34, 138
  - system programs 34, 88
- EXCEPTIONQ option
  - FEPI INQUIRE POOL 102
  - FEPI INQUIRE PROPERTYSET 105
  - FEPI INSTALL PROPERTYSET 113
- EXEC CICS command format
  - application programming 169
  - system programming 88
- EXEC interface block (EIB) 89, 171
- exit programming interface (XPI) 79
  - with XSZARQ global user exit 82
  - with XSZBRQ global user exit 80
- extended data stream
  - device attributes 22, 35
  - getting attributes 142, 145
  - storage requirements 24
  - VTAM configuration 30
- EXTRACT command
  - CONV 187
  - extracting field data 142, 146
  - FIELD 189
  - STSN 192

## F

- Feno
  - CEMT INQUIRE FENODE 65
- FENODE option
  - CEMT DISCARD command 60
- FEPI
  - applications 153
  - CICS-supplied transactions 59
  - commands 87, 169
  - configuration 29
  - environmental requirements 6
  - functions and services 9
  - hardware requirements 6
  - how it fits into your system 4
  - installation 27
  - introduction 3

- FEPI (*continued*)
  - operator control 59
  - planning 6, 19
  - programming interface 9
  - resources 12
  - sample programs 219
  - setup program
    - sample program 224
  - software requirements 6
  - storage requirements 6
  - system integrity 6
  - translator option 89, 171
- FEPI commands
  - ADD POOL 90
  - ALLOCATE 172
  - ALLOCATE POOL 173
  - AP NOOP 175
  - application programming commands 169
  - CONVERSE DATASTREAM 176
  - CONVERSE FORMATTED 181
  - DELETE POOL 91
  - DISCARD NODELIST 92
  - DISCARD POOL 93
  - DISCARD PROPERTYSET 94
  - DISCARD TARGETLIST 94
  - EXTRACT CONV 187
  - EXTRACT FIELD 189
  - EXTRACT STSN 192
  - FREE 193
  - INQUIRE CONNECTION 95
  - INQUIRE NODE 98
  - INQUIRE POOL 100
  - INQUIRE PROPERTYSET 104
  - INQUIRE TARGET 107
  - INSTALL NODELIST 108
  - INSTALL POOL 109
  - INSTALL PROPERTYSET 111
  - INSTALL TARGETLIST 115
  - ISSUE 195
  - RECEIVE DATASTREAM 198
  - RECEIVE FORMATTED 201
  - REQUEST PASSTICKET 204
  - SEND DATASTREAM 205
  - SEND FORMATTED 207
  - SET CONNECTION 116
  - SET NODE 118
  - SET POOL 120
  - SET TARGET 121
  - SP NOOP 122
  - START 209
  - system programming commands 87
- FEPI configuration
  - coding of programs 33
    - addressing mode 34
    - exception conditions 34
    - system programming commands 33
    - translator option 34
  - debugging programs 34
  - example configuration 37
  - global user exits 45

FEPI configuration (*continued*)

- monitoring program
  - sample program 225
  - triggering of 41
  - writing of 41
- planning 6, 19
- sample configuration 37
- setup program
  - optional functions 35
  - required functions 35
  - running of 35
  - sample 224
  - writing operator transactions 47
- FEPI=YES|NO, system initialization parameter 28
- FEPIRESOURCE, resource identifier for RACF 28
- Fepo
  - CEMT INQUIRE FEPOOL 67
- FEPOOL option
  - CEMT DISCARD 60
- Fepr
  - CEMT INQUIRE FEPROPSET 69
- FEPROPSET option
  - CEMT DISCARD 60
  - CEMT INQUIRE FEPROPSET 69
- Feta
  - CEMT INQUIRE FETARGET 70
- FETARGET option
  - CEMT DISCARD 60
- FIELDATTR option
  - FEPI EXTRACT FIELD 190
- FIELDLOC option
  - FEPI EXTRACT FIELD 190
- FIELDNUM option
  - FEPI EXTRACT FIELD 190
- fields, getting data and attributes 142, 145
- FIELDS option
  - FEPI CONVERSE FORMATTED 183
  - FEPI RECEIVE FORMATTED 202
- FJOURNALNAME option
  - FEPI INQUIRE POOL 102
  - FEPI INSTALL PROPERTYSET 113
- FJOURNALNUM option
  - FEPI INQUIRE POOL 102
  - FEPI INQUIRE PROPERTYSET 105
  - FEPI INSTALL PROPERTYSET 113
- FLENGTH field
  - start data 212
- FLENGTH option
  - FEPI EXTRACT FIELD 190
  - FEPI RECEIVE DATASTREAM 199
  - FEPI RECEIVE FORMATTED 202
  - FEPI SEND DATASTREAM 205
  - FEPI SEND FORMATTED 207
  - FEPI START 209
- FMH option
  - FEPI CONVERSE DATASTREAM 178
- FMHSTATUS option
  - FEPI CONVERSE DATASTREAM 178
  - FEPI RECEIVE DATASTREAM 199
- FORCE option
  - FEPI FREE 193
- forced shutdown 52
- FORMAT field
  - start data 212
  - TDQ record 124
- FORMAT option
  - FEPI EXTRACT CONV 187
  - FEPI INQUIRE POOL 102
  - FEPI INQUIRE PROPERTYSET 105
  - FEPI INSTALL PROPERTYSET 113
- formatted data 10
  - performance 166
  - programming 139
  - RECEIVE and EXTRACT field sample program 230
  - SEND and START sample program 229
- FREE 193
- FROM option
  - FEPI CONVERSE DATASTREAM 178
  - FEPI CONVERSE FORMATTED 183
  - FEPI SEND DATASTREAM 205
  - FEPI SEND FORMATTED 207
- FROMCURSOR option
  - FEPI CONVERSE FORMATTED 183
- FROMLENGTH option
  - FEPI CONVERSE DATASTREAM 178
  - FEPI CONVERSE FORMATTED 183
- front-end system 5
  - configuration 29
  - glossary entry 246
  - hardware and software requirements 6
  - XRF takeover 53
- function identifiers, journaling 84
- function shipping, restrictions on 29
- functions and services provided by FEPI 9

## G

- generic resources, VTAM 23
- global user exits 79
  - glossary entry 247
  - introduction 45, 79
- XSZARQ
  - exit-specific parameters 82
  - overview 82
  - return codes 82
  - UEPSZACN parameter 82
  - XPI calls 82
- XSZBRQ
  - exit-specific parameters 80
  - modifiable parameters 79
  - overview 79
  - return codes 80
  - UEPSZACT parameter 82
  - XPI calls 80
- glossary of terms and abbreviations 245
- GOINGOUT status 47
- good morning message 23, 154

## H

- handler, glossary entry 247
- hardware requirements 6
- HIGHLIGHT option
  - FEPI EXTRACT FIELD 190

HOLD option  
FEPI FREE 193

## I

immediate shutdown 52  
IMS (Information Management System)  
  considerations for application design 163  
  end of session 164  
  glossary entry 247  
  message protocols 163  
  recovery 165  
  response mode 164  
  SLU P conversational sample program 233  
  SLU P recovery 165  
  SLU2 recovery 165  
  STSN handling 23, 167  
    sample program 235  
  terminal definitions 33  
  unsolicited-data handler 154  
  using MFS 164  
inbound data  
  3270 data stream considerations 151  
  data format 214  
  initial data 23, 154  
  journaling 83  
  terminology 9  
INITIALDATA option  
  FEPI INQUIRE POOL 102  
  FEPI INQUIRE PROPERTYSET 106  
  FEPI INSTALL PROPERTYSET 113  
INPUTCONTROL option  
  FEPI EXTRACT FIELD 190  
INQUIRE, CEMT  
  FECONNECTION 61  
  FENODE 65  
  FEPOOL 67  
  FEPROPSET 69  
  FETARGET 70  
INQUIRE command  
  CONNECTION 95  
  NODE 98  
  POOL 100  
    use in event handlers 37  
  PROPERTYSET 104  
  TARGET 107  
Inservice  
  CEMT INQUIRE FECONNECTION 62  
  CEMT INQUIRE FENODE 66  
  CEMT INQUIRE FEPOOL 68  
  CEMT INQUIRE FETARGET 71  
INSERVICE option  
  CEMT SET FECONNECTION 72  
  CEMT SET FENODE 74  
  CEMT SET FEPOOL 75  
  CEMT SET FETARGET 76  
INSERVICE status 47  
INSTALL command  
  NODELIST 108  
  POOL 109  
  PROPERTYSET 111

INSTALL command (*continued*)  
  TARGETLIST 115  
Installed  
  CEMT INQUIRE FECONNECTION 62  
  CEMT INQUIRE FENODE 66  
  CEMT INQUIRE FEPOOL 68  
  CEMT INQUIRE FETARGET 71  
INSTALLED status 49  
INSTALLFAIL event 41  
installing FEPI  
  defining security profiles 28  
  loading modules in the LPA 27  
  overview 27  
  planning considerations 6  
  RDO definitions 28  
  sample programs 221  
  starting CICS 28  
  updating CICS definitions  
    PLTPI list 29  
    supplied RDO group, DFHFPEPI 27  
    system initialization parameter,  
      FEPI=YES|NO 28  
    transient data queues 27  
INSTLSTATUS, resource status 49  
INSTLSTATUS option  
  FEPI INQUIRE CONNECTION 96  
  FEPI INQUIRE NODE 99  
  FEPI INQUIRE POOL 102  
  FEPI INQUIRE TARGET 107  
integrity of FEPI system 6  
interactive problem control system (IPCS) 125  
INTO option  
  FEPI CONVERSE DATASTREAM 178  
  FEPI CONVERSE FORMATTED 184  
  FEPI EXTRACT FIELD 190  
  FEPI RECEIVE DATASTREAM 199  
  FEPI RECEIVE FORMATTED 202  
INVITE option  
  command sequence 148  
  FEPI SEND DATASTREAM 205  
IPCS (interactive problem control system) 125  
ISC (intersystem communication) 4  
  glossary entry 247  
  hardware requirements 6  
ISSUE 195  
  sending SNA commands 168  
ISTINCLM, LOGON mode table 31

## J

journaling 15, 83  
  use of property set for 23, 35

## K

key stroke and screen-image applications 10  
  CONVERSE 146  
  data formats 212  
  extracting field data 146  
  general sequence of commands 139  
  glossary entry 247  
  multiple attentions 143

key stroke and screen-image applications 10  
 (continued)  
 performance considerations 166  
 receiving field-by-field 142  
 receiving screen-image data 145  
 sample programs  
 key stroke converse 228  
 screen image RECEIVE and EXTRACT 230  
 screen image SEND and START 229  
 sending key stroke data 140  
 sending screen-image data 144  
 writing 139

KEYSTROKES option  
 FEPI CONVERSE FORMATTED 184  
 FEPI SEND FORMATTED 208

**L**

Lacqcode  
 CEMT INQUIRE FECONNECTION 64  
 CEMT INQUIRE FENODE 66

LACQCODE option  
 resource status 49

LASTACQCODE option  
 FEPI INQUIRE CONNECTION 97  
 FEPI INQUIRE NODE 100

LINES option  
 FEPI CONVERSE FORMATTED 184  
 FEPI RECEIVE FORMATTED 202

Link Pack Area (LPA), loading FEPI modules into 27

list of resources  
 benefits of using 50  
 errors 35, 89

list processing 89

LOGON mode table, VTAM 31

LPA (Link Pack Area), loading FEPI modules into 27

LU (logical unit)  
 glossary entry 247

**M**

magnetic stripe reader, sending key stroke data to 141

managing sessions, use of property set for 23, 35

manipulative keys 141, 213

MAXLENGTH option  
 FEPI CONVERSE DATASTREAM 178  
 FEPI CONVERSE FORMATTED 184  
 FEPI EXTRACT FIELD 190  
 FEPI INQUIRE POOL 103  
 FEPI INQUIRE PROPERTYSET 106  
 FEPI INSTALL PROPERTYSET 114  
 FEPI RECEIVE DATASTREAM 199  
 FEPI RECEIVE FORMATTED 202

MDT (modified data tag) setting 144, 212

MDT option  
 FEPI EXTRACT FIELD 190

Message Format Services (MFS) 164

message protocols (IMS) 163

messages  
 format of FEPI messages 129  
 handling unexpected events 20

messages (continued)  
 IMS protocols 163  
 produced during XRF takeover 52  
 resynchronizing with STSN 167

MFS (Message Format Services) 164

mode table, VTAM 31

modified data tag (MDT) setting 144, 212

module identifiers, journaling 84

monitoring, CICS  
 performance class records  
 FEPI-related fields 50

monitoring program  
 glossary entry 247  
 handling CLSDST(PASS) 44  
 sample program 225  
 triggering of 41  
 writing of 41

MRO (multiregion operation)  
 AOR considerations for FEPI 29  
 general considerations 4

MSGJRNL option  
 FEPI INQUIRE POOL 103  
 FEPI INQUIRE PROPERTYSET 106  
 FEPI INSTALL PROPERTYSET 114

multiple attentions 143

MVS/ESA  
 Integrity Programming Announcement 6

**N**

naming conventions  
 network resources 30  
 nodes 19, 30  
 pools 22  
 property sets 23  
 sample programs 10  
 targets 19  
 VTAM 30

network availability 30

no response, glossary entry 247

node  
 acquiring and releasing 47  
 defining to VTAM 30  
 definition of 12  
 determining contents of a pool 47  
 glossary entry 247  
 INQUIRE NODE command 98  
 name restrictions 30  
 number of nodes 21  
 sample node lists 39  
 SET NODE command 118  
 setup sample program 224  
 storage requirements 24

Node  
 CEMT INQUIRE FECONNECTION 61, 62  
 CEMT INQUIRE FENODE 65, 66

NODE field  
 start data 212  
 TDQ record 124

NODE option  
 CEMT SET FECONNECTION 72



NODE option *(continued)*  
 FEPI EXTRACT CONV 188  
 FEPI INQUIRE CONNECTION 97  
 FEPI INQUIRE NODE 100  
 FEPI SET CONNECTION 117  
 FEPI SET NODE 119

NODELIST option  
 FEPI ADD 90  
 FEPI DELETE 92  
 FEPI DISCARD NODELIST 93  
 FEPI INSTALL NODELIST 109  
 FEPI INSTALL POOL 110  
 FEPI SET CONNECTION 117  
 FEPI SET NODE 119

nodename option  
 CEMT SET FENODE 74

NODENUM option  
 FEPI ADD 90  
 FEPI DELETE 92  
 FEPI DISCARD NODELIST 93  
 FEPI INSTALL NODELIST 109  
 FEPI INSTALL POOL 110  
 FEPI SET CONNECTION 117  
 FEPI SET NODE 119

non-response mode, glossary entry 247

normal shutdown 51

Notinstalled  
 CEMT INQUIRE FECONNECTION 62  
 CEMT INQUIRE FENODE 66  
 CEMT INQUIRE FEPOOL 68  
 CEMT INQUIRE FETARGET 71

NOTINSTALLED status 49

## O

one-out one-in conversational applications  
 application design 155  
 sample program 233

operator control  
 commands 59  
 FEPI trace 77  
 operator/system action error 162  
 transactions, user-written 47  
 VTAM commands 77

operator/system action error 162

order of FEPI commands 139, 148

organizing pools 22

organizing property sets 22

outbound data  
 3270 data stream considerations 151  
 data formats 212  
 journaling 84  
 terminology 9

OUTLINE option  
 FEPI EXTRACT FIELD 190

Outservice  
 CEMT INQUIRE FECONNECTION 62  
 CEMT INQUIRE FENODE 66  
 CEMT INQUIRE FEPOOL 68  
 CEMT INQUIRE FETARGET 71

OUTSERVICE option  
 CEMT SET FECONNECTION 72

OUTSERVICE option *(continued)*  
 CEMT SET FENODE 74  
 CEMT SET FEPOOL 75  
 CEMT SET FETARGET 76

OUTSERVICE status 47

## P

spacing of FEPI sessions 32

PASS option  
 FEPI FREE 193

pass-through  
 contention state handling 150  
 problem with received data 150  
 sample program 231

PASSCONVID option  
 FEPI ALLOCATE PASSCONVID 172  
 getting ownership of conversations 158

passing conversations 158

PASSTICKET option  
 FEPI REQUEST PASSTICKET 204

PassTickets, for signon security 14, 159

PASSWORDLIST option  
 FEPI INSTALL NODELIST 109

PERFORM STATISTICS RECORD command 50

performance  
 application programs 49  
 formatted data 166  
 key stroke and screen-image applications 166  
 of a CICSplex  
 using VTAM generic resources 23  
 optimization through application design 166  
 tuning using CICS monitoring data 50  
 tuning using CICS statistics data 50

performance class monitoring records 50

persistent sessions, VTAM  
 use of with FEPI 55

PI/I language  
 sample programs 219

PL/I language  
 copybook 34, 170

planning  
 back-end applications 19  
 configuration 6, 19  
 general considerations 5, 19  
 grouping of connections, for functional purposes 21  
 handling special events 20  
 installation 6  
 journaling requirements 20  
 names of nodes and targets 19  
 number of nodes 21  
 operator control requirements 20  
 organizing pools 22  
 organizing property sets 22  
 pools  
 using for control purposes 20  
 using for functional purposes 21  
 signon and signoff procedures 20  
 storage 24

PLT (program list table) 29, 35  
 glossary entry 247  
 post initialization (PLTPI) 29

PLTPI (program list table post initialization)  
   configuring CICS for FEPI 29  
   glossary entry 247  
   running setup programs 36  
 PLU (primary logical unit)  
   glossary entry 247  
 Pool  
   CEMT INQUIRE FECONNECTION 62  
   CEMT INQUIRE FEPOOL 68  
 POOL field  
   start data 212  
   TDQ record 124  
 POOL option  
   FEPI ADD 90  
   FEPI ALLOCATE POOL 173  
   FEPI CONVERSE DATASTREAM 178  
   FEPI CONVERSE FORMATTED 184  
   FEPI DISCARD POOL 93  
   FEPI EXTRACT CONV 188  
   FEPI INQUIRE CONNECTION 97  
   FEPI INQUIRE POOL 103  
   FEPI INSTALL POOL 110  
   FEPI SET POOL 120  
 POOLLIST option  
   FEPI SET POOL 120  
 POOLNUM option  
   FEPI SET POOL 120  
 pools  
   connections in 47  
   definition of 12  
   determining contents of a pool 47  
   glossary entry 247  
   INQUIRE POOL command 100  
   INSTALL POOL command 109  
   name restrictions 22  
   organizing pools 22  
   sample configuration 37  
   SET POOL command 120  
   setup sample program 224  
   storage requirements 24  
   transient data queues 27, 41  
   using for control reasons 20  
   using for functional reasons 21  
 POSITION option  
   FEPI EXTRACT FIELD 190  
 prerequisites, hardware and software 6  
 presentation space 247  
   glossary entry 247  
 previously allocated conversation 176, 181  
 primary logical unit (PLU)  
   glossary entry 248  
 problem determination  
   abends 129  
   debugging 125  
   functions provided by FEPI 15  
   handling unexpected events 41  
   messages 129  
   reporting problems to IBM 131  
   shutdown not proceeding 51  
   trace 128  
   using CICS dumps 127  
   problem determination (*continued*)  
     using FEPI dumps 125  
 product tape 6  
 Program Temporary Fix (PTF)  
   glossary entry 248  
 property set  
   data handling 22, 35  
   definition of 12  
   device attributes 22, 35  
   DISCARD PROPERTYSET command 94  
   glossary entry 248  
   INQUIRE PROPERTYSET command 104  
   INSTALL PROPERTYSET command 111  
   journaling 23, 35  
   name restrictions 23  
   organizing 22  
   sample configuration 40  
   session management 23, 35  
   setup sample program 224  
   storage requirements 24  
   unexpected events 23, 35  
 PROPERTYSET option  
   FEPI DISCARD PROPERTYSET 94  
   FEPI INQUIRE POOL 103  
   FEPI INQUIRE PROPERTYSET 106  
   FEPI INSTALL POOL 110  
   FEPI INSTALL PROPERTYSET 114  
 PROTECT option  
   FEPI EXTRACT FIELD 190  
 PS/55  
   FEPI device type 102  
   TYPETERM 32  
 PS option  
   FEPI EXTRACT FIELD 190  
 pseudoconversational applications  
   application design 156  
   sample program 234  
 PTF (Program Temporary Fix)  
   glossary entry 248

## Q

query, device 154

## R

RACF (Resource Access Control Facility)  
   general security considerations 28  
   glossary entry 248  
 RDO (resource definition online)  
   definitions for sample programs 220  
   glossary entry 248  
   updating CICS definitions for FEPI 27  
   XRF considerations 53  
 RECEIVE command  
   completion 142, 149  
   DATASTREAM 198  
   error handling 143, 150  
   FORMATTED 201  
 receiving data  
   data stream applications 148  
   field-by-field 142

- receiving data (*continued*)
  - screen-image 145
- reference section
  - application programming 169
  - operator commands 59
  - system programming 87
- RELEASE option
  - FEPI FREE 193
- Released
  - CEMT INQUIRE FECONNECTION 62
  - CEMT INQUIRE FENODE 66
- RELEASED option
  - CEMT SET FECONNECTION 72
  - CEMT SET FENODE 74
- RELEASED resource status 47
- RELEASING, resource status 47
- REMFLNGTH option
  - FEPI CONVERSE DATASTREAM 178
  - FEPI RECEIVE DATASTREAM 199
- reporting FEPI problems to IBM 131
- REQUEST PASSTICKET command 204
- request unit (RU)
  - glossary entry 248
  - receiving 149
- requirements, hardware and software 6
- resources
  - benefits of using list of resources 50
  - configuring 36
  - definitions 12
  - diagram showing relationship 12
  - sample configuration 37
  - status 47
- RESP2 values
  - application programming commands 170
  - system programming commands 88
  - table of 241
- response mode 164
- response mode, glossary entry 248
- responses
  - DRx responses 167
- RESPSTATUS option
  - FEPI CONVERSE DATASTREAM 178
  - FEPI CONVERSE FORMATTED 184
  - FEPI RECEIVE DATASTREAM 199
  - FEPI RECEIVE FORMATTED 202
- restriction on use of DFH
  - in node names 30
  - in pool names 22
  - in property set names 23
- return codes
  - application programming 170
  - system programming 88
  - user exits 80, 82
  - VTAM 49
- RU option
  - FEPI CONVERSE DATASTREAM 179
  - FEPI RECEIVE DATASTREAM 199

## S

- sample FEPI configuration 37
- sample programs 219
  - 3270 data stream pass-through 231
  - begin session 226
  - CICS back-end 222
  - end-session handler 232
  - FEPI configuration 37
  - IMS back-end 223
  - installing of 221
  - introduction 10
  - key stroke CONVERSE 228
  - monitor and unsolicited data handler 225
  - naming conventions 10
  - one-out one-in 233
  - program descriptions and code 219
  - pseudoconversational 234
  - screen image RECEIVE and EXTRACT FIELD 230
  - screen image SEND and START 229
  - setup 224
  - SLU P one-out one-in 233
  - SLU P pseudoconversational 234
  - STSN handler 235
  - using the samples 222
- sample resource definitions 39
- screen-image interface 10, 248
  - data formats 212
  - RECEIVE and EXTRACT field sample program 230
  - SEND and START sample program 229
- secondary logical unit (SLU)
  - glossary entry 248
  - terminals supported by FEPI 14
- security
  - command-level 15, 28
  - handling violations with access program 153
  - restricting access to system programming
    - commands 28
  - signoff 20
  - signon 14, 20, 153, 159
  - using PassTickets 14, 159
  - using RACF 28
- SEND command
  - DATASTREAM 205
  - error handling 162
  - errors 141, 143, 150
  - FORMATTED 207
- sending data
  - data stream applications 151
  - key stroke data 140
  - screen image 144
- sense data 162
- SENSEDATA option
  - FEPI EXTRACT CONV 188
  - FEPI ISSUE 196
- SEQNUMIN option
  - FEPI ALLOCATE POOL 173
  - FEPI CONVERSE DATASTREAM 179
  - FEPI EXTRACT STSN 192
  - FEPI RECEIVE DATASTREAM 199
  - FEPI SEND DATASTREAM 205

- SEQNUMOUT option
  - FEPI ALLOCATE POOL 173
  - FEPI CONVERSE DATASTREAM 179
  - FEPI EXTRACT STSN 192
  - FEPI RECEIVE DATASTREAM 199
  - FEPI SEND DATASTREAM 205
- sequence number handling 167
- sequence of FEPI commands 139, 148
- SERVSTATUS, resource status 47
- SERVSTATUS option
  - FEPI ADD 90
  - FEPI INQUIRE CONNECTION 97
  - FEPI INQUIRE NODE 100
  - FEPI INQUIRE POOL 103
  - FEPI INQUIRE TARGET 108
  - FEPI INSTALL NODELIST 109
  - FEPI INSTALL POOL 110
  - FEPI INSTALL TARGETLIST 116
  - FEPI SET CONNECTION 117
  - FEPI SET NODE 119
  - FEPI SET POOL 120
  - FEPI SET TARGET 121
- session 248
  - loss of 162
  - management using property sets 23, 35
  - pacing values 32
  - parameters, selection of 31
- SESSION event 42
- SESSIONFAIL event 42
- SESSIONLOST event 42
- SET, CEMT
  - FECONNECTION 72
  - FENODE 74
  - FEPOOL 75
  - FETARGET 76
- SET command
  - CONNECTION 116
  - NODE 118
  - POOL 120
  - TARGET 121
- SETFAIL event 42
- setup program, for FEPI resources 12, 21
  - glossary entry 248
  - sample program 224
- shutdown
  - error handling 163
  - of CICS 51
  - of FEPI 52
- signon security 14, 20, 153, 159
- SIT (system initialization table)
  - glossary entry 248
  - SIT parameter, FEPI=YES|NO 28
- SIZE option
  - FEPI EXTRACT FIELD 190
- SLU (secondary logical unit)
  - glossary entry 248
  - terminals supported by FEPI 14
- SLU P 14
  - begin-session sample 226
  - data stream applications 152
  - glossary entry 248
- SLU P 14 (*continued*)
  - IMS recovery 165
  - one-out one-in sample program 233
  - pseudoconversational sample program 234
  - sample configuration 40
  - sample programs 219
  - STSN request 167
- SLU P
  - device attributes 22
- SLU2 14
  - begin-session sample 226
  - data stream applications 151
  - device attributes 22
  - glossary entry 248
  - IMS recovery 165
  - key stroke format 212
  - sample configuration 40
  - sample programs 219
- SMP/E (System Modification Program/Extended)
  - glossary entry 248
  - installing FEPI 6
- SNA (Systems Network Architecture)
  - glossary entry 248
  - sending commands 168
- software requirements 6
- special keys 141, 213
- specialized functions
  - DRx responses 167
  - SNA commands 168
  - STSN 167
- START command 209
  - failure during shutdown 163
- start data 156, 211
- started tasks 156
- State
  - CEMT INQUIRE FECONNECTION 63
- STATE, resource status 49
- STATE option
  - FEPI INQUIRE CONNECTION 97
- statistics, CICS
  - FEPI-related
    - COLLECT STATISTICS command 50
    - PERFORM STATISTICS RECORD command 50
- storage planning 24
- stripe reader, sending key stroke data 141
- STSN (set and test sequence number) 13
  - general considerations 167
  - glossary entry 248
  - sample program 235
- STSN handler
  - defining to FEPI 35
  - glossary entry 248
- STSN option
  - FEPI INQUIRE POOL 103
  - FEPI INQUIRE PROPERTYSET 106
  - FEPI INSTALL PROPERTYSET 114
- syncpoints, use of in FEPI 154
- syntax notation 89, 171
- system programming commands 33, 87
- SZ, dump control keyword 125

## T

### target

- definition of 12
- determining contents of a pool 47
- glossary entry 249
- INQUIRE TARGET command 107
- naming conventions 19
- sample target lists 39
- SET TARGET command 121
- setup sample program 224
- storage requirements 24

### Target

- CEMT INQUIRE FECONNECTION 61, 62

### TARGET field

- start data 212
- TDQ record 124

### TARGET option

- CEMT SET FECONNECTION 73
- FEPI ALLOCATE POOL 173
- FEPI CONVERSE DATASTREAM 179
- FEPI CONVERSE FORMATTED 184
- FEPI EXTRACT CONV 188
- FEPI INQUIRE CONNECTION 98
- FEPI INQUIRE TARGET 108
- FEPI SET CONNECTION 117
- FEPI SET TARGET 121

### TARGETLIST option

- FEPI ADD 91
- FEPI DELETE 92
- FEPI DISCARD TARGETLIST 95
- FEPI INSTALL POOL 111
- FEPI INSTALL TARGETLIST 116
- FEPI SET CONNECTION 118
- FEPI SET TARGET 121

### TARGETNUM option

- FEPI ADD 91
- FEPI DELETE 92
- FEPI DISCARD TARGETLIST 95
- FEPI INSTALL POOL 111
- FEPI INSTALL TARGETLIST 116
- FEPI SET CONNECTION 118
- FEPI SET TARGET 121

### tasks, started 156

### temporary conversation 159

- glossary entry 249

### TERMINAL option

- FEPI START 209

### terminal

- back-end definitions 32
- simulated terminal usage 155
- storage requirements 24
- VTAM logon mode table entries 31
- XRF environment 52

### time-outs, error handling 161

### TIMEOUT option

- FEPI ALLOCATE POOL 173
- FEPI CONVERSE DATASTREAM 179
- FEPI CONVERSE FORMATTED 184
- FEPI RECEIVE DATASTREAM 200
- FEPI RECEIVE FORMATTED 202
- FEPI START 209

### TOCURSOR option

- FEPI CONVERSE FORMATTED 184

### TOLENGTH option

- FEPI CONVERSE DATASTREAM 179
- FEPI CONVERSE FORMATTED 184

### trace control 77

### trace points 128

### transactions

- CETR 77, 128
- CZBC 222
- CZBI 223
- CZPA 234
- CZPS 233
- CZQS 235
- CZTD 231
- CZTK 228
- CZTR 230
- CZTS 229
- CZUC 226
- CZUU 232
- CZUX 225
- CZXS 224

### TRANSID option

- FEPI START 209

### transient data queues

- command errors 34
- CSZL, for FEPI messages 27
- CSZX, for unexpected events 27
- defining to CICS 27
- handling 41
- planning 20
- pool-specific 27, 41
- records 122
- sample program 225
- unexpected event reporting 41

### translator options

- application programming commands 171
- FEPI option 34, 171
- system programming commands 89

### TRANSPARENCY option

- FEPI EXTRACT FIELD 191

### TYPETERMs for CICS back-end systems 32

## U

### UEPSZACN, exit-specific parameter for XSZARQ 82

### UEPSZACT, exit-specific parameter for XSZBRQ 82

### unbind, glossary entry 249

### unexpected events 27

- in CSZX TD queue 41
- in pool-specific TD queue 20, 42
- using event handlers 36
- using property set for 23, 35

### unknown conversation ID, error handling 162

### UNSOLDATA option

- FEPI INQUIRE POOL 103
- FEPI INQUIRE PROPERTYSET 106
- FEPI INSTALL PROPERTYSET 114

### UNSOLDATAACK option

- FEPI INQUIRE POOL 103
- FEPI INQUIRE PROPERTYSET 106
- FEPI INSTALL PROPERTYSET 114

- unsolicited data-handler
  - sample program 225
- unsolicited-data handler 13
  - application design 154
  - defining to FEPI 23, 35
  - glossary entry 249
- UNTILCDEB option
  - FEPI CONVERSE DATASTREAM 179
  - FEPI RECEIVE DATASTREAM 200
- USERDATA field
  - start data 212
- USERDATA option
  - FEPI INQUIRE CONNECTION 98
  - FEPI INQUIRE NODE 100
  - FEPI INQUIRE POOL 103
  - FEPI INQUIRE TARGET 108
  - FEPI SET CONNECTION 118
  - FEPI SET NODE 119
  - FEPI SET POOL 120
  - FEPI SET TARGET 122
  - FEPI START 209

## V

- VALIDATION option
  - FEPI EXTRACT FIELD 191
- VALUE option
  - FEPI ISSUE 196
- VTAM (Virtual Telecommunications Access method)
  - persistent sessions 55
- VTAM (Virtual Telecommunications Access Method)
  - APPL statement 30
  - application minor nodes 30
  - BIND during XRF takeover 52
  - CLSDST(PASS) 43
  - commands 77
  - configuration of 30
  - DISPLAY command 77
  - DISPLAY SESSIONS command 77
  - FEPI commands 10, 11
  - generic resources 23
  - ISTINCLM, supplied mode table 31
  - LOGON mode table 31
  - minor nodes, sample configuration 40
  - naming conventions 30
  - password protection 30
  - program-to-program support 4
  - releasing a connection 48
  - session pacing values 32
  - session parameters 31
  - TYPETERMs for CICS/MVS Version 2 32
  - VARY command 77
  - VARY TERM command 77
  - XRF considerations 52
- VTAM persistent sessions
  - use of with FEPI 55

## W

- Waitconvnum
  - CEMT INQUIRE FECONNECTION 63

- Waitconvnum (*continued*)
  - CEMT INQUIRE FEPOOL 68
- WAITCONVNUM option
  - event handlers 37
  - FEPI INQUIRE CONNECTION 98
  - FEPI INQUIRE POOL 103
- WAITCONVNUM resource status 49
- WCC (write control character)
  - handling 151
- workload balancing
  - in a CICSplex
    - using VTAM generic resources 23
- writing application programs 137

## X

- XLT (transaction list table)
  - application programming 163
  - glossary entry 249
  - operations 51
- XPI (exit programming interface) 79
  - with XSZARQ global user exit 82
  - with XSZBRQ global user exit 80
- XRF (extended recovery facility) 52
  - back-end system configuration 32
  - FEPI resource definition 53
  - glossary entry 249
  - takeover of back-end CICS
    - effect on applications 54
    - effect on FEPI connections 54
  - takeover of FEPI CICS
    - effect on alternate CICS 54
    - effect on back-end terminals 53
    - effect on back-end transactions 53
  - varying setup resources 66
  - VTAM considerations 52
- XSZARQ, global user exit
  - exit-specific parameters 82
  - overview 82
  - return codes 82
  - UEPSZACN parameter 82
  - XPI calls 82
- XSZBRQ, global user exit
  - exit-specific parameters 80
  - modifiable parameters 79
  - overview 79
  - return codes 80
  - UEPSZACT parameter 82
  - XPI calls 80





Program Number: 5655-147



Printed in the United States of America  
on recycled paper containing 10%  
recovered post-consumer fiber.

SC33-1692-30





Spine information:



CICS TS for OS/390

CICS Front End Programming Interface User's Guide

Release 3