

iSeries Server Consolidation: LPAR, Linux, and Windows



iSeries Server Consolidation

Single server, multiple applications

- ▶ LPAR for iSeries and AS/400
- ▶ Domino for NT Domino
- ▶ iNotes for Exchange
- ▶ Linux partition for Linux or NT consolidation
- ▶ OS/400 PASE for UNIX applications ¹
- ▶ IXS/IXA for Windows applications

Supported across the iSeries product line

Incorporates eServer technology

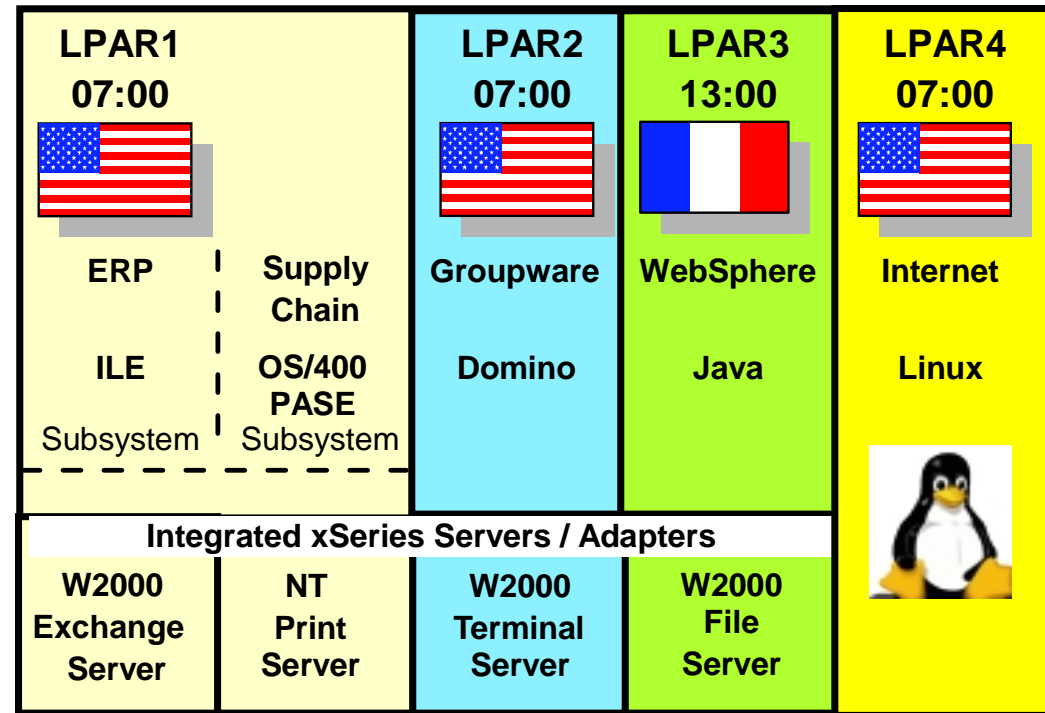

¹ Statement of Direction for AIX in a logical partition

Low Staffing Costs, High Availability = Low TCO

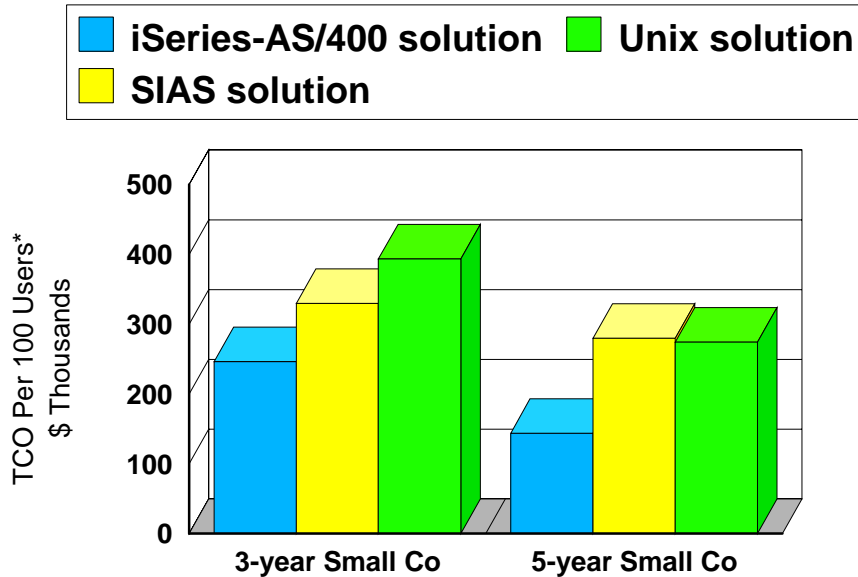

Availability

- iSeries solution 99.98%
- Unix solution 99.90%
- SIAS solution 99.67%

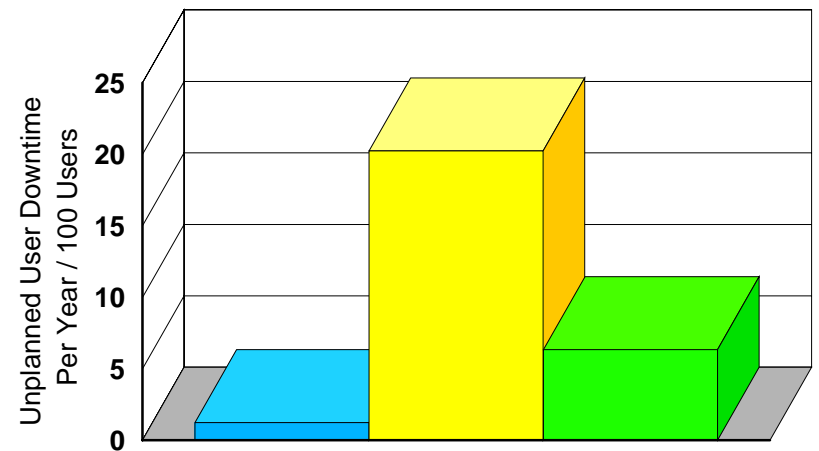

IT Staff for iSeries*

- Only 2/3 the staff of Unix solutions
- Only 40% of the staff of SIAS solutions

* Source "Server Cost of Ownership in ERM Customer Sites: A Total Cost of Ownership (TCO) Study" IDC September 2001

SIAS = Standard Intel Architecture Server

Logical Partitioning

I/T Marketplace

I/T challenges:

- ▶ Multiple data centers
 - Hardware, software, time zones, languages, network complexities
- ▶ Skills shortage, Cost of deploying solutions
 - Maintaining corporate standards, Higher service levels

I/T objectives:

- ▶ Reduce costs through automation and consolidation
 - Reduce number of hardware and software platforms
- ▶ Maintain application independence
 - Deploy applications faster, exploit new technologies
- ▶ Maximize investments in skills, and I/T infrastructure
- ▶ Plan to support growth in business volumes and continuous availability

LPAR Today

Enterprise class, flexible and scalable

- ▶ Dynamic resource movement
- ▶ Shared processor support
- ▶ Uni-processor partitioning
- ▶ Up to 32 partitions
- ▶ Across Server Line: 270, 8xx
- ▶ Virtual Ethernet LAN
- ▶ Graphical management
- ▶ New Application Programming Interfaces to automatically move resources
- ▶ Linux Support

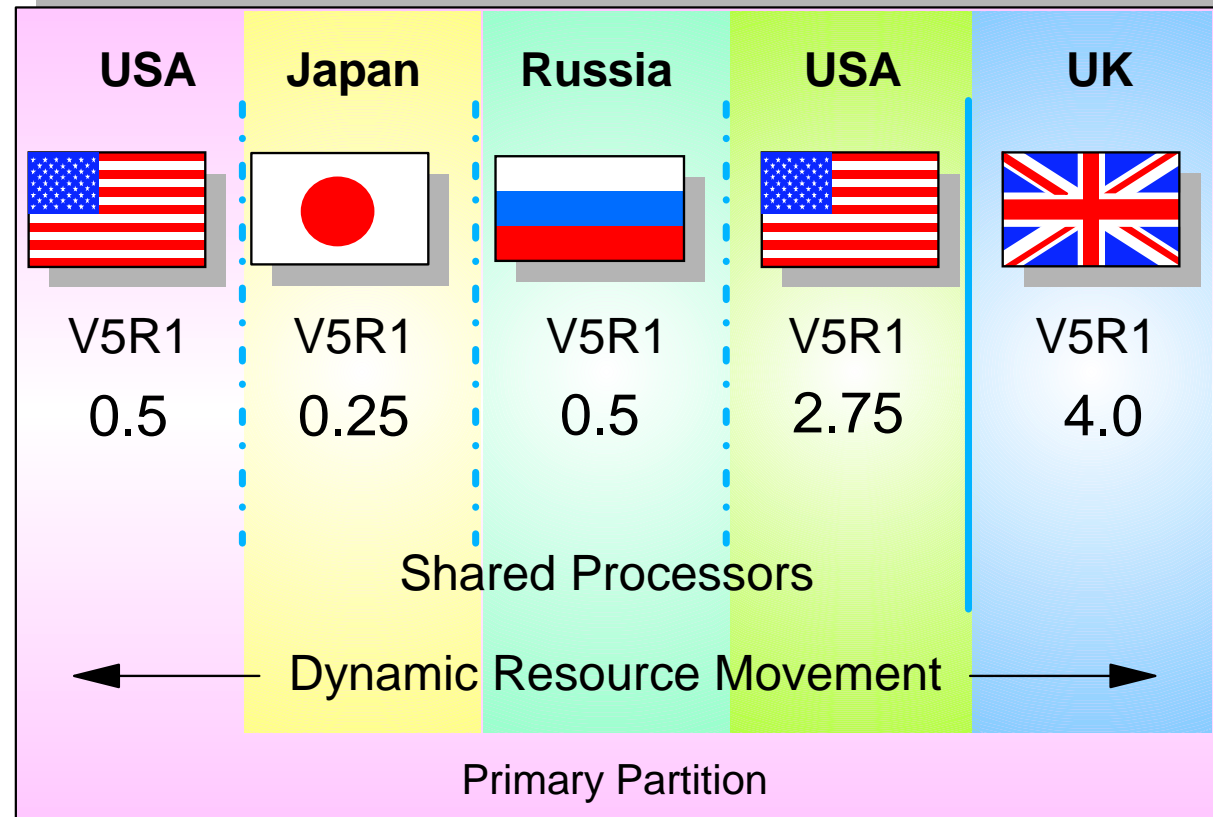

iSeries 830
8 Way

IBM @server

LPAR Innovations

Dynamic Resource Movement

- ▶ Move resources without an IPL
- ▶ Granular resource movement
 - Immediate or Scheduled
 - 100th of a processor movement on iSeries
 - 1 MB memory
 - 1% Interactive performance
 - Virtual network enablement

Shared Processors

- ▶ Up to 4 partitions per processor
 - Allows Uni-processor partitioning
 - Minimum is 0.10 processor per partition
- ▶ Maximum up to 32 partitions
- ▶ Supported on iSeries Model 8xx and Selected 270 Models with V5R1

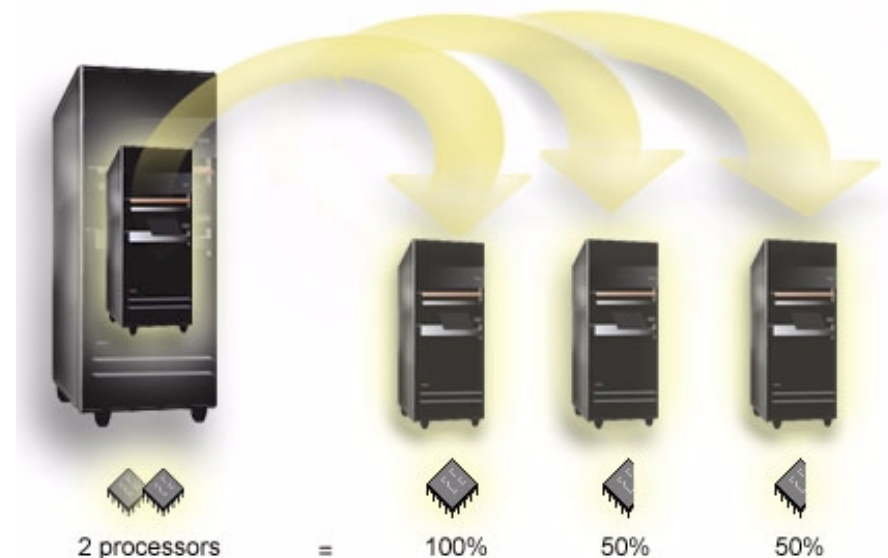

LPAR Scenarios

Workload Consolidation

- ▶ Partition server to support workloads that traditionally require separate servers
 - ERP, Web Serving, and Business Intelligence

Foot Print Consolidation

- ▶ Partition server to support workloads from different parts of the world
 - USA, Europe, AP

Production and Test

- ▶ Partition server to support production and test workloads

High Availability

- ▶ Consolidated servers offer a simpler environment for high availability solutions

Service Bureau, Application Service Provider, Business Recovery Service

- ▶ Partition server to support a different business in each partition

LPAR Advantages

Partitioning for the Midrange Market

- ▶ LPAR is supported on 1-way to 32-way servers

Dynamic Resource Movement

- ▶ Processor, memory, interactive, and select I/O resources can be moved between partitions without an IPL

Independent Resource Movement

- ▶ Processor, memory, and I/O resources can be moved independently of each other

Small Resource Increments

- ▶ .01 of a processor and 1 MB of memory can be moved between partitions

Shared Processor Support

- ▶ Multiple partitions on a uni-processor

Fast Internal Communications

- ▶ Virtual Ethernet provides high speed communication between partitions

Simple Setup and Administration

- ▶ iSeries Navigator Wizards and GUI

Heterogeneous OS Support

- ▶ OS/400, Linux and Statement of Direction for AIX

H.B. Fuller Company

4-Stage approach to Server Consolidation to reduce from 19 systems to 4 systems

1. Data Center Consolidation:

- ▶ Asia Pacific, EMEA and NA ERP systems to single regional ERP system

2. LPAR 1999:

- ▶ Consolidated 1 NA, 1 EMEA, 1 Global Sales Analysis on AS/400 730 8-way with 3 LPARs

3. LPAR 2000:

- ▶ Consolidated 1 Global Development of AP and 1 LA ERP system on AS/400 730 2-way with 2 partitions

4. LPAR 2001 / 2002:

- ▶ Consolidating 3 AP, 1 EMEA, 1 LA ERP systems, 2 Global systems, and 1 new e-business system on iSeries Model 830 4-way with 9 partitions using Shared Processor support and V5R1

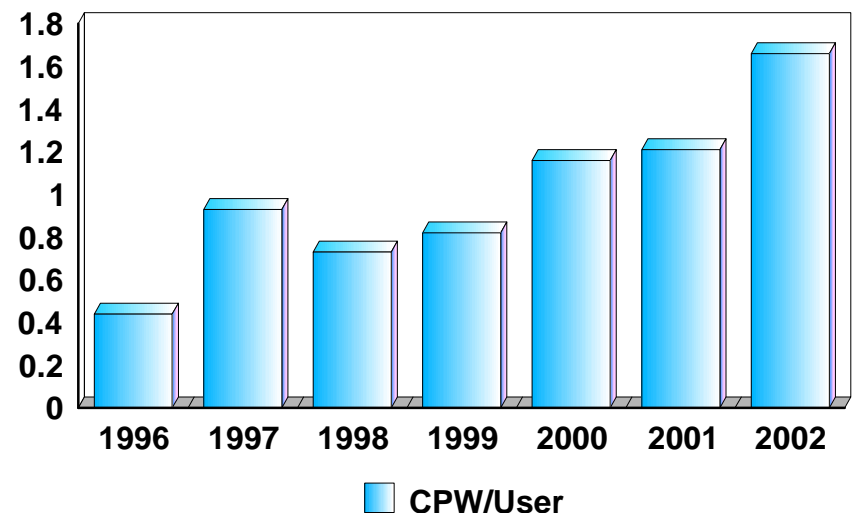
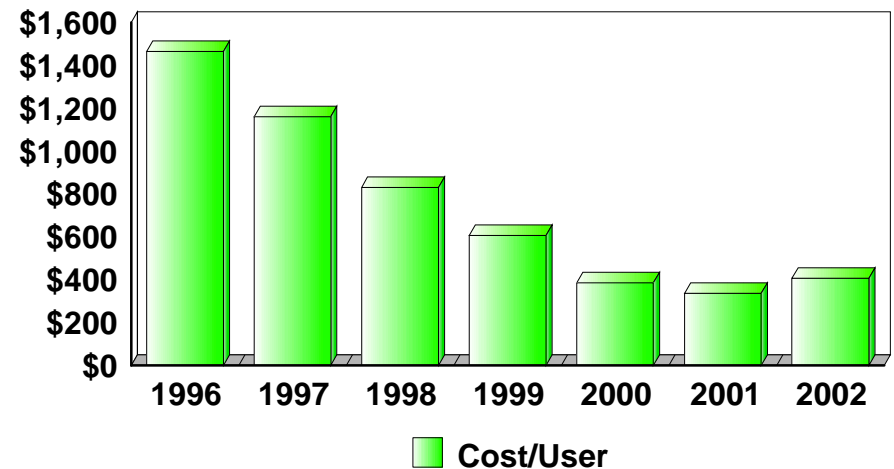

LPAR Summary

Enterprise-class Logical Partitioning:

- ▶ Available across the iSeries product family
- ▶ Provides application flexibility, maximizes resource usage
- ▶ Supports multiple versions of OS/400 in the same system
- ▶ Simple to implement, ideal for server consolidation

iSeries is at the forefront of partitioning technologies

- ▶ Dynamic resource movement, uni-processing partitioning
- ▶ CPU movement granularity as low as 1/100th of a CPU
- ▶ Enabled for automatic resource movement

<http://www.ibm.com/eserver/series/lpar>

Linux on iSeries



Linux Marketplace

Linux shipments projected to show the highest growth of any operating system in the next three years*

- ▶ Driving Cross Industry Support: Hardware, Software, Services

* International Data Corporation (IDC)
 "Server Operating Environments
 Market Forecasts & Analysis" January
 2001

Linux Usage Intentions

	Today	In 12 Months
HTML Server	45%	68%
e-mail Server	50%	66%
Web Application Server	43%	65%
Intranet Server	49%	64%
Firewall	48%	63%
File and Print	50%	62%
Software Development	43%	58%
Database Server	38%	50%
Non-Internet, non-Web	33%	49%

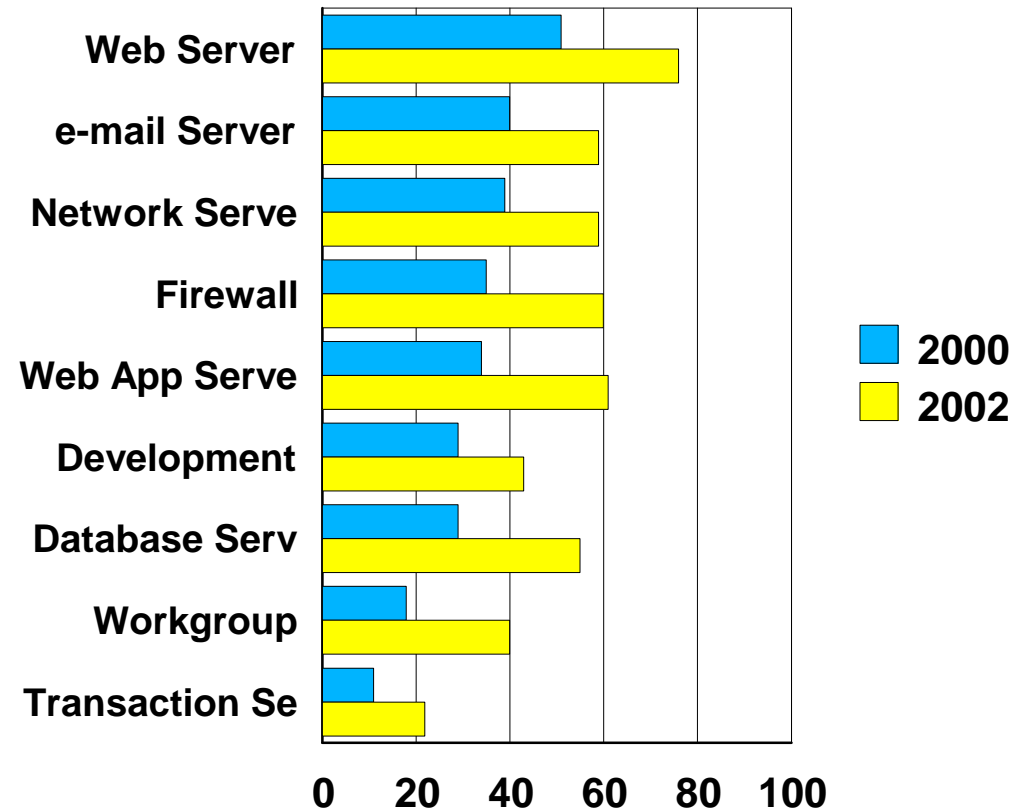

Zona Research Market Survey of IT and ISP customers with buying authority: 10/2000

Functions for Which Linux is being used (2000 vs 2002) - IBM Worldwide Linux Study 3/01 - 1704 Responses

IBM @server

Linux and iSeries

What does Linux Bring to iSeries

- ▶ e-Infrastructure workloads
- ▶ New generation of web-based applications
- ▶ Flexibility and choice of environment
- ▶ Rapid delivery of open source components
- ▶ Leverage of a virtual, worldwide development team
- ▶ Enables broad skill base to deliver iSeries solutions
- ▶ Leverages other IBM investments in Linux

What does iSeries Bring to Linux

- ▶ Ability to consolidate multiple Linux servers
- ▶ A reliable, scalable server to run Linux
- ▶ Resource sharing and management
- ▶ Integration with OS/400



IBM eServer iSeries Wins "Best of Show"

LinuxWorld

San Francisco, CA August 28-30, 2001

IBM @server

Linux on iSeries Today

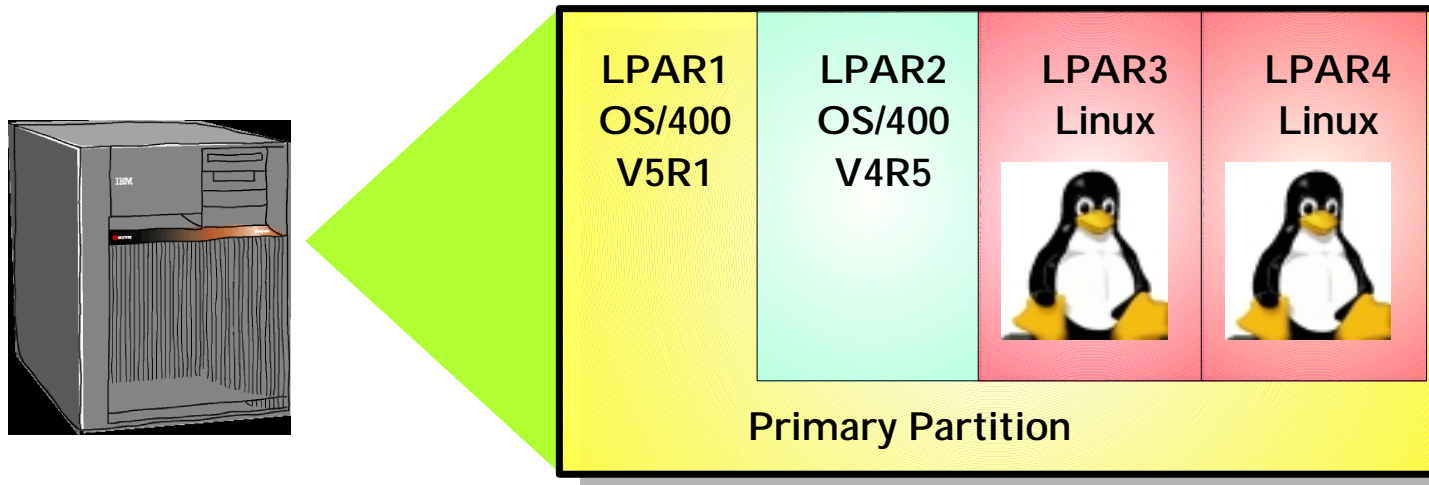

Available since August 2001

- ▶ Based on a 2.4, 32 and 64-bit PowerPC kernel
- ▶ SuSE, Turbolinux, and Red Hat distributions available

Consolidate up to 31 Linux servers on one iSeries

- ▶ Linux runs in iSeries logical partition
- ▶ Move processor, memory, and I/O resources between partitions
- ▶ Supported with V5R1 on iSeries Model 270, 820, 830, and 840

I/O Flexibility

- ▶ Virtual - share iSeries disk, tape, CD-ROM, and LAN resources
- ▶ Direct - Linux owns I/O resources



Linux and LPAR

Linux runs in a secondary partition

- ▶ Requires OS/400 V5R1 primary partition

Shared Processor Support for SStar Processors (announced in 2001)

- ▶ On selected iSeries 270 and 8xx models, Linux can share a processor with other Linux or OS/400 partitions
- ▶ Up to 4 partitions per processor
- ▶ Minimum 0.10 processor in a partition
- ▶ Minimum processor movement: 0.01

Dedicated Processor Support for IStar Processors (announced in 2000)

- ▶ On selected 8xx servers, Linux requires dedicated processors
- ▶ 1 partition per processor
- ▶ Minimum processor movement: 1

Resource Movement

- ▶ Processors, Memory, I/O
- ▶ Requires IPL of Linux partition
 - ◆ Dynamic resource movement in V5R2

I/O Flexibility

Virtual I/O

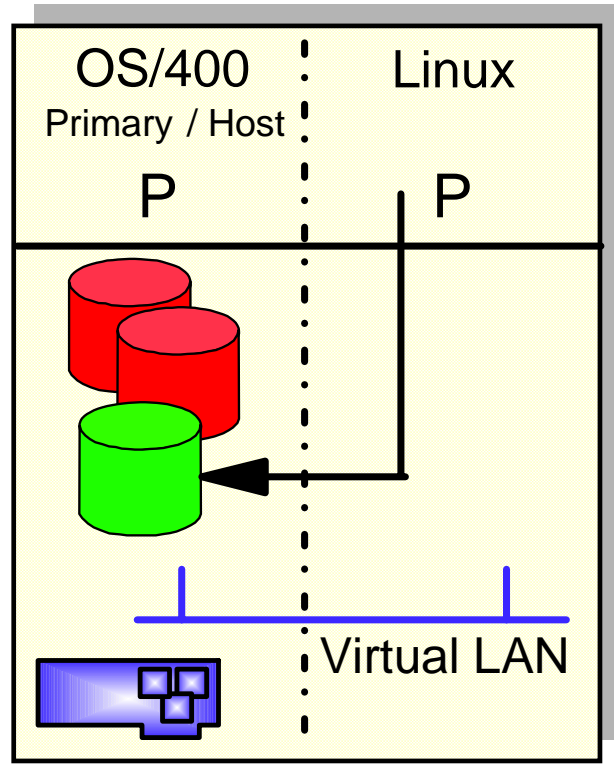

- ▶ Leverage iSeries resources
- ▶ OS/400 management

Direct I/O

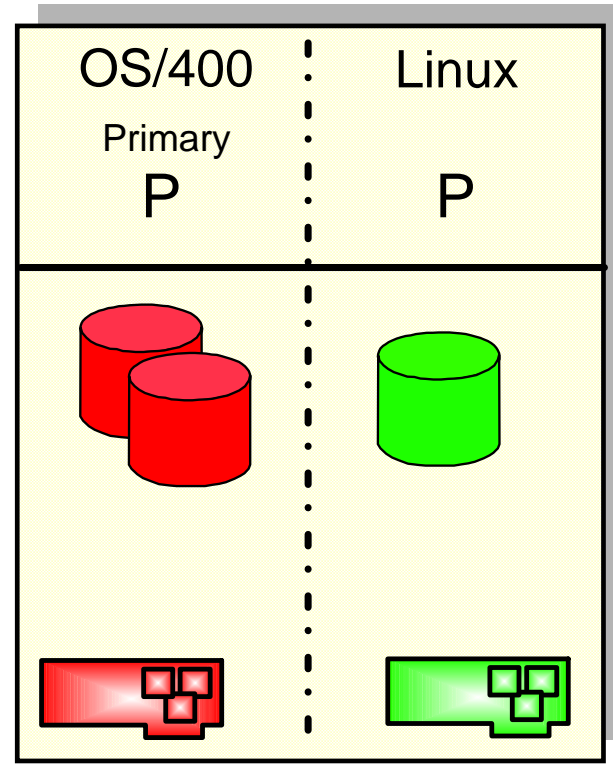

- ▶ Dedicated resources
- ▶ Linux management

iSeries Linux Example

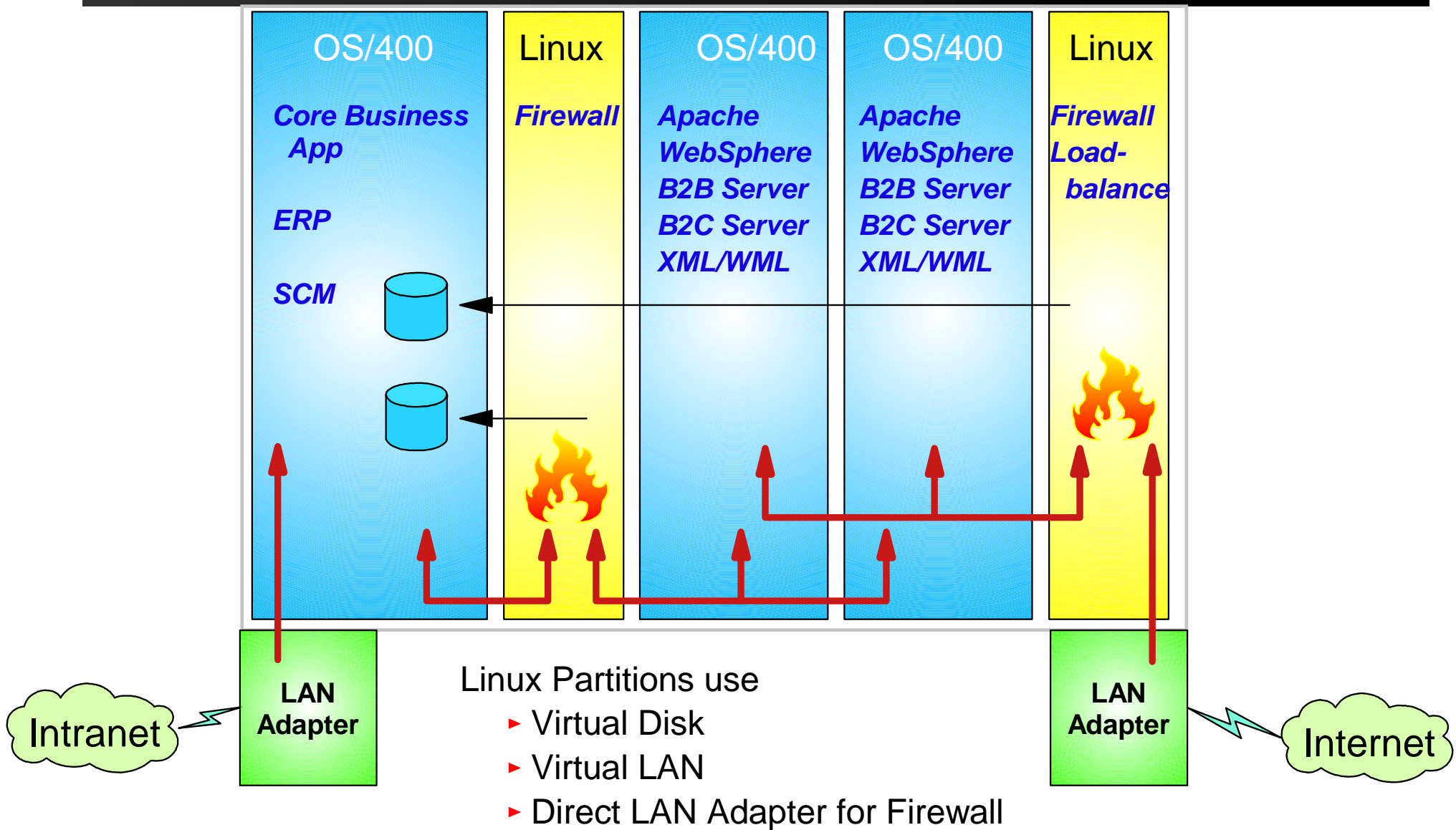

Linux and OS/400 Integration

File and Print Sharing

- ▶ OS/400 NetServer Support for Samba

File Sharing

- ▶ NFS

Database Access

- ▶ IBM Toolbox for Java including JDBC
- ▶ iSeries ODBC Driver for Linux (access DB2 UDB for OS/400)

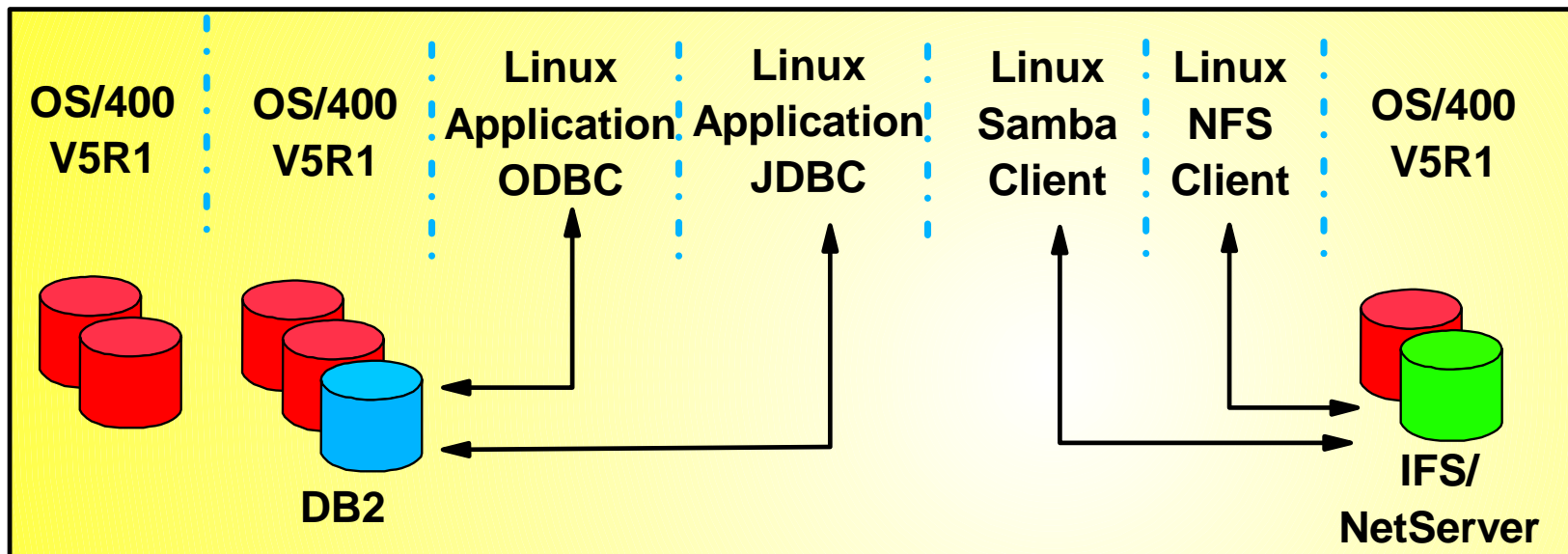

Linux for iSeries Scenarios

Consolidation

- ▶ Replace Windows or Linux infrastructure servers
- ▶ Run multiple Linux servers in partitions
- ▶ Consolidation lowers the cost of computing

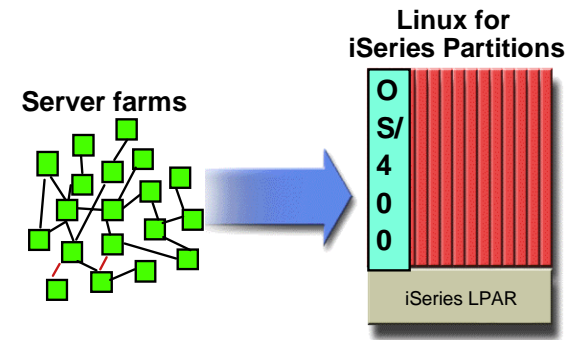

Integration

- ▶ Extend OS/400 applications with Linux applications
- ▶ Run Linux applications on same server as OS/400
- ▶ Integration lowers the cost of computing

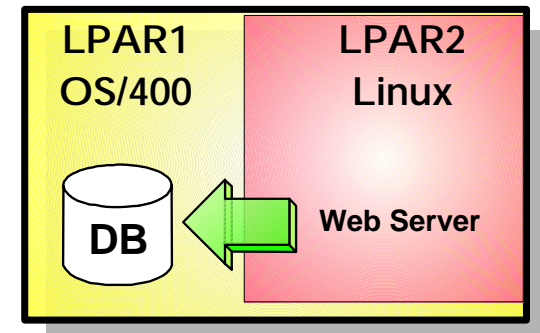

Application Flexibility

- ▶ Leverage Linux LOB application portfolio
- ▶ Run Linux applications on iSeries
- ▶ Flexibility lowers the cost of computing

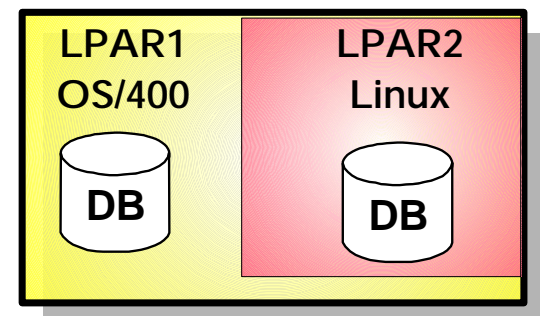

Linux on iSeries Advantage

Server Consolidation

- ▶ OS/400, Linux, and Windows 2000 servers
- ▶ Support for up to 31 Linux partitions

Resource Sharing

- ▶ Partitioning
- ▶ Shared Processors
- ▶ Virtual I/O: Disk, LAN, Tape, CD-ROM

Minimal Hardware Requirements for a Linux Environment

- ▶ Part of a processor, memory
- ▶ Virtual I/O: Disk, LAN, Tape, CD-ROM

Reliable Server

- ▶ Leading single server availability
- ▶ Unique virtual disk support provides excellent test/development environment

Storage Area Network facilities

- ▶ Full OS/400 system backup provides disaster recovery for Linux virtual disks
- ▶ Linux backup saves daily Linux files changes direct to iSeries tape device

OS/400 Integration

The Challenge

- ▶ The need to develop a robust and scalable commerce for e-business supply chain management system

The Solution

- ▶ An ideal system for Churchill's needs was developed using Wizz400, a Clover product, running in a Logical Partition (LPAR) environment, with a Linux based firewall system on a powerful iSeries * Model 820

The Benefit

- ▶ Churchill now have a solution that perfectly meets their commerce for e-business supply chain management needs and is scalable to meet the company's future needs.

“iSeries has dramatically reduced our costs by providing the power to run different applications on different operating systems on a single machine. The legendary reliability of the system makes it the perfect platform for taking our business online.”

David Garnett, Information Technology (IT) Director, Churchill China

Linux on iSeries Summary

Linux for iSeries is available from distributors

iSeries offers consolidation solution for Linux by leveraging LPAR and Virtual I/O resources

OS/400 applications can be extended with Linux Offerings

www.ibm.com/eserver/series/linux

iSeries Windows Server Integration



iSeries and Windows Servers

75% of iSeries and AS/400 customers have NT Installed

**ISVs and IBM are delivering complementary applications
with Windows® Servers**

Customers want to consolidate servers

iSeries Windows Server Integration

Solutions

- ▶ Extend OS/400 applications with Windows portfolio
- ▶ Consolidate Windows servers
- ▶ Simplify branch offices

Approach

- ▶ Leverage xSeries hardware
- ▶ Use standard Windows server software
- ▶ Add value to Windows servers by leveraging iSeries I/O resources and integrating with OS/400 management

Choice of Offerings

- ▶ Server under the covers - Integrated xSeries Server
- ▶ Directly attach xSeries server - Integrated xSeries Adapter

Integrated xSeries Server

Intel 1 GHz Pentium III Server

- ▶ Up to 4 GB memory
- ▶ Up to 2 TB of disk storage

iSeries Models 270, 820, 830, 840, 890

- ▶ Share iSeries disk, tape, DVD, and CD-ROM
- ▶ OS/400 V5R1, V5R2

iSeries Model	# of IXS
270	3
820	12
830	28
840	32
890	32

IBM ServerProven Platform

Logo'd by Microsoft

- ▶ NT Server 4.0
- ▶ Windows 2000 Server

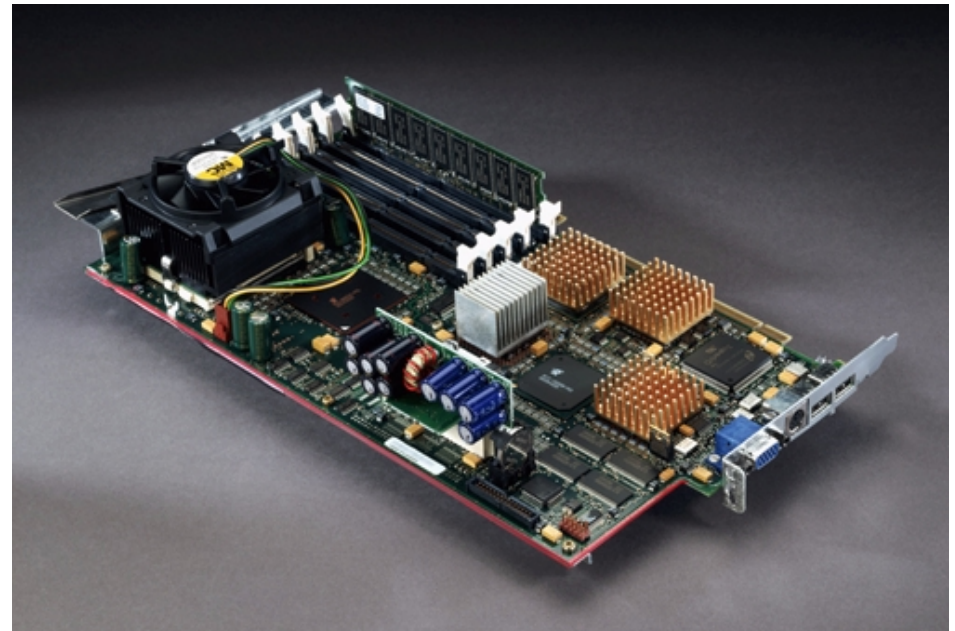

IBM @server

Integrated xSeries Adapter

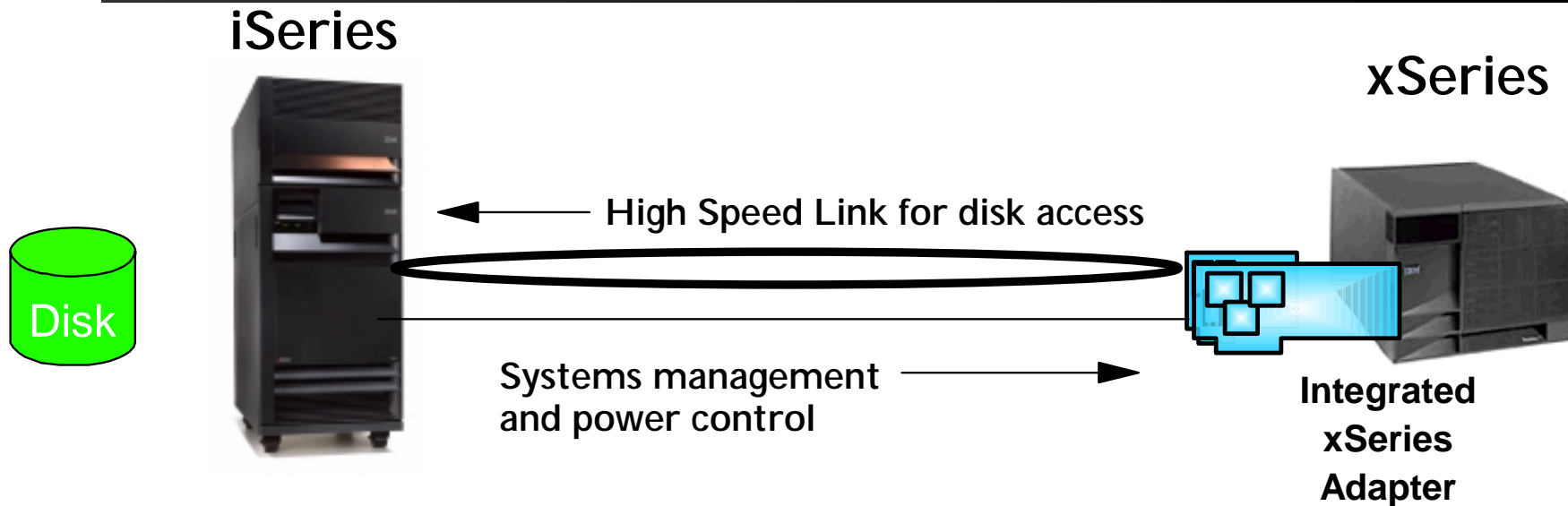

IXA attaches n-way IBM xSeries servers to iSeries 8xx and 270

Retains features and value of Integrated xSeries Server

- ▶ Uses OS/400 storage consolidation and systems management
- ▶ xSeries Server has processors, memory, ServerProven adapters but no disks

Complementary application support

Server Consolidation

Integrated xSeries Adapter

Attaches 4-way xSeries Servers

- ▶ x250, x350, x360, and x440
- ▶ Netfinity 7100 and 7600

iSeries Models 270, 820, 830, 840, 890

- ▶ Share iSeries disk, tape, DVD, and CD-ROM
- ▶ OS/400 V5R1, V5R2

iSeries Model	# of IXA
270	2
820	4
830	8
840	16
890	32

IBM ServerProven Adapter

Logo'd by Microsoft

- ▶ SCSI Storage Adapter
- ▶ For Windows 2000 Server



iSeries Adds Value to Windows Servers

User Administration

Disk Management

Backup

Testing

Reliability

Availability

Remote Server Admin

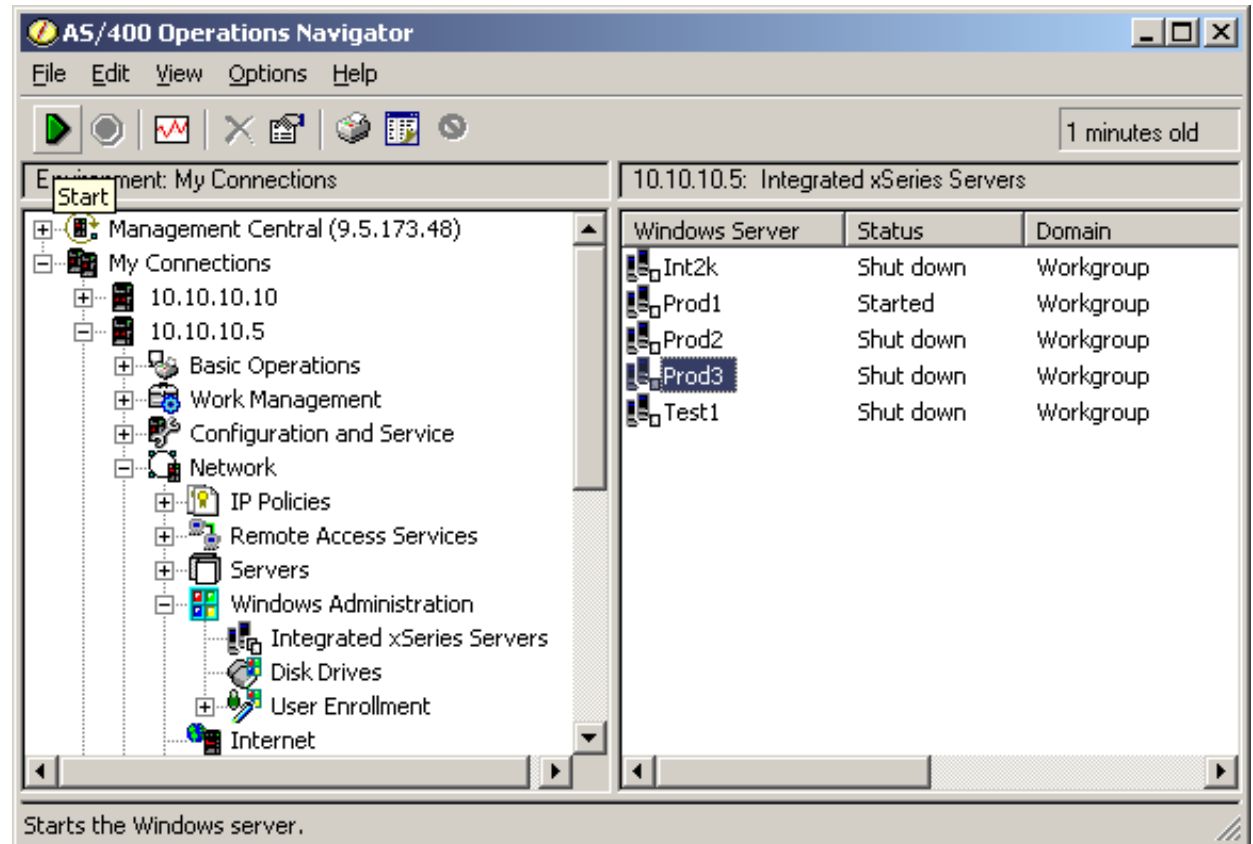

Windows Server Integration Scenarios

Branch Office

- ▶ Central management of distributed iSeries server supporting OS/400 and Windows applications

Large Consolidation

- ▶ iSeries is the Storage Area Network for Windows servers

Windows Server

- ▶ File/Print, Exchange, SQL Server

Citrix Metaframe

- ▶ Run heavy Windows client application on server, send user interface to client

Complementary Application Support

- ▶ Application requires OS/400 and Windows servers
 - Siebel eBusiness
 - JD Edwards APS

Windows Server Integration Advantages

Manage multiple applications and services from a single server

Lower the cost of user administration

Provide flexible storage area network management for Windows Servers

Improve Windows server uptime and stability

Reduce operations and skills costs by extending OS/400 management to Windows

Lower costs by consolidating and leveraging iSeries resources

Sea Island

iSeries and xSeries Solution

Citrix used to deliver Lotus Notes Network Stations

iSeries IXA Value*

- ▶ **75%** Typical resource utilization on a dual processor server with SCSI storage and 2 GB of RAM with 50 users
- ▶ **35%** Sea Island resource utilization on a dual processor IXA server using iSeries for storage and 1 GB of RAM with 50 users



iSeries



Domino Server

← High-Speed Link for disk access



→ Systems management and power control

xSeries



Windows 2000
Lotus Notes
Citrix MetaFrame XP

IBM @server

*Source: CHOICE! Computer, Sea Island Briefing 11/6/01. 2000 Citrix Solutions Network Gold Partner of the Year for US

Windows Server Integration Summary

iSeries offers multiple solutions for Windows server integration

iSeries integration offers Storage Area Network, Server Management, and User Management for Windows servers

Integration opportunities include Branch Offices, Server Consolidation, and Complementary applications

www.ibm.com/eserver/series/windowsintegration

Summary

Top 10 Reasons for Server Consolidation

1. IBM Customers Prefer a Simpler, More Efficient Environment

- ✓ Many machines are more difficult to manage than a few.

2. I/T Optimization Provides Enhanced Corporate Communications

- ✓ Centralized, current information enables improved company-wide data access.

3. Better Ability to Adhere to Corporate Standards

- ✓ Business processes such as security, backup, and software standards are more easily maintained.

4. More Accurate Business Planning Becomes Achievable

- ✓ I/T forecasts are easier with fewer servers and budget projections can be made more accurately.

5. Superior Change Management

- ✓ Fewer servers equates to a more flexible I/T environment for future application requirements

6. Better User and Customer Service Levels

- ✓ Centralized processing power is more easily utilized and redirected.

7. Continuous Availability (24 x 7) Becomes Feasible

- ✓ High availability and disaster recovery solutions are more achievable with fewer points of potential failure and less complex networks.

8. More Manageable Technology Updates

- ✓ It is easier to maintain currency with future iSeries technology announcements (HW & SW).

9. Faster Application Deployment

- ✓ Implementing new applications can be done more quickly when fewer servers are involved.

10. Reduced Operational Costs

- ✓ "It costs less to run 2 systems versus 100 systems"

iSeries Server Consolidation

Single server, multiple applications

- ▶ LPAR for iSeries and AS/400
- ▶ Domino for NT Domino
- ▶ iNotes for Exchange
- ▶ Linux partition for Linux or NT applications
- ▶ OS/400 PASE for UNIX applications ¹
- ▶ IXS/IXA for Windows applications

Supported across the iSeries product line

Incorporates eServer technology

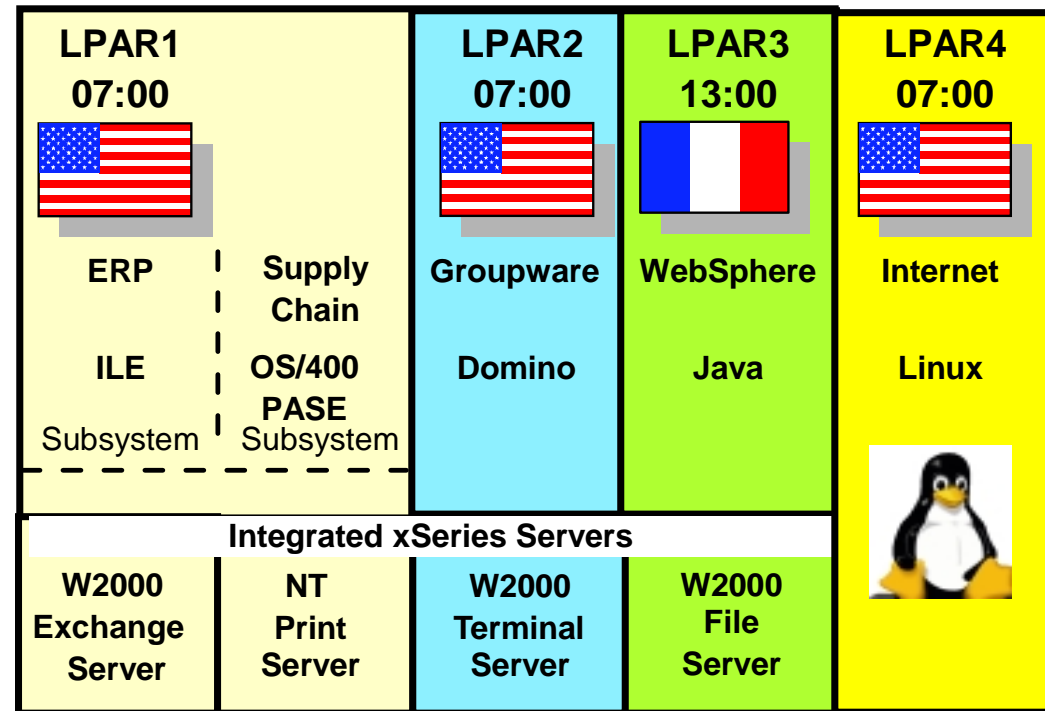

¹ Statement of Direction for AIX in a logical partition

Trademarks and Disclaimer

© Copyright International Business Machines Corporation 2001

References in this document to IBM products or services do not imply that IBM intends to make them available in every country.

The following terms are trademarks or registered trademarks of International Business Machines Corporation in the United States, other countries, or both:

AS/400	IBM Logo	pSeries
AS/400e	iSeries	zSeries
e-business logo	OS/400	eServer
IBM	xSeries	

Lotus, Freelance, and Word Pro are trademarks of Lotus Development Corporation in the United States, other countries, or both.

Tivoli and NetView are trademarks of Tivoli Systems Inc. in the United States, other countries, or both.

C-bus is a trademark of Corollary, Inc. in the United States, other countries, or both.

Java and all Java-based trademarks and logos are trademarks or registered trademarks of Sun Microsystems, Inc. in the United States, other countries, or both.

Microsoft, Windows, Windows NT, and the Windows logo are trademarks of Microsoft Corporation in the United States, other countries, or both.

PC Direct is a trademark of Ziff Communications Company in the United States, other countries, or both and is used by IBM Corporation under license.

ActionMedia, LANDesk, MMX, Pentium and ProShare are trademarks of Intel Corporation in the United States, other countries, or both.

UNIX is a registered trademark of The Open Group in the United States and other countries.

SET and the SET Logo are trademarks owned by SET Secure Electronic Transaction LLC.

Other company, product and service names may be trademarks or service marks of others.

Information is provided "AS IS" without warranty of any kind.

All customer examples described are presented as illustrations of how those customers have used IBM products and the results they may have achieved. Actual environmental costs and performance characteristics may vary by customer.

Information in this presentation concerning non-IBM products was obtained from a supplier of these products, published announcement material, or other publicly available sources and does not constitute an endorsement of such products by IBM. Sources for non-IBM list prices and performance numbers are taken from publicly available information, including vendor announcements and vendor worldwide homepages. IBM has not tested these products and cannot confirm the accuracy of performance, capability, or any other claims related to non-IBM products. Questions on the capability of non-IBM products should be addressed to the supplier of those products.

All statements regarding IBM future direction and intent are subject to change or withdrawal without notice, and represent goals and objectives only. Contact your local IBM office or IBM authorized reseller for the full text of the specific Statement of Direction.

Some information in this presentation addresses anticipated future capabilities. Such information is not intended as a definitive statement of a commitment to specific levels of performance, function or delivery schedules with respect to any future products. Such commitments are only made in IBM product announcements. The information is presented here to communicate IBM's current investment and development activities as a good faith effort to help with our customers' future planning.

Performance is based on measurements and projections using standard IBM benchmarks in a controlled environment. The actual throughput or performance that any user will experience will vary depending upon considerations such as the amount of multiprogramming in the user's job stream, the I/O configuration, the storage configuration, and the workload processed. Therefore, no assurance can be given that an individual user will achieve throughput or performance improvements equivalent to the ratios stated here.

Photographs shown are of engineering prototypes. Changes may be incorporated in production models.