

Eclipse Tooling For RPG and COBOL Development

in WDSC

Phil Coulthard, George Farr,
Claus Weiss
IBM Toronto Laboratory

WDS for iSeries

New World

New Servers

New Tools

ITSO iSeries Technical Forum
SP16

Disclaimer

Acknowledgement:

- This presentation is a collaborative effort of the IBM Toronto AS/400 Application Development presentation team, including work done by:
 - ▶ Phil Coulthard, George Farr, Claus Weiss, Don Yantzi, David Slater, Alison Butteril, Linda Cole

Disclaimer:

- The information contained in this document has not been submitted to any formal IBM test and is distributed on an as is basis without any warranty either express or implied. The use of this information or the implementation of any of these techniques is a customer responsibility and depends on the customers' ability to evaluate and integrate them into the customers' operational environment. While each item may have been reviewed by IBM for accuracy in a specific situation, there is no guarantee that the same or similar results will result elsewhere. Customers attempting to adapt these techniques to their own environment do so at their own risk.

Reproduction:

- The base presentation is the property of IBM Corporation. Permission must be obtained PRIOR to making copies of this material for any reason.



WDS Sc 4.0!



iSeries AD, IBM Toronto

WebSphere Development Studio for iSeries

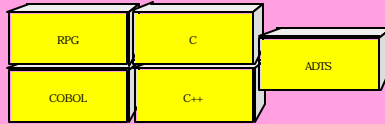

Host

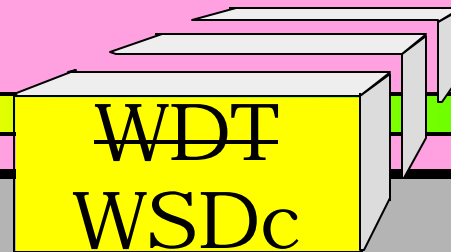

WSSDa + iSeries Tools

Client

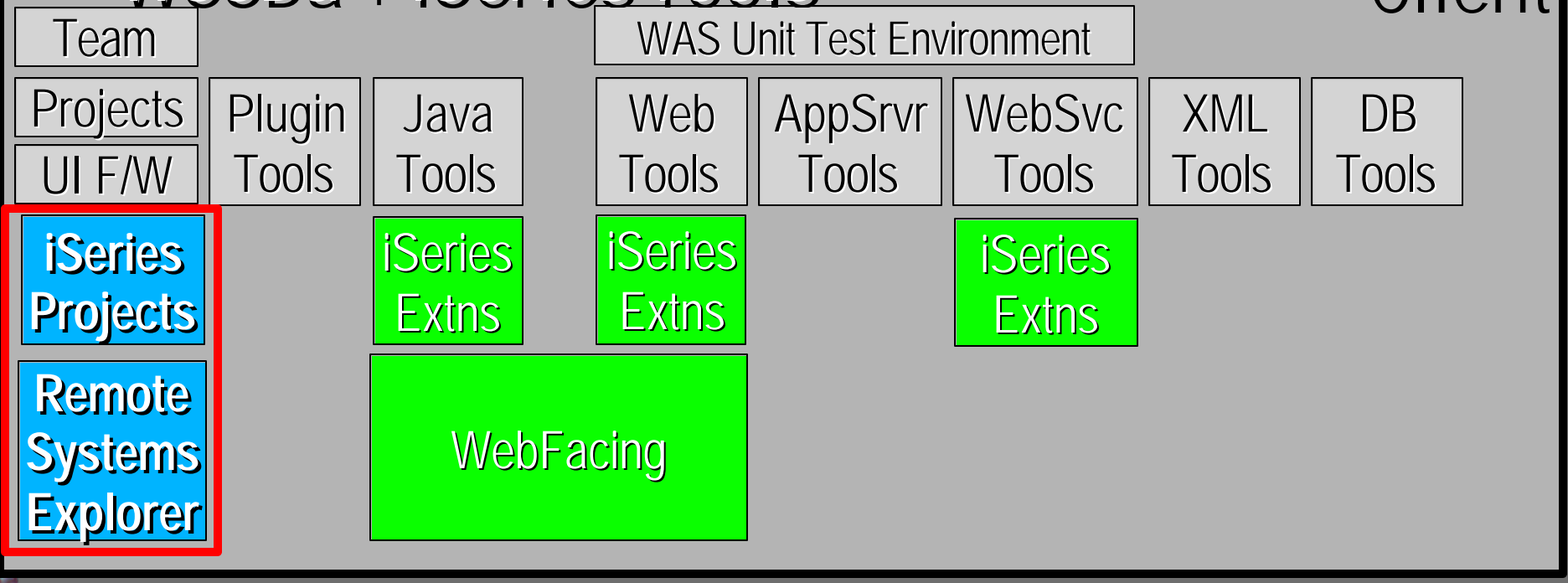

CODE

VARPG

~~VJava~~

~~Studio~~

Eclipse

ToolingForRPGandCOBOLPart2.ppt

IBM e-server. For the next generation of e-business.



▶ RPG and COBOL Tools



iSeries Tools for RPG and COBOL

1. Remote Systems Explorer

▶ **PDM-like drill-down or filtered access to:**

- ✓ **iSeries** libraries, objects, members, records, fields
- ✓ **iSeries** Jobs
- ✓ **iSeries IFS** Folders and Files
- ✓ **Linux** (including iSeries **LPAR**) Folders and Files
- ✓ **Unix** and **Windows** Folders and Files
- ✓ **Local** Folders and Files

2. iSeries Projects

- ▶ **Project-based, team-sharable, development**



1. Remote Systems Explorer (RSE)

- **A perspective with many views**
 - ▶ **Remote Systems**
 - ✓ the primary "tree" view for exploring
 - ▶ **Commands**
 - ✓ the view for running and logging commands
 - ▶ **Properties**
 - ✓ the view for showing information about selected object(s)
 - ▶ **iSeries Error List**
 - ✓ the view for showing errors returned by compilers
 - ▶ **many more views...**

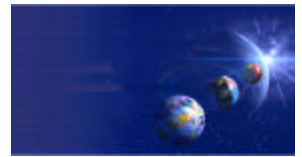

RSE: Connections

- ✓ What is a "connection"?
 - Information identifying a remote system
 - Given an arbitrary name
 - Contains environment info such as lib list
 - Used in many WDS*c* tools
 - ▶ RSE, iSeries Projects, Java Tools, Web Tools, WebFacing

- ✓ RSE manages connections
 - Create connections here (using wizard)
 - Change, rename, copy, delete them here
 - Expand them to work with resources here



Remote Systems Explorer



iSeries AD, IBM Toronto

The screenshot shows the Remote Systems Explorer interface with the 'New Connection Wizard' dialog box open. The wizard is titled 'New Connection' and 'Remote System Connection'. It contains the following fields:

- Parent profile: coulthar
- Connection name: My iSeries (labeled 'Arbitrary name')
- System type: iSeries (labeled 'Remote system type: iSeries')
- Host name: TORONTO (labeled 'Host name')
- Default User ID: COULTHAR (labeled 'User ID')
- Description: Connection to Toronto system

At the bottom of the wizard are buttons for '< Back', 'Next >', 'Finish', and 'Cancel'. The 'Finish' button is highlighted with a red circle. A red arrow points from the 'Finish' button to the 'My iSeries' connection in the 'Remote Systems View' tree on the left. The tree shows a folder 'Remote Systems' containing 'Local' and 'My iSeries'. Under 'My iSeries' are sub-items: 'iSeries Objects', 'iSeries Commands', 'iSeries Jobs', and 'IFS Files'. A blue box labeled 'Remote Systems View' points to this tree. Below the tree is a 'Properties' window showing details for the selected 'iSeries Objects' folder:

Property	Value
Connected	No
Name	iSeries Objects
Number of children	0
Port	0
Type	Subsystem
User ID	COULTHAR (Inherit)
Version	Not available

At the bottom of the interface, there are tabs for 'Commands', 'Tasks', 'Outline', and 'Series Job Log'. A blue box labeled 'Properties of selected object' points to the Properties window, and another blue box labeled 'Various helper views' points to these tabs. A 'Run' button is visible in the bottom right corner of the interface.

Properties of selected object

Various helper views



Connection Actions



iSeries AD, IBM Toronto

Remote Systems Explorer - Development Studio Client

File Edit Perspective Project Window Help

Remote Systems

- New Connection...
- Local
- My iSeries
- My Other iSeries
- My Linux
- My Windows
- Unix
- My Unix

Context Menu Actions:

- Create Another Connection...
- Open in New Perspective
- Refresh
- Rename
- Copy
- Move
- Delete
- Move Up
- Move Down
- Disconnect All
- Properties

Callouts:

- Rename Connection
- Copy Connection
- Move Connection
- Delete Connection
- ReOrder Connections
- Popup Menu for Connections

Properties

Property	Value
Connection status	
Default User ID	
Description	
Host name	
Name	My iSeries
Number of children	4
Parent profile	coulthar

My Linux Commands Run

Commands Tasks Outline iSeries Job Log

Define another connection to the same or another remote system



▶ Connections expand to

- "subsystems"

- ✓ Named grouping of functionality

▶ Subsystems for iSeries:

- **iSeries Objects**

- ✓ For working with Libraries, Objects and Members

- **iSeries Commands**

- ✓ For pre-defining and running QSYS command sets

- **iSeries Jobs**

- ✓ For working with jobs

- **IFS Files**

- ✓ For working with Integrated File System files

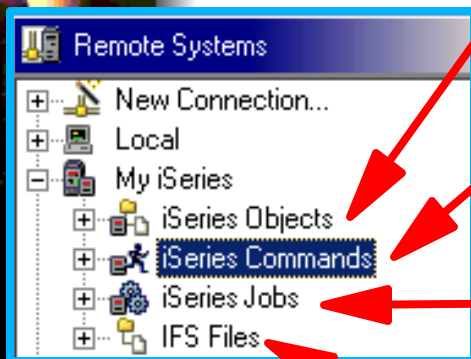



iSeries Objects SubSystem



iSeries AD, IBM Toronto

- ▶ iSeries Objects SubSystem
 - For drill-down or filtered access to QSYS

Expand "Library List"

- Create library filter
- Create object filter
- Create member filter
- List libraries on library list

Enter Password

System type: iSeries
 Host name: TORAS14M.TOROLAB.IBM.COM
 User ID: COULTHAR
 Permanently change user ID
 Password: [masked]
 OK Cancel

Prompted to signon

iSeries Objects SubSystem



- ▶ "Library list" is only pre-defined filter

The screenshot shows the 'Remote Systems Explorer' window with a tree view on the left. The tree view includes 'My iSeries', 'Series Objects', 'Your libraries...', 'Your objects...', 'Your members...', 'Library list', 'iSeries Commands', 'iSeries Jobs', and 'IFS Files'. The 'Library list' folder is expanded, showing a list of libraries: QSYS, QHLPSYS, QUSRSYS, COULTHAR, TESTTOOLS, QTEMP, and QGPL. A context menu is open over the 'COULTHAR' library, showing options: New, Refresh, Rename, Copy, Delete, Show in table, Properties, Basic, and Extra. A 'Library popup menu' callout points to this menu. A 'Properties' window is open at the bottom, showing details for the selected library: Name: COULTHAR, Number of ...: 0, Source: QSYS, Status: OK, Subtype: PROD-CUR, Text: Phils library, Type: *LIB. A 'Commands' window is also visible at the bottom right. Red arrows and callouts highlight specific features: 'Icon changes when "connected"' points to the 'My iSeries' icon; 'Lists libraries in *LIBL' points to the library list; 'Expand a library' points to the 'Library list' folder; and a large arrow points from the bottom of the screenshot towards the right.



- ▶ Expanding a library lists all objects

Remote Systems Explorer - Development Studio Client

File Edit Perspective Project Window Help

Remote Systems

COULTHAR

- GETDATA.*pgm.rpgle
- HELLOW.*pgm.rpgle
- CALLPGM.*module.rpgle
- HELLOW.*module.rpgle
- PHILMSGS.*msgf
- CUSTOMERO.*file.pf-dta
- CUSTOML3D.*file.lf
- DATADICTO.*file.pf-dta
- EVFEVENT.*file.pf-dta
- QDDSSRC.*file.pf-src
- QRPGLESRC.*file.pf-src
- QRPGSRC.*file.pf-src
- SIMPLEDSPF.*file.dspf
- TEST.*file.savf
- TESTTYPES.*file.pf-dta

Expanding a library lists all objects in the library

Src File popup menu

Expand a source file

Property	Value
Name	QRPGLESRC
Number of children	0
Source	COULTHAR
Status	OK
Subtype	PF-SRC
Text	
Type	*FILE

Commands

My iSeries iSeries Command

Commands Outline Tasks iSeries Job Log

*FILE



- ▶ Expanding a src file lists all members

Remote Systems Explorer - Development Studio Client

File Edit Perspective Project Window Help

Remote Systems

- COULTHAR
 - GETDATA.*pgm.rpgle
 - HELLOW.*pgm.rpgle
 - CALLPGM.*module.rpgle
 - HELLOW.*module.rpgle
 - PHILMSGS.*msgf
 - CUSTOMERO.*file.pf-dta
 - CUSTOML3D.*file.lf
 - DATADICTO.*file.pf-dta
 - EVFEVENT.*file.pf-dta
 - QDDSSRC.*file.pf-src
 - QRPGLSRC.*file.pf-src
 - CALLPGM.rpgle
 - GETDATA.rpgle
 - HELLOW2.rpgle
 - QRPGSRC.*file.pf-src

Src Member popup menu

- Open With
 - LPEX Editor
 - CODE Editor
- Rename
- Copy
- Move
- Delete
- Compile
- Compile (No Prompt)
- Properties
- Other...
- Work With Commands...

Expanding a DB file lists all members in the file

Properties

Property	Value
Name	GETDATA
Number of children	0
Source	COULTHAR/QRPGLSRC
Status	OK
Subtype	SRC
Text	text for getdata
Type	RPGLE

RPGLE

Commands

My iSeries | iSeries Command |

Commands | Outline | Tasks | iSeries Job Log



iSeries Objects SubSystem



iSeries AD, IBM Toronto

Source Member Edit Actions

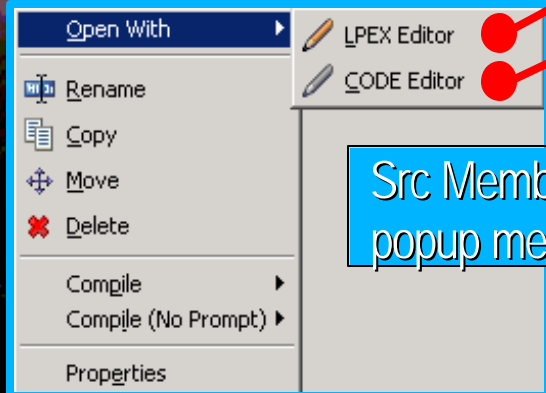

- Launch built-in Lpex editor
- Launch external CODE editor



▶ Lpex ("JLpex") built-in IDE editor

Remote Systems Explorer - Development Studio Client

File Edit Perspective Project Window Help

Remote Systems

GETDATA.RPGLE X HELLOW2.RPGLE

Row 8 Column 10 Replace

.....CLONO1Factor1+++++Opcode(E)+Factor2+++++Result+++++Len++D

000100 FCUSTOML3 IF E K Disk

000200 DCustnoi s like(CUSTNO)

000300 D* extname(custom13:cu

000400 D CSTRUC E DS

000500 d field2 10

000600 D return s 20

000700 D*

000800 c *entry plist

000900 c parm custnoi

001000 c parm cstruc

001100 c parm return

001200 c eval return=*blank

001300 c custnoi chain custom13

001400 c if *in50

001500 c eval return='CUS0001 ' + CUSTNOI

Source Prompter

Line type: C: Calculation

Control level Indicator NO1 Factor 1 Operation and extender Factor 2 Resu

*entry PLIST

.....CLONO1Factor1+++++Opcode(E)+Factor2+++++Result+++++Len++D

Commands | Outline | Tasks | iSeries Job Log | Source Prompter

Properties

Property	Value
Name	GETDATA
Number of children	0
Source	COULTHAR/QRPGLES
Status	OK
Subtype	SRC
Text	text for getdata
Tune	RPGLE

LPEX Editor Actions



Popup menu within Lpex editor

- Cut
- Copy
- Paste
- Find selection
- Select line
- Select character
- Select rectangle
- Deselect
- Copy selected text
- Overlay with selected text
- Move selected text
- Delete selected text
- Filter selection
- Exclude selection
- Show all
- Add
- Save
- Show Date Area

clipboard actions

selection actions

include / exclude actions

show dates in prefix area

```

*CALLPGM.RPGLE x HELLOW2.RPGLE
Row 7      Column 6      Replace 1 change.
.....LON01Factor1+++++Opcod
000100 01/11/13      FCUSTOML3  IF      E
000200 01/11/13      DCustnoi           s
000300 01/11/13      D*
000400 01/11/13      D CSTRUC           E DS
000500 01/11/13      D return           s
000600 01/11/13      D*-----
000700 02/03/22      C EVAL
000701 02/06/30
000800 02/03/22      c CALL
000801 01/11/13      c
000900 01/11/13      c parm
001000 01/11/13      c parm
001100 01/11/13      c parm
001200 01/11/13      c eval
    
```



LPEX Editor Actions



iSeries AD, IBM Toronto

Edit Menu when Lpex editor has focus

Remote Systems Explorer - Development Studio Client

File Edit Perspective Project Window Help

- Undo Ctrl+Z
- Redo Ctrl+Y
- Cut Ctrl+X
- Copy Ctrl+C
- Paste Ctrl+V
- Delete Delete
- Select All Ctrl+A
- Find/Replace... Ctrl+F
- Search... Ctrl+H
- Find Next Shift+F4
- Find Previous Ctrl+U
- Find Other
 - Find Selection
 - Find Start of Selection/Block Alt+Page up
 - Find End of Selection/Block Alt+Page down
 - Find Last Change Ctrl+J
 - Find Quick Mark Alt+Q
 - Find Mark...
- Filter Selection
- Exclude Selection
- Show All Ctrl+W
- Add Bookmark
- Select
- Selected
- Deselect Alt+U
- Mark
- Compare
- Keystroke Recorder

*CALLPGM.RPGLE x HELLOW2.RPGLE

Row 7 Column 30 Replace 1 change.

```

.....CLON01Factor1+++++Opcode(E)+Extended-factor
000100 01/11/13 FCUSTOML3 IF E K Disk
000200 01/11/13 DCustnoi s like(CU
000300 01/11/13 D*
000400 01/11/13 D CSTRUC E DS extname
000500 01/11/13 D return s 20
000600 01/11/13 D*-----
000700 02/03/22 C EVAL custnii='001010
000701 02/06/30
000800 02/03/22 c CALL 'GETDATA'
000801 01/11/13 c
000900 01/11/13 c parm
001000 01/11/13 c parm
001100 01/11/13 c parm
001200 01/11/13 c eval *INLR = *ON
  
```

My Linux Commands

Commands | iSeries Job Log | Outline | Tasks

Find and filter actions

Selection actions

Tools

Compares two members visually

Records keystrokes for repetitive tasks

LPEX vs CODE Editor



- ▶ Lpex Editor
 - **Re-write of CODE Editor for Eclipse**
- ▶ What it has today:
 - **All base support from CODE Editor, such as:**
 - ▶ Alt+L/C/M/D/U/S/J to select/copy/move/delete/unselect/split/join
 - ▶ Select streams, lines, blocks and rectangles (Edit menu)
 - ▶ Command-line for directly entering editor commands
 - ▶ Keystroke recording for repetitive tasks
 - ▶ Compare utility
 - ▶ Rich search, find and replace
 - ▶ Bookmarks and quick marks
 - ▶ Ctrl+L to locate a line
 - ▶ Line-number and datestamp maintenance + prefix area
 - ▶ File->Get File to import a file
 - ▶ Filter Selection to only show lines containing selected text
 - ▶ Printing



▶ Lpex iSeries Support

- ▶ Color highlighting for RPG, COBOL, CL, DDS
- ▶ Maintenance of 12-byte line number and datestamp
- ▶ F4 Prompting
- ▶ SEU prefix area commands (eg I, II, D, DD)
- ▶ RPG/DDS ruler

▶ What is yet to come:

- **REXX macros (Java macros are supported)**
- **Outline View support**
- **F1 context sensitive help**
 - ▶ but all reference manuals are available in Help perspective
- **Syntax checking and Program Verify**
- **Miscellaneous CODE tools and extensions**
 - ▶ RPG SmartGuides, Field Reference tool, Navigator Tool, Zoom...



Source Member Compile Actions

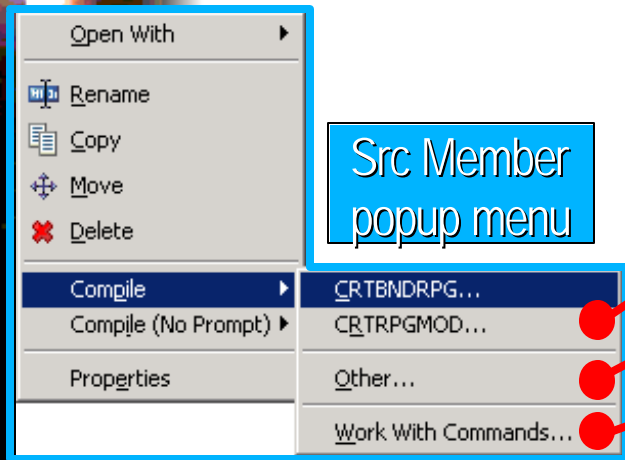

Compile using typical command

Compile using your pre-defined command

Create your own pre-defined command



Compile With Prompt

Create Bound RPG Program (CRTBNDRPG)

File Edit View Help

Program: Name

Library: Name

Source file: Name, QRPGLESRC

Library: Name

Source member: Name

Generation severity level: 0-20

Text 'description': Character value...

Default activation group: *YES *NO

Advanced Parameters

Compiler options: Add

Remove

Move up

Move down

Advanced OK Cancel Help ?



iSeries Objects SubSystem



iSeries AD, IBM Toronto

Compile Commands

Profile: coulthar

Member type: RPGLE

Compile Names

- CRTBNDRPG
- CRTRPGMOD

Buttons: Add..., Change..., Delete, Duplicate, Move Up, Move Down

Command string: CRTBNDRPG PGM(&L/&M) SRCFILE(&L/&F) SRCMBR(&M) OPTION(*EVENTF)

Buttons: OK, Cancel

Select member type to scope command to

Work With Compile Commands

New

Compile Name

Create a new compile name.

Compile name: My Compile Command

Command string: MYCOMP SRCFILE(&L/&F) SRCMBR(&M) MODULE(&L/&M) OF

Buttons: List..., Prompt...

Show in menu of promptable compile names

Show in menu of non-promptable compile names

Buttons: Finish, Cancel

If these checkboxes not selected, you must use Other... to select command

Enter compile command string

Open With

- Rename
- Copy
- Move
- Delete
- Compile
 - CRTBNDRPG...
 - CRTRPGMOD...
 - MY COMPILE COMMAND...
 - Other...
- Compile (No Prompt)
- Properties

Buttons: Work With Commands...



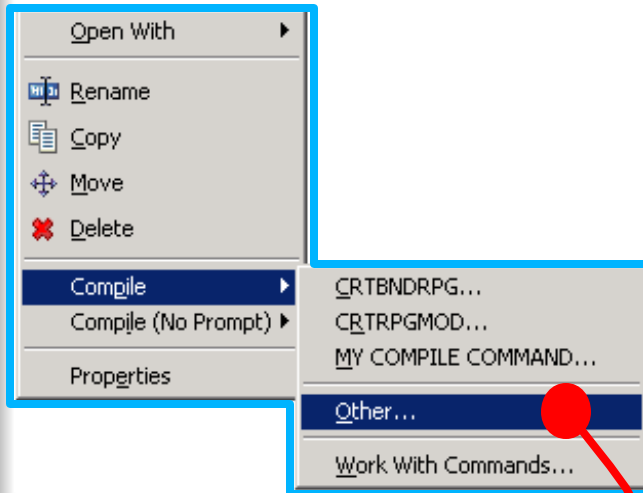

Other...

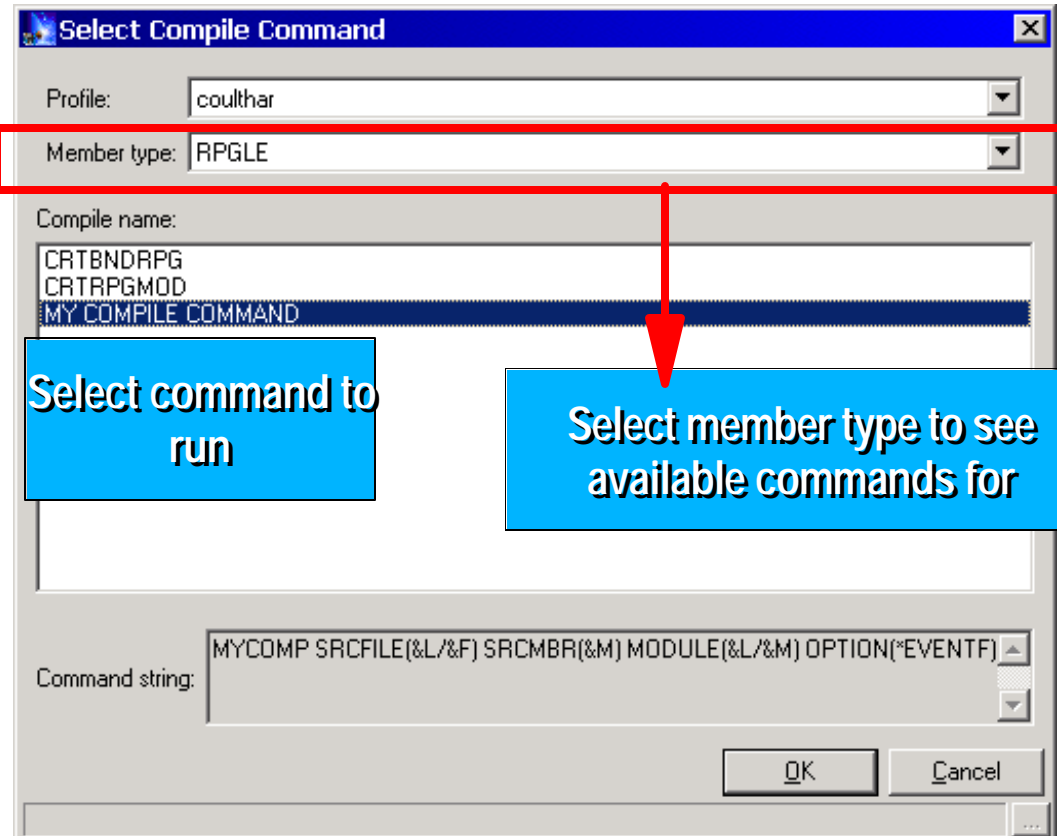

Select command to run

Select member type to see available commands for



► Compile Action...

Compile errors shown in iSeries Error List view

Filter errors by severity

Double click on error

Open With

- Rename
- Copy
- Move
- Delete
- Compile
- Compile (No Prompt)
- Properties

Work With Commands...

- CRTBNDRPG...
- CRTTRPGMOD...
- Other...
- Work With Commands...

Property Value

Property	Value
Name	GETDATA
Number of children	0
Source	COULTHAR/QRPGLES
Status	OK
Subtype	SRC
Text	text for getdata
Tune	RPGLE

iSeries Error List - COULTHAR/EVFEVENT(GETDATA)

ID	Message	Severity
RNS9308	Compilation stopped. Severity 40 erro...	50
RNF2120	External descriptions for file CUSTO...	40
RNF3523	External description for data structure...	40
RNF7030	The name or indicator CUSTNO is not defined.	2
RNF7030	The name or indicator CUSTNOI is n...	30
RNF7503	Expression contains an operand that ...	30

Actions on QSYS Objects



- ▶ Pre-defined right-click actions
 - **Common actions**
 - ▶ Rename, Delete, Copy, Move, Properties
 - ▶ Rename checks for name uniqueness as you type!
 - **Library actions**
 - ▶ Create Source Physical File
 - ▶ Show in table (Basic or Extra)
 - **Program actions**
 - ▶ Run (normal, batch, interactive)
 - ▶ Debug
 - ▶ Update
 - **Module actions**
 - ▶ Create Program, Service Program
 - ▶ Update Program, Service Program
 - **Data and Source Physical File actions**
 - ▶ Show in table (Members or Fields) ...continued...

Actions on QSYS Objects



- ▶ Pre-defined right-click actions
 - **Display and Printer File actions**
 - ▶ Show in Table (fields)
 - **Member actions**
 - ▶ Open with->Lpex Editor, CODE Editor, CODE Designer
 - ▶ Compile (with and without prompt)
 - ✓ Can specify what compile command to execute per member type
 - ✓ Compilers errors displayed in iSeries Error List view
 - ✓ Double click on error to position editor at offending line
 - **Job actions**
 - ▶ End (Immediate or Controlled)
 - ▶ Hold
 - ▶ Release
 - ▶ Display Job Log
 - ▶ Properties



Table Views



iSeries AD, IBM Toronto

Library COULTHAR table view

Name	Type	Attribute	Text	Status
GETDATA	*PGM	RPGLE		OK
HELLOW	*PGM	RPGLE		
CALLPGM	*MODULE	RPGLE		
HELLOW	*MODULE	RPGLE		
PHILMSGS	*MSGF			

Objects:
Basic

Table Views

- ▶ Columner views
- ▶ Sortable by column

Library COULTHAR table view

Name	Type	Attribute	Text	Status	Last modified	Created	Size
GETDATA	*PGM	RPGLE		OK	October 4, 2000 8:53:12 AM EDT	October 4, 2000 8:53:12 AM EDT	118784
HELLOW	*PGM	RPGLE		OK	October 4, 2000 8:53:13 AM EDT	October 4, 2000 8:53:13 AM EDT	98304
CALLPGM	*MODULE	RPGLE		OK	November 9, 2000 9:50:37 AM EST	November 9, 2000 9:50:37 AM EST	90112
HELLOW	*MODULE	RPGLE		OK	October 4, 2000 8:53:13 AM EDT	October 4, 2000 8:53:13 AM EDT	
PHILMSGS	*MSGF			OK	March 22, 2001 8:59:52 AM EST	March 22, 2001 8:59:52 AM EST	
CARDB	*FILE	PF-DTA		OK	October 4, 2000 9:13:21 AM EDT	October 4, 2000 9:13:21 AM EDT	2
CUSTOMERO	*FILE	PF-DTA		OK	March 23, 2001 8:09:43 AM EST	October 4, 2000 8:53:13 AM EDT	
CUSTOML30	*FILE	LF		OK	March 23, 2001 8:09:44 AM EST	October 4, 2000 8:53:13 AM EDT	
DATADICTO	*FILE	PF-DTA	DATA ...	OK	March 23, 2001 8:09:44 AM EST	October 11, 2000 10:10:10 AM EDT	

Objects:
Extra

File COULTHAR/QDDSSRC member table view

Name	Type	Attribute	Text	Status
ABCDEF	DSPF	SRC		OK
CUSTOMER	PF	SRC		OK
CUSTOML3	LF	SRC		OK
MYSTUFF	DSPF	SRC		OK
SIMPLEDSPF	DSPF	SRC		OK
TESTTYPES	PF	SRC		OK

Members

DATADICTO field table view

Record	Type	Length	Text
CT	Character	1	Active Record Code
CT	Character	40	Address
CT	Character	40	Customer Address Line 1
CT	Character	40	Customer Address Line 2
CT	Character	40	Customer Address Line 3
CT	Character	40	Customer Address Line 4
CT	Character	40	Customer Address Line 5
CT	Packed Decimal	9.2	Amount
CT	Packed Decimal	9.2	Customer Amount Due
CT	Packed Decimal	9.2	Amount Received

Fields



ToolingForRPGandCOBOLPart2.ppt

IBM @server. For the next generation of e-business.



RSE: User Actions

- ▶ User-Defined Actions (like PDM!)
 - **Right-click on iSeries Objects**
 - ▶ **Work With File Types**
 - ✓ Create named types to scope actions against
 - ✓ Eg. "RPG" might be RPG + RPGLE + SQLRPGLE
 - ▶ **Work With Actions**
 - ✓ Create, delete or change user-defined actions
 - ✓ Scope them by File Type

▶ Tip: you can import CPO Actions!

File Types for User Actions

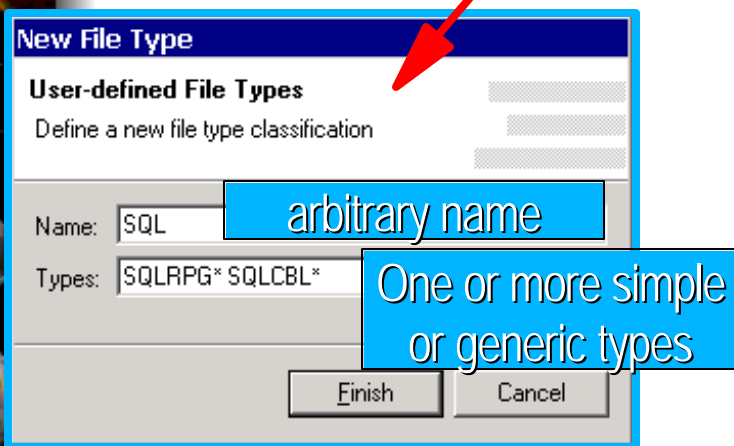
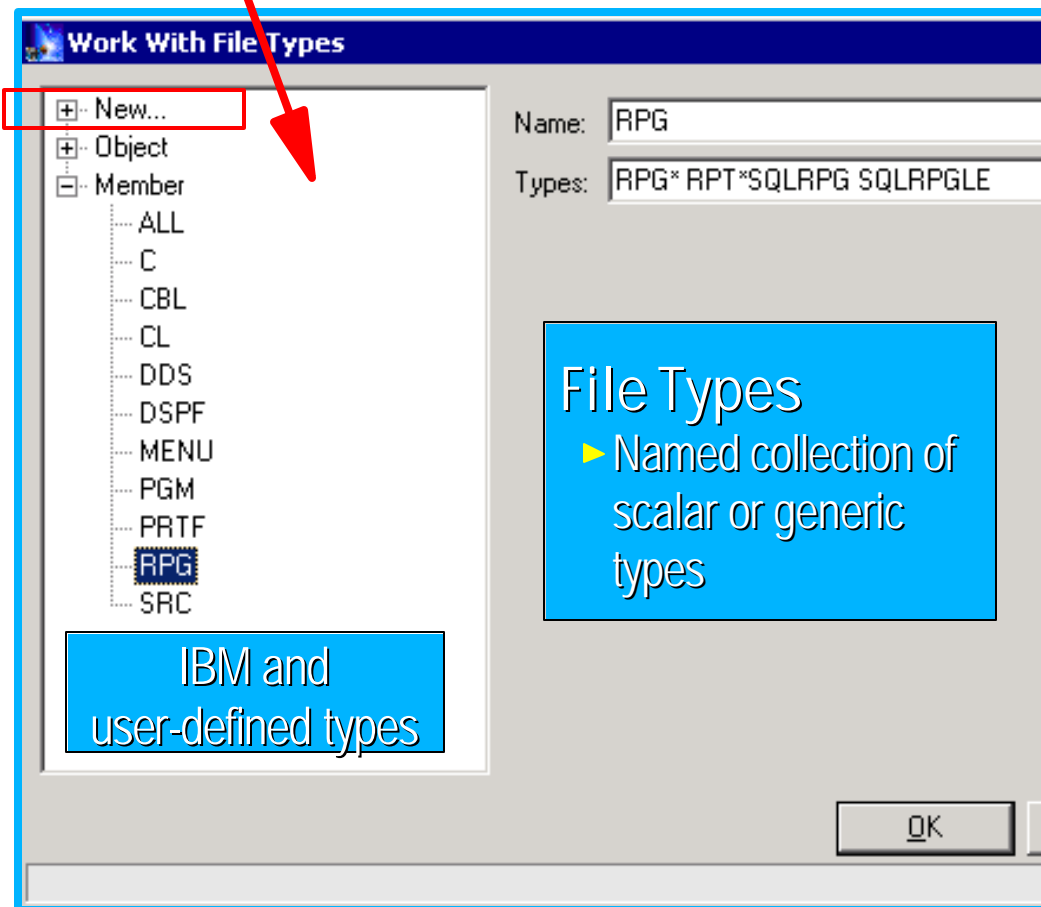
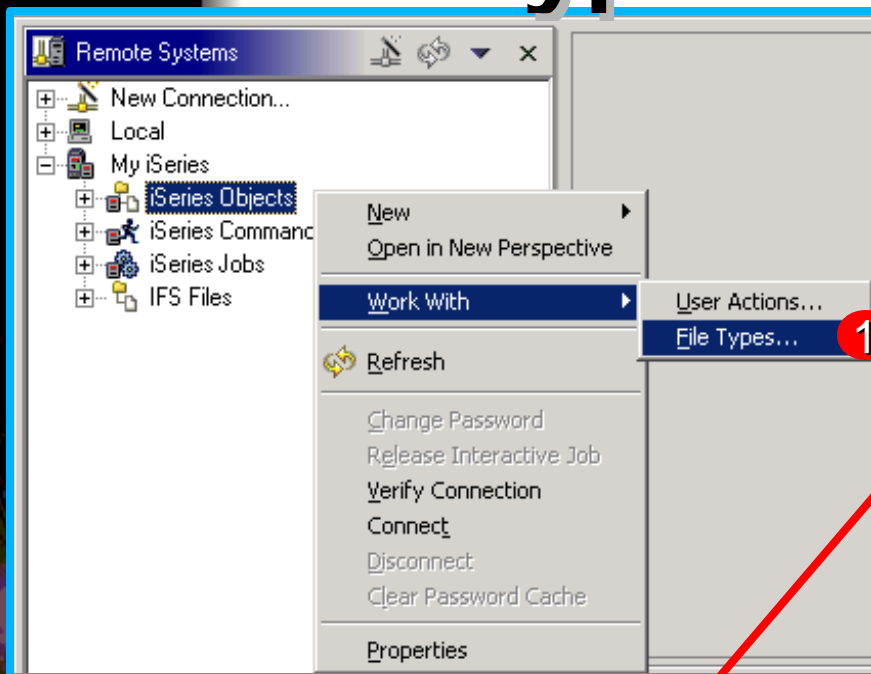

Defining User Actions

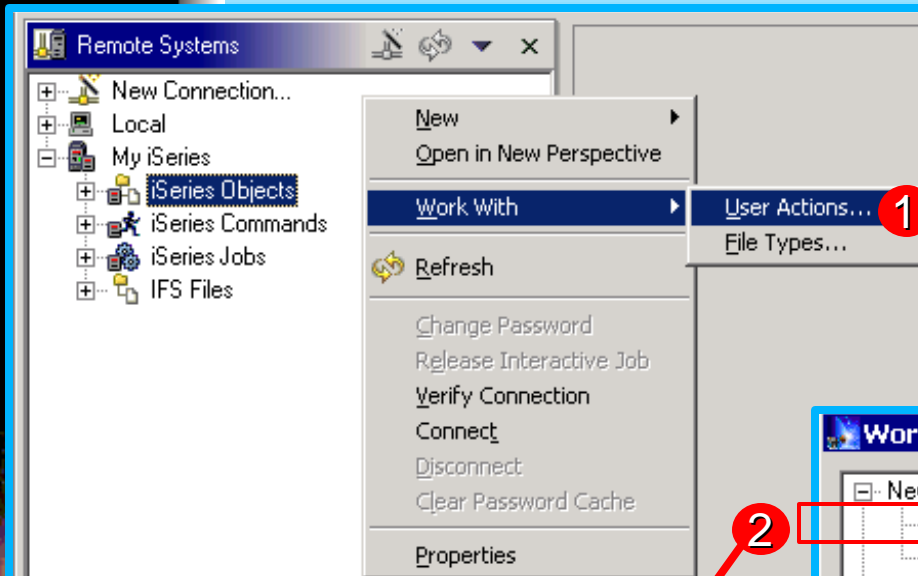

User Actions

- ▶ Define object and member actions
- ▶ Edit existing actions

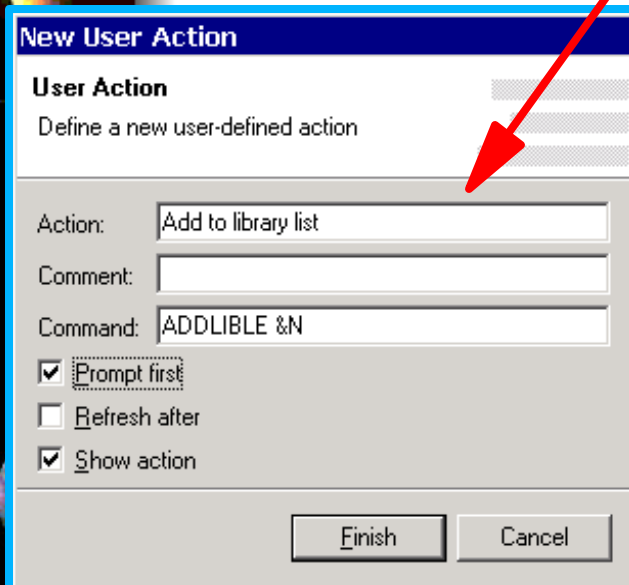
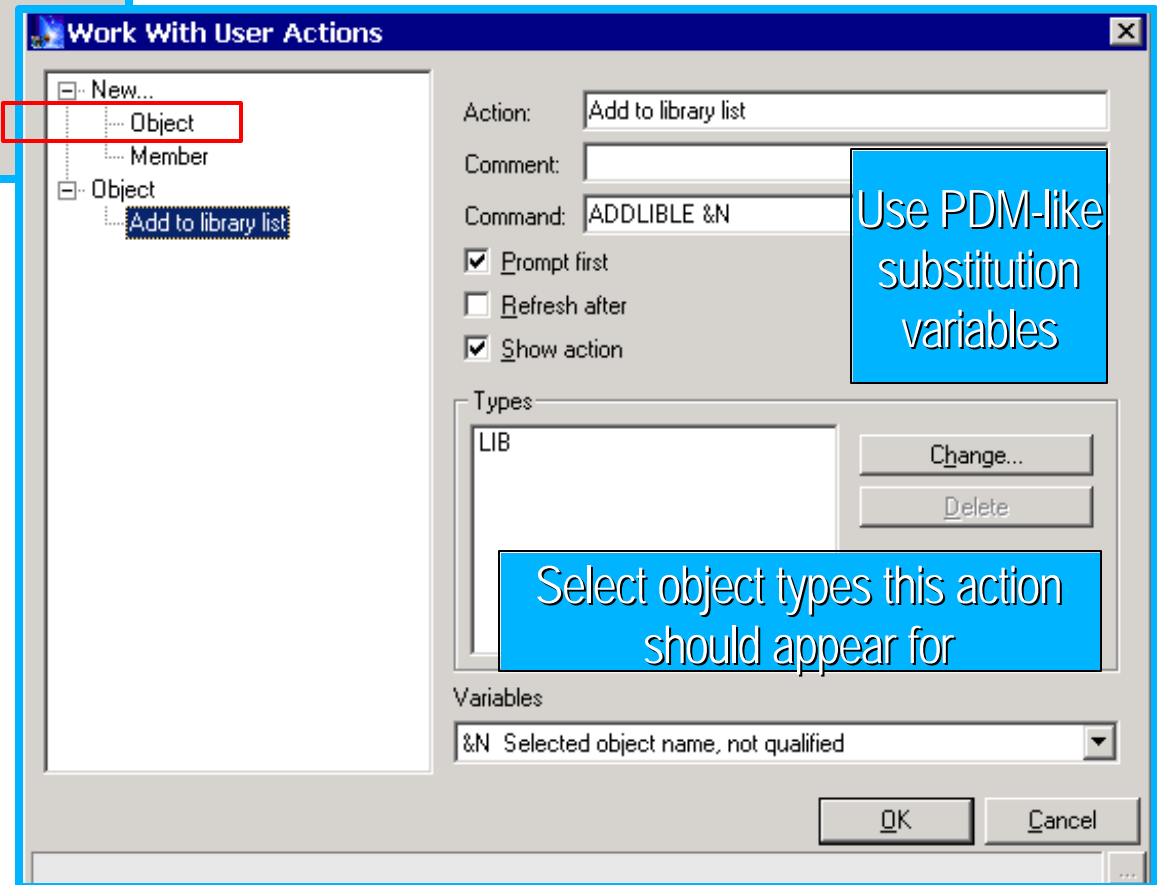

Using User Actions



The screenshot shows the Eclipse IDE interface. On the left, the 'Remote Systems' tree view shows a hierarchy: Local > My iSeries > iSeries Objects > My Libraries > COULTHAR2. A context menu is open over 'COULTHAR2', with 'User Actions' > 'Add to library list' selected. A dialog box titled 'Add Library List Entry (ADDLIB)' is displayed, containing the following fields:

- Library: COULTHAR2 (Name)
- Library list position:
- List position: *FIRST (dropdown)
- Reference library: (Name)

The 'OK' button is highlighted with a red circle '2'. A red arrow points from the 'Add to library list' menu item to the dialog box.

```

My iSeries: ADDLIB LIB(COULTHAR2)
Library COULTHAR2 added to library list.
Cause . . . . . : If the ADDLIB command was
  
```

The 'Commands' window shows the output of the command. At the bottom, the 'My iSeries' dropdown is set to 'My iSeries' and the 'iSeries Command' dropdown is set to 'iSeries Command'.



RSE: Filters

- ▶ Expand a subsystem to see "filters"
 - **Like WRKXXXPDM generic name filters but**
 - ▶ Are named and saved
 - **There are some predefined**
 - ▶ Such as Library List to see *LIBL libraries in iSeries Objects
 - ▶ Such as popular commands in iSeries Commands
 - **To create your own, right click on subsystem object**
 - ▶ Or select "Your XXXX..."
 - **Each filter can contain multiple filter strings**
 - ▶ So you can list all libraries that start with *A and B*



▶ Library filters

▶ Specify simple, generic or special library names

- ✓ Library name can be simple, generic or special

▶ Object filters

▶ Specify simple / generic object names, lib-qualified

- ✓ Library name can be simple, generic or special
- ✓ Object name can be simple or generic

▶ Specify simple / generic object types and attributes

- ✓ Can specify one or more type:attribute pairs (OR operation)

▶ Member filters

▶ Specify simple / generic mbr names, lib/file-qual'fd

▶ Specify simple / generic member types

- ✓ Can specify one or more member types (OR operation)

▶ Tip: you can import CPO Filters!

RSE Filters



▶ Library Filters

All filters are named and persisted

1. Expand

2

Specify simple, special or generic library name

2. Filters contain one or more "filter strings"
 ▶ Results are OR 'd

Property	Value
Name	Your iSeries
Number of children	1
Number of filter st...	1
Parent filter	Not applicable
Parent filter pool	Default Filter Pool
Type	iSeries prompting library filter



► Expanding Library Filters

The screenshot shows the Remote Systems Explorer interface. The 'Remote Systems' tree on the left is expanded to 'My Libraries', where a red box highlights the 'COULTHAR' library. A blue callout box with a red arrow points to this library, containing the text: 'Filter created. When expanded, lists all libs matching filter string(s) criteria'. The 'Properties' window at the bottom left shows details for the selected library:

Property	Value
Name	COULTHAR
Number of children	0
Source	QSYS
Status	OK
Subtype	PROD
Text	Phils library
Type	*LIR

The 'Commands' window at the bottom right shows the 'My iSeries' and 'iSeries Commands' dropdown menus.



► Object Filters

The screenshot shows the 'Remote Systems Explorer - Development Studio Client' interface. The 'Remote Systems' tree on the left is expanded to show 'My iSeries' > 'iSeries Objects' > 'Your objects...'. A red arrow labeled '1' points to this tree with the text 'Expand'. The 'New Object Filter' dialog box is open, showing 'Filter name: My Objects' and 'Filter Strings: CARDEMO/* OBJTYPE(*)'. A red arrow labeled '2' points to the 'Add...' button in the 'Filter Strings' list. The 'New Object Filter String' dialog box is also open, showing 'Library: PHILDEMO' and 'Object:'. A red arrow labeled '3' points to the 'Add...' button in the 'Type and attributes to subset by' list. A red arrow points from the 'Specify simple, special or generic library name' text to the 'Library' dropdown. Another red arrow points from the 'Specify simple or generic object name' text to the 'Object' dropdown. A third red arrow points from the 'Optionally subset by object type and attribute' text to the 'Add...' button in the 'Type and attributes to subset by' list.

Expand

1

2

3

Specify simple, special or generic library name

Specify simple or generic object name

Optionally subset by object type and attribute

Name	Your objects...
Number of children	0
Number of filter st...	1
Parent filter	Not applicable
Parent filter pool	Default Filter Pool
Type	iSeries prompting obje



▶ Object Filters: Filtering by type+attr

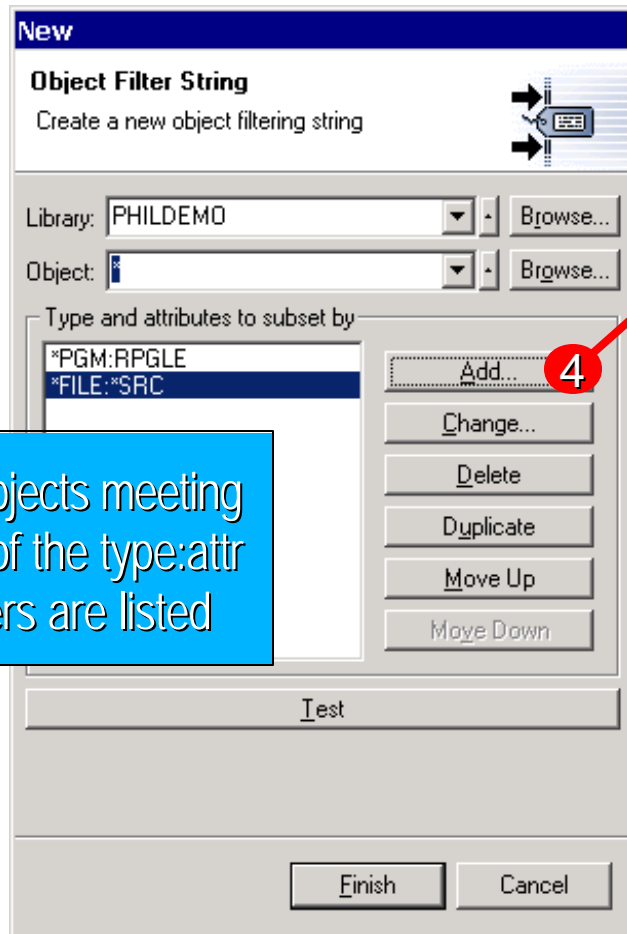

All objects meeting any of the type:attr filters are listed

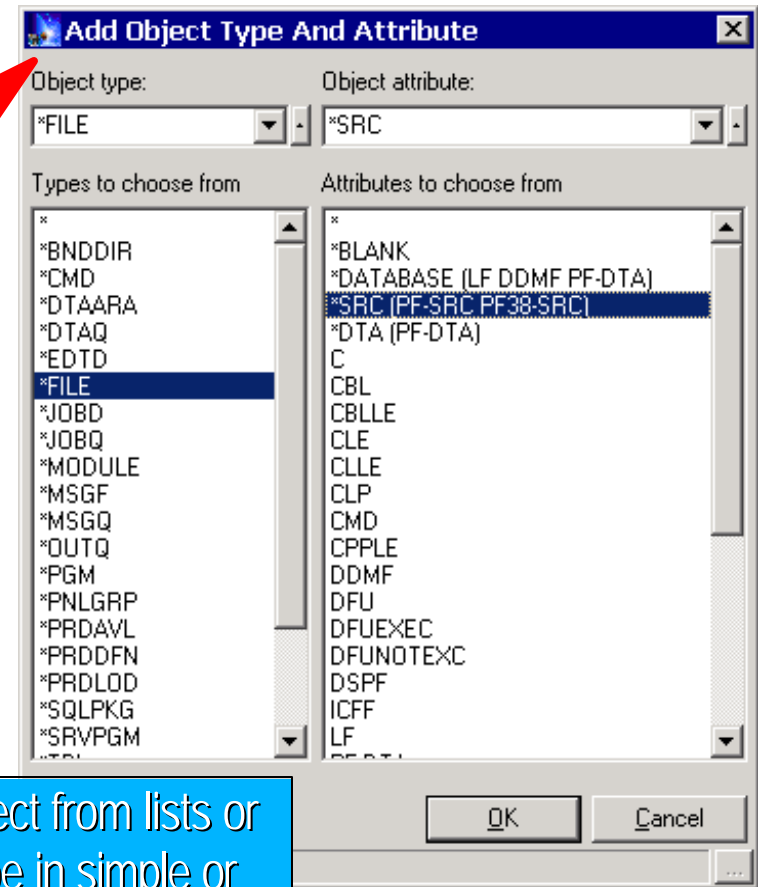

Select from lists or type in simple or generic type and attribute



► Expanding Object Filters

Remote Systems Explorer - Development Studio Client

File Edit Perspective Project Window Help

Remote Systems

- My iSeries
 - iSeries Objects
 - Your libraries...
 - Your objects...
 - Filter created successfully.
 - Your members...
 - Library list
 - My Libraries
 - My Objects
 - CUSTBAL.*pgm.rpgle
 - DISPLAYCAR.*pgm.rpgle
 - RENTCAR.*pgm.rpgle
 - RETURNCAR.*pgm.rpgle
 - CARCLASSES.*file.pf-dta
 - CARCOLORS.*file.pf-dta
 - CARDB.*file.pf-dta

Filter created. When expanded, lists all objects matching filter string(s) criteria

Properties

Property	Value
Name	CUSTBAL
Number of children	0
Source	CARDEMO
Status	OK
Subtype	RPGLE
Text	
Type	*PGM

Commands

My iSeries | iSeries Commands

Commands | Outline | Tasks | iSeries Job Log | Source Prompter



▶ Member Filters

The screenshot shows the 'Remote Systems Explorer - Development Studio Client' interface. A 'New Member Filter' dialog box is open, with a 'Member Filter String' sub-dialog box also open. The sub-dialog box contains the following fields and options:

- Library:** COULTHAR
- File:** *SRC
- Member:** TEST*
- Source members
- Data members
- Member types to subset by:** (Empty list)

Annotations and callouts:

- Expand:** Points to the '+' icon in the Remote Systems Explorer tree view.
- 1:** Points to the 'Member Filter String' dialog box.
- 2:** Points to the 'Add...' button in the 'New Member Filter' dialog box.
- 3:** Points to the 'Add...' button in the 'Member Filter String' dialog box.
- Specify simple, special or generic library name:** Points to the 'Library' field.
- Specify simple or generic file name:** Points to the 'File' field.
- Specify simple or generic member name:** Points to the 'Member' field.
- Subset by data or source mbrs:** Points to the 'Source members' and 'Data members' checkboxes.
- Optionally subset by member type:** Points to the 'Member types to subset by' list.



▶ Member Filters: filtering by mbr type

New

Member Filter String
Create a new member filtering string

Library: COULTHAR

File: *SRC

Member:

Source members Data members

Member types to subset by

RPG*
CBLLE

Add Member Type

Member type: CBLLE

Types to choose from

*BLANK
C
CBL
CBLLE
CLD
CLE
CLLE
CLP
CMD
CPP
CPPLE
DSPF
ICFF

All members meeting any of the type filters are listed

Select from list or type in simple or generic member type



▶ Expanding Member Filters

Remote Systems Explorer - Development Studio Client

File Edit Perspective Project Window Help

Remote Systems

- My iSeries
 - iSeries Objects
 - Your libraries...
 - Your objects...
 - Your members...
 - Filter created successfully.
 - Library list
 - My Libraries
 - My Objects
 - My Members
 - CALLPGM.rpgle
 - GETDATA.rpgle
 - HELLOW2.rpgle
 - MYPROGRAM.rpg
 - iSeries Commands
 - iSeries Jobs

Properties

Property	Value
Name	CALLPGM
Number of children	0
Source	COULTHAR/QRPGLE
Status	OK
Subtype	SRC
Text	text 1
Tune	RPGLE

Commands

My iSeries iSeries Commands

Commands Outline Tasks iSeries Job Log Source Prompter

Filter created. When expanded, lists all members matching filter string(s) criteria



RSE: Filter Pools

- ▶ Eventually, you'll have too many filters
 - **Time to turn on "Show Filter Pools" via preferences or pulldown in RSE title bar**
 - ▶ Expanding subsystems will then first show filter pools
 - **Filters are grouped into named pools**
 - ▶ By default they are added to the single default filter pool named Default Filter Pool
 - **You can create your own filter pools**
 - ▶ Then add filters to it
 - ▶ Expand a filter pool to see just the filters in it
 - **Filters pools group filters**
 - ▶ Group by project, release, connection, task, etc etc



- ▶ Filter pools are shared
 - Subsystem don't "contain" filters!
 - ▶ They "contain" *references* to filter pools
 - ▶ All filters in all referenced pools are shown in list
 - ▶ All subsystems reference a default pool initially
 - ▶ Changes to a pool's contents are reflected in all subsystems that reference that filter pool

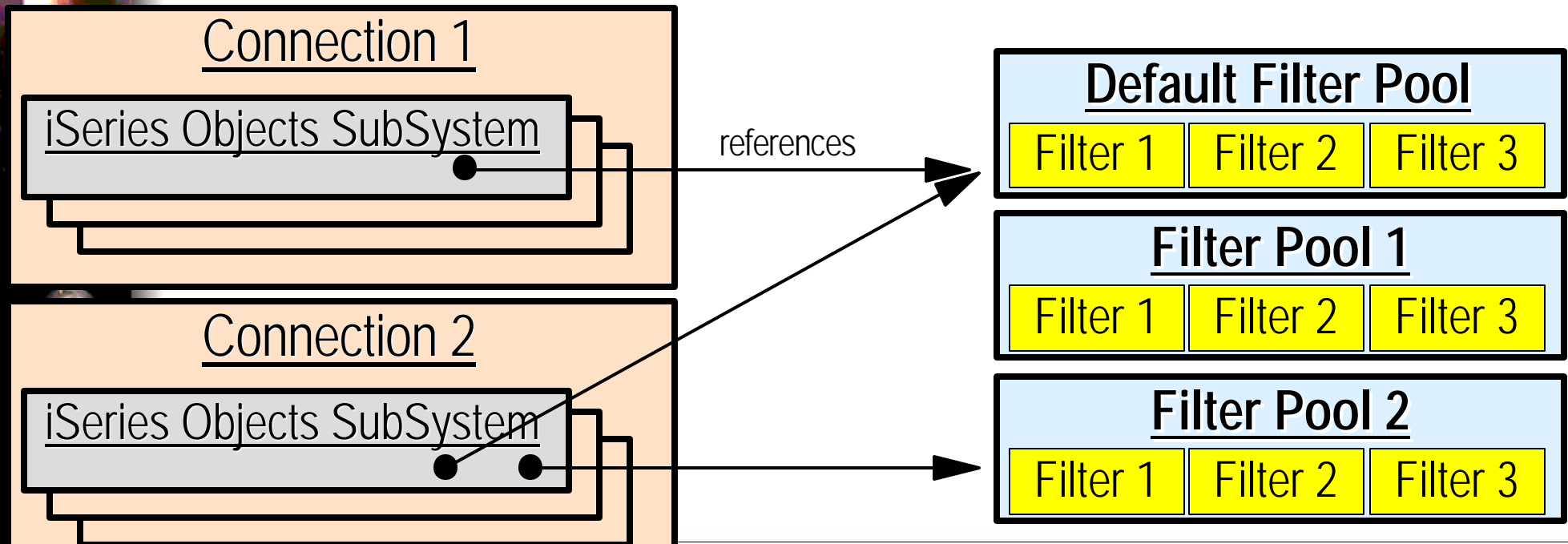



▶ Why share filter pools?

1. Filters shared across connections

- ▶ Filter created in connection A can be re-used in connection B

- ✓ By placing the filter in a filter pool shared by both connections

2. Filters private per connection

- ▶ Create a unique filter pool per connection if sharing not desired

3. Filters both shared and private per connection

- ▶ Some filter pools can be private, some shared

Filter Pools

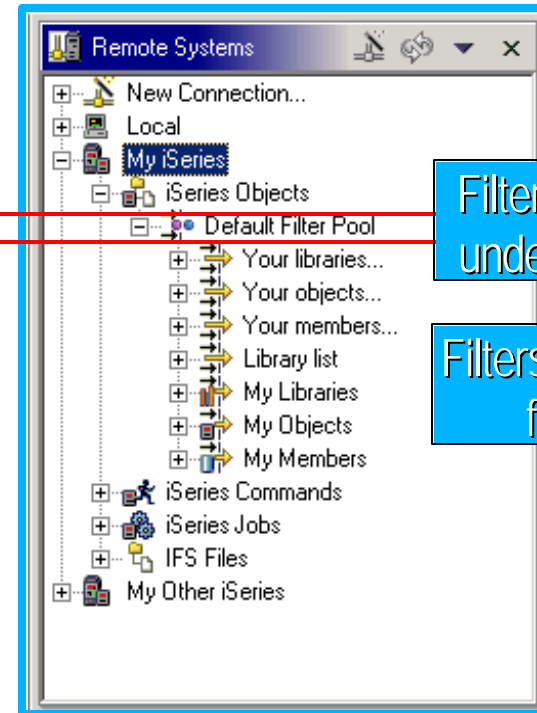
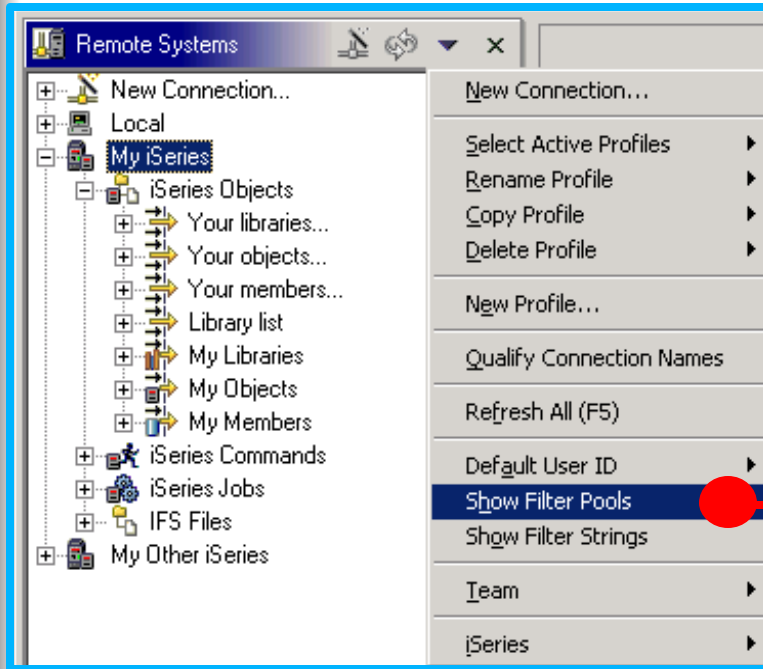

Filter pools shown under subsystems

Filters shown under filter pools

"Show Filter Pools" changes RSE tree-view to display filter pools underneath subsystems

Filter Pools



Right-click for subsystem popup

1

2

3

Finish Cancel

Remote Systems

- New Connection...
- Local
- My iSeries
 - iSeries Objects
 - Default Filter Pool
 - Your libraries...
 - Your objects...
 - Your members...
 - Library list
 - My Libraries
 - My Objects
 - My Members
 - iSeries Commands
 - iSeries Jobs
 - IFS Files
 - My Other iSeries

New

- Select Filter Pools...
- Open in New Perspective
- Work With
- Refresh
- Change Password
- Release Interactive Job
- Verify Connection
- Connect
- Disconnect
- Clear Password Cache
- Properties

Filter Pool... Filter Pool Reference

New Filter Pool

System Filter Pool

Define a new pool for filters

Pool name: My Pool

Profile: coulthar

Remote Systems

- New Connection...
- Local
- My iSeries
 - iSeries Objects
 - Default Filter Pool
 - Your libraries...
 - Your objects...
 - Your members...
 - Library list
 - My Libraries
 - My Objects
 - My Members
 - My Pool
 - iSeries Commands
 - iSeries Jobs
 - IFS Files
 - My Other iSeries

"Show Filter Pools" enables user-defined filter pools and filter pool actions in subsystem popup menu

"New Filter Pool" creates a filter pool and adds a reference to it in the selected subsystem

Filter Pool References

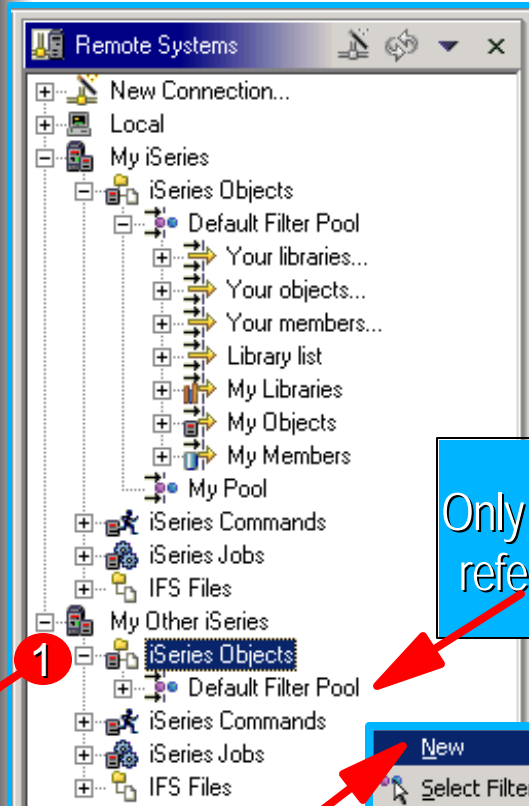

Only default filter pool is referenced by default!

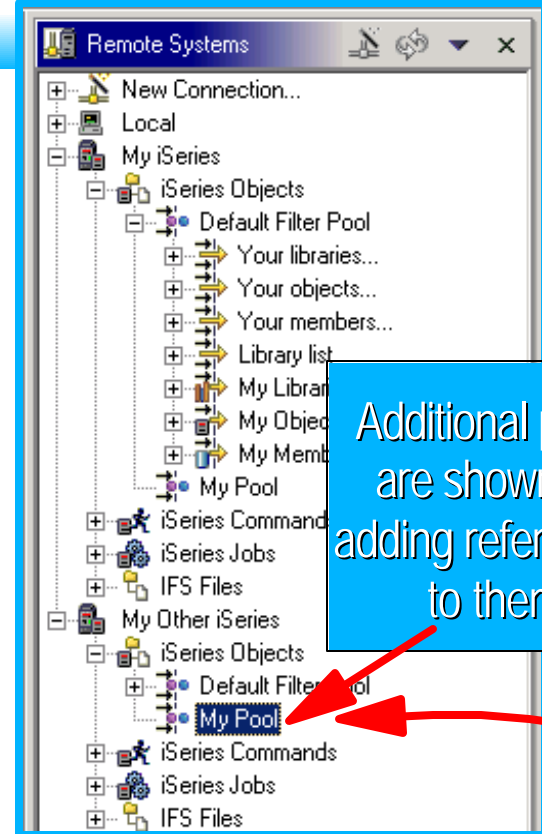

Additional pools are shown by adding references to them

Right-click for subsystem popup

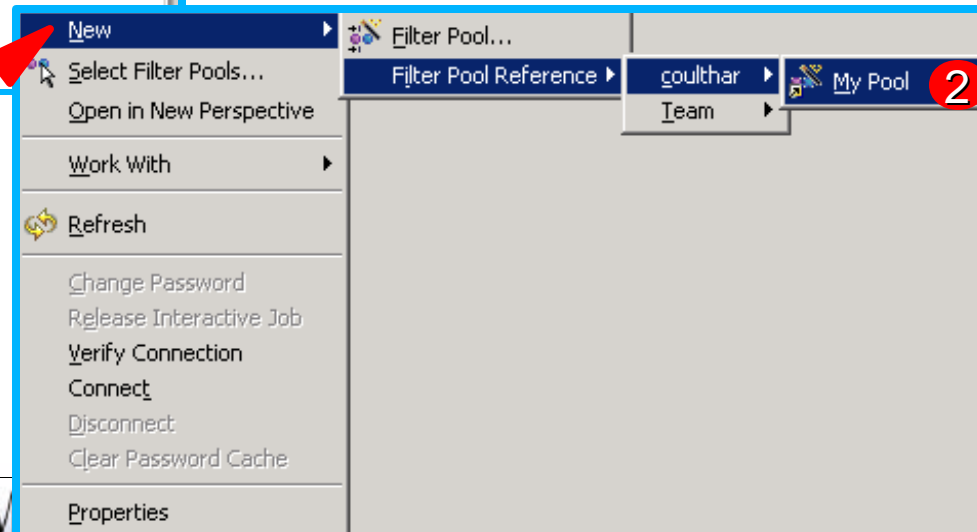

Filter Pool References

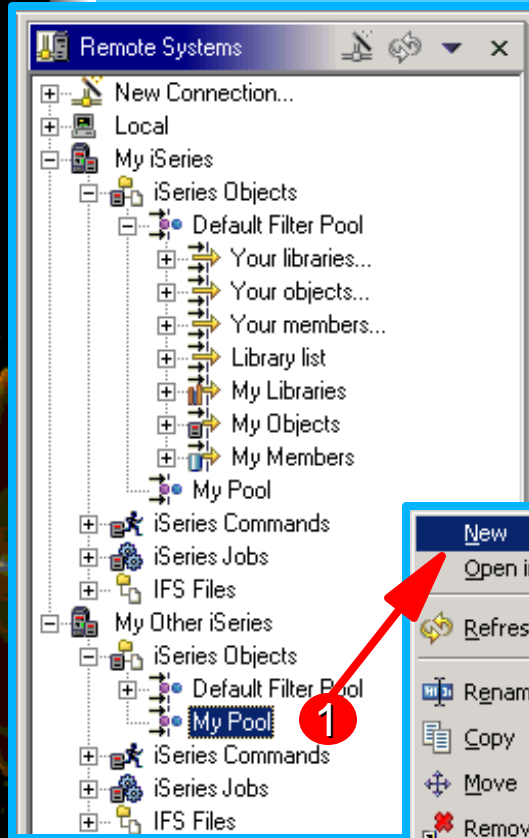

All references to a filter pool, within subsystems, are updated to reflect any changes to that filter pool:

- ▶ new filters
- ▶ deleted filters
- ▶ renamed filters
- ▶ reordered filters

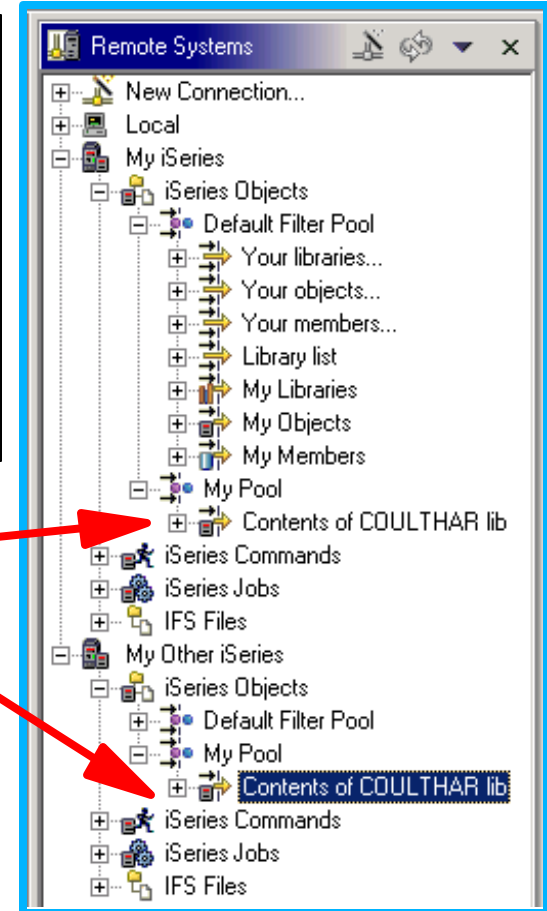
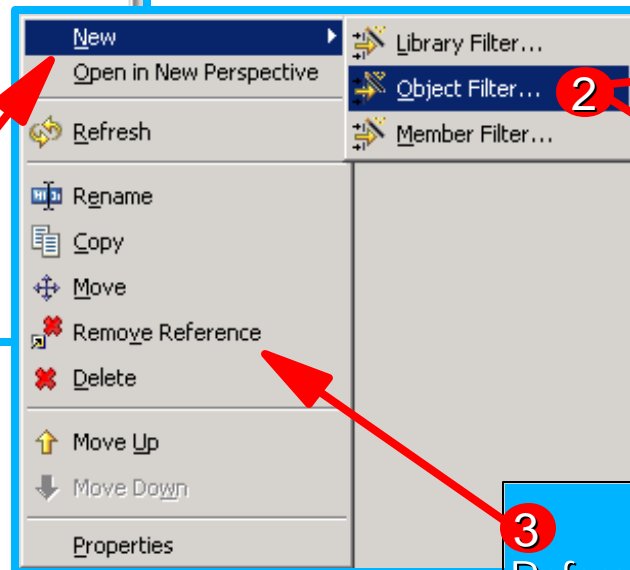

References to filter pools can be removed



- ▶ Popup menu actions for filters:
 - Update parent filter pool that contains the filter
 - Reflected in all subsystems that reference pool

Filter actions

Edit filter

Rename filter

Copy filter to another filter pool

Move filter to another filter pool

Delete filter

Reorder filters

Property	Value
Name	Contents of COULTHAR lib
Number of children	0
Number of filter strings	1
Parent filter	Not applicable
Parent filter pool	My Pool
Type	iSeries object filter



RSE: Profiles

- ▶ The RSE is designed for team sharing
 - of connections
 - of filter pools
 - of user-defined actions
- ▶ Team sharing is enabled via profiles
 - **All connections, filter pools, user actions are scoped per profile**
 - ▶ Each profile is a folder within the RSE project
 - ▶ All data stored within subfolders
 - **When RSE project is team-synched**
 - ▶ All out-going changes sent to team repository
 - ▶ All in-coming changes received from team repository



- ▶ All persistent data in the RSE is stored in an Eclipse project "under the covers"
 - Project is named RemoteSystemsConnections
 - ▶ Visible in Eclipse-supplied Navigator view
 - This project is team-sharable by the common Eclipse team support for projects
 - ▶ Using the Navigator view
 - ▶ Or using Team cascading menu of the RSE pulldown

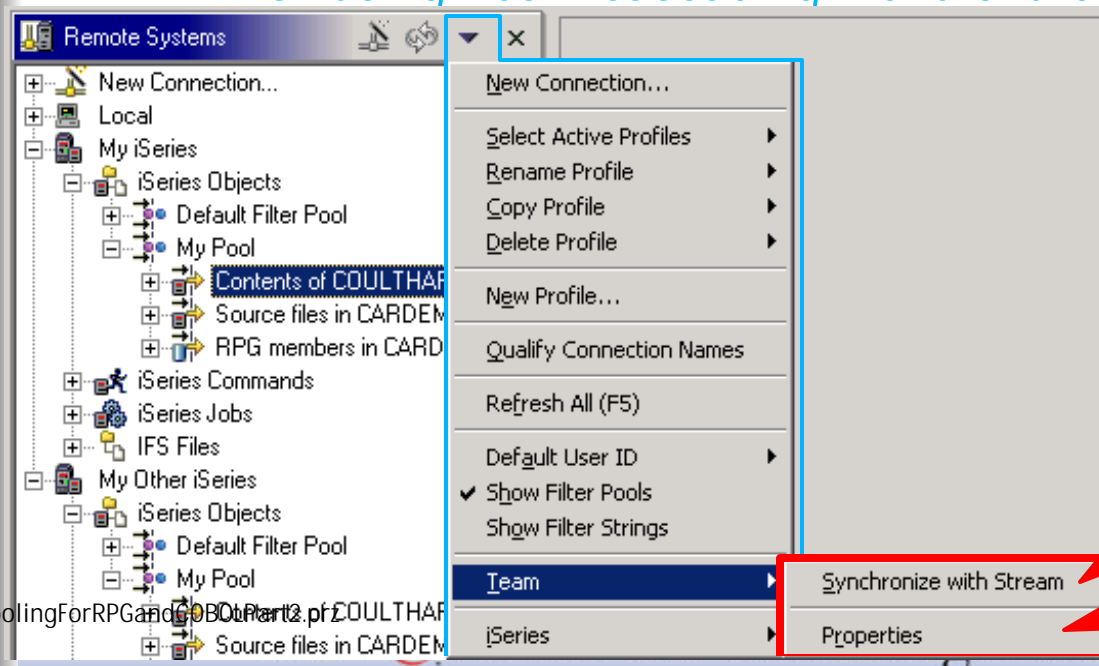

Synchronize with team repository

Identify team repository

Profiles and Teams



The screenshot shows the Remote Systems Explorer interface with the following annotations:

- RSE Project**: Points to the overall Remote Systems Explorer window.
- Navigator view**: Points to the Navigator pane on the left.
- "coulthar" profile folder**: Points to the "coulthar" folder in the Navigator.
- all connections defined for profile coulthar**: Points to the "Connections" subfolder.
- all filter pools defined for profile coulthar**: Points to the "Filters" subfolder.
- all user actions defined for profile coulthar**: Points to the "UserActions" subfolder.
- all compile commands for profile coulthar**: Points to the "compileNames.xml" and "profile.xmi" files.
- "farr" profile folder**: Points to the "farr" folder in the Navigator.
- "team" profile folder**: Points to the "Team" folder in the Navigator.

Profiles and Teams

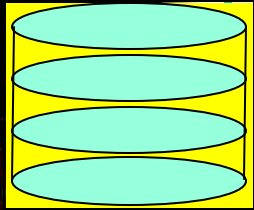

Team Repository

RSE project

- ▶ Team profile
 - ▶ connections
 - ▶ filter pools
 - ▶ user actions
- ▶ Developer1 profile
 - ▶ connections
 - ▶ filter pools
 - ▶ user actions
- ▶ Developer2 profile
 - ▶ connections
 - ▶ filter pools
 - ▶ user actions

Developer1 IDE

RSE project

- ▶ Team profile
- ▶ Developer1 profile
 - ▶ connections
 - ▶ filter pools
 - ▶ user actions
- ▶ Developer2 profile

Developer2 IDE

RSE project

- ▶ Team profile
- ▶ Developer1 profile
- ▶ Developer2 profile
 - ▶ connections
 - ▶ filter pools
 - ▶ user actions

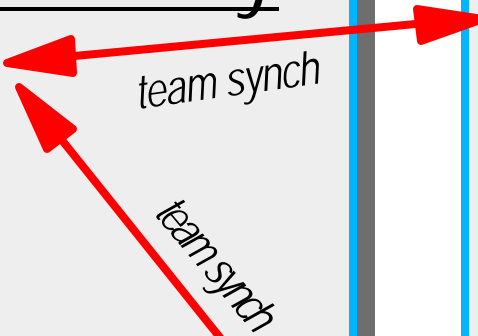

Active Profiles



- ▶ After a team-synch on the RSE project, a developer's IDE will have all the profiles for the whole team
 - However, they only see connections, filter pools and user defined actions for their "active" profiles
 - By default, the "team" and the user's private profile are the only active profiles
 - ▶ So developer only sees all connections, filter pools and user actions that are in the team and developer-unique profiles
 - It is easy to make addition profiles active
 - ▶ Use the menu items in the RSE title bar pulldown menu

Profiles Actions

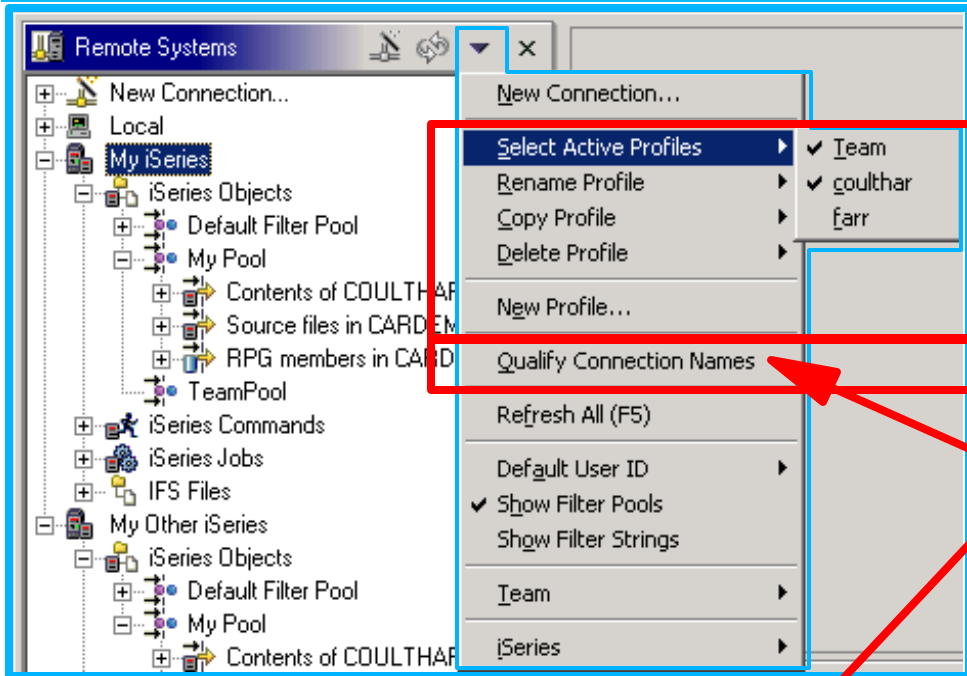

Profile actions

Select this to show connections qualified by profile name

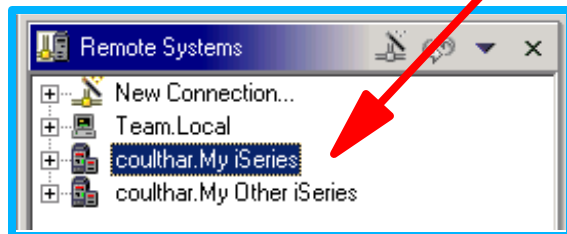

Profiles and Teams

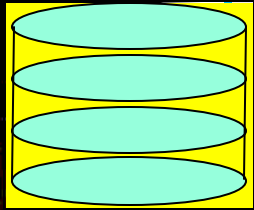

Team Repository

RSE project

- ▶ Team profile
 - ▶ connections
 - ▶ filter pools
 - ▶ user actions
- ▶ Developer1 profile
 - ▶ connections
 - ▶ filter pools
 - ▶ user actions
- ▶ Developer2 profile
 - ▶ connections
 - ▶ filter pools
 - ▶ user actions

team synch

team synch

Developer1 IDE

RSE project

- ▶ Team profile
- ▶ Developer1 profile
 - ▶ connections
 - ▶ filter pools
 - ▶ user actions
- ▶ Developer2 profile

Active profiles for Developer 1

Developer2 IDE

RSE project

- ▶ Team profile
- ▶ Developer1 profile
- ▶ Developer2 profile
 - ▶ connections
 - ▶ filter pools
 - ▶ user actions

Active profiles for Developer 2

Why Profiles?



1. Team-shared connections and filter pools

- ▶ So everyone on the team sees common connections for with common library list, environment settings and filter pools
 - ✓ For common development work. Eg: define profiles such as "team", "fix team", "project1 team", "release 1", "emergency fix", etc,etc
 - ✓ Ask each team member to make these profiles active

2. Developer-unique connections and filter pools

- ▶ So developers can have connections with unique library list, environment settings and filter pools
 - ✓ For developer-unique work via their unique profiles
 - ✓ Each such private profile only made active by one developer

3. Team-shared and developer-unique

- ▶ Each developers "sees" connections and filter pools from both shared and private profiles: whatever is "active"

4. Roaming developer

- ▶ On PC 1: Developer synchronizes with team repository
 - ✓ Sends all connections, filter pools, actions to repository
- ▶ On PC 2: Developer synchronizes RSE with team repository
 - ✓ Gets all connections, filter pools, actions from repository
 - ✓ Makes his profile "active"



- ▶ When creating connections and filter pools you must specify the active profile to contain the new connection or profile

New Connection

Remote System Connection
Define connection information

Parent profile: coulthar
Team
coulthar
Connection name: farr

System type: iSeries

Host name: TORAS14M

Default User ID: COULTHAR

Description:

< Back Next > Finish Cancel

New Filter Pool

System Filter Pool
Define a new pool for filters

Pool name:

Profile: coulthar
Team
coulthar
farr

Finish Cancel

Active Profiles



- ▶ Connections and filter pools can be copied or moved to other profiles

This screenshot shows the 'Remote Systems Explorer' window with a context menu open over the 'coulthar.My iSeries' connection profile. A red arrow labeled '1' points to the profile in the tree, and another red arrow labeled '2' points to the 'Copy' option in the menu.

This screenshot shows the 'Remote Systems Explorer' window with a context menu open over the 'My Pool' filter pool. A red arrow labeled '1' points to the filter pool in the tree, and another red arrow labeled '2' points to the 'Copy' option in the menu.

Work With Filter Pools



- ▶ For one-stop shopping for working with filter pools, select Work With->Filter Pools from subsystem popup menu

▶ You must be in "Show filter pools" mode

Active profiles

Filter Pools per profile

Filter pool actions



► Underlying Model of RSE

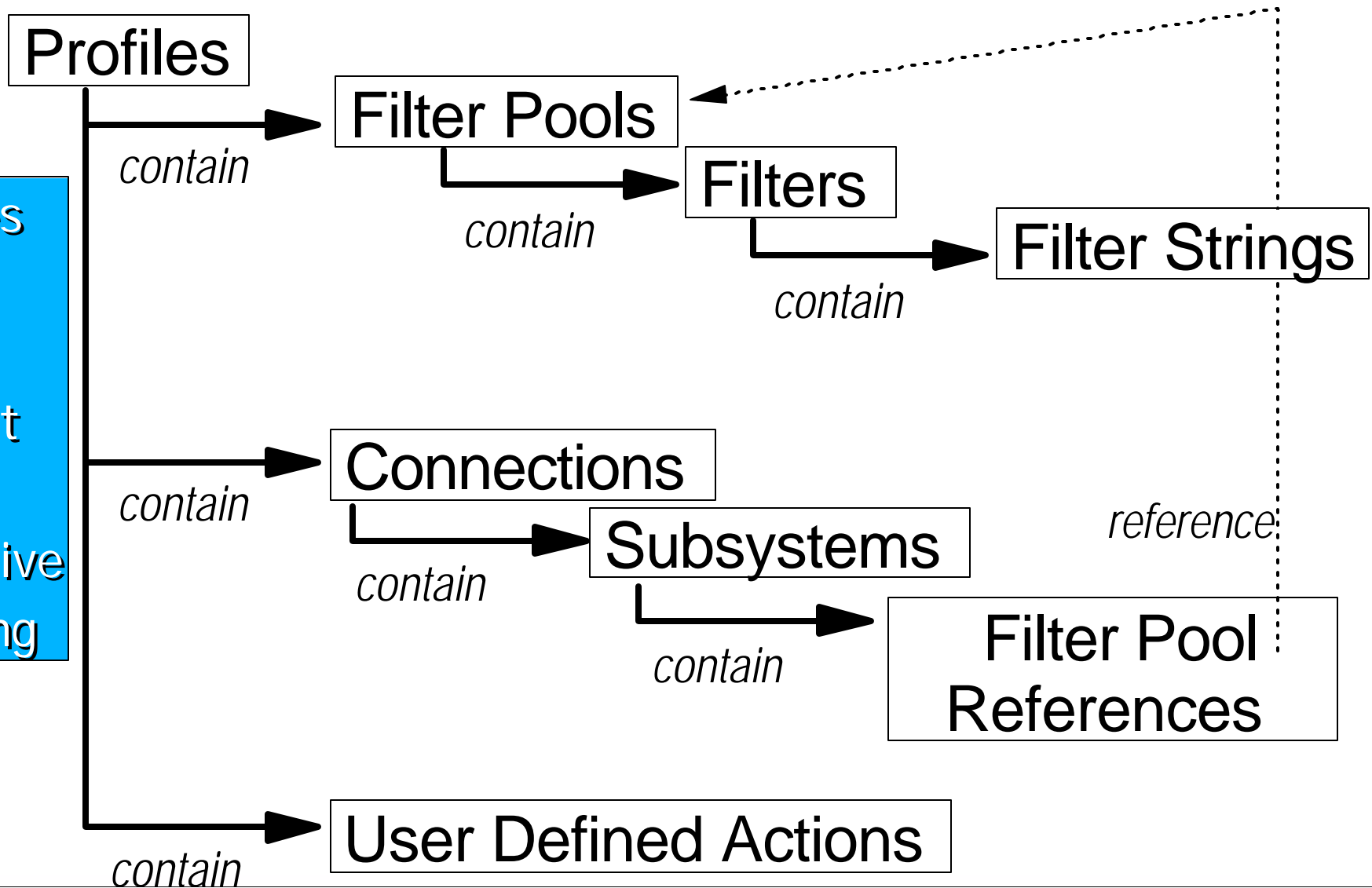

Profiles enable team support and effective grouping



2. iSeries Projects

- **A special project type**
 - ▶ For holding source destined to be compiled on iSeries
- **A dedicated perspective**
 - ▶ For working with all, and only, iSeries projects

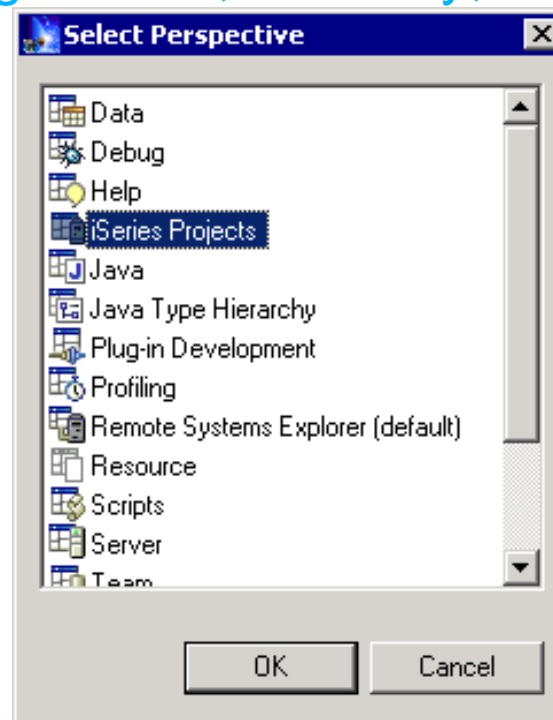



- ▶ iSeries Project Wizard
 - **For creating iSeries projects**

- ▶ What is an iSeries project?
 - ▶ **Typical Eclipse project**
 - ✓ Contains folders and files, can be shared by a team
 - ✓ Can have its own tools and perspectives
 - ▶ **But also**
 - ✓ Holds copies of some source members from an iSeries library
 - ✓ Those copies are "pushed" up occasionally and the project re-built



iSeries Projects

iSeries
Project
Wizard

Toronto

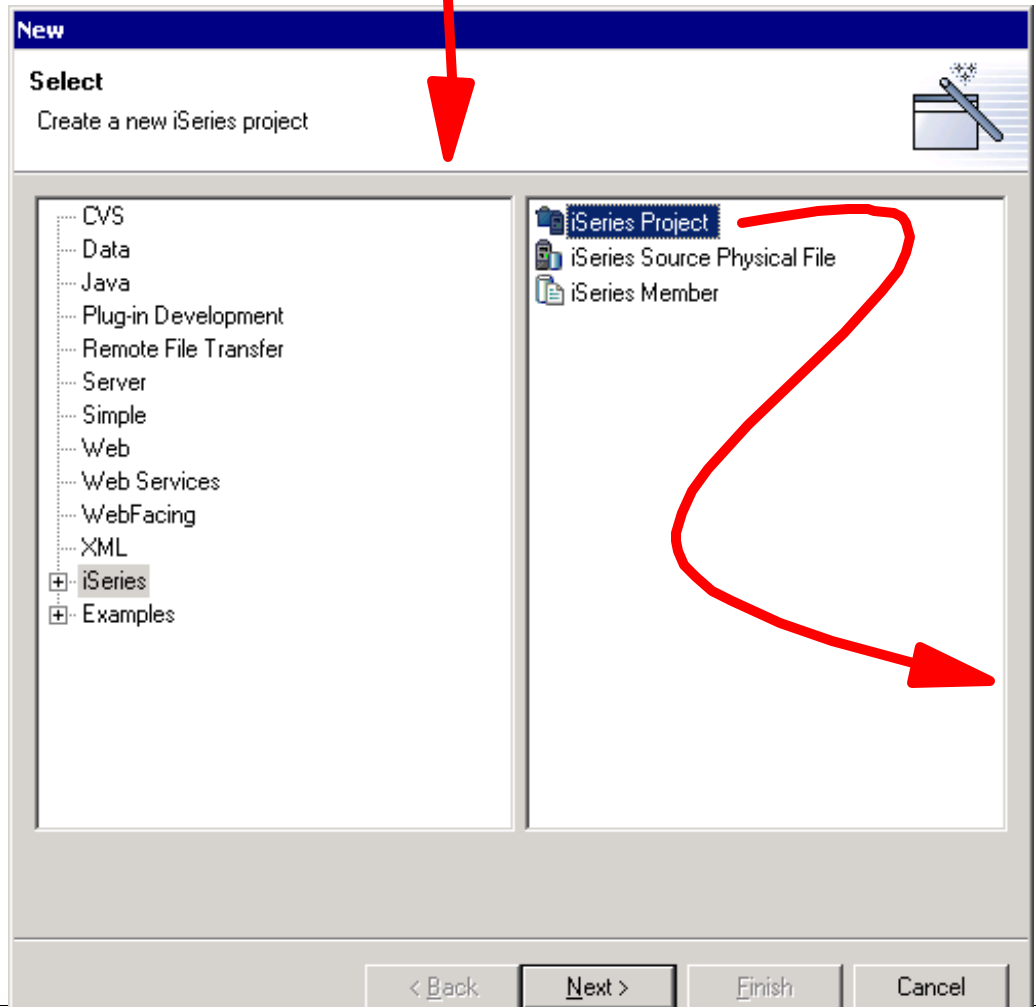
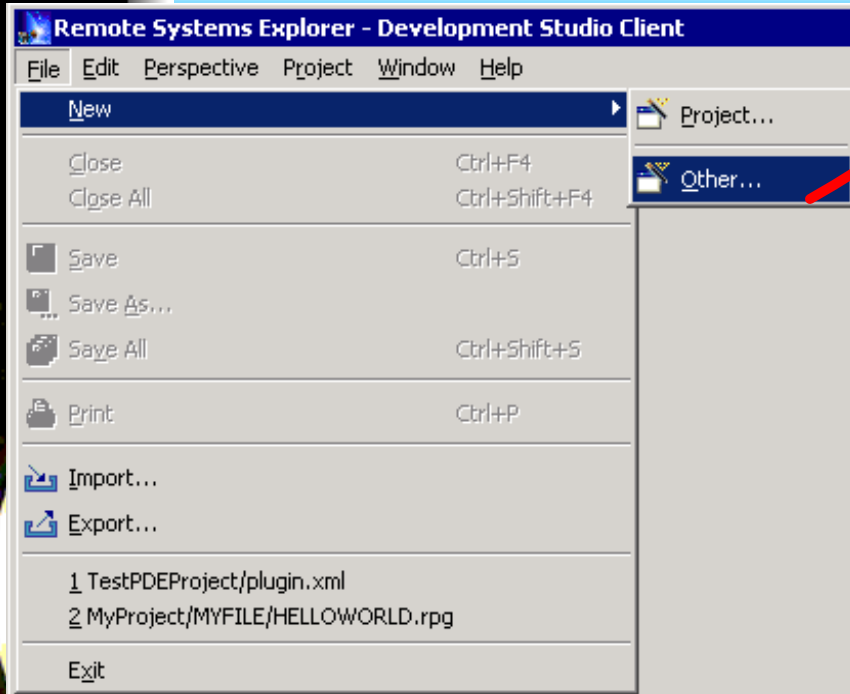

Use **File->New**
to launch
iSeries Project
Wizard



iSeries Projects

iSeries
Project
Wizard

Toronto

New

iSeries Project
Create a new iSeries project that maps to an iSeries library.

Project name:

Use default location

Location:

Specify the name and location of the iSeries project being created. An iSeries project allows for local development, while performing builds on a remote iSeries host machine.

Give your project a name

New

iSeries Project Properties
Specify the iSeries project properties.

Connection:

Associated library:

Specify the connection and library name that you wish to associate with this iSeries project. The connection allows for remote access to the iSeries host machine. Code changes made locally are pushed to the specified remote library. That library is also used for performing builds on the remote host.

Choose connection from RSE list

Identify Associated Library: this is the target library for pushes and builds

New

Build Properties
Specify the build command.

Build command:

Enter the build command to be issued on the remote host that will build this iSeries project.

Identify command to call for Build action

iSeries Projects

iSeries
Projects
Perspective

Toronto

► Dedicated Perspective for iSeries Projects

Create iSeries
Project

Create Source
File

Create Source
Mbr

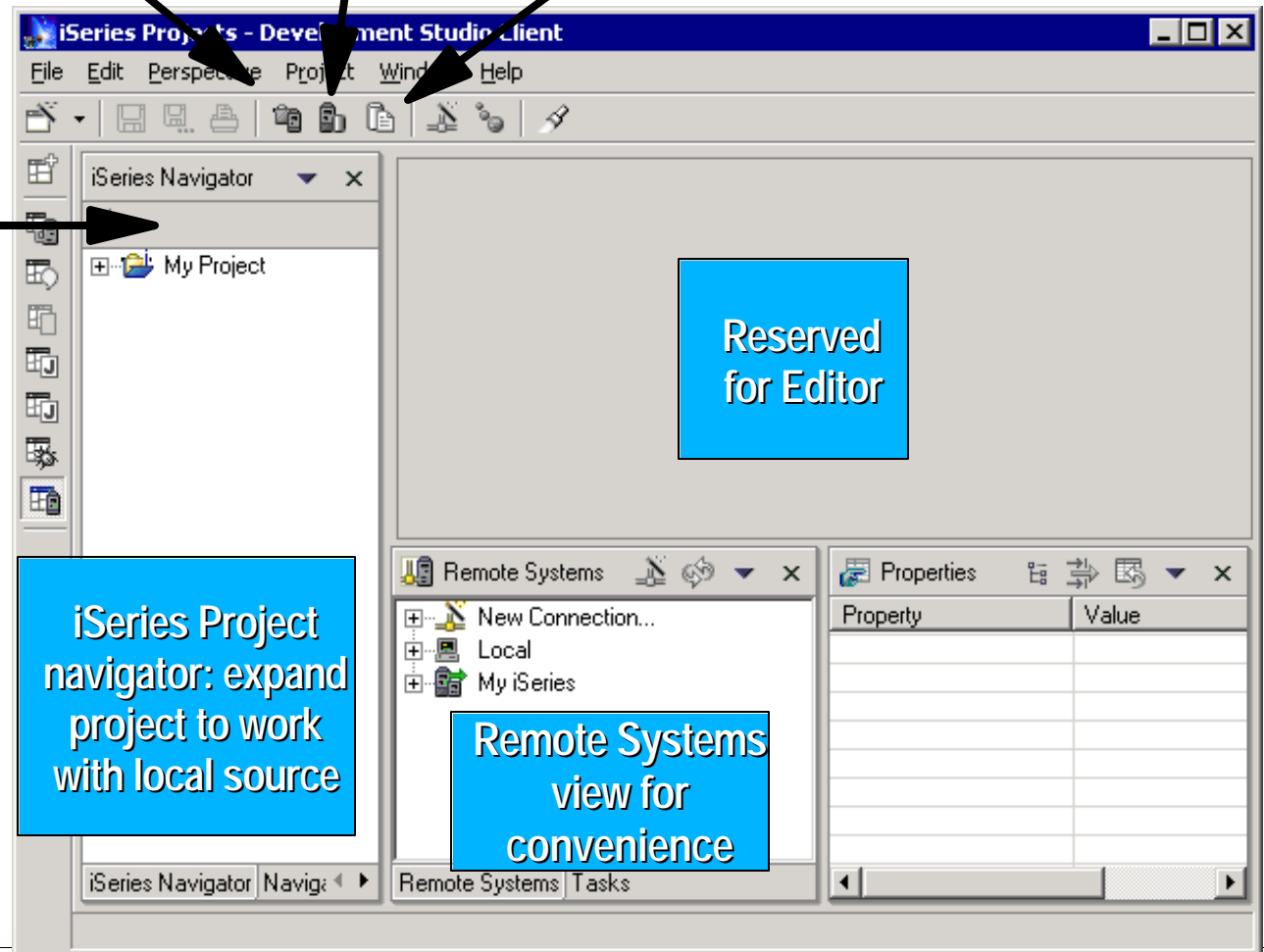
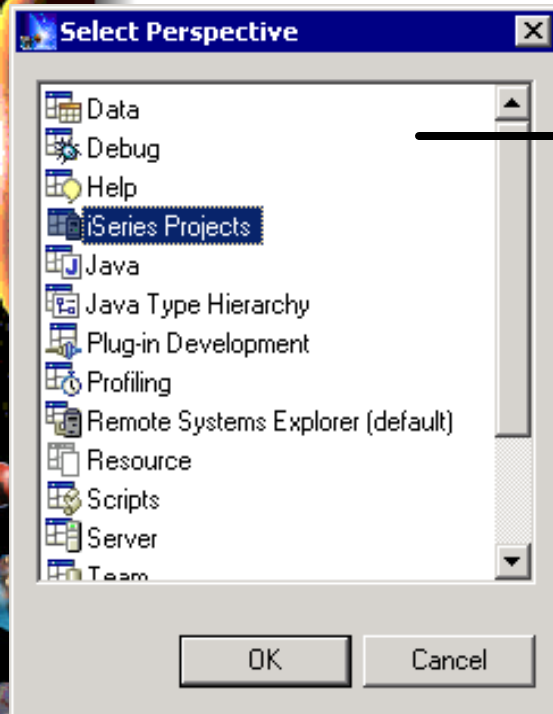

iSeries Project
navigator: expand
project to work
with local source

Remote Systems
view for
convenience

iSeries Projects

iSeries File Wizard

Toronto

- ▶ iSeries File Wizard
 - For creating files in your iSeries project

New

iSeries Source Physical File
Create a new iSeries source physical file.

New File Wizard

Enter or select the folder:

My Project

- My Project
- MyWebProject
- PhiDemo
- PhiJavaDemo
- RemoteSystemsConnections
- RemoteSystemsTempFiles

Select Project

Folder name: QRPGLSRC

Select an iSeries project and enter the name of the new source physical file being created. The source physical file will map to a folder in the selected iSeries project.

< Back Next >

New

iSeries Source Physical File Parameters
Specify additional parameters.

CCSID: *JOB

Record length: 92

These attributes are used when the *FILE is created in the associated library of the iSeries project.

Specify attributes that are used when file is finally created in associated library

Finish Cancel

Source File = a folder in your project

- ▶ Until you "Push" your changes.
- ▶ Then a CRTSRCPF is done

iSeries Projects

iSeries
Member
Wizard

Toronto

- ▶ iSeries Member Wizard
 - For creating mbrs in your iSeries project

New

iSeries Member
Create a new iSeries member.

New Mbr Wizard

Enter or select the folder:
My Project/QRPGLESRC

Select the parent folder.

Member name: MYPROGRAM.RPGLE

Name the member: name.type

Member = a file in your folder

- ▶ Until you "Push" your changes.
- ▶ Then an ADDPFM is done

Finish Cancel



- ▶ What about existing members?
 - Use **Add to Project** action to copy them
 - ▶ Right click on project, select "Show Remote Objects"
 - ▶ Drill down to source file, right click, select "Add to Project"
 - ▶ Drill down to members, right click, select "Add to Project"
 - Files added become folders locally
 - Members added are copied to that folder
 - Developer works on local copy
 - ▶ Edits file
 - ▶ Pushes changes using "Push" action
 - ▶ Does a build using "Build" action
 - ▶ Shares with team using "Synchronize" action
 - Full power of Eclipse at disposal
 - ▶ Team support
 - ▶ Marker/bookmark support
 - ▶ Editor registration support ...



Project "Bleedthrough"



The screenshot shows the 'iSeries Projects - Development Studio Client' interface. The 'iSeries Navigator' pane on the left displays a project tree with 'My Project' expanded. Under 'My Project', there are sub-projects 'NEWFILE' and 'QRPGLSRC'. Under 'QRPGLSRC', the file 'CALLPGM.rpgle' is selected. A context menu is open over 'CALLPGM.rpgle', with 'Show Remote Objects' highlighted by a red box. A red arrow points from this box to the right side of the main editor area. The 'Properties' pane at the bottom right shows the following data:

Property	Value
editable	true
last modified	5/15/02 11:47 AM
name	CALLPGM.rpgle
path	/My Project/QRPGLSRC/CALLPGM.rpgle
size	0

iSeries Project Perspective

iSeries Projects



iSeries Project navigator:

- ▶ local files and members
 - Use Push popup menu action to copy from project to library
 - Use Build to build project
 - Use Team->Sync to copy to/from team repository
- ▶ remote objects, files and mbrs
 - Use Add to Project to copy from library to project

(Remote) =>

- ▶ only exists in associated library

(Local/Remote) =>

- ▶ exists locally and in associated lib

(Local/Remote) =>

- ▶ conflict between local and remote

otherwise =>

- ▶ only exists locally

iSeries Project navigator:

- ▶ local files and members
 - Use Push popup menu action to copy from project to library
 - Use Build to build project
 - Use Team->Sync to copy to/from team repository
- ▶ remote objects, files and mbrs
 - Use Add to Project to copy from library to project

(Remote) =>

- ▶ only exists in associated library

(Local/Remote) =>

- ▶ exists locally and in associated lib

(Local/Remote) =>

- ▶ conflict between local and remote

otherwise =>

- ▶ only exists locally

```

Device+. Keywords+++++
Disk
  Take(CUSTNO)
  20
  extname(custom13:custom01)
-----
custnoi='0010100'
'GETDATA'
      custnoi
      cstruc
      return
*INLR = *ON
    
```

Value
true
5/5/02 12:27 PM
CALLPGM.rpgle
/My Project/QRPGLESRC/CALLPGM.rp
1222

iSeries Projects

The screenshot displays the Eclipse Studio Client interface for iSeries projects. The main editor window shows the Lpex editor for a local member named CALLPGM.rpgle. The editor content is as follows:

Row	Column	Replace
000100	FCUSTOML3	IF E K Disk
000200	D Custnoi	S like(CUSTNO)
000300	D*	
000400	D CSTRUC	E DS extname(customl3:custom01)
000500	D return	S 20
000600	D*	
000700	C	EVAL custnoi='0010100'
000800	C	CALL 'GETDATA'
000801	C	
000900	C	parm custnoi
001000	C	parm cstruc
001100	C	parm return
001200	C	eval *INLR = *ON

Red boxes highlight the 'Push Selected' menu item, the editor window, the 'Remote Systems Explorer', and the 'Properties' view. Blue callout boxes provide text for these highlighted areas:

- Push Selected** (Menu item)
- Lpex editor for local members or choose favorite editor** (Editor window)
- Remote Systems Explorer to work with objects in remote library** (Remote Systems Explorer view)
- Property Sheet to show properties of selected local or remote object** (Properties view)

Property	Value
editable	true
last modified	5/5/02 12:27 PM
name	CALLPGM.rpgle
path	/My Project/QRPGLESRC/CALLPGM.rpgle
size	1222



▶ Using projects

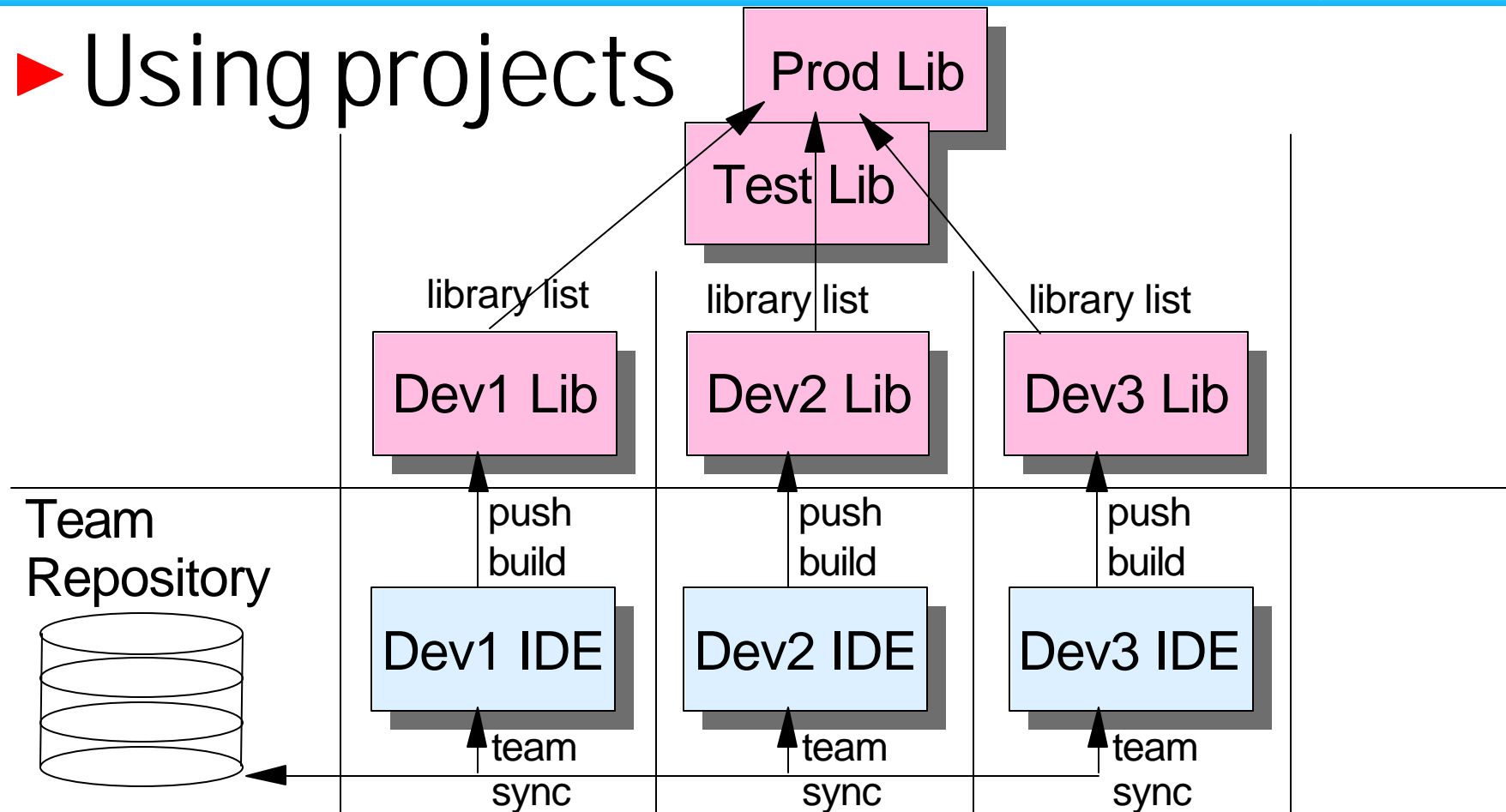

- **Projects typically hold small delta**
 - ▶ Eg: Files necessary to implement new feature
- **Each developer can have unique ass'd lib**
 - ▶ Eg: For private builds
 - ▶ Use team synch to pick up colleague's work so far

iSeries Projects



- ▶ Stay tuned...
- **iSeries Projects are new, and their functionality is still immature**
 - ▶ They are offered initially to gather feedback so they can subsequently be optimized to best match your development patterns
- **The support for iSeries project will iterate quickly in coming releases**
 - ▶ Including much better integration support for iSeries change management vendors such as Aldon, MKS and SoftLanding.



▶ Information Sources

- **www.ibm.com/software/ad/wds400**
 - ▶ Portal for WDS*c*
- **www.eclipse.org**
 - ▶ Eclipse and information about eclipse
- **www.ignite400.org**
 - ▶ Introduction to eclipse article
- **eServer iSeries magazine, July issue**
 - ▶ 3 articles on WDS*c*
- **www.ibm.com/websphere/developer**
 - ▶ WebSphere Developer Domain
 - ▶ Many articles and tutorials on technology and tools, including eclipse and WSWB and WebSphere Studio configurations



Trademarks & Disclaimers



iSeries AD, IBM Toronto

© IBM Corporation 1994-2002. All rights reserved.

References in this document to IBM products or services do not imply that IBM intends to make them available in every country.

The following terms are trademarks or registered trademarks of International Business Machines Corporation in the United States, other countries, or both:

AS/400	IBM(logo)
AS/400e	iSeries
e (logo) business	OS/400
IBM	

Lotus, Freelance Graphics, and Word Pro are registered trademarks of Lotus Development Corporation and/or IBM Corporation. Domino is a trademark of Lotus Development Corporation and/or IBM Corporation.

C-bus is a trademark of Corollary, Inc. in the United States, other countries, or both.

Java and all Java-based trademarks are trademarks of Sun Microsystems, Inc. in the United States, other countries, or both.

Microsoft, Windows, Windows NT, and the Windows logo are trademarks of Microsoft Corporation in the United States, other countries, or both.

ActionMedia, LANDesk, MMX, Pentium and ProShare are trademarks of Intel Corporation in the United States, other countries, or both.

UNIX is a registered trademark of The Open Group in the United States and other countries.

SET and the SET Logo are trademarks owned by SET Secure Electronic Transaction LLC.

Other company, product and service names may be trademarks or service marks of others.

Information is provided "AS IS" without warranty of any kind.

All customer examples described are presented as illustrations of how those customers have used IBM products and the results they may have achieved. Actual environmental costs and performance characteristics may vary by customer.

Information in this presentation concerning non-IBM products was obtained from a supplier of these products, published announcement material, or other publicly available sources and does not constitute an endorsement of such products by IBM. Sources for non-IBM list prices and performance numbers are taken from publicly available information, including vendor announcements and vendor worldwide homepages. IBM has not tested these products and cannot confirm the accuracy of performance, capability, or any other claims related to non-IBM products. Questions on the capability of non-IBM products should be addressed to the supplier of those products.

All statements regarding IBM future direction and intent are subject to change or withdrawal without notice, and represent goals and objectives only. Contact your local IBM office or IBM authorized reseller for the full text of the specific Statement of Direction.

Some information in this presentation addresses anticipated future capabilities. Such information is not intended as a definitive statement of a commitment to specific levels of performance, function or delivery schedules with respect to any future products. Such commitments are only made in IBM product announcements. The information is presented here to communicate IBM's current investment and development activities as a good faith effort to help with our customers' future planning.

Performance is based on measurements and projections using standard IBM benchmarks in a controlled environment. The actual throughput or performance that any user will experience will vary depending upon considerations such as the amount of multiprogramming in the user's job stream, the I/O configuration, the storage configuration, and the workload processed. Therefore, no assurance can be given that an individual user will achieve throughput or performance improvements equivalent to the ratios stated here.

Photographs shown are of engineering prototypes. Changes may be incorporated in production models.