

ibm.com

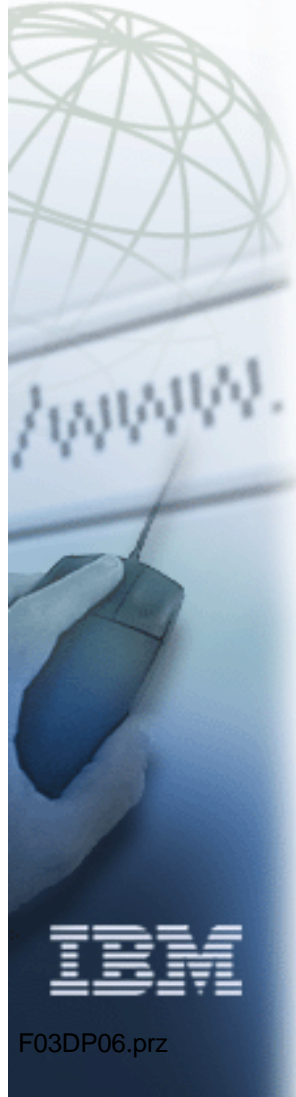

e-business



Domino and iSeries Integration with BlueNotes

DP06

ITSO iSeries Technical Forum

John Taylor



Redbooks

International Technical Support Organization

© 2003 IBM Corporation

Abstract

- ◆ IBM's BlueNotes Suite - Directory, Document and Data integration, Workflow and CRM products - integrates Notes and Domino with OS/400's file system, database and directory. It is used for e-business, CRM, Server Consolidation, Knowledge Management, Mobile and migration from OfficeVision/400 and MS Exchange.
- ◆ Level: Basic. Prerequisite: OS/400 and Domino familiarity.

Agenda

- ◆ BlueNotes Product Suite Overview
- ◆ For each product
 - What Problems are we solving?
 - Background
 - What the product does
 - Demo/ScreenCam
 - How the product works
 - Benefits
 - FAQs
 - Development Plans
 - Positioning
- ◆ Summary
 - Support, Pricing, Ordering, More Info

What is the BlueNotes Family?

- ▶ IBM OS/400-Notes integration products
 - ◆ A **'Blue'** iSeries Server enhanced by **'Notes'**
 - **'OS/400 & Lotus Notes in perfect harmony'**
 - ◆ **IBM world-wide products, developed by Typex**
- ▶ **A Success!**
 - Lotus Beacon Award Finalist
 - 'AD Tools Network for AS/400' logo
 - IBM 'Powered By AS/400e' Award
 - IBM 'Netfinity Server Proven'
 - Domino Extreme Team Member
 - Bought with 1 in 3 of OS/400 Migration Tools
 - \$M IBM Revenue

BlueNotes Family Members

- ◆ Directory Integration Products
 - Directory Synchronisation
 - Directory Taxonomy for Domino
- ◆ Document Integration Products
 - Document Warehouse
 - MailStore for Domino
- ◆ Data Integration Products
 - Direct Messaging
 - DataPump
- ◆ Workflow Products
 - Task Manager
- ◆ CRM Products
 - iContact

Directory Integration Products



What problems are we solving?

- ▶ Eliminate Multiple Signons
- ▶ Server & Directory consolidation
- ▶ Messaging Migration
- ▶ Internet/Extranet Directory

What are Directories?

- ▶ Specialised databases
 - ◆ optimised for read, not update
- ▶ Usually lists of people
 - ◆ associated attributes
 - ◆ often used for e-mail
 - ◆ sometimes the basis for security
- ▶ Not the same as file system directories
 - ◆ DOS DIR command, etc.

Major Directory Products

- ▶ Novell NetWare
 - ◆ eDirectory (Novell Directory Services - NDS)
- ▶ Windows 2000
 - ◆ Active Directory
- ▶ Lotus Domino
 - ◆ Domino Directory (DD)
- ▶ IBM OS/400
 - ◆ IBM System Distribution Directory
 - ◆ IBM SecureWay Directory
 - also cross-platform
- ▶ Oracle, Netscape.....

Directory Trends

- ▶ LDAP standard
 - ◆ Lightweight Directory Access Protocol
 - ◆ Well supported (IBM, Microsoft, Novell, Netscape.....)
- ▶ Add system and network data
 - ◆ e.g. printers
- ▶ Consolidate Enterprise Directories
 - ◆ Metadirectory (a 'join' of all directories) is 'interim'
- ▶ Directory-based security for applications
 - ◆ the next 'big thing' in AD, e.g. WebSphere
- ▶ Basis for Knowledge Management
 - ◆ The 'People' in 'People, Places & Things'

Public LDAP Example - IBM

The screenshot shows a Netscape browser window titled "Contact IBM - Employee email directory - Netscape". The address bar shows "http://whois.ibm.com/". The page features the IBM logo and a search bar at the top. A navigation menu includes "Home", "Products & services", "Support & downloads", and "My account". A sidebar on the left contains links for "Select a country", "Contact IBM", "E-mail directory", "IBM FAQs", "Worldwide directory", and "Job opportunities". The main content area is titled "IBM employee e-mail directory" and contains the instruction: "Enter the name of an IBM employee to find his or her e-mail address." Below this are two input fields: "Last name: (Required)" and "First name: (Optional)", followed by a "Search" button. A link for "French version" is also present. An "Instructions" section lists search rules, such as "The last name must be entered, and must be spelled exactly and completely." and "Upper case and lower case letters are treated the same." The footer of the page includes "About IBM", "Privacy", "Legal", and "Contact".

iSeries as Directory Server

- ▶ 1. Security is in the User Profile
- ▶ 2. Most users also in OS/400 System Distribution Directory (SDD)
 - ◆ Client Access, OS/400, Distribution, Shared Folders
 - ◆ SDD is X.500 compatible (LDAP-like)
- ▶ 3. IBM SecureWay Directory
 - ◆ Free OS/400 Opt 32 Directory Services
 - ◆ LDAP-enabled directory
- ▶ 4. Premier platform for Domino Directory
- ▶ 5. Enterprise Identity Mapping
 - ◆ Requires LDAP

OS/400 SDD

Display Directory Entry Details

```
User ID/Address . . . . . : MODELLCL TYPEXNCL
Description . . . . . : Model, Local, <local_model@typex.com>
System name/Group . . . : TYPEXNCL
User profile . . . . . : MODELLCL
Network user ID . . . . . : MODELLCL TYPEXNCL
```

Name:

```
Last . . . . . : Surname
First . . . . . : First Name
Middle . . . . . : (Middle)
Preferred . . . . . : (Preferred)
Full . . . . . : Surname, First Name (Middle) ((Preferred))
```

```
Department . . . . . : TPX
Job title . . . . . : Job Title
Company . . . . . : Typex Business Centre
```

More

Press Enter to continue.

```
F3=Exit   F12=Cancel   F18=Display location details
F19=Display name for SMTP   F20=Display user-defined fields
```

IBM SecureWay

The screenshot displays the IBM SecureWay Directory Management Tool interface. On the left is a tree view of the directory structure, including folders for Introduction, Server, Schema, Attributes, Directory tree, Search tree, and Log file. The main window shows a 'Browse tree' pane with a toolbar containing icons for Search, Expand, Add, Edit, Duplicate, Delete, ACL, Edit RDN, and Add auxiliary class. An 'Edit an LDAP User' dialog box is open, showing fields for Object class, DN, Initials, Common name, and Last name. Below these are tabs for Business, Personal, Other, Summary, and Memberships. The Summary tab is active, displaying a list of LDAP attributes and their values.

Attribute	Value
Common name:	First Name (Middle) Surname
Last name:	Surname
Object class:	top
publisherName:	dc=TYPEXTST,dc=typex,dc=com
Department:	TPX
description:	Model, Local, <local_model@typex.com>
E-mail:	MODELLCL_TYPENCL@TYPEXTST.typex.com
facsimileTelephoneNumber:	0191 226 0252
First name:	First Name
Office phone:	0191 256 4406 (X564406)
registeredAddress:	123 The Crescent\$Geordieland\$NE1 4ME\$(Home address)
Title:	Job Title
uid:	MODELLCL

Lotus Domino

The screenshot shows the Lotus Notes application window titled "Person record for: Andrew J Horsford/TYPEX - Lotus Notes". The interface includes a menu bar (File, Edit, View, Create, Actions, Attachment, Help) and a toolbar with various icons. The window title bar shows several open documents: "Welcome", "BNDWFULL - Obj...", "Typex' Address Book...", "Typex' Address Book - People", and "Person record for: An...". The main content area displays the "PERSON: Andrew J Horsford/TYPEX" record, with the email address "Andrew J Horsford/TYPEX@TYPEX" visible. Below the name, there are tabs for "Basics", "Mail", "Work/Home", "Other", "Miscellaneous", "Certificates", and "Administration". Under the "Work/Home" tab, there are sub-tabs for "Work", "Home", and "Corporate Hierarchy Information". The "Work" sub-tab is active, showing a table of contact information. The "Company Information" sub-tab is also visible, showing fields for street address, city, state/province, zip/postal code, country, and office number.

Work		Company Information	
Title:	Technical Support	Street address:	
Company:	Typex (UK) Ltd	City:	
Department:	TPX	State/Province:	
Employee ID:		Zip/postal code:	
Location:		Country:	
Manager:		Office number:	
Office phone:	564410 - 0191 256 4410		
FAX phone:			
Cell phone:			
Pager number:			
Assistant:			

What do we need with OS/400?

- ▶ Problem
 - ◆ Synchronise the four different lists, but...
 - ◆ support for SDD-Domino synch withdrawn with R6
- ▶ Requirements
 - ◆ Replacement synch product
 - ◆ Synchronisation with additional OS/400 data
 - ◆ A metadirectory tool
- ▶ Solution
 - ◆ BlueNotes Directory Synchronisation

BlueNotes Directory Synchronisation

- ▶ OS/400 to LDAP Enablement
 - ◆ Automated publishing of User Profiles to System Distribution Directory
 - ◆ Enablement of application data to SDD
 - ERP, H-R, etc.
 - ◆ Publishing of SDD to SecureWay (LDAP)
 - use for directory-enabled applications such as WebSphere, QuickPlace, etc.
- ▶ OS/400 to Domino Directory Integration
 - ◆ LDAP referrals to/from SecureWay to Domino
 - ◆ Export of SDD to Domino Person documents
 - ◆ Substitute for dirsynch in R6
 - ◆ Metadirectory tool for iSeries and Domino

BlueNotes Directory Integration

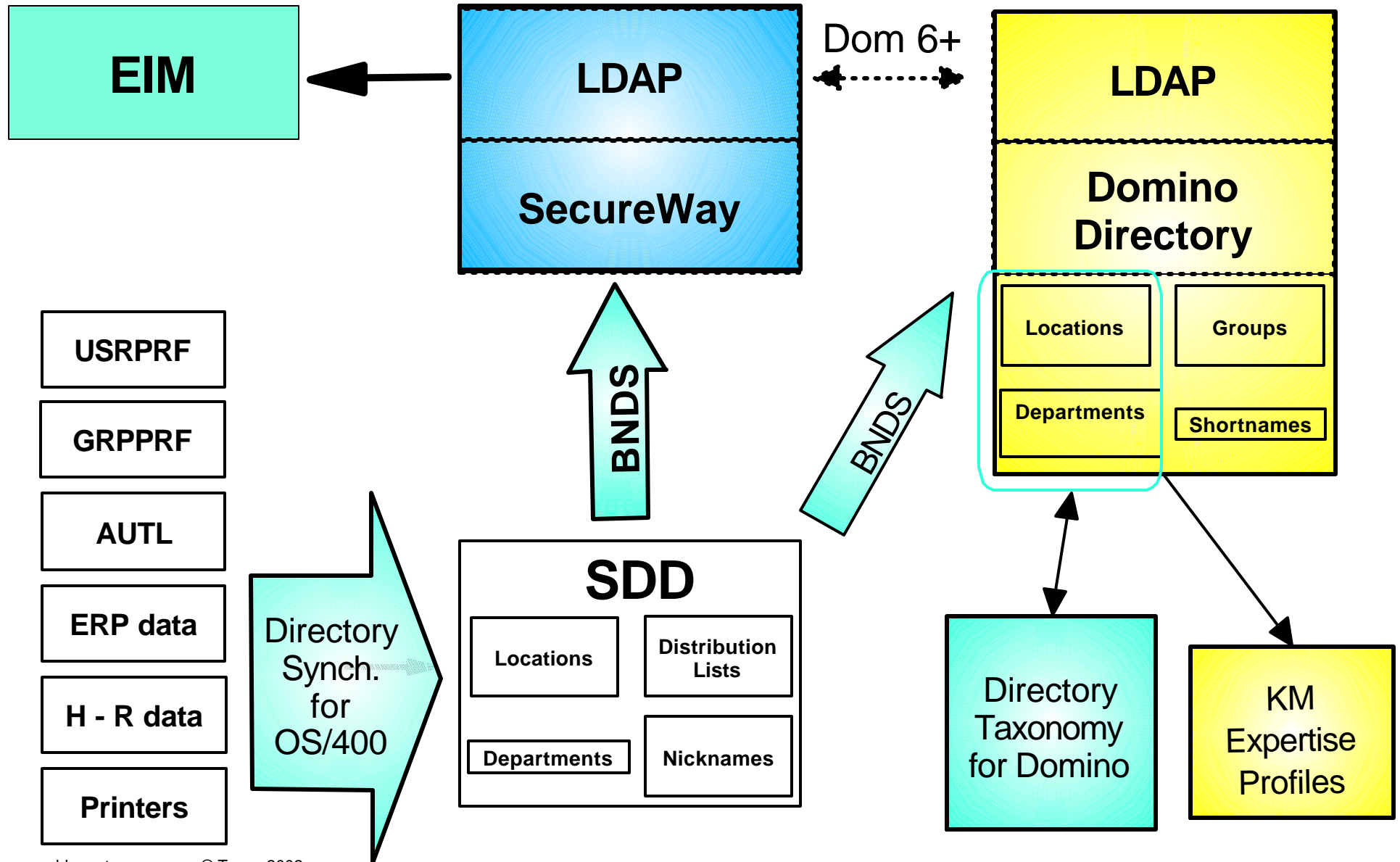

Consolidating Directories with LDAP

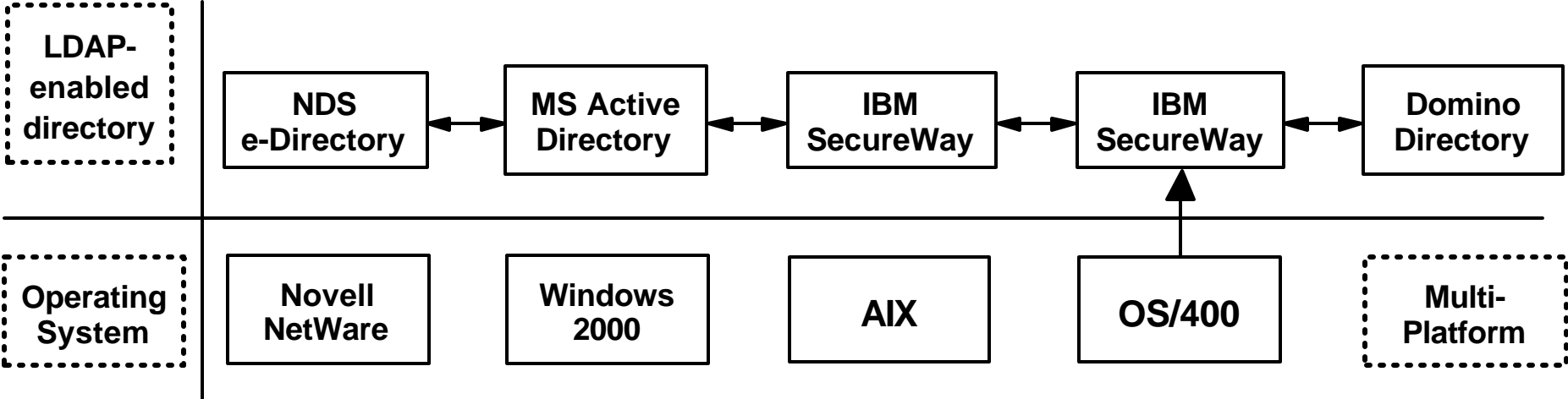

Taxonomies and Directories

- ▶ Taxonomy
 - ◆ A hierarchical definition of the organisation's knowledge
 - Like the index cards in a library
- ▶ Domino Directory
 - ◆ A flat file listing of people
 - difficult to find people
- ▶ Issue
 - ◆ People work in hierarchies
 - Departments, locations, reporting lines
- ▶ Fix
 - ◆ We need to define hierarchies for our Directory

Taxonomy Example: IBM-like

- ▶ Product/Service
 - ◆ Servers
 - iSeries
 - processor, disk ...
 - pSeries, xSeries, zSeries
 - ◆ Storage
 - Shark...
 - ◆ Workstations
 - PCs, Thin Clients...
 - ◆ Software
 - DB2, Lotus, Tivoli...
 - ◆ Global Services
 - Education, ITSS...
- ▶ Customer
 - ◆ Industry
 - Oil, Chemical, SMB, Government, Finance...
- ▶ Management
 - Corporate, National...
 - Finance
 - Banking, Treasury...
 - Human Resources
 - Payroll...
 - Infrastructure
 - Intranet, Helpdesk...
- ▶ Geography
 - NA, EMEA, AP
 - US, UK...

Directory Taxonomy for Domino

- ▶ Administrator creates an Enterprise Taxonomy
 - ◆ Read Directory fields e.g. Location, Department.
 - ◆ Defines hierarchies for them (a Taxonomy)
- ▶ Refresh to Domino Directory's Corporate Hierarchy
 - ◆ Enhances Notes Mail interface
 - ◆ Basis for Intranet/Extranet Directory
 - ◆ Basis for selection of EIM entries
- ▶ Exports the Taxonomy
 - ◆ Basis for categorisation of other databases
 - Document Warehouse, MailStore for Domino, etc.

Directory Taxonomy for Domino Demo

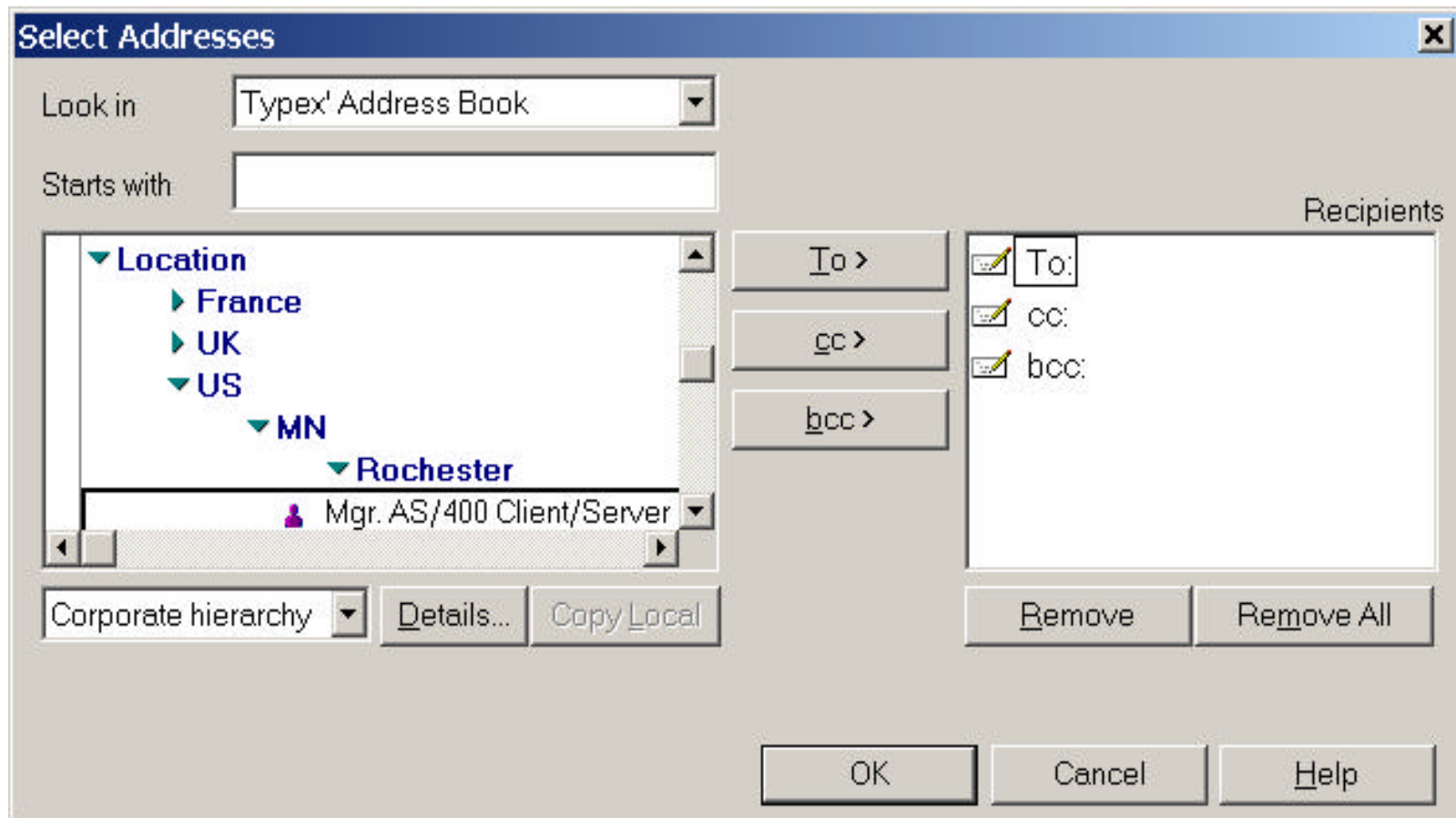

Development Plans

- ◆ BlueNotes Directory Synchronisation for OS/400
 - OS/400 Security export to LDAP and Domino
 - OS/400 Group Profiles with Notes Groups
 - OS/400 Authorisation Lists with ACLs
 - Export data to Enterprise Identity Mapping
- ◆ BlueNotes Directory Taxonomy for Domino
 - HR application toolkit
 - export selected H-R data to LDAP
 - Domino Navigators
 - for geography and organisational chart
 - Knowledge Management Schemas
 - field mapping for Expertise Profiles
- ◆ BluePages
 - Intranet version of 'taxonomised' Directory

Summary - Directory Products

- ▶ BlueNotes Directory Synchronisation
 - ◆ Domino integration with OS/400 Directory
 - ◆ Feed to LDAP and EIM
- ▶ BlueNotes Taxonomy for Domino
 - ◆ Domino Directory management
 - ◆ Corporate Taxonomy tool
- ▶ BlueNotes BluePages
 - ◆ Intranet Directory

Directory Products Positioning

- ▶ Domino Customers and/or OS/400 Customers
 - ◆ Messaging Migration and Coexistence
 - ◆ e-business
 - publishing contact information to the Web
 - directory-enabling applications
 - ◆ Server Consolidation
 - Enterprise Directory
 - ◆ CRM
 - contact management
 - ◆ Authority and security tool
 - enable Web-based authority
 - ◆ Knowledge Management
 - Puts the 'People' into 'People, Places & Things'

BlueNotes Directory Benefits

▶ Users

- find people

▶ Administrators

- consolidate directories
- reduce helpdesk load

- ▶ 20% to 40% of all calls to a help desk involve forgotten passwords costing a company \$14 to \$26 per reset.
- ▶ - Source: Gartner Group.

- tighten security

▶ Developers

- modernise applications
- take OS/400 info to the 'net

▶ Managers

- get started with Knowledge Management

Document Integration Products



What problems are we solving?

- ▶ How can I find a PC file (document)?
- ▶ How can I consolidate file servers?
- ▶ How can I manage disk space?
- ▶ How can I monitor for unwanted files?
- ▶ How can I boost server performance?
- ▶ How can I migrate to Notes?
- ▶ How can I access file servers from my Intranet?
- ▶ How can I publish my product catalogue to the Web?

What is Document Warehouse?

- ▶ Document Warehouse Products
 - Document Warehouse for OS/400
 - A Notes interface to the Integrated File System's /QDLS
 - OfficeVision/400 Conversion Tool
 - Enables conversion from OfficeVision/400 to Lotus Notes
 - Document Warehouse for Multiplatforms
 - A Notes interface to any DOS-compatible file system
 - MailStore for Domino
 - Central store of Notes email
 - Document Warehouse for Domino
 - Index of Notes documents
 - Document Warehouse for the Web
 - Shared Bookmarks

What is a Document Warehouse?

- ▶ Like a Data Warehouse but for documents
 - ◆ Collects and maintains index of file server objects
 - ◆ Replicates indices to one or more Domino servers
 - ◆ Adds Domino value to the index
 - Notes & Web interfaces
 - consolidated view across multiple file servers
 - 'logical folder' views based on index fields
 - search facility on index data
 -makes it easier to find that document!
 - ◆ Provides a 'Shortcut' back to the document
 - ◆ Launches editors and viewers

Document Warehouse for MultiPlatforms

- ▶ For legacy, 32-bit servers
 - ◆ All platforms supporting DOS DIR command
 - NT, 2000, OS/2 Warp, NetWare, Linux servers, OS/400 IFS
 - Intel clients in development
 - ◆ Batch index build
 - ◆ Notes/Domino Index on server or client
 - ◆ Migrates files alongside of e-mail migration
 - e.g. MS Exchange
 - ◆ Points-based licensing for flexibility

Document Warehouse for OS/400

- ▶ IBM 5620-FHM
- ▶ Document Warehouse for the OS/400 file system
 - ◆ Collects and maintains in DB2/400 an index of objects in OS/400's Integrated File System
 - ◆ Incremental index build
 - ◆ Combines OS/400 with Intel index
 - ◆ Enables Enterprise file index consolidation
 - ◆ Prepares for Server Consolidation
 - ◆ QDLS in current release
 - QRYDOCLIB-based
 - ◆ Full IFS in next
 - Multiplatforms product gives batch access to IFS now

Document Warehouse Demo

The screenshot shows the Lotus Notes interface for a document warehouse. The window title is "BNDW for AS/400 Index on R5 - Objects\By Folder - Lotus Notes". The menu bar includes File, Edit, View, Create, Actions, and Help. The toolbar contains icons for navigation and search. The left-hand pane shows a tree view of the document warehouse structure, with "Objects" expanded to "By Folder". The main pane displays a table of objects with columns for Object, Description, and Type.

Object	Description	Type
TYPEXDEM		
TYPEXNCL		
QDLS		
ORGS		
AHED		
ANON		
BA		
BLKD		
CUA		
ELUX		
QUMBREPO		
BBBDF		
QWPDOCS		
COMPSLIP	Compliment Slips NCL Version 3112	RFT
PURCHREQ	Purchase Requisition Form	RFT
TXADM		
JOBS		
JOB1839	I B Sugar - PC52ST	RFT
TXMKT		
TXMNGMON		
TXSPTACC		
CASH12WK	12 week cash flow	RFT
SALARY	Salary Documentation	RFT
TXSPTADM		
TXSPTFAC		
TXSTF		
TXWEB		

File Server Consolidation

- ▶ Domino index of file system files
 - ◆ Builds consolidated, cross-server Views
 - by server, by name, by owner, by extension, by size
 - easier to find that file
 - ◆ A 'virtual SAN'
 - ◆ Also cross-platform
 - OS/400, NT, NetWare, Linux, etc
- ▶ Use in Consolidation
 - ◆ eliminate duplicates, e.g. templates
 - ◆ remove illegal and unwanted files (MP3, MPEG)
 - ◆ review old files by revision date
 - ◆ review documents owned by leavers
 - ◆ plan the new filing hierarchy

Notes or Domino?

- ▶ Domino customers
 - ◆ DB2 index on server
 - ◆ Domino index on server
 - ◆ Available to end users
 - ◆ Notes or Web client
- ▶ Non-Domino customers
 - ◆ DB2 index on server
 - ◆ Notes index on service deliverer's PC
 - ◆ No Domino infrastructure required

Can iSeries be a PC Server?

- ▶ It works like any PC file server
 - ◆ PC client apps can be installed from CD or disk.
 - e.g. suites like SmartSuite, MS Office, Corel
 - Windows Imaging, AutoCAD, Adobe Acrobat, Flight Simulator.
 - ◆ PC files (documents) can be saved to it, printed through it and backed up to tape.
 - ◆ It is reliable, secure, scalable and gets backed up
 - ◆ Software is free in OS/400 NetServer
 - ◆ Also PC data server - spreadsheet, text merge, etc
- ▶ BlueNotes makes it faster, especially remotely
 - ◆ Notes database is like a cached directory
 - ◆ No drill-down means less server hits

Three Tier Scenarios

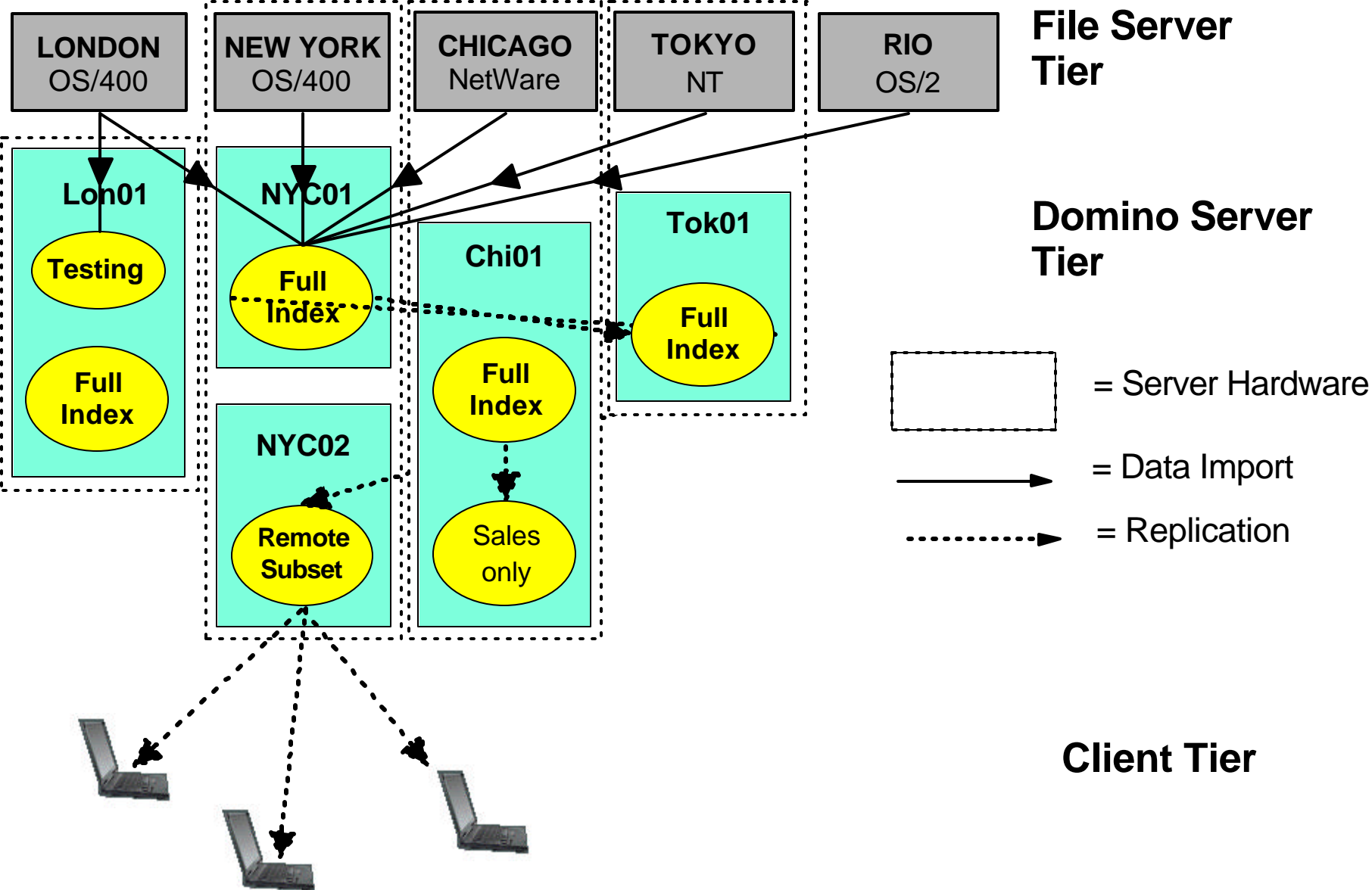

Messaging Migration Issues

- ▶ Migration from MS Exchange to Domino
 - ◆ Notes or iNotes/Outlook options
 - ◆ Standard tools migrate mail and Exchange folders from NT to Domino, e.g. on iSeries
 - ◆ User's NT folder documents remain on NT
 - ◆ Requirement is to consolidate servers
 - ◆ Same applies to other migrations

Document Migration or Coexistence?

▶ Migration Options

◆ 1. Rich Text Field

- Cut and paste text, copy profile to other fields, remap security?

◆ 2. Notes Attachment

- Copy document 'as is', copy profile to other fields, remap security? 3x disk space.

◆ 3. Restructure

- Some WP documents, e.g. product manual, one page per product, table of contents. Create Notes document per page, cut and paste each field, build Views?

◆ You may need all three options

▶ Coexistence Option

- ◆ Migrate the subset you need and provide links from Notes to the documents

Migrate-to-Notes function

- ▶ Notes Administrator:
 - ◆ uses BNDW to find documents
 - ◆ selects document(s) to migrate
 - ◆ migrates documents to Notes attachment
- ▶ What has happened?
 - ◆ Content and index now in same document
 - ◆ Migrated 'as is' (i.e. no content conversion).
 - ◆ Original document is flagged for optional deletion
- ▶ Migration Issues
 - ◆ No access via 5250 or non-Notes clients
 - ◆ No applications based on APIs
 - ◆ Lose text formatting

Migration to Domino.Doc

- ▶ Lotus Domino.Doc
 - ◆ Room, Cabinet, Binders, Folders, Documents
 - ◆ Author, check in/out, review, publish, audit
 - ◆ Document content (usually as Notes attachments)
 - ◆ Document profile (system, security, user data)
 - ◆ Archive content to file system, retain profile
 - ◆ (Does this all sound familiar?)
- ▶ Migration from file system
 - ◆ BNDW converts OS/400 /QDLS profiles to Notes
 - ◆ BNDW migrates content to Notes attachment
 - ◆ Use Domino.Doc client APIs to migrate with profile
 - Plans: automated migration with full field mapping

Development Plans

- ▶ Document Warehouse V2
 - ◆ OS/400 builds cross-platform index to DB2
 - POSIX APIs via QNTC
 - ◆ Three interfaces
 - User: Notes/Domino as at present
 - Admin: ODBC (Access, Approach, etc. for analysis)
 - Admin: iSeries Navigator for file management

OfficeVision/400 Background

- ▶ OV/400 'End of Life'
 - ◆ End of support was 2001
 - ◆ Installing OS/400 V5R1 deletes OV/400
- ▶ Lotus Notes is IBM's upgrade product
- ▶ Customer Requirements
 - ◆ 1. Replacement WP Editor
 - ◆ 2. Notes-based document library interface
 - ◆ 3. Mail and Calendar Data Migration to Notes

OfficeVision/400 Conversion Tool

- ▶ IBM 5620-FHN
- ▶ 1. Replacement WP Editor
 - ◆ New and old documents can stay on OS/400
 - folders are an OS/400 function
 - ◆ PC WP can handle the document types
 - Notes can attach, then view RFT, but not FFT. No edit capabilities. WordPro and Word can edit RFT. AFP Viewer (free) can view FFT.
 - ◆ Issue: no '.EXT' in document names
 - hence 'Open With...' every time
 - ◆ OV/400 Conversion Tool
 - Adds Document Type to profile index. Uses to launch PC applications. Adds '.EXTension' to Attachments for e-mail and Fax.

OfficeVision/400 Conversion Tool, contd.

- ▶ 2. Notes-Based Document Library
- ▶ OV/400 had a 5250 interface to:
 - ◆ OS/400 Document Library Services (DLS)
- ▶ A Document Library Object (DLO) combines:
 - ◆ Document in OS/400 shared folders (/QDLS), plus
 - ◆ Profile in DB2/400 (QUSRSYS)
 - system data (name, path, size, date created, revised, etc.)
 - security data (owner plus public and private authorities)
 - user data (Description, Document Class, Keywords, etc.)
 - ◆ These all help us to find a document
- ▶ OV/400 Conversion Tool.
 - ◆ Adds QDLS profile to index. Provides a Notes interface to folders. Enables migration to Domino.Doc.

OfficeVision/400 Conversion Tool, contd.

- ▶ 3. E-mail & Calendar Migration
- ▶ OV/400 Conversion Tool.
- ▶ Converts e-mail and calendars to documents in folders.
 - ◆ Access via BNDW as usual.
 - Not a full migration tool

BlueNotes Office Portal

- ▶ Sample Notes Welcome Pages (a portal)
 - ◆ Manageable user interface to corporate and departmental intranets, extranets and Internet sites and to personal and workgroup applications
- ▶ Workgroup page
 - ◆ Includes Notes equivalents of OV/400 menu.
- ▶ Based on Notes R5 Portal Builder
 - ◆ Tailorable by administrators and developers
 - ◆ Automatically distributed to users
- ▶ Free feature of OV/400 Conversion Tool

BlueNotes Office Portal

BlueNotes Office Portal - Lotus Notes

File Edit View Create Actions Text Help

Welcome BlueNotes Office Portal - Admin\Layout Setting BlueNotes Office Portal

notes

Edit Tab

Notes Database Catalog for [] Search

Magiparts General IT Office

Document Library

Exit database Expand All Collapse All

Object	Description
TYPEXDEM	
QDLS	
ABNDWDEM	
CAD	
BOAT_HSE.IGR	BOAT_HSE.IGR
PUMP.CGM	PUMP.CGM
RISER.IGR	RISER.IGR
FAX	
B401PP	Birmingham Metropole Hotel
FAX11MAY	Facsimile from 0131 220 3731
FAXAT1	Facsimile from

Personal Address Book

Add Contact Delete Directories Write Memo Schedule

Name	Phones	Bu
Demo, John	Office phone: +44 (0)191 256 4402	Ty De
Petrie, Jerry	Office phone: +44 (0) 191 256 4403 Office fax: +44 (0) 191 226 0252	Ty Se Alt Ne En
Taylor, John	Office phone: +44 (0) 191 256 4406 Office fax: +44 (0) 191 226 0252	Ty Te Alt Ne En

Inbox

Create New Memo

New Memo Reply Delete Folder Copy into

Who	Date	Size	Subject
John Demo	02/12/2000	388	Domino.Doc API Co
John Demo	02/12/2000	351	Flight NCL to LHR
John Demo	02/12/2000	377	Typex Xmas Lunch
LocalDomainServ	02/24/2000	7,543	Subject
John Demo	03/08/2000	358	Prepare presentation

Calendar - Wednesday, October 11, 2000

Schedule a Meeting New Owner Actions Participant Actio

October 2000

Monday	Tuesday	Wednesday	Thursday	Friday	Saturday - Su
25	26	27	28	29	30
2	3	4	5	6	7
9	10	11	12	13	14

To Do

New To Do Item Mark Completed Unmark Completed Delete

To do	Due	Status
Send copy presentations	04/07/2000	Future
Send out presentation copies	03/10/2000	Overdue
What was this all about?	04/04/2000	Current
Prepare presentation	03/09/2000	Complete

Office

FAQs

- ▶ Q. Can I access the rest of the IFS?
 - ◆ In development for Root, QOpenSys, QNTC, etc..
- ▶ Q. Languages?
 - ◆ All supported SBCS languages can be replicated. Notes panels in major European languages.
- ▶ Q. Document limits?
 - ◆ Tested with 1.2 million, no limit reached
- ▶ Q. Support for UNIX/Linux?
 - ◆ Yes. Tested with IBM Hursley laboratory
- ▶ Q. Web Enabled?
 - ◆ Yes. Download or Open. Content may require PC editor or viewer. Alternative to Notes client

Document Warehouse for Domino

- ▶ Document Warehouse for Notes Documents
- ▶ Multiple Notes databases
 - ◆ Document Library
 - ◆ Discussion
 - ◆ Email
 - ◆ Domino.doc
 - ◆ CRM, etc.
- ▶ Separate product

Document Warehouse for the Web

- ▶ Team Web Bookmarks
 - ◆ Bookmarked Web URLs
 - ◆ Indexed by Domino, not the browser
 - ◆ Shareable
 - ◆ Multiple categorisations
 - ◆ Securable views by Group membership
- ▶ Document Warehouse for Web Documents
- ▶ Categorisation by Taxonomy
- ▶ Separate Module

MailStore for Domino

- ▶ Shared incoming and outgoing mail store
 - ◆ e.g. logging customer interactions in CRM
- ▶ Auto filing option
- ▶ Categorisation by Taxonomy
- ▶ Separate product

Global Catalog - a single view

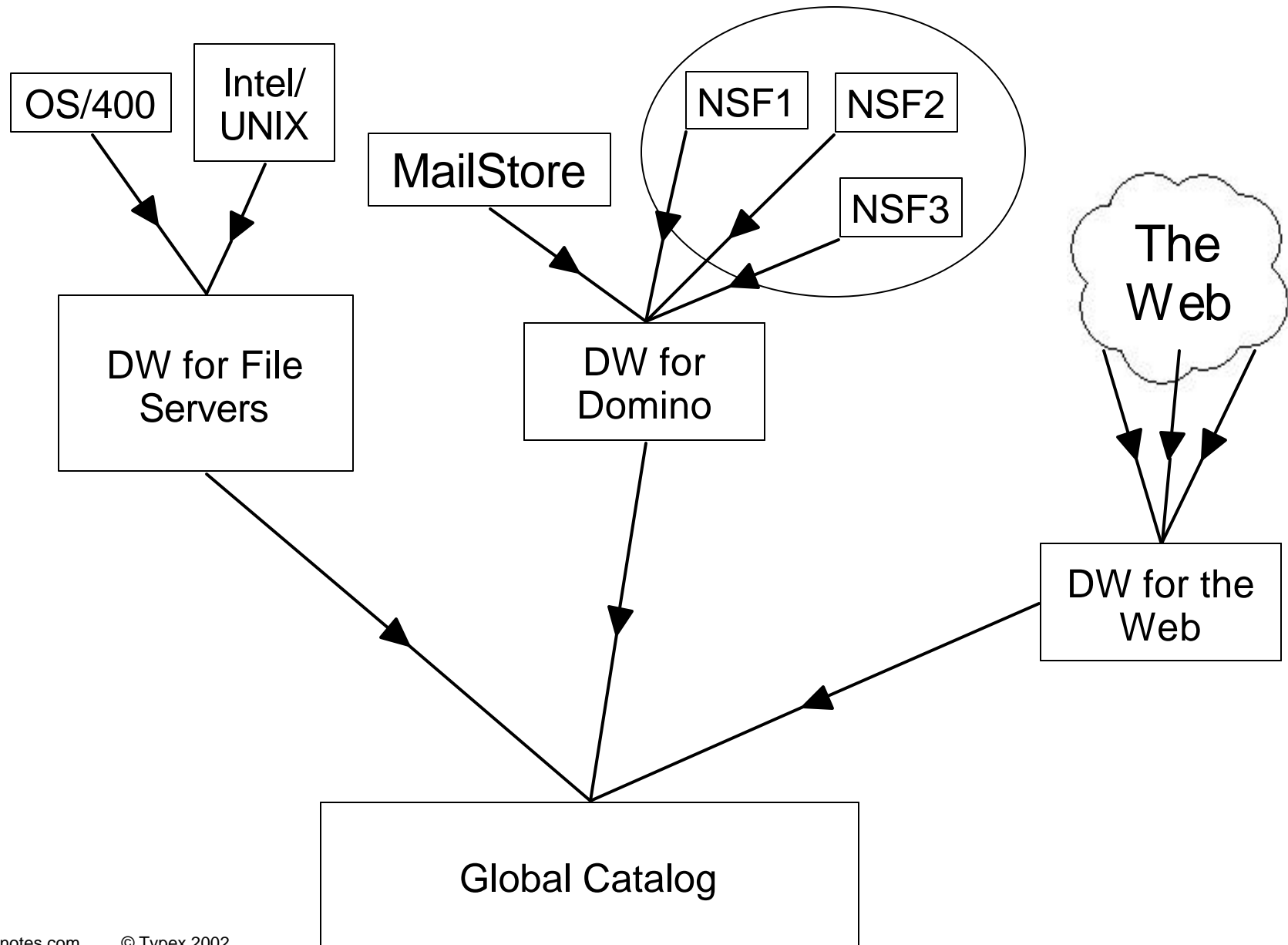

Summary: Document Integration Products

- ▶ BlueNotes Document Warehouse
 - ◆ Notes & Domino integration with:
 - File Server documents
 - OS/400 Integrated File System
 - Intel
 - UNIX/Linux
 - and later:
 - Domino documents and applications
 - Web pages

Product Positioning

- ▶ Domino and OS/400 customers
 - ◆ Messaging Migration and Coexistence
 - OS/400 and MS Exchange to Domino and Domino.Doc
 - ◆ CRM
 - logging customer interactions
 - ◆ Remote & Mobile
 - Reduces server hits and network traffic. Faster responses
 - ◆ e-business
 - e-Catalog delivers multimedia product info to the Web
 - ◆ Server Consolidation
 - Consolidated view of files on many servers
 - find old, unowned or duplicate files
 - ◆ Knowledge Management
 - know it, then manage it, but first find it

Document Warehouse Benefits

- ▶ Users
 - find documents
- ▶ Developers
 - modernise applications
- ▶ Administrators
 - reduce helpdesk load
 - do document housekeeping
 - reduce server hits
 - reduce network load
 - consolidate servers
 - migrate documents to Notes

Data Integration Products



What problems are we solving?

- ▶ How can I mass produce letters, emails, reports and statements in Notes?
- ▶ How can I distribute these based on customer preferences?
- ▶ How can I get Domino to print?
- ▶ How can I quickly import data to Notes?

What is Data/Text Merge?

- ▶ Databases contain structured information
 - ◆ names, addresses, amounts
 - easy to sort, select, calculate
- ▶ Documents contain unstructured information
 - ◆ words, sentences, paragraphs
 - easy to format
- ▶ Sometimes we need the combination
 - ◆ We want 'data-driven' documents where the text varies based on the data content

Merge Form Types

- ▶ Letter or Label
 - one record per document
 - e.g. Marketing Letters and labels, Credit Control letters
- ▶ Report
 - one record per line
- ▶ Statement
 - one master record per document
 - e.g. customer
 - one secondary record per line
 - e.g. invoice item

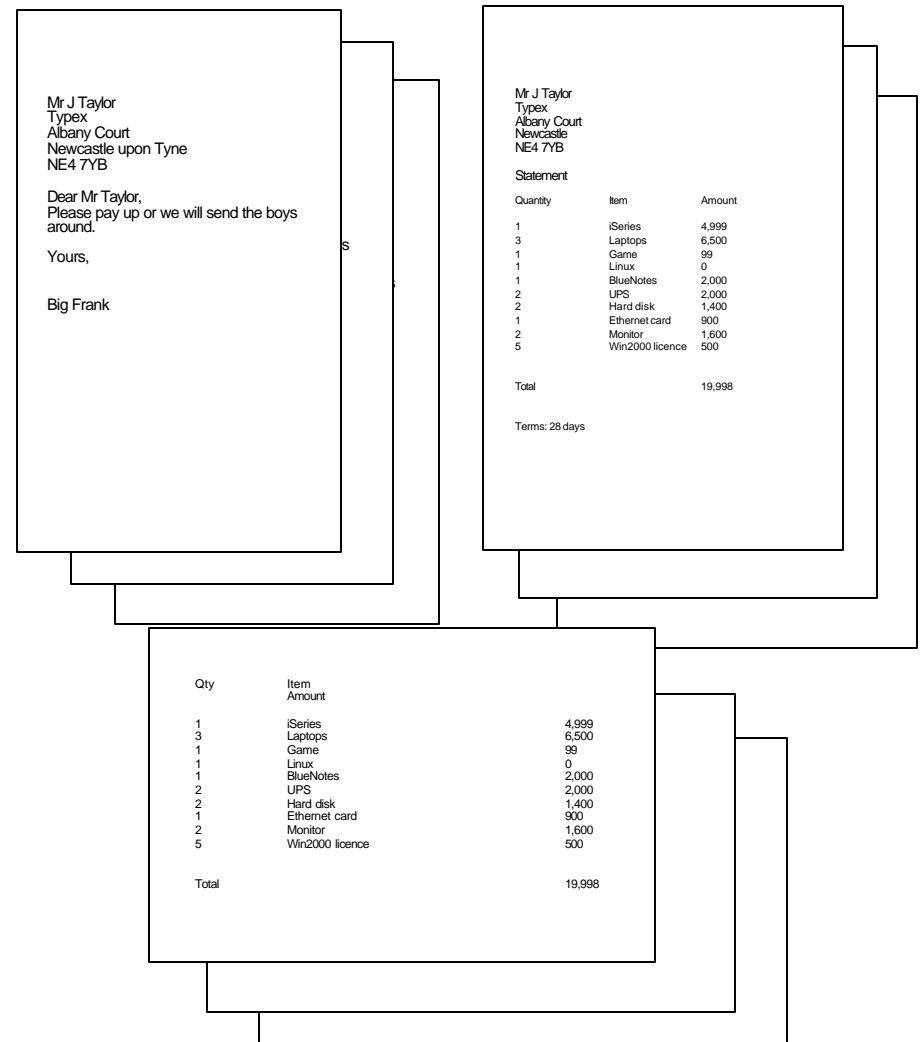

What problems are we solving?

- ▶ Existing Data/text merge tools
 - ◆ RPG, OfficeVision, Word... all create a single spool file per set of documents
 - Hence, print is usually the only direct option
 - ◆ All require database files
- ▶ The world has changed. We need:
 - ◆ individual customer preferences
 - ◆ new options, e.g. print, fax, e-mail, Web, workflow. WAP, SMS
 - ◆ faster speeds
 - ◆ access to Directories

BlueNotes Direct Messaging

- ▶ Notes-based data/text merge tool (was IBM BNDM)
 - ◆ 1. Notes-based form design
 - User design option
 - Prompt for files, fields. Record selection.
 - Developer design option
 - sample forms incl. EBPP. Field mapping
 - ◆ 2. Notes or Domino Merge with database
 - any ODBC, e.g. DB2/400, MS Access, Oracle
 - any Notes/Domino database incl. Directory
 - ◆ 3. Merge to Individual Notes Documents
 - ◆ 4. Output to variable targets
 - print, fax, e-mail, Notes applications and the Web
 - one operation based on predefined preferences

Direct Messaging ScreenCam



BlueNotes DataPump

- ▶ New Product
 - ◆ subset of Direct Messaging function
- ▶ Relational to Notes Database
 - ◆ Define ODBC database selection or SQL
 - ◆ Select target Notes database
 - ◆ Include relevant form
 - ◆ Map fields
 - ◆ Click to populate, e.g. CRM database
- ▶ Lightning fast!
 - ◆ Half the time of DECS to define
 - ◆ 30X the speed to run

BlueNotes Data Products

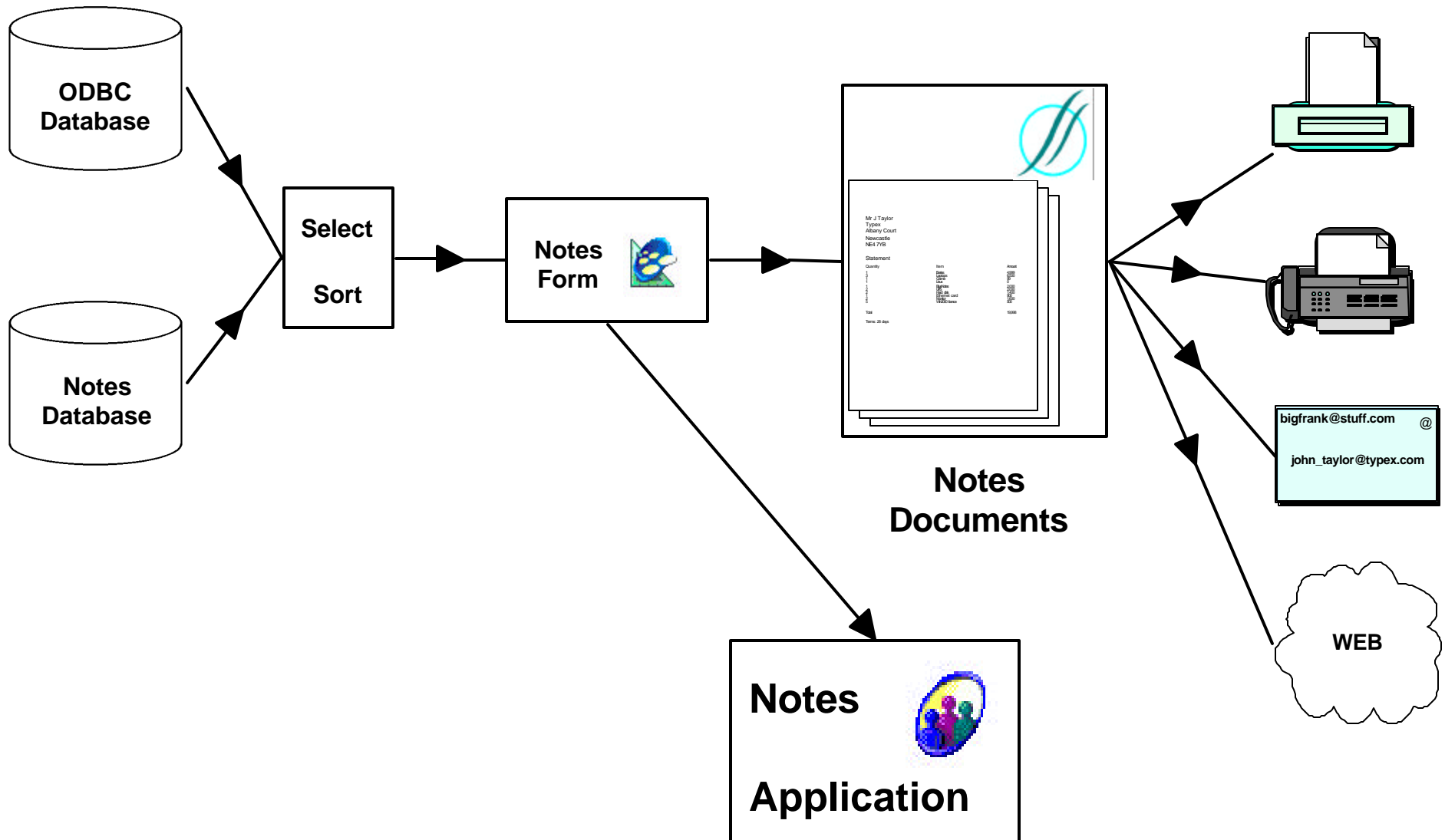

OfficeVision/400 Issues

- ▶ Many apps use OV/400 data/text merge
- ▶ Notes is IBM's follow-on product and is a basis for application development and e-commerce
- ▶ Notes options might include
 - ◆ Driving merge from Notes workflow
 - ◆ SQL access to DB2 Universal Database for AS/400
 - ◆ Linking OS/400 files with Notes data
 - ◆ Logging correspondence in client files
- ▶ We want to replace OV/400 function and restructure applications to use new functions

Choosing an OV/400 Replacement

- ▶ BlueNotes Direct Messaging
 - ◆ Notes interface
 - ◆ Simple to use, fast, low cost, versatile
- ▶ Other data/text merge tools
 - ◆ available for:
 - 5250 and client-server interfaces
 - existing shells and commands
 - ◆ not as competitively priced
 - ◆ may not offer as many output options
- ▶ White Paper at OV/400 Migration web site
 - ◆ www.dominodotoffice.com

FAQs

- Q. What about performance?
 - Tested using DB2/400 to over 500K letters per hour. This is approx. 30X the speed of OS/400 data/text merge or DECS.
- Q. Can I reuse existing OS/400 text shells?
 - Text, but not instructions, can be cut and pasted. Exploit the superior reformatting and output options with Notes.
- Q. Must I run Domino on iSeries?
 - No, any Notes client or Domino server can run BNDM.
- Q. Can I reuse existing OS/400 Queries?
 - Not in plan. New DB2 UDB for OS/400 functions require SQL, not Query. SQL is supported.
- Q. Am I restricted to DB2/400 files?
 - No, any ODBC source is valid, e.g. SQL Server, Oracle; also any Notes or Domino database including Directory
- Q. How can I get Domino to print?
 - It can't. Direct Messaging uses a print engine client.

Development Plans

- ▶ SMS support
 - ◆ send a text message to a mobile phone
- ▶ WAP support
 - ◆ display as Web page on mobile phone
- ▶ ASP enablement
 - ◆ enable for hosting services

Summary - Data Integration Products

- ▶ BlueNotes Direct Messaging
 - ◆ Notes integration with:
 - any ODBC database
 - including DB2/400
 - any Domino Database
 - including Domino Directory
- ▶ BlueNotes DataPump
 - ◆ Data integration and population
 - Relational-to-Notes and Notes-to-Notes data transfer

Product Positioning

- ▶ Domino and OS/400 Customers
 - ◆ Messaging Migration and Coexistence
 - especially OV/400
 - ◆ e-business
 - Intelligent e-mail
 - e-mail, fax, Notes, Web publishing, WAP/SMS
 - Electronic Bill Presentation & Payment (eBPP)
 - Send invoice or statement as secure Web document.
 - Add options to approve payment
 - Replace greenbar with online viewing
 - ◆ CRM contact management
 - import data
 - intelligent messaging and logging the message
 - ◆ AD Tool

Workflow Products



What problems are we solving?

▶ Managers

- Do you give instructions that are not carried out?
- Do you find that out in time to fix it?
- Can you remember what you asked for?
- Can you manage your staff effectively?

▶ Everyone

- Are you asked to do too much?
- Do the orders come from all sides?
- Are the timescales unreasonable?
- Do you need to prioritise your work?
- Can you manage your time effectively?



Analysis of problems

- ▶ Notes has task management function
 - ◆ calendar, To Do, etc.
- ▶ We need to manage
 - ◆ small projects
 - ◆ business processes
- ▶ but, PM tools...
 - ◆ are too complex
 - ◆ don't integrate with our routine work in Notes
- ▶ We need enterprise task management

BlueNotes Task Manager V1R1

- ▶ Enterprise 'To Do' List Management
 - ◆ The Manager
 - defines tasks, relationship and duration
 - allocates tasks to people
 - checks calendar free time for simple Critical Path Analysis
 - sends task requests (Group To Do) to...
 - ◆ Team Members
 - who accept, decline, delegate, propose new time
 - prioritise with other Personal and Group To Do's
 - check their availability and schedule tasks in calendar
 - notify completion
 - ◆which updates the Manager's schedule

BlueNotes Task Manager Pre-Release Demo



Development Plans

- ▶ Pervasive/mobile-enabled subset
 - ◆ Return completion messages only
 - ◆ Auto-send next task on completion
 - ◆ Task scheduling, e.g. service visits, deliveries, etc
- ▶ OS/400-Driven Tasks
 - ◆ e.g. new DB2 customer record triggers action for salesman to call
- ▶ Drive OS/400 Tasks
 - ◆ e.g. completion of Notes task generates OS/400 spool file

Product Summary

- ▶ BlueNotes Task Manager
 - ◆ Corporate 'To Do's for Notes users
 - ◆ Simple project and process management

Product Positioning

- ▶ Notes/Domino Customers
 - ◆ Team workers
 - ◆ Workforce schedulers, e.g. delivery firms, service operations, etc.

CRM Products



BlueNotes iContact

- ▶ Company & Contact Tracking
 - ◆ Prospects, clients, suppliers and partners
 - ◆ Company categorisation by SIC code, annual spend, geography, etc.
 - ◆ E-mails, telephone calls and meetings held as record against each contact, integrated with Notes e-mail and calendar
 - ◆ E-mail confirmation to client of meetings
 - ◆ General notes against the Company or Contact
 - ◆ Actions against Companies or Contacts are integrated with your To Do List.
 - ◆ Revision history automatic for all documents.
 - ◆ All documents support OLE

iContact, cond.

- ▶ Marketing Functions
 - ◆ Extensive support for Telemarketing operations.
 - ◆ Marketing Campaigns stored as separate documents, along with the actual literature used in the campaign
 - ◆ Target companies selected and assigned to campaign in one operation.
 - ◆ For telemarketing follow up of campaigns, a script can be recorded, and this script automatically picked up when phone calls are made
- ▶ Sales Functions
 - ◆ Full Lead and Quote tracking by account manager
 - ◆ Sales forecasting

Customisation

System Options - Lotus Notes

File Edit View Create Actions Text Help

Welcome Typex iContact - 1. Companies\lb. Details System Options

Save Close Go To Navigator... Enable Background Agents

System Details

Company Name	Typex Group plc	Industry Sector	Integrated Collaboration through Networking
---------------------	-----------------	------------------------	---

Look-Up Lists

Annual Turnover Bands (£m)	0-1 1-10 10+	Annual Industry Spend Bands (£m)	
Sales Areas	Hardware Software Services	Lead Sources	Sales Force 0800 Web Referral
Reasons for Phone Call	Initial enquiry Order Order query Complaint	Results of Phone Call	
SIC Codes	Agriculture Mining Construction Manufacturing Transportation Communications Utilities Wholesale Retail Finance Insurance Real Estate Services Government	Information Types	
Job Roles	Managing Director Finance Director Sales Manager	Purchasing Roles	Buyer Influencer

iContact Product Positioning

- ▶ Notes/Domino customers
- ▶ Business-to-Business operations
- ▶ Full function
 - ◆ Contact, Sales and Marketing Management
 - ◆ High function Direct Marketing option
 - Direct Messaging
- ▶ Mid-market
- ▶ Rapid Implementation
 - ◆ DataPump population
 - ◆ Customisable

Putting It All Together

The box that does the work of many



BlueNotes Family

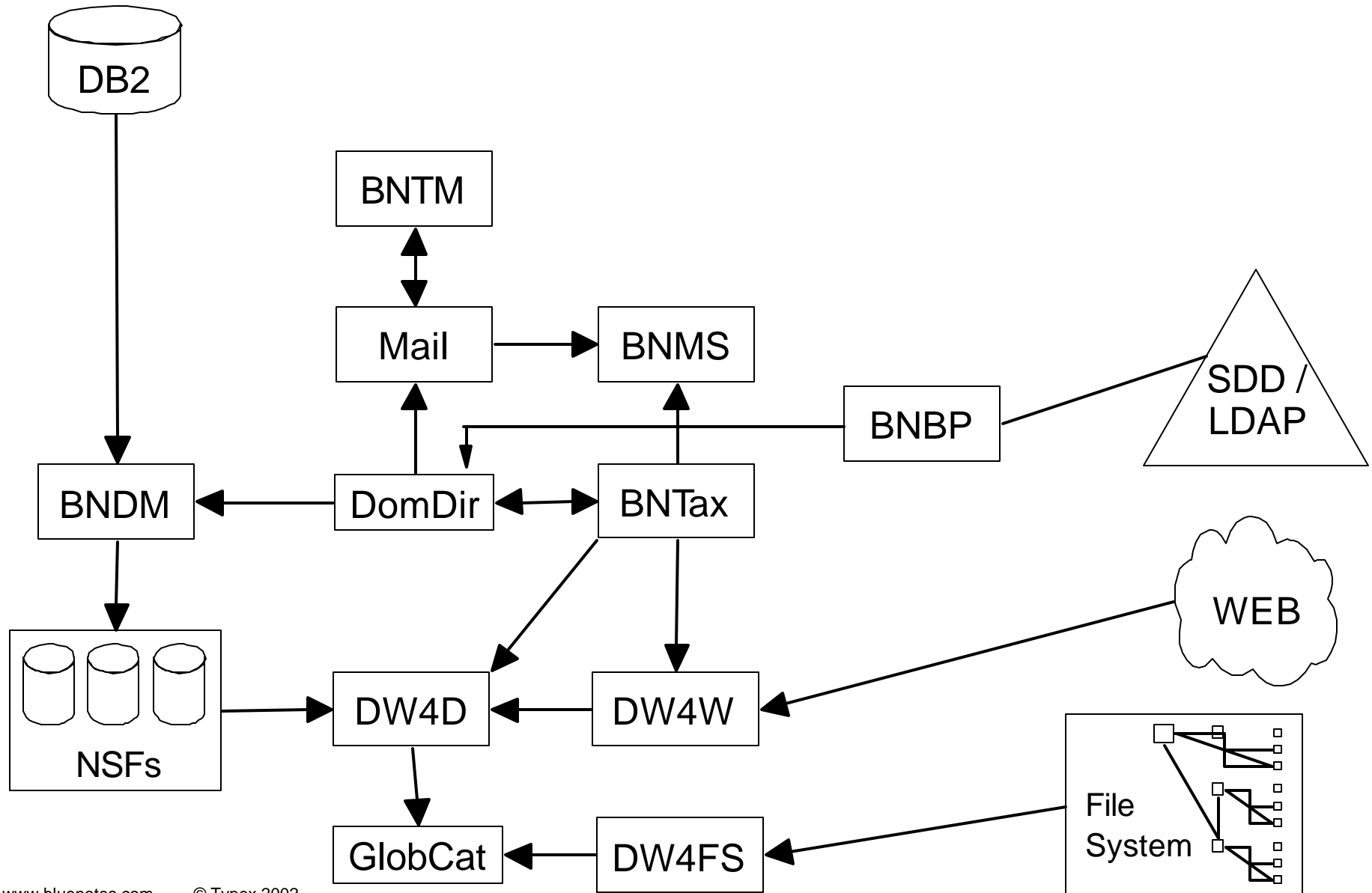

BlueMagic Box

- ▶ Why is iSeries the Magic Box?
 - ◆ It can combine multiple workloads (and even operating systems) on a single server
 - the OS/400 SuperServer
- ▶ What is BlueMagic Box?
 - ◆ It is what the Magic Box can become with the power of Domino and BlueNotes
 - e.g. share knowledge with your customers over the Web
 - Only limited by your imagination

BlueNotes BlueMagic

- ◆ Sample functions
 - file & print (MS Office, AFP & migration)
 - groupware (Domino and BlueNotes)
 - fax (FxD)
 - Internet E-mail, browse and Web site (ESPresso)
 - low end datamart (Access/Approach)
 - automated sys ops (Op Assist/Ops Nav)
 - firewalled DMZ (e.g. Linux)
 - Web Server (e.g. Domino)
 - AT&T connectivity
- ◆ Positioning
 - departmental
 - branch (+ 5494 & PC replacement)
 - SMB (mid-market)

BlueMagic Box

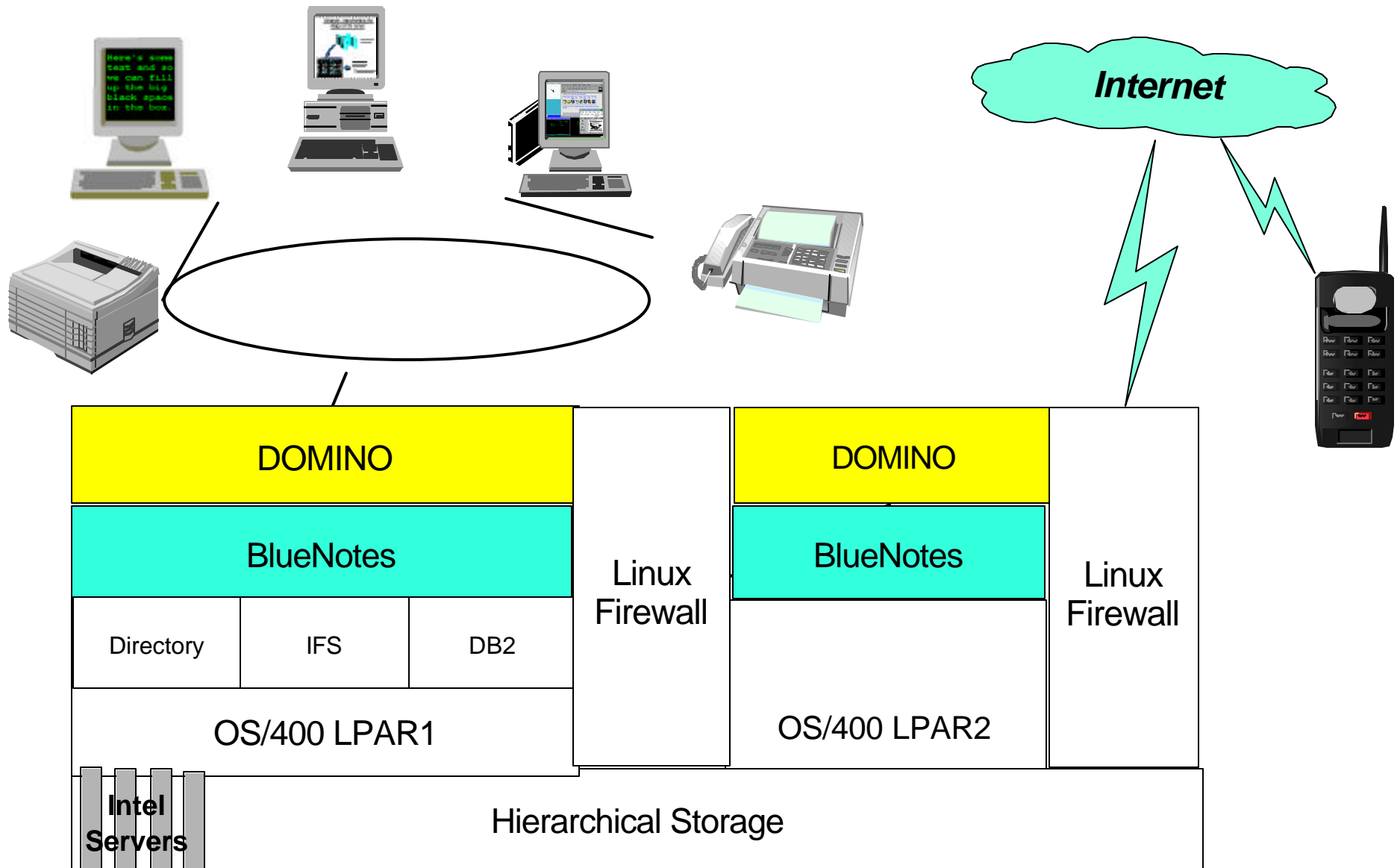

BlueNotes Suite Summary, Support, Pricing, Ordering & Information



Product Positioning Summary

	Docs	Data	Directory	Workflow	iContact	Blue Magic
Messaging Migration	Y	Y	Y			
Server Consolidation	Y		Y			Y
CRM	Y	Y	Y	Y	Y	
Knowledge Management	Y		Y			
Collaborative e-business	Y	Y	Y	Y		Y
Home/mobile Working	Y	Y	Y	Y		Y

Customer Technical Support

- ▶ Simple products to install and maintain
 - ◆ Document Warehouse requires basic OS/400 and Notes admin skills
 - ◆ Direct Messaging requires basic ODBC and Notes admin skills
 - ▶ High quality code
 - ◆ Still supported as LPP by IBM Raleigh via ASSIST. Very few calls. Only one code defect in 2 years. Developers support latest version directly
 - ▶ IBM/Business Partner
 - ◆ May offer additional support and tailoring plus application integration
 - ◆ 200+ IBM-trained IBM/BPs listed at OV/400
- Migration Web site: www.dominodotoffice.com

Ordering

- ▶ From IBM or IBM Business Partners
 - Document Warehouse for OS/400, IBM 5620-FHM
 - One licence per file server. Processor-based pricing. No Domino or client-based charges.
 - Server Consolidation Bundle - free products to 12/2002
 - ▶ Document Warehouse for MultiPlatforms
 - ▶ Directory Synchronisation for OS/400
 - OfficeVision/400 Conversion Tool, IBM 5620-FHN
 - OV/400 Conversion Bundle - free products to 12/ 2002
 - ▶ Direct Messaging
 - ▶ Office Portal
- ▶ Direct from Developers
 - Free upgrade from IBM 5697-F08 OV/400 Migration Tools BlueNotes features (BNDW and BNDM)
 - Full family. Only if difficulty with IBM order

More BlueNotes information

- ▶ IBM/Lotus Product Information
 - Announcement Letters, software configurator, pricing tools, etc.. Domino 'Using this database' documentation
- ▶ www.bluenotes.com
 - FAQs, ScreenCams, Demos, Licensed Program Specifications, Documentation (PDF), Sales & Marketing Materials
- ▶ Come to:
 - iSeries Technical Conferences and Forum, COMMON Conferences, Lotusphere

More Info: Conference

- ▶ Related Conference Sessions
 - DP17 OfficeVision/400 Died with V5R1
 - DP18 Notes from the Beach
 - EP03 Introduction to LDAP and its implementation and use on iSeries

Close

- ▶ E-mail:
 - ◆ info@typex.com
 - ◆ john_taylor@typex.com
- ▶ Telephone
 - ◆ +44 (0)191 256 4406
- ▶ Evaluation Forms please, while you think about....
- ▶ Questions