



z/VSE Live Virtual Class Series

Bringing you up-to-date with z/VSE V4

z/VSE Live Virtual Class Series

October 18, 2007

G. M. (Jerry) Johnston
Senior Advisor – Boeblingen Lab

Trademarks

Trademarks

The following are trademarks of the International Business Machines Corporation in the United States and/or other countries. For a complete list of IBM Trademarks, see www.ibm.com/legal/copytrade.shtml: AS/400, DBE, e-business logo, ESCO, eServer, FICON, IBM, IBM Logo, iSeries, MVS, OS/390, pSeries, RS/6000, S/30, VM/ESA, VSE/ESA, Websphere, xSeries, z/OS, zSeries, z/VM

The following are trademarks or registered trademarks of other companies

Lotus, Notes, and Domino are trademarks or registered trademarks of Lotus Development Corporation
Java and all Java-related trademarks and logos are trademarks of Sun Microsystems, Inc., in the United States and other countries
LINUX is a registered trademark of Linux Torvalds
UNIX is a registered trademark of The Open Group in the United States and other countries.
Microsoft, Windows and Windows NT are registered trademarks of Microsoft Corporation.
SET and Secure Electronic Transaction are trademarks owned by SET Secure Electronic Transaction LLC.
Intel is a registered trademark of Intel Corporation
* All other products may be trademarks or registered trademarks of their respective companies.

NOTES:

Performance is in Internal Throughput Rate (ITR) ratio based on measurements and projections using standard IBM benchmarks in a controlled environment. The actual throughput that any user will experience will vary depending upon considerations such as the amount of multiprogramming in the user's job stream, the I/O configuration, the storage configuration, and the workload processed. Therefore, no assurance can be given that an individual user will achieve throughput improvements equivalent to the performance ratios stated here.

IBM hardware products are manufactured from new parts, or new and serviceable used parts. Regardless, our warranty terms apply.

All customer examples cited or described in this presentation are presented as illustrations of the manner in which some customers have used IBM products and the results they may have achieved. Actual environmental costs and performance characteristics will vary depending on individual customer configurations and conditions.

This publication was produced in the United States. IBM may not offer the products, services or features discussed in this document in other countries, and the information may be subject to change without notice. Consult your local IBM business contact for information on the product or services available in your area.

All statements regarding IBM's future direction and intent are subject to change or withdrawal without notice, and represent goals and objectives only.

Information about non-IBM products is obtained from the manufacturers of those products or their published announcements. IBM has not tested those products and cannot confirm the performance, compatibility, or any other claims related to non-IBM products. Questions on the capabilities of non-IBM products should be addressed to the suppliers of those products.

Prices subject to change without notice. Contact your IBM representative or Business Partner for the most current pricing in your geography.

References in this document to IBM products or services do not imply that IBM intends to make them available in every country.

Any proposed use of claims in this presentation outside of the United States must be reviewed by local IBM country counsel prior to such use.

The information could include technical inaccuracies or typographical errors. Changes are periodically made to the information herein; these changes will be incorporated in new editions of the publication. IBM may make improvements and/or changes in the product(s) and/or the program(s) described in this publication at any time without notice.

Any references in this information to non-IBM Web sites are provided for convenience only and do not in any manner serve as an endorsement of those Web sites. The materials at those Web sites are not part of the materials for this IBM product and use of those Web sites is at your own risk.

Agenda

- § 2007 in Review
- § z/VSE Version 4 Release 1
- § z/VSE V4.2 Preview
- § Encryption Facility for z/VSE
- § VSE “PIE” Strategy
- § Summary/Wrap-up
- § Q&A

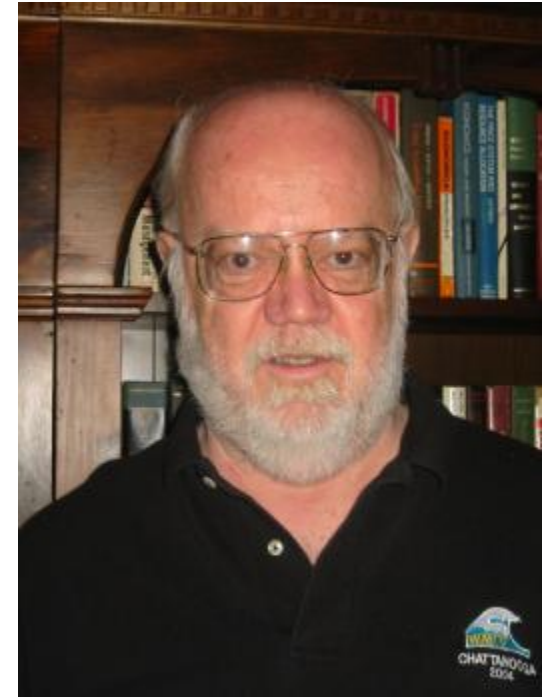



2007 in Review



Announcements Since the February Call

§ February 2007

- z/VM V5.3, Announce
- End-of-Service (EoS) for VSE/ESA V2.7, effective 2/28/2007

§ March 2007

- z/VSE V4.1 with MWLC pricing on z9, GA 3/16/2007

§ April 2007

- IBM System z9 EC and z9 BC enhancements

§ May 2007

- z/VSE V4.1, GA support for TS1120

§ June 2007

- z/VSE V3.1, GA support for TS1120
- End-of-Marketing (EoM) for z/VSE V3.1, effective 5/31/2008
- z/VM V5.3, GA 6/29/2007

§ August 2007

- EoS for z/VSE V3.1, effective 7/31/2009

§ October 2007

- **z/VSE V4.2, Preview 10/9/2007**
- **Encryption Facility for z/VSE V1.1, Announce 10/9/2007 and GA 11/30/2007**
- **SCRT V14.2 running on z/VSE V4.1, GA 10/10/2007**



z/VSE Version 4 Release 1



z/VSE Version 4 Release 1

§ **General Availability 3/16/2007** (Announce 1/9/2007, Preview 4/27/2006)

§ **z/Architecture mode only**

- 64-bit *real* addressing (31-bit *virtual* addressing)
 - up to 8 GB real processor storage
- IBM System z9 EC and z9 BC servers
- IBM eServer zSeries 990, 890, 900, and 800 servers

§ **New MWLC pricing metrics (z/VSE V4 on z9 EC and z9 BC only)**

- Improved price/performance with full-capacity MWLC price points
- Sub-capacity MWLC option for added price/performance

§ **Encryption enhancements**

- CPACF enhancements (AES-128)
- Configurable Crypto Express2 (new accelerator option)
- SecureFTP
- IBM System Storage TS1120 encrypting tape

§ **Security and Auditability enhancements**

§ **SOA and Interoperability**

§ **FSU from z/VSE V3.1 and VSE/ESA V2.7**

§ **Requires z/VM V5.2 (or later) if running as a VM guest**



Midrange Workload License Charge (MWLC)

§ Requires current hardware (IBM System z9 EC or z9 BC) & software (z/VSE V4)

- exception: z9 BC Capacity Setting A01 remains zELC

§ VSE Central Functions + 12 IBM middleware products are eligible

– 5686 CF8	VSE Central Functions	– 5686 068	IBM COBOL for VSE/ESA
– 5696 234	HLASM	– 5686 A01	IBM C for VSE/ESA
– 5648 054	CICS TS for VSE/ESA V1	– 5686 069	IBM PL/1 for VSE/ESA
– 5686 065	ACF/VTAM® VSE/ESA V4	– 5746 SM3	IBM DFSORT/VSE V3
– 5686 A04	TCP/IP for VSE/ESA V1.5	– 5746 XX1	DL/I VSE
– 5648 099	DITTO/ESA® for VSE	– 5686 A06	MQSeries® for VSE/ESA
– 5697 F42	DB2 Server for VSE & VM		

§ Full-Capacity and Sub-Capacity MWLC options

§ Full-Capacity mode offers improved price/performance compared to GOLC, zELC, and TWLC

§ Additional price/performance may be possible using Sub-Capacity option

- Sub-Capacity usage based on peak 4 hour rolling averages each month
- Customers must measure each LPAR & VM and report monthly on a timely basis
- Measurement data is analysed by Sub-Capacity Measurement Tool (SCRT)



MWLC Sample Stack vs. TWLC and FWLC

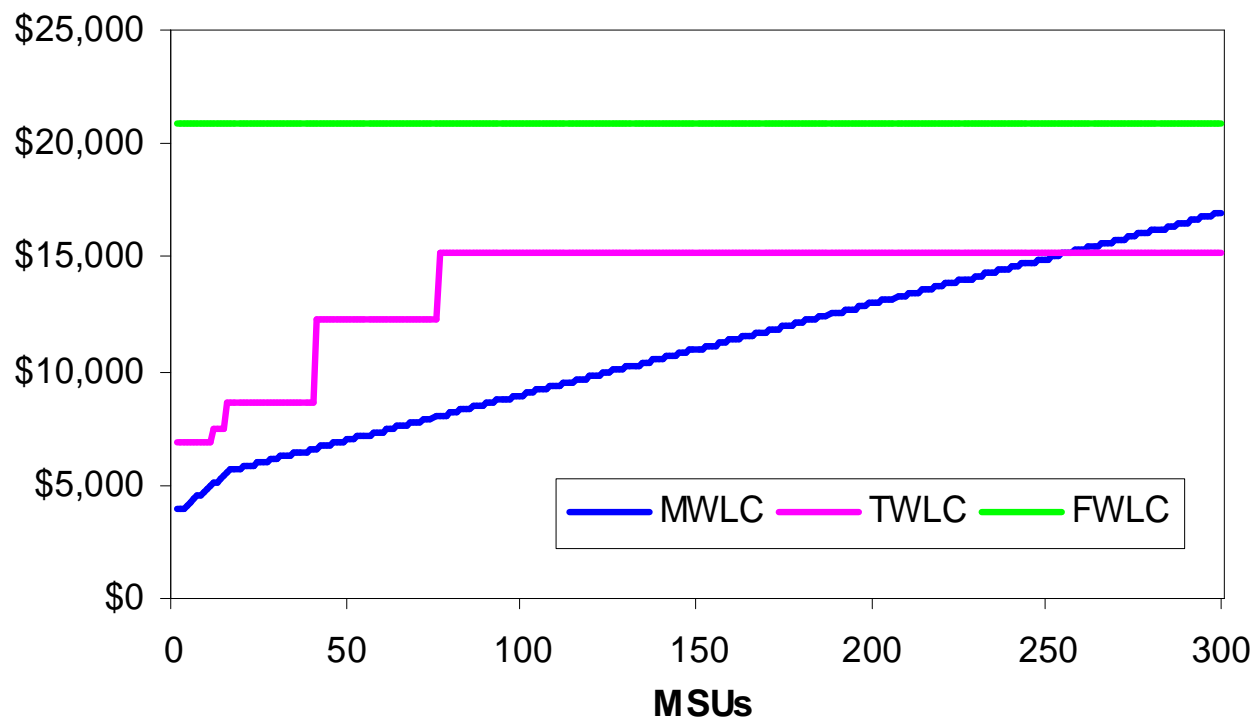

- § Customers may choose between MWLC/TWLC or MWLC/FWLC as appropriate to their machine
- § Additional price/performance may be possible with sub-capacity mode

*Sample software stack includes: VSE CF V8, HLASM, VTAM, DITTO, COBOL

*Prices subject to change without notice; all prices shown in USD

MWLC Sample Stack vs. TWLC and FWLC

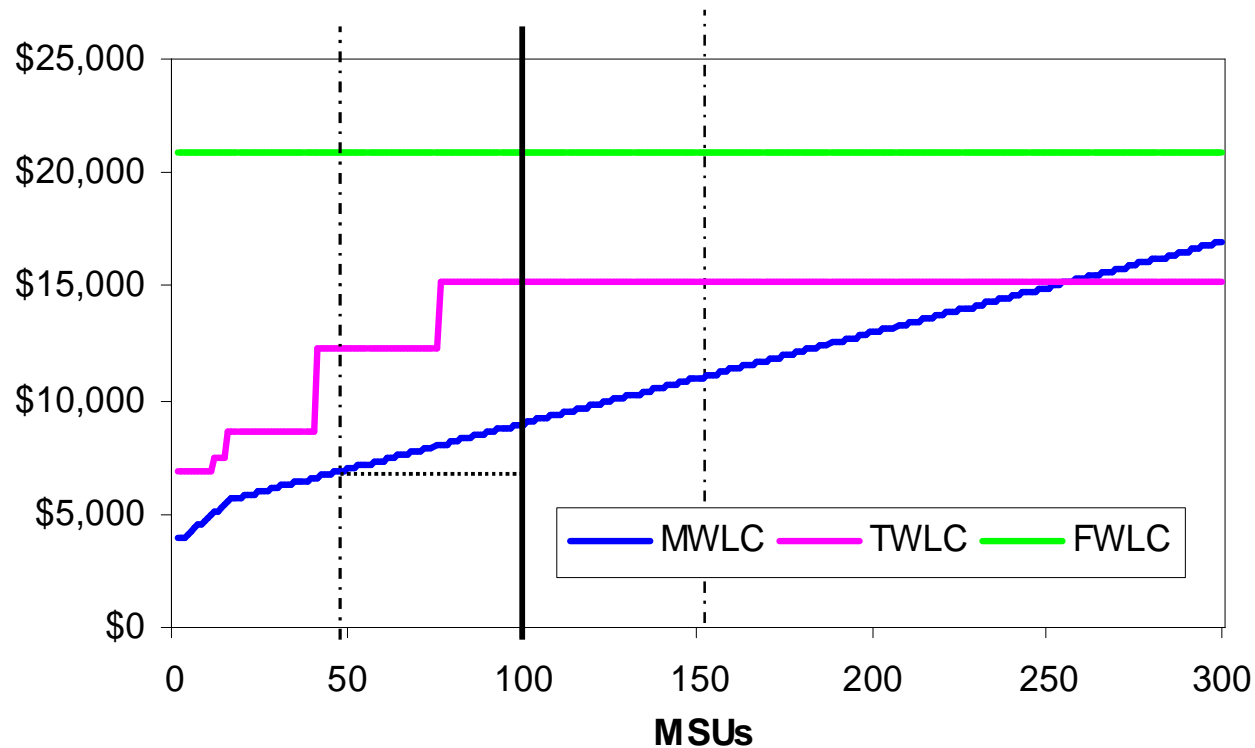

- § Customers may choose between MWLC/TWLC or MWLC/FWLC as appropriate to their machine
- § Additional price/performance may be possible with sub-capacity mode

*Sample software stack includes: VSE CF V8, HLASM, VTAM, DITTO, COBOL

*Prices subject to change without notice; all prices shown in USD

IBM TS1120 Tape Drive Encryption

§ IBM System Storage TS1120 - first encrypting tape drive

- Standard feature on new TS1120 tape drives
- Supports “traditional” and “encrypted” modes of operation
 - encryption “disabled” unless otherwise specified
- Implements data encryption using AES-256 encryption
- Data is automatically compressed *then* encrypted – no change in media utilization
- Encryption performed with minimal (< 1% data rate performance impact)



TS1120
500 GB
100 MB/sec

§ Systems Managed Encryption with z/VSE V4.1 (or later) & V3.1

§ IBM Encryption Key Manager (EKM) for Java platform™

- EKM stores and manages *labels* and *key encrypting keys*
 - runs on z/OS, AIX, Linux (incl System z), i5/OS, HP, Sun, & Windows
- Secure TCP/IP connection between EKM and TS1120
- ESM supplies data encrypting keys to TS1120 on request
- TS1120 encrypts files using data encrypting key
- TS1120 stores *encrypted* data encrypting key on cartridge
 - EKM *does not* store data encryption keys
 - data encryption keys are stored on cartridge using one or two key encrypting keys

Encryption Key
Manager



IBM Tape Encryption – TS1120

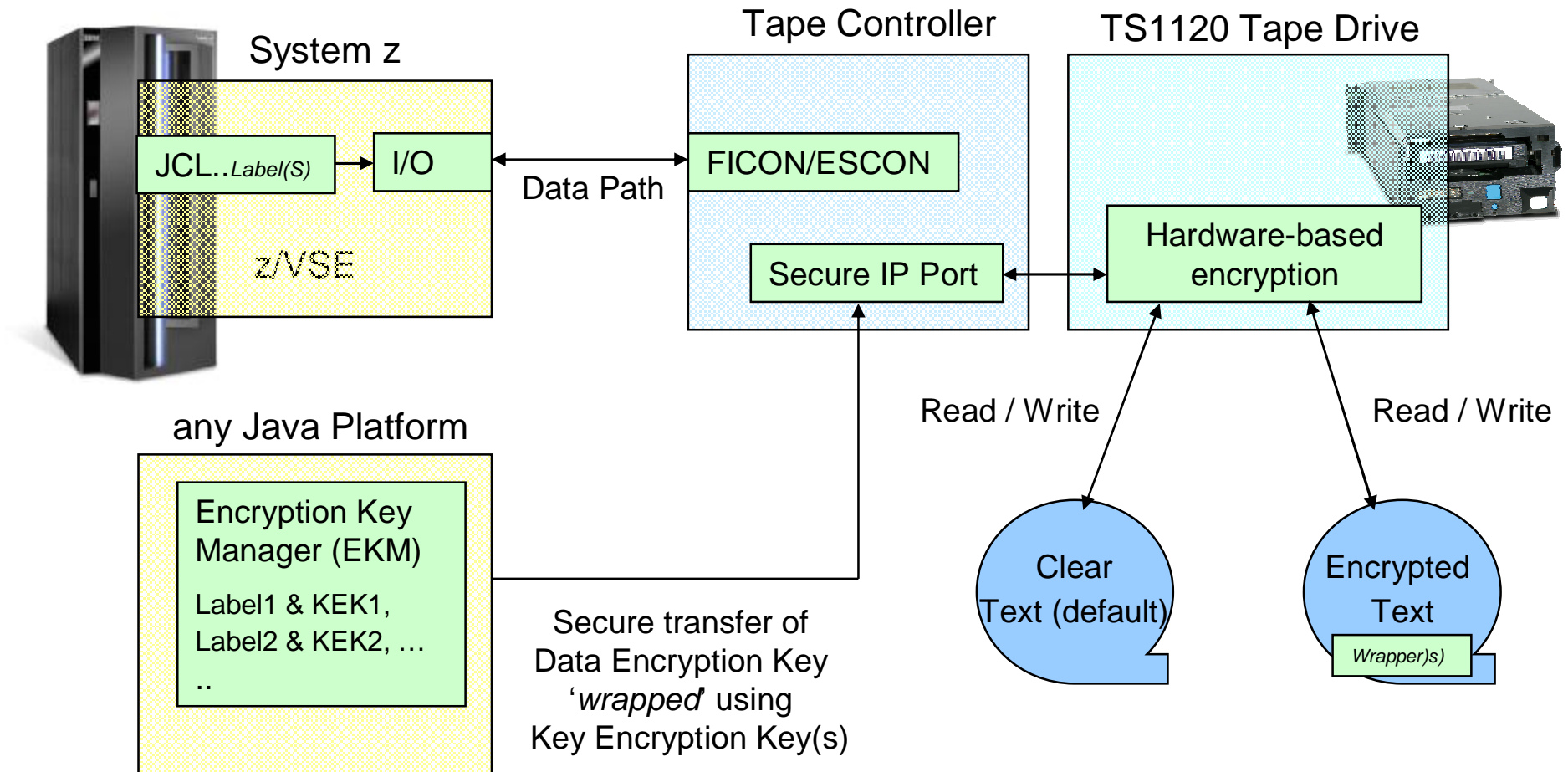

z/VSE Support for Mainframe Servers

IBM Servers	z/VSE V4.1 & V4.2	z/VSE V3.1 (1), (2)
IBM System z9 Enterprise Class (z9 EC, formerly z9-109)	Yes	Yes
IBM System z9 Business Class (z9 BC)	Yes	Yes
IBM eServer zSeries 990, 890, 900, 800	Yes	Yes
S/390® Parallel Enterprise Server™ G5/G6	No	Yes
S/390® Multiprise® 3000	No	Yes

Note 1: z/VSE V3 can operate in 31-bit mode only. It does not implement z/Architecture and specifically does not implement 64-bit mode capabilities. z/VSE V3 is designed to support selected features of IBM System z hardware.

Note 2: z/VSE V3 marketing ends 5/31/2008, support ends 7/31/2009;

z/VSE Status

VSE Version and Release	Marketed	Supported	End of Support
z/VSE V4.2	tbd	tbd	tbd
z/VSE V4.1	Yes	Yes	tbd
z/VSE V3.1	Yes... until 5/31/2008	Yes ... until 7/31/2009	07/31/2009
VSE/ESA V2.7	No	No	02/28/2007

Press and Analyst Statements

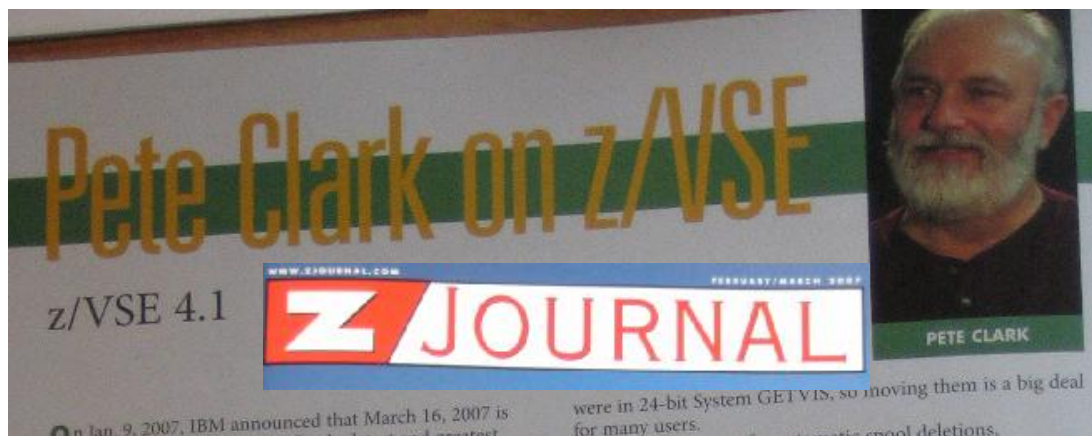

VSE users receive an offer they can't refuse

Most of the activity in the IBM mainframe world not surprisingly focuses on the z/OS environment, but there is still a sizeable population of users running systems based on VSE, often in conjunction with the VM hypervisor.

Many of these sites are slow growers with limited in-house technical skills and a reluctance to upgrade their hardware or software even in exchange for significant cost savings. As a result their relationship with IBM (and with other ISVs supporting their applications) is a difficult one.

In its recent announcement of z/VSE 4.1, IBM has shown some of the 'carrot and stick' tactics that often characterize its product developments in this part of the market.

The latest version of the operating system offers many attractions for small mainframe users, including some important enhancements to SOA/web service support and tape encryption. Moreover the software is accompanied by a new pricing scheme (Midrange Workload License Charge), which can bring sub-capacity benefits and very significant savings to VSE users. But to get the savings they need to upgrade to a z9 BC or EC.

Even for VSE users, it is becoming increasingly difficult to make a cost case for avoiding an upgrade to the latest hardware, and the months ahead are likely to witness a steady stream of VSE-base upgrades to the z9 BC.

© Arcati Limited, 2007 Source: The Arcati Mainframe Yearbook 2007, UK 33

IBM VSE mainframe operating system gets upgrade

By Mark Fontecchio, News Writer
21 Mar 2007 | SearchDataCenter.com

RSS FEEDS: [IT infrastructure news](#)



IBM has upgraded the VSE mainframe operating system to include storage, security and networking improvements, as well as introduced pricing schemes that can lower mainframe software licensing costs.

Source: SearchDataCenter.com, March 2007

IBM Systems

Features

Print

Ahead of the Pack

July 2007

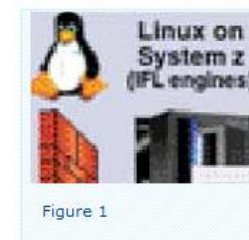

Figure 1

Although z/OS* is correctly regarded as the flagship OS for the IBM* System z** platform, z/VSE* remains an important part of IBM's mainframe portfolio and a viable option for many satisfied IBM customers. At the risk of oversimplification, z/VSE is similar to z/OS but relatively smaller, simpler and less capable. z/VSE is designed for smaller IBM mainframe clients with somewhat less demanding requirements. For z/VSE users, many of whom have been using it for decades, z/VSE is robust enough without additional applications found in z/OS, and comes

with a lower TCO than z/OS. However, both z/OS and z/VSE are equally committed to product quality and customer service that are second to none.

Heritage

z/VSE V4 has a long tradition that spans more than four decades. DOS/360 was launched in 1965 along with the famed IBM System/360*. Originating as a basic alternative to OS/360*, a distant ancestor of z/OS, DOS/360 quickly became a workhorse OS, especially for the popular S/360 Model 30. In the 1970s and '80s,

Source: Systems Magazine, July/August 2007



z/VSE V4.2 Preview



z/VSE Version 4 Release 2 Preview

§ **Preview** 10/09/2007

§ **z/Architecture mode only**

- 64-bit *real* addressing (31-bit *virtual* addressing)
 - up to **32** GB real processor storage
- IBM System z9 EC and z9 BC servers
- IBM eServer zSeries 990, 890, 900, and 800 servers

§ **More than 255 VSE tasks**

§ **MWLC pricing metrics (z/VSE V4 on z9 EC and z9 BC only)**

- Improved price/performance with full-capacity MWLC price points
- Sub-capacity MWLC option for added price/performance
- **SCRT V14.2 runs 'natively' on z/VSE V4.1 and later as of 10/10/2007**

§ **Encryption enhancements**

- CPACF enhancements (AES-128)
- Configurable Crypto Express2 (new accelerator option)
- SecureFTP
- IBM System Storage TS1120 encrypting tape
- **Encryption Facility for z/VSE V1.1 optional, priced feature (GA 11/30/2007)**

§ **Security and Auditability enhancements**

§ **SOA and Interoperability**

§ **FSU from z/VSE V4.1 and V3.1**

§ **Requires z/VM V5.2 (or later) if running as a VM guest**

§ **SOD - last z/VSE release to offer CICS/VSE V2.3**





Encryption Facility for z/VSE V1.1



Encryption Facility for z/VSE V1.1



- § **Announce:** 10/09/2007
- § **GA:** 11/30/2007
- § **Optional priced feature for VSE Central Functions V8**
 - requires z/VSE V4.1 or later
 - MWLC-eligible
- § **Requires CP Assist for Cryptographic Function (CPACF)**
 - CPACF is a no charge feature only on z990, z890, z9 EC, and z9 BC servers
- § **Protection using Password-based or RSA-based (Public/Private Key Encrypting Keys) keys**
 - TCP/IP for VSE/ESA V1.5 required for RSA-based keys
 - KEYMAN (or equivalent) no charge, downloadable tool recommended for RSA-based keys
- § **Option to compress data** (compression must occur prior to encryption)
- § **Extends affinity between z/VSE and z/OS**
 - function roughly equivalent to EF for z/OS V1.1
 - data format compatible with EF for z/OS V1.1/1.2 (Encryption Facility System z format)
 - EF for z/VSE tapes can be read by EF for z/OS, EF for z/OS Java Client, and Decryption Client for z/OS
 - EF for z/OS V1.1 and EF for z/OS Java client tapes can be read by EF for z/VSE V1.1
- § **Complements z/VSE support for IBM TS1120 tape**
 - TS1120 is the preferred solution for high volume backup/archive
 - EF option for limited backup/archive and/or exchange with partners who have no TS1120

Encryption Facility for z/VSE V1.1

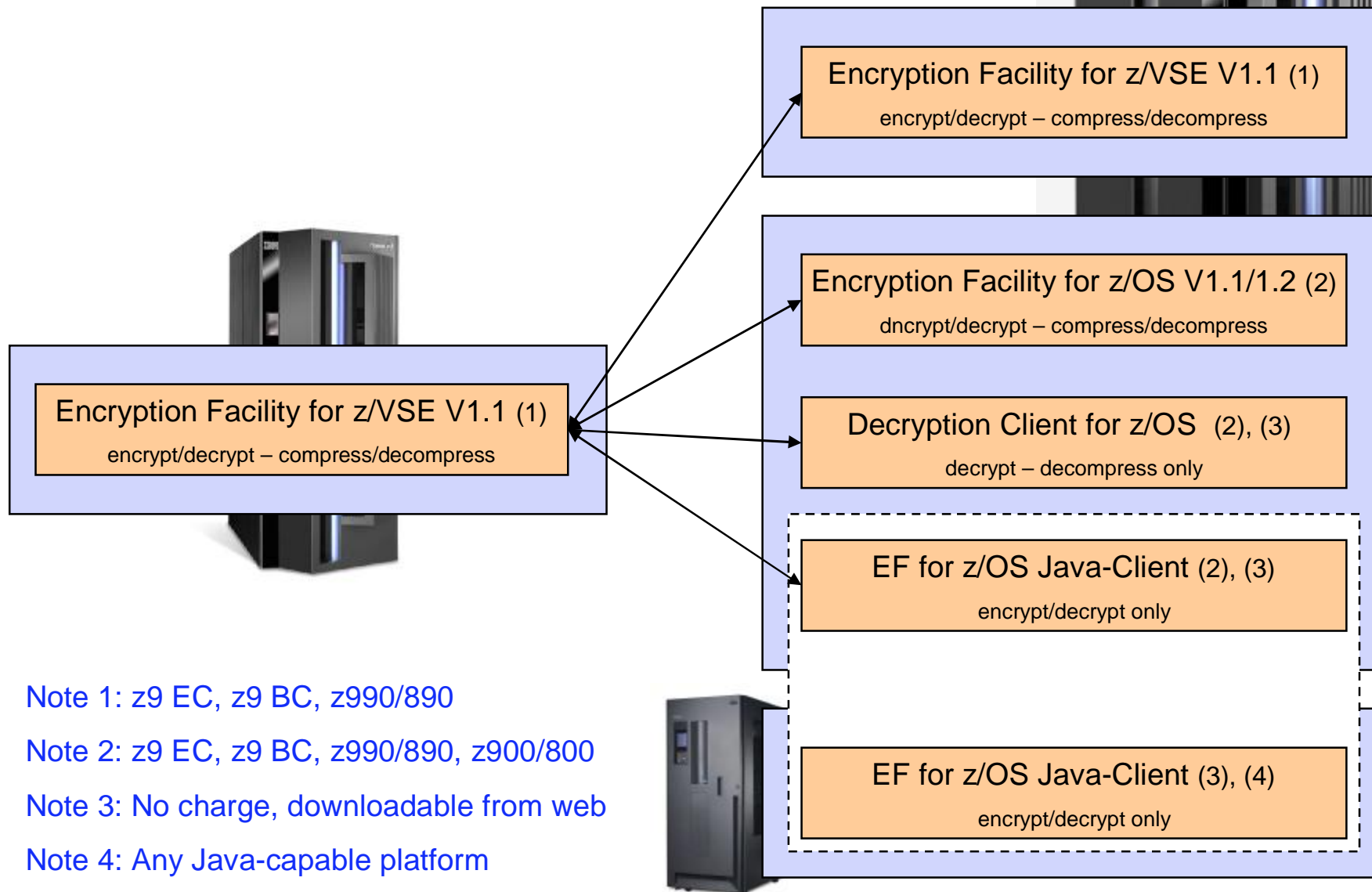

Note 1: z9 EC, z9 BC, z990/890

Note 2: z9 EC, z9 BC, z990/890, z900/800

Note 3: No charge, downloadable from web

Note 4: Any Java-capable platform



z/VSE Strategy

z/VSE “PIE” Strategy

- § Help **P**rotect existing customer investments in core z/VSE programs, data, equipment, IT skills, *plus* business processes, end user training
 - Modernize, i.e. extend z/VSE resources to Web
 - Exploit IBM servers, storage, and software
 - z/OS affinity
- § Help **I**ntegrate z/VSE with the rest of IT, based on open and industry standards
 - VSE connectors and SOA Web services
 - IBM middleware
- § Help **E**xtend solutions with Linux on System z
 - Linux as preferred platform for new workloads
 - leverage existing core VSE investments
 - low cost, low risk, fast time-to-market for new solutions
 - New line-of-business applications
 - Low TCO and infrastructure simplification



z/VSE V4 and Linux on System z

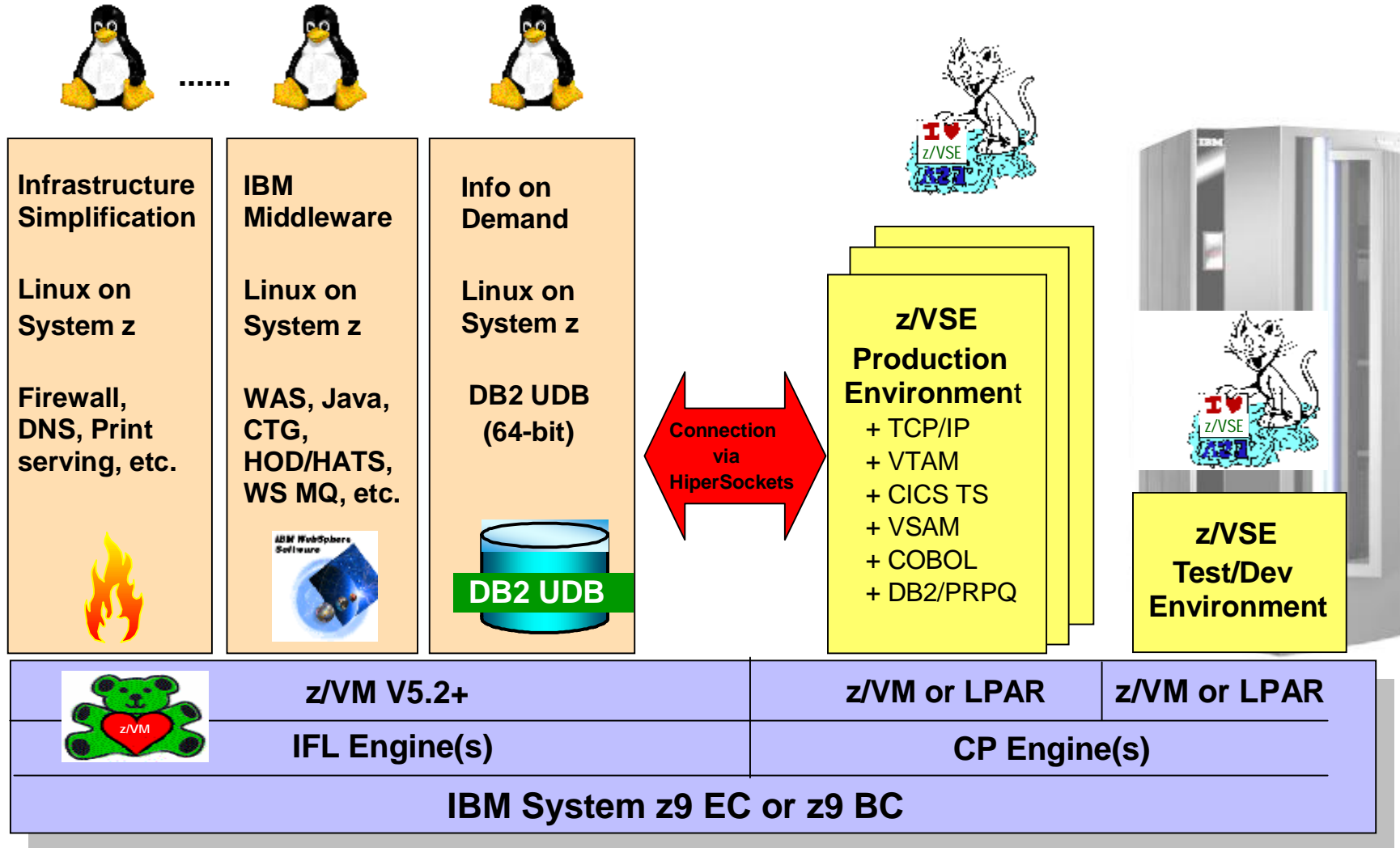



Summary/Wrap-up

z/VSE Version 4 Release 1



§ Announce 1/9/2007 (Preview 4/29/2006)

§ **General Availability 3/16/2007**

§ **z/Architecture (64-bit) mode only**

- 64-bit real addressing (31-bit virtual addressing)
 - Up to 8 GB real processor storage
- IBM System z9 EC *and* z9 BC
- IBM eSeries zSeries 990, 890, 900, 800



§ **New MWLC pricing metrics (z9 only)**

- Low full capacity price points
- Sub-capacity option



§ **Encryption enhancements**

- CPACF enhancements (AES-128)
- Crypto Express2 (configurable)
- SecureFTP
- TS1120 encrypting tape

Web



§ **Security and auditability enhancements**

§ **SOA and interoperability**

§ **FSU from z/VSE V3.1 & VSE/ESA V2.7**

§ **Requires z/VM V5.2 or later (if using VM)**

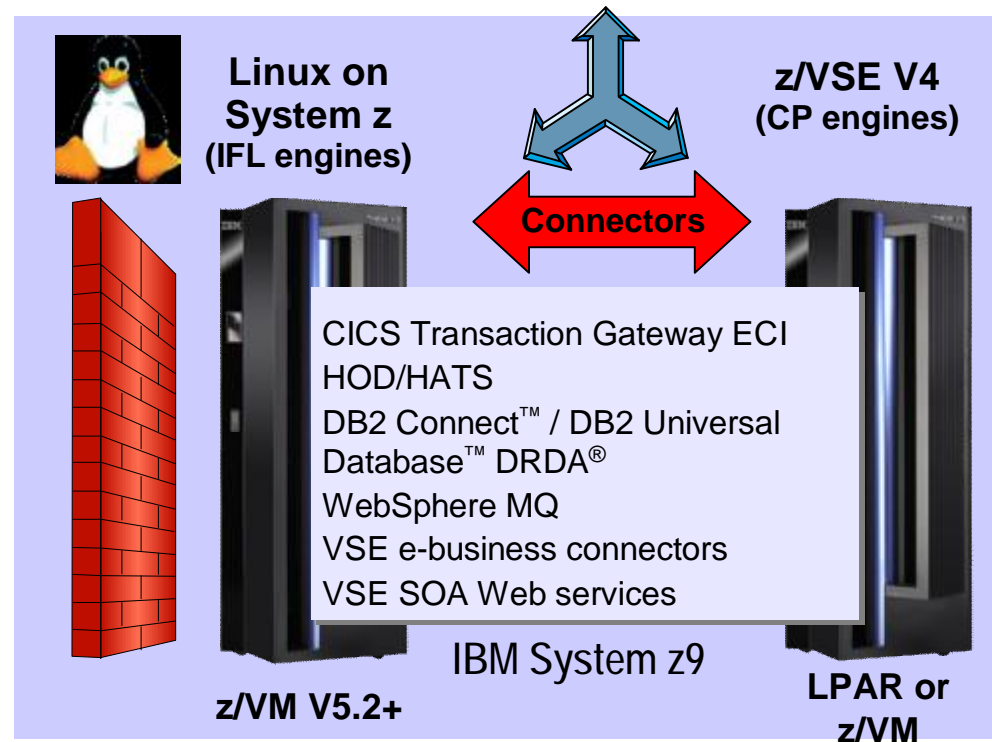

z/VSE Learning Opportunities

§ z/VSE V4 Live Virtual Classes

- § z/VSE and MWLC Announcement Overview
- § Midrange Workload Licence Charges (MWLC)
- § z/VSE V4.1 Solutions based on SOA and DB2
- § z/VSE Security
- § z/VSE V4.1 User Experience
- § IBM System z Hardware
- § New VSAM Tools
- § **Bringing You up to Date with z/VSE V4**
- § **Wellness - November 8**
- § **tbd - November 29**

- § more plannedi.e. EF for z/VSE and DB2 Update

Note: Charts are available on the z/VSE web site the day following each call. Replay available approximately one week later. For more information, please see the z/VSE web site at:

<http://www-03.ibm.com/servers/eserver/zseries/zvse/>

§ z/VSE-related Events



- § **2008 WAVV Conference -**
featuring z/VM, z/VSE, and Linux on System z
 - April 18 - 22
 - Chattanooga, TN
- § **2008 European IBM Tech Conference -**
featuring z/OS, z/VM, z/VSE, and Linux on System z
 - May 5 - 9
 - Dresden, Germany
- § **2008 US IBM System z Expo -**
featuring z/OS, z/VM, z/VSE, and Linux on System z
 - October 13 – 17
 - Las Vegas, NV

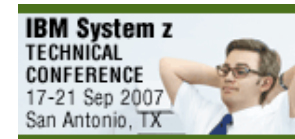

For more information, please see the z/VSE web site:
<http://www-03.ibm.com/servers/eserver/zseries/zvse/>

The screenshot shows a Mozilla Firefox browser window displaying the IBM z/VSE website. The browser title is "IBM: z/VSE Operating System - Mozilla Firefox: IBM Edition". The address bar shows the URL "http://www-03.ibm.com/servers/eserver/zseries/zvse/". The website features the IBM logo, a search bar, and a navigation menu with options like Home, Solutions, Services, Products, Support & downloads, and My IBM. A "Welcome back" message is visible, along with links for "IBM Sign in" and "Register".

The main content area is titled "z/VSE" and includes a sidebar with links for "About VSE", "How to buy", "News & announcements", "Events", "Solutions", "Products & components", "Documentation", "Service & support", "Downloads", "Education", "Partners", "FAQ", and "Contact VSE". The main text describes z/VSE as a robust, cost-effective solution for various capacity needs, highlighting its 40-year heritage. A prominent banner announces "z/VSE V4.1 is available", noting its built-in heritage of innovation. Below this, a "z/VSE V4.2 Preview" section details the new version's capabilities, such as supporting up to 255 VSE tasks and 32 GB of real processor storage, and mentions the Sub-Capacity Reporting Tool (SCRT). A "Data encryption" section is also visible, emphasizing the protection of critical data.

The browser's taskbar at the bottom shows the Windows Start button, system tray with temperature (57.9°F in Dallas), and several open applications including "IBM: z/VSE...", "On Deman...", "Lotus...", and "Microsoft...". The system clock indicates the date and time as 19.10.2007, 07:37 AM.

Thanks for listening



Your friends, the VSE development team

