

---

# zEnterprise and integration solutions of Linux and traditional workload

Wilhelm Mild  
IT Integration Architect  
[mildw@de.ibm.com](mailto:mildw@de.ibm.com)

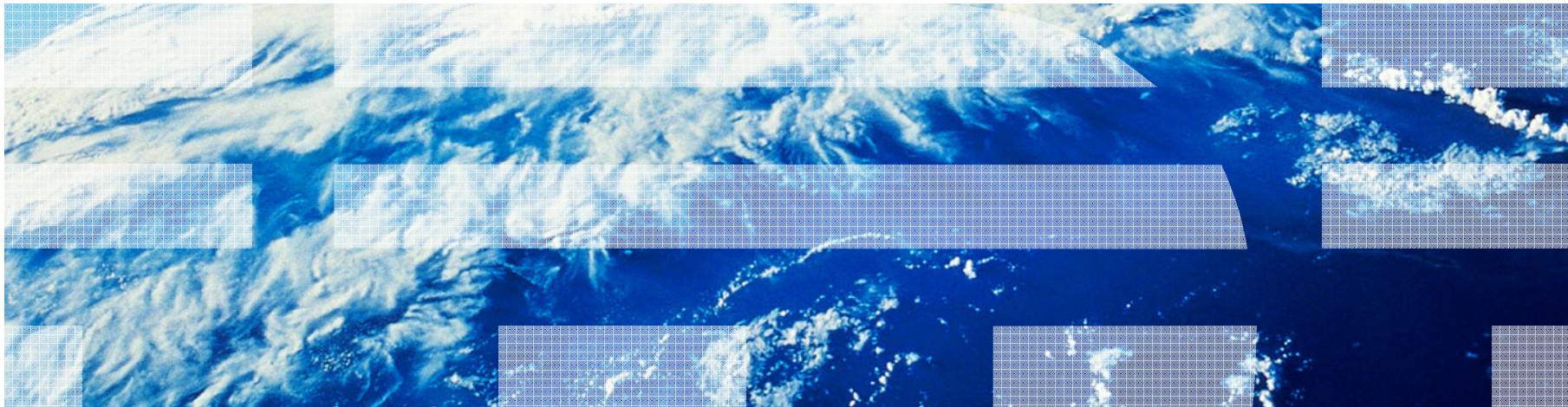



# Trademarks

The following are trademarks of the International Business Machines Corporation in the United States and/or other countries.

AIX*	IBM*	PR/SM	WebSphere*	z/OS*
BladeCenter*	IBM (logo)*	System Storage*	XIV*	z/VM*
DataPower*	NetWeaver*	System x*	z9*	z/VSE
DB2*	Parallel Sysplex*	System z*	z10 EC	
FICON*	POWER*	System z9*	zEnterprise	
FlashCopy*	POWER7*	System z10*		
GDPS*	Power Systems			

\* Registered trademarks of IBM Corporation

The following are trademarks or registered trademarks of other companies.

Adobe, the Adobe logo, PostScript, and the PostScript logo are either registered trademarks or trademarks of Adobe Systems Incorporated in the United States, and/or other countries.

Cell Broadband Engine is a trademark of Sony Computer Entertainment, Inc. in the United States, other countries, or both and is used under license there from.

Java and all Java-based trademarks are trademarks of Sun Microsystems, Inc. in the United States, other countries, or both.

Microsoft, Windows, Windows NT, and the Windows logo are trademarks of Microsoft Corporation in the United States, other countries, or both.

InfiniBand is a trademark and service mark of the InfiniBand Trade Association.

Intel, Intel logo, Intel Inside, Intel Inside logo, Intel Centrino, Intel Centrino logo, Celeron, Intel Xeon, Intel SpeedStep, Itanium, and Pentium are trademarks or registered trademarks of Intel Corporation or its subsidiaries in the United States and other countries.

UNIX is a registered trademark of The Open Group in the United States and other countries.

Linux is a registered trademark of Linus Torvalds in the United States, other countries, or both.

ITIL is a registered trademark, and a registered community trademark of the Office of Government Commerce, and is registered in the U.S. Patent and Trademark Office.

IT Infrastructure Library is a registered trademark of the Central Computer and Telecommunications Agency, which is now part of the Office of Government Commerce.

\* All other products may be trademarks or registered trademarks of their respective companies.

## Notes:

Performance is in Internal Throughput Rate (ITR) ratio based on measurements and projections using standard IBM benchmarks in a controlled environment. The actual throughput that any user will experience will vary depending upon considerations such as the amount of multiprogramming in the user's job stream, the I/O configuration, the storage configuration, and the workload processed. Therefore, no assurance can be given that an individual user will achieve throughput improvements equivalent to the performance ratios stated here.

IBM hardware products are manufactured from new parts, or new and serviceable used parts. Regardless, our warranty terms apply.

All customer examples cited or described in this presentation are presented as illustrations of the manner in which some customers have used IBM products and the results they may have achieved. Actual environmental costs and performance characteristics will vary depending on individual customer configurations and conditions.

This publication was produced in the United States. IBM may not offer the products, services or features discussed in this document in other countries, and the information may be subject to change without notice. Consult your local IBM business contact for information on the product or services available in your area.

All statements regarding IBM's future direction and intent are subject to change or withdrawal without notice, and represent goals and objectives only.

Information about non-IBM products is obtained from the manufacturers of those products or their published announcements. IBM has not tested those products and cannot confirm the performance, compatibility, or any other claims related to non-IBM products. Questions on the capabilities of non-IBM products should be addressed to the suppliers of those products.

Prices subject to change without notice. Contact your IBM representative or Business Partner for the most current pricing in your geography.

# The Data Center Challenge - Controlling IT complexity and cost while maintaining daily operations

- **An Integrated system of multiple architectures for optimizing the deployment of multi-tier workloads**
- **Creating a single point of control for management and administration to reduce operational overhead by up to 80%, including:**
  - ▶ Power and Facilities
  - ▶ Labor
  - ▶ Software License

## zEnterprise

- **Lowers cost of acquisition by up to 56%**
- **Reduces cost of ownership by up to 55%\***



A strategic systems platform....  
 Helping to free up resources for critical projects and establish a base for the future

• Based on IBM analysis of a large Financial Services company Datacenter. See details on [ibm.com/systems/zenterprise/](http://ibm.com/systems/zenterprise/) Deployment configurations based on IBM studies and will vary based on workload characteristics. Price calculations based on publicly available US list prices, prices will vary by country.

# IBM zEnterprise System

Business Applications require integration of multiple workload components with varying workload characteristics

Explosive systems and data growth inhibit responsiveness to client needs, and market opportunities

## zEnterprise

1. Enables mixed workload business processes to be deployed and centrally managed
2. Allows optimized single system integration of data, applications, and web serving
3. Delivers dynamically responsive IT
4. Meets the need of heterogeneous data centers

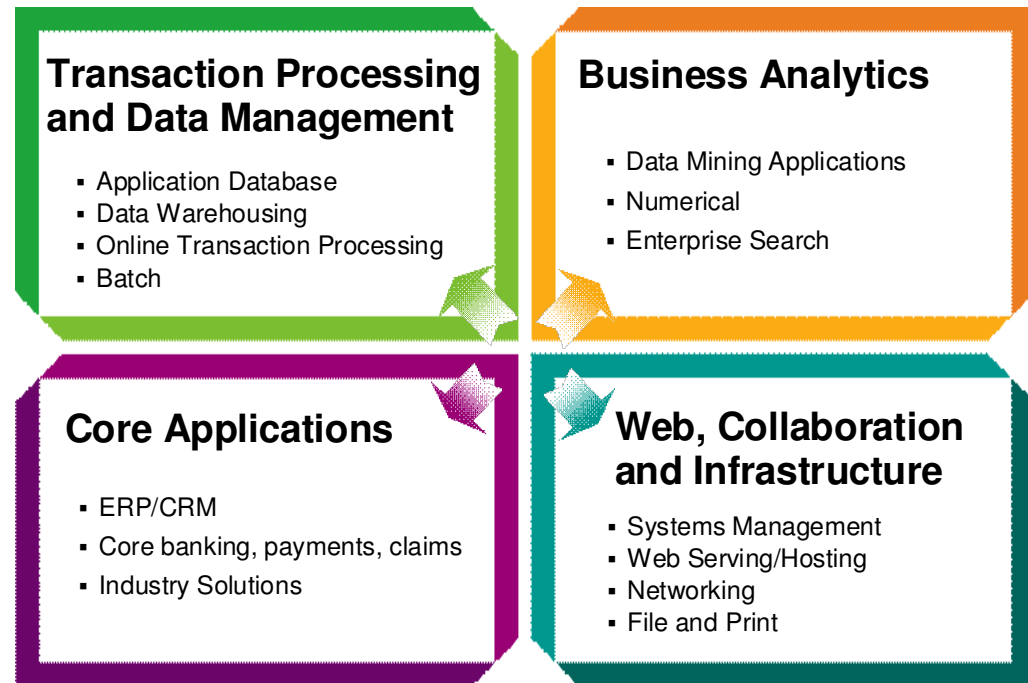

A strategic systems platform for critical enterprise applications  
 Helps to integrate workloads and establish a base for the future

# IBM zEnterprise System

The broadest systems architecture

Enabling integration and centralized management of multi-platform systems, applications, and data



## zEnterprise z196 and z114

- Industry’s most robust design for systems and data continuously availability
- Optimized to host large-scale database, transaction, and mission critical applications
- The most efficient platform for large-scale Linux® consolidation
- Massive scale up

## Unified Resource Manager

- Unifies management of resources, extending IBM System z® qualities of service end-to-end across workloads
- Provides platform, hardware and workload management

## BladeCenter Extension (zBX)

- AIX®, Linux®, and Microsoft® Windows®\* applications
- Appliance Blades - Smart analytics, DataPower®
- Dedicated high-performance private network
- Massive scale out

\*(Statement of Direction) on 9

# Major Operating Systems on IBM System z

## Traditional Mainframe Operating Systems

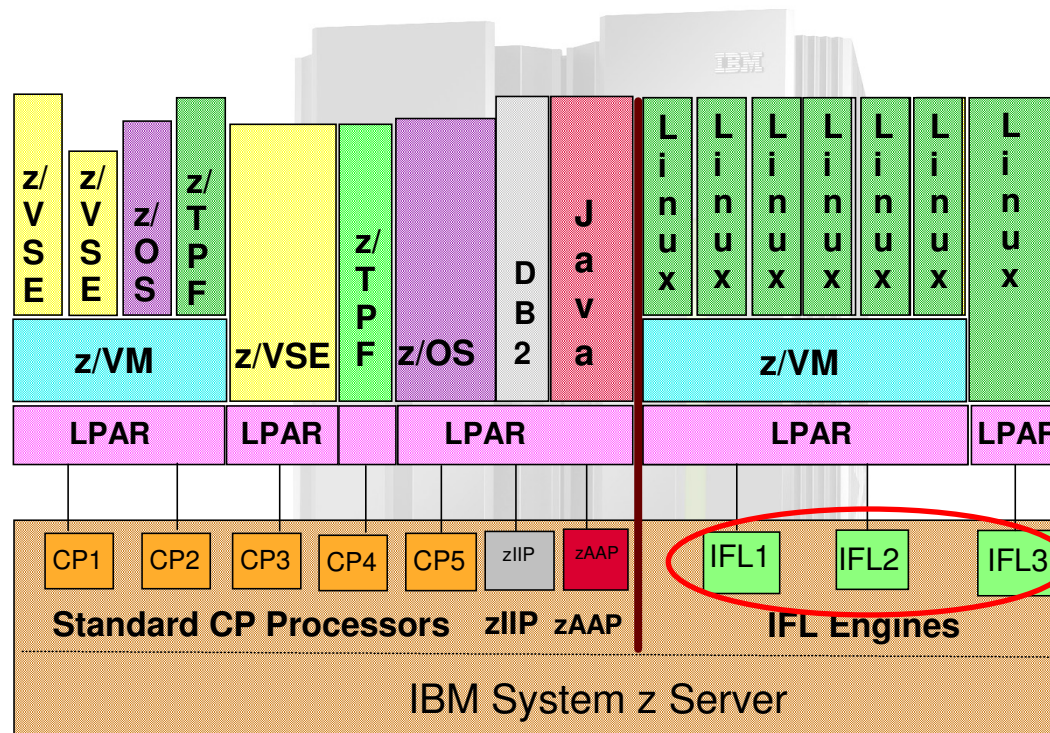
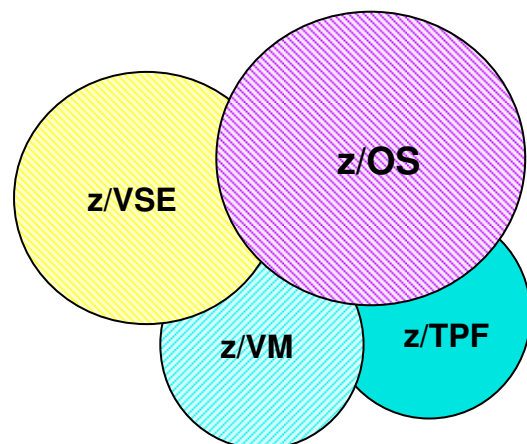

## Standard Processors

- CP
  - For z/OS, z/VSE, TPF, z/VM workloads

## Specialty Processors

- CF (Coupling Facility)
  - For Parallel Sysplex with z/OS
- IFL (Integrated Facility for Linux)
  - For Linux and Linux applications
- zAAP (zSeries Application Assist Processor)
  - For offload of Java applications from z/OS
- zIIP (System z9 Integrated Information Processor)
  - For z/OS offload of DB2 distributed requests

## Implement Virtualization on System z: LPAR and z/VM, when to use what

### ■ z/VM Virtualization

- **Vertical virtualization** - Grow workloads without linearly growing number of virtual guest machines
  - one guest can be increased by allocating more resources (CPUs, memory)
- **Horizontal virtualization** – for isolation between servers
  - isolation of guests in a network
  - Redundancy for application high availability
- **Dynamically** add, remove and shift physical resources to optimize business results

### ■ LPAR Virtualization

- High Isolation with fixed resources
- Direct attached I/O devices for max bandwidth

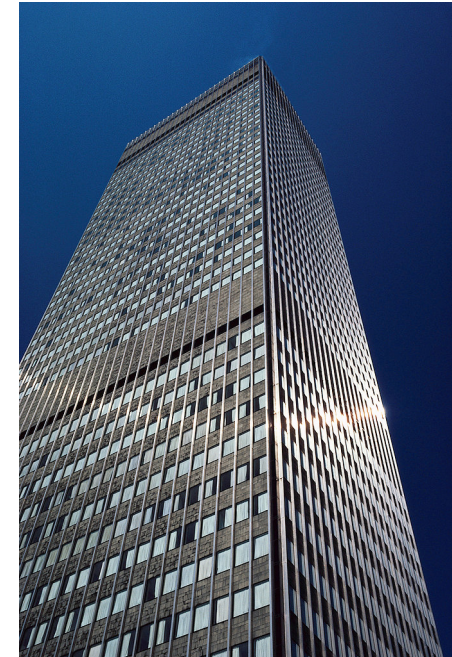

# Virtualization in System z and zEnterprise

## z/VM Technology: Share everything

- z/VM simulates the existence of a dedicated real machine, including processor functions, storage, and input/output resources.
- z/VM includes network Virtualization, high availability and integrated security between VMs
- It supports uniquely, over commitment on all levels.

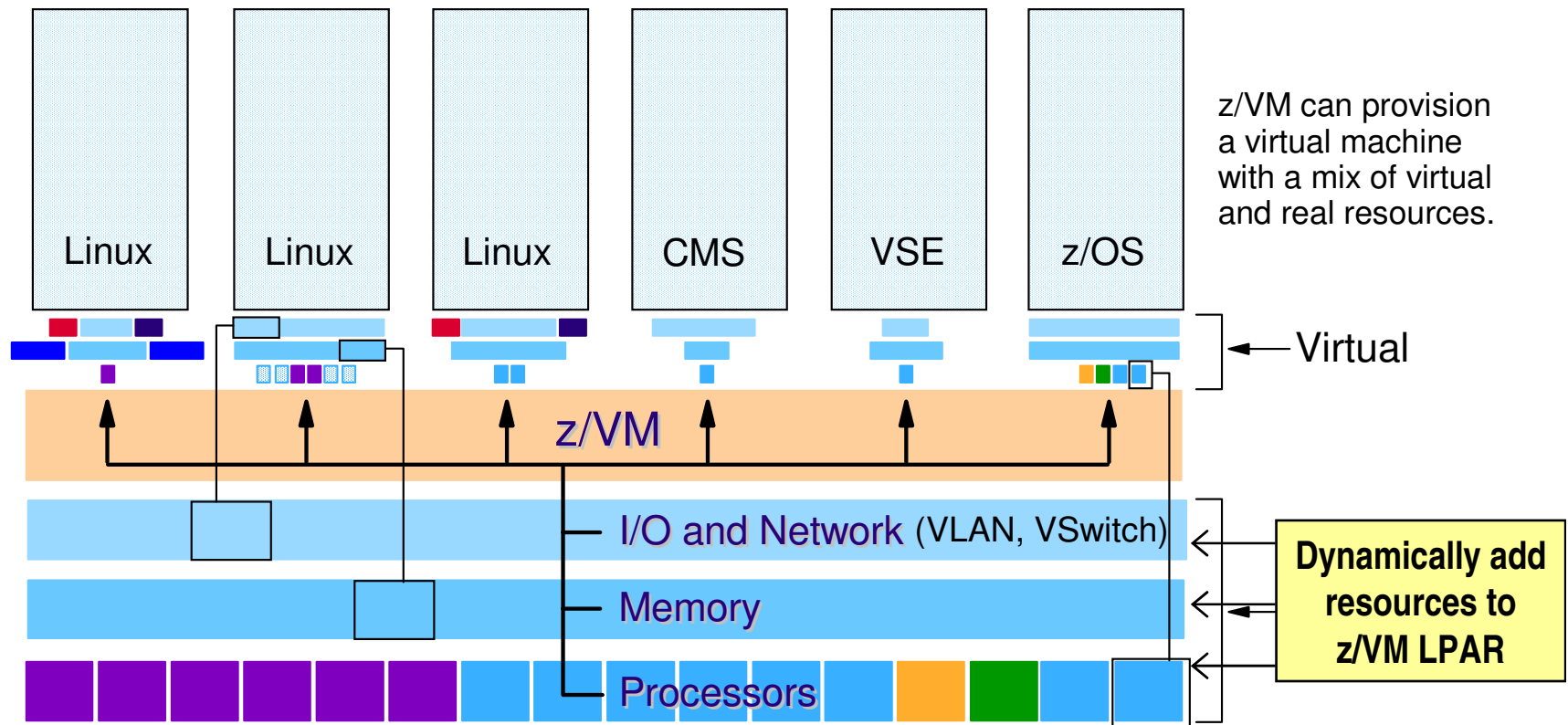

Linux on z/VM is the industry's most advanced virtual solution



## z/VM V6.2 - Available since Dec, 2011

*Single System Image, Clustered Hypervisor, Live Guest Relocation*

- **Single System Image (SSI)** - connect up to four z/VM systems as members of a cluster
- **Provides a set of shared resources for member systems and their hosted virtual machines**
  - Directory, minidisks, spool files, virtual switch MAC addresses
- **Cluster members can be run on the same or different z10, z196, or z114 servers**
- **Simplifies systems management of a multi-z/VM environment**

- Single user directory
- Cluster management from any member
  - Apply maintenance to all members in the cluster from one location
  - Issue commands from one member to operate on another
- Built-in cross-member capabilities
- Resource coordination and protection of network and disks

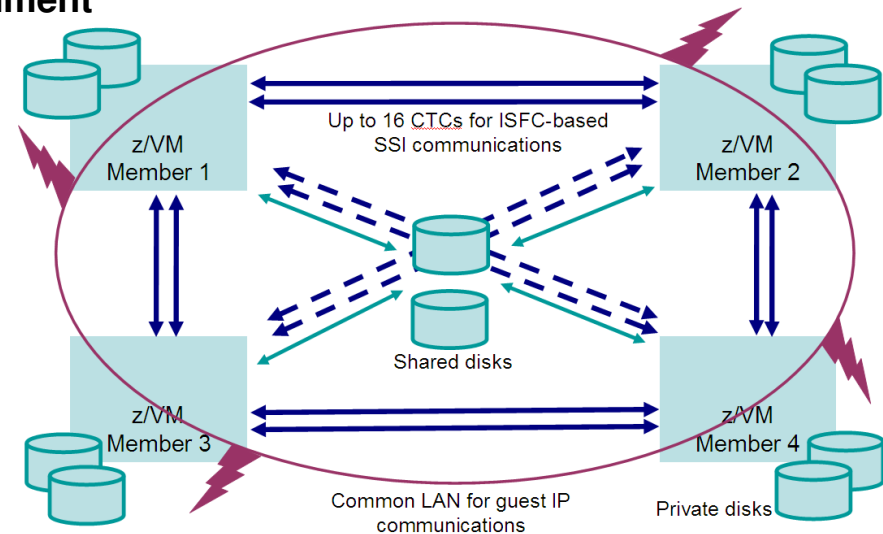

- **Live Guest Relocation (LGR)** – Dynamically move Linux guests from one z/VM member to another

### Reduce planned outages; enhance workload management

- Non-disruptively move work to available system resources **and** non-disruptively move system resources to work
- When combined with Capacity Upgrade on Demand, Capacity Backup on Demand, and Dynamic Memory Upgrade, you will get the best of both worlds

# Mixed workload consolidation with zEnterprise

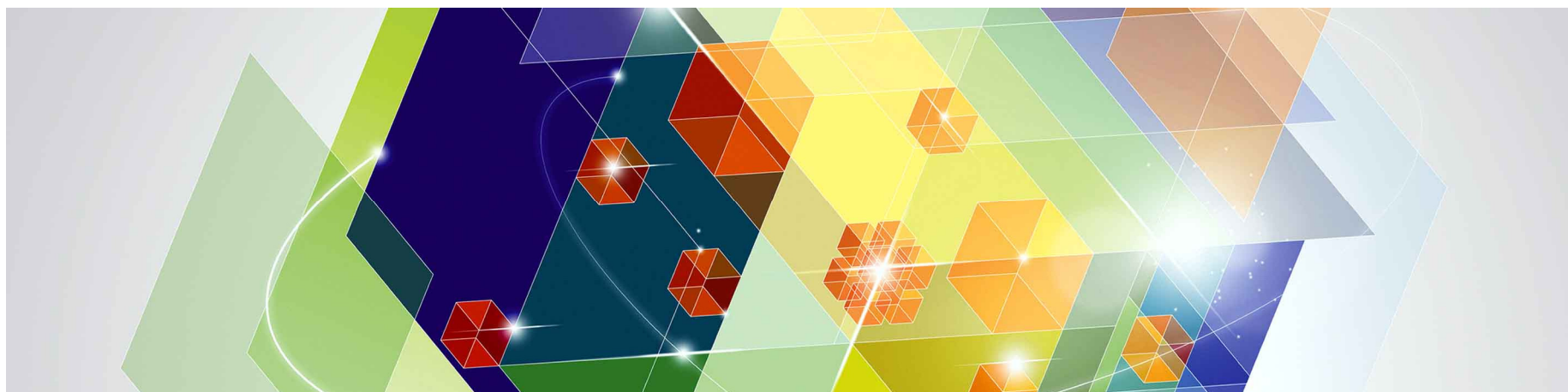

# Mixed Workload consolidation on zEnterprise

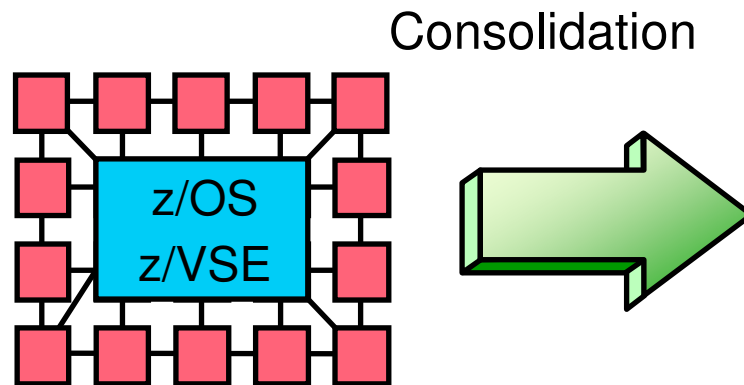

## zBX + Linux on z + zEnterprise

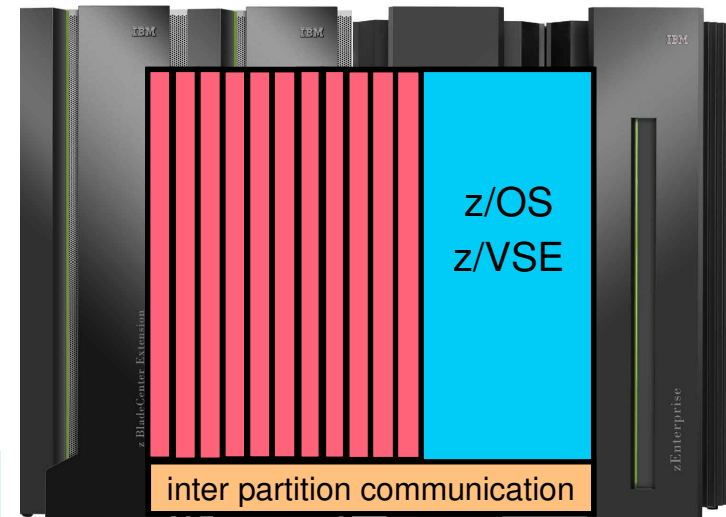

For System z customers, zEnterprise opens new horizons:

- ◆ Integration of multiple platforms of the Enterprise
- ◆ The integration of existing applications and data using Connector components
- ◆ Reduction of network components (Router, switch)
- ◆ Maintain isolation in an fully integrated environment
- ◆ Centralized Management of the entire Ensemble

## Multi-zone Network with VSWITCH (red zone physical isolation)

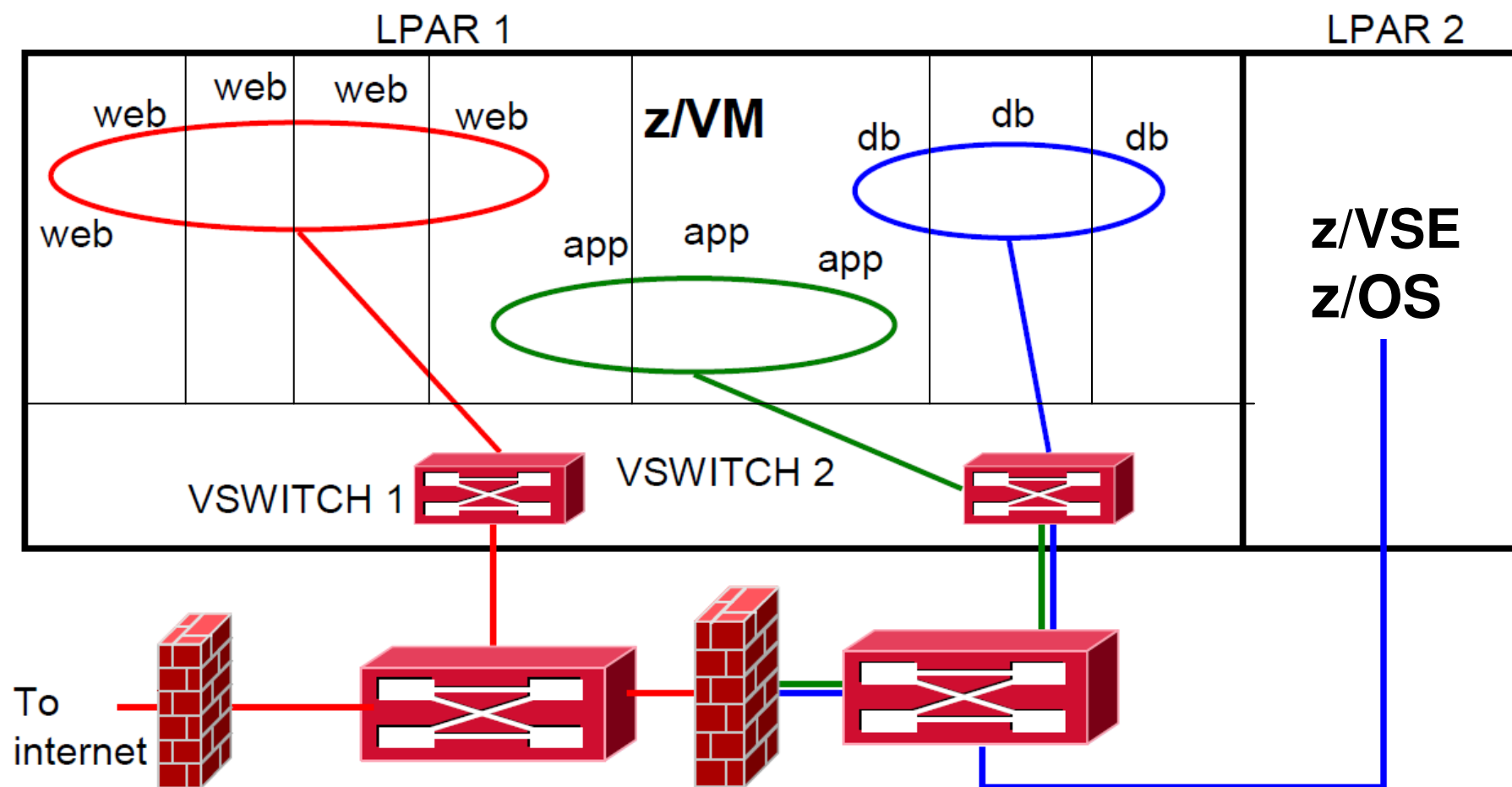

With 2 VSWITCHes, 3 VLANs, and a multi-domain firewall

## Insurance Company Consolidated 292 Servers to a z10

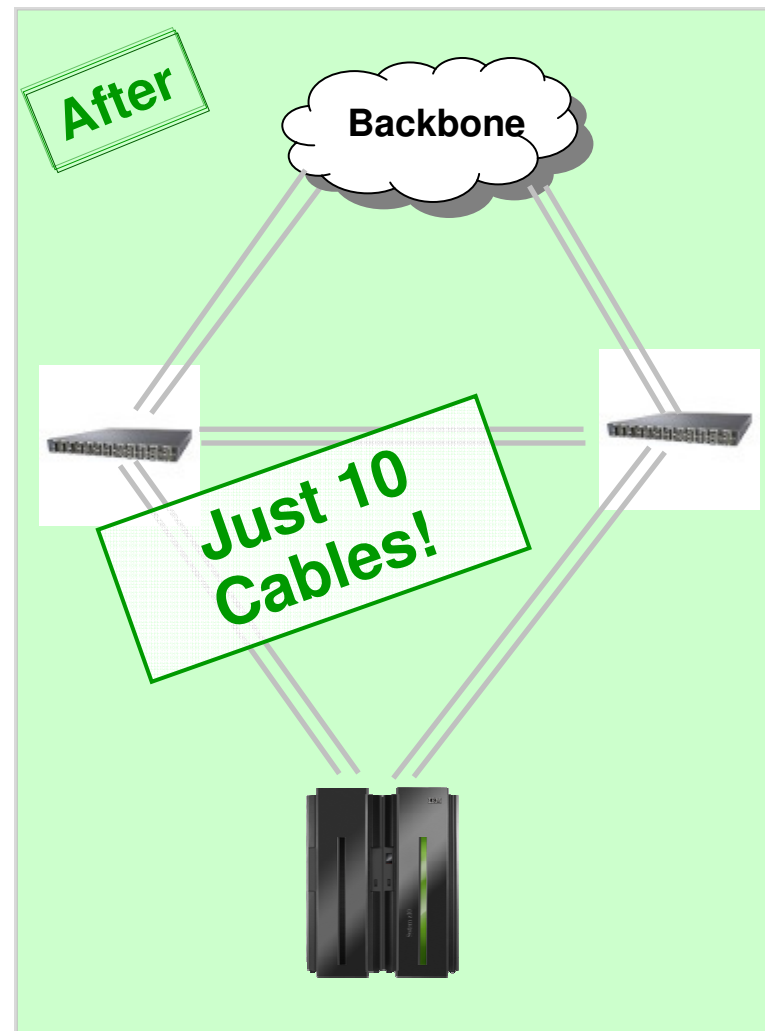
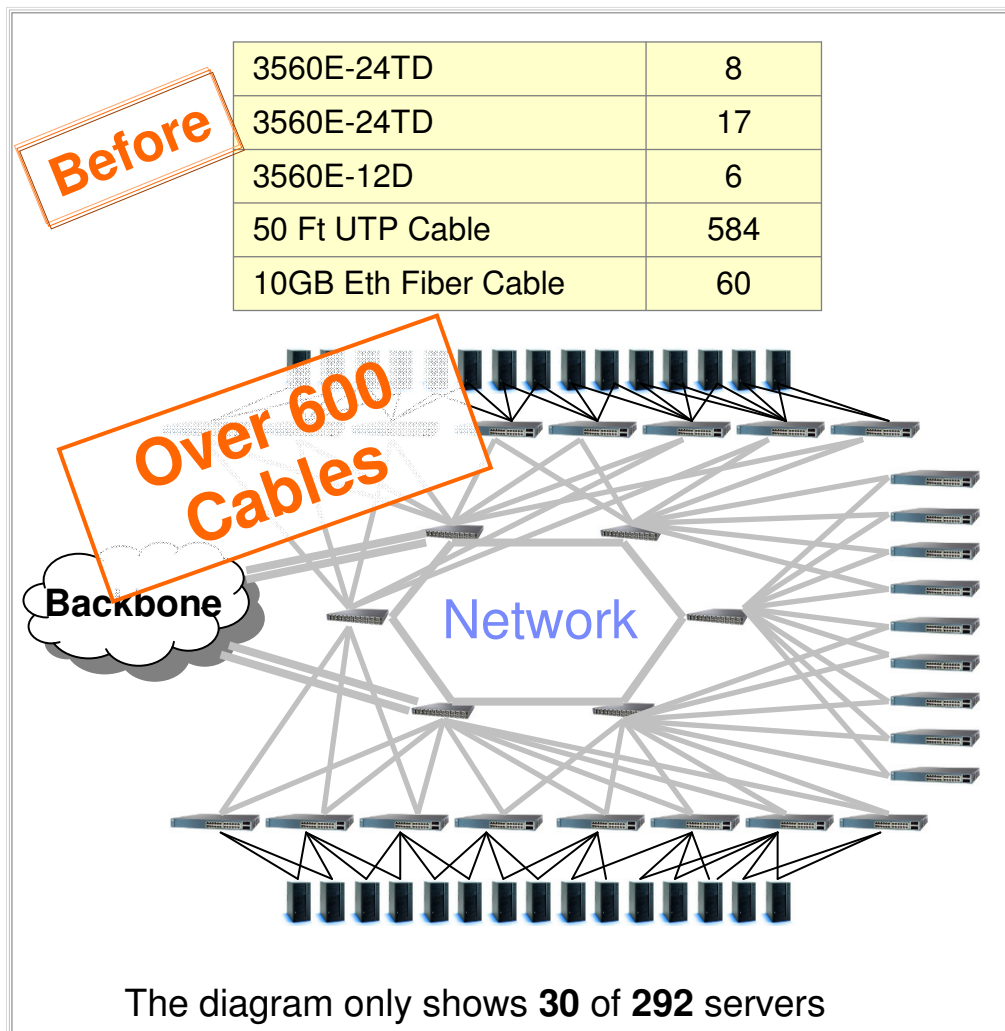

---

Linux Application integration  
**cross platforms**  
with zEnterprise  
- technology study -

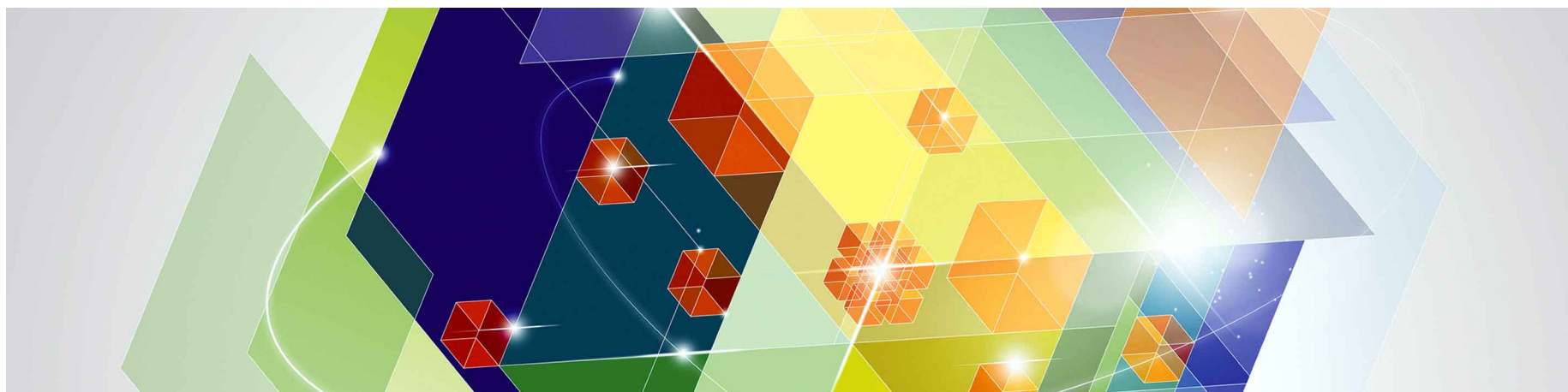

---

## The Feature

- **Run any application in Linux on System z**
  - particularly including x86 applications
  - scope: zEnterprise
  
- **Blade virtual servers considered “co-processors” to Linux on System z**
  
- **Linux on System z manages application lifecycle**

# Application Integration: Implementation Details

- **Run x86 Linux applications from Linux on System z**
  - lifecycle of x86 applications and resources are entirely managed from Linux on System z
    - proxy processes on System z don't use cycles or memory
    - proxy resources allow for managing x86 system resources
  - retains certified x86 distribution environments (no kernel changes required)

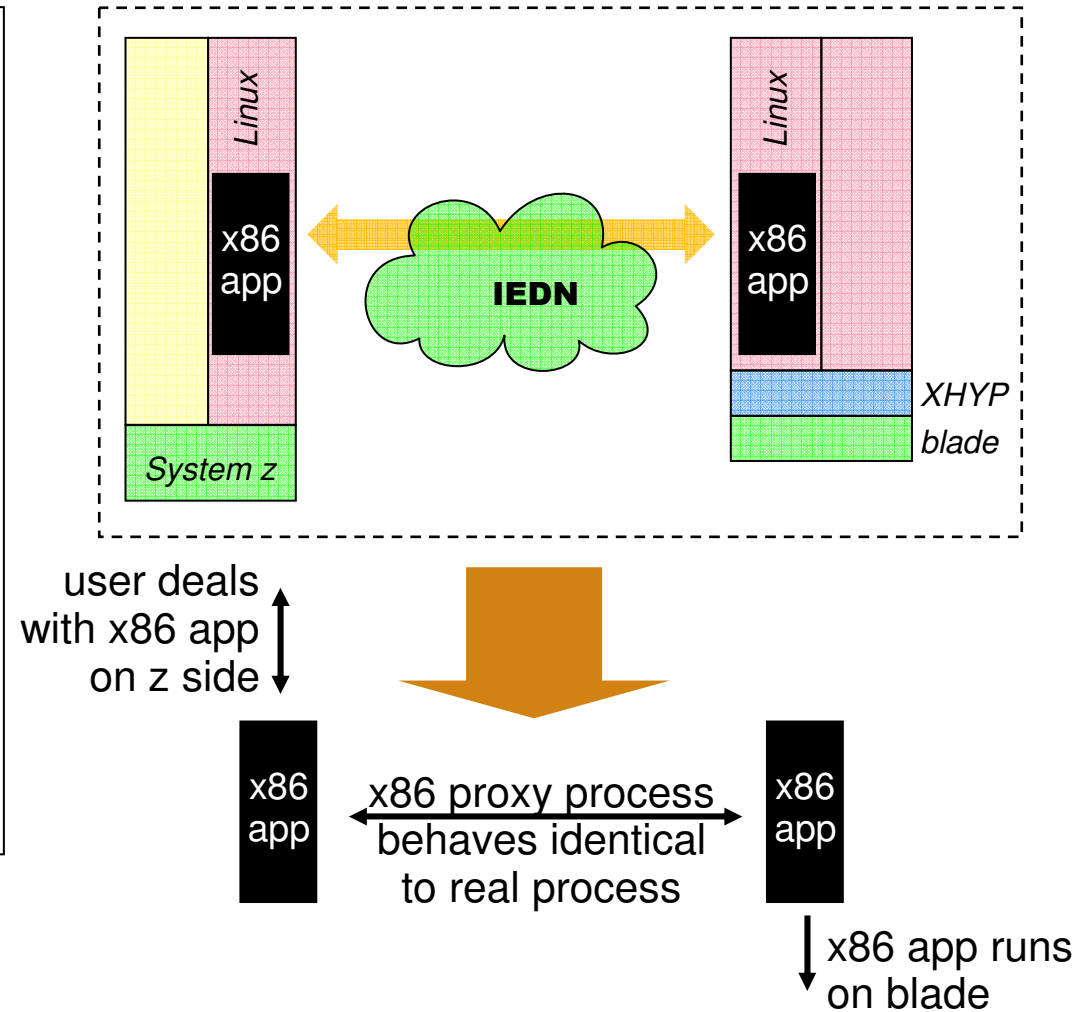



---

## Application Integration: Aspects Covered

- **Execution of x86 Binaries**
- **Process Management**
- **Userids, Authorization, Authentication**
- **File System Integration**
- **Network Integration**
- **Time Synchronization**
- **Logging**
- **Software Package Management (online and offline)**
- **x86 Blade Virtual Server Attachment**

# Application Integration

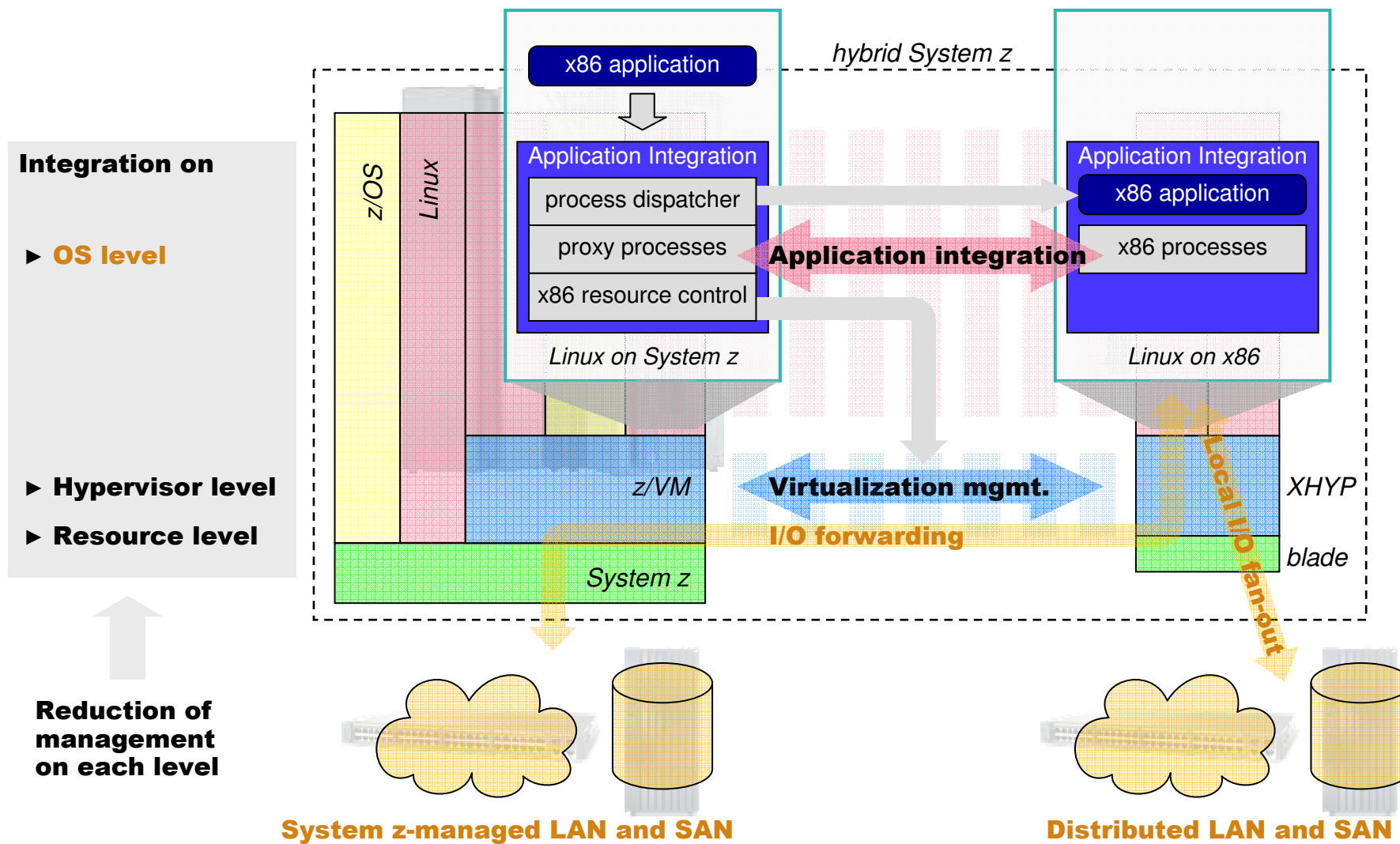

# Web integration with Linux and traditional

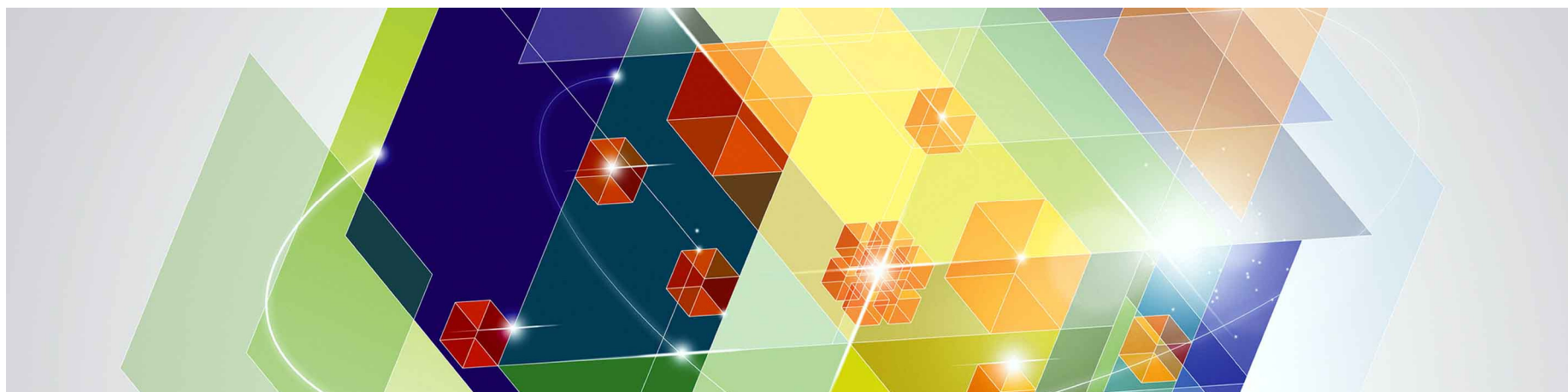

# Linux on System z as Central Access Point

Web enable, improve interface, simplify, extend existing applications

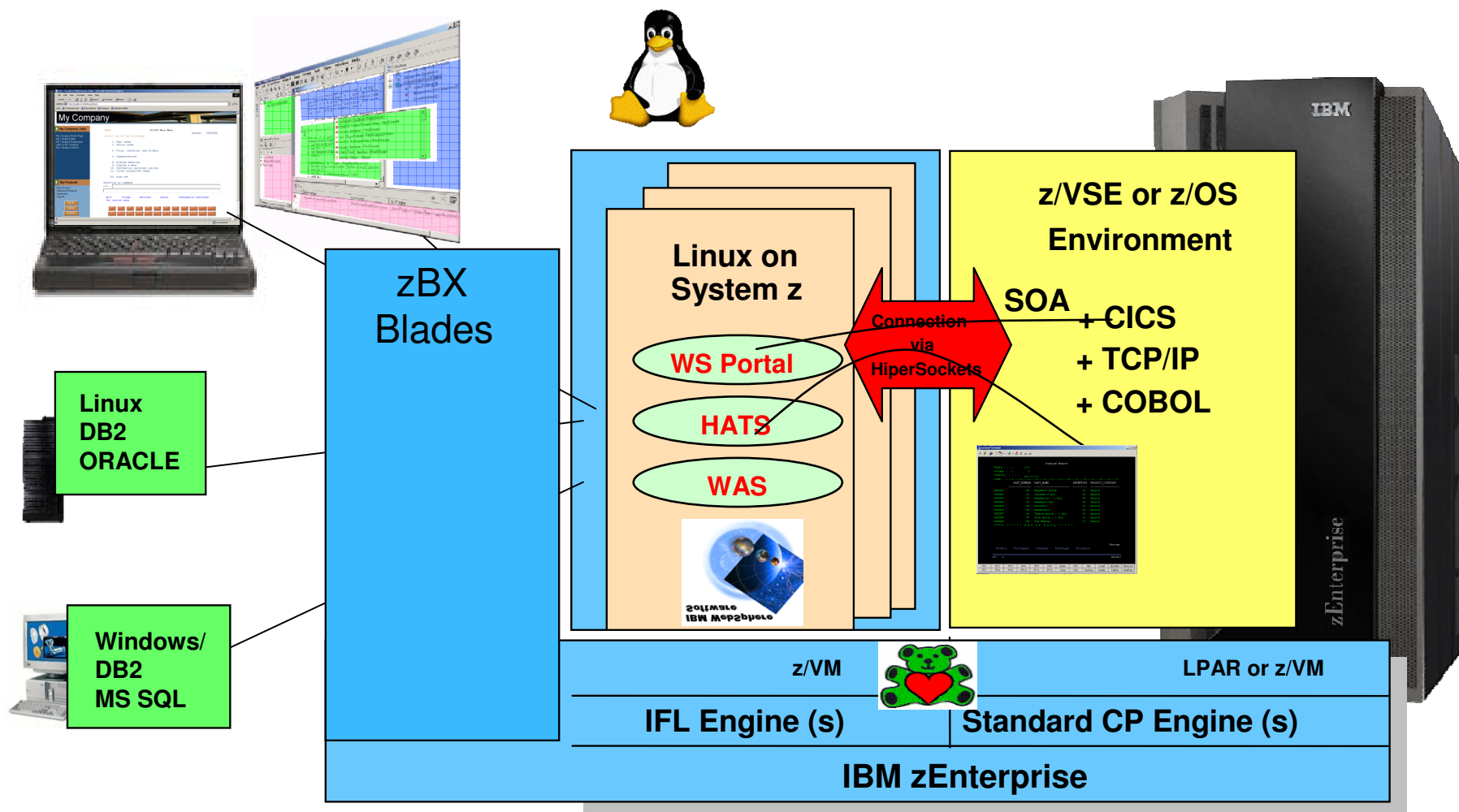

# Application Integration with Host Access Transformation Services (HATS)

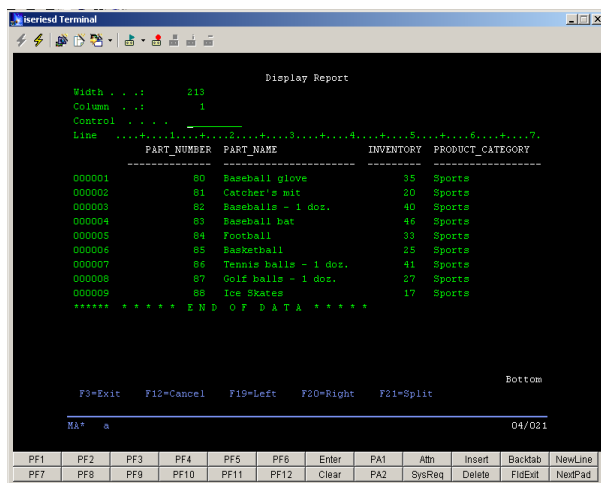

- No software download to the client
- Converts **green screens to GUI**
- **Integration with distributed applications**
- improves ease of use of host applications
- **Web Service** on the fly

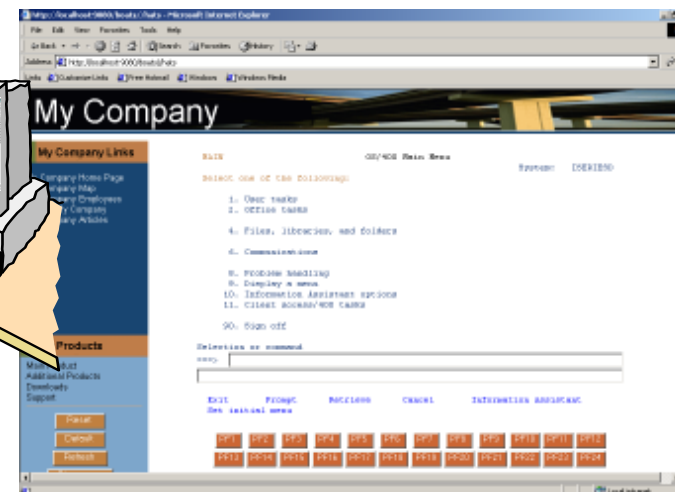
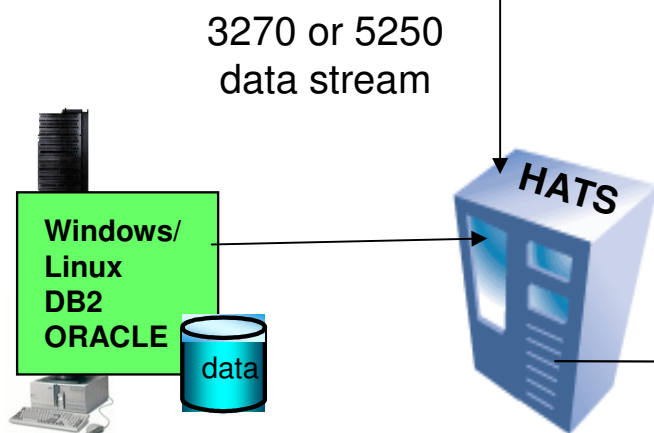

Screen transformation rules running on WebSphere Application Server

HTML in a Browser

# Integration variety of WebSphere Portal

User Perspective

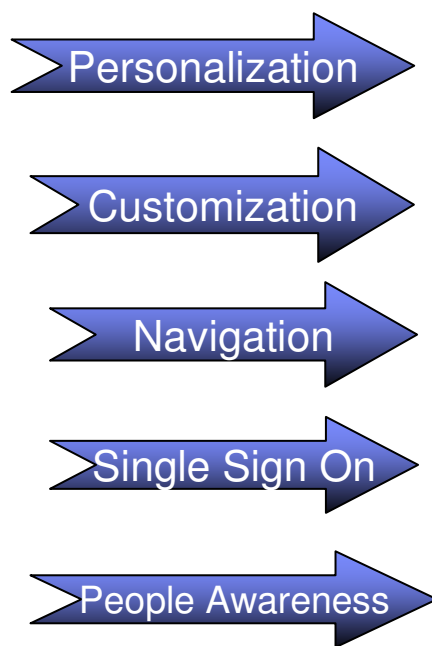

IT Perspective

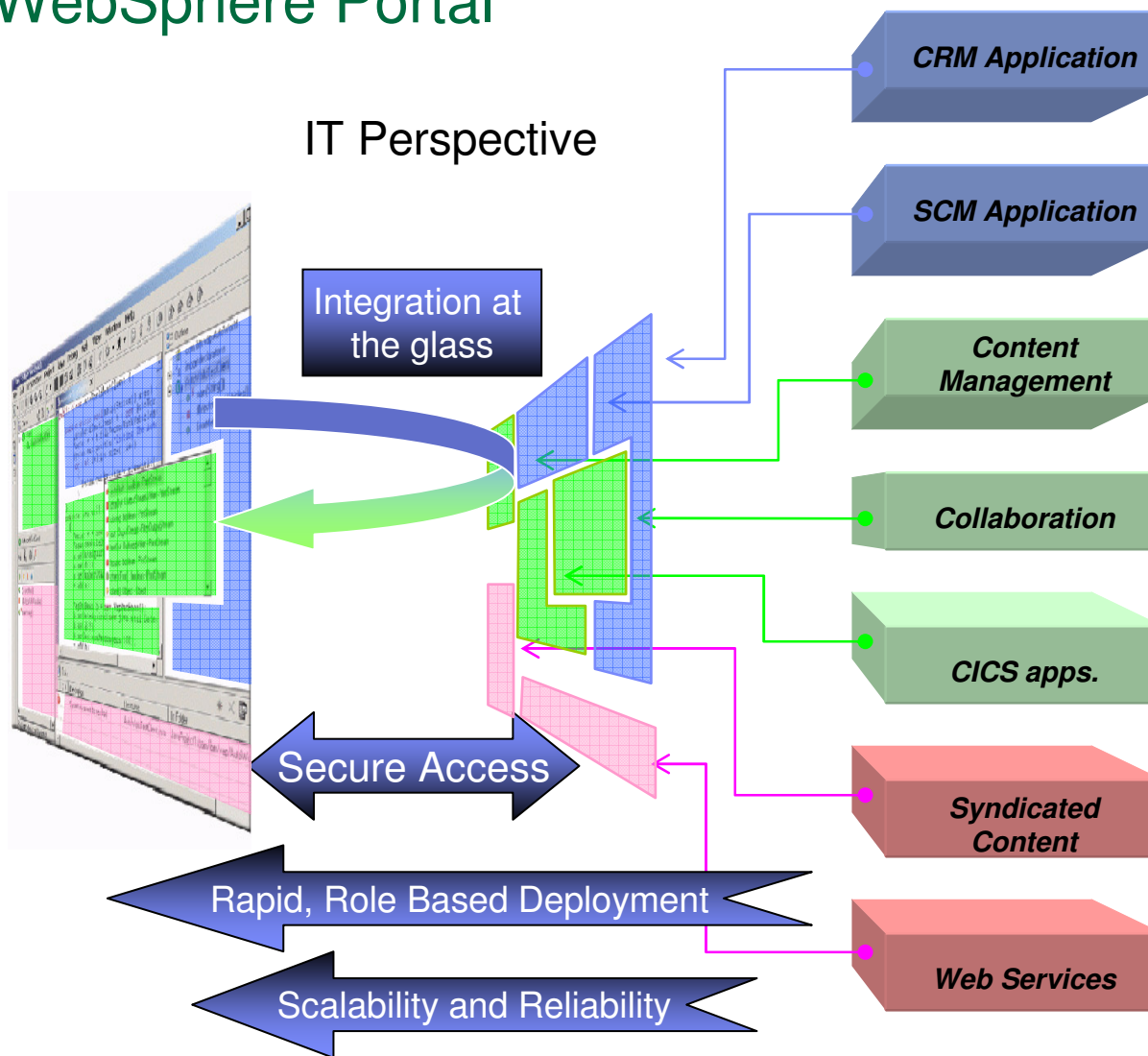

# Special Network Integration for z/VSE with Linux on System z

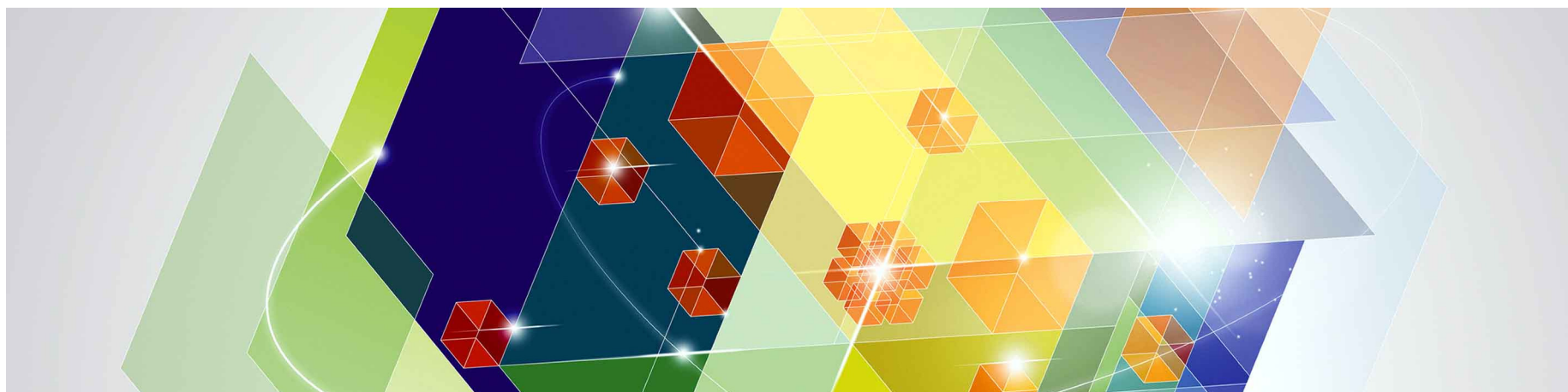

# Linux Fast Path in a z/VM-mode LPAR - Supported by z/VSE 4.3 + 5.1

Faster communication between z/VSE and Linux applications

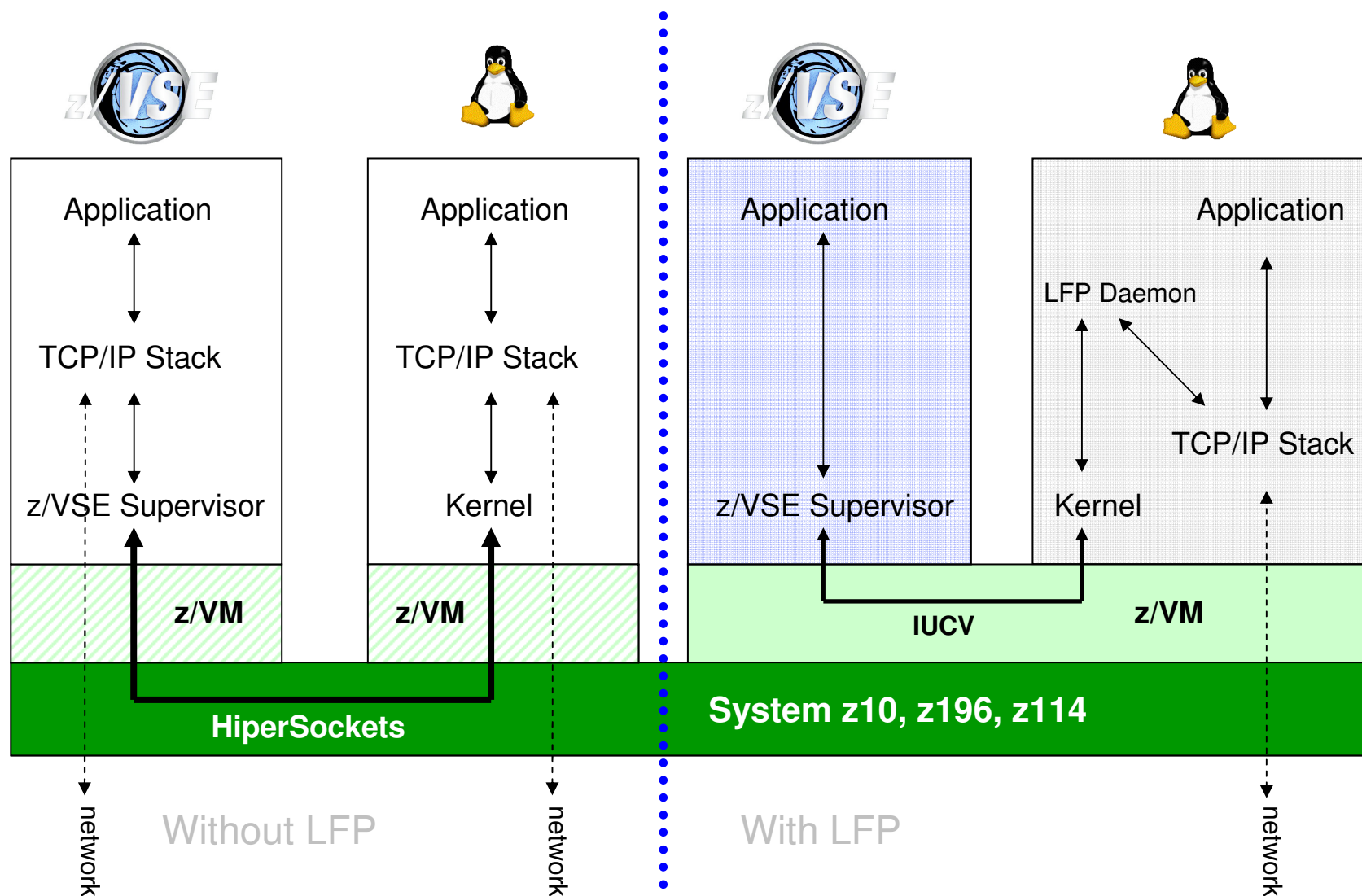



## z/VSE z/VM IP Assist (VIA) - Supported by z/VSE V5 + z/VM V6

With z/VM IP Assist (VIA), no Linux on System z is needed to utilize the LFP advantage

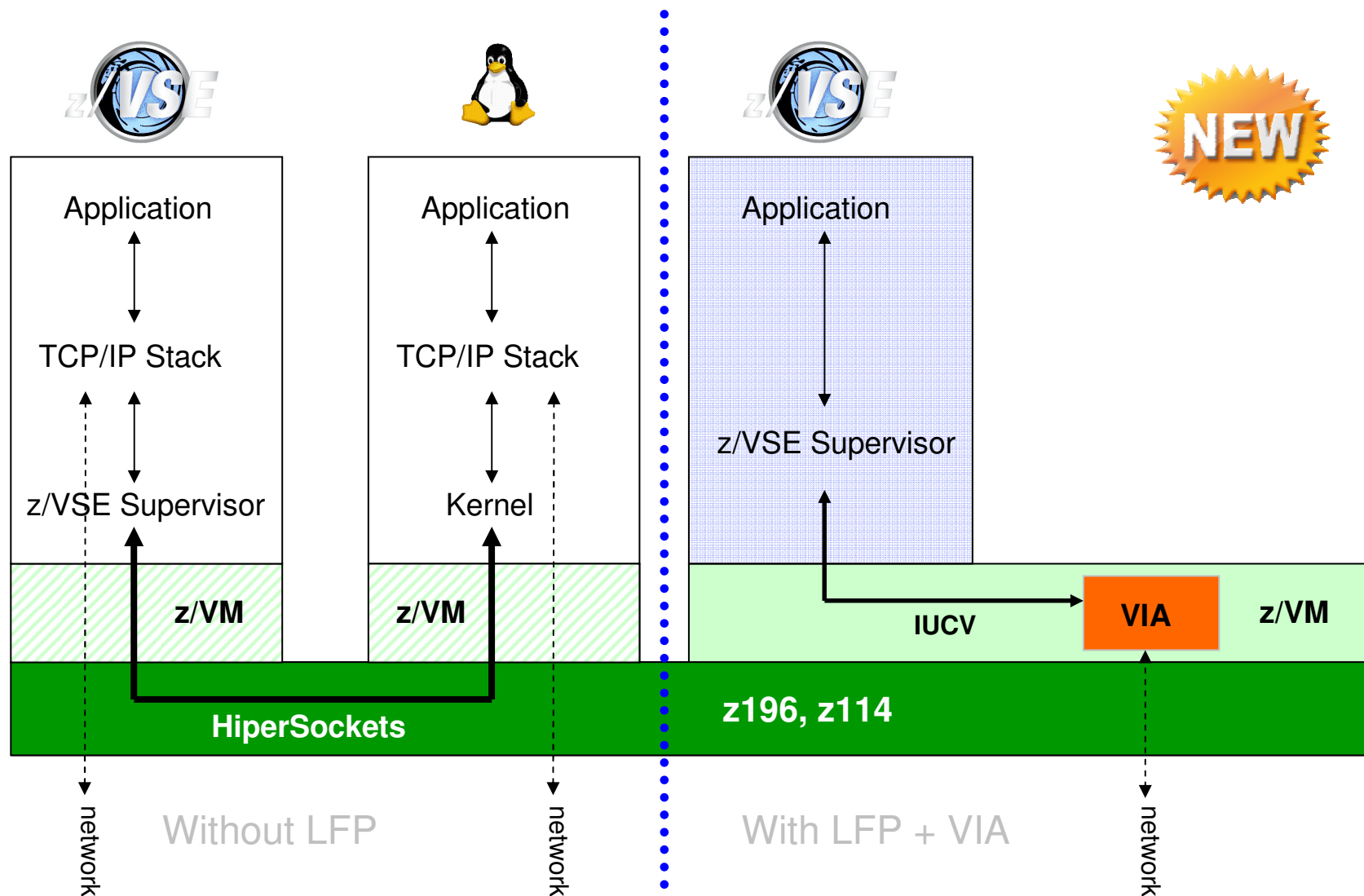

# Linux Fast Path in an LPAR

**Linux Fast Path in LPAR environment:**  
 GA 06/2012: Linux Fast Path function for LPAR environments Exploiting the zEnterprise HiperSockets Completion Queue.

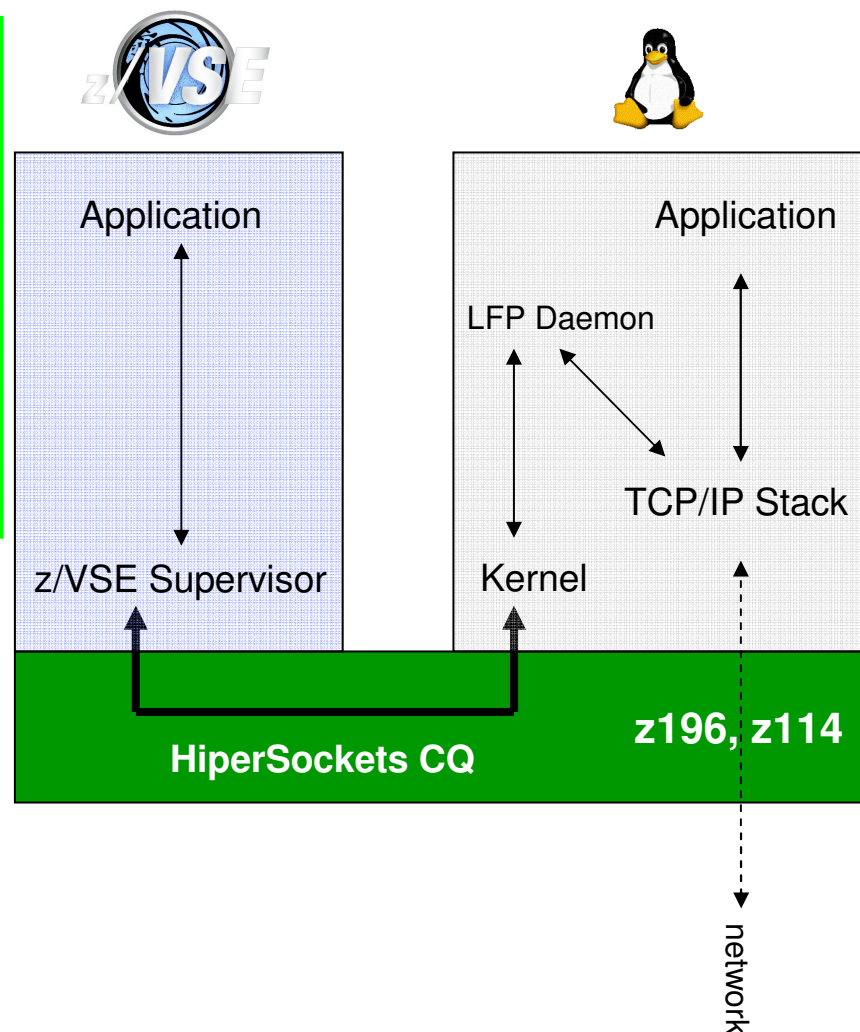

# CICS workload integration with Linux on System z

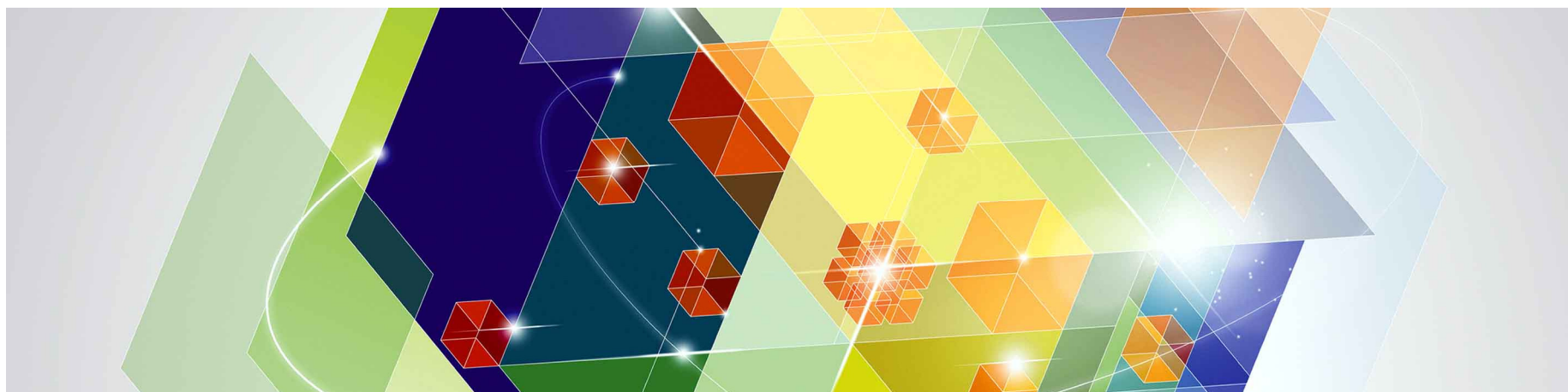

# Connectivity to CICS transactions



## HTTP Access:

*CICS Web Interface/Services (CWI/CWS) within CICS*

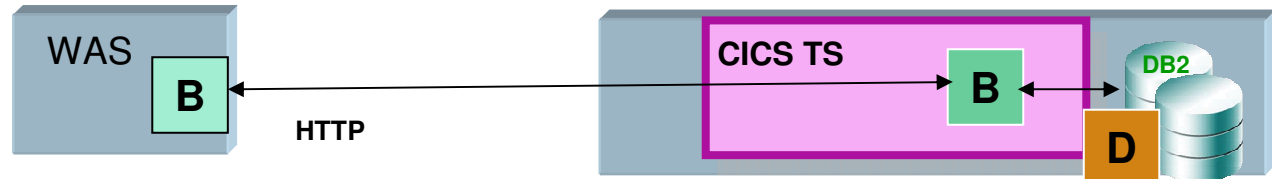

**WebSphere**  
*Host Access Transformation Services (HATS)*

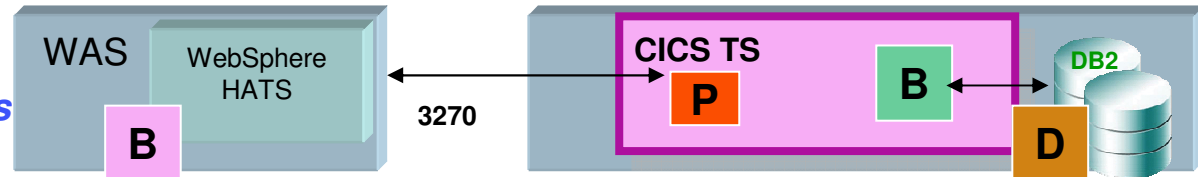

**J2C Connector:**  
*CICS Transaction Gateway (CTG)*

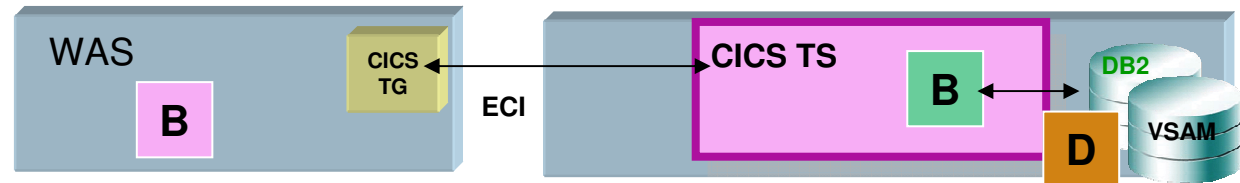

**JMS Connector:**  
*MQ to CICS Bridge*

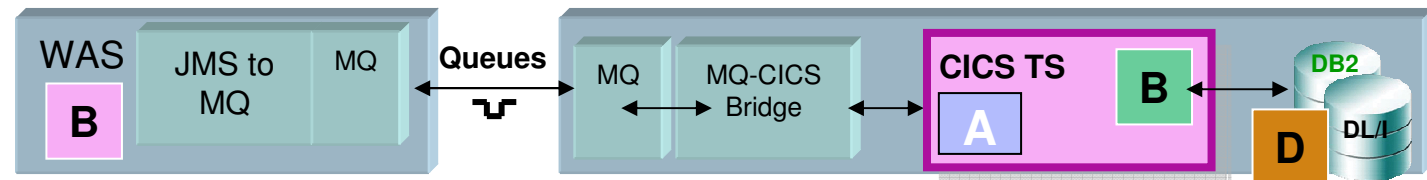

**SOA Integration:**  
*Web Services access to CICS*

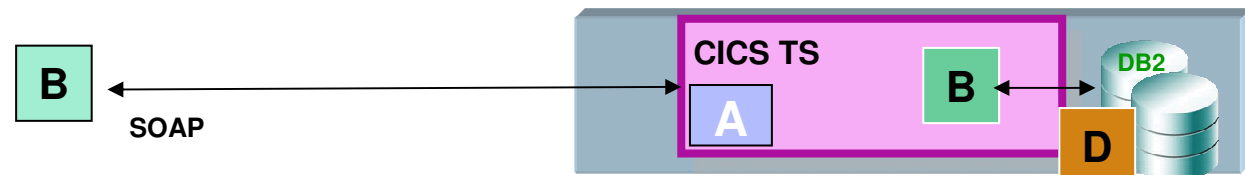

**WAS can be on Linux on z or on another distributed platform. Qualities of Services will vary.**

# The Two Models of SOA CICS Integration via Web Services

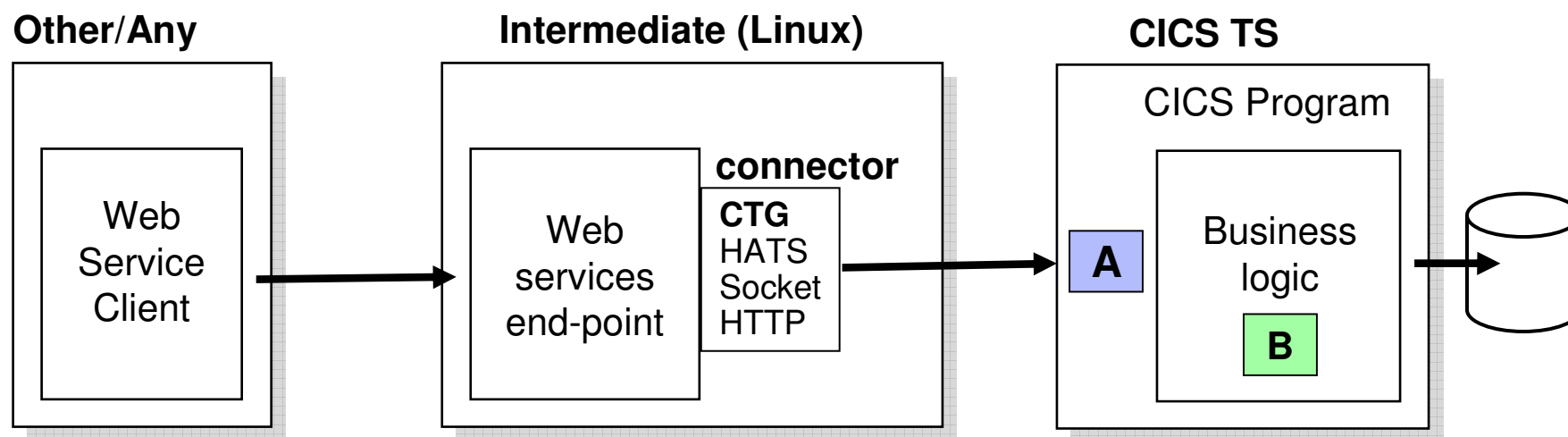
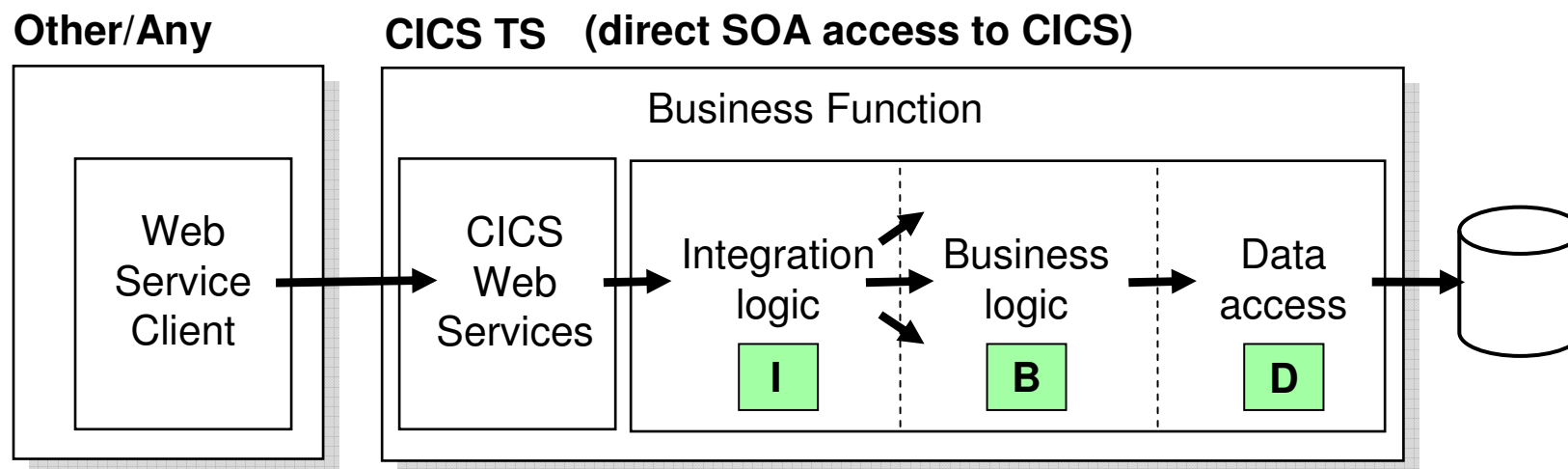

# z/VSE support for IBM CICS Explorer – The “new face of CICS Transaction Server for VSE/ESA”

## CICS Explorer

- **New systems management framework for CICS TS**
- **Consists of client and server part**
- **Based on the Eclipse Rich Client Platform (RCP)**
- **Provides integration platform**
- **Scalable and intuitive way to monitor CICS systems**
- **Can be extended via plug-ins**
- **Client part of CICS Explorer common for z/OS and z/VSE**
- **Fulfills Statement of Direction: IBM intends to provide CICS Explorer capabilities for CICS TS for VSE/ESA, to deliver additional value. Server part requires CICS TS and z/VSE 5.1**

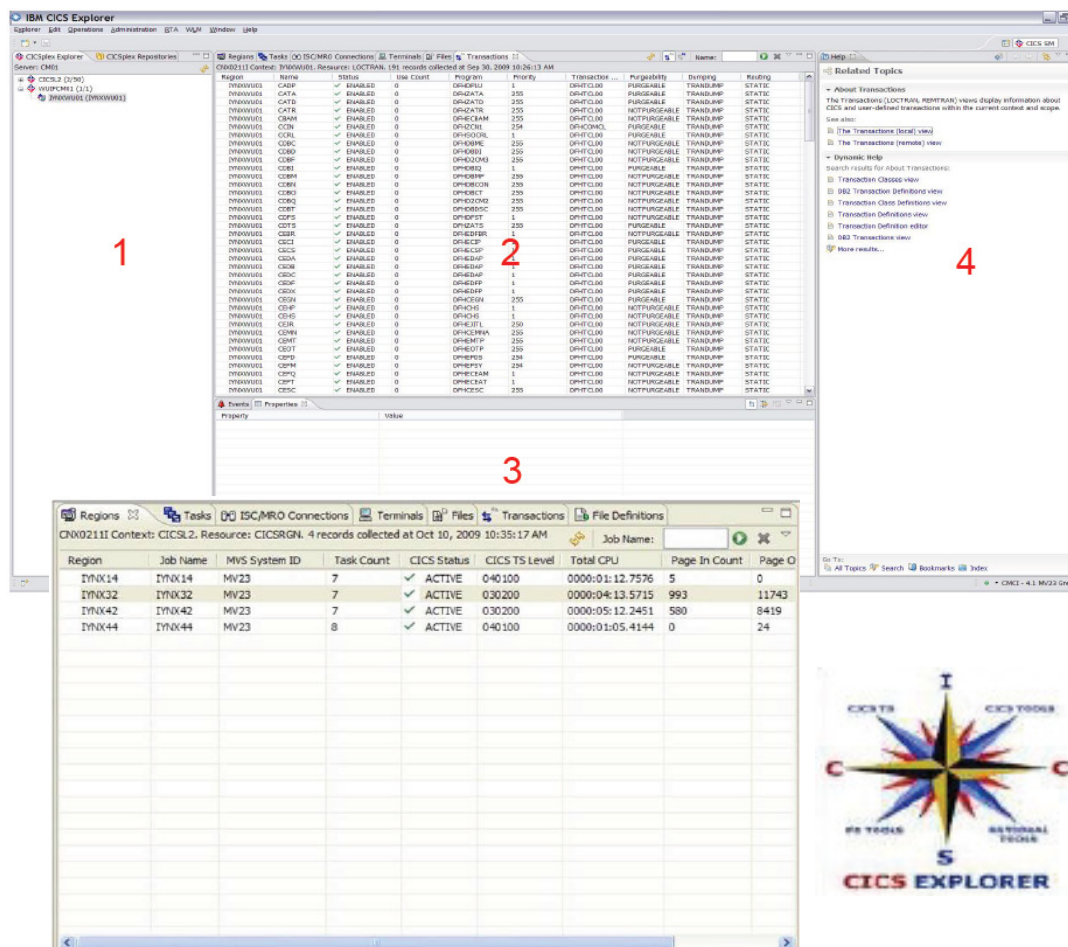

## Service Oriented Architecture (SOA) – the way to new processes

- Applications look the same for all users
- Core applications can be enhanced with an interface (independent of their language, COBOL, ASM, PL/I, Java, C#)
- New business logic is built

**Increased success for the Enterprise**

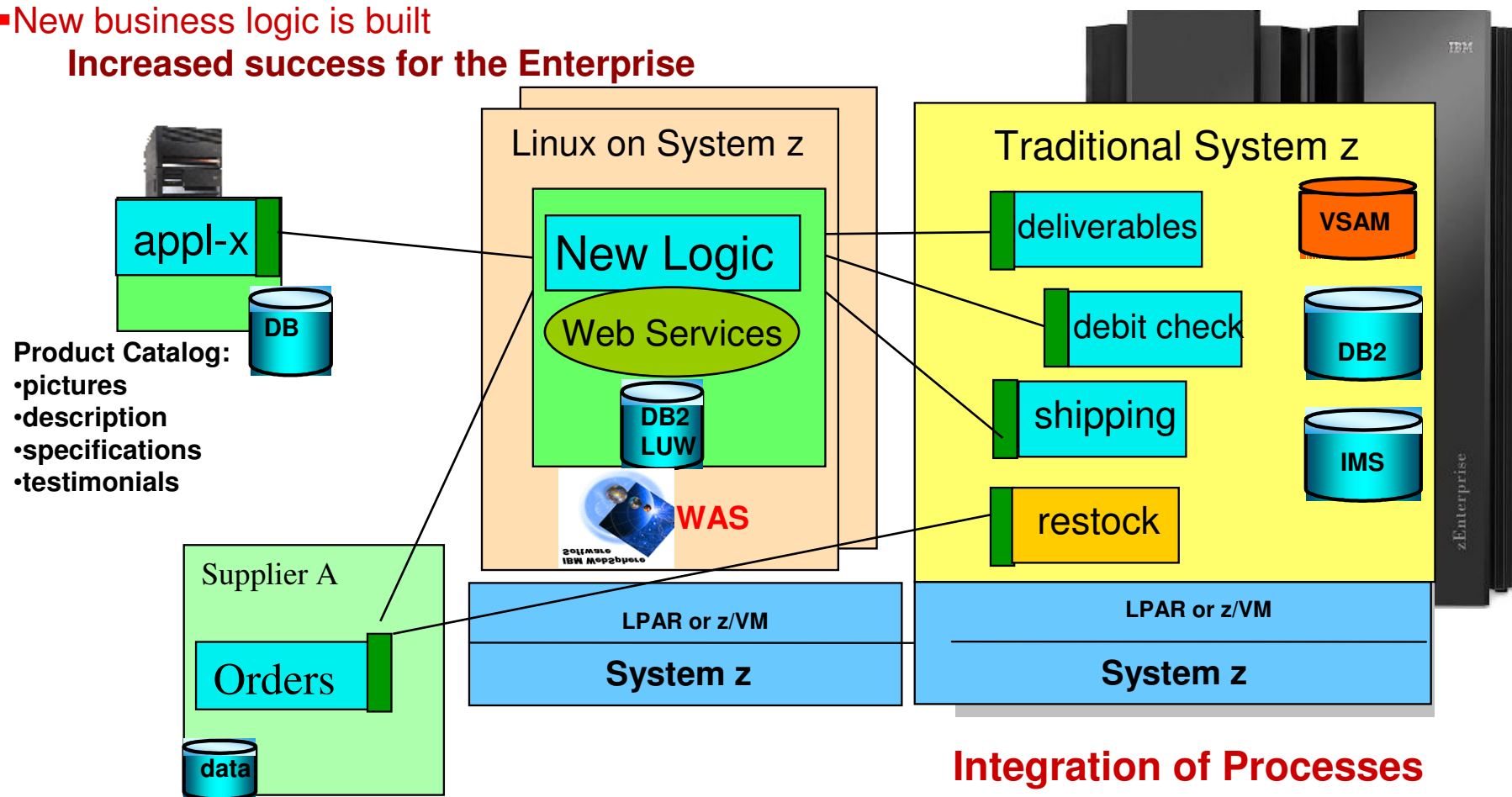

## What is an Enterprise Service Bus?

*An Enterprise Service Bus (ESB) is a flexible Infrastructure for services and application integration*

*An ESB reduces the number, size and complexity of your interfaces in a SOA solution.*

*An ESB realizes following tasks between requestor and service*

- **ROUTING** of messages between Services
- **CONVERTING** the transport protocol between requestor and service
- **TRANSFORMING** message formats between requestor and service
- **HANDLING** of business events between different types of services

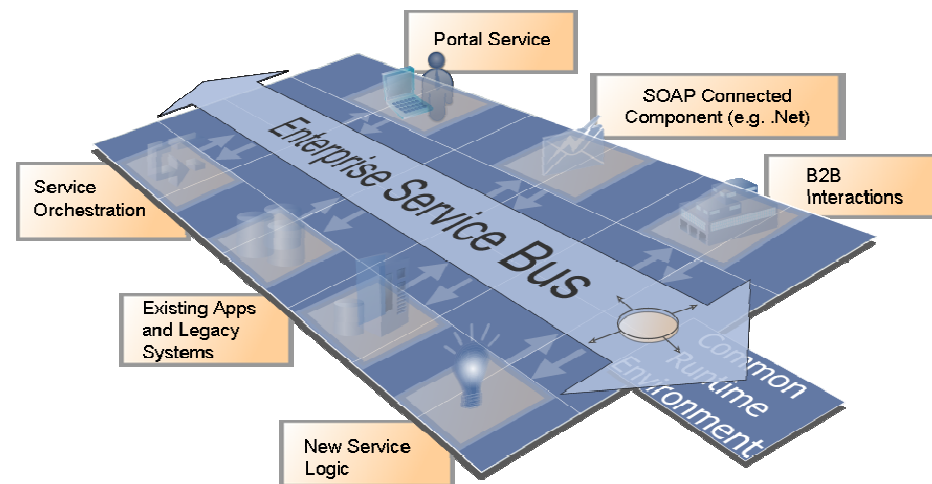



# Integrated SOA Tooling Across ESB Runtimes

All 3 ESBs integrate with Eclipse, WTX, ITCAM for SOA and WSRR



Legacy Mapping Tool:  
**WebSphere TX**  
(Transformation Extender)

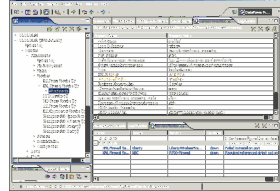

Development Tools:  
**Eclipse/RAD/RDz**

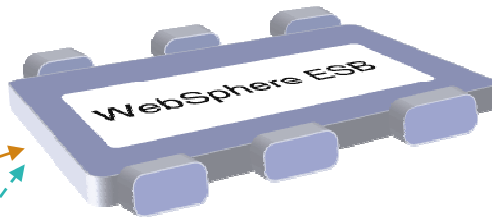
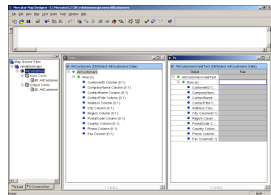

SOA Registry:  
**WSRR**

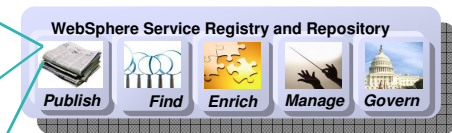

SOA Management:  
**ITCAM for SOA**

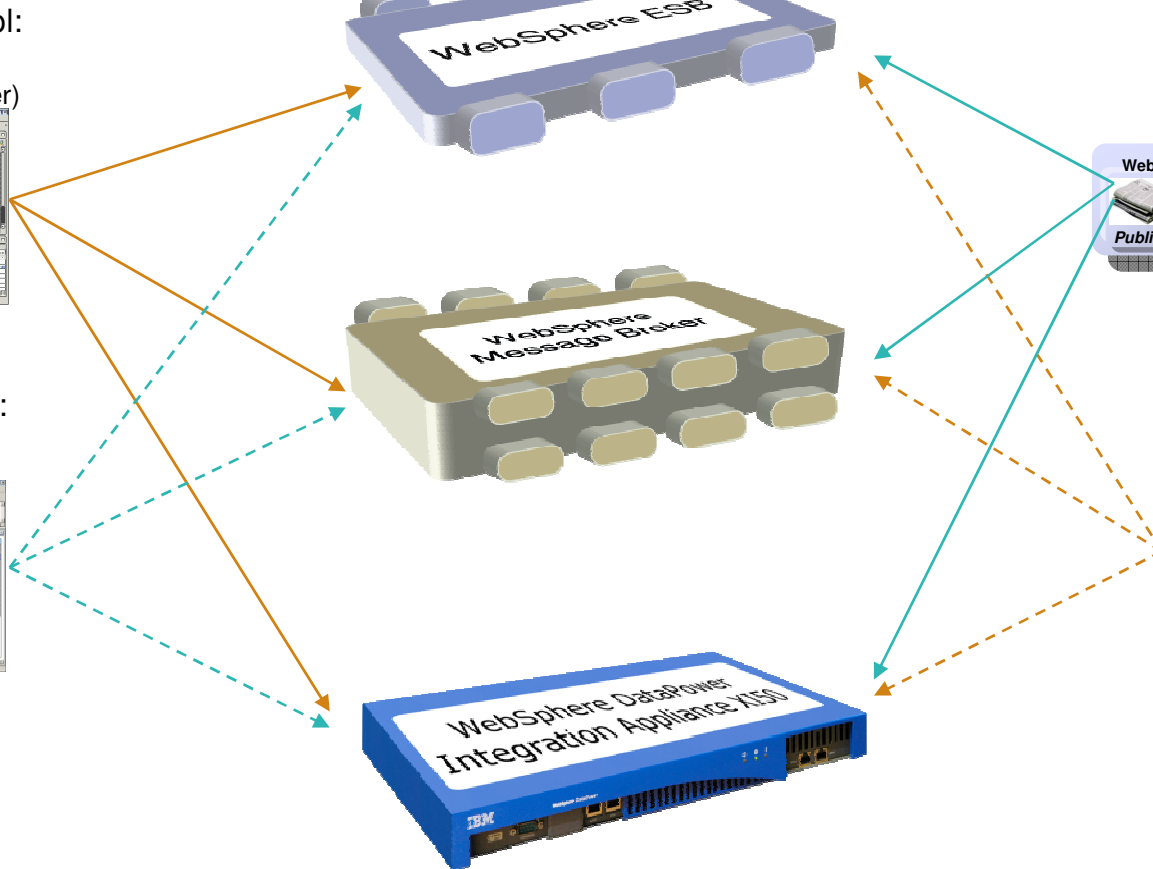
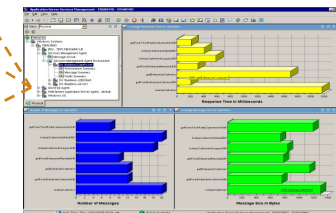

# Integration Appliance XI50

*Purpose-built hardware for Enterprise Service Bus functionality*

- SOA Integration / ESB Message Enrichment / Web Service virtualization for legacy applications
- Enforce high levels of security independent of protocol or payload format
- Integrate with enterprise monitoring systems
- Service level management options to shape traffic

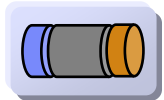

- Advanced protocol-bridging seamlessly supports a wide array of transports, including HTTP, WebSphere MQ, WebSphere JMS, Tibco EMS, FTP, NFS, et al.



- Any-to-any “DataGlue” engine supports XML and Non-XML (Binary) payloads, promoting asset reuse and enabling integration without coding

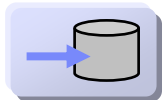

- Direct database access enables message-enrichment and data-as-a-service messaging patterns (DB2, Oracle, MS-SQL, Sybase)



- High performance architecture creates low-cost, easily-scalable ESB solution for Smart SOA needs

# Example of Federated ESB

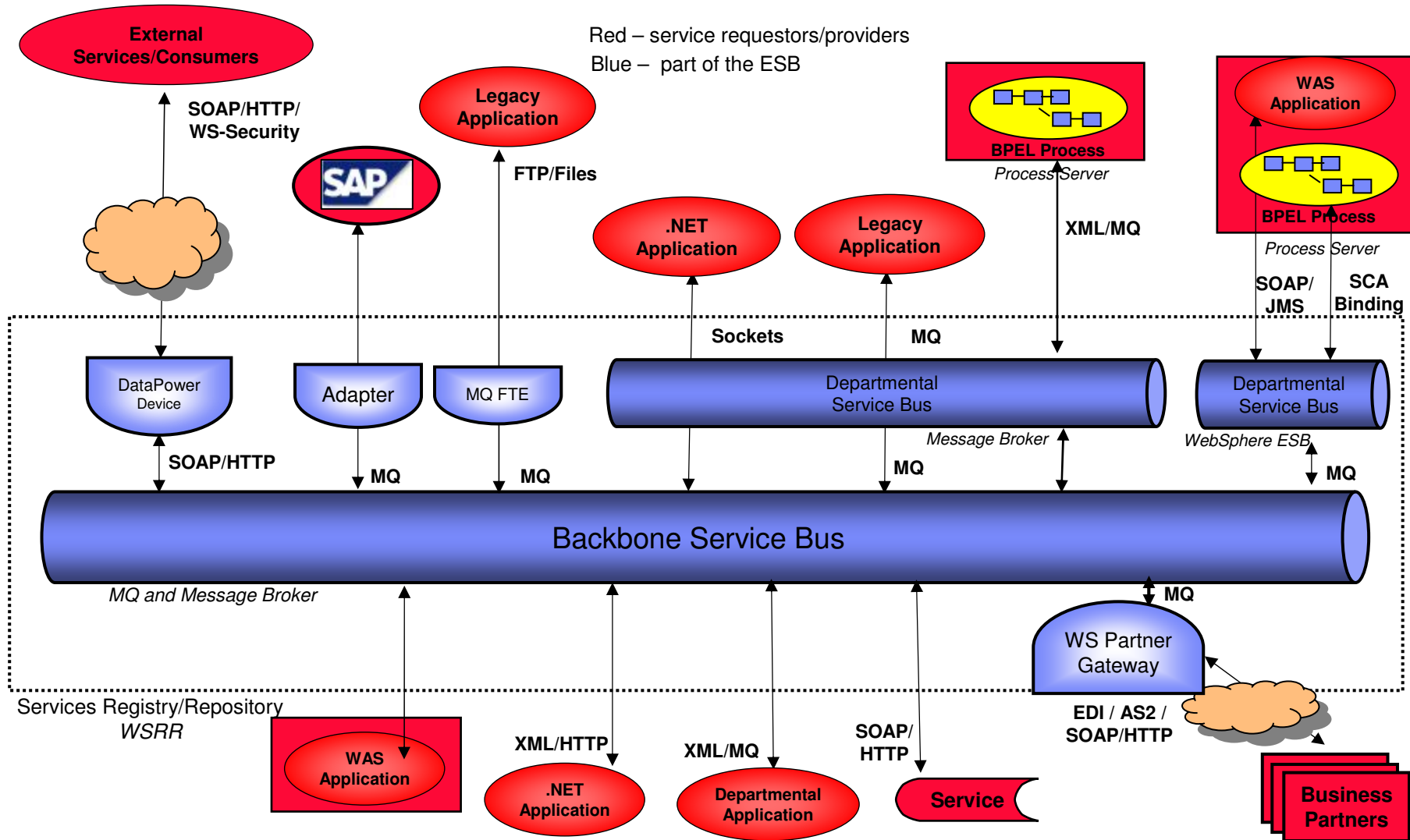

# The SOA ESB with Datapower in zEnterprise connecting via IEDN to z/VSE

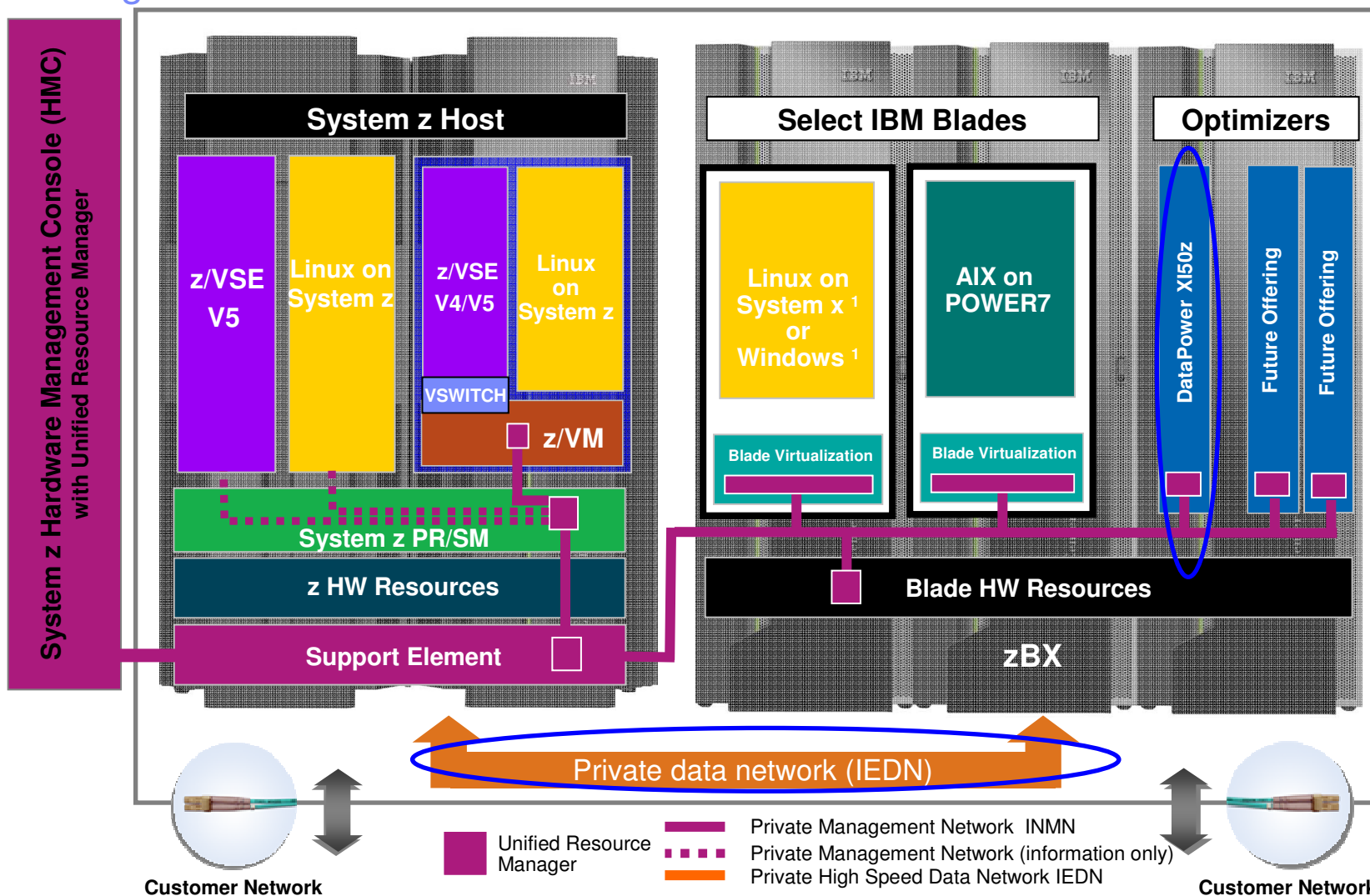

<sup>1</sup> All statements regarding IBM future direction and intent are subject to change or withdrawal without notice, and represents goals and objectives only.

# Data Warehouse and BI Solutions with Linux on System z

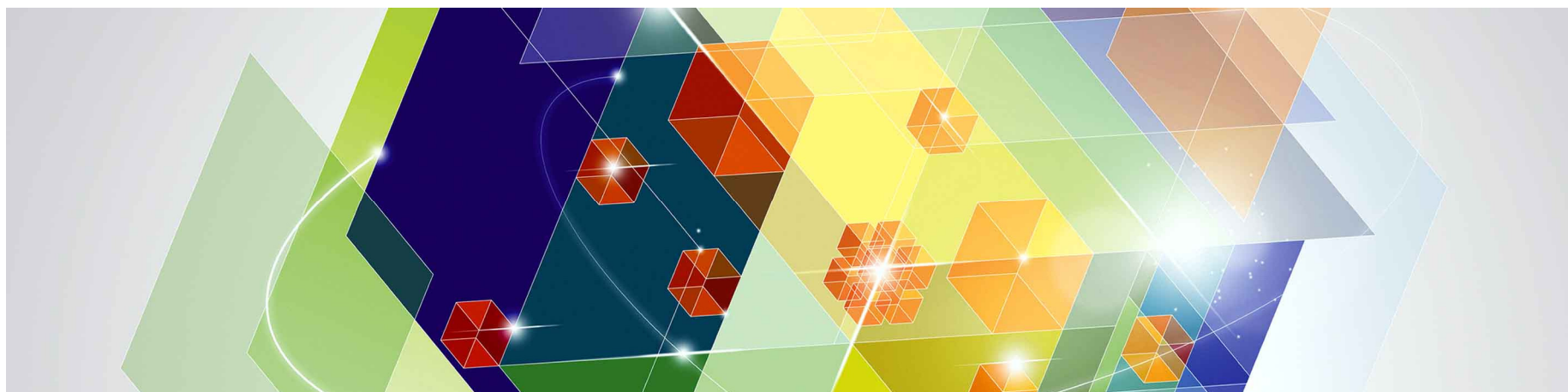

## Integrate, Consolidate, Evaluate, Decide, Explore Business Intelligence (BI)

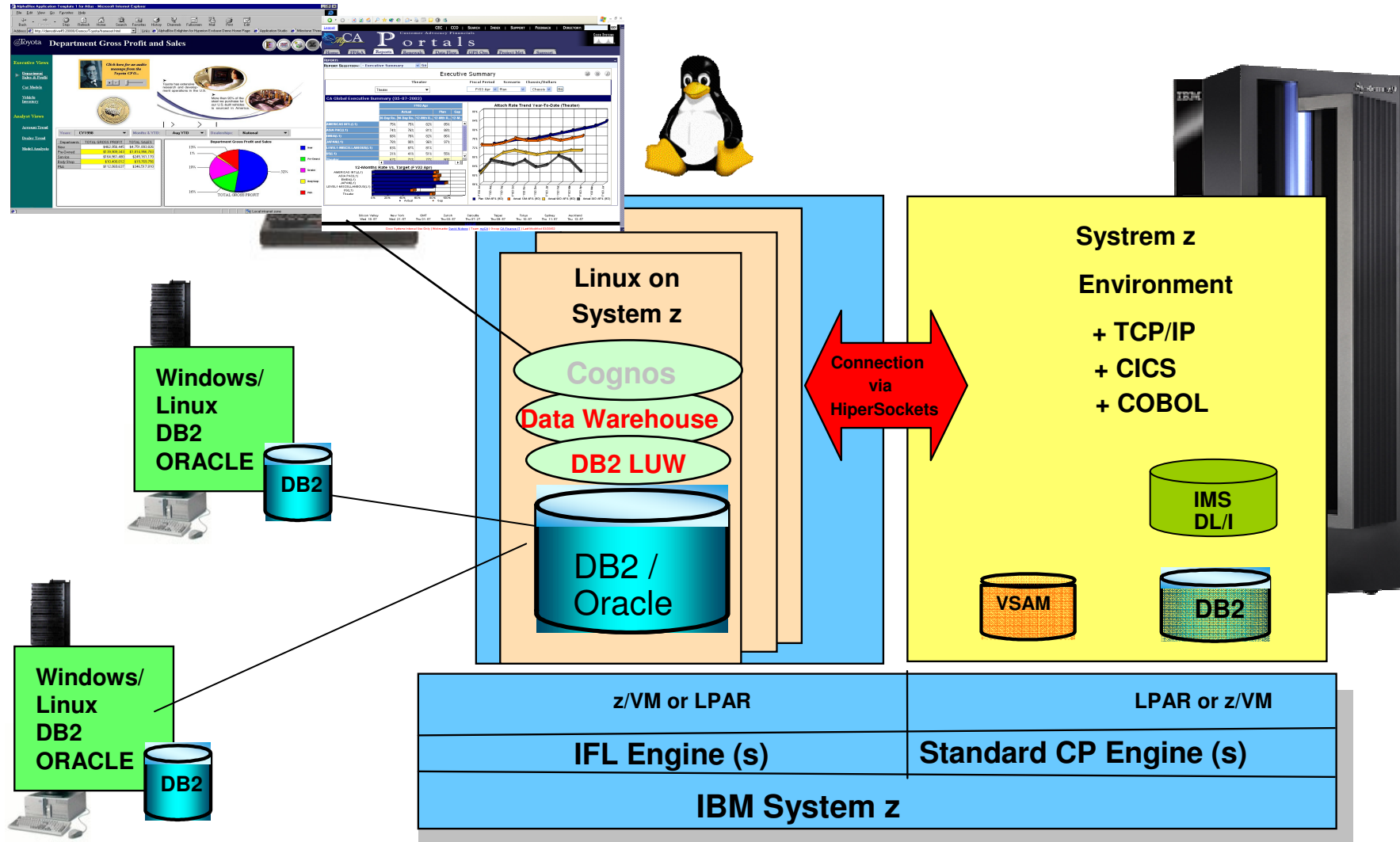

# InfoSphere Federation Server on Linux on System z

- **Integrating at the data layer – Federation of data**
  - Read from and write to federated mainframe data sources using SQL
  - Standards-based access via JDBC, ODBC, or Call Level Interface
    - Including for mainframe VSAM data and flat files
  - Multithreaded with native drivers for scalable performance
  - Metadata-driven means...
    - No mainframe programming required
    - Fast installation & configuration
    - Ease of maintenance
  - Works with existing and new...
    - Mainframe infrastructure
    - Application infrastructure
    - Toolsets

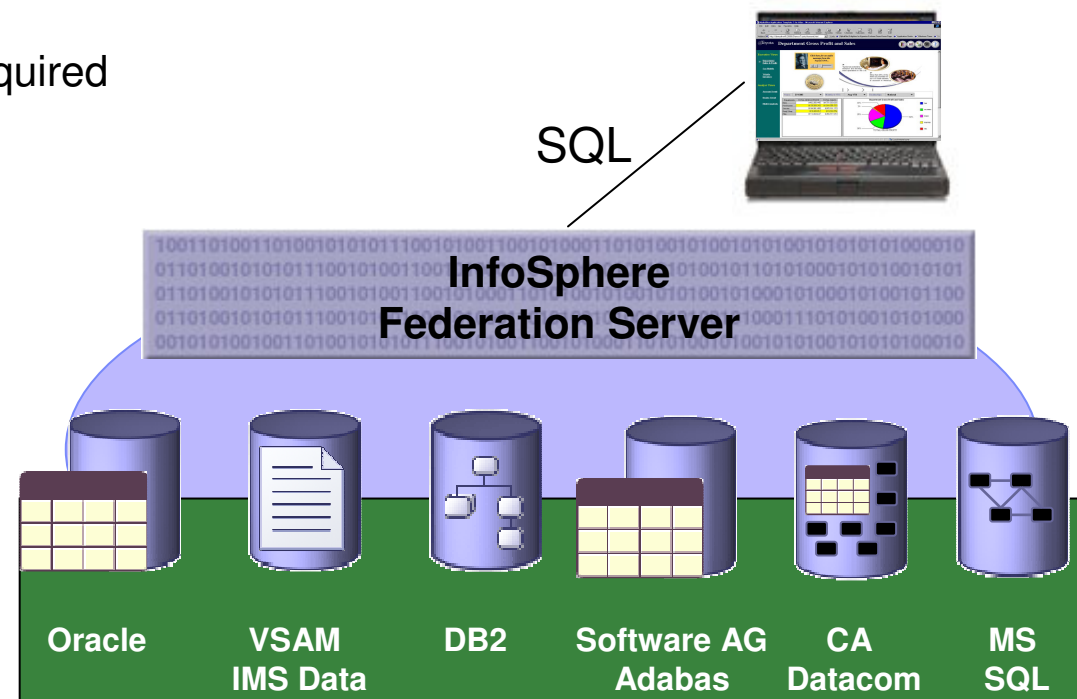

# COGNOS Model Elements

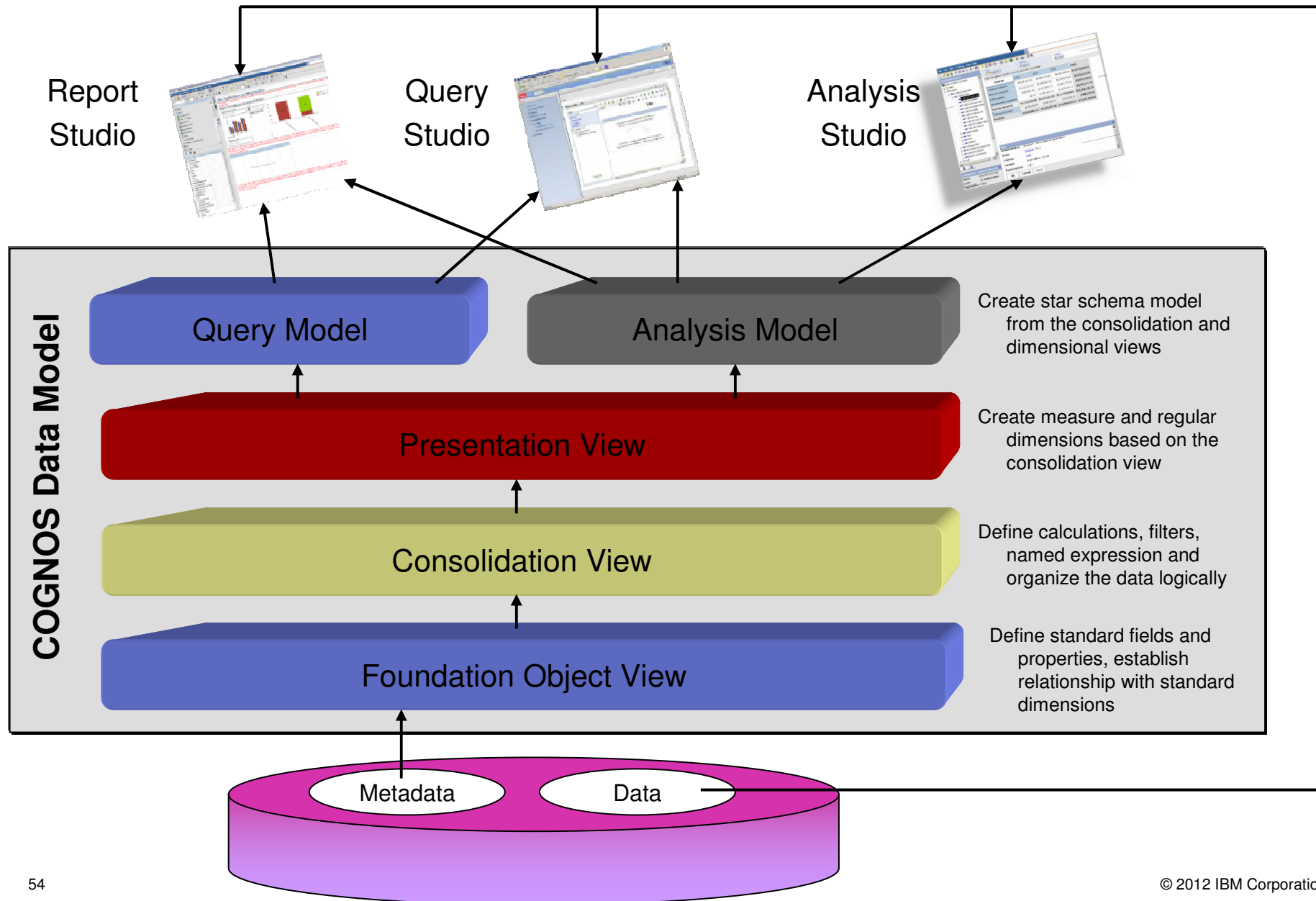



# IBM DB2 Analytics Accelerator V2.1

*Capitalizing on the best of both worlds – System z and Netezza*

## What is it?

*The IBM Smart Analytics Optimizer is a workload optimized, appliance add-on, that enables the integration of business insights into operational processes to drive winning strategies. It accelerates select queries, with unprecedented response times.*



## How is it different

- **Performance:** Unprecedented response times to enable 'train of thought' analyses frequently blocked by poor query performance.
- **Integration:** Connects to DB2 through deep integration providing transparency to all applications.
- **Self-managed workloads:** queries are executed in the most efficient way
- **Transparency:** applications connected to DB2 are entirely unaware of the Optimizer
- **Simplified administration:** appliance hands-free operations, eliminating many database tuning tasks



**Breakthrough Technology Enabling New Opportunities**

## Customers are talking about our Business Analytics solutions



"The IBM® DB2 Analytics Accelerator delivers the speed to create the insights we need to work smarter. By putting the right answers into the hands of decision makers across our business, enables us to quickly adapt and grow."

*Reto Estermann, Director of Information Technology, Swiss Reinsurance Company Ltd.*

"The goal is to book inventory down to the last room available to maximize yield," said Kravchenko. We can expeditiously do this from a centralized reservations system, no matter where in the world the reservation is requested."

**Misha Kravchenko, Vice President, Global Enterprise Mainframe Systems for Marriott International**



"Moved from data mining to full scale data warehousing on System z to deliver the high performance and 24x7 availability required for hospital processes and the consistent uptime, superior scalability and recoverability"

*Bob Goodman, Senior Database Administrator, Florida Hospital*

Business users at Chartis Insurance require SLA with no down time, high performance and fast time to market. With System z, business users benefit from seamless up time of 99.99 percent, the fastest performance available and time to market measured in days."

*Travis Neel, VP BICC, Chartis Insurance*



"Running our data warehouse platform on System z allows us to achieve consistent performance and reliable uptime, which are crucial for maintaining the highest degree of customer confidence in the bank and its services."

*Hermann Schelling, Head of Database Engineering, Zürcher Kantonalbank*

"Our commitment to informed decision making led us to consider private cloud delivery of Cognos BI via System z, which is the enabling foundation that makes possible the support of 200,000 users and +\$25M savings over 5 years."

*IBM CIO Office*



# SAP Solutions on IBM zEnterprise System

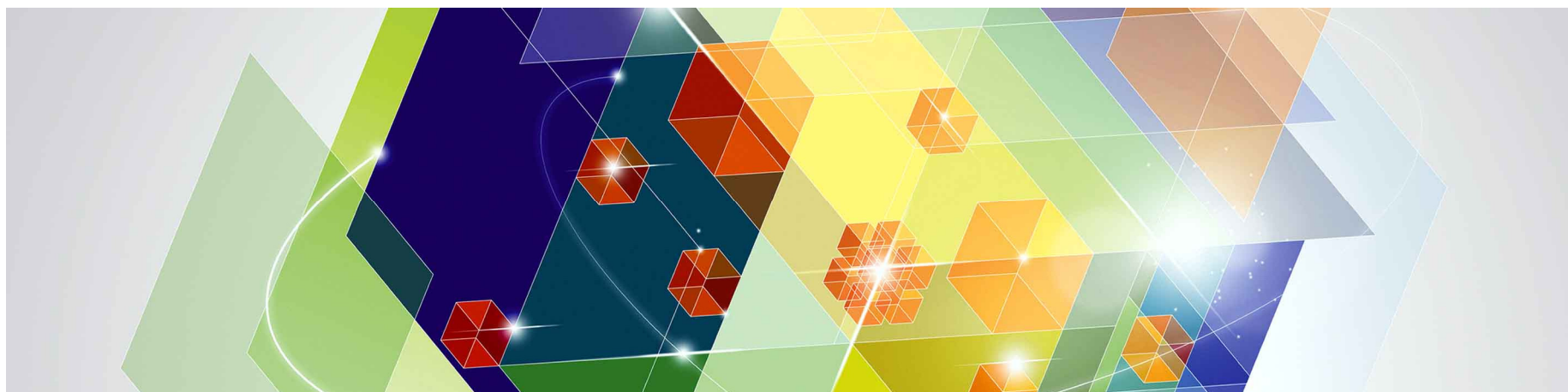

# SAP solutions remain In high demand to meet client requirements for business insight, improved productivity, and innovation

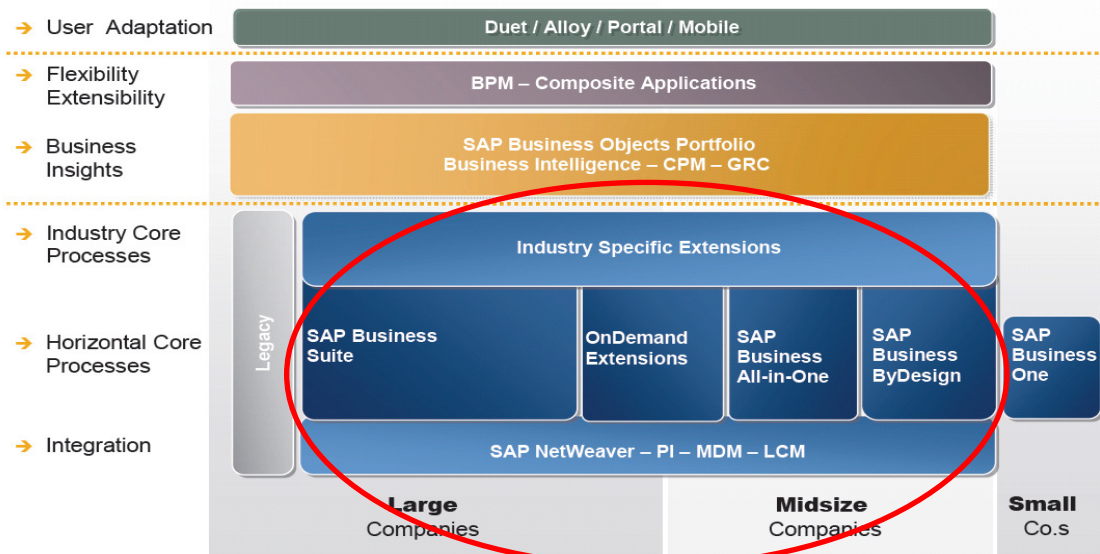

© SAP 2008 / Page 10

## SAP on System z:

- ERP financials, HR, CRM/SCM /SRM
- Industry solutions, like:
  - Banking, core banking, Bank Analyzer (reporting), risk and compliance
  - Insurance
  - Retail
  - Automotive

**Improve visibility, empower better decision making**

**Expand and innovate without disruption**

**Improve mission critical industry business processes**

Today there are over 1500 installations of SAP on System z, and plenty of IT organizations looking to consolidate their SAP instances.

# SAP on IBM zEnterprise System

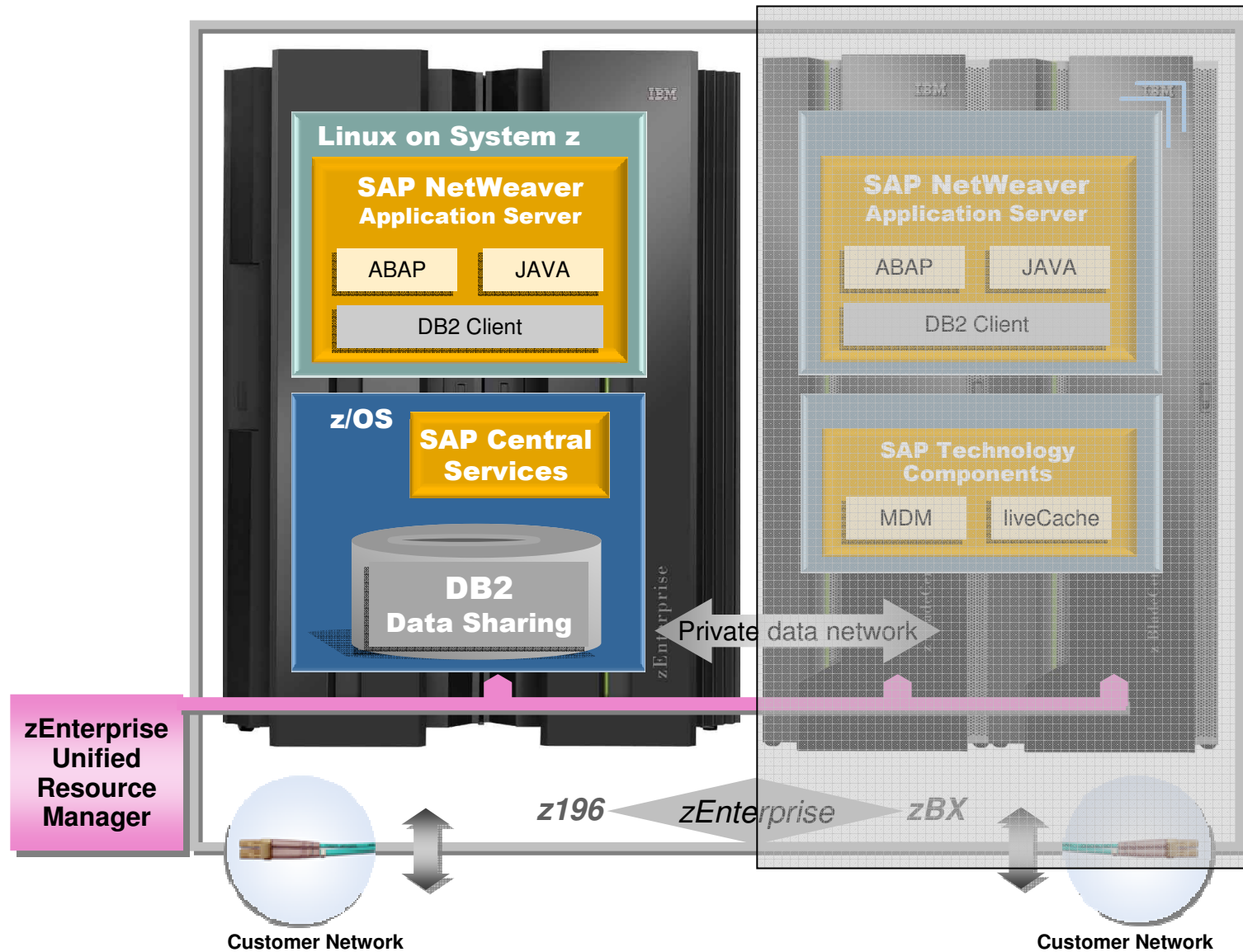

# Core Banking on IBM System zEnterprise

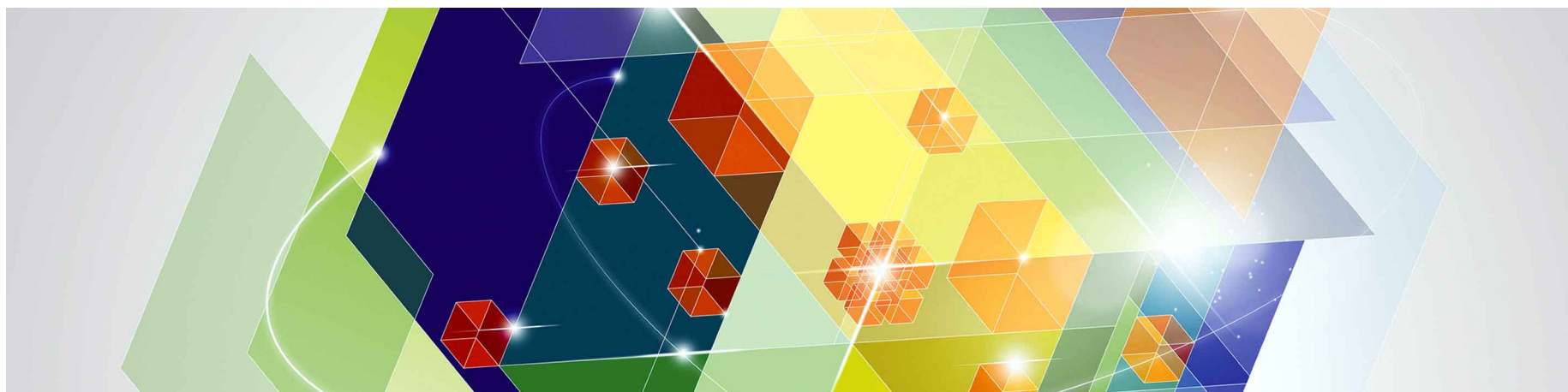

# 113 of top 120 banks by asset size choose System z...

## To directly impact the bottom line

### SMART IS

Reducing costs and serving the client



**Caixa Galicia:** Dramatic growth and national success, spurred by lean, efficient System z to deliver bank transaction costs 30% below Spain Average

## To serve the customer

### SMART IS

Business continuity, security and agility



**Handelsbanken (Sweden):** *“Customers entrust us with their hard earned savings so it’s paramount that we select one of the industry’s most powerful and secure servers - the IBM System z,”* said Roger Rydberg, technical manager at Handelsbanken. *“[System z] allows us to keep up with business climate changes because we can add or eliminate capacity any time based on customer demands. We can even make changes easily without having to stop any services.”*

## To deliver growth

### SMART IS

Improved speed to market with integration



**St Georges Bank:** Integration of disparate systems and data to improve customer service, bringing new products to market. *“We no longer want to invest the time and resources in two or three year initiatives. Business is changing so fast these days that we can’t afford to roll something in production that represents the thinking of three years ago.”*

**Smart is not just for existing mainframe clients:**

**Vietnam:** Protecting data from risks, while allowing responsiveness to the high demands of banking



# Core Banking Solutions on IBM System zEnterprise

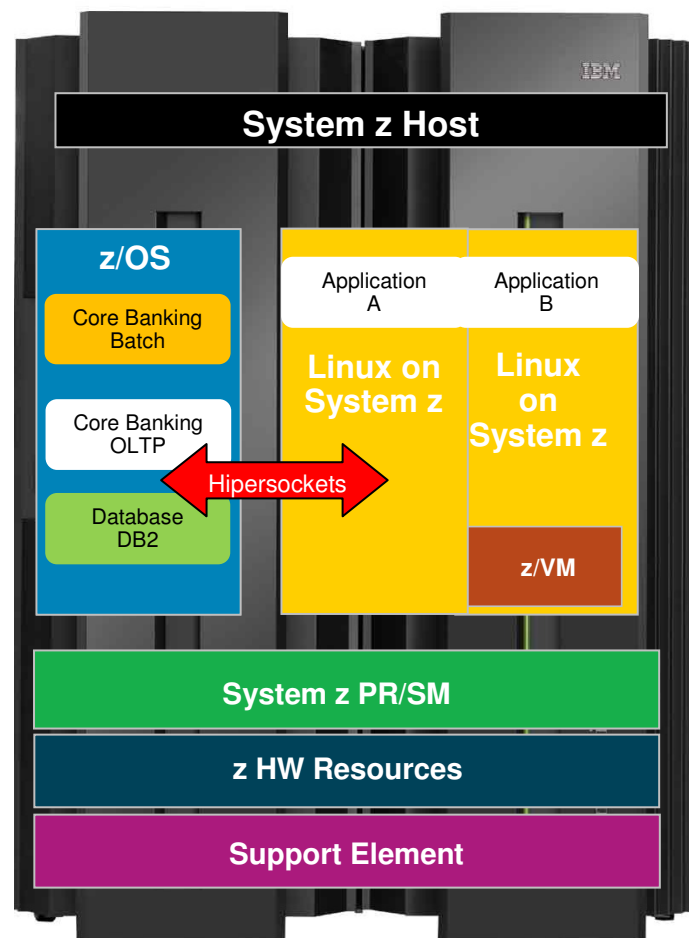



---

## Collaboration – Call Centers on Linux on System z and interaction with CICS workload via SOA

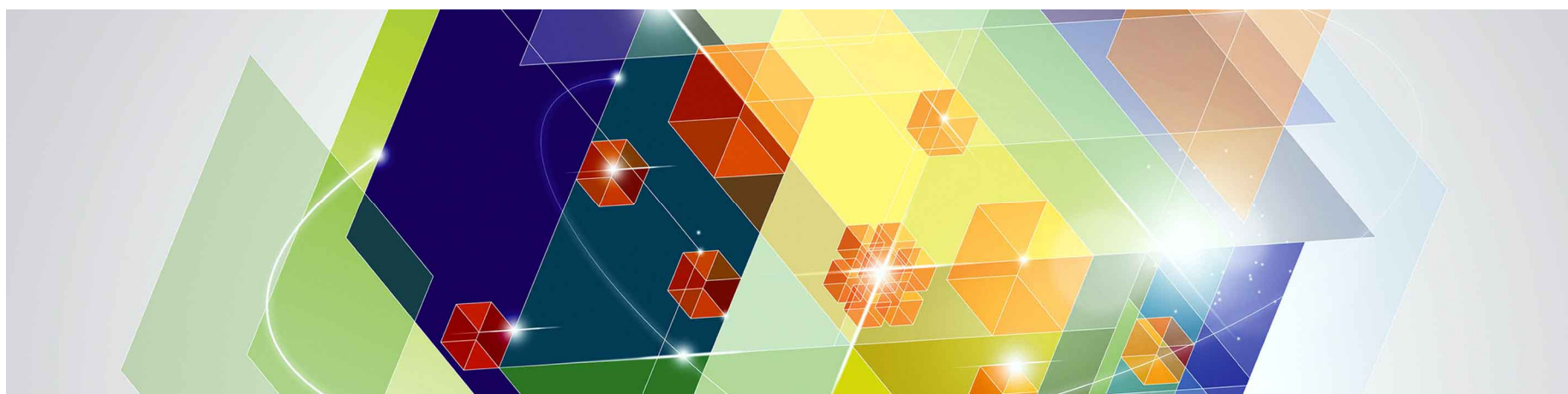

# IBM System z – the next generation **voice** Hub! – more than a simple Phone Server

*„Asterisk® is the world’s leading open source telephony engine and tool kit“*

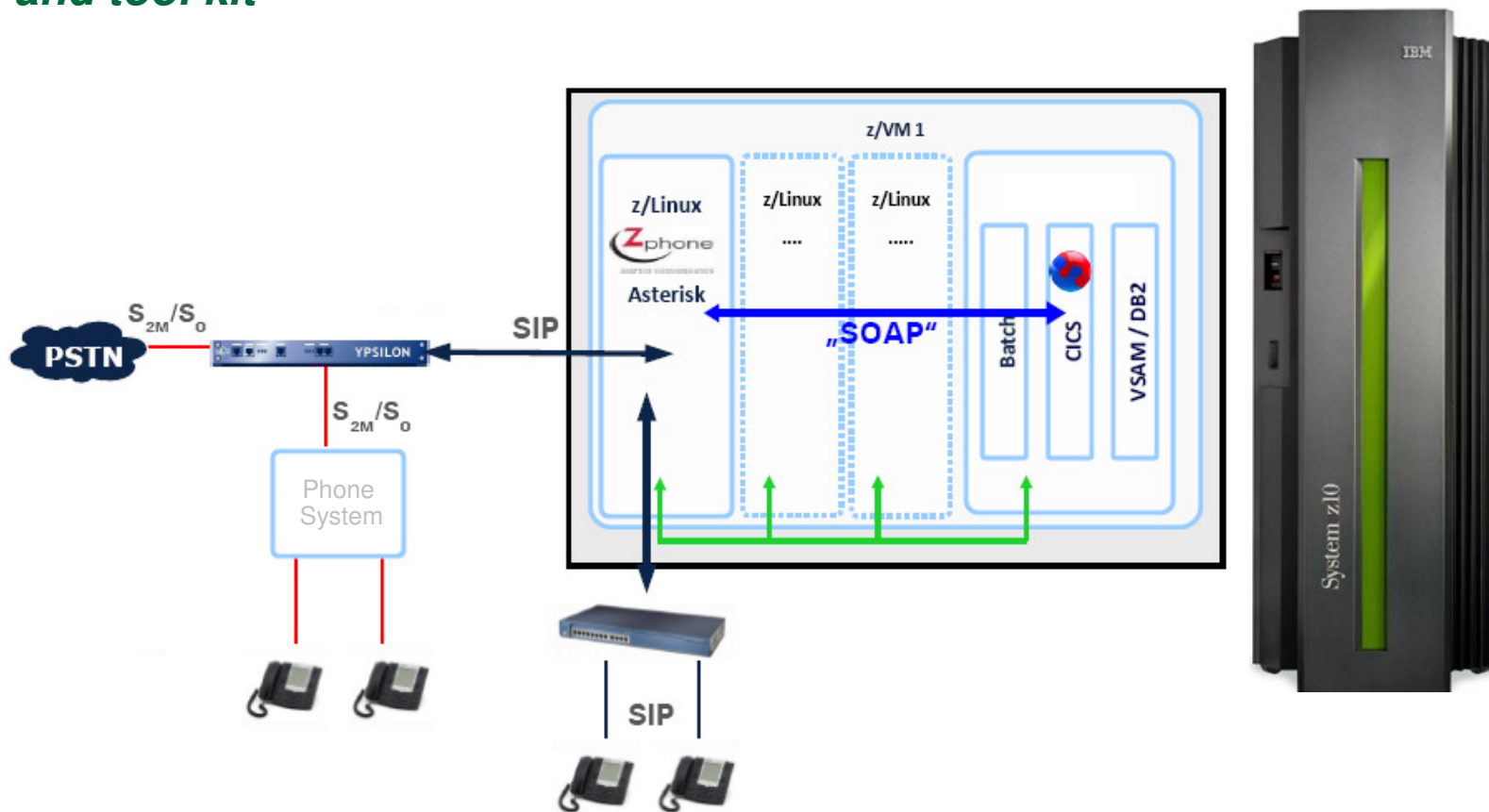

(<http://www.asterisk.org/support/about>)

# Central Backup for the Enterprise with Linux on System z

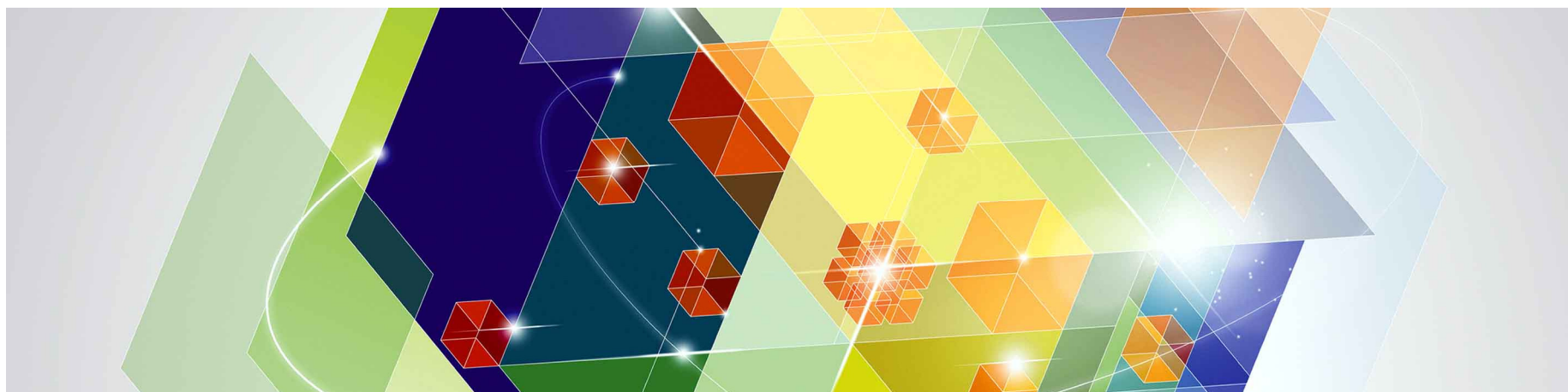

# Enterprise Backup with Linux on System z

## Implement TSM on Linux on System z as central Backup Hub

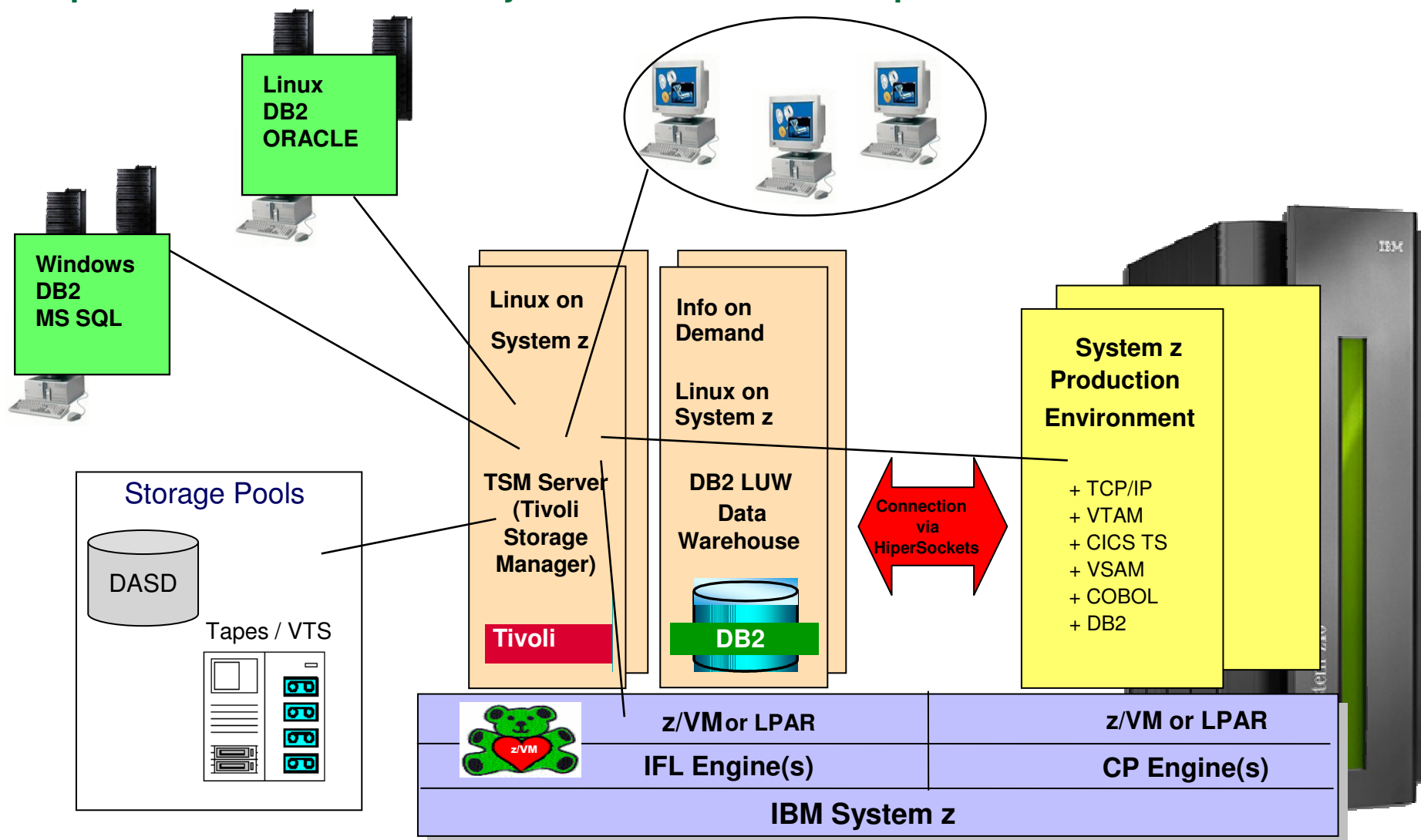

---

## Solution Benefits with Linux on System z

- **Centralized Backup procedure for the enterprise**
- **One central tool for System z and distributed backups and archives**
- **Use of Stability of System z for Recovery and High availability**

---

## High Availability integration of z/OS and Linux on System z using GDPS

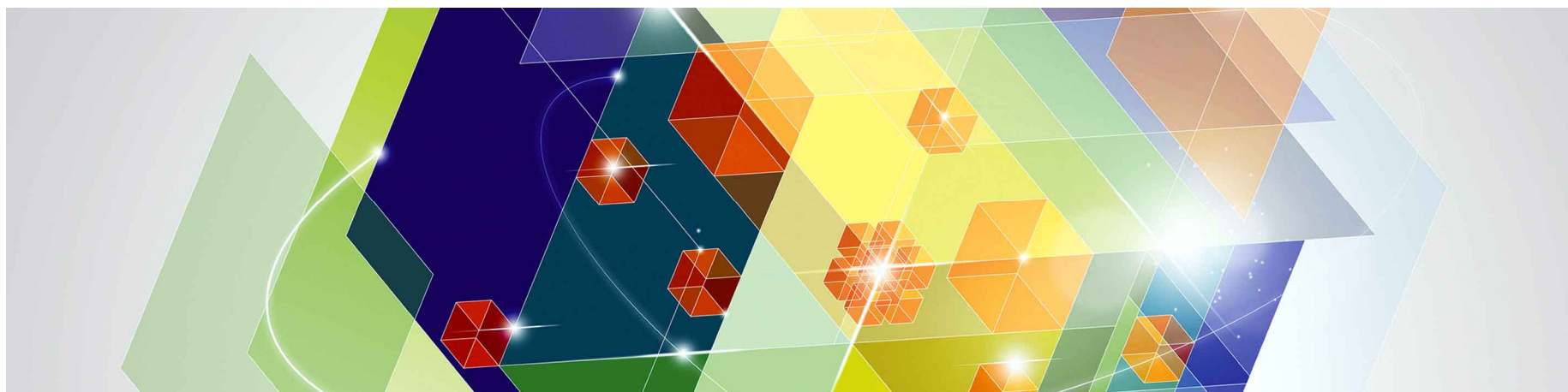

# GDPS and xDR with z/VM guests – High availability



- Proxy
  - One linux system is configured as Proxy for GDPS which has special configuration
    - (Memory locked, Access rights to VM, One-Node-Cluster)
  - Is used for tasks that have z/VM scope
    - HyperSwap, shutdown z/VM, IPL z/VM guest
  
- Production Nodes
  - Run Linux Workload
  - Are used for local actions ( Shut down node, Maintenance Mode)
  
- Other Systems
  - Enabled for HyperSwap via xDR Proxy (Linux, z/VSE)
  - No re-IPL in place, no start/stop via GDPS (init, reipl, maint)

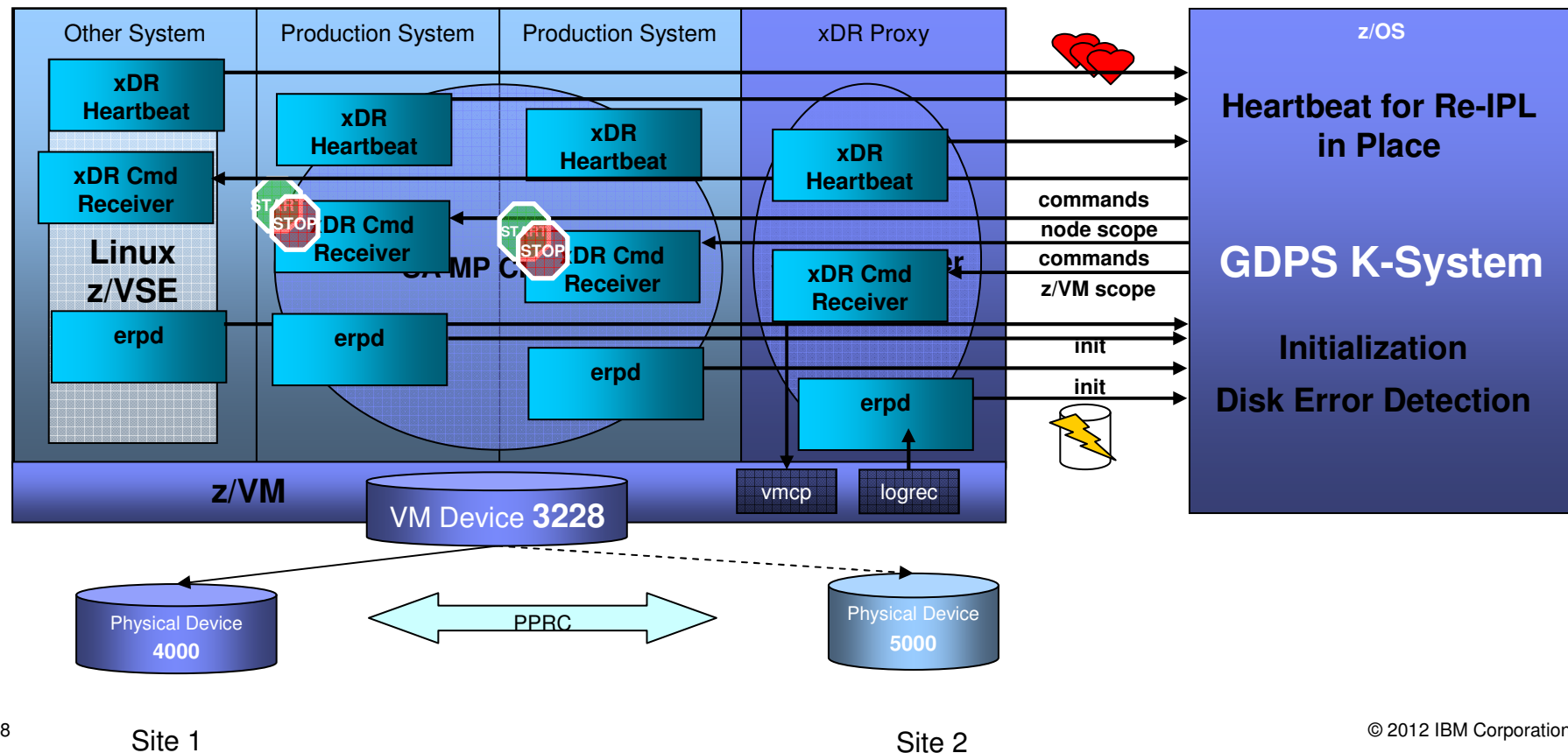

---

## Cloud Computing with Linux on System z and integration of cloud and traditional

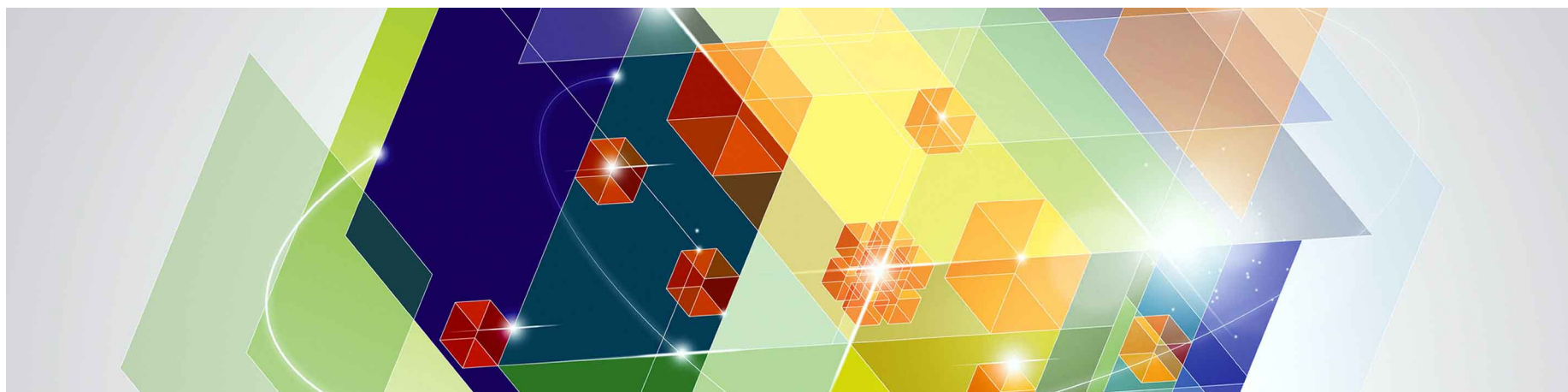



# Cloud computing service Layers

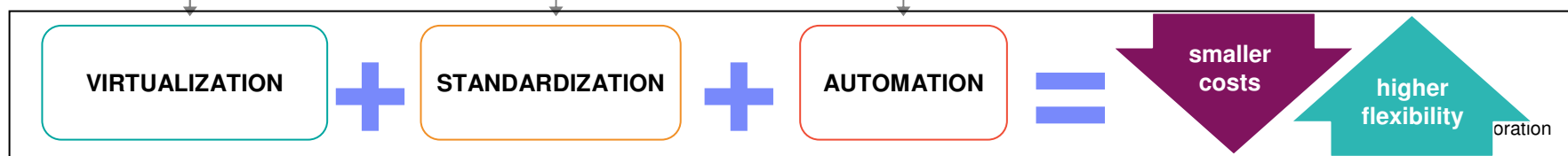
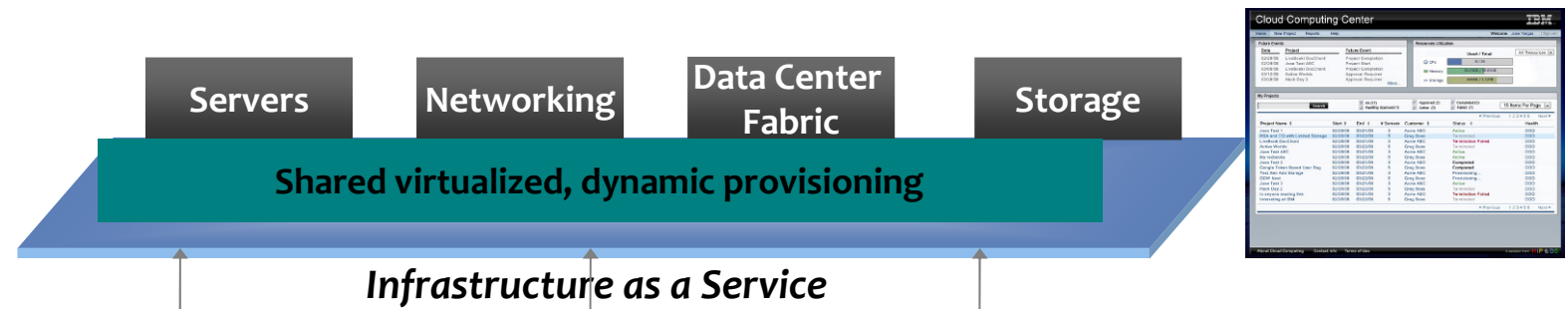
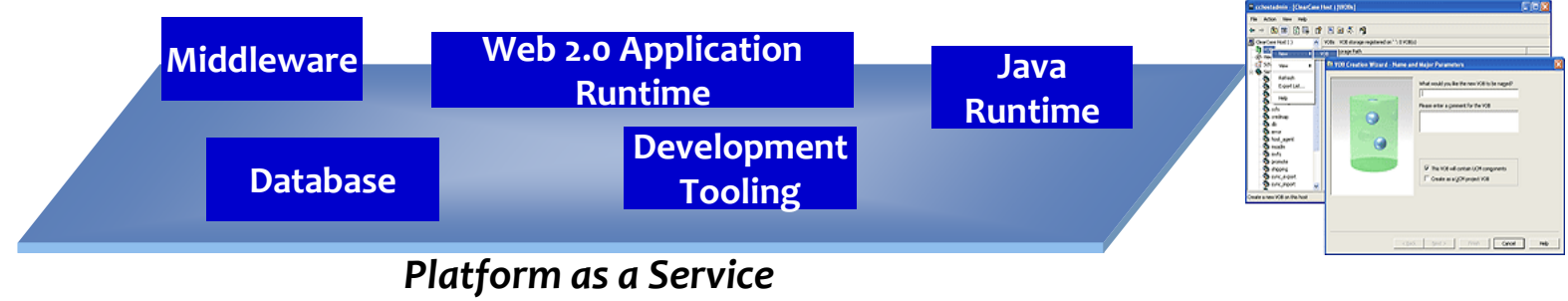
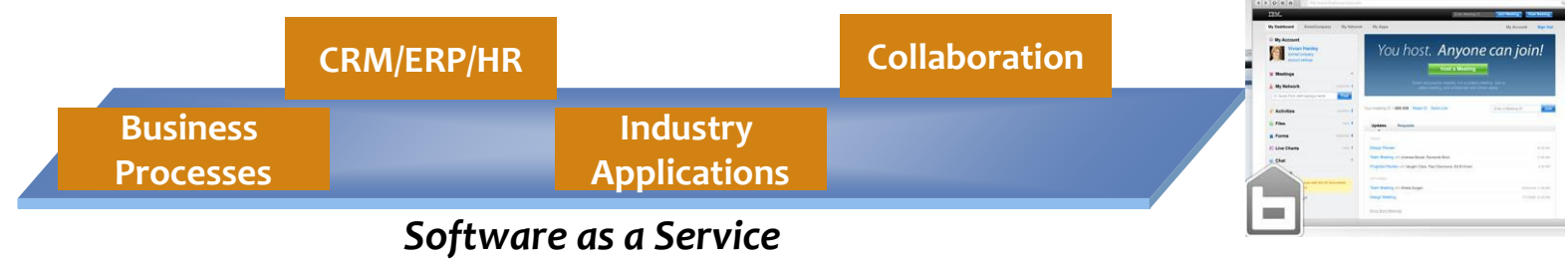

# Universita di Bari

## Innovative Cloud Solutions

### **Wine Market**

*Support for 60 wineries to determine demand and get best market price*

### **Fish Market**

*Electronic fish auction for fishermen while on boats*

### **MoniCA**

*Logistics solution tracks and collects data real time*

**Solution Edition for Cloud Computing**



**Solve community challenges**

## BENEFITS to Clients

**Cloud computing allows multiple organizations to tap into heavy-duty computing power at minimal cost.**

**It lowers the barrier for local businesses to benefit from this technology.**



**UNIVERSITÀ  
DEGLI STUDI DI BARI  
ALDO MORO**

Universita di Bari, established in 1924, is developing cloud-based solutions for a consortium of companies and universities from five regions of southern Italy.



# SAP on IBM zEnterprise System with zBX

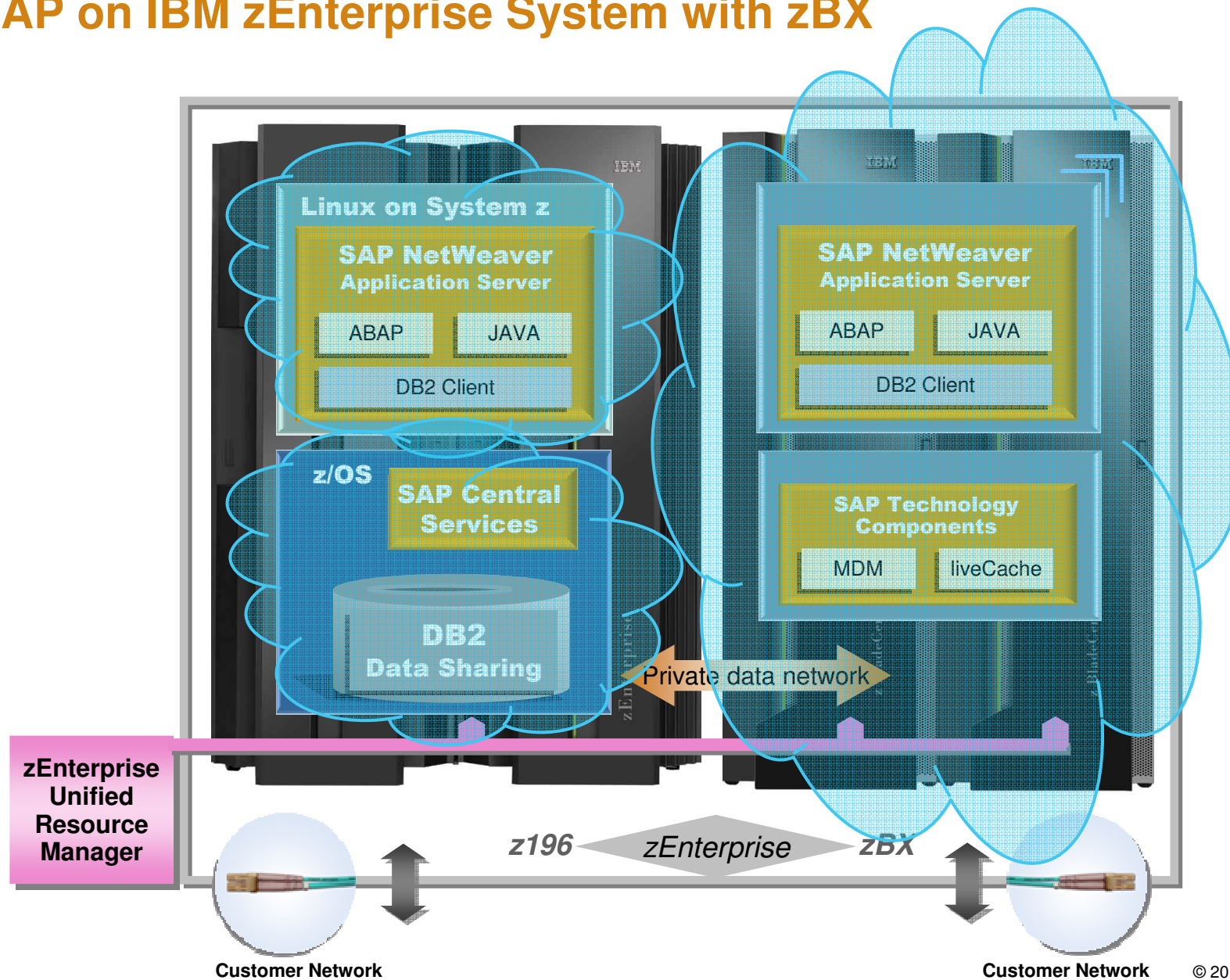

# Examples of Oracle Solutions on IBM System zEnterprise

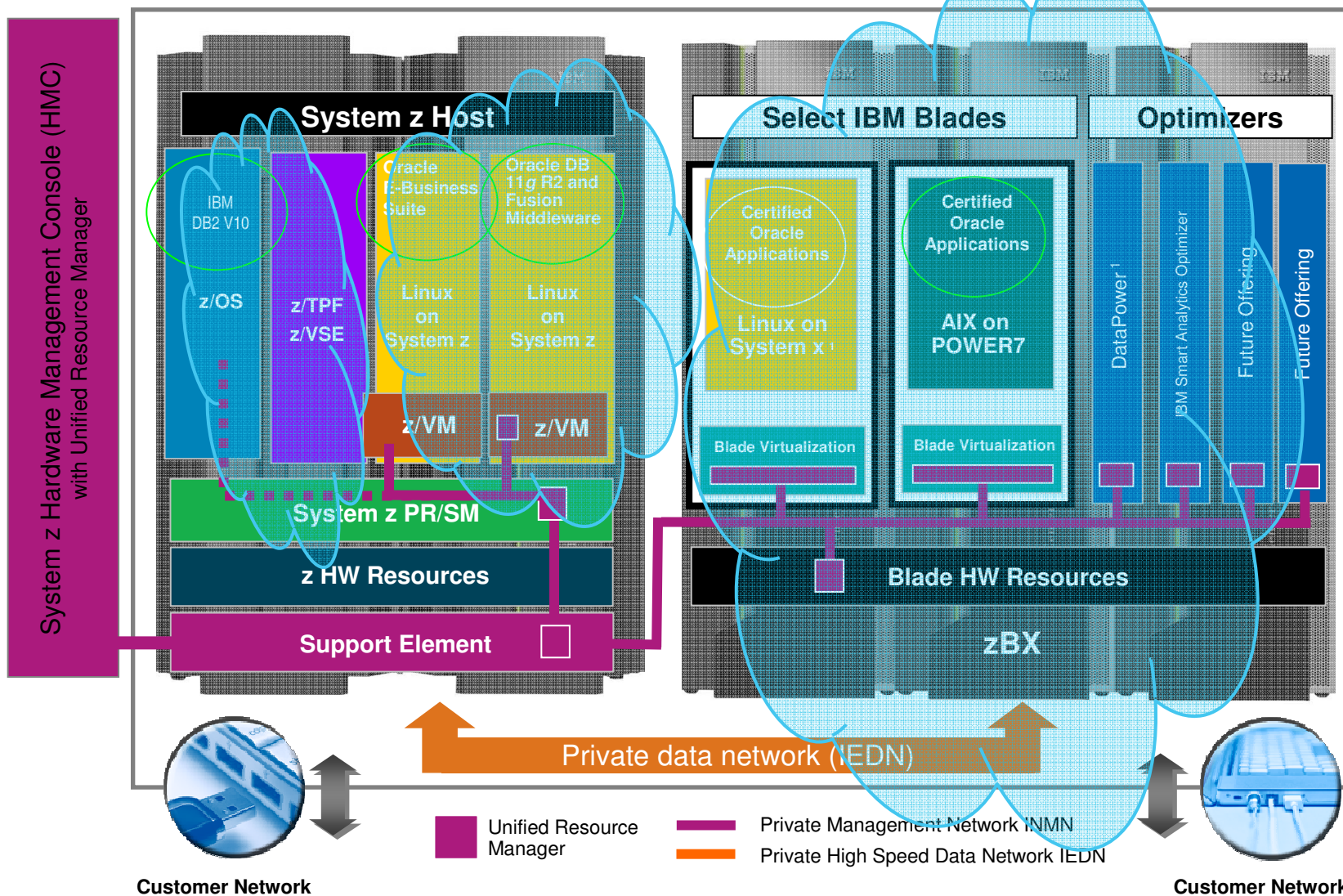

# Systems Management

## IBM Systems Director

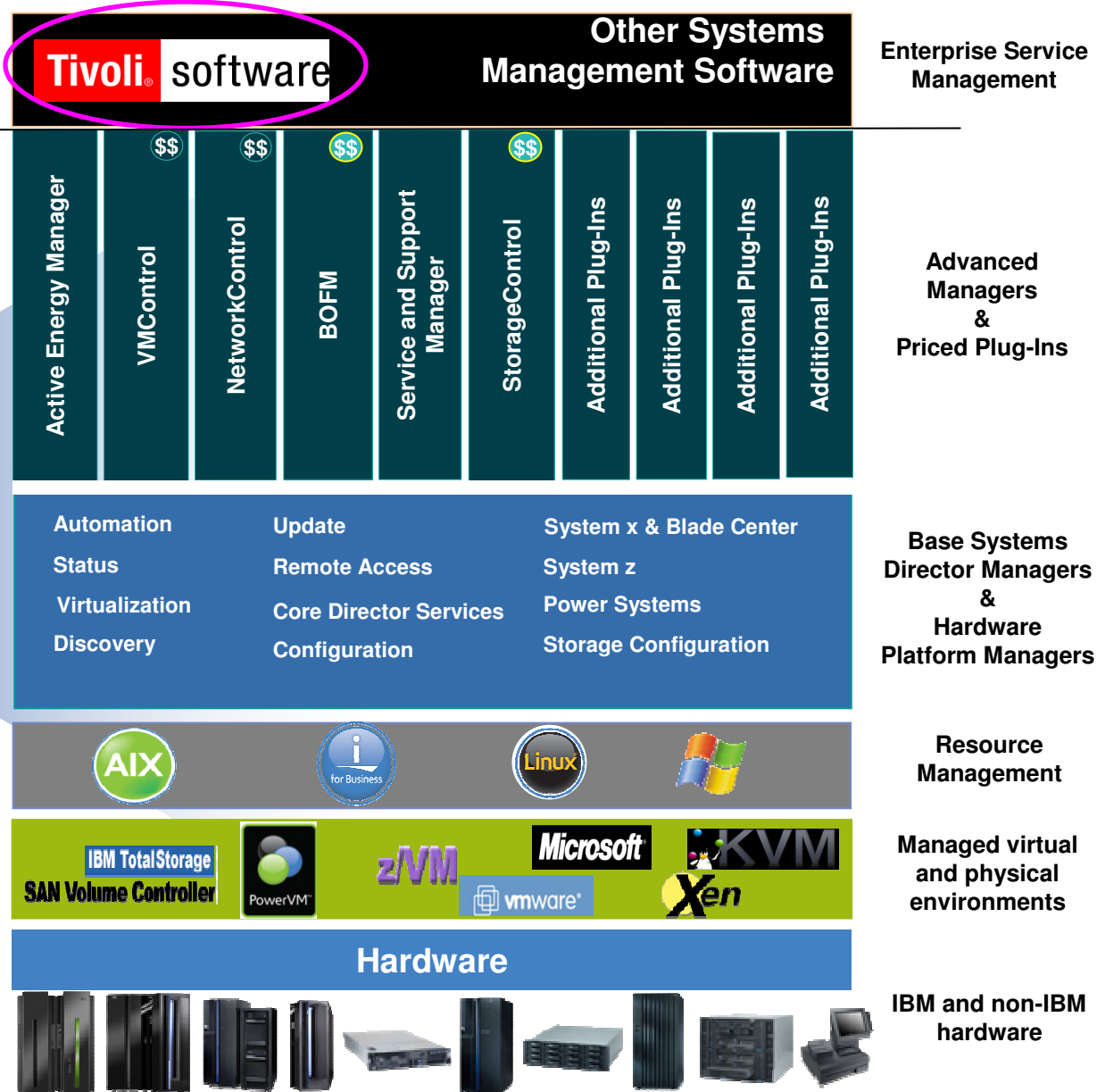

# From Infrastructure to Cloud Management Control point with Tivoli SaaS Cloud Ecosystem

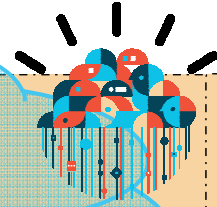

## Workloads

- Service measurement
- Service reporting
- Usage accounting
- Auditing and controls

### Web, Collaboration and Infrastructure

**Technology**  
 Highly Threaded  
 Throughput-oriented  
 Scale Out Capable  
 Lower Quality of Service

### Analytics and High Performance Computing

**Technology**  
 Compute intensive  
 High I/O Bandwidth  
 High Memory Bandwidth  
 Floating point  
 Scale out Capable

### Transaction Processing and Database

**Technology**  
 Scale  
 High Transaction Rates  
 High Quality of Service  
 Handle Peak Workloads  
 Resiliency and Security

### Business Applications

**Technology**  
 Scale  
 High Quality of Service  
 Large Memory Footprint  
 Responsive Infrastructure

## Tivoli Service Automation Layer

- Automate process of instantiating and managing a distributed IT environment.

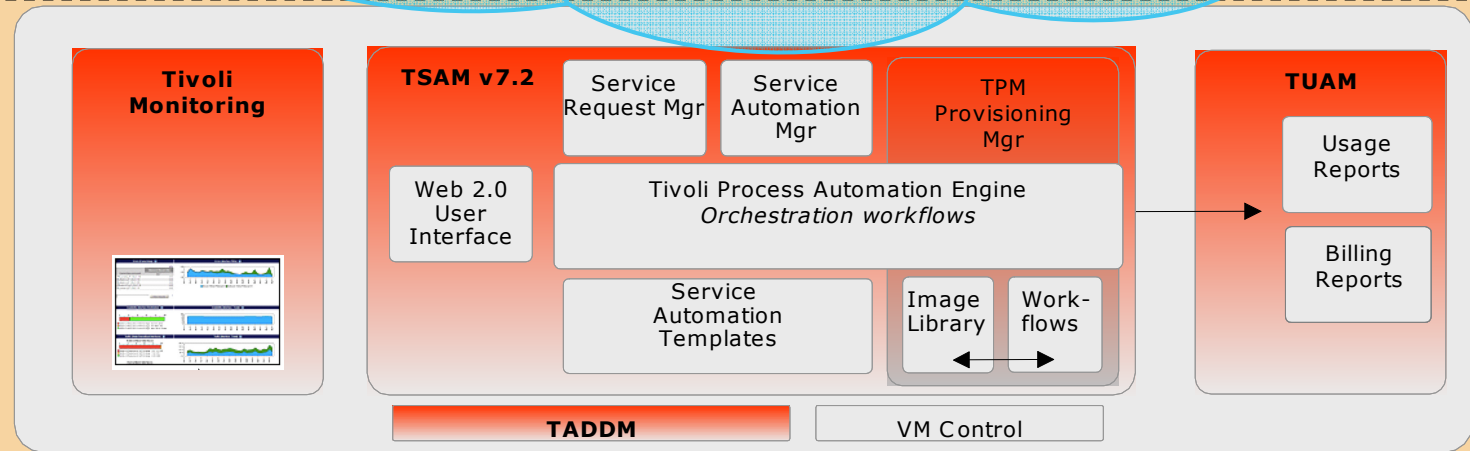

End to End Service Management

## Virtualized Infrastructure Layer

- Virtualized resources
- Virtualized aggregation
- Physical infrastructure

## IaaS Cloud Ecosystem

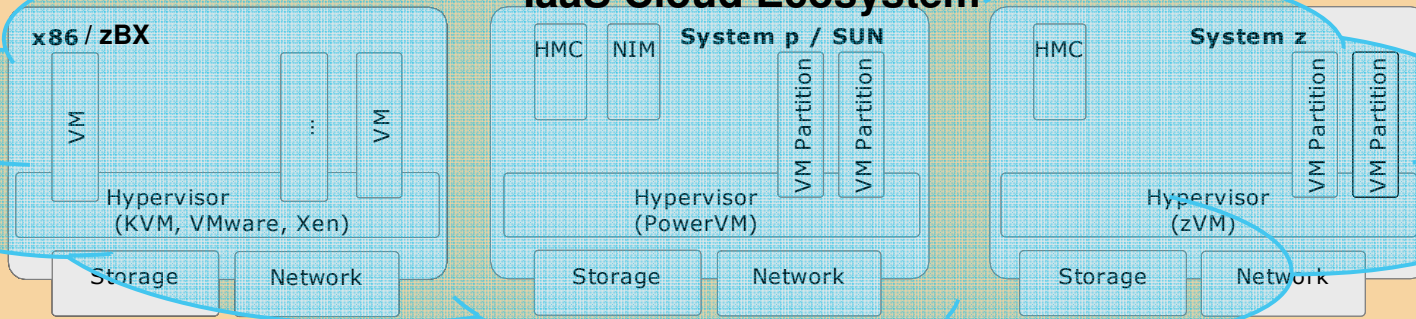

# Automate cross platform workload with Linux on System z

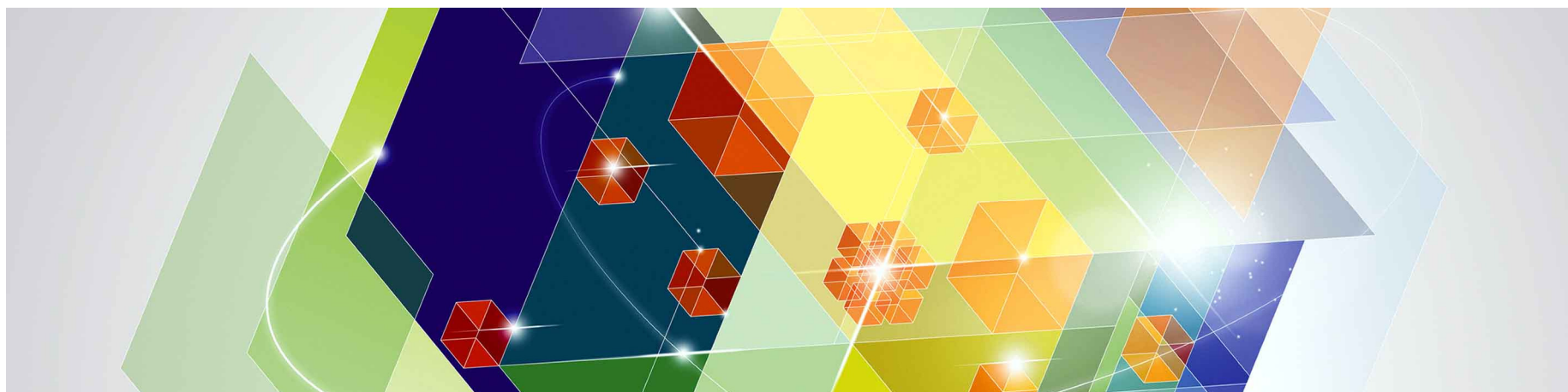

# Tivoli Workload Automation Integration Points

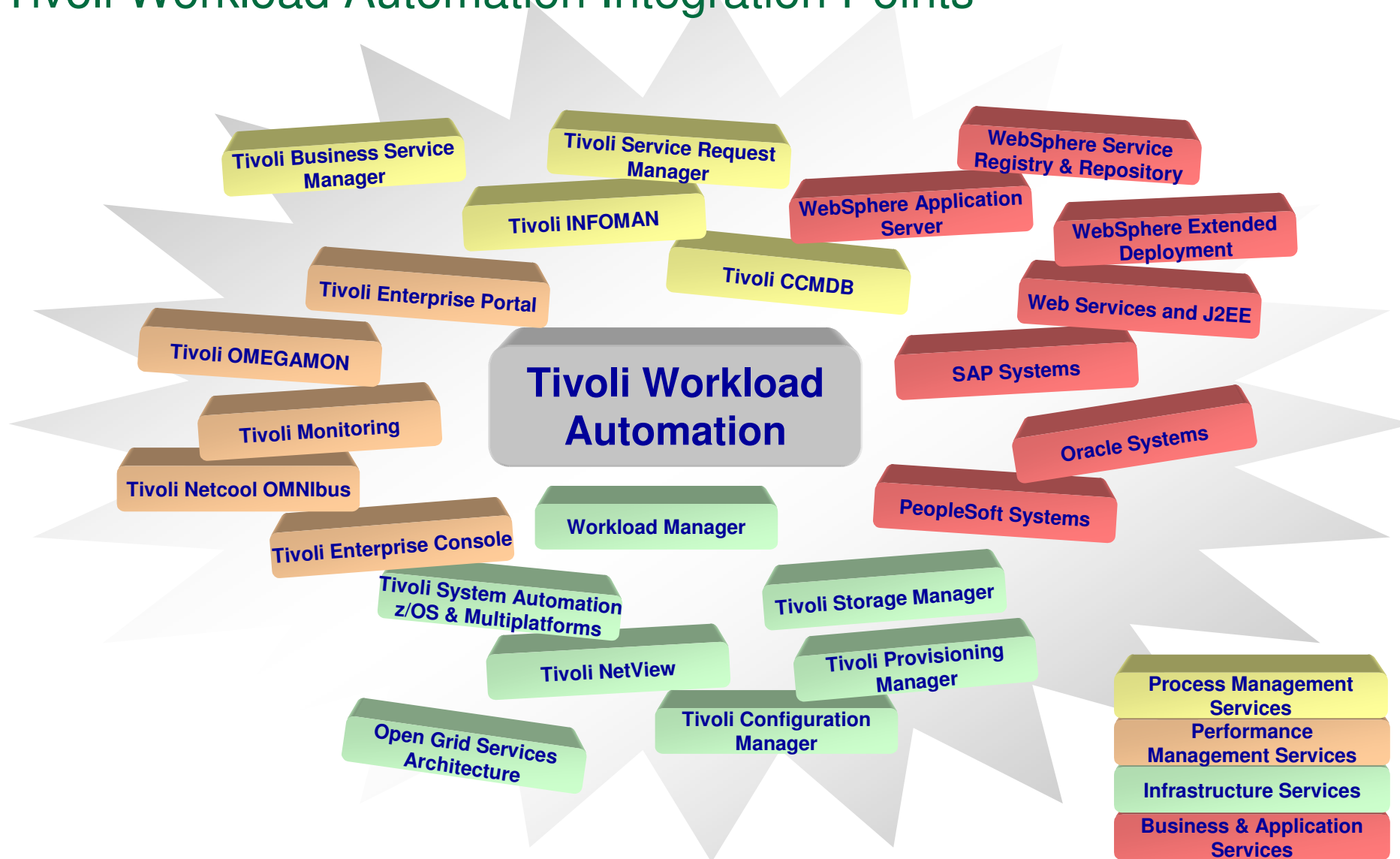



# Workload Automation on zEnterprise

## Fit for purpose workload deployment

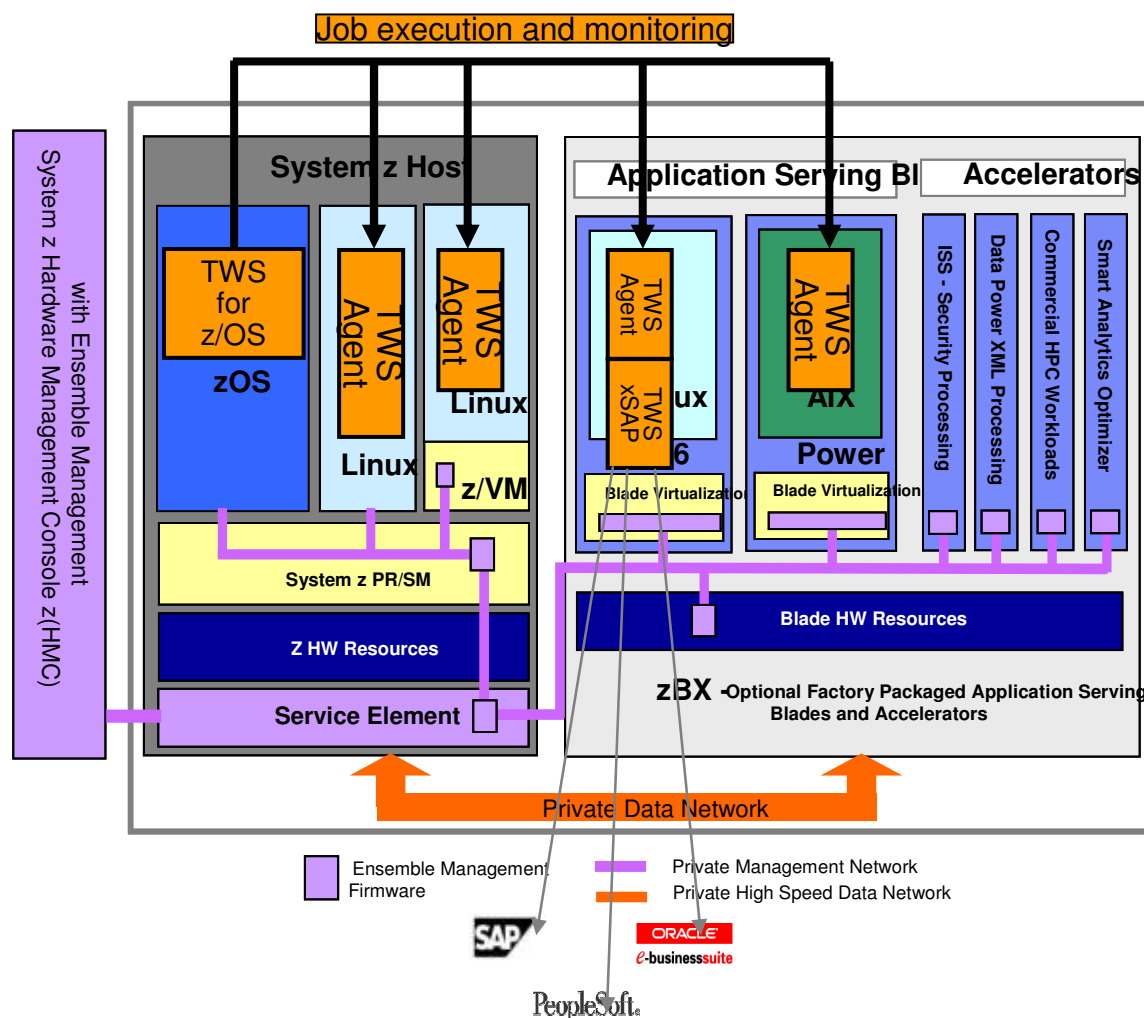

- zCentric end-to-end solution ideal to manage heterogeneous workloads across System z and Blade extensions, under a single point of control and management
- Future option to exploit Unified Resource Management interfaces would provide unprecedented workload moving and optimization capabilities

## Business benefits

- ★ *Reduce costs with fit-for-purpose platform, and implement a virtualized and green data center*
- ★ *Realize data-proximity processing with high bandwidth for distributed applications*

# Application Extensions allow business users to take advantage of processes in a managed approach

## New Tivoli Workload Automation application extensible framework

- Customers shifting from traditional backend transaction focused systems to modern systems running web applications and heterogeneous applications
- Workload Automation role is maintaining a single point of control over workloads
- TWS 8.6 easily build and deploy application plugins to extend the reach of automation to any new workload type 

## Business benefits

- ★ *Share infrastructure among applications*
- ★ *Reduces labor costs, enabling to automate new workloads with the same staff of people*
- ★ *No request for new skill: re-using of workload automation processes and procedures already in place*

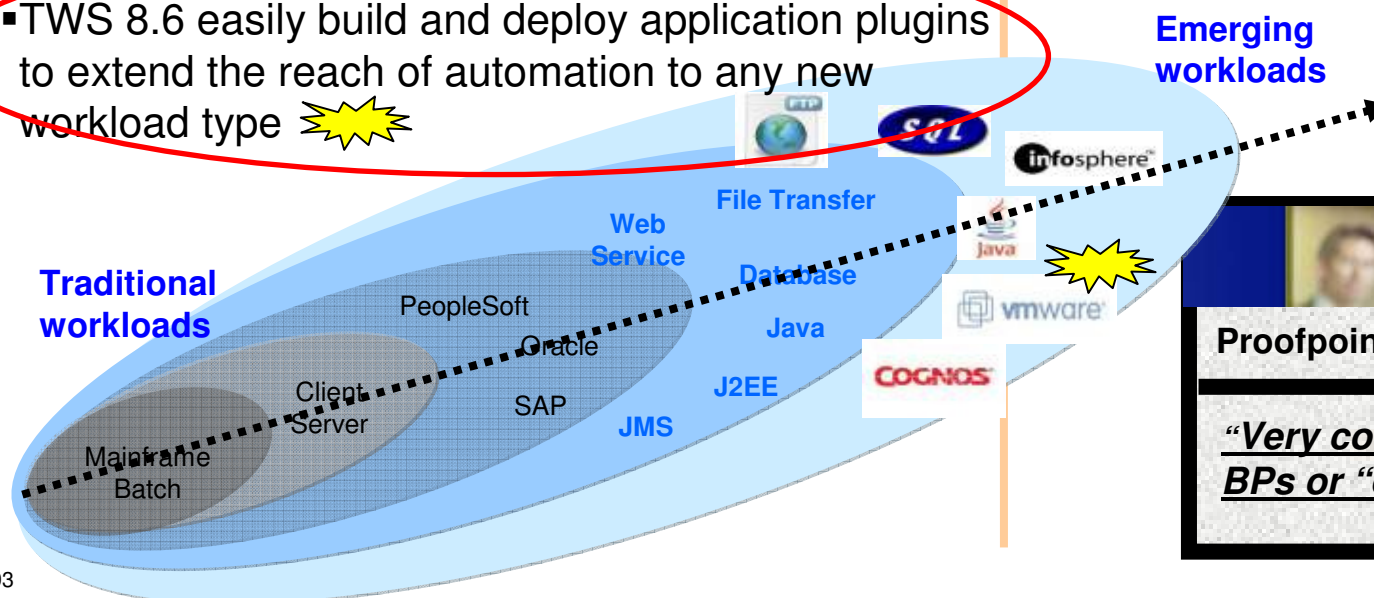

**Proofpoints – Customer quotes**

**“Very concrete needs” from BPs or “early adopters”**

## Summary

The demands placed on the data center have never been greater.

### IBM System zEnterprise:

1. **Enables** mixed workload Business Processes to be deployed, and centrally managed
2. Allows **optimized integration** of data, applications, and web serving
3. Delivers **dynamically responsive IT** with **lower acquisition and operating costs**
4. **Meets the need** of heterogeneous data centers



A strategic systems platform....

Helping to free up resources for critical projects and establish a base for the future

## Links to Information on System z

### **IBM System z Data sheets:**

[IBM System z Solution Edition for Enterprise Linux](#)

[Enterprise Linux Server](#)

[IBM zEnterprise System](#)

[Linux on System z](#)

[z/VM virtualization and Linux on IBM zEnterprise System](#)

### **IBM Offerings:**

[Financing](#)

### **Client Case Studies For Oracle On Linux For System Z Servers:**

[Transzap](#)

[Bank of New Zealand](#)

### **Clabby Analytics Whitepapers:**

[ELCOT](#)

[KMD](#)

### **Other Client Studies:**

[Dundee](#)

### **Ziff Davis Enterprise Whitepaper:**

[Scaling Your Oracle E-Business Suite with IBM System z and Linux](#)

### **Video**

[Oracle on System z Enterprise - YouTube](#)

### **Oracle Solutions on System z Server Data Sheets:**

[FAQ Running Oracle Database 11g Release 2 on Linux on IBM System z Servers](#)

[Oracle and System z FAQ](#)

- [Link is also available on Oracle website](#)

[IBM System z running Linux Oracle Database and Middleware Solutions](#)

[Oracle E-Business Suite on Linux for IBM System zEnterprise](#)

[Siebel on Oracle on Linux for IBM System z Servers](#)

[Siebel on DB2 z/OS on IBM System z Servers](#)

[PeopleSoft on Oracle on Linux for IBM System z Servers](#)

[PeopleSoft on DB2 z/OS on IBM System z Servers](#)

# Questions?



**Wilhelm Mild**  
IBM IT Architect



IBM Deutschland Research  
& Development GmbH  
Schönaicher Strasse 220  
71032 Böblingen, Germany

Office: +49 (0)7031-16-3796  
mildw@de.ibm.com