

z/VSE Tools Overview

Ingo Franzki, IBM

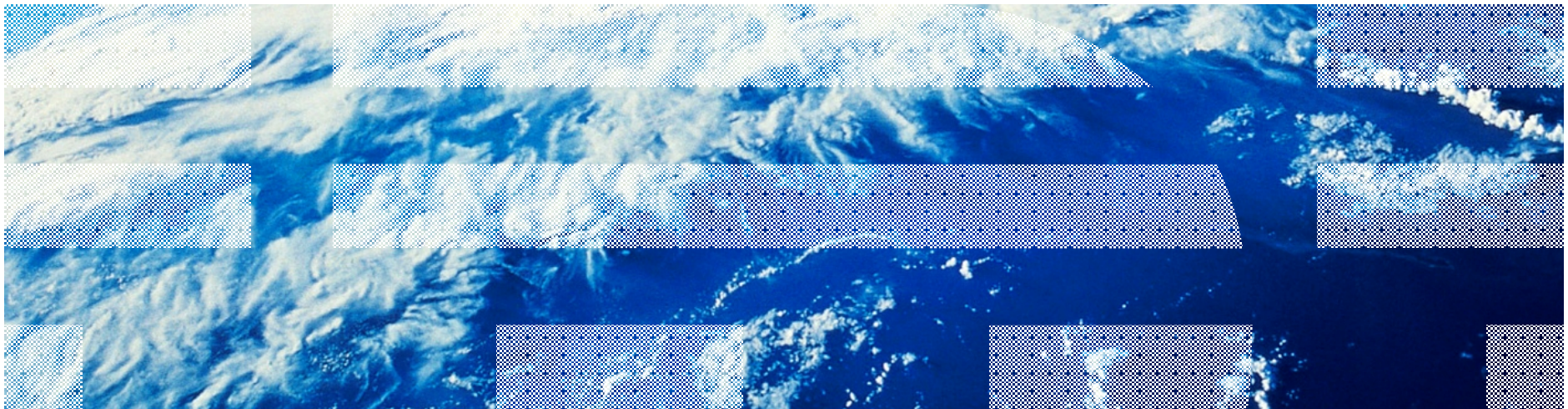

Trademarks

The following are trademarks of the International Business Machines Corporation in the United States, other countries, or both.

Not all common law marks used by IBM are listed on this page. Failure of a mark to appear does not mean that IBM does not use the mark nor does it mean that the product is not actively marketed or is not significant within its relevant market.

Those trademarks followed by ® are registered trademarks of IBM in the United States; all others are trademarks or common law marks of IBM in the United States.

For a complete list of IBM Trademarks, see www.ibm.com/legal/copytrade.shtml:

*, AS/400®, e business(logo)®, DBE, ESCO, eServer, FICON, IBM®, IBM (logo)®, iSeries®, MVS, OS/390®, pSeries®, RS/6000®, S/30, VM/ESA®, VSE/ESA, WebSphere®, xSeries®, z/OS®, zSeries®, z/VM®, System i, System i5, System p, System p5, System x, System z, System z9®, BladeCenter®

The following are trademarks or registered trademarks of other companies.

Adobe, the Adobe logo, PostScript, and the PostScript logo are either registered trademarks or trademarks of Adobe Systems Incorporated in the United States, and/or other countries.

Cell Broadband Engine is a trademark of Sony Computer Entertainment, Inc. in the United States, other countries, or both and is used under license therefrom.

Java and all Java-based trademarks are trademarks of Sun Microsystems, Inc. in the United States, other countries, or both.

Microsoft, Windows, Windows NT, and the Windows logo are trademarks of Microsoft Corporation in the United States, other countries, or both.

Intel, Intel logo, Intel Inside, Intel Inside logo, Intel Centrino, Intel Centrino logo, Celeron, Intel Xeon, Intel SpeedStep, Itanium, and Pentium are trademarks or registered trademarks of Intel Corporation or its subsidiaries in the United States and other countries.

UNIX is a registered trademark of The Open Group in the United States and other countries.

Linux is a registered trademark of Linus Torvalds in the United States, other countries, or both.

ITIL is a registered trademark, and a registered community trademark of the Office of Government Commerce, and is registered in the U.S. Patent and Trademark Office.

IT Infrastructure Library is a registered trademark of the Central Computer and Telecommunications Agency, which is now part of the Office of Government Commerce.

* All other products may be trademarks or registered trademarks of their respective companies.

Notes:

Performance is in Internal Throughput Rate (ITR) ratio based on measurements and projections using standard IBM benchmarks in a controlled environment. The actual throughput that any user will experience will vary depending upon considerations such as the amount of multiprogramming in the user's job stream, the I/O configuration, the storage configuration, and the workload processed. Therefore, no assurance can be given that an individual user will achieve throughput improvements equivalent to the performance ratios stated here.

IBM hardware products are manufactured from new parts, or new and serviceable used parts. Regardless, our warranty terms apply.

All customer examples cited or described in this presentation are presented as illustrations of the manner in which some customers have used IBM products and the results they may have achieved. Actual environmental costs and performance characteristics will vary depending on individual customer configurations and conditions.

This publication was produced in the United States. IBM may not offer the products, services or features discussed in this document in other countries, and the information may be subject to change without notice. Consult your local IBM business contact for information on the product or services available in your area.

All statements regarding IBM's future direction and intent are subject to change or withdrawal without notice, and represent goals and objectives only.

Information about non-IBM products is obtained from the manufacturers of those products or their published announcements. IBM has not tested those products and cannot confirm the performance, compatibility, or any other claims related to non-IBM products. Questions on the capabilities of non-IBM products should be addressed to the suppliers of those products.

Prices subject to change without notice. Contact your IBM representative or Business Partner for the most current pricing in your geography.

Agenda

§ The z/VSE web site offers more than 20 tools ('as is', at no additional charge) for download.

- The tools are designed make certain z/VSE tasks easier and more interesting.
- Because of the sheer number of tools, you may have lost track about what tools are provided and what they are for.
- There may be a tool available that you are not aware of, for a task you need to perform.

§ This session will provide an overview of each the tools that are currently available on the VSE homepage.

- For every tool, a short description and usage scenarios will be discussed.

Overview – z/VSE Homepage

<http://ibm.com/vse>

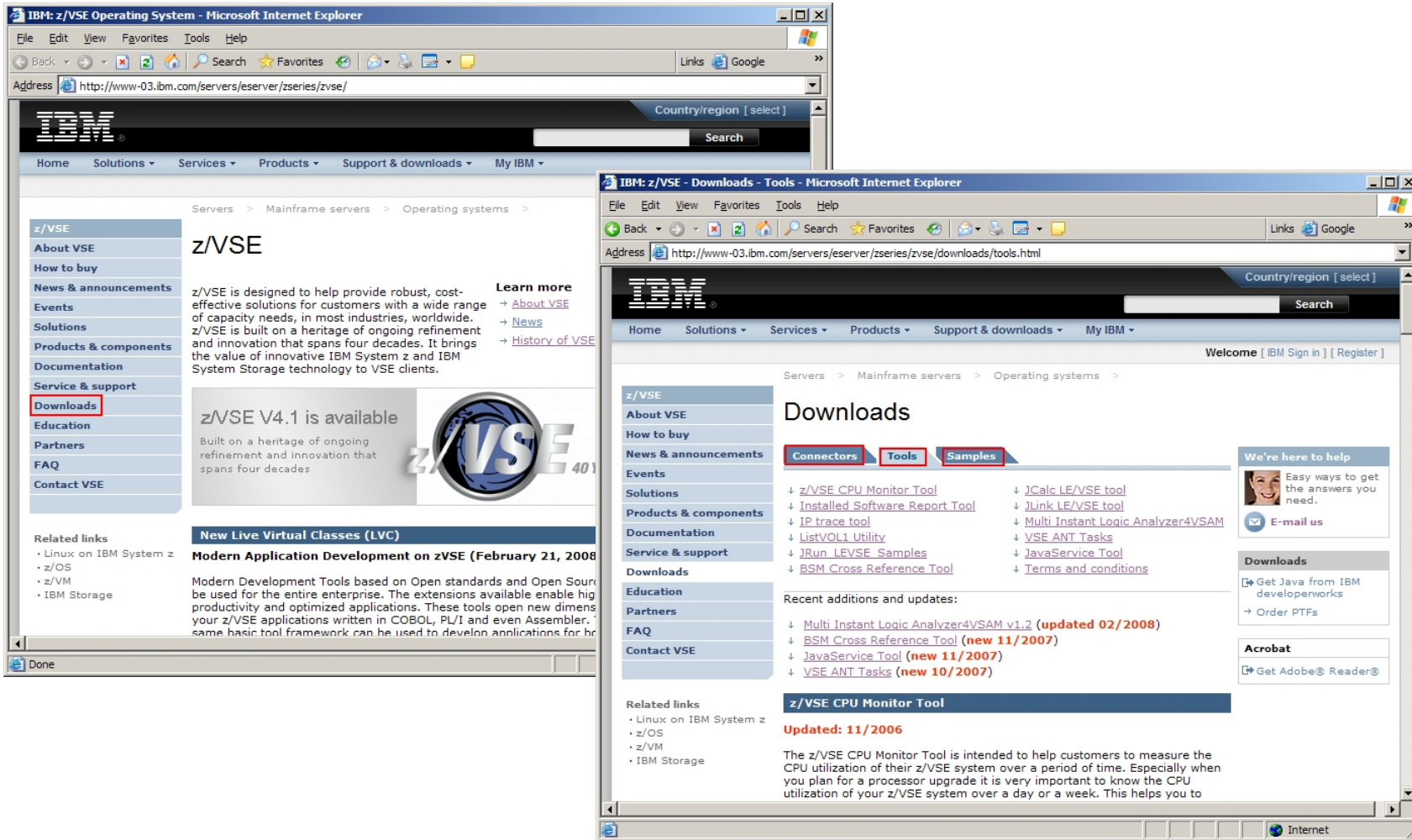

Overview - All Tools

The screenshot displays a collection of IBM System z tools and utilities. At the top left, there are browser windows for 'VSE e-business Connectors' and 'VSE Health Checker'. In the center, a Wireshark window shows network traffic analysis. To the right, the 'CICS2WS Toolkit' is open, displaying a 'Welcome to the CICS2WS Toolkit!' message. Below these, the 'Multi Instant Logic Analyzer4V5AM V1.2' is visible, showing a 'LISTCAT' window with input settings and analysis options. A prominent dialog box titled 'Bulk Volume Information Retrieval' is overlaid, listing various retrieval options such as 'CACHE CONTENTS', 'VOLUME MAP', and 'PHYSICAL MEDIA POOLS'. Below this, the 'LEVSE Control Center - Copyright IBM Corp. 2008 - Build id: 20081021V2.4' is shown, featuring an 'Advisory Pilot - Choices with Language Environment for z/VSE' dialog with three columns: Task, Topic, and Subtopic. At the bottom, a terminal window shows the command 'LISTVOL1 UTILITY - FINISHED'.



Overview – Components

§ Connector components (Part of z/VSE)

- VSE Connector Client à updated with APAR PK93908
- VSAM Redirector Server à updated with z/VSE V4.2
- VSE Script Server à updated with z/VSE V4.2
- VSE Virtual Tape Server à updated with APAR PM09719

§ Connector Tools

- VSE Navigator
- VSAM Maptool
- Keyman/VSE à Added support for OpenPGP
- VSE Health Checker
- CICS2WS Toolkit à Added support for saving projects
- VSE ANT Tasks
- VSEPrint Utility

Overview – Components

§ Tools

- z/VSE CPU Monitor Tool
- z/VSE Installed Software Report Tool
- IP Trace Tool
- ListVOL1 Utility
- TS7700 Bulk Volume Information Retrieval Tool
- Multi Instant Logic Analyzer4VSAM
- JavaService - Run a Java program as a Windows Service
- BSM Cross Reference Tool
- RACROUTE Encapsulation Services
- LE/VSE CEETRACE Tool
- LE/VSE Control Center
- JCalc LE/VSE Tool
- JLink LE/VSE Tool
- JRun_LEVSE_Samples

Connector components

§ Part of z/VSE (5686-CF8-35/38)

§ Officially supported

VSE Connector Client

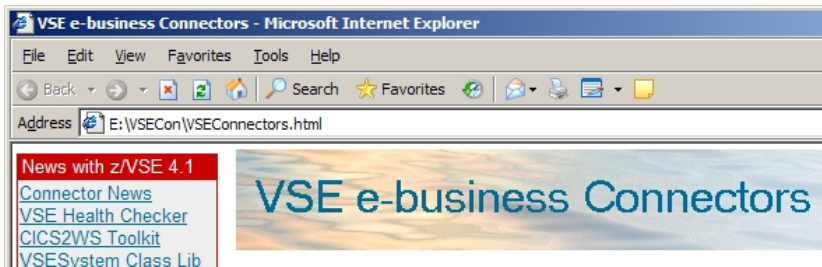

VSAM Redirector Server

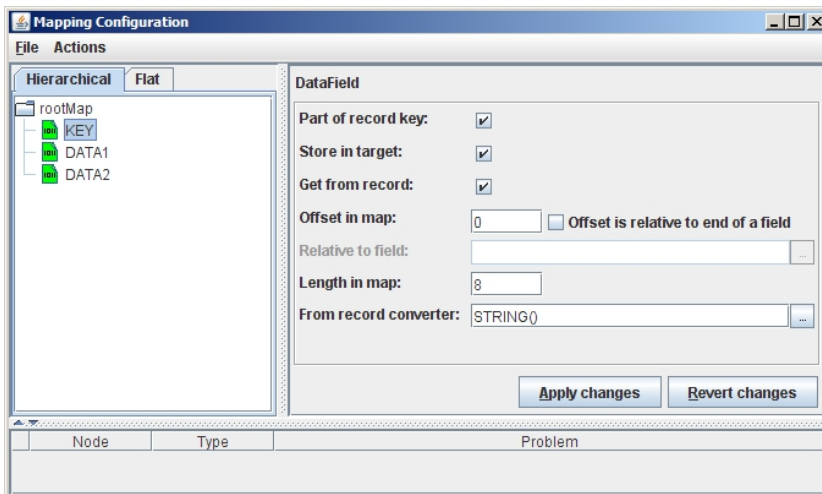

VSE Virtual Tape Server

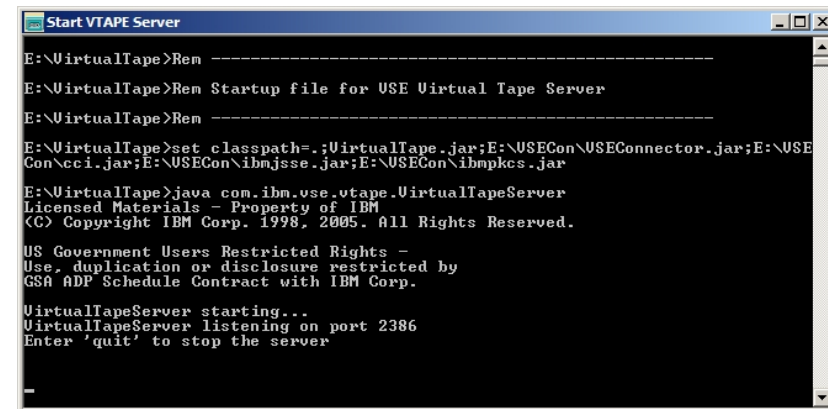

VSAM Script Server

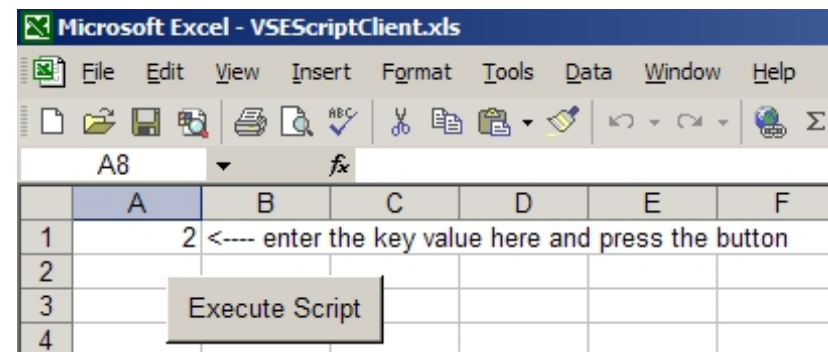

VSE Navigator

- § Graphical user interface for z/VSE
 - Look and feel similar to Windows Explorer
- § Based on functions provided by VSE Connector Client
- § Browse VSE libraries, POWER queues, ICCF libraries, VSAM catalogs
- § Copy members via Drag & Drop
- § Display and edit members with your favourite editor
- § Display and change VSAM data
- § Provides graphical system management functions
 - System activity,
 - Retrace MSHP history file
 - ... and many more

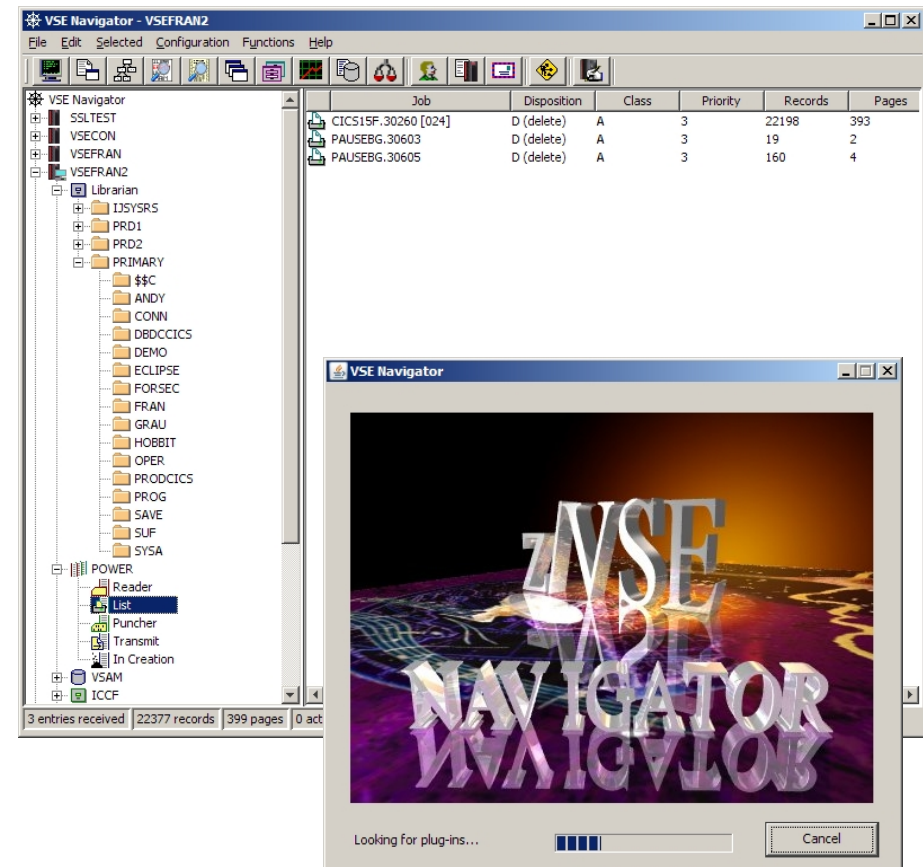

VSAM Maptool

§ Assists you in creating a mapping of your VSAM files

- Mapping is used by VSE Connector Client and VSAM Redirector
- Mapping can also be created using the IDCAMS RECMAP command.

§ Import Cobol or PLI copybook to create the mapping from it

§ Import (receive) a given map from a given z/VSE system

§ Export a map to a VSE system (send it to z/VSE)

§ Import a map from a XML file

§ Export a map to a XML file

§ Create a Java source file from a given map. The Java program can get all records from the related VSAM file via the given map.

VSE/VSAM Record structure from EMPPROG.COBOL

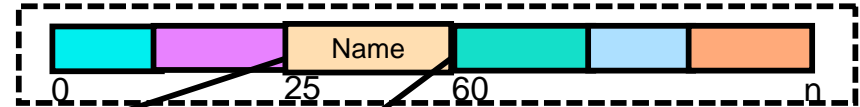

Column:

- è title: Name
- è Offset: 25
- è length: 35
- è type: STRING
- è Descr: Person name

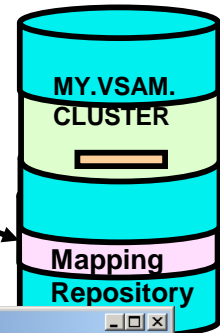

The screenshot shows the 'MapToolGui - cbsample.cb' window. It contains a table with the following columns: Fieldname, Length, Offset, Type, and Description. Below the table are two groups of buttons: 'Field options' (Append, Edit, Insert, Delete) and 'Map options' (Lookup a field, Export, Import new, Change map info, Insert map, Exit).

Fieldname	Length	Offset	Type	Description
BANDA-SA	1	0	STRING	05 BANDA-SA PIC X VALUE 'A'.
BANDA-KZ	2	1	STRING	05 BANDA-KZ PIC XX VALUE 'GK'.
BANDA-BLZSPKDT	5	3	PACK...	05 BANDA-BLZSPKDT PIC 9(8) COMP-3.
BANDA-BLZSPKABS	5	8	PACK...	05 BANDA-BLZSPKABS PIC 9(8) COMP-3 VALU...
BANDA-ABS	27	13	STRING	05 BANDA-ABS PIC X(27) VALUE 'CUSTOM...
BANDA-ERSTELLDAT	4	40	PACK...	05 BANDA-ERSTELLDAT PIC 9(6) COMP-3.
FILLER-1	4	44	STRING	05 FILLER PIC X(4) VALUE SPACE.
BANDA-KTOABS	6	48	PACK...	05 BANDA-KTOABS PIC 9(10) COMP-3 VALUE ...
BANDA-REFERENZ	10	54	UZON...	05 BANDA-REFERENZ PIC 9(10) VALUE ZE...
FILLER-2	82	64	STRING	05 FILLER PIC X(82) VALUE SPACE.
BANDC-SA	1	146	STRING	05 BANDC-SA PIC X VALUE 'C'.
BANDC-AUFBLZ1	5	147	PACK...	05 BANDC-AUFBLZ1 PIC 9(8) COMP-3.
BANDC-BLZ	5	152	PACK...	05 BANDC-BLZ PIC 9(8) COMP-3.
BANDC-KTO	6	157	PACK...	05 BANDC-KTO PIC 9(10) COMP-3.
BANDC-NULL1	10	163	STRING	07 BANDC-NULL1 PIC X(10).
BANDC-NULL2	3	173	PACK...	07 BANDC-NULL2 PIC 9(5) COMP-3.
BANDC-TXSCHL-FI...	3	176	PACK...	05 BANDC-TXSCHL PIC 9(5) COMP-3.

Keyman/VSE

§ Keyman/VSE is a tool to manage the z/VSE specific public key infrastructure

- Create RSA key pairs
- Create self-signed certificates for testing and learning purposes
- Create PKCS#10 certificate requests
- Sign certificate requests
- Import and export certificates
- Read and write PKCS#12 keyring files
- Now also able to import and export OpenPGP public keys for use with Encryption Facility for z/VSE
- Catalog keys and certificates on VSE
- Maintain the mappings of VSE client certificates to VSE user IDs

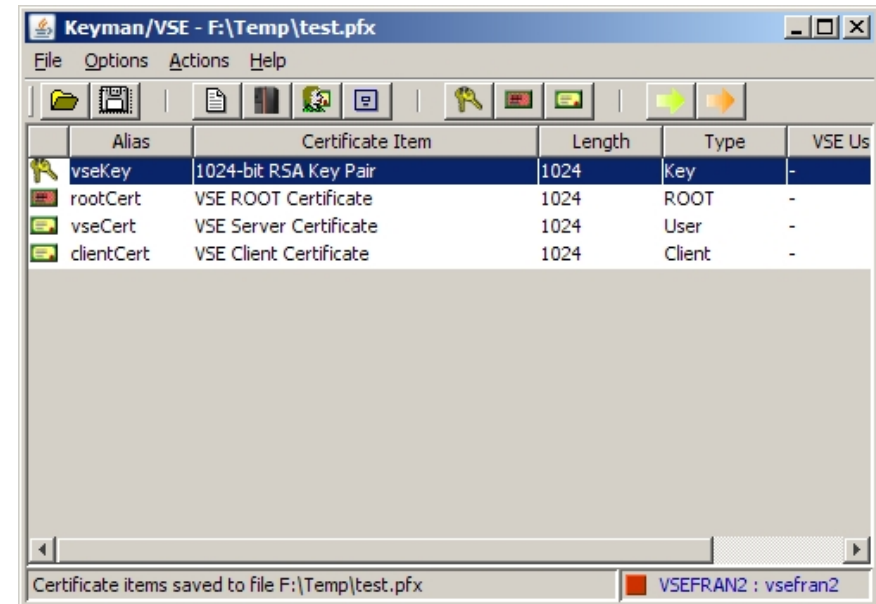

VSE Health Checker

§ The VSE Health Checker is a Java-based system diagnosis utility

- Retrieves, displays, and analyzes performance relevant configuration settings and status information from a z/VSE system.
- Gathered data can be exported and imported in XML format.

§ A health check is performed by applying a set of rules against a snapshot of retrieved z/VSE data.

- A printable report can be generated

§ VSE data is retrieved by sending console commands, submitting VSE/POWER jobs, downloading VSE Librarian members, and invoking CICS transactions.

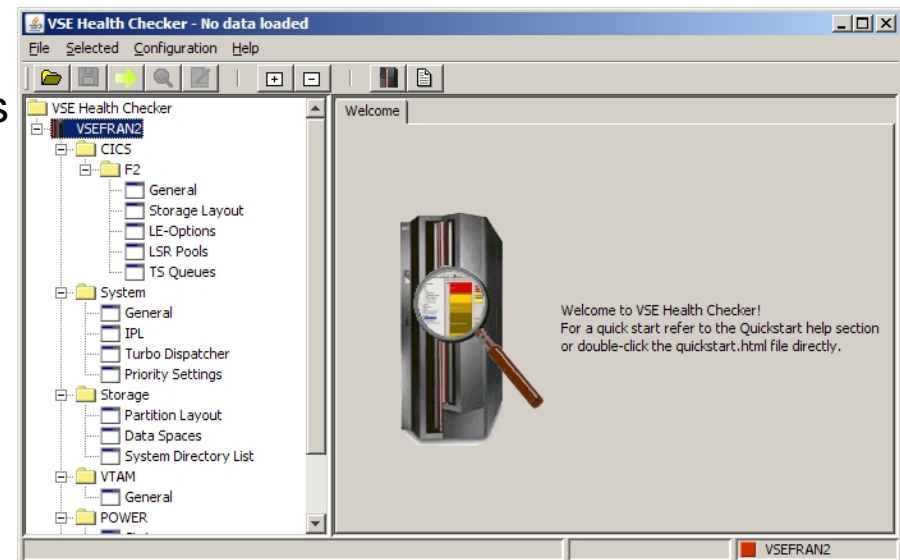

CICS2WS Toolkit

§ The CICS2WS Toolkit helps you to use Web Services with z/VSE

- Creates proxy code that you use as a layer between your existing programs and the VSE SOAP engine.
- The proxy code is generated as Assembler program, therefore you do not need a Cobol or PL/I compiler.

§ Now allows to save a project to a file and load it in later on.

§ Web Service enable an existing CICS program:

- The tool reads COBOL and PL1 copybooks and creates the proxy code and WSDL file.

§ Call an external Web Service from a CICS program

- Reads an WSDL file and creates the proxy code and a copybook for the COMMAREA mapping.



WSDL = Web Service Description Language
Contains all information required to call a particular Web Service.

VSE ANT Tasks

§ Apache ANT is an Java-based Open-Source Build-Tool, similar to Make.

- Originally intended for automated build (compile) of Java code
- ANT provides Java-Classes (Tasks) for automating different things
- Build-Scripts are formulated in XML
- Web Page: <http://ant.apache.org/>

§ z/VSE provides a set of ANT-Tasks to automate VSE specific operations

- Submit VSE Jobs
- Upload & Download members and files
- Issue console commands and retrieve messages
- Access VSAM data

§ Allows to automate VSE processes from a central place



```
<submit jobfile="c:\vsejobs\define_vtape.job"
      waitforoutput="true"
      outfile="c:\vsejobs\output\definetape.txt"
      propertyprefix="definetape.job"
      vsesystem="TESTVSE1"/>

<condition property="definetape.failed">
  <not>
    <equals arg1="${definetape.job.maxrc}"
           arg2="0000"/>
  </not>
</condition>

<fail if="definetape.failed"
      message="Define VTAPE failed with
              MAXRC=${definetape.job.maxrc}."/>
```



VSEPrint

- § The VSEPrint utility allows you to print VSE/POWER list queue entries on any locally or LAN-attached printer.
- § The queue entry can be formatted for proper output by specifying a meta-file which contains instructions for formatting the file.
- § The print-file can be previewed on the platform where the LAN-printer is attached.
- § On VSE, the TCP/IP command DEFINE EVENT is used to setup a listener for list queue entries which have a given class.
- § These queue entries are then sent via AUTOFTP to a platform, where the VSEPrint utility runs.
- § The VSEPrint utility then performs all print setup, formatting and optional previewing.

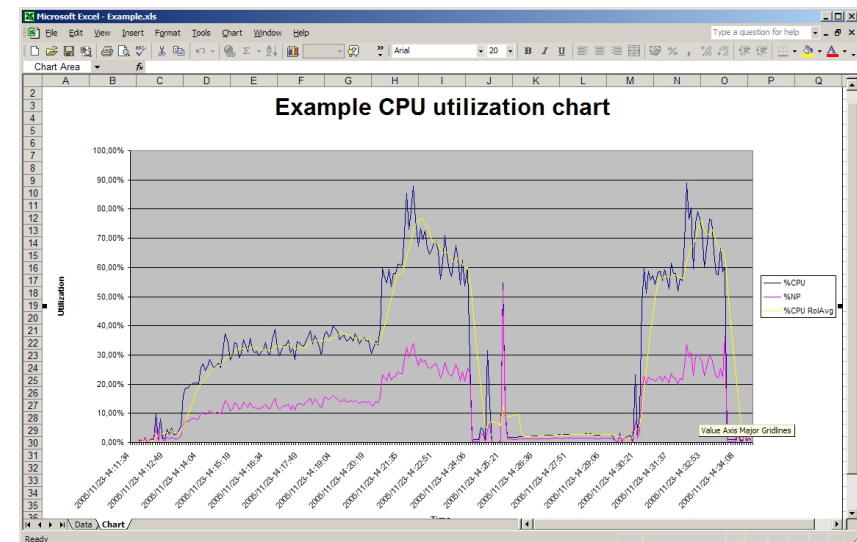

VSE CPU Monitor Tool (CPUMON)

- § Intended to help customers to measure the CPU utilization of their VSE system over a period of time.
- § When you plan for a processor upgrade it is very important to know the CPU utilization of your VSE system over a day or a week.
 - Helps you to estimate the size of the new processor.
- § The VSE CPU Monitor Tool is not intended to replace any existing monitoring product provided by partners.
- § It provides only very basic monitoring capabilities on an overall VSE system level.
- § No details about CPU usage of certain applications are provided



z/VSE Installed Software Report Tool

§ This tool is able to generate a z/VSE Installed Software Report as used by IBM ShopzSeries.

– <http://www.ibm.com/software/shopzseries>

§ It connects to z/VSE via FTP and submits 2 MSHP Jobs

§ The output is retrieved and a service bitmap is created

§ The service bitmap (= Installed Software Report) can then be uploaded to ShopzSeries when ordering service for z/VSE.

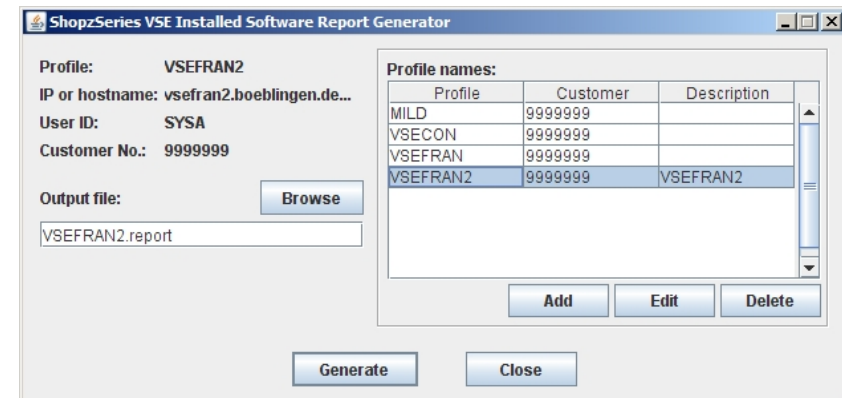

§ Note: This tool is officially supported by IBM.

IP Trace Tool

§ This tool is able to read IP packet traces captured with TCP/IP for VSE and convert it into the CAP trace format

§ Trace can then be viewed and analyzed with Wireshark (formerly Ethernet) or Packetyzer.

- <http://www.wireshark.org/>
- <http://sourceforge.net/projects/packetyzer/>

§ Wireshark provides very powerful network and protocol analysis functions like

- Follow TCP stream
- Packet flow graph
- TCP round trip time graph
- Statistic and performance analysis
- ... And many more.

§ Supports TCP/IP for VSE 1.5D, 1.5E and 1.5F

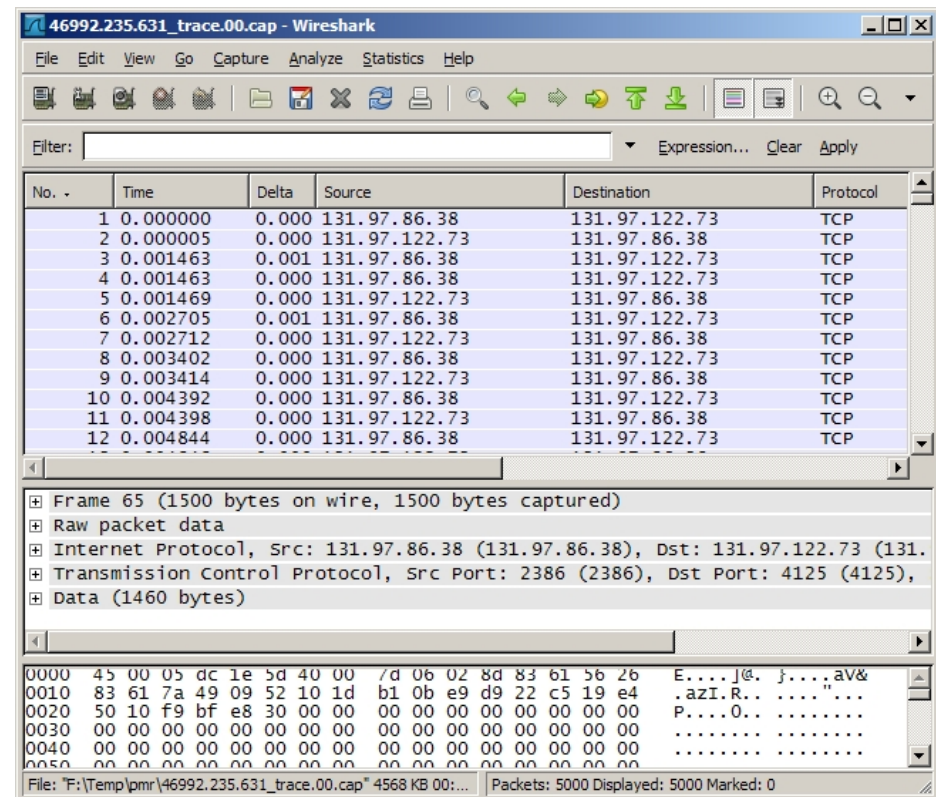

ListVOL1 Utility

- § This tool helps to manage VSE VTAPE images stored in VSAM files
- § It can display the VOLSER and File-ID of the files stored on the virtual tape without mounting it as VTAPE.
- § The ListVOL1 utility reads the first 2 tape records of tape image
 - You can specify multiple VTAPE files
- § It prints the VOLSER and FILE-ID from the VOL1 and HDR1 labels on the tape:

```
LISTVOL1 UTILITY - LIST VOL1/HDR1 LABELS OF VTAPES

FILENAME: VOLSER  FILE-ID
-----
VTAPE1   : TAPE00  TAPE.DATASET.00
VTAPE2   : PRDDAT  PRODUCTION.DATA
VTAPE3   : BACKUP  MY.BACKUP.FILE
-----

LISTVOL1 UTILITY - FINISHED
```

TS7700 Bulk Volume Information Retrieval Tool

§ The Bulk Volume Information Retrieval (BVIR) tool is intended to enable customers to obtain information about all of the logical volumes a TS7700 manages

§ Requests:

- VOLUME STATUS zzzzzz
- CACHE CONTENTS
- VOLUME MAP
- POINT IN TIME STATISTICS
- HISTORICAL STATISTICS FOR xxx-yyy
- PHYSICAL MEDIA POOLS
- PHYSICAL VOLUME STATUS VOLUME zzzzzz
- PHYSICAL VOLUME STATUS POOL xx
- COPY AUDIT COPYMODE INCLUDE/EXCLUDE libids

§ More information about the different request types and how to read their results, please have a look at the IBM System Storage Virtualization Engine TS7700 Redbook

- <http://www.redbooks.ibm.com/abstracts/sg247312.html>

Multi Instant Logic Analyzer4VSAM

§ The Multi Instant Logic Analyzer4VSAM combines several VSAM analysis tools:

- Extent analysis
- Space map analysis
- HALRBA/HUSRBA analysis
- Capacity analysis
- The SNAP013 analysis:
 - Extracts Snap013 trace tables from a given hex dump.
- INDEX analysis tool:
 - Error analysis
 - Index component capacity analysis providing reorganization indicator

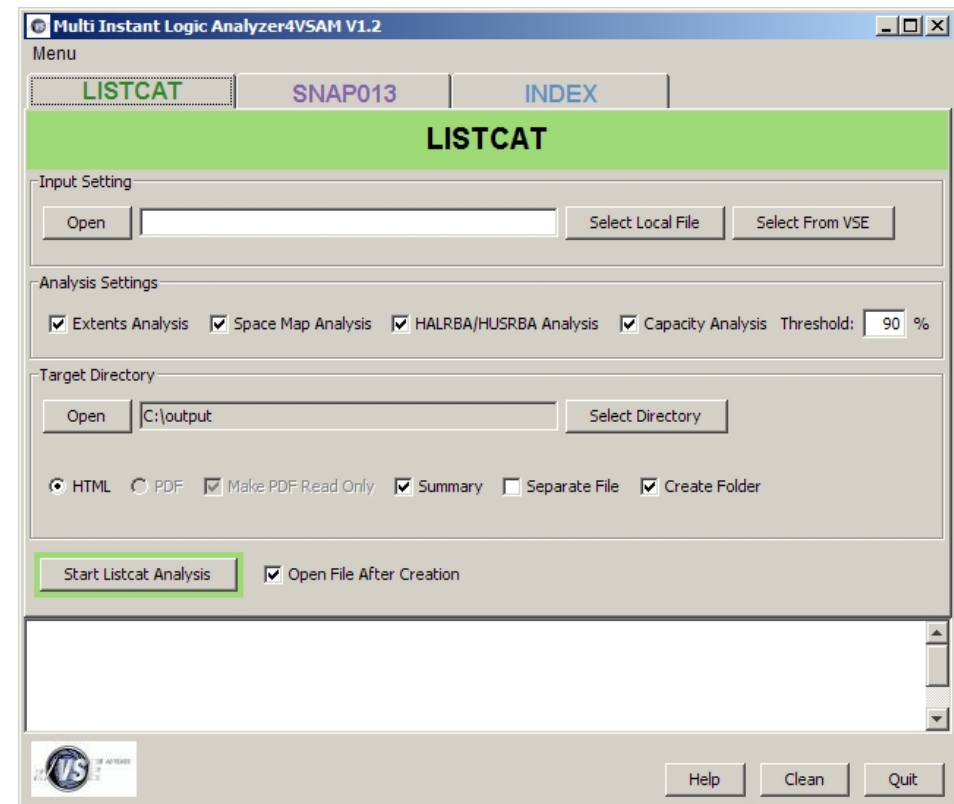

JavaService - Run a Java program as a Windows Service

§ IBM provides several server applications for use with z/VSE that are implemented in Java:

- VSAM Redirector Server
- VSE VTAPE Server
- VSE Script Server

§ You may wish to run such a server on an unattended Windows system.

- Even if no user is signed-on

§ The JavaService tool allows running a Java application as a Windows service in the background.

§ It acts as a wrapper in-between the Windows Service Control Manager and the Java Program.

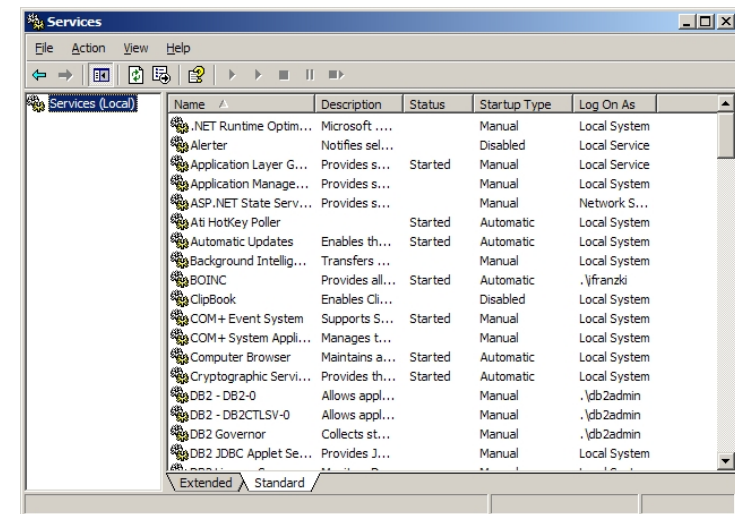

BSM Cross Reference Tool

§ The z/VSE BSM Cross Reference Tool is intended to help administrators control the profile definitions in the BSM control file.

§ Example:

- When you delete a user ID, you can use it to ensure that you have removed the user ID from all access lists and groups.

§ The following functions are provided:

- List all groups and resource profiles which contain a specified user ID.
- List all resource profiles where a specified group is on the access list.
- List all user IDs found in the BSM control file but is not defined in the VSE control file.
- List all resource profiles that allow any user to access a resource (UACC not NONE).

```
// EXEC BSTXREF,PARM='GROUP=*'
1854I  PHASE BSTXREF  IS TO BE FETCHED FROM IUSYSRS.SYSLIB

                                     BSM Cross Reference Report
                                     of All Groups

Occurrences of group GROUP01

Group description TRANSEC CLASS MIGRAT
Connect group for user $SRV
Connect group for user CICSUSER
Connect group for user OPER
Connect group for user PROG
Update authority in access list of profile FACILITY DFHRCP.BRSLFU
Update authority in access list of profile FACILITY DFHRCP.BRSL01
```

RACROUTE encapsulation services for TCP/IP

§ The IBM-provided TCP/IP security exit BSSTISX supports a pre- and post-processing interface

- These interfaces are solely intended to be used by customers to add self-written security checks

§ In particular when it is used to exploit the security definitions of the security manager, e.g. special profiles of the resource class FACILITY, normally one has to use the RACROUTE macro interface

- However, coding of RACROUTE requests can be very complex

§ Therefore these services were provided with BSSTXRRS to encapsulate the three basic RACROUTE requests:

- sign on
- sign off
- authorization checking for resource access.

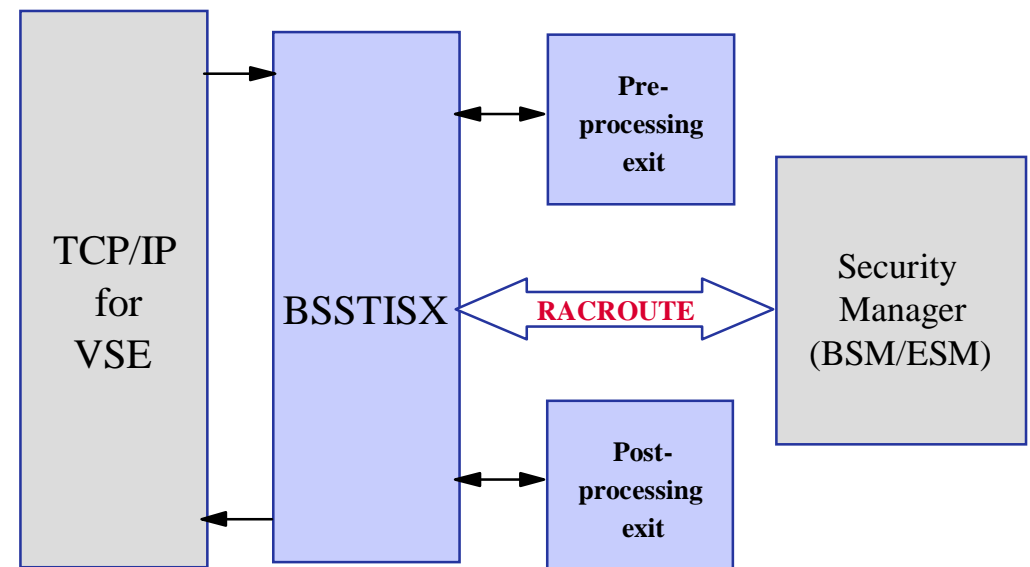

LE/VSE CEETRACE Feature

- § CEETRACE is designed to complement the already available LE z/VSE dump information to aid in application problem analysis
 - by providing an execution statement history prior to any subsequent application failure
 - similar to the previously available READY TRACE facility of DOS/VS COBOL
- § Applications that do not abend will not automatically produce an execution statement report.
- § CEETRACE is not intended to replace the LE z/VSE dump information or the Debug Tool for VSE/ESA

LE/VSE Control Center

§ The LE/VSE Control Center is a Java based tool for easy access to z/VSE language resources.

- It follows an integrated approach to understand, plan and perform common language tasks and is comparably intended for new or experienced VSE users.
- It offers various tools and usage options for language planning-, customization-, diagnostics-, environmental verification- and programming purposes including status and service reports.

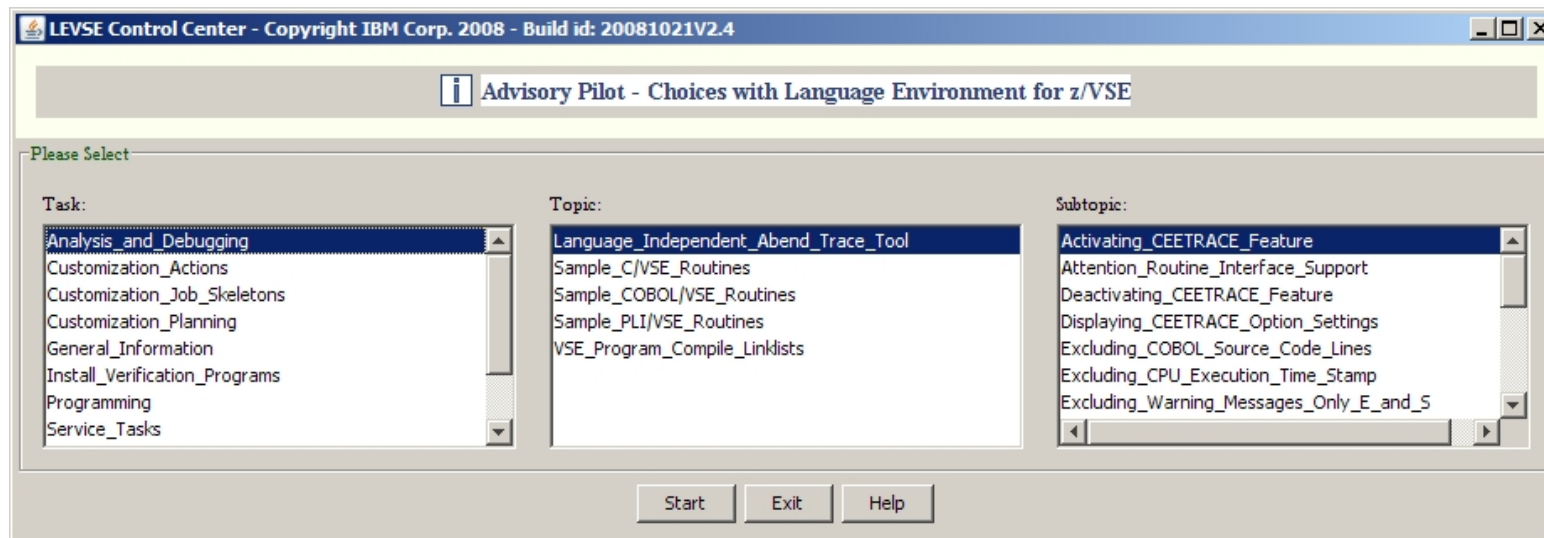

JCalc LE/VSE Tool

- § This tool is able to calculate and provide an online view of SVA-eligible Language Environment for VSE
- § It also takes into consideration whether default-, recommended- and/or optional LE/VSE supplied SVA-loadlists are intended to be used.

Routine Name	Description	Decimal Size	SVA Eligible	AMODE	RMODE	SVA List
CEEBINIT	Initialization/termination for batch	53640	YES	ANY	24	\$\$VACEE
CEEBLIBM	Library routine retention init/term	20784	YES	ANY	24	\$\$VACEE
CEEBLRR	Library routine retention interface	936	YES	ANY	24	\$\$VACEE
CEEBNATX	Null Abnormal termination exit	2	YES	31	ANY	\$\$VACEE
CEEBXITA	Assembler User Exit Interface	156	YES	31	ANY	\$\$VACEE
CEEBXTAN	Batch Abnormal termination exit table	274	YES	31	ANY	\$\$VACEE
CEECCICS	CICS library support routines	42008	YES	31	24	\$\$VACEE
CEECOPP	Compiler options parsing program	50424	YES	31	ANY	\$\$VACEE
CEECOPT	CICS Installation-wide default runopts	26688	YES	31	ANY	\$\$VACEE
CEECXTAN	CICS Abnormal Termination Exit table	290	YES	31	ANY	-
CEEDOPT	Batch Installation-wide default runopts	26688	YES	31	ANY	\$\$VACEE
CEEKDS	Contains dump services	94256	YES	31	ANY	\$\$VACEE
CEELCLE	Contains locale services	11064	YES	31	ANY	\$\$VACEE
CEELEDT	LE/VSE to VSE/POWER Interface Routine	8144	YES	31	ANY	-
CEELRRIN	Library routine retention init interface	352	YES	31	ANY	\$\$VACEE
CEELRRTR	Library routine retention term interface	344	YES	31	ANY	\$\$VACEE
CEEMENU0	Msg file + mixed-case Engl.msgs 000-999	9600	YES	31	ANY	\$\$VACEE
CEEMENU2	Msg file + mixed-case Engl.msgs 2000-2999	10384	YES	31	ANY	\$\$VACEE
CEEMENU3	Msg file + mixed-case Engl.msgs 3000-3999	33032	YES	31	ANY	\$\$VACEE
CEEMENU4	Msg file + mixed-case Engl.msgs 4000-4999	1032	YES	31	ANY	\$\$VACEE
CEEMENU5	Msg file + mixed-case Engl.msgs 5000-5999	696	YES	31	ANY	\$\$VACEE
CEEMJPN0	Msg file with Jap.msgs 000-999	9536	YES	31	ANY	-
CEEMJPN2	Msg file with Jap.msgs 2000-2999	10488	YES	31	ANY	-
CEEMJPN3	Msg file with Jap.msgs 3000-3999	33400	YES	31	ANY	-

Note: Large phases marked red, default SVA entries in blue

Buttons: Help, Calculate SVA loadlist, Cancel

JLink LE/VSE Tool

§ Coping with Language Environment for VSE run-time problems often is a complex task

– It requires analysis of the failing application and environment.

§ A useful approach is to cross-check program compile/link lists (e.g in regard to languages, interfaces, products, options, stubs involved).

§ This tool validates VSE compile/link list(s) to judge whether or not a run-time problem might be related to the way the application is built.

– The tool has initially been developed to help IBM support people to analyze LE related problems.

– It is now also available to customers.

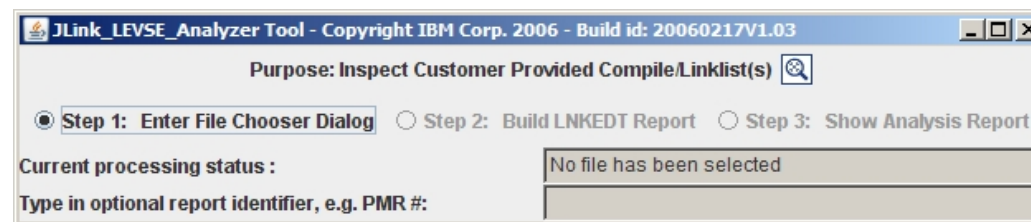

JRun_LEVSE_Samples

§ This tool provides an integrated front-end to download and try out IBM provided LE/VSE sample source programs

- Supports samples written in the COBOL, PL/I and C programming language.
- LE/VSE callable services which can be coded cross programming language.

§ The following samples are covered:

- Condition Handling
- Date and Time
- Dynamic Storage
- General, Initialization and Termination
- Locales
- Math
- Message Handling
- National Language Support

§ Note: A corresponding LE/VSE conforming compiler (COBOL/VSE, PLI/VSE and/or C/VSE) must be installed on z/VSE

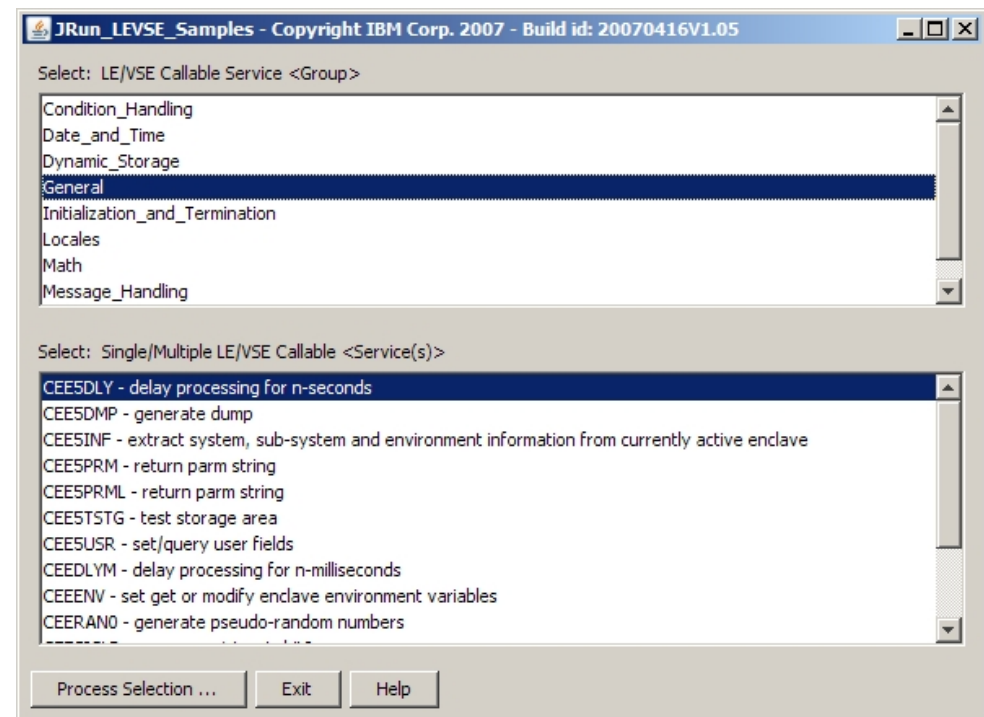

Summary

§ IBM offers a huge set of tools available on the VSE Homepage

– <http://ibm.com/vse>

Click on Download on the left

§ Most tools are 'as is', at no additional charge.

§ Connector components (part of z/VSE and officially supported) are also available here

Check it out now !

The image displays two screenshots of the IBM z/VSE website. The top screenshot shows the 'z/VSE' homepage with a navigation menu on the left where 'Downloads' is highlighted. The bottom screenshot shows the 'Downloads' page with a list of tools and connectors, including 'z/VSE CPU Monitor Tool' and 'JCalc LE/VSE tool'.

Questions ?

