



e-business



# VSE/ESA Security

in a heterogeneous environment

Ingo Franzki

e-mail: [ifranzki@de.ibm.com](mailto:ifranzki@de.ibm.com)  
VSE/ESA Development



e-business



# Trademarks

The following are trademarks of the International Business Machines Corporation in the United States and / or other counties.

CICS*	IBM*	Virtual Image
DB2*	IBM logo*	Facility
DB2 Connect	IMS	VM/ESA*
DB2 Universal	Intelligent	VSE/ESA
Database	Miner	VisualAge*
e-business logo*	Multiprise*	VTAM*
Enterprise Storage	MQSeries*	WebSphere*
Server	OS/390*	xSeries
HiperSockets	S/390*	z/Architecture
	SNAP/SHOT*	z/VM
		zSeries

\* Registered trademarks of IBM Corporation

The following are trademarks or registered trademarks of other companies.

LINUX is a registered trademark of Linus Torvalds

Tivoli is a trademark of Tivoli Systems Inc.

Java and all Java-related trademarks and logos are trademarks of Sun Microsystems, Inc., in the United States and other countries

UNIX is a registered trademark of The Open Group in the United States and other countries.

Microsoft, Windows and Windows NT are registered trademarks of Microsoft Corporation.

SET and Secure Electronic Transaction are trademarks owned by SET Secure Electronic Transaction LLC.

Intel is a registered trademark of Intel Corporation.



e-business



# Security in a heterogeneous environment

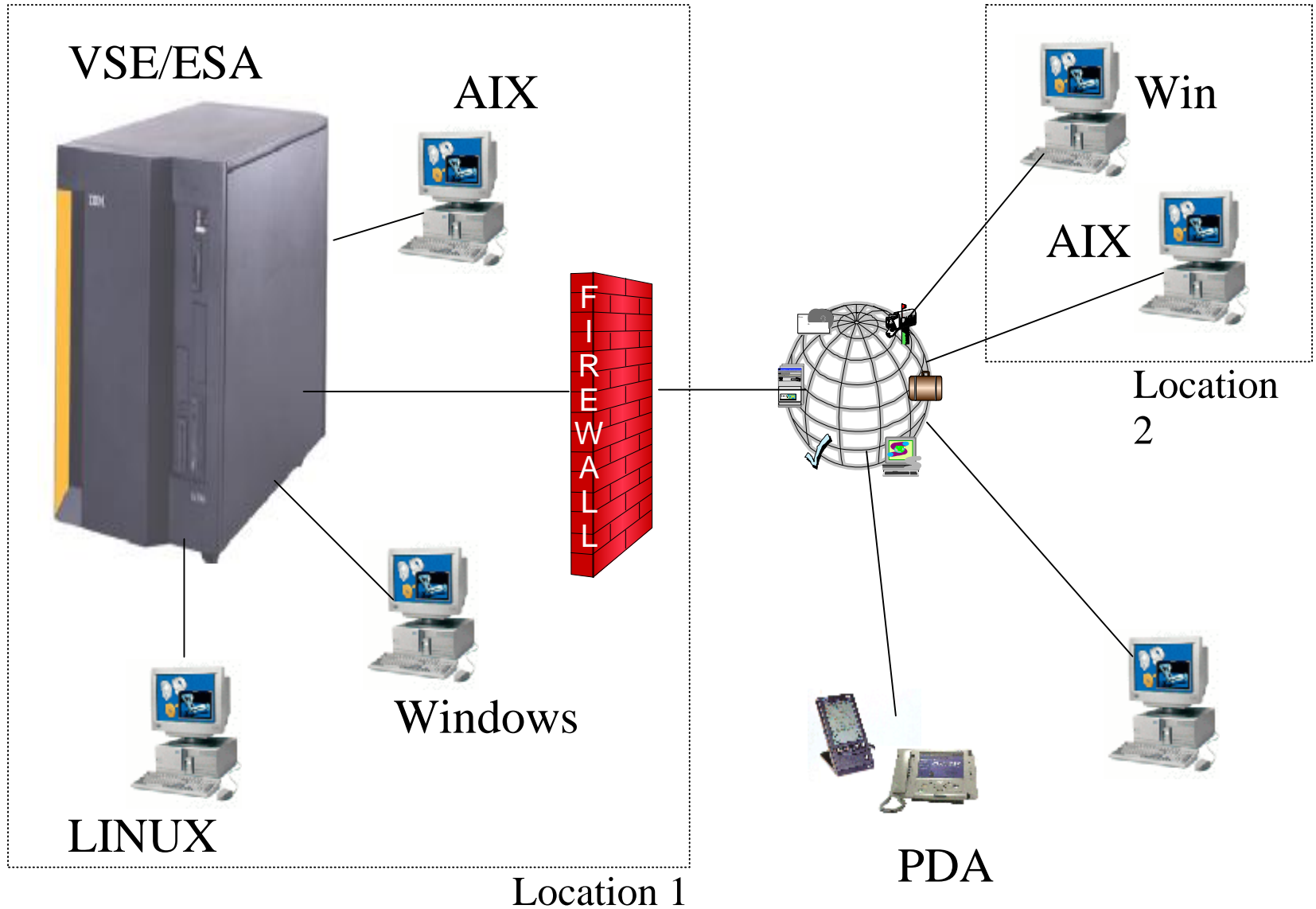



e-business



# Security in a heterogeneous environment

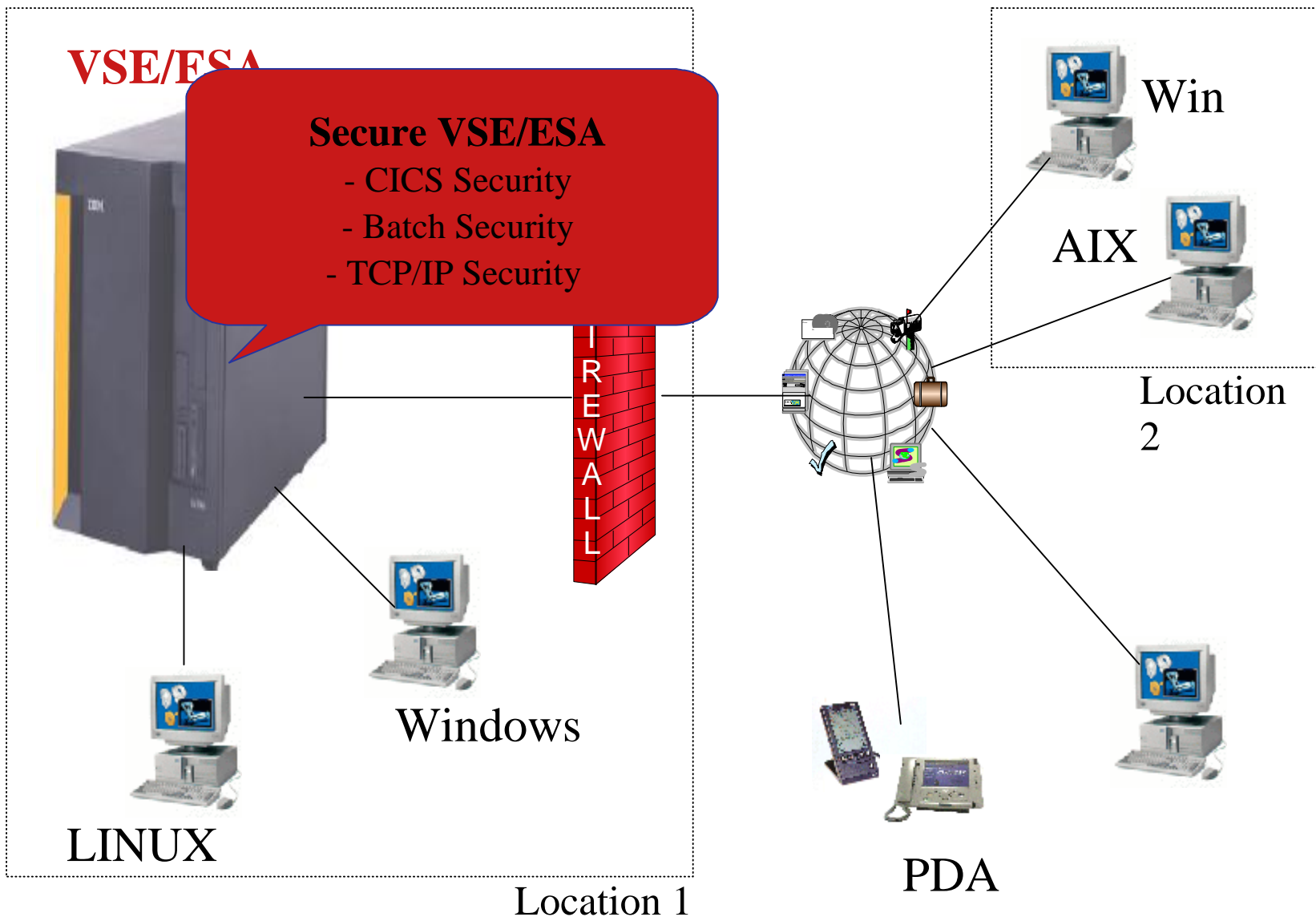



e-business



# Security in a heterogeneous environment

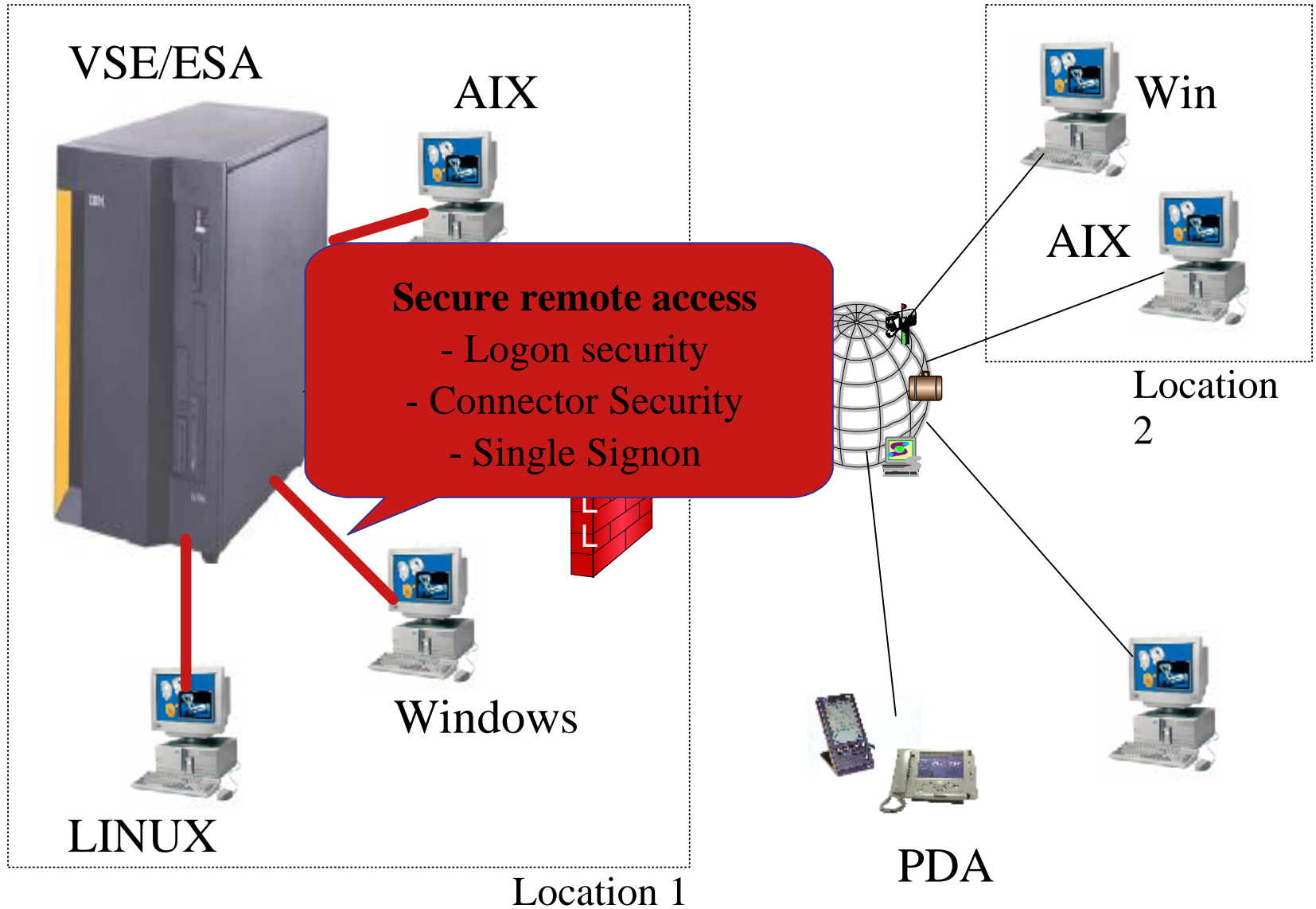



e-business



# Security in a heterogeneous environment

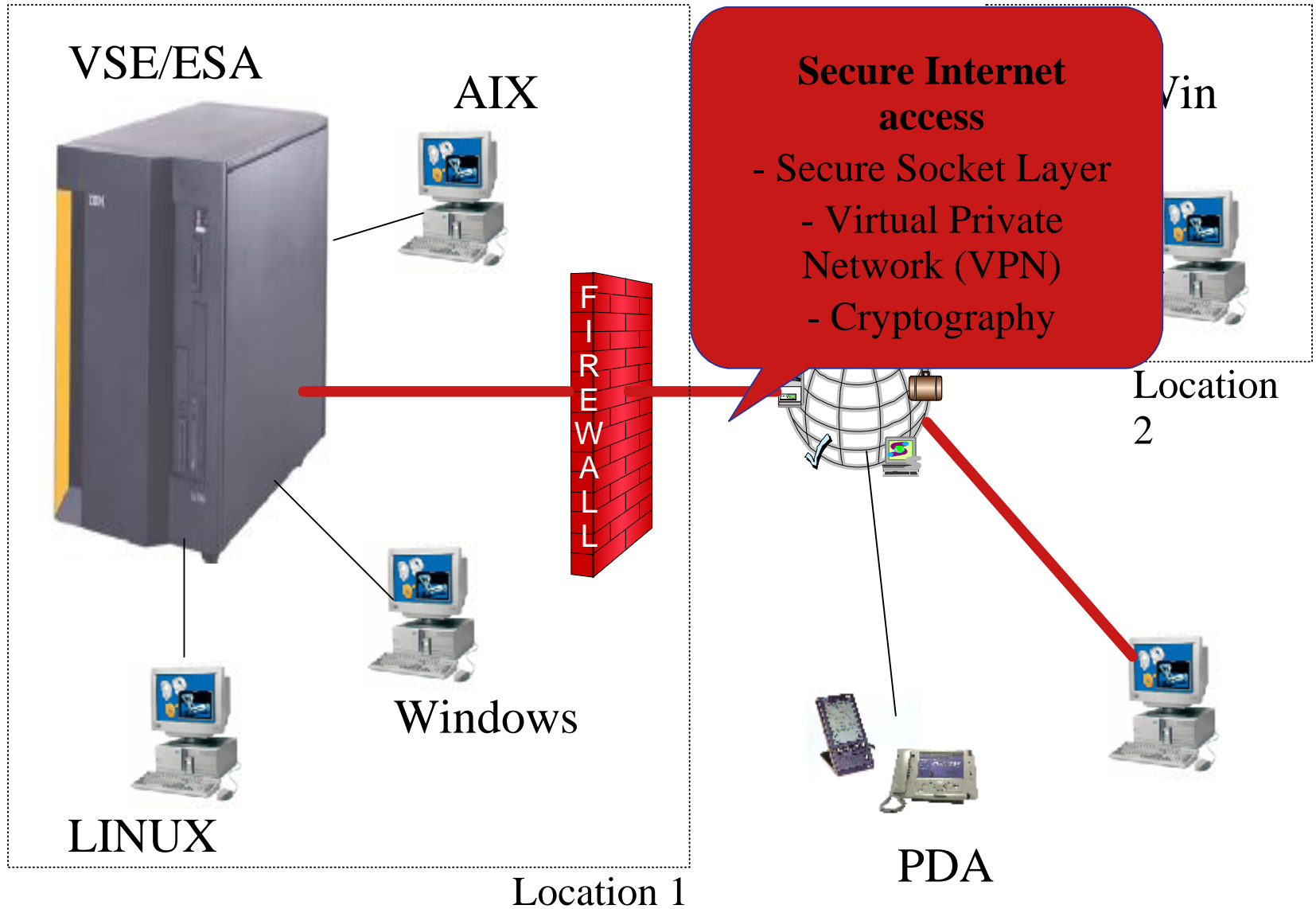



e-business



## Security in a heterogeneous environment

### Security is very important

- Restrict access to systems
- Keep secrets
- Prove identity of users
- Prevent data modification

### Security can be very complex

- In an heterogeneous environment
- A lot of different servers and technologies

### You must know what you are doing !

- Incomplete security setup can be more dangerous than NO security



# Security in a heterogeneous environment

e-business

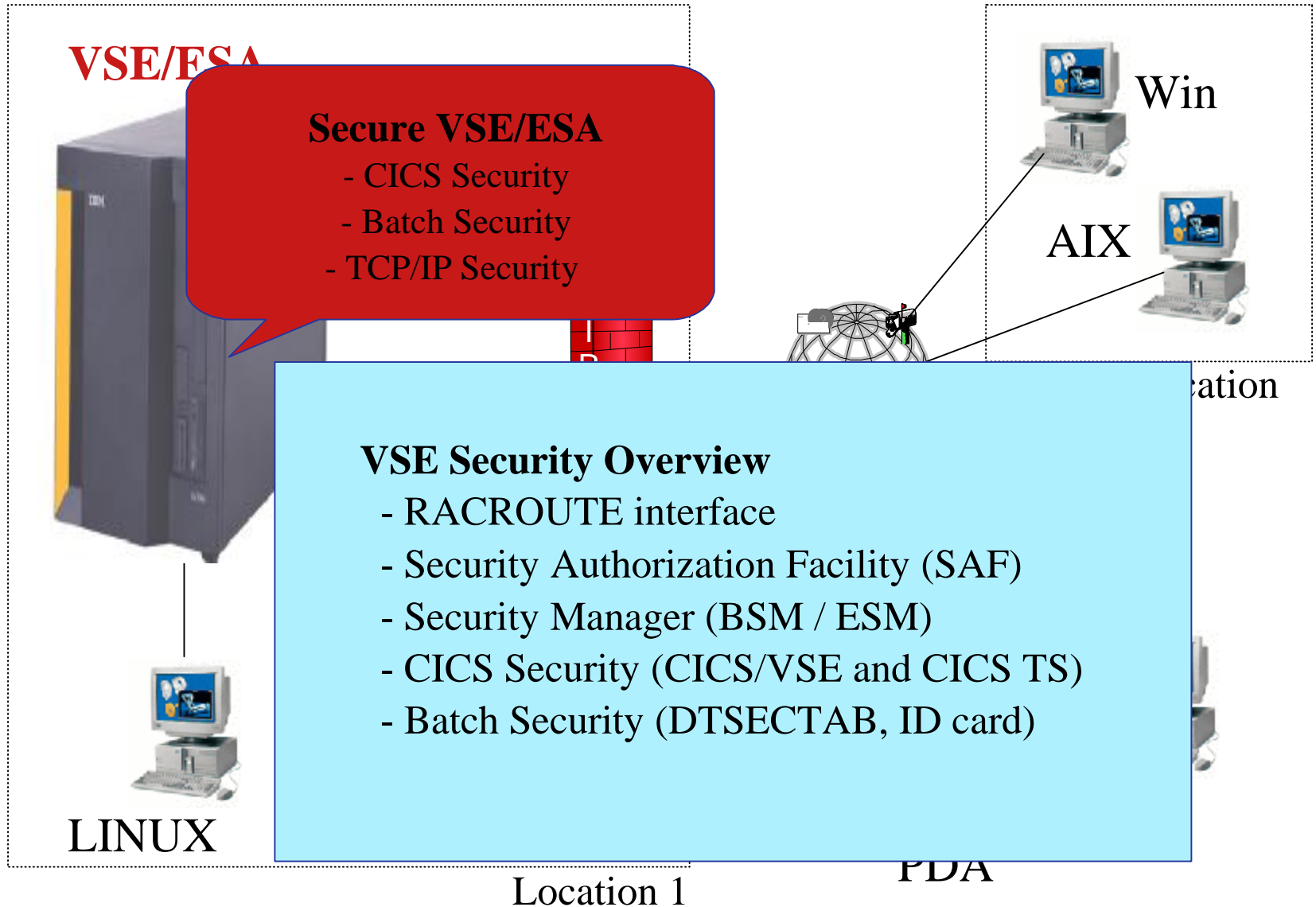





e-business



## Why secure VSE/ESA ?

- Prevent unauthorized access to VSE/ESA and data
  - ▶ Keep secret data secret
  - ▶ Data modification by unauthorized users
- Prevent users from damaging the VSE/ESA system (maybe by accident)
  - ▶ Deletion of members or entries
  - ▶ Submission of jobs



e-business



## VSE Security Overview

- VSE/ESA 2.3 (or below)
  - ▶ SECHECK macro (DTSECTAB)
  - ▶ CICS/VSE internal security
  
- VSE/ESA 2.4, 2.5, 2.6 (2.7)
  - ▶ RACROUTE calls
  - ▶ Security Server (BSM/ESM)
  - ▶ **Security decisions delegated to Security Manager**
  - ▶ Architected interface (RACROUTE)



e-business



# RACROUTE

- **Architected interface**
- External interface to the Security Authorization Facility (SAF)
- To be used by Resource Managers and Subsystems
  - ▶ CICS TS
  - ▶ VSE Connector Server
  - ▶ DITTO/ESA for VSE
  - ▶ TCP/IP Security Exit
  - ▶ Interactive Interface Signon



e-business



# Security Authorization Facility (SAF)

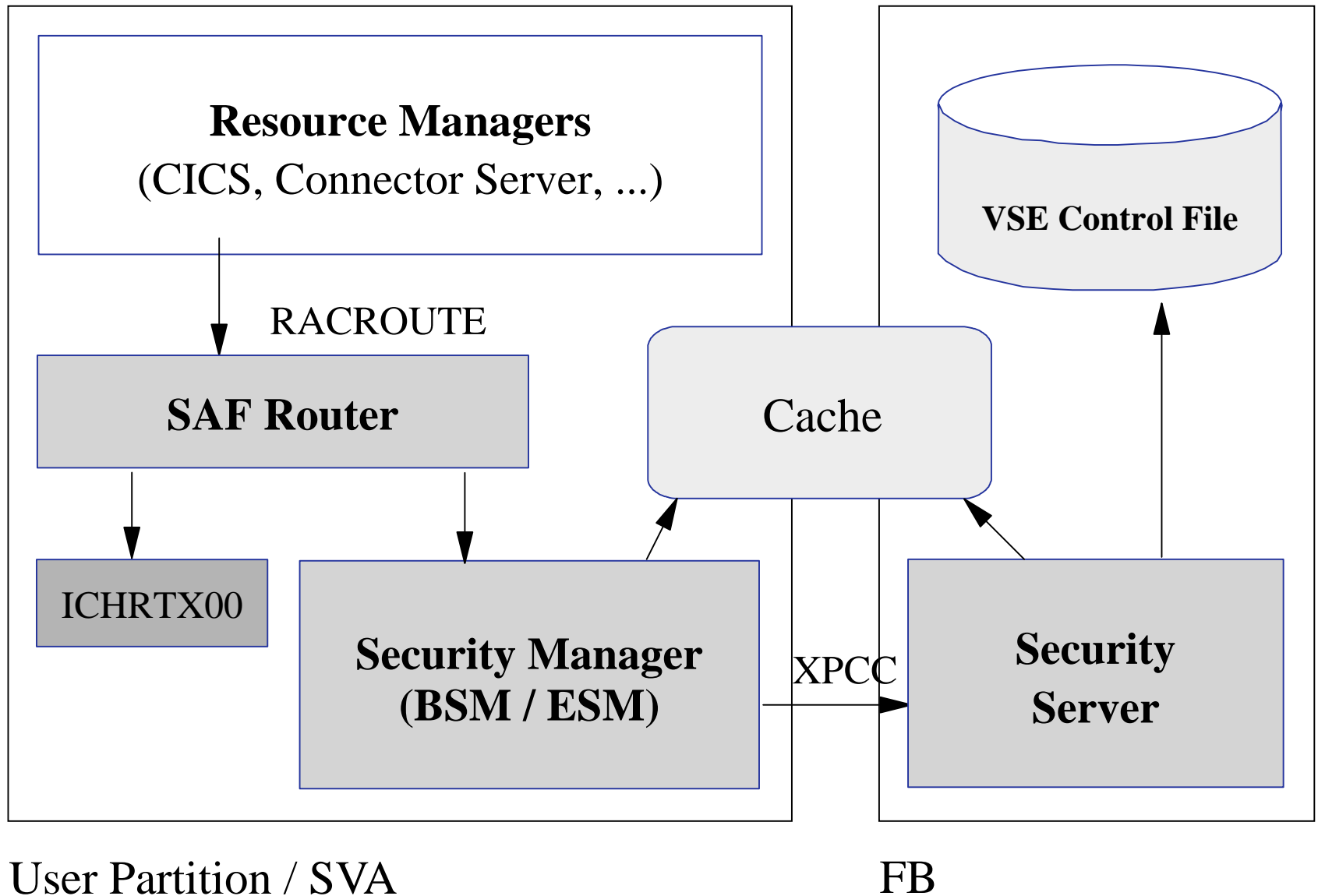

User Partition / SVA

FB



e-business



# Common Security Startup

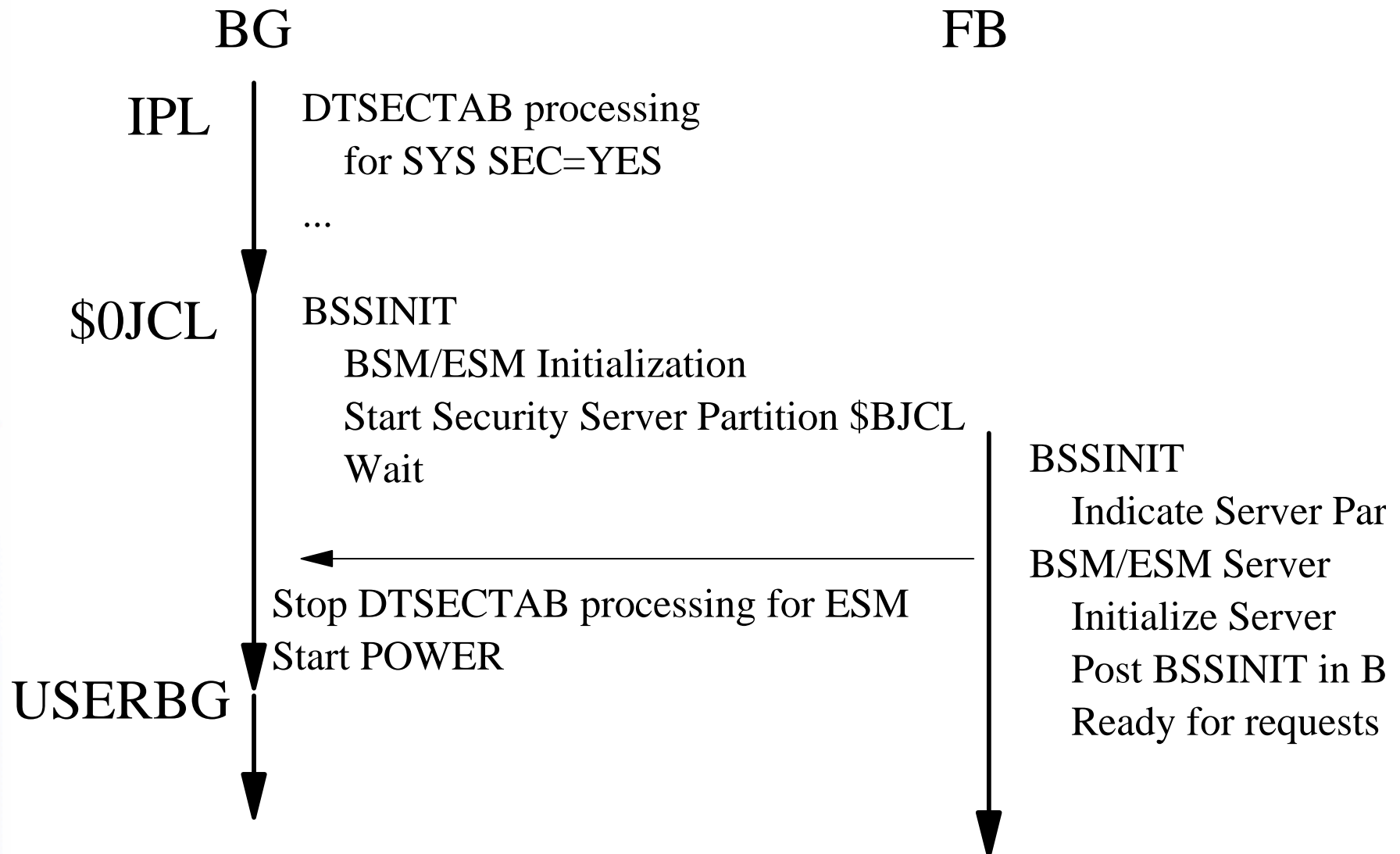



e-business



## Common Security Startup (continued)

- Security manager (BSSINIT) has to initialize before other partition or POWER are active
- BSSINIT will fail, if there are other partition active
- Static partition required for Security Server
- SYS ESM=phasename in IPL proc to start ESM
- If no ESM is started, BSM is activated
- For SYS SEC=YES with ESM a DTSECTAB protection is active until ESM is initialized



e-business



# Security Managers

- Basic Security Manager (BSM)
  - ▶ Part of VSE Central Functions
  - ▶ Signon Security
  - ▶ Transaction Security
  - ▶ DTSECTAB Security
  
- External Security Manager (ESM)
  - ▶ CA-Top Secret
  - ▶ BIM Alert
  - ▶ Vendor



# Basic Security Manager

e-business

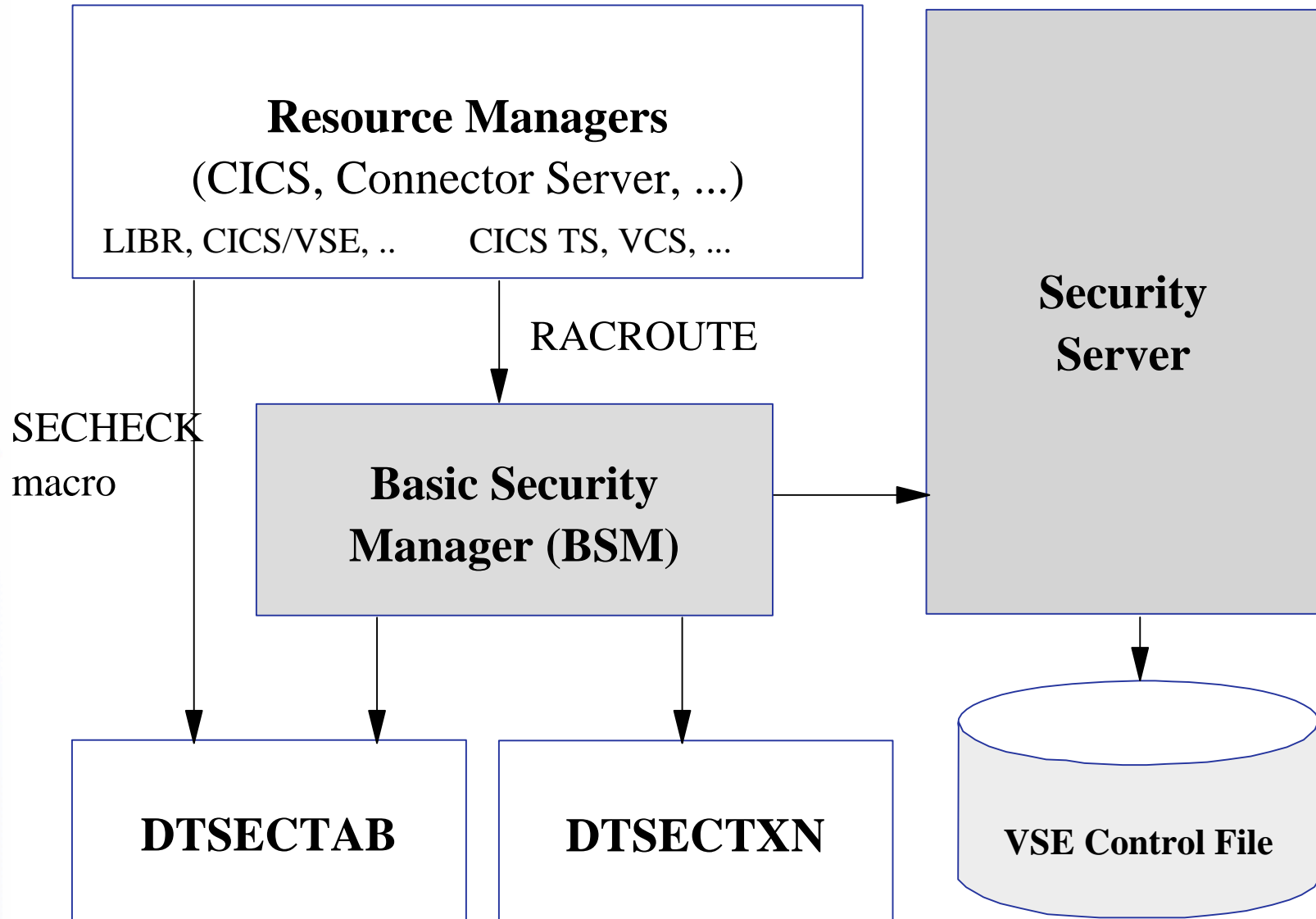





e-business



## Basic Security Manager (continued)

- Provides RACROUTE support for
  - ▶ Signon (CICS and VSE Connector Server)
  - ▶ Batch signon (ID statement)
  - ▶ Transaction security
- Supports also the SVC-based security calls
  - ▶ SECHECK
- Resource classes
  - ▶ USER
  - ▶ DATASET
  - ▶ VSELIB, VSESLIB, VSEMEM
  - ▶ TCICSTRN



e-business



## Basic Security Manager - Repositories

- VSE Control File (IESCNTL)
  - ▶ VSAM KSDS file
  - ▶ Contains all user profiles
  - ▶ used for CICS, Batch and Connector Signon
- DTSECTAB
  - ▶ Contains resources like files, libraries, sublibraries and members
  - ▶ Only 2 userids are still needed in DTSECTAB (FORSEC, DUMMY)
- DTSECTXN (new with VSE 2.4)
  - ▶ Transaction security profiles
  - ▶ Dialog (28) to define the profiles



e-business



## Basic Security Manager - Recovery

- If an active Security Manager does not allow to recover from a problem
  - ▶ IPL cuu LOADPARM ..P
  - ▶ STOP=DPD
  - ▶ 0 SYS SEC=RECOVER
    - BSSINIT will not start a Security Manager
    - Re-IPL required to start Security Manager again



e-business



## Basic Security Manager - User Profiles

- VSE Control File (IESCNTL)
  - ▶ All Users must be defined here (SNT no longer supported by CICS TS)
  - ▶ VSE 2.4 (or above) Control File records are NOT compatible with previous releases
  - ▶ Definition
    - User Maintenance Dialog (211)
    - Batch utility IESUPDCF
- DTSECTAB
  - ▶ Contains 2 userids for ASI procedure
  - ▶ No CICS TS user settings



e-business



## CICS Security

- CICS/VSE uses SNT for user verification
  - ▶ Duplicate user definitions
  - ▶ SNT users can not change password
  
- CICS TS uses RACROUTE calls for
  - ▶ Signon
  - ▶ Resource Security
  - ▶ Transaction Security



e-business



## CICS TS Signon

- Native CICS TS signon (CESN)
- VSE/Interactive Interface signon (IEGM)
- Private signon programs based on CICS SIGNON
- Signon characteristics
  - ▶ Inherit user identification and password verification by Security Manager
  - ▶ CICS TS and Interactive Interface extracts subsystem specific user settings
    - CICS: Operator ID, Operator classes, ...
    - II: User type, Initial panel, access flags, ...
  - ▶ No user definitions to subsystems necessary



e-business



## CICS Security - Coexistence

- Exit program for CICS/VSE to do user verification against BSM user profiles
- DFHXSE and DFHXSSCO in PRD1.BASE
  - ▶ Requires RACROUTE macro from GENLIB
- Requires default user entry in SNT
- Activate ESM in CICS/VSE
  - ▶ EXTSEC=YES in SIT



e-business



## CICS Security - Prefixing

- CICS Prefixing can be used to differentiate between two or more CICS TS running on the same VSE/ESA system
- CICS Prefix is identical with the userid of the CICS startup job
  - ▶ SECPRFX=YES in SIT
  - ▶ SYS SEC=YES: userid in \* \$\$ JOB or ID statement is used
  - ▶ SYS SEC=NO: userid in ID statement is used
  - ▶ When no userid is given: FORSEC is used





e-business



## CICS Security - Migration

- Security related resource to be migrated
  - ▶ Interactive Interface user profiles from an old VSE control file
  - ▶ ICCF user records in DTSTFILE
  - ▶ CICS user profiles from a CICS/VSE signon table (SNT)
  - ▶ Transaction definitions from CICS/VSE PCT
  - ▶ For Batch security users: DTSECTAB
- VSE migration utility IESBLDUP
  - ▶ migrate user profiles
  - ▶ see VSE/ESA System Utilities



e-business



## CICS Security - DTSECTXN Macro

- Macro to support CICS transaction profiles
  - ▶ CICS-region = userid in CICS startup job
  - ▶ transid = up to 4 characters
  - ▶ class = 1-64
    - 1 = public transactions
    - 64 = interactive interface transactions

```
DTSECTXN NAME={CICS-region.}transid,  
              TRANSEC=(class)  
              [,SUBTYPE={INITIAL | FINAL}]  
              [,TYPE=GENERIC]
```



e-business



## Batch Security

- ID statement or \* \$\$ JOB specifies userid and password for a job
- Userid and password are verified against
  - ▶ DTSECTAB
  - ▶ Security Manager (RACROUTE)
- Subsystems (LIBR, VSAM, ...) uses this userid to verify access rights against DTSECTAB



e-business



## Security Checklist for VSE/ESA

- SYS SEC=YES/NO
  - ▶ YES if batch security is required
- CICS SIT SEC=YES (!)
  - ▶ If NO, all users can logon without a password
- Change passwords for predefined users
  - ▶ POST, PROG, OPER, SYSA, ...



e-business



# Security in a heterogeneous environment

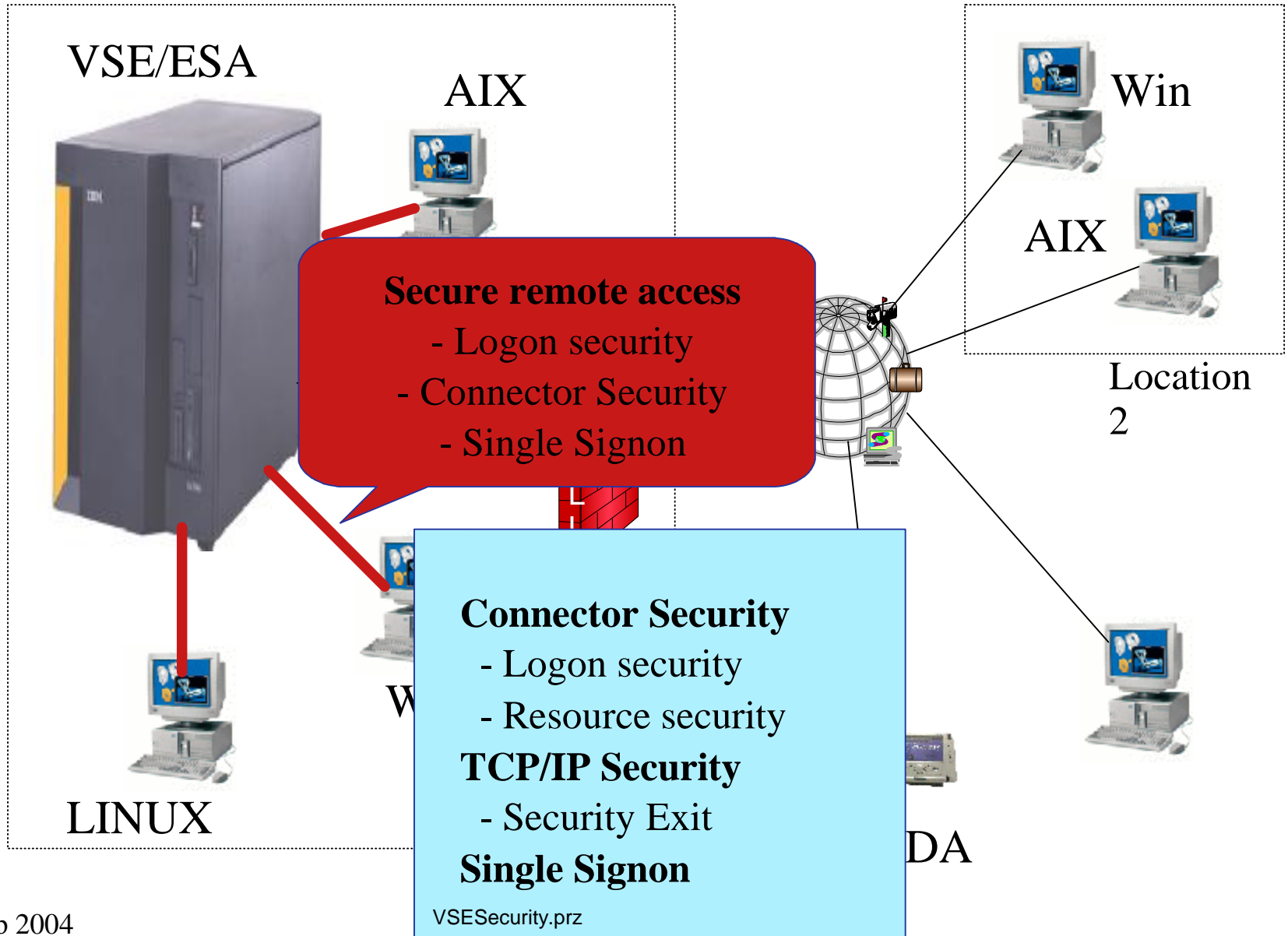



e-business



## Why secure remote access ?

- Today most computers are part of a network
  - ▶ Can connect to your VSE/ESA system
- Prevent unauthorized access to VSE/ESA and data
  - ▶ Requires to authenticate the user (logon)
- FTP allows to access production data
  - ▶ VSAM
  - ▶ POWER entries (listings)



e-business



## Connector Security

- VSE Connector Server acts as a Resource Manager
  - ▶ Issues RACROUTE calls for
    - Userid and password verification
    - Resource security
- Connector userids are the same as for CICS TS and Batch
- No additional user profile setup required
- But:
  - ▶ Additional access restriction by userid and/or IP address possible



e-business



## Connector Security - Logon

- VSE Connector Server requires a client to logon with valid userid and password
- Userid and password is checked via RACROUTE calls
- Additional information is extracted from ACEE and IUI or AF segment
  - ▶ User type, access flags, ...
- The user's ACEE is kept during the whole session
  - ▶ Used to do resource access checking
- Multiple logon attempts with same userid is possible





e-business



## Connector Security - Resource Security

- When a client issues a resource access request
  - ▶ The server does RACROUTE calls to check if the user is allowed to access the resource
  - ▶ Access is done only if user is allowed to access the resource
- VSE Connector Server runs under a special userid (VCSRVR)
  - ▶ specified in ID statement in startup job
  - ▶ should be allowed to access all resources



e-business



## Connector Security - Internals

- Logon processing
  - ▶ RACROUTE VERIFY CREATE
  - ▶ RACROUTE EXTRACT (user type checking)
    - AF segment, if this fails (e.g. CA-TopSecret) IUI segment
  - ▶ Flags used in AF segment
    - AFADMIN            user is a administrator = type 1
    - AFMCONS           user is allowed to open a console
  - ▶ Flags used in IUI segment
    - IESISUTP           user type (1,2 or 3)
    - IESISFL1           user flag byte 1
    - IESISFL2           user flag byte 2



e-business



## Connector Security - User types

- Type 1 (Administrator)
  - ▶ read and write access for all resources
- Type 2 (Programmer)
  - ▶ read only access for all resources
  - ▶ allowed to submit jobs
- Type 3 (Application User)
  - ▶ read only access for selected resources



e-business



## Connector Security - Resource classes

- The following Resource class are used
  - ▶ VSELIB, VSESLIB, VSEMEM (LIBR)
  - ▶ DATASET (VSAM)
- Resource not protected by Security Manager
  - ▶ POWER queue entries
    - protected by user type and access flag
  - ▶ Console
    - protected by user type and access flag
    - If user is allowed to access the console, he can issue all console commands, even REIPL NOPROMPT (!)
  - ▶ ICCF Libraries and Members
  - ▶ VSAM Record Mappings



e-business



## Connector Security - Additional Security

- Configuration member allows to restrict logon (connect) by
  - ▶ Userid
  - ▶ IP address
- See skeleton SKVCSUSR in ICCF library 59

```

* *****
* USERS FROM THIS IP'S ARE ALLOWED TO LOGON
* *****

IP = *,          LOGON = ALLOWED
* IP = 9.164.123.456, LOGON = DENIED
* IP = 9.165.*   , LOGON = DENIED
* IP = 10.0.0.* , LOGON = ALLOWED
* *****

* THIS USERS ARE ALLOWED TO LOGON
* *****

USER = *,          LOGON = ALLOWED
* USER = BOBY,    LOGON = ALLOWED
* USER = SYS*,    LOGON = DENIED

```



e-business



## Deactivation of Connector Security

- Since PTF UQ66736 (VSE 2.6), UQ66733 (VSE 2.5) Connector Security can be deactivated
- New keyword SECURITY in main configuration member:
  - ▶ SECURITY = FULL (default, as before)
  - ▶ SECURITY = RESOURCE (no user type checking)
  - ▶ SECURITY = LOGON (no resource, only logon)
  - ▶ SECURITY = NO (no security at all)
- Access restriction (previous foil) is still active, even if SECURITY = NO



e-business



## TCP/IP Security

- In general TCP/IP uses its own userid definitions
  - ▶ DEFINE USER, ID=user, PASSWORD=pwd
  - ▶ Readable in initialization member (IPINITxx.L)
  - ▶ Duplicate user definitions
  - ▶ Used for
    - FTP
- Security Exit available from IBM to check the userids and resource access via Security Manager
  - ▶ see next foil



e-business



# TCP/IP Security Exit

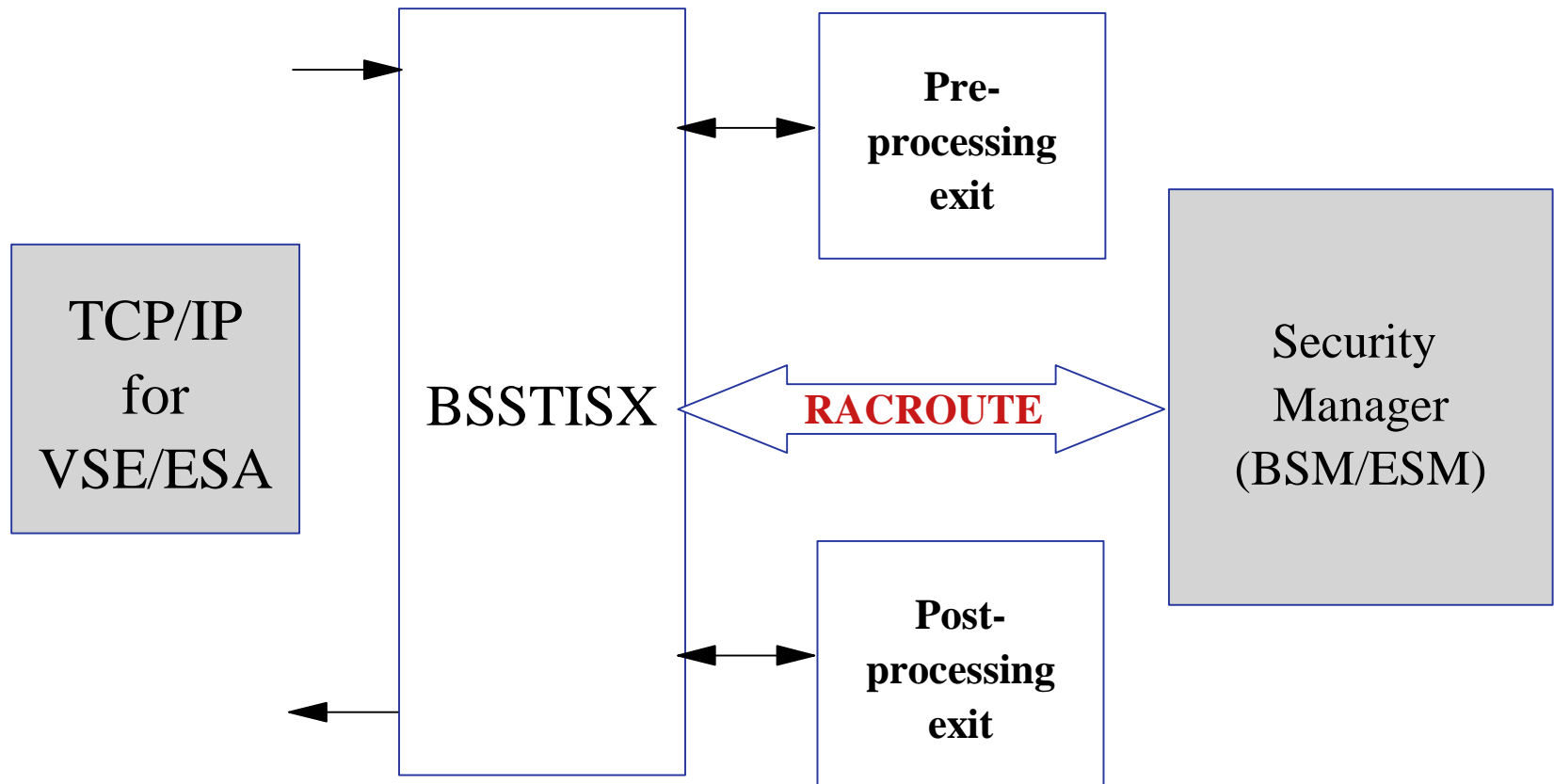





e-business



## TCP/IP Security Exit

- Issues RACROUTE calls for
  - ▶ User identification and verification
  - ▶ Resource access control
    - VSE files, libraries, members
    - POWER entries
    - SITE commands
- Provides a pre- and post-processing exit interface
- Activation
  - ▶ DEFINE SECURITY, DRIVER=BSSTISX[, DATA=data]
    - DATA=anonym\_uid, anonym\_pwd, preproc, postproc, mode
  - ▶ SET SECURITY=ON
  - ▶ For details see VSE/ESA Software Newsletter #20 (First/Second Quarter, 2000)



e-business



## TCP/IP Security - HTTPHACK.L

- Typical hacker attacks are normally no problem for VSE, only for Windows
- Rejects hacker attacks
  - ▶ by filtering known URL prefixes
- HTTPHACK.L:

\* Example:

\*

\* "SCRIPTS/" will cover...

\*       GET /SCRIPTS/ROOT.EXE?C+D

\*       GET /SCRIPTS/ROOT.EXE?CAT+PASSWD

\*       etc...

\* =====

SCRIPTS/

MSADC/

\_VTI\_BIN/

\_MEM\_BIN/

C/WINNT/SYSTEM32/CMD.EXE

D/WINNT/SYSTEM32/CMD.EXE

CGI-BIN/



e-business



## Single Signon Solutions

- Every server/application requires you to logon
  - ▶ Different user ids and passwords for each server
- A single signon solution
  - ▶ Requires a user to signon only once
    - one user id, one password
  - ▶ Stores signon information for several servers or applications
  - ▶ Automatically performs a signon on each server or application
    - Using the stored signon information
- Example: LDAP



e-business



## Security Checklist for TCP/IP

- Connector Security
  - ▶ Set SECURITY=FULL (SKVCSCFG)
  - ▶ Define resource access rights (BSM/ESM)
  - ▶ Restrict remote access to specific users and IPs (SKVCSUSR)
  
- TCP/IP Security
  - ▶ SET SECURITY=ON in IPINIT member
  - ▶ Use Security Exit
  - ▶ Do not define users in IPINIT member



e-business



# Security in a heterogeneous environment

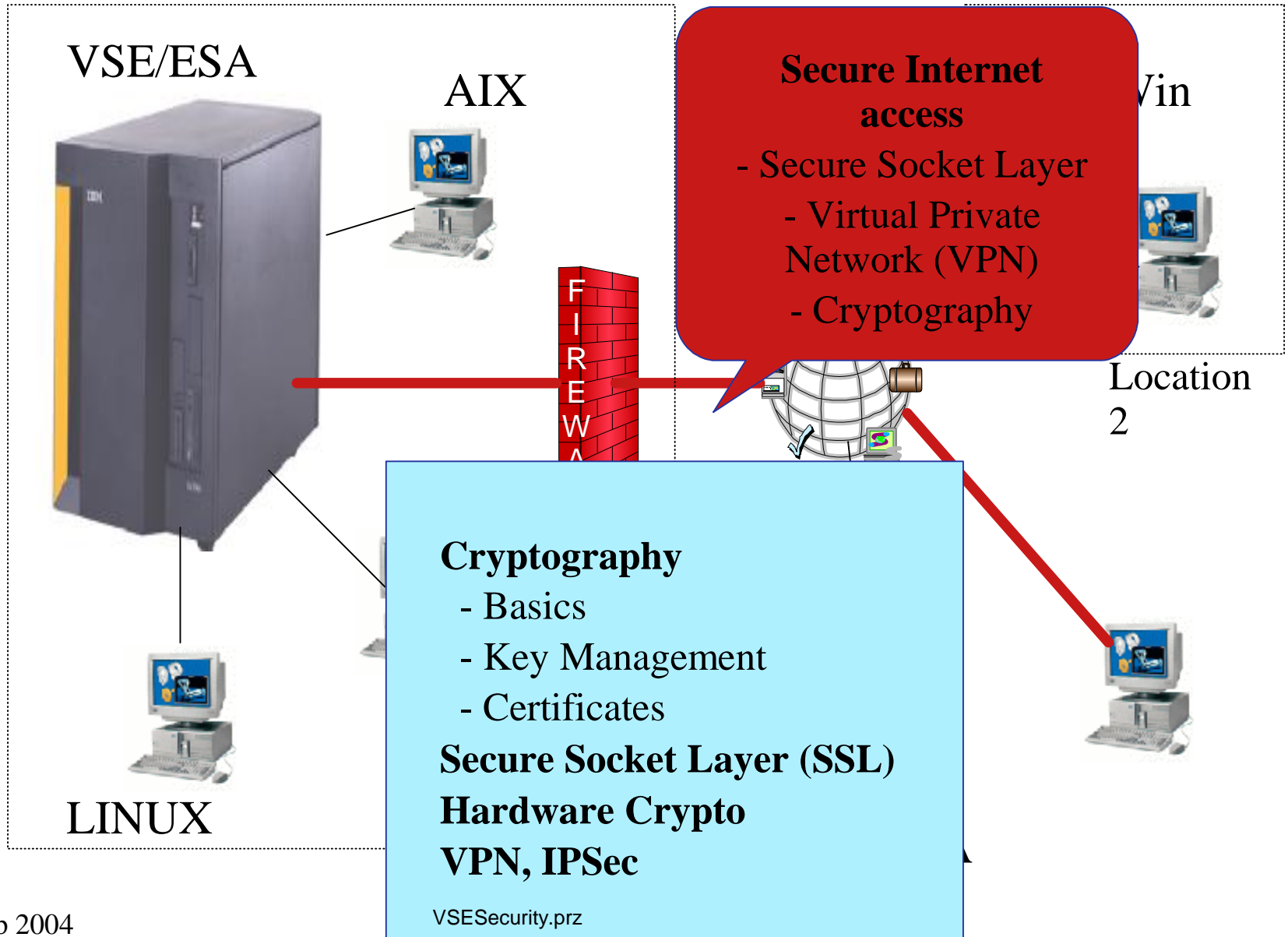



e-business



## Why Cryptography ?

- **Keeping secrets**

- ▶ Alice wants to send Bob confidential information, Charly should not be able to read it.

- **Proving identity**

- ▶ Bob receives a message from Alice. How he can be sure that it is really from Alice?

- **Verifying information**

- ▶ Bob receives a message from Alice. How he can be sure that the content has not been modified?



e-business



# Keeping Secrets



Charly

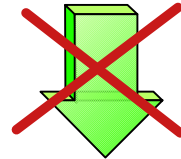

Alice

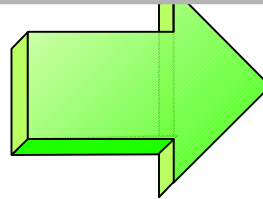
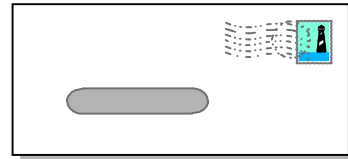
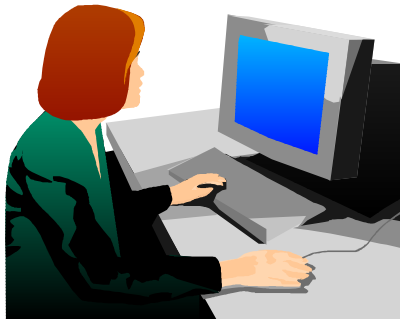

Bob



Alice encrypts the message with a secret code that only she and Bob knows



e-business



# Proving Identity



Charly

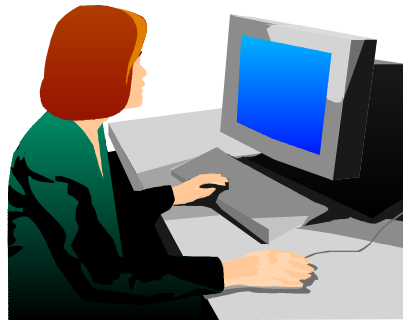
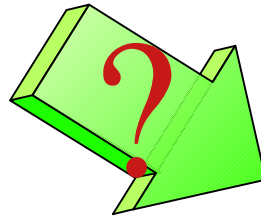

Alice

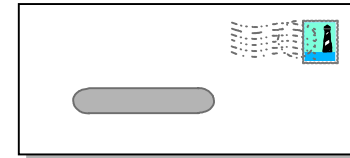
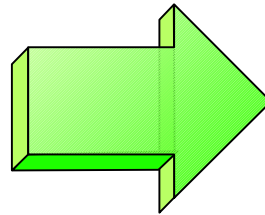

Bob

Alice "signs" the message by attaching a secret phrase that only she and Bob knows





e-business



# Verifying Information

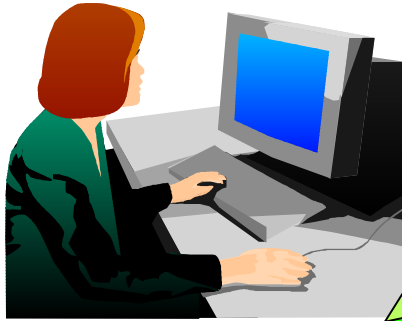

Alice

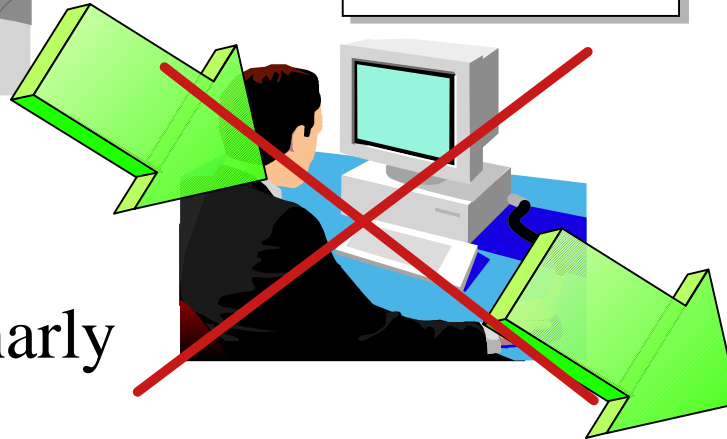
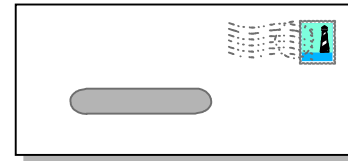

Charly

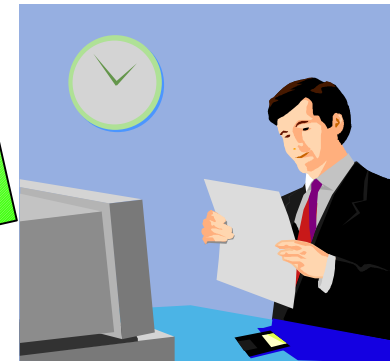

Bob

Alice generates a "hash" from the message using a secret code and attaches it to the message. Bob also generates the hash from the received message and compares it.



e-business



## Secret Key Cryptography (symmetric)

- Both parties know the same secret code (key)
  - The key must be kept secret
  - Encryption algorithm = mathematical transformation of the data with the key
- 
- ▶ DES      Data Encryption standard
  - ▶ 3DES     Triple strength DES
  - ▶ RC2      Rivest Cipher 2
  - ▶ RC4      Rivest Cipher 4

Typical key length: 40, 56 or 128 bit



e-business



## Secret Key Cryptography - continued

Alice

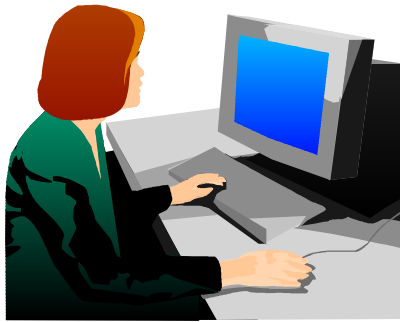

Bob

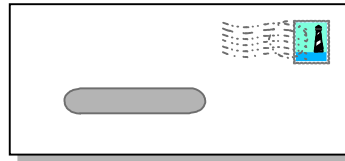
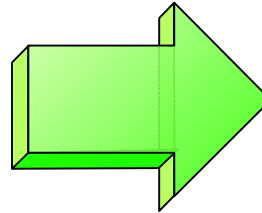

Alice encrypts the message with the secret key and sends it to Bob. Bob decrypts the message with the secret key.



e-business



## Public Key Cryptography (asymmetric)

- One "public key" and one "private key"
- "Private key" is kept secret (private)
- "Public key" is published
- Asymmetric cryptography is based on mathematical problems, that are much easier to create than to solve
  - ▶ RSA      Rivest Shamir Adleman
  - ▶ DSA      Digital Signature Algorithm
  - ▶ DHE      Diffie Hellman Algorithm

Typical key length: 512 or 1024 bit



e-business



## Public Key Cryptography - Encrypting

Alice



Bob

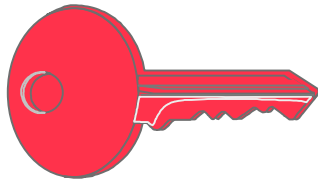
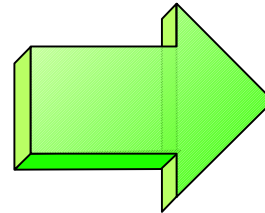

Bob's public key

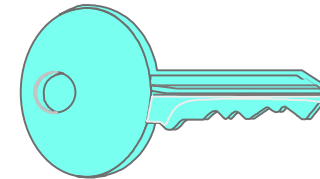
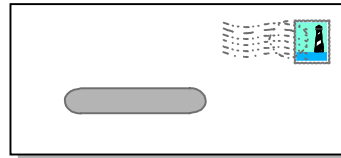

Bob's private key

Alice encrypts the message using Bob's public key and sends it to Bob. Bob decrypts it using his private key. Since only Bob knows his private key, only he can read the message.



e-business



## Public Key Cryptography - Signing

Alice



Bob

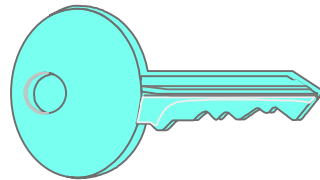
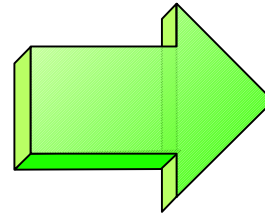

Alice's private key

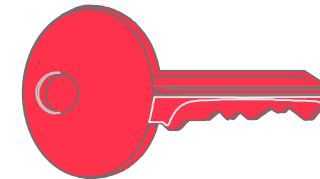
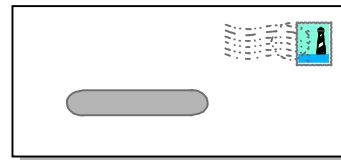

Alice's public key

Alice encrypts the message using her private key and sends it to Bob. Bob decrypts it using Alice's public key. The message is "signed" by Alice since it can only be decrypted using **her** public key.



e-business



## Combined Symmetric and Asymmetric Cryptography

- Asymmetric cryptography is very CPU-time consuming
- Use asymmetric cryptography only for secret key exchange
- Data encryption uses symmetric cryptography
- Secret key is generated by random
- SSL also uses this mechanism



e-business



# Combined Symmetric and Asymmetric Cryptography - continued

Alice

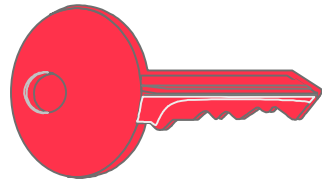

Bob's public key

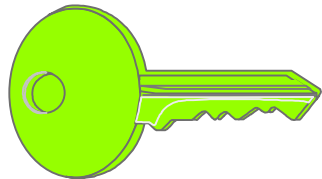

secret key

Bob



secret key

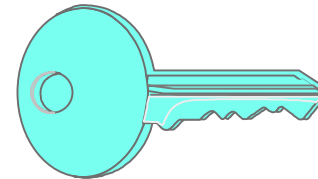
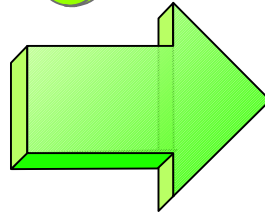
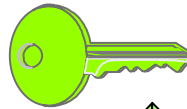

Bob's private key

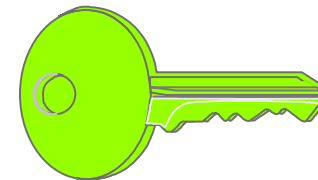
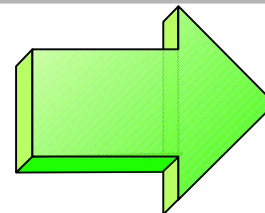
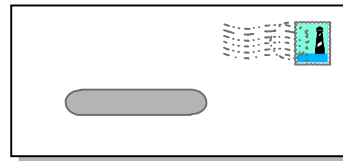

secret key





e-business



# Key Management

- Key management is not trivial:
  - ▶ Is the public key really from the right person?

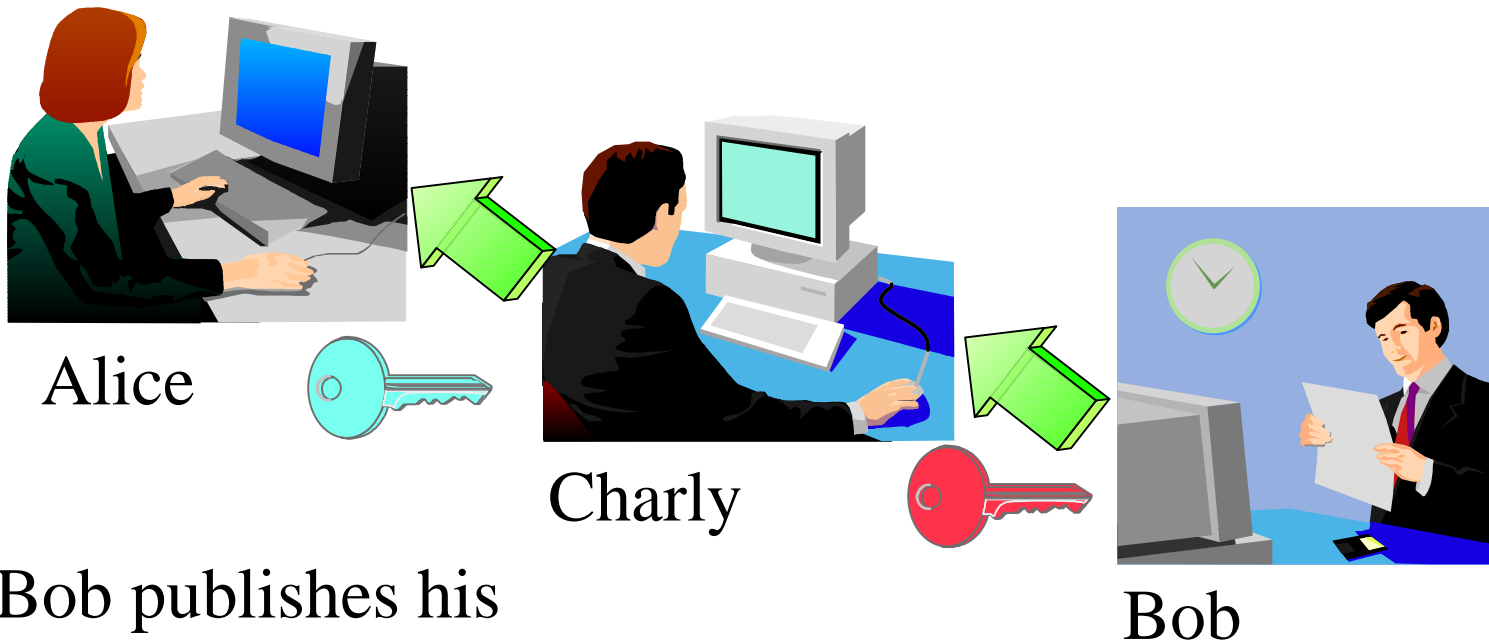

Bob publishes his public key, but Charly intercepts this and instead sends his public key to Alice.



e-business



## Certificates

- A certificate contains the following items
  - ▶ The subject (name of the person)
  - ▶ The subject's public key
  - ▶ Period of validity
  - ▶ The issuer
  - ▶ Issuers signature
- The issuer "signs" the certificate by encrypting a hash of the certificate content with his private key
- Everyone can check the sign by decrypting it with the issuers public key



e-business



## Certificate Authorities

- A certificate is issued by a certificate authority (CA)
- If a user trusts the certificate authority, he can trust the certificates issued by this CA
- CAs identify itself with a "self signed certificate":
  - ▶ The public key in the certificate is also the public key used to decrypt the signature
  - ▶ Subject and issuer are the same
- It is possible to build certificate hierarchies
- Certificate revocation lists are used to mark certificates that have been issued by error



e-business



## SSL (Secure Socket Layer)

- As the name implies, SSL is a layer on top of TCP
- SSL uses a TCP connection to transfer encrypted messages
- Uses asymmetric cryptography for session initiating
- Uses symmetric cryptography for data encryption

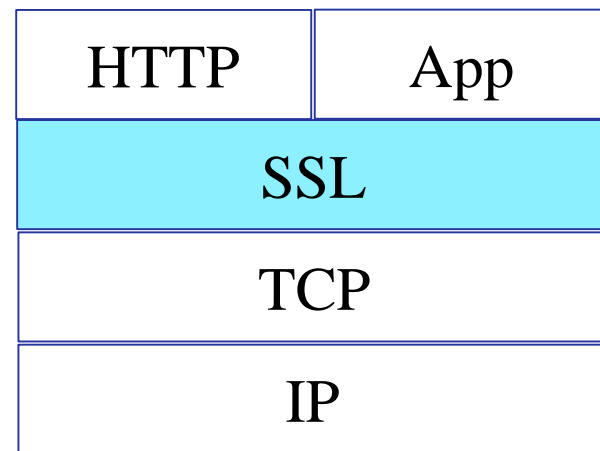
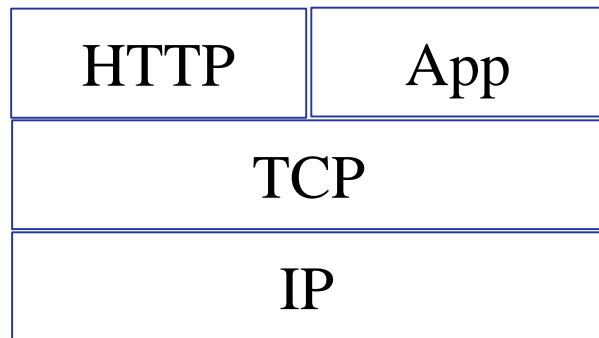



e-business



# SSL Protocol

- The SSL protocol defines a set of messages

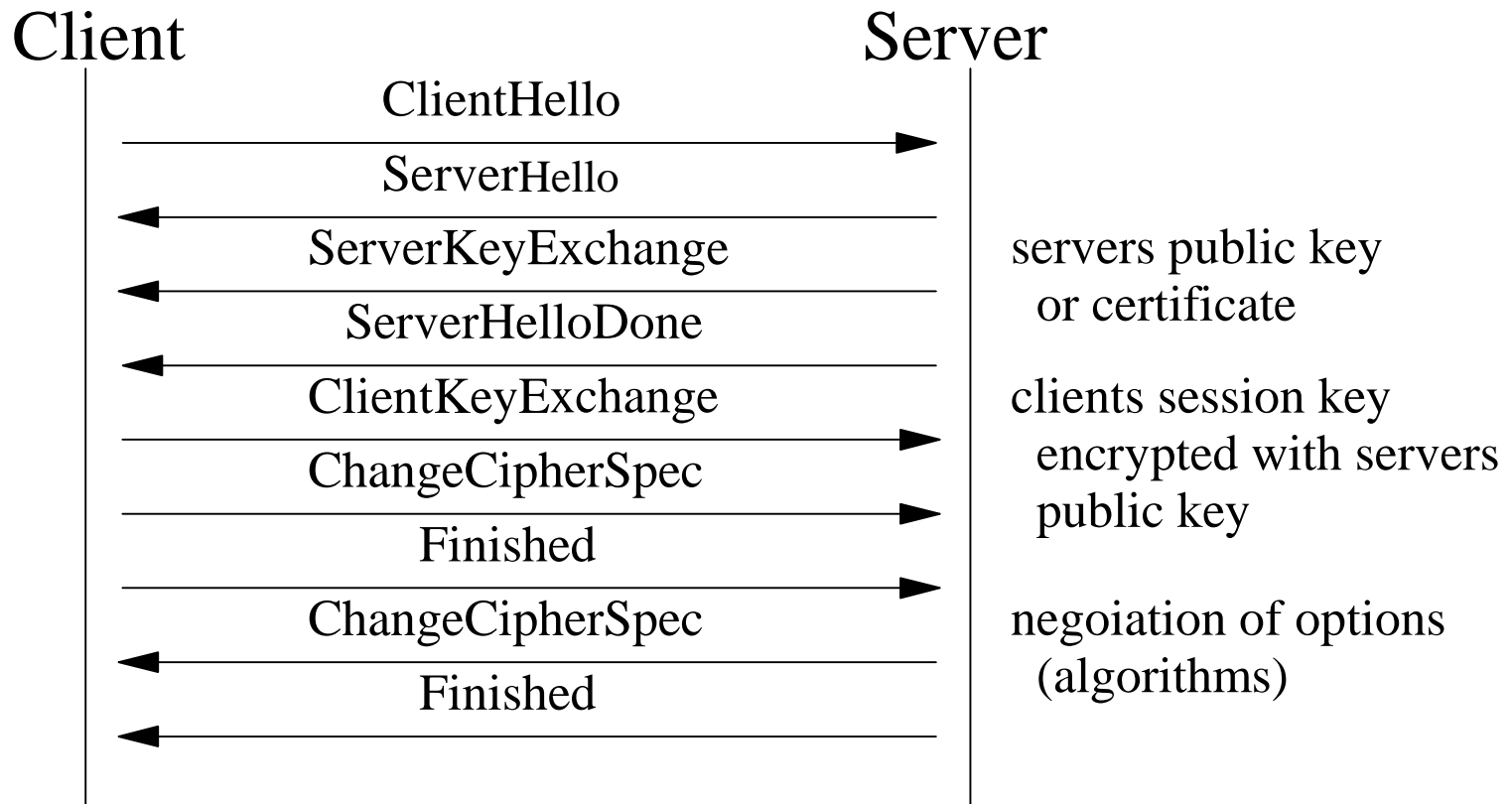



e-business



## Cipher Suites

- Cipher suites defines the algorithms used:
  - ▶ For key exchange
  - ▶ For encryption
  - ▶ For hash algorithm

SSL\_**RSA**\_WITH\_**DES\_CBC**\_SHA

↑  
Key exchange

↑  
Encryption

↑  
Hash algorithm



e-business



## Server / Client Authentication

- Server authentication means:
  - ▶ The server sends his certificate to the client
  - ▶ Client checks the certificate (using the signature)
  - ▶ Client does not authenticate itself
- Client authentication means:
  - ▶ The client sends his certificate to the server
  - ▶ Server checks the certificate
  - ▶ Optionally associates access rights or privileges



e-business



## Session Caching

- "SSL Session" means
  - ▶ Secret key used for data encryption
  - ▶ Negotiated algorithms
- Establishing a SSL Session is a complex and time consuming mechanism
- Session caching allows to reuse previously negotiated SSL parameters
- No need of repeating the negotiations or authentications
  - ▶ The same symmetric key is used
- The connection becomes more unsecured
- A SSL Session time-out defines how long a session is kept alive





e-business



## SSL for VSE/ESA

- SSL for VSE is part of the TCP/IP for VSE/ESA base
- Enabled with the Application Pak
- Integrated into TCP/IP for VSE/ESA
- Supports SSL 3.0 and TLS 1.0
- Key exchange: RSA
- Data Encryption: DES and Triple DES
- Hash algorithm: MD5, SHA
- Supports X.509v3 PKI Certificates
- SSL daemon implementation for HTTPS, Telnet
- SSL API compatible with the OS/390 SSL API



e-business



## SSL Daemon (SSLD)

- Define a SSL daemon for each TCP port that you want to secure:
  - ▶ DEFINE TLSD, ID=MYSSLD,
 

PORT=443,	HTTPS port
PASSPORT=443,	
CIPHER=0A096208,	Cipher suites
CERTLIB=CRYPTO,	library name
CERTSUB=KEYRING,	sublibrary name
CERTMEM=MYKEY,	member name
TYPE=1,	server application
MINVERS=0300,	SSL 3.0
DRIVER=SSLD	Driver phase name



e-business



## Secure Socket Layer API

- Compatible to OS/390 SSL API
- Functions available for
  - ▶ Session initiating
  - ▶ Sending/receiving data
  - ▶ Ending a session
- SSL API is based on Socket API
- SSL API can be called from
  - ▶ LE-C programs
  - ▶ Assembler programs



e-business



## CryptoVSE API

- Native cryptographic API (not available though LE)
- Provides cryptographic services:
  - ▶ Data encryption
    - DES
    - Triple DES
    - RSA PKCS #1
  - ▶ Message Digest
    - MD5
    - SHA-1
  - ▶ Digital Signatures
    - RSA PKCS #1 with SHA1 or MD5
  - ▶ Message Authentication
    - HMAC



e-business



## Hardware Crypto Overview

- Requires VSE/ESA 2.7 and TCP/IP for VSE/ESA 1.5
- Supported crypto cards
  - ▶ PCI Cryptographic Accelerator (PCICA)
    - Feature code 0862
    - Available for zSeries (z800, z900)
- The crypty card is plugged into the Adjunct Processor
- Currently only RSA (asymmetric) is supported
  - ▶ Of benefit for Session initiation (SSL-Handshake)
- Also supported with
  - ▶ z/VM 4.2 + APAR VM62905
  - ▶ z/VM 4.3



e-business



## Hardware Crypto Overview - continued

- New crypto subtask in Security Server (SECSECV) running in FB
  - ▶ Or as separate job if no SECSECV is running
  - ▶ Crypto card is polled by crypto task

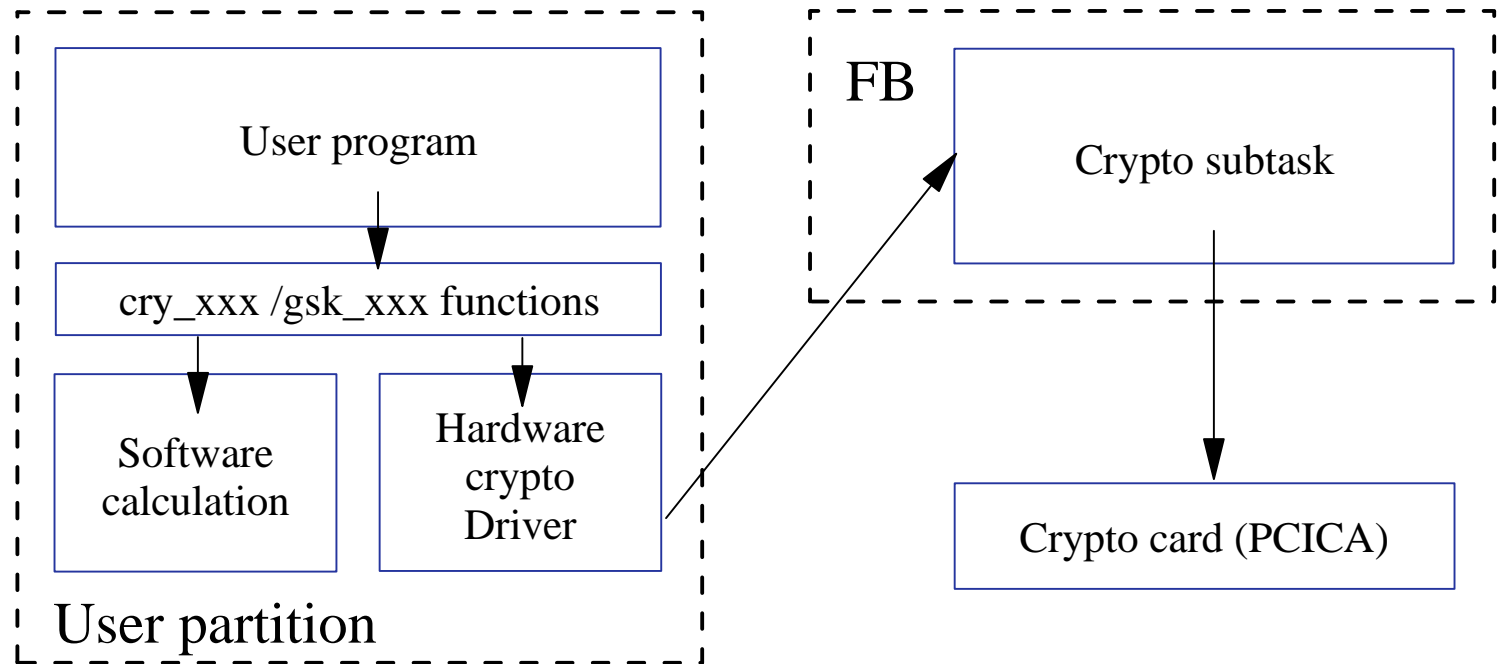



e-business



## Virtual Private Network, IPSec

- Can be used to define a secure tunnel between two locations
  - ▶ Makes use of cryptographic functions

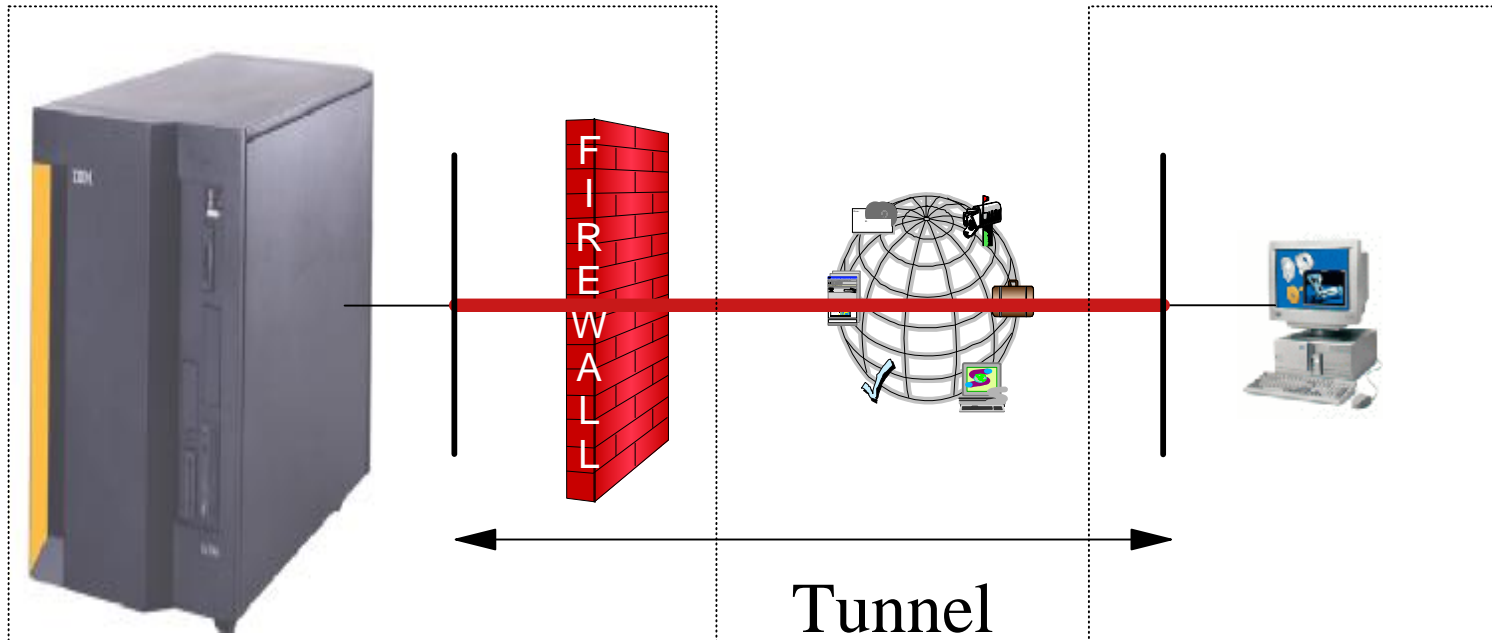



e-business



## Security Checklist for SSL / Crypto

- Secure Socket Layer
  - ▶ Use SSL if you have a need for
    - Keeping secrets
    - Proving identity
    - Verifying information
  - ▶ Use suitable cipher suite
    - E.g. RSA512\_ **NULL** \_MD5: No data encryption
  - ▶ Use Hardware Crypto if available
  
- VPN, IPSec
  - ▶ Use if you dial in from outside the company
  - ▶ Encrypt data before sending through the Internet





e-business



## Related Documentation

- **New:** VSE Security Homepage:  
<http://www-1.ibm.com/servers/eserver/zseries/os/vse/support/vsesec.htm>
- VSE/ESA Planning (SC33-6703)
- VSE Administration (SC33-6705)
- VSE/ESA Software Newsletter No. 17 (G225-4508-17)
- VSE/ESA Software Newsletter No. 18 (G225-4508-18)
- VSE/ESA Software Newsletter No. 20 (G225-4508-20)
- OS/390 Security Server External Security Interface (RACROUTE) Macro Reference (GC28-1922)
- OS/390 Security Server (RACF) Data Areas (SY27-2640)



e-business



---

# Questions

