

2009 System z Expo
October 5 – 9, 2009 – Orlando, FL



z/VSE in an Elevator

Session ID: zEG02

Klaus Goebel

z/VSE Systems Mgr., kgoebel@de.ibm.com



Trademarks

The following are trademarks of the International Business Machines Corporation in the United States and/or other countries.

APPN*	HiperSockets	OS/390*	VM/ESA*
CICS*	HyperSwap	Parallel Sysplex*	VSE/ESA
DB2*	IBM*	PR/SM	VTAM*
DB2 Connect	IBM eServer	Processor Resource/Systems Manager	WebSphere*
DirMaint	IBM e(logo)server*	RACF*	z/Architecture
e-business logo*	IBM logo*	Resource Link	z/OS*
ECKD	IMS	RMF	z/VM*
Enterprise Storage Server*	Language Environment*	S/390*	z/VSE
ESCON*	MQSeries*	Sysplex Timer*	zSeries*
FICON*	Multiprise*	System z9	
GDPS*	NetView*	TotalStorage*	
Geographically Dispersed Parallel Sysplex	On demand business logo	Virtualization Engine	

* Registered trademarks of IBM Corporation

The following are trademarks or registered trademarks of other companies.

Java and all Java-related trademarks and logos are trademarks of Sun Microsystems, Inc., in the United States and other countries

Linux is a registered trademark of Linus Torvalds in the United States, other countries, or both.

UNIX is a registered trademark of The Open Group in the United States and other countries.

Microsoft, Windows and Windows NT are registered trademarks of Microsoft Corporation.

Red Hat, the Red Hat "Shadow Man" logo, and all Red Hat-based trademarks and logos are trademarks or registered trademarks of Red Hat, Inc., in the United States and other countries.

SET and Secure Electronic Transaction are trademarks owned by SET Secure Electronic Transaction LLC.

* All other products may be trademarks or registered trademarks of their respective companies.

Notes:

Performance is in Internal Throughput Rate (ITR) ratio based on measurements and projections using standard IBM benchmarks in a controlled environment. The actual throughput that any user will experience will vary depending upon considerations such as the amount of multiprogramming in the user's job stream, the I/O configuration, the storage configuration, and the workload processed. Therefore, no assurance can be given that an individual user will achieve throughput improvements equivalent to the performance ratios stated here.

IBM hardware products are manufactured from new parts, or new and serviceable used parts. Regardless, our warranty terms apply.

All customer examples cited or described in this presentation are presented as illustrations of the manner in which some customers have used IBM products and the results they may have achieved. Actual environmental costs and performance characteristics will vary depending on individual customer configurations and conditions.

This publication was produced in the United States. IBM may not offer the products, services or features discussed in this document in other countries, and the information may be subject to change without notice. Consult your local IBM business contact for information on the product or services available in your area.

All statements regarding IBM's future direction and intent are subject to change or withdrawal without notice, and represent goals and objectives only.

Information about non-IBM products is obtained from the manufacturers of those products or their published announcements. IBM has not tested those products and cannot confirm the performance, compatibility, or any other claims related to non-IBM products. Questions on the capabilities of non-IBM products should be addressed to the suppliers of those products.

Prices subject to change without notice. Contact your IBM representative or Business Partner for the most current pricing in your geography.

Objective

**Learn
Everything
You needed to know about z/VSE**

And tell others about it !



IBM Böblingen Research & Development Center

The Home of z/VSE and Linux on System z



The Difference between Perception ...



... and Reality: Your Friends, the z/VSE Team !

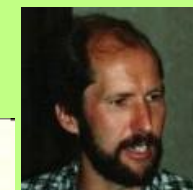
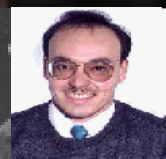

The most important z/VSE Centers, worldwide

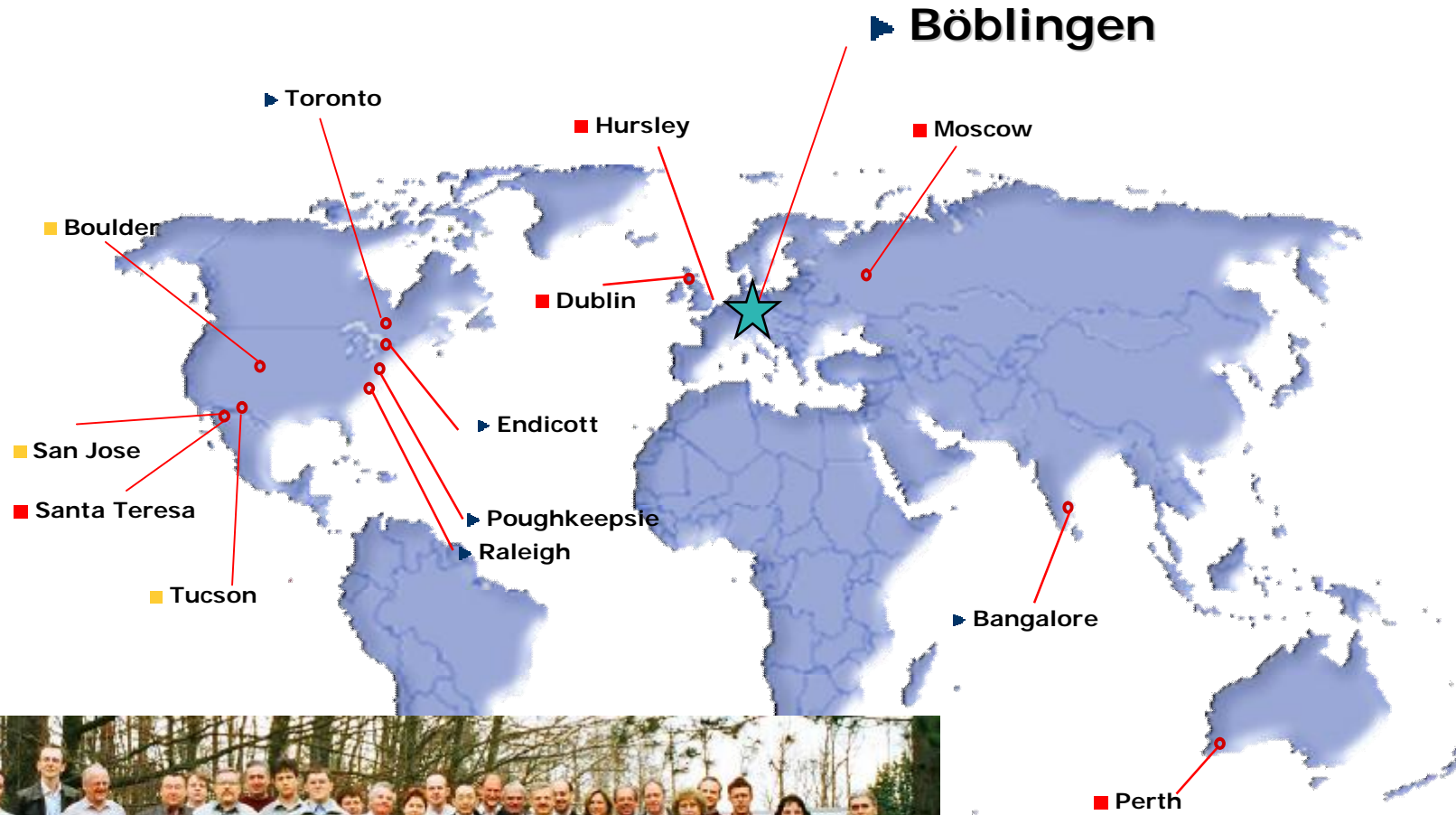

- ▲ Research
- Hardware Development
- Software Development
- ▶ Hardware and Software Development

45-Years of IBM Mainframe and z/VSE Heritage

§ S/360->S/370->4300->9370->ES9000->S/390->zSeries->System z

§ DOS/360->DOS/VS->DOS/VSE->(SSX)->VSE/SP
->VSE/ESA V1->VSE/ESA V2->z/VSE V3->z/VSE V4

§ S/360 Model 30

- ▶ 30 KIPS (.03 MIPS)
- ▶ 16 – 64 KB

§ DOS/360

- ▶ 1 batch partition
- ▶ basic, but lovable

§ System z10 BC/EC

- ▶ 26-900+ MIPS (1-way)
- ▶ 4 GB – 1.5 TB

§ z/VSE V4

- ▶ Batch and OLTP
- ▶ SOA
- ▶ still lovable



1960s



1970s



1980s



1990s



2000s

Operating Systems on IBM System z

§ 33% of worldwide traditional mainframe operating system installs are z/VSE or VSE/ESA

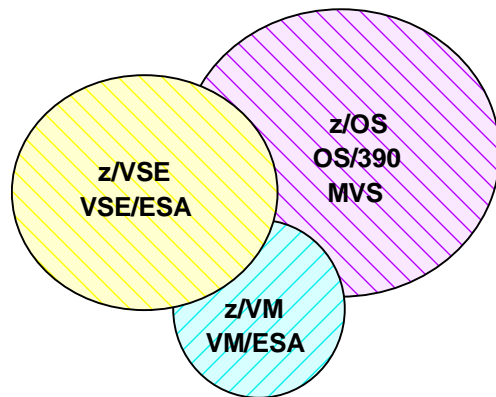

§ VSE* population is 40% in US, 40% in Europe, 20% in RoW

§ Worldwide 50% run VSE under VM, in Europe 90+% are VSE under VM

§ IFLs play an important role in VSE's strategy

§ zIIP/zAAP have no meaning to VSE

(*) The term "VSE" stands for both, VSE/ESA and z/VSE.

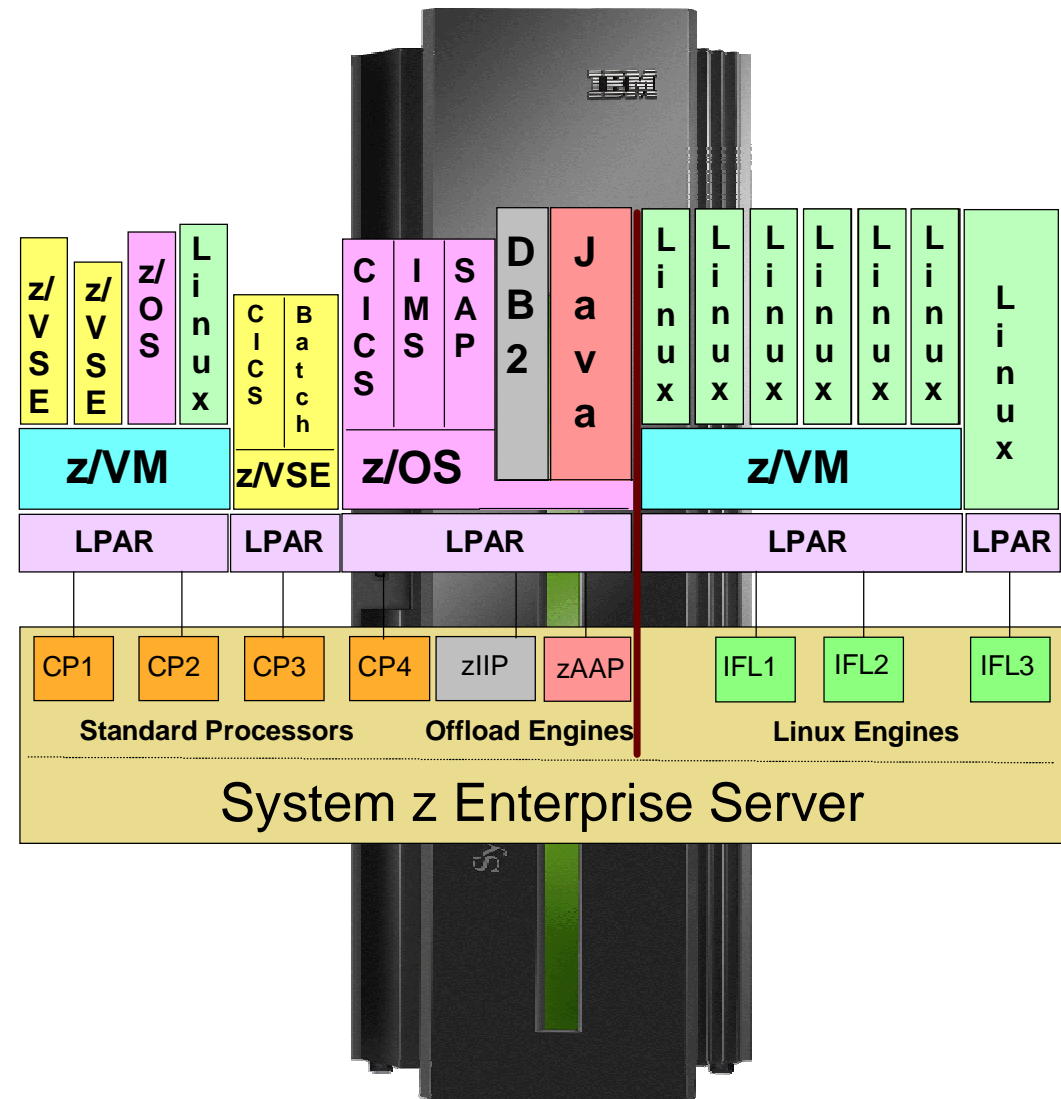

Typical VSE Customer

What is VSE?

- § Traditional mainframe operating system, similar to z/OS but smaller and simpler
- § Less capacity, availability, security; no Unix system services
- § Designed for smaller accounts with less demanding needs

Why do customers use VSE?

- § Cost-efficient, high performance, robust (almost no downtime)
- § Customers have a significant cumulative investment in proven, highly evolved homegrown core VSE application code (CICS and batch), data, equipment, IT skills, company & industry expertise, business processes, and end-user training
- § History – familiarity, comfort, confidence

What are VSE customer's biggest concerns?

- § **Applications!!** (no Java, WAS, Tivoli, Lotus, SAP, Oracle, etc.)
- § **Cost!!** (or at least the perception of high mainframe costs)
- § **Skills!** (especially availability of new mainframe skills)
- § **Future!** (vitality of VSE key components and products)

Why not just migrate to another platform?

- § Cost, time, risk, lost opportunity – not an easy task
- § z/OS: cost, skills, benefits perceived to be marginal
- § Unix, Linux, Windows, or i5/OS: complete redesign and rewrite of tailored, homegrown VSE CICS applications often required and/or packaged applications may be costly and not meet customer requirements

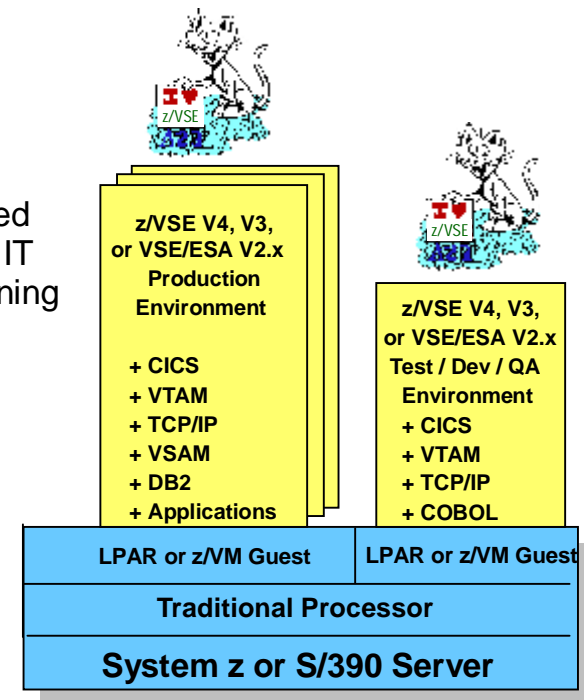

Note: The term "VSE" stands for both, VSE/ESA and z/VSE.

Top Concerns of VSE* Customers

→ **1. Applications**



2. Cost



3. Skills



4. Future



(*) The term "VSE" stands for both, VSE/ESA and z/VSE.

z/VSE Strategy

alias

- § 3-tier Strategy
- § Hybrid Strategy
- § Connector Strategy
- § Migration Strategy
- § Coexistence Strategy
- § Linux Strategy
- § **PIE Strategy**

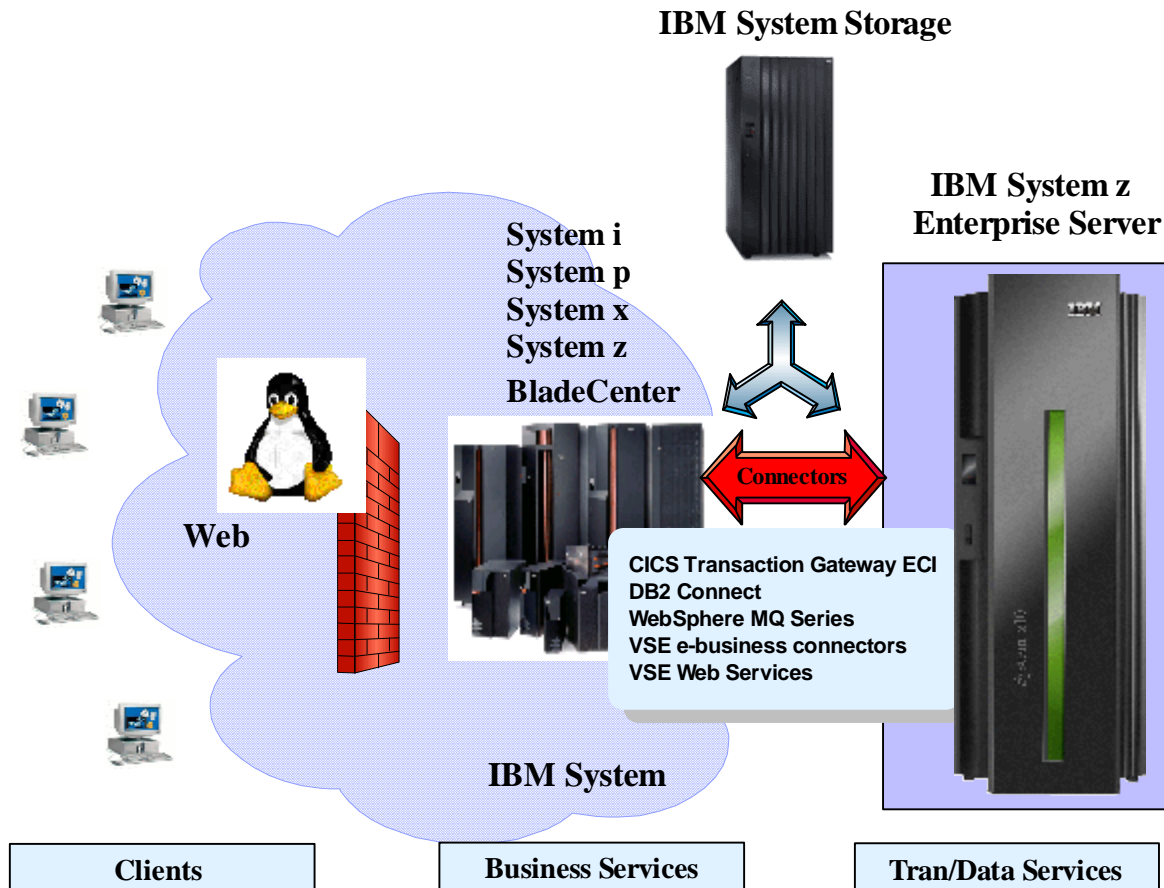

- P**rotect existing VSE investments
- I**ntegrate using middleware and VSE connectors
- E**xtend with Linux on IBM System z technology & solutions

z/VSE Strategy with Linux on System z

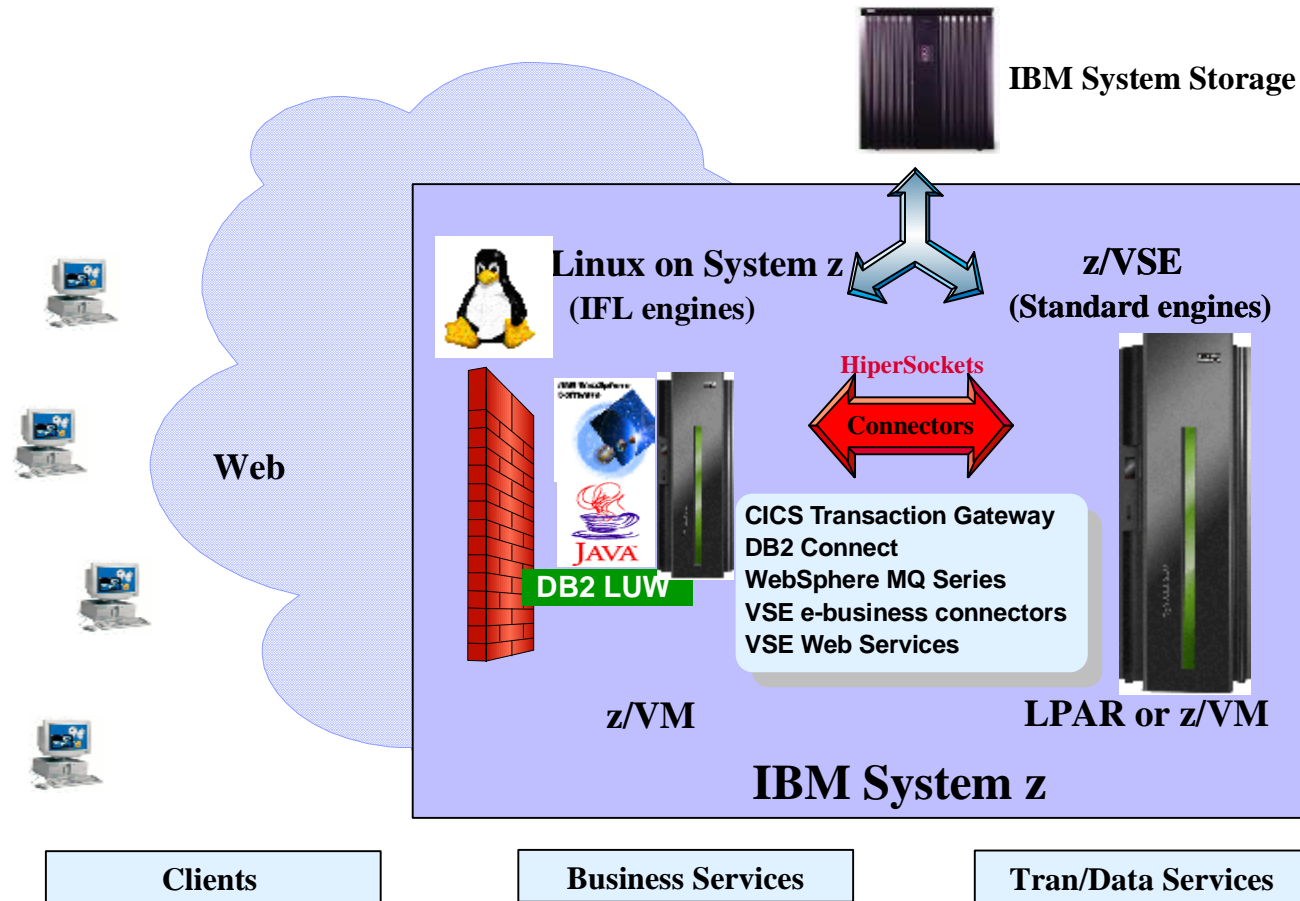

z/VSE Vision: Hybrid Environment leveraging z/VSE V4, z/VM V5, Linux on System z

- P**rotect existing VSE investments
- I**ntegrate using middleware and VSE connectors
- E**xtend with Linux on IBM System z technology & solutions

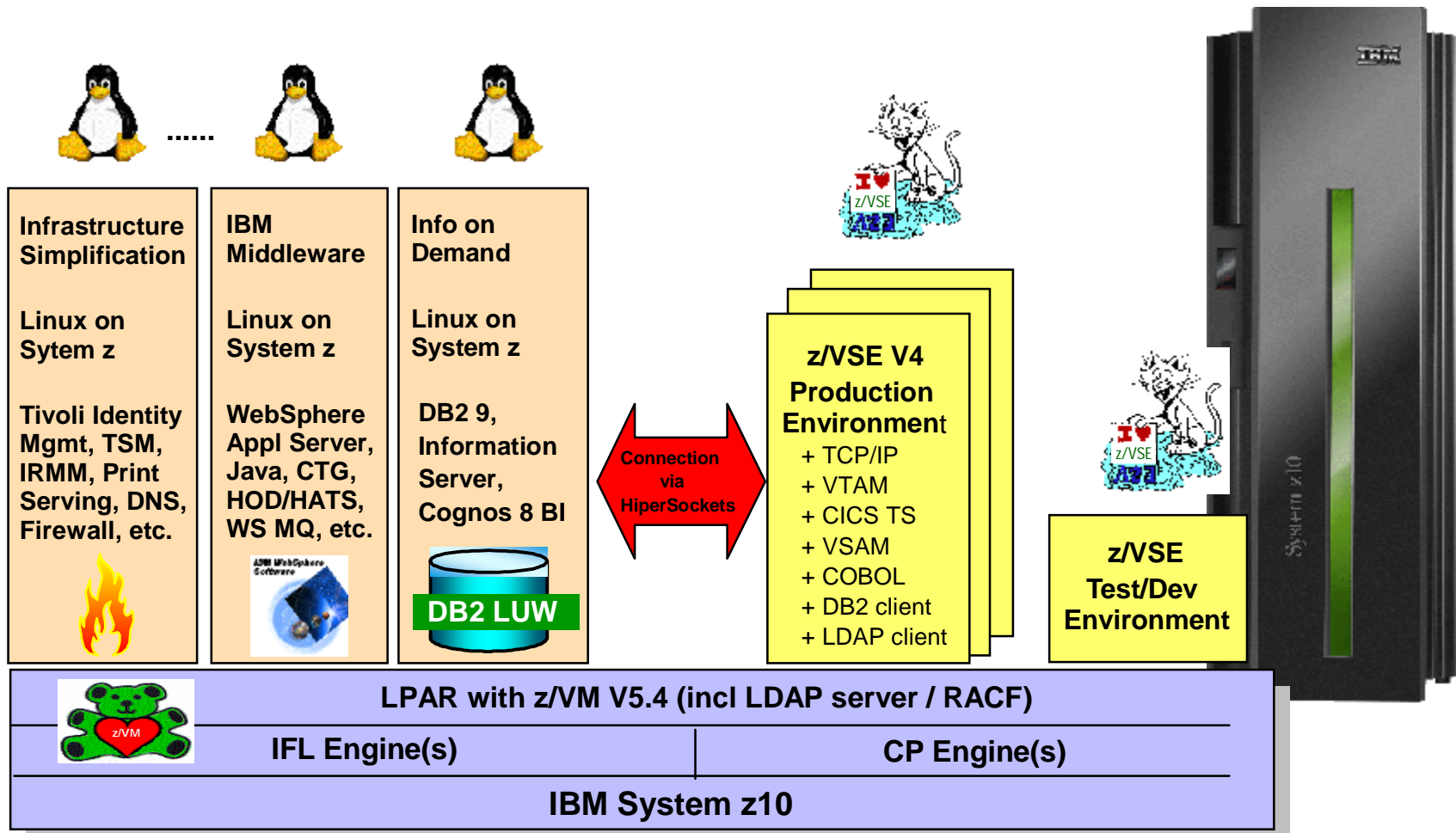

z/VSE Reference Customers

- **Wessels & Müller, Germany**
 - z9 BC, z/VSE V4, IFL, DB2 UDB
- **Häfele, Germany**
 - z9 BC, z/VSE V4, ESS
- **Bau Rechenzentrum, Germany**
 - z9 BC, z/VSE V4, DS6000
- **WM Gruppe, Germany**
 - z9 EC, z/VSE V4, DB2, DL/1
- **Hypo Real Estate Systems, Germany**
 - z9 BC, z/VSE V4, DS8000, TSM
- **Peter Hahn, Germany**
 - z9 BC, z/VSE V4, IFL, DB2, SVC
- **Scheidt & Bachmann, Germany**
 - z9 BC, z/VSE V4, DS6000, IFL
- **Rheinland Versicherung, Germany**
 - z9 BC, z/VSE V4, IFL, DB2, Oracle
- **Edeka Rhein-Ruhr, Germany**
 - z9 BC, z/VSE V4, IFL, DB2 UDB
- **Brunata, Germany**
 - z9 BC, z/VSE V4, IFL, DB2 UDB
- **Supreme Court of Virginia, USA**
 - 2x z10 BC, z/VSEV4, 10x IFL, WAS, DB2 UDB
- **American Stock Transfer & Trust, USA**
 - z9 BC, z/VSE V4, DB2 UDB
- **Calkins Media, USA**
 - z10 BC, z/VSE V4, ESS, HATS
- **Alabama Judicial Datacenter, USA**
 - z9 BC, z/VSE V4
- **Olio Carli, Italy**
 - z10 BC, z/VSE V4, IFL, RHEL, DB2 UDB
- **GE Money Bank, Switzerland**
 - z890, z/VSE V4, AFP, Macro4
- **Pulsen, Sweden**
 - z10 BC, z/VSE V4, 2x IFL, DB2 UDB
- **Securex, Belgium**
 - z9 EC, z/VSE V4, 2x IFL, DB2 UDB, BEA Weblogic, WebSphere MQ
- **Alcad, Slovenia**
 - z9 BC, z/VSE V4, IFL, DB2 UDB, SOA, RAD, WDz, WAS, WS Process Server

Supreme Court of Virginia

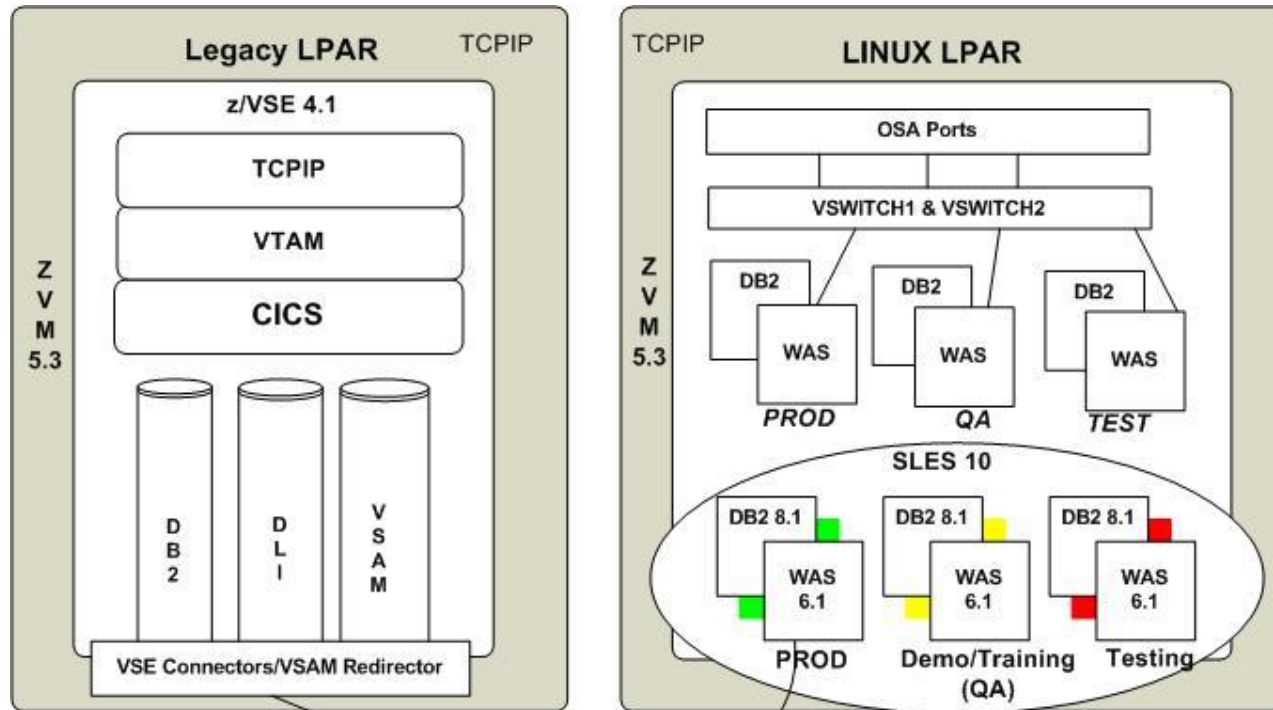

- ▶ 1 + 1 z10 BC
- ▶ 2 + 2 CPs
- ▶ 5 + 5 IFLs
- ▶ 48 + 32 GB memory
- ▶ 2 + 2 z/VM V5 LPARs
- ▶ 7 + 4 z/VSE V4 guests
- ▶ 41 + 14 SLES 10 guests

§ z10 BC for Court System (internal)

- ▶ Serves 325 courts, 5.000+ users, 4 million cases (2007)
- ▶ Integrating z/VSE, DB2/UDB and WebSphere applications
- ▶ eMagistrate* system serves 125 locations, 2.800 trans per day

**2007 ComputerWorld Honors Program Laureate*

§ z10 BC for Internet

- ▶ eCommerce application integrating z/VSE and WebSphere apps



Wessels+Müller AG

Improves application response times and cuts operating costs with an IBM System z mainframe

Business challenge:

Wessels+Müller had migrated many of its key business systems to an IBM zSeries® 890 mainframe. And, while it was pleased with the platform, it found that the IBM hardware was unable to keep pace with the company's growing processing demands. With the system operating at 80 percent just to handle day-to-day operations, the business was concerned about peak processing periods when high volumes of data need to be analyzed.

Solution:

Working with IBM Business Partner Becom, Wessels+Müller migrated its business systems to an IBM System z9® Business Class mainframe. The IBM hardware, leveraging the IBM z/VSE™ operating platform, supports multiple Linux® virtual machines that host the client's online parts ordering and information management systems as well as an IBM DB2® data server containing part information.

Benefits:

- § Improved application speeds and reduced response times—even during peak processing periods
- § Increased staff productivity with a more responsive environment
- § Reduced operating costs by simplifying the infrastructure

“This System z mainframe has reaffirmed our confidence in IBM’s hardware. Not only does the server offer more power but more control over the environment as well.”

— Wessels+Müller AG

Solution components:

- § IBM System z9 Business Class (BC) mainframe
- § IBM DB2 data server



Alcad / Impol

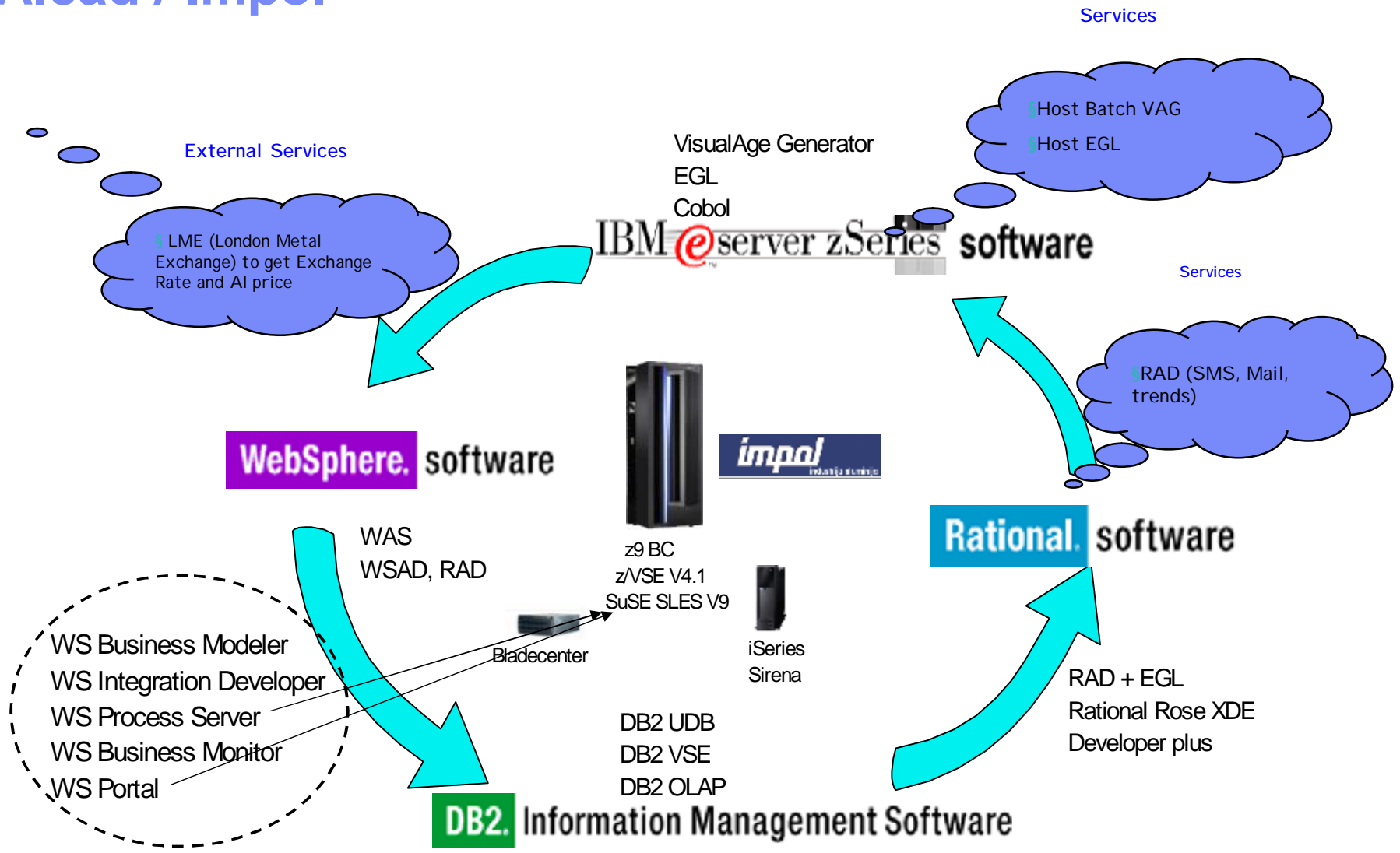

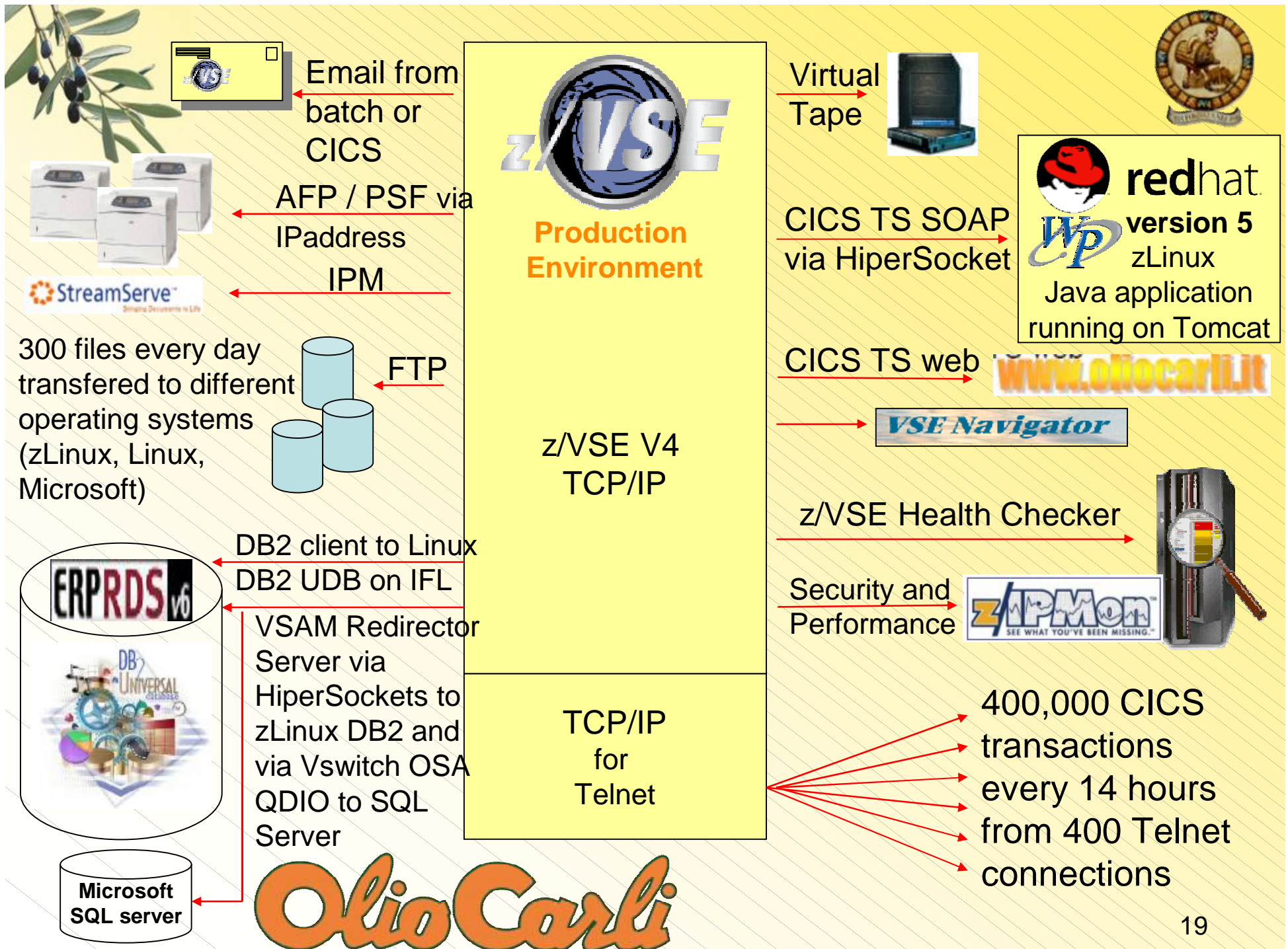

400,000 CICS transactions every 14 hours from 400 Telnet connections

Top Concerns of VSE* Customers

1. Applications



2. Cost



3. Skills



4. Future



(*) The term "VSE" stands for both, VSE/ESA and z/VSE.

MWLC – Midrange Workload License Charge

Price for typical z/VSE stack

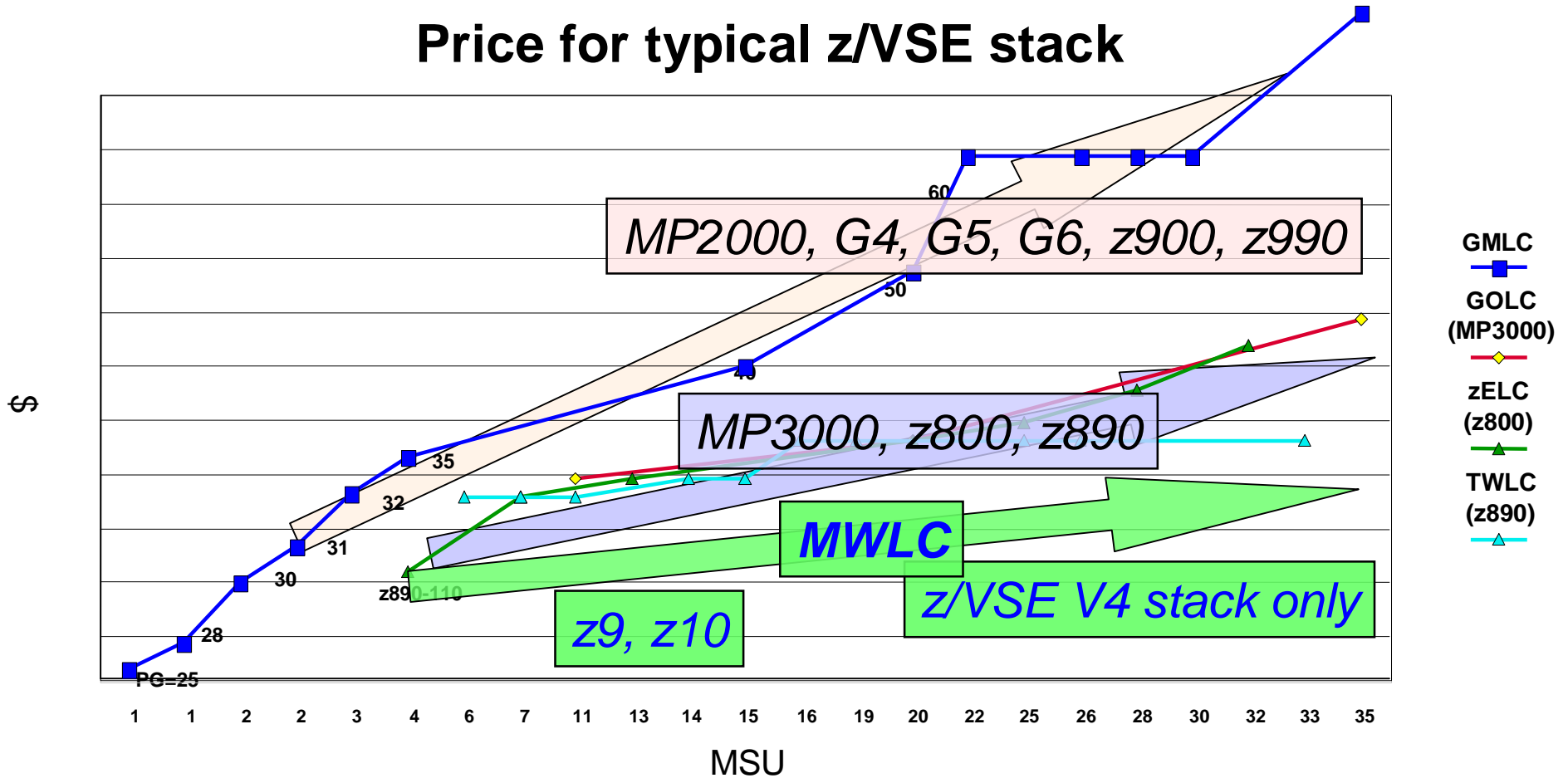

§ “I just got our April software bill from IBM for the first month on our z9 under z/VSE 4.1 and MWLC. We were paying \$22,965 per month on our z800 under z/VSE 3.1.2. The April bill is for the same software and it is \$12,318: a difference of \$10,647 per month.”
Mike Moore, IT Manager, Alabama Judicial Datacenter, Alabama

Improved TCO through new Pricing Metric and Sub-Capacity Pricing with z/VSE V4

§ z/VSE price/performance through new pricing metric

- ▶ Midrange Workload License Charge (MWLC)
- ▶ MWLC requires current HW (z9* or z10*) and z/VSE V4

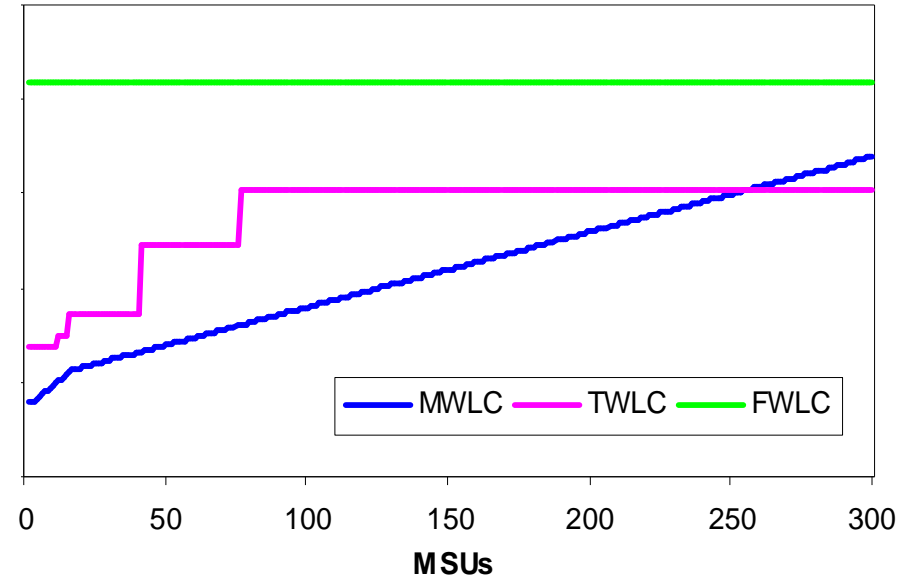

§ Additional price/performance through sub-capacity option

- ▶ Some hardware footprint **consolidations** more attractive now
- ▶ Presence of z/VSE V3 or VSE/ESA™ forces full-capacity pricing

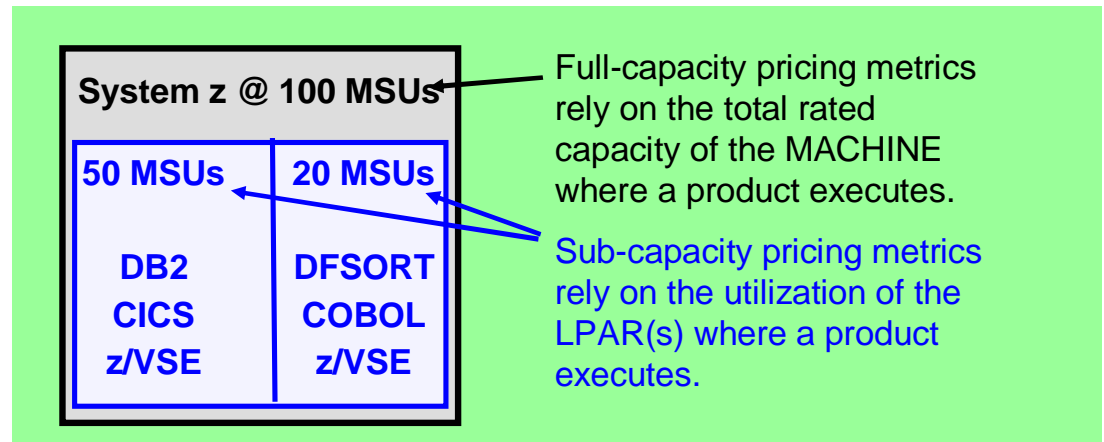

* z9 BC A01 and z10 BC A01 are priced zELC, not MWLC.

Sub Capacity Reporting Tool: Sample Report

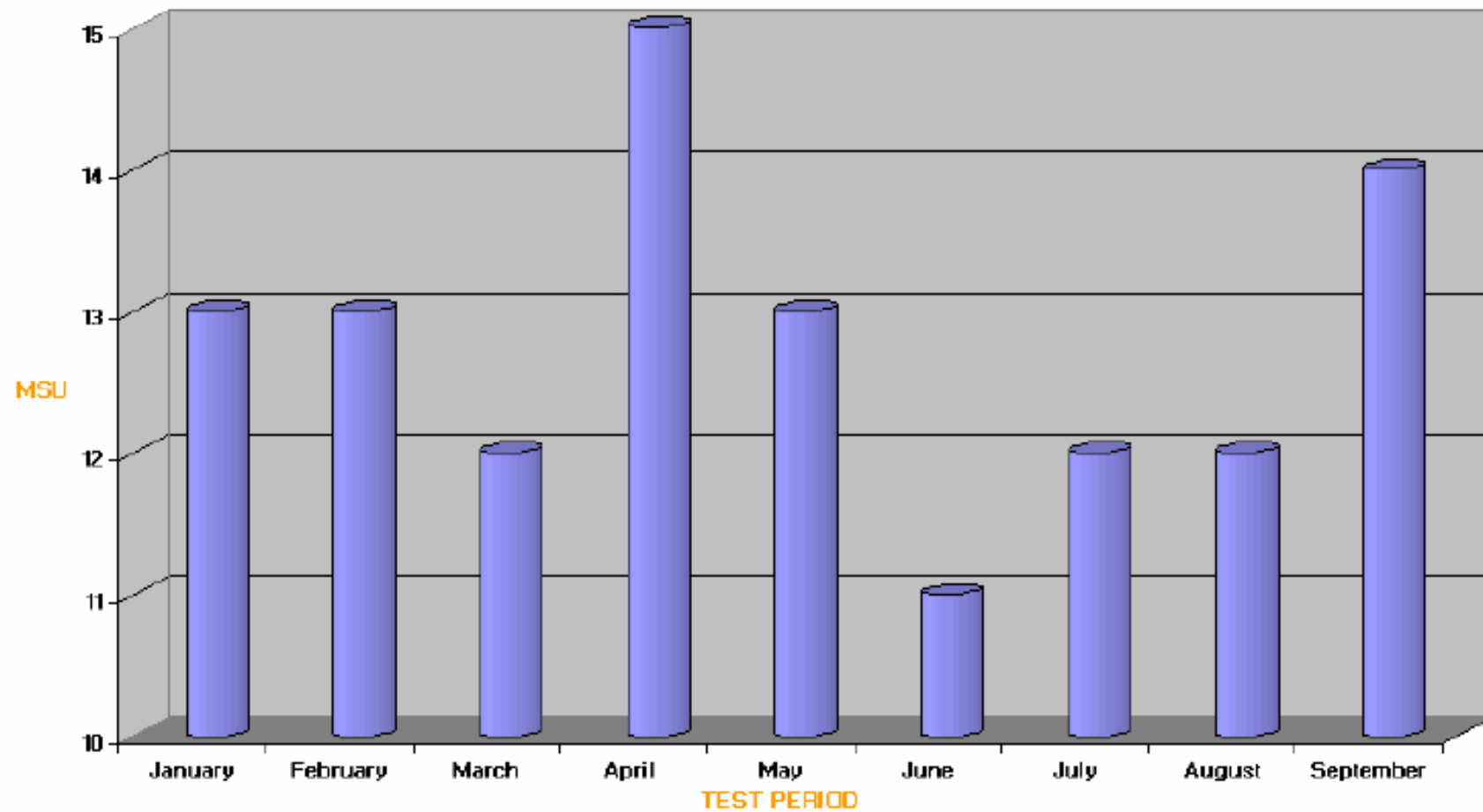

Press on z/VSE Cost Savings VSE users receive an offer they can't refuse

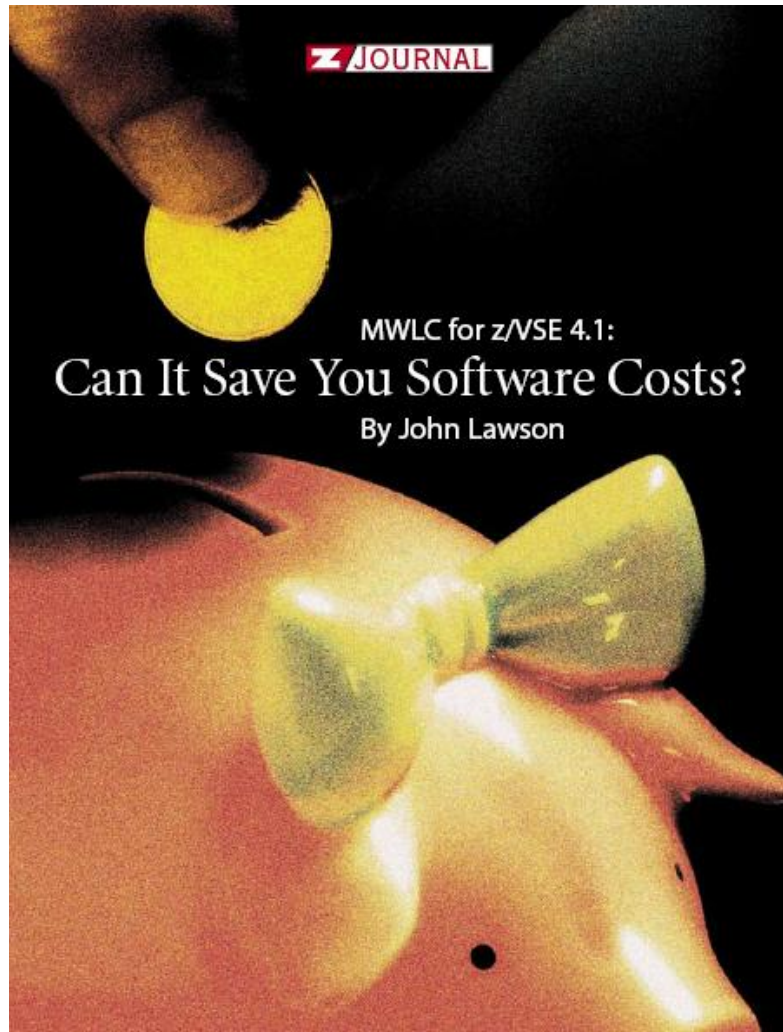

Source: z/Journal, April / May 2007

Most of the activity in the IBM mainframe world not surprisingly focuses on the z/OS environment, but there is still a sizeable population of users running systems based on VSE, often in conjunction with the VM hypervisor.

Many of these sites are slow growers with limited in house technical skills and a reluctance to upgrade their hardware or software even in exchange for significant cost savings. As a result their relationship with IBM (and with other ISVs supporting their applications) is a difficult one.

In its recent announcement of z/VSE 4.1, IBM has shown some of the 'carrot and stick' tactics that often characterize its product developments in this part of the market.

The latest version of the operating system offers many attractions for small mainframe users, including some important enhancements to SOA/web service support and tape encryption. Moreover the software is accompanied by a new pricing scheme (Midrange Workload License Charge), which can bring sub capacity benefits and very significant savings to VSE users. But to get the savings they need to upgrade to a z9 BC or EC.

Even for VSE users, it is becoming increasingly difficult to make a cost case for avoiding an upgrade to the latest hardware, and the months ahead are likely to witness a steady stream of VSE-base upgrades to the z9 BC.

© Arcati Limited, 2007 Source: The Arcati Mainframe Yearbook 2007 33

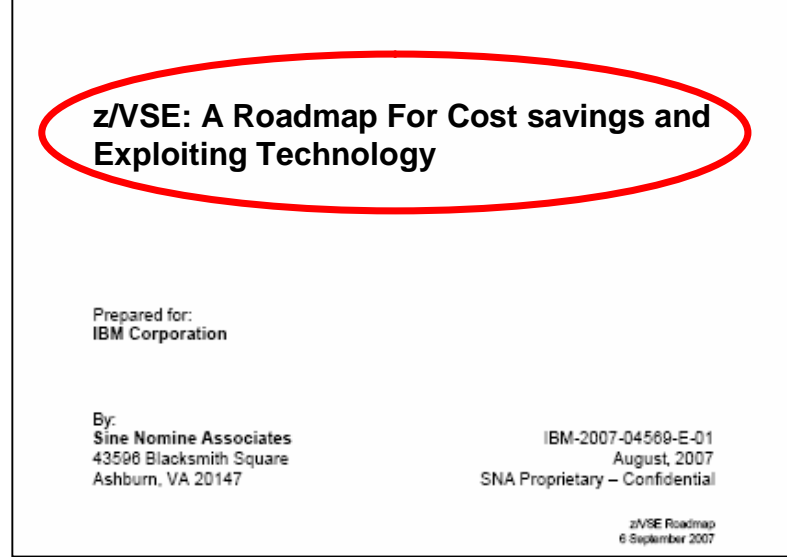

Source: Sine Nomine Associates, August 2007

MWLC is driving z9/z10 Adoption with z/VSE V4

z9/z10 CECs with z/VSE V4

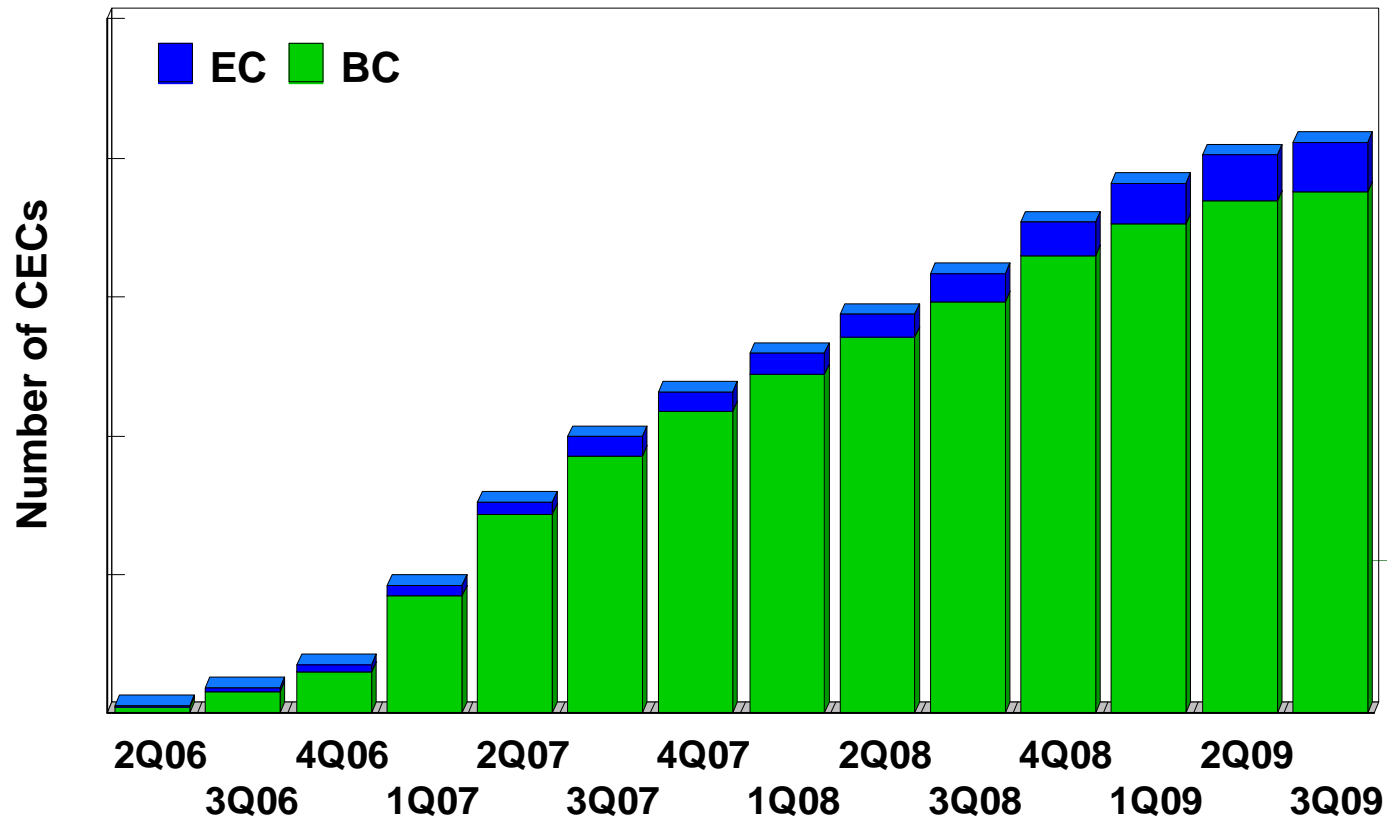

Top Concerns of VSE* Customers

1. Applications

2. Cost



3. Skills



4. Future



(*) The term "VSE" stands for both, VSE/ESA and z/VSE.

Building Mainframe Skills for the Community

Growing Academic Initiative

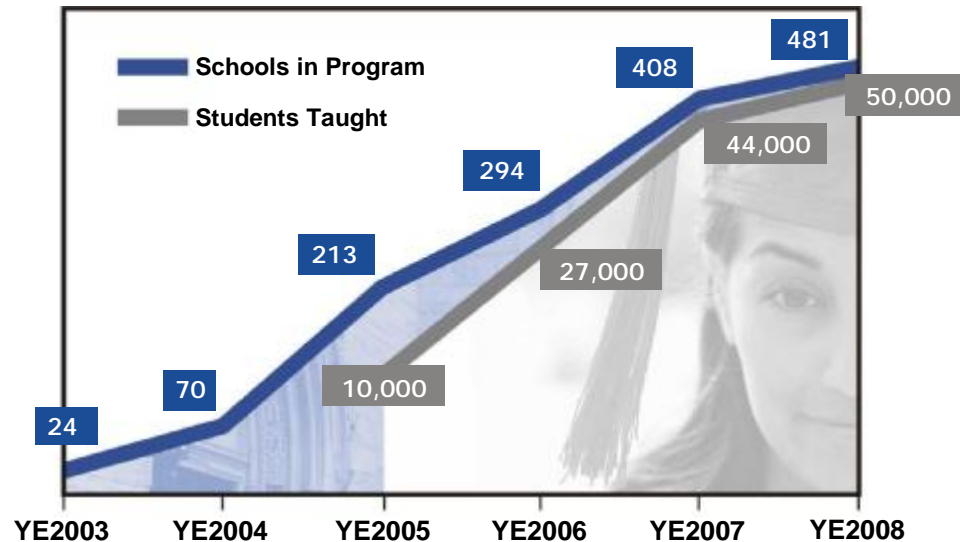

§ IBM Academic Initiative System z by the numbers:

- ▶ Web site: www.ibm.com/university/systemz
- ▶ Participation – 481 schools registered, 50,000 students attended mainframe education
- ▶ Courses – 29+ Courses (plus more under development) & Mastery Exam Certification
- ▶ Resources – Access to Mainframes worldwide for teaching (6 Univ hubs)
- ▶ Student MF Contests – 10 contests with 8,630 students, 1,167 schools...more planned
- ▶ Assist Professors – Seminars, Faculty awards, education coupons
- ▶ zCommunity – Roundtable events with Clients / Schools / ISVs / Business Partners
- ▶ IBM zSkills (zskills@us.ibm.com) + over 300 IBM Mainframe ambassadors
- ▶ Collateral / WW Analyst & Press events / Corporate PR Campaign

... including courses on z/VM, Linux on System z and z/VSE

Professors are starting to get it

Enterprise Systems and Large Systems Thinking

“The U.S. Department of Labor is predicting that the US will need 1.5 million more computing professionals in this decade,” **Professor Haiduk** said.

“With the support of IBM’s z Academic Initiative, we can actively prepare students to be better qualified for all of the promising and exciting jobs we see in today’s computing professions, particularly pertaining to large-scale systems.”



IBM Customers are starting to see results

Charlotte-based Bank of America Corp., for example, **works with three universities offering the System z program and "leverages the program's student base in its recruiting efforts,** says B.J. Smith, vice president of engineering and operations management.

"It addresses the increasing risk to the industry of the aging workforce and the potential loss of intellectual capital within our technology groups," Smith says

"The program is essentially, developing the next generation of mainframe technicians".



Examples – For a complete list of schools world wide teaching mainframes, see: ibm.com/university/systemz

Illinois State University (US)
Enterprise Computing
Major



University of Arkansas (US)
Into Linux on z
Enterprise Transaction Sys
University HUB

Oslo University (Sweden)
4 years running Enterprise
Mainframe Courses



Stevens Institute (US)
Undergraduate and
Graduate Programs

Marist College (US)
On-Demand with Enterprise
Systems Certificate program



Tongji University (China)
Mainframe Concentration
Partnerships with Banks



University
of Southampton



**Republic Polytechnic
(Singapore)**

Enterprise Computing
Learning Center
Teaches mainframe classes

Southampton University (UK)
Partner with IBM Customers and
Teaches System z Course

West Texas A&M
Undergraduate CS
Mainframe Concentration

z/VSE and z/VM Beginner's Education

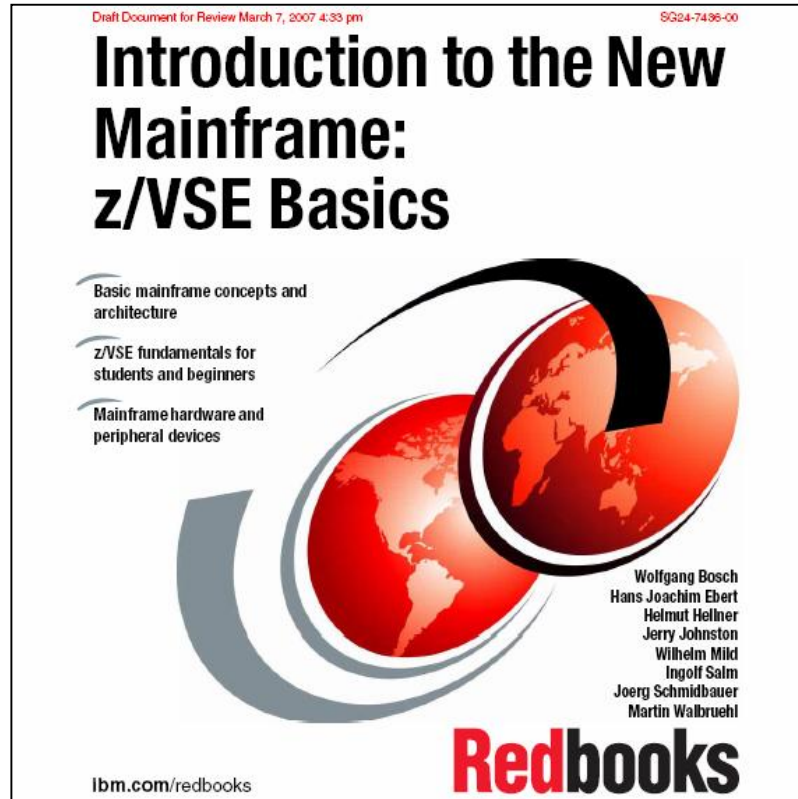

SG24-7436-00

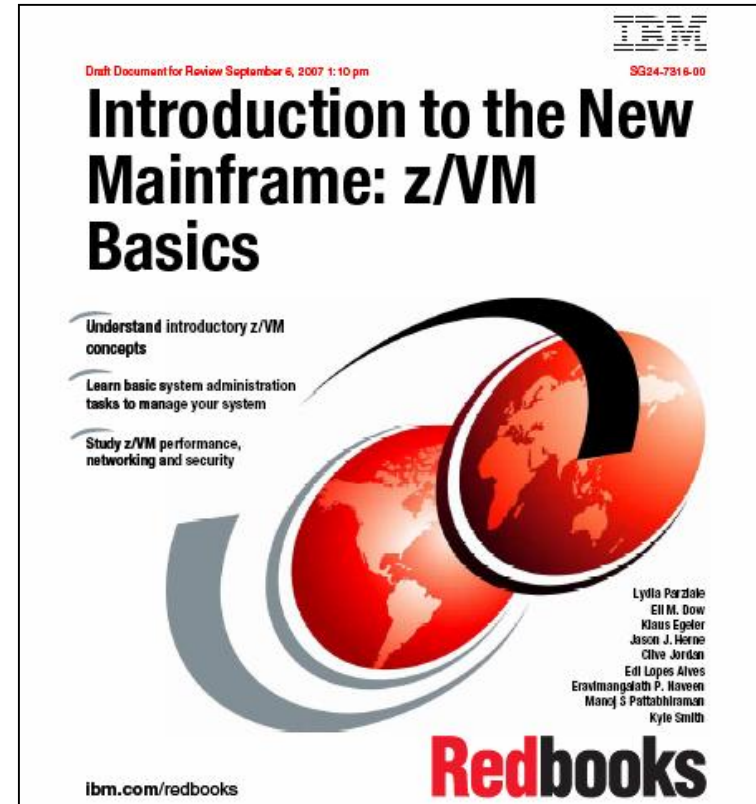

SG24-7316-00

www.redbooks.ibm.com

Enhance Skills with IBM Red Books



SG24-7691-00

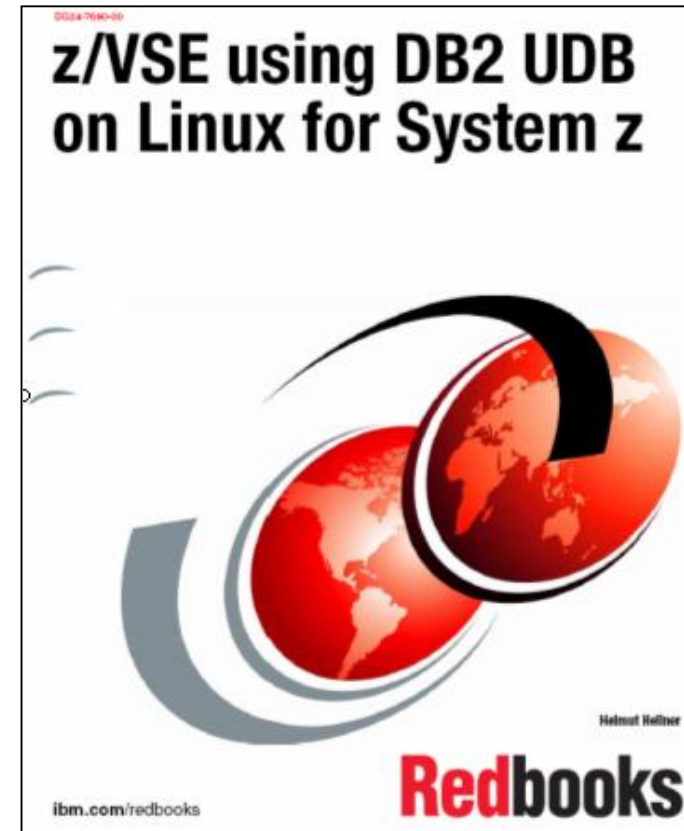

SG24-7690-00
planned for 2010

www.redbooks.ibm.com

z/VSE Navigator: Windows-like VSE Interface

File Edit Selected Configuration Functions Help

KEY	FIRMA	TEXT	PLZ
TST010	<-----NEW RECORD	10-----	----
00001	Stinnes-Data-Service GmbH	3	45472
00003	GUILLEAUME-WERK GmbH	5	53229
00004	Zuger Kantonalbank	2	6301
00009	Württembergische Bau BG	4	71032
00013	A.V.U.S. GmbH	3	80339
00014	prego services GmbH	4	66121
00015	Flora Frey GmbH	3	42653
00018	E.ON AG	5	40479
00020	ZF Getriebe GmbH	4	66117
00027	Brunata Wärmemesser GmbH & Co	3	81379
00030	Stadlbauer GesmbH & Co.KG	2	4600
00031	Markenverlag GmbH	4	50968
00037	EnBW Ostwürttemb. DonauRies AG	3	73479
00039	Ravensburger AG	4	88214
00044	SCHNEIDER electronics GmbH		86842
00050	Franz Wiltmann GmbH & Co.KG	5	33775
00051	D M W Datenservice GmbH	4	81377
00053	BG-PHOENICS GmbH	5	80335
00058	Bremer Tageszeitungen AG	3	28195
00060	Steigenberger Rechenzentrum	1	60528
00062	STI	5	36341
00064	Ludwig Schokolade GmbH & Co.KG	5	51469
00066	Motorenfabrik Hatz		94099
00067	Stadtverwaltung Pirmasens	2	66953
00079	Stadtwerke Saarbrücken AG	3	66117
00082	Heidelberger Medien Gestaltung	4	69117

153 row(s) received

CPGQWK

0 view(s) loaded 8 data fields in map

Refresh
Rename
Add ...

z/VSE Live Virtual Class

- § z/VSE V4 and MWLC Announcement Overview
- § Midrange Workload License Charges (MWLC)
- § z/VSE V4.1 Solutions based on SOA and DB2
- § z/VSE Security
- § z/VSE V4.1 User Experience
- § IBM System z Hardware
- § New VSAM Tools
- § Bringing You up to Date with z/VSE V4
- § z/VSE Wellness
- § Encryption Facility for z/VSE
- § DB2 for z/VM and z/VSE V7.5
- § Modern Application Development for z/VSE
- § Live Demo of WebSphere Developer for System z
- § z/VSE V4.2
- § z10 BC for VSE customers
- § Using the new LDAP client in z/VSE
- § WebSphere MQ for z/VSE V3 Exploitation & Solutions
- § VSAM Enhancements in z/VSE V4.2
- § z/VSE Update

- § + more planned ...

- § typically set for Wednesday or Thursday, 11:00 am – Noon EST



Note: Charts are available on the z/VSE web site the day following each call. Replay available approximately one week later. For more information, please see the z/VSE web site at:

<http://www-03.ibm.com/servers/eserver/zseries/zvse/>

z/VSE and z/VM-Linux Customer Conferences in 2009

§ GSE in Dortmund (Germany), April 27-29, 2009



§ IBM System z TC in Brussels (Belgium), May 4-8, 2009



§ WAVV in Orlando (Florida), May 15-19, 2009

§ IBM System z EXPO in Orlando (Florida), Oct 5-9, 2009



§ IBM Server Systems TC in Mannheim (Germany), Oct 19-23, 2009



§ GSE European Working Group in Dresden (Germany), Oct 26-28, 2009



Top Concerns of VSE* Customers

1. Applications

2. Cost



3. Skills



→ 4. Future



(*) The term "VSE" stands for both, VSE/ESA and z/VSE.



Press on z/VSE Future



- HOME
- NEWS
- MARKETS
- MY PORTFOLIO
- TECHNOLOGY
- JOBS
- PERSONAL FINANCE
- LUXU

<http://money.cnn.com/news/newsfeeds/articles/marketwire/0317343.htm>

IBM Continues the Evolution of Its z/VSE Mainframe Operating System

October 19, 2007: 08:01 AM EST



IBM (NYSE: IBM) today announced that the z/VSE mainframe operating system is being updated to help address customer needs for scalability, security and integration. z/VSE V4.2 is designed to support growing mainframe applications and drive stronger investment protection.

"Many customers are beginning to put new Linux applications on the same IBM System z9 mainframe that also runs their production z/VSE applications. This integrated approach is designed to offer the best of Linux, the robust data serving capabilities of z/VSE, and the potential for low total cost of ownership of the System z9 mainframe," said Dr. Klaus Goebel, Development Executive Project Manager and z/VSE PDT Leader. "IBM's powerful mainframe virtualization system, z/VM, is fundamental to these integrated environments. It helps customers get the most from their Linux and z/VSE applications, integrate their business, and support business growth."

Previewed at a special international meeting of the GUIDE SHARE EUROPE (GSE) mainframe user group earlier this week, z/VSE enhancements include a range of new features, especially important to modern applications, such as on-line commerce. Capabilities include:

-- More z/VSE tasks and more real storage designed to improve scalability

- | | |
|---------------------|-----------------------------|
| and many more, e.g. | § Wall Street Journal |
| § yahoo.com | § news.moneycentral.msn.com |
| § pressebox.de | § marketwatch.com |
| § verivox.de | § businessweek.com |
| § boerse-go.de | § smartmoney.com, etc. etc. |

The screenshot shows the top of the New York Times website with the 'Research' section selected. The article title is 'IBM Continues the Evolution of Its z/VSE Mainframe Operating System'. Below the title, there is a MarketWatch logo and a 'GET QUOTE' button. The article text begins with 'IBM (NYSE: IBM) today announced that the z/VSE mainframe operating system is being updated...'. To the right of the article, there are advertisements for Emirates and Arkeia Software. At the bottom of the screenshot, there is a 'COMPUTERWOCHE.de' banner and a 'PREMIUM-Login' form.

z/VSE Evolution and z/VSE Success Factors

**End of Service
effective since
July 31, 2009**

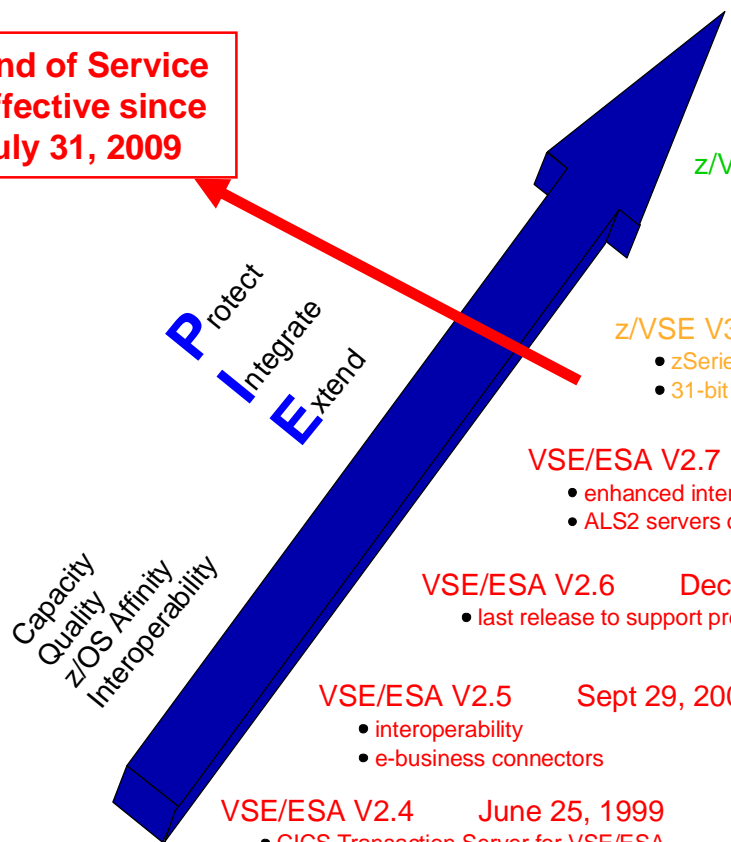

z/VSE V4.2.1 July 17, 2009

- Delivering on SoD
- Additional enhancements

Future

z/VSE V4.2 Oct 17, 2008

- More tasks, more memory, LDAP client
- PAV, SVC, EF, SCRT on z/VSE
- SoD** for CICS/VSE, RBD V7 extension, WMQ V3

z/VSE V4.1 March 16, 2007

- z/Architecture only
- 64-bit real addressing
- MWLC full & subcapacity pricing

Pricing

z/VSE V3.1* March 4, 2005

- zSeries features, FCP/SCSI
- 31-bit mode only

Rebranding

VSE/ESA V2.7 March 14, 2003

- enhanced interoperability
- ALS2 servers only

VSE/ESA V2.6 Dec 14, 2001

- last release to support pre-G5 servers

VSE/ESA V2.5 Sept 29, 2000

- interoperability
- e-business connectors

Strategy

VSE/ESA V2.4 June 25, 1999

- CICS Transaction Server for VSE/ESA
- e-business

• Note: z/VSE V3 can operate in 31-bit mode only. It does not implement z/Architecture and specifically does not implement 64-bit mode capabilities. z/VSE V3 is designed to support selected features of IBM System z hardware.

** All statements regarding IBM's plans, directions, and intent are subject to change or withdrawal without notice.

z/VSE V4.2 and z/VSE V4.2.1 Contents



§ Servers

- ▶ IBM System z10 Enterprise Class (z10 EC) and z10 Business Class (z10 BC)
- ▶ IBM System z9 Enterprise Class (z9 EC) and z9 Business Class (z9 BC)
- ▶ IBM eServer zSeries 990, 890, 900, and 800

§ Scalability

- ▶ Up to 512 tasks (2x z/VSE V4.1)
- ▶ Up to 32 GB real processor storage (4x z/VSE V4.1)
- ▶ Turbo dispatcher enhancements (CP balancing)
- ▶ Parallel Access Volume (PAV) feature of IBM System Storage DS8000 and DS6000 series
- ▶ IBM System Storage DS8000 Space Efficient Flashcopy

§ Security

- ▶ Lightweight Directory Access Protocol (LDAP) sign-on support using a z/VSE LDAP client
- ▶ IBM System z10 extensions to CP Assist for Cryptographic Function (CPACF)
- ▶ SOA Message Layer and Transport layer security
- ▶ IBM System Storage TS1130 and TS1120 're-keying' function
- ▶ Basic Security Manager (BSM) improvements
- ▶ Encryption Facility for z/VSE V1.2 as an optional priced feature supporting OpenPGP format

z/VSE V4.2 and z/VSE V4.2.1 Contents ...



§ Enhanced storage options

- ▶ IBM System Storage SAN Volume Controller (SVC) access to FCP-attached SCSI disks
- ▶ IBM System Storage TS3400 Tape Library
- ▶ IBM System Storage TS1130 Tape Drive
- ▶ DS8000 Full Disc Encryption
- ▶ IBM Virtualization Engine TS7700 Release 1.5
 - including support for IBM System Storage TS7720 Virtual Tape System

§ Interoperability

- ▶ IBM Rational COBOL Runtime for z/VSE V7.5
- ▶ IBM WebSphere MQ for z/VSE V3.0

§ Pricing

- ▶ MWLC (full- or sub-capacity options) eligible on z10 EC, z10 BC, z9 EC, and z9 BC
- ▶ 'Traditional' price metrics for other servers

§ Migration

- ▶ Fast Service Upgrade (FSU) from z/VSE V4.1 and z/VSE V3.1

§ Virtualization

- ▶ Requires z/VM V5.2 or later if running under z/VM



z/VSE V4.2 Statement of Direction (SoD)*



§ Delivering on the SoD:

- ▶ New Enterprise Generation Language (EGL) extension to Rational Business Developer
- ▶ New version of WebSphere MQ for z/VSE



§ Reemphasizing the SoD:

- ▶ z/VSE V4.2 will be the last release to offer CICS/VSE V2.3
 - CICS/VSE V2.3 and DL/I V1.10 will not be included in any future version or release of z/VSE

§ For planning purposes:

- ▶ Expect any future version or release of z/VSE not sooner than second half of 2010

* All statements regarding IBM's plans, directions, and intent are subject to change or withdrawal without notice.

z/VSE Evolution

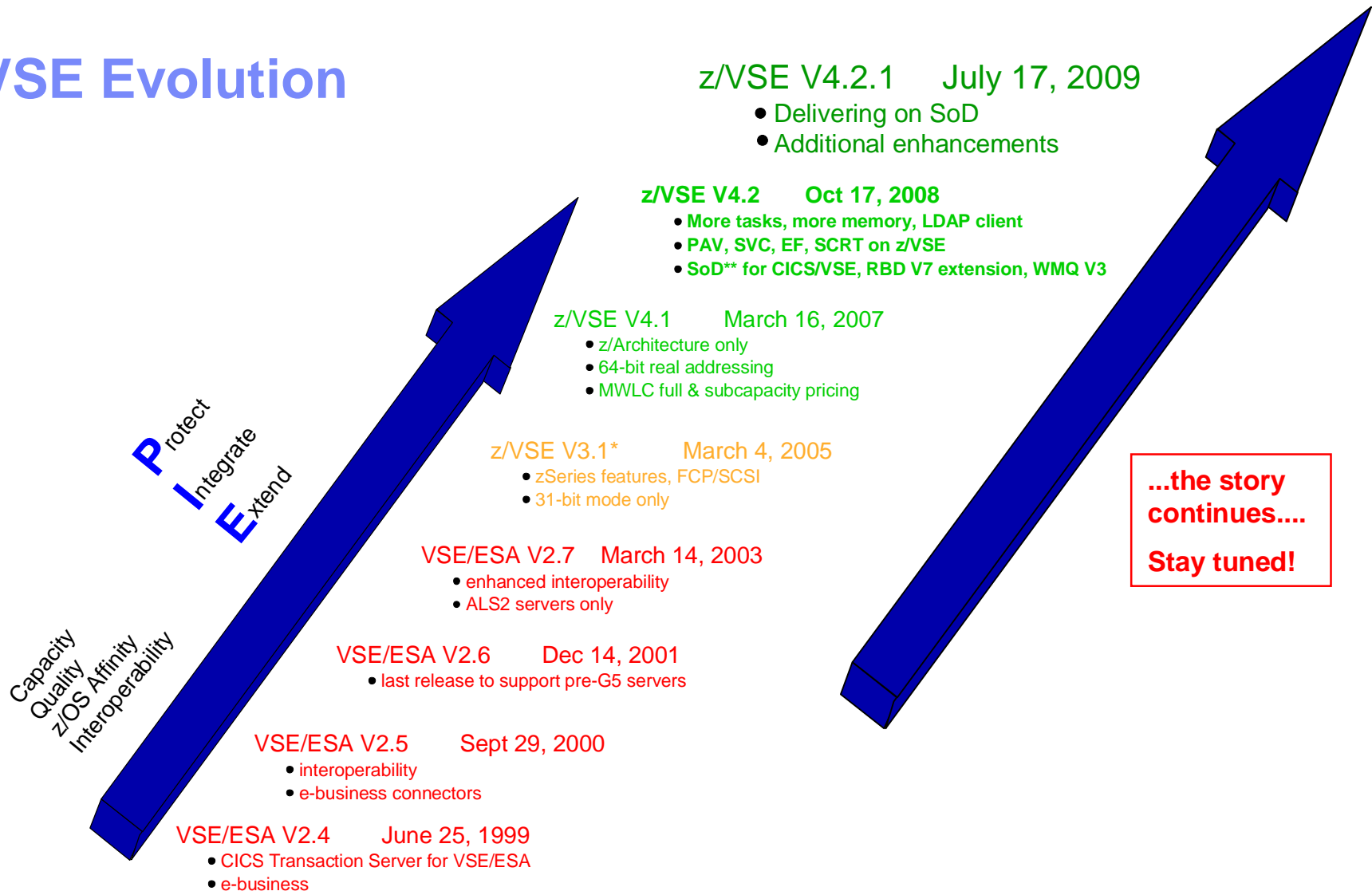

• Note: z/VSE V3 can operate in 31-bit mode only. It does not implement z/Architecture and specifically does not implement 64-bit mode capabilities. z/VSE V3 is designed to support selected features of IBM System z hardware.

** All statements regarding IBM's plans, directions, and intent are subject to change or withdrawal without notice.

IBM System z10 can do IT all - Smart, Cool, Affordable

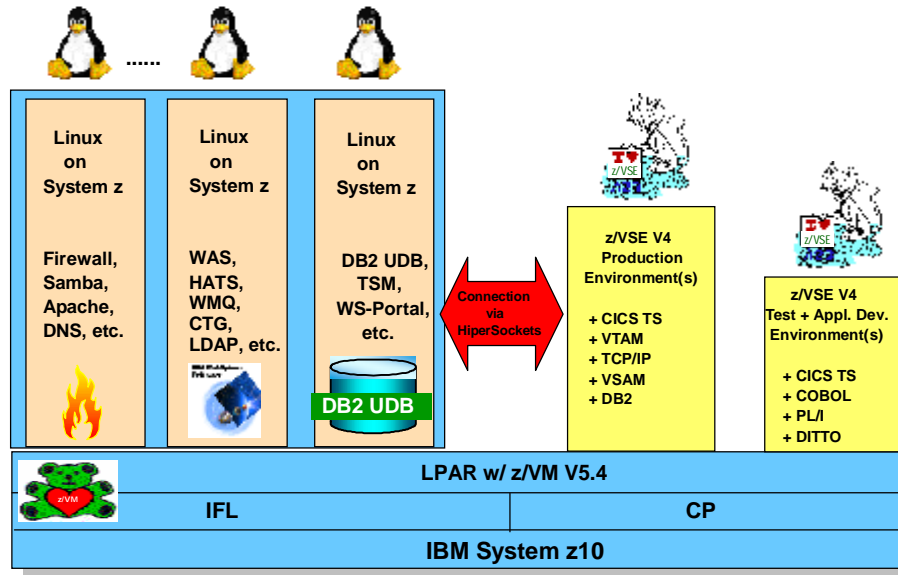

§ z/VSE V4

- ▶ Protect core IT investments thru PIE
- ▶ Robust, secure enterprise server
- ▶ Cost-effective solutions
- ▶ Interoperability with network / servers
- ▶ Highly improved price / performance

§ z/VM V5

- ▶ Highly flexible, industrial strength
- ▶ Advanced virtualization
- ▶ Multiple z/VSE and Linux images
- ▶ Designed to exploit System z9 and z10

§ Linux on System z

- ▶ Large portfolio of new applications
- ▶ Platform for IBM middleware
- ▶ Infrastructure Simplification
- ▶ Massive scalability and consolidation



One more time: The Difference between Perception ...

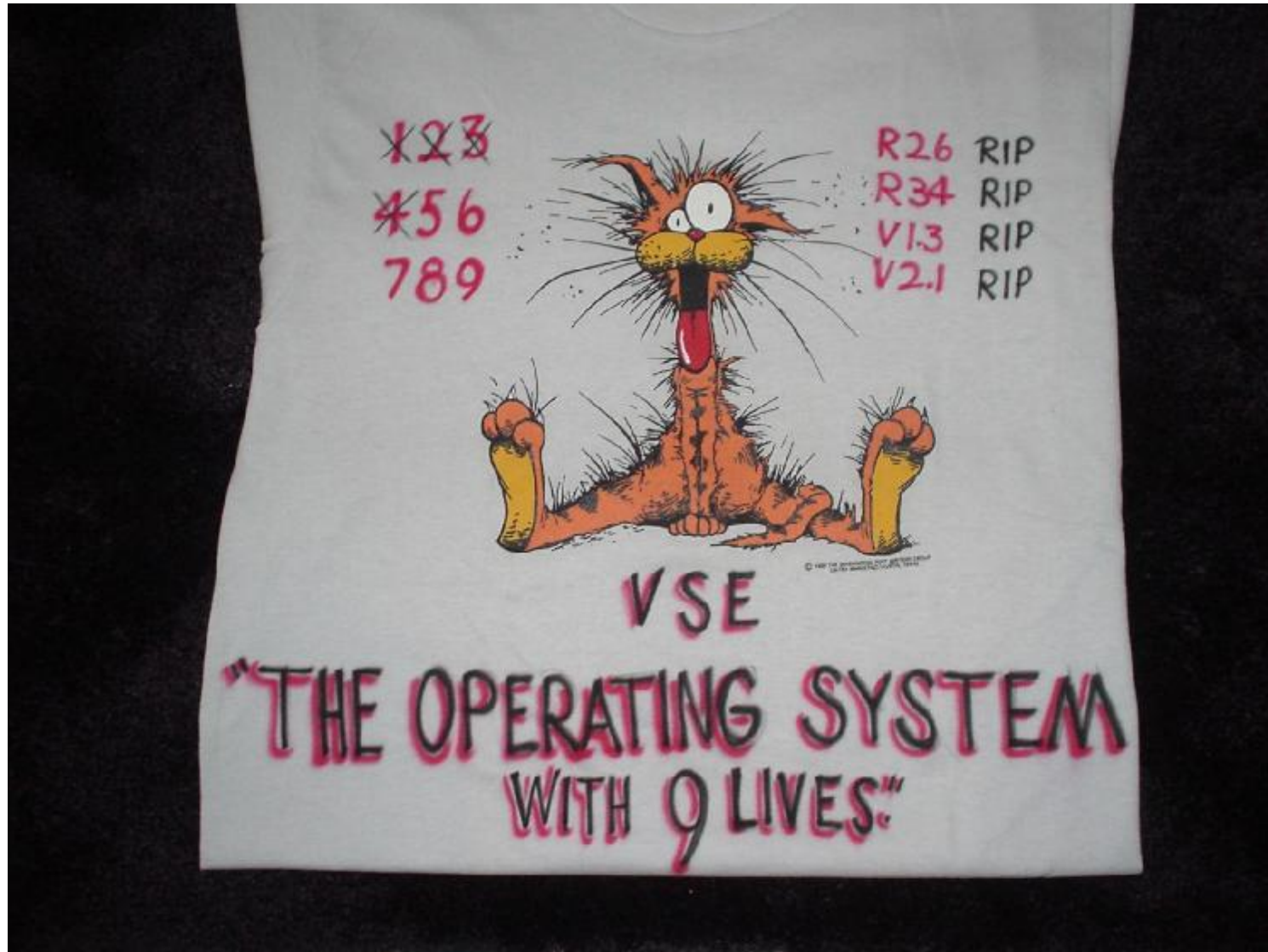

.... and Reality



Survived the 25th anniversary, celebrated the 45th birthday

Offers very modern functionality, e.g. SOA, XML, SCSI, SVC, XIV, PAV, LDAP, EF, SSL

... and lots more - to be announced in the **NEAR** future !

Preparing for the Half Century Anniversary Party in 2015 !

For more information, please see the z/VSE web site:
<http://www-03.ibm.com/servers/eserver/zseries/zvse/>

IBM: z/VSE Operating System - Mozilla Firefox: IBM Edition

File Edit View History Bookmarks Tools Help

http://www-03.ibm.com/servers/eserver/zseries/zvse/

United States [change]

IBM Search

Home Solutions Services Products Support & downloads My IBM

Welcome Mr. Gerald Johnston [Not you?] [IBM Sign in]

IBM Systems > Servers > Mainframe servers >

z/VSE

About VSE

How to buy

News & announcements

Events

Solutions

Products & components

Documentation

Service & support

Downloads

Education

Partners

FAQ

Contact VSE

Related links

- Linux on IBM System z
- z/OS
- z/VM
- IBM Storage

z/VSE

z/VSE is designed to help provide robust, cost-effective solutions for customers with a wide range of capacity needs, in most industries, worldwide. z/VSE is built on a heritage of ongoing refinement and innovation that spans four decades. It brings the value of innovative IBM System z and IBM System Storage technology to VSE clients.

Learn more

- [About VSE](#)
- [News](#)
- [History of VSE](#)

We're here to help

Easy ways to get the answers you need.

E-mail us

Mark your calendar

IBM Systemz Expo:
October 13-17, 2008
Las Vegas, NV, USA

→ [Register now](#)

Attention System z Infoprint software users

→ [Get information on development and support of System z Infoprint software products.](#)

Announcing

Announcing z/VSE V4.2

Built on a heritage of ongoing refinement and innovation that spans four decades

z/VSE V4.2 Availability Announced

z/VSE Version 4 Release 2 (z/VSE V4.2) is the latest in the ongoing evolution of z/VSE. z/VSE V4.2 continues the z/VSE focus on scalability, security, interoperability, and service-oriented architecture. It is designed to help protect and leverage existing investments in VSE information assets.

z/VSE V4.2 supports IBM System z servers:

- IBM System z10 Enterprise Class (z10 EC)
- IBM System z9 EC and z9 Business Class (z9 BC)
- IBM eServer zSeries 990, 890, 900, and 800

z/VSE V4.2 is designed to support:

- Scalability enhancements
 - Up to 512 VSE tasks (two times the 255 limit in z/VSE V4.1)

Done

start 73.3°:Dallas AT&T Net... 2 IBM L... Microsoft ... IBM: z/VS... IBM Lotus... 100% 73° 09:24 AM