

# VSE Connectors Workshop

## E12 - Setup of VSAM Redirector on Windows

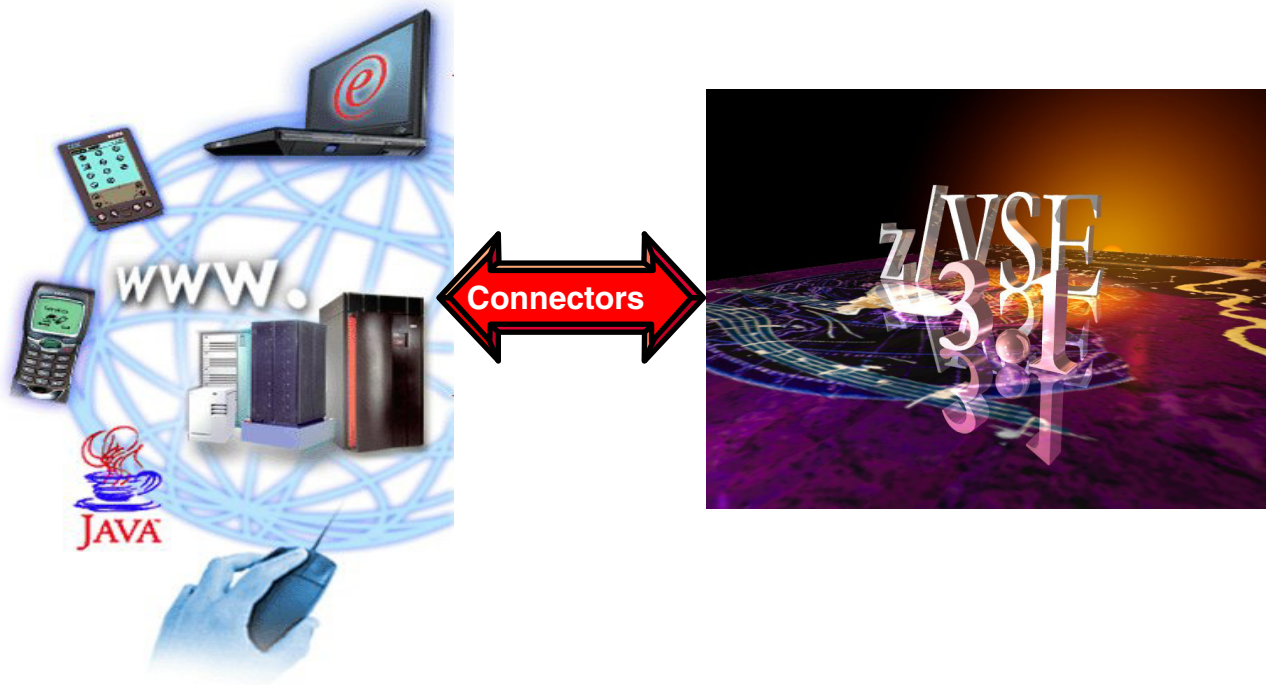

Wilhelm Mild  
Ingo Franzki  
zVSE@de.ibm.com

## Trademarks

References in this publication to IBM products or services do not imply that IBM intends to make them available in every country in which IBM operates. Consult your local IBM business contact for information on the products, features, and services available in your area.

AIX\*, APPN\*, CICS\*, CICS/VSE\*, CICS, DB2\*, DB2 Connect, DB2 Universal Database, DFSORT, DRDA\*, e-business logo\*, Enterprise Storage Server, FlashCopy, HiperSockets, IBM\*, IBM logo\*, IBM eServer, iSeries, Language Environment\*, MQSeries\*, Multiprise\*, pSeries, S/390\*, S/390 Parallel Enterprise Server, TotalStorage, VSE/ESA, z/VSE, VTAM\*, WebSphere\*, xSeries, z/OS, z/VM, zSeries and Distributed Relational Database Architecture are trademarks or registered trademarks of International Business Machines Corporation in the United States, other countries, or both.

Linux is a registered trademark of Linus Torvalds.

SUN, Java and all Java-related trademarks and logos are trademarks or registered trademark of Sun Microsystems, Inc.

UNIX is a registered trademark in the United States and other countries, licensed exclusively through The Open Group.

Microsoft, Windows, Windows NT, Visual Basic and the Windows flat logo are Trademarks of Microsoft Corporation.

Other trademarks and registered trademarks are the properties of their respective companies.

IBM hardware products are manufactured from new parts, or new and used parts. Regardless, our warranty terms apply. This equipment is subject to all applicable FCC rules and will comply with them upon delivery.

Information concerning non-IBM products was obtained from the suppliers of those products. Questions concerning those products should be directed to those suppliers.

All statements regarding IBM's future direction and intent are subject to change or withdrawal without notice, and represent goals and objectives only.

# VSE/ESA 2.6/2.7

## VSAM Redirector

The VSAM Redirector is a newer VSE connector, introduced with VSE/ESA 2.6. The VSAM Redirector allows you to redirect all requests issued against a certain VSAM file into any other file system or database on any other (Java-enabled) platform. VSE is the client, while the server part runs on any other Java-enabled platform like Windows or Linux on zSeries.

Furthermore the VSAM redirector has a VSE Vendor Exit to allow additional VSE operations (i.e. cleansing, checks) for a VSAM request.

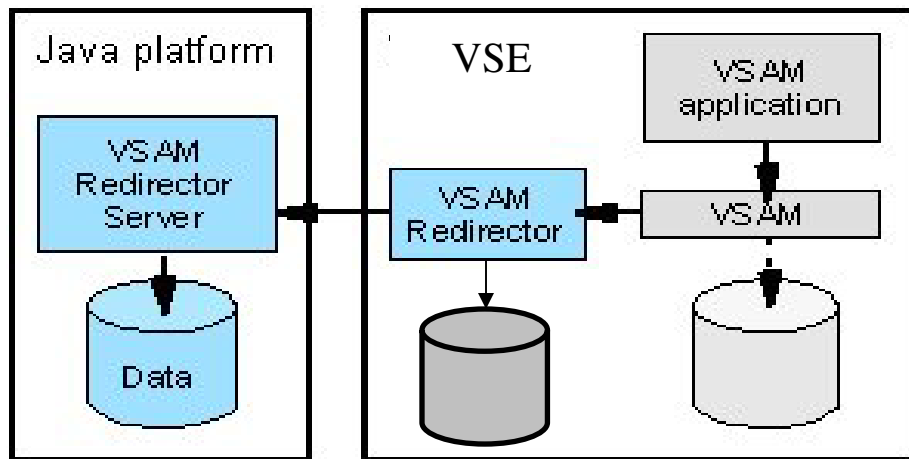

For example you could use the VSAM Redirector to synchronize a VSAM file with a DB2 database running on a Windows or Linux on S/390 or zSeries. By using the VSAM Redirector your existing VSAM programs doesn't require any revisions.

The VSAM Redirector makes use of a so called VSAM Data Access Exit (VDA). This exit intercepts all VSAM requests. The exit gets control at OPEN, CLOSE, and for all data requests (GET, PUT, INSERT,...).

A configuration table is used to define which VSAM files are being "redirected". The VSAM Redirector Client on VSE forwards all requests against a redirected file to the VSAM Redirector Server which then handles the request.

The VSAM Redirector Server is a Java application. It can run on any Java enabled platform.

# Setup a VSAM Redirector environment

Java platform  
(Windows )

VSE/ESA V2.6/2.7 or z/VSE

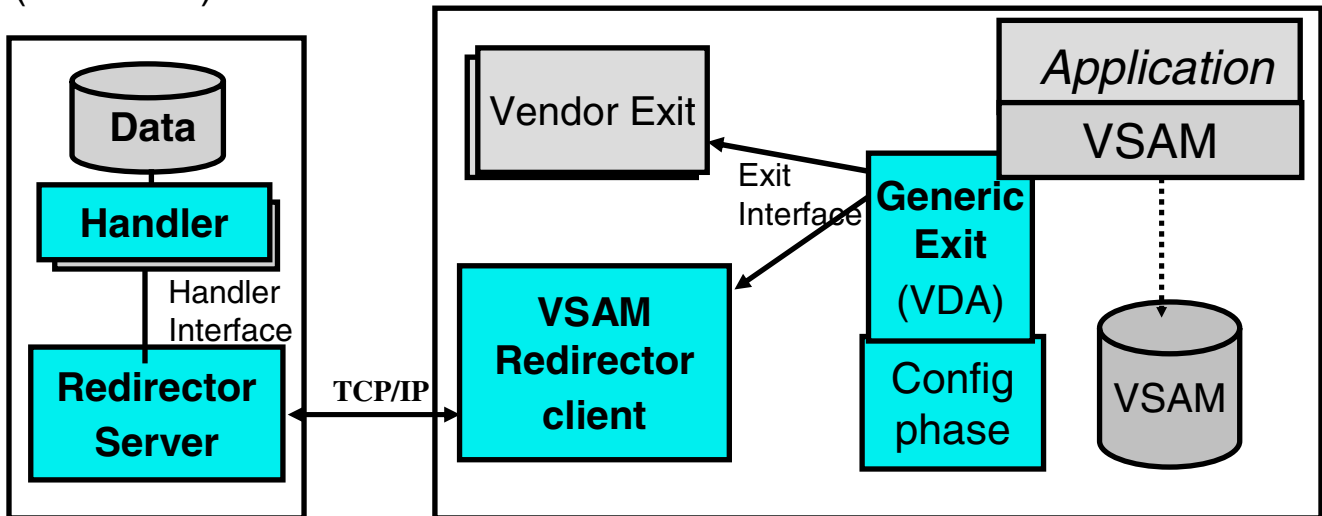

The setup for a VSAM Redirector environment:

On Windows

- Setup Redirector server
- Adjust the handler(s) for data manipulation

On VSE:

- choose the VSAM file(s) to be redirected
- define the options in the Configuration phase
  - define the type of redirection
    - local ( Vendor Exit)
    - remote (Redirector client )
  - for remote redirection choose
    - Synchronization
    - pure remote work (with NO VSAM access)

# Workshop Objective

## Redirect VSAM requests to a HTML page on Windows

### Initial state:

→ You have a VSAM file that contains data

**FLIGHT.ORDERING.ORDERS**

→ You have applications that work with that VSAM file  
(i.e. batch applications, CICS Application, tools like Ditto )

### Goal:

→ Redirect all VSAM INSERT requests to a HTML page on Windows

→ This operation can be done with existing applications (without changing/touching them)

**NOTE: The VSAM Redirector Server does NOT require the VSE Connector Client on Windows**

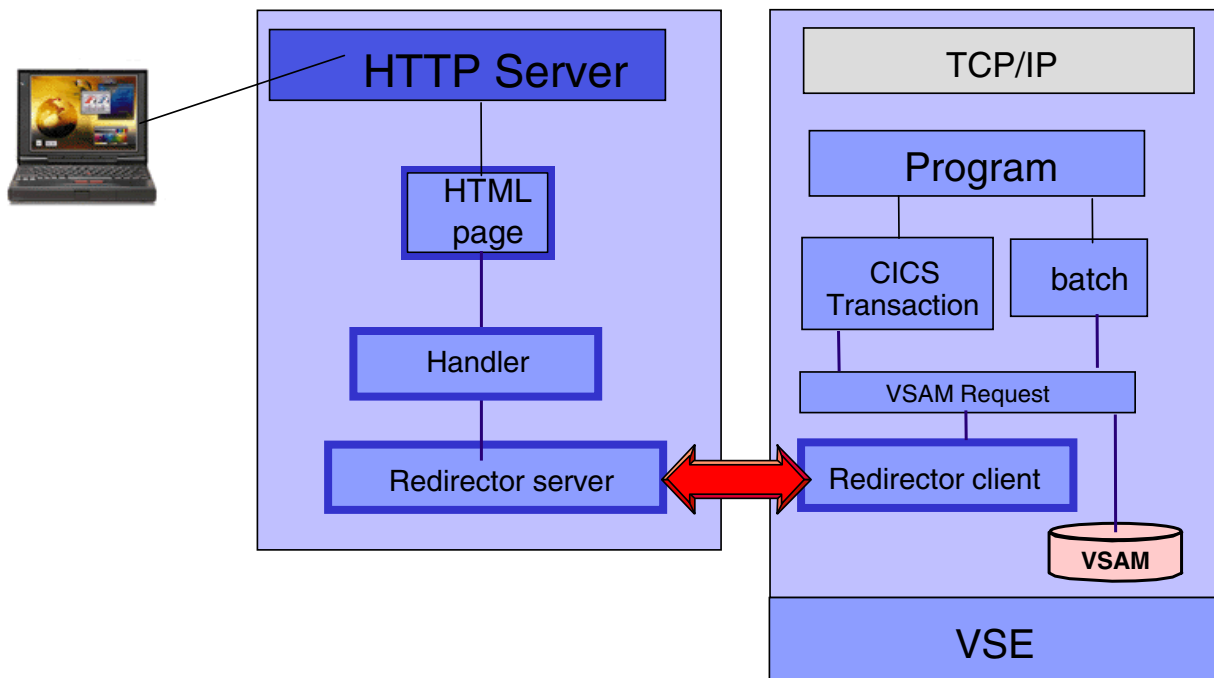

# Chapter 1. Software prerequisites for Windows

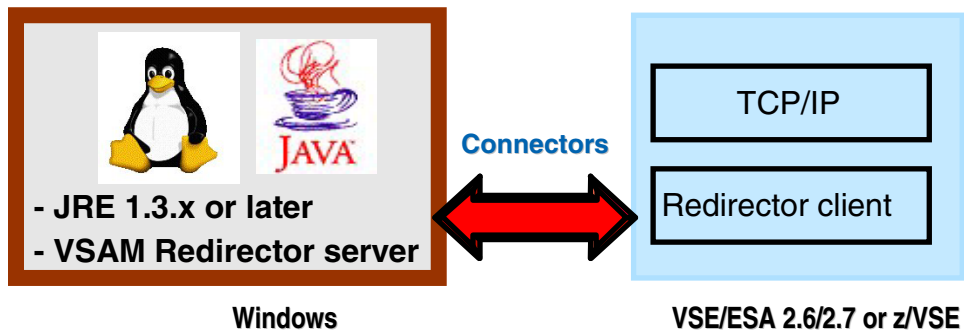

## STEP1.1: Verification if Java environment installed

To install the VSE Connector Client, a Java Virtual Machine (JVM) must be installed in Windows.

The JVM can be installed in different flavors.

- To just run Java programs, the JRE 1.3.x or later is needed (Java Runtime Environment),
- to develop/compile Java programs, JDK 1.3.x or higher is needed (Java Developer Kit, which includes the JRE).

To verify if a Java Virtual Machine is installed, open a Command prompt and enter command:

```
java -version
```

You should see something like:

```
Java version "1.4.2"  
Java(TM) 2 Runtime Environment, Standard Edition
```

If the messages above are shown go to Chapter 2.

## STEP1.2 Install a Java Environment

If following message (or similar) is shown:

```
java' is not recognized as an internal or external command,  
operable program or batch file.
```

then your system has no Java virtual machine (Runtime Environment) installed or it can not be found in the path.

To install a Java Virtual machine download the code from IBM:

<http://www.ibm.com/developerworks/java/>

or download a SUN Version from <http://www.sun.com>

Install the downloaded JDK 1.3.x. or later.

# Components in a VSAM Redirector environment

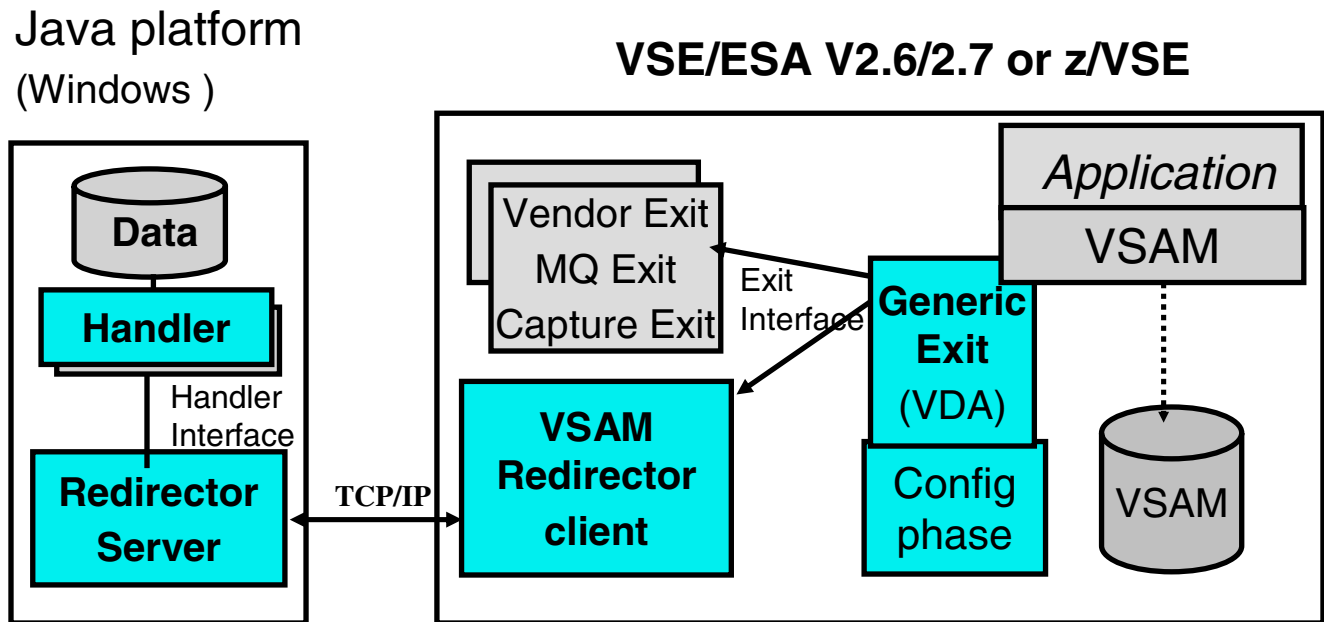

**The setup for a VSAM Redirector environment:**

**On Windows**

- **Setup Redirector server**
- **Adjust the handler(s) for data manipulation**

**On VSE:**

- **choose the VSAM files to be redirected**
- **define the options in the Configuration phase**
  - **Synchronization**
  - **pure remote access**

## Chapter 2. Setup Redirector Sever on Windows

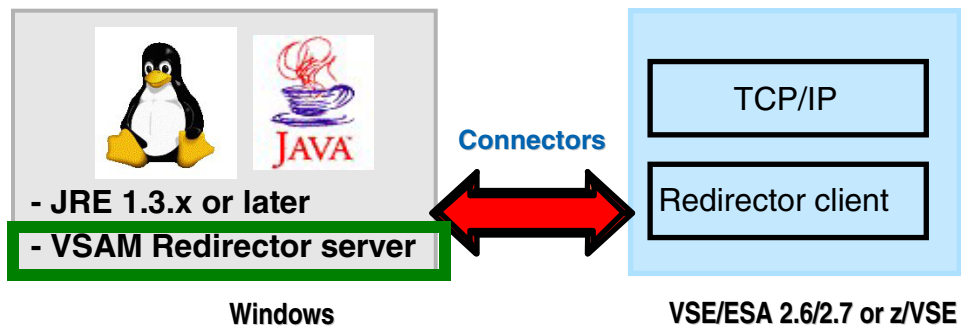

### Download of Redirector server code

The download of VSAM Redirector server for this workshop was already done from the VSE homepage.

The Steps are described in [Appendix A](#)

### STEP2.1: Install VSE Redirector Server

In a command prompt enter:

**C:**

**cd C:\vsamredir**

**install.bat**

This will guide you through the installation process of the VSAM Redirector Server.

*The VSAM Redirector Server consists of:*

- *the VSAM Redirector Server code*
- *a detailed HTML documentation about the functions and possibilities*
- *two sample handlers, one for relational database DB2 and one for HTML*
  - *The HTML handler allows, to collect data inserted into a VSAM cluster, on a HTML page on Windows*
  - *The DB2 handler allows the synchronization of a VSAM cluster with a remote DB2 database or to redirect all VSAM requests to DB2*
- *documentation how to develop own handlers.*

**NOTE:** The VSE Redirector Server does NOT require the VSE Connector Client or any other VSE Connector component



## STEP2.2: Verify Redirector Server Documentation

To verify that the VSAM Redirector Server is installed properly, open the HTML Documentation:

**START -> Programs -> VSAM Redirector -> Online Help**

The Main HTML page will be opened.

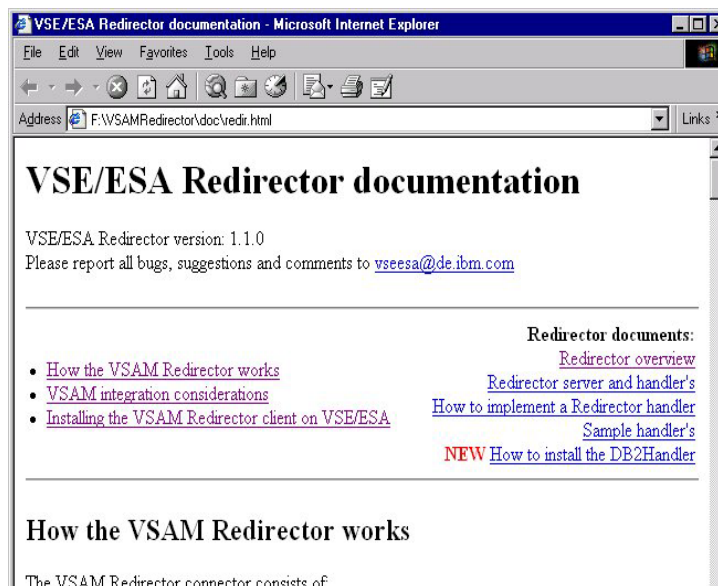

## STEP2.3: Operations with VSAM Redirector server

To start the VSAM Redirector Server, in a command prompt enter:

**C:**

***cd C:\vsamredir***

***run.bat***

• Commands for Redirector server:

**status** - shows the status of the server

**stop x / all** - stop client with number 'x' (show in status) or stop all clients

**quit** - stop all clients and exit server



In the HTML handler:

**C:\vsamredir\com\ibm\vse\htmlhandler\HtmlHandler.java**

the mapping for the VSAM record is hard coded.

The Record Layout of the **FLIGHT.ORDERING.ORDERES** cluster is defined as follows:

Offset	Length	Type	Key	Field Name	Description
0	20	STRING	no	FIRST_NAME	First Name
20	20	STRING	no	LAST_NAME	Last Name
40	4	UNSIGNED	no	FLIGHT_NUMBER	Flight Number
44	4	UNSIGNED	no	SEATS	Seats
48	1	BINARY	no	NON_SMOKE	Smoker 0=no

The **Record length** is **49 Bytes**

**The handler will be used as it is shipped in the VSAM redirector package available for free download on the VSE home page.**

**The handler is a program that can be modified and adapted to your private needs. Appendix C shows how to change the HtmlHandler.**



On the CICS logon screen enter:

User: **LLxx** (xx- is your team number 00 – 10)

Password: **linlabxx**

You are now in the **Interactive User Interface (IUI) of VSE.**

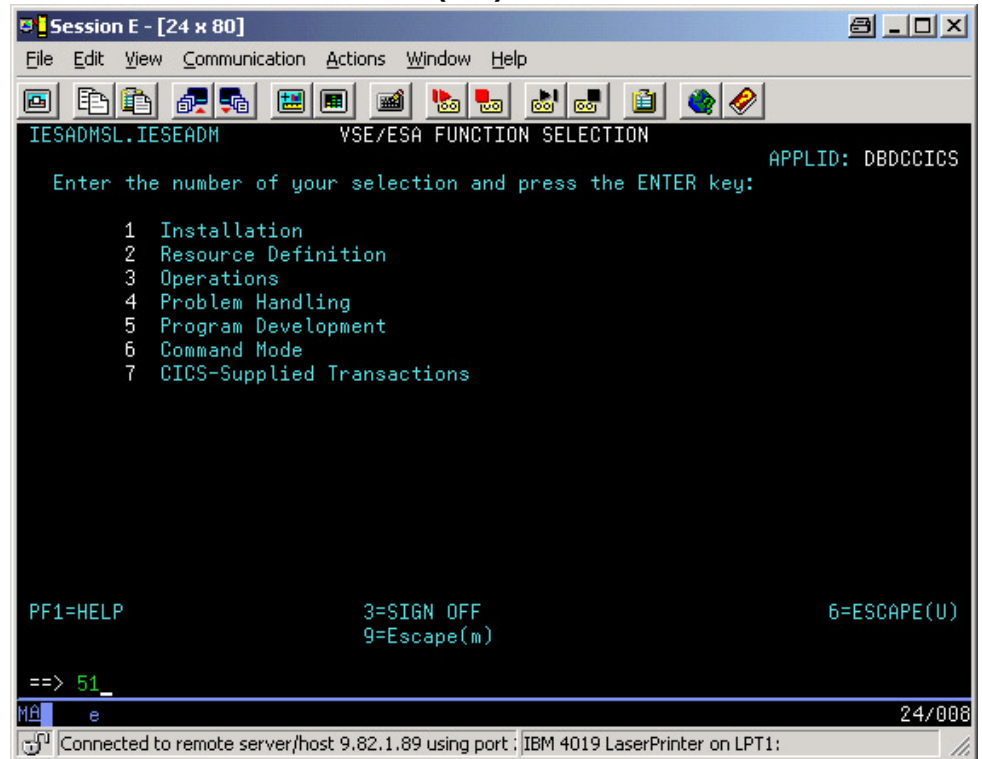

Enter: **51** (to go into your primary development library)

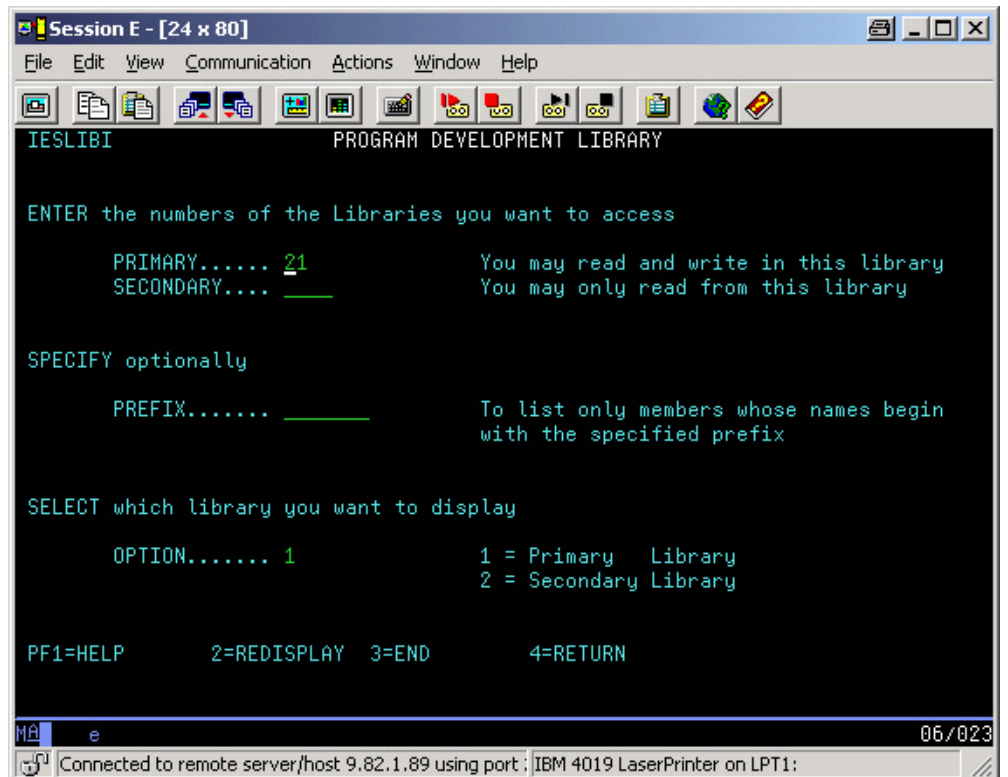

Hit the **<enter>** key to see the member in your primary library.

We have to setup the Configuration phase (**IESRDCFG.PHASE**).

In this phase we have to define which VSAM cluster should be redirected to which remote location, and optionally decide which requests.

For that a skeleton in ICCF Library 59 is shipped, called **SKRDCFG**  
**It was copied to your primary library.**

The definitions for the redirected file were extracted into member **RDCFGxx** where xx is your team ID

This was done to be able to build one phase with the settings from all attendees of this workshop.

We want to redirect the requests for the:

- VSAM cluster: **FLIGHT.ORDERING.ORDERS.TEAMxx**
- in VSAM catalog: **VSESP.USER.CATALOG**

Edit skeleton **RDCFGxx** and change the text in the configuration member.

Enter:

**1 <enter>** (in the left margin of **RDCFGxx**)

```
Session E - [24 x 80]
File Edit View Communication Actions Window Help
IESLIBP PRIMARY LIBRARY PAGE 1 of 1
PRIMARY (READ/WRITE): 21 PREFIX:
OPTIONS: 1 = EDIT 2 = CHANGE 3 = PRINT 4 = COPY 5 = DELETE
         6 = RENAME 7 = SUBMIT 8 = COMPILE 9 = DISPLAY
OPT MEMBER NAME NEW NAME NEW LIB LAST ACCESSED OWNER PASSW PRIVATE
1 RDCFG01 _____ 03/10/2004 MILD -
- SKRDCFG _____ 03/10/2004 MILD -
PF1=HELP 2=REFRESH 3=END 4=RETURN 6=ADD MEMBER
9=SORT.DATE 10=SORT.NAME 11=SORT.SIZE 12=LIST QUEUE
LOCATE MEMBER/LIST QUEUE PREFIX ==> _____ MEMBER PREFIX (PF2) ==> _____
MA e 10/022
Connected to remote server/host 9.82.1.89 using port ; IBM 4019 LaserPrinter on LPT1:
```

Enter **CASE M** in the command line to switch to mixed case mode before editing.  
 Change the text as shown below. Please keep track of the mixed case format.

```

IESRDENT CATALOG='VSESP.USER.CATALOG',           X
      CLUSTER='FLIGHT.ORDERING.ORDERS.TEAMxx',     X
      EXIT='IESREDIR',                             X
      OWNER=REDIRECTOR,                            X
      IP='x.x.x.x',                                 X
      HANDLER='com.ibm.vse.htmlhandler.HtmlHandler', X
      OPTIONS=' '
  
```

Replace x.x.x.x with the IP address of your PC. Enter **ipconfig** in a Windows command prompt to find out which IP address has been assigned to your PC.

The most important parameter is **OWNER**:

**OWNER=VSAM** means the READ requests will be done from the VSAM cluster and the INSERTS will be done to VSAM and to the remote site specified in IP. That means a synchronization takes place.

**OWNER=REDIRECTOR** means all requests are redirected to the remote site. The **HANDLER** parameter specifies the Java class that should be invoked for this VSAM cluster by the Redirector server on Windows.

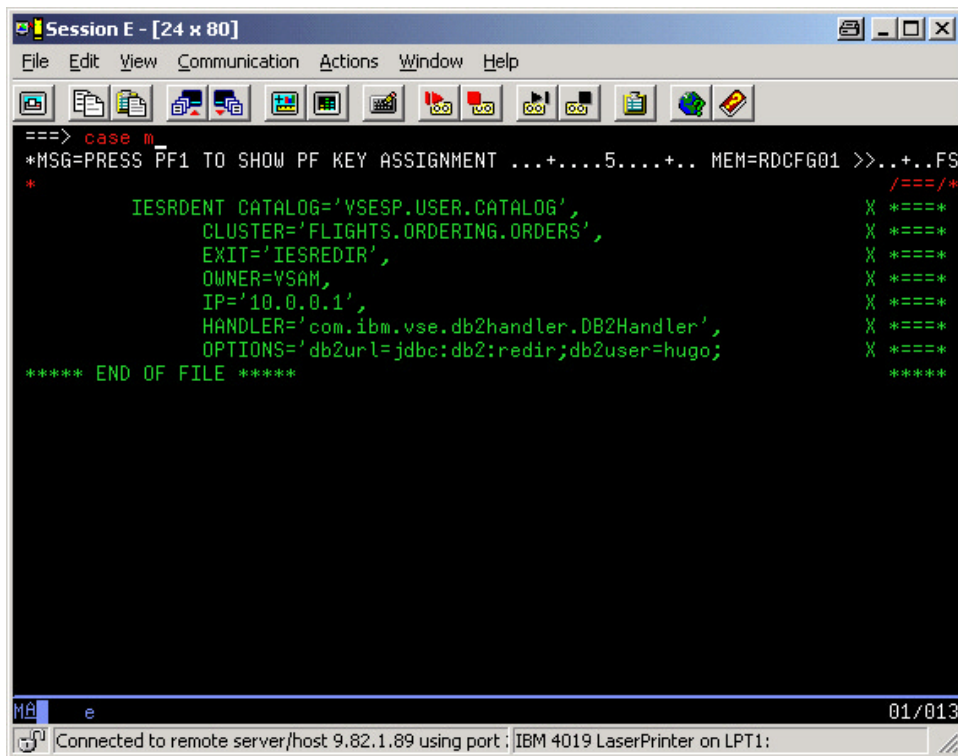

Save the changes, enter: **PF3**

In the Primary library were you changed the member **RDCFGxx** you have a skeleton to compile and check for errors for the settings done. Edit your skeleton **SKRDCFG**.  
Enter: **1 <CR>** if you want to edit it and look at it.  
Hit: **PF3** (to save and exit )

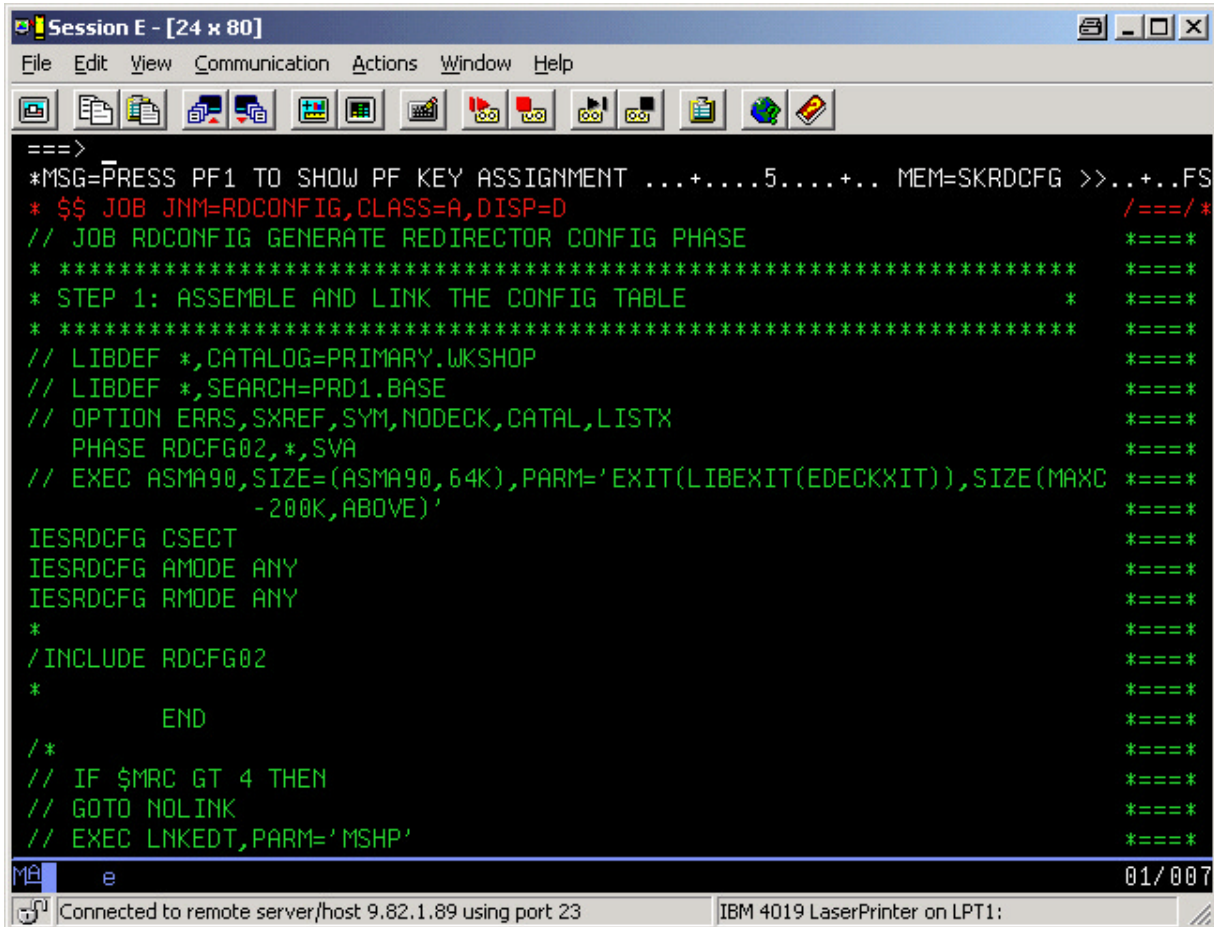

```

===>
*MSG=PRESS PF1 TO SHOW PF KEY ASSIGNMENT ...+....5....+.. MEM=SKRDCFG >>..FS
* $$ JOB JNM=RDCONFIG,CLASS=A,DISP=D /==*/
// JOB RDCONFIG GENERATE REDIRECTOR CONFIG PHASE *****
* *****
* STEP 1: ASSEMBLE AND LINK THE CONFIG TABLE * *****
* *****
// LIBDEF *,CATALOG=PRIMARY.WKSHOP *****
// LIBDEF *,SEARCH=PRD1.BASE *****
// OPTION ERRS, SXREF, SYM, NODECK, CATAL, LISTX *****
// EXEC ASMA90, SIZE=(ASMA90, 64K), PARM='EXIT(LIBEXIT(EDECKXIT)), SIZE(MAXC *****
- 200K, ABOVE)' *****
IESRDCFG CSECT *****
IESRDCFG AMODE ANY *****
IESRDCFG RMODE ANY *****
* *****
/INCLUDE RDCFG02 *****
* *****
END *****
/* *****
// IF $MRC GT 4 THEN *****
// GOTO NOLINK *****
// EXEC LNKEDT, PARM='MSHP' *****

```

MA e 01/007

Connected to remote server/host: 9.82.1.89 using port 23 IBM 4019 LaserPrinter on LPT1:



Submit **SKRDCFG** and check for RC=0000 (this is only to test for errors)

Enter: **7 <CR>** (in the left margin)

Enter: **RDC** to the *List queue prefix* field and hit **PF12** (look for your Team name in List queue)

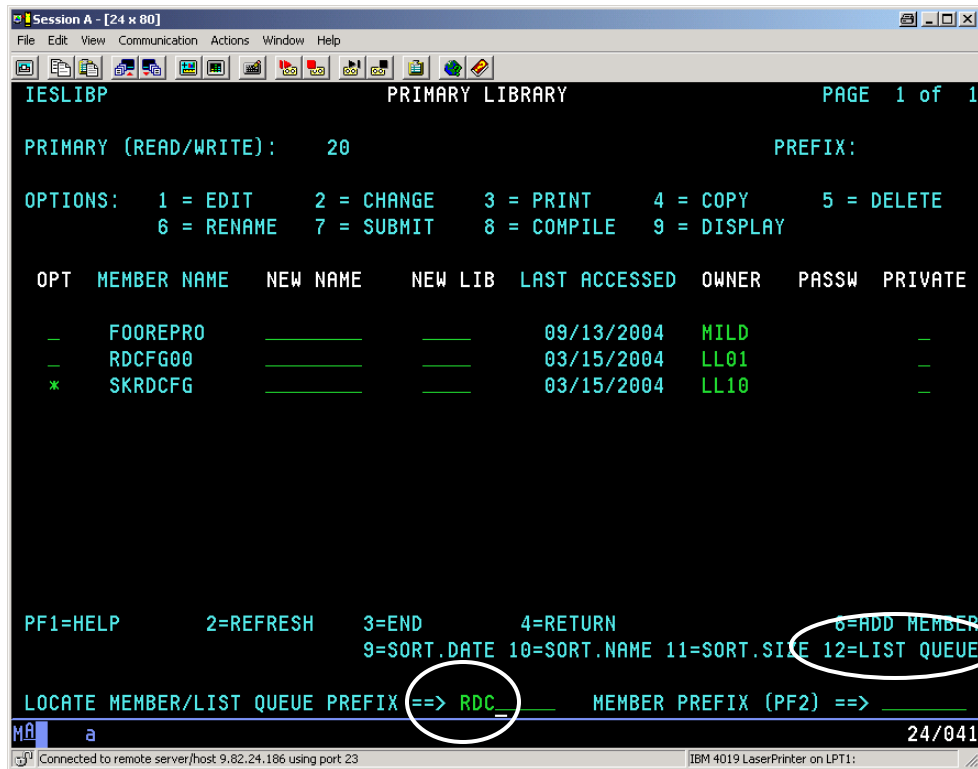

The screenshot shows the IESLIB PRIMARY LIBRARY screen. At the bottom, the 'LOCATE MEMBER/LIST QUEUE PREFIX' field contains 'RDC' and the 'MEMBER PREFIX (PF2)' field is empty. The '12=LIST QUEUE' option is circled in red.

```
IESLIB          PRIMARY LIBRARY          PAGE 1 of 1
PRIMARY (READ/WRITE):  20                PREFIX:
OPTIONS:  1 = EDIT    2 = CHANGE    3 = PRINT    4 = COPY    5 = DELETE
          6 = RENAME  7 = SUBMIT   8 = COMPILE  9 = DISPLAY
OPT  MEMBER NAME  NEW NAME  NEW LIB  LAST ACCESSED  OWNER  PASSW  PRIVATE
--  -
-   FOOREPRO      _____  _____  09/13/2004    MILD
-   RDCFG00       _____  _____  03/15/2004    LL01
*   SKRDCFG       _____  _____  03/15/2004    LL10

PF1=HELP    2=REFRESH    3=END        4=RETURN        6=ADD MEMBER
          9=SORT.DATE 10=SORT.NAME 11=SORT.SIZE 12=LIST QUEUE

LOCATE MEMBER/LIST QUEUE PREFIX ==> RDC_  MEMBER PREFIX (PF2) ==>
MA a                                             24/041
Connected to remote server/host 9.82.24.186 using port 23  IBM 4019 LaserPrinter on LPT1:
```

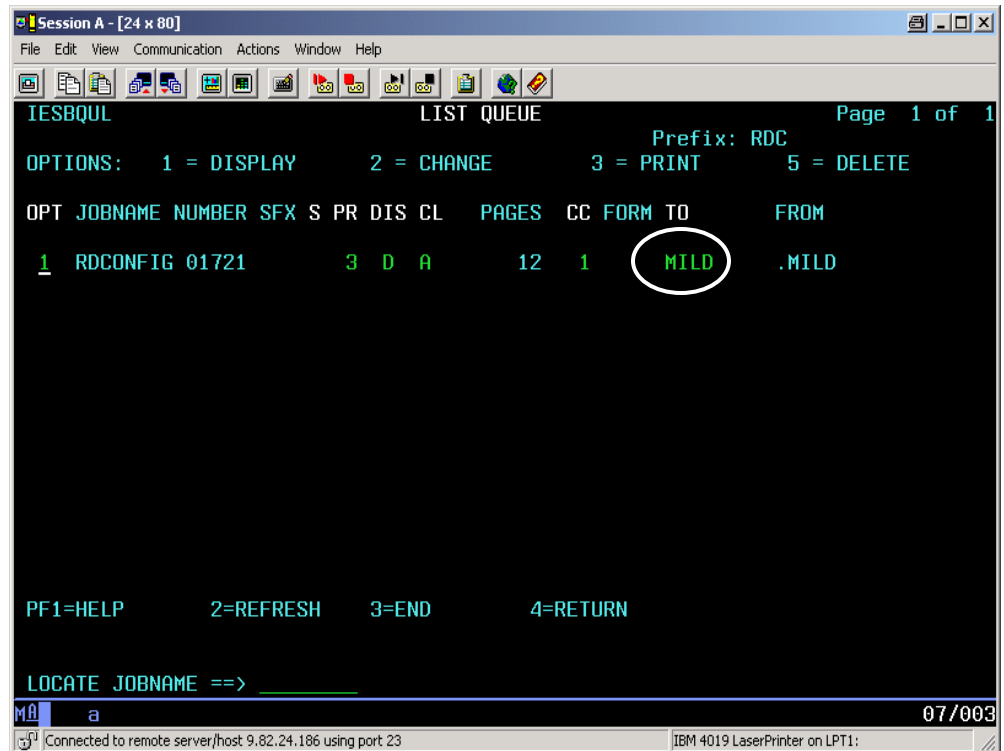

The screenshot shows the IESBQUL LIST QUEUE screen. The 'Prefix: RDC' is displayed. The table below shows a single entry with 'MILD' circled in red.

```
IESBQUL          LIST QUEUE          Page 1 of 1
Prefix: RDC
OPTIONS:  1 = DISPLAY  2 = CHANGE  3 = PRINT  5 = DELETE
OPT  JOBNAME  NUMBER  SFX  S  PR  DIS  CL  PAGES  CC  FORM  TO  FROM
-   -
1   RDCONFIG  01721   3   D   A   12   1   MILD   .MILD

PF1=HELP    2=REFRESH    3=END        4=RETURN

LOCATE JOBNAME ==>
MA a                                             07/003
Connected to remote server/host 9.82.24.186 using port 23  IBM 4019 LaserPrinter on LPT1:
```

Enter **1** to display the member and **PF12** to go to bottom.

If the **RC=0** tell the instructor and he'll activate your definitions.

## Chapter 4. Use a standard program to redirect VSAM requests

### **STEP4.1: Copy the VSAM file to a remote file (HTML)**

Make sure the Redirector server is started on your Windows PC (STEP2.6)

Use **IDCAMS REPRO** to copy the VSAM file to another VSAM file which is redirected to a remote location. The copy job will transfer all VSAM records to Windows and generate an HTML page via the HTMLHandler.

On the *main IUI Panel* enter:

(To get there hit PF3 until you see the screen title 'z/VSE function selection')

**51<Enter>**

**1** (Edit) for file **FOOREPRO**

**Update the file name with your team number:**

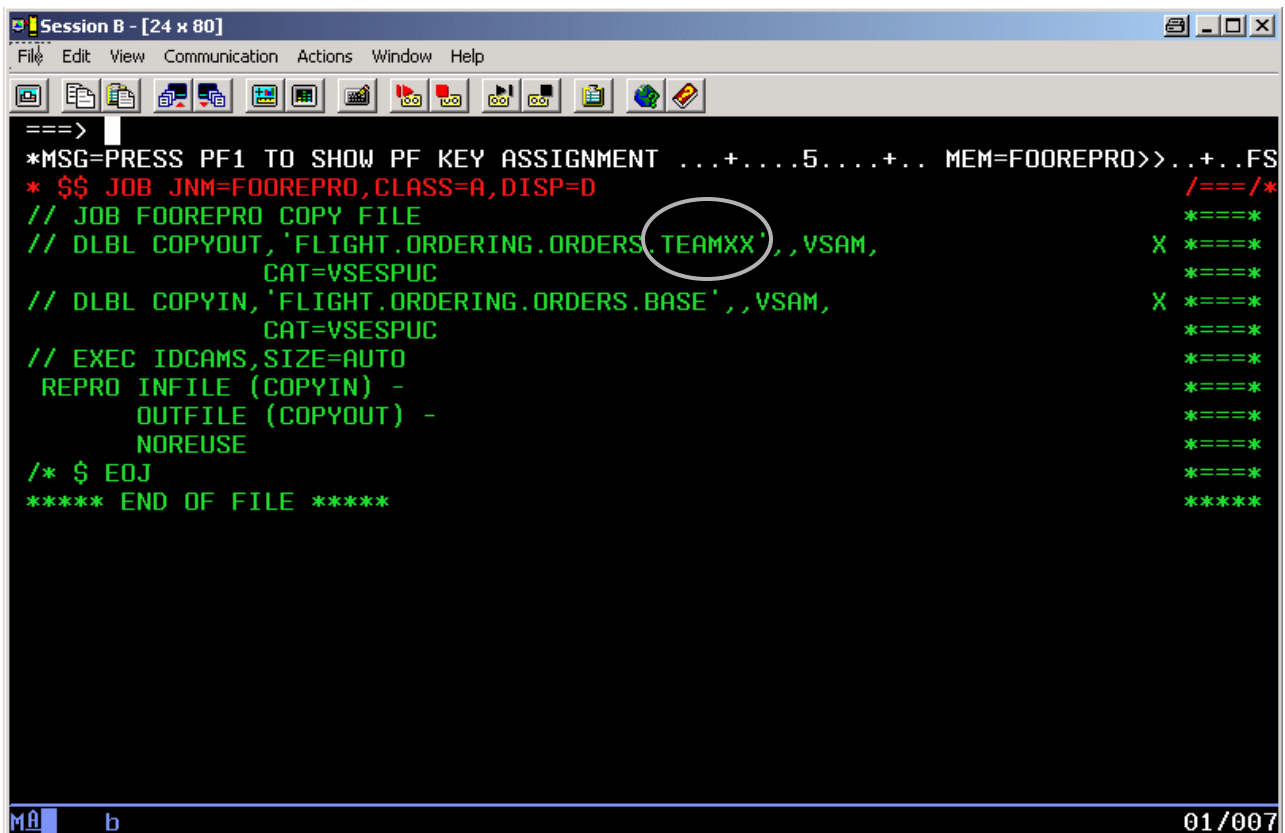

```
====>
*MSG=PRESS PF1 TO SHOW PF KEY ASSIGNMENT ...+....5....+.. MEM=FOOREPRO>>..+..FS
* $$ JOB JNM=FOOREPRO,CLASS=A,DISP=D /====/*
// JOB FOOREPRO COPY FILE *====*
// DLBL COPYOUT,'FLIGHT.ORDERING.OORDERS.TEAMXX',,VSAM, X *====*
// DLBL COPYIN,'FLIGHT.ORDERING.OORDERS.BASE',,VSAM, X *====*
// EXEC IDCAMS,SIZE=AUTO *====*
// REPRO INFILE (COPYIN) - *====*
// OUTFILE (COPYOUT) - *====*
// NOREUSE *====*
/* $ EOJ *====*
***** END OF FILE ***** *****
```

Enter:

**PF3** (Exit and save)

**7** (Submit the job)

The Redirector Server Console on Windows should show some messages with the number of records processed and that the **output.html** page was created.

Open the HTML page in Windows to verify that the Copy function did transfer your Data from VSAM to Windows, translated them from EBCDIC to ASCII, and generated a HTML file.

In the Internet Explorer, open the file (File -> Open... -> Browse)

**C:\vsamredir\output.html**

You should see the records from your VSAM file:

**FLIGHT.ORDERING.ORDERS.TEAMxx**

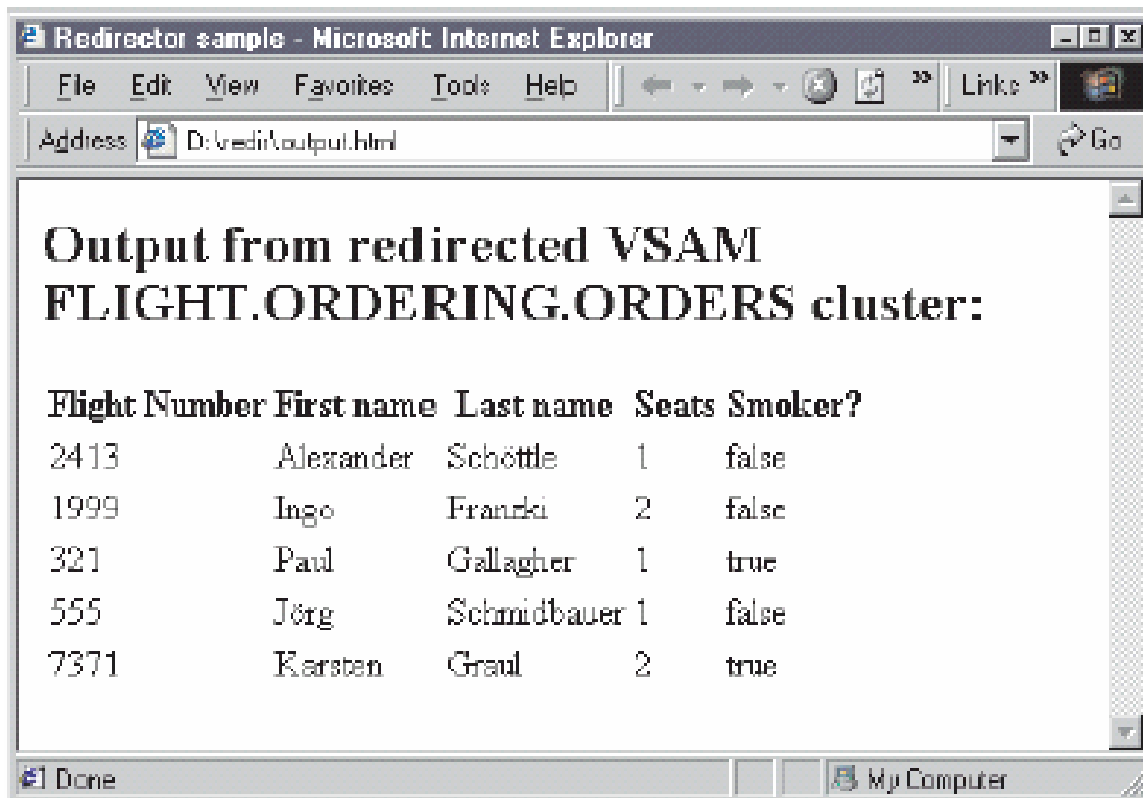

**Similar to a batch program, the Redirector can work with a CICS transaction. The description for DITTO is in [Appendix B](#).**

# Summary

## Major Steps to install VSAM Redirector Server on any Java Platform

- ✓ install Java Runtime Environment (JRE) or
- ✓ Java Developer Kit (JDK)
  - ✓ free download from SUN or IBM
  - ✓ version 1.3.x or later

<http://www.ibm.com/developerworks/java/>
- ✓ download VSAM Redirector Server

<http://www-1.ibm.com/servers/eserver/zseries/zvse/download/#redir>

- ✓ install VSAM Redirector Server
  - ✓ in a command prompt run: [install.bat](#)
- ✓ Configure the VSAM clusters to be redirected on the VSE side using skeleton SKRDCFG from ICCF lib 59.

# Appendix A: Download from the Internet

Open the VSE Homepage with a web browser:

<http://www-1.ibm.com/servers/eserver/zseries/zvse/>

Click on “download” link on the left side  
and then on “VSAM Redirector Server”.

The page opened contains the VSE Connector pieces and other tools and Add-On's that can be downloaded for free, like VSAM Redirector server.

The **VSAM Redirector Server** represents the remote component in Java, of the VSE VSAM Redirector function.

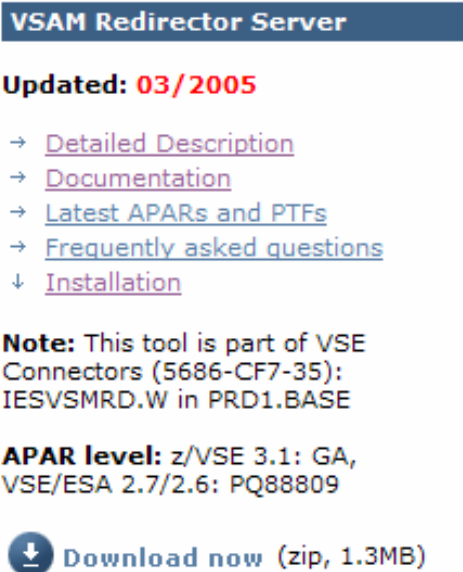

The screenshot shows a web page for the VSAM Redirector Server. At the top, there is a dark blue header with the text "VSAM Redirector Server" in white. Below the header, the text "Updated: 03/2005" is displayed in red. A list of links follows, each preceded by a right-pointing arrow: "Detailed Description", "Documentation", "Latest APARs and PTFs", and "Frequently asked questions". The final link, "Installation", is preceded by a downward-pointing arrow. Below the links, a "Note" section states: "Note: This tool is part of VSE Connectors (5686-CF7-35): IESVSMRD.W in PRD1.BASE". Underneath the note, the "APAR level" is specified as "z/VSE 3.1: GA, VSE/ESA 2.7/2.6: PQ88809". At the bottom of the screenshot, there is a blue circular icon with a white downward arrow, followed by the text "Download now (zip, 1.3MB)".

You find links for documentation and description of the the most important functions of the VSAM Redirector Server and the communication with VSE. It also mentions that a **Java** environment is needed.

To Download latest Code. Click on:

**Download now**

The file name may vary since it contains an APAR number. Please make sure you have applied the corresponding APAR on your VSE system.

# Appendix B. Use standard program to redirect VSAM requests

## Access the VSAM file with Ditto

Similar to a batch program (Chapter 4), the Redirector can work with a CICS transaction. Here the description how to use DITTO to write to a HTML page on Windows.

Make sure the Redirector server is started on your Windows PC (STEP2.7)

Use **Ditto** to edit a VSAM file. All inserts, and only the inserts, that will be done in VSAM, will be also redirected into a HTML page in Windows.

On the main UI Panel enter:

(To get there hit PF3 until you see the screen title '*VSE/ESA function selection*')

**PF6**

**ditto**

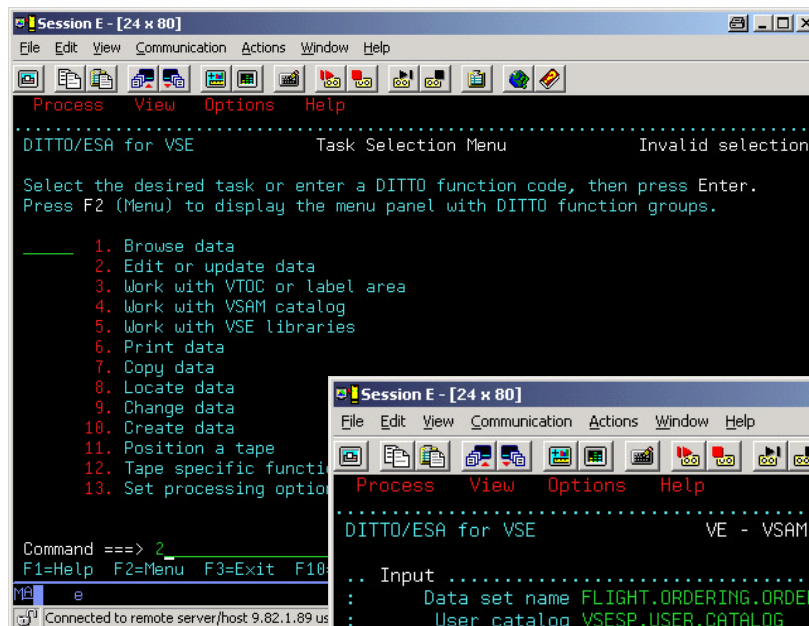

```
Session E - [24 x 80]
File Edit View Communication Actions Window Help
-----
Process View Options Help
DITTO/ESA for VSE          Task Selection Menu          Invalid selection

Select the desired task or enter a DITTO function code, then press Enter.
Press F2 (Menu) to display the menu panel with DITTO function groups.

-----
1. Browse data
2. Edit or update data
3. Work with VTOC or label area
4. Work with VSAM catalog
5. Work with VSE libraries
6. Print data
7. Copy data
8. Locate data
9. Change data
10. Create data
11. Position a tape
12. Tape specific function
13. Set processing options

Command ==> 2
F1=Help F2=Menu F3=Exit F10=
```

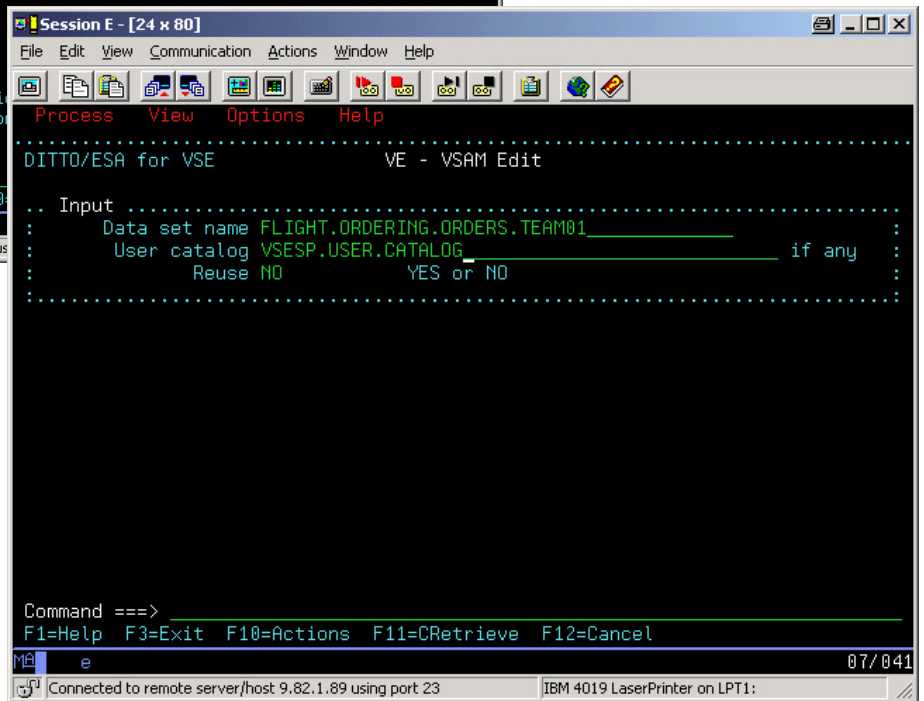

```
Session E - [24 x 80]
File Edit View Communication Actions Window Help
-----
Process View Options Help
DITTO/ESA for VSE          VE - VSAM Edit

.. Input ..
: Data set name FLIGHT.ORDERING.ORDERS.TEAM01
: User catalog VSESP.USER.CATALOG if any
: Reuse NO YES or NO

Command ==>
F1=Help F3=Exit F10=Actions F11=CRetrieve F12=Cancel
M  e 07/041
Connected to remote server/host 9.82.1.89 using port 23 IBM 4019 LaserPrinter on LPT1:
```

Enter:

**2** (Edit or update data)

**1** (Edit VSAM data)

Enter the VSAM cluster name: **FLIGHT.ORDERING.ORDERS.TEAMxx**

Enter the catalog name: **VSESP.USER.CATALOG**

Monitor the Redirector server console on Windows and press **<ENTER>** On the Ditto window.  
 You have to see the connection messages.

```

Select Start Server
F:\USE\vsecon27\Redir271>Rem Startup file for USE Redirector Server
F:\USE\vsecon27\Redir271>Rem -----
F:\USE\vsecon27\Redir271>set classpath=.;UsamRedir.jar;.;F:\DB2\java\db2java.zip;F:\DB2\java\runtime.zip;F:\DB2\java\sqlj.zip;F:\DB2\bin;. ;f:\vse\vsecon27\USEConnector.jar;f:\vse\vsecon27\cci.jar;f:\vse\vsecon27\ibmjse.jar
F:\USE\vsecon27\Redir271>java com.ibm.vse.redirector.USAMRedirectorServer
Licensed Materials - Property of IBM
(C) Copyright IBM Corp. 1998, 2000. All Rights Reserved.

US Government Users Restricted Rights -
Use, duplication or disclosure restricted by
GSA ADP Schedule Contract with IBM Corp.

USAMRedirectorServer starting...
Mar 10, 2004 11:04:44 PM - Listening socket created on port 2387
Enter 'quit' to stop the server
Mar 10, 2004 11:04:44 PM - Waiting for connections...
Mar 10, 2004 11:11:49 PM - Client connection request from 9.152.82.153
Mar 10, 2004 11:11:49 PM - Client has been accepted.
Mar 10, 2004 11:11:49 PM - Connection has been accepted from 9.152.82.153
  
```

On VSE :

You should see the preloaded records from VSAM file (OWNER=VSAM).

The effect of your previous **<ENTER>** caused:

- OPEN of the VSAM file FLIGHT.ORDERING.ORDERS.TEAMxx
- check with the Configuration phase if requests for this file should be redirected
- in our case YES, therefore further check of the OWNER(OWNER=VSAM), therefore the VSAM file was read and is shown to you.

1. Enter 1 in the line Top of data
2. Make sure Ditto works in **CHAR** mode (upper right corner)
3. **Insert** in the first **40 (0-39)** characters of the record (first name, last name)

```

Session E - [24 x 80]
File Edit View Communication Actions Window Help
Process View Options Help
.....
DITTO/ESA for VSE          VE - VSAM Edit
.....
CATALOG VSESP.USER.CATALOG
DSNAME FLIGHT.ORDERING.ORDERS.TEAM01          Col 1          Format CHAR
VOLSER DOSRES Type RADS                      Insert length 40
1...5...10...5...20...5...30...5...40...5...50...5...60...5...70...
00000 **** Top of data ****
00001 John-Watson          Smith          ...K.....
00002 Joerg                Schmidbauer   .....
00003 Ingo                 Franzki       .....
00004 Donald              Duck          ...=.....
00005 Arnold              Schwarzenegger ..?......
00006 **** End of data ****

Command ==>
F1=Help F2=Zoom F3=Save+Exit F4=Left F5=Right F6=RFind F7=Bkwd F8=Fwd
F10=RChange F11=CRetrieve F12=Quit
MA e 10/047
Connected to remote server/host 9.82.1.89 using port 23 IBM 4019 LaserPrinter on LPT1:
  
```

4. Change the mode Ditto works in **HEX** (upper right corner)
5. Now from position **39** you can key in the numeric fields (two times 4 byte numbers and a binary field that can be 00 or 01 – as the map describes them in *STEP1.8*)

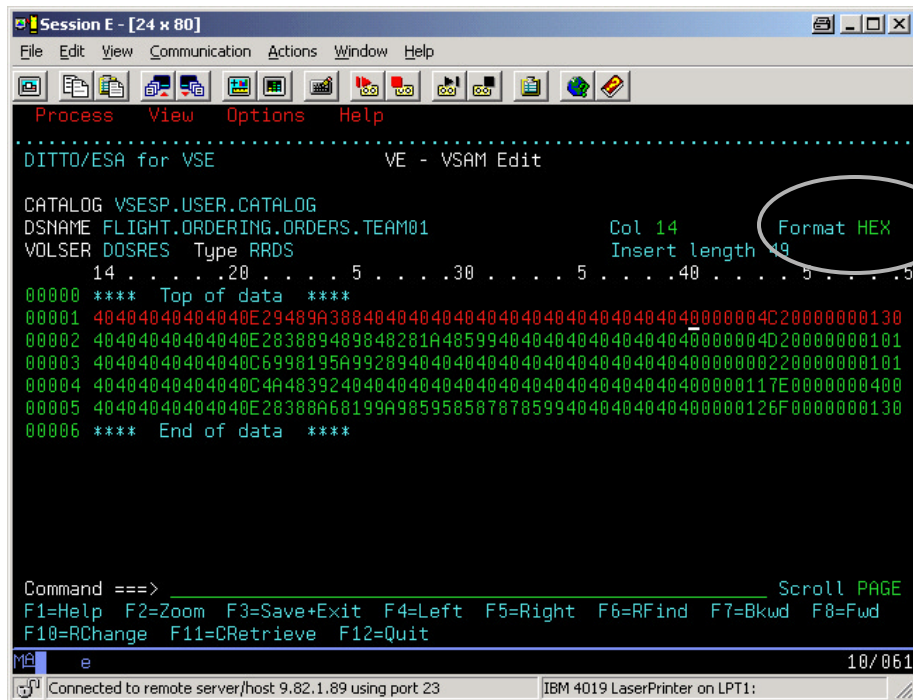

Add as much records as you want and then save the changes.

At the command line hit **save** or press **PF3**

The Redirector Console on Windows should show a message that the **output.html** page was created.

Open the HTML page with the Internet Explorer  
**C:\vsamredir\output.html**

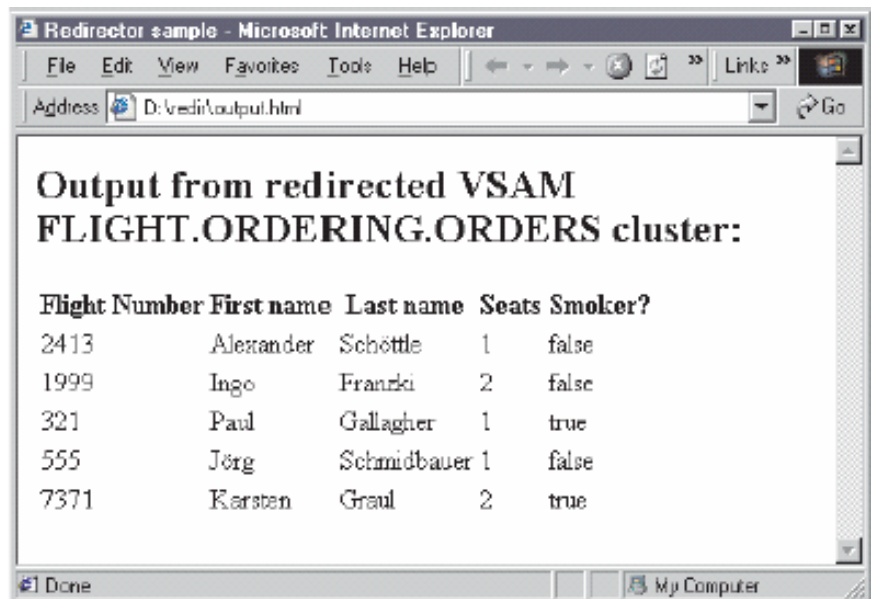

You should see your inserted records only.

If the **OWNER** in the configuration phase on VSE is changed to **REDIRECTOR** and you'll see each time you open in Ditto the cluster, it's empty – because it will not read from VSAM anymore.



## Appendix C. Change the handler on Windows

### **STEP C.1: Change Handler to treat the entire VSAM record as string.**

Exit Ditto on VSE (PF3).

Stop the Redirector server on Windows using command **Quit** in the Redirector console window.

To avoid the complexity with Ditto to enter hex values, we'll change the HtmlHandler on **Windows**.

That would allow to use string fields in Ditto for the entire VSAM record.

Use a Windows command prompt and **Notepad** to edit the handler:

**C:**

**cd C:\vsamredir\com\libml\vse\htmlhandler**

**Notepad HtmlHandler.java**

Make following changes:

1. Change the HTML header tag to create an HTML page that will refresh itself all 5 seconds.

```
<html><head><title>VSE/ESA Redirector sample</title>
    <meta http-equiv=refresh content=5></head>
```

2. Change the lines in the source as below to read a string of 49 char.  
- Define all fields as String:

**String** **firstname, lastname, flightnumber, seats, smoker;**

- Make the changes below in the source code (it's in the last 3-rd )

```
    firstname = requestInfo.getString(0, 20);
    lastname  = requestInfo.getString(20, 20);
    flightnumber = requestInfo.getString(40, 4);
    seats      = requestInfo.getString(44, 4);
    smoker = requestInfo.getString(48, 1);
//    smoktmp = requestInfo.getString(48, 1);
//    if(smoktmp.length > 0)
//        if( smoktmp[0] == 0 )
//            smoker = false;
//            else
//            smoker = true;
        htmloutput.newLine();
htmloutput.flush();
```

## STEP C.2: Save and recompile the changed handler

To be able to compile it we have to update the CLASSPATH temporary.

In a *Windows command prompt* enter:

```
set CLASSPATH=VsamRedir.jar;.;%CLASSPATH%
```

**C:**

```
cd C:\vsamredir
```

```
javac com\ibm\vse\htmlhandler\HtmlHandler.java
```

## STEP C.3: Activate the changed handler

Restart the Redirector server on Windows.

In *the command prompt* enter:

```
run.bat
```

In VSE repeat STEP 4.1

Use Ditto again, in **CHAR** mode (right upper corner) add some records with 49 characters each. **SAVE** the changes you made in VSE.

Open the HTML page  
with the Internet Explorer

**C:\vsamredir\output.html**

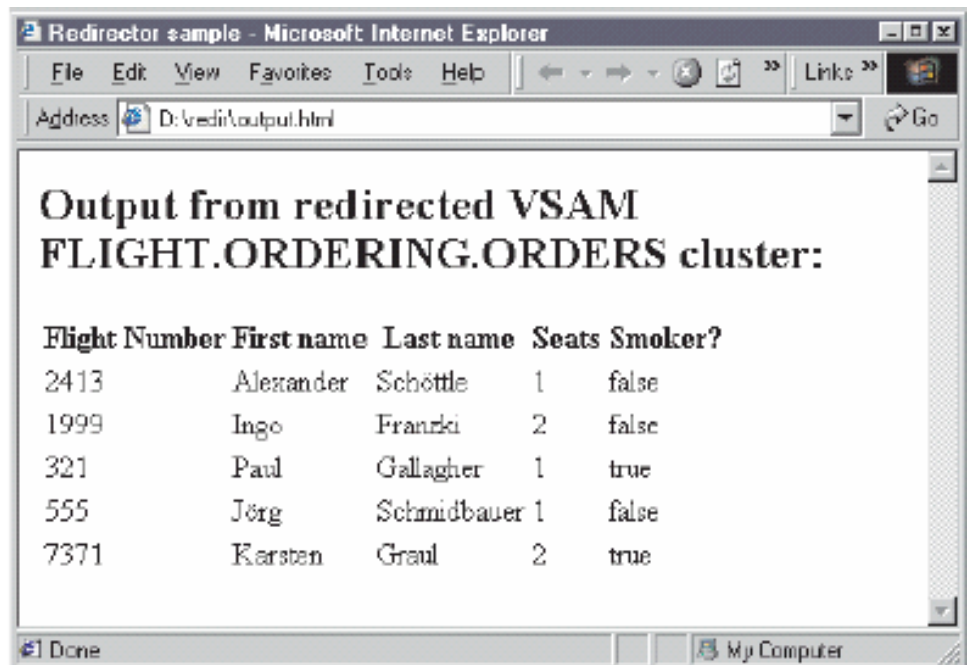

Now the **output.html** should refresh itself each 5 seconds and show the inserted records.

# Appendix D: Redirect VSAM requests to a DB2 UDB on Windows

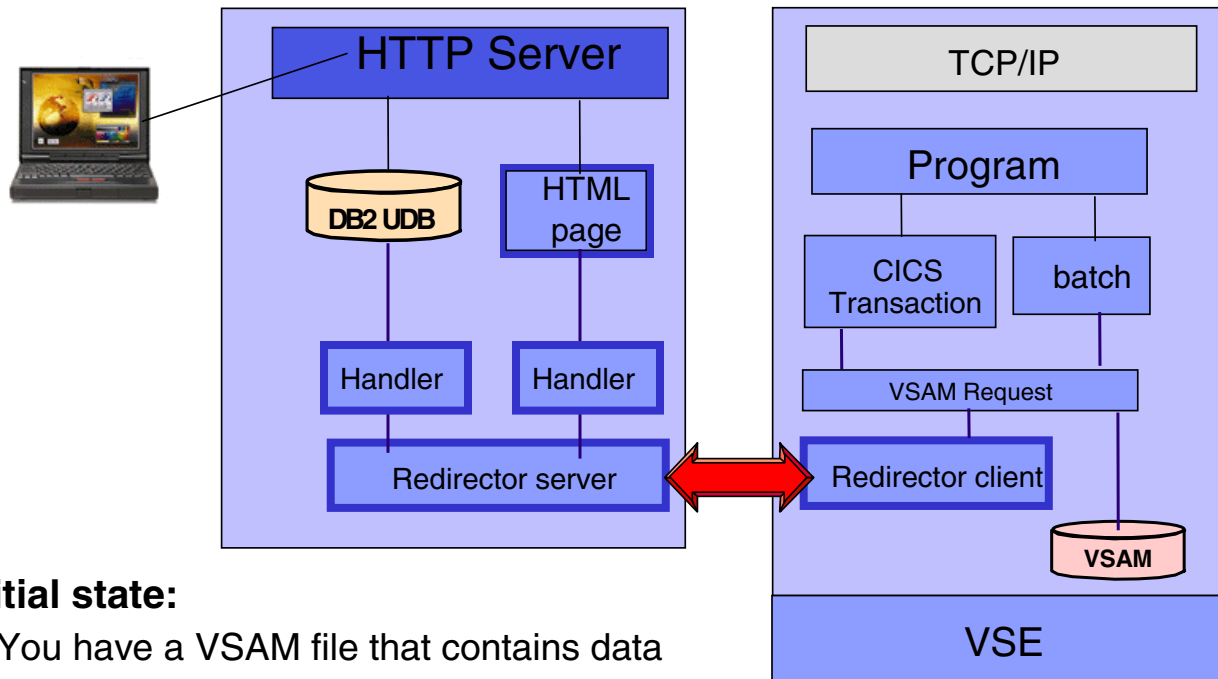

## Initial state:

- You have a VSAM file that contains data (i.e. FFSTORES.DEMO.CLUSTER)
- You have applications that work with that VSAM file (i.e. FFST a CICS Transaction accessing FFSTORES)

## Goal:

- Redirect all VSAM requests to DB2 UDB on Windows
- Access the data with existing applications (without changing them)

**NOTE: The VSAM Redirector Server does NOT require the VSE Connector Client on Windows**

## STEP D.1: Define a map

Relational databases have columns with specific characteristics.

To move VSAM data into a database, we must know the internal structure and format of the records. Therefore we need a mapping containing all fields of a VSAM record including their offset in the record, length and type. Easiest a map can be created with the Maptool or VSE Navigator.

- Start the VSE Navigator, connect to the VSAM host, and navigate to the VSAM cluster **FFSTORES.DEMO.CLUSTER**.
- Right click the Cluster, choose "Create map definition". Enter a name for the map, e.g. "FFMAP"
- Right click on the map, choose "Change map definition":

Insert the definitions based on the mapping information below.

**Mapping of FFSTORES.DEMO.CLUSTER:**

Field name	Type	Offset	Length
STOREID	STRING	0	6
STORENAME	STRING	6	25
LOCSTREET	STRING	31	25
LOCCITY	STRING	56	25
LOCZIP	STRING	81	10
LOCCOUNTRY	STRING	91	25
LOCREP	STRING	116	20
STOREN1	UNSIGNED	136	4
STOREN2	UNSIGNED	140	4
LDATE	STRING	144	10
WEBPIC1	STRING	154	20
WEBPIC2	STRING	174	20
ACODE	STRING	194	10

To verify the mapping, use the VSE Navigator to display the VSAM data. Right click on the map, choose "Display VSAM Data". On the "Display Filter" dialog box, press "OK" to display all records (no filter).

STO...	STORENAME	LOCSTREET	
000001	Frechdax	Elbeplatz 2	Boeblingen
000002	Cafe Keese	Reeperbahn 15	Hamburg
000003	Hotel Sacher	Hauptstr. 15	Wien
000004	Cafe Frech	Postplatz 3	Boeblingen
000005	Cafe Frech Filiale 1	Seestrasse 2	Boeblingen
000006	Cafe Frech Filiale 2	Schoenaicherstrasse	Boeblingen
000007	Cafe Frech Filiale 3	Blumenstrasse	Boeblingen

**Note:** If the structure definition of the VSAM record exists in a Cobol Copy book or PL/I structure, use **MAPTOOL** to import the definitions and generate the map

**STEP D.2: Export the mapping to a XML File**

The VSAM Redirector "Create DB2 Tables" tool reads the mapping from a XML file. Therefore we export the definitions from Navigator into XML form.

Right click on the map and choose "Export map to XML". Enter a filename 28 (e.g. [ffstores.xml](#)). This file is needed in the next step.

### STEP D.3: Create the tables in the DB2 database

To continue with the next steps

- you must have installed a database management system (i.e. DB2).
- you must have a JDBC Driver for it (i.e. db2java.zip in <db2>\java\).
- you must be able to connect to the database (userid/password)

Make sure the JDBC driver is in the utility CLASSPATH. You may have to edit the **create.bat/create.cmd/create.sh** batch files as well as the **run.bat/run.cmd/run.sh** batch files and add the JDBC Driver Archive to the classpath:

```
set CLASSPATH=.;xerces.jar;<db2>\java\db2java.zip;  
%CLASSPATH%
```

Also the path must setup to contain the DB2 libraries.

Start the "Create DB2 Tables" utility (**create.bat/create.sh** or **START - Programs - VSAM Redirector - Create DB2 Tables**).

Enter following parameters when prompted by the tool:

- XML Filename:** name of the XML File you exported before (i.e. **ffstores.xml**)
- DB url:** the JDBC URL for your database, i.e. **jdbc:db2:sample**
- DB user:** a user id you use for accessing the database
- DB password:** db users password
- DB table name:** name of the data table, i.e. **FFSTORES**. This table will contain the VSAM data later on.
- Map table name:** Enter the name of the table that contains the mapping information, (structure of VSAM record) i.e. **FFSTORES\_MAP**. You can use the same map table for several clusters.
- Map name:** Enter the name of the map, that will be the selection key in the 'Map table' i.e. **FFSTORES**. This name is independent from the map defined with the VSE Navigator.
- DB system:** Enter **1 for DB/2**, 2 for Oracle.
- The tool now imports the XML file and connects to the database.
- Next, the map info table is created (**FFSTORES\_MAP**).  
Enter **Yes** to continue.
- The data table is created (**FFSTORES**).  
Enter **Yes** to continue.
- Cluster Type:** Enter **1 (KSDS without AIX)**.
- Primary key field:** Enter the name of the key field: **STOREID**.  
Press enter to create the table and indexes.

Before we can work with data in that database, we have to load/migrate once the whole data from VSAM into the database. To do this we define a 'twin' cluster, with the same characteristics as the one with the data, redirect this cluster and copy (repro) the original cluster into the redirected one.

#### **STEP D.4: Define 'twin' cluster FFSTORES.REPRO.CLUSTER**

Define it with the same attributes as FFSTORES.DEMO.CLUSTER:

- KSDS
- Max/Avg. record length: 210
- Key Position: 0, Keylength: 6

#### **STEP D.5: Configure the Redirector for FFSTORES.REPRO.CLUSTER:**

Copy skeleton SKRD CFG from ICCF Library 59 to your primary library.

Edit/add an entry to the configuration table. Enter **CASE M** in the command line to switch to mixed case mode before editing.

```
IESRDENT CATALOG='VSESP.USER.CATALOG',           X
        CLUSTER='FFSTORES.REPRO.CLUSTER',         X
        EXIT='IESREDIR',                           X
        OWNER=REDIRECTOR,                           X
        IP='<ip-addr>',                             X
        HANDLER='com.ibm.vse.db2handler.DB2Handler', X
        OPTIONS='dburl=jdbc:db2:<db>;dbuser=<userid>;  X
                maptable=FFSTORES_MAP;map=FFSTORES;  X
                dbpassword=<password>;dbtable=FFSTORES'
```

- let the job load IESRD CFG into the SVA (Step 2)
- let the job copy IESVEX01 to IKQVEX01 in PRD2.CONFIG (Step 3)
- let the job load IKQVEX01 into the SVA (Step 4)
- let the job load IESRDANC into the SVA, if not already done (Step 5)
- let the job execute IESRD LDA to register the new configuration (Step 6)
- submit and check for RC=0000

**STEP D.6: Copy FFSTORES.DEMO.CLUSTER into FFSTORES.REPRO.CLUSTER:**

Use the IDCAMS REPRO function to copy the contents of FFSTORES.DEMO.CLUSTER into the redirected FFSTORES.REPRO.CLUSTER:

```
* $$ JOB JNM=REPRO,CLASS=A,DISP=L
// JOB REPRO COPY FILE
// DLBL COPYIN,'FFSTORES.DEMO.CLUSTER',,VSAM,CAT=VSESPUC
// DLBL COPYOUT,'FFSTORES.REPRO.CLUSTER',,VSAM,CAT=VSESPUC
// EXEC IDCAMS,SIZE=AUTO
  REPRO INFILE (COPYIN) -
        OUTFILE (COPYOUT) -
        NOREUSE
/*
/&
* $$ EOJ
```

During the copy process, the VSAM Redirector Client will get control (at open time of FFSTORES.REPRO.CLUSTER) and will connect to the VSAM Redirector Server and to the database. In case this fails, a VSAM open error message will be displayed.

To verify the data in the DB/2 table, issue the following SQL statement in a DB2 command window, or use the DB/2 Control Center:

**SELECT \* FROM FFSTORES**

UNIQRBAC...	STOREID	STORENA...	LOCSTREET	LOCCITY	LOCZIP	LOCCOUN...	LOCREP	STOREI
0	000001	Frechdax ...	Elbeplatz 2...	Boeblinge...	71032	Germany ...	Hiller	3i
1	000002	Cafe Kees...	Reeperbah...	Hamburg ...	20000	Germany ...	Domina ...	3i
2	000003	Hotel Sach...	Hauptstr. 1...	Wien ...	11111	Austria ...	Arnold S ...	3i
3	000004	Cafe Frech...	Postplatz 3...	Boeblinge...	71032	Germany ...	Hiller	3i
4	000005	Cafe Frech...	Seestrass...	Boeblinge...	71032	Germany ...	Hiller	3i
5	000006	Cafe Frech...	Schoenaic...	Boeblinge...	71032	Germany ...	Hiller	3i
6	000007	Cafe Frech...	Blumenstr...	Boeblinge...	71034	Germany ...	Hiller	3i
7	000008	Cafe Frech...	Dahlienstr...	Boeblinge...	71034	Germany ...	Hiller	3i
8	000009	Cafe Frech...	Rosenstra...	Boeblinge...	71034	Germany ...	Hiller	3i
9	000010	Cafe Muell...	Marienplatz...	Munich ...	0000080000	Germany ...	Hiller	3i
10	000011	McDonalds...	Main Street...	Melbourne ...	20000	Australia ...	Hiller	3i
11	000012	Cafe Howa...	Harbor Ro...	Sydney ...	10000	Australia ...	Hiller	3i
12	000013	McDonlads...	Main Street...	Perth ...	30000	Australia ...	Hiller	3i

## STEP D.7: Configure the Redirector for FFSTORES.DEMO.CLUSTER:

Edit skeleton SKRDCFG:

Change the previously created entry in the configuration table.

Enter **case m** in the command line to switch to mixed case mode before editing.

Change FFSTORES.**REPRO**.CLUSTER to FFSTORES.**DEMO**.CLUSTER

```
IESRDENT CATALOG='VSESP.USER.CATALOG',           X
        CLUSTER='FFSTORES.DEMO.CLUSTER',         X
        EXIT='IESREDIR',                          X
        OWNER=REDIRECTOR,                         X
        IP='<ip-addr>',                            X
        HANDLER='com.ibm.vse.db2handler.DB2Handler', X
        OPTIONS='dburl=jdbc:db2:<db>;dbuser=<userid>; X
                maptable=FFSTORES_MAP;map=FFSTORES; X
                dbpassword=<password>;dbtable=FFSTORES'
```

–let the job load IESRDCFG into the SVA (Step 2)

–let the job copy IESVEX01 to IKQVEX01 in PRD2.CONFIG (Step 3)

–let the job load IKQVEX01 into the SVA (Step 4)

–do NOT let the job load IESRDANC into the SVA, because it has already be done (Step 5)

–let the job execute IESRDLDA to register the new configuration (Step 6)

–submit and check for RC=0000

## STEP D.8: Reopen the file in CICS and start applications.

You have to reopen the VSAM file in CICS, since the VSAM Redirector configuration becomes active at open time.

You can now work with your VSAM applications which will transparently access DB2 data and think they are working with VSAM data .



# Additional Information

- **z/VSE Home Page**  
<http://www.ibm.com/servers/eserver/zseries/zvse/>
- **e-business Connectors User's Guide**  
**SC33-6719**  
<http://www-1.ibm.com/servers/eserver/zseries/zvse/documentation/#conn>
- **VSE Connectors: Components, tools**  
<http://www.ibm.com/servers/eserver/zseries/zvse/downloads>
- **z/VSE modern solutions**  
<http://www.ibm.com/servers/eserver/zseries/zvse/solutions>



- **e-business Connectivity for VSE/ESA** **SG24-5950**
- **e-business Solutions for VSE/ESA** **SG24-5662**
- **Servlet and JSP Programming** **SG24-5755**
- **WebSphere V5 for Linux on zSeries Connectivity Handbook** **SG24-7042**

[zVSE@de.ibm.com](mailto:zVSE@de.ibm.com)