

LAN Data Interoperability for S/390

VM/ESA, VSE/ESA and Linux for S/390

2000 VM and VSE Technical Conference, Session G23

Jim Elliott, Product Manager,
Enterprise Servers, IBM Americas Group

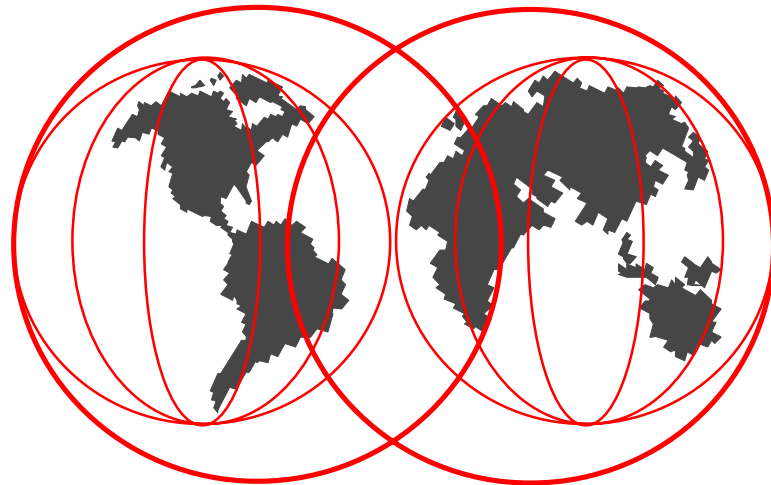

Disclaimer



The information contained in this document is distributed on an "as is" basis without any warranty either express or implied. The customer is responsible for use of this information and/or implementation of any techniques mentioned. IBM has reviewed the information for accuracy, but there is no guarantee that a customer using the information or techniques will obtain the same or similar results in its own operational environment.

In this document, any references made to an IBM licensed program are not intended to state or imply that only IBM's licensed program may be used; any functionally equivalent program may be used instead.

Any performance data contained in this document was determined in a controlled environment and, therefore, the results which may be obtained in other operating environments may vary significantly. Users of this document should verify the applicable data for their specific environment.

It is possible that this material may contain reference to, or information about, IBM products (machines and programs), programming, or services that are not announced in your country or not yet announced by IBM. Such references or information must not be construed to mean that IBM intends to announce such IBM products, programming, or services.

Credits



- Much of the information contained in this presentation was developed as a result of a residency at the ITSO Poughkeepsie in the fall of 1999 which resulted the IBM Redbook, *S/390 File and Print Serving*, SG24-5330-01
- Special thanks to the following people for their assistance:
 - ▶ Romney White, Mary Ellen Carollo - VM Development
 - ▶ Mike MacIsaac, Erich Amrehn - ITSO Poughkeepsie
 - ▶ Alan Martens - OS/390 Development
 - ▶ Alan Nichols - independent consultant

Technology proliferation and distributed computing



- The cause: late 1980s and early 1990s
 - ▶ Fundamental re-engineering of core business processes
 - ▶ Shift in control towards decentralization and departmental control
 - ▶ Low acquisition costs and relatively low labor costs were attractive to early users
- And the effect:
 - ▶ Increased Total Cost of Ownership (TCO) and reduced IT efficiency
 - Proliferation of support and administrative staff
 - Lack of adherence to standards
 - Increased security and data integrity risks
 - Spiraling software and maintenance costs
 - Inefficient utilization of computing resources
 - ▶ Inability to integrate data and applications across the enterprise
 - ▶ More difficult financial management and control of assets

What is the "Total Cost of Ownership" in a distributed model?

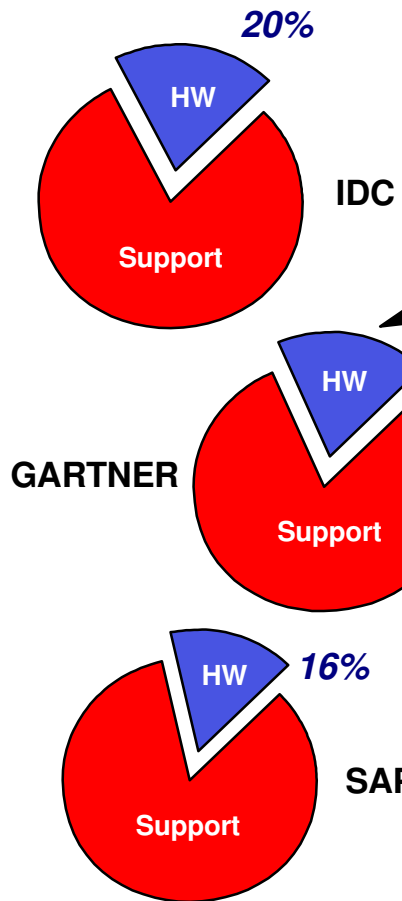

- **Server Components** (approx 20%)
 - ➔ HW incl. storage subsystems
 - ➔ Server upgrades
 - ➔ Management software/utilities
 - ➔ Vendor hardware maintenance

- **System Support**
 - ✓ Monitoring
 - ✓ Performance tuning
 - ✓ Troubleshooting
 - ✓ Hardware activity (planning, upgrades)
 - ✓ Administration (releases, ...)
 - ✓ User administration (user profile, security)
 - ✓ Storage management
 - ✓ Backup services (data backup & restore)
- **Applications**
 - ✓ Application support
 - ✓ User help desk

Definition by Gartner Group

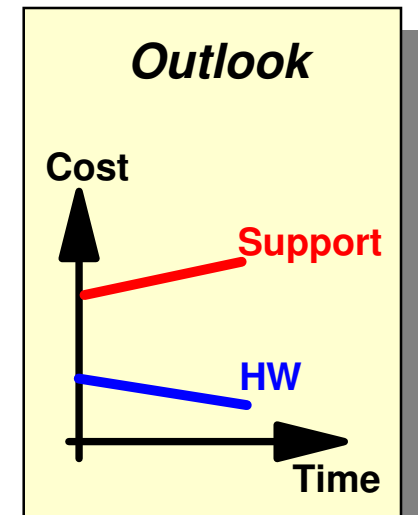

ITSO

Server consolidation offers important answers

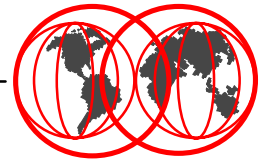

- Transportation company: People got drunk on technology about six years ago and went berserk on adding servers. It got out of hand! We need to do server consolidation now to make our server architecture manageable.
- Computer company: We've seen a major improvement in response time and level of service. Now applications are actually processing at a faster rate. We require less manpower, and we have higher manageability.
- Chemical company: The number of IT people should have decreased due to the consolidation, but instead we retrained our personnel, gave them new responsibilities, and actually increased [effective] headcount.
- Petroleum refining company: We're consolidating to save money in hardware, personnel, and the network. It also makes things easier to support -- everyone will be at the same software level. We'll finally have some standardization.
- Forest products company: Server consolidation has given us more credibility with the business units. We've been able to deliver a higher level of performance and service, which makes us look good.

Customer excerpts from The Forrester Report, December 1997 - Building Server Cooperatives

What is server consolidation?



- Server consolidation is an enabling technology involving the reduction in the number of servers in use within an organization by centralizing many applications or data onto fewer servers to reduce costs, increase the efficiency of systems management, security and resource utilization
 - ▶ Optimizing and simplifying existing IT infrastructure
 - ▶ Providing a foundation for new solution investment and implementation
 - ▶ Aligning the IT infrastructure with current and future business requirements

Reasons for LAN server consolidation

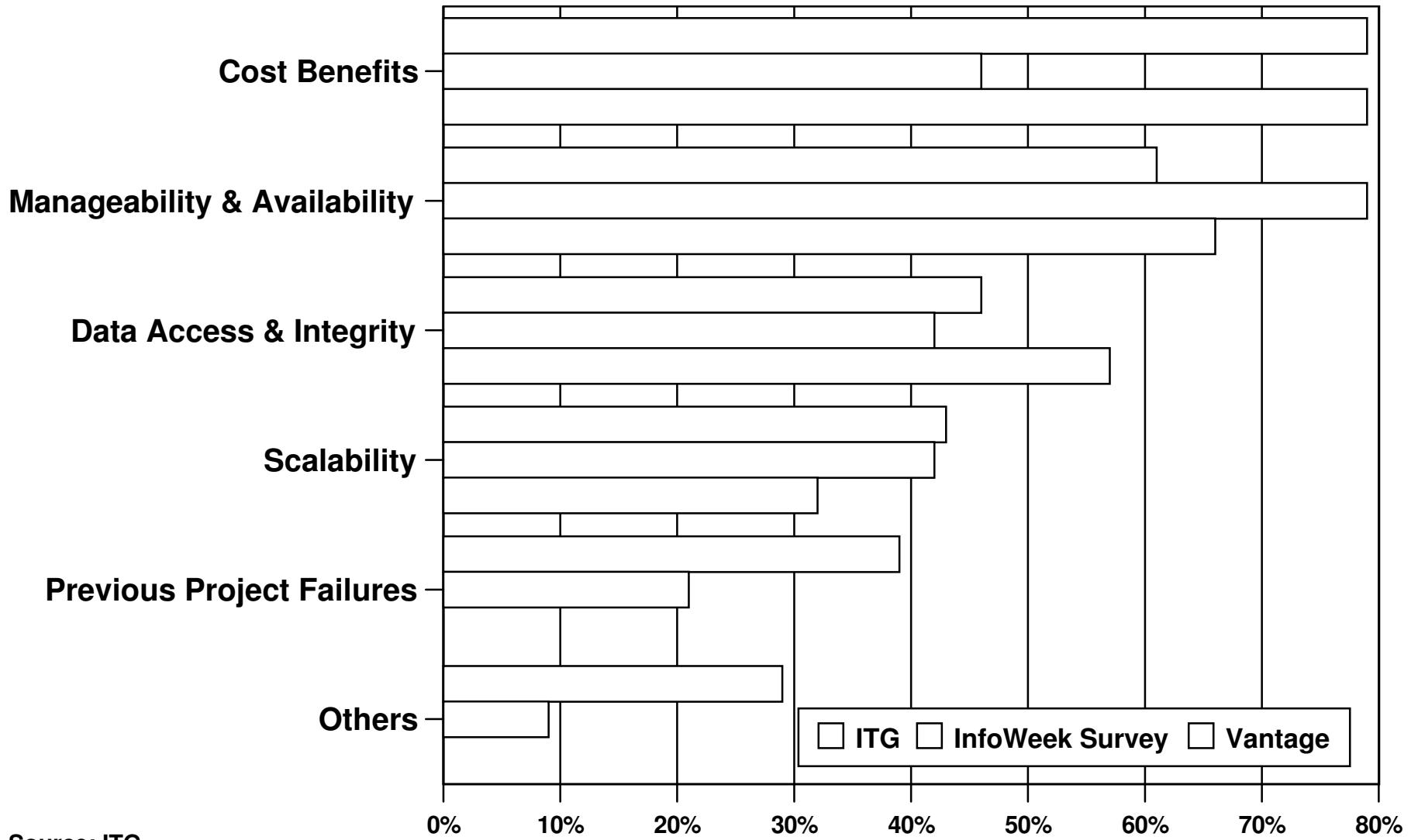

Source: ITG

ITSO

Server deployment trends

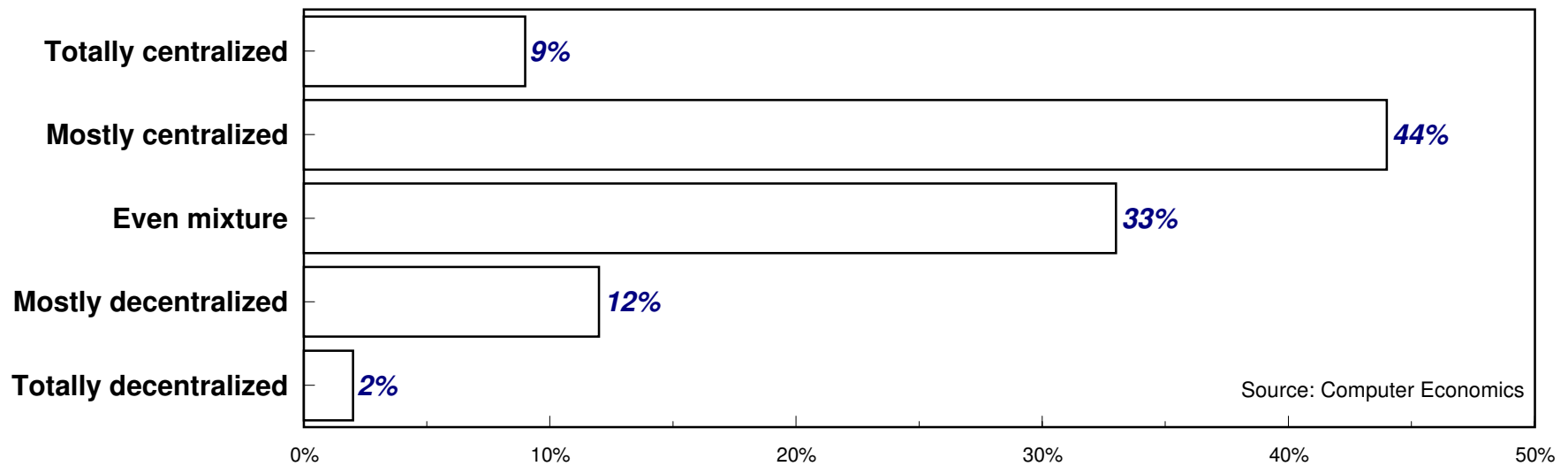
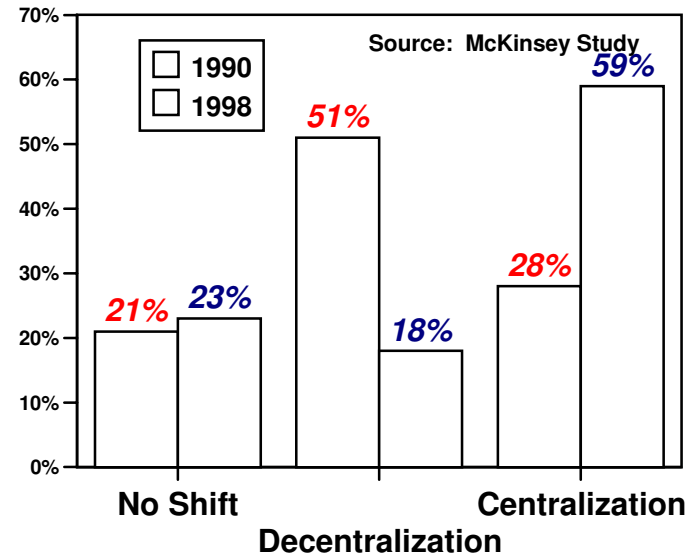
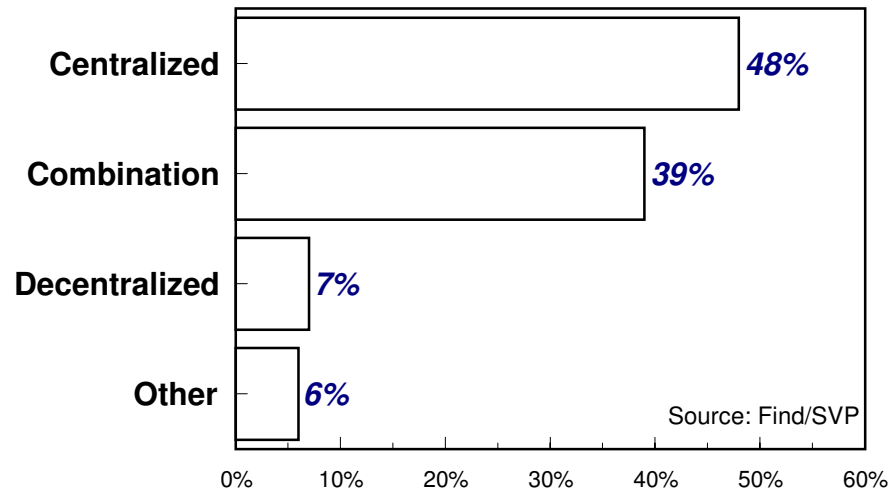

Why now?



- **Total cost of ownership:** more efficiently manage human, financial, and IT resources
- **Application service level:** faster response, higher availability, and increased data access
- **New solution investments:** current distributed / decentralized environment impeding deployment of new business applications
- **Information:** a strategic business tool requiring enterprise-wide access

Total cost of ownership



- “Lowering hardware costs and the realization that other platforms, in most cases, were not yet ready for mission critical applications caused a revival of the mainframe. Today, many enterprises are reexamining the role the mainframe plays in the operations center”

Source: Gartner Group, “What is the role of the mainframe through 2003?”, 12/1998

- “Total cost of ownership is one of the primary reasons for the resurgence of the mainframes. For large corporations, client-server computing definitely did not prove to be as economical as expected.”

Source: Cal Braunstein, Robert Frances Group

Availability impact



- 99.999% availability equates to 5 minutes downtime per year
- 97% availability equates to a loss of 263 hours per year
- 93% availability equates to a loss of 613 hours per year

Source: "WAN Downtime and SLAs", Infonetics Research 12/1998

Scalability of the mainframe



- Powerful back-end platforms are necessary to support immediate availability of data
 - ▶ Server availability critical
 - ▶ Ensuring system can handle future demand is imperative
- “A mainframe scales much more than NT or UNIX servers. And they are light years ahead of both in availability and manageability.”

Source: Carl Greiner, META Group

What is LAN data interoperability?



- For our purposes, LAN data interoperability is the ability for clients on a LAN to access data stored on S/390

LAN data interoperability solutions

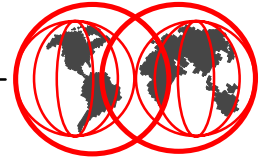

- TCP/IP network
 - ▶ Network File System (NFS)

- Novell NetWare server network
 - ▶ LAN Resource Extension and Services (LANRES, VM/ESA)
 - ▶ Network File System (NFS)

- Microsoft Windows NT server network
 - ▶ LAN Resource Extension and Services (LANRES, VM/ESA)
 - ▶ Network File System (NFS)

- SMB clients
 - ▶ Samba (VM/ESA and Linux for S/390)

LAN data interoperability solutions ...



	NFS server	LANRES	Samba
NetWare client	Via NetWare server plus gateway	Via NetWare server	
NFS client	Direct		
SMB client	Via NT server plus gateway	Via NetWare server in NT domain	Direct

LAN Resource Extension and Services

LANRES



- LANRES establishes a server environment on S/390 to allow NetWare clients transparent access to mainframe resources
- No charge feature of VM/ESA
- LANRES/VM services include:
 - ▶ Disk serving
 - ▶ Print serving
 - ▶ Data distribution
 - ▶ Central administration
- A NetWare server can be part of a Windows NT domain to provide access for Windows NT clients
- NetWare V3, V4 and V5 supported
 - ▶ Support for NetWare V5 servers is available in VM/ESA with the APAR PW00425 for VM/ESA 2.2 and later

Disk services

LANRES

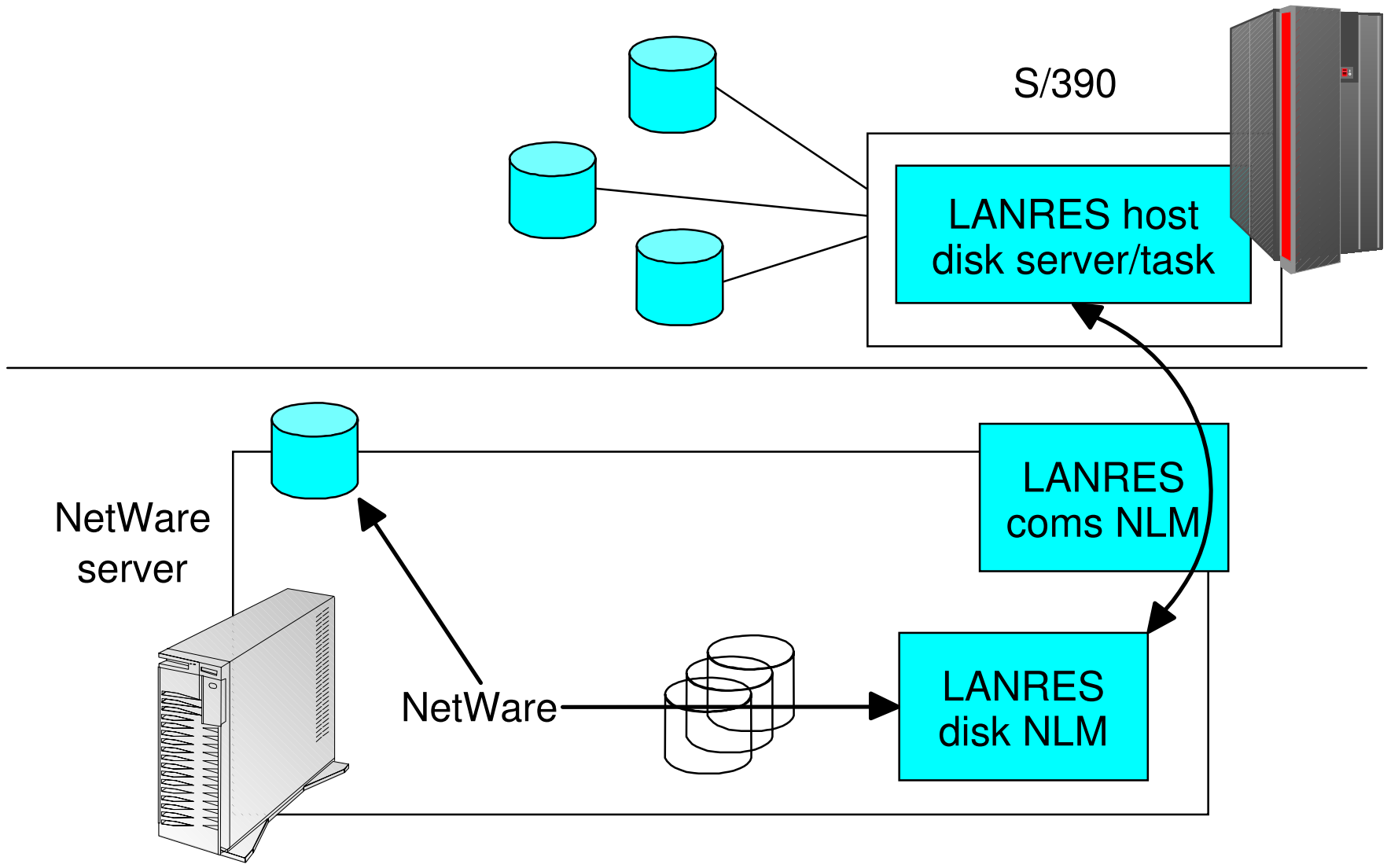

ITSO

Network File System

NFS



- Distributed file standard in the UNIX world
- NFS client and server available for Linux for S/390; NFS server available for VM/ESA and VSE/ESA
- Windows client access via:
 - ▶ 2-tier solution with an NFS client
 - ▶ 3-tier solution with SMB access to an NT server with an NFS gateway
- Access via mount and other commands on UNIX;
Access via network neighborhood or commands on Windows

Connectivity - 2-tier vs. 3-tier

NFS

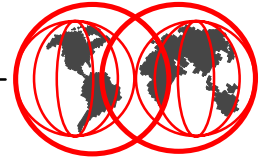

3-tier

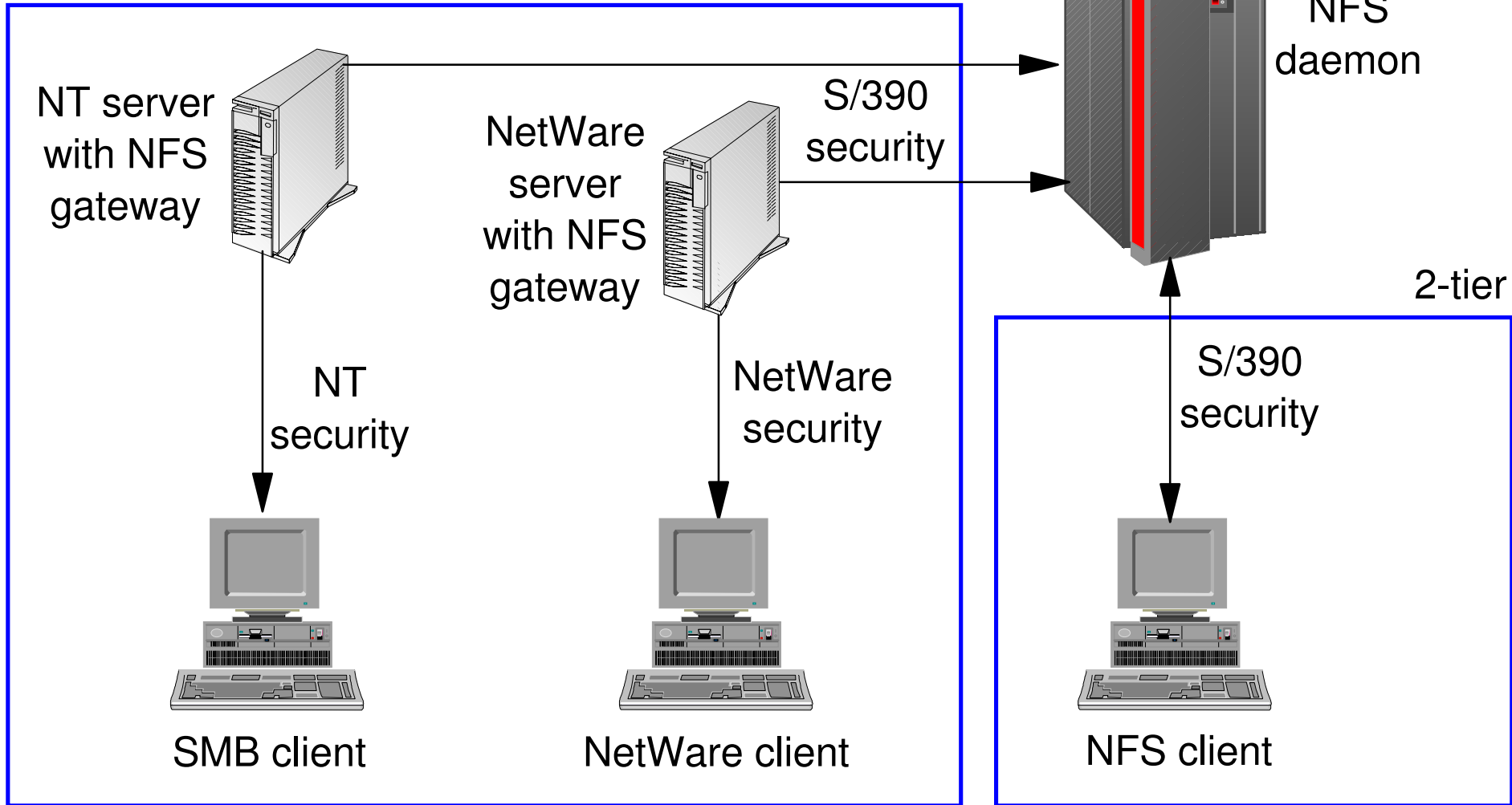

ITSO

S/390 advantages

NFS

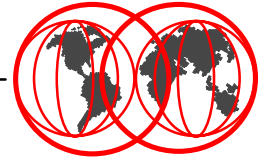

- Enjoy all the advantages of keeping your data on S/390!
 - ▶ Automatic, secure facilities to back up and recover data
 - ▶ System managed storage
 - ▶ Host access control
 - ▶ Centralized space administration

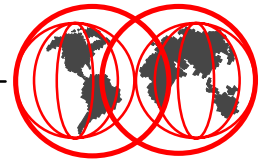

- Feature of TCP/IP for VM/ESA feature; server only
- NFS Version 3 and Mount Version 3 protocols
- NFS clients can use the UDP or TCP transport protocols
- NFS enables access to files stored on:
 - ▶ CMS minidisks
 - ▶ CMS Shared File System (SFS)
 - ▶ CMS UNIX file system, the Byte File System (BFS)
- From any platform with an NFS Client
 - ▶ PCNFSD supported for Windows clients
 - ▶ Windows environment -> VM mdisks and directories appear as a network drive
 - ▶ UNIX systems -> VM mdisks and directories can be mounted to any point in the UNIX file hierarchy



- Client and server both included in Linux distribution
- Real time access to Linux files from any environment that has NFS client capability
 - ▶ Windows environment, Linux directories appear as a network drive
 - ▶ UNIX systems, the Linux file system can be mounted to any point in the UNIX file hierarchy
- Full NFS function at Version 3 level as available on other UNIX platforms



- Feature of TCP/IP for VSE/ESA product; server only
- Real time access to VSE files from any environment that has NFS client capability
 - ▶ Windows environment, VSE files appear as a network drive
 - ▶ UNIX systems, the VSE file system can be mounted to any point in the UNIX file hierarchy
- Numerous VSE file types can be accessed via NFS, including:
 - ▶ VSAM ESDS datasets
 - ▶ POWER spool files
 - ▶ VSE library and sub-library datasets (VSE/ESA 1.3 and above)
 - ▶ Bim-Edit™ files
- NFS can allow you to use PC based tools to operate on VSE files
 - ▶ You can use Windows Explorer utility or Windows Wordpad to browse POWER spool files
 - ▶ It can also allow you to write PC or UNIX applications that transparently access VSE data

Clients and gateways for Windows

NFS

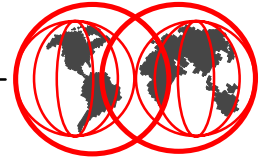

- NFS Maestro from Hummingbird
<http://www.hummingbird.com/>
- AccessNFS from Intergraph
<http://www.intergraph.com/>
- InterDrive from NetManage
<http://www.netmanage.com/>
- NFS Client and NFS Gateway from XLink Technology
<http://www.xlink.com/>

Note: This is a partial list, there are many vendors.

NFS gateway for Novell Netware servers

NFS



- Netware 5 NFS Services
 - ▶ NetWare 5 NFS Services is software that enables users to share files and print services between NetWare and any other NFS, FTP, and LPR/LPD protocol platform, including UNIX.
 - ▶ NetWare 5 NFS Services includes NFS Gateway and the NFS Server. It also includes the Print Gateway, an FTP Server, and NFS Naming Services. With NetWare 5 NFS Services, you can share files across a mixed UNIX and NetWare environment, you can print to UNIX peripherals from NetWare, and UNIX clients can print to NetWare print queues.
 - ▶ NetWare 5 NFS Services is based on the Sun Network File System protocol version 2.0 and runs on a NetWare 5 server.
- intraNetWare NFS Services 2.3 for Netware 4
- <http://www.novell.com/>

Samba



- Samba is an open source software suite that provides seamless file and print services to SMB/CIFS clients
- Samba is freely available under the GNU General Public License
- Normal SMB (LAN Manager) protocol used, clients supported include OS/2, Windows, Macintosh
- Two papers on Samba available from IBM



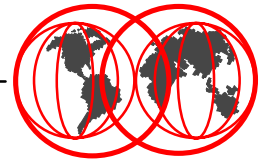

- Provides access to the Byte File System (BFS)
- Distribution:
 - ▶ On the CD-ROM which accompanies the Redbook *Porting UNIX Applications to VM/ESA*, SG24-5459
 - ▶ Download from <http://pucc.princeton.edu/~neale/>
- Installation instructions in the Redbook or on the web site



Linux for S/390

Samba

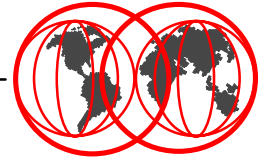

- Provides access to the Linux file system
- Distribution:
 - ▶ Download from <http://linux.s390.org/>
- Installation instructions are available in many Linux or Samba books available at many book stores



Comparison of LAN data consolidation options

VM/ESA

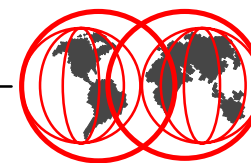

Server	NFS	Samba	LANRES
CMS Minidisk File System	Yes	No	No
CMS Shared File System	Yes	No	No
CMS Byte File System	Yes	Yes	No
NetWare File System on VM	No	No	Yes
NFS Client	Yes	No	No
Netware Client - Windows, OS/2, UNIX	Gateway	No	Yes
LAN Requester - NT Server	Gateway	No	No
LAN Requester - no server	No	Yes	No
Access Control	VMNFS	Samba	Netware

ITSO

Conclusions and action plan

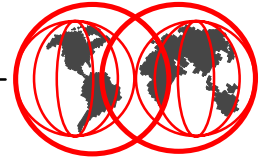

- Understand the business requirements
 - ▶ Not just short term cost and implementation speed
 - ▶ Consider long term cost and benefit
 - ▶ Flexibility
 - ▶ Data access and protection
 - ▶ Performance
 - ▶ Availability
 - ▶ Management cost and effort

- You have a choice of solutions and servers

- Select a solution based on your business needs

Sources of information on the internet



- VM/ESA <http://ibm.com/vm/>
- VSE/ESA <http://ibm.com/vse/>
- Linux for S/390 <http://ibm.com/s390/linux/>
- S/390 Server Consolidation <http://ibm.com/s390/sc/>
 - ▶ ITG Management Brief *Business Value of Consolidation* GF22-5034
<http://ibm.com/s390/sc/consult.html>
- *TCP/IP Solutions for VM/ESA*, SG24-5459-00
S/390 File and Print Serving, SG24-5330-01
Porting UNIX Applications to OpenEdition for VM/ESA, SG24-5458
<http://ibm.com/redbooks/>
- Samba and Linux papers
<http://ibm.com/software/developer/library/>



Jim Elliott
Product Manager
Enterprise Servers
IBM Americas Group

3600 Steeles Avenue East
Markham, Ontario L3R 9Z7

Telephone 905-316-5813
FAX 905-316-3737
Internet: jelliott@ca.ibm.com
Notes: Jim Elliott/Markham/IBM@IBMCA

<http://ibm.com/vm/devpages/jelliott/>