



IBM @server™

# Linux und VM/VSE - die erfolgreiche Symbiose für die Zukunft

Dr. Klaus Goebel

VSE Product Manager & Linux Technical Support Marketing Manager



# Trademarks

## The following are trademarks of the International Business Machines Corporation in the United States and/or other countries.

BladeCenter	e-business logo*	pSeries
CICS*	e-business on demand	RMF
DataPropagator	Enterprise Storage Server*	S/390*
DB2*	GDPS*	S/390 Parallel Enterprise Server
DB2 Connect	IBM*	WebSphere*
DB2 Universal Database	IBM eServer/ IBM @server	z/Architecture
DFSMSdss	IBM logo*	z/OS*
DFSMSHsm	IMS	z/VM*
DFSMSrmm	MQSeries*	zSeries*
DFSORT*	OS/390*	zSeries Entry License Charge (zELC)

\* Registered trademarks of IBM Corporation

## The following are trademarks or registered trademarks of other companies.

Java and all Java-related trademarks and logos are trademarks of Sun Microsystems, Inc., in the United States and other countries

UNIX is a registered trademark of The Open Group in the United States and other countries.

Microsoft, Windows and Windows NT are registered trademarks of Microsoft Corporation.

SET and Secure Electronic Transaction are trademarks owned by SET Secure Electronic Transaction LLC.

\* All other products may be trademarks or registered trademarks of their respective companies.

### Notes:

Performance is in Internal Throughput Rate (ITR) ratio based on measurements and projections using standard IBM benchmarks in a controlled environment. The actual throughput that any user will experience will vary depending upon considerations such as the amount of multiprogramming in the user's job stream, the I/O configuration, and the workload processed. Therefore, no assurance can be given that an individual user will achieve throughput improvements equivalent to the performance ratios stated here.

IBM hardware products are manufactured from new parts, or new and serviceable used parts. Regardless, our warranty terms apply.

All customer examples cited or described in this presentation are presented as illustrations of the manner in which some customers have used IBM products and the results they may have achieved. Actual environmental costs and performance characteristics will vary depending on individual customer configurations and conditions.

This publication was produced in the United States. IBM may not offer the products, services or features discussed in this document in other countries, and the information may be subject to change without notice. Consult your local IBM business contact for information on the product or services available in your area.

All statements regarding IBM's future direction and intent are subject to change or withdrawal without notice, and represent goals and objectives only.

Information about non-IBM products is obtained from the manufacturers of those products or their published announcements. IBM has not tested those products and cannot confirm the performance, compatibility, or any other claims related to non-IBM products. Questions on the capabilities of non-IBM products should be addressed to the suppliers of those products.

Prices subject to change without notice. Contact your IBM representative or Business Partner for the most current pricing in your geography.

# Agenda

**Linux**

**z/VM**

**VSE/ESA**

**... und die Symbiose.**



# What is Linux?

- UNIX-like operating system
- Developed / tested by the Open Source community
- Packaged and shipped by distributors
  - ▶ Red Hat, SuSE, Turbolinux
  - ▶ Other regional distributors: Red Flag, Conectiva, Mandrake, etc...
- United Linux = open industry consortium providing a binary-compatible Linux distribution

*"Hello everybody... I'm doing a (free) operating system (just a hobby, won't be big and professional...)."*

Linus Torvalds, creator of Linux, from the first Internet announcement on August 25, 1991. Even he initially underestimated its potential.

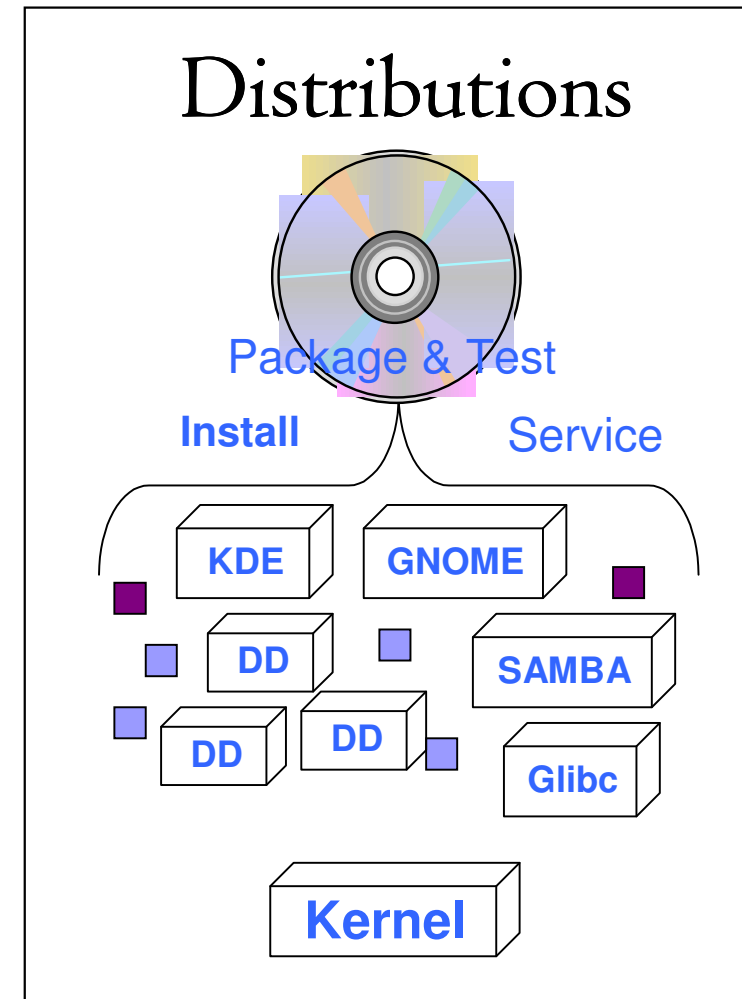

# Linux on zSeries Roadmap

## 1999 - December

IBM introduces Linux running on mainframes

## 2000

All S/390 models currently in production support Linux

z900 servers introduced with Linux support

IBM Support Line for Linux on zSeries available

IFL (Integrated Facility for Linux) available for all current models

## 2001

Awarded Best Hardware at LinuxWorld NYC

z/VM Version 4 support for Integrated Facility for Linux

Growing software vendor support including mySAP.com

## 2002

IBM @server zSeries Offering for Linux (z800 Linux only offering)

PCICA cryptography support

z800 model 0E1

## 2003

Integrated Platform for e-Business on zSeries

System Automation for Linux on zSeries

Informix for Linux on zSeries

Lotus Domino for Linux on zSeries

z990 servers introduced with Linux support

Pricing actions via mainframe charter

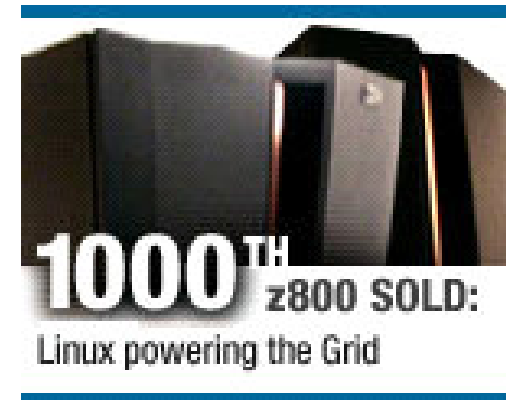

## August 2003 Announcement

	Announced	Planned Implementation
<b>Mainframe Charter</b>	<b>Now</b>	<b>8/22</b>
<b>Pricing Initiatives</b>		
<ul style="list-style-type: none"> <li>■ Memory Pricing</li> </ul>	<b>Now</b>	8/22
<ul style="list-style-type: none"> <li>■ IFL Pricing</li> </ul>	<b>Now</b>	8/22
<ul style="list-style-type: none"> <li>■ Base Configuration Changes</li> </ul>	<b>Now</b>	9/8
<ul style="list-style-type: none"> <li>■ Daily On/Off CoD Software Charges</li> </ul>	<b>Now</b>	9/15
<ul style="list-style-type: none"> <li>■ Software Price/Performance Improvements for z990</li> </ul>	<b>Now</b>	10/1
<ul style="list-style-type: none"> <li>■ WLC Pricing Enhancements</li> </ul>	<b>Now</b>	10/1
<ul style="list-style-type: none"> <li>■ NALC Price Reduction</li> </ul>	<b>Now</b>	10/1
<ul style="list-style-type: none"> <li>■ On/Off CoD for z990 IFL Engines</li> </ul>	<b>Now</b>	10/31
<ul style="list-style-type: none"> <li>■ WebSphere® Sub-Capacity SOD</li> </ul>	<b>Now</b>	Planned By Year-End 2003
<b>z990 On Demand Business Investment Promotion</b>	<b>Now</b>	Planned for 8/26



## Why Linux on zSeries?

- Exploding number of applications & solutions on Linux
- Large number of highly skilled programmers familiar with Linux
- Integrated business solutions
  - ▶ Data richness from zSeries
  - ▶ Web capabilities of Linux applications
- Industrial strength environment
  - ▶ Qualities of service from zSeries
  - ▶ Flexibility and openness of Linux
- Unique ability to easily consolidate large number of servers



# Linux on zSeries Development Focus Areas

- New Hardware support & exploitation
  - Virtual Server Environments
  - Systems Management
  - Workload Management
  - Security
  - High Availability
  - Networking
  - SCSI/FCP and SAN considerations
  - Compiler enhancements
  - Performance & Scalability
  - RAS
- Linux Kernel 2.6 technology
    - ▶ Updated I/O and memory subsystem for faster throughput and scalability
    - ▶ Faster, more scalable processor scheduler
    - ▶ Faster, POSIX compliant threading library
    - ▶ User-mode Linux to allow multiple system images running on the same box to aid server consolidation and application separation
    - ▶ Asynchronous I/O and completion events - a big improvement for Web servers and databases
    - ▶ Support for disks larger than 2 TB and for SGI's XFS enterprise file system





 business on demand

## The IBM Linux Strategy

1. Fully *participate in the evolution of Linux* through open source submission of IBM developed technologies and by partnering with the OSC to enhance Linux
2. Create a *pervasive application development and deployment environment* built on Linux
3. Produce an *industry-leading product line* built to run Linux and Linux applications optimally
4. Ensure that all *IBM operating environments have Linux affinity* that fully supports Linux, coexistence with Linux or compatibility with Linux interfaces
5. Create *bundled offerings* including hardware, software, and services built on Linux

# z/VM: Status & Strategy



# VM Roadmap

## z/VM Version 4: Best-of-Breed Virtualization Technology

- ★ Generating new business with Linux on zSeries
- ★ Enabling growth for existing VM customers

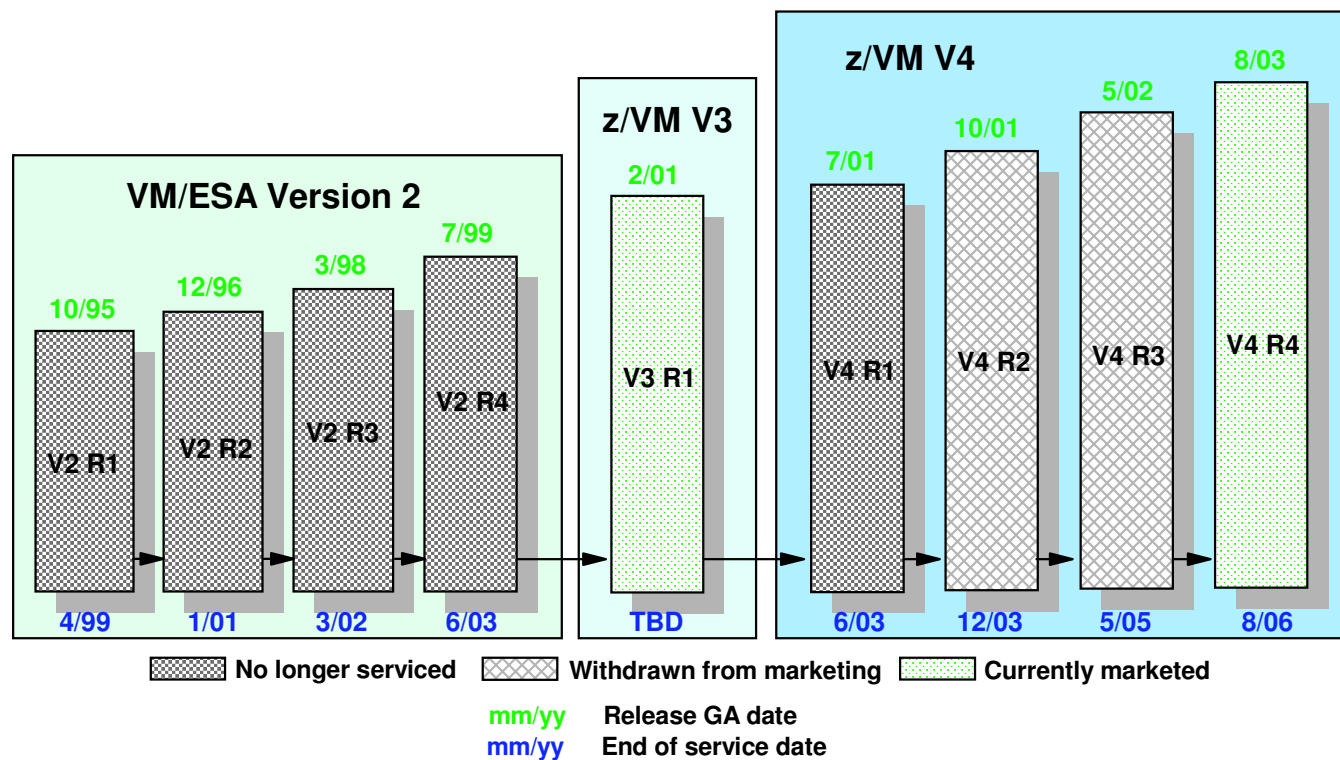

## Major Differentiators in VM's Versions

### • Hardware Support:

- z/VM V4 supports both, standard processors and IFLs
- z/VM V4 supports ALS2 only

### • Pricing:

- z/VM V4 has IPLA pricing, ie. OTC per processor

<b>VM/ESA V2</b>	<b>z/VM V3</b>	<b>z/VM V4</b>
-	eServer zSeries	eServer zSeries
S/390 Parallel Enterprise Servers incl. G3, G4, G5, G6	S/390 Parallel Enterprise Servers incl. G3, G4, G5, G6	S/390 Parallel Enterprise Servers G5 and G6
S/390 Multiprise 2000 S/390 Multiprise 3000	S/390 Multiprise 2000 S/390 Multiprise 3000	S/390 Multiprise 3000
S/390 Integrated Server P/390 R/390	S/390 Integrated Server P/390 R/390	-
-	-	IFL for z800, z900, z990, G5, G6, Multiprise 3000

**ALS1**

**ALS2**

## z/VM V4.4

*Announced 13 May 2003, available since 15 August 2003*

- **Processor and device support**
  - ▶ IBM eServer zSeries Model 990
  - ▶ Cascaded FICON directors
  - ▶ Newest z800 servers
  - ▶ Integrated 3270 console support
  - ▶ IBM ESS PPRC-XD support
  - ▶ ESS FlashCopy V2 and PPRC V2
  - ▶ Guest IPL support for SCSI disks
- **Virtual networking enhancements**
  - ▶ Enhanced QDIO performance
  - ▶ Virtual FICON CTCA support
  - ▶ Guest LAN support for IPv6
  - ▶ Virtual IP switch
- **Connectivity enhancements**
  - ▶ IEEE VLAN support
  - ▶ Extended HiperSockets support
  - ▶ TCP/IP stack security enhancements
  - ▶ TCP/IP stack performance improvements
  - ▶ VM SSL server upgrade for Linux
  - ▶ IMAP server authentication enhancements
- **Server hosting support**
  - ▶ Systems management APIs
  - ▶ VMRM enhancements
  - ▶ 2nd-level Guest Parallel Sysplex support
  - ▶ Reduced scheduler lock contention
  - ▶ CP command response suppression
- **System management enhancements**
  - ▶ Performance Toolkit for VM
  - ▶ HCD and HCM support
  - ▶ LPAR Monitor enhancements
  - ▶ Automated SFS shutdown
  - ▶ Installation and service enhancements
- **Language support enhancements**
  - ▶ Language Environment upgrade
  - ▶ C/C++ compiler support

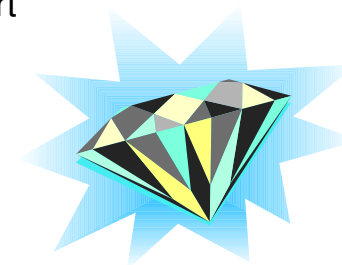

## Statements of Direction for z/VM

- Future releases of z/VM will support greater than 16 processors in a single VM image
- Future releases of z/VM will require z/Architecture
- z/VM V4.4 or later will provide support for up to 60 LPARs
- z/VM V4.4 or later will provide support for up to four logical channel subsystems (LCSS)
- Future releases of z/VM will provide guest support for the PCIX Cryptographic Coprocessor (PCIXCC)
- z/VM V4.4 is planned to be the last release offering the RTM and PRF features; future performance management enhancements are intended to be delivered via the Performance Toolkit for VM



Note: All statements regarding IBM's plans, directions, and intent are subject to change or withdrawal without notice. Any reliance on this Statement of Direction is at the relying party's sole risk and will not create any liability or obligation for IBM.

# VM Future Enhancements

## z/VM Version 4: Best-of-Breed Virtualization Technology

- ★ Generating new business with Linux on zSeries
- ★ Enabling growth for existing VM customers

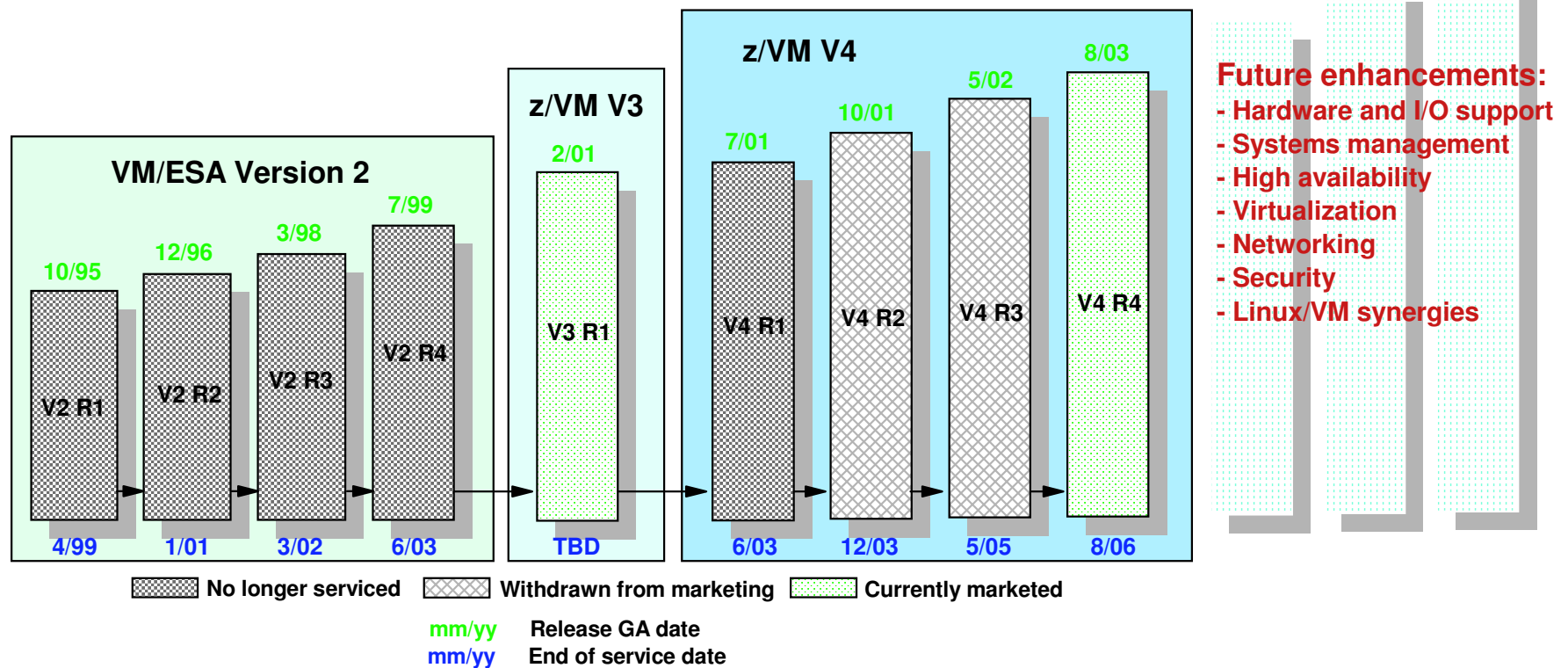

- Future enhancements:**
- Hardware and I/O support
  - Systems management
  - High availability
  - Virtualization
  - Networking
  - Security
  - Linux/VM synergies

# VSE/ESA: Status & Strategy





# VSE/ESA Roadmap

Capacity  
Quality  
z/OS & OS/390 Affinity  
e-business Enablement

## VSE/ESA V2.5, V2.6, V2.7

Sept. 2000+

- Enhanced Interoperability
- e-business Connectors



## VSE/ESA Version 2.4 1999

- CICS Transaction Server for VSE/ESA
- e-business

## VSE/ESA Version 2.3 1997

- TCP/IP based Communication



## VSE/ESA Version 2 1994

- N-way S/390 Servers
- Investment Protection - Year 2000

## VSE/ESA Version 1 1990

- Constraint Relief
- ESA Exploitation



# Infrastructure for e-business on demand

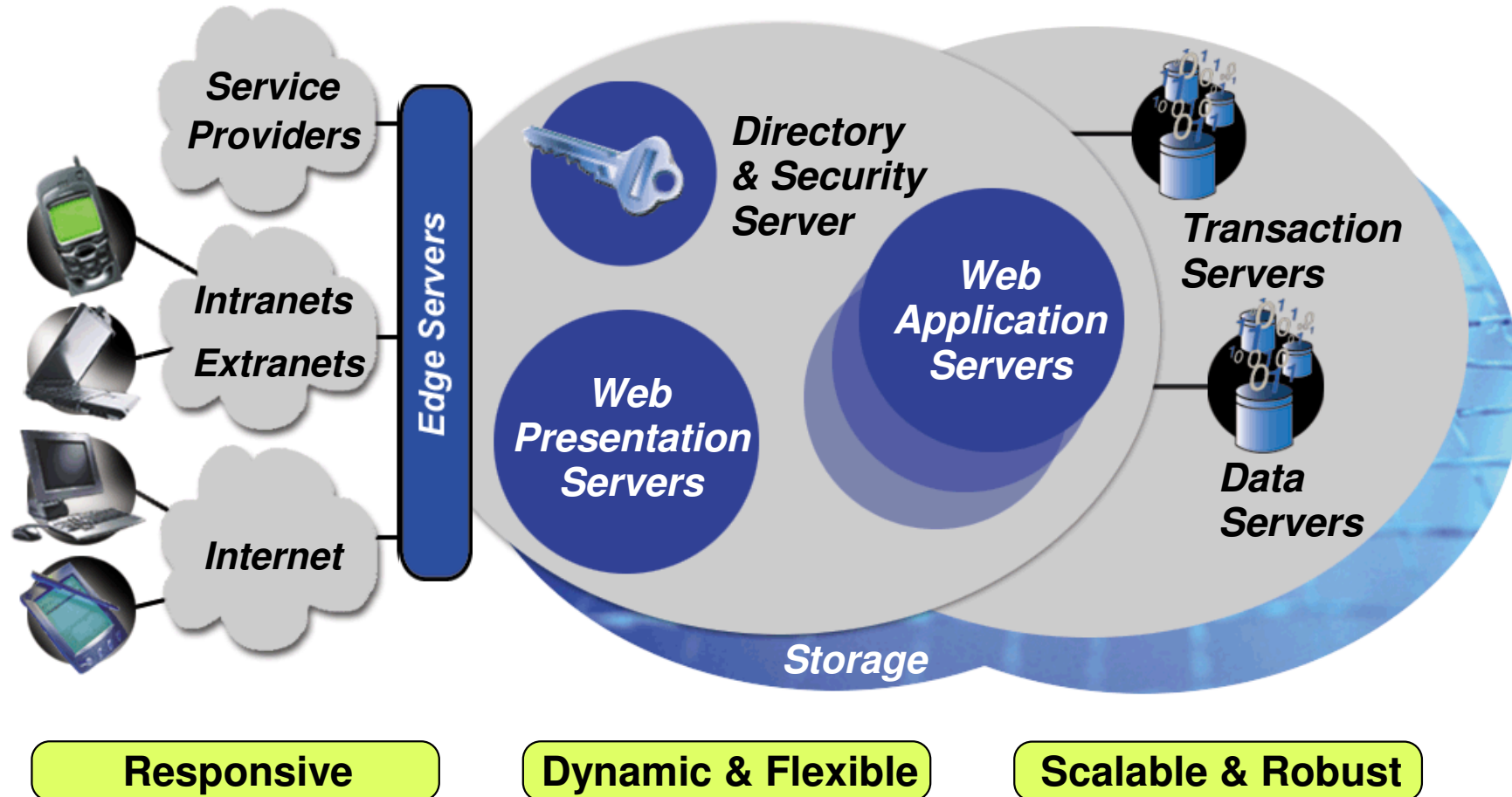

# VSE Strategy

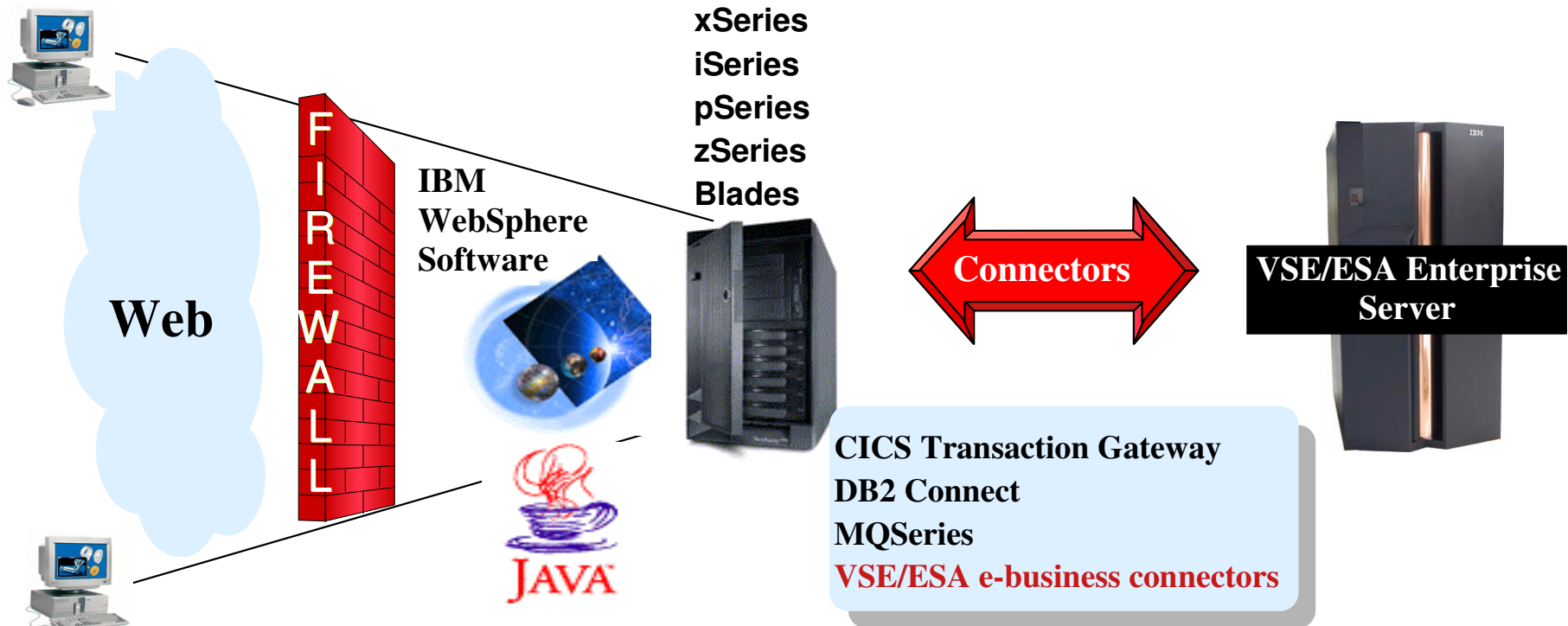

**Client**

**Business Services**

**Appl/Data Services**

# VSE/ESA V2R5

V2R4 plus CWS and Java & DB2 Connectors

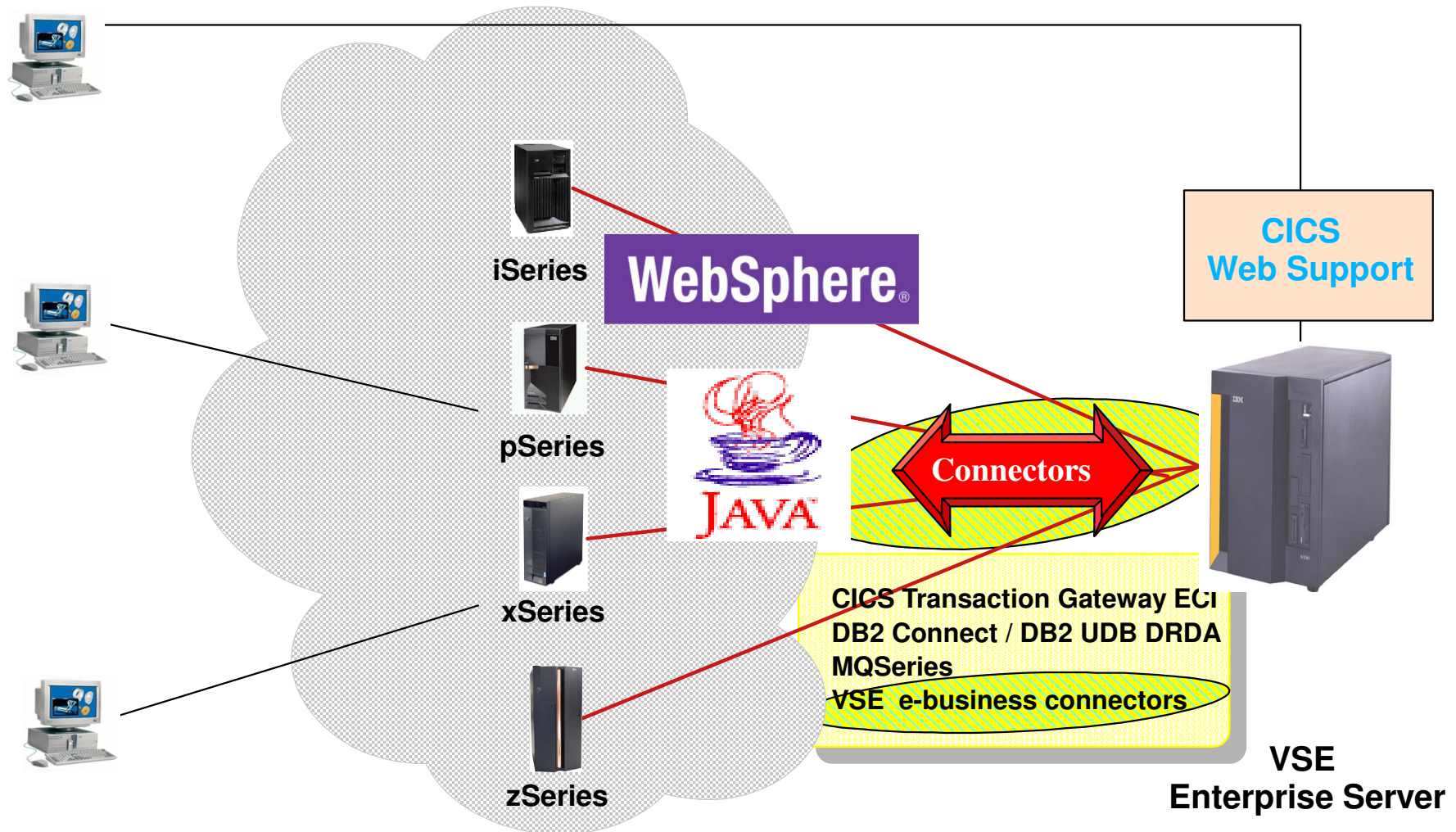

**Client**

**Business Services**

**Tran/Data Services**

# VSE/ESA V2R6

V2R5 *plus* SSL and OSA Express

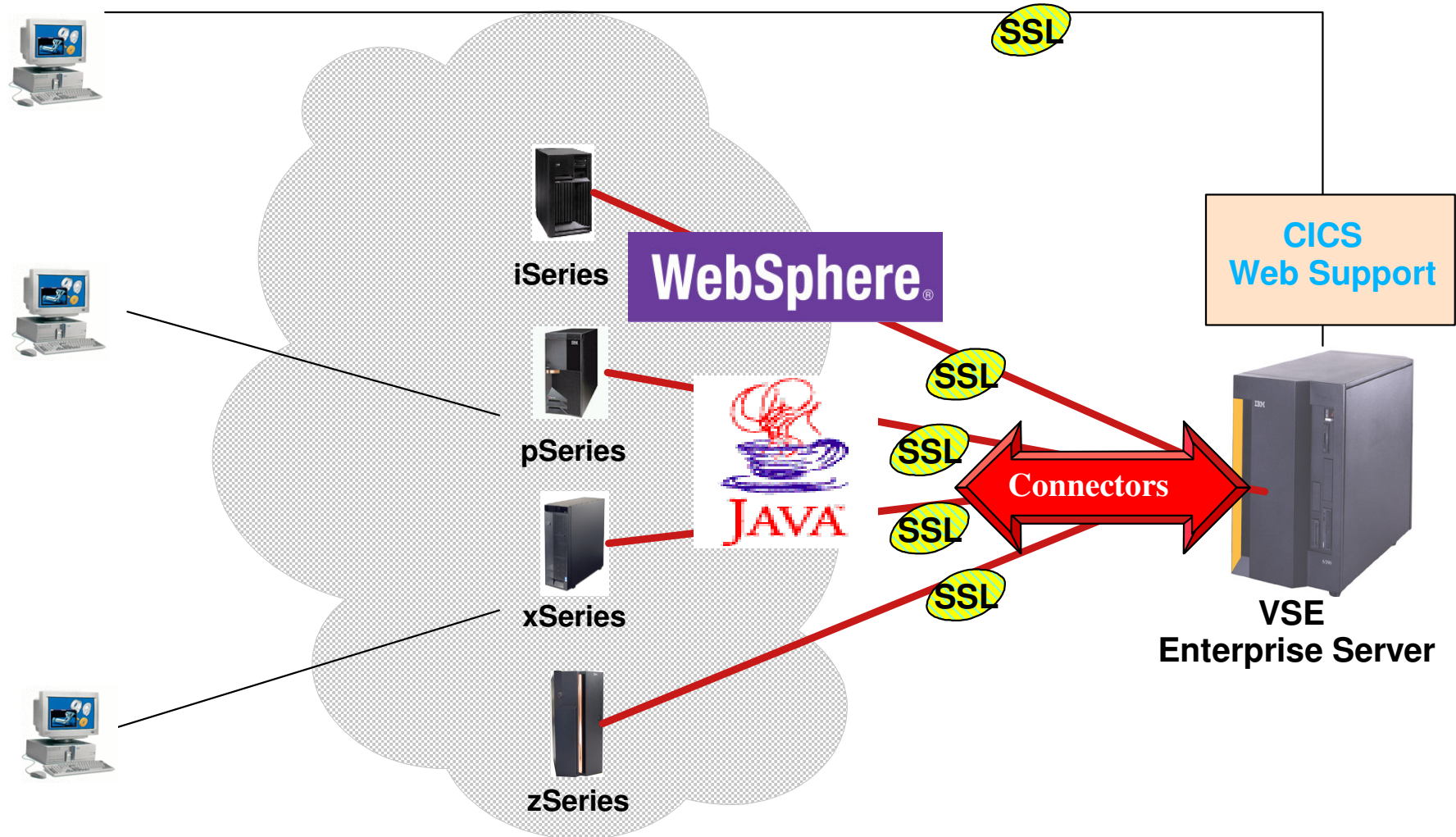

**Client**

**Business Services**

**Tran/Data Services**

| z/VM, VSE/ESA, and Linux on zSeries

# VSE/ESA V2R7

V2R6 *plus* HiperSockets and PCICA

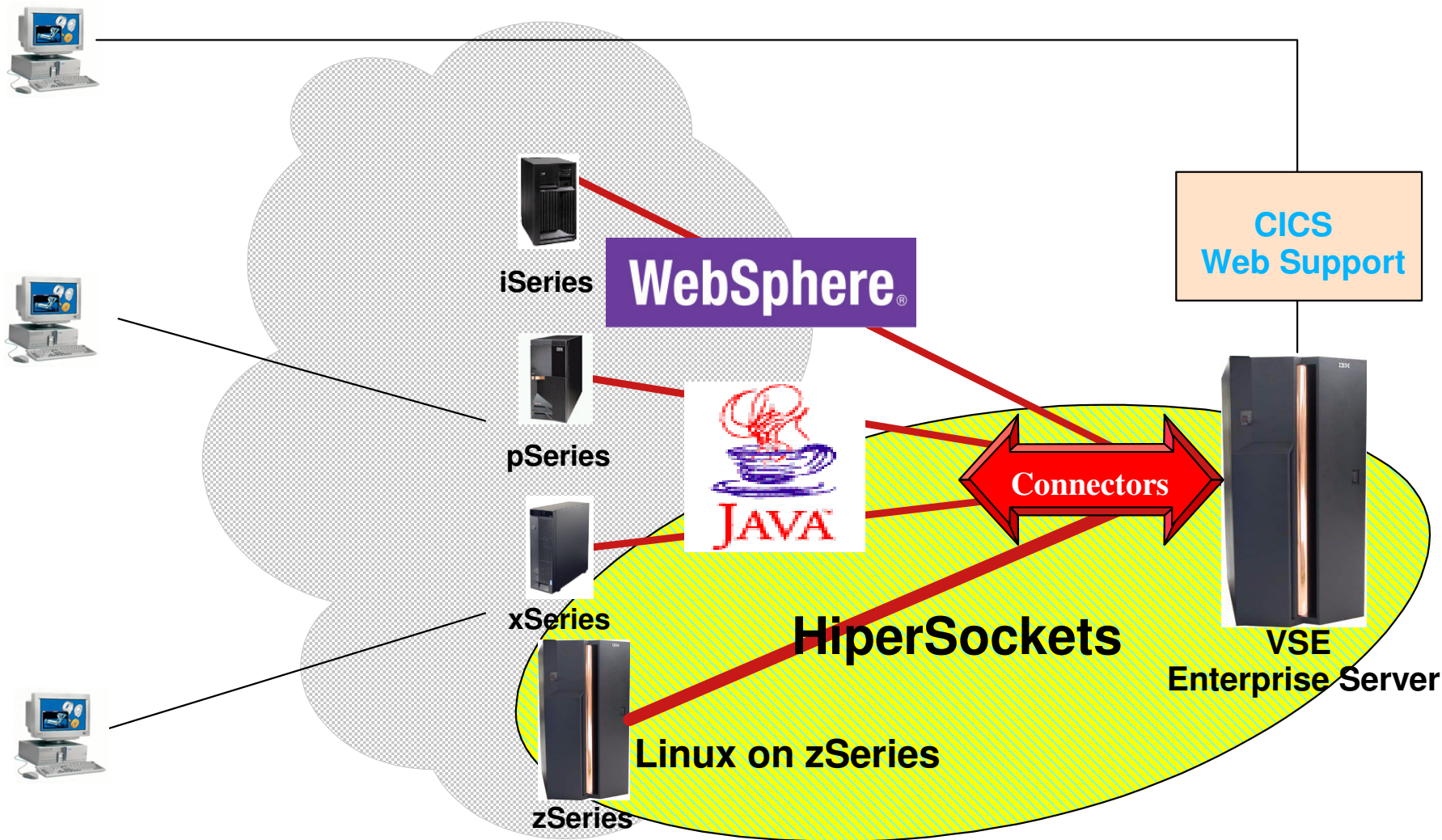

**Client**

**Business Services**

**Tran/Data Services**

| z/VM, VSE/ESA, and Linux on zSeries

# VSE Future Development Focus

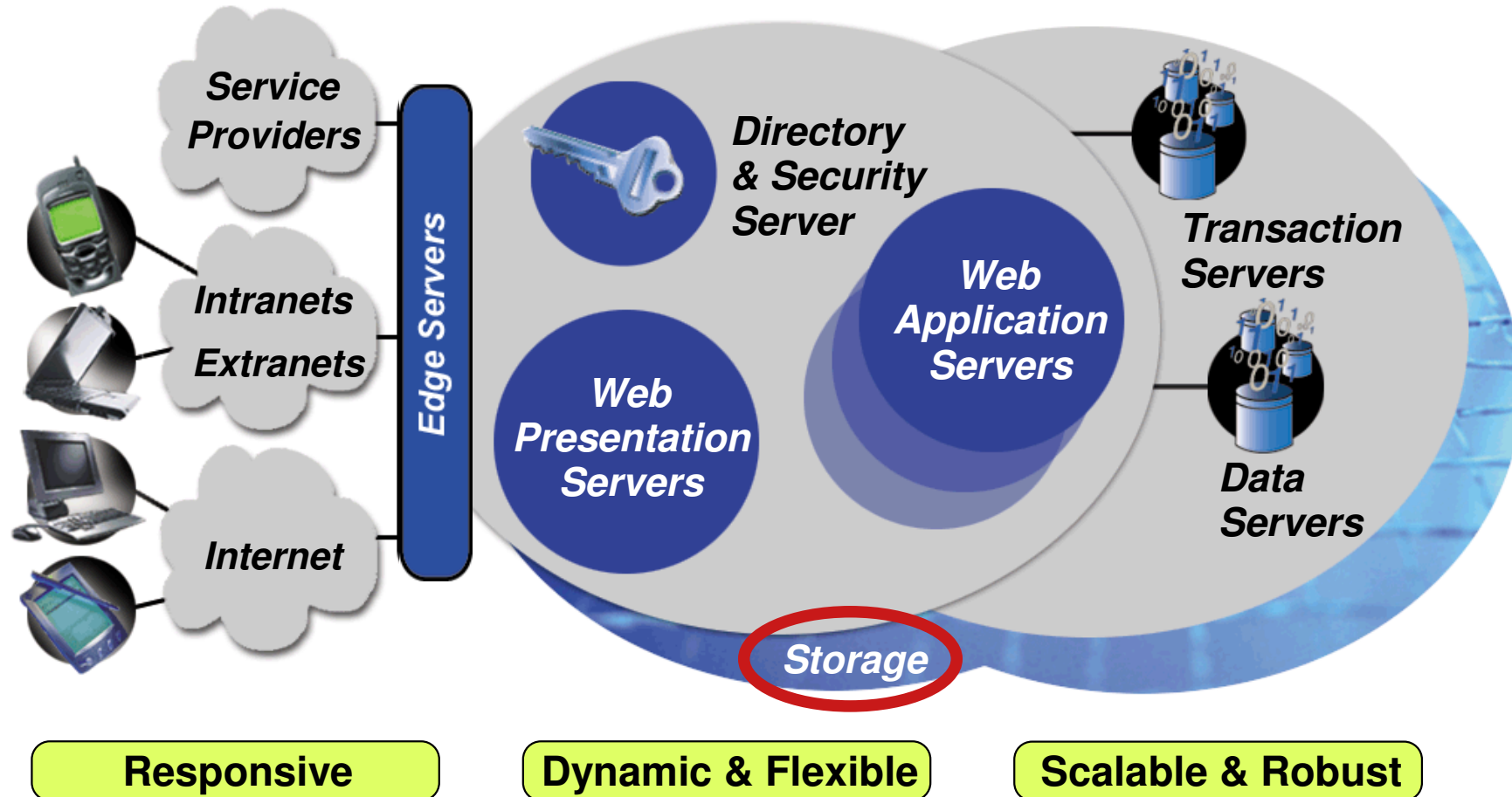

# VSE/ESA Future Direction

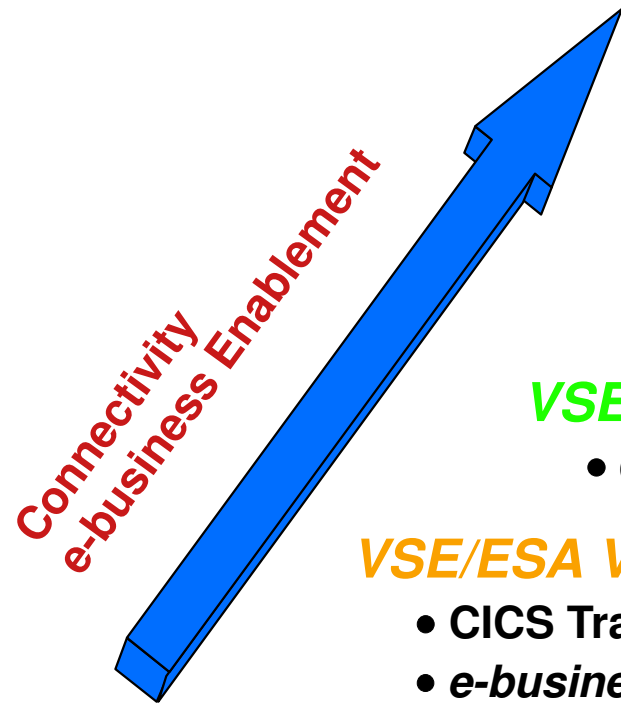

## **VSE/ESA V2.7**    *March 2003*

- HiperSockets, ALS2

## **VSE/ESA V2.6**    *Dec. 2001*

- ECI via TCP/IP, SSL

## **VSE/ESA V2.5**    *Sept. 2000*

- e-business Connectors

## **VSE/ESA V2.4**    *June 1999*

- CICS Transaction Server for VSE/ESA
- *e-business*



### **Strategy:**

- **P**rotect customer investments
- **I**ntegrate in hybrid environments
- **E**xploit Linux, especially Linux under z/VM



# Linux & VM/VSE: Die Symbiose



# Usage Scenarios

## Consolidation of servers

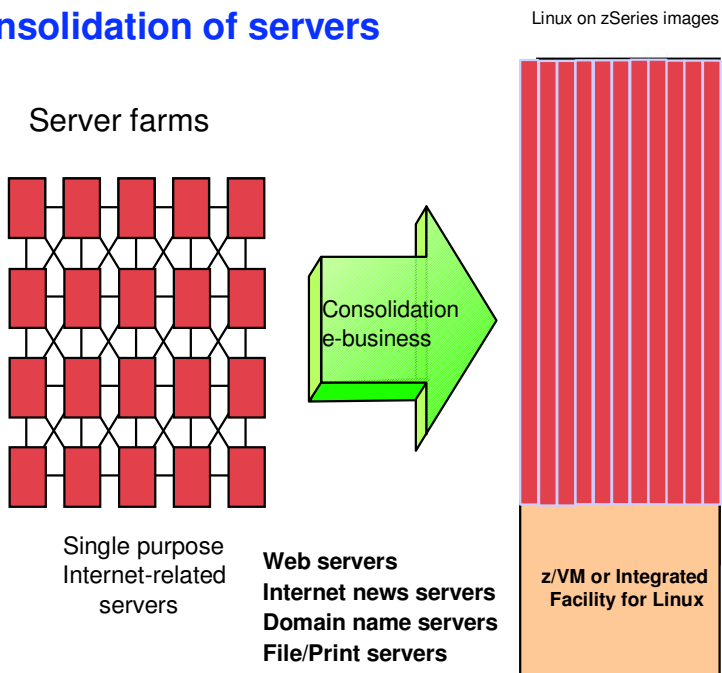

## Enhancing the S/390 investment

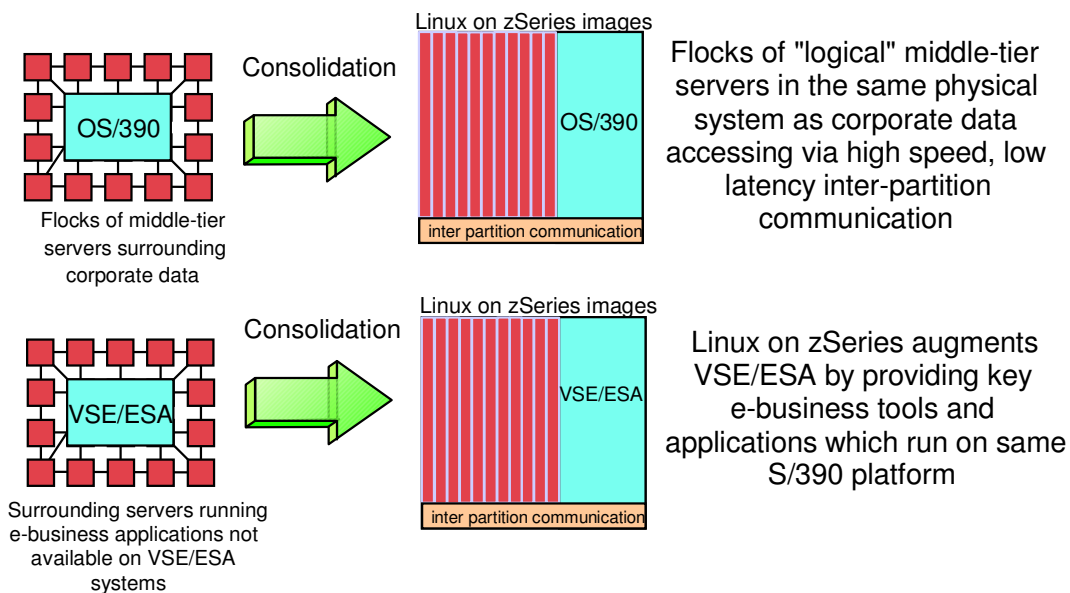

## Bringing it all together!

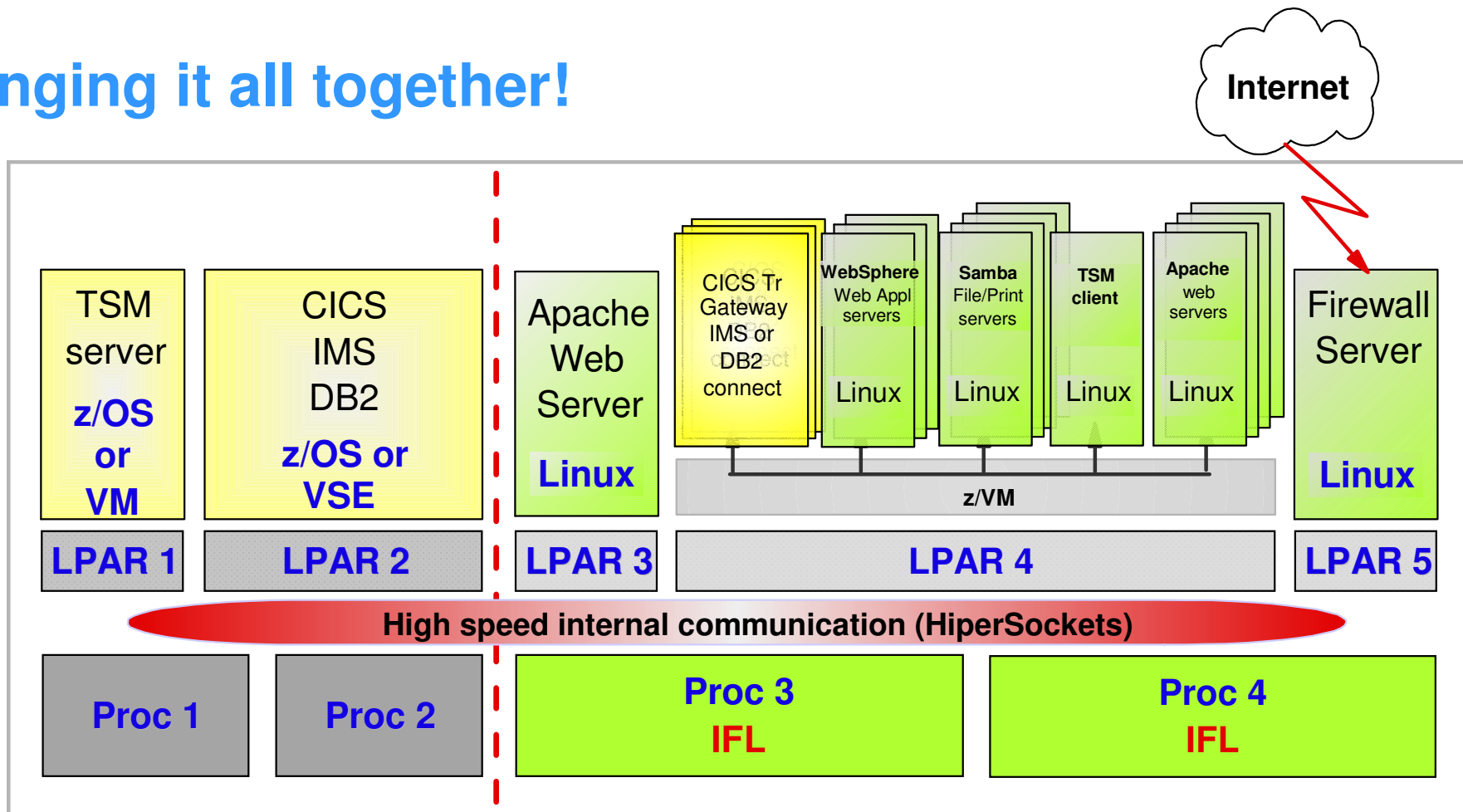

### ■ Integrated solution

- ▶ Linux applications provide front-end to DB2, CICS, IMS
- ▶ 3-tier architecture on 2-tier hardware
- ▶ High speed communication between virtual servers

## Summary



...die erfolgreiche Symbiose für die Zukunft!