

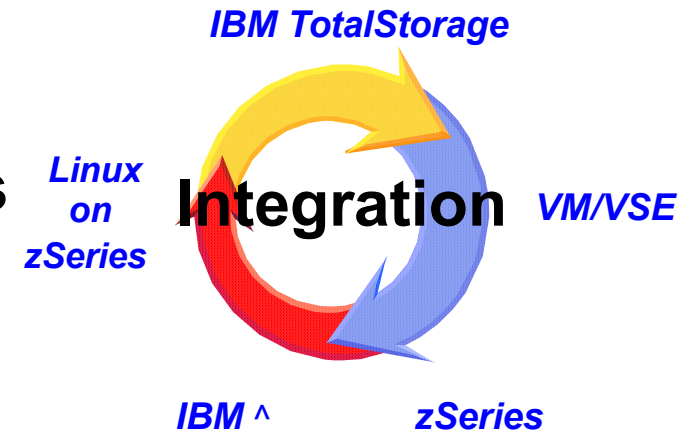

IBM eServer™

# Neues von IBM im Umfeld von z/VM, z/VSE und Linux auf zSeries

VM/VSE GSE Dortmund



**Dr. Klaus Goebel**

VSE Systems Mgr. & Linux Technical Support Marketing Mgr.

# Trademarks

## The following are trademarks of the International Business Machines Corporation in the United States and/or other countries.

AIX*	FlashCopy*	OS/390*	z/Architecture
CICS*	HiperSockets	Multiprise*	z/OS*
DB2*	HyperSwap	Parallel Sysplex*	z/VM
DFSMSrmm	IBM*	Performance Toolkit for VM	zSeries*
DFSORT*	IBM e((logo)server*	PR/SM	zSeries Entry License Charge
Domino	IBM eServer	RMF	
e-business logo*	IBM logo*	S/390*	
e-business on demand	IMS	Tivoli*	
Enterprise Storage Server*	iSeries	TotalStorage*	
ESCON*	Language Environment*	VSE/ESA	
FICON	Lotus*	WebSphere*	
FICON Express			

\* Registered trademarks of IBM Corporation

## The following are trademarks or registered trademarks of other companies.

Java and all Java-related trademarks and logos are trademarks of Sun Microsystems, Inc., in the United States and other countries

UNIX is a registered trademark of The Open Group in the United States and other countries.

Microsoft, Windows and Windows NT are registered trademarks of Microsoft Corporation in the United States, other countries, or both.

SET and Secure Electronic Transaction are trademarks owned by SET Secure Electronic Transaction LLC.

\* All other products may be trademarks or registered trademarks of their respective companies.

### Notes:

Performance is in Internal Throughput Rate (ITR) ratio based on measurements and projections using standard IBM benchmarks in a controlled environment. The actual throughput that any user will experience will vary depending upon considerations such as the amount of multiprogramming in the user's job stream, the I/O configuration, the storage configuration, and the workload processed. Therefore, no assurance can be given that an individual user will achieve throughput improvements equivalent to the performance ratios stated here.

IBM hardware products are manufactured from new parts, or new and serviceable used parts. Regardless, our warranty terms apply.

All customer examples cited or described in this presentation are presented as illustrations of the manner in which some customers have used IBM products and the results they may have achieved. Actual environmental costs and performance characteristics will vary depending on individual customer configurations and conditions.

This publication was produced in the United States. IBM may not offer the products, services or features discussed in this document in other countries, and the information may be subject to change without notice. Consult your local IBM business contact for information on the product or services available in your area.

All statements regarding IBM's future direction and intent are subject to change or withdrawal without notice, and represent goals and objectives only.

Information about non-IBM products is obtained from the manufacturers of those products or their published announcements. IBM has not tested those products and cannot confirm the performance, compatibility, or any other claims related to non-IBM products. Questions on the capabilities of non-IBM products should be addressed to the suppliers of those products.

Prices subject to change without notice. Contact your IBM representative or Business Partner for the most current pricing in your geography.

# Agenda

- IBM zSeries Server z890
- z/VSE V3.1
- z/VM V5.1
- Linux Kernel 2.6
- Zusammenfassung



# Agenda

- **IBM zSeries Server z890**
- **z/VSE V3.1**
- **z/VM V5.1**
- **Linux Kernel 2.6**
- **Zusammenfassung**

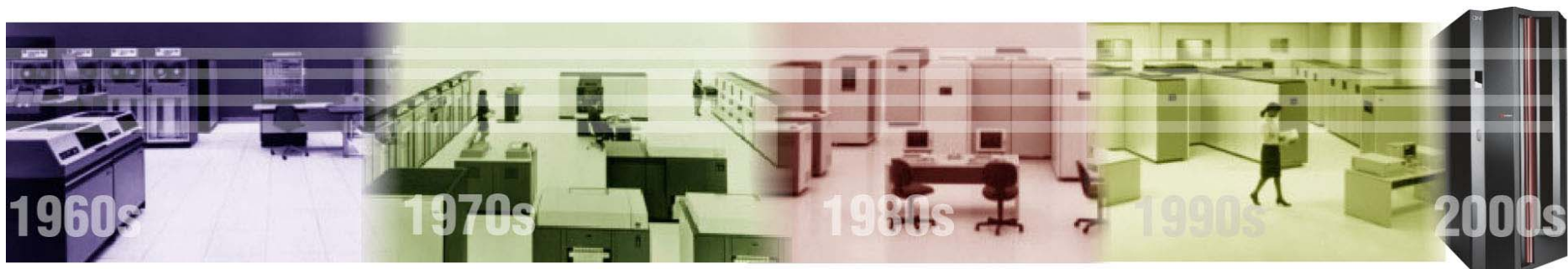

# Das neueste Mitglied der zSeries Familie: z890

- **Basiert auf z990 Technologie**
  - Beinhaltet z990 Features & Funktionen (z.B. On/Off Capacity on Demand)
- **Verschiedene 'capacity settings' bringen Flexibilität und Granularität**
  - Uniprocessor Performance bei ca. 350 MIPS
  - EIN Modell mit Capacity Settings von 26....1300 MIPS
  - Spezielle Prozessoren für Coupling (ICF), Java (zAAP) und Linux (IFL)
- **Volle Upgrade Möglichkeiten innerhalb der Familie**
  - Terms & Conditions beachten
- **Verbesserungen bei Networking & Connectivity**
  - OSA-Express Integrated Console Controller
- **Neue Preis-Modelle**
  - Entry Workload License Charge (EWLC)
  - EWLC Tiered Pricing

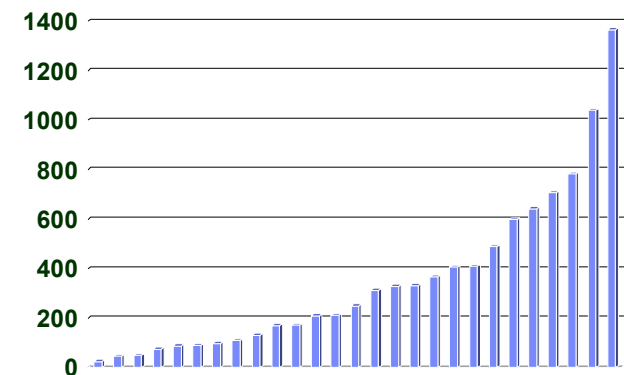
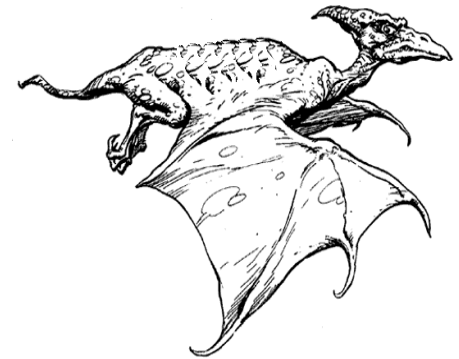

# zAAP - zSeries Application Assist Processor

***New specialty assist processor dedicated exclusively to execution of Java workloads under z/OS® – e.g. WebSphere®***

- ▶ Available on IBM Server™ zSeries® 990 (z990) and zSeries 890 (z890) and future zSeries servers only
- ▶ Leveraged by workloads with Java cycles, e.g. WebSphere, DB2®
- ▶ Attractively priced at \$125K USD per zAAP engine
- ▶ Up to 1 zAAP per general purpose processor in an LPAR
- ▶ Executes Java Code with no changes to applications
- ▶ Traditional IBM zSeries software charges unaffected
- ▶ Sub-capacity eligible IBM software charges can be reduced
- ▶ zAAP feature availability was June 30<sup>th</sup>, 2004; software exploitation was September 24<sup>th</sup>, 2004 with z/OS 1.6

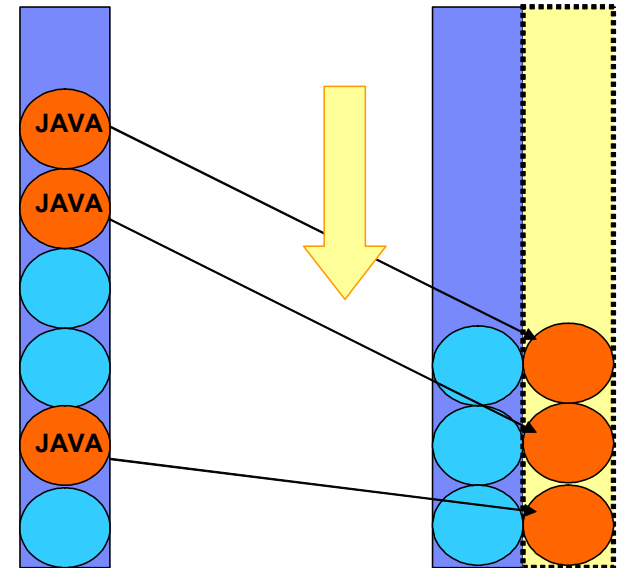

***Objective: Enable integration of new Java based Web applications with core z/OS backend database environment for high performance, reliability, availability, security, and lower total cost of ownership***

# z890 – Capacity Setting 110 im Überblick

- **zSeries Technologie in ihrer kleinsten Ausführung**
  - ▶ 26 MIPS
- **2 Logische Channel SubSysteme (LCSS)**
  - ▶ Bis zu 240 ESCON Kanäle und/oder 32 FICON Kanäle
  - ▶ OSA-Express Ports für Gigabit Ethernet, 1000BASE-T Ethernet, Token-Ring, Integrated Console Controller
  - ▶ Open FCP/SCSI
  - ▶ HiperSockets Support für 16 interne LANs
- **IFL**
- **Memory**
  - ▶ 8 GB Standard
- **Bis zu 15 LPARS**
- **zELC Pricing**



# IBM Software Pricing Modelle

## Price for VSE Stack

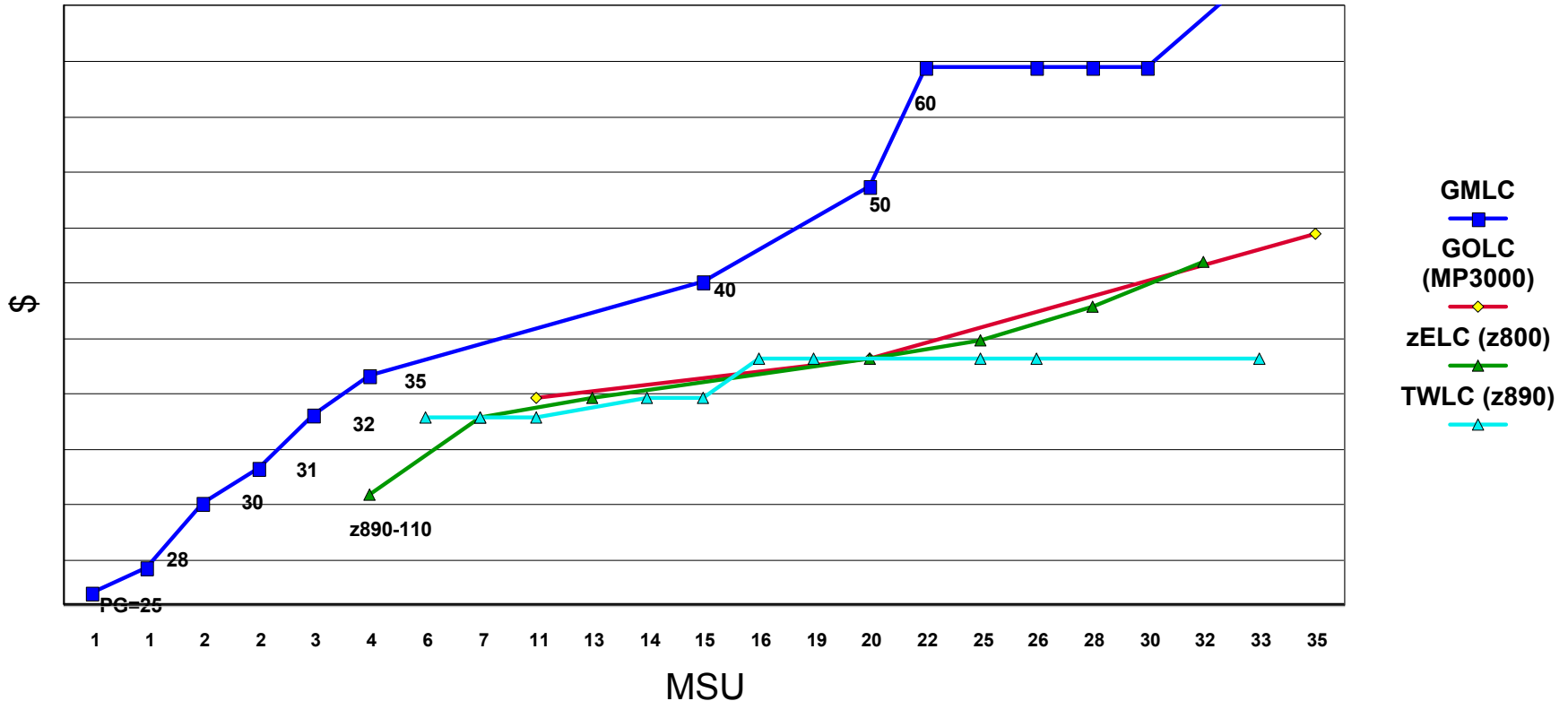

**Notes:**

- only (at least) ALS2 capable processors listed up to 35 MSUs
- MOSP = 85% of GMLC
- 1 MSU = 6 MIPS
- stack = VSE, LE, CICS, VTAM, TCP/IP, DB2



## ... und Zuwachs in der ESS Familie

### ▪ **ESS Model 750**

- ▶ Für moderate Kapazitätsanforderungen - bis zu 4.6 TB
- ▶ Mit attraktivem Preis
- ▶ Und der Möglichkeit zum 'non-disruptive' Upgrade auf ESS Model 800

### ▪ **ESS Model 800**

- ▶ Exzellente Skalierbarkeit bis zu 55.9 TB
- ▶ Bestens geeignet für die überwiegende Anzahl von Workload Anforderungen
- ▶ Große Auswahl an Plattenkapazitäten und -geschwindigkeiten

### ▪ **ESS Model 800 Turbo**

- ▶ Bis zu 30% höherer Durchsatz als beim ESS Basismodell 800
- ▶ Geeignet für höchstperformante Umgebungen
- ▶ Möglichkeit zum 'non-disruptive' Upgrade vom ESS Basismodell 800

# Agenda

- IBM zSeries Server z890
- z/VSE V3.1
- z/VM V5.1
- Linux Kernel 2.6
- Zusammenfassung

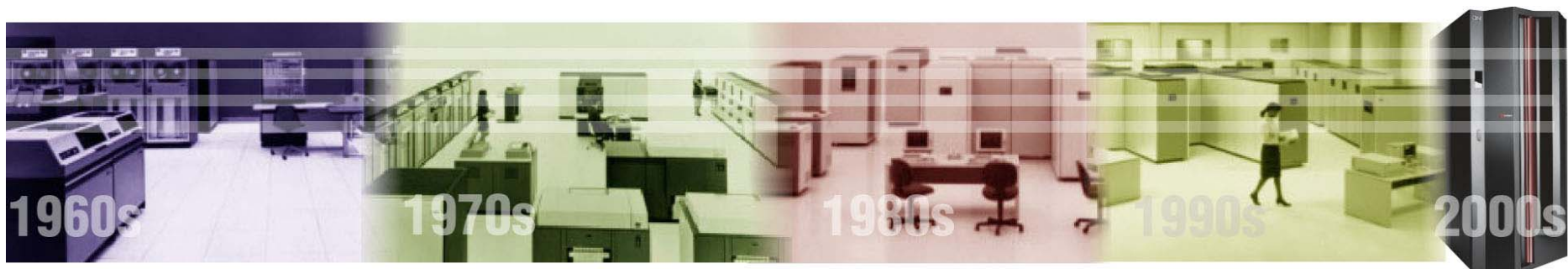

# VSE Roadmap

???

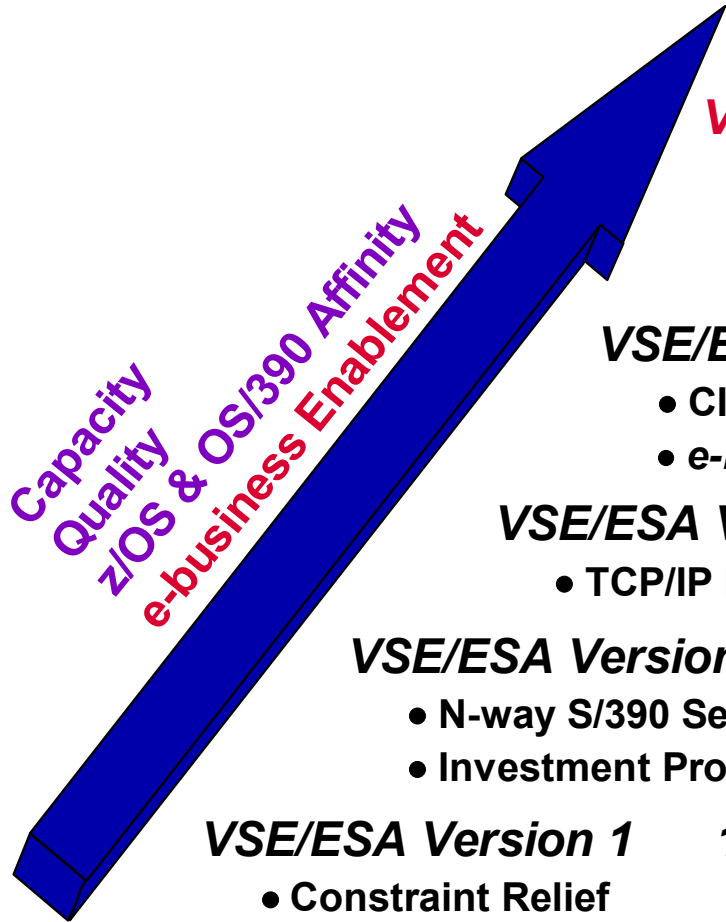

## VSE/ESA V2.5, V2.6, V2.7

Sept. 2000+

- Enhanced Interoperability
- e-business Connectors



## VSE/ESA Version 2.4 1999

- CICS Transaction Server for VSE/ESA
- e-business

## VSE/ESA Version 2.3 1997

- TCP/IP based Communication



## VSE/ESA Version 2 1994

- N-way S/390 Servers
- Investment Protection - Year 2000

## VSE/ESA Version 1 1990

- Constraint Relief
- ESA Exploitation



# Die VSE Evolution geht weiter ...

## VSE/ESA V2.8 → z/VSE V3.1

- **Preview Announcement, April 8, 2004**
  - ▶ SCSI/FCP Support
- **Rebranding**
  - ▶ z/VSE can execute in 31-bit mode only. It does not implement z/Architecture, and specifically does not implement 64-bit mode capabilities. z/VSE is designed to exploit selected features of IBM zSeries hardware
- **Reversioning**
  - ▶ FSU von V2 nach V3
  - ▶ Auch weiterhin Unterstützung von ALS2
- **Repackaging**
  - ▶ LE Runtime integriert in VSE Base
- **Repricing**
  - ▶ 'Net neutral' Pricing mit Preisminderung bei LE Runtime
- **No change in strategy**



# z/VSE Strategie

- **Protect** existierende Kundeninvestitionen in VSE Programme, Daten, Umgebungen, Skills, Geschäftsprozesse, Endanwender-Ausbildungen, etc.
  - Modernisierung und Web-Enablement von CICS Anwendungen
  - z890 Server, IBM TotalStorage und Software
  
- **Integrate** VSE mit dem Rest der IT
  - VSE Connectors und Web Services
  - IBM Middleware
  
- **Extend** mit Linux on zSeries
  - Neue Anwendungen
  - Vereinfachungen der Infrastruktur

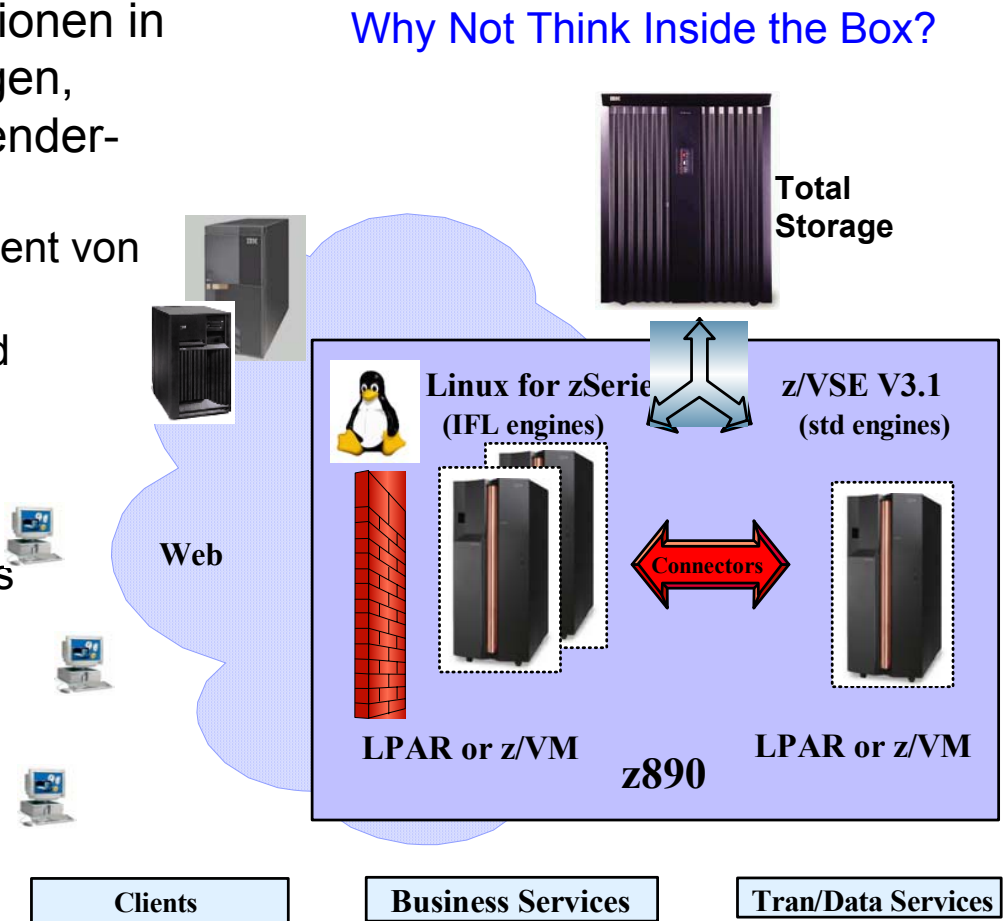

# Agenda

- IBM zSeries Server z890
- z/VSE V3.1
- z/VM V5.1
- Linux Kernel 2.6
- Zusammenfassung



# z/VM V5.1 – GA geplant für Sept. 24, 2004

- **Virtualisierung und Linux Enablement**
  - ▶ Linux Server unter z/VM mit SCSI Platten
  - ▶ Verbesserte Crypto Performance für Linux und z/OS Gäste
- **Netzwerk Virtualisierung und Security**
  - ▶ Verbesserungen im Recovery Verhalten
- **Technologie Erweiterungen**
  - ▶ Unterstützungen für OSA-Express Integrated Console Controller
  - ▶ Unterstützung für 'external spanned channels'
  - ▶ Routing von IPv6 Paketen
- **Systems Management**
  - ▶ Verbesserungen im Performance Toolkit
- **Usability Features**
  - ▶ Installation jetzt via DVD
  - ▶ Neues Buch "*Getting Started with Linux on zSeries*"
- **Übergang zu ALS3**

# Neues Engine-based Pricing für z/VM Version 5

- **Niedrigerer Lizenz-Preis als bei z/VM V4**
- **Nicht-lineare Preiskurve bei wachsender Anzahl von z/VM V5 Lizenzen**
- **On/Off Capacity on Demand auf Tagesbasis**
- **Aggregation von mehreren Lizenzen im Enterprise**

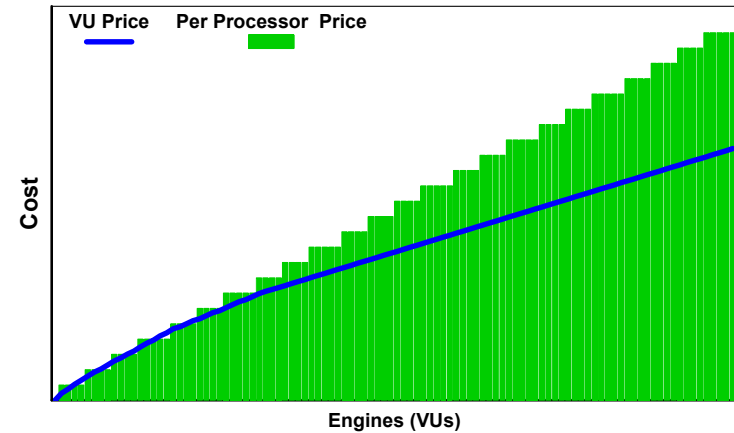



# Agenda

- IBM zSeries Server z890
- z/VSE V3.1
- z/VM V5.1
- Linux Kernel 2.6
- Zusammenfassung



# Linux Technology Evolution

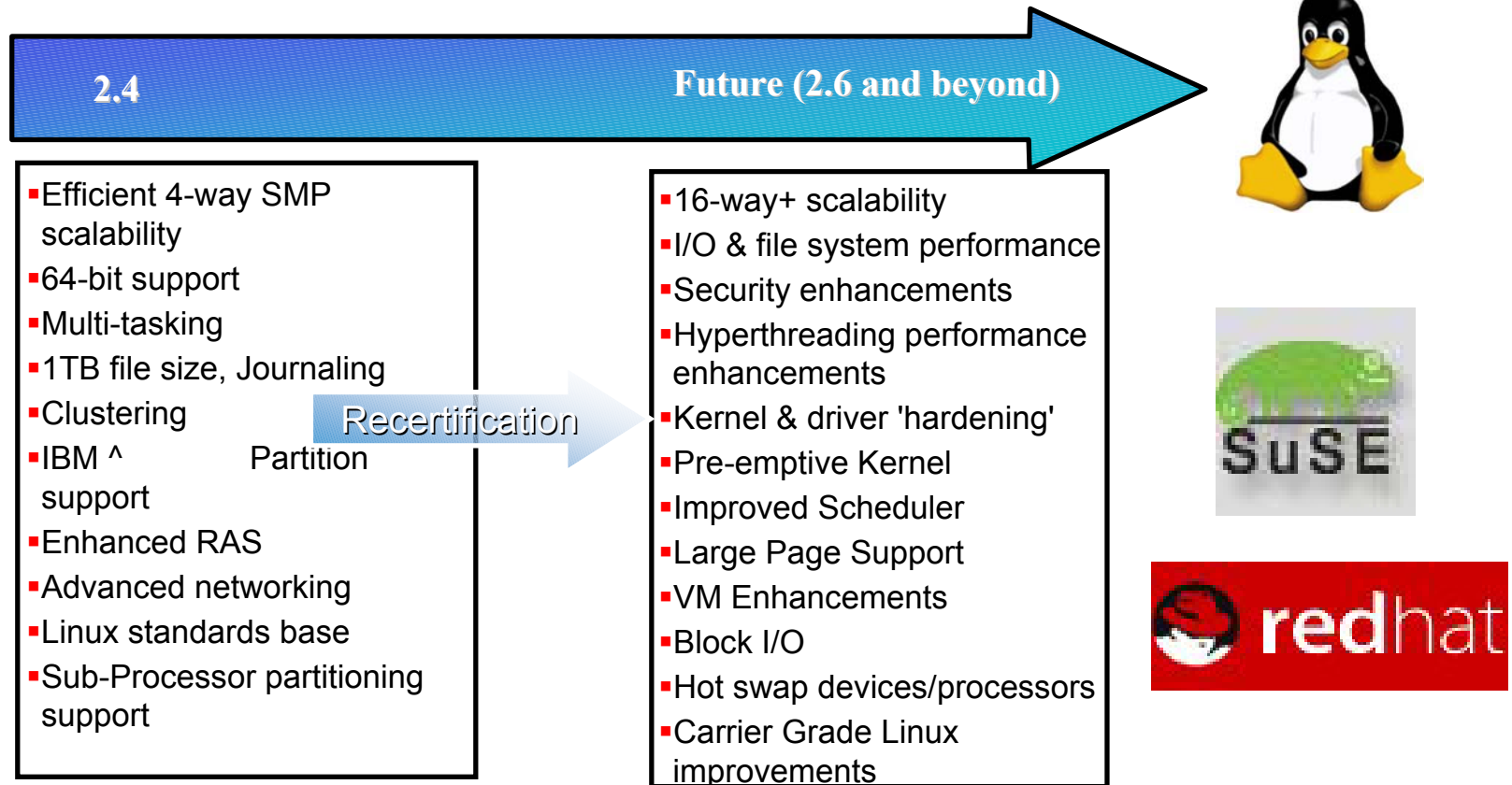

This represents a combination of current open source community priorities and IBM LTC project plans. Open source communities do not publish schedules or commit to specific dates or functions.

# Linux Kernel 2.6

- Scale Up: Large SMP & NUMA
  - ▶ 16 CPU xSeries
  - ▶ 16-32 CPU pSeries/iSeries
  - ▶ 16 CPU zSeries
- Major kernel internal overhauls for robustness, performance, scalability
  - ▶ VM, Scheduler, NUMA topology,
  - ▶ Filesystem & block IO
  - ▶ HT, SMT support
  - ▶ xSeries 64 GB memory support
  - ▶ Max users/Groups 64K – 4 billion
  - ▶ PIDs/processes 32K to 1 billion
  - ▶ 16 TB filesystems, 1 million devices
- Common Hot Plug infrastructure for
  - ▶ PCI
  - ▶ Devices
  - ▶ CPUs
  - ▶ USB
  - ▶ Firewire
- Security
  - ▶ Policy based security architecture
  - ▶ New security policies – SELinux, etc.
- Scalable APIs
  - ▶ Futexes
  - ▶ epoll
  - ▶ Direct I/O & Async I/O
  - ▶ Large Page APIs
  - ▶ NPTL
  - ▶ NUMA APIs & Topology
  - ▶ Distributed Filesystem Support
  - ▶ IRQ & Scheduling Affinity
- Native Architecture Support
  - ▶ Power
  - ▶ zSeries
  - ▶ AMD x86-64
  - ▶ Intel IA32e
  - ▶ IA64
  - ▶ And all V2.4 based architectures
- New networking protocols
  - ▶ SCTP, IPv6, Mobile IPv6, DHCPv6
- Enhanced file system support
  - ▶ NFSv4
  - ▶ hardened JFSs

# Linux bringt neue Anwendungen auf zSeries



- Zur Zeit 454 Anwendungen von 205 Software Vendors
  - [ibm.com/servers/eserver/zseries/solutions/s390da/linuxisv.html](http://ibm.com/servers/eserver/zseries/solutions/s390da/linuxisv.html)



# S2 Systems OpenN/2

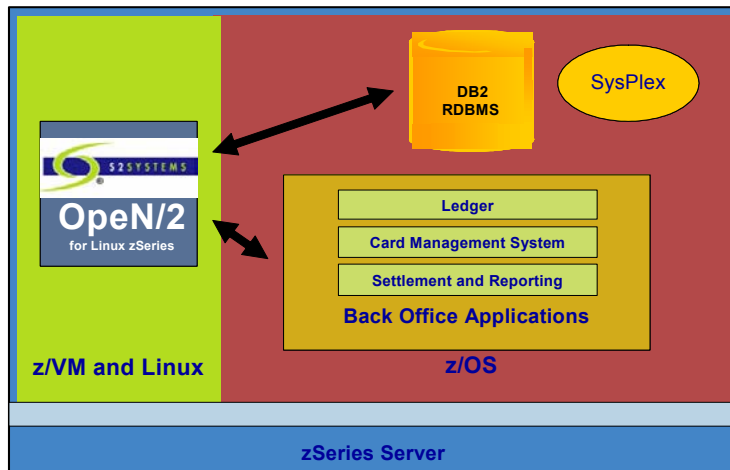

## Why OpenN/2 ?

- Finance industry has been in a hold status for 10 years, Tandem (ACI) ruled the market, followed by Stratus (ON/2) with regards to Front Office applications (i.e. the EFT processing software)
- New standards (e.g. Smart Card) and technologies (i.e. Triple DES) require changes in the Front Office solutions
- FUD around future of Tandem and TCO of Tandem and Stratus solutions caused strain on the dramatically reduced budgets
- Current (Cobol) technology prohibits rapid development of new business requirement; the industry demands a faster time to market
- OpenN/2 for Linux on zSeries provides an optimal synergy with the RAS characteristics of the zSeries platform

## Citi US Merchant

- Replaced 4 Tandem/Base24 systems with zSeries OpenN/2 for Linux
- TCO went from \$12M on Tandem/Base24 to \$3.7M on zSeries/Open/2 implementation, 70% savings “No Brainer” (Citi quote)
- Resulted in activity within Citi EMEA
- Generic case study available with no-name – however, contact S2 and they can arrange one on one customer call with Citibank

## American First Credit Union

- Replaced OCM24 on VSE/ESA™ with OpenN/2 for Linux on zSeries
- Justified the purchase and existence of z800-001
- Back office will remain under VSE/ESA, Front Office will be OpenN/2 for Linux and DB2® for Linux

# IBM Communications Server

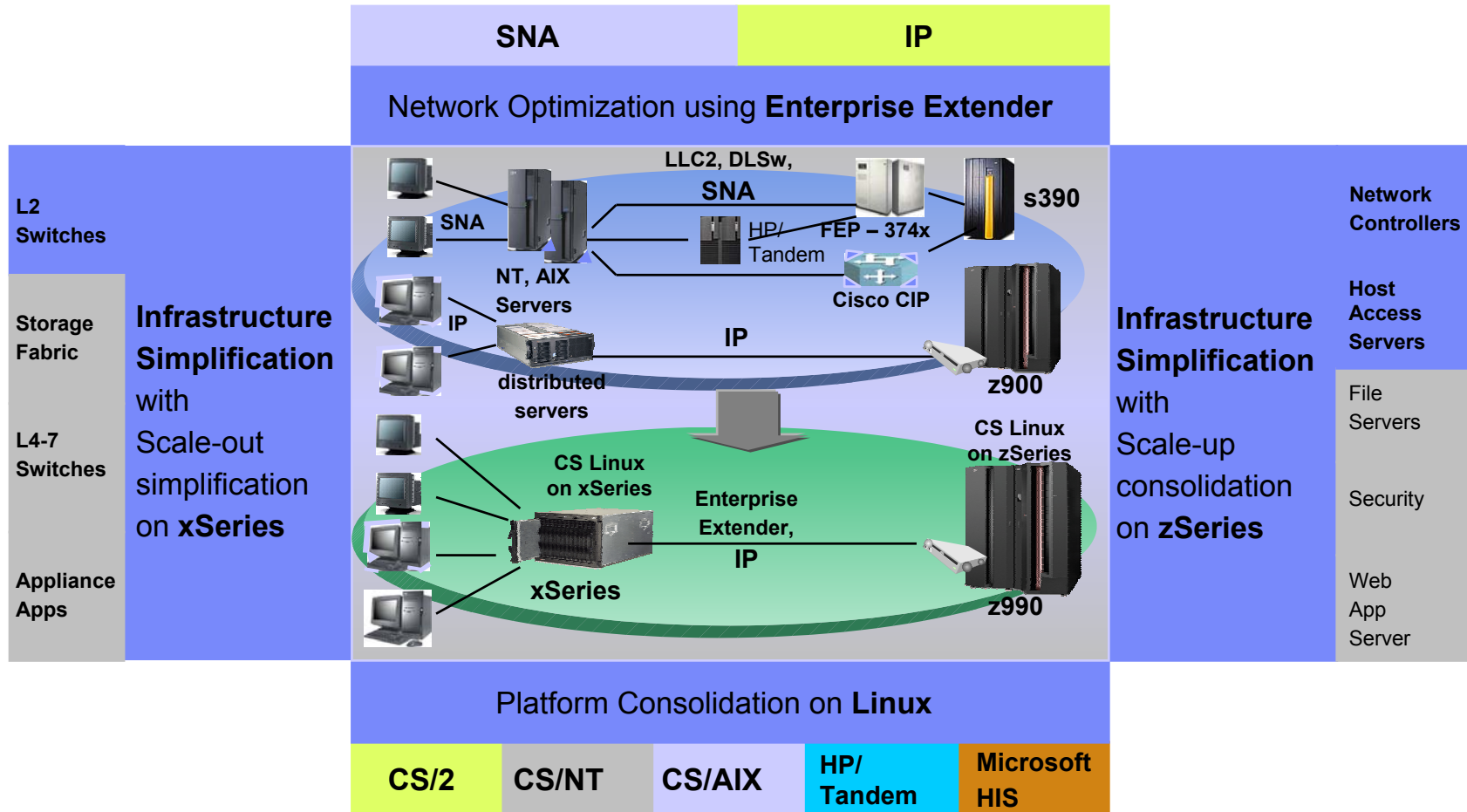

# IBM Dynamic Infrastructure for mySAP

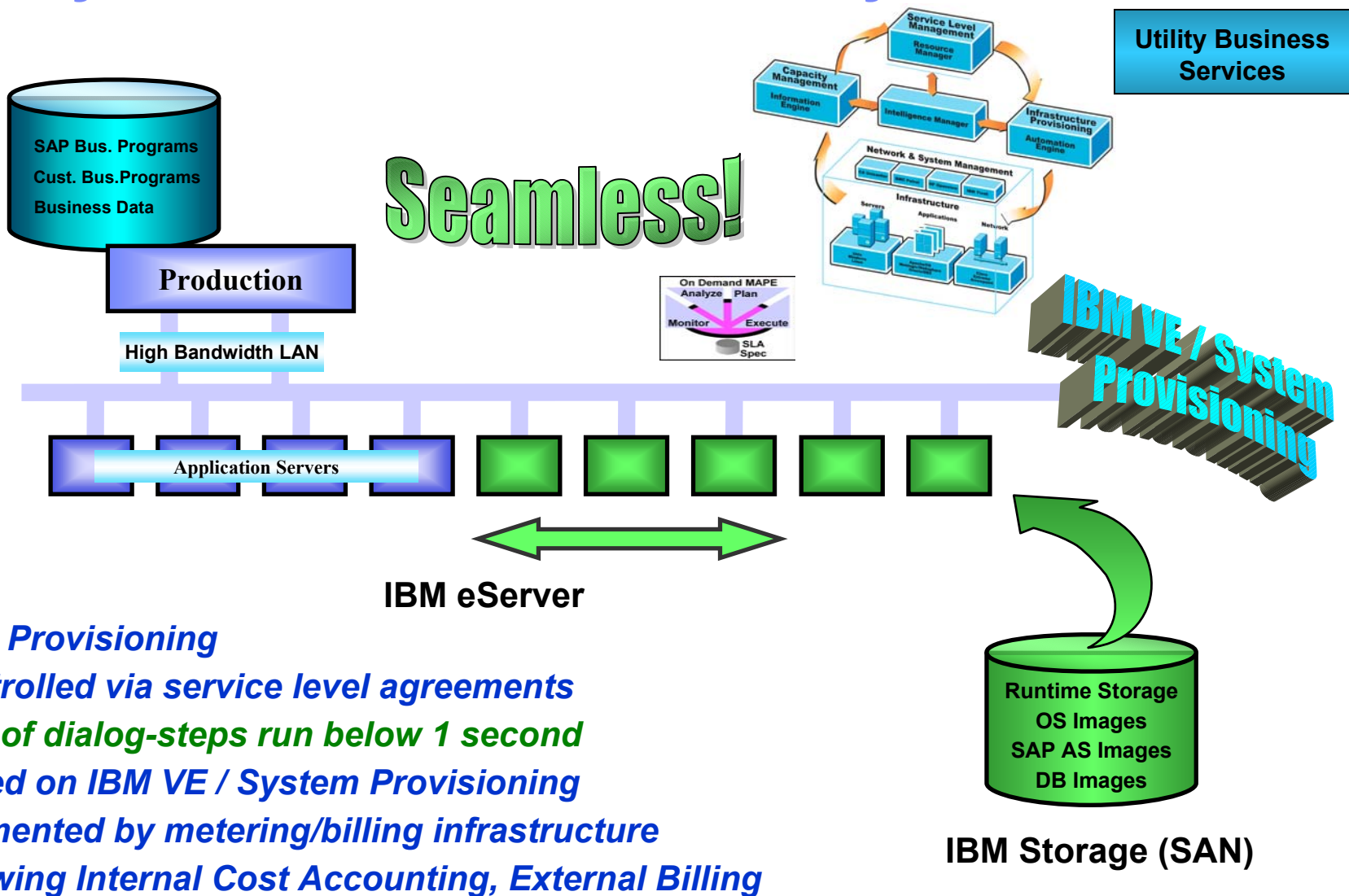

## Dynamic Provisioning

Controlled via service level agreements

80% of dialog-steps run below 1 second

Based on IBM VE / System Provisioning

Complemented by metering/billing infrastructure

Allowing Internal Cost Accounting, External Billing

# Agenda

- IBM zSeries Server z890
- z/VSE V3.1
- z/VM V5.1
- Linux Kernel 2.6
- Zusammenfassung

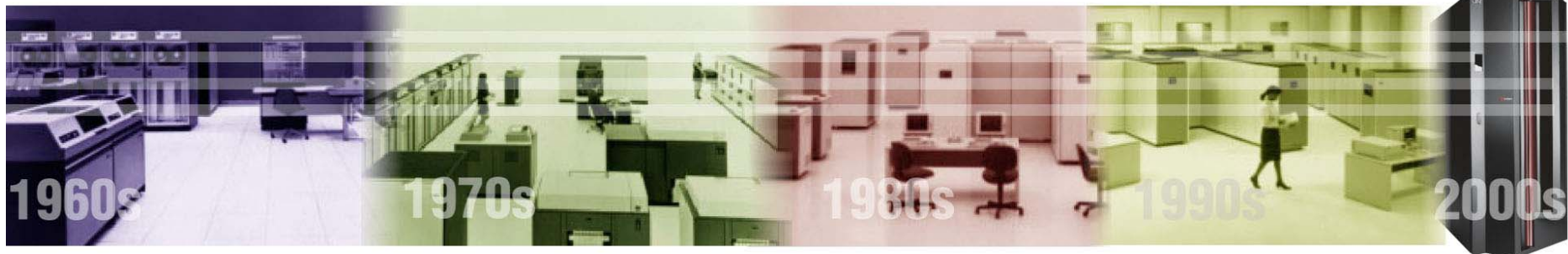



# Zusammenfassung

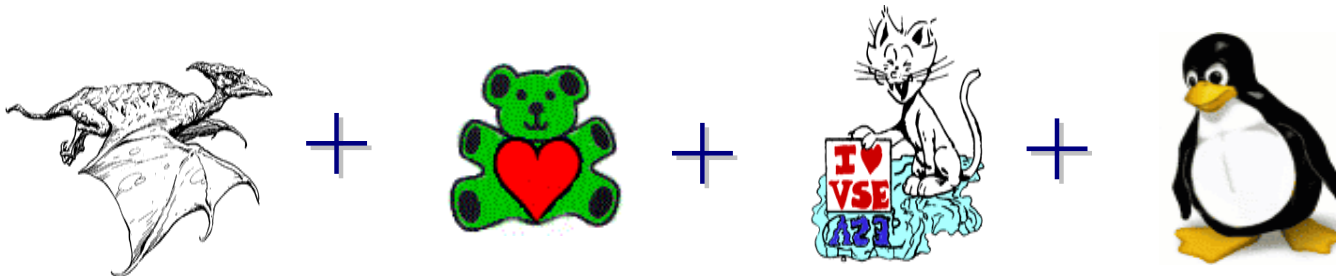
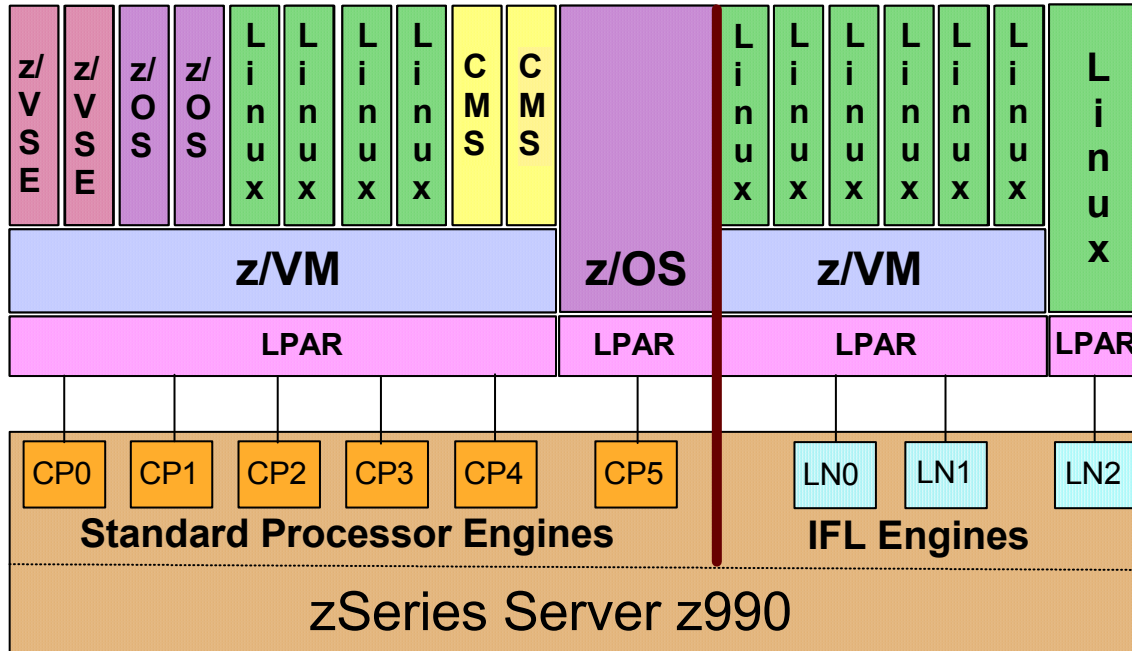

...die erfolgreiche Symbiose für die Zukunft !