

IBM Tivoli System Automation for z/OS



Customizing and Programming

Version 3 Release 1

IBM Tivoli System Automation for z/OS



Customizing and Programming

Version 3 Release 1

Note!

Before using this information and the product it supports, be sure to read the general information under "Notices" on page xi.

Second Edition (September 2005)

This edition applies to IBM Tivoli System Automation for z/OS (Program Number 5698-SA3) Version 3, Release 1, an IBM licensed program, and to all subsequent releases and modifications until otherwise indicated in new editions or technical newsletters.

Order publications through your IBM representative or the IBM branch office serving your locality. Publications are not stocked at the address given below.

IBM welcomes your comments. A form for readers' comments appears at the back of this publication. If the form has been removed, address your comments to:

IBM Deutschland Entwicklung GmbH
Department 3248
Schoenaicher Strasse 220
D-71032 Boeblingen
Federal Republic of Germany

If you prefer to send comments electronically, use one of the following methods:

FAX (Germany): 07031 + 16-3456
FAX (Other Countries): (+49)+7031-16-3456
Internet: s390id@de.ibm.com

When you send information to IBM, you grant IBM a nonexclusive right to use or distribute the information in any way it believes appropriate without incurring any obligation to you.

© Copyright International Business Machines Corporation 1996, 2005. All rights reserved.

US Government Users Restricted Rights – Use, duplication or disclosure restricted by GSA ADP Schedule Contract with IBM Corp.

Contents

Figures vii

Tables ix

Notices xi

Web Site Disclaimer xi
Programming Interface Information xi
Trademarks xii

Accessibility xiii

Using assistive technologies xiii
Keyboard navigation of the user interface xiii
z/OS information xiii

About This Book xv

Who Should Use This Book xv
Prerequisites xv
Where to Find More Information xv
 The System Automation for z/OS Library xv
 Related Product Information xvi
 Using LookAt to look up message explanations xvi

Chapter 1. How to Add a New Application to Automation 1

Step 1: Define an Application Policy Object 1
Step 2: Define Outstanding Reply Processing 1
Step 3: Build New System Operations Configuration Files 3
Step 4: Code Entries for Application Messages in the MPF List (Optional) 3
Step 5: Add SDF Entries for the Subsystem (Optional) 3
Step 6: Enable the Application for the SA z/OS Graphical Interface 3
Step 7: Reload MPF List and Automation Configuration Files 4

Chapter 2. How to Create Automation Procedures 5

Programming Additional SA z/OS Automation Procedures 5
How Automation Procedures Are Called 5
How CLIST or REXX Automation Procedures Are Structured 6
 Performing Initialization Processing 7
 Determining whether Automation Is Allowed 8
 Performing Automation Processing 8
How to Make Your Automation Procedures Generic 12
 Processor Operations Commands 13
Developing Messages for Your Automation Procedures 13
 Example AOCMSG Call 14
Example Automation Procedure 14
 Notes on the Automation Procedure Example 16
Installing Your Automation Procedures 16

Testing and Debugging Automation Procedures 17
 The Assist Mode Facility 17
 Using Assist Mode to Test Automation Procedures 18
 Using AOCTRACE to Trace Automation Procedure Processing 20
 NetView Testing and Debugging Facilities 21
 Where to Find More Testing Information 22
Coding Your Own Information in the Automation Status File 22
Programming Recommendations 22
Global Variable Names 23

Chapter 3. How to Add a Message to Automation 25

Conceptual Overview 25
Defining Actions for Messages 26
 Defining CMD or REP Actions 26
 Defining AUTO Actions 27
 Defining OVR Actions 28
Defining the NetView AT Scope 29
Build 29
NetView Automation Table Build Concept 30
 When Is an AT Built? 30
 Predefined Message Automation 31
 AT Entry Sequence 32
Load 33
 Enabling Message Automation for the Automation Agent 33
 Listing ATs 33
A Guide to SA z/OS Automation Tables 33
 Automation Table Structure 33
 Integrating Automation Tables 35
 Generic Synonyms—AOFMSGSY 36
 Generic Automation Table Statements 43

Chapter 4. How to Monitor Applications 45

How to Write Your Own Monitor Routines 45
Monitor Resources 46
 Writing Monitor Resource Commands 47
 Writing a Monitor Routine 47
 Writing a Recovery Routine 48
Monitoring JES3 Components 49
 AOFJR3MN Routine 50
 AOFJR3RC Routine 52

Chapter 5. Exception-Based Monitoring with OMEGAMON 53

Overview 53
Scenario 53
Topologies 54
OMEGAMON Interaction 55
 Programming Interface INGOMX for OMEGAMON 55
 Monitor Command INGMTRAP 56

Health Based Automation Using OMEGAMON	57	Step 4: Defining the System	100
Recovery Techniques	57	Step 5: Connecting the System to the Processor	100
Programming Techniques.	58	Step 6: Defining Logical Sysplexes	100
Recommendations	59	Step 7: Defining the Physical Sysplex	100
Chapter 6. How to Automate Your Resources	61	Enabling Continuous Availability of Couple Data Sets	100
Using Automation Flags	61	Enabling System Log Failure Recovery	101
Example	61	Enabling WTO(R) Buffer Shortage Recovery	102
When SA z/OS Checks Automation Flags	62	Enabling System Removal	104
The Automation Manager Global Automation Flag	62	Step 1: Defining the Processor and System.	104
Chapter 7. How to Automate Processor Operations-Controlled Resources	65	Step 2: Defining the Application with Application Type IMAGE	104
Automating Processor Operations Resources of z/OS Target Systems Using Proxy Definitions	65	Step 3: Automating Messages IXC102A and IXC402D	105
Concept	65	Enabling Long Running Enqueues (ENQs)	106
Customizing Automation for Proxy Resources.	66	Step 1: Defining Resources	106
Preparing Message Automation.	68	Step 2: Making Job/ASID Definitions	107
Automating Linux Console Messages.	68	Step 3: Defining IEADMCxx Symbols	107
The Linux Console Connection to NetView	68	Step 4: Defining Commands	107
Linux Console Automation with Mixed Case Character Data	69	Step 5: Defining Snapshot Intervals	107
Security Considerations	69	Enabling Auxiliary Storage Shortage Recovery	107
Restrictions and Limitations	69	Step 1: Defining the Local Page Data Set	107
How to Add a Processor Operations Message to Automation	69	Step 2: Defining the Handling of Jobs	107
Messages Issued by a Processor Operations Target System	70	Defining Common Automation Items	108
Building the New Automation Definitions	74	Important Processor Operations Considerations	108
Loading the Changed Automation Environment	74	Customizing the System to Use the Functions	108
VM Second Level Systems Support	74	Additional Automation Operator IDs	108
Guest Target Systems	74	Switching Sysplex Functions On and Off	109
Customizing Target Systems.	75	Chapter 10. DB2 Automation for System Automation for z/OS	111
Chapter 8. How to Automate USS Resources	79	Overview	111
Integration of z/OS UNIX System Services	79	Line Mode Functions	111
Infrastructure Overview	79	Planning Requirements	112
Setting Up z/OS UNIX Automation	80	IMS	112
Customization of z/OS UNIX Resources.	80	CICS	112
Example: inetd	84	Installation	112
Hints and Tips	87	Automation Control File (ACF)	112
Trapping UNIX syslogd Messages	87	Defining Automation Policy	112
Debugging	87	Tailoring Your DB2 ACF Entries	112
Chapter 9. How to Enable Sysplex Automation	89	DB2 Automated Functions—Line Command Functions.	115
Sysplex Functions	89	Command Handler	115
Managing Couple Data Sets	89	Command Requests	116
Managing the System Logger	90	Maintenance Start	116
Managing Coupling Facilities	91	Terminate Threads.	118
Recovery Actions	93	Start/Stop Tablespace	120
Hardware Validation	97	Event-Driven Functions	122
Enabling Hardware-Related Automation.	99	Connection Monitoring	122
Step 1: Defining the Processor	99	Critical Event Monitoring	125
Step 2: Using the Policy Item PROCESSOR INFO	99	Chapter 11. SA z/OS User Exits	129
Step 3: Defining Logical Partitions.	99	Initialization Exits	130
		Environmental Setup Exits	130
		AOFEXDEF	131
		AOFEXI01	131
		AOFEXI02	131
		AOFEXI03	132
		AOFEXI04	132
		AOFEXINT	132

Static Exits	132	JES3 Dump Processing	173
AOFEXSTA	132	AOFRSE0J	174
AOFEXX01	133	TWS Automation PPI and Gateway Failures	175
AOFEXX02	134	EVJEAC01	175
AOFEXX03	134	EVJEAC02	175
Flag Exits.	134	TWS Automation Operation and Job Errors	175
Parameters	136	EVJEAC03	176
Return Codes	137	EVJEAC04	176
Customization Dialog Exits.	138	EVJRAC05	177
User Exits for BUILD Processing	138	EVJRSJOB	177
User Exits for COPY Processing	139	TWS Status Observer Control	178
User Exits for DELETE Processing	140	EVJEOBSV	178
User Exits for CONVERT Processing	140	TWS Controller Status	178
User Exits for MIGRATION, RENAME, and IMPORT Functions	141	EVJRSACT	178
Invocation of Customization Dialog Exits	141	CICS-Related Processing and Recovery	178
Command Exits	142	CICS Region Abend Recovery	178
AOFEXC00	142	CICSplex Processing	180
AOFEXC01	142	CICS Link Monitoring	181
AOFEXC02	144	CICS VSAM RLS Status	181
AOFEXC03	145	CICS Shutdown	182
AOFEXC04	145	CICS Short on Storage	184
AOFEXC05	145	CICS Startup	185
AOFEXC06	145	CICS Transaction Recovery	187
AOFEXC07	146	CICS Unit of Work Recovery	189
AOFEXC08	146	IMS-Related Processing and Recovery	190
AOFEXC09	146	EVIEX002—Retrieve IMS Subsystem Data	191
AOFEXC10	146	EVIEX003—Update IMS Subsystem Data	192
AOFEXC11	146	IMSBMSG—Build Message Processor	195
AOFEXC12	146	IMSCMD—Issue IMS Commands	197
AOFEXC13	146	IMSQRY—Name Lookup	198
Pseudo-Exits	146	IMSRCMD—Request an IMS Function	201
Automation Control File Reload Permission Exit	147	Appendix A. Global Variables 203	
Automation Control File Reload Action Exit	147	Read-Only Variables	203
Subsystem Up at Initialization Commands	147	Read/Write Variables.	204
Testing Exits.	147	Parameter Defaults for Commands	213
Chapter 12. Automation Routines. 149		Appendix B. Customizing the Status Display Facility (SDF). 217	
LOGREC Data Set Processing	150	Overview of Status Display Facility	217
AOFRSA01	150	How SDF Works	217
AOFRSA02	151	Types of SDF Panels	217
SMF Data Set Processing	153	Status Descriptors	218
AOFRSA03	153	SDF Tree Structures	219
SYSLOG Processing	155	How Status Descriptors Affect SDF	220
AOFRSA08	155	How SDF Helps Operations to Focus on Specific Problems	224
SVC Dump Processing	157	How SDF Panels Are Defined	224
AOFRSA0C	157	Dynamically Loading Tree Structure and Panel Definition Members	225
Deletion of Processed WTORs from SDF	161	Using SDF for Multiple Systems	225
AOFRSA0E	161	SDF Components	226
AMRF Buffer Shortage Processing	162	How the SDF Task Is Started and Stopped	226
AOFRSA0G	162	SDF Definition	227
JES2 Spool Recovery Processing	164	Summary of SDF Definition Process	227
AOFRSD01	164	Step 1: Defining SDF Hierarchy	228
AOFRSD09	165	Step 2: Defining SDF Panels	229
AOFRSD0H	167	Step 3: Customizing SDF Initialization Parameters	231
JES2 Shutdown Processing	169		
HASP099	170		
Drain Processing Prior to JES2 Shutdown	170		
AOFRSD07	170		
AOFRSD0F	171		
AOFRSD0G	173		

Step 4: Defining SDF in the Customization Dialog	232	Other Forced AT Entries	236
		Restricted Message IDs	236
Appendix C. Message Automation	233	Appendix D. TSO User Monitoring	239
FORCED AT Entry Type	233	Glossary	241
RECOMMENDED AT Entry Type	233	Index	261
CONDITIONAL AT Entry Type	234		
Known Messages	234		
Unknown Messages	235		

Figures

1.	Example of a WTORS Entry	2		23.	Three Threshold Levels Are Defined in the Automation Policy for MVS Component SYSLOG	156
2.	Automation Procedures for System Operations	6		24.	Automation Policy Item MESSAGES/USER DATA to Entry/Type-Pair MVSESA/SYSLOG Contains One Command without Selection Value	157
3.	Automation Procedures for Processor Operations	7		25.	MVSDUMP Thresholds	159
4.	Skeleton of an Automation Procedure	13		26.	MVSESA/MVSDUMP Command Entries	160
5.	SDF Detail Status Display Panel with Assist Mode	19		27.	MVSESA/MVSDUMPTAKEN Command Entries	160
6.	AT Structure	34		28.	MVSESA/MVSDUMPRESET Command Entries	160
7.	Sample Monitor Command	48		29.	MVSESA AMRF Command Definitions	163
8.	z/OS UNIX Control Specification Panel for Type INSTANCE	80		30.	JES2 SPOOLSHORT Recovery Definition	168
9.	Startup Definition for a Process	83		31.	DISPACF Command Response Panel	169
10.	Creating a Softlink	83		32.	JES2 DRAIN Specifications Panel	172
11.	Stop Definitions for a Process	84		33.	DISPACF Panel	172
12.	Delete a File	84		34.	DISPACF JES2 INITDRAIN Panel	173
13.	inetd Structure	85		35.	Example SDF Panels	218
14.	Dependency Graphic	86		36.	Example SDF Tree Structure	220
15.	Example of a UNIX Message	87		37.	Status Descriptors Chained to Status Components	222
16.	Sample Panel for Command Processing	106		38.	Example Tree Structure Definition.	228
17.	Sample Panel for Code Processing	106		39.	Example SDF Panel	230
18.	SA z/OS Exit Sequence during SA z/OS Initialization	130		40.	Example Panel Definition Entry	230
19.	Three Threshold Levels Are Defined in the Automation Policy for MVS Component LOGREC	152		41.	Sample FORCED AT Entry	233
20.	Automation Policy Item MESSAGES/USER DATA to Entry/Type-Pair MVSESA/LOGREC Contains One Command without Selection Value	152		42.	Sample FORCED AT Entry with ISSUECMD and ISSUEREPACTION	233
21.	Three Threshold Levels Are Defined in the Automation Policy for MVS Component SMFDUMP	154		43.	Sample RECOMMENDED AT Entry Type	234
22.	Automation Policy Item MESSAGES/USER DATA to Entry/Type-Pair MVSESA/SMFDUMP Contains One Command without Selection Value	154		44.	CONDITIONAL AT Entry for a Specific Message	234
				45.	CONDITIONAL AT Entry for a Generic Message	235
				46.	BEGIN-END Block Statements	236

Tables

1.	System Automation for z/OS Library	xv	7.	Global Variables That Define the Installation Defaults for Specific Commands	213
2.	Health State Return Codes	47	8.	SDF Components	226
3.	Automation Flags: Typical Uses in SA z/OS	62	9.	Panel Definition Entry Description	230
4.	WTOBUF Recovery Process	103	10.	AT Entries That Are Generated by AUTO Actions	235
5.	Externalized Common Global Variables	203			
6.	Global Variables to Enable Advanced Automation (CGLOBALS)	205			

Notices

References in this publication to IBM products, programs, or services do not imply that IBM intends to make these available in all countries in which IBM operates. Any reference to an IBM product, program, or service is not intended to state or imply that only IBM product, program, or service may be used. Subject to IBM's valid intellectual property or other legally protectable rights, any functionally equivalent product, program, or service may be used instead of the IBM product, program, or service. The evaluation and verification of operation in conjunction with other products, except those expressly designated by IBM, are the responsibility of the user.

IBM may have patents or pending patent applications covering subject matter in this document. The furnishing of this document does not give you any license to these patents. You can send license inquiries, in writing, to:

IBM Director of Licensing
IBM Corporation
North Castle Drive
Armonk, NY 10504-1785
USA

Licensees of this program who wish to have information about it for the purpose of enabling: (i) the exchange of information between independently created programs and other programs (including this one) and (ii) the mutual use of the information which has been exchanged, should contact:

IBM Deutschland Entwicklung GmbH
Department 3248
Schoenaicher Strasse 220
D-71032 Boeblingen
Federal Republic of Germany

Such information may be available, subject to appropriate terms and conditions, including in some cases, payment of a fee.

Web Site Disclaimer

Any pointers in this publication to non-IBM Web sites are provided for convenience only and do not in any manner serve as an endorsement. IBM accepts no responsibility for the content or use of non-IBM Web sites specifically mentioned in this publication or accessed through an IBM Web site that is mentioned in this publication.

Programming Interface Information

This publication primarily documents information that is NOT intended to be used as a Programming Interface of System Automation for z/OS.

This publication also documents intended Programming Interfaces that allow the customer to write programs to obtain the services of System Automation for z/OS.

This information is identified where it occurs, either by an introductory statement to a chapter or section or by the following marking:

Programming Interface information

This section contains Programming Interface Information.

End of Programming Interface information

Trademarks

The following terms are trademarks or service marks of the IBM Corporation in the United States or other countries, or both:

CICS	DB2
IBM	IMS
MVS	NetView
OS/390	Parallel Sysplex
PR/SM	Processor Resource/Systems Manager
RACF	RMF
S/390	Tivoli
Tivoli Enterprise Console	VTAM
WebSphere	z/OS
z/VM	zSeries

The following terms are trademarks of other companies:

- Linux is a registered trademark of Linus Torvalds.
- UNIX is a registered trademark of The Open Group in the United States and other countries.

Accessibility

Accessibility features help a user who has a physical disability, such as restricted mobility or limited vision, to use software products successfully. The major accessibility features in z/OS™ enable users to:

- Use assistive technologies such as screen readers and screen magnifier software
- Operate specific or equivalent features using only the keyboard
- Customize display attributes such as color, contrast, and font size

Using assistive technologies

Assistive technology products, such as screen readers, function with the user interfaces found in z/OS. Consult the assistive technology documentation for specific information when using such products to access z/OS interfaces.

Keyboard navigation of the user interface

Users can access z/OS user interfaces using TSO/E or ISPF. Refer to *z/OS TSO/E Primer*, *z/OS TSO/E User's Guide*, and *z/OS ISPF User's Guide Vol I* for information about accessing TSO/E and ISPF interfaces. These guides describe how to use TSO/E and ISPF, including the use of keyboard shortcuts or function keys (PF keys). Each guide includes the default settings for the PF keys and explains how to modify their functions.

z/OS information

z/OS information is accessible using screen readers with the BookServer/Library Server versions of z/OS books in the Internet library at:

<http://www.ibm.com/servers/eserver/zseries/zos/bkserv/>

About This Book

This book describes how to adapt your completed standard installation of IBM® Tivoli® System Automation for z/OS (SA z/OS) as described in *IBM Tivoli System Automation for z/OS Planning and Installation* to your environment. This book contains information on how to add new applications to automation and how to write your own automation procedures. It also contains information about how to add new messages for automated applications.

Who Should Use This Book

This book is primarily intended for automation programmers responsible for:

- Customizing system automation and the operations environment
- Developing automation procedures and other operations capabilities

Prerequisites

Throughout this book, it is expected that readers will be familiar with System Automation for z/OS and the following documentation:

- *IBM Tivoli System Automation for z/OS Operator's Commands*
- *IBM Tivoli System Automation for z/OS Programmer's Reference*
- *IBM Tivoli System Automation for z/OS Defining Automation Policy*

Where to Find More Information

The System Automation for z/OS Library

The following table shows the information units in the System Automation for z/OS library:

Table 1. System Automation for z/OS Library

Title	Order Number
<i>IBM Tivoli System Automation for z/OS Planning and Installation</i>	SC33-8261
<i>IBM Tivoli System Automation for z/OS Customizing and Programming</i>	SC33-8260
<i>IBM Tivoli System Automation for z/OS Defining Automation Policy</i>	SC33-8262
<i>IBM Tivoli System Automation for z/OS User's Guide</i>	SC33-8263
<i>IBM Tivoli System Automation for z/OS Messages and Codes</i>	SC33-8264
<i>IBM Tivoli System Automation for z/OS Operator's Commands</i>	SC33-8265
<i>IBM Tivoli System Automation for z/OS Programmer's Reference</i>	SC33-8266
<i>IBM Tivoli System Automation for z/OS CICS Automation Programmer's Reference and Operator's Guide</i>	SC33-8267
<i>IBM Tivoli System Automation for z/OS IMS Automation Programmer's Reference and Operator's Guide</i>	SC33-8268
<i>IBM Tivoli System Automation for z/OS TWS Automation Programmer's Reference and Operator's Guide</i>	SC23-8269
<i>IBM Tivoli System Automation for z/OS End-to-End Automation Adapter</i>	SC33-8271

The System Automation for z/OS books are also available on CD-ROM as part of the following collection kit:

IBM Online Library z/OS Software Products Collection (SK3T-4270)

SA z/OS Home Page

For the latest news on SA z/OS, visit the SA z/OS home page at <http://www.ibm.com/servers/eserver/zseries/software/sa>

Related Product Information

You can find books in related product libraries that may be useful for support of the SA z/OS base program by visiting the z/OS Internet Library at <http://www.ibm.com/servers/eserver/zseries/zos/bkserv/>

Using LookAt to look up message explanations

LookAt is an online facility that lets you look up explanations for most of the IBM messages you encounter, as well as for some system abends and codes. Using LookAt to find information is faster than a conventional search because in most cases LookAt goes directly to the message explanation.

You can use LookAt from these locations to find IBM message explanations for z/OS elements and features, z/VM[®], VSE/ESA[™], and Clusters for AIX[®] and Linux[™]:

- The Internet. You can access IBM message explanations directly from the LookAt Web site at <http://www.ibm.com/servers/eserver/zseries/zos/bkserv/lookat/>.
- Your z/OS TSO/E host system. You can install code on your z/OS or z/OS.e systems to access IBM message explanations using LookAt from a TSO/E command line (for example: TSO/E prompt, ISPF, or z/OS UNIX[®] System Services).
- Your Microsoft[®] Windows[®] workstation. You can install LookAt directly from the *z/OS Collection* (SK3T-4269) or the *z/OS and Software Products DVD Collection* (SK3T4271) and use it from the resulting Windows graphical user interface (GUI). The command prompt (also known as the DOS > command line) version can still be used from the directory in which you install the Windows version of LookAt.
- Your wireless handheld device. You can use the LookAt Mobile Edition from <http://www.ibm.com/servers/eserver/zseries/zos/bkserv/lookat/lookatm.html> with a handheld device that has wireless access and an Internet browser (for example: Internet Explorer for Pocket PCs, Blazer or Eudora for Palm OS, or Opera for Linux handheld devices).

You can obtain code to install LookAt on your host system or Microsoft Windows workstation from:

- A CD-ROM in the *z/OS Collection* (SK3T-4269).
- The *z/OS and Software Products DVD Collection* (SK3T4271).
- The LookAt Web site (click **Download** and then select the platform, release, collection, and location that suit your needs). More information is available in the LOOKAT.ME files available during the download process.

Chapter 1. How to Add a New Application to Automation

This chapter describes the steps that are required to automate and monitor a new application by SA z/OS.

The main tasks involved in extending automation include:

- Adding or changing values via the SA z/OS customization dialog
- Building a new automation control file
- Adding or changing entries in the message processing facility (MPF) message list and the NetView automation table.
- Adding new resources to the status display facility (SDF)
- Reloading the changed files and tables, such as the MPF list, NetView automation table, and automation control file, to enable the new or changed automation

Note that messages that have been defined for the automation are automatically added to the NetView Automation Table and MPFLSTSA member. For more details see Chapter 3, “How to Add a Message to Automation,” on page 25.

Step 1: Define an Application Policy Object

To add a new application to SA z/OS, you must create and define a new *Application* policy object using the SA z/OS customization dialog. With the customization dialog, you also define how the new application should be automated by SA z/OS, for example:

- Setting automation flags for the application
- Specifying startup or shutdown commands for the application
- Linking the application into an application group

How to do this is described in detail in *IBM Tivoli System Automation for z/OS Defining Automation Policy*.

Step 2: Define Outstanding Reply Processing

SA z/OS keeps a record of all outstanding Write-to-Operator Replies (WTORs) that it receives if it does not reply to them immediately through ISSUEREP. Because some applications may have more than one WTOR at the same time, and not all WTORs are equally important, they are classified accordingly.

If SA z/OS receives a WTOR through OUTREP, ACTIVMSG, HALTMSG, TERMMMSG, or ISSUEREP, and does not reply to it immediately, it first searches through the automation control file for 'application WTORs', and then 'MVSESA WTORs', using the message ID as the first value and the job name as the second. This produces a value pair where the first word is the priority of the WTOR and the second is the type of WTOR.

How to Add a New Application to Automation

Performance:

You should define a WTORS entry in the *Message Processing* panel for applications that frequently issue WTORS (see Figure 1). This will improve performance by reducing searches within the automation control file as mentioned above.

1. Message Processing Panel:

Action	Message ID	Description	Cmd Rep	Code	User	Auto	Ovr
CODE	WTORS	Classification of IMS WTORS		3			

2. Code Processing Panel:

Code 1	Code 2	Code 3	Value Returned
DFS996I	*		NORMAL PRI
DFS3139I	*		NORMAL PRI
*	*		IMPORTANT SEC

Figure 1. Example of a WTORS Entry

The priority-type value pairs that are specified in the Value Returned field of the Code Processing Panel can be interpreted as follows:

Priority	Meaning
NORMAL	This is an ordinary message that does not indicate a problem. Displayed in SDF in GREEN (NWTOR status).
UNUSUAL	This might indicate a problem. It is not a WTOR that is normally outstanding. Displayed in SDF in YELLOW (UWTOR status). This is the default if a WTOR is not matched in either table.
IMPORTANT	This indicates a problem. It must be replied to promptly and may indicate more serious problems. Displayed in SDF in RED (IWTOR status). It may be abbreviated to IMPORT.
IGNORE	This tells SA z/OS to ignore the WTOR (RWTOR status). The WTOR is not displayed on the SDF screen and is not recorded in the automation status file. This priority can only have a type of SEC.
Notes:	
1. These priorities are also represented on the WTORS icon on the NMC workstation.	
2. The colors are default SA z/OS colors.	

Type	Meaning
PRI	This is the primary WTOR for the application. If SA z/OS needs to issue a reply to the application but the reply number or message ID (or both) is not specified (such as on a shutdown pass), SA z/OS responds to the last primary WTOR that it received for the application. This is the default type. PRI is not applicable if the priority is IGNORE.
SEC	This is the secondary WTOR for the application. SA z/OS does not reply to this WTOR if it has a primary or an older, secondary WTOR recorded for the application. SEC is the default if the priority is IGNORE.

SA z/OS uses a list to keep track of the WTORs for each application:

1. New primary WTORs are added to the front of the list
2. New secondary WTORs are added to the back of the list

When SA z/OS needs to get a reply number for an application, it takes the first reply in the list. If a secondary WTOR has been received but a primary has not, SA z/OS replies to the secondary WTOR. Generally it replies to the latest primary WTOR that is still outstanding, or the earliest secondary WTOR that is still outstanding if there are no primary WTORs.

Step 3: Build New System Operations Configuration Files

When you finish defining the application in the customization dialog, build the new system operations configuration files (automation control file, automation manager configuration file, NetView Automation Tables, and the MPFLSTSA member) from the updated policy database. See *IBM Tivoli System Automation for z/OS Defining Automation Policy* for more information.

After you have completed this step and “Step 7: Reload MPF List and Automation Configuration Files” on page 4, the application is known to SA z/OS and can therefore be automated according to the policy that was defined in “Step 1: Define an Application Policy Object” on page 1.

For advanced application automation, you should consider completing some or all of the following steps.

Step 4: Code Entries for Application Messages in the MPF List (Optional)

If necessary, code your entries for the application startup, abend, and shutdown messages in the MPF list, specifying the AUTO(YES) parameter. This step is optional. If the default is already AUTO(YES) for the messages, bypass this step.

You can use the MPFLSTSA member, which contains all messages that are relevant to SA z/OS, as a basis for your own messages.

If you are automating a message, you probably also want to suppress the message from appearing on operator consoles. To mark a message for suppression, code SUP(YES) in the MPF list entry for the message.

For more information on coding MPF list entries, see *z/OS MVS Initialization and Tuning Reference*.

Step 5: Add SDF Entries for the Subsystem (Optional)

If you want the application to appear in SDF status displays, update the SDF tree structure and SDF panels with information about the new application. Refer to Appendix B, “Customizing the Status Display Facility (SDF),” on page 217 for more details.

Step 6: Enable the Application for the SA z/OS Graphical Interface

If you want the new application to appear in any of the special views on the NMC workstation, you need to update the member in the DSIPARM data set that holds the BLDVIEWS cards for the sysplex that your application will run in.

How to Add a New Application to Automation

If you want the application to appear in an existing view, you need to add a NONSNA statement:

```
NONSNA=plexname.subsysname/APL/sysname*,  
QUERYFIELD=MYNAME
```

where *plexname* is the name of your sysplex, *subsysname* is the 11-character subsystem name of your application, and *sysname** is a wildcard for the system names that you want to see the application in this view.

If you want to add a new view, you will need to add a view statement:

```
VIEW=ING.plexname,  
ANNOTATION='view description'
```

This needs to be followed by the NONSNA statement for the application as described above.

Note: By default, the application will be included on NMC within the automatically generated views representing the application groups that it is a member of.

Step 7: Reload MPF List and Automation Configuration Files

| Reload the MPF list and automation configuration files to enable automation of the
| application.

To reload the MPF list, type the following command:

- From the z/OS console:
SET MPF=xx
- From a NetView console using the MVS™ prefix:
MVS SET MPF=xx

where *xx* is the suffix of the MPF member in the SYS1.PARMLIB data set to load.

| To reload the automation manager configuration file, all updated automation
| control files and the automation tables issue:

| INGAMS REFRESH

| and specify a data set name or an * which means reload the current one.

If SDF tree structures and panels have been loaded dynamically, you do not have to recycle SDF to have the application reflected in SDF at this point.

When you have completed these steps, the application is added to your automation policy and environment, and can be monitored using SDF.

Chapter 2. How to Create Automation Procedures

You can write additional automation procedures to supplement the basic automation procedures that are supplied by SA z/OS. For example, you may want to develop procedures to automate an application used exclusively on your system or to perform specialized automated operations for a subsystem.

SA z/OS generic routines and common routines perform basic functions such as logging messages and checking automation flags. You can use them in your own automation procedures.

SA z/OS generic routines and common routines are convenience routines that provide your automation procedures with a simple, standard way of interfacing with the automation control file, automation status file, and NetView log file. It is strongly recommended that you use these routines wherever possible in your own code.

“How CLIST or REXX Automation Procedures Are Structured” on page 6 describes how to structure your automation procedures. Refer to *IBM Tivoli System Automation for z/OS Programmer's Reference* for detailed descriptions and examples of the generic routines, common routines and file manager commands you can use in your automation procedures.

Programming Additional SA z/OS Automation Procedures

You can write additional automation procedures to supplement the basic automation procedures that are supplied by SA z/OS. For example, you may want to develop procedures to automate an application used exclusively on your system or to perform specialized automated operations for a subsystem.

SA z/OS generic routines, common routines, and utility routines perform basic functions such as logging messages and checking automation flags.

SA z/OS generic routines, common routines, and utility routines are convenience routines that provide your automation procedures with a simple, standard way of interfacing with the automation control file, automation status file, and NetView log file. It is strongly recommended that you use these routines wherever possible in your own code.

“How CLIST or REXX Automation Procedures Are Structured” on page 6 describes how to structure your automation procedures. Refer to *IBM Tivoli System Automation for z/OS Programmer's Reference* for detailed descriptions and examples of the generic routines, common routines and file manager commands you can use in your automation procedures.

How Automation Procedures Are Called

There are several ways to call an automation procedure including:

- Calling the automation procedure from the NetView automation table using SA z/OS generic routines
- Keying in the automation procedure name or its synonym into a NetView command line

How Automation Procedures Are Called

- Calling the automation procedure from another program
- Starting the automation procedure with a timer
- Starting the automation procedure with the NetView EXCMD command
- Starting the automation procedure on an automation operator with the SA z/OS AOFEXCMD command routine
- In the customization dialog, entering your automation procedure name in the **Command text** or **Command** field of the following entry types:
 - Application
 - MVS Component
 - Timers
 - Monitor Resources

Note: Not all routines can be called through all interfaces as some require extensive environmental setup before they are invoked.

How CLIST or REXX Automation Procedures Are Structured

Automation procedures can be written in the NetView CLIST language or in REXX. It is recommended that the structure of these automation procedures should contain three main parts, as shown in the following figures. These parts are:

1. Perform initialization processing
2. Determine whether automation is allowed
3. Perform automation processing.

The following sections provide more details about each part of an automation procedure.

Figure 2 illustrates the structure of automation procedures for system operations and Figure 3 on page 7 for processor operations.

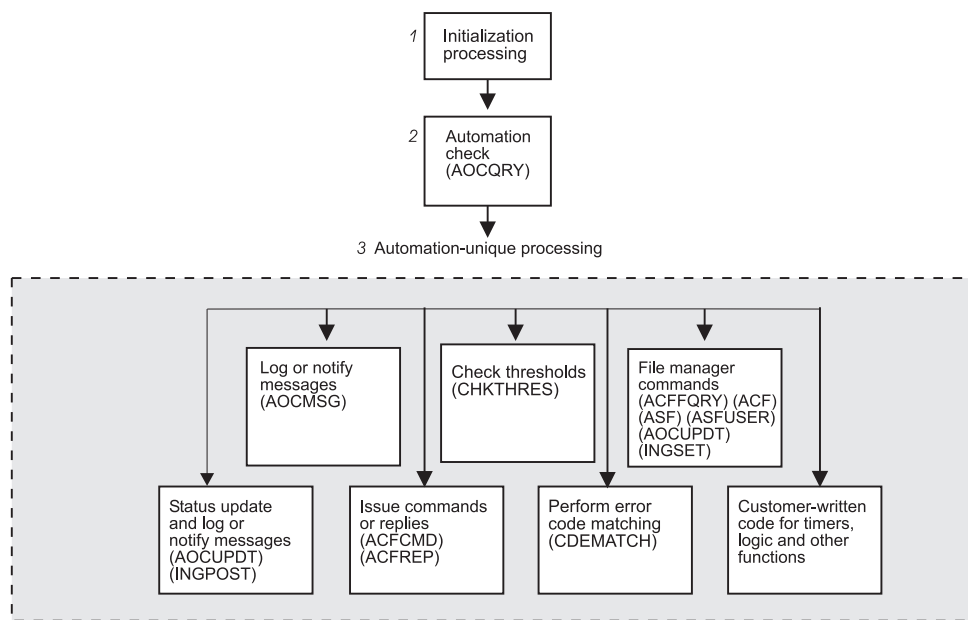

Figure 2. Automation Procedures for System Operations

How CLIST or REXX Automation Procedures Are Structured

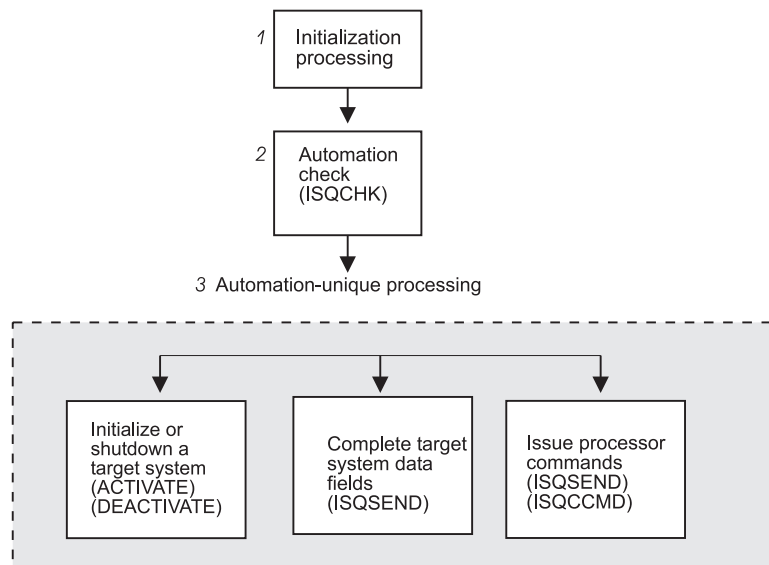

Figure 3. Automation Procedures for Processor Operations

Performing Initialization Processing

Initialization processing may not be required for simple automation procedures.

Initialization processing is responsible for:

- Setting up any error trap routines.
- Identifying the automation procedure by setting a local variable either explicitly or at execution time. This step makes it simpler to code routines that log messages and send notifications.

From REXX, the name of the CLIST is returned by the “parse source” statement.

- Declaring the global variables, such as CGLOBALs and TGLOBALs, that are used for subsystem definition values in CLIST.

See Appendix A, “Global Variables,” on page 203 for descriptions of global variables. In REXX, you must GET the first time you reference the globals, and PUT when you update them.

- Checking to see if debugging (general or CLIST-specific) is on.
- Issuing debugging messages, if debugging is turned on.
- Validating the automation procedure call.

This step can help prevent an operator from calling the automation procedure inappropriately. Automation procedures can also be validated using NetView scope checking.

- Saving NetView message parameters. This step is necessary if your automation procedure uses the NetView WAIT statement and you need to access the original message text or control information.

For more information on coding automation procedure initialization sections, refer to “Example Automation Procedure” on page 14, to *Tivoli NetView for z/OS Customization Guide* and to *Tivoli NetView® for z/OS Automation Guide*.

Determining whether Automation Is Allowed

System Operations

Automation procedures for applications and MVS components, which are called from the NetView automation table should always perform an automation check by calling the AOCQRY common routine. AOCQRY checks that the automation flags allow automation. These checks eliminate the risk of automating messages for applications that should not be automated, or for which automation is turned off. AOCQRY also initializes most of the CGLOBALs and TGLOBALs used in the automation procedure with values specific to the application.

Refer to *IBM Tivoli System Automation for z/OS Programmer's Reference* for more information on coding the automation check routine.

Processor Operations

Most of the processor operations commands run only when processor operations has been started. To determine whether processor operations is active, you can use the ISQCHK command in your automation routines. If processor operations is not running, ISQCHK returns return code 32 and issues the message:

```
ISQ0301 Cannot run cmd-name command until Processor Operations has started.
```

Your application can then issue the ISQSTART command to begin processor operations.

Performing Automation Processing

Automation processing is performed by any combination of SA z/OS routines and your own code. The following documentation gives more information on coding automation procedures:

- “Automation Processing in System Operations”
- “Automation Processing in Processor Operations” on page 10

Automation Processing in System Operations

This section contains information on how to customize automation processing for system operations.

Updating Status Information: You can update status information by calling the AOCUPDT common routine. This routine is used when a message indicates a status change. This would normally be done from the generic routines ACTIVMSG, HALTMSG, and TERMMSG. Making your own status updates may cause unpredictable results.

For more information, see *IBM Tivoli System Automation for z/OS Programmer's Reference*.

Logging Messages and Sending Notifications: You can log messages and send notifications by calling the AOCMSG common routine.

AOCMSG will:

- format a message for display or logging
- issue messages as SA z/OS notification messages to notification operators.

For more information, see *IBM Tivoli System Automation for z/OS Programmer's Reference*.

How CLIST or REXX Automation Procedures Are Structured

Issuing Commands and Replies: You can issue commands and replies by calling the ACFPCMD and ACFREP common routines. You can use these routines to:

- Issue one or more commands in response to a message.
- Issue a single reply in response to a message.
- Use the step-by-step (PASS) concept to react to or recover from an automation event.

ACFPCMD issues one or more commands. It supports both a single reaction and the step-by-step (PASS) concept. For more information, see *IBM Tivoli System Automation for z/OS Programmer's Reference*.

ACFREP issues a single reply. It supports both a single reaction and the step-by-step (PASS) concept. For more information see *IBM Tivoli System Automation for z/OS Programmer's Reference*.

In many cases you may be able to use the ISSUECMD and ISSUERE generic routines which also support single and pass processing.

Checking Thresholds: You can check and update thresholds by calling the CHKTHRES common routine. Use CHKTHRES to track and maintain a threshold, and to change the recovery action based on the threshold level exceeded. For more information see *IBM Tivoli System Automation for z/OS Programmer's Reference*.

Checking Error Codes: You can check error codes by calling the CDEMATCH common routine. Use CDEMATCH to compare error codes in a message to a set of automation-unique error codes to determine the action to take. For more information, see *IBM Tivoli System Automation for z/OS Programmer's Reference*.

In some cases you may be able to use the code matching capabilities of the ISSUERE and TERMMSG generic routines.

Using File Manager Commands: You can use file manager commands to access SA z/OS control files such as the automation control file and automation status file. Use ACF if you need to load or display the automation control file. Use ACFFQRY to query the automation control file quickly. Use ASF to display the automation status file. Use ASFUSER to modify the automation status file fields reserved for your own information. For more information, see *IBM Tivoli System Automation for z/OS Programmer's Reference*.

Using External Code for Timers, Logic, and Other Functions: Your automation procedures may require code to set timers, to perform logic unique to your enterprise or to the automation procedure itself, and to perform other functions. Some examples include:

- Issuing commands and trapping responses.
You can issue commands and trap responses using the NetView WAIT or PIPE commands. You may need to use these commands in your code if it is necessary to check the value or status of a system component or application before continuing processing. For more information, see *Tivoli NetView for z/OS Customization Guide*
- Setting Common Global and Task Global values to control processing.
You can set Common and Task Global values by using NetView commands. You may need to set these values if it is necessary to set a flag indicating progress, message counts, and other indicators that must be kept from one occurrence of a message to the next. See *IBM Tivoli System Automation for z/OS Defining Automation Policy* for a table of all externalized SA z/OS global variables.

How CLIST or REXX Automation Procedures Are Structured

Also refer to the discussion of CGLOBALS and TGLOBALS in *Tivoli NetView for z/OS Customization Guide*

- Setting timer delays to resume processing.

You can set timer delays by using the NetView AT, AFTER, EVERY and CHRON commands. You can use these commands when an automation procedure must either resume processing or initiate another automation procedure after a given time to do additional processing. For example, you could use these commands to perform active monitoring of subsystems. For more information, see the discussion of AT, AFTER, EVERY and CHRON commands in *Tivoli NetView for z/OS Automated Operations Network User's Guide*

Automation Processing in Processor Operations

This section contains information on how to customize automation processing for processor operations.

Initializing a Target System: If your routines need to start target systems (hardware and/or operating system), issue the ISQCCMD ACTIVATE command.

Shutting Down a Target System: If your routines need to shut down a target system, issue the ISQCCMD DEACTIVATE OCF command. Before issuing the command to close the target system, shut down all of your functioning subsystems. This avoids any unexpected situations at the target system.

Issuing Other OCF Commands: All OCF commands supported by processor operations can be issued from automation routines. See *IBM Tivoli System Automation for z/OS Operator's Commands* for details about these commands.

Reserved SA z/OS Commands: The SA z/OS commands ISQISUP, ISQISTAT, ISQCMPT, ISQSTRT, ISQXIPM, ISQGPOLL, and ISQGSMMSG are not intended for your use. Do not use these in your automation routines. Unexpected results may occur.

The following commands can only be used from an operator console and should not be used in your automation routines or with ISQEXEC: ISQXDST, ISQXOPT, and ISQHELP.

The following commands are for automation and should not be used in your automation routines: ISQI101, ISQI212, ISQMCLR, ISQI320, ISQIUNX, ISQI347, ISQI470, ISQI886, ISQI888, ISQI889, ISQI128, ISQIVMT, ISQMVM11, ISQMVM12, ISQMWAIT, ISQMDCCF, ISQM020, and ISQIPLC.

Serializing Command Processing: Serializing command processing ensures that commands and automation routines are processed in the order in which they are sent to a target system console. It can also prevent the command sequence from being interrupted by other tasks.

Specific target control tasks are assigned to specific target systems during initialization of the target system. More than one target system can share a target control task, but a target system never has more than one target control task allocated to it to perform work.

When a command or an automation routine is sent to a target system, it can be processed partly in the issuing task (a logged-on operator or an autotask) and partially in a target control task. When the command or automation routine is to be processed by a target control task, it is either allocated to the target control task and processed, or queued to be processed by the target control task. This serializes

How CLIST or REXX Automation Procedures Are Structured

the processing of commands and automation routines. Serializing ensures that they are processed in the order in which they were sent to the target system console.

The NetView program has priority defaults established during its initialization. Usually, everything running under NetView has a low priority. You can use the NetView DEFAULTS command to see what the settings are, but you should not change them. For SA z/OS command processing to be serialized as designed, all commands used in SA z/OS must have a priority setting of "low". If you change the priorities or have more than one priority for commands used in SA z/OS, the difference in the priorities may defeat the serialization that results from the architecture of the target control task.

Sending an Automation Routine to a Target Control Task: If you run the same series of SA z/OS commands regularly, you can program the commands into a NetView automation routine. Follow the guidelines you use for any NetView automation routine.

A NetView autotask or a logged-on operator can then run this routine or send it to a target control task. Use the following command to transfer an automation routine to a target control task:

```
ISQEXEC target-system-name SC routine-name
```

When you issue the ISQEXEC command to process an automation procedure, all of the commands are processed in the order in which they occur in the automation procedure. This is because the ISQEXEC command sends work to a target control task, which processes commands serially. Any other commands or automation routines issued to the same console by the ISQEXEC command are queued for processing by the target control task and do not start until the previous command or automation procedure completes.

The ISQEXEC command also frees the original task from any long-running command sequence. This lets you use the issuing task, such as an OST, for other work.

The ISQEXEC command does not lock consoles to ensure command serialization; the command serialization process is due to the target control task allocation scheme. Commands and automation routines are processed in the order in which they occur; however, it is possible for commands from other tasks to interrupt the command sequence.

For more information about the ISQEXEC command, see *IBM Tivoli System Automation for z/OS Operator's Commands*.

Locking a Console: Several routines and operators may attempt to address the same console at the same time. The ISQEXEC command does not prevent other tasks from interrupting the sequence of commands being processed by the target control task; it does not lock the console.

To prevent a sequence of commands from being interrupted, use the ISQXLOC and ISQXUNL commands. The ISQXLOC command locks access to the console. If a task attempts to issue a command to a locked console, the task is told that the console is locked, and the command fails. When you are finished with the sequence of commands that must be processed without interruption, issue the ISQXUNL command to unlock access to the console.

How CLIST or REXX Automation Procedures Are Structured

You can use the ISQXLOC and ISQXUNL commands within automation routines to ensure that they complete without interference from other tasks. For automation routines that issue a number of SA z/OS commands, put the following command after the ISQEXEC command and near the beginning of the routine:

```
ISQXLOC target-system-name SC
```

This locks access to the target system console to the current task until the lock is dropped by the command:

```
ISQXUNL target-system-name SC
```

Only the task that issued ISQXLOC can successfully issue ISQXUNL. If an ISQXLOC command is issued from a locked sequence of commands, it is rejected because the console is already locked.

When you lock a system console for a target system running on a logical partition, you lock that system console for all other target systems using that processor. A command sent to a system console for any other target system (logical partition) on that target hardware definition will not run until the console is unlocked.

If your automation routine cannot wait for a console to be released, use the ISQOVRD command to gain control of the console. Use the following command only in **critical** automation routines:

```
ISQOVRD target-system-name SC
```

When the routine issuing the override command completes, the lock is removed and the console is available.

How to Make Your Automation Procedures Generic

By using the SA z/OS common routines, you can make your own automation procedures generic. A generic automation procedure comprises three parts. For each part, there are special common routines that help you to fulfill your tasks:

Preparation

Check if automation is allowed and should be done. Use common routine AOCQRY.

Evaluation

What should be done? Use common routine CDEMATCH.

Execution

Do what should be done. Use common routines ACFCMD or ACFREP.

How to Make Your Automation Procedures Generic

```
*****
*****      Preparation      *****
*****

AOCQRY

- check if the resource is controlled by SA z/OS

- check if automation is allowed

- prepare/set task global variables for CDEMATCH, ACFCMD and ACFREP

...

CDEMATCH

- code matching (table search in ACF)

- find out required action

...

ACFCMD/ACFREP

- do required action:
  issue command / respond reply
```

Figure 4. Skeleton of an Automation Procedure

For more information on the mentioned common routines refer to *IBM Tivoli System Automation for z/OS Programmer's Reference*. For more information on command processing or reply processing refer to *IBM Tivoli System Automation for z/OS Defining Automation Policy*.

Processor Operations Commands

Whenever possible, your automation routines should make use of SA z/OS's processor operations OCF commands, also called common commands. These commands are independent of the hardware type of the target system's processor. Therefore, the use of these commands minimizes the need for changes to your automation routines if you need to add new processors to your configuration. See *IBM Tivoli System Automation for z/OS Operator's Commands* for a detailed description of the processor operations commands.

Developing Messages for Your Automation Procedures

Depending on the scope of additional programming, creating new automation procedures may also require developing additional messages.

Some SA z/OS facilities and commands you can use to develop messages include:

- The AOCMSG common routine (see *IBM Tivoli System Automation for z/OS Programmer's Reference*).
- The AOCUPDT common routine (see *IBM Tivoli System Automation for z/OS Programmer's Reference*).

The following steps summarize the message development process.

1. Choose a message ID. Make sure it is unique.
2. Use NetView message services to define the message to NetView.
Put an entry for the message in a DSIMSG data set. This data set must be identified in a DSIMSG data definition (DD) name.

Developing Messages for Your Automation Procedures

3. Use the AOCMSG common routine to issue the message (see *IBM Tivoli System Automation for z/OS Programmer's Reference*).
4. Add an entry for the message to your production copy of the NetView DSIMSG data set.

Example AOCMSG Call

This example shows how to code AOCMSG to issue message ABC123I.

Entries for messages in DSIMSG member DSIABC12 are as follows:

```
*****  
120I ...  
121I ...  
122I ...  
123I 10 40 THE EAGLE HAS &1  
124I ...  
*****
```

Your automation procedure contains the following AOCMSG call:

```
<other automation procedure code>  
:  
:   AOCMSG LANDED,ABC123  
:  
:  
<other automation procedure code>
```

When AOCMSG is called as specified in the automation procedure, DSIMSG member DSIABC12 is searched for message ABC123I. Substitution for variable &1 occurs, and the following message is generated:

```
ABC123I THE EAGLE HAS LANDED
```

Note that the message is defined with a 10 and a 40 between the message ID and the first word of the message. These are the SA z/OS message classes to which the message belongs. When the message is issued a copy is sent to every notification operator who is assigned class 10 or class 40 messages.

Refer to *Tivoli NetView for z/OS Customization Guide* for further information on developing new messages.

Example Automation Procedure

This section provides an example of an application program that handles an z/OS message. The automation procedure uses a subset of the SA z/OS common routines or generic routines.

```
/* Example SA z/OS Automation Procedure */
```

- 1** Signal on Halt Name Aof_Error; Signal on Failure Name Aof_Error
Signal on Novalue Name Aof_Error; Signal on Syntax Name Aof_Error
- 2** Parse source .. ident .
- 3** "GLOBALV GETC AOFDEBUG AOF."||ident||".0DEBUG AOF."||ident||".0TRACE"
If AOFDEBUG = 'Y' Then
 "AOCMSG "||ident||",700,LOG,"||time()||","||opid()||","||Arg(1)
 loc.0debug = AOF.ident.0DEBUG
 loc.0trace = AOF.ident.0TRACE
 loc.0me = ident
 If loc.0trace <> '' Then Do
 loc.0debug = ''
 Trace Value loc.0trace

```

End

4 save_msg = msgid()
save_text = msgstr()
lrc = 0

5 /* This procedure can only be called for msg IEA099A */
If save_msg <> 'IEA099A' Then Do
  "AOCMSG "||loc.0me||",203,"||time()||","||opid()
  Exit
End

6 "GLOBALV GETC AOFSYSTEM"
cmd = 'AOCQRY '||save_msg||' RECOVERY '||AOFSYSTEM
cmd
svretcode = rc
If loc.0debug = 'Y' Then
  "PIPE LIT /Called AOCQRY; Return Code was "||svretcode||"/" ,
  "| LOGTO NETLOG"

/* ----- **
** Check return code from AOCQRY **
** 0 = ok 1 = global flag off **
** 2 = specific flag off 3 = resource not in ACF **
** 4 = bad parms 5 = errors/timeout **
** ----- */
Select
7 When svretcode >= 3 Then Do
  "AOCMSG "loc.0me",206,,,"time()",,,,"cmd",RETCODE="svretcode
  lrc = 1
End
8 When svretcode > 0 Then Do
  "GLOBALV GETT AUTOTYPE SUBSAPPL SUBSTYPE SUBSJOB"
  "AOCMSG "loc.0me",580,,,"time()",,"SUBSAPPL","SUBSTYPE", ,
  SUBSJOB",,"AUTOTYPE",,"save_msg
  lrc = 1
End
Otherwise Do
9 Parse Var save_text With . 'JOBNAME=' save_job 'ASID=' save_asid .

10 ehkvar1 = save_job
ehkvar2 = save_asid
"GLOBALV PUTT EHKVAR1 EHKVAR2"
11 cmd = 'ACFCMD ENTRY='||AOFSYSTEM||',MSGTYP='||save_msg
cmd
svretcode = rc
If loc.0debug = 'Y' Then
  "PIPE LIT /Called ACFCMD; Return Code was "||svretcode||"/" ,
  "| LOGTO NETLOG"

/* ----- **
** Check return code from ACFCMD **
** 0 = ok 1 = no commands found in ACF **
** 4 = bad parms 5 = errors/timeout **
** ----- */
12 If svretcode > 1 Then Do
  "AOCMSG "loc.0me",206,,,"time()",,,,"cmd",RETCODE="svretcode
  lrc = 1
End
End
End /* End of Select svretcode */

13 Exit lrc

14 Aof_Error:
Signal Off Halt; Signal Off Failure
Signal Off Novalue; Signal Off Syntax

```

Example Automation Procedure

```
errtype = condition('C')
errdesc = condition('D')
Select
  When errtype = 'NOVALUE' Then rc = 'N/A'
  When errtype = 'SYNTAX' Then errdesc = errortext(rc)
  Otherwise Nop
End
"AOCMSG "errtype",760,, "loc.0me", "sigl", "rc", "errdesc
Exit -5
```

Notes on the Automation Procedure Example

- 1** This step sets error traps for negative return codes, operator halt commands, and REXX programming errors.
- 2** This step defines the identity of the automation procedure.
- 3** This step handles the debug and trace settings (refer to “Using AOCTRACE to Trace Automation Procedure Processing” on page 20).
- 4** Save the NetView message variables the automation procedure uses.
- 5** Perform authorization check. This procedure can only be called for a particular message.
- 6** This section performs the automation check:
 1. Fetch the AOFSYSTEM CGlobal that contains the information under which entry name the system messages are stored in the automation control file (ACF).
 2. The automation procedure calls the AOCQRY common routine. This routine performs the automation flag check and presets some TGlobal variables that are used by other common routines like ACFCMD.
- 7** Issue message AOF206I if call to AOCQRY fails.
- 8** Issue message AOF580I if automation flag is off.
- 9** Get the job name and asid reported in the message.
- 10** Set EHKVARn variables for ACFCMD.
- 11** Call ACFCMD to issue the command specified in the ACF. The Automation Control File entry for the message IEA099A could look like this:

```
MVSESA IEA099A,
CMD=(,,'MVS C &EHKVAR1,A=&EHKVAR2')
```
- 12** Issue message AOF206I if call to ACFCMD fails.
- 13** Exit with return code that indicates successful or unsuccessful processing.
- 14** This code logs a message if an error is trapped at step **1**.

Installing Your Automation Procedures

The installation process for a new automation procedure depends on the language in which the automation procedure is written.

- If the automation procedure uses a compiled language, such as PL/I, C, or Assembler:
 1. Compile or assemble your source into an object module.
 2. Link-edit the object module into a NetView load library.

3. Include an entry for the automation procedure in the DSICMD member of the NetView DSIPARM data set.
- If the automation procedure uses an interpreted language such as NetView command list or REXX:
 1. Copy the automation procedure into a NetView command list library
 2. Optionally include an entry for this automation procedure in the DSICMD member of the NetView DSIPARM data set. Then it is more quickly found and invoked.

For more information on preparing your code for use and installing it, refer to *Tivoli NetView for z/OS Customization Guide*

Testing and Debugging Automation Procedures

This section describes SA z/OS and NetView facilities you can use for testing automation procedures, including:

- SA z/OS assist mode
- SA z/OS AOCTRACE operator facility
- NetView testing and debugging facilities

The Assist Mode Facility

SA z/OS provides the *assist mode* facility, so that you can verify actions of automation procedures and automation policy before letting them run in a completely automated environment.

When assist mode is on, actions normally taken by SA z/OS automation procedures, such as issuing a command or reply or calling a common routine, are instead written to a log file or displayed through SDF. Operators using SDF can view assist mode displays to validate the actions. The operator can choose to have SA z/OS do the scheduled automated action, change it, or end it. For example, SDF might indicate that the current automation procedure issues a command to restart TSO. You can then continue the automation action as it is, change the automation action, or cancel it.

Assist settings are associated with specific automation flags (Initstart, Start, Recovery, Shutdown or Restart). The assist setting used for any action is determined by the automation flag that is checked to see if the action is permitted.

You can activate assist mode using the automation flag panels of the customization dialog. You can turn assist mode on and off for all automated resources, resource groups, or individual resources. You can also use the SETASST command dialog to change the assist mode settings for a resource.

Cases where you might want to use assist mode include:

- During early stages of developing and using your automation policy
- After changing your automation policy, such as after adding an application to automation
- After adding a new automation procedure to the SA z/OS code

Note: Assist mode is unavailable for subsystems controlled by IMS™ Automation.

Using Assist Mode to Test Automation Procedures

Assist mode can help detect problems with your automation procedures before they are added to your production code. Assist mode works by intercepting commands and replies before they are issued through NetView. The intercepted commands and replies, as coded in the automation control file, are reformatted into message AOF317A, sent to the NetView log and, optionally, to the SDF. Message AOF317A has the following format:

```
AOF317A time : ASSIST: KEY: {type|keyword} - COMMAND: text
```

Message AOF317A contains detailed information regarding:

- The time the message was generated
- The type field from the automation control file entry that defines the command
- The command selection field from the automation control file entry
- The actual command or reply

Assist mode can be enabled and disabled using the SETASST command. The DISPASST command can be used to view the current assist settings. You can also define permanent assist settings in your policy, but it is recommended that you use SETASST.

The following levels of assist are available:

Value	Description
-------	-------------

D (Display)	
--------------------	--

Activates assist mode for a particular automation flag. When Display is specified, message AOF317A is logged and added to the SDF detail status information. When you start the SDF user interface you can use assist mode to take further action. You may choose to:

- Issue the SA z/OS-generated command
- Change the command
- End the operation

Note: Do not stop the AOFTDDF task while you are using an application in assist mode as this will stop automation for your application.

Using assist mode, you can perform a step-by-step validation of commands and replies specified in the automation policy.

Attention: You should not use Assist mode before VTAM[®] is up as you will find it impossible to respond to the assist display dialog through SDF. This will cause your automation to stall until VTAM is up.

L (Log)	
----------------	--

Sets assist mode in logging-only mode. When an event triggers an automated action, SA z/OS logs the action in the NetView log. The log can be reviewed to ensure that automation has run as expected. Logging-only mode can be used to check your customized automation policy before putting it into production.

N (None)	
-----------------	--

Deactivates assist mode.

Assist mode works for all commands or replies issued using the following common routines:

- ACFCMD

- ACFREP

Assist mode works for the following generic routines as they call the ACFCMD and ACFREP common routines (if AOCQRY was called before).

- ACTIVMSG
- HALTMSG
- TERMMSG
- ISSUECMD
- ISSUEREPE

When assist mode is on interactively (D), it uses SDF to display information on automation. To access SDF, type SDF at any NetView command line and press the ENTER key. For more information on how to use SDF see *IBM Tivoli System Automation for z/OS User's Guide*.

When assist mode is on for a resource automation flag and an event occurs that triggers automation, the resource goes into ASSIST status and appears on the SDF panels in the color associated with the ASSIST status. (The default color for ASSIST is blinking white.)

When a resource appears in ASSIST status:

1. Move the cursor to the system or resource.
2. Press PF2.

You see the Detail Status Display with the message from assist mode at the bottom of the panel. This message identifies the resource that is in assist mode and the command or reply that automation issues.

```

----- DETAIL STATUS DISPLAY -----
                                     1 OF 1

COMPONENT      : RMF          SYSTEM   : ATLMVS1
COLOR          : PINK        PRIORITY : 255
DATE           : 07/14/05    TIME     : 12:05:01
REPORTER       : GATCNM01    NODE    : ATL01

REFERENCE VALUE: RMF

AOF317A 12:04 : ASSIST DISPLAY FROM CNM01/AUTWRK01 - FOR:
SUBSYSTEM/RMF - KEY: RMF/SHUTDOWN/PASS1 - CMD: MVS P RMF

===>
1=HELP 3=RETURN 4=DELETE 6=ROLL 7=UP 8=DOWN 9=ASSIST 11=BOTTOM 12=TOP
    
```

Figure 5. SDF Detail Status Display Panel with Assist Mode

In this example, the automation operator AUTWRK01 in system CNM01 issues the MVS P RMF command for the RMF™ subsystem. (P is an abbreviation for STOP. See the *MVS/ESA Operations: System Commands* for information on MVS commands.) This action was specified using the Shutdown option for the RMF subsystem in the customization dialog.

3. To indicate whether you want automation to continue with the command indicated, press PF9.

You see the Operator Assist panel.

Testing and Debugging Automation Procedures

4. You now have three options. You can:
 - Route the command to the original operator with or without modifications. To do this, type ROUTE, and if you want to modify the command, type in your changes over the command text that is there. When you have finished modifying the command press the Enter key.
 - Delete the command from the SDF display so you are no longer in assist mode. The command is not issued and the shutdown will hang until an operator intervenes. This also changes the subsystem to the status it was in before it entered assist mode (in this case, AUTOTERM).

Note: While the subsystem is in Assist mode, no further shutdown passes will be issued for it. This means you must action (either ISSUE or DELETE) all Assist panels from the first pass before any are generated for the second.

- Return to the SDF without taking any action. This suspends the automation until you do take an action. (Assist mode does not time out.)
To do this, press PF3.

In the example, if you choose to issue the command, you type a character beside the first option. This issues the command to MVS and RMF shuts down.

Using AOCTRACE to Trace Automation Procedure Processing

The AOCTRACE command dialog maintains both global execution flow traces and automation procedure (CLIST) specific debugging flags. Setting the global flag causes all routines that support tracing and all message IDs to record a statement in the NetView log whenever they are invoked. The AOFDEBUG global variable is used to pass the global flag information to the CLIST. The global flag is set to null if the global trace is off, or Y if the global trace is on.

Setting the CLIST-specific flags lets you obtain information about what the CLIST is doing when it executes, or lets you activate a REXX trace. The debug flag is either null or Y, and is stored in the AOF.*clist*.0DEBUG common variable (where *clist* is the true CLIST name).

The trace flag is set to null or a valid REXX trace type, which are as follows:

- A (All)
- R (Results)
- I (Intermediate)
- C (Commands)
- E (Errors)
- F (Failures)
- L (Labels)
- O (Off)
- N (Normal)

The S (Scan) trace type cannot be used.

The trace flag is stored in the common global variable AOF. *clist*.0TRACE (where *clist* is the true CLIST name).

Message tracing can only be set from the command line, using the command AOCTRACE MSG/*id*,ON|OFF where *id* is the message to be traced.

AOCTRACE is documented in *IBM Tivoli System Automation for z/OS Operator's Commands*.

REXX Coding Example

The following statements are sample code that can be placed at the beginning of your REXX automation routines to handle trace and debug settings:

```
/* REXX example of trace and debug processing */

Parse Source . . ident .
'GLOBALV GETC AOFDEBUG AOF.'||ident||'.0DEBUG AOF.'||ident||'.0TRACE'
If aofdebug = 'Y' Then
  'AOCMSG' ident||',700,LOG,'||time()||','||opid()||','||Arg(1)
  loc.0debug = aof.ident.0debug
  loc.0me = ident
If aof.ident.0trace <>' ' Then Do
  loc.0debug = '
  Trace Value aof.ident.0trace
End
If loc.0debug = 'Y' Then
  'PIPE LIT /' ident ' called with >' Arg(1) '</' ,
  '| LOGTO NETLOG'
```

In this example, CLIST-specific debugging is disabled when the REXX tracing is activated. This is intended to reduce extraneous information that may otherwise be generated by the trace. A message is logged that shows the CLIST name, the trace setting, the operator ID and the parameters.

When writing code to support the debug feature you should expose *loc.* on all your procedures and insert fragments of code to check the value of the *loc.0debug* flag and output relevant information. The *loc.0me* assignment makes the CLIST name available everywhere, so you can prefix all debug messages with it. You can then tell where the messages are coming from. For example:

```
| Myproc:
|   Procedure expose loc.
|   If loc.0debug = 'Y' Then
|     'PIPE LIT /' loc.0debug ' has called procedure MYPROC/',
|     '| LOGTO NETLOG'
|   Return
```

NetView Testing and Debugging Facilities

NetView provides several facilities to assist in testing and debugging automation procedures.

To do detailed testing, you may want to trace every statement issued from automation procedures. This type of testing is enabled through the `&CONTROL` statement for NetView command lists and through the `TRACE` statement for REXX procedures.

You can also specify less detailed tracing on the `TRACE` and `&CONTROL` statements, so that only commands are traced. A comparable facility, the interactive debugging aid, is available for programs coded in PL/I and C.

Perform specific tracing by issuing NetView `MSG LOG`, `PIPE LOGTO NETLOG` commands at appropriate points throughout a NetView command list, REXX procedure, or PL/I routine.

To test for proper parsing and reaction to a message, write a short automation procedure to issue a NetView `WTO` command. This `WTO` is processed by the NetView automation table and triggers the appropriate automation procedure. If the automation procedure requires the job name, the job name must be temporarily hard-coded to the appropriate name. In this case, because the `WTO` was issued

Testing and Debugging Automation Procedures

from the NetView region, the job name associated with the message is the NetView region. A sample automation procedure follows:

```
WRITEWTO CLIST
      WTO &PARMSTR
      &EXIT
```

The sample automation procedure can issue any single-line message by calling the routine. For example, to issue message ABC123I, which indicates the start of a program, the command is:

```
WRITEWTO ABC123I My testprogram PRGTEST has started.
```

Where to Find More Testing Information

More information on testing can be found in the following books:

- *Tivoli NetView for z/OS Customization Guide*
This book lists requirements for your programs, including preparing your code for use, and detailed information on writing exit routines and command processors.
- *Tivoli NetView for z/OS Automation Guide*
This book has guidelines for creating new automation procedures, including a recommended development process.

Coding Your Own Information in the Automation Status File

You can code your own information in the automation status file with the ASFUSER command.

The automation status file has 40 user data fields that are associated with each resource that is defined within it. You may use these fields to store persistent information about resources that your code needs to access later. The information in the ASF is not lost when SA z/OS is shut down. It will last until either of the following occurs:

- The ASF VSAM data set is deleted and redefined,
- You bring SA z/OS up with an automation control file that does not include the application that the information has been defined for

Note that you should verify that the information you have stored in the automation status file is accurate whenever SA z/OS initializes, as circumstances may have changed while SA z/OS was down.

Each automation status file field reserved for your data can contain up to 20 characters. The ASFUSER command allows you to update and display data in these fields. See *IBM Tivoli System Automation for z/OS Programmer's Reference* for the ASFUSER command description.

Programming Recommendations

This section contains tips and techniques that may help to reduce the coding effort required when writing your own automation procedures, and to improve performance of your automation procedures.

- Use variables, such as &IDENT, &SUBSAPPL, &SUBSTYPE, and &SUBSJOB in place of parameter values.
Using &IDENT for automation procedure names allows for changes to automation procedure names (only the &IDENT variable value needs changing).

The &SUBSxxx variables allow for subsystem and job name changes (changes to subsystem and job names need only be made in automation policy).

Using NetView command list language variable JOBNAME for the resource field on an AOCQRY call, an automation procedure can be written to support a known message for any job that can issue a message.

- Use defaults when possible to minimize coding.
- Use generic error codes (see CDEMATCH).
- Use available message parsing techniques:
 - Use the NetView command PARSEL2R or REXX PARSE command to parse a message without relying on a field position in a message.
 - Parse a message in the NetView automation table and send only necessary fields to an automation procedure.
- Consider not coding the ENTRY field in CDEMATCH calls (default is the SUBSAPPL returned from the last AOCQRY call).
- Use appropriate automation flags.
- Review the coding requirements in *Tivoli NetView for z/OS Customization Guide* including restrictions to consider when writing code, such as:
 - Restrictions when TVBINXIT is on
 - Variable names
 - Macro use
 - Register use
 - Re-entering programs
- Use SA z/OS generic routines where possible, because they:
 1. Reduce your maintenance overhead.
 2. Often use internal interfaces that are more efficient than the common routines. Similarly, it is better to use a common routine than to write your own code to process the response from an ACF display request.
- Use SA z/OS's processor operations common commands where possible, because these:
 1. Are independent of the hardware type of the target system's processor
 2. Minimize the need for changes to your automation routines as you add new processors to your enterprise
- Consider using the NetView VIEW command to display online help text associated with new code, and to develop a fullscreen interface for new commands that are a part of the new code. Refer to *Tivoli NetView for z/OS Customization Guide* for information on the VIEW command.

Global Variable Names

When creating your own automation procedures, you must ensure that the names of any global variables you create do not clash with SA z/OS external or internal global variable names. SA z/OS external global variables are documented in *IBM Tivoli System Automation for z/OS Defining Automation Policy*. In addition, you should not use names beginning with:

- CFG
- AOF
- ING
- ISQ
- EVI
- EVE

Global Variable Names

- EVJ

Chapter 3. How to Add a Message to Automation

SA z/OS exploits the NetView automation table (AT) technique. The ATs contain traps for messages that must be automated. If an action must be taken in response to a message, this action needs to be defined in the customization dialog. A related AT entry is required to call a routine to execute the action.

SA z/OS automatically generates the ATs.

Conceptual Overview

This section gives a brief overview of the main aspects of SA z/OS message automation:

- A list of messages that are involved in SA z/OS automation is generated by SA z/OS. This can then be used as an MPF member.
- Message automation is a NetView AT-based process.
- ATs are generated by SA z/OS.
- AT entries will be created for messages where actions are defined for.
- Messages can be defined to indicate a status change.
- Messages can be marked to be ignored or suppressed, thus not generating an AT entry.
- Messages can be marked to be captured for further display
- Most AT entries trap messages independent of the issuing product instance, component or module.
- Predefined AT entries can be changed.
- You can define the AT scope to determine precisely if and what kind of ATs are built.
- The following action codes are available in message processing:

CMD (C)

Allows you to enter a command in response to a message.

REP (R)

Allows you to enter a reply in response to a message.

CODE (K)

Allows you to enter codes which can be checked within a message to prompt a certain command.

USER (U)

Allows you to enter any user data in keyword-data pairs.

AUTO (A)

Allows you to enter a resource status indicated by a message.

OVR (O)

Allows you to override a default AT entry that is generated for a message.

Note that AUTO cannot be defined in combination with OVR.

Defining Actions for Messages

AT entries are generated by SA z/OS for messages that are defined for APL, MTR or MVC policy entries and that have actions (for example, CMD or REPLY) defined.

Note: Throughout this chapter, whenever the term *policy entry* is used, it implies either an APL, MTR or MVC policy entry, unless otherwise stated.

There are two kinds of messages that influence the build of AT entries:

- **Known** messages — These are messages where SA z/OS provides specific automation that is unique for the given message (for example, IAT3011). Thus this message is *known* to SA z/OS). A single AT entry is predefined just for this known message.
- **Unknown** messages — These are messages where SA z/OS provides automation that is generic for messages that are *unknown* to SA z/OS. SA z/OS maintains wildcard message automation for those messages not having a specific automation defined. (For example, message IAT9999 is unknown to SA z/OS.) A wildcard niche within an AT is the place where unknown messages are placed.

The first step in defining actions is to select a policy entry from the Policy Selection panel. From its policy selection list, select the MESSAGES/USER DATA policy item. This leads to the Message Processing panel, where you can then define actions for message IDs. If an AT entry is built according to the action, it will only check for the message ID by default, independently of the product instance, component or module issuing that message. If this is not intended, you can use the OVR action (see “Defining OVR Actions” on page 28).

There are many messages that are known to SA z/OS. For these messages specific AT entries are predefined by SA z/OS. Here, the action defined in the customization dialog does not determine the AT entry. If you want to know what kind of AT entry is built for automating a particular message, you can check the generated AT fragment member after generating the AT.

Note: SA z/OS symbols (AOCCLONES) and System Symbols should not be used for or within message IDs. Otherwise the correct sequence of entries within a generated AT cannot be guaranteed.

Defining CMD or REP Actions

Define a CMD or REP action for message XYZ222I in the CMD Processing or Reply Processing panel, where XYZ222I is a message that is unknown to SA z/OS.

This definition leads to the creation of an AT entry for message XYZ222I using the generic routine ISSUECMD or ISSUEREP after the next Configuration Build process.

Note that for MVC entries, unknown messages will have the parameter SYSTEMMSG=YES added to the SA z/OS generic routine (ISSUECMD or ISSUEREP). If the same message ID is defined for MVC and APL, the APL entry will cause the AT entry to be generated. No additional AT entry is built for the message ID that is defined for MVC.

Defining AUTO Actions

Defining Status Messages

Many messages that indicate a state change of APL, MTR, and MVC resources are known to SA z/OS. The related AT entries are already predefined. For these messages there is no need to define them in the policy database.

If necessary, you can define additional application messages that indicate a state change. You must do this for non-IBM or user application messages that indicate a state change. The AUTO action therefore leads to a selection panel that lists resource states.

The Status Message Report shows all Status Messages. It lists all user-defined and predefined Status Messages and their associated statuses.

Status messages can be defined for MVC policy entries as well as for APL and MTR instances or classes. The following description is for an UP status message based on an APL resource definition.

As an example, define an UP state indicated by message XYZ444I in the Message Type Selection panel. Here, XYZ444I is a message that is unknown to SA z/OS.

This definition leads to the creation of an AT entry for message XYZ444I using the generic routine ACTIVMSG after the next Configuration Build process.

Notes:

1. There are certain messages that can be used as Status Messages, but for some messages, CODE definitions are required (for example, IEF450I, HASP095, etc.). TERMMSG will set the status depending on these definitions. For more details about TERMMSG, see *IBM Tivoli System Automation for z/OS Programmer's Reference*.
2. The status (AUTO) action is mutually exclusive with the OVR action.

Defining Captured Messages

If messages only need to be captured to be displayed but not automated, the AUTO selection panel provides an additional CAPTURE function.

Messages that have a CMD or REPLY action defined for them or that are defined as Status Message are implicitly captured. There is no need to explicitly define these messages to be captured.

Define message XYZ555I to be captured in the Message Type Selection panel. Here XYZ555I is a message that is unknown to SA z/OS.

This definition leads to the creation of an AT entry for message XYZ555I using the generic routine AOFCPMSG after the next Configuration Build process.

Note: The status (AUTO) action is mutually exclusive with the OVR action.

Preventing the Building of AT Entries

Inhibiting AT and MPFLSTSA Entries: Using the AUTO action you can select IGNORE or SUPPRESS for certain messages:

- Messages that are marked IGNORE will not cause an AT entry or an MPFLSTSA entry to be generated.

Defining Actions for Messages

- Messages that are marked SUPPRESS will not cause an AT entry to be generated. An MPFLSTSA entry is generated with the options SUP(YES),AUTO(NO).

IGNORE and SUPPRESS overrule other actions (except OVR) that are defined for the same message, even though these actions are defined on other PDB entries.

The MPFLSTSA member is built for each PDB. Because IGNORE and SUPPRESS affect the build of the MPFLSTSA member, these definitions also have a PDB-wide scope.

For example, if the following definitions are made within the same PDB then *no* MPFLSTSA entry is generated for ABC111I even though this entry is required for SYSPLEX1 or SYS1:

- The AT scope is set to SYSPLEX or SYSTEM
- A CMD is defined for message ABC111I on APL1 that is linked to SYS1 within SYSPLEX1
- IGNORE is defined for message ABC111I on APL2 that is linked to SYS2 within SYSPLEX2

AT Entries That Are Never Built: There are many keywords that can be entered as message IDs in the Customization Dialog (for example, message MVSDUMPFULL). No AT entry is built for these keywords. A list of these keywords is given in “Restricted Message IDs” on page 236.

Defining OVR Actions

You can apply an OVR action in the Message Processing panel to a message ID for an APL instance, APL class or an MVC PDB entry.

The OVR action allows you to preview an AT entry as it would be built according to the actions that are defined for a message of an APL or MVC policy entry.

If you are using the OVR action to preview an AT entry for a message that is unknown to SA z/OS and where no other action (CMD, REPLY or AUTO) is defined, then no AT entry is predefined. The condition and action fields of the Automation Processing panel are empty.

The OVR action allows you to override an AT entry. The condition and action statements of an AT entry can be changed. Action statements can be added or deleted. Deleting the condition statement will remove the AT override.

AT entries cannot be changed by an OVR action if an AT entry is *forced* by SA z/OS or if there is already an AUTO action defined for that message on the same policy entry.

You can define '&SUBSJOB' as part of an AT condition statement that will be replaced by the job name of the given policy entry when building the AT. This is very valuable when defining an AT entry for an APL class. Then each APL instance linked to that class will have its own AT entry with its job name in the AT condition statement. Checking for the job name may also be required if different instances of a product issue the same message but you want only certain jobs to be affected by that message.

SA z/OS symbols (AOCCLONEs) and system symbols may be contained in an AT override definition. They will be resolved at AT load time.

Defining an OVR action for message XYZ666I (that is unknown to SA z/OS) in the Message Processing panel leads to the Automation Processing panel. Here you can either change a predefined AT entry that then becomes a user-defined AT entry, or, if no predefinitions are available, you can define a user specific AT entry. If message XYZ666I should be trapped, enter MSGID = 'XYZ666I' in the NetView AT condition field. If routine MYREXX1 should be called in that case, enter for example:

```
EXEC(CMD('MYREXX1')ROUTE(ONE %AOFOPWTORS%))
```

This definition leads to the creation of an AT entry for message XYZ666I using the routine MYREXX1 after the next Configuration Build process.

Note: The status (AUTO) action is mutually exclusive with the OVR action.

Defining the NetView AT Scope

In the Edit Policy Data Base Entry panel in the customization dialog, the entry field AT Scope allows you to define the scope of a NetView Automation Table. Valid AT scope values are:

NONE

No AT or MPFLSTSA member will be built at configuration build time. Use this value if you want to maintain ATs yourself.

ENTERPRISE

One AT will be built to be shared within the whole enterprise.

SYSPLEX

One AT will be built to be shared within a sysplex.

SYSTEM

One AT will be built for each system of the selected PDB. (This is the default.)

If the AT scope changes from NONE to SYSTEM, a build of type ALL is required.

If the AT Scope is set to SYSPLEX, a standalone system must be linked to a sysplex group otherwise no AT is built for that system.

The AT Scope for MPFLSTSA is always ENTERPRISE or NONE.

Build

Once you have made all the message definitions you need, you can start the Configuration Build Process to build the configuration files containing the NetView Automation Table. For more information about the build function, refer to *IBM Tivoli System Automation for z/OS Defining Automation Policy*.

When building the NetView ATs for the first time, the Build Type field in the Build Options section of the Build Parameters panel must be set to ALL, for example:

```
Build options:
Output Data Set . . . . 'OPER.OUTPUT.CONFIG'
Mode . . . . . ONLINE (ONLINE BATCH)
Type . . . . . ALL (MODIFIED ALL)
Configuration . . . . . NORMAL (NORMAL ALTERNATE)
```

The AT fragments and the MPFLSTSA member will be built into the configuration data output data set.

Build

This may require more space than you have allocated for the output data set. Thus enlarging the output data set may be required.

This also applies to the DSILIST data set where the AT listings are stored.

It is recommended that you copy the build output to a Generation Data Group (GDG) to avoid token mismatch conditions and AT load errors.

NetView Automation Table Build Concept

This section covers the following:

- When is an AT built? (See “When Is an AT Built?.”))
- Predefined message automation (see “Predefined Message Automation” on page 31)
- The AT entry sequence (see “AT Entry Sequence” on page 32)

When Is an AT Built?

An AT is built depending on the following conditions:

- If the AT Scope has *not* been set to NONE. (If it has been set to NONE then neither an AT nor an MPF list is built.)
- Depending on the Build Type, ATs will either always be built or only be built in the case of a policy modification:
 - ALL* All ATs will be built.
 - MOD* Only ATs are built where changes have been made in the PDB that affect those ATs.
- For any Build Option:
 1. Build a complete enterprise
 2. Build sysplex group or standalone system
 3. Build entry type or entry name (if changes have been made to the AT, a complete enterprise build is made)

The following changes may affect the AT, thus causing an AT rebuild:

- Defining the first CMD, REPLY, CODE, USER, AUTO, or OVR action for a message ID, or deleting the last action
- Changing or deleting a message ID that has at least one of the above actions defined for it
- Changing AUTO or OVR definitions
- Changing the link between an APL, MVC, or MTR and a system
- Changing the link between an APL instance and a class
- Installing a new version of the internal AT build template (when applying service)
- Changing the job name
- Changing the AT Scope to SYSTEM, SYSPLEX or ENTERPRISE

These changes only affect the AT build if the APL, MVC, or MTR entries are linked to a system.

Note: If the MPF Header or Footer definitions have changed, an automatic AT build is not performed.

Predefined Message Automation

SA z/OS provides predefined message automation for messages that are known to SA z/OS.

The type of AT entry defines *whether* an AT entry is built for a particular message. There are three AT entry types:

- *Forced* AT entries—Always builds an AT entry. Modifications are not allowed. See “FORCED AT Entry Type” on page 233.
- *Recommended* AT entries—Always builds an AT entry. Modifications are allowed. See “RECOMMENDED AT Entry Type” on page 233.
- *Conditional* AT entries—Only builds an AT entry if the message is defined in the Customization Dialog.

CODE and USER actions generate AT entries only for those messages that are known to SA z/OS. See “CONDITIONAL AT Entry Type” on page 234.

There are also other specialized AT entries (for example, for message IEF403I) that:

- Are always built because they are critical to the structure of the AT, see “AT Entries Built for Messages Known to SA z/OS” and “AT Entries for SA z/OS Internal Messages”
- Are never built because they contain SA z/OS keywords, see “AT Entries That Are Never Built” on page 28
- Are related to specialized activities, see “AT Entry Specialties”
- Have multiple actions defined per policy database entry, see “AT Entries for Messages That Have Multiple Actions Defined” on page 32

AT Entries Built for Messages Known to SA z/OS

A messages that is known to SA z/OS will always cause an AT entry to be generated if it is defined as a forced entry. These entries are critical to SA z/OS for proper functioning. In certain cases CMD and REPLY actions are allowed and will cause an additional (optional) AT entry action statement to be built.

There are many forced and recommended AT entries that require a CMD, REPLY, CODE, or USER action to be defined on the related message ID in the policy. Note that no warning is issued if an action is defined for a message where a forced or recommended AT entry does not honor the action. See also “Other Forced AT Entries” on page 236.

AT Entries for SA z/OS Internal Messages

SA z/OS predefines automation for specific internal AOF, HSA, ING, EVE, EVI and EVJ messages and builds the corresponding AT entries. For non-predefined SA z/OS internal messages (for example, AOF*, HSA*, ING*, EVE*, EVI*, EVJ*), AT entries will be created that will not honor a CMD, REPLY, CODE, or USER action. These entries are created to avoid any interference with SA z/OS automation.

AT Entry Specialties

Defining message IEF403I, IEF404I, or IEF450I as a status message for a resource will generate an AT statement that contains a check for the job name in the AT statement condition.

Note: It is not recommended that you define the IEF403I message as a generic UP message under MVC, because this may cause the resource to be placed in an UP state at a time that is not accurate. Dependent resources may start too early and may fail.

AT Entries for Messages That Have Multiple Actions Defined

For certain messages there may be multiple actions defined for a single PDB entry or for several PDB entries. This influences the way ATs are built:

If an Override (OVR) action is defined for any policy entry, a corresponding AT entry is created at build time.

If there is an OVR action in conflict with a Type/Status Selection (AUTO action) for one message that is defined on several application instances, the AUTO action will cause a conflict warning to be issued at build time.

For messages *known* to SA z/OS, an AT entry is created as predefined by SA z/OS and not according to the AUTO, CMD, REPLY, CODE, or USER actions that may be defined.

For messages *unknown* to SA z/OS, then the behavior is as follows:

- If an AUTO action has been defined together with a CMD, REPLY, CODE, or USER action for the same message ID, then an AT entry is created honoring the AUTO action.

Note: The generic routines (ACTIVMSG, HALTMSG, TERMMSG) check for optional commands or replies that are to be issued.

- If there is a CMD action defined together with a REPLY action for the same message ID, then an AT entry is created to issue a reply and then the command.
- If there is a CMD or REPLY action defined together with a CODE or USER action for the same message ID, then an AT entry is created to issue a command or reply.
- If there is a CODE action defined together with a USER action for the same message ID, or if there are only CODE or only USER actions defined for the same message ID, then no AT entry is built. If an AT entry is needed, then an override is required.

AT Entry Sequence

The sequence of AT entries for messages that are known to SA z/OS cannot be changed.

The location of wildcard niches (AT entries for unknown message IDs) cannot be changed.

AT entries in the same wildcard niche are sorted in a particular sequence, first by action and then by policy entry type. AT entries are created in order for the following actions:

1. OVR actions, then
2. AUTO actions, then
3. CMD or REPLY actions

Then the next level of sequencing within each of the above actions depends on the policy entry type:

1. APL instances, then
2. APL classes, then
3. MVS components (MVC)

Load

After the NetView automation tables have been generated using the customization dialog, they are ready to be loaded. INGAMS REFRESH can be used to refresh the complete SA z/OS configuration, that is, the Automation Manager Configuration (AMC), the agent's Automation Control Files (ACFs) and the related NetView Automation Tables (ATs) as they are defined in the SA z/OS Policy Database.

Alternatively, ATs can be loaded using ATLOAD.

Enabling Message Automation for the Automation Agent

READ authority *must* be given to AUTO1, AUTO2 and user tasks that will load the AT.

You can define those ATs in the PDB that are to be loaded by SA z/OS at initialization. Only those ATs defined in the PDB in entry type SYS, policy item SYSTEM INFO are refreshed.

Listing ATs

The DSILIST data set is used to store the AT listings, so if you want to view the listing of INGMSG01, issue the command:

```
br dsilist.ingmsg01
```

An AT listing is produced when SA z/OS loads an AT. You can use the advanced automation option (AAO) AOFMATLISTING to suppress listing by setting it to zero (see Appendix A, "Global Variables," on page 203).

The AT can be reloaded at configuration refresh (INGAMS, ACF ATLOAD)

Because of this you should:

- Use a separate DSILIST data set for each NetView
- Allocate the DSILIST data set as a PDSE in order to prevent Sx37 errors

A Guide to SA z/OS Automation Tables

Automation Table Structure

SA z/OS provides a ready-to-use AT, INGMSG01. To activate the AT, perform the following steps:

1. Define the AT member INGMSG01 in the SYSTEM INFO policy of the system in the customization dialogs
2. Build the automation configuration files
3. Refresh the configuration using INGAMS REFRESH
4. Restart NetView with the new configuration

The SA z/OS AT contains:

- All entries for the SA z/OS basic automation
- Entries for subsystems and resources, such as MVS messages, JES2, JES3, OMVS, VTAM, TSO, NetView SSI, NetView Application, Automation Manager, SysOps, ProcOps, I/O Ops, SA z/OS Product Automation, OMEGAMON, RODM, GMFHS, TCP/IP, OMPROUTE, RESOLVER, ZFS, RMF, RMF Monitor III, VLF,

Automation Table Structure

DLF, LLA, APPC, ASCH, TWS, RACF[®], DFHSM, DFRMM, MQ, DB2[®], IMS, FDR, CICS[®], CMAS, IRLM, NFS Server, TPX (Terminal Productivity Executive), WebSphere[®], LDAP, etc.

- AT entries for messages that are defined in the PDB
- User include fragments

You do not have to customize this AT. All unused entries are disabled automatically according to the configuration that you use. If you want to have additional entries that are valid only for your environment, you can use either a separate AT (specified in the customization dialog) or use one of the user includes.

Figure 6 shows the structure of the AT:

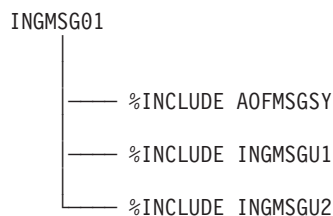

Figure 6. AT Structure

For information about how to use the INCLUDE fragments that SA z/OS provides, refer to “Using SA z/OS %INCLUDE Fragments” on page 35.

The following fragments are used by the AT:

Synonym Definitions

There is one fragment, AOFMSGSY, that is used to initialize the various synonyms used throughout the rest of the table. SA z/OS requires the synonyms to be suitably customized to reflect your environment.

SA z/OS Functional Definitions

These definitions (located in the fragment that is loaded as INGMSG02) contain automation table statements for specific functions of SA z/OS. You should not change these statements. Any modifications can be made in INGMSGU1.

Master Automation Tables

This section discusses the three master automation tables that SA z/OS provides.

INGMSG00: The automation table INGMSG00 is used for SA z/OS initialization. INGMSG00 should not be modified by the user.

This table makes use of the synonyms defined in AOFMSGSY.

INGMSG01: INGMSG01 is suitable for use as a primary automation table.

INGMSG01 should not be included into any other table but should be activated as a separate table.

AOFMSGST: This is a table suitable for a NetView with a SA z/OS Satellite installed.

Integrating Automation Tables

If you have any user-written automation table statements that you still want to use, you must now combine your primary table with SA z/OS's. There are several approaches to achieve this.

Refer to the NetView documentation for more information on how to use NetView automation tables.

Multiple Master Automation Tables

Besides INGMMSG01, you can specify multiple additional NetView automation tables for a system in the customization dialog. The tables are concatenated as entered in this panel and processed in this concatenation order.

You need not modify the INGMMSG01 automation table or any of the fragments, except AOFMSGSY. It is easy to maintain SA z/OS automation table fragments. However, you have to watch for new messages. It is easy to maintain your entries, because they are independent from SA z/OS entries.

Using SA z/OS %INCLUDE Fragments

INGMMSG01 is the master include member. It provides some message suppression that is necessary to prevent mismatches and duplicate automation before the first %INCLUDE.

The fragment INGMMSGU1 can be used for user entries. These entries have precedence over the SA z/OS entries. The default INGMMSGU1 is an empty member.

The fragment INGMMSGU2 can be used for all entries that SA z/OS does not provide any entries for. The default INGMMSGU2 is an empty member. During ACF COLD/WARM start the AT (or ATs) is (or are) loaded and write a listing to the DSILIST data set. This enables the use of the NetView AUTOMAN command to monitor and manage the AT (or ATs). Make sure that the size of your DSILIST data set is sufficient to store these listings. Without these listings you can just monitor/manage the ATs using AUTOTBL. It is recommended that you define your DSILIST data set as a PDSE so that regular data set compression is not required. Also you should make sure that the DSILIST DSN is unique to your NetView procedure.

An example output of AUTOTBL STATUS:

```
BNH361I THE AUTOMATION TABLE CONSISTS OF THE FOLLOWING LIST OF MEMBERS:
AUTO2   COMPLETED INSERT  FOR TABLE #1: INGMMSG01 AT 04/16/02 19:34:59
AUTO2   COMPLETED INSERT  FOR TABLE #2: HAIMSG01 AT 04/16/02 19:35:00
```

IPSN0

```
BNH363I THE AUTOMATION TABLE CONTAINS THE FOLLOWING DISABLED STATEMENTS:
```

```
TABLE: INGMMSG01 INCLUDE: __n/a__ GROUP : INGCICS
TABLE: INGMMSG01 INCLUDE: __n/a__ GROUP : INGIMAGE
TABLE: INGMMSG01 INCLUDE: __n/a__ GROUP : INGIMS
TABLE: INGMMSG01 INCLUDE: __n/a__ GROUP : INGJES3
TABLE: INGMMSG01 INCLUDE: __n/a__ GROUP : INGOPC
```

An example of the AUTOMAN panel:

Integrating Automation Tables

EZLKATGB AUTOMATION TABLE MANAGEMENT					
MEMBER	TYPE	LABEL/BLOCK/GROUP NAME(S)	STATUS	NUMBER OF STATEMENTS	
INGMSG02	GROUP	INGCICS	DISABLED	222	
INGMSG02	GROUP	INGDB2	ENABLED	120	
INGMSG02	GROUP	INGIMAGE	DISABLED	1	
INGMSG02	GROUP	INGIMS	DISABLED	107	
INGMSG02	GROUP	INGJES2	ENABLED	1	
INGMSG02	GROUP	INGJES3	DISABLED	1	
INGMSG02	GROUP	INGOPC	DISABLED	10	
INGMSG02	GROUP	INGUSS	ENABLED	1	

In this example the configuration loaded does not use the IMS, CICS, OPC product automation and the IXC102A automation. It uses JES2, DB2 and USS automation.

Generic Synonyms—AOFMSGSY

This automation table fragment contains a number of synonyms that must be appropriately set. It is used in most master automation tables to set up the environmental parameters for the other fragments. The AOFMSGSY member is supplied by SA z/OS (in the SINGNPRM data set). You must customize it for each of your systems. The customized copy should be placed in the domain-specific data set for that system.

Note that many values in this table fragment are enclosed in triple single quotation marks. This means that the value of the synonym is the value entered surrounded by a single set of single quotation marks. This is necessary so that the value is treated as a literal and not an automation table variable.

Synonym	Usage and Default
%AOFALWAYSACTION%	<p>This synonym contains the action statement used for all the messages within a Begin-End block that SA z/OS does not trigger any action for.</p> <p>Default: NULL</p> <p>The default is that <i>no</i> action will be taken and the message does not continue to search for further matches within the same AT.</p>
%AOFDOM%	<p>This synonym should contain the domain ID of the SA z/OS NetView on the system that it is automating. The synonym is used to screen messages to prevent the SA z/OS on this machine from reacting to a message that originated on another machine. If not set correctly, your automation will fail.</p> <p>Default: &DOMAIN.</p> <p>This is a default domain name used in a number of the samples.</p>

Synonym	Usage and Default
%AOFSYS%	<p>This synonym should contain the system name used in the last IPL of the system. It is used to screen messages to prevent the SA z/OS on this machine from reacting to events that have occurred on other machines. It is important if you are running on a JES3 global or in a sysplex with EMCS consoles. If not set correctly, your automation will fail.</p> <p>Default: &SYSNAME.</p> <p>This is a default system name used in a number of the samples.</p>
%AOFSIRTASK%	<p>NetView has a CNMCSSIR task that handles communications between the main NetView task and its SSI address space. This synonym should be set to the name of the task. If the synonym is not set properly, SA z/OS fails to initialize.</p> <p>Default: &DOMAIN.SIR</p>
%AOFARMPPI%	<p>This synonym should contain the name of the NetView autotask that is running the PPI interface from SA z/OS to z/OS. It is used to route commands from the NetView automation table to the autotask.</p> <p>Default: AOFARCAT</p>
%AOFGMFHSWAIT%	<p>The time interval SA z/OS waits after GMFHS initialization is complete before issuing the command to update the RODM with the current application automation states. Following the issuing of message DUI4003I GMFHS NETWORK CONFIGURATION INITIALIZED SUCCESSFULLY, GMFHS resets the color of all SA z/OS icons to grey (unknown). To set the SA z/OS icons' color to the current automation states after the initialization of GMFHS, SA z/OS must wait and issue the update command AFTER GMFHS has reset the colors to grey.</p> <p>Default: 00:02:00</p>

SA z/OS Message Presentation—AOFMSGSY

The presentation of SA z/OS messages (prefixed with AOF, ING, HSA, EVJ, EVE and EVI) under NetView is controlled by the automation table. This uses a number of synonyms and task globals indicating your message display characteristics. The following synonyms determine the display characteristics for each type of message. There is one set for the normal presentation of the message (AOFNORMx) and a second set for the held presentation (AOFHOLDx).

Synonym	Usage and Default
%AOFHOLDI%	<p>This synonym defines the actions taken for SA z/OS information (type I) messages that are held on your NCCF console.</p> <p>Default: HOLD(Y) COLOR(GRE) XHILITE(REV)</p> <p>This:</p> <ul style="list-style-type: none"> • Ensures that the message is held • Causes the message to be displayed in reverse video green

SA z/OS Message Presentation—AOFMSGSY

Synonym	Usage and Default
%AOFHOLDA%	<p>This synonym defines the actions taken for SA z/OS immediate action (type A) messages that are held on your NCCF console. As a rule, you should specify HOLD(Y) in the action.</p> <p>Default: HOLD(Y) COLOR(RED) XHILITE(REV) BEEP(Y)</p> <p>This:</p> <ul style="list-style-type: none"> • Ensures that the message is held • Causes the message to be displayed in reverse video red • Sounds the terminal alarm when the message is displayed
%AOFHOLDD%	<p>This synonym defines the actions taken for SA z/OS decision (type D) messages that are held on your NCCF console. As a rule, you should specify HOLD(Y) in the action.</p> <p>Default: HOLD(Y) COLOR(WHI) XHILITE(REV) BEEP(Y)</p> <p>This:</p> <ul style="list-style-type: none"> • Ensures that the message is held • Causes the message to be displayed in reverse video white • Sounds the terminal alarm when the message is displayed
%AOFHOLDE%	<p>This synonym defines the actions taken for SA z/OS eventual action (type E) messages that are held on your NCCF console. As a rule, you should specify HOLD(Y) in the action.</p> <p>Default: HOLD(Y) COLOR(YEL) XHILITE(REV) BEEP(Y)</p> <p>This:</p> <ul style="list-style-type: none"> • Ensures that the message is held • Causes the message to be displayed in reverse video yellow • Sounds the terminal alarm when the message is displayed
%AOFHOLDW%	<p>This synonym defines the actions taken for SA z/OS wait state (type W) messages that are held on your NCCF console. As a rule, you should specify HOLD(Y) in the action.</p> <p>Default: HOLD(Y) COLOR(PIN) XHILITE(REV) BEEP(Y)</p> <p>This:</p> <ul style="list-style-type: none"> • Ensures that the message is held • Causes the message to be displayed in reverse video pink • Sounds the terminal alarm when the message is displayed
%AOFNORMI%	<p>This synonym defines the actions taken for SA z/OS information (type I) messages that are not held on your NCCF console. As a rule, you should not specify HOLD(Y) in the action.</p> <p>Default: COLOR(GRE)</p> <p>This:</p> <ul style="list-style-type: none"> • Ensures that the message is not held • Causes the message to be displayed in green

SA z/OS Message Presentation—AOFMSGSY

Synonym	Usage and Default
%AOFNORMA%	<p>This synonym defines the actions taken for SA z/OS Immediate Action (type A) messages that are held on your NCCF console. As a rule, you should not specify HOLD(Y) in the action.</p> <p>Default: COLOR(YEL) XHILITE(REV) BEEP(Y)</p> <p>This:</p> <ul style="list-style-type: none"> • Ensures that the message is held • Causes the message to be displayed in yellow • Sounds the terminal alarm when the message is displayed
%AOFNORMD%	<p>This synonym defines the actions taken for SA z/OS Decision (type D) messages that are held on your NCCF console. You may find it beneficial to force these messages to be held.</p> <p>Default: COLOR(WHI) XHILITE(BLI)</p> <p>This:</p> <ul style="list-style-type: none"> • Ensures that the message is held • Causes the message to be displayed in blinking white
%AOFNORME%	<p>This synonym defines the actions taken for SA z/OS Eventual Action (type E) messages that are not held on your NCCF console. As a rule, you should not specify HOLD(Y) in the action.</p> <p>Default: COLOR(YEL)</p> <p>This:</p> <ul style="list-style-type: none"> • Ensures that the message is not held • Causes the message to be displayed in yellow
%AOFNORMW%	<p>This synonym defines the actions taken for SA z/OS Wait State (type W) messages that are held on your NCCF console. You may find it beneficial to force these messages to be held.</p> <p>Default: HOLD(Y) COLOR(PIN) XHILITE(REV) BEEP(Y)</p> <p>This:</p> <ul style="list-style-type: none"> • Ensures that the message is held • Causes the message to be displayed in reverse video pink • Sounds the terminal alarm when the message is displayed

Operator Cascades—AOFMSGSY

The next set of synonyms defines a series of *operator cascades*. A cascade is basically a list of automation operators used in many of the fragments to route commands. If %CASCADE% is defined as a synonym for 'AUTMON AUTOBASE AUTO1' and you route a command to it with ROUTE (ONE %CASCADE%) on an EXEC statement, the command is run on the first autotask in the cascade that is logged on. This provides you with a flexible, controllable means of providing backup processing tasks in case one of your normal tasks is unavailable.

Operator Cascades—AOFMSGSY

Synonym	Usage and Default
%AOFLOPAUTOx%	<p>This cascade defines the actions taken for SA z/OS information (type I) messages that are being held on your NCCF console. Given the number of informational messages that SA z/OS produces you may find it beneficial HOLD(N) to stop them from being held even if the user has asked for them to be held.</p> <p>Default: ' 'AUTOx' '</p>
%AOFOPAUTO1%	<p>This cascade is used to route commands to AUTO1. If you have renamed AUTO1 you must change the synonym.</p> <p>Default: AUTO1</p> <p>There is no backup for AUTO1. If it fails when it is needed, many other things will probably fail as well.</p>
%AOFOPAUTO2	<p>This cascade is used to route commands to AUTO2. If you have renamed AUTO2 you must change this synonym.</p> <p>Default: AUTO2 AUTO1</p> <p>If AUTO2 is not active, AUTO1 does its work.</p>
%AOFOPBASEOPER%	<p>This cascade is used to send commands to BASEOPER. If you are not using the standard names for SA z/OS autotasks you must change this synonym. BASEOPER is mainly defined as a fallback operator and has very little work directly routed to it.</p> <p>Default: AUTOBASE AUTO1</p> <p>AUTOBASE is the operator ID that SA z/OS uses for BASEOPER in its other samples. If AUTOBASE is not active, AUTO1 is tried.</p>
%AOFOPRPCOPER%	<p>This cascade is used for XCF communication management. If you are not using the standard names for SA z/OS autotasks you must change this synonym.</p> <p>Default: AUTRPC AUTSYS AUTOBASE AUTO1</p>
%AOFOPSYSOPER%	<p>This cascade is used to send commands to SYSOPER. If you are not using the standard names for SA z/OS autotasks you must change this synonym. SYSOPER is mainly defined as a fallback operator and has very little work directly routed to it.</p> <p>Default: AUTSYS AUTOBASE AUTO1</p> <p>AUTSYS is the operator ID that SA z/OS uses for SYSOPER in its other samples.</p>
%AOFOPMSGOPER%	<p>This cascade is used to send commands to MSGOPER. If you are not using the standard names for SA z/OS autotasks you must change this synonym. MSGOPER is mainly defined to respond to miscellaneous messages.</p> <p>Default: AUTMSG AUTSYS AUTOBASE AUTO1</p> <p>AUTMSG is the operator ID that SA z/OS uses for MSGOPER in its other samples.</p>

Synonym	Usage and Default
%AOFOPNETOPER%	<p>This cascade is used to send commands to NETOPER. If you are not using the standard names for SA z/OS autotasks you must change this synonym. NETOPER is defined for VTAM automation.</p> <p>Default: AUTNET1 AUTNET2 AUTSYS AUTOBASE AUTO1</p> <p>AUTNET1 and AUTNET2 are the operator IDs that SA z/OS uses for NETOPER in its other samples. NETOPER is the only sample automation function to have a backup defined in the samples.</p>
%AOFOPJESOPER%	<p>This cascade is used to send commands to JESOPER. If you are not using the standard names for SA z/OS autotasks you must change this synonym. JESOPER is mainly defined for JES automation.</p> <p>Default: AUTJES AUTSYS AUTOBASE AUTO1</p> <p>AUTJES is the operator ID that SA z/OS uses for JESOPER in its other samples.</p>
%AOFOPMONOPER%	<p>This cascade is used to send commands to MONOPER. If you are not using the standard names for SA z/OS autotasks you must change this synonym. MONOPER is used for regular monitoring and subsystem startups.</p> <p>Default: AUTMON AUTSYS AUTOBASE AUTO1</p> <p>AUTMON is the operator ID that SA z/OS uses for MONOPER in its other samples.</p>
%AOFOPRECOPER%	<p>This cascade is used to send commands to RECOPER. If you are not using the standard names for SA z/OS autotasks you must change this synonym. RECOPER is used for recovery processing.</p> <p>Default: AUTREC AUTSYS AUTOBASE AUTO1</p> <p>AUTREC is the operator ID that SA z/OS uses for RECOPER in its other samples.</p>
%AOFOPSHUTOPER%	<p>This cascade is used to send commands to SHUTOPER. If you are not using the standard names for SA z/OS autotasks you must change this synonym. SHUTOPER coordinates automated shutdowns.</p> <p>Default: AUTSHUT AUTSYS AUTOBASE AUTO1</p> <p>AUTSHUT is the operator ID that SA z/OS uses for SHUTOPER in its other samples.</p>

Operator Cascades—AOFMSGSY

Synonym	Usage and Default
%AOFOPGSSOPER%	<p>This cascade is used to send commands to GSSOPER. If you are not using the standard names for SA z/OS autotasks you must change this synonym. GSSOPER is used for generic subsystem automation.</p> <p>Default: * AUTGSS AUTSYS AUTOBASE AUTO1</p> <p>AUTGSS is the operator ID that SA z/OS uses for GSSOPER in its other samples.</p> <p>If you want to turn off the "ASSIGN BY JOBNAME" feature, that is, the advanced automation CGLOBAL variable <i>AOF_ASSIGN_JOBNAME</i> (see Appendix A, "Global Variables," on page 203) has been set to 0, you must remove the asterisk (*), because this may cause serialization problems.</p> <p>Note: NetView's ASSIGN-BY-JOBNAME command that occurs prior to the automation-table processing will only affect messages that are associated with an MVS job name.</p>
%AOFOPWTORS%	<p>This cascade is used to route commands concerning WTORS. If you are not using the standard names for SA z/OS autotasks you must change this synonym. Its use ensures that all WTOR processing is done on the same task and this is serialized.</p> <p>Default: AUTSYS AUTOBASE AUTO1</p> <p>This specifies that AUTSYS is to do all the WTOR processing.</p>
%AOFOPGATOPER%	<p>This cascade is used to route commands to this domain's gateway autotask. As the autotask name contains the domain ID you must modify this synonym.</p> <p>Default: GATA0F01</p> <p>AOF01 is the default domain used in the other samples. There is no backup as the gateway CLISTs expect to be running on GATOPER.</p>

TEC Notification—AOFMSGSY

These synonyms are being used for notification of the Tivoli Enterprise Console[®] (TEC).

Synonym	Usage and Default
%AOFTECTASKQ%	<p>This is the name of the autotask for sending SA z/OS events to the Tivoli Enterprise Console (TEC) with quotes.</p> <p>Default: ' 'AUTOTEC' '</p>
%AOFTECTASK%	<p>This is the name of the autotask for sending SA z/OS events to the Tivoli Enterprise Console (TEC) without quotes. AOFTECTASK and AOFTECTASKQ must contain the same name (with and without quotes).</p> <p>Default: AUTOTEC</p>

Synonym	Usage and Default
%AOFTECPPI%	This is the NetView PPI Receiver ID of the NetView message adapter (with quotes). Default: ' 'IHSATEC' '
%AOFTECMODE%	Event generation mode (with quotes). Possible values are: LOCAL The NetView message adapter is running on this system. LOCAL is valid for the local configuration and for the focal point in the distributed configuration. REMOTE The NetView message adapter is running on a remote automation focal point. SA z/OS messages will be generated on this target system and forwarded to a remote automation focal point system. There is no local NetView message adapter that can process SA z/OS messages. REMOTE is valid for the target system in a distributed configuration. Default: ' 'LOCAL' '

SA z/OS Topology Manager for NMC—AOFMSGST

These synonyms are used and defined in the AOFMSGST fragment.

Synonym	Usage and Default
%AOFOPTOPOMGR%	This is the name of the autotask that the SA z/OS topology manager runs on this system. Default: &DOMAIN.TPO
%AOFINITOPOCMD%	This is the command issued to initialize the SA z/OS topology manager. Default: INGTOPO INIT &DOMAIN.TPO
%AOFOPHB%	This is the name of the heart beat task needed on focal point. Default: AUTHB

Generic Automation Table Statements

The basic automation table contains a number of generic automation table entries that can reduce your automation table overhead considerably. These samples use some of the advanced features of SA z/OS to make automating your applications as simple and reliable as possible.

For some of these entries (IEF403I and IEF404I in particular) the message flow may be quite high. To handle this, you can insert additional entries in INGMSGU1 to suppress a block of messages. For example, if all your batch jobs started with the characters BAT or JCL, then the following entry would suppress them:

```
IF MSGID = 'IEF40'. & DOMAINID = %AOFDOM% THEN BEGIN;
*
  IF (TOKEN(2) = 'BAT'. | TOKEN(2) = 'JCL'.)
    THEN DISPLAY(N) NETLOG(N);
*
END;
```

Generic Automation Table Statements

Chapter 4. How to Monitor Applications

This chapter provides information about the different ways that you can monitor your applications:

- Using monitor routines, see “How to Write Your Own Monitor Routines”
- The monitor resource (MTR), see “Monitor Resources” on page 46
- JES3 monitoring, see “Monitoring JES3 Components” on page 49

How to Write Your Own Monitor Routines

SA z/OS determines the status of an application by running a routine identified by the policy administrator in the customization dialog. The routine can be specified for an individual application (refer to *IBM Tivoli System Automation for z/OS Defining Automation Policy*), and a default monitor routine can be specified for all applications on an entire system (see policy item AUTOMATION INFO in the customization dialog).

The routines that can be specified as application monitors are:

AOFADMON	This routine determines the status of an application by issuing the MVS D A, <i>jobname</i> command. The job name used is the job name defined in the customization dialog for the application. Possible values for the application monitor status as determined by this routine are Active, Starting, Inactive.
AOFATMON	This routine is used to determine the status of a task operating within the NetView environment. The task status is determined by issuing the NetView LIST <i>taskname</i> command.
AOFAPMON	This routine determines the status of a program-to-program interface (PPI) receiver. It calls DISPPI and checks if a specific PPI receiver is active.
AOFCPSM	This routine is a dedicated routine used to monitor the status of the SA z/OS processor operations applications using the ISQCHK service.
AOFUXMON	This routine determines the status of a resource with application type USS. This resource can either be a z/OS UNIX process, a file system in the UNIX file system (HFS), or a TCP port. Depending on the nature of the resource (process, file, or port) AOFUXMON decides which internal monitoring method to use.
INGPJMON	This routine determines the status of an application by running a routine that searches the MVS address space control blocks (ASCBs) for address spaces with a particular job name. The job name used is the job name defined in the customization dialog for the application.
INGMTSYS	With this routine, IMAGE applications for BCPII usage can be monitored.
ISQMTSYS	With this routine, a processor operations target system resource represented by its proxy can be monitored. You can find examples of how to use a proxy definition in <i>IBM Tivoli System Automation for z/OS Customizing and Programming</i> . Active operator console connections are mandatory and will be used for sending a z/OS command (for example, d t) and receiving the related response.

SA z/OS expects certain return codes from all monitor routines, either from SA z/OS provided ones or from your own routines. These can be one of the following:

RC	Meaning
0	Active
4	Starting
8	Inactive
12	Error

Monitor Resources

Monitor resources are policy objects used to obtain the health state of other resources, typically Applications or Application Groups. The health state is useful when you need to know how well the resource is performing and not just that it is active. The Health Status can be used to provide application specific performance and health monitoring information. For example, an Application may be active but it is failing to meet performance objectives defined by the system administrator.

The health status can be used for information or by the automation manager to make decisions and, if necessary, trigger automation for the application.

With application-specific performance and health monitoring, a separate status shows up to inform you about an application's health. This health status can be used for information or by the automation manager to make decisions and, if necessary, trigger automation for the application.

The MTR policy object is an SA z/OS resource and, as such, is treated like all other SA z/OS resources. MTRs are started and stopped using the INGREQ command and can have a Service Period defined for them.

Monitor resources obtain the health state of an object in two different ways:

- Actively, by polling—that is executing a monitoring command periodically
- Passively, by processing events

Monitor resources (MTRs) are connected to application resources (APLs) or application group resources (APGs). The health status of the monitored object is propagated to the APLs and APGs and results in a combined health status there. You can define and connect MTRs in the customization dialog (see *IBM Tivoli System Automation for z/OS Defining Automation Policy*).

Monitors can be Active or Passive. Passive monitors do not have a monitor interval defined but might have a monitor command assigned for initial health status determination. They rely on other events to set the Health Status using the INGMON command. Active monitors are scheduled periodically based on the interval defined in the MTR policy. Instead of using a monitor routine to proactively determine the MTR status, a Passive monitor waits for an event to trigger a predefined action for example an INGMON STATUS= command.

Associated with each health status (NORMAL, WARNING, MINOR, CRITICAL and FATAL) can be one or multiple commands (referred to as recovery routine) that are invoked by SA z/OS when the monitor resource switches to the corresponding health status.

Monitor resources are displayed and controlled with the DISPMTR command.

Writing Monitor Resource Commands

When defining an MTR you can specify activate, deactivate and monitor commands. Any command is suitable that can be executed in the NetView environment. These commands are divided into two groups:

- NetView activate and deactivate commands that expect a certain return code
- Monitor commands

The main difference between these two groups is that the activate and deactivate commands are executed only once, and SA z/OS expects a return code of zero. The activate and deactivate commands are optional.

- The activate command establishes the environment the monitoring routine can run in. The command is executed every time the monitor is started. The command must exit with return code 0.
- The deactivate command can be used to cleanup the environment. The command is executed every time the monitor is stopped. The command must exit with return code 0.
- The monitor command is executed after the activate command and then periodically if a monitoring interval is given. SA z/OS expects the monitor command to return a valid health status code. Additionally the monitor command can issue a message that is then attached to the health status.

The command can be a command procedure written in any language that is supported by NetView: REXX, Assembler, PL/I, C, or the NetView Command List (Clist) language. Writing a monitor routine can be simple or it can be complex. The complexity depends upon the Application that you are attempting to monitor.

Writing a Monitor Routine

In general, the monitor routine will need to issue one or more commands to generate data, process the data, and set a return code. The return code is then used by SA z/OS to determine the health state for the resource. The possible return codes and the corresponding Health Status are given in Table 2.

Table 2. Health State Return Codes

Return code	Health Status	Description
1	BROKEN	The monitor detected an unrecoverable error. SA z/OS will stop monitoring.
2	FAILED	The monitor is currently unable to obtain a health state. SA z/OS will keep the monitor active because the problem might disappear.
3	NORMAL	The monitor detected normal operation of the monitored object.
4	WARNING	The monitor detected a certain degree of degradation in the operation of the monitored object.
5	MINOR	The same as WARNING, but more severe.
6	CRITICAL	The same as MINOR, but more severe.
7	FATAL	The same as CRITICAL, but more severe.
8	DEFER	Used internally.

The Health Status values (with the exception of unknown) will affect the Compound Status in the Automation Manager.

Most monitor routines will use unknown, normal, and warning statuses. The minor, critical, and fatal statuses can be used as gradients to indicate that a problem is getting worse. BROKEN and FAILED are states that describe the status of the monitor itself and may be seen if an error is encountered with the monitor routine.

Optionally, the monitor routine can issue a message describing the condition that will be trapped by the SA z/OS process which invoked the monitor. The message will be seen on the DISPMTR panel.

Every monitor routine will need several basic steps:

1. Issue one or more commands to collect data and interrogate the results.
2. Based on the results from the command(s), set the return code to a value from one (1) to eight (8) and, optionally, perform processing based on that value.
3. Optionally, supply more descriptive information about the Health Status in a message that can be seen with the DISPMTR command.
4. Exit with the return code so SA z/OS can set the Health Status appropriately.

Figure 7 is an example using the NetView PING command within a PIPE to query the status of a TCP/IP stack on a remote system. The IP address is passed on input. The routine uses the average round trip time (RTT) for the request provided in message BNH770I to determine the health.

```
/*REXX MYMON */
Arg parm
monrcs='BROKEN FAILED NORMAL WARNING MINOR CRITICAL FATAL DEFER'
'PIPE (STAGESEP | NAME PING)',
'| NETV PING' parm,
'| LOCATE 1.8 /BNH770I /',
'| STEM out.'
if out.0 = 0 then
  lrc = wordpos('FATAL',monrcs)
else
  do
    parse var out.1 . 'averaging' ms 'ms' .
    say 'PING lasted' ms 'ms'
    select
      when ms < 10 then lrc = wordpos('NORMAL',monrcs)
      when ms < 20 then lrc = wordpos('WARNING',monrcs)
      when ms < 30 then lrc = wordpos('MINOR',monrcs)
      when ms < 40 then lrc = wordpos('CRITICAL',monrcs)
      otherwise lrc = wordpos('FATAL',monrcs)
    end
  end
Return lrc
```

Figure 7. Sample Monitor Command

Writing a Recovery Routine

The "health" recovery routine is invoked every time the monitor resource switches to the health state that the recovery routine is defined for. The goal of the recovery routine is to bring the monitored resources back to normal.

The following task globals can be accessed by the recovery routine:

EHKVAR1

Contains the monitor name

EHKVAR2

Contains the current health status

EHKVAR3

Contains the old health status

EHKVAR4

Contains the message associated with the health status

Monitoring JES3 Components

The concept of a Monitor Resource is used to monitor the health of various JES3 components. SA z/OS provides two commands that support a strict separation of the monitoring part and the resulting recovery processing:

- AOFRJ3MN—used to monitor components in the JES3 environment, for example spool space.
- AOFRJ3RC—used to perform recovery actions against the monitored JES3 object.

The following example defines a spool space monitor:

1. Define a monitor resource with a “HasParent” relationship to the corresponding JES3 since it only makes sense to monitor the spool space when JES3 is active.
2. Activate and deactivate commands are not necessary for the spool monitor.
3. Use the AOFRJ3MN command as the monitor command and setup the monitoring interval as desired. In this example, spool usage of up to 60% is NORMAL, 61-70% WARNING, 71-80% MINOR, 81-90% CRITICAL and greater than 90% FATAL.

```
AOFRJ3MN JES3_subsys SPOOLSHORT 60,70,80,90
```

4. Define the recovery action in the HEALTHSTATE policy, for example:

```
NORMAL : AOFR3RC JES3_subsys SPOOLSHORT RESET
CRITICAL: AOFR3RC JES3_subsys SPOOLSHORT 05
FATAL : AOFR3RC JES3_subsys SPOOLSHORT 01
```

Issue one recovery command every minute. The commands are read from the SPOOLSHORT policy of the JES3 subsystem. When the spool usage goes down to 60% or less, the health status will go to NORMAL. This causes to invoke the AOFR3RC command but now with the RESET option - the RESET option stops recovery. It is recommended that you use JESOPER as the auto-operator for the recovery commands. Note, that the recovery commands for the SPOOLSHORT condition must be defined for the JES3 subsystem.

5. For the JES3 subsystem, define the necessary actions that should be performed for SPOOLSHORT in the Message/User data policy:

Pass	Automated Function	Command
1	JESOPER	MVS &SUBSCMDPFXF U,Q=HOLD,AGE=30D,N=ALL,C
2	JESOPER	MVS &SUBSCMDPFXF U,Q=HOLD,AGE=10D,N=ALL,C
3	JESOPER	MVS &SUBSCMDPFXF U,Q=HOLD,AGE=3D,N=ALL,C
10	JESOPER	MVS &SUBSCMDPFXF U,Q=HOLD,AGE=1D,N=ALL,C

This will purge all jobs from the hold queue that are older than 30 days in the

| first pass. On pass 2, all jobs older than 10 days are purged. On pass 3 all jobs
 | older than 3 days are purged. Finally, after 10 times the pass interval (in our
 | example 5 minutes), all jobs older than 1 day will be deleted if the recovery
 | action is not reset meanwhile.

AOFRJ3MN Routine

| Use this routine to monitor various objects in a JES3 environment. The following
 | objects can be monitored:

- | • MDS queues (Fetch queue, Verify queue, Wait volume queue, Error queue,
 | Allocation queue, Breakdown queue, Unavailable queue, Restart queue, System
 | select queue, System verify queue)
- | • Current setup depth
- | • Spool space

| For each of the 10 JES3 MDS queues, thresholds may be set for each of the 4 health
 | states (Warning, Minor, Critical and Fatal) indicating the number of jobs that
 | particular queue may contain causing to set the corresponding health status. If, for
 | example, the WARNING threshold for the Error queue is set to 5, if 5 or more jobs
 | are pending on the MDS Error queue, the health status is set to Warning.

| For the spool space the thresholds define the amount of used space that when
 | exceeded causes to set the corresponding health status.

| Whenever AOFRJ3MN is called, it issues the appropriate JES3 command (*I,Q,S for
 | SPOOLSHORT and *I,S for the MDS queues) and parses the response. The value
 | extracted from the message text is compared with the thresholds and then the
 | return code is set to the corresponding health status. This simply sets the health
 | status of the Monitor resource (MTR). No recovery action is taken by AOFRJ3MN
 | routine. Use the HEALTHSTATE policy of the Monitor resource to define a
 | recovery action for each health status, if necessary.

The syntax of the AOFRJ3MN routine is as follows:

▶▶ AOFRJ3MN—*jes3apl*—| object |—| threshold-list |—————▶▶

object:

MDCOUNTQ
MDCOUNTF
MDCOUNTV
MDCOUNTW
MDCOUNT E
MDCOUNTA
MDCOUNTB
MDCOUNTU
MDCOUNTR
MDCOUNTSS
MDCOUNTSV
SPOOLSHORT

threshold-list:

|—warning—, —minor—, —critical—, —fatal—|—————|

jes3apl Specifies the name of an APL of category JES3 for which this monitor works.

monitor

Specifies the JES3 object to be monitored:

MDSCOUNTQ Current setup depth
MDSCOUNTF Fetch queue
MDSCOUNTV Verify queue
MDSCOUNTW Wait volume queue
MDSCOUNTE Error queue
MDSCOUNTA Allocation queue
MDSCOUNTB Breakdown queue
MDSCOUNTU Unavailable queue
MDSCOUNTR restart queue
MDSCOUNTSS System select queue
MDSCOUNTSV System verify queue
SPOOLSHORT Spool

threshold-list

Specifies a list of four threshold values separated by commas:

warning Set health status to WARNING if this value is exceeded
minor Set health status to MINOR if this value is exceeded
critical Set health status to CRITICAL if this value is exceeded
fatal Set health status to FATAL if this value is exceeded

If *warning* is not exceeded the health status is set to NORMAL.

Note that for SPOOLSHORT the values are in percent but for the MDS queues they are absolute numbers. No value checking is done by AOFRJ3MN except for whole numbers.

Note also that the thresholds are tested from FATAL to WARNING. So if you want to go directly from NORMAL to FATAL, you could specify 50,50,50,50

AOFRJ3RC Routine

This routine performs the recovery action against a monitored object in a JES3 environment.

When AOFRJ3RC is called, it checks whether the system that it is running that holds the JES3 global processor. If not AOFRJ3RC terminates without any further action.

The syntax of the AOFRJ3RC routine is as follows:

```
▶▶AOFRJ3RC—jes3apl—msg-type—pass-interval—▶▶  
                                  └─RESET─┘
```

jes3apl Specifies the name of an APL of category JES3.

msg-type

Specifies the message type within the given JES3 APL that the recovery commands are to be read from:

pass-interval

Specifies the time interval that AOFRJ3RC should wait before executing the next pass. The format is in NetView notation (mm, hh:mm, hh:mm:ss or :ss).

RESET

If RESET is specified AOFRJ3RC stops the recovery.

AOFRJ3RC looks into the MESSAGE/USER DATA policy definition of the specified JES3 APL. It issues the command that is defined for PASS1 of the given message type. As long as there are commands in higher passes it sets up a NetView timer that re-calls AOFRJ3RC after the given pass interval. Whenever AOFRJ3RC is executed the command that is defined for the next pass is issued as long as one exists.

If RESET is specified instead of a pass interval any pending timer is killed and processing stops.

The return code is always zero.

Note: AOFRJ3RC issues the recovery commands in a *fire-and-forget* manner. It does not check whether the recovery action has the desired result. This is done by the monitor. After one or more monitor intervals the health status will change to a less severe one if the recovery shows an effect. If you want to stop recovery actions when the health status returns to NORMAL, for example, you have to code a HEALTHSTATE command that calls AOFRJ3RC with RESET.

Chapter 5. Exception-Based Monitoring with OMEGAMON

SA z/OS has been enhanced to enable you to use Monitor Resources to connect to classic OMEGAMON[®] monitors to send commands and receive responses.

Overview

The OMEGAMON interface lets you gather a wide range of performance data on a system. You can gather data from the following performance monitoring products:

- OMEGAMON for MVS
- OMEGAMON for CICS
- OMEGAMON for IMS
- OMEGAMON for DB2

Exception analysis is an OMEGAMON feature that monitors predefined *thresholds* in a system. Each time exception analysis is invoked, an exception is displayed on the OMEGAMON console if a threshold is exceeded. Using SA z/OS, you can then act on these exception alerts by running execs or issuing commands, including issuing commands back to the host OMEGAMON.

You can set up Monitor Resources to:

- Monitor sets of exceptions that may be of interest
- Set an application's health state based on the existence of such exceptions
- React to and resolve conditions that cause those exceptions

Scenario

To illustrate how SA z/OS and OMEGAMON operate together, consider the following scenario.

Suppose there is a DB2 application that should be continuously monitored. Of particular interest is the availability of primary active logs. The LOGN exception indicates that fewer primary active logs exist than specified by the respective threshold value. This is considered a critical health indicator because it can cause a DB2 hang situation if the last primary active log becomes 100% full. Such a situation can only be resolved by making one or more additional primary active logs available again.

In order to monitor this situation and react accordingly, the automation policy has to be changed. First, define the session attributes for the OMEGAMON for DB2 monitor, if they do not yet exist, to be able to establish a VTAM connection. The OMEGAMON session is referred to by its *session name*. Then review the number of session operators (automation operators) that will be started to handle the VTAM session traffic and add an additional one if a higher degree of parallelism is required. You need to ensure that the number of session operators and predefined NetView tasks are identical.

Next, add a new monitor resource (MTR) that periodically requests exception information from this OMEGAMON session. Add the MTR by means of a *HasParent* relationship to the DB2 subsystem to be monitored. This ensures that the MTR will be activated when the DB2 subsystem is started, and deactivated when

Exception-Based Monitoring with OMEGAMON

the DB2 subsystem is stopped. Also define the MTR via a *HasMonitor* relationship to the DB2 subsystem to ensure that the monitor's health state can be propagated to the application.

While the MTR is active, it uses the new monitor command, INGMTRAP, to gather OMEGAMON exceptions that currently exist, based on the thresholds that are defined in the OMEGAMON for DB2 installation profile. INGMTRAP analyses all exceptions returned by OMEGAMON and filters out those exceptions that the MTR is interested in, in this example, LOGN. SA z/OS subsequently issues message ING080I to initiate exception processing.

Finally, also add a new rule to the automation table (via the SA z/OS policy) that executes a REXX exec to add a new log data set to the pool of primary active data sets whenever the LOGN exception is reported and the health state is CRITICAL (6). The MTR's health state is considered CRITICAL if the number of available primary active logs is equal to 1. If the LOGN exception is reported again in the next monitor interval, a second rule in the automation table sets the MTR's health state to FATAL (7), which triggers an application move since normal recovery handling doesn't seem to work anymore. In addition, an alert is sent to the operator to inform him about this situation. If the LOGN exception is no longer reported, the MTR's health state will be set to NORMAL (3).

The health state assigned to the MTR by means of the automation table is propagated to the DB2 application that owns this MTR. Thus, you can see at a glance whether the DB2 subsystem is okay or not.

Topologies

Various topologies are possible for SA z/OS with OMEGAMON:

- There can be one or more systems
- There can be one or more OMEGAMON monitors per system
- Connectivity is through VTAM and the NetView Terminal Access Facility (TAF)
- SA z/OS can act as a focal point either:
 - globally, monitoring data from OMEGAMON monitors running on different systems
 - locally, monitoring data from OMEGAMON monitors running on the local system

The following assumptions are made about the topologies that can be adopted:

1. The OMEGAMON product is installed on each system where MVS and CICS, DB2, or IMS is installed.
2. OMEGAMON monitors are installed and configured already to support multiple VTAM-based connections to it. For interoperability with SA z/OS, logical units of type 3270 model 2 (24x80) are required.
3. OMEGAMON monitors are setup to interact with an external security product such as IBM SecureWay Security Server for z/OS (formerly RACF).
4. OMEGAMON exceptions are reported when the threshold that is defined in OMEGAMON is exceeded. That threshold must be agreed within an installation because it must cater for the least severe condition that there might be an alert for.

OMEGAMON Interaction

The following subsections assume that you have defined one or more OMEGAMON sessions and automated functions that are designated to handle network communication using the SA z/OS customization dialog. For details on defining OMEGAMON sessions, refer to the OMEGAMON SESSIONS and AUTHENTICATION policies within entry type Network (NTW) and to the OPERATORS policy within entry type Auto Operators (AOP) described in *IBM Tivoli System Automation for z/OS Defining Automation Policy*.

Programming Interface INGOMX for OMEGAMON

INGOMX acts as the interface between operators (or auto-operators) and any of the classic OMEGAMON monitors for CICS, DB2, IMS, and MVS.

It can be used to issue OMEGAMON major, minor, and immediate commands, and to filter one or more exceptions of interest from the list of exceptions reported by OMEGAMON exception analysis. Each request is written to the console (but not exposed to NetView) in the format as produced by the OMEGAMON monitor. When exception filtering is requested, multiple exception lines for one exception are combined into a single line and written to the console as a single message if the filter criteria (XTYPE) matches. INGOMX is best used within a NetView PIPE.

The following examples illustrate the use of INGOMX. They are based on an OMEGAMON for MVS session with the name OMSY4MVS. The same techniques also apply to other OMEGAMON monitors. For more details, refer to *IBM Tivoli System Automation for z/OS Programmer's Reference*.

Example 1: Returning Information on Common Storage Utilization Using the CSAA Command

```
INGOMX EXECUTE,NAME=OMSY4MVS,CMD=CSAA
| IPXNG CSAA SUMMARY
| IPXNG +
| IPXNG + System
| IPXNG + Maximum Pre-CSAA Orphan Usage
| IPXNG + -----0 2 4 6 8 100
| IPXNG + CSA 3312K 1247K 0 1247K 37.6%----->
| IPXNG + ECSA 307740K 78797K 0 78797K 25.6%----->
| IPXNG + SQA 1620K 660K 0 660K 40.8%----->
| IPXNG + ESQA 145696K 23930K 0 23930K 16.4%-->
```

Example 2: Using OMEGAMON command modifiers

```
INGOMX EXECUTE,NAME=OMSY4MVS,CMD=ALLJ,MOD=#
| IPXNG #ALLJ 166
INGOMX EXECUTE,NAME=OMSY4MVS,CMD=ALLJ,MOD=<
| IPXNG <ALLJ *MASTER* PCAUTH RASP TRACE DUMPSRV XCFAS GRS SMSPDSE+
| IPXNG + CONSOLE WLM ANTMMAIN ANTAS000 OMVS IEFSCHAS JESXCF ALLOCAS+
| IPXNG ...
```

Example 3: Trapping outstanding operator replies

```
INGOMX TRAP,NAME=OMSY4MVS,XTYPE=(XREP)
| IPXNG + XREP Number of Outstanding Replies = 5
```

Example 4: Issuing OMEGAMON minor commands

```
/* REXX-Routine EXMINOR */
cmd.1 = "CMD=SYS" /* Major command, issued ahead of its minors */
cmd.2 = "CMD=FCSA" /* Minor: CSA frames below 16M */
cmd.3 = "CMD=FCOM" /* Minor: CSA, LPA, SQA, and nucleus below 16M */
cmd.0 = 3
'PIPE STEM cmd. COLLECT',
'| NETV INGOMX EXECUTE,NAME=OMSY4MVS,CMD=*',
'| CONSOLE ONLY'
* IPXNG EXMINOR
IPXNG SYS >> WLM Goal mode OPT=00 SYSRES=(150526,8812) <<
IPXNG fcsa 328 1312 K
IPXNG fcom 849 3396 K
```

There is no need to explicitly establish a session between an operator and a particular OMEGAMON monitor before using INGOMX; such sessions are established automatically on their first use.

Selective protection of individual OMEGAMON sessions and commands, or both, is possible based on the NetView Command Authorization Table. Details can be found in the appendix "Security and Authorization" in *IBM Tivoli System Automation for z/OS Planning and Installation*.

Monitor Command INGMTRAP

INGMTRAP is a customized interface to INGOMX that provides filtering capabilities for exceptions of interest as reported by OMEGAMON exception analysis and triggering of automation on behalf of such exceptions. For each exception that matches the XTYPE filter that is provided by the caller, INGMTRAP issues message ING080I, which is exposed to NetView. For example:

```
ING080I CI2XREP/MTR/KEYA OMSY4MVS OMIIMVS XREP Number of Outstanding Replies = 4
```

If no exception matches the XTYPE filter that is provided by the caller, INGMTRAP creates a ING081I message that is not exposed to NetView but written to the Monitor Resource's log to document that no exception has been found. For example:

```
ING081I CI2XREP/MTR/KEYA OMSY4MVS OMIIMVS NO EXCEPTION FOUND
```

INGMTRAP can only be used as a monitor command. This means that it has to be specified directly as a monitor command in the definition of a Monitor Resource, or it has to be called on behalf of such a monitor command. The following example illustrates what you need to specify on the MONITOR INFO policy in entry type Monitor Resource (MTR) in order to trap outstanding operator replies that are reported by OMEGAMON for MVS session OMSY4MVS:

```
INGMTRAP NAME=OMSY4MVS,XTYPE=(XREP)
```

Be careful when specifying a list of exceptions: each exception may cause an ING080I message to be issued. Because each occurrence of an ING080I message will trigger health state processing of the Monitor Resource, make sure you understand the impact that this may have on the Monitor Resource's final health state.

For more details about INGMTRAP refer to *IBM Tivoli System Automation for z/OS Programmer's Reference*. For more details about defining Monitor Resources, refer to *IBM Tivoli System Automation for z/OS Defining Automation Policy*.

Health Based Automation Using OMEGAMON

By combining Monitor Resources and the OMEGAMON interaction methods described in “OMEGAMON Interaction” on page 55, automation can be triggered as a result of analyzing the output reported by OMEGAMON and by the setting of an appropriate health state.

OMEGAMON exceptions can be periodically monitored using a Monitor Resource and the monitor command INGMTRAP. There are a variety of ways to handle such exceptions:

1. In the customization dialog, the MESSAGES/USER DATA policy of a given Monitor Resource needs to state the health state of each exception that INGMTRAP has been set up to monitor. Unlike messages, OMEGAMON exceptions are denoted by a '+' sign, followed by a blank and then a 4-character OMEGAMON exception ID.
2. In addition to the health state, a series of one or more commands can be specified to handle that particular exception. Commands are processed in the same way as for any other resources that a MESSAGES/USER DATA policy is provided for, such as applications (APL). This includes escalation processing based on a PASS count, or processing based on a selection value that can be defined using CODEs that are derived from a message.
3. The HEALTHSTATE policy can be used to issue recovery commands on behalf of an OMEGAMON exception each time the health state changes.

No matter which method or combination of method are chosen, the process of handling an exception is triggered by the occurrence of an ING080I message for a particular Monitor Resource and exception. The automation table that is built from the definitions in the MESSAGES/USER DATA policy contains statements that invoke the generic routine INGMON to set the Monitor Resource's health state and to issue commands in response to exceptions. In most cases, the necessary entries in the NetView Automation Table are created automatically by SA z/OS. In some rare cases when, for example, command selection should be based on CODEs, it is necessary to override the automation table definition of the exception, and to specify up to 3 codes (CODE1, CODE2, and CODE3) on the invocation of INGMON.

Alternatively, an installation-written monitor command can be used to issue INGOMX for a series of exceptions to one or more OMEGAMON monitor. Such a monitor command then returns with an appropriate health state that is based on the analysis of the output produced by INGOMX. The recovery commands that are issued when the health state changes are specified in the HEALTHSTATE policy of that Monitor Resource.

Recovery Techniques

User data in the MESSAGES/USER DATA policy can be used to disable additional recovery processing while other recovery is already in progress. In combination with the predefined keyword DISABLETIME, the recovery disable time can be specified in the formats hh:mm:ss, mm:ss, :ss, or mm. While recovery is disabled, no commands are processed on behalf of this Monitor Resource for messages and exceptions that are specified in the MESSAGES/USER DATA policy.

Recovery is automatically enabled after the recovery disable time has expired. Recovery can also be enabled prematurely by calling the generic routine INGMON with the option CLEARING=YES, for example:

```
INGMON CI2XREP MSGTYPE=XREP CLEARING=YES
```

Exception-Based Monitoring with OMEGAMON

In some cases, it is necessary to force increasingly strong recovery actions over a period of time. This can be accomplished using a PASS count that starts at 1 and runs to 99. SA z/OS maintains the PASS count individually per message or exception, and increments the PASS count each time that message or exception is processed. Upon successful recovery, it is the installation's responsibility to reset the PASS count. When specified with option CLEARING=YES, INGMON enables command processing for messages and exceptions, and resets the PASS count.

Programming Techniques

Commands that are called by INGMON have access to the message that triggered the invocation using the NetView SAFE, AOFMSAFE, for example:

```
/* REXX */
'PIPE SAFE AOFMSAFE | VAR triggerMsg'
If Symbol('triggerMsg') \= 'LIT' Then Do
  Parse Var triggerMsg tok1, tok2, ...
End
```

INGMON fills the task global variables &EHKVAR0, &EHKVAR1-9, and &EHKVART with certain tokens that are derived from the message or exception that INGMON was invoked by. For messages, the assignment starts with the message ID, and for exceptions, it starts with the exception ID. The following two examples illustrate how message and exception tokens are assigned to these task global variables.

Example 1:

```
$HASP9211 JES MAIN TASK NOT RUNNING. DURATION- hh:mm:ss.xx
```

Task Global	Value
&EHKVAR0	\$HASP9211
&EHKVAR1	JES
&EHKVAR2	MAIN
&EHKVAR3	TASK
&EHKVAR4	NOT
&EHKVAR5	RUNNING.
&EHKVAR6	DURATION-
&EHKVAR7	hh:mm:ss.xx
&EHKVAR8 &EHKVAR9 &EHKVART	NULL

Example 2:

```
ING080I CI2XREP/MTR/KEYA OMSY4MVS OMIIMVS XREP Number of Outstanding Replies = 4
```

Task Global	Value
&EHKVAR0	XREP
&EHKVAR1	Number
&EHKVAR2	of
&EHKVAR3	Outstanding
&EHKVAR4	Replies
&EHKVAR5	=

Task Global	Value
&EHKVAR6	4
&EHKVAR7 &EHKVAR8 &EHKVAR9 &EHKVART	NULL

Recommendations

You should consider the following recommendations when using OMEGAMON in combination with Monitor Resources:

- Avoid monitoring multiple exceptions using INGMTRAP. Note that there can be more than one exception that may trip and thus multiple ING080I messages may be generated. The Monitor Resource's health state, however, depends on the last ING080I message.
- Avoid setting different health states for the same exception that is monitored by different Monitor Resources using INGMTRAP. Note that only one automation table entry will be generated by SA z/OS to process message ING080I for such an exception.

In these cases, the use of INGOMX, invoked from an installation-written monitor command, to determine a combined health state from multiple exceptions or to determine an individual health state for each Monitor Resource, is preferred to using INGMTRAP .

Chapter 6. How to Automate Your Resources

This chapter contains information on how to customize your SA z/OS installation by programming various routines and procedures. It describes various ways of how to adapt your installation to your requirements.

Using Automation Flags

SA z/OS extended automation flags (automation flags for minor resources) give you the ability to control the automation for individual messages and status changes. You cannot use extended automation flags to stop a status change from occurring, but you can use them to stop commands or replies being issued in response to a change to a particular status.

You can define messages and status information as minor resources with a major resource that is either:

- The application that issued the message or changed status
- MVSESA, if the message or status change is not associated with an application.

To define messages or status information as minor resources, use the customization dialog to edit the *Minor Resources* policy item of the appropriate *Application* policy object or the *MVS Component* policy object. See *IBM Tivoli System Automation for z/OS Defining Automation Policy* for more information.

When an application is about to change to a new status, the status change routines (ACTIVMSG, HALTMSG and TERMMMSG) check whether the new status has been defined as a minor resource for the application before they issue any commands associated with the status change. See “Programming Additional SA z/OS Automation Procedures” on page 5 and *IBM Tivoli System Automation for z/OS Programmer’s Reference* for more information about SA z/OS routines.

The command and reply routines (ISSUECMD and ISSUEREP) check to see if the message ID of the message that triggered them is defined as a minor resource under the associated application (or under MVSESA for a system message).

Note: Calling either ISSUECMD or ISSUEREP with AUTOTYP=NOCHECK disables this checking, but as it causes a number of incongruities, this is not recommended.

By default a minor resource inherits the automation flag settings of its major resource. You can use the customization dialog or INGAUTO to set specific flags for minor resources. You can see the current automation flag settings for both major and minor resources on the DISPFLGS panel.

Example

When TSO issues message IKT001D and this is trapped by an automation table statement that runs ISSUEREP AUTOTYP=START, the following actions are taken:

1. The TSO Start flag will be checked
2. If either the TSO Start flag is turned on or minor resource checking is enabled, the TSO.IKT001D Start flag is checked.

Using Automation Flags

3. If the TSO.IKT001D Start flag is turned on, ISSUEREPLY issues any replies appropriate to the message.
4. If the TSO.IKT001D Start flag is turned off (even though the TSO Start flag may be turned on), SA z/OS does not attempt to reply to the message.

When SA z/OS Checks Automation Flags

This section describes how SA z/OS uses automation flags. It provides background information to help you customize SA z/OS-provided automation and to help you write your own automation procedures.

Table 3 summarizes how SA z/OS typically uses automation flags. SA z/OS provides a common routine, AOCQRY, to perform automation flag checking. See *IBM Tivoli System Automation for z/OS Programmer's Reference* for a description of AOCQRY.

Table 3. Automation Flags: Typical Uses in SA z/OS

Automation Flag	Typical Use In SA z/OS
Automation	Checked before any other automation flag to determine if overall automation for the resource is on or off. If it is off, none of the following flags will be checked.
Initstart	Checked after the SA z/OS initialization for the first start of an application. If this is on, SA z/OS will start the resource - provided its goal is to be available.
Recovery	Checked to determine whether to proceed with performing recovery actions other than restarting a resource.
Restart	If this is on, SA z/OS checks whether or not the resource is eligible for restart.
Shutdown	Checked to determine whether to proceed with a shutdown for the specified resource.
Start	Checked after the initial application start command or commands are issued and additional commands or replies are issued for the subsystem, to determine if startup is to be automated. This flag can be used to control how much of the complete resource startup process is automated.

Note: SA z/OS will invoke an exit only if it needs to in order to evaluate a flag. For example, if an exit is specified on a subsystem restart flag but the global SUBSYSTEM Automation flag is off, SA z/OS does not invoke the exit when it checks the restart flag because the setting for the subsystem Automation flag (inherited from the SUBSYSTEM Automation flag) is off.

If the situation is reversed (exit for the subsystem Automation flag and the SUBSYSTEM Restart flag is off) the exit would also not be invoked. See "Flag Exits" on page 134 for more information on automation flag exits.

Do not rely on SA z/OS to invoke an exit every time a flag is checked. You can only rely on SA z/OS to invoke an exit before it concludes that a flag is turned on.

The Automation Manager Global Automation Flag

Using the INGLIST or the INGSET command (see *IBM Tivoli System Automation for z/OS User's Guide* or *IBM Tivoli System Automation for z/OS Operator's Commands*)

When SA z/OS Checks Automation Flags

you can set an automation flag for the individual resources, which is checked by the automation manager before it sends any order to the automation agent to start or stop the specific resource.

The purpose of this flag is to prevent (if flag is set to NO) or enable (YES) the starting or stopping of resources. This can be done for resources that reside on systems that are currently inactive, for example, to prevent the startup of the resource at IPL time of the system.

When SA z/OS Checks Automation Flags

Chapter 7. How to Automate Processor Operations-Controlled Resources

This chapter contains information on how to customize your SA z/OS installation to enable the automation of messages coming from target systems that are controlled by processor operations. These target systems or resources are referred to as *processor operations resources* in the following.

Notes:

1. VM guest systems are treated as any other target systems which is controlled by ProcOps (see *IBM Tivoli System Automation for z/OS Operator's Commands* for details).
2. PSMs are "virtual" hardware and therefore not all Target hardware commands apply (see *IBM Tivoli System Automation for z/OS Operator's Commands* for details).

With the method described in this chapter, you can use SA z/OS system operations to react on these messages. This information is contained in "Automating Processor Operations Resources of z/OS Target Systems Using Proxy Definitions," which introduces the general process how to achieve such message automation.

Automating Processor Operations Resources of z/OS Target Systems Using Proxy Definitions

SA z/OS processor operations can be used to automate messages which cannot be automated on the target systems themselves. Typically these messages include those appearing at IPL time.

In a sysplex environment there are additional messages (XCF WTORs) being displayed at IPL time when joining the sysplex and at shutdown time when a system is leaving a sysplex. These WTOR messages cannot be automated yet because SA z/OS system operations is not active at that time.

With the XCF message automation framework described in this chapter, you have a method of exploiting your own XCF message automation. SA z/OS will also deliver samples in the sample policy database exploiting this framework.

Note: There are XCF WTOR messages which are automatable by Sysplex Failure Management (SFM). In these cases, to avoid conflicting automation, it is not recommended that you automate these messages by SA z/OS.

Concept

You can use the SA z/OS standard interface and routines to handle system external messages in almost the same way as system internally generated messages. This applies to the way of defining message automation in the customization dialog as well as to the means available for controlling message automation at automation time.

How to Automate Processor Operations Controlled Resources

To exploit the system operations mechanism for message automation, a *proxy resource* representing the processor operations resources must be generated in the customization dialog as entry type *Application* (APL).

There is a one-to-one relation between a proxy and a processor operations resource (target system). How to implement this relation in the customization dialog is described in the following subsections.

Messages which are generated on external systems, where no SA z/OS is active or not yet active, can also be automated. Therefore, these resources generating these messages are called *processor operations resources*. They are defined in the customization dialog as entry type *System* (SYS).

Customizing Automation for Proxy Resources

It is assumed that you have already used the customization dialog to define processor operations target systems and made these systems accessible to the processor operations focal point via the Processor Control file (see also *IBM Tivoli System Automation for z/OS Defining Automation Policy*). So for every processor operations target system defined on the processor operations focal point, you should define a proxy resource. You do this by defining the proxy resource as entry type *Application* (APL) in the customization dialog.

Note: If you want to define many proxy resource applications, you can use the application class concept as described in *IBM Tivoli System Automation for z/OS Defining Automation Policy*.

The rules that you need to obey when defining the proxy resource are described in the subsequent list.

Defining the proxy resource as *Application* (APL) has another advantage: The system is then visible in the INGLIST panel and it can be managed and monitored like an application resource. SA z/OS users will be able to not only use message automation for target system messages, they also can issue start and stop commands to IPL and to shutdown systems. These commands can be defined like any start and stop command for an application. But other than application resources, target systems are managed by processor operations commands (e.g. ISQCCMD target_system_name ACTIVATE FORCE(NO) or ISQSEND target_system_name OC vary xcf,target_system_name,off,retain=yes). Processor operations commands allow you to send MVS commands to target systems as well as to send hardware commands to the processor (support element).

Here is the list of rules:

1. As mentioned, you need to define (or have defined) the processor operations target systems that you want to automate. For those systems, the following rule applies:

<p>MVS SYSNAME = ProcOps name The <i>MVS SYSNAME</i> must be identical with the <i>ProcOps name</i>.</p>

If this is not the case, you need to change it subsequently.

- 2.

How to Automate Processor Operations Controlled Resources

Job Name = ProcOps name

The *Job Name* of the application for the proxy resource must match the processor operations target system's name as defined when creating this system in the customization dialog.

3.

Job Type = NONMVS

The *Job Type* for the proxy application must be NONMVS.

4. The *Monitor Routine* for the proxy application must be ISQMTSYS.

5.

Sysname = MVS SYSNAME

The *Sysname* for the proxy application must match the *MVS SYSNAME* defined for the processor operations target system. This definition is used for resource monitoring.

6.

Note:

If you want to inhibit operators from performing a startup or shutdown for a target system resource using the INGREQ command, *External Startup* and *External Shutdown* must be set to 'ALWAYS'.

7. If you do not want the proxy resource to be started at an IPL or on NetView recycle of the processor operations focal point, you should specify NO for both fields *Start on IPL* and *Start on RECYCLE*.

8. As you can only automate applications by linking them to systems via an application group, you need to define an application group for the proxy applications. Do not merge the proxy applications with other applications into this application group because destructive requests applied to a merged application group would also affect the proxy resources contained in that group.

You may choose PASSIVE behavior to not forward requests against the application group to each member. This will prevent you from unintentionally sending requests to processor operations target systems represented by their proxies.

9. In the *Message Processing* panel for the proxy application define the messages to be automated in column *Message ID*. Do not specify message ID ISQ900I, as this message is used as a carrier for the original target system message.

Enter 'cmd' in the *Action* column to specify the command to be processed if the defined message occurs.

10. If the message to be automated is a WTOR, then the variable &EHKVAR1 will contain the reply ID. This variable may then be used as a parameter to the ISQSEND command:

```
ISQSEND &SUBSJOB OC R &EHKVAR1,COUPLE=00
```

How to Automate Processor Operations Controlled Resources

Startup and Shutdown Considerations

Processor operations commands must be used to start or stop processor operations resources, for example:

Start example:

```
ISQCCMD &SUBSJOB LOAD FORCE(NO)
```

Stop example:

```
Pass 1 ISQSEND &SUBSJOB OC Z EOD
```

```
Pass 2 ISQSEND &SUBSJOB OC VARY XCF,&SUBSAPPL,OFF,RETAIN=YES
```

Note:

If the delay time between sending the commands in pass 1 and pass 2 is not appropriate, you may define a resource specific Shut Delay in the *Application Automation Definition* panel.

For more details about processor operations commands refer to *IBM Tivoli System Automation for z/OS Operator's Commands*.

Preparing Message Automation

The interaction with target systems is based on the SA z/OS processor operations component. Therefore the installation and customization of this component must be complete at this point.

Operating System messages from processor operations target systems receiving at the focal point will be transferred to ISQ900I messages.

ISQ901I is not relevant. It is used to inform interested operators about target system messages. It is not used for automation purposes.

MSCOPE() parameter in CONSOLxx member

MSCOPE allows you to specify those systems in the sysplex from which this console is to receive messages not explicitly routed to this console. An asterisk (*) indicates the system on which this CONSOLE statement is defined. Since the default is *ALL, indicating that unsolicited messages from all systems in the sysplex are to be received by this console, this parameter must be set to '*' for correct automation by SA z/OS processor operations.

Automating Linux Console Messages

The Linux Console Connection to NetView

When a Linux target system IPLs, its boot messages are displayed on the Console Integration facility (CI) of the zSeries® or 390-CMOS processor Support Element (SE). For SA z/OS processor operations, CI is the only supported interface to communicate with the Linux operating system. The communication between the processor operations focal point and CI is based on the NetView RUNCMD and the Support Element's Operator Command Facility (OCF), an SNA application. In SA z/OS processor operations, this connection path is referred to as a NetView Connection (NVC).

Linux Console Automation with Mixed Case Character Data

Unlike operating systems which translate console command input into uppercase characters, Linux is case sensitive. The NetView automation table syntax allows the use of mixed case characters in compare arguments of an IF statement. When an automation command is to be scheduled as a result of such a comparison, any message token arguments passed, are not translated into uppercase by NetView. Make sure that your automation routine does not do an uppercase translation of parameters passed. For example, in REXX use the statement 'PARSE ARG P1 P2' instead of 'ARG P1 P2', which implicitly performs a translation into uppercase. If a Linux message invokes your automation code and the message information is retrieved using NetView's GETMLINE function, no uppercase translation will occur. In order to send mixed case command data to the Linux console consider the following REXX statement:

```
Address Netvasis 'ISQsend MYlinux Oc whoami'
```

The addressed REXX command environment 'Netvasis' passes the command string without doing an uppercase translation. The ISQSEND command internally translates its destination parms into 'MYLINUX' and 'OC' but leaves command 'whoami' as is.

Security Considerations

After Linux system initialization, usually a LOGIN prompt message is displayed allowing users defined to the system to login. The ISQSEND command interface does not suppress any password data from being displayed. You may use the NetView LOG suppression character to avoid the password information to be visible in the NetView log. In SNA/VTAM traces or Support Element log files, such password data can be viewed in text form.

Restrictions and Limitations

The following Linux systems are supported:

- Linux systems running in an LPAR of a zSeries or 390-CMOS processor hardware
- Linux systems running on a zSeries or 390-CMOS processor hardware, configured in Basic mode
- Linux systems running as VM guest machines under z/VM Version 4.3 or higher

Linux systems running under a VM, which itself runs as a VM guest, are not supported.

In the command shell environments of a Linux console it is possible to pass control keys as character strings instead of pressing the keyboard control key combination to perform functions like Control-C. The current Linux support of SA z/OS processor operations has not been tested using this Linux capability. Any Linux program or command script that requires a user interaction with control keys should not be invoked using the SA z/OS processor operations ISQSEND interface.

How to Add a Processor Operations Message to Automation

Use the NetView automation table (AT) and the SA z/OS command set to implement console automation. You can automate the routine functions that an operator performs when a particular message is generated. For more information see *IBM Tivoli System Automation for z/OS Defining Automation Policy*, SC33-7039.

Messages Issued by a Processor Operations Target System

When a target system issues a message, the message is forwarded to the processor operations focal point system. The focal point system repackages the message within an SA z/OS ISQ900I message, an ISQ901I message, or both, and routes the message to the appropriate task:

- ISQ900I messages are routed to SA z/OS processor operations autotasks. If you want automation that you write to receive ISQ900I messages, use the ISQEXEC command to run the automation in a target control task. For information about using the ISQEXEC command, see section *Sending an Automation Routine to a Target Control Task* in “Issuing Other OCF Commands” on page 10. Your NetView automation table entries for SA z/OS should acknowledge the ISQ900I identifier for all target system messages forwarded to the processor operations focal point system. You can specify your ISQ900I automation table entries to be target system specific, however, this is not recommended.
- ISQ901I messages are routed to all logged-on operators identified as interested operators by the ISQXMON command or marked as such in the customization dialog.

For information about the ISQEXEC and ISQXMON commands, see *IBM Tivoli System Automation for z/OS Operator’s Commands*.

A message forwarded from a NetView connection or an SNMP connection consists of the following:

- ISQ900I or ISQ901I message identifier
- Name of target system where the message originated
- Console designator form describing where the message originated
- Message identifier and text of the original message from the target system

For example, if a NetView connection forwards the message IEA101A SPECIFY SYSTEM PARAMETERS from the operating system to the focal point system, SA z/OS creates one or both of the following SA z/OS messages:

```
ISQ900I target-system-name OC IEA101A SPECIFY SYSTEM PARAMETERS
ISQ901I target-system-name OC IEA101A SPECIFY SYSTEM PARAMETERS
```

This message format applies to all processor operations target system messages. It is independent of the target system resource that generated the original message.

The processor operations target system message is sent in the same format as it would be displayed on the processor Support Element (SE) or Hardware Management Console (HMC).

Specifics of VM second level systems:

Messages from guest machine operating system appear in the following format:

```
ISQ900I psm-name.guest-name OC IEA101A SPECIFY SYSTEM PARAMETERS
```

Messages from CP on the virtual machine appear in the following format:

```
ISQ900I psm-name.guest.name OC HCPGSP2627I The virtual machine is
placed in CP mode due to a SIGP initial CPU reset from CPU 00.
```

Messages from the PSM itself appear in the following format:

```
ISQ700I psm-name SC ISQCS0314E Message Handler has failed.
```

Note:

Make sure your consoles issue messages in the format that you expect and write your NetView automation table entries accordingly.

Sample NetView Automation Table Statements

The following message response example presents a request for system parameters when the message ID string contains 'IEA101A':

```
IF      TEXT = . 'IEA101A SPECIFY SYSTEM PARAMETERS'  
      & MSGID = 'ISQ900I' .  
THEN    EXEC( CMD('ISQI101 ' ) ROUTE ( ONE * ) )  
        DISPLAY(N) NETLOG(Y);
```

This NetView automation table statement initiates the ISQI101 routine when the message condition is true.

Note: Text within messages may be in mixed case. Be sure your coding accounts for mixed case text.

Message ISQ211I

Some SA z/OS commands attempt to lock and unlock ports. Where an operator owns the lock for a port, the SA z/OS unlock command, ISQXUNL, returns RC=12 associated with message ISQ211I Unable to unlock *target name console*.

In such a case, you have the choice of either using the ISQOVRD command to force an unlock or you may end your automation with a message. Thereafter, you can view your NetView log to find out the reason for the lock of the port.

Your automation may encounter this message ISQ211I frequently. Attempting to unlock a locked port is not an error condition; however, it may be a sign that the calling command did not succeed. Schedule your automation from messages that indicate positively that a command did not run, not from the ISQ211I message.

Processor Operations Command Messages

Some SA z/OS commands run on the target system. The message returned from these commands indicates only that the support element was told to schedule the operation. Consequently, the operation at the target system may not complete even though the SA z/OS message indicates a successful completion.

SA z/OS acknowledges only that the command was successfully forwarded to the support element. An unsuccessful operation at the target system generates an unsolicited message that the support element forwards to the focal point system in an ISQ900I message. Schedule your automation from the message that positively indicates that a target system operation did or did not complete.

The SINGSAMP SA z/OS sample library contains the PL/I source code for several automation routines that issue responses to selected messages. You can select the response that is most appropriate for your enterprise. You can also use them as models to create your own automation routines. The following list summarizes these routines, the messages they respond to, and the responses they issue initially:

How to Automate Processor Operations Controlled Resources

SINGSAMP		
Member	Routine	Description
INGEI120	ISQI120	<p>Responds to the following messages:</p> <p>IEA120A Device ddd valid read, reply cont or wait.</p> <p>IOS120A Device ddd shared (PR valid not read.) the recovery task, reply cont or wait.</p>
INGEI357	ISQI357	<p>Issues the following response to the target: CONT</p> <p>Responds to the following message:</p> <p>IEE357A Reply with SMF values or U.</p>
INGEI426	ISQI426	<p>Issues the following response to the target: U</p> <p>Responds to the following message:</p> <p>\$HASP426 Specify options - subsystem_id.</p>
INGEI502	ISQI502	<p>Issues the following response to the target: WARM,NOREQ.</p> <p>Responds to the following message:</p> <p>ICH502A Specify name for primary/backup RACF data set sequence nnn or none.</p>
INGEI877	ISQI877	<p>Issues the following response to the target: NONE</p> <p>Responds to the following message:</p> <p>IEA877A Specify full DASD SYS1.DUMP data sets to be emptied, tape units to be used as SYS1.DUMP data sets or GO.</p>
INGEI956	ISQI956	<p>Issues the following response to the target: GO</p> <p>Responds to the following message:</p> <p>IEE956A Reply - ftime = hh.mm.ss, name = operator,reason = (ipl,reason) or u.</p> <p>Issues the following response to the target: U</p>

The SA z/OS automation table entries in the ISQMSG0 member of the SINGNPRM data set include inactive entries that call these automation routines. To incorporate these routines into your automation, do the following:

1. Remove the comments from the corresponding automation table entries for the messages that initiate the automation routines you want to use. If you perform these steps as part of the initial SA z/OS installation, make these changes before you incorporate the SA z/OS entries. If you do this after the initial SA z/OS installation, change the NetView automation table.
2. Code the routines you will be using to issue the responses you want.
3. Compile the PL/I source code for the routines you want to use, and link the resulting object code to your PL/I library.
4. Recycle the NetView program to activate the new entries.

For automation processing to occur, each message in the NetView automation table at the focal point system and at each target system must be made available to the system's NetView program. In z/OS, MPF controls message availability to the NetView program. Examine the MPF list member in the SYS1.PARMLIB data set to ensure that the necessary messages are marked for automation. For target systems using other operating systems, check the message suppression facilities used on those systems.

Testing Messages

SA z/OS provides a collection of NetView automation table entries for your SA z/OS configuration. NetView automation table entries are in the AOFCDM member of the SA z/OS SINGNPRM installation data set. When these entries are moved to your NetView automation table, they may need additional editing.

For example, you may already test for a particular message in your production NetView automation table. If you add an entry that tests for that same message, your automation table will not run as you expect. After a match with the test criteria is found, the search of the automation table is aborted. The second NetView Automation Table statement is not found. Consequently, the message does not drive all of your required actions.

To avoid this, combine entries into a single test condition. This ensures that all required actions are scheduled for all messages. For the following message:

```
IEA320A RESPECIFY PARAMETERS OR CANCEL
```

your NetView automation table may already have the following entry: (1)

```
IF      MSGID = 'IEA320A'  
THEN    EXEC (CMD('USERJOB') ROUTE( ONE * ) ) CONINUE(Y);
```

With SA z/OS installed, the following message appears when forwarded from a PC

```
ISQ900I TSCF30 A IEA320A RESPECIFY PARAMETERS OR CANCEL
```

With SA z/OS installed, the following message appears when forwarded from zSeries or 390-CMOS processor hardware:

```
ISQ900I TAR30 OC IEA320A RESPECIFY PARAMETERS OR CANCEL
```

After the SA z/OS entries are added, the NetView automation table includes the following entry:

```
IF      TEXT = . 'IEA320A RESPECIFY PARAMETERS' .  
        & MSGID = 'ISQ900I' .  
THEN  
        EXEC (CMD('ISQI320 ' ) ROUTE( ONE * ) )  
        DISPLAY(N) NETLOG(Y);
```

In this case, the first entry satisfies the IF test and the command USERJOB runs (1). The second command, ISQI320, is not scheduled to run because once the message matches a table entry, the autotask stops searching. Combine these two entries into a single entry, such as:

```
IF      TEXT = . 'IEA320A RESPECIFY PARAMETERS' .  
        & MSGID = 'ISQ900I' .  
THEN  
        EXEC(CMD('ISQI320 ' ) ROUTE( ONE * ) )  
        EXEC(CMD('USERJOB ' ) ROUTE( ONE * ) )  
        DISPLAY(N) NETLOG(Y);
```

When you use the second example, both commands are scheduled.

If your NetView automation table tests the text of SA z/OS messages, the message format must match the character case for which you test. This can be done by requiring all sites to use the same format for their messages, or by duplicating AT entries in uppercase and in mixed formats.

Building the New Automation Definitions

When you are finished using the customization dialog to add message response and automation operator information to the automation policy, you need to build the system operations control files. The complete description of how to build and distribute these files is provided in *IBM Tivoli System Automation for z/OS Defining Automation Policy*.

The SA z/OS build function will place the new automation definitions in the data set defined in the *Build Parameters* panel.

Copy the new automation definitions into the SA z/OS NetView DSIPARM concatenation in the NetView startup procedures, or concatenate it to the NetView DSIPARM data set.

Loading the Changed Automation Environment

To reload the AMC file, automation control file and the AT perform the actions described in “Step 7: Reload MPF List and Automation Configuration Files” on page 4.

VM Second Level Systems Support

This feature provides ProcOps support to control and monitor guest machines running under VM.

ProcOps allows an operating system to be IPLed into a processor, amongst other facilities. Such an operating system is VM. Within VM other operating systems can be IPLed as guest machines. Of particular interest are LINUX guest machines, but MVS, VSE and even VM guest machines may be possible. (Lower levels of guest machines are not considered). Previously there was no effective way to enter commands to and receive messages from such a guest target system in order to validate that it had IPLed correctly, or that it is behaving correctly.

With second level guest machine support you can:

- Capture messages issued by the guest machine itself and route these back to the ProcOps process for display or automated processing, or both
- Send commands to the guest machine from ProcOps, either as operator requests or automated actions

Guest Target Systems

The most likely guest machine that is used as a target system is a LINUX system. When a LINUX machine has a secondary user, the secondary user can use CP SEND commands to:

- Issue CP commands to the guest machine
- Log on as a user to LINUX
- Enter LINUX commands (after logging on)

(It is also possible to set up the LINUX system in such a way that LINUX commands can be entered on the VM console without logging on to LINUX.)

The secondary user receives:

- All “boot up messages”
- Responses to CP commands that are run on the guest machine
- Responses to logon and LINUX commands

Loading the Changed Automation Environment

MVS machines are more complex. When an MVS machine is running, the original VM user first becomes an NIP console and then an MCS console. In these console modes MVS takes over all I/O to and from the console, and MVS messages to it cannot be intercepted by any CP facilities. Hence the SCIF SEND command cannot be used to send commands to MVS, nor can MVS messages to this console be intercepted.

However a "virtual SCLP console" for the guest machine can be used. During the NIP phase of initialization, use of this console can be forced by configuring the guest virtual machine so that it has no usable 3270 consoles. NIP then directs its messages to the guest machine as line mode commands. This is analogous to the stream of messages sent to the Operating System Messages (OSM) window on an HMC by an MVS system running in a logical partition.

Responses to any NIP messages are entered using the CP VINPUT command. Internally this is done when an ISQSEND command is issued to the operator console (OC) of the target system. To ensure that such VINPUT commands are processed correctly, the guest machine must be operating in RUN ON state at this time.

To ensure that RUN ON state is set, a CP SET RUN ON command is sent to all MVS guest machines at the time when the guest machine is started by the PSM.

Once MCS operation is established, important messages requiring operator action are directed to the guest machine. Again, these are analogous to the stream of messages directed to the OSM window of the HMC. Initially, commands cannot be entered to MVS. To do so, it is necessary to enter "Problem Determination Mode". To enter this mode, a VARY CONSOLE(*),ACTIVATE command must be entered. Once this is done:

- All MVS messages that are displayed are routed to the guest machine
- Commands may be entered using the CP VINPUT command.

Problem Determination is not generally recommended.

To enter LINUX commands it is normally necessary to log on to LINUX. This requires a user ID and a password. So, to provide for LINUX commands would require the specification of a user ID and a password to ProcOps, with all the attendant difficulties in the area of security. At present the LINUX system is considered IPL COMPLETE when specified messages have appeared. These do not require a user logon.

VM machines may also be guest machines. Third level guest machines are not supported.

VSE machines may also be guest machines.

Customizing Target Systems

LINUX

The LINUX target system should have in its VM Directory entry, a CONSOLE statement that sets its PSM as its default secondary user. For example, if the virtual machine LNXAO1 is controlled by a PSM running in virtual machine ISQPSM1, then its CONSOLE statement might be:

```
CONSOLE 009 3215 T ISQPSM1
```

Loading the Changed Automation Environment

When a LINUX target system is to be deactivated a FORCE command is used to shut it. The default guest signal timeout interval values (set by the SET SIGNAL command) and values defined for the guest machine determine the interval used when allowing the LINUX system to shut in an orderly fashion. If this function is required for a guest, you must ensure that this is set accordingly.

Such actions may include updating the etc/inittab entry on the LINUX system itself, and setting up a SHUTTRAP module on the VM host.

MVS

This too should have a CONSOLE statement in its VM directory entry that defines its PSM as its secondary user:

```
CONSOLE 01F 3270 T ISQPSM1
```

It should also IPL a CMS system as its initial action. Once this CMS system is IPLed it should run a PROFILE EXEC that includes the statements similar to the following:

```
SET RUN ON
DETACH 01F
IPL 7700
```

The SET RUN ON is needed so that when a response is to be sent to a NIP console the VINPUT command used is effective.

The DETACH is used so that when the MVS system IPLs it will find none of its defined 3270 consoles available to it. (You should also ensure that no user issues a VM DIAL to an address that is defined as a NIP or MCS console.)

The IPL command is used to IPL the MVS system.

The MVS system itself should have included in its active CONSOL xx definition a CONSOLE statement for the SYSCONS so that commands can be entered to MVS after it is IPLed, for example:

```
CONSOLE DEVNUM(SYSCONS)
        ROUTCODE(ALL)
        AUTH(MASTER)
        MSCOPE(*)
        CMDSYS(*)
        MONITOR(JOBNAMES-T)
        UD(Y)
```

VM

This too should have a CONSOLE statement in its VM directory entry that defines its PSM as its secondary user:

```
CONSOLE 01F 3270 T ISQPSM1
```

It should also IPL a CMS system as its initial action. Once this CMS system is IPLed it should run a PROFILE EXEC that includes the statements similar to the following:

```
SET RUN ON
DETACH 01F
IPL 7700
```

The SET RUN ON is needed so that when a response is to be sent to a console the VINPUT command used is effective.

Loading the Changed Automation Environment

The DETACH is used so that when the VM system IPLs it will find none of its defined 3270 consoles available to it. (You should also ensure that no user issues a VM DIAL to an address that is defined as a Operator Console)

The IPL command is used to IPL the VM system.

The VM system itself should include within its OPERATOR_CONSOLES statement in the SYSTEM CONFIG file (which resides on the "parm disk") a specification for the emulated system console, for example:

```
OPERATOR _CONSOLES 01F 020 System_Console
```

This ensures that when VM IPLs and finds no regular consoles available, it then uses the emulated system console. This in turn directs the messages to the secondary user as a stream of line-mode messages.

VSE

This too should have a CONSOLE statement in its VM directory entry that defines its PSM as its secondary user:

```
CONSOLE 01F 3270 T ISQPSM1
```

It should also IPL a CMS system as its initial action. Once this CMS system is IPLed it should run a PROFILE EXEC that includes the statements similar to the following:

```
TERM CONMODE 3215  
IPL 7700
```

The TERM CONMODE 3215 command sets the console into line mode.

Chapter 8. How to Automate USS Resources

Note: USS tasks behave differently when started as STCs rather than directly in the USS environment.

When started as an STC, the starting user ID may differ so that the AOFUXMON monitor routine is in most cases not able to internally trigger ACTIVMSG UP=YES.

Thus it is much simpler for automation to start these applications with INGUSS. There is then no AT entry required for the UP message. SA z/OS is able to internally simulate this so that you do not have to worry about UP messages.

Job names (at least the last character of the jobname) are not predictable for USS resources. However, AOFUXMON is able to handle this by monitoring the path within USS and changing the defined job name in SA z/OS accordingly. For the syslog daemon you would define the job name as SYSLOGD. When the application is started and changes the jobname to, say, SYSLOGD7, AOFUXMON adjusts the SA z/OS data model to reflect this.

This cannot be handled in the AT with a generic entry for SYSLOGD* because the change in job name is caused by the USS process that creates a new address space with the new name, whereby the 'old' address space with the 'old' name terminates. This means that you get an ended message for the old address space and an up message for the new address space. Again the sequence of these messages is unpredictable.

Integration of z/OS UNIX System Services

The following functions are supported by SA z/OS for z/OS UNIX applications:

- Starting and stopping of applications
- Monitoring of:
 - Processes (represented by the command or path and user ID)
 - TCP Ports
 - Files and file systems
 - Generic User Monitoring (the user supplies a z/OS UNIX monitoring routine or script)
- Using an API to execute z/OS UNIX commands (INGUSS command)

Infrastructure Overview

The z/OS UNIX resources that should be automated must run in the z/OS UNIX of a z/OS system that is already automated by SA z/OS. From the automation manager's perspective the NetView agent of this system is responsible for the z/OS UNIX resources.

For command execution through INGUSS or user-defined monitoring, a z/OS UNIX program (provided by SA z/OS) is directly invoked by SA z/OS. This program (*ingccmd*) executes UNIX commands and runs when started by SA z/OS with the jobname INGCUNIX. *ingccmd* is the extension of the NetView-based

Setting Up z/OS UNIX Automation

agent into z/OS UNIX. To monitor the standard z/OS UNIX resources (process, port, or file) an SA z/OS internal routine is started.

Setting Up z/OS UNIX Automation

Customization of z/OS UNIX Resources

z/OS UNIX resources are introduced to SA z/OS by defining them in the SA z/OS customization dialogs.

The customization dialogs support the application type USS. If USS is selected, you can enter z/OS UNIX-specific data such as a UNIX user ID, command or path, filename, or monitored port. Choose one of these fields to enter the data.

The start and stop definitions can be varied between MVS and z/OS UNIX commands. For example, to stop an application you can issue a UNIX kill command first and (if this was not successful) you can perform an MVS cancel later.

Definitions for Automation Setup

The HFS path where the program shipped with SA z/OS is located must be defined in the SA z/OS setup panel. This has to be the same path that was used as the destination in the sample job INGUSCPY. When user-defined UNIX monitoring is used and no absolute path is specified for the monitoring routine, SA z/OS tries to start the user-defined monitoring routine in this directory.

Definitions for z/OS UNIX Resources

To define a new application entry (APL, class, or instance), specify the application type USS on the Define New Entry panel. When choosing the application type USS, the option USS Control is displayed on the Policy Selection panel.

When selecting USS Control on the Policy Selection panel, you can enter the data for the new z/OS UNIX resource. For a class only the user ID and the z/OS UNIX monitoring routine can be specified on this panel. All other definitions (for example, from/to, dependencies, etc.) can be entered as usual.

USS applications must be defined with a HASPARENT relationship to JES.

For object type INSTANCE you can define whether this resource is one of a process, a TCP port, or a file or file system, as shown in Figure 8.

Monitoring Command. . .

Enter or update one of the following fields:
Command/Path. . .
/u/camp/usstest/usstest

File Name

Monitored Port. . _____

Figure 8. z/OS UNIX Control Specification Panel for Type INSTANCE

Note: There are two monitoring routines:

- AOFUXMON, which is called by SA z/OS for UNIX System Services resources. (This must always be specified.)
- A program in the HFS that is entered in the *Monitoring Command* field of the z/OS UNIX Control Specification panel, and is called by AOFUXMON. This means that if you specify this monitoring command, you also have to specify AOFUXMON.

If this program does not begin with a "/" it must reside in the same directory as the SA z/OS-supplied z/OS UNIX routine ingccmd. Otherwise the name specified is considered to be an absolute path identifier.

The UNIX monitoring routine must have an exit value. It can be one of the following:

- 0 Resource is available
- 4 Resource is starting
- 8 Resource is unavailable
- 12 Error occurred

If the user-specified monitoring routine loops, it will receive a SIGKILL after the AOFUSSWAIT time (defined in AOFEXDEF).

Hint:

It is possible to write a message from this UNIX monitoring routine to the MVS system log, in order to trigger an action or perform a status change through the NetView Automation Table (AT).

The monitoring routine AOFUXMON must be specified, otherwise the default monitoring routine (usually INGPJMON) will be called, which is not sufficient for z/OS UNIX resources.

The *Job Type* field can be either MVS or NONMVS:

MVS Is only used for resources that represent a process with a unique jobname. For these resources SA z/OS accepts the following messages for status changes:

- IEF403I Job started
- IEF404I Job ended
- IEF450I Job abended

If no start command is specified, the default MVS start method (s <JOBNAME>) is used.

NONMVS

SA z/OS ignores the messages listed above for status changes. This is necessary if the jobname is not unique.

For z/OS UNIX resources the Start Timeout interval begins when SA z/OS issues a start command for an application. After the start timeout the monitoring method is triggered. When the monitor detects the resource as available, the agent status is set to 'ACTIVE'. After another start timeout interval and successful monitoring, the

Setting Up z/OS UNIX Automation

ACTIVMSG generic routine is triggered which sets the agent status to 'UP'. The default value for Start Timeout is 2 minutes.

Automated Resources

Process Monitoring: No UNIX process identifiers (PIDs) can be monitored. The monitoring routine needs the start command and the user ID that the process belongs to. This information can be obtained with the UNIX command `ps`. In the following example all processes belonging to user CAMP are displayed:

```
CAMP:/u/camp/ingcmd>ps -e -o comm
COMMAND
/bin/sh
/usr/sbin/rlogind2
/bin/ps
/bin/sh
/usr/sbin/rlogind2
CAMP:/u/camp/ingcmd>
```

This means that automation could not distinguish between the two processes started by `/usr/sbin/rlogind2`. Processes started by identical commands must have different user IDs.

If it is necessary to automate processes running multiple instances, a user could use softlinks to distinguish between the different processes. For example, the process:

```
/u/camp/usstest/testme
```

should be started more than once. In this case, create some softlinks:

```
CAMP:/u/camp/usstest> ln -s testme test1
CAMP:/u/camp/usstest> ln -s testme test2
```

This results in:

```
CAMP:/u/camp/tt>ls -al
total 216
drwxrwxr-x  2 CAMP  DE#03243  8192 Jan 24 16:24 .
drwxr-xr-x 19 CAMP  DE#03243  8192 Jan 24 16:23 ..
lrwxrwxrwx  1 CAMP  DE#03243    6 Jan 24 16:24 test1 -> testme
lrwxrwxrwx  1 CAMP  DE#03243    6 Jan 24 16:24 test2 -> testme
-rwxrwxr-x  1 CAMP  DE#03243  94208 Jan 24 16:23 testme
```

These three programs (being the same "real" program) can be automated with the three different start commands `test1`, `test2`, and `testme`. These links may be created as a prestart command and deleted as a shutfinal command.

Note: Only the command is used, not the parameters that were used to start the program. This is because a program may be started by SA z/OS with different startup parameters, depending on what the automation manager told the automation agent to do. In this case, the only constant value is the command, not the parameters.

TCP Port Monitoring: Exactly one TCP port number can be entered for one resource. SA z/OS monitors the local host as returned by the function `gethostid()`. When this port has a state of 'listening,' this resource is considered to be 'available' in terms of SA z/OS. All other states of the port will map to 'unavailable.'

File or File-System Monitoring: The existence of a file (belonging to a certain user) is verified. Many applications create files at startup and delete these files

when terminating normally. If more than one file should be monitored, this can be modeled as an application group (APG) in the automation manager.

This monitoring can be used to determine if a certain file system is mounted. The start command for this resource would be a UNIX 'mount' command, the stop command a UNIX 'umount'.

Start and Stop Definitions (INGUSS Command)

If the resource is to be controlled by traditional MVS commands, this could be done in the same way as for all other MVS applications. Issuing commands in the z/OS UNIX environment is done by specifying the INGUSS command at the start or stop definitions.

To issue commands in the USS environment use the INGUSS command (for more details see *IBM Tivoli System Automation for z/OS Programmer's Reference*).

Note: INGUSS can only be used if the primary JES is available. Therefore, z/OS UNIX resources using INGUSS need a HASPARENT dependency to JES. Most z/OS UNIX applications have this dependency. If you want to issue prestart commands, an additional PREPAVAILABLE dependency is necessary.

z/OS UNIX and MVS commands can be mixed in different shutdown passes.

Command Examples:

Start Command for a Process: To start a process with the command and jobname specified in the customization dialogs, enter INGUSS JOBNAME=&SUBSJOB &SUBSPATH on the Startup Command Processing panel, as shown in Figure 9.

Type	Automated Function/'*'
Command text	
INGUSS JOBNAME=&SUBSJOB &SUBSPATH	

Figure 9. Startup Definition for a Process

Only the command that was used to start an application or a process can be monitored. If the same program is to be started multiple times, a softlink as prestart command could be used to distinguish the processes.

Use a Softlink to Distinguish Processes that Run the same Executable as Prestart Command: Figure 10 shows an example to create a softlink for &SUBSPATH (the path parameter of the resource issuing the command, for example, /u/user1/uss1) and link to the file /u/user1/usstest.

Type	Automated Function/'*'
Command text	
INGUSS /bin/ln -s /u/user1/usstest &SUBSPATH	

Figure 10. Creating a Softlink

When looking at the HFS, this results in:

Setting Up z/OS UNIX Automation

```
USER1:/u/user1>ls -l
total 408
lrwxrwxrwx  1 USER1      DE#03243      7 Feb 13 12:44 uss1 -> usstest
-rwxrwxr-x  1 USER1      DE#03243    163840 Jan 29 14:55 usstest
```

Stop Commands for a Process: An z/OS UNIX process may be stopped in different ways (escalation passes). For example, you can first use the z/OS UNIX kill command, if that does not work use z/OS UNIX kill -9, and finally enter an MVS cancel command.

Enter the definitions for this example as shown in Figure 11.
%PID% is replaced at run time by the real PID of the process.

Pass	Automated Function/'*'
1	INGUSS /bin/kill %PID%
3	INGUSS /bin/kill -9 %PID%
4	MVS C &SUBSUSSJOB,A=&SUBSASID

Figure 11. Stop Definitions for a Process

Stop Command for a File: A stop command for a file may be deleting the file. The filename entered in the customization dialogs can be found in &SUBSFILE, as shown in Figure 12.

Pass	Automated Function/'*'
1	INGUSS /bin/rm &SUBSFILE

Figure 12. Delete a File

Example: inetd

The inetd is the UNIX internet daemon. It allows you to invoke several others and it should be started at IPL time (normally through /etc/rc). It then listens for connections on certain internet sockets. Its configuration file is /etc/inetd.conf

The following is a sample inetd configuration file:

```
login  stream tcp  nowait  OMVSKERN  /usr/sbin/rlogind rlogind -m
exec   stream tcp  nowait  OMVSKERN  /usr/sbin/orexecd orexecd -d
otelnets  stream tcp  nowait  OMVSKERN  /usr/sbin/otelnets otelnets -k -t
daytime stream tcp  nowait  OMVSKERN  internal
time   stream tcp  nowait  OMVSKERN  internal
netbios-ssn stream tcp  nowait  OMVSKERN  /local/samba/bin/smbd smbd
```

When a service request is detected at one of its sockets, it decides what service the socket corresponds to and invokes a program to service the request. Then it normally continues to listen on the socket the last request came in at (see Figure 13 on page 85).

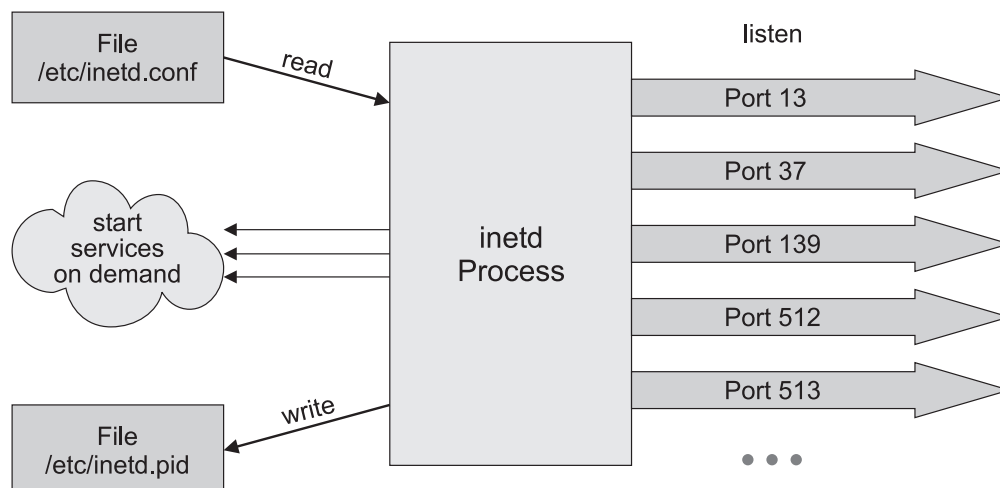

Figure 13. inetd Structure

The inetd started with the configuration file above will listen on the following sockets:

```
CAMP:/etc>netstat -a | grep INET
INETD1  00006B80 0.0.0.0..13      0.0.0.0..0      Listen
INETD1  00006B7D 0.0.0.0..513    0.0.0.0..0      Listen
INETD1  00006B7E 0.0.0.0..512    0.0.0.0..0      Listen
INETD1  00006B7F 0.0.0.0..623    0.0.0.0..0      Listen
INETD1  00006B82 0.0.0.0..139    0.0.0.0..0      Listen
INETD1  00006B81 0.0.0.0..37     0.0.0.0..0      Listen
```

Whereas the services and the real port numbers correspond according to /etc/services:

```
daytime      13/tcp      #Daytime
time         37/tcp      timservr    #Time
netbios-ssn  139/tcp     #NETBIOS Session Service
exec         512/tcp     #remote process execution;
login        513/tcp     #remote login a la telnet;
otelnets     623/tcp     #OE telnet
```

The UNIX internet daemon (inetd) can be defined in the customization dialogs, for example:

```
Application Name: INETD/APL  Application Type: USS
Command/Path:  /usr/sbin/inetd  User ID: OMVSKERN
Port: -        File:
```

```
Application Name: INETFILE/APL  Application Type: USS
Command/Path:      User ID: OMVSKERN
Port: -           File: /tmp/inetd.pid
```

```
Application Name: INETPORT/APL  Application Type: USS
Command/Path:      User ID: OMVSKERN
Port: 513         File:
```

Define a basic group containing all resources with relationships which indicate that:

- The file is created by the inetd process and can never be started or created directly by SA z/OS.

Setting Up z/OS UNIX Automation

- The inetd process listening on the port can never be started or created directly by SA z/OS.

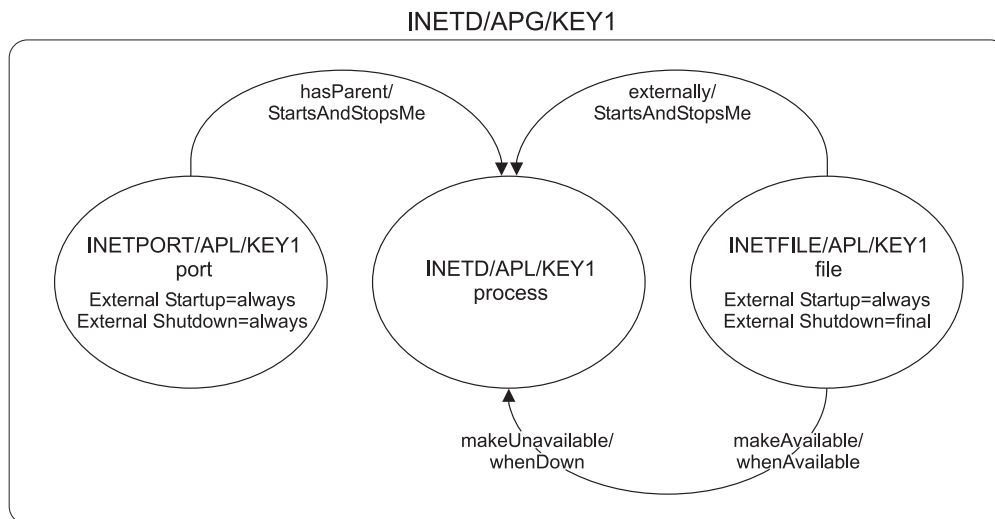

Figure 14. Dependency Graphic

The example above recognizes the inetd (modeled as a group) as up and running when the process `/usr/sbin/inetd` started by user OMVSKERN shows up, the file `/tmp/inetd.pid` exists and port 513 is in status 'listen' (inetd will listen to this port for incoming login requests).

You can only choose a port that is defined in `inetd/conf`.

Start definition for INETFILE/APL

None.

Start definition for INETPORT/APL

None.

Start definition for INETD/APL

CMD: `INGUSS JOBNAME=&SUBSJOB &SUBSPATH /etc/inetd.conf`

(&SUBSPATH is substituted at run time by the parameter `command/path`.)

Stop definitions for INETFILE/APL

CMD: `INGUSS /bin/rm &SUBSFILE`

(This will remove the file if not yet removed by the inetd process.)

Stop definition for INETPORT/APL

None.

Stop definitions for INETD/APL

CMD: `INGUSS /bin/kill %PID%`

CMD: `INGUSS /bin/kill -9 %PID%`

CMD: `MVS C &SUBSUSSJOB,A=&SUBSASID`

`%PID%` will be replaced by the z/OS UNIX command routine with the real PID that matches the parameters `command/path` and user ID. In the following example this is 33554821:

```

CAMP:/u/camp/ingcmd>ps -e -o pid,comm -u OMVSKERN
PID COMMAND
33554481 /bin/sh
50331698 /usr/sbin/rlogind2
  
```



```

33554486 /usr/lpp/netview/bin/cnmeunix
67108927 /bin/sh
83886176 /bin/ps
33554821 /usr/sbin/inetd
83886472 FTPD
67109276 /bin/sh
16777629 /usr/sbin/rlogind2
33554924 HSAPYTCP

```

Hints and Tips

Trapping UNIX syslogd Messages

To trap UNIX syslogd messages, an entry must be added to the syslogd configuration file `/etc/syslog.conf` in order to forward the messages to the MVS system log. Thus, messages can be processed by the Automation Table (AT).

To forward all messages to the MVS log add the following entry:

```
 *.* /dev/console
```

To send special messages to the MVS log only, follow the syslog message naming guidelines (for example, for warning messages use `*.warn`). `/dev/console` can be used as an ordinary file to write to.

The UNIX messages have the MVS message ID BPXF024I and are multiline messages.

Figure 15 shows an example of a UNIX message:

```

M 13:45:21.34 STC03602 00000090 BPXF024I (CAMP) Feb 13 13:45:21 B0EKEY1 syslogtest 67109100 : This is
S                               498
D                               498 00000090 a test message

```

Figure 15. Example of a UNIX Message

Debugging

Debugging can be activated for z/OS UNIX monitoring and command execution on the AOCTRACE panel. The clist for monitoring is AOFUXMON and for command execution AOFRSUSS.

Turning on debugging for AOFRSUSS implicitly turns on debugging for `ingccmd` (the SA z/OS command server).

The debugging messages will be written to the netlog and to the z/OS UNIX system log (syslogd).

Hints and Tips

Chapter 9. How to Enable Sysplex Automation

This chapter describes the enhancements to Parallel Sysplex[®] automation, how to use the SA z/OS customization dialogs to enable them, and how to customize your system.

Note: If you use a host code page other than 037, the hexadecimal representation of the at sign (@) can be different. Use the letter represented by the hex code X'7C' for the at sign.

Sysplex Functions

Managing Couple Data Sets

Couple data sets (CDSs) contain control information about the sysplex and its resources, and are of crucial importance for the functioning of a Parallel Sysplex. Particularly important are the SYSPLEX couple data set, which contains information about the systems and the communication structure (XCF groups) of the sysplex, and the CFRM couple data set, which specifies its coupling facilities (CFs) and structures (see “Managing Coupling Facilities” on page 91). Every MVS system in a Parallel Sysplex must have access to these CDSs, and to those of all other implemented sysplex functions, such as SFM and Application Response Measurement (ARM).

If a member system cannot access a CDS, the corresponding sysplex function is impacted, and in some cases the sysplex will go down. It is therefore recommended that you define two CDSs to XCF for every CDS type required for the implementation of the sysplex. One of these, the *primary* CDS, is the one that is actually used. The other, which is called the *alternate* CDS, serves as a backup copy. The two CDSs contain the same data. Whenever the primary CDS changes, XCF updates the alternate CDS accordingly. If an alternate CDS is available for a certain type, XCF automatically switches to this alternate CDS whenever a member can no longer access the primary CDS.

All CDSs except the sysplex couple data set contain one or more user-defined configurations, called *policies*. For each CDS type, only one policy can be active. However, it is possible to switch the active policy at run time. Refer to *IBM Tivoli System Automation for z/OS Operator's Commands* for further information about the INGPLEX command.

SA z/OS offers two functions for easier CDS management:

- Automated creation and recovery of alternate couple data sets for continuous availability
- INGPLEX CDS, which simplifies management of couple data sets

Ensuring Continuous Availability of Couple Data Sets

When an alternate CDS exists for a given CDS type and the current primary CDS fails, XCF makes this alternate the primary CDS. After this switch, however, an alternate CDS no longer exists, and if the current primary CDS also fails, the problems that were to be avoided by the creation of an alternate occur again. To

Managing Couple Data Sets

avoid this single-point-of-failure situation, SA z/OS provides a recovery mechanism that tries to ensure that an alternate CDS is always available for every CDS type used.

SA z/OS creates a new alternate CDS in the following two situations:

- During initialization, SA z/OS checks that an alternate CDS is specified for every primary CDS. If there is a primary CDS for which no alternate CDS exists, SA z/OS automatically creates it.
- At run time, SA z/OS ensures that a new alternate is created whenever the current alternate has been removed or switched to the primary one.

Customization

Recovery of alternate CDSs is initiated either by the CDS function of INGPLEX or in the background (for example, at initialization time). Background recovery can be switched on and off by using the SA z/OS customization dialogs. Automatic re-creation with INGPLEX CDS is always enabled.

You must specify the spare volumes that SA z/OS may use for creating missing alternate CDSs (using the policy item SYSPLEX from the *Policy Selection* panel for sysplex groups). This is also required for automatic creation with INGPLEX CDS. Every CDS type has its own pool of spare volumes. Note that if you do not define spare volumes for a CDS type, no recovery will be performed for this type. For details on the use of the customization dialogs, see “Enabling Continuous Availability of Couple Data Sets” on page 100.

You can control access to those functions of INGPLEX CDS that modify the sysplex configuration. Refer to Appendix A of *IBM Tivoli System Automation for z/OS Planning and Installation* for details.

Managing the System Logger

Terms and Concepts

The *system logger* provides a sysplex-wide logging facility. Applications that use the system logger write their log data into *log streams*. Within a Parallel Sysplex, these log streams are usually associated with a coupling facility structure. For further information about coupling facility structures, refer to “Managing Coupling Facilities” on page 91. By using a coupling facility log stream, members of a multisystem application can merge their logs even when residing on different systems.

When an application writes data to a log stream this data is stored at first temporarily in the associated structure (coupling facility log stream) or a local buffer (DASD-only log stream). From there, it is off-loaded into a log stream data set which is automatically allocated by the system logger. When this log stream data set is full, the system logger allocates a second one, and so on.

The control information for the system logger, which includes a directory for the log stream data sets of every log stream, is contained in the LOGR couple data set. The total number of log stream data sets that can be allocated by the system logger is determined when the LOGR couple data set is formatted.

Two problems that can arise in connection with the log stream data sets are a shortage of directory space in the LOGR CDS and incorrect share options for the log stream data sets. SA z/OS provides the following recovery actions for these problems:

- The primary and alternate LOGR CDSs are automatically re-sized if there is a directory shortage
- The operator is notified if the share options for log stream data sets are not defined correctly

Re-sizing the LOGR Couple Data Sets in Case of Directory Shortage

The LOGR CDS contains information about the log stream data sets used by the system logger. This information is stored in *directory extents*. Every directory extent record can hold information about up to 168 log stream data sets. The number of directory extents available in a LOGR CDS is specified when the CDS is formatted (DSEXTENT parameter). When all available directory extents are used up the system logger can no longer allocate new log stream data sets. This can cause considerable problems for applications that use the system logger.

With SA z/OS, you can avoid this situation. If you switch on logger recovery, SA z/OS automatically reformats your primary and alternate LOGR CDS with an increased DSEXTENT parameter whenever the system reports a directory shortage.

Customization

Automation of system logger recovery is enabled through the SA z/OS customization dialogs. For more details, see “Enabling System Log Failure Recovery” on page 101.

Managing Coupling Facilities

A *coupling facility* (CF) is a logical partition that provides storage for data exchange between components of an application that is distributed across different systems in a Parallel Sysplex. A Parallel Sysplex can contain more than one CF. The storage of a coupling facility is divided into areas that are called *structures*. You can imagine a structure as a special kind of data set. It is these structures, which are identified by their name, that are accessed for reading and writing by the application components.

The association between CFs and structures is dynamic. A structure that is used by an application need not be allocated at all (for example, when the application is not running), and can be allocated on different CFs at different points in time. For every structure, there exists a *preference list* that defines the CFs on which it may be allocated. The order of the CFs in that list determines which CF is selected when more than one member of the list satisfies all allocation requirements (for example, provides enough space).

The preference list, the space requirements, and other properties of the structures are defined in the active CFRM policy. This policy is contained in the CFRM couple data set. Refer to “Managing Couple Data Sets” on page 89 for further information.

XES allocates a structure that does not yet reside on any CF when an application component needs to be connected to it. Note that the application component only specifies the name of the structure that it wants to access. It is XES that decides on which CF the structure is allocated. This decision is influenced by the structure definition in the active CFRM policy. After the structure has been allocated, the requesting application component can access it, and further components of this application can require to connect to it. An application component that has access to an allocated structure is referred to as an *active connector* to this structure.

Managing Coupling Facilities

In the simplest case, XES deallocates a structure when all connected application components have disconnected from the structure. However, an application component can require that the structure or its own connection to the structure be *persistent*. When the *structure* is persistent it remains allocated even when the application component is no longer connected to it. When a *connection* is persistent the structure remains allocated after a failure of that connection. The application component in question remains a connector to the structure, although not an active one. It is now a *failed persistent* connector. In both cases, you can force the deallocation of the structure as soon as it no longer has active connectors.

Allocated structures can be *rebuilt*. Rebuilding is the process of reconstructing a structure on the same or another CF. A rebuild consists of three main steps. First, XES allocates the new structure instance. Then, the data of the old structure is reconstructed in the new structure. Finally, XES deallocates the old structure instance. Note that you cannot specify the target CF in your rebuild request. As with structure allocation, XES selects it from the preference list.

There are two methods for rebuild: user-managed and (from OS/390® 2.8 onward) system-managed. With user-managed rebuild, the active connectors are responsible for reconstructing the data. With system-managed rebuild, XES transfers the data to the new structure instance. System-managed rebuild is thus also available for structures without active connectors. These structures can either themselves be persistent or have failed persistent connections.

When an application component connects to a structure, it specifies whether it allows the structure to be rebuilt through user-managed or system-managed rebuild. For structures with active connectors, both rebuild methods require that all active connectors allow the respective rebuild method.

You can also *duplex* structures. Duplexing means maintaining two instances of the same structure on different CFs at the same time. Duplexing serves to increase availability and usability of a structure.

Typical management tasks for CFs are removing a CF from the sysplex and reintegrating it again. These tasks have several steps that must be performed in a certain order and can be quite complex. To simplify these operations, SA z/OS offers the INGCF command. INGCF has several functions, which serve to manipulate structures and the CFs themselves. For more information, see *IBM Tivoli System Automation for z/OS Operator's Commands* and the online help.

Some functions deal with the sender paths of a coupling facility. They have the following limitations. First, at least one system in the sysplex that is running the automation must know the control unit id (CUID) of the coupling facility. If this is not the case, no missing sender paths can be resolved.

A missing sender path occurs when a coupling facility is deactivated prior to a system IPL (or reIPL) and then activated afterwards. The system that has been IPLed (or reIPLed) does not recognize the coupling facility. To determine the missing sender paths, the automation calls the HOM interface of HCD. Resolving the missing path information is only possible when either the complete network address is defined in HCD along with the processor id, or you provide the CPC synonym used by the automation as the processor id. However, it is recommended that you define both. If neither is defined, the system that misses the sender paths must run the automation.

Recovery Actions

Resolving a System Log Failure

SYSLOG message automation has been enhanced with a recovery function. Both functions (recovery and automation of message IEE043I) exist in parallel. Recovery takes place if the system log becomes inactive. It responds to message IEE037D following one of the messages IEE043I, IEE533E, or IEE769E, and it responds to message IEE041I. For details refer to “Enabling System Log Failure Recovery” on page 101. Except for the decision message, you can define individual action commands in the customization dialogs for the above messages.

Because the recovery and the former automation of message IEE043I affect the same resource SYSLOG, only one threshold can be defined in the policy SYSLOG THRESHOLDS. To allow the separate control of SYSLOG recovery from the former SYSLOG message automation, use the minor resource flag LOG. For the run time environment, two thresholds are generated from the single threshold definition. The names of these thresholds correspond to the names of the minor resource flags.

Note: Action commands that are executed for the old SYSLOG message automation are defined in the customization dialog using the entry SYSLOG in the messages policy for the entry type MVS Components. Action commands that are executed for the new SYSLOG recovery of message IEE043I are defined in the customization dialog in entry IEE043I in the same policy. If SYSLOG message and recovery commands are defined, both action commands will be issued, if message IEE043I followed by message IEE037D is trapped.

Customization: Automation of system log recovery is enabled through the SA z/OS customization dialogs. For more details, see “Enabling System Log Failure Recovery” on page 101.

Resolving WTO(R) Buffer Shortages

When all WTO(R) buffers are in use, it is possible that commands can no longer be processed. To resolve this, there are several options: you can extend the buffer, change the properties of the affected consoles, or cancel jobs that issue WTO(R)s.

SA z/OS provides recovery of buffer shortage in two stages. It first tries to extend the buffer and modify the console characteristics, if applicable. If this does not help, it then cancels jobs that issue WTO(R)s. You must specify which jobs can be canceled by SA z/OS if there is a buffer shortage.

Customization: Automation of buffer shortage recovery is enabled using the SA z/OS customization dialogs. For more information, see “Enabling WTO(R) Buffer Shortage Recovery” on page 102.

Handling Long-Running Enqueues (ENQs)

This type of recovery is divided into the following individual functions:

- Long-running enqueue recovery
- SYSIEFSD resource recovery
- “Hung” command recovery
- Command flooding recovery

All these recoveries can be enabled and disabled individually or globally.

The long-running enqueue recovery function lets you:

Recovery Actions

- Check which resources are blocked
- Customize automation to cancel or keep the jobs that block the resource
- Customize automation to dump the jobs before they are canceled

You can determine which resources you want to monitor. You can define a value for the maximum time a job can lock a resource while other jobs are waiting for it. If this amount of time is exceeded, recovery takes place. Identification of and elimination of these potential bottlenecks helps to reduce the risk of a Parallel Sysplex outage.

While the time definition describes an inclusion list, you also have the possibility to define an *exclusion list* of resources that are not monitored at all.

For more information about enabling the ENQ function, see “Enabling Long Running Enqueues (ENQs)” on page 106.

This function has been extended by three supplementary functions:

- “SYSIEFSD Resource Recovery”
- “Hung” Command Recovery”
- “Command Flooding Recovery” on page 95

SYSIEFSD Resource Recovery: The purpose of this function is to detect critical ENQ resources that, if held for extended periods of time, can cause commands to hang. Hung commands often result in multisystem outages. The focus of this function is on the SYSIEFSD family of resources that are involved in 98% of hung command outages:

- SYSIEFSD Q10 – this resource is required for every command. It is used to serialize changes to the CSCB chain. If any task gets this resource and then hangs, *all commands* will be locked out of the system. This also means that *all consoles* will be locked out of the system. This is because, as soon as a console issues a command after Q10 has hung, it will be waiting behind Q10, and that locks out the task that handles all MCS consoles. EMCS consoles will then also get locked out one by one as they issue a command and also get hung behind Q10. Actions taken to free up this hang cannot include issuing a command (for example, D GRS)—the task has to be terminated via CALLRTM.
- SYSIEFSD Q4 – this resource is used to serialize changes to the UCB by allocation and VARY command processing. Allocation obtains the resource as SHARED, while the VARY command obtains it exclusively. If a VARY command hangs while holding this resource, all allocations will also hang. The VARY command that is hung can be displayed and abended with the CMDS command.

If any of these resources do not execute within 10 seconds, they are considered to have hung.

“Hung” Command Recovery: The purpose of this function is to detect hung commands that often result in multisystem outages. We distinguish two situations:

1. Commands that inhibit other commands from completing execution
2. Jobs that inhibit commands from completing execution

In either case only locked resources are taken into consideration. The recovery looks for blocked resources that have not been defined during customization. If the long-running ENQ recovery is disabled all resources, even those that have been defined during customization, are considered as not having been defined.

Because commands are executed by the master and the console address space, the recovery first looks for blockers and waiters of these address spaces. As with resources you can make similar definitions for commands (see “Enabling Long Running Enqueues (ENQs)” on page 106).

In the second case the recovery does not take place immediately. Only after the threshold—the invocation after next—has been reached is the recovery action performed.

In both cases the action is identical to the long-running ENQ recovery action.

Command Flooding Recovery: The purpose of this function is to detect jobs that flood a command class. Command flooding can cause log buffer shortages and inhibits other commands from executing. Both can lead to a multisystem outage.

When all (50) TCBs that are reserved for command processing are in use, new commands are queued to the waiting queue. In this case the system issues message IEE806A which triggers this function to evaluate what jobs are causing the situation.

Jobs that just issue a set of commands, such as 200 (or more) "VARY dev,ONLINE" commands should *not* be considered during the evaluation. This is achieved by comparing the current and the previous snapshot of the affected command class.

Snapshot processing is scheduled when message IEE806A is trapped. The interval time between the snapshots is 3 seconds by default (see “Enabling Long Running Enqueues (ENQs)” on page 106 for details about adjusting this value if necessary). The interval should give these jobs enough time to finish issuing commands before the first snapshot is taken. Only jobs that issue commands on two consecutive snapshots become subject of the recovery action.

Before the recovery action takes place, the number of commands that are issued by the job must exceed a threshold (see below) and at least one of the commands must not be involved in a lock contention that is handled by the "hung" commands recovery.

The recovery action depends on the job definitions (see “Enabling Long Running Enqueues (ENQs)” on page 106). If the job can be canceled, the recovery also removes its waiting commands and terminates its executing commands. The recovery action is completed either with message ING922E or with message ING924E. The latter message is repeatedly issued approximately every minute until the waiting queue becomes empty.

The threshold is calculated by subtracting the number of jobs that are issuing commands in the command class from the total number of TCBs (50) that are reserved for command processing. This prevents jobs that repeatedly issue few commands from being evaluated .

The recovery ends when the message IEE061I is issued.

Note: The dump definitions are not in effect if a dump should be taken when the job is canceled. This is because the recovery routine of the job that is being canceled can suppress the dump.

Recovery Actions

Customization: Automation of handling long-running enqueues is enabled through the SA z/OS customization dialogs. For more details, see “Enabling Long Running Enqueues (ENQs)” on page 106.

SYSIEFSD resource recovery needs no further customization; it is enabled and disabled whenever you enable or disable the recovery of long-running enqueues.

System Removal

The purpose of this function is to isolate failed systems from a Parallel Sysplex by removing them as quickly as possible. It also ensures fast mean time to recovery (MTTR) for those system images that you wish to restart immediately if an unavoidable outage occurs.

Note: This function is unavailable when running on a z/OS image which runs under z/VM, even if the function is enabled.

In particular, the function automates the messages IXC102A and IXC402D.

The automation of the first message completes the Sysplex Failure Management (SFM). Under certain circumstances SFM cannot complete the isolation of a failed system. This is because SFM’s HW isolation, resetting the channel subsystem (CSS) of the failed system, is driven through the CF. When connectivity between the system image and the coupling facility is lost, SFM cannot perform the hardware isolation (ISOLATE command) and defers resetting the system image until manual operator intervention occurs. Message IXC102A tells the operator to manually reset the HW and then reply “DOWN” to the message, after which SFM safely partitions the system image out of the sysplex. The longer the delay lasts, the more the components and applications that rely on XCF messaging are impacted. The delay can eventually lead to a sysplex outage when the failed system has I/O operations pending. Automation of this message minimizes the delay.

The second message has the same impact as the first one. However, this message indicates a possible temporary inoperative status of the system due to a missing status update. For this reason the automation gives the system the chance to recover before the removal takes place by replying “INTERVAL=sss” to the first occurrence of message IXC402D. The interval time, *sss*, is the failure detection interval that is displayed by the command D XCF,CPL.

The automation does the removal of a system in two stages. The first stage clears any pending I/O operations by sending a hardware command to the Support Element. This requires information about the software running on the hardware. Because the system issuing message IXC102A or IXC402D does not necessarily have access to the hardware of the failed system, the automation needs predefined mapping between software and hardware. Depending on this mapping, it then routes the hardware command to the system that has access to the hardware of the failed system. For information about how to do the mapping refer to “Enabling System Removal” on page 104. For further information about the hardware requirements refer to *IBM Tivoli System Automation for z/OS Planning and Installation*.

The second stage replies to the outstanding WTOR with “DOWN” triggering the removal of the system from the sysplex.

Customization: Automation of message IXC102A is enabled through the SA z/OS customization dialogs. For more details, see “Step 3: Automating Messages IXC102A and IXC402D” on page 105.

Recovering Auxiliary Storage Shortage

With the automation of local page data sets, SA z/OS prevents auxiliary storage shortage outages by dynamically allocating spare local page data sets when needed. The function checks which jobs cause the shortage condition and whether additional page data sets can be added. If this is not possible, the job that is causing the shortage will be canceled if this has been defined.

To enable local page data set automation customize the PAGTOTL parameter (defined in one of the IEASYSxx PARMLIB members used during IPL). Make sure to set the PAGTOTL parameter to a value greater than the number of local page data sets currently used.

Local page data sets must be defined in the master catalog and should not be SMS-managed. It is recommended to use preallocated local data sets instead of dynamically allocated ones. This makes the process faster because formatting newly allocated page data sets is timeconsuming (10sec./35MB). Each predefined local page data set should be allocated with 10% space of local page space currently used by the system. If predefined page data sets can no longer be allocated, new local page data sets will be created dynamically.

Customization: Automation of the recovery of auxiliary storage shortage is enabled through the SA z/OS customization dialogs. For more details, see “Enabling System Removal” on page 104.

Hardware Validation

This function performs cross-validation of the hardware configuration mapped out in the customization dialogs against the actual hardware configuration that is running. This information is critical to accurately control logical partitions (LPARs) on any supported CPC within the HMC/SE LAN over the BCP Internal Interface.

Hardware validation uses the CPC name, Partition name and Partition number to ensure that the LPARs defined in the customization dialogs are on the correct CPC and located on the correct partition number. However, this helps only for coupling facilities because their partition identifiers must be defined in the active CFRM policy.

For MVS images, information from the HMC/SE (such as system name and sysplex name that are stored during initialization) is used to verify the corresponding customization dialog definitions. During initialization of the automation’s Hardware Command Interface and just before a disruptive request is sent to a partition, new checks are made to ensure that everything matches correctly.

Note: Only active images can be verified. For inactive images we must still rely on definitions made in the customization dialogs.

An active system in this context is a system belonging to the same sysplex as the system that runs the hardware validation, that is SA z/OS checks only systems and coupling facilities within its own sysplex.

Hardware validation runs on an SA z/OS system primarily during startup, and subsequently when changes to the definition in the customization dialogs are applied through the ACF command (ACF COLD, and ACF REFRESH when any CPC or image data has changed). The validation checks the definitions of all registered systems, that is whenever an SA z/OS system performs the hardware validation, it validates all systems and coupling facilities that are active in the

Hardware Validation

sysplex at this point in time. Registered systems are systems running msys for Operations or SA z/OS that have joined the same XCF group.

The validation of active systems and coupling facilities requires that the CPCs that host the active systems must all be defined in the customization dialogs.

The data for inactive systems cannot be verified. However, these definitions are checked for consistency across all registered systems. As soon as one of these inactive systems or coupling facilities joins the sysplex or is made available for use, the validation is run for the particular image only.

Retrieving actual hardware information can take up to 5 minutes per CPC depending on the model and its LPARs. During the time that the hardware validation takes place all other hardware-related automation is either delayed or cannot be performed, depending on the type of recovery. For this reason the validation carries out "delta" processing. That is validating only the data that has changed. This also includes the absence of data resulting in terminating CPC connections when CPC definitions are missing that have been applied by a prior validation. The actions resulting from the validation are performed on ALL registered systems. This has two advantages:

- you don't need to recycle NetView for changes in hardware definitions.
- you only need to make the changes available to one system.

The first part of the hardware validation triggered by the ACF command or the automation startup determines what CPC connections must be terminated and initiated, namely in this sequence. The resulting actions are performed on all registered systems. When this step has been completed successfully the image validation is performed.

The image validation collects actual hardware information, and verifies the current hardware definitions against the actual data and the definitions found on all other registered systems. It informs you if:

- A real system or coupling facility could not be validated because either actual hardware information or user definitions are not available
- The image definitions could not be evaluated because the actual hardware information is not available
- The real system or coupling facility is not active and the image definitions of some of the registered systems are different
- Any definition value has been corrected that was improperly defined or not defined at all

Changes in hardware definitions can be made available to all registered systems by simply invoking the command `INGAMS REFRESH` on only one of the these systems. There is one exception: the change of the authorization token value used for the communication with a particular CPC. A change of this value requires 3 steps:

1. In the first step you must remove the particular CPC definition and then invoke the ACF command as above.
2. When the command completes successfully the next step is to change the authorization token value of the CPC at the Support Element.
3. The final step is to define the CPC again with the new token value and invoke the ACF command again.

Note: This behavior of the INGAMS command applies to the hardware definitions *only*.

The second part of the validation is triggered by either the message IXC517I that is issued when a coupling facility is made available for use, or by the automation itself when notified that a system joined the sysplex. Both trigger the automation to perform only the validation of the new system or coupling facility. Multiple occurrences of messages for the same system or coupling facility are ignored while this system or coupling facility is validated. In case of a new system, the advantage here is that the real hardware is validated before the system starts NetView and the automation. If this automation then detects no difference between its current definitions and the definitions of the other registered systems—which is the normal case—only a consistency check takes place. This check does not require any real hardware information.

Prerequisites

Hardware validation has the following prerequisites:

- All coupling facilities that are used in the sysplex must reside on a CMOS-S/390[®] G5 processor or higher. Only these processors return the partition identifier that is required for validating coupling facilities.
- The BCP Internal Interface must have been initialized to accept requests. Or, when unavailable, at least one other registered system must have access to the hardware. Registered systems are systems running msys for Operations or SA z/OS that have joined the same XCF group.

Note: Hardware validation is not supported on MVS systems running under z/VM.

Enabling Hardware-Related Automation

To enable the sysplex automation that SA z/OS provides for recovery actions and coupling facility management, the following definitions must be made in the customization dialog.

Step 1: Defining the Processor

Use the customization dialog to define a new processor of Entry Type PRO. The name should be the real physical name of the processor defined in HCD. For more information, refer to the online help or the section "Creating a New Processor" in *IBM Tivoli System Automation for z/OS Defining Automation Policy*.

Step 2: Using the Policy Item PROCESSOR INFO

Use the Processor Information panel, to define a processor using entry type PRO.

Note: The connection type protocol must be INTERNAL
For more information, refer to the online help or the section "More about Policy Item PROCESSOR INFO" in *IBM Tivoli System Automation for z/OS Defining Automation Policy*.

Step 3: Defining Logical Partitions

If the processor that you have defined runs in LPAR mode, define its logical partitions using the LPAR Definitions panel. You should define all LPARs that are physically available on your processor, together with the systems that run on them.

Enabling Hardware-Related Automation

For more information, refer to the online help or the section "More about Policy Item LPARS AND SYSTEMS" in *IBM Tivoli System Automation for z/OS Defining Automation Policy*.

Step 4: Defining the System

Define a system using entry type SYS, and the Define New Entry panel.

Note: To avoid receiving hardware validation messages during SA z/OS initialization, you should define all your systems (including your coupling facilities).

For more information, refer to the online help or the section "Creating a New System" in *IBM Tivoli System Automation for z/OS Defining Automation Policy*.

Step 5: Connecting the System to the Processor

Connect this system to the processor that you defined in "Step 2: Using the Policy Item PROCESSOR INFO" on page 99 and to its logical partition (if you set the processor mode as LPAR).

Connect this system to the sysplex or standard group (see "Step 6: Defining Logical Sysplexes" and "Step 7: Defining the Physical Sysplex").

Note: MVS SYSNAME and the Image/ProcOps Name *must* be the same.

Restriction:

Usually, the MVS SYSNAME may begin with a number. However, in this case, it must be the same as the Image/ProcOps Name, which *cannot* begin with a number. Therefore, this naming restriction also applies to the MVS SYSNAME.

Step 6: Defining Logical Sysplexes

Define EACH logical sysplex (systems within the same XCF group ID) using entry type GRP with group type SYSPLEX.

Use policy SYSPLEX to enter the real physical sysplex name. You can use the same name in several SYSPLEX GRPs.

Use policy SYSTEMS to connect all systems within the same XCF group ID to the SYSPLEX GRP. A system can only be connected to one SYSPLEX GRP.

Step 7: Defining the Physical Sysplex

Define your real physical sysplex using entry type GRP with group type STANDARD.

Use policy SYSTEMS to connect all systems of your physical sysplex to the STANDARD GRP.

Enabling Continuous Availability of Couple Data Sets

Couple data sets (CDSs) contain important information about how to manage certain aspects of your sysplex. For example, the SFM CDS (sysplex failure management couple data set) defines how the system manages system and signalling connectivity failures and PR/SM™ (Processor Resource/Systems Manager™) reconfiguration actions.

Enabling Continuous Availability of Couple Data Sets

The following couple data sets are particularly important for the functioning of your Parallel Sysplex:

- The SYSPLEX couple data set, which defines the systems and the XCF groups of the sysplex
- The CFRM couple data set, which defines the coupling facilities and structures of the sysplex

It is recommended that you define alternate couple data sets for all couple data sets in your sysplex. These alternate couple data sets serve as backups when the primary CDS fails.

With the customization dialog you can specify a series of spare volumes for every CDS type, for example, SYSPLEX, ARM, CFRM. The first volume in the series is used to create an alternative CDS if one of the primary alternate CDSs fails.

In the customization dialog you define the potential alternate couple data sets using the *Group* entry type. Select a sysplex group, then select its policy item SYSPLEX (define sysplex policy) from the panel *Policy Selection*.

The Sysplex Policy Definition panel is displayed if you select policy item SYSPLEX from the *Policy Selection* panel for sysplex groups.

For a description of this panel refer to the online help or the section "More About Policy Item SYSPLEX" in *IBM Tivoli System Automation for z/OS Defining Automation Policy*.

Enabling System Log Failure Recovery

The SA z/OS customization dialog supports the automation of the system log failure recovery by defining commands for the following messages:

- IEE041I
- IEE043I
- IEE533E
- IEE769E

Use the *MVS Component* entry type to specify the commands that will be issued in case of a SYSLOG problem. Select the MESSAGES/USER DATA policy item of a selected *MVS Component* policy object to display the *Message Processing* panel. Enter CMD in the *Action* column and the message ID in the *Message ID* column.

Press Enter to display the *CMD Processing* panel. On this panel you specify in the *Command Text* field the MVS command that will be executed in case of message IEE041I. For example, enter MVS VARY SYSLOG, HARDCPY to have the SYSLOG receive the hardcopy log. (This action is recommended by IBM.)

In case of message IEE043I, the IBM recommended action is to enter the MVS command MVS WRITELOG START to restart the system log.

For the remaining messages repeat the steps as shown in the preceding panels.

You can use the customization dialog *Minor Resource Selection* to disable the system log recovery by setting the automation flag of the minor resource LOG to NO. For details refer to the section "More About Policy Item MINOR RESOURCE FLAGS" in *IBM Tivoli System Automation for z/OS Defining Automation Policy*.

Enabling WTO(R) Buffer Shortage Recovery

The SA z/OS customization dialog supports the automation of WTO(R) buffer shortage recovery.

When using the *MVS Component* entry type (MVC), you can specify jobs that will be canceled or kept in case a WTO(R) buffer shortage is threatening. The jobs that you select for cancellation will then no longer issue WTO(R)s.

Select the MESSAGES/USER DATA policy item of a selected *MVS Component* policy object to display the Message Processing panel.

Enter CODE in the *Action* column and WTOBUF in the *Message ID* column

After pressing Enter, the Code Processing panel is displayed. For more information about this panel, refer to the online help or to the section "More About Policy Item MESSAGES/USER DATA" in *IBM Tivoli System Automation for z/OS Defining Automation Policy*.

WTO Recovery is performed when different messages are received by SA z/OS. The action taken when each of these messages is received is described in Table 4 on page 103.

Enabling WTO(R) Buffer Shortage Recovery

Table 4. WTOBUF Recovery Process

Recovery	Message	Actions in sequence	Command	
WTO	IEA405E	Set console attributes.		
		If the deletion mode is not roll or wrap, set the mode to roll.	K S,DEL=R,L=x	
		If any out-of-line display area exists, delete the status display.	K E,D,L=x	
		If the interval between message rolls is not '*' or less than or equal to 1 second, set the interval to 0.25 seconds.	K S,RTME=1/4,L=x	
		If the console receives messages not only from the local system and the WTO message buffer size has reached its maximum, remove the buffering systems from the list and add the local system to the list.	V CN(x),MSCOPE=(1)	
	IEA404A	Suspend the console.		
		Requeue the messages to the hardcopy log.	K Q,L=x	
		Vary the active console (COND=A) offline. For SMCS consoles, issue the appropriate VTAM command (OA05706).	V {CN(x),OFFLINE NET,TERM,LU1=x, TYPE=FORCE }	
		Cancel the job or TSO user that caused the shortage, but only when defined as a candidate during the customization.	C {jobnm,A=asid U=userid }	
	IEA406I	Resume the console if it was suspended and if it is not a SMCS console. (OA05706)		V CN(x),ONLINE
		Restore console attributes.		
		Set the deletion mode to the value before the buffer shortage occurred (OA05706).	K S,DEL=old,L=x	
Set the interval between message rolls to the value before the buffer shortage occurred.		K S,RTME=old,L=x		
Set the list from which the console is to receive unsolicited messages to the list before the buffer shortage occurred.		V CN(x),MSCOPE=(1)		
Increase the WTO message buffer size to minimize future shortages as follows: <pre> new = min(9999 ,max(1500 ,1.2 * current MLIM)) </pre>		K M,MLIM=new		
Issue message AOF929 for permanent changes (MLIM). (OA05706.)				

Enabling WTO(R) Buffer Shortage Recovery

Table 4. WTOBUF Recovery Process (continued)

Recovery	Message	Actions in sequence	Command
WTOR	IEA230E	Increase the maximum number of reply IDs to the maximum allowable value if the maximum number of systems in the sysplex is greater than 8 or the system runs in local mode.	K M,RMAX=9999
		Increase the WTOR message buffer size if the current RMAX value is greater than the current RLIM value as follows: <pre> new = min(9999 ,max(10 + 2 * maxsys_in_sysplex ,1.2 * current RLIM)) </pre>	K M,RLIM=new
	IEA231A	Cancel all jobs and TSO users that have outstanding WTORs and that are defined as candidates during the customization.	C {jobnm,A=asid U=userid }
	IEA232I	Issue message AOF928 for irreversible changes (RMAX).	
		Issue message AOF929 for permanent changes (RLIM).	

Enabling System Removal

The SA z/OS Parallel Sysplex enhancements help you to resolve pending I/Os for systems being removed from the sysplex.

Because the automation must know where the system is located to send the command to the appropriate Support Element, you must use the customization dialog to define its hardware configuration.

Step 1: Defining the Processor and System

The processor and system must be defined as described in “Enabling Hardware-Related Automation” on page 99.

Step 2: Defining the Application with Application Type IMAGE

Use entry type APL to define a new application with Application Type IMAGE and subsystem name that is the same as the Image Name of the system that this application represents (as defined in “Step 4: Defining the System” on page 100).

Use entry type APL and select policy item APPLICATION INFO for your system. On the panel *Application Information* you can define a new application type IMAGE. For more information, refer to the online help or the section “Policy Items for Applications” in *IBM Tivoli System Automation for z/OS Defining Automation Policy*.

Because the application has been defined as type IMAGE, the job name is set by default to the subsystem name and cannot be changed.

The Subtype, Scheduling Subsystem, JCL Procedure Name, ARM Element Name, and WLM Resource Name are forced to be blank.

Some other definitions in the policy item AUTOMATION INFO are also defaulted:

- the Job Type is defaulted to NONMVS
- the Monitor Routine is defaulted to INGMTSYS if nothing is specified
- the External Startup is defaulted to ALWAYS if the Monitor Routine is INGMTSYS

- the External Shutdown is defaulted to ALWAYS if the Monitor Routine is INGMTSYS

For more information, refer to the online help or the section "More About Policy Item AUTOMATION INFO" in *IBM Tivoli System Automation for z/OS Defining Automation Policy*.

Step 3: Automating Messages IXC102A and IXC402D

You can automate messages IXC102A and IXC402D to avoid sysplex outages.

Note: The following shows examples for defining commands and codes for message IXC102A.

You can specify one of the following four hardware commands for each system in the sysplex that is automated.

- SYSRESET [CLEAR]
- DEACTIVATE
- ACTIVATE [P(image_profile_name)]
- LOAD [P(load_profile_name)] [CLEAR]

where

CLEAR indicates that the storage will be cleared

P specifies the profile to be used. The name can consist of up to 16 alphanumeric characters. If the parameter is omitted, the last profile is used.

Note:

The following restriction applies to the hardware commands ACTIVATE and LOAD:

Both commands invoke processor functions that can cause asynchronous events such as operator messages at BCP (Basic Control Program) Internal Interface initialization time or processor hardware wait states. Currently, the BCP Internal Interface does not allow the monitoring and control of these events.

Use policy item MESSAGES/USER DATA of the SA z/OS customization dialog to define commands and codes for message IXC102A and IXC402D. Enter CMD in the **Action** column and IXC102A in the **Message ID Description** column (or IXC402D for IXC402D message automation). For more information, refer to the online help or the section "More About Policy Item MESSAGES/USER DATA" in *IBM Tivoli System Automation for z/OS Defining Automation Policy*. The definitions here also apply to message IXC402D.

Pressing Enter will bring up the CMD Processing panel, as shown in Figure 16 on page 106. Use this panel to specify a valid command for the image and a "Pass/Selection" value that must match the "Value Returned" definition specified on the *Code Processing* panel.

Enabling System Removal

ACTCODE
LOAD P(LOADPROF) CLEAR

Figure 16. Sample Panel for Command Processing

On the *Code Processing* panel, as shown in Figure 17, specify the following:

Code 1	Code 2	Code 3	Value Returned
IXC102A	BCPII		ACTCODE

Figure 17. Sample Panel for Code Processing

If you want to automate messages IXC102A and IXC402D using the Parallel Sysplex enhancements, you must enter IXC102A for Code 1 and BCPII for Code 2. Refer to “Important Processor Operations Considerations” on page 108 for more information.

Enabling Long Running Enqueues (ENQs)

If you automate long running ENQs, you must define the following:

- The resource(s) being checked
- The time frame when a long ENQ is detected

If you automate “hung” commands, you must define the following:

- The command (or commands) that are being monitored or excluded from monitoring
- The time frame for each command that a command is granted for completion or, if commands are to be excluded from monitoring, the exclusion keyword

In addition, the following definitions can be made:

- The names of jobs that should be canceled or kept when detecting a long ENQ, a “hung” command, or command flooding
- The snapshot interval for a command class
- The title of the dump taken before the job is cancelled
- The default storage areas to be dumped
- Symbol definitions to be used when the dump specifications are provided by a PARMLIB member

Use the dialog support via entry type GRP to define the following policies:

- Resource definition
- JOB/ASID definitions
- IEADMCxx symbols
- Command definition
- Snapshot interval definition

Step 1: Defining Resources

Use the Long Running ENQ Resource Definition panel to define your resources. This panel is displayed if you select policy item RESOURCE DEFINITIONS from the Long Running Enqueue Policy section of the *Policy Selection* panel for sysplex groups. For more information, refer to the online help or the section “More About Policy Item RESOURCE DEFINITIONS” in *IBM Tivoli System Automation for z/OS Defining Automation Policy*.

Step 2: Making Job/ASID Definitions

Use the Long Running ENQ Job/ASID Definitions panel that is displayed if you select policy item JOB/ASID DEFINITIONS from the Long Running Enqueue Policy section of the *Policy Selection* panel for sysplex groups. For more information, refer to the online help or the section "More About Policy Item JOB/ASID DEFINITIONS" in *IBM Tivoli System Automation for z/OS Defining Automation Policy*.

Step 3: Defining IEADMCxx Symbols

Use the *Long Running ENQ IEADMCxx Symbols* panel that is displayed if you select policy item IEADMCxx SYMBOLS from the Long Running Enqueue Policy section of the *Policy Selection* panel for sysplex groups. For more information, refer to the online help or the section "More About Policy Item IEADMCxx SYMBOLS" in *IBM Tivoli System Automation for z/OS Defining Automation Policy*.

Step 4: Defining Commands

Use the Long Running Command Definition panel to define your commands. This panel is displayed if you select policy item COMMAND DEFINITIONS from the Long Running Enqueue Policy section of the *Policy Selection* panel for sysplex groups. For more information, refer to the online help or the section "More About Policy Item COMMAND DEFINITIONS" in *IBM Tivoli System Automation for z/OS Defining Automation Policy*.

Step 5: Defining Snapshot Intervals

Use the Command Flooding Definition panel to define the individual snapshot times. This panel is displayed if you select policy item COMMAND FLOODING from the Long Running Enqueue Policy section of the *Policy Selection* panel for sysplex groups. For more information, refer to the online help or the section "More About Policy Item COMMAND FLOODING" in *IBM Tivoli System Automation for z/OS Defining Automation Policy*.

Enabling Auxiliary Storage Shortage Recovery

To prevent auxiliary storage shortage outages you can predefine local page data sets, using the SA z/OS customization dialog for entry type GRP to define the following:

- local page data set
- job definitions

Step 1: Defining the Local Page Data Set

Use the Local Page Data Set Recovery panel that is displayed if you select policy item LOCAL PAGE DATA SET from the Local Page Data Set Policy section of the *Policy Selection* panel for sysplex groups. For more information, refer to the online help or the section "More About Policy Item LOCAL PAGE DATA SET" in *IBM Tivoli System Automation for z/OS Defining Automation Policy*.

Step 2: Defining the Handling of Jobs

Use the Local Page Data Set Recovery Job Definition panel that is displayed if you select policy item JOB DEFINITIONS from the Local Page Data Set Policy section of the *Policy Selection* panel for sysplex groups. For more information, refer to the online help or the section "More About Policy Item JOB DEFINITIONS" in *IBM Tivoli System Automation for z/OS Defining Automation Policy*.

Defining Common Automation Items

There are definitions that relate to utilities running as a started task. The first one (Temporary Data Set HLQ/TEMPHLQ) replaces the usage of the first qualifier of the automation status file. The second definition (Started Task Job Name/STCJOBNM) allows the unique assignment of started task job names scheduled by the automation in case you have dedicated job name assignments that conflict with the procedure names provided by the automation.

It is recommended that you define the Temporary Data Set HLQ/TEMPHLQ. If it is not defined, the automation uses the first qualifier of the automation status file.

You can define both of these items using the Sysplex Policy Definition panel that is displayed if you select the policy item SYSPLEX from the *Policy Selection* panel for sysplexes. For more information, refer to the online help or the section "More About Policy Item SYSPLEX" in *IBM Tivoli System Automation for z/OS Defining Automation Policy*.

Important Processor Operations Considerations

Currently, the IXC102A automation and Coupling Facility activation or deactivation is the product automation that uses the BCP (Basic Control Program) Internal Interface to control the processor hardware.

If you use the automation capabilities of SA z/OS processor operations in your environment, make sure they do not conflict with the automation supplied by the Parallel Sysplex enhancements.

With the Parallel Sysplex enhancements, IXC102A and IXC402D automation uses the BCP Internal Interface, which is currently not compatible with processor operations.

If you want to use the IXC102A automation that is supplied as part of the Parallel Sysplex enhancements, make sure there is no processor operations related IXC102A automation defined in your automation policy.

Likewise, if you want to continue to use the processor operations based automation of messages IXC102A and IXC402D, the IXC102A automation flag provided by the Parallel Sysplex enhancements must be disabled.

Processor operations, which is a Focal Point type function, allows you to monitor and control processor hardware, including Coupling Facility images, from a single NetView, the processor operations Focal Point.

The BCP Internal Interface of the Parallel Sysplex enhancements allows you to perform hardware operations from each NetView in your sysplex member, as long as its processor hardware supports this. Refer to *IBM Tivoli System Automation for z/OS Planning and Installation* for more information.

Customizing the System to Use the Functions

Additional Automation Operator IDs

To support the Parallel Sysplex enhancements, you must define the following automation operators:

Customizing the System to Use the Functions

Automation Operator ID	Automated Function	Profile
AUTXCF	XCFOPER	AOFPRFAO
AUTXCF2	XCFOPER2	AOFPRFAO
AUTPLEX	PLEXOPER	AOFPRFAO
AUTPLEX2	PLEXOPR2	AOFPRFAO
AUTPLEX3	PLEXOPR3	AOFPRFAO
AUTHW001	HWOPER01	AOFPRFAO
AUTHW002 ... AUTHW033	HWOPER02 ... HWOPER33	AOFPRFHW

After you made the definitions, you have to build the new definition files via the customization dialog build function. Recycle your automation NetViews to activate the changes in the DSIPARM members.

Note: If you have different naming conventions in your setup and you change the NetView autotask IDs in the parmlib member AOFOPFA, you have to change the Primary Automation Operator fields of the AOP definitions accordingly.

Switching Sysplex Functions On and Off

Use the SA z/OS customization dialog to specify the following minor resource names:

- CDS** For the recovery of alternate CDSs.
- ENQ** Enables the handling of the next four individual recoveries.
- ENQ.CMDFLOOD** Enables the handling of commands that flood a particular command class.
- ENQ.HUNGCMD** Enables the handling of jobs and commands that inhibit other commands from completing execution.
- ENQ.LONGENQ** Enables the handling of long-running ENQs.
- ENQ.SYSIEFSD** Enables the handling of ENQs related to the major resource SYSIEFSD and the minor resources Q4 and Q10.
- HEALTHCHK** For checking active sysplex settings and definitions.
- LOG** For the recovery of the system log.
- LOGGER** For the recovery of the system logger.
- PAGE** For the recovery of auxiliary storage shortage.
- WTO** For the recovery of WTO(R) buffer shortages.
- XCF** For automating messages IXC102A and IXC402D.

By default, all recovery actions are enabled. If you want to disable them, use the customization dialog *Flag Automation Specification* and set the recovery flag to NO.

Note: You can change the automation recovery flag during run time by using the command INGAUTO.

Customizing the System to Use the Functions

Chapter 10. DB2 Automation for System Automation for z/OS

Automation has been produced to provide automated functions for the DB2 software product.

Unlike other SA z/OS automation products (CICS, IMS and OPC), DB2 Automation has been designed as part of base automation. Consequently DB2 is treated as a normal SA z/OS application, relying heavily on base functionality. Therefore the material provided here should be read in conjunction with base documentation. Only DB2 Automation-specific information is provided in this document.

Overview

Automated functions provided by DB2 Automation are implemented using two distinct methods. The first being line mode invocation which allows for an operator (or OPC) initiated task to be performed on an on-demand basis. The second method is via event-driven functions such as timer expiration and NetView automation table traps. Timed commands are mainly used to provide for connection monitoring of links to IMS and CICS. Automation table commands support the dynamic discovery of IMS and CICS connections as well as Critical Event Monitoring.

Line Mode Functions

DB2 Automation offers the following operator line command functions:

- **maintenance start**

This provides the ability to start DB2 in a non-standard mode. This is a command line function that will allow for an ACCESS(MAINT) type start and/or a PARM(modname) start.

- **terminate threads**

This provides the ability to stop threads attached to DB2 in order to free DB2 to perform special tasks (backup).

- **start/stop tablespace**

This provides the ability to stop or start a specific Tablespace.

- **event-driven functions**

DB2 Automation event driven functions are via Timer commands or NetView automation table (AT) Traps.

- **connection monitoring (timer and AT driven)**

This function will facilitate the monitoring of IMS and CICS connections. This is done at connection level via either an ACF entry definition or via dynamic self discovery, or both. If required, a recovery command will be issued to re-establish a lost connection.

- **critical events (AT driven)**

This function is handled at 2 levels, each of which can forward messages to SDF:

1. Specific event (for example, excessive logging).
2. General events using a NetView AT entry to drive a message threshold/recovery process.

Planning Requirements

DB2 Automation requires SA OS/390 2.2 and its associated prerequisites. For more information on this topic refer to *IBM Tivoli System Automation for z/OS Planning and Installation*.

For dynamic discovery of connections, certain messages must be available:

IMS

For IMS, connection monitoring requires that messages DSNM001I, DSNM002I and DSNM003I are available to automation in order to detect the current status of a DB2 connection with IMS. This requires that IMS Automation is installed. For non DBCTL regions the IMS Automation EVISPINM member must be updated with the above mentioned messageIDs so as to expose them to automation via the IMS Automation AOI user exit. For more information please refer to *IBM Tivoli System Automation for z/OS IMS Automation Programmer's Reference and Operator's Guide*. The IMS non-DBCTL regions should also be defined to SA z/OS in order for the dynamically discovered connections to have recovery commands issued as a reply to the correct subsystem.

CICS

For CICS V4, connection monitoring requires that messages DSN2023I, DSN2025I and DSN2016I are available to automation. As this is not possible dynamic discovery is not available to this level of CICS and the ACF CONN entry must be used. For CICS TS, connection monitoring requires that messages DFHDB2023I, DFHDB2025I and DFHDB2037 are available to automation. These are exposed to automation automatically and therefore dynamic discovery is available.

Installation

Automation Control File (ACF)

Samples of DB2 Automation are contained in the policy database samples (all except the *DEFAULT sample). The DB2 entries are contained in CLASS/INSTANCE application (APL) relationships. Please refer to "Defining Automation Policy" for detailed information on how to implement these and other (SCR) entries into your automation policy.

Defining Automation Policy

Tailoring Your DB2 ACF Entries

After you have created your PDB you will need to edit it in order to add your specific DB2 Automation requirements. To do this, follow the subsequent steps:

1. Select option 4 *Policies* from the *Customization Dialog Primary Menu*.
2. Select the required policy database that is to contain the DB2 subsystem from the *Policy Database Selection* panel.
3. Select entry type *Application* from the *Entry Type Selection* panel.
4. From the *Entry Name Selection* panel for *Applications*, enter "NEW *entryname*" on the command line and press ENTER in order to create a new policy object that will represent the DB2 MSTR subsystem.
5. On the *Define New Entry* panel, you will need to enter the DB2 master subsystem name, an application type of DB2, the subtype (one of: MSTR SPAS

IRLM DBM1 DIST WLMS) and the MVS jobname, where the *db2id* represents the prefix used when you defined your DB2 jobnames to z/OS:

```
Subsystem Name. . . . . subsystem
Application Type. . . . . DB2
Subtype . . . . . MSTR
Job Name. . . . . db2idMSTR
```

6. Press END to save this information. This will bring you to the *Policy Selection* panel for *Applications*.
7. From here select policy item LINK TO CLASS.

Note: One policy item that is inherited at this point is the SHUTDOWN NORM command. This command looks like:

```
INGRDTTH &SUBSAPPL S
```

This has the effect of notifying of, and cancelling, any outstanding threads prior to DB2 shutdown. If you would prefer that threads are not cancelled then this command should be changed to read:

```
INGRDTTH &SUBSAPPL S N
```

8. From the list presented, select CLASS_DB2_MASTER and press END, returning to the *Policy Selection* panel.
9. From here select policy item AUTOMATION INFO.
10. When presented with panel *Application Automation Definition*, enter the command prefix character(s) for this DB2 subsystem in the entry:

```
Command Prefix . . cmdprfx      Console command character(s)
```

11. Press END to save this information.
12. For *connection monitoring* you must enter CMD and CODE entries for a CONN message to describe any connections that require a forced monitoring action at each monitoring cycle (for example, CICS V4 connection). Refer to "Connection Monitoring" on page 122 for further details on how to add these entries to the MESSAGES/USER DATA policy item:

```
MESSAGES          Define Application messages
```

If you wish to force connection status refresh at NetView restart, then add an extra parameter "Y" to the end of the command to be issued for the ACORESTART message entry, for example:

```
AFTER 00:00:10,INGRDCNM &SUBSAPPL Y
```

This has the effect of ensuring that any lost connections during a NetView outage are recovered. This option is not required if you can rely on connections being automatically re-established (that is, CICS/TS).

13. Press END to save this information.
14. Select the extended DB2 subsystem information policy:

```
DB2 CONTROL      Define DB2 Control entries
```

15. On the *DB2 control entries* panel define DB2 specific subsystem information. The DB2Id should be defined to indicate the subsystem ID and the Active log data set name should be entered.

```
DB2 subsystem id . . . . . db2id
Active log dataset name. . . . dsname
```

16. Press END to return to the *Policy Selection* panel.
17. Press END again to return to the *Entry Name Selection* panel for *Applications*.
18. Now enter "NEW *entryname*" on the command line and press ENTER in order to create a new policy object that will represent the DB2 DBM1 subsystem. On *Define New Entry* panel AOFGLN00 you will need to enter the subsystem name and the MVS jobname:

```
Subsystem Name. . . . . subsystem
Job Name. . . . . db2idDBM1
```

19. Press END to save this information and the *Policy Selection* panel will appear.
20. From here select policy item LINK TO CLASS.
21. From the list presented select CLASS_DB2_DATABASE and press END, returning to the *Policy Selection* panel.
22. From here select policy item RELATIONSHIPS.
23. Enter "New HASPARENT" on the command line and press Enter. In the *Supporting Resource* field of the upcoming *Define Relationship* panel, enter the subsystem name that you gave for the *db2idMSTR* job and press Enter. For the *Condition* field enter "StartsMeAndStopsMe". The relevant entries on the *Define Relationship* panel should now look like:

```
Relationship Type. . . . . HASPARENT
Supporting Resource. . . . . subsystem/APL/=
Condition . . . . . StartsMeAndStopsMe
```

24. Press END until you reach the *Entry Name Selection* panel for *Applications*.
25. Now enter "NEW *entryname*" on the command line and press ENTER to create a new policy object that will represent the DB2 DIST subsystem. Perform the steps described for the DBM1 subsystem accordingly now for the DIST subsystem.
26. Create a new policy object that will represent the DB2 IRLM subsystem. Perform the steps described for the DBM1 subsystem accordingly now for the IRLM subsystem.
27. Create a new policy object that will represent the DB2 SPAS subsystem. Perform the steps described for the DBM1 subsystem accordingly now for the SPAS subsystem.
28. After the MSTR, DBM1, DIST, IRLM, and SPAS subsystems have been created, they must be linked to an application group (APG).
29. The application group should be linked to the required system(s) that this DB2 subsystem is to be automated on.
30. To support the SDF requirements of DB2 Automation, the status details (SCR) settings are required and should be linked to the same system(s). The policy item is:

```
DB2_SDF_STATUSES          DB2 Automation status settings
```

31. After all the relevant ACF definitions have been entered, the ACF can be created using the BUILD command.

DB2 Automated Functions—Line Command Functions

Once a DB2 subsystem has been defined to automation, then there are a number of functions that can be performed against it. These are either invoked by a line command or are event-driven (timer or NetView AT).

Command Handler

Purpose

“INGDB2” is the only line command delivered by DB2 Automation. This is referred to as the “Command Handler”.

Syntax

```
▶▶—INGDB2—request—subsystem—[ ,parm ] [ ,TARGET=domid ]▶▶
```

Parameters

request

START-- DB2 startup (in non-standard mode)
 TERM -- Terminate threads
 TABLE -- Start/Stop Tablespace

For more information refer to “Command Requests” on page 116.

subsystem

The DB2 subsystem that the request is for

parm

A comma delimited positional parameter string.

The number of parameters depends on the command request.

START

parm1 MAINT (for maintenance startup)
 or an asterisk (*, for standard start)
parm2 An optional module name for a non-standard startup.

TERM

None

TABLE

parm1
 START (to start a tablespace) or
 STOP (to stop a tablespace)

parm2
 a database name

parm3
 a tablespace name

domid

A domain within the sysplex on which you wish this command to be invoked (default is current domain). DB2 Automation must be installed on each of the domains that would be required to act as a target.

Command Handler

Messages

```
AOF010I  WRONG NUMBER OF PARAMETERS ENTERED
AOF204I  time : EXPECTED PARAMETERS MISSING OR INVALID FOR REQUEST clist_name
                                                -parameter_name
AOF332I  SUBSYSTEM name COULD NOT BE LOCATED ON target
```

Command Requests

This is a detailed description of each of the requests that can be invoked via the Command Handler.

Maintenance Start

Purpose

This function will start a DB2 subsystem in a non-standard startup mode.

Using this function, a DB2 subsystem may be started in the following non-standard startup modes:

- Maintenance mode using the default module
- Maintenance mode using a custom module
- Normal startup mode using a custom module.

If a DB2 subsystem is started in maintenance mode then:

- The DDF will be stopped to inhibit any further connections
- Connection monitoring will be suppressed

To perform a standard startup (normal startup mode using default module) the SA z/OS SETSTATE command should be used to take full advantage of base automation features.

By using the INGREQ command it is possible to start DB2 with the necessary maintenance parameters entered on the "Appl Parms" field. For instance an applparm field value of:

```
ACCESS(MAINT), PARM(DSNxxxxx)
```

for a normal start would be the equivalent of a command line maintenance start, through substitution of the EHKVAR1 parameter. If the maintenance start parameters are consistent, then they may be entered into the ACF via the flexible startup policy. This provides for a variety of start types to be identified and initiated from the INGREQ request panel. See the INGREQ command documentation for further information.

The Maintenance Start function may also be invoked from TWS Automation as a Non subsystem Operation. For further information regarding invocation from the OPC product, refer to *IBM Tivoli System Automation for z/OS TWS Automation Programmer's Reference and Operator's Guide*.

Syntax

```
INGDB2  START subsystem,start_type,modname
```

Parameters

subsystem

Name of the DB2 subsystem to be started in a non-standard startup mode.

start_type

Specify MAINT for a DB2 subsystem to be started in maintenance mode.

Specify * for a DB2 subsystem to be started in maintenance mode (*modname* must be specified for this option.)

modname

If *modname* is supplied then this module name will be used to start up DB2 subsystem, otherwise the default module name will be used to start up the DB2 subsystem (this parameter must be specified if *start_type* is *).

Restrictions and Limitations

Maintenance Start can only be used when

- SA z/OS is initialized
- The DB2 subsystem is defined to SA z/OS
- When a standard start is not required
- The OPC interface can only be used if TWS Automation is installed.

Note: When DB2 is started in maintenance mode, the SPAS (stored procedures) address space is not started by DB2. However, SA z/OS is not aware of this and expects it to be an external startup. As a result the status of SPAS goes into an ambiguous STARTING status. The status will return to normal, when DB2 is next re-started in normal mode. For sites that frequently start up DB2 in maintenance mode, a separate DB2 application group could be defined and used in which the SPAS application is excluded.

Usage

This command may be used to start a DB2 subsystem in a non-standard startup mode, it may be invoked by the INGDB2 command handler or via TWS Automation.

Input parameters are validated for accuracy and any errors found are logged and the process is terminated. The requested subsystem is then checked to determine if automation is enabled. Once these preliminary checks have been successfully completed the requested function is initiated.

Examples

The type of startup performed will depend on the invocation parameters.

To startup a DB2 subsystem called DB2P in a non-standard startup mode, enter one of the following commands on the command line:

Example 1

```
INGDB2 START DB2P MAINT
```

Start a DB2 subsystem DB2P in maintenance mode using the default module.

Example 2

```
INGDB2 START DB2P MAINT,DSNMOD1
```

Start a DB2 subsystem DB2P in maintenance mode using custom module DSNMOD1.

Example 3

```
INGDB2 START DB2P *,DSNMOD1
```

Maintenance Start

Start a DB2 subsystem DB2P in normal mode using custom module DSNMOD1.

Policy Entries

The following DB2 startup command can be found in the sample CLASS_DB2_MASTER subsystem class STARTUP policy:

```
MVS &SUBSCMDPFX START DB2 &EHKVAR1
```

The specified command is appended with the required invocation parameters depending on the parameters provided.

To invoke the maintenance start function via the TWS Automation interface, the following startup command is required to be coded against an "Automation Function" of UXxxxxxx.

```
INGRDMST &EHKVAR1
```

Where UXxxxxxx must match the first token of the operation text as specified in the OPC plan.

The SHUTDLY ACF entry is used to delay maintenance start should the DB2 subsystem be ACTIVE when this function is invoked.

The STRTDLY ACF entry is used to decide how long to wait before checking to see if the DB2 subsystem is UP once this function is invoked.

Messages

```
AOF014I SPECIFIED PARAMETER parameter INVALID
AOF146I PARAMETER MUST BE NUMERIC
AOF204I EXPECTED PARAMETERS MISSING OR INVALID FOR REQUEST INGRDMST - text
AOF289I SUBSYSTEM subsystem HAS EXCEEDED NORMAL STARTUP INTERVAL.
AOF313I START FOR SUBSYSTEM subsystem (JOB jobname) WAS NOT ATTEMPTED - text
AOF332I SUBSYSTEM subsystem COULD NOT BE LOCATED ON domain
AOF583I AUTOMATION FOR SUBSYSTEM subsystem (JOB jobname) IS SET OFF -
AUTOMATION NOT ATTEMPTED
```

Return Codes

```
8      Process failure -- see accompanying message.
4      Automation not allowed.
0      Normal End.
-1     Command, instruction or nested command list encountered an error.
-5     Command list cancelled.
```

Error Codes Posted to TWS

```
UX21  Automation not allowed.
UX22  Automation control file error.
UX23  DB2 subsystem cannot be started, incorrect status.
UX24  DB2 subsystem is already started.
UX25  DB2 subsystem did not start.
UX26  Error response from AOCQRY.
```

Terminate Threads

Purpose

The terminate threads command will terminate all active threads for a DB2 subsystem. These include REMOTE, DB2CALL, BATCH, TSO, CICS/IMS connections and all remaining ('Other') threads.

TSO users will be issued with a message informing them that their thread is about to be terminated prior to actual thread termination.

The Terminate Threads function may also be invoked from the TWS Automation as a Non-subsystem Operation. For further information regarding invocation from TWS Automation, refer to *IBM Tivoli System Automation for z/OS TWS Automation Programmer's Reference and Operator's Guide*.

Syntax

```
INGDB2 TERM subsystem
```

Parameters

subsystem

Name of DB2 subsystem for which all active threads are to be terminated.

Restrictions and Limitations

Terminate threads can only be used when:

- SA z/OS is initialized
- The DB2 subsystem is defined to SA z/OS
- The status of the DB2 subsystem is 'UP'
- The OPC interface can only be used if TWS Automation is installed.

Usage

Use this command to terminate all active threads for a DB2 subsystem. It may be invoked by the INGDB2 command issued from the command line or via TWS Automation.

Input parameters are validated for accuracy and any errors found are logged and the process is terminated. The requested subsystem is then checked to determine if automation is enabled. Once these preliminary checks have been successfully completed the requested function is initiated.

Example

To terminate threads for a DB2 subsystem called DB2P, enter the following from the command line:

```
INGDB2 TERM DB2P
```

Policy Entries

DB2 Control policy item entries can be used to control the length of time to Terminate Threads.

"Terminate Threads Delay" represents the delay between each iteration of the terminate threads request.

"Cycles" represents the maximum number of iterations of the terminate threads request automation is to attempt.

To invoke the terminate threads function via the TWS Automation interface, the following startup command is required to be coded against an "Automation Function" of UXxxxxxx.

```
INGRDTTH &EHKVAR1
```

Where UXxxxxxx must match the first token of the operation text as specified in the OPC plan.

IMS BMP threads can be handled separately by requesting this via the Connection Monitoring Policy Entries. Using the CONN Message Policy entry for the DB2 subsystem, create a coded entry as required by the CDEMATCH common routine.

Terminate Threads

Code 1	Code 2	Code 3	Value Returned
IMSCONID	IMSCTLJB	STOPBMP	YES/NO

where

Code 1

is the IMS connection ID

Code 2

is the IMS Control Region job name

Code 3

is a fixed request identifier

Value Returned

is Yes or No, to indicate if this IMS job's BMPs should be stopped using the IMS /STOP REG ABDUMP command or not.

Messages

AOF004I PROCESSING FAILED FOR *db2cmd*
AOF014I SPECIFIED PARAMETER *cycle* INVALID
AOF144I PARAMETER *parameter_name* INVALID
AOF146I PARAMETER MUST BE NUMERIC
AOF204I EXPECTED PARAMETERS MISSING OR INVALID FOR REQUEST INGRDTH - *text*
AOF332I SUBSYSTEM *subsystem* COULD NOT BE LOCATED ON *domain*
AOF583I AUTOMATION FOR SUBSYSTEM *subsystem* (JOB *jobname*) IS SET OFF -
AUTOMATION NOT ATTEMPTED
ING107E INDOUBT THREADS EXIST - SHUTDOWN OF *subsystem* WILL NOT PROCEED
ING108I NO THREADS LEFT IN *subsystem*
ING109E *thread_number* THREADS COULD NOT BE TERMINATED FROM *subsystem*.
ING112I YOUR TSO DB2 (*subsystem*) THREAD IS ABOUT TO BE TERMINATED BY AUTOMATION.
ING113I YOUR TSO DB2 (*subsystem*) THREAD HAS BEEN TERMINATED BY AUTOMATION.
ING114E *jobname* CANCELLED BY AUTOMATION DUE TO *subsystem* THREAD TERMINATION.
ING127A THREADS FOUND AFTER LAST CYCLE OF DB2 (*subsystem*), FORCE SHUTDOWN.

Return Codes

8 Process failure -- see accompanying message.
4 Automation not allowed.
0 Normal End.
-1 Command, instruction or nested command list encountered an error.
-5 Command list cancelled.

Error Codes Posted to TWS

UX41 Automation not allowed.
UX43 Termination of connections unsuccessful.
UX44 Error response from DB2 command.

Start/Stop Tablespace

Purpose

For DB2 Tablespace Start, the necessary Tablespace start command will be issued.

For DB2 Tablespace Stop, certain active threads that use the Tablespace will be terminated. These include REMOTE, DB2CALL, BATCH and TSO. TSO users will be issued with a message informing them that their thread is about to be terminated prior to actual thread termination.

The Tablespace Start/Stop function may also be invoked from the TWS Automation as a Non-subsystem Operation. For further information regarding

invocation from TWS Automation, refer to *IBM Tivoli System Automation for z/OS TWS Automation Programmer's Reference and Operator's Guide*.

Syntax

```
INGDB2 TABLE subsystem,request_type,dbname,tsname
```

Parameters

subsystem

Name of DB2 subsystem

request type

'START' (start Tablespace)

'STOP' (stop Tablespace)

dbname

Database name

tsname Tablespace name to be started/stopped

Restrictions and Limitations

Tablespace Start/Stop can only be used when:

- SA z/OS is initialized
- The DB2 subsystem is defined to SA z/OS.
- The OPC interface can only be used if TWS Automation is installed.

Usage

Use this command to start/stop a Tablespace for a DB2 subsystem. It may be invoked by the INGDB2 command handler or via TWS Automation.

Input parameters are validated for accuracy and any errors found are logged and the process is terminated. The requested subsystem is then checked to determine if automation is enabled. Once these preliminary checks have been successfully completed the requested function is initiated.

Examples

Example 1

To start a Tablespace where the DB2 subsystem is DB2P, the database name is DB2PDBN and the Tablespace name is DB2PTSN, then enter the following command on the command line:

```
INGDB2 TABLE DB2P,START,DB2PDBN,DB2PTSN
```

Example 2

To stop a Tablespace where the DB2 subsystem is DB2P, the database name is DB2PDBN and the Tablespace name is DB2PTSN, then enter the following command on the command line:

```
INGDB2 TABLE DB2P,STOP,DB2PDBN,DB2PTSN
```

Policy Entries

DB2 Control policy item entries can be used to control the length of time to Terminate Threads.

"STOP tablespace delay" represents the delay between each iteration of stop Tablespace attempt.

Start/Stop Tablespace

TSO logoff delay represents the delay before issuing the TSO logoff message to users of the Tablespace.

To invoke the start/stop Tablespace function via the TWS Automation interface, the following startup command is required to be coded against an "Automation Function" of UXxxxxxx.

```
INGRDSTS &EHKVARI[START|STOP]
```

Where UXxxxxxx must match the first token of the operation text as specified in the OPC plan. The STOP or START request parameter is optional and can be used if all of the required parameters cannot fit in the operation text field.

Messages

```
AOF004I PROCESSING FAILED FOR db2cmd
AOF144I PARAMETER parameter_name INVALID
AOF204I EXPECTED PARAMETERS MISSING OR INVALID FOR REQUEST INGRDSTS - text
AOF332I SUBSYSTEM subsystem COULD NOT BE LOCATED ON domain
AOF583I AUTOMATION FOR SUBSYSTEM subsystem (JOB jobname) IS SET OFF -
AUTOMATION NOT ATTEMPTED
ING109E thread_no THREADS COULD NOT BE TERMINATED FROM subsystem
ING129E jobname CANCELLED. TABLESPACE dbname.tsname(subsystem)
NEEDED TO BE STOPPED.
ING130I TABLESPACE dbname.tsname(subsystem) IS TO BE STOPPED. PLEASE STOP USING IT.
ING131I YOU WERE CANCELLED BECAUSE TABLESPACE dbname.tsname(subsystem)
IS TO BE STOPPED.
ING132I thread_no THREADS CANCELLED DUE TO STOP OF TABLESPACE
dbname.tsname(subsystem)
```

Return Codes

```
8      Process failure -- see accompanying message.
4      Automation not allowed.
0      Normal End.
-1     Command, instruction or nested command list encountered an error.
-5     Command list cancelled.
```

Error Codes Posted to TWS

```
UXA1  Automation not allowed.
UXA2  Error response from DB2 command.
UXA4  Tablespace is still allocated.
```

Event-Driven Functions

This is a detailed description of each of the commands that can be invoked as the result of an event, either a NetView AT trap or a NetView Timer expiration.

Connection Monitoring

Purpose

Connection monitoring is designed to, where possible, dynamically discover CICS and IMS connections to a DB2 subsystem. Once discovered the status of a connection can be maintained by tracking the relevant messages generated as the connection is affected by the operating environment.

When dynamic discovery is not feasible (due to the inability of automating the relevant messages) then the connection information can be read from ACF CONN entry-type entries, and the status checked by issuing the relevant MVS commands.

In all cases, should the connection be found in the "DOWN" status then the necessary restart command will be automatically issued.

Restrictions and Limitations

Connection Monitoring can only be used when:

- SA z/OS is initialized.
- The DB2 connection is defined to SA z/OS.
- The CICS and IMS application is defined to SA z/OS.
- The CICS or IMS attachment facility is installed for the relevant subsystems.

Usage

This function is driven by a NetView Timer expiration in order to check the connections that are being monitored to be "UP" and, if necessary, issue a recovery command. This function can also be driven from the NetView AT trap in order to update the connection status.

Input parameters are validated for accuracy and any errors found are logged and the process is terminated. The requested subsystem is then checked to determine if automation is enabled. Once these preliminary checks have been successfully completed the requested function is initiated.

For the NetView AT event driven process the automation flag for the connection minor resource is **not** checked and, depending on the message that was trapped, the relevant CGlobal information for the particular connection will be updated.

If the process is driven as a result of a NetView Timer expiration then all known connections are checked for availability. The connections to check are identified from the ACF CONN entry-type entries, as well as the Cglobals built from the NetView AT driven process. The individual connection's automation flags are checked to see if recovery should be considered. For each connection, if automation is "ON" and the connection status is "DOWN" (all ACF CONN connection entries are assumed to be "DOWN" for this purpose) then the connection is checked for its current status. If the connection is confirmed to be "DOWN" then a recovery command will be issued. For ACF entry identified connections the recovery command is issued from the ACF, otherwise a command is built from discovered information and then issued.

Policy Entries

DB2 Control policy item entries can be used to control the length of time between Connection Monitoring cycles.

"Connection monitor delay" represents the delay between each NetView Timer expiration which will trigger the connection status checking cycle.

Connection monitoring is initially invoked to run on a timer initiated by the DB2 UP or NetView restart messages.

You can control Connection Monitoring by using the CONN and CONN.*connid* minor resource automation flags, where *connid* represents the name of a connection that requires automation to be switched off.

The connection identification entries can be entered into your automation policy using the Customization Dialog MESSAGES/USER DATA policy item for the DB2 subsystem. The Message ID should be CONN against which the CODE and CMD entries should be made:

Connection Monitoring

Code 1	Code 2	Code 3	Value Returned
CICONID	CICS4A	CICS	CICS4A ENTRY

where

Code 1 is the connection ID (CICS applid)

Code 2 is the CICS jobname

Code 3 is the connection type (CICS or IMS)

Code 4 is the connection description.

and this could be the CMD entry required:

Pass or Selection	Automated Function	Command Text
CICONID		MVS F CICS4A,DSNC STRT Z

where

Pass or Selection
is the connection ID

Automated Function
is not used

Command Text
is the required recovery command to be issued.

AT Entries

Messages DSNM001I, DSNM002I, and DSNM003I will trigger connection monitoring (INGRDCNM) to run from the NetView automation table.

These messages require IMS Automation to be installed, as they are required to be added to the EVISPINM table and be available to IMS Automation AOI exit in the case of non-DBCTL regions, or pre-message set to "YES" for DBCTL regions. Please refer to the chapter "Optional Additions to the PPI", in the *IBM Tivoli System Automation for z/OS IMS Automation Programmer's Reference and Operator's Guide*.

Messages

```
AOF004I PROCESSING FAILED FOR db2cmd
AOF144I PARAMETER parameter_name INVALID
AOF204I EXPECTED PARAMETERS MISSING OR INVALID FOR REQUEST INGRDCNM - text
AOF205A time : command COMMAND FAILED FOR clist_name : interval -
WAIT TIME EXPIRED
AOF332I SUBSYSTEM subsystem COULD NOT BE LOCATED ON domain
AOF583I AUTOMATION FOR SUBSYSTEM subsystem (JOB jobname) IS SET OFF -
AUTOMATION NOT ATTEMPTED
ING101A subsystem CONNECTION TO conn_desc (conn_id) DOWN. RECOVERY
COMMAND ISSUED
ING102I subsystem CONNECTION TO conn_desc (conn_id) IS UP.
```

Return Codes

8 Process failure -- see accompanying message.
4 Automation not allowed.
0 Normal End.
-1 Command, instruction or nested command list encountered an error.
-5 Command list cancelled.

Critical Event Monitoring

Purpose

Critical Event Monitoring handles specific critical events that may occur during normal day-to-day running of DB2.

These include:

Message	Description
DSNB250E, DSNB311I, DSNB312I, DSNB320, DSNB321I, DSNB322I, DSNB323I, DSNB350I, DSNB351I	Recover failed dataspace (for data sharing only)
DSNB309I	Recover failed group buffer pool
DSNV086E	Unrecoverable/Recoverable DB2 abends
DSNJ002I	Switch active log data sets
DSNR004I	Restart process completed
DSNP007I	Data set could not be extended
DSNJ110E	Last active log data set is % full
DSNJ111E	All active log data sets full
DSNJ115I	Archive data set could not be allocated
DSNT500I/DSNT501I	Resource unavailable

Required recovery commands are to be defined for the message in the automation policy item MESSAGES/USER DATA for any DB2 subsystem that requires DB2 critical event message recovery.

If the DB2 subsystem is known to SA z/OS as an application of type DB2, event message recovery can be controlled by parameters entered via the DB2 CONTROL policy item for the subsystem.

AT statements that call the generic routine ISSUECMD or a DB2-specific routine are only created during the build process for messages that have commands defined in the automation control file. If a recovery action is only to be processed when the triggering message is issued by a subsystem of type DB2, the created automation table statement is labeled with the group name DB2. Otherwise the automation table statement is created without a label.

Created automation table statements that call the generic routine ISSUECMD are conditional and can be overwritten via automation policy item MESSAGES/USER DATA.

Restrictions and Limitations

Critical event monitoring is only done if the DB2 subsystem is defined to SA z/OS and if recovery is enabled for the invoking message ID minor resource.

Critical event monitoring with DB2-specific routines is only done if the DB2 subsystem is known to SA z/OS as an application of type DB2

For some recovery actions SYSOPR needs SYSCTRL authority.

Critical Event Monitoring

Usage

For each of the Event Monitoring processes, the input parameters are validated for accuracy and any errors that are found are logged and the process is terminated. The requested subsystem is then checked to determine if automation is enabled for the major resource, and also that recovery is enabled for the invoking message ID minor resource. Once these preliminary checks have been successfully completed, the requested recovery action is performed.

DSNB250E, DSNB311I, DSNB312I, DSNB320I, DSNB321I, DSNB322I, DSNB323I, DSNB350I, DSNB351I - Recover Failed Dataspace:

Description: Affected dataspace are identified by using the DIS DB() SPACE() RESTRICT LIMIT() command. Using the returned DSNT397I message, the status of each dataspace is checked for LPL or GRECP. If matched then the dataspace is tagged for recovery. This is achieved by issuing the STA DB() SPACENAM() ACCESS() command for each tagged database or dataspace. Priority is given to databases DSNDB01 and DSNDB06 if necessary.

Policy Entries: Any database or tablespace that is to be excluded from recovery should be entered using the MESSAGES/USER DATA policy item. The Message ID should be "DATABASE" against which the "CODE" entry should be made. For example:

Code 1	Code 2	Code 3	Value Returned
Database	Tablespace		IGNORE

Refer to CDEMATCH in *IBM Tivoli System Automation for z/OS Programmer's Reference* for code matching rules.

DSNB309I - Recover Failed Group Buffer Pool:

Description: This function will stop DB2 on receipt of the DSNB309I for Group Buffer Pool GBP0. This is triggered using an AT trap that will invoke INGRDTTH to perform the INGREQ STOP command. SA z/OS will then attempt to start any other DB2 that is defined within the sysplex, based on preference values.

DSNV086E - Unrecoverable/Recoverable DB2 Abends:

Description: This function will identify specific DB2 abends as non-recoverable. This will cause the DB2 subsystem to *break* DB2. SA z/OS will then attempt to start any other DB2 that is defined within the sysplex, based on preference values. Other DB2 abends will be recoverable.

DSNJ002I - Switch Active Log Data Sets:

Description: If commands are defined in the automation policy item MESSAGES/USER DATA for this message to an application of type DB2, these commands are only issued when the triggering message is for the log data set that is specified by the "Active log data set name" in the DB2 CONTROL policy item.

If the application is not of type DB2, the defined commands are issued unconditionally.

DSNR004I - Restart Process Completed:

| *Description:* If the message reports an INDOUBT counter greater than zero at the
| end of a DB2 restart process, ISSUECMD is called to issue commands that are
| defined in the automation policy item MESSAGES/USER DATA of the DB2
| application for this message.

DSNP007I - Data Set Could Not Be Extended:

| *Description:* The created automation table statement calls ISSUECMD with its code
| specifications as the parameters. The code values are extracted from the message
| text. The data set name is passed as the CODE1 value, the return code is passed as
| the CODE2 value, and the connection ID is passed as the CODE3 value. If a code
| match is found with the ID of the triggering message in policy item
| MESSAGES/USER DATA, the value that is returned is used to select and issue the
| related commands as defined in the automation policy.

DSNJ110E- Last Active Log Data Set Is % Full:

| *Description:* If commands are defined in the automation policy item
| MESSAGES/USER DATA for this message to an application of type DB2, these
| commands are only issued when the message reports a percentage full figure that
| is equal to or greater than the critical threshold that is defined in the "Log full
| threshold" field of the DB2 CONTROL policy item.

| If the application is not of type DB2, the defined commands are issued
| unconditionally.

DSNJ111E - All Active Log Data Sets Full:

| *Description:* If commands are defined in the automation policy item
| MESSAGES/USER DATA for this message to an application of type DB2, these
| commands are only issued when the number of received messages within a time
| period exceeds a given threshold. The time period and the threshold can be
| entered via the DB2 CONTROL policy item in the "Active log alerts" field and the
| related "Threshold" field.

| If the application is not of type DB2, the defined commands are issued
| unconditionally.

DSNJ115I - Archive Data Set Could Not Be Allocated:

| *Description:* If commands are defined in the automation policy item
| MESSAGES/USER DATA for this message to an application of type DB2, these
| commands are only issued when the elapsed time since having been triggered by
| this message is greater than a given time interval, as specified in the "Log offload
| interval" field in the DB2 CONTROL policy item.

| If the application is not of type DB2, the defined commands are issued
| unconditionally.

DSNT500I/501I - Generate DSNT500I/DSNT501I Alert:

| *Description:* The created automation table statement calls ISSUECMD with its code
| specifications as the parameters. The code values are extracted from the message
| text. The name is passed as CODE1, the reason is passed as CODE2 and the type is
| passed as CODE3. If a code match is found with the ID of the triggering message
| in policy item MESSAGES/USER DATA, the value that is returned is used to select
| and issue the related commands as defined in the automation policy.

Chapter 11. SA z/OS User Exits

To allow customer-specific activities that are not covered by the customization dialogs, SA z/OS provides support for the following classes of user exits:

- Initialization exits that are called at the start of SA z/OS initialization, before message AOF603D is issued, see “Initialization Exits” on page 130
- Static exits that are called at fixed points during SA z/OS processing, see “Static Exits” on page 132
- Flag exits that are called when SA z/OS needs to evaluate an automation flag, see “Flag Exits” on page 134
- Customization Dialog exits that can be called during certain phases when working with the customization dialog, see “Customization Dialog Exits” on page 138
- Command exits that can be called during the processing of certain commands, see “Command Exits” on page 142

Additionally, SA z/OS has a number of facilities that behave in an exit-like manner.

Figure 18 on page 130 shows the sequence in which exits may be invoked during SA z/OS initialization.

Initialization Exits

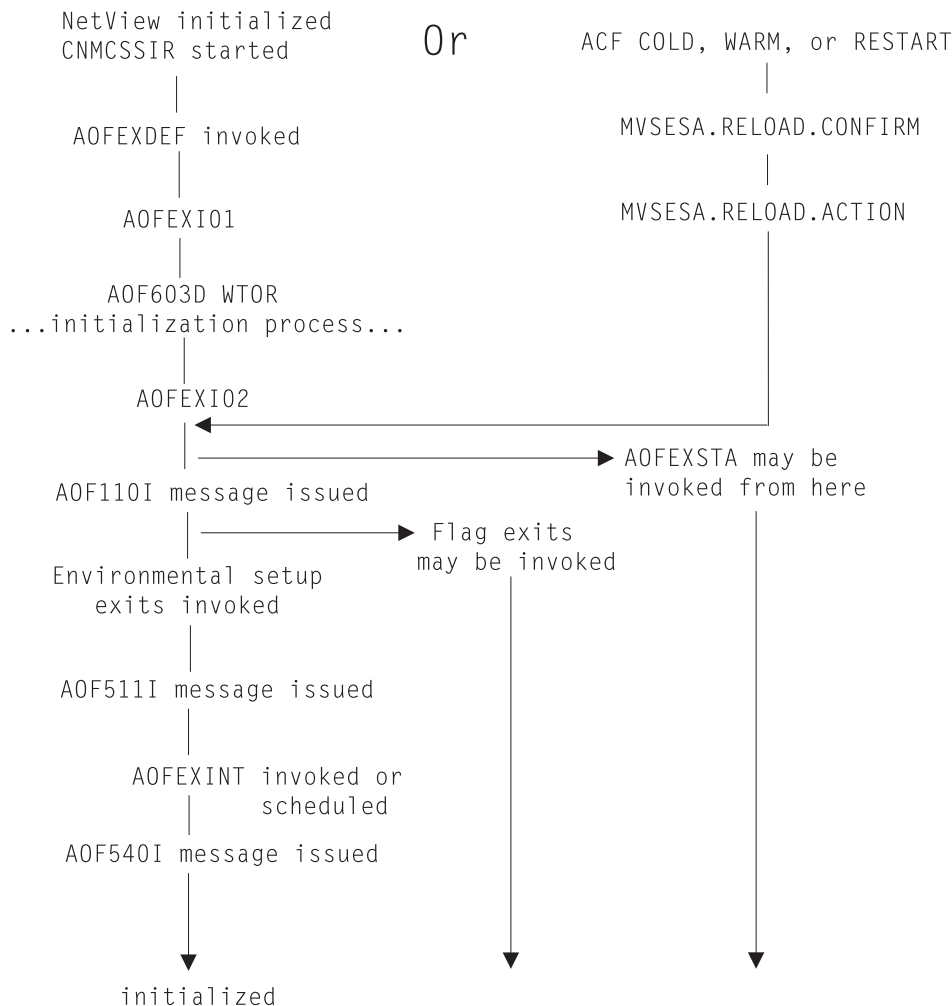

Figure 18. SA z/OS Exit Sequence during SA z/OS Initialization

Initialization Exits

These exits are invoked at the start of SA z/OS initialization, before message AOF603D is issued.

Environmental Setup Exits

The SA z/OS customization dialog allows you to define a string of exits which are invoked during SA z/OS initialization processing. These exits are defined using the AUTOMATION SETUP policy item of the *System* policy object. See *IBM Tivoli System Automation for z/OS Defining Automation Policy* for more information. Environmental setup exits are invoked after SA z/OS has started its various tasks, but before the primary automation table has been loaded. You can use these exits to initiate your own automation, but some SA z/OS services may be unavailable as SA z/OS has not yet finished initializing when these exits are called. In particular, status information may be inaccurate as SA z/OS may not have finished resynchronization. Environmental setup exits runs on AUTO1.

Parameters

Parameters are passed in sequence, delimited by blanks.

INITIALIZATION

INITIALIZATION is a constant.

Either RELOAD or REFRESH or IPL or RECYCLE

RELOAD indicates that the automation control file has been reloaded.
 REFRESH indicates that the automation control file has been refreshed.
 IPL indicates that SA z/OS has just been restarted after a system IPL.
 RECYCLE indicates that NetView has been restarted.

Return Codes

0 is expected. If you return a non-zero return code you may prevent other exits from being invoked or disrupt SA z/OS initialization.

Usage Notes

- These exits are not driven if you run RESYNC.
- Unlike the other static exits, you must specify the name of the routine or routines to invoke in the automation control file.

AOFEXDEF

This exit is called at the start of SA z/OS initialization, before message AOF603D is issued. This exit should be used to change your advanced automation options. For example, using AOFEXDEF you can:

- Load a different MPF table
- Set advanced automation options

See Appendix A, “Global Variables,” on page 203 for information on advanced automation options.

This exit is run on AUTO1.

Parameters: None.

Return Codes: 0 is expected.

AOFEXI01

This exit is invoked before the AOF603D ENTER AUTOMATION OPTIONS reply is issued. It is invoked in a NetView PIPE and gets the data that is displayed in the AOF767I message as input in the default SAFE. With this exit you can add or remove lines from the message and add additional options to the reply.

Parameters: None.

Return Codes: 0 is expected.

AOFEXI02

This exit is invoked after the operator has replied to the AOF603D reply. It gets the operator’s response to the reply as input in the default safe and it can remove, add, or change the options that the operator has entered.

Parameters: None.

Return Codes: 0 is expected.

Initialization Exits

AOFEXI03

This exit is invoked before SA z/OS loads NetView automation table. It can be used to create statistics of the currently loaded ATs. Together with the AT listings that SA z/OS produces at load, these statistics can be used for any purpose.

Parameters: None.

Return Codes: 0 is expected.

AOFEXI04

This exit is invoked after SA z/OS loads NetView automation tables. It can be used to store the AT listings that SA z/OS produces at load.

Parameters: None.

Return Codes: 0 is expected.

AOFEXINT

This exit is called when SA z/OS initialization is complete, before message AOF540I is issued. You can use AOFEXINT to call your own initialization processing after SA z/OS has finished. Refer also to the description of the global variable AOFSERXINT in “AOFSERXINT global variable” on page 210.

Parameters: The input parameter is the *Starttype* which is one of the following: RESYNC, IPL, REFRESH, RELOAD, RECYCLE.

Return Codes: 0 is expected.

Static Exits

These exits are invoked at fixed points in SA z/OS processing. They are always invoked if they are found in the DSICLD concatenation. Positive return codes from these exits are generally ignored, though it is recommended that you always exit with a return code of 0.

The main purpose of static exits is to allow you to take your own actions at specific points during SA z/OS processing. The static exits available are described below.

AOFEXSTA

This exit is called from AOCUPDT every time the automation status of an application is updated.

Note: It is not necessary for AOCUPDT to *change* an application automation status for this exit to be called. The exit is still invoked if the update does not result in a change of status.

AOFEXSTA can be used to perform any special status transition processing that cannot be triggered by other methods.

Note: This exit is invoked frequently, and will be invoked at times when SA z/OS is not fully initialized. Your exit code should be as robust and efficient as possible.

SA z/OS will attempt to load AOFEXSTA into storage at initialization. If this

attempt fails, AOFEXSTA will not be invoked on any AOCUPDT calls. To activate the exit it must be present in the DSICLD concatenation when the automation control file is loaded or reloaded.

AOFEXSTA runs on the task that called AOCUPDT, after all other processing has finished.

Attention: AOFEXSTA is scheduled with EXCMD opid(). If your operators are issuing commands which change application statuses and you wish to use AOFEXSTA, you may have to modify your scope definitions.

Parameters: Parameters are passed in sequence, delimited by commas.

Resource type

SA z/OS uses types of SUBSYSTEM, MVSESA, WTORS, and SPOOL. Other users may use other resource types.

Resource Name

For an application, this is the name of the subsystem it is defined as.

Automation Status

For an application, this is one of the twenty six SA z/OS-supported automation statuses.

SDF Root

This is the SDF Root, as specified in the customization dialog, for the system that originated the status update. Generally the exit is driven only for status changes on other systems on the automation focal point.

Return Codes: 0 is expected.

Restrictions:

- Because the exit is scheduled with EXCMD, the status update and subsequent processing in the caller will have completed before the exit is invoked.
- Check the resource type and the SDF root to ensure you are only trying to process the right things.
- Plan carefully before you take any action to change the status of an application from this exit. If you are not careful you may create a loop (AOCUPDT to AOFEXSTA to AOCUPDT to AOFEXSTA).

Note:

Consider using ISSUEREP, ISSUECMD or status change commands as alternatives to AOFEXSTA, since AOFEXSTA is invoked for **every** status update which seriously degrades performance.

The generic routines ACTIVMSG and TERMMSG will, if the advanced automation options are set up appropriately, issue commands whenever an application changes to a particular status. It may be more appropriate to place commands here, rather than in the status change exit, which gets driven for every status update of every resource. It is recommended to use status change commands for better performance.

AOFEXX01

This sample can be used as model for exit AOFEXINT.

Static Exits

The exit obtains a list of the resources that are in the CTLDOWN state by calling the DISPSTAT command. Then the exit uses the ACFFQRY interface to determine which of the resources have the StartOnIPL option set to NOSTART.

For all resources that are not supposed to be started at IPL, the exit issues a stop request via the INGREQ command, and then sets the agent status to AUTODOWN using the SETSTATE command.

AOFEXX02

The exit allows the installation to decide whether or not an SDF update should be performed for the specified resource.

A non-zero return code from the exit causes the SDF update processing to be skipped, both locally as well as for the focal point.

This exit is called prior to posting entries to SDF to provide the facility to filter out specific events.

Refer to the sample exit for details of the parameters passed to the exit and the return codes.

AOFEXX03

The exit allows the installation to decide whether or not status change notification should be forwarded to the NMC focal point for the specified resource.

A non-zero return code from the exit causes status change forwarding to be skipped.

This exit is called prior to posting entries to NMC to provide the facility to filter out specific events.

Refer to the sample exit for details of the parameters passed to the exit and the return codes.

Flag Exits

Using automation flag exits you can cause your automated operations code to exit normal SA z/OS processing to an external source, such as a scheduling function, to determine whether automation should be on or off for a given resource at that particular instant.

Flag exits can be defined for :

- Any flag (Automation, Initstart, Start, Recovery, Shutdown or Restart).
- Any resource.
- Any minor resource. See the description of the policy item MINOR RESOURCES in *IBM Tivoli System Automation for z/OS Defining Automation Policy* for more information on minor resources.

You can specify multiple exits for each flag. A flag exit is invoked only if SA z/OS needs an “opinion” on the current flag setting. Flag exits and flags all work on a “veto” basis. A flag is ON when all flags and flag exits agree that it is on.

Flags are set to YES, NO, or EXIT.

- When a flag is set to YES, exits are not called.

- When a flag is set to NO, exits are not called.
- When a flag is set to EXIT, the exits are checked.

Specifying FORCE=YES on your AOCQRY call will force the exits to be called when the flag is set to ON or OFF. In this case a flag exit can turn an ON flag OFF, but it cannot turn an OFF flag ON.

Flag settings are determined by:

- The automation control file
- NOAUTO periods (the flag is OFF during a NOAUTO period)
- User-entered INGAUTO command

For example, if the following flag settings are entered:

Resource	Flag	Setting
DEFAULTS	AUTOMATION	ON
SUBSYSTEM	RESTART	OFF
JES2	AUTOMATION	Call Exit J2AUT
JES2	START	Call Exit J2STR
JES2	SHUTDOWN	Call Exits J2SD1 and J2SD2
JES2	RECOVERY	OFF

the effective flags for JES2 are:

Flag	Effective setting
AUTOMATION	Call Exit J2AUT
INITSTART	ON
START	Call Exit J2STR
RECOVERY	OFF
SHUTDOWN	Call Exits J2SD1 and J2SD2
RESTART	OFF

When SA z/OS checks the current value of any flag for the JES2 application, the process is as follows:

- AUTOMATION - Call Exit J2AUT
If OFF,
AUTOMATION flag is OFF
If ON,
AUTOMATION flag is ON
- INITSTART - Call Exit J2AUT
If OFF,
INITSTART flag is OFF
If ON,
INITSTART flag in ON
- START - Call Exit J2AUT
If OFF,
START flag is OFF
If ON,
Call Exit J2STR
If OFF,
START flag is OFF
If ON,
START flag is ON
- RECOVERY - The RECOVERY flag is OFF
- SHUTDOWN - Call Exit J2AUT
If OFF,
SHUTDOWN flag is OFF
If ON,
Call Exit J2SD1
If OFF,

Flag Exits

```
SHUTDOWN flag is OFF
If ON,
  Call Exit J2SD2
If OFF,
  SHUTDOWN flag is OFF
If ON,
  SHUTDOWN flag is ON
RESTART - The RESTART flag is OFF
```

Notes:

1. No exit is called for the Recovery and Restart flags. This is because the specific flags have been turned off. The Recovery flag is OFF at the application level. The Restart flag is OFF at the application defaults (SUBSYSTEM) level. The exits cannot change the state of these flags, so SA z/OS does not invoke them.
2. The J2STR and J2SD1 exits are called only if the J2AUT exits indicate that automation is allowed.
3. The J2SD2 exit is called only if the J2SD1 exits indicate that automation is allowed. The J2SD1 exit is called only if the J2AUT exit indicates that automation is allowed.

As this example shows, you should not assume that an exit is called every time SA z/OS needs to evaluate the flag that it is defined on. You *can* assume that an exit is called before SA z/OS decides that a given flag is ON and takes action on the basis of the flag setting. Additionally, you should think carefully about initiating processes from within flag exits as a later exit may give a return code which will indicate that the flag is turned OFF.

Parameters

Parameters are supplied in sequence, delimited by blanks.

Flag

This is the name of the flag that is being checked. Possible values are Automation, Initstart, Start, Recovery, Terminate or Restart.

Note: The Terminate flag is referred to as the Shutdown flag elsewhere.

Time Setting

Time Setting is a constant. It can be either:

- AUTO - automation is currently turned on.
- NOAUTO - automation is currently turned off by a NOAUTO period.

A value of NOAUTO is possible only if AOCQRY is called with FORCE=YES specified.

Note: This ensures that the exit is invoked, but it is not possible for an exit to override a NOAUTO period.

Resource Name

This is the name of the resource that the flag is being checked for. For minor resources it will contain the fully qualified minor resource name that the exit has been defined for. Given no definition for TSO.USER.MAG1 and an exit defined for TSO.USER, the resource name passed to the exit would be TSO.USER if a check was made for TSO.USER.MAG1.

This behavior is slightly different for exits that are defined for DEFAULTS or SUBSYSTEM. In this case the resource name passed is the name of the application that the flag is being evaluated for. Given no definition for TSO

AUTOMATION and an exit defined for SUBSYSTEM AUTOMATION, the exit is invoked with a resource name of TSO.

Resource Type

This is always SUBSYSTEM, regardless of the actual type of the resource.

Target Prefix

This is the TGPFX value with which AOCQRY was invoked. If TGPFX is not specified, the value SUB is passed.

Return Codes

0 Automation is allowed by the exit.

greater than 0

Automation is not allowed.

Attention: You should not return a return code of -5 as this will cause multiple CLIST abends (AOFRAEXI, AOFRSCHK, caller, and others) and may seriously disrupt automation. Symptoms of this are AOF760 messages for the SA z/OS CLIST that invoked the exit, for any CLIST that invoked the SA z/OS CLIST, to the initiating CLIST.

Notes:

1. Flag exits are always called through AOCQRY. This means that the TGLOBALS for the application have been primed and are available for use. Normally the set of globals are found in the SUB task globals, but if AOCQRY is called with TGPFX then they will be in a different set. You should use the TGPFX parameter that is passed to locate the globals.
2. AOCQRY can be invoked in a manner that will determine a flag value but not set up the globals. You should be careful if you write code which invokes AOCQRY in this way and you have exits which rely on the task globals being set up.
3. Your exit should not assume that AOCQRY has been called without TGPFX being specified. That is, do not assume that the SUB task globals refer to the resource it has been invoked for.
4. If an exit is invoked for a minor resource, the task globals are set for the major resource associated with that minor resource.
5. If an exit is invoked for a non-subsystem resource, most of the task globals will be meaningless.
6. If you call AOCQRY from inside your exit you must specify a TGPFX value. You cannot use SUB. The TGPFX value you specify should be different from the TGPFX parameter you were passed. You are responsible for ensuring the uniqueness of all TGPFXs if you nest AOCQRY exits. Since this can become quite complex, it is recommended you avoid nesting exits.
7. Do not code calls to ACFCMD, ACFREP, or CDEMATCH as these use the SUB task globals, which may not be set up for the application that you want to process.
8. Do not change any of the AOCQRY task globals.
9. Flag exits may be called frequently, so performance is important.
10. If AOCQRY is specified with FORCE and multiple exits are defined for a flag, the exits are called in order. If an exit indicates that the flag is OFF, subsequent exits will not be called.

Customization Dialog Exits

SA z/OS provides a series of user exits that can be invoked during certain phases while working with the customization dialog. They are:

- “User Exits for BUILD Processing”
- “User Exits for COPY Processing” on page 139
- “User Exits for DELETE Processing” on page 140
- “User Exits for CONVERT Processing” on page 140
- “User Exits for MIGRATION, RENAME, and IMPORT Functions” on page 141

“Invocation of Customization Dialog Exits” on page 141 provides information on how to activate the user exits.

User Exits for BUILD Processing

The following user exits are provided for the process of building the automation control file (BUILDF).

- INGEX10, which is called before the automation control file build function starts. This exit is only available when the build process is initiated from the customization dialogs.
- INGEX01, which is called before the automation control file build function starts. This exit is available when the build process is initiated from the customization dialogs, from a batch job submitted via the customization dialogs, or from a batch job submitted independently from the customization dialogs. When a BUILD mode of BATCH is selected in the customization dialogs, the JCL for the batch job is submitted and INGEX01 is called when the job begins execution and before the automation control file build function starts in batch.
- INGEX02, which is called after the automation control file build function (BUILDF) has ended. This exit is available when the BUILD process is initiated from the customization dialogs, from a batch job submitted through the customization dialogs, or from a batch job submitted independently from the customization dialogs.

The following parameters are passed to both INGEX01 and INGEX02 exits, separated by commas:

- Parm1 = PolicyDB name
- Parm2 = Enterprise name
- Parm3 = BUILD output data set
- Parm4 = entry type (or blank)
- Parm5 = entry name (or blank)
- Parm6 = BUILD type (MOD/ALL)
- Parm7 = BUILD mode (ONLINE/BATCH)
- Parm8 = Configuration (0=NORMAL/1=ALTERNATE)
- Parm9 = Sysplex name (or blank)
- Parm10 = Build option (1,2, or 3)
- Parm11 = return code (for INGEX02 *only*)

If user exit INGEX10 produces return code RC = 0, BUILDF processing continues. If a return code RC > 0 is produced, an error message is returned and the BUILDF processing terminates.

If user exit INGEX10 ends with return code RC > 0, user exits INGEX01 and INGEX02 are not called. Processing terminates.

If user exit INGEX10 ends with return code RC > 0 and a BUILD mode of BATCH was selected in the customization dialogs, no JCL is submitted to run the build in batch (because BUILDF does not start). Processing terminates.

If user exit INGEX01 produces return code RC = 0, BUILD processing continues. If a return code RC > 0 is produced, an error message is returned. BUILDF processing terminates. If the build is run in batch mode, and a return code RC > 0 is produced, the job finishes with a return code RC 08.

If user exit INGEX01 ended with return code RC > 0, user exit INGEX02 are not (because BUILDF does not start). Processing terminates.

User exit INGEX02 is always called when the BUILD process has started, irrespective of whether it has completed or not.

If user exit INGEX02 produces a return code RC > 0, an error message is displayed. If the build is run in batch mode, and a return code RC > 0 is produced, the job completes with a return code RC 04. If a severe build error occurred, the job completes with a return code RC 20.

The return codes and their meaning are as follows:

- 0 Successful
- 4 Build with minor errors
- 12 No build (data is inconsistent)
- 20 No build (severe errors)

User Exits for COPY Processing

Two user exits are implemented for the COPY processing.

1. INGEX03, which is called before the COPY function starts. The following parameters are passed:
 - Entry name of the entry to be copied to (target)
 - Entry name of the entry to be copied from (source)
 - Entry type (e.g. APL)
2. INGEX04, which is called after the COPY function has ended. The following parameters are passed:
 - Entry name of the entry to be copied to (target)
 - Entry name of the entry to be copied from (source)
 - Entry type (e.g. APL)
 - Indicator whether the COPY process was successful or not (S=successful, U=unsuccessful)

If user exit INGEX03 produces return code RC = 0, the COPY processing continues. If a return code RC > 0 is produced, an error message is displayed, the COPY function will not start, and processing terminates.

If user exit INGEX03 ended with return code RC > 0, the user exit INGEX04 will not be called as the COPY processing will terminate.

Customization Dialog Exits

User exit INGEX04 is always called once the COPY function has started. The information about the success or failure of the COPY function is passed as a parameter.

If user exit INGEX04 produces a return code RC > 0, an error message is displayed.

User Exits for DELETE Processing

Two user exits are implemented for the DELETE processing.

1. INGEX05, which is called before the DELETE process starts. The following parameters are passed:
 - Entry name of the entry to be deleted
 - Entry type (e.g. APL)
2. INGEX06, which is called after the DELETE process has ended. The following parameters are passed:
 - Entry name of the entry to be deleted
 - Entry type (e.g. APL)
 - Indicator whether the DELETE process was successful or not (S=successful, U=unsuccessful)

If user exit INGEX05 produces return code RC = 0, the DELETE processing continues. If a return code RC > 0 is produced, an error message is displayed, the DELETE function will not start and the processing terminates.

If user exit INGEX05 ended with a return code RC > 0, user exit INGEX06 will not be called as the DELETE processing will terminate.

User exit INGEX06 will always be called once the DELETE function has started. The information about the success or failure of the DELETE function will be passed as a parameter.

If user exit INGEX06 produces a return code RC > 0, an error message will be displayed.

User Exits for CONVERT Processing

Two user exits are implemented for the CONVERT processing.

1. INGEX07, which is called before the CONVERT process starts. No parameters are passed.
2. INGEX08, which is called after the CONVERT process has ended. No parameters are passed.

If user exit INGEX07 produces return code RC = 0, the CONVERT processing continues. If a return code RC > 0 is produced, an error message is displayed, the CONVERT function will not start and the processing terminates.

If user exit INGEX07 ended with a return code RC > 0, user exit INGEX08 will not be called as the CONVERT processing will terminate.

User exit INGEX08 will always be called once the CONVERT function has started.

If user exit INGEX08 produces a return code RC > 0, an error message will be displayed.

User Exits for MIGRATION, RENAME, and IMPORT Functions

The following user exits are provided for the migration, rename, and import functions.

1. INGEX09—called when log data set is switched, usually because the current data set is full. One parameter is passed:
 - Name of current log data set, for example, the data set that went out of space
2. INGEX12—called after the MIGRATION function has ended. The following parameters are passed:
 - MIGRATE mode (ONLINE / BATCH)
 - Target system entry name
 - Source data set name with member (enclosed in quotes)
3. INGEX14—called after an entry has been deleted while the MIGRATION function is running. The following parameters are passed:
 - Entry Name
 - Entry Type
4. INGEX15—called before an entry is renamed. The following parameters are passed:
 - Entry Name
 - Entry Type
5. INGEX16—called after an entry has been renamed. The following parameters are passed:
 - Entry Type
 - Old Entry Name
 - New Entry Name
6. INGEX17—called during the IMPORT function, when reading data from the source policy database. One parameter is passed:
 - Name of copy data work table, this table contains the entry types and entry names of the data to be copied
7. INGEX18—called after the IMPORT function has ended. One parameter is passed:
 - Indicator whether the IMPORT process was successful or not (S=successful/U=unsuccessful)
8. INGEX20—called after the links have been changed. No parameters are passed.
9. INGEX21—called before the PDB report is invoked. No parameters are passed.

Invocation of Customization Dialog Exits

The user exits are part of the SA z/OS product. Therefore they are supplied in the same data set as all other ISPF REXX modules (part of SINGIREX). The supplied samples for ACF BUILD, DELETE, and COPY processing just do a 'RETURN' with return code RC=0.

You have two possibilities to apply your user modifications:

1. Edit the user exit(s) in the supplied library. Your changes will not have any consequences on the code of the SA z/OS, product. These exits will not be serviced (via PTF) by IBM as they do not include any code at the time of product delivery.

Customization Dialog Exits

2. Supply the modified user exit in a private data set. Then you have to concatenate your private data set to your SYSEXEC library chain. As INGDLG supports multiple data set names specified for ddname SYSEXEC, this can be done in the following way:

```
INGDLG SELECT(ADMIN) ALLOCATE(YES) HLQ(SYS1)
        SYSEXEC(usr.private.dsn SYS1.SINGIREX)
```

This example assumes that the high level qualifier of the data sets where the IBM supplied parts exist is SYS1.

If you specify the SYSEXEC parameter in the INGDLG call, you need to specify the IBM supplied library explicitly with its **fully qualified** data set name.

Command Exits

These exits can be called during the processing of certain commands.

AOFEXC00

The AOFEXC00 exit routine will be called if the selection *L* has been entered in the AOFPOPER panel. No parameters are passed to the routine. The purpose of this routine is to act as the starting point for installation provided local functions.

AOFEXC01

If this exit is defined, it will be invoked during INGREQ processing before "Precheck" and "Verification" processing.

The exit allows you to modify the passed parameters. The following INGREQ parameters can be modified:

- APPLPARMS
- CMT
- EXPIRE
- INTERRUPT
- OVERRIDE
- PRECHECK
- PRI
- REMOVE
- RESTART
- SCOPE
- SOURCE
- TIMEOUT
- TYPE
- VERIFY

Modified parameters are specified by their keyword/value pair and returned to the INGREQ command by sending a message (single or multiline message) to the console. For example: PRI=HIGH REMOVE=SYSGONE

Parameters: The following parameters are passed from the INGREQ command and are positional:

Request

The request type.

- SCOPE**
The scope of the command.
- OVERRIDE**
The override specification.
- RESTART**
The restart specification.
- TYPE** Contains the start/stop type.
- PRIORITY**
The priority given to the request.
- SOURCE**
Identifies the originator of the request.
- REMOVE**
Indicates the condition under which the request is automatically removed.
- TO_INTERVAL**
Specifies the timeout interval.
- TO_OPTION**
Specifies the timeout option.
- EXPIRATION**
Specifies the date and time when the request is removed.
- APPL_PARMS**
Specifies the application parameters. It is enclosed in quotation marks.
- COMMENT**
The comment — given by the operator — associated with the request.
- INTERRUPT**
Specifies the interrupt. It is enclosed in quotation marks.
- PRECHECK**
Specifies whether or not the startup or shutdown process should pre-validate any actions before actually performing them.
- VERIFY**
Specifies whether the startup or shutdown process should be verified.

Note: The parameters are separated by a comma.

Return Codes:

- 0** OK - continue.
- 1** Error - reject command.

The list of resources that are involved in the INGREQ command is passed to the exit by using the default SAFE. Each resource is described by its location and name. The format of the location is:

sysplex_name.domain_ID.system_name\sa_version\xcf_groupname

Specifying the xcf_groupname is optional.

The format of the resource name is:

name/type/system_name

For example:

Command Exits

```
AOCPLEX.IPUFA.SA1D\V2R1M0 RMFGAT/APL/SA1D
```

The user exit is called in a PIPE. If the user exit returns a bad RC and additional data is written to the console, this data is shown in a message panel. If no additional data is passed in the exit, then message AOF227I is issued.

A typical example for modifying the priority of an INGREQ REQ=STOP request is for the sysname/SYG/sysname resource (SHUTSYS ALL). Here, the priority can be forced to FORCE by returning the PRI=FORCE string and setting the return code to zero.

AOFEXC02

If this exit routine is defined, it is invoked during INGSCHED processing before the schedule override file is updated. The parameters are positional and separated by a comma. The following parameters are passed to the exit:

Parameters:

user ID

is the user ID making the update or delete

resource

The resource is described by two words. The first word is the location of the resource. The second word is the resource name. The format of the location is:

```
sysplex_name.domain_ID.system_name\sa_version
```

The format of the resource name is:

```
name/type/system_name
```

For example:

```
AOCPLEX.IPUFA.AOC8\V2R1M0 TSO/APL/AOC8
```

action can be UPD or DEL

date specifies the date in the format YYYYMMDD

UP priority

specifies the priority. It can be L or H

UP time slots

specifies the time slots when the application is up. The format is hhmm-hhmm... hhmm-hhmm

DOWN priority

specifies the priority.

DOWN

specifies the time slots when the application is down. The format is hhmm-hhmm... hhmm-hhmm

Return Codes:

0 OK - continue

1 error - reject command

The user exit is called in a PIPE. If the user exit returns a bad return code and additional data is written to the console, this data is shown in a message panel. If no additional data is passed in the exit, then message AOF227 is issued.

The format of the location is:

```
sysplex_name.domain_ID.system_name\sa_version\xcf_groupname
```

Specifying the xcf_groupname is optional.

AOFEXC03

If this exit routine is defined, it is invoked by the DISPINFO command slave to retrieve user-supplied information about the subsystem. The input for the routine is the subsystem name. The data returned by the exit is shown as part of the DISPINFO output.

Note: Certain special symbols are interpreted as panel attribute symbols. For more information about attribute symbols, refer to the *NetView Customization Guide*. The DISPINFO panel uses the default attribute set 1. This allows the exit to color the data to be displayed. To display a particular symbol, place a double quotation mark (") in front of the character.

Parameters:

subsystem name

Is the name of the subsystem.

Return Codes:

- 0 OK.
- 1 An error occurred.

AOFEXC04

If this exit routine is defined, the command code U is supported for the DISPSTAT and INGLIST commands. The input for the AOFEXC04 exit is the resource name (subsystem name for DISPSTAT) and the location of the resource. The location is either the system name if the resource resides on a system member of the local sysplex, or the domain ID if the resource resides on a system which is outside of the local sysplex. The parameters are separated by a comma.

Parameters:

subsystem name

Is the location of the subsystem. It is either the system name if the subsystem resides on a system member of the local sysplex, or the domain ID if the subsystem resides on a system which is outside of the local sysplex.

AOFEXC05

This exist is called on entry of the INGLIST command. The exit allows you to modify the input parameters. The modified input parameters are returned to the INGLIST command by sending a message (single or multiline) to the console.

Example: OBSERVED=* DESIRED=*

AOFEXC06

This exist is called on entry of the INGSET command. The exit allows you to perform authorization checking of the resources for the INGSET command. Refer to the sample exit for details of the parameters that are passed to the exit and the return codes.

Command Exits

AOFEXC07

This exist is called on entry of the INGIMS command. The exit allows you to perform authorization checking of the IMS subsystem that is the subject of the INGIMS command. Refer to the sample exit for details of the parameters that are passed to the exit and the return codes.

AOFEXC08

This exit is called on entry of the INGVOTE command. The exit allows you to perform authorization checking of the resources for the INGVOTE command. Refer to the sample exit for details of the parameters that are passed to the exit and the return codes.

AOFEXC09

This exit is called on entry of the SETSTATE command. The exit allows you to perform authorization checking of the resources for the SETSTATE command. Refer to the sample exit for details of the parameters that are passed to the exit and the return codes.

AOFEXC10

This exit is called on entry of the INGEVENT command. The exit allows you to perform authorization checking of the resources for the INGEVENT command. Refer to the sample exit for details of the parameters that are passed to the exit and the return codes.

AOFEXC11

This exit is called on entry of the INGCICS command. The exit allows you to perform authorization checking of the resources for the INGCICS command. Refer to the sample exit for details of the parameters that are passed to the exit and the return codes.

AOFEXC12

This exit is called on entry to the command slave (EVJRVCMD) for TWS/OPC command server (EVJRVCMD0). The exit allows you to perform authorization checking of the commands scheduled via the TWS/OPC batch interface (EVJRYCMD) against the user ID of the batch job requesting the command.

Refer to the sample exit for details of the parameters passed to the exit and the return codes.

AOFEXC13

This exit is called on entry to the INGGROUP command. The exit allows you to perform authorization checking of the user ID that issues the command.

Refer to the sample exit for details of the parameters passed to the exit and the return codes.

Pseudo-Exits

This section discusses a number of places where SA z/OS either makes special use of a flag exit or has a function with certain, exit-like, qualities.

Automation Control File Reload Permission Exit

When an operator asks SA z/OS to reload the automation control file, SA z/OS checks the automation flag of minor resource MVSESA.RELOAD.CONFIRM. If the flag is set to NO, the automation control file reload is not allowed. If the flag is set to YES, the task global AOFCONFIRM is checked. If AOFCONFIRM has been set to a non-null value, the user is prompted to confirm that they want the automation control file to be reloaded.

Notes:

1. Note that an exit can be associated with the automation flag for this resource.
2. An automation control file cannot be loaded if the automation flag for major resource MVSESA is set to 'N'. If the automation flag for minor resource MVSESA.RELOAD.CONFIRM is set to 'Y', reload of the ACF is permitted.

Automation Control File Reload Action Exit

After the automation control file reload permission exit is checked, when SA z/OS is committed to reloading the automation control file, it will check the automation flag for minor resource MVSESA.RELOAD.ACTION. The actual setting of this flag (ON or OFF) is ignored, but any exits defined for it are invoked. All exits should return a return code of 0.

Subsystem Up at Initialization Commands

Using the customization dialog you can specify commands that are run if SA z/OS finishes resynchronizing statuses and an application is found to be up. These commands can be useful for synchronizing local automation that has been built on top of SA z/OS.

Testing Exits

Exits should be well tested with a variety of different input parameters before they are put into production. For exits that need AOCQRY task globals, you can call AOCQRY to set up the globals without evaluating the flag exits, and then invoke the exit on its own for testing purposes. This method saves the overhead of calling AOCQRY every time you run the exit.

Attention!

If you have a syntax error or a no-value-condition in your exit it can cause parts of SA z/OS to abend, resulting in severe disruption of your automation.

Testing Exits

Chapter 12. Automation Routines

System Automation for z/OS provides automation routines that enable automatic processing of z/OS components, data sets and job scheduling systems as well as automation procedures that are useful tools in the automation processing context. By using these prefabricated automation procedures you can save the time to develop your own procedures to handle the processing in corresponding situations.

In particular these automation routines provide solutions for:

- LOGREC data set processing
- SMF data set processing
- SYSLOG processing
- SVC dump processing
- AMRF buffer shortage automation
- JES2 spool recovery
- JES2 shutdown
- JES3 dump processing
- JES3 start option automation
- JES3 monitoring
- Deletion of processed WTORs from SDF
- TWS Automation PPI and gateway failures
- TWS Automation operation and job errors
- CICS-related processing and recovery
- IMS-related processing and recovery

The solutions for automatic processing of these situations include definitions in the automation configuration files and automation procedures.

It is common to all these provided solutions that the automation procedures first determine whether automation is allowed by checking the corresponding automation flags with common routine AOCQRY. See *IBM Tivoli System Automation for z/OS Defining Automation Policy* for further information concerning types and settings of automation flags. Use the DISPFLGS command to display or temporarily change the actual settings of the automation flags.

Some of the automation routines respond to messages by issuing commands from the ACF. Most of these automation routines keep track of the reception of these messages and compare the frequency of the incoming messages with predefined thresholds of infrequent, frequent and critical level. If such a defined threshold is exceeded, it is taken as option for selecting the appropriate commands according to the first field in the command entry of policy item MESSAGES/USER DATA of the ACF. If no threshold is exceeded the commands to selection option ALWAYS are issued. Refer to the section "How SA z/OS Uses Error Thresholds" in *IBM Tivoli System Automation for z/OS Defining Automation Policy* for further information on setting up thresholds.

This chapter describes the details of the automation functions that are provided with SA z/OS.

LOGREC Data Set Processing

The logrec recovery function responds to system messages saying that the logrec data set is full or nearly full by issuing predefined commands to dump and clear the logrec data sets. While the recovery function is in progress, it prevents the automation processing being started a second time.

The logrec recovery function includes the following items:

- Automation routines AOFRSA01 and AOFRSA02
- Automation table entries for system messages IFB040I, IFB060E, IFB080E, IFB081I, and IFC001I
- Error threshold definitions for MVS component LOGREC
- Command specification in automation policy item MESSAGES/USER DATA of the entry/type-pair MVSESA/LOGREC in the ACF

AOFRSA01

Purpose

You can use the AOFRSA01 automation routine to respond to logrec data set nearly full or full messages from your system by issuing commands from the ACF to dump and clear the contents of the logrec data set.

AOFRSA01 keeps track of the incoming logrec data set messages and compares their occurrence with predefined thresholds of infrequent, frequent and critical level. An exceeded threshold is taken as the option to select the appropriate commands according to the first field in the command entry of the entry/type-pair MVSESA/LOGREC in the ACF. If no threshold is exceeded the commands to selection option ALWAYS are issued.

AOFRSA01 is expected to be called from the NetView automation table.

Format

▶▶—AOFRSA01—▶▶

Restrictions

- Actions are only taken in AOFRSA01 if the recovery automation flag for LOGREC is on.
- Processing in AOFRSA01 is only done if it is called from NetView automation table by one of the expected messages IFB040I, IFB060E, IFB080E or IFB081I.
- The commands from automation policy to dump and clear the LOGREC data set are only issued if a LOGREC recovery function is not already in progress.

Usage

Automation routine AOFRSA01 is intended to respond to the following messages:

```
IFB040I SYS1.LOGREC AREA IS FULL, hh.mm.ss  
IFB060E SYS1.LOGREC NEAR FULL  
IFB080E LOGREC DATA SET NEAR FULL, DSN=dsname  
IFB081I LOGREC DATA SET IS FULL,hh.mm.ss, DSN=dsn
```

The commands to issue are selected from the command entry of the entry/type-pair MVSESA/LOGREC in the ACF.

If no threshold is reached when one of the expected messages arrive, all commands to entries with no selection option and to selection option ALWAYS are selected. If the threshold at level infrequent is exceeded, all commands to entries with no selection specification option and to selection option INFR are selected. In the same way a level of frequent corresponds to selection option FREQ and a level of critical corresponds to selection option CRIT.

Make sure that the automation routine AOFRSA02 is issued by message IFC001I from the NetView automation table, to indicate the completion of the LOGREC recovery function.

Flags

&EHKVAR1

When defining the commands in the ACF to dump and clear the contents of the LOGREC data set, the variable &EHKVAR1 can be used for the name of the LOGREC data set. This variable will be substituted with the complete data set name of the LOGREC data set name.

AOFRSA02

Purpose

You can use the AOFRSA02 automation routine to respond to the initialization message of the LOGREC data set to reset the flag, which indicates that the LOGREC recovery function is in progress

AOFRSA02 is expected to be called from the NetView automation table.

Format

▶▶—AOFRSA02—————▶▶

Restrictions

- Actions are only taken in AOFRSA02 if the recovery automation flag for LOGREC is on.
- Processing in AOFRSA02 is only done if it is called from NetView automation table.

Usage

Automation routine AOFRSA02 is intended to respond to the message:

```
IFC001I D=devtyp N=x F=track1* L=track2* S=recd** DIP COMPLETE
```

which is produced during the initialization of the LOGREC data set and describes the limits of the data set.

The flag, indicating that the LOGREC recovery function is in progress, is used by automation routine AOFRSA01.

Flags

This example shows a sample scenario to the LOGREC data set processing:

The following entries in the NetView automation table are created by Easy Message Management to issue the appropriate automation routine when one of the expected messages arrives:

LOGREC Data Set Processing

```

IF MSGID = 'IFB040I' | MSGID = 'IFB060E' |
  MSGID = 'IFB080I' | MSGID = 'IFB081I'
THEN
EXEC(CMD('AOFRSA01')ROUTE(ONE %AOFOPRECOPER%));

IF MSGID = 'IFC001I'
THEN
EXEC(CMD('AOFRSA02')ROUTE(ONE %AOFOPRECOPER%));

```

COMMANDS		HELP			

Thresholds Definition					
Command ==> _____					
Entry Type :	MVS Component	PolicyDB Name :	DATABASE_NAME		
Entry Name :	MVS_COMPONENTS	Enterprise Name :	YOUR_ENTERPRISE		
Resource :	LOGREC				
Specify the number of times an event must occur to define a particular level.					
----- Threshold Levels -----					
Critical		Frequent		Infrequent	
Number	Interval	Number	Interval	Number	Interval
	(hh:mm)		(hh:mm)		(hh:mm)
<u>3</u>	<u>00:05</u>	<u>3</u>	<u>00:30</u>	<u>3</u>	<u>24:00</u>

Figure 19. Three Threshold Levels Are Defined in the Automation Policy for MVS Component LOGREC

Pass/Selection Automated Function/'*'	Command Text
	MVS S CLRLOG,DSN=&EHKVAR1_____

Figure 20. Automation Policy Item MESSAGES/USER DATA to Entry/Type-Pair MVSESA/LOGREC Contains One Command without Selection Value

Assume that the following message arrives the first time for one day:

```
IFB080E LOGREC DATA SET NEAR FULL, DSN=SYS1.AOC1.MAN3
```

Since none of the defined thresholds is exceeded, the automation routine AOFRSA01 searches for defined commands without selection option and to selection option ALWAYS to be issued. With the control file shown above the command MVS S CLRLOG,DSN=&EHKVAR1 is selected. Before issuing this command, the variable &EHKVAR1 is substituted by the data set name of the received message resulting in MVS S CLRLOG,DSN=SYS1.AOC1.MAN3.

If message IFB080E continues to arrive and the occurrence of the expected messages thus exceeds the infrequent, frequent or critical threshold, the automation routine AOFRSA01 searches for defined commands without selection option and to selection option INFR, FREQ or CRIT to be issued.

Because no command is defined with any selection option, only the defined command with no selection option is selected and issued, as in the previous case.

Message AOF589I, AOF588I or AOF587I is issued in cases, where an infrequent, frequent or critical threshold has been exceeded. These messages indicate that an infrequent, frequent or critical threshold action has been processed.

If the recovery processing for a LOGREC data set is still in progress when an expected error message arrives, the following message is issued:

```
AOF585I 15:45 : RECOVERY OF LOGREC IS ALREADY IN PROGRESS -
```

The recovery process is considered to be finished, when message IFC001I arrives telling that the LOGREC data set has been initialized.

SMF Data Set Processing

The provided SMF recovery function responds to system messages telling that the SMF data set is full or has been switched. Predefined commands from the ACF are selected to dump and clear the contents of the SMF data set. The commands to be selected can be defined depending on the occurrence of the incoming messages. The SMF recovery function includes the following items:

- Automation routine AOFRSA03
- Automation table entries for system messages IEE362A, IEE362I, IEE391A and IEE392I
- Error threshold definitions for MVS component SMFDUMP
- Command specification in automation policy item MESSAGES/USER DATA to entry/type-pair MVSESA/SMFDUMP of the ACF

AOFRSA03

Purpose

You can use the AOFRSA03 automation routine to respond to SMF data set full or switch messages from your system. AOFRSA03 issues commands from the ACF to dump and clear the contents of the SMF data set.

AOFRSA03 keeps track of the incoming SMF data set messages and compares their occurrence with predefined thresholds at level infrequent, frequent and critical. An exceeded threshold is taken as option for selecting the appropriate commands according to the first field in the command entry of the entry/type-pair MVSESA/SMFDUMP in the ACF. If no threshold is exceeded the commands to selection option ALWAYS are issued.

AOFRSA03 is expected to be called from the NetView automation table.

Format

▶▶—AOFRSA03—▶▶

Restrictions

- Actions in AOFRSA03 are only taken if the recovery automation flag for SMFDUMP is on.
- Processing in AOFRSA03 is only done if it is called from NetView automation table by one of the expected messages IEE362A, IEE262I, IEE391A or IEE392I.

Usage

Automation routine AOFRSA03 is intended to respond to the following messages:

```
IEE362A SMF ENTER DUMP FOR SYS1.MANn ON ser
IEE362I SMF ENTER DUMP FOR SYS1.MANn ON ser
IEE391A SMF ENTER DUMP FOR DATA SET ON VOLSER ser, DSN=dsname
IEE392I SMF ENTER DUMP FOR DATA SET ON VOLSER ser, DSN=dsname
```

SMF Data Set Processing

which indicates that the SMF data set is ready to be dumped.

Flags

&EHKVAR1

When defining the commands in the ACF to dump and clear the contents of the SMF data set, the variable &EHKVAR1 can be used for the name of the SMF data set. This variable will be substituted with the complete data set name by AOFRSA03 when message IEE391A or IEE392I is received. In case of message IEE362A or IEE362I this variable will be substituted with MANn, the second part of the SMF data set name.

&EHKVAR2

When defining the commands in the ACF to dump and clear the contents of the SMF data set, the variable &EHKVAR2 can be used for the name of the SMF data set. This variable will be substituted with the complete data set name by AOFRSA03 when message IEE391A, IEE392I, IEE362A, or IEE362I is received.

Flags

This example shows a sample scenario to the SMF data set processing:

The following entries in the NetView automation table are created by Easy Message Management to issue the appropriate automation routine when one of the expected messages arrives:

```
IF (MSGID = 'IEE362I' | MSGID = 'IEE362A' |
    MSGID = 'IEE391A' | MSGID = 'IEE392I')
THEN
EXEC(CMD('AOFRSA03')ROUTE(ONE %AOFOPRECOPER%));
```

COMMANDS		HELP	

Thresholds Definition			
Command ==> _____			
Entry Type :	MVS Component	PolicyDB Name :	DATABASE_NAME
Entry Name :	MVS_COMPONENTS	Enterprise Name :	YOUR_ENTERPRISE
Resource :	SMFDUMP		
Specify the number of times an event must occur to define a particular level.			
----- Threshold Levels -----			
Critical	Frequent	Infrequent	
Number	Interval	Number	Interval
	(hh:mm)	(hh:mm)	(hh:mm)
<u>3</u>	<u>00:05</u>	<u>3</u>	<u>00:30</u>
		<u>3</u>	<u>24:00</u>

Figure 21. Three Threshold Levels Are Defined in the Automation Policy for MVS Component SMFDUMP

Pass/Selection Automated Function/'*'
Command Text
MVS S SMFDUMP1,DA='&EHKVAR1'' _____

Figure 22. Automation Policy Item MESSAGES/USER DATA to Entry/Type-Pair MVSESA/SMFDUMP Contains One Command without Selection Value

Assume that the following message arrives the first time for one day:

IEE391A SMF ENTER DUMP FOR DATASET ON VOLSER 123, DSN=SYS1.AOC1.MAN3

Since none of the defined thresholds is exceeded, the automation routine AOFRSA01 searches for defined commands without selection option and to selection option ALWAYS to be issued. With the control file shown above the command `MVS S SMFDUMP1,DA='&EHKVAR1'` is selected. Before issuing this command, the variable `&EHKVAR1` is substituted by the data set name of the received message resulting in `MVS S SMFDUMP1,DA='SYS1.AOC1.MAN3'`.

If message IEE391A continues to arrive and the occurrence of the expected messages thus exceeds the infrequent, frequent or critical threshold, the automation routine AOFRSA03 searches for defined commands without selection option and to selection option INFR, FREQ or CRIT to be issued.

Because no command is defined with any selection option, only the defined command with no selection option is selected and issued, as in the previous case.

Message AOF589I, AOF588I or AOF587I is issued in cases, where an infrequent, frequent or critical threshold has been exceeded. These messages indicate that an infrequent, frequent or critical threshold action has been processed.

SYSLOG Processing

The provided syslog function responds to syslog being queued messages by starting an external writer to save the syslog that was queued. The commands to be selected can be defined depending on the occurrence of the incoming messages.

The provided syslog function includes the following items:

- Automation routine AOFRSA08
- Automation table entry for system message IEE043I
- Error threshold definitions for MVS component SYSLOG
- Command specification in automation policy item MESSAGES/USER DATA to entry/type-pair MVSESA/SYSLOG of the ACF

AOFRSA08

Purpose

You can use the AOFRSA08 automation routine to respond to syslog being queued messages by starting an external writer to save the syslog that was queued.

AOFRSA08 keeps track of the incoming syslog queued messages and compares their occurrence with predefined thresholds at level infrequent, frequent and critical. An exceeded threshold is taken as option for selecting the appropriate commands according to the first field in the command entry of the entry/type-pair MVSESA/SYSLOG in the ACF. If no threshold is exceeded the commands to selection option ALWAYS are issued.

AOFRSA08 is expected to be called from the NetView automation table.

Format

▶▶—AOFRSA08—▶▶

Restrictions

- Processing in AOFRSA08 is only done if it is called from NetView automation table by the expected message IEE043I.
- Actions are only taken in AOFRSA08 if the recovery automation flag for SYSLOG is on and if the status of JES is UP or HALTED.

Usage

Automation routine AOFRSA08 is intended to respond to the message:

```
IEE043I A SYSTEM LOG DATA SET HAS BEEN QUEUED TO SYSOUT CLASS class
```

which indicates that the system closed the system log (SYSLOG) data set and queued the data set to a SYSOUT class.

The commands to issue are selected from the command entry of the entry/type-pair MVSESA/SYSLOG in the ACF.

If no threshold is reached when one of the expected messages arrive, all commands to entries with no selection option and to selection option ALWAYS are selected. If the threshold at level infrequent is exceeded, all commands to entries with no selection specification option and to selection option INFR are selected. In the same way a level of frequent corresponds to selection option FREQ and a level of critical corresponds to selection option CRIT.

Flags

This example shows a sample scenario to the SYSLOG processing:

The following entry in the NetView automation table is created by Easy Message Management to issue AOFRSA08 as response to incoming message IEE043I:

```
IF MSGID = 'IEE043I'
THEN
EXEC(CMD('AOFRSA08')ROUTE(ONE %AOFOPRECOPE%));
```

COMMANDS		HELP			

Thresholds Definition					
Command ==> _____					
Entry Type :	MVS Component	PolicyDB Name :	DATABASE_NAME		
Entry Name :	MVS_COMPONENTS	Enterprise Name :	YOUR_ENTERPRISE		
Resource :	SYSLOG				
Specify the number of times an event must occur to define a particular level.					
----- Threshold Levels -----					
Critical		Frequent		Infrequent	
Number	Interval	Number	Interval	Number	Interval
	(hh:mm)		(hh:mm)		(hh:mm)
<u>3</u>	<u>00:05</u>	<u>3</u>	<u>00:30</u>	<u>3</u>	<u>24:00</u>

Figure 23. Three Threshold Levels Are Defined in the Automation Policy for MVS Component SYSLOG

```

Pass/Selection Automated Function/ '*'
Command Text
-----
MVS S SAVELOG

```

Figure 24. Automation Policy Item MESSAGES/USER DATA to Entry/Type-Pair MVSESA/SYSLOG Contains One Command without Selection Value

Assume that the following message arrives the first time for one day:

```
EE043I A SYSTEM LOG DATA SET HAS BEEN QUEUED TO SYSOUT CLASS A
```

Since none of the defined thresholds is exceeded, the automation routine AOFRSA08 searches for defined commands without selection option and to selection option ALWAYS to be issued. With the control file shown above the command MVS S SAVELOG is selected.

If message IEE043I continues to arrive and the occurrence of the expected messages thus exceeds the infrequent, frequent or critical threshold, the automation routine AOFRSA08 searches for defined commands without selection option and to selection option INFR, FREQ or CRIT to be issued.

Because no command is defined with any selection option, only the defined command with no selection option is selected and issued, as in the previous case.

Message AOF589I, AOF588I or AOF587I is issued in cases, where an infrequent, frequent or critical threshold has been exceeded. These messages indicate that an infrequent, frequent or critical threshold action has been processed.

SVC Dump Processing

The provided SVC dump processing function responds to an SVC dump taken message by issuing predefined commands from the ACF to handle the dump. The commands to be selected can be defined depending on the occurrence of the incoming messages.

The provided SVC dump processing function includes the following items:

- Automation routine AOFRSA0C
- Automation table entries for system messages IEA611I and IEA911E
- Error threshold definitions for MVS component MVSDUMP
- Command specification in automation policy item MESSAGES/USER DATA to entry/type-pair MVSESA/MVSDUMP, MVSESA/MVSDUMPTAKEN and MVSESA/MVSDUMPPRESET of the ACF

AOFRSA0C

Purpose

You can use the AOFRSA0C automation routine to respond to a SVC dump taken to a dump data set message by issuing commands from the ACF to format the dump, to clear the dump data sets or to prevent further dumping. The commands to issue are taken from the entry/type-pair MVSESA/MVSDUMP and MVSESA/MVSDUMPTAKEN and selected according to the frequency of the incoming messages and the thresholds defined in the automation policies. The first field in the command entry gives detailed criteria to select the appropriate commands from the ACF.

SVC Dump Processing

AOFRSA0C is expected to be called from the NetView automation table.

Format

▶▶—AOFRSA0C—▶▶

Restrictions

- Actions in AOFRSA0C are only taken if the recovery automation flag for MVSDUMP is on.
- Processing in AOFRSA0C is only done if it is called from NetView automation table by one of the expected messages IEA611I or IEA911E.

Usage

Automation routine AOFRSA0C is intended to respond to the messages:

```
IEA611I {COMPLETE|PARTIAL} DUMP ON dsname  
DUMPID=dumpid REQUESTED BY JOB (jobname)  
FOR ASIDS(id,id,...)  
...
```

```
IEA911E {COMPLETE|PARTIAL} DUMP ON SYS1.DUMPnn  
DUMPID=dumpid REQUESTED BY JOB (jobname)  
FOR ASIDS(id,id,...)  
...
```

which indicates that the system wrote a complete or partial SVC dump to an automatically allocated or pre-allocated dump data set on a direct access storage device or a tape volume.

AOFRSA0C keeps track on the reception of these messages and compares the frequency of the incoming messages with predefined thresholds of infrequent, frequent and critical level, where the thresholds to MVS component MVSDUMP are considered. The commands to issue are selected according to the frequency of the incoming messages.

If no threshold is reached, all commands to entries with no selection option and to selection option ALWAYS are selected. If the threshold at level infrequent is exceeded, all commands to entries with no selection option and to selection option INFR are selected. In the same way a level of frequent corresponds to selection option FREQ and a level of critical corresponds to selection option CRIT.

The commands to issue are taken from entry/type-pair MVSESA/MVSDUMP of the ACF with respect to the frequency of the incoming of these messages.

If AOFRSA0C has been triggered on receipt of message IEA911E, additionally all commands from entry/type-pair MVSESA/MVSDUMPTAKEN of the ACF are selected and issued, as long as the critical threshold is not exceeded.

After dump processing has been done, AOFRSA0C further monitors the frequency of messages IEF611I and IEF911E in intervals of 15 minutes. As soon as the frequency falls below the infrequent threshold, all commands of entry/type-pair MVSESA/MVSDUMPRESET are issued.

Flags

When defining the commands in the ACF to handle the SVC dump data set, the variables &EHKVAR1 to &EHKVAR6 can be used to be substituted by variable

contents of message IEA611I or IEA911E. The variables &EHKVAR1 to &EHKVAR6 are not available in command entries of type MVSDUMPRESSET. These variables will be substituted as follows:

&EHKVAR1

dsname of IEA611I or suffix of SYS1.DUMPnn in IEA911E

&EHKVAR2

data set name

&EHKVAR3

dumpid

&EHKVAR4

jobname

&EHKVAR5

id of address space

&EHKVAR6

dump type (PARTIAL or COMPLETE)

Flags

This example shows the use of automation routine AOFRSA0C in a sample context:

An entry in the NetView automation table is used to issue AOFRSA0C when one of the expected messages arrives:

```
IF MSGID = 'IEA611I' | MSGID = 'IEA911E'
THEN
EXEC(CMD('AOFRSA0C ')ROUTE(ONE %AOFOPRECOPER%));
```

Three threshold levels are defined in the automation policy for MVS component MVSDUMP:

AOFKAASR SA z/OS - Command Dialogs

Domain ID = IPSNO ----- INGTHRES ----- Date = 08/28/03

Operator ID = SAUSER Time = 09:38:02

Specify thresholds and resource changes:

Resource	=>	MVSDUMP	Group or specific resource
System	=>	KEY3	System name, domain ID, sysplex name or *all
Critical	=>	<u>6</u> errors in <u>00:30</u>	Time (HH:MM)
Frequent	=>	<u>4</u> errors in <u>00:20</u>	Time (HH:MM)
Infrequent	=>	<u>2</u> errors in <u>00:20</u>	Time (HH:MM)

Pressing ENTER will set the THRESHOLD values

Command ==>

PF1=Help
PF2=End
PF3=Return
PF6=Roll

PF12=Retrieve

Figure 25. MVSDUMP Thresholds

SVC Dump Processing

Automation policy item MESSAGES/USER DATA of entry/type-pair MVSESA/MVSDUMP contains the following command entries with selection options at different levels:

```
Command = ACF ENTRY=MVSESA,TYPE=MVSDUMP,REQ=DISP
SYSTEM = KEY3      AUTOMATION CONFIGURATION DISPLAY - ENTRY= MVSESA
-----
AUTOMATION CONFIGURATION DISPLAY - ENTRY= MVSESA
TYPE IS MVSDUMP
CMD           = (FREQ,, 'MVS DD ALLOC=INACTIVE')
CMD           = (INFR,, 'MVS DD ALLOC=ACTIVE')
CMD           = (CRIT,, 'MVS DD ALLOC=INACTIVE')
END OF MULTI-LINE MESSAGE GROUP
```

Figure 26. MVSESA/MVSDUMP Command Entries

Automation policy item MESSAGES/USER DATA to entry/type-pair MVSESA/MVSDUMPTAKEN contains the following command entries with no selection options:

```
Command = ACF ENTRY=MVSESA,TYPE=MVSDUMPTAKEN,REQ=DISP
SYSTEM = KEY3      AUTOMATION CONFIGURATION DISPLAY - ENTRY= MVSESA
-----
AUTOMATION CONFIGURATION DISPLAY - ENTRY= MVSESA
TYPE IS MVSDUMPTAKEN
CMD           = (,, 'MVS DD CLEAR,DSN=&EHKVAR1')
END OF MULTI-LINE MESSAGE GROUP
```

Figure 27. MVSESA/MVSDUMPTAKEN Command Entries

Automation policy item MESSAGES/USER DATA to entry/type-pair MVSESA/MVSDUMPRESET contains the following command entries with no selection options:

```
Command = ACF ENTRY=MVSESA,TYPE=MVSDUMPRESET,REQ=DISP
SYSTEM = KEY3      AUTOMATION CONFIGURATION DISPLAY - ENTRY= MVSESA
-----
AUTOMATION CONFIGURATION DISPLAY - ENTRY= MVSESA
TYPE IS MVSDUMPRESET
CMD           = (,, 'MVS DD ALLOC=ACTIVE')
END OF MULTI-LINE MESSAGE GROUP
```

Figure 28. MVSESA/MVSDUMPRESET Command Entries

As long as no threshold is exceeded at receipt of one of the IEA611I and IEA911E messages, no action is taken.

If dumps have been taken more often than defined with the infrequent threshold, command MVS DD ALLOC=ACTIVATE, specified in entry type MVSDUMP is issued, which makes sure that automatic dump data set allocation is enabled. In case when the dump has been written to a pre-allocated SYS1.DUMP data set, additionally the data set will be cleared by command MVS DD CLEAR,DSN=&EHKVAR1, specified in entry type MVSDUMPTAKEN. Variable &EHKVAR1 will be substituted by the numeric suffix of the SYS1.DUMP data set.

The same processing will be done in case, when the incoming dump data set messages exceeds the frequent level.

As soon as the critical threshold is exceeded, the automation routine stops clearing pre-allocated SYS1.DUMP data sets.

After commands having been issued by the automatic processing of dump data sets, automation routine AOFRSA0C checks every 15 minutes whether the infrequent threshold is satisfied again. As soon as this situation is reached, automatic dump data set allocation will be enabled again by command MVS DD ALLOC=ACTIVE, as defined in entry type MVSDUMPRESET.

Deletion of Processed WTORs from SDF

The provided WTOR processing function deletes WTORs from SDF when replied to or cancelled.

The provided WTOR processing function includes the following items:

- Automation routine AOFRSA0E
- Automation table entries for system messages IEE400I and IEE600I

AOFRSA0E

Purpose

Automation routine AOFRSA0E deletes WTORs from SDF when replied to or cancelled.

Format



Parameters

id The reply identifiers for cancelled messages.

Restrictions

Processing in AOFRSA0E is only done if it is called from NetView automation table by message IEE400I or IEE600I or if one of these messages are passed by parameter.

Usage

Automation routine AOFRSA0E is intended to respond to the following messages:

```
IEE400I THESE MESSAGES CANCELED- id,id,id
IEE600I REPLY TO id IS; text
```

Message IEE400I says that the system cancelled messages because the issuing task ended or specifically requested that the messages be cancelled. Message IEE600I notifies all consoles that received a message that the system accepted a reply to the message.

As well AOFRSA0E can extract the identifiers of the messages to delete from passed parameters.

Flags

The following example shows how to issue AOFRSA0E from the NetView automation table:

```
IF MSGID = 'IEE400I' | MSGID = 'IEE600I'
THEN
EXEC(CMD('AOFRSA0E ')ROUTE(ONE %AOFOPWTORS%));
```

AMRF Buffer Shortage Processing

The provided AMRF buffer shortage processing function responds to messages, reporting buffer shortage of the action message retention facility (AMRF) by issuing commands from the ACF to process buffer shortage automation.

The provided AMRF buffer shortage processing function includes the following items:

- Automation routine AOFRSA0G
- Automation table entries for system messages IEA359E, IEA360A and IEA361I
- Command specification in automation policy item MESSAGES/USER DATA to entry/type-pair MVSESA/AMRFSHORT, MVSESA/AMRFFULL and MVSESA/AMRFCLEAR of the ACF

AOFRSA0G

Purpose

You can use the AOFRSA0G automation routine to respond to messages, reporting buffer shortage of the action message retention facility (AMRF) by issuing commands from the ACF to process buffer shortage automation. In case of an incoming buffer shortage message the commands to issue are taken from the entry/type-pair MVSESA/AMRFSHORT with selection option PASS1 and reissued in 1 minute intervals with incremented pass count. In case of buffer full message the commands to issue are taken from entry/type-pair MVSESA/AMRFFULL. If buffer shortage relieved is reported, the commands to entry/type-pair MVSESA/AMRFCLEAR are selected.

AOFRSA0G is expected to be called from the NetView automation table.

Format

▶▶—AOFRSA0G—▶▶

Restrictions

- Actions are only taken in AOFRSA0G if the recovery automation flag for AMRF is on.
- Processing of system messages in AOFRSA0G is only done if it is called from NetView automation table by message IEA359I, IEA360A or IEA361I.

Usage

Automation routine AOFRSA0G is intended to respond to the messages:

IEA359E BUFFER SHORTAGE FOR RETAINED ACTION MESSAGES - 80% FULL
IEA360A SEVERE BUFFER SHORTAGE FOR RETAINED ACTION MESSAGES - 100% FULL
IEA361I BUFFER SHORTAGE RELIEVED FOR RETAINED ACTION MESSAGES

IEA359E and IEA360A reports buffer shortage of the buffer area for immediate action messages, non-critical and critical eventual action messages and WTOR messages. IEA361I indicates the reduction of the number of retained action messages so that the buffer is now less than 75% full.

If AOFRSA0G has been triggered on receipt of message IEA359I the commands to issue are taken from entry/type-pair MVSESA/AMRFSHORT, starting at selection option PASS1 and continuing with incremented selection options in 1 minute

AMRF Buffer Shortage Processing

intervals until message IEA361 reports that buffer shortage has relieved. After arriving the maximal used selection option for a defined command processing restarts at selection option PASS1.

If AOFRSA0G has been triggered on receipt of message IEA360A all commands from entry/type-pair MVSESA/AMRFFULL are issued.

If AOFRSA0G has been triggered on receipt of message IEA361I all commands from entry/type-pair MVSESA/AMRFCLEAR are issued.

Flags

The following example shows a sample scenario to the AMRF shortage processing:

Entries in the NetView automation table are used to issue AOFRSA0G when message IEA359E, IEA360E or IEA361I arrives:

```
IF MSGID = 'IEA359I'  
THEN  
EXEC(CMD('AOFRSA0G')ROUTE(ONE %AOFOPRECOPER%));  
IF MSGID = 'IEA360A'  
THEN  
EXEC(CMD('AOFRSA0G')ROUTE(ONE %AOFOPRECOPER%));  
IF MSGID = 'IEA361I'  
THEN  
EXEC(CMD('AOFRSA0G')ROUTE(ONE %AOFOPRECOPER%));
```

To specify how to respond to message IEA359E and IEA361I, the following command definitions are made in the automation policy under the entry/type-pair MVSESA/AMRFFULL and MVSESA/AMRFCLEAR:

```
Command = ACF ENTRY=MVSESA,TYPE=AMRF*,REQ=DISP  
SYSTEM = AOC1      AUTOMATION CONFIGURATION DISPLAY - ENTRY= MVSESA  
-----  
AUTOMATION CONFIGURATION DISPLAY - ENTRY= MVSESA  
TYPE IS AMRFCLEAR  
CMD          = (.,'MVS CONTROL M,AMRF=Y')  
TYPE IS AMRFFULL  
CMD          = (.,'MVS CONTROL M,AMRF=N')  
END OF MULTI-LINE MESSAGE GROUP
```

Figure 29. MVSESA AMRF Command Definitions

If for example message

```
IEA360A SEVERE BUFFER SHORTAGE FOR RETAINED ACTION MESSAGES - 100% FULL
```

arrives, AOFRSA0G is issued by the shown statement in the NetView automation table, which causes the command CONTROL M,AMRF=N to be issued to clear the AMRF buffers.

After AMRF buffer shortage is relieved, the incoming message

```
IEA361I BUFFER SHORTAGE RELIEVED FOR RETAINED ACTION MESSAGES
```

causes command CONTROL M,AMRF=Y to be issued to reactivate AMRF.

JES2 Spool Recovery Processing

The provided JES2 spool recovery processing function responds to JES2 spool shortage and spool full messages by JES2 spool recovery processing to downgrade the problem of excessive spool usage.

The provided JES2 spool recovery processing function includes the following items:

- Automation routines AOFRSD01, AOFRSD09, AOFRSD0H
- Automation table entries for system messages HASP050 and HASP355
- Configuration parameters for the JES2 spool recovery process in policy item JES2 SPOOLSHORT and JES2 SPOOLFULL of the ACF
- Recovery commands defined in policy item JES2 SPOOLSHORT and JES2 SPOOLFULL of the ACF

Spool Usage Predictions: The automation routines of JES2 spool recovery processing makes predictions about spool usage which are presented through the SDF status update. There are three different predictions made: See appropriate section of SA for z/OS: Defining Automation Policy, page 166

AOFRSD01

Purpose

You can use the AOFRSD01 automation routine for JES2 spool recovery processing. It responds to JES2 spool shortage messages by initiating the recovery process for JES2 spool shortage. It responds to JES2 spool full messages by initiating the recovery process for JES2 spool full to downgrade the problem of excessive spool usage.

For this purpose AOFRSD01:

- Makes linear and first order predictions of spool usage, based on actual and historical values
- Posts the spool status to SDF
- Determines the target of recovery process as difference between the actual warning threshold for TG and the buffer value from the ACF. Achieving this target by the recovery process the spool shortage condition will be considered as relieved
- Initiates pass processing to execute the recovery commands of the ACF, defined via policy item JES2 SPOOLSHORT or JES2 SPOOLFULL. The pass processing itself is done by automation routine AOFRSD09 which is issued every retry interval. The retry interval is taken from the ACF.

Recovery commands and configuration parameters like buffer value and retry interval for the JES2 recovery processing can be defined via automation policy item JES2 SPOOLSHORT for spool shortage recovery processing and JES2 SPOOLFULL for spool full recovery processing.

For further information on the automation policy items JES2 SPOOLSHORT and JES2 SPOOLFULL refer to section Defining JES Subsystem in System Automation for z/OS Automation Policy.

AOFRSD01 is expected to be called from the NetView automation table.

Format

▶—AOFRSD01—▶

Restrictions

- Processing in AOFRSD01 is only done if it is called from NetView automation table by JES2 messages HASP050 or HASP355.
- Message HASP355 is only processed if it reports a shortage of track groups (TG).

Usage

Automation routine AOFRSD01 is intended to respond to the following messages:

HASP050 JES2 RESOURCE SHORTAGE OF TGs - nnn% UTILIZATION REACHED

HASP355 SPOOL VOLUMES ARE FULL

HASP050 indicates that JES2 has a shortage of track groups and the current spool utilization exceeds the current TGWARN value on this JES. TGWARN is defined in the SPOOLDEF statement in the JES initialization member and can be changed dynamically. HASP355 indicates that a request for JES2 direct access spool space cannot be processed, because all available space has been allocated to JES2 functions or no spool volumes are available. Therefore the recovery targets in this case are based on a figure of 100% spool utilization.

You should code TGWARN in the SPOOLDEF statement in the JES initialization member so that a SPOOLSHORT recovery will be initiated before a SPOOLFULL condition is reached. If this is not done, the recovery process may become unpredictable. When resetting after a SPOOLFULL condition, the problem is downgraded to a SPOOLSHORT. SA z/OS expects the previously running SPOOLSHORT recovery to activate and try to downgrade the problem to an OK. Without the prior SPOOLSHORT recovery, the spool status will remain in SPOOLSHORT after a successful SPOOLFULL recovery.

The NetView automation table entries for JES2 messages have to respect the one character prefix in front of the message identifier of JES2 messages, identifying the issuing JES.

The spool status is posted to SDF under the SPOOL generic, with the name of the subsystem as its specific name. To get these displayed on an SDF panel, you need status fields for xxxx.SPOOL, elements 1 through n, where n is the number of different subsystems that use the spool.

see section Spool Recovery Limitations of SA Defining Automation Policy, page 166

AOFRSD09

Purpose

Automation routine AOFRSD09 is used for JES2 spool recovery. It is called by AOFRSD01 via a timer every retry interval to monitor spool utilization of JES2 and to successive issue the recovery commands of policy item JES2 SPOOLSHORT or JES2 SPOOLFULL.

For this purpose AOFRSD09 processes the following steps:

- AOFRSD09 issues the JES2 command D SPOOL to obtain the current spool usage.

JES2 Spool Recovery Processing

- AOFRSD09 re-evaluates the target of recovery process based on the actual warning threshold for TG and the buffer value from the ACF.
- If the recovery target has not yet been achieved and the own JES2 subsystem is responsible for the spool recovery, AOFRSD09 increments the pass count and issues the appropriate commands from the ACF. To determine the responsible JES2 subsystem for spool recovery in a shared JES2 environment, where all JES2 subsystems receive a copy of the spool shortage message, AOFRSD09 compares the list of cpuids, defined in ACF, with the response to JES2 command D MEMBER,STATUS=ACTIVE. The first active cpuid of the list is considered to be the responsible JES2 subsystem for spool recovery.
- In case the spool shortage problem has already relieved, AOFRSD09 stops the recovery process and sets a timer to reset the pass count for the recovery commands after the reset interval.

Recovery commands and configuration parameters like buffer value, reset interval and cpuid list for the JES2 recovery processing can be defined via automation policy item JES2 SPOOLSHORT for spool shortage recovery processing and JES2 SPOOLFULL for spool full recovery processing.

For further information on the automation policy items JES2 SPOOLSHORT and JES2 SPOOLFULL refer to section Defining JES Subsystem in System Automation for z/OS Automation Policy.

Format

▶—AOFRSD09*subsystemrecovery type*————▶

Parameters

subsystem

The subsystem name of JES2. This parameter is required.

recovery type

This parameter is used to distinguish between a JES2 spool shortage and a JES2 spool full condition. This parameter is required.

SHORT

The automatic recovery from a JES2 spool shortage condition is to be processed.

FULL The automatic recovery from a JES2 spool full condition is to be processed.

Restrictions

- Processing of recovery commands in AOFRSD09 is only done if the recovery automation flag for JES2 is on. Otherwise the recovery process is suspended and the pass count for selection recovery commands from the ACF is not incremented.
- Automation routine AOFRSD09 is expected to be processed by JESOPER. If it is called on another task it is routed back to JESOPER.
- Processing in AOFRSD09 is only done if the specified type of spool recovery process has been initiated by automation routine AOFRSD01.
- During a SPOOLFULL recovery condition, the processing for SPOOLSHORT recovery is suspended.

Usage

The recovery commands to issue are selected from the command entry of policy item JES2 SPOOLSHORT or JES2 SPOOLFULL. A pass count is used as selection option and incremented at each successive processing of automation routine AOFRSD09. At initialization of the recovery process, the pass count is set to value PASS1 by automation routine AOFRSD01.

If pass processing runs out of defined recovery commands before the spool shortage condition is resolved, AOFRSD09 re-executes the recovery sequence from PASS1. You can change this behaviour by setting the appropriate advanced automation option at start up of System Automation. You can use the AOFSPoolSHORTCMD variable (for SPOOLSHORT conditions) and the AOFSPoolFULLCMD variable (for SPOOLFULL conditions) to tell automation routine AOFRSD09 to stop recovery attempts when all commands have been executed and to issue message AOF294I to inform the operator that manual intervention is required in order to resolve the spool condition. For more information on advanced automation options refer to 'Global Variables to Enable Advanced Automation' in System Automation for z/OS: Customization and Programming.

Flags

When defining the commands in the SPOOLFULL or SPOOLSHORT processing panel of the ACF to handle the recovery, the variables &EHKVAR1 and &EHKVAR2 can be used to be substituted by variable contents. Variable &EHKVAR1 will be substituted by the current spool utilization and &EHKVAR2 contains the recovery target.

AOFRSD0H

Purpose

Automation routine AOFRSD0H is used for JES2 spool recovery. It is called by AOFRSD09 via a timer command after the reset interval and cleans up the pass counter for the pass processing of the recovery commands of the ACF.

Format

▶▶—AOFRSD0H*subsystemrecovery type*————▶▶

Parameters

subsystem

The subsystem name of JES2. This parameter is required.

recovery type

This parameter is used to distinguish between a JES2 spool shortage and a JES2 spool full condition. This parameter is required.

SHORT

The pass counter for spool shortage recovery processing is to be reset.

FULL The pass counter for spool full recovery processing is to be reset.

Restrictions

- Automation routine AOFRSD0H is expected to be processed by JESOPER. If it is called on another task it is routed back to JESOPER.
- Each recovery action during the reset interval

JES2 Spool Recovery Processing

- AOFRSD0H is only scheduled after the reset interval if no new recovery action of the corresponding type SHORT or FULL has been taken during this time.
- The pass counter for spool full recovery processing is reset by AOFRSD0H after the reset interval, even if spool short recovery is still in progress.

Flags

The following example shows a sample scenario to JES2 spool recovery processing:

The following entries in the NetView automation table are used to issue automation routine AOFRSD01 from the NetView automation table, when one of the expected messages arrives:

```
IF MSGID(2) = 'HASP050' & TEXT = '.'TGS'.
THEN
EXEC(CMD('AOFRSD01')ROUTE(ONE %AOFOPJESOPER%));
IF MSGID(2) = 'HASP355'
THEN
EXEC(CMD('AOFRSD01')ROUTE(ONE %AOFOPJESOPER%));
```

The SPOOLSHORT recovery is configured via automation policy item JES2 SPOOLSHORT as shown in Figure 30.

COMMANDS HELP

SPOOLSHORT Processing

Command ==> _____

Entry Type : Application PolicyDB Name : DATABASE_NAME
Entry Name : JES2 Enterprise Name : YOUR_ENTERPRISE

Enter SPOOLSHORT settings.

Retry Time 00:05:00 Spool recovery attempt interval (hh:mm:ss)
Buffer 5 Recovery target below TGWARN (0->50)
Reset Time 00:15:00 Recovery reset interval (hh:mm:ss)

Priority of systems for spool recovery:

CPUID	1	2	3	4	5	6	7	8	
	9	10	11	12	13	14	15	16	
	17	18	19	20	21	22	23	24	
	25	26	27	28	29	30	31	32	

Edit Spoolshort Pass Commands . . YES YES NO

Figure 30. JES2 SPOOLSHORT Recovery Definition

Because no cpuids are defined, the own JES2 subsystem is responsible for JES2 spool recovery processing. Entering YES in field Edit Spoolshort Pass Commands allows you to edit the pass recovery commands that are defined as shown by the following response panel to command DISPACF JES2:

```

Command = ACF ENTRY=JES2,TYPE=*,REQ=DISP
SYSTEM = KEY3      AUTOMATION CONFIGURATION DISPLAY - ENTRY= JES2
-----
TYPE IS SPOOLSHORT
CMD      = (PASS1,, 'MVS $PQ,Q=N,A=3')
CMD      = (PASS1,, 'MVS $OQ,Q=N,A=3,CANCEL')
CMD      = (PASS1,, 'MVS $PQ,Q=V,A=3')
CMD      = (PASS1,, 'MVS $OQ,Q=V,A=3,CANCEL')
CMD      = (PASS2,, 'MVS $PQ,ALL,A=4')
CMD      = (PASS2,, 'MVS $OQ,ALL,A=4,CANCEL')
CMD      = (PASS3,, 'MVS $PQ,ALL,A=3')
CMD      = (PASS3,, 'MVS $OQ,ALL,A=3,CANCEL')
CMD      = (PASS4,, 'AORRSPLS RANGE=JOB1-5000,NAME=T*')
CMD      = (PASS4,, 'AORRSPLS RANGE=JOB5000-10000,NAME=T*')
CMD      = (PASS4,, 'AORRSPLS RANGE=JOB10000-15000,NAME=T*')
CMD      = (PASS4,, 'AORRSPLS RANGE=JOB15000-20000,NAME=T*')
    
```

Figure 31. DISPACF Command Response Panel

Assume, a JES2 spool shortage problem is reported by message
 \$HASP050 JES RESOURCE SHORTAGE OF TGS - 80% UTILIZATION REACHED

issuing automation routine AOFRSD01 by the appropriate NetView automation table entry, which initiates the JES2 SPOOLSHORT recovery process and sets an every timer, to call the pass processing routine by issuing AOFRSD09 JES2 SHORT every 5 minutes, as defined in the customization dialog for SPOOLSHORT processing shown above.

AOFRSD09 redetermines the actual spool usage, compares it with the defined TGWARN of 80% and calculates the target of recovery as difference of TGWARN and the buffer value resulting in a value of 75.

If this value is exceeded by the actual spool usage, all recovery commands with selection option PASS1 of the ACF to recovery type SPOOLSHORT are issued. After the retry interval of 5 minutes, AOFRSD09 is re-issued again by the timer.

If AOFRSD09 now determines that the JES2 spool shortage problem has been relieved, it stops recovery processing and sets a timer to issue AOFRSD0H JES2 SHORT after the reset interval of 15 minutes.

If none of the expected JES2 messages arrives by the end of the reset interval, automation routine AOFRSD0H resets the pass count to 1, so that the next SPOOLSHORT recovery process issues recovery commands beginning again at selection option PASS1.

JES2 Shutdown Processing

The JES2 shutdown processing function that is provided responds to an all function complete message at JES2 shutdown by issuing the corresponding ACF commands that are defined in automation policy item MESSAGES/USER DATA for JES2 message HASP099.

The shutdown type is used as option to select the commands.

This JES2 shutdown processing function is included in the generic routine ISSUECMD, which is expected to be called from the NetView automation table.

HASP099

Restrictions

Shutdown processing of the JES2 message HASP099 is only done if:

- Shutdown automation for JES2 is on
- JES2 is in the process of being shut down

Usage

The generic routine ISSUECMD responds to message:

```
HASP099 ALL AVAILABLE FUNCTIONS COMPLETE
```

This indicates that all JES2 job processors have become dormant, and no JES2 RJE lines are active.

Drain Processing Prior to JES2 Shutdown

SA z/OS provides functions for drain processing of JES2 resources prior to JES2 shutdown.

The provided JES2 drain processing function includes the following items:

- Automation routines AOFRSD07, AOFRSD0F, AOFRSD0G
- Automation table entries for system message HASP607
- Specifications in automation policy item JES2 DRAIN to which JES2 resources are to be drained and how they are to be drained prior to JES2 shutdown.

AOFRSD07

Purpose

You can use the AOFRSD07 automation routine to respond to a JES2 not dormant message during JES2 shutdown by issuing commands for resources that are not drained.

The commands to issue are taken from the automation policy item JES2 DRAIN of application JES2.

Additionally AOFRSD07 calls AOFRSD0F which outputs a list of all active jobs and started tasks and a list of all resources not yet drained.

AOFRSD07 is expected to be called from the NetView automation table.

Format

▶▶—AOFRSD07—◀◀

Restrictions

Processing in AOFRSD07 is only done if:

- It is called from NetView automation table by JES2 message HASP607
- The terminate automation flag for JES2 is on
- JES2 is in shutdown progress

Usage

Automation routine AOFRSD07 is intended to respond to message

```
HASP607 JES2 NOT DORMANT -- MEMBER DRAINING, RC=rc text
```

which indicates in case the P JES2 command was entered to withdraw JES2 from the system that not all of JES2's functions have completed.

To find out all resources not drained, the response to JES2 command DU,STA is processed. For each resource in status DRAINING the corresponding command from the automation policy item JES2 DRAIN for this resource type to force drain is issued. Resources in status ACTIVE are first stopped with JES2 command P resource, before the command from the automation policy item to force drain is issued. Resources in status INACTIVE are only stopped with JES2 command P resource.

In cases, where the automation is unable to issue actions on not yet drained resources, JES2 is set to status STUCK and a message is issued which tells that an operator action is required. Those situations occur if no command is specified in automation policy item JES2 DRAINED of JES2 to drain a resource or if a not yet drained resource is in an unknown status

AOFRSD0F

Purpose

Automation routine AOFRSD0F is used by AOFRSD07 for drain processing prior to JES2 shutdown. Every shutdown delay interval, AOFRSD0F displays all JES2 resources not yet drained. For this purpose it scans the response to JES2 command DA,S for executing tasks, the response to JES2 command DA,J for executing jobs and the response to JES2 command DU,STA for started devices or lines not yet drained and displays the result in a message.

Format

▶▶—AOFRSD0F—*subsystem*—————▶▶

Parameters

subsystem

The subsystem name of JES2.

Restrictions

Processing in AOFRSD0F is only done

- The subsystem is of type JES2
- JES2 is in shutdown progress
- The terminate automation flag is on

Usage

This automation routine is performed as part of the SHUTDOWN processing.

Flags

This example shows a sample scenario to JES2 drain processing prior to JES2 shutdown.

The following statement shows how AOFRSD07 is issued from the NetView automation table by JES2 message

Drain Processing Prior to JES2 Shutdown

```
$HASP607: IF MSGID(2) = 'HASP607'
THEN
EXEC(CMD('AOFRSD07')ROUTE(ONE %AOFOPJESOPER%));
```

Assume the following drain processing specifications in automation policy item JES2 DRAIN:

```

COMMANDS  HELP
-----
                                JES2 DRAIN Specifications
Command ==> _____

Entry Type : Application          PolicyDB Name  : DATABASE_NAME
Entry Name  : JES2                Enterprise Name: YOUR_ENTERPRISE

Subsystem: JES2
Enter information (Yes or No) for initial drain to bring down JES2 facilities.
LIN . . . . . YES                Drain lines
LOG . . . . . YES                Drain JES2-VTAM interface
OFF . . . . . NO                 Drain spool offloaders
PRT . . . . . YES                Drain printers
RDR . . . . . YES                Drain readers
PUN . . . . . YES                Drain punches
Enter information (Command or No) for force drain if normal drain fails.
LIN . . . . . $E                 Force drain lines
LOG . . . . . $E                 Force drain JES2-VTAM interface
OFF . . . . . NO                 Force drain spool offloaders
PRT . . . . . $I                 Force drain printers
RDR . . . . . $C                 Force drain readers
F1=HELP    F2=SPPLIT    F3=END      F4=RETURN   F5=RFIND    F6=RCHANGE
F7=UP      F8=DOWN     F9=SWAP    F10=LEFT   F11=RIGHT   F12=RETRIEVE

```

Figure 32. JES2 DRAIN Specifications Panel

The list of commands to force drain of JES2 resources are passed to entry/type-pair JES2/FORCEDRAIN in the ACF and can be displayed with the DISPACF command:

```

Command = ACF ENTRY=JES2,TYPE=FORCEDRAIN,REQ=DISP
SYSTEM = KEY3      AUTOMATION CONFIGURATION DISPLAY - ENTRY= JES2
-----
AUTOMATION CONFIGURATION DISPLAY - ENTRY= JES2
TYPE IS FORCEDRAIN
LIN          = "$E"
LOG          = "$E"
OFF          = "NO"
PRT          = "$I"
RDR          = "$C"
PUN          = "$E"
END OF MULTI-LINE MESSAGE GROUP

```

Figure 33. DISPACF Panel

Assume that during a shutdown of JES2 message \$HASP607 arrives, indicating that not all of JES2's functions have completed and that JES2's response to command \$DU,STATUS is:

```
$HASP636 13.53.22 $DU,STA
LINE1     UNIT=0FF3,STATUS=ACTIVE/BOEVM9,DISCON=NO
```

Automation routine AOFRSD07 first issues JES2 command \$PLINE1 to stop the line and then issues JES2 command \$E, according to the policy specifications FOR entry/type-pair JES2/FORCEDRAIN.

Then automation routine AOFRSD0F is executed every shutdown delay interval, to list all JES2 resources not drained.

AOFRSD0G

Purpose

You can use the AOFRSD0G automation routine to drain JES2 resources prior to JES2 shutdown. AOFRSD0G issues commands to drain the initiators, offloader tasks, lines, printers, punches and readers, depending on which resources are listed and enabled in the automation policy item JES2 DRAIN of application JES2.

AOFRSD0G is used by the DRAINJES command.

Format

▶▶—AOFRSD0G—*subsystem*—▶▶

Parameters

subsystem

The subsystem name of JES2.

Restrictions

- Processing in AOFRSD0G is only done if the subsystem is of type JES2.

Usage

For all resources enabled to initial drain in automation policy item JES2 DRAIN of application JES2 the JES2 command P is issued.

Flags

Call AOFRSD0G JES2 to stop all resources enabled in JES2 DRAIN for init drain.

These resources can be listed with command DISPACF JES2 INITDRAIN.

```
Command = ACF ENTRY=JES2,TYPE=INITDRAIN,REQ=DISP
SYSTEM = AOC1      AUTOMATION CONFIGURATION DISPLAY - ENTRY= JES2
-----
AUTOMATION CONFIGURATION DISPLAY - ENTRY= JES2
TYPE IS INITDRAIN
LIN           = "YES"
LOG           = "YES"
OFF           = "NO"
PRT           = "YES"
RDR           = "YES"
PUN           = "YES"
END OF MULTI-LINE MESSAGE GROUP
```

Figure 34. DISPACF JES2 INITDRAIN Panel

JES3 Dump Processing

The provided JES3 dump processing function initiates recovery automation processing as response to a specify dump option message. It includes the following items:

- Automation routine AOFRSE0J.
- Automation table entry for JES3 message IAT3714.
- Error threshold definitions for JES3, defined in automation policy item JES3 ABEND.
- Recovery command and reply specifications in automation policy item MESSAGES/USER DATA to entry/type-pair JES3/JESABEND of the ACF.

AOFRSE0J

Purpose

You can use the AOFRSE0J automation routine for JES3 dump processing to respond to a specify dump option message at JES3 abend by replying a dump option and by initiating recovery automation processing.

AOFRSE0J keeps track of the incoming expected JES3 messages and compares their occurrence with predefined thresholds at level infrequent, frequent and critical. An exceeded threshold is taken as option for selecting corresponding recovery commands and replies from the entry/type-pair JES3/JESABEND in the ACF. If no threshold is exceeded the commands or replies to selection option ALWAYS are issued together with the commands without selection option.

AOFRSE0J is expected to be called from the NetView automation table.

Format

▶▶—AOFRSE0J—▶▶

Restrictions

- Actions are only taken in AOFRSE0J, if the recovery automation flag for JES3 is on.
- Processing in AOFRSE0J is only done, if it is called from NetView automation table by message IAT3714 from JES3.

Usage

Automation routine AOFRSE0J is intended to respond to message:

```
id IAT3714 SPECIFY DUMP OPTION FOR _ JES3 GLOBAL,main _____ ><
                                     | JES3 LOCAL,main _____ |
                                     | _FSS fssname,ASID=asid_ |
```

which requests the operator to specify the type of dump. The thresholds for comparing purpose are to be defined in the automation policy item JES3 ABENDS of entry JES3.

If the incoming messages do not reach a predefined threshold, all replies and commands to entries of entry/type-pair JES3/JESABEND with selection option ALWAYS and to entries with no selection option are selected to be issued.

If the threshold at level infrequent is exceeded, all replies and commands to entries with no selection option and to selection option INFR are selected.

In the same way a level of frequent corresponds to selection option FREQ and a level of critical corresponds to selection option CRIT.

Flags

The following example shows how to issue AOFRSE0J from the NetView automation table:

```
IF MSGID = 'IAT3714'
THEN
EXEC(CMD('AOFRSE0J')ROUTE(ONE %AOFOPJESOPER%));
```

TWS Automation PPI and Gateway Failures

There are two routines that are provided by SA z/OS to deal with PPI and gateway timeouts or failures.

EVJEAC01

Purpose

This routine is called to determine the TWS operations that have previously ended in error because the NetView PPI was not available (the error code is UNTV) and reset them using OPCAPOST.

Usage

The routine should be called in the following cases:

- From UP processing for the TWS Controller, coded in the control file as:

```
UP,CMD=(OPCAOPR2,, "EVJEAC01")
```
- from ACORESTART for the TWS/OPC Controller, coded in the control file as:

```
ACORESTART,CMD=(OPCAOPR2,, "EVJEAC01")
```

The routine uses the Operation reset delay (defined in the OPC SYSTEM DETAILS policy) that specifies how long the NetView interface to TWS may be unavailable before TWS Automation resets operations that ended in error while it was down.

If either no value or OPRESET=NEVER is coded, then no operations are reset when the interface becomes available again. The default value is NEVER.

It is expected that the routine will be used in the policy database.

EVJEAC02

Format

This routine is called to reset TWS operations that are in error due to Gateway timeouts or failures.

Usage

This routine is called when:

- The TWS controller comes UP, coded in the control file as:

```
UP,CMD=(, 'EVJEAC02')
```
- A gateway is connected, or reconnected

If the routine runs on a TWS Controller node, it determines the operations that have previously ended in error due to gateway failures (with an error code of S999). If this is the case, the routine will issue an OPCAPOST to RESET them.

It is expected that the routine will be used in the policy database.

TWS Automation Operation and Job Errors

SA z/OS provides functions to respond to errors with TWS operations and jobs.

The functions that are provided include the following routines and AT entries for associated messages:

- EVJEAC03 and EQQE036I
- EVJEAC04 and EVJ120I

TWS Automation PPI and Gateway Failures

- EVJRAC05 and EQQE026I
- EVJRSJOB and EQQE107I, EQQE107I, and EQQW079W

EVJEAC03

Purpose

This routine is called when message EQQE036I is trapped. This message is issued by TWS when a TWS operation has detected a job error. This causes an entry to be added to SDF and the error situation to be posted to NMC.

The EVJEAC03 routine is expected to be called from the NetView automation table.

Format

▶▶—EVJEAC03—▶▶

Usage

The automation routine EVJEAC03 is intended to respond to message:

```
EQQE036I JOB JOBNAME(JNUM), OPERATION (OPERNUM) ENDED IN ERROR EC.  
        PRTY=PRI, APPL = APPL, WORK STATION = WSID, IA = IA
```

This requests the operator to perform error recovery actions for the current job.

EVJEAC04

Purpose

This routine is called when message EVJ120I is trapped. The message is issued by SA z/OS when a TWS operation has been put into or reset from TWS error status.

The EVJEAC04 routine is expected to be called from the NetView automation table.

Format

▶▶—EVJEAC04—▶▶

Usage

The automation routine EVJEAC04 is intended to respond to message:

```
EVJ120I applid iatime opnum job status wsname errcode  
        abcode usrcode
```

This causes a Status Display Facility update and an NMC update to occur.

For an operation changing to error status the update will add an entry to SDF and NMC while an operation changing from error status will remove an entry from SDF and NMC.

SDF entries are added to the OPC Automation Application in Error panel (OPCERR).

EVJRAC05

Purpose

This routine is called when message EQQE026I is trapped. This message is issued by TWS when a TWS operation has detected a job error. This causes an entry to be added to SDF and the error situation to be posted to NMC.

The EVJRAC05 routine is expected to be called from the NetView automation table.

Format

▶▶—EVJRAC05—◀◀

Usage

The automation routine EVJRAC05 is intended to respond to message:

```
EQQE026I APPLICATION APPL ENDED IN ERROR EC. OPER = OPERNUM,
          PRTY = PRI, IA = IA
```

This requests the operator to perform error recovery actions for the current job.

EVJRSJOB

Purpose

This routine is called when trapping the following messages:

- EQQE107I
- EQQW079W
- EQQE037I

These messages are issued by TWS when the state of a batch job has changed. This causes an entry to be added to SDF and the error situation to be posted to NMC.

The EVJRSJOB routine is expected to be called from the NetView automation table.

Format

▶▶—EVJRSJOB—◀◀

Usage

The automation routine EVJRSJOB is intended to respond to messages:

```
EQQE107I OPC-WLM SUCCESSFULLY PROMOTED JBNAM: JBNUM IN
          HI PERFORMANCE CLASS
```

```
EQQW079W JBNAM WILL NOT BE SUBMITTED TO WLM FOR
          PROMOTION. WLM REQUEST IS TOO OLD
```

```
EQQE037I JOB JOBNAME(JNUM), OPERATION (OPERNUM) IN
          APPLICATION APPL, IS LATE, WORK STATION = WSID,
          IA = ARRTIME
```

This requests the operator to investigate what is keeping the job from starting and take appropriate actions to enable it to start.

TWS Status Observer Control

EVJEOBSV

Purpose

This routine is used to start and stop the TWS status observer.

The EVJEOBSV routine called from within the Policy definitions when starting or stopping the status observer. It is also called internally at SA z/OS initialization time and when an automation manager takeover has been completed as indicated by message HSAM1309I.

Format

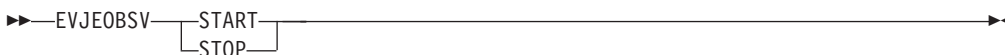

Parameters

START

Establishes the subscription for the list of special resources defined in the policy.

STOP Removes the subscription.

TWS Controller Status

EVJRSACT

Purpose

This routine keeps track of whether or not the TWS controller is active or in standby. The information is stored in the automation manager.

The routine is called when trapping the following messages:

- EQQN013I
- EQQZ128I
- EQQZ201I

Format



CICS-Related Processing and Recovery

CICS Region Abend Recovery

EVEET003

Purpose: This routine is a part of the Abend Recovery for CICS Regions. It is intended to be invoked from the Automation Table.

Format:

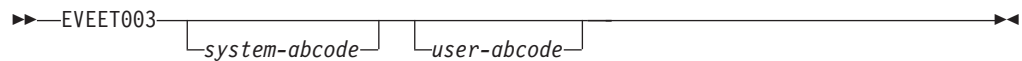
**Parameters:***system-abcode*

Optional System abend code.

user-abcode

Optional User abend code.

Usage: The automation routine EVEET003 is intended to respond to messages:

DFHCC0001 applid An abend (code aaa/bbbb) has occurred at offset X"offset" in the {local | global} catalog, module modname

DFHPC0401 applid Abend abcode issued by yyy task.

DFHPC0405 applid Abend abcode2 has been issued while processing abend abcode1 for the same task, transaction tranid.

DFHPC0408 applid Abend abcode has been issued during post commit processing, transaction tranid.

DFHPC0409 applid Abends abcode2 and abcode3 have been issued while processing abend abcode1 for the same task, transaction tranid.

DFHSR0601 applid Program interrupt occurred with system task taskid in control

DFHSR0602 applid Program interrupt routine has been entered while processing program interrupt for same task

DFHSR0603 applid Program interrupt has occurred

DFHSR0605 applid Error from KE Domain - DFHSRP initialization

DFHSR0606 applid Abend (code aaa/bbbb) has been detected.

DFHSR0612 applid Abend recovery has been entered by same task

DFHSR0613 applid Abend has occurred with system task taskid in control

DFHSR0615 applid Program interrupt has occurred in recovery task

DFHTC1001 applid Terminal control initialization failed (modname).

DFHTM1797 applid System termination program has abended.

DFHDM0106 applid The Domain Manager records on the CICS Catalog may have been corrupted.

DFHKE1800 applid ABNORMAL TERMINATION OF CICS IS COMPLETE.

DFHLG0736 applid A failure has occurred while reading from the system log (journalname). The requested data could not be found. CICS will be quiesced allowing some tasks to complete. Further work requires an initial start.

DFHLG0738 applid A failure has occurred while reading the system log (journalname). The requested data could not be found. CICS will be terminated. Further work requires an initial start.

DFHLG0740 applid While writing data to the system log (journalname), a lost data warning was received. CICS will be quiesced without logging, allowing tasks to complete. Further work requires an initial start.

DFHSI1542 applid Takeover by the CICS alternate system has failed. Emergency restart could not be performed.

This informs an operator that a CICS region has abended.

This routine will stop health check monitors and write an SMF record (optionally) to log the abend.

In addition the routine does a CDEMATCH for message id ABCODESYSTEM with *code1* set to the *messageid* that invoked the routine, *code2* set to the *system-abcode* and *code3* set to the *user-abcode*. The result of the match is used as the determine the parameters to TERMMSG. If NORESTART is returned then the BREAK=YES parameter is used on TERMMSG. If RESTART is returned then the ABEND=YES parameter is used on TERMMSG. If neither of these values are returned, NO TERMMSG command is invoked.

CICSplex Processing

EVERCMRC

Purpose: This routine is a part of the CICSplex Event notification. This routine will capture CICSplex SM events that have actions of WTO and will display them in SDF or NMC, or both.

This routine is intended to be invoked from the Automation Table. The format of the NMC and SDF resource names are detailed in *IBM Tivoli System Automation for z/OS CICS Automation Programmer's Reference and Operator's Guide*.

Format:

▶▶—EVERCMRC—▶▶

Usage: The automation routine EVERCMRC is intended to respond to messages:

EYUPN0005W Notify created for SAM, Context=plexname, Target=targetsys, Sev=level, Event=evntname, Text=usertxt.
 EYUPN0006W Notify created for RTADEF defname by APM, Context=plexname, Target=targetsys, Sev=level, Resource=restype Key=resname, Text=usertxt.
 EYUPN0007W Notify created for deftype defname by MRM, Context=plexname, Target=targetsys, Sev=level, Resource=restype Key=resname, Text=usertxt.
 EYUPN0008W Notify updated for SAM, Context=plexname, Target=targetsys, Sev=level, Event=evntname, Text=usertxt.
 EYUPN0009W Notify updated for RTADEF defname by APM, Context=plexname, Target=targetsys, Sev=level, Resource=restype Key=resname, Text=usertxt.
 EYUPN0010W Notify updated for deftype defname by MRM, Context=plexname, Target=targetsys, Sev=level, Resource=restype Key=resname, Text=usertxt.
 EYUPN0011W Notify action for SAM, Context=plexname, Target=targetsys, Sev=level, Event=evntname, Text=usertxt.
 EYUPN0012W Notify action for RTADEF defname by APM, Context=plexname, Target=targetsys, Sev=level, Resource=restype, Key=resname, Text=usertxt.
 EYUPN0013W Notify action for deftype defname by MRM, Context=plexname, Target=targetsys, Sev=level, Resource=restype, Key=resname, Text=usertxt.

This informs SA z/OS that a CICSplex SM event has occurred or been resolved.

EVERSCMI

Purpose: This routine is a part of the CICSplex SM topology management. This routine maintains a map of CICSplex SM MAS names against the System Automation resource names.

This routine is intended to be invoked from the Automation Table

Format:

▶▶—EVERSCMI—
 └── subsystem ─┘▶▶

Parameters:

subsystem

Optional Subsystem name. If not supplied the SUBSAPPL task global will be used.

Usage: The automation routine EVERSCMI is intended to respond to messages:

EYUTS0003I Topology event for sysname Complete - APPLID (applid) CICSplex (plexname)
 EYUXL0010I CMAS initialization complete

In addition the EVERSCMI routine should be invoked from the ACORESTART
 MESSAGES/USER DATA policy for the CICSplex CMASs defined to SA z/OS.

CICS Link Monitoring

EVEED004

Purpose: This routine will post or remove Link Monitoring events for links that are defined to be monitored to SDF or NMC, or both. The resource name formats are defined in *IBM Tivoli System Automation for z/OS CICS Automation Programmer's Reference and Operator's Guide*.

This routine is intended to be invoked from the Automation Table.

Format:



Parameters:

message

The full message text from the Automation Table trap.

Usage: The automation routine EVEED004 is intended to respond to the following messages for Link recovery:

- EVE811I procname : connid - Critical connection to applid in trouble.
- EVE812I procname : connid - Connection to applid in trouble.
- EVE813I procname : connid - Critical conn. to applid repaired, actions = count1
- EVE814I procname : connid - Connection to applid repaired, actions = count1.
- EVE815I procname : connid - Critical connection to applid is up.
- EVE816I procname : connid - Connection to applid is up.
- EVE817I procname : connid - Critical connection to applid, AV=count1 MX=count2 AC=count3.
- EVE818I procname : connid - Connection to applid, AV=count1 MX=count2 AC=count3.
- EVE819I procname : connid - Critical connection to applid is down.
- EVE820I procname : connid - Connection to applid is down.

CICS VSAM RLS Status

EVEERLSI

Purpose: This routine is a routine to track the CICS VSAM RLS status.

This routine is intended to be invoked from the Automation Table

Format:

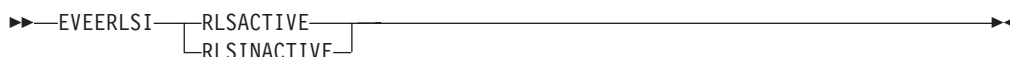

Parameters:

RLSACTIVE

Specifies that CICS is using RLS.

TWS Automation PPI and Gateway Failures

RLSINACTIVE

Specifies that CICS is not using RLS.

Usage: The automation routine EVEECO05 is intended to respond to the following messages for VSAM RLS status processing:

DFHFC0153 applid The previous instance of the SMSVSAM server has failed. File control RLS access is being closed down.
DFHFC0501 applid RLS OPEN of file filename failed. VSAM has returned code 16 in R15. RLS access has been disabled.
DFHFC0504 applid RLS OPEN of file filename failed. The VSAM SHOWCB macro has detected a RLS VSAM server failure. RLS access has been disabled.
DFHFC0508 applid RLS OPEN of file filename failed. VSAM has returned code X'AA' in register 15. RLS access has been disabled.
DFHFC0563 applid The RLS control ACB has been successfully unregistered by CICS.
DFHFC0562 applid The RLS control ACB has been successfully registered by CICS.
DFHFC0564 applid The register of the RLS control ACB has failed. VSAM macro IDAREGP return code X'rrrr', reason code X'cccc', error data X'dddd'.
DFHFC0565 applid The unregister of the RLS control ACB has failed. VSAM macro IDAUNRP return code X'rrrr', reason code X'cccc', error data X'dddd'.
DFHFC0566 applid The register of the RLS control ACB has failed. VSAM macro IDAREGP return code X'rrrr', reason code X'cccc'.
DFHFC0567 applid The unregister of the RLS control ACB has failed. VSAM macro IDAUNRP return code X'rrrr', reason code X'cccc'.
DFHFC0571 applid RLS access cannot be restarted.
DFHFC0570 applid File control RLS access has been enabled.
DFHFC0577 applid RLS offsite recovery is now complete. RLS access is allowed.

CICS Shutdown

EVERSPPI

Purpose: This routine is sets the shutdown status for the PPI running in a CICS address space.

This routine is intended to be invoked from the Automation Table

Format:

►►—EVERSPPI—◄◄

Usage: The automation routine EVERSPPI is intended to respond to the following messages for PPI shutdown processing:

EVE173I applid : PPI inactive.

CICSPURG

Purpose: This routine will purge transactions running in the CICS subsystem at the time it is issued. It is used in the pre-shut command policy or as phase of the shutdown commands policy.

This routine is intended to be invoked from the ACF SHUTDOWN commands policies.

Format:

►►—CICSPURG—◄◄
 └──subsystem──┘

Parameters:

subsystem

Optional Subsystem name. If not supplied the SUBSAPPL task global will be used.

Usage: This command works with the LISTSHUT MESSAGES/USER DATA policy to determine which transactions can be purged. It is normally not required as CICS has it's own transaction purge function.

CICRSYSC

Purpose: This routine will resynchronize the SA z/OS Agent knowledge of the CICS subsystem when the Agent detects that the subsystem is already running during Agent start up.

This routine is intended to be invoked from the ACF ACORESTART MESSAGES/USER DATA commands policies.

Format:



Parameters:

subsystem

Optional Subsystem name. If not supplied the SUBSAPPL task global will be used.

Usage: This command is run during Agent start up against an already running CICS subsystem to resynchronize the Agent information for the subsystem.

CICSSHUT

Purpose: This routine will issue the shutdown commands for a CICS subsystem.

This routine is intended to be invoked from the ACF SHUTDOWN commands policies.

Format:

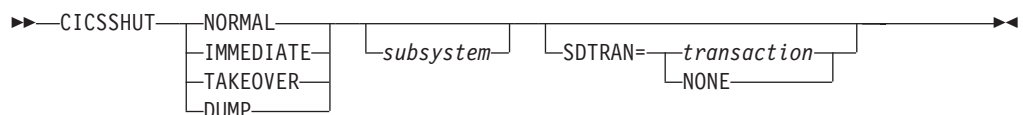

Parameters:

NORMAL

A Normal shutdown will be started via CEMT PERFORM SHUTDOWN.

IMMEDIATE

An Immediate shutdown will be started via CEMT PERFORM SHUTDOWN IMMED.

TWS Automation PPI and Gateway Failures

TAKEOVER

A Takeover shutdown will be started via CEMT PERFORM SHUTDOWN TAKEOVER.

DUMP

A Dump is produced at shutdown via CEMT PERFORM SHUTDOWN DUMP.

subsystem

Optional Subsystem name. If not supplied the SUBSAPPL task global will be used.

transaction

Optional transaction CICS is to use to purge transactions from CICS during shutdown.

If no CICS invoked shutdown transaction is desired use NONE.

Usage: This command will issue the CEMT PERFORM SHUTDOWN command.

CMASSHUT

Purpose: This routine will issue the shutdown commands for a CICSplex SM CMAS subsystem.

This routine is intended to be invoked from the ACF SHUTDOWN commands policies.

Format:

▶▶—CMASSHUT—subsystem————▶▶

Parameters:

subsystem

Optional Subsystem name. If not supplied the SUBSAPPL task global will be used.

Usage: This command will issue the COSD command.

CICS Short on Storage

EVEEY00S

Purpose: This routine is a generic routine that invokes state table processing based on the message id it is invoked with. In this case the message id's cause the routine to handle the CICS Short on Storage events.

This routine is intended to be invoked from the Automation Table

Format:

▶▶—EVEEY00S————▶▶

Usage: The automation routine EVEEY00S is intended to respond to the following messages for CICS Short on Storage events:

DFHSM0131 applid CICS is under stress (short on storage below 16MB).
 DFHSM0132 applid CICS is no longer short on storage below 16MB.
 DFHSM0133 applid CICS is under stress (short on storage above 16MB).
 DFHSM0134 applid CICS is no longer short on storage above 16MB.

EVEERDMP

Purpose: This routine will cause CICS to take a snap dump.

This routine is intended to be invoked from the ACF MESSAGES/USER DATA RCVRSOS policy.

Format:

▶▶—EVEERDMP—◀◀

Usage: The automation routine EVEERDMP is intended to allow the user to take a snap dump of a CICS subsystem that is in Short on Storage state. It should be placed in the RCVRSOS MESSAGES/USER DATA policy as a command.

CICS Startup

EVEEARMW

Purpose: This routine will reply to the DFHKE0408D message. This message is issued when CICS is started with TYPE=COLD or INITIAL and attempts to register with ARM and fails to do so. The appropriate reply is ASIS or AUTO.

This routine is intended to be invoked from the Automation Table

Format:

▶▶—EVEEARMW—◀◀

Usage: The automation routine EVEEARMW is intended to respond to the following message.

DFHKE0408D applid PLEASE SPECIFY START TYPE, 'ASIS' OR 'AUTO'.

The automation routine will reply with the data specified in the MESSAGES/USER DATA reply policy for the message. The Selection field is set to ARMSTART if CICS was started by ARM or NOARMSTART if CICS was started manually.

EVEEI115

Purpose: This routine will reply to the DFHPA1104 message. This message is issued to get system start up parameters.

This routine is intended to be invoked from the Automation Table

Format:

▶▶—EVEEI115—◀◀

TWS Automation PPI and Gateway Failures

Usage: The automation routine EVEEI115 is intended to respond to the following messages.

```
DFHPA1104 applid SPECIFY ALTERNATIVE SIT PARAMETERS, IF ANY, AND THEN TYPE '.END'.
DFHPA1105 applid CONTINUE SPECIFYING SIT PARAMETERS AND THEN TYPE '.END'.
```

The automation routine will reply with the data specified in the INGREQ command, INGSET command or the CICSOVRD command. The START= parameter is always specified and is the start type as coded in the INGREQ command. Data from the INGREQ applparms field is appended. Alternatively, data from the CICSOVRD command or INGSET command is appended. Please note, there is only one field for this override, order of processing is INGREQ applparms take precedence over INGSET or CICSOVRD which both update the same field.

EVEEI004

Purpose: This routine will determine the version number of the CICS subsystem being started.

This routine is intended to be invoked from the Automation Table

Format:

▶▶—EVEEI004—*version*—————▶▶

Parameters:

version CICS version in *version.release.modlevel* format.

Usage: The automation routine EVEEI004 is intended to process the following message.

```
DFHSI1500 applid element startup is in progress for CICS Transaction Server Version version
```

The automation routine will get the version number and store it for later use. In addition the routine will optionally write an SMF record to record the start of the CICS subsystem.

EVEEI006

Purpose: This routine will determine the start type of the CICS subsystem being started.

This routine is intended to be invoked from the Automation Table

Format:

▶▶—EVEEI006—————▶▶

Usage: The automation routine EVEEI006 is intended to process the following message.

```
DFHSI1502I applid CICS startup is {Cold | Warm | Emergency | Initial}.
```

EVEEI009

Purpose: This routine will set the CICS, CICSplex CMAS or the PPI associated with the CICS subsystem to UP.

This routine is intended to be invoked from the Automation Table

Format:

▶▶—EVEEI009—┐
 └PPI┘

Parameters:

PPI Specifies that the PPI not the CICS Subsystem is in UP state.

Usage: The automation routine EVEEI009 is intended to process the following messages.

DFHSI1517 applid Control is being given to CICS.
EYUXL0010I CMAS initialization complete
EVE172I applid : PPI active.

EVEEI010

Purpose: This routine will start active monitoring for Link Monitoring and Health Checking.

This routine is intended to be invoked from the Automation Table

Format:

▶▶—EVEEI010—▶▶

Usage: The automation routine EVEEI010 is intended to process the following message.

EVE172I applid : PPI active.

EVEECMSI

Purpose: This routine will detect that the CICS subsystem being started is actually a CICSplex CMAS instead of a normal CICS subsystem.

This routine is intended to be invoked from the Automation Table

Format:

▶▶—EVEECMSI—▶▶

Usage: The automation routine EVEECMSI is intended to process the following message.

EYUXS1002I Interval Timing initialization complete

CICS Transaction Recovery

EVEERTRN

Purpose: This routine will handle transaction recovery.

This routine is intended to be invoked from the Automation Table

TWS Automation PPI and Gateway Failures

Format:



Parameters:

tranid Optional transaction id that has abended.

abend_code
Optional abend code.

program
Optional program name of abending program.

If no parameters are specified, these values are derived from the message that invoked this routine.

Usage: The automation routine EVEERTRN is intended to respond to the following messages.

DFHAC2231 date time applid Transaction tranid running program program name term
termid has lost contact with its coordinator system during syncpoint and
has abended with code ASP1. The unit of work is shunted until contact is
restored{. EXCI job = }exci_id. condmsg

DFHAC2232 date time applid Transaction tranid running program program name term
termid has lost contact with its coordinator system during syncpoint and
has abended with code ASP0. All updates will be unilaterally
committed{. EXCI job = }exci_id. condmsg

DFHAC2233 date time applid Transaction tranid running program program name term
termid has lost contact with its coordinator system during syncpoint and
has abended with code ASPP. All updates will be unilaterally backed
out{. EXCI job = }exci_id. condmsg

DFHAC2236 date time applid Transaction tranid abend secondary abcode in program
program name term termid. Updates to local recoverable resources will be
backed out{. EXCI job = }exci_id. condmsg

DFHAC2245 date time applid A CICS-generated syncpoint request could not be completed
normally because a connected system has requested that the unit of work be
rolled back. Transaction tranid running program program name term termid
has been abnormally terminated with code ASPF{. EXCI job = }exci_id. condmsg

DFHAC2246 date time applid Transaction termination processing could not be completed
normally because a connected system has requested that the unit of work be
rolled back. Transaction tranid, terminal termid has been abnormally
terminated with code ASPN{. EXCI job = }exci_id. condmsg

DFHAC2247 date time applid Transaction tranid running program program name term
termid has requested rollback, but was using a type of processing for which
rollback is not supported. The transaction has been abnormally terminated
with code ASP8 {. EXCI job = }exci_id. condmsg

DFHAC2248 date time applid Transaction tranid running program program name term
termid has failed with abend ASP7 following the failure of a local
resource owner in the prepare phase of syncpoint. Updates will be backed
out{. EXCI job = }exci_id. condmsg

DFHAC2249 date time applid Transaction tranid running program program name term
termid has failed with abend ASP7 following the failure of a remote system
in the prepare phase of syncpoint. Updates will be backed
out{. EXCI job = }exci_id. condmsg

DFHAC2251 date time applid Transaction tranid running program program name term
termid has failed with abend ASPQ. Syncpoint commit processing has failed
while communicating with a remote system{. EXCI job = }exci_id. condmsg

DFHAC2252 date time applid Transaction tranid in program program name term termid
has lost contact with its coordinator system during syncpoint processing.
No updates have been performed by this system; it has abended with code
ASPR{. EXCI job = }exci_id. condmsg

```
DFHAC2253 date time applid Transaction tranid running program program name term
          termid has failed with abend ASP2 due to the links to the remote systems
          being in an invalid state. Updates will be backed out{. EXCI job = }exci_id.
          condmsg
```

Note, these messages are not normally issued to the system console, so if transaction recovery is required the messages should be included in the MESSAGES/USER DATA policy so that the CICS message exit will force CICS to WTO them.

CICS Unit of Work Recovery

EVEETUOW

Purpose: This routine will process messages to handle the status of the UOW processing. It provides two services:

1. Detecting if units of work are outstanding at CICS shutdown and optionally forcing an AUTO start for the next start up of the CICS subsystem.
2. Detecting if an INITIAL start is required and optionally forcing an INITIAL start at the next start up of the CICS subsystem.

This routine is intended to be invoked from the Automation Table

Format:

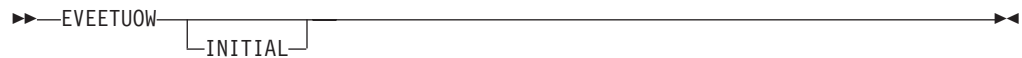

Parameters:

INITIAL

Optional, specified when INITIAL restart is to be forced.

Usage: The automation routine EVEETUOW is intended to respond to the following messages.

- ```
DFHDM0106 applid The Domain Manager records on the CICS Catalog may have been
 corrupted.
DFHLG0736 applid A failure has occurred while reading from the system log
 (journalname). The requested data could not be found. CICS will be
 quiesced allowing some tasks to complete. Further work requires an
 initial start.
DFHLG0738 applid A failure has occurred while reading the system log (journalname).
 The requested data could not be found. CICS will be terminated. Further
 work requires an initial start.
DFHLG0740 applid While writing data to the system log (journalname), a lost data
 warning was received. CICS will be quiesced without logging, allowing
 tasks to complete. Further work requires an initial start.
DFHRM0130 applid Recovery manager has successfully quiesced.
DFHRM0134 applid Recovery manager domain failed reading the global catalog, or
 did not find its control record.
DFHRM0136 applid The applid has changed from old_applid to new_applid. Recovery
 cannot continue.
DFHRM0144 applid Recovery manager catalog record indicates that no recovery is
 possible. An initial start is required.
DFHRM0203 applid There are indoubt_uows indoubt, cfail_uows commit-failed and
 bfail_uows backout-failed UOWs.
DFHRM0204 applid There are no indoubt, commit-failed or backout-failed UOWs.
DFHRM0400 applid A unit of work was incompletely reconstructed from the system log.
DFHRM0401 applid There is no system log or an empty system log has been detected.
```

## TWS Automation PPI and Gateway Failures

### EVEET002

**Purpose:** This routine will process messages to handle the status of the UOW processing.

This routine is intended to be invoked from the Automation Table

**Format:**

▶▶—EVEET002—

**Usage:** The automation routine EVEET002 is intended to respond to the following message.

DFHRM0130 applid Recovery manager has successfully quiesced.

---

## IMS-Related Processing and Recovery



## EVIEX002—Retrieve IMS Subsystem Data

### Purpose

The purpose of this command is to retrieve data from the IMS subsystem information.

### Syntax

```
EVIEX002 subsystem,keyword1,...keywordN
```

### Parameters

*subsystem*

The name of the subsystem for which the information will be retrieved.

*keywordN*

The name of the keyword of the data to return. The possible values are:

BUILDQCKPT, DBRCRESRV, DCSTATUS, DEPREGID, ENDDT,  
LASTABENDCODE, RUNSTARTYPE, STARTDT, STARTTYPE, VER.

For more information about the keywords, refer to common routine “EVIEX003—Update IMS Subsystem Data” on page 192.

### Usage

When the EVIEX002 command is issued, the values will be returned in the following task global variables:

1. EVISTSV $n$

These variables will contain the value of the keywords in the order in which they were requested. These variables are used for any number of keywords requested. If the keyword requested is invalid, the value returned will be blanks.

2. EVISTSN

This variable contains the value of the number of keywords requested.

### Examples

The following example shows how to call EVIEX002 from within a REXX CLIST. The results (as they would appear at a NCCF operator session) are displayed after the sample CLIST.

```

/*****/
TRACE OFF
SAY 'THIS IS AN EXAMPLE OF A CALL TO COMMON ROUTINE EVIEX002'
'EVIEX002 IMS05Z,STARTTYPE,RSTCKPT'
'GLOBALV GETT EVISTSV1 EVISTSV2 EVISTSN'
SAY 'EVISTSV1 VARIABLE IS: ' EVISTSV1
SAY 'EVISTSV2 VARIABLE IS: ' EVISTSV2
SAY 'EVISTSN VARIABLE IS: ' EVISTSN
RETURN

```

### Note:

Sample output

```

THIS IS AN EXAMPLE OF A CALL TO COMMON ROUTINE EVIEX002
EVISTSV1 VARIABLE IS: AUTO
EVISTSV2 VARIABLE IS: 93301/081251
EVISTSN VARIABLE IS: 2

```

## EVIEX003—Update IMS Subsystem Data

### Purpose

The purpose of this command is to update data on the IMS subsystem information.

### Syntax

```
EVIEX003 subsystem,keyword1=value1,...keywordN=valueN
```

### Parameters

*subsystem*

The name of the subsystem for which the information will be updated.

*keywordN*

The name of the field to be updated.

*valueN*

The value of the field to be updated.

The following keywords can be specified:

#### **BUILDQCKPT=**

Specifies the last checkpoint ID that is valid for loading DC blocks.

The value is extracted from message DFS3804I, which indicates the completion of an IMS checkpoint.

The format is yyddd/hhmmss.

#### **DBRCRESRV=**

Specifies the DBRC (IMS Database Recovery Control) reserve indicator. This will tell the old active that a reserve has been detected. The old active will then cancel its DBRC to free the reserve, allowing the new active to proceed with the takeover. The possible values are RESERVE or blank.

#### **DCSTATUS=**

Specifies the value of the Data Communication Status field.

The possible values are UP, STOPPED, or DOWN.

#### **DEPREGID=**

Exists only for dependent regions; specifies the ID of the dependent processing region: Fast Path, Message, or Batch.

#### **ENDDT=**

Specifies the date and time that the IMS subsystem terminated. Normally, this is when IMS shutdown message DFS994I has been processed.

The format is dd/mm/yy,hh:mm:ss.

The value is set to '--/--/--,--:--:--', when the termination of the IMS subsystem is initiated (due to the fact that a stop request has been issued, or when an IMS subsystem is about to abend and message DFS629I is being processed).

#### **LASTABENDCODE=**

Specifies the abend code for the last abnormal termination of the particular IMS subsystem.

**RUNSTARTYPE=**

Specifies the last requested start type. The field is populated after receiving message DFS629I, DFS627I, or IEF450I, indicating that an IMS has terminated.

The possible values are:

**AUTO**

The IMS system has been started with 'AUTO=Y'.

**BUILDQ**

The IMS system has been started using the BUILDQ entry from the STARTUP policy item.

A BUILDQ start implies that all messages on the queues are to be saved across restarts.

**COLD**

The IMS system has been COLD started.

**MANUAL**

The IMS system has been started using the IMS subsystem RESTART command, entered by the user.

**WARMSDBL**

The IMS system has been started by loading the Main Storage Date Base (MSDB) during a WARM start.

**STARTDT=**

Specifies the time and date when message DFS3410I has been received during IMS startup. At the same time, SERVSTARTDT is set to a value of '--/--/--,--:--:--'.

The format is dd/mm/yy,hh:mm:ss.

**STARTTYPE=**

Specifies the start type to be used to start the IMS system. The possible values are:

**AUTO**

The IMS system will be started with 'AUTO=Y'.

**BUILDQ**

The IMS system will be started using the BUILDQ entry from the STARTUP policy item.

A BUILDQ start implies that all messages on the queues are to be saved across restarts.

**COLD**

The IMS system will be COLD started using the 'COLD' entry from the STARTUP policy item.

**MANUAL**

The IMS system will be started using RESTART commands, entered by the user.

**WARMSDBL**

The IMS system will be started by loading the Main Storage Date Base (MSDB) during a WARM start.

**VER=**

Specifies the IMS product version and release level executing in the particular IMS subsystem. It has the format "version.release".

## EVIEX003

### **Usage**

When the EVIEX003 command is issued, the values for the named subsystem will be changed in the status file.

No validation is performed on the values you specify. If you specify incorrect values, unpredictable results can occur.

### **Examples**

If the following statement were coded:

```
EVIEX003 IMSCTL,DCSTATUS=UP
```

The IMS subsystem information for the subsystem IMSCTL would be updated to reflect the value of UP for the data field DCSTATUS.

## IMSBMSG—Build Message Processor

### Purpose

This processor allows programs written in REXX, NetView command lists, and high level languages to build a single or multi-line message and have it delivered to a designated task on any connected NetView domain.

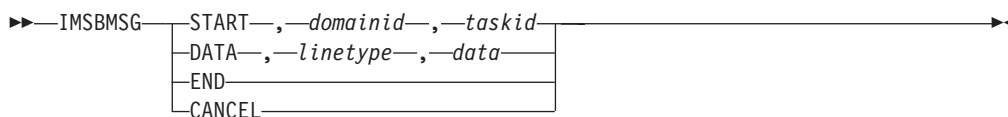

The parameters are positional.

### START

This parameter is used for the first call to IMSBMSG. Parameters on the START indicate the target of the message or messages, where *domainid* is the identifier of the domain to which the message is to be routed and *taskid* is the identifier of the task on that domain. The *taskid* can be a real operator name or the name of an autotask on the receiving system.

### DATA

This identifies a user message being passed to the IMSBMSG processor where *linetype* and *data* is the message that is to be passed to the target task to which the message is to be routed. The line type of the element of a multi-line message, valid values, and their meanings are as follows.

|          |                    |
|----------|--------------------|
| <b>C</b> | Control line       |
| <b>L</b> | Label line         |
| <b>D</b> | Data line          |
| <b>E</b> | End line           |
| <b>F</b> | End-with-data line |
| <b>S</b> | Single line.       |

If a multi-line message is to be issued, a valid combination of line types must be passed.

### END

Indicates to the IMSBMSG processor that processing is complete. It causes the processor to route previously issued data lines to the target indicated on the IMSBMSG START command. All storage obtained during processing is released. An IMSBMSG START must be issued before any other DATA items.

### CANCEL

This indicates to the IMSBMSG processor that processing is not to continue. All storage is released without any message being issued. Use CANCEL to abort the message.

### Usage

1. All calls must be made from the same invocation of the same program.
2. A correct sequence of line types should be passed. However, if the processor detects that a multi-line message is being passed and no E or F type has been received by the time the IMSBMSG END is received, then message **EVI698 END generated** is added to the group.
3. Single-line and multi-line messages can be mixed in the same START-END bracket.
4. The return codes are:
 

|          |     |
|----------|-----|
| <b>0</b> | OK. |
|----------|-----|

## IMSBMSG

|  |    |                                                                   |
|--|----|-------------------------------------------------------------------|
|  | 4  | Invalid type. Type should be START, DATA, END or CANCEL.          |
|  | 8  | Invalid line type. Type should be C, L, D, E, F, or S.            |
|  | 12 | Execution failed. A message is issued that describes the failure. |
|  | 16 | DATA, END or CANCEL issued without START.                         |
|  | 20 | START issued while previous start in effect.                      |
|  | 24 | Wrong number of parameters.                                       |
|  | 28 | Invalid domainid. Ensure the domainid specified is correct.       |
|  | 32 | The domain identified by domainid is not active.                  |
|  | 36 | The taskid specified is invalid or not active.                    |
|  | 40 | The value of the CGLOBAL EVI_BASE_PRODUCT is NULL or invalid.     |

### Examples

The following example shows how to call IMSBMSG from within a REXX CLIST. The results (as shown on an operator NCCF session) follow the code sample.

```

/*****
TRACE OFF
TRACE OFF
SAY 'THIS IS AN EXAMPLE OF A CALL TO COMMON ROUTINE IMSBMSG'

'IMSBMSG START,AOF05,ROMAN'
'IMSBMSG DATA,S,This is a test..... '
'IMSBMSG END'

SAY 'RC FROM IMSBMSG IS : ' RC

RETURN

```

#### Note:

Sample output  
CLISTX

```

THIS IS AN EXAMPLE OF A CALL TO COMMON ROUTINE IMSBMSG
THIS IS A TEST.....
RC FROM IMSBMSG IS : 0

```

**Note:** Data is echoed back to caller.

## IMSCMD—Issue IMS Commands

### Purpose

IMSCMD now acts as a stub for INGIMS for compatibility. Refer to *IBM Tivoli System Automation for z/OS Operator's Commands* for information on the INGIMS command.

▶—IMSCMD—*subsystem*—*IMS\_command*—▶

### Parameters

*subsystem*

The IMS subsystem that can be controlled by the domain. It can be either a local or a remote IMS subsystem.

*IMS\_command*

The actual IMS command to be issued.

### Usage

Refer to *IBM Tivoli System Automation for z/OS Operator's Commands* for comments and usage on the INGIMS command.

**Note:** The IMS command prefix character "/" is now optional for IMSCMD. Also the IMS subsystem can be represented by a fully defined SA z/OS resource (for example, IMS811C4/APL/SYS1).

### Examples

IMSCMD IMSCTL DIS A DC

```
DFS4444I DISPLAY FROM ID=M911
 VTAM STATUS AND ACTIVE DC COUNTS
 VTAM ACB OPEN -LOGONS ENABLED
 IMSLU=N/A.N/A APPC STATUS=DISABLED TIMEOUT= 0
 OTMA GROUP=N/A STATUS=NOTACTIVE
 APPC/OTMA SHARED QUEUE STATUS - LOCAL=INACTIVE GLOBAL=INACTIVE
 APPC/OTMA RRS MAX TCBS - 40 ATTACHED TCBS - 1 QUEUED RRSWKS-
 0
 APPLID=IPSAMI91 GRSNAME= STATUS=DISABLED
 LINE ACTIVE-IN - 1 ACTIV-OUT - 0
 NODE ACTIVE-IN - 0 ACTIV-OUT - 0
 05237/075227
*** END OF DISPLAY ***
```

## IMSQRV—Name Lookup

### Purpose

Use this routine to retrieve IMS subsystem information.

Note that IMSQRV does not recognize subsystems that are in FALLBACK or MOVED status.

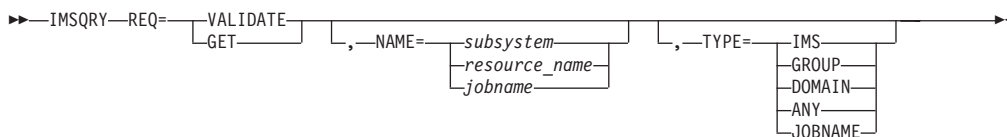

### Parameters

#### REQ=

The request type. The request types are:

##### VALIDATE

IMS Automation searches for the name (NAME=) and type (TYPE=) specified to validate the name.

##### GET

IMS Automation searches for a specific IMS subsystem to retrieve the subsystem characteristics. NAME= is valid with this request.

NAME={*subsystem* | *resource\_name* | *jobname*}

Used with VALIDATE to provide a specific subsystem, resource or job name for the search. Used with GET to provide a specific subsystem value. Valid values for the NAME= variables are:

|                      |                                                                                                                     |
|----------------------|---------------------------------------------------------------------------------------------------------------------|
| <i>subsystem</i>     | The name by which an IMS subsystem is known to SA z/OS                                                              |
| <i>resource_name</i> | The resource name in the <i>name/APL/system</i> format. Thus, the type must be APL; APG, for example, is not valid. |
| <i>jobname</i>       | The jobname by which an IMS subsystem is known to SA z/OS.                                                          |

#### TYPE=

Used to provide a specific type. The types are:

##### IMS

Search for a specific IMS subsystem name, as it is known to SA z/OS. This is the default type. IMS is used with VALIDATE.

##### ANY

Search for an IMS name first, then a domain, then a group name. If the name is longer than 5 characters the search for a domain is bypassed. ANY is used with VALIDATE.

##### DOMAIN

The NetView domain name coded in DSIDMNK with the NCCFID parameter.

**Note:** For NetView 5.1 and above DSIDMNK entries have been moved to CNMSTYLE.

##### GROUP

If you specify GROUP, IMSQRV returns the name of the group to which the subsystem belongs in the EVILOOKUP\_GROUP variable.

##### JOBNAME

Used with GET to provide a specific jobname. Works only when NAME=jobname.



## Usage

- Valid IMSQR return codes include:

| RC | Meaning                                                                                                                                                                    |
|----|----------------------------------------------------------------------------------------------------------------------------------------------------------------------------|
| 0  | Good.                                                                                                                                                                      |
| 4  | An internal error occurred.                                                                                                                                                |
| 8  | A timeout occurred on a request forwarded to a remote system.                                                                                                              |
| 12 | An internal error occurred.                                                                                                                                                |
| 20 | A subsystem, group, or domain was not found for the search criteria specified.                                                                                             |
| 24 | The parameters for this request are invalid.                                                                                                                               |
| 28 | An internal error occurred.                                                                                                                                                |
| 32 | Unsupported function.                                                                                                                                                      |
| 36 | Resource name is ambiguous (more than one resource of the same name exists within the sysplex but none are defined on the local system).                                   |
| 40 | System name where the IMS resource resides is not unique within the enterprise.                                                                                            |
| 44 | The IMS resource is not unique within the enterprise and its resource tree contains more than one MOVE vgroup (MOVE groups within MOVE groups are not supported by IMSQR). |

- The following are set in the caller's variable pool:

### EVILOOKUP\_NAME

Set to the value of the NAME= parameter, otherwise set to null.

### EVILOOKUP\_TYPE

Set to the value of the TYPE= parameter, unless TYPE=ANY in which case it is set to IMS or DOMAIN or GROUP as appropriate.

### EVILOOKUP\_JOBNAME

The jobname associated with the subsystem.

### EVILOOKUP\_DOMAIN

The NetView domain on which the SA z/OS managing this subsystem is running.

### EVILOOKUP\_AUTOOPS

The NetView automated operator that handles automation for this subsystem.

### EVILOOKUP\_USERVAR

The VTAM USERVAR (or generic application ID) associated with this subsystem. This is set to '\*\*\*\*\*' if a VTAM USERVAR is not defined.

### EVILOOKUP\_SUBTYPE

The value of the **Subtype** field in the IMS ENVIRON policy item .

### EVILOOKUP\_APPLID

The specific VTAM application ID associated with this subsystem.

### EVILOOKUP\_RESHOME

The location of the resource in the following format:

*sysplex.domain.system\VxRyMz*

### EVILOOKUP\_RESLIST

The resource name in the following format

*name/type/system*

## IMSQRY

| **EVILOOKUP\_AGENTDATA**  
| Information about the agent responsible for the subsystem in the  
| following format  
| *agent\_name sysplex\_name system domain agent\_version [NetView\_version]*

| **EVILOOKUP\_GROUP**  
| The name of the group(s) to which the resource belongs.  
|

## IMSRCMD—Request an IMS Function

### Purpose

This common routine is used to perform the requested function (CMD=) on the domain where the named IMS resides, whether local or remote. The calling program does not have to be aware of where the IMS resides. It is particularly useful with single-point-of-control as IMSRCMD first determines the domain in which the subsystem resides before building and issuing the request. It then either calls the requested function if the subsystem is on the local domain, or it forwards the command to the remote domain, thus allowing cross-domain communications.

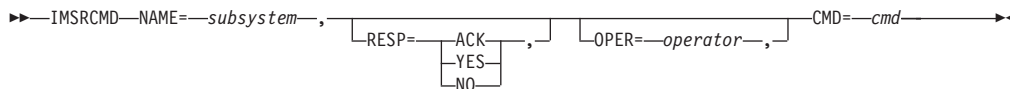

### Parameters

#### NAME=

The name by which the target IMS subsystem is known to SA z/OS, as defined in the APPLICATION policy object.

#### RESP=

Send back a response (YES or NO) or just send an acknowledgement (ACK).

#### OPER=

The operator, on the target domain, that will execute this command. If this is omitted, the work operator assigned to the subsystem will be used.

#### CMD=

The requested function to be performed. This may be delimited by single quotes, double quotes, or slashes.

### Usage

The return codes are:

| RC | Meaning                                   |
|----|-------------------------------------------|
| 0  | Good                                      |
| 4  | Subsystem name was not supplied           |
| 8  | Function to be performed was not supplied |
| 12 | Incorrect keyword supplied                |
| 16 | Incorrect parameter for RESP supplied     |
| 20 | Subsystem was not found on any domain     |



## Appendix A. Global Variables

You must ensure that the names of any global variables you create do not clash with SA z/OS external or internal global variable names. You should check the following tables before creating any global variables of your own.

### Read-Only Variables

There are two different classes of variables, based on the level of access available to the programmer:

**Class 1:**

Read-only variables. These variables are set by SA z/OS and require at minimum an automation control file reload to be changed.

**Class 2:**

Read-only variables. These variables are set by SA z/OS CLISTs. They should not be changed except by calling the appropriate CLISTs.

Table 5. Externalized Common Global Variables

| Variable Name         | Description                                                                                                                                                                                                                               | Class | Reference                                                                                                                           |
|-----------------------|-------------------------------------------------------------------------------------------------------------------------------------------------------------------------------------------------------------------------------------------|-------|-------------------------------------------------------------------------------------------------------------------------------------|
| AOF.clst.0DEBUG       | Contains either a Y or blank. If it contains Y then an intermediate level of debug supported by SA z/OS CLISTs is turned on.                                                                                                              | 2     |                                                                                                                                     |
| AOF.clst.0TRACE       | Contains a REXX trace setting to be used by the CLIST <i>clst</i> .                                                                                                                                                                       | 2     |                                                                                                                                     |
| AOFAOCCLOn            | Where <i>n</i> either does not exist (AOFAOCCLOn) or is a value from 1 through 9 or A through Z. The AOFAOCCLOn global variables contain the values specified for the &AOCCLOn. IDs for this system.                                      | 1     | See the description of the <i>System</i> policy object in <i>IBM Tivoli System Automation for z/OS Defining Automation Policy</i> . |
| AOFCOMPL              | Contains YES if initialization is complete.                                                                                                                                                                                               | 2     |                                                                                                                                     |
| AOFDEBUG              | Contains a REXX trace setting to be used globally.                                                                                                                                                                                        | 2     | See <i>IBM Tivoli System Automation for z/OS Planning and Installation</i> .                                                        |
| AOFINITIALSTARTTYP    | Contains the value 'IPL' or 'RECYCLE' depending on whether SA z/OS has been started the first time after an IPL or after a NetView recycle.                                                                                               | 1     |                                                                                                                                     |
| AOF_NETWORK_DOMAIN_ID | Contains the domain name for the NetView that runs network automation as defined in the customization dialog. If not defined, the value of this variable is null.                                                                         | 1     | See the description of the <i>System</i> policy object in <i>IBM Tivoli System Automation for z/OS Defining Automation Policy</i> . |
| AOF_PRODLVL           | Contains the release level of AOC/MVS or SA z/OS. <ul style="list-style-type: none"> <li>For SA OS/390 2.2, the value is V2R2M0.</li> <li>For SA z/OS 2.3, the value is V2R3M0.</li> <li>For SA z/OS 3.1, the value is V3R1M0.</li> </ul> | 1     |                                                                                                                                     |

## Global Variables

Table 5. Externalized Common Global Variables (continued)

| Variable Name | Description                                                               | Class | Reference                                                                            |
|---------------|---------------------------------------------------------------------------|-------|--------------------------------------------------------------------------------------|
| AOFJESPREFIX  | The command prefix for the primary scheduling subsystem.                  | 1     |                                                                                      |
| AOFSUBSYS     | The subsystem name of the primary scheduling subsystem.                   | 1     |                                                                                      |
| AOFSYSNAME    | Contains the name of the system.                                          | 1     | See AOCUPDT in <i>IBM Tivoli System Automation for z/OS Programmer's Reference</i> . |
| AOFSYSTEM     | Contains the system type (MVSESA) as defined in the customization dialog. | 1     | The SYSTEM INFO panel of the customization dialog.                                   |

## Read/Write Variables

Table 6 on page 205 lists the common global variables that can be user-defined. You can set them in your startup exit to change the way that SA z/OS behaves. These variables should be set only once for an SA z/OS system. You can enable or disable advanced automation options (AAOs) by changing the settings of the global variables in your initialization defaults exit (AOFEXDEF).

The following is an example on how to use the AOFEXDEF exit to assign a value to the CGLOBAL AOFRPCWAIT:

```
aofrpcwait = '30'
'GLOBALV PUTC AOFRPCWAIT'
```

Alternatively you can use the CNM stylesheet:

```

* System Automation AAO CGlobals

COMMON.AOFCNMASK = 290C0D0E0F101518
COMMON.INGREQ_ORIGINATOR = 1
COMMON.AOFRESTARTALWAYS = 0
COMMON.AOFUPDRODM = NO
COMMON.AOFUPDAM = NO
COMMON.AOFSMARTMAT = 0
```

After modifying the exit, an SA z/OS COLD START is required for these changes to take effect.

Table 6. Global Variables to Enable Advanced Automation (CGLOBALS)

| Variable                     | Value        | Effect                                                                                                                                                                                                                                                                  |
|------------------------------|--------------|-------------------------------------------------------------------------------------------------------------------------------------------------------------------------------------------------------------------------------------------------------------------------|
| AOF_AAO_MSG_EHKVAR           | YES          | This indicates that when calling generic routines, the tokens of the triggering message are to be stored in variables EHKVAR0 through EHKVAR9 and EHKVART, if not specified in parameter EHKVAR.<br>YES is the default.                                                 |
| AOF_ASSIGN_JOBNAME           | NO           | This indicates that the tokens of the triggering message are not to be stored in EHKVAR variables, if not specified in parameter EHKVAR.                                                                                                                                |
| AOF_ASSIGN_JOBNAME           | 1            | This indicates that SA z/OS will exploit Tivoli NetView "ASSIGN BY JOBNAME" feature.<br>This is the default setting.                                                                                                                                                    |
| AOF_AAO_MVSTAPEMON           | 0            | SA z/OS will not exploit Tivoli NetView "ASSIGN BY JOBNAME" feature.                                                                                                                                                                                                    |
| AOF_AAO_MVSTAPEMON           | > 0          | Set this value to represent the number of iterations for INGRTAPE to continue monitoring using MVS commands after after the LATE alert has been reached. A non-zero entry will also indicate to use MVS commands for all tape mount monitoring prior to the LATE alert. |
| AOF_E2E_EAS_PPI              | 0            | INGRTAPE will rely on receipt of the DOMMED message to satisfy any outstanding alerts.                                                                                                                                                                                  |
| AOF_E2E_EVT_RETRY            | User-defined | PPI receiver ID of the event/automation service to be used to forward events to the end-to-end automation adapter.                                                                                                                                                      |
| AOF_E2E_TKOVN_TIMEOUT        | 1 to n       | Specifies the number of retries, at intervals of one second, that are used to transfer events via PPI TECROUTE to the message adapter of the event automation service. The events are destined to be forwarded to the end-to-end automation adapter.                    |
| AOF_EMCS_AUTOTASK_ASSIGNMENT | hh:mm:ss     | If a hot restart of the automation manager takes longer than the value specified in this variable, the end-to-end automation manager is informed about the outage and has to resynchronize with the first-level automation.                                             |
| AOF_EMCS_CN_ASSIGNMENT       | 1            | SA z/OS will assign an autotask to extended MCS consoles with a console status of MASTER or ACTIVE                                                                                                                                                                      |
| AOF_EMCS_CN_ASSIGNMENT       | 0            | SA z/OS will not assign an autotask to extended MCS consoles with a console status of MASTER or ACTIVE<br>0 is the default.                                                                                                                                             |
| AOF_EMCS_CN_ASSIGNMENT       | 1            | SA z/OS will obtain an extended MCS console with a unique name for operator station tasks (OSTs). If an MVS console was obtained for the OST previously, it will be released.<br>1 is the default setting.                                                              |
| AOF_EMCS_CN_ASSIGNMENT       | 0            | SA z/OS will not obtain an extended MCS console with a unique name for OSTs and the command AOCGETCN will be disabled.                                                                                                                                                  |

## Global Variables

Table 6. Global Variables to Enable Advanced Automation (CGLOBALS) (continued)

| Variable         | Value                       | Effect                                                                                                                                                                                                                                                                                                                   |
|------------------|-----------------------------|--------------------------------------------------------------------------------------------------------------------------------------------------------------------------------------------------------------------------------------------------------------------------------------------------------------------------|
| AOFACFINIT       | 1                           | This indicates that SA z/OS will attempt to proceed with initialization despite error messages such as AOF722I during the processing of the automation control file.<br>1 is the default setting.                                                                                                                        |
|                  | 0                           | SA z/OS will stop the initialization process upon such errors.                                                                                                                                                                                                                                                           |
| AOFARMQUERYRETRY | User-defined numeric value. | The number of times AOFARMQ will be called to query the ARM status of an element after a status of UNKNOWN is returned. If the ARM status does not change to another status before the number of retries is exhausted, SA z/OS will continue processing and assume the element is not ARM-enabled.<br>The default is 10. |
| AOFARMQUERYWAIT  | User-defined numeric value. | The number of seconds to wait between retries as specified in the AOFARMQUERYRETRY value above.<br>The default is 15.                                                                                                                                                                                                    |



Table 6. Global Variables to Enable Advanced Automation (CGLOBALS) (continued)

| Variable          | Value             | Effect                                                                                                                                                                                                                                                                                                                                                                                                                                                                                                                                                                                                                                                                                                                                                                                                                                                                                                                                                                                                                                                                                                                                                                                                                                                                                                                                                                                                                                                                |
|-------------------|-------------------|-----------------------------------------------------------------------------------------------------------------------------------------------------------------------------------------------------------------------------------------------------------------------------------------------------------------------------------------------------------------------------------------------------------------------------------------------------------------------------------------------------------------------------------------------------------------------------------------------------------------------------------------------------------------------------------------------------------------------------------------------------------------------------------------------------------------------------------------------------------------------------------------------------------------------------------------------------------------------------------------------------------------------------------------------------------------------------------------------------------------------------------------------------------------------------------------------------------------------------------------------------------------------------------------------------------------------------------------------------------------------------------------------------------------------------------------------------------------------|
| AOFCNMASK         |                   | <p>The characters that are used in determining unique console names can be tailored by updating the common global variable AOFCNMASK. This global is used as a hex mask to extract characters from the following string when generating unique console names with command AOCGETCN.</p> <pre> left(opid(),8)  right(opid(),8),   left(aofsysname,4)  right(aofsysname,4),   left(applid(),8)  right(applid(),8),   'ABCDEFHGHIJKLMNOPQRSTUVWXYZ0123456789\$&amp;#155;#@!?' </pre> <p>Where: opid() is a function which returns the OST task name<br/> aofsysname is a common global which stores the system name<br/> applid() is a function which returns VTAM LU name</p> <p>The default for AOFCNMASK is 290C0D0E0F101718. 29x selects character A in position 41, 0Cx - 10x selects the last five characters of the opid in positions 12 to 16, 17x and 18x select the last two characters of the sysname in positions 23 and 24. If AOFCNMASK is null, AOCGETCN will attempt to obtain a unique extended MCS console after a 1 minute interval, followed by a two minute interval and so forth for a maximum of 5 passes (15 minutes elapsed from the initial invocation of the command).</p> <p>For example:<br/> AOFCNMASK: 2A01020304051718</p> <p>2Ax selects character B in position 42, 01x - 05x selects the first five characters of the opid in positions 1 to 5, 17x and 18x select the last two characters of the sysname in positions 23 and 24.</p> |
| AOFCTLOPT         | YES               | This indicates that SA z/OS will ignore any IPL or RECYCLE options defined for a subsystem that has a status of CTLDOWN at SA z/OS initialization.                                                                                                                                                                                                                                                                                                                                                                                                                                                                                                                                                                                                                                                                                                                                                                                                                                                                                                                                                                                                                                                                                                                                                                                                                                                                                                                    |
|                   | NO                | SA z/OS will honor all IPL and RECYCLE option definitions at SA z/OS initialization.<br>NO is the default setting.                                                                                                                                                                                                                                                                                                                                                                                                                                                                                                                                                                                                                                                                                                                                                                                                                                                                                                                                                                                                                                                                                                                                                                                                                                                                                                                                                    |
| AOFDEFAULT_TARGET | User-defined      | Sets a default for the TARGET parameter for all commands where this parameter is used.                                                                                                                                                                                                                                                                                                                                                                                                                                                                                                                                                                                                                                                                                                                                                                                                                                                                                                                                                                                                                                                                                                                                                                                                                                                                                                                                                                                |
| AOFDESCA          | 01000010000001000 | Descriptor code for action messages                                                                                                                                                                                                                                                                                                                                                                                                                                                                                                                                                                                                                                                                                                                                                                                                                                                                                                                                                                                                                                                                                                                                                                                                                                                                                                                                                                                                                                   |
| AOFDESCD          | 01000010000001000 | Descriptor code for decision messages                                                                                                                                                                                                                                                                                                                                                                                                                                                                                                                                                                                                                                                                                                                                                                                                                                                                                                                                                                                                                                                                                                                                                                                                                                                                                                                                                                                                                                 |
| AOFDESCE          | 00100010000001000 | Descriptor code for eventual action messages                                                                                                                                                                                                                                                                                                                                                                                                                                                                                                                                                                                                                                                                                                                                                                                                                                                                                                                                                                                                                                                                                                                                                                                                                                                                                                                                                                                                                          |

Table 6. Global Variables to Enable Advanced Automation (CGLOBALS) (continued)

| Variable          | Value                             | Effect                                                                                                                                                                                                                                                                                                                                                                                                           |
|-------------------|-----------------------------------|------------------------------------------------------------------------------------------------------------------------------------------------------------------------------------------------------------------------------------------------------------------------------------------------------------------------------------------------------------------------------------------------------------------|
| AOFDESCI          | 0000011000001000                  | Descriptor code for informational messages                                                                                                                                                                                                                                                                                                                                                                       |
| AOFDESCW          | 1000001000001000                  | Descriptor code for wait messages                                                                                                                                                                                                                                                                                                                                                                                |
| AOFEXPLAIN_USER   | User-defined                      | The EXPLAIN command accepts this variable to include help support for customer installation supplied terms. It can hold one or more pairs of <i>term/help panel</i> specifications separated by a blank. If the specified status in the EXPLAIN command is not a valid SA z/OS status, the command routine will check whether it is an installation defined term. If so, the associated help panel is displayed. |
| AOFIMSCMDMSG      | 0                                 | IMSCMD will only produce messages generated by INGIMS.<br>0 is the default setting.                                                                                                                                                                                                                                                                                                                              |
| AOFINITREPLY      | 1<br><br>hh:mm:ss                 | IMSCMD will produce the EVI20L, EVI690L, EVI691I and EVI692I messages.<br>The initial reply AOF603D is issued and automatically responded after hh:mm.<br>00:02:00 (2 minutes) is the default setting.                                                                                                                                                                                                           |
| AOF_INIT_MCSFLAG  | 0<br><br>User-defined valid value | The initial reply AOF603D will not be issued and automation continues with the default start without asking the operator.<br>This variable contains the MCSFLAG that is used for WTOs and WTORS that are issued by SA z/OS during initialization.<br>The default is '00001000'.                                                                                                                                  |
| AOF_INIT_ROUTECD  | User-defined valid value          | This variable contains the ROUTCDE (routing code) that is used for WTOs and WTORS that are issued by SA z/OS during initialization.<br>The default is '10000000'.                                                                                                                                                                                                                                                |
| AOF_INIT_SYSCONID | User-defined valid value          | This variable contains the SYSCONID that is used for WTOs and WTORS that are issued by SA z/OS during initialization.<br>The default is '01'.                                                                                                                                                                                                                                                                    |
| AOFLOCALHOLD      | 0<br><br>1                        | INGNTFY and SA z/OS initialization will execute the SETHOLD AUTO command on the notify operator.<br>0 is the default setting.<br>SETHOLD must be manually invoked.                                                                                                                                                                                                                                               |
| AOFMATLISTING     | 0                                 | Setting this variable means that the Automation Table listing is not placed in the DSILIST data set at Automation Table load time.                                                                                                                                                                                                                                                                               |

Table 6. Global Variables to Enable Advanced Automation (CGLOBALS) (continued)

| Variable     | Value  | Effect                                                                                                                                                                                                                                                                                                                                                                                                                                  |
|--------------|--------|-----------------------------------------------------------------------------------------------------------------------------------------------------------------------------------------------------------------------------------------------------------------------------------------------------------------------------------------------------------------------------------------------------------------------------------------|
| AOFMOVOPT    | YES    | This indicates that SA z/OS will ignore any IPL or RECYCLE options defined for a subsystem that has a status of MOVED at initialization. This does not apply to any subsystem that is defined to Automatic Restart Manager that SA z/OS is aware of.                                                                                                                                                                                    |
|              | NO     | SA z/OS will honor all IPL and RECYCLE option definitions at SA z/OS initialization. NO is the default setting.                                                                                                                                                                                                                                                                                                                         |
| AOFOPCCMDMSG | 0      | OPCAMOD will only produce messages generated by INGOPC. 0 is the default setting.                                                                                                                                                                                                                                                                                                                                                       |
|              | 1      | OPCAMOD will produce EVJ011I, EVJ412I, EVJ420I, and EVJ423I messages.                                                                                                                                                                                                                                                                                                                                                                   |
| AOFPAUSE     | 0 to 5 | This is the number of seconds that SA z/OS will allow for applications that have shut down to be cleared by MVS, in addition to their termination delay. As the AOFPAUSE value is applied to all applications it should be kept small. AOFPAUSE may be useful on a slow machine, where allowing an extra second or two before SA z/OS checks if the application has been cleared could avoid the need to use a termination delay timer. |
|              |        | No matter how AOFPAUSE is set, the application status will not be updated to AUTODOWN or CTLDOWN until SA z/OS is sure that the application has been cleared from the system by MVS.                                                                                                                                                                                                                                                    |
|              | 0      | 0 is the default setting.                                                                                                                                                                                                                                                                                                                                                                                                               |
| AOFQUICKWTOR | 0      | Before a WTOR reply is responded to, an MVS display command is issued to check if it is outstanding.                                                                                                                                                                                                                                                                                                                                    |
|              | 1      | Trust the CGLOBALS for WTOR reply processing.                                                                                                                                                                                                                                                                                                                                                                                           |
|              |        | 1 is the default setting.                                                                                                                                                                                                                                                                                                                                                                                                               |
| AOFRELOADOPT | No     | Will ignore the Start on RECYCLE option during an ACF reload. This is the default.                                                                                                                                                                                                                                                                                                                                                      |
|              | Yes    | Will honour the Start on RECYCLE option during an ACF reload. If Start on RECYCLE is NO then an inactive subsystem will be set to CTLDOWN.                                                                                                                                                                                                                                                                                              |

Table 6. Global Variables to Enable Advanced Automation (CGLOBALS) (continued)

| Variable                 | Value                 | Effect                                                                                                                                                                                                                          |
|--------------------------|-----------------------|---------------------------------------------------------------------------------------------------------------------------------------------------------------------------------------------------------------------------------|
| AOFRESTARTALWAYS         | 1                     | An application that has been shut down normally, outside the control of SA z/OS, with RESTARTOPT=ALWAYS, will be restarted regardless of whether or not it has reached its critical error threshold.                            |
|                          | 0                     | An application that has been shut down normally, outside the control of SA z/OS, with RESTARTOPT=ALWAYS, will <i>not</i> be restarted if it has reached its critical error threshold. 0 is the default setting.                 |
| AOFRMTCMDWAIT            | See NetView<br>RMTCMD | Contains the installation wait time when RMTCMD is used for communication.                                                                                                                                                      |
| AOFRPCWAIT               | 0 to n                | 60 seconds is the default setting for RMTCMD.<br>This is the number of seconds that SA z/OS will wait for command responses from other systems in the sysplex.                                                                  |
| AOFSENDALERT             | Yes or No             | 10 is the default setting.<br>This defines whether NetView alert forwarding (YES) or the command handler (NO) is used to forward data to the focal point.                                                                       |
| AOFSEXINT                | 1                     | Yes is the default setting.<br>The exit AOFEXINT is processed under the BASEOPER automation operator under the initialization process. This is the default.                                                                     |
|                          | 0                     | The exit AOFEXINT execution is serialized within the initialization process.                                                                                                                                                    |
| AOF_SET_AVM_RESTART_EXIT | 1                     | SA z/OS will set the AVM restart exit during the initialization of the automation environment.                                                                                                                                  |
|                          | 0                     | 1 is the default.<br>The AVM restart exit needs to be set in the SYS1.PARMLIB PROGxx member. Please refer to <i>IBM Tivoli System Automation for z/OS Planning and Installation</i> for more information.                       |
| AOFSHUTDELAY             | 0 to 59               | This is the number of minutes that SA z/OS will wait for a termination message before continuing the shutdown process. Any values outside this range are treated as 0. With a setting of 0, message AOF745E will not be issued. |
|                          |                       | 0 is the default setting.                                                                                                                                                                                                       |

Table 6. Global Variables to Enable Advanced Automation (CGLOBALS) (continued)

| Variable        | Value     | Effect                                                                                                                                                                                                                                                                                                                                                                                                                                                                                                                      |
|-----------------|-----------|-----------------------------------------------------------------------------------------------------------------------------------------------------------------------------------------------------------------------------------------------------------------------------------------------------------------------------------------------------------------------------------------------------------------------------------------------------------------------------------------------------------------------------|
| AOFSMARTMAT     | 0         | The SA z/OS Agent is disabled from refreshing ATs. The AT fragment INGMMSG02 (as delivered with SA z/OS) is included when SA z/OS initially loads INGMMSG01.                                                                                                                                                                                                                                                                                                                                                                |
|                 | 1         | The SA z/OS Agent is enabled to refresh ATs when an INGAMS REFRESH is issued. The AT fragment built by the customization dialog is <i>not</i> loaded; INGMMSG02, that is delivered with SA z/OS, is used instead.<br><br>The ATs will be loaded after a successful test load. This will allow the agent to inform the AM about a load problem of the AT. The agent may inform the AM of an AT load failure, thus stopping the configuration refresh.                                                                        |
|                 | 2         | The SA z/OS Agent is enabled to load the AT that is generated by the customization dialog and to refresh ATs when an INGAMS REFRESH is issued. The AT that is built by the customization dialog is dynamically loaded into storage as the INGMMSG02 fragment.<br><br>The ATs will be loaded after a successful test load. This will allow the agent to inform the AM about a load problem of the AT. The agent may inform the AM of an AT load failure, thus stopping the configuration refresh. This is the default value. |
| AOFPOOLFULLCMD  | 1         | SA z/OS will not execute the Spool recovery passes more than once. Message AOF2941I will be issued if the SPOOLFULL condition persists.                                                                                                                                                                                                                                                                                                                                                                                     |
|                 | 0         | SA z/OS will re-execute the Spool recovery commands.<br><br>0 is the default setting.                                                                                                                                                                                                                                                                                                                                                                                                                                       |
| AOFPOOLSHORTCMD | 1         | SA z/OS will not execute the Spool recovery passes more than once. Message AOF2941I will be issued if the SPOOLSHORT condition persists.                                                                                                                                                                                                                                                                                                                                                                                    |
|                 | 0         | SA z/OS will re-execute the Spool recovery commands.<br><br>0 is the default setting.                                                                                                                                                                                                                                                                                                                                                                                                                                       |
| AOFSTATUSCMDSEL | 0         | Issue all status commands associated with the new status. If AOFSTATUSCMDSEL is not set, or set to a value other than 0, then only commands associated with the startype or stopype are issued.                                                                                                                                                                                                                                                                                                                             |
| AOFUPDAM        | Yes or No | This controls whether updates are made in the automation manager.<br><br>No is the default setting.                                                                                                                                                                                                                                                                                                                                                                                                                         |
| AOFUPDRODM      | Yes or No | This controls whether updates are made in RODM and must be set to the same value for each system within a sysplex.<br><br>No is the default setting.                                                                                                                                                                                                                                                                                                                                                                        |

Table 6. Global Variables to Enable Advanced Automation (CGLOBALS) (continued)

| Variable          | Value    | Effect                                                                                                                                                                                                                                                                                                                                                                              |
|-------------------|----------|-------------------------------------------------------------------------------------------------------------------------------------------------------------------------------------------------------------------------------------------------------------------------------------------------------------------------------------------------------------------------------------|
| AOFUSSWAIT        | 1 to n   | This is the number of seconds SA z/OS waits for the completion of a user-defined z/OS UNIX monitoring routine (specified in the z/OS UNIX Control Specification panel) until it gets a timeout. When the timeout occurs, SA z/OS does no longer wait for a response from the monitoring routine and sends a SIGKILL to the monitoring routine.<br><b>10</b> is the default setting. |
| AOF3WTIME         | 1 to n   | This is the number of seconds that the SHOWME command will wait for command responses.<br><b>10</b> is the default setting.                                                                                                                                                                                                                                                         |
| INGOPC_MULTIPLIER | 1 to n   | This is used in conjunction with AOFRMTCMDWAIT and AOFRPCWAIT to determine how long to wait before giving up.                                                                                                                                                                                                                                                                       |
| INGREQ_ORIGINATOR | 1        | Indicates that SA z/OS assigns individual originator IDs for each operator issuing an INGREQ command.                                                                                                                                                                                                                                                                               |
|                   | <b>0</b> | All operators are grouped under originator ID OPERATOR.<br><b>0</b> is the default setting.                                                                                                                                                                                                                                                                                         |

## Parameter Defaults for Commands

Table 7. Global Variables That Define the Installation Defaults for Specific Commands

| Variable Name       | Description                                                                                                                                                                                                                                                                                              | Reference <sup>1</sup> |
|---------------------|----------------------------------------------------------------------------------------------------------------------------------------------------------------------------------------------------------------------------------------------------------------------------------------------------------|------------------------|
| AOFSETSTATEOVERRIDE | Sets the default OVERRIDE value for the SETSTATE command.                                                                                                                                                                                                                                                | SETSTATE               |
| AOFSETSTATESCOPE    | Allows you to override the predefined default for the SCOPE parameter of the SETSTATE command.                                                                                                                                                                                                           | SETSTATE               |
| AOFSETSTATESTART    | Allows you to override the predefined default for the START parameter of the SETSTATE command.                                                                                                                                                                                                           | SETSTATE               |
| AOFSHUTCHK          | Sets the default PRECHECK parameter for the SHUTSYS command.                                                                                                                                                                                                                                             | SHUTSYS                |
| AOFSHUTOVERRIDE     | Will set the default OVERRIDE value for the INGREQ command.                                                                                                                                                                                                                                              | INGREQ                 |
| AOFSHUTSCOPE        | Sets the default SCOPE parameter for the SHUTSYS command.                                                                                                                                                                                                                                                | SHUTSYS                |
| DISPEVT_WAIT        | Sets the WAIT parameter of the DISPEVT command to the specified value.                                                                                                                                                                                                                                   | DISPEVT                |
| DISPEVTS_WAIT       | Sets the WAIT parameter of the DISPEVTS command to the specified value.                                                                                                                                                                                                                                  | DISPEVTS               |
| DISPTRG_WAIT        | Sets the WAIT parameter of the DISPTRG command to the specified value.                                                                                                                                                                                                                                   | DISPTRG                |
| INGAUTO_INTERVAL    | Sets the default for the INTERVAL parameter of the INGAUTO command.                                                                                                                                                                                                                                      | INGAUTO                |
| INGEVENT_WAIT       | Sets the WAIT parameter of the INGEVENT command to the specified value. The parameter specifies whether or not to wait until the request is complete.                                                                                                                                                    | INGEVENT               |
| INGGROUP_WAIT       | Sets the WAIT parameter of the INGGROUP command to the specified value. The parameter specifies whether or not to wait until the request is complete.                                                                                                                                                    | INGGROUP               |
| INGHIST_MAX         | Sets the MAX parameter of the INGHIST command to the specified value.                                                                                                                                                                                                                                    | INGHIST                |
| INGRELS_SHOW        | Sets the SHOW parameter of the INGHIST command to the specified value.                                                                                                                                                                                                                                   | INGHIST                |
| INGINFO_WAIT        | Sets the WAIT parameter of the INGINFO command to the specified value.                                                                                                                                                                                                                                   | INGINFO                |
| INGLIST_WAIT        | Sets the WAIT parameter of the INGLIST command to the specified value.                                                                                                                                                                                                                                   | INGLIST                |
| INGRELS_WAIT        | Sets the WAIT parameter of the INGRELS command to the specified value.                                                                                                                                                                                                                                   | INGRELS                |
| INGREQ_EXPIRE       | Sets the default EXPIRE parameter of the INGREQ command to the specified value.                                                                                                                                                                                                                          | INGREQ                 |
| INGREQ_INTERRUPT    | Sets the default INTERRUPT parameter of the INGREQ command to the specified value. The parameter specifies whether or not the automation manager should wait until the resource has reached its UP state, but the resource is still in the startup phase when the higher priority stop request is given. | INGREQ                 |
| INGREQ_OVERRIDE     | Sets the default OVERRIDE parameter of the INGREQ command to the specified value.                                                                                                                                                                                                                        | INGREQ                 |
| INGREQ_PRECHECK     | Sets the default PRECHECK parameter of the INGREQ command to the specified value.                                                                                                                                                                                                                        | INGREQ                 |
| INGREQ_PRI          | Sets the default priority (PRI parameter) of the INGREQ command to the specified value.                                                                                                                                                                                                                  | INGREQ                 |

## Global Variables

Table 7. Global Variables That Define the Installation Defaults for Specific Commands (continued)

| Variable Name       | Description                                                                                                                                                                                                                            | Reference <sup>1</sup> |
|---------------------|----------------------------------------------------------------------------------------------------------------------------------------------------------------------------------------------------------------------------------------|------------------------|
| INGREQ_PRI.E2EMGR   | Specifies the priority that incoming requests from the end-to-end automation manager are executed at. Default: LOW                                                                                                                     | INGREQ                 |
| INGREQ_REMOVE       | Sets the default value for the REMOVE parameter of the INGREQ command to the specified value. If the resource reaches the specified status (condition), the request is automatically removed.                                          | INGREQ                 |
| INGREQ_REMOVE.START | Sets the default value for the REMOVE parameter of the INGREQ START command. If not specified the value set by INGREQ_REMOVE will be used.                                                                                             | INGREQ                 |
| INGREQ_REMOVE.STOP  | Sets the default value for the REMOVE parameter of the INGREQ STOP command. If not specified the value set by INGREQ_REMOVE will be used.                                                                                              | INGREQ                 |
| INGREQ_RESTART      | Sets the default for the RESTART parameter of the INGREQ command when shutting down the resource.                                                                                                                                      | INGREQ                 |
| INGREQ_SCOPE        | Sets the SCOPE parameter of the INGREQ command to the specified value.                                                                                                                                                                 | INGREQ                 |
| INGREQ_SOURCE       | Sets the default SOURCE parameter of the INGREQ command to the specified value. The parameter specifies the originator of the request.                                                                                                 | INGREQ                 |
| INGREQ_TIMEOUT      | Sets the interval in minutes used to check for the INGREQ command used to check whether the request has been successfully completed, and whether to send a message or cancel the request if it has not been satisfied after that time. | INGREQ                 |
| INGREQ_TYPE         | Sets the default startup/shutdown type (TYPE parameter) of the INGREQ command to the specified value.                                                                                                                                  | INGREQ                 |
| INGREQ_VERIFY       | Sets the default VERIFY parameter of the INGREQ command to the specified value.                                                                                                                                                        | INGREQ                 |
| INGREQ_WAIT         | Sets the WAIT parameter of the INGREQ command to the specified value.                                                                                                                                                                  | INGREQ                 |
| INGSCHED_WAIT       | Sets the WAIT parameter of the INGSCHED command to the specified value. The parameter specifies whether or not to wait until the request is complete.                                                                                  | INGSCHED               |
| INGSET_VERIFY       | Sets the default VERIFY parameter of the INGSET command to the specified value.                                                                                                                                                        | INGSET                 |
| INGSET_WAIT         | Sets the WAIT parameter of the INGSET command to the specified value. The parameter specifies whether or not to wait until the request is complete.                                                                                    | INGSET                 |
| INGTRIG_WAIT        | Sets the WAIT parameter of the INGTRIG command to the specified value.                                                                                                                                                                 | INGTRIG                |
| INGVOTE_EXCLUDE     | Sets the EXCLUDE parameter of the INGVOTE command to the specified value. The parameter specifies the resource types (for example SVP or GRP) to be excluded when showing all requests. Resources of that type are filtered out.       | INGVOTE                |
| INGVOTE_STATUS      | Sets the STATUS parameter of the INGVOTE command to the specified value. The parameter specifies which requests should be displayed - winning, losing or all.                                                                          | INGVOTE                |
| INGVOTE_VERIFY      | Sets the default VERIFY parameter of the INGVOTE command to the specified value.                                                                                                                                                       | INGVOTE                |
| INGVOTE_WAIT        | Sets the WAIT parameter of the INGVOTE command to the specified value.                                                                                                                                                                 | INGVOTE                |

1. See the specified command in *IBM Tivoli System Automation for z/OS Operator's Commands*.





## Global Variables

---

## Appendix B. Customizing the Status Display Facility (SDF)

---

### Overview of Status Display Facility

This appendix explains how to customize SDF panels, descriptors, and operations.

#### How SDF Works

The SA z/OS Status Display Facility (SDF) uses colors and highlighting to represent subsystem resource states. Typically, a subsystem shown in green on the SDF status panel indicates it is up, while red indicates a subsystem in a stopped or problem state. SDF can be tailored to present the status of system components in a hierarchical manner.

**Note:** SDF works only with MVS systems and resources.

#### Types of SDF Panels

Figure 35 on page 218 shows several SDF screens for system CHI01. This figure shows the main types of panels used in SDF.

- The *root component*
- The *status component*
- The *detail status display*

In addition to these panel types, you can create other types of panels according to your system requirements and the applications you are monitoring.

**Note:** All SDF panels must contain 24 rows and 80 columns. Because SDF uses only the display's default screen size, the default size must be defined as 24 x 80.

## Overview of Status Display Facility

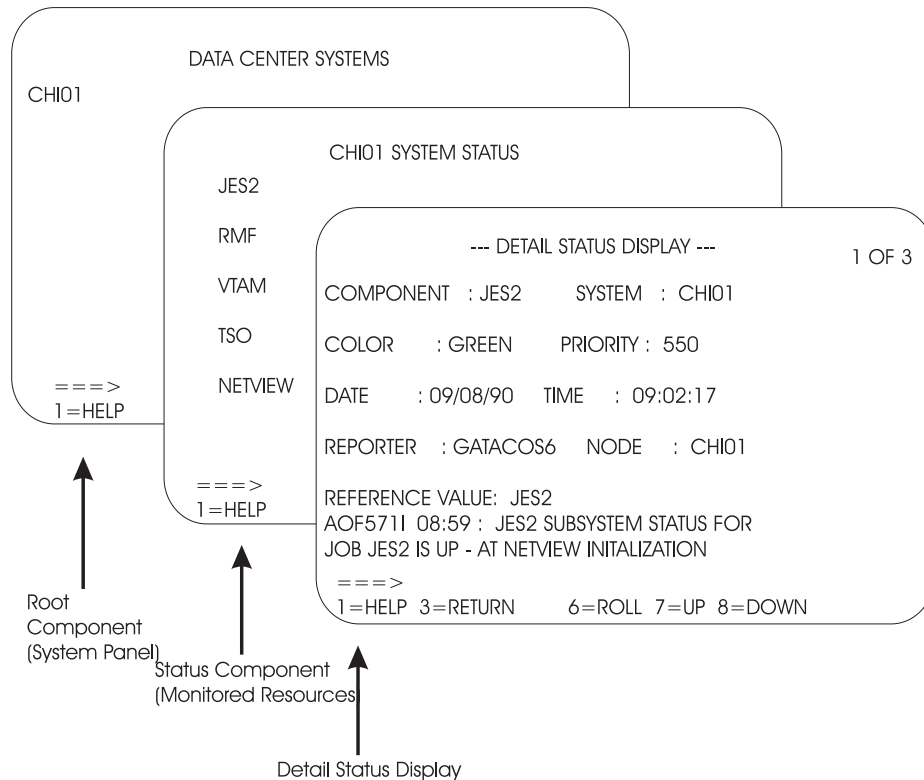

Figure 35. Example SDF Panels

### Root Component

The root component is typically an element appearing on the first screen displayed when SDF is started. In Figure 35, the CHI01 system is the root component.

### Status Component

Resources monitored by SDF are called *status components*. In Figure 35, system CHI01 has JES2, RMF, VTAM, TSO, and NetView status components, as shown on the CHI01 System Status panel. The status component panel displays all monitored resources in a system. Each monitored resource is shown in the color of its current status. For example, JES2 is shown in green if it is up.

### Detail Status Display

A detail status display is built from information in a status descriptor (see "Status Descriptors"). This panel is displayed by tabbing to the appropriate resource on the status component panel and pressing the detail PF key. Each status component can have one or more status descriptors, or detail records, associated with it.

Figure 35 shows an example detail status display for a JES2 status descriptor. The 1 of 3 on the panel indicates that JES2 currently has three status descriptors, and therefore three detail status displays, associated with it.

## Status Descriptors

A *status descriptor* is a detailed record of information about a resource status. In its raw form, a status descriptor is a multiline SA z/OS message containing information such as:

- Root component and status component to which the status descriptor applies

- Priority, color, and highlighting associated with the status descriptor (see “How Status Descriptors Affect SDF” on page 220 for more information)
- Date and time the status descriptor was generated
- Actual resource status information; for example, an SA z/OS message indicating the resource is up

SDF uses information in a status descriptor to generate a detail status display (see “Detail Status Display” on page 218). You do not usually look directly at a status descriptor; rather, you look at portions of it through a detail status display. For example, in Figure 35 on page 218, the detail status display presents information from a status descriptor for status component JES2. The 1 of 3 on the panel indicates that JES2 currently has three status descriptors associated with it.

SDF generates, displays, and deletes status descriptors.

### SDF Tree Structures

SDF uses *tree structures* to set up the hierarchy of monitored resources displayed on SDF status panels. An SDF tree structure always starts with the system name as the root node and has a level number of one. Tree structure levels subordinate to the root node are the monitored resources. The level numbers of these resources reflect their dependency on each other.

You define SDF tree structures in NetView DSIPARM data set member AOFREE.

Figure 36 on page 220 shows an example SDF tree structure. Following the tree structure definition statements is a diagram showing how these statements result in a tree structure.

## Overview of Status Display Facility

- 1 SY1
- 2 SYSTEM
- 3 WTOR
- 3 APPLIC
- 4 AOFAPPL
- 5 AOFSSI
- 4 JES
- 4 VTAM
- 3 TSO
- 3 RMF
- 2 GATEWAY

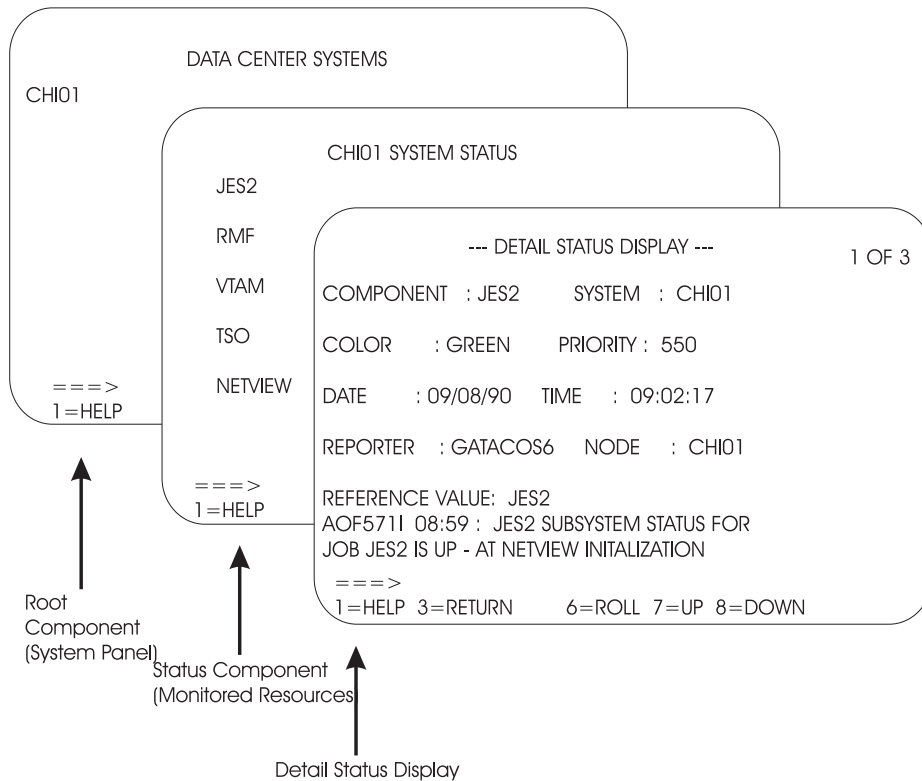

Figure 36. Example SDF Tree Structure

SA z/OS supplies a sample SDF tree structure in the SA z/OS sample library. This tree structure is referenced by a %INCLUDE statement in member AOFRTREE in the NetView DSIPARM data set. You can customize this sample tree structure to meet your requirements. This order of dependency does *not* have to be the same as that used for system startup or shutdown using SA z/OS.

For example, using the tree structure in Figure 36, if there is a problem with TSO, it is not desirable to also change the VTAM status color, because VTAM is not having any problems. In contrast, in the SA z/OS startup and shutdown procedures, TSO is dependent on VTAM.

More details on SDF tree structure definitions are in “Step 1: Defining SDF Hierarchy” on page 228.

## How Status Descriptors Affect SDF

Status descriptors are the main units of information SDF uses. The information in status descriptors determines how your SDF status displays look at any point in time. This section explains how SDF uses status descriptors.

### Priority and Color Assignments

Status descriptors are assigned both a priority number and a color. These color and priority assignments determine the colors in which status components are displayed. In SDF, a lower number indicates a higher priority. Status descriptors are connected to the status component in ascending order of priority.

Color and priority assignments for status descriptors are defined in two places:

- In the PRIORITY parameter in the AOFINIT member of the NetView DSIPARM data set. This parameter defines initial priority and color assignments used for status descriptors. The values defined in AOFINIT are used if no further customization is done to priority and color assignments. The default priority ranges and colors used in AOFINIT are:

| Priority Range | Color     |
|----------------|-----------|
| 001 to 199     | Red       |
| 200 to 299     | Pink      |
| 300 to 399     | Yellow    |
| 400 to 499     | Turquoise |
| 500 to 599     | Green     |
| 600 to 699     | Blue      |

White is used as the default status descriptor color (the DCOLOR parameter in member AOFINIT, described in *IBM Tivoli System Automation for z/OS Programmer's Reference*) and as the default color for a status component without a tree structure entry (the ERRCOLOR parameter in member AOFINIT, described in *IBM Tivoli System Automation for z/OS Programmer's Reference*). For more information on the PRIORITY parameter, see *IBM Tivoli System Automation for z/OS Programmer's Reference*.

- In the SDF definitions in the Status Details policy object. These entries define colors, highlighting, and priorities used for particular resource statuses. Color and priority assignments defined in the customization dialog can be used to override assignments in the AOFINIT member.

**Note:** Some of the resource statuses that appear in SDF displays do not directly correspond to resource statuses used in the automation status file. *IBM Tivoli System Automation for z/OS User's Guide* shows the default resource status types, colors, highlighting, and priorities provided with SA z/OS. These settings define to SA z/OS the parameters used when adding status descriptors to SDF.

For more information on the SDF Status Details definition, see "Step 4: Defining SDF in the Customization Dialog" on page 232.

### Chaining of Status Descriptors to Status Components

A resource status change causes a status descriptor to be generated. SDF adds this status descriptor to a chain of status descriptors. Chained status descriptors determine the status and color of status components. The highest-priority status descriptor in a chain determines the initial color in which the status component is displayed. The underlying chained priority numbers determine the color in which successive detail status displays will be shown.

Status descriptors are chained off each level of status component in a tree structure. Status descriptors chained to lower-level status components are also chained to a higher-level status component, again in order of priority. Status

## Overview of Status Display Facility

descriptors are also chained off the root component. These status descriptors are all the status descriptors that currently exist at all levels of the tree structure.

For example, Figure 37 shows status descriptors currently generated for system SY1. The priority for each status descriptor is shown by a number.

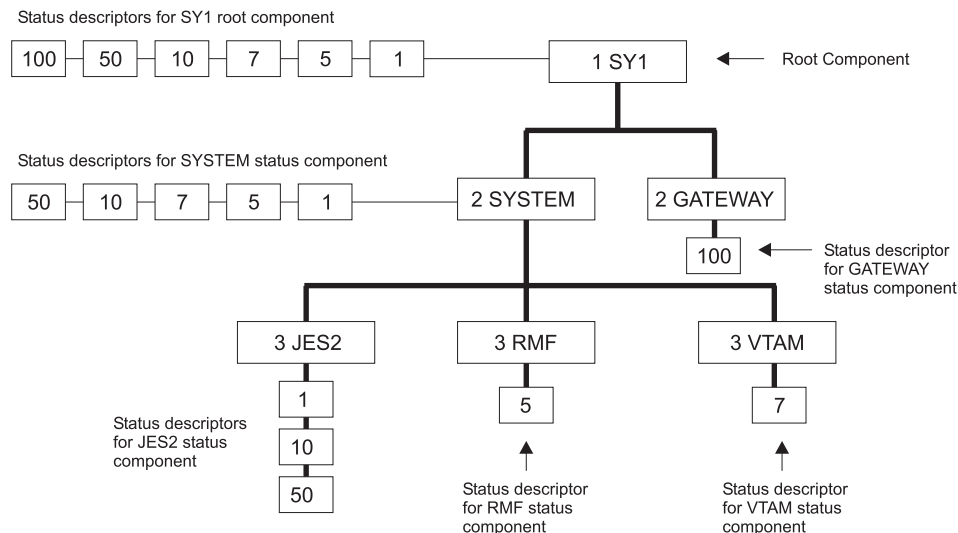

Figure 37. Status Descriptors Chained to Status Components

The status components at the lowest level in this tree structure, JES2, RMF, and VTAM, have status descriptors chained off them. Status component JES2 has three status descriptors chained, with priorities 1, 10, and 50. Because 1 is the highest priority, the status descriptor with priority 1 is organized first in the chain. This highest-priority status descriptor determines the color in which JES2 is displayed on the status panel. If an operator uses the detail PF key to view detail status displays for JES2, the information contained in the status descriptor with priority 1 will be displayed first, then the detail status display for the status descriptor with priority 10, and so on.

At the SYSTEM status component level in the tree structure, all status descriptors from the lower-level status components are also chained. Because the status descriptors chained to RMF and VTAM have higher priorities than the priority 10 and 50 status descriptors for JES2, they are organized after the priority 1 status descriptor in the chain. An operator using the detail PF key at the SYSTEM level could view five detail status displays, ranging from priority 1 to priority 50.

Similarly, at the SY1 level in the tree structure, all status descriptors chained to all status components in the tree structure are chained in order of priority. An operator using the detail PF key at the SY1 level could view six detail status displays, ranging from priority 1 to priority 100.

If a status component has multiple status descriptors with equal priorities, the status descriptors are chained off the status component in order of arrival time.

When a status descriptor no longer accurately reflects the actual status of a resource, SDF automatically deletes it from status descriptor chains. As an example of how priority determines order of status descriptors, suppose two status descriptors currently exist for status component JES2. If there are two status



descriptors for JES2 with priorities of 120 and 140, the status descriptor with priority 120 is displayed first. In both cases, JES displays in red on the SDF status panel.

In SA z/OS, all status types are defined in the automation control file. When an automation event occurs, the SA z/OS AOCUPDT common routine scans the automation control file for the SDF entry for that status. SA z/OS issues a request to add the status using the information from the automation control file.

For example, suppose subsystem RMF, shown on the example SDF panels in Figure 35 on page 218, is set to a STOPPING state. The SA z/OS AOCUPDT common routine scans the automation control file for the STOPPING state entry for SDF and generates a status descriptor, specifying a priority of 330. SDF adds the status descriptor to the RMF status component. RMF appears as yellow and blinking on the status panel. Once RMF is in a stopped state, the AOCUPDT common routine scans the automation control file for the STOPPED state SDF entry and generates a status descriptor with priority 130. SDF adds this new status descriptor to the RMF status component. Now, RMF appears in red on the SDF status panel.

### Propagating Status Descriptors Upward and Downward in a Tree Structure

Based on the order of dependencies defined in a tree structure, status descriptors can be *propagated* upward or downward to status components in a tree structure. This propagation of status descriptors affects the color in which status components are displayed, as well as the detail status displays operators can view by using the detail PF key on a particular status component.

Propagation of status upward and downward in a tree structure is defined by the PROPUP and PROPDOWN parameter in the AOFINIT member (see *IBM Tivoli System Automation for z/OS Programmer's Reference* for descriptions).

The SA z/OS-provided defaults for status propagation in the AOFINIT member are to propagate status upward (PROPUP=YES) but not downward (PROPDOWN=NO).

When status is propagated upward in a tree structure, if a status descriptor is added or deleted at a lower level in the tree structure, it is also added or deleted from the cumulative chain of status descriptors at a higher-level node in the tree structure.

Propagation of status upward in a tree structure consolidates the status of all monitored resources in the system at the root node. In this way, the color of the root node reflects the most important or critical status in a computer operations center. For example, in Figure 36 on page 220, any color changes for AOFSSI are reflected in AOFAPPL, APPLIC, SYSTEM, and SY1, if SDF propagates status changes upward in the tree structure. In Figure 35 on page 218, if all monitored resources are green, the root node CHI01 on the Data Center Systems panel is also shown in green.

When status is propagated downward in a tree structure, if a status change occurs at a higher level in a tree structure, the changes are sent downward in the tree structure. This propagating downward could cause status descriptors at lower levels in the tree structure to be added or deleted.

## Overview of Status Display Facility

Propagating status downward can be useful when an entire system is down. In such a case, you want SDF status panels to accurately reflect the system status. You do not want status components lower in the tree structure to retain previously generated status descriptors indicating that the components are up and running, because these status descriptors do not accurately reflect the status of the components. You can configure your SDF implementation to propagate status downward, and remove all status descriptors from all status components in a tree structure. If an operator tries displaying detailed status about any of the status components lower in the tree structure, they receive "NO DETAIL INFO AVAILABLE" messages. The empty chain color, defined by the EMPTYCOLOR parameter in member AOFINIT with a default color of blue, is also used to indicate that no detail information is available. See *IBM Tivoli System Automation for z/OS Programmer's Reference* for the EMPTYCOLOR description.

### How SDF Helps Operations to Focus on Specific Problems

SDF structure and processing allows the program identifying a problem to be concerned only with the specific problem.

For example, suppose an application program detects a warning message for status component JES on CHI01. The following processing steps occur:

1. The application program issues a request to SDF to add a status descriptor for JES.
2. The status entry for JES on system CHI01 now indicates there is a problem with JES. If the SDF is configured to propagate status up the hierarchical tree structure, the status for system CHI01 also reflects the problem state. See *IBM Tivoli System Automation for z/OS Programmer's Reference* for details on the PROPUP SDF initialization parameter.
3. Now, suppose another more serious problem occurs. The application program which detects this new problem issues another request to SDF to add a status descriptor having a lower priority number than the status descriptor for the first problem.
4. Because status descriptors are chained in order of priority, the JES status now reflects the status descriptor color of the more serious problem.
5. When the more serious problem is resolved, the application program detecting the problem resolution issues a request to SDF to remove the status descriptor for this problem from the chain of JES status descriptors.
6. The status panel is updated to reflect the first problem.

### How SDF Panels Are Defined

All SDF status panels, apart from detail status display panels, are defined in the AOFPNLS member of the NetView DSIPARM data set.

Member AOFPNLS can contain either one or both of the following:

- %INCLUDE statements referencing other NetView DSIPARM members containing definitions of panels. The %INCLUDE statement causes the named panel definition member to be loaded. This is the recommended method, and the method used in the SA z/OS-provided version of AOFPNLS.
- Panel structure definitions for all SDF panels.

Panel members defined or referenced in AOFPNLS are loaded into system memory, and may be deleted, replaced, or temporarily made resident using the SDFPANEL command (see *IBM Tivoli System Automation for z/OS Programmer's Reference* for command description).

Panels that are to be dynamically loaded as needed (see “Dynamically Loading Tree Structure and Panel Definition Members”) must be defined in a NetView DSIPARM member having the same member name as the panel itself.

It is recommended that you include only frequently used panels in AOFFNLS, to conserve system memory. Other panels can be dynamically loaded when needed, either by pressing a SDF function key or by using the SCREEN command.

**Note:** Dynamic refresh will only work with panels defined in AOFFNLS.

SDF internally formats and builds detail status display panels from the information in a status descriptor. You do not have to define and format detail status display panels. Status components defined in the panel definitions must also be defined in the corresponding tree structure. However, not all status components defined in the tree structure require a corresponding entry on the SDF status panel. For example, in Figure 36 on page 220, the APPLIC status component is only a pseudo-entry and may not actually be displayed on any SDF status display panel.

SDF status panels can be customized to reflect any environment. For example, you can define a panel to show the status of all JES subsystems on all processors in a computer operations center. The JES operator can view the panel to determine the status of any JES subsystem in the complex.

For detailed information on defining SDF panels, see “Step 2: Defining SDF Panels” on page 229.

### Dynamically Loading Tree Structure and Panel Definition Members

Using %INCLUDE statements in the main SDF tree structure and panel definition members allows you to dynamically load tree structure and panel definition members without restarting SDF (see *IBM Tivoli System Automation for z/OS Programmer's Reference*). The SDFTREE command loads a tree structure definition member. The SDFPANEL command loads a panel definition member. You can dynamically reload members AOFTREE and AOFFNLS themselves.

### Using SDF for Multiple Systems

You can configure SDF so that multiple systems in an automation network can forward their resource status information to the SDF on the focal point system. In a multiple-system environment, the following must be defined:

- The tree structure for each system must be defined in the AOFTREE member of NetView DSIPARM on the focal point system SDF. The root name must be unique for each system tree structure.
- The focal point root name must match the SYSNAME value defined in the automation policy. This value is specified in the customization dialog.

**Note:** The SYSNAME for each system under SA z/OS control must be the same as the system name under which the system was IPLed

- For target system SDF status update to occur on a focal point SDF, SA z/OS focal point services must already be implemented.

Because each root name must be unique in a multiple-system environment, any status component on any system defined to the focal point SDF can be uniquely addressed by prefixing the status component with the root component name:

```
ROOT_COMPONENT.STATUS_COMPONENT
```

## Overview of Status Display Facility

For example:

SY1.JES2

Similarly, any SDF status descriptors forwarded from the target system to the focal point SDF are prefixed with the root name of the target system by SA z/OS routines.

## SDF Components

SDF consists of the following components:

Table 8. SDF Components

| Name              | Type       | Purpose                                                                                                                                                                                                                                                                             |
|-------------------|------------|-------------------------------------------------------------------------------------------------------------------------------------------------------------------------------------------------------------------------------------------------------------------------------------|
| AOFTDDF           | Task       | Initializes SDF and maintains the status database. This initialization is an automated function.                                                                                                                                                                                    |
| SDF               | Command    | Starts an SDF operator session.                                                                                                                                                                                                                                                     |
| SDFTREE           | Command    | Dynamically loads or deletes an SDF tree structure definition member from the NetView DSIPARM data set.                                                                                                                                                                             |
| SDFPANEL          | Command    | Dynamically loads or deletes an SDF panel definition member from the NetView DSIPARM data set.                                                                                                                                                                                      |
| AOFINIT           | Input file | Contains SDF initialization parameters defined with the statements described in <i>IBM Tivoli System Automation for z/OS Programmer's Reference</i> . AOFINIT is in the NetView DSIPARM data set.                                                                                   |
| AOFTREE           | Input file | Contains tree structures described in <i>IBM Tivoli System Automation for z/OS Programmer's Reference</i> . This member usually consists of a list of %INCLUDE statements referencing other members containing tree structures. AOFTREE is in the NetView DSIPARM data set.         |
| AOFPNLS           | Input file | Contains SDF panel parameters defined by the statements described in "Step 2: Defining SDF Panels" on page 229. This member usually consists of a list of %INCLUDE statements referencing other members containing panel definitions. AOFPNLS is in the NetView DSIPARM data set.   |
| <i>panel_name</i> | Input file | A DSIPARM member containing the definition of one or more SDF panels or %INCLUDE statements identifying other DSIPARM panel definition members. It is highly recommended that panel definition members contain the definition of a single panel having the same name as the member. |
| <i>tree_name</i>  | Input file | A DSIPARM member containing the definition of one or more tree structures. It is highly recommended that tree definition members contain the definition of a single tree having the same root component name as the member name.                                                    |

## How the SDF Task Is Started and Stopped

During SA z/OS initialization, the AOFTDDF task loads members defining panel format, panel flow, and tree structures. Member AOFINIT defines parameters common to all SDF panels and basic initialization specifications, such as screen size, default PF keys, and the initial screen displayed when a SDF session is started. These AOFINIT parameters are described in *IBM Tivoli System Automation for z/OS Programmer's Reference*.

## Starting the SDF Task

In SA z/OS code, the AOFTDDF task is started by the following command:

```
START TASK=AOFTDDF
```

## Stopping the SDF Task

In SA z/OS code, the AOFTDDF task is stopped by the following command:

```
STOP TASK=AOFTDDF
```

**Note:** When SDF is restarted, all existing SDF status descriptors are lost, as they are kept only in memory.

---

## SDF Definition

The following section describes the SDF definition process.

### Summary of SDF Definition Process

This section summarizes the steps for defining the SDF. Use this procedure to define the panels displayed in an SDF session. Details on each step are provided later in this chapter and in *IBM Tivoli System Automation for z/OS Programmer's Reference*.

1. Define the hierarchy of monitored resources used for your SDF panels, using tree structure statements in NetView DSIPARM data set members. These tree structure definition members should be referenced by %INCLUDE statements in the main SDF tree structure definition member, AOFTREE, in the NetView DSIPARM data set. See *IBM Tivoli System Automation for z/OS Programmer's Reference* for details.
2. Define SDF status panels using panel definition statements in NetView DSIPARM data set members. Panels can either be automatically loaded when SDF starts, or dynamically loaded using the SDFPANEL command. For panels to be automatically loaded, add a %INCLUDE statement specifying the panel definition member to the main panel definition member, AOFPNLS, in the NetView DSIPARM data set. See "Step 2: Defining SDF Panels" on page 229 for details.  
 Define and customize SDF status panels in the following general order:
  - a. Root panel
  - b. Status component panel for each entry on the root panel
  - c. Any other customized status panels.
3. Customize the SDF initialization parameters in NetView DSIPARM member AOFINIT, if necessary (optional), or use defaults. See *IBM Tivoli System Automation for z/OS Programmer's Reference* for detailed descriptions of SDF initialization parameters. Using defaults is recommended.
4. Define SDF resource status, color, highlight and priority values using the customization dialog to edit the SDF Status Details policy object, or use defaults. This step is optional. See *IBM Tivoli System Automation for z/OS Defining Automation Policy* for the description of the Status Details policy object. Using defaults is recommended.

#### Notes:

1. Resources that SA z/OS is not currently automating are not displayed on SDF panels.
2. To display the status of multiple systems and forward status from target systems to SDF on a focal point system, SA z/OS focal point services must already be implemented. See *IBM Tivoli System Automation for z/OS Defining Automation Policy* for details on configuring focal point services.

## Step 1: Defining SDF Hierarchy

Member AOFTREE in the NetView DSIPARM data set contains a set of definitions that define the propagation hierarchy for status color changes. When the status changes for a component, the corresponding color change is propagated up or down the tree to the next higher or lower level component. The level is determined by the level number assigned to each component. The type of propagation is determined either by the entry in the AOFINIT member or by individual requests to add a status descriptor to a status component.

**Note:** SA z/OS does not use this SDF hierarchy for subsystem shutdown or startup procedures. Instead, SA z/OS uses subsystem entries defined in the automation policy to determine startup and shutdown relationships and hierarchies.

### Tree Structure Definitions

AOFTREE contains tree structure definitions. To define tree structures, you can:

- Use %INCLUDE statements referencing other members containing definitions for specific tree structures. This is the recommended method, and the method used in the SA z/OS-provided version of AOFTREE.

On the %INCLUDE statement, the name of the referenced member must be enclosed in parentheses.

- Place all tree structure definitions in AOFTREE.
- Use a combination of both.

Figure 38 shows a typical tree structure definition:

```

1 SY1
 2 APPLIC
 3 AOFAPPL
 4 AOFSSI
 3 JES
 3 VTAM
 3 TSO
 3 RMF
 2 GATEWAY

```

Figure 38. Example Tree Structure Definition

In this tree structure, SY1 is the root component. This definition is in a separate member, named SY1. It is referenced by the following statement in the AOFTREE member:

```
%INCLUDE(SY1TREE)
```

**Loading Tree Structures:** All tree structures need not be loaded during initialization. Some can be loaded dynamically after SDF is started. To do this, use AOFTREE to define those tree structure entries that will be loaded during initialization, then, use the SDFTREE command to load additional tree structures as needed. For more information, see *IBM Tivoli System Automation for z/OS Programmer's Reference*.

Tree structures loaded after SDF is started must be contained in separate members. Each member must be named after the root component for which the tree structure is defined.

## Step 2: Defining SDF Panels

SDF status panels are defined in NetView DSIPARM member AOFPNLS. SA z/OS loads the panel definitions in AOFPNLS when SDF is initialized.

### Panel Definition Methods

To define panels in AOFPNLS, you can:

- Use %INCLUDE statements referencing separate NetView DSIPARM members containing panel definitions. This is the recommended method, and the method used in the SA z/OS-provided version of AOFPNLS. See “%INCLUDE Statement for SDF Panels” on page 231 for details on using the %INCLUDE statement for SDF panel definition members.
- Include actual definitions for all panels.
- Use a combination of both %INCLUDE statements and panel definitions.
- Include a subset of panel entries to load during initialization, so that additional panel definitions can be loaded only when needed (see *IBM Tivoli System Automation for z/OS Programmer's Reference*).

### Panel Definition Structure

The structure of each panel definition is as follows:

- Begin panel definition statement (PANEL)
- Status component definition statements, consisting of pairs of the following statements:
  - STATUSFIELD: defines location of a status component on a panel
  - STATUSTEXT: defines the text displayed in the STATUSFIELD
- Text fields and data definition statements, consisting of pairs of the following statements:
  - TEXTFIELD: defines locations and attributes for constant fields on panels
  - TEXTTEXT: defines text displayed in the TEXTFIELD
- Status panel PF key definitions (PFKnn)
- End panel statement (ENDPANEL)

Descriptions of these panel definition statements are in *IBM Tivoli System Automation for z/OS Programmer's Reference*.

### Recommended Order for Defining Panels

When defining panels, it is recommended that you define them in the following order:

1. The root panel
2. The status components for each item listed on the root panel
3. Any other customized status panels

**Note:** This order of defining panels is a recommendation only. You can define your SDF panels in any order desired.

### Example Panel Definition

Figure 39 on page 230 shows how an SDF panel looks when displayed:

```

SYSTEM DATA CENTER SYSTEMS

SY1 GATEWAY

===>
1=HELP 2=DETAIL 3=RET 6=ROLL 7=UP 8=DN 10=LF 11=RT 12=TOP

```

Figure 39. Example SDF Panel

Figure 40 shows the panel definition statements required to define the panel in Figure 39.

```

PANEL (SYSTEM,24,80)
TEXTFIELD(01,02,10,WHITE,NORMAL)
TEXTTEXT(SYSTEM)
TF(01,25,57,WHITE,NORMAL)
TT(DATA CENTER SYSTEMS)
STATUSFIELD(SY1,04,04,11,N,,SY1SYS)
STATUSTEXT(SY1)
SF(SY1.GATEWAY,02,40,47,N,,GATEWAY)
ST(GATEWAY)
TF(24,01,79,T,NORMAL)
TT(1=HELP 2=DETAIL 3=RET 6=ROLL 7=UP 8=DN ,
10=LF 11=RT 12=TOP)
PFK1(AOCHELP SDF)
PFK2(DETAIL)
PFK3(RETURN)
PFK6(ROLL)
PFK7(UP)
PFK8(DOWN)
PFK10(LEFT)
PFK11(RIGHT)
PFK12(TOP)
ENDPANEL

```

Figure 40. Example Panel Definition Entry

In Figure 40, the panel name is SYSTEM. This panel definition can either be in a separate member referenced by a %INCLUDE statement in AOFPNLS or be directly coded in AOFPNLS. The recommended method is to use a separate member and a %INCLUDE statement. If it is in a separate member, the member name is SYSTEM. You do not have to explicitly define every PF key for the panel. PF key definitions not specified are picked up from definitions in NetView DSIPARM member AOFINIT.

Table 9 describes each statement in Figure 40:

Table 9. Panel Definition Entry Description

| Statement                        | Description and Example Value                                                                                                                                                                |
|----------------------------------|----------------------------------------------------------------------------------------------------------------------------------------------------------------------------------------------|
| PANEL (SYSTEM,24,80)             | The panel definition statement. The panel name is SYSTEM, the panel length is 24, and the panel width is 80.                                                                                 |
| TEXTFIELD(01,02,10,WHITE,NORMAL) | The text location statement defining constant panel fields. This field starts on line 01 in position 02 and ends in position 10. The color of the field is white and highlighting is normal. |
| TEXTTEXT (SYSTEM)                | The text data statement specifying the actual data that goes in the text field just defined. This field contains the word SYSTEM.<br><br>TEXTFIELD and TEXTTEXT are always grouped in pairs. |



Table 9. Panel Definition Entry Description (continued)

| Statement                                                                                                                              | Description and Example Value                                                                                                                                                                                                                                                                                                                                                   |
|----------------------------------------------------------------------------------------------------------------------------------------|---------------------------------------------------------------------------------------------------------------------------------------------------------------------------------------------------------------------------------------------------------------------------------------------------------------------------------------------------------------------------------|
| TF(01,25,57,WHITE,NORMAL)                                                                                                              | Another TEXTFIELD statement for another constant field.                                                                                                                                                                                                                                                                                                                         |
| TT(DATA CENTER SYSTEMS)                                                                                                                | Another TEXTTEXT statement for the text field just defined.                                                                                                                                                                                                                                                                                                                     |
| STATUSFIELD(SY1,04,04,11,N,,SY1SYS)                                                                                                    | The location of the status component field. The status component is SY1. This field starts on line 04 in position 04 and ends in position 11. The highlighting level is normal. The next panel displayed when the Up PF key is pressed is SY1SYS.                                                                                                                               |
| STATUSTEXT(SY1)                                                                                                                        | The text data used for the name of the field just defined with the STATUSFIELD statement. In this case, the field name is SY1.<br><br>STATUSFIELD and STATUSTEXT statements are grouped in pairs.                                                                                                                                                                               |
| SF(SY1.GATEWAY,02,40,47,N,,GATEWAY)                                                                                                    | Another STATUSFIELD definition.                                                                                                                                                                                                                                                                                                                                                 |
| ST(GATEWAY)                                                                                                                            | Another STATUSTEXT definition.                                                                                                                                                                                                                                                                                                                                                  |
| TF(24,01,79,T,NORMAL)<br>TT(1=HELP 2=DETAIL 3=RET 6=ROLL 7=UP,<br>8=DN 10=LF 11=RT 12=TOP)                                             | Here, TEXTFIELD and TEXTTEXT are used to display PF key definitions. For this panel, these are the default definitions defined in AOFINIT. If you need values differing from the defaults, there is a statement for defining PF keys unique to this panel, DPFKnn. See <i>IBM Tivoli System Automation for z/OS Programmer's Reference</i> for a description of this statement. |
| PFK1(AOCHELP SDF)<br>PFK2(DETAIL)<br>PFK3(RETURN)<br>PFK6(ROLL)<br>PFK7(UP)<br>PFK8(DOWN)<br>PFK10(LEFT)<br>PFK11(RIGHT)<br>PFK12(TOP) | PF key definition statements.                                                                                                                                                                                                                                                                                                                                                   |
| ENDPANEL                                                                                                                               | The end panel statement, indicating that this is the end of definitions for this panel.                                                                                                                                                                                                                                                                                         |

### %INCLUDE Statement for SDF Panels

The %INCLUDE statement for SDF has the following features:

- The SDF %INCLUDE statement allows specifying a list of members rather than a single member only. Each member name in the list represents a DSIPARM member to be loaded. Member names in the list are delimited by a comma.
- The SDF %INCLUDE statement requires parentheses around the specified member or members.
- The target DSIPARM members may contain only complete panel definitions or additional %INCLUDE statements. Panel definitions must be contained within a single member, and therefore cannot be built using commonly defined segments.

### Step 3: Customizing SDF Initialization Parameters

Member AOFINIT allows you to define parameters common to all SDF panels and SDF initialization specifications, such as:

- Initial screen shown when SDF is started
- Maximum operator logon limit
- Default PF key definitions
- Detail status display panel PF key definitions
- Detail status display panel PF key descriptions

- Default priorities and colors

These parameters define values for SDF when it is started.

This step of SDF customization is optional. Using SA z/OS-provided default values for these parameters is recommended.

**Note:** User-defined statuses are not saved across a recycle or a monitor cycle. This means the status of a subsystem will change from the user-defined status to an appropriate SA z/OS status.

## **Step 4: Defining SDF in the Customization Dialog**

The SDF entries in the Status Details policy object allow you to define statuses and the priorities assigned to those statuses. These entries are used by SA z/OS common routines to gather data for requests to add status descriptors to status components. The format and values used in SDF Status Detail definitions are described in *IBM Tivoli System Automation for z/OS Programmer's Reference*.

This step of SDF customization is optional. Using SA z/OS-provided definitions for SDF is recommended.

---

## Appendix C. Message Automation

---

### FORCED AT Entry Type

This AT entry must be generated in the predefined way. An AT entry is generated as shown in INGMMSG02 (see Figure 41) even though the message may not appear in the Customization Dialog. The AT entry cannot be overridden. No AUTO action is valid.

```
INGMSG02
*
* - FORCED AT ENTRY
IF
MSGID = 'EVE172I'
THEN
EXEC(CMD('AOCFILT * EVEEI010 ')ROUTE(ONE %AOFOPGSSOPER%))
EXEC(CMD('AOCFILT * EVEEI009 PPI')ROUTE(ONE %AOFOPGSSOPER%))
EXEC(CMD('AOCFILT * EVEEY00S MSGID=PPIOPN')ROUTE(ONE %AOFOPGSSOPER%));
*
```

Figure 41. Sample FORCED AT Entry

Because you may need to issue a command or a reply in response to a forced message, you can define a CMD or REPLY for several (but not all) forced messages. This will append an ISSUECMD or ISSUEREP action to the AT entry, as shown in Figure 42.

```
INGMSG02
*
* Tape mount monitoring
* - FORCED AT ENTRY
IF (GROUP:INGTAPE)
MSGID = 'IEF233A'
THEN
EXEC(CMD('INGRTAPE ')ROUTE(ONE %AOFOPSYSOPER%))
DOMACTION(AUTOMATE)
* - CONDITIONAL AT ACTION ENTRY
EXEC(CMD('ISSUEREP ')ROUTE(ONE %AOFOPWTORES%))
* - CONDITIONAL AT ACTION ENTRY
EXEC(CMD('ISSUECMD ')ROUTE(ONE %AOFOPGSSOPER%));
*
```

Figure 42. Sample FORCED AT Entry with ISSUECMD and ISSUEREP Action

It is recommended that you refer to INGMMSG02 to obtain those AT entries where optional actions are or are not supported.

---

### RECOMMENDED AT Entry Type

You are recommended to use this AT entry in the predefined way. An AT entry is generated as shown in INGMMSG02 (see Figure 43 on page 234) even though the message may not have been defined in the Customization Dialog. The AT entry *can* be overridden (using the OVR action) in the Customization Dialog.

```

INGMSG02
*
* AMRF Buffer recovery
*
* - RECOMMENDED AT ENTRY
IF
MSGID = 'IEA359E'
THEN
EXEC(CMD('AOFRSA0G ')ROUTE(ONE %AOFOPRECOPER%));
*
* AMRF Buffer recovery
*
* - RECOMMENDED AT ENTRY
IF
MSGID = 'IEA360A'
THEN
EXEC(CMD('AOFRSA0G ')ROUTE(ONE %AOFOPRECOPER%));
*
* AMRF Buffer recovery
*
* - RECOMMENDED AT ENTRY
IF
MSGID = 'IEA361I'
THEN
EXEC(CMD('AOFRSA0G ')ROUTE(ONE %AOFOPRECOPER%));
*

```

Figure 43. Sample RECOMMENDED AT Entry Type

Defining a CMD, REPLY, CODE or USER action does not change the recommended AT entry. AUTO(IGNORE) and AUTO(SUPPRESS) prevent an AT entry being created. For other AUTO actions the recommended AT entry is built.

---

## CONDITIONAL AT Entry Type

A CONDITIONAL AT entry can be defined for either known or unknown messages.

### Known Messages

This AT entry is optional. It is only generated if the message has been defined in the Customization Dialog together with a CMD, REPLY, CODE, USER, AUTO, or OVR action (see Figure 44).

```

INGMSG02
*
* JES2 shutdown
*
* - CONDITIONAL AT ENTRY
IF
MSGID(2) = 'HASP099'
THEN
EXEC(CMD('AOFRSD0D ')ROUTE(ONE %AOFOPGSSOPER%));
*

```

Figure 44. CONDITIONAL AT Entry for a Specific Message

The AT entry is generated as predefined in INGMSG02 for the known message but *can* be overridden with an OVR action. Defining a CMD, REPLY, CODE, USER, or AUTO action does not overrule the predefined behavior (that is, a stop message will still be a stop message, for example).

## Unknown Messages

This AT entry is optional. It is only generated if the message has been defined in the Customization Dialog together with a CMD, REPLY, AUTO, or OVR action (see Figure 45).

```
INGMSG02
*
* - IEA* MESSAGES ARE PLACED HERE
*
```

Figure 45. CONDITIONAL AT Entry for a Generic Message

You can refer to the INGMSG02 to see where entries for unknown messages (for example, IEA\*) would be placed in the generated AT.

The action statement of the AT entry depends on the action as defined in the Customization Dialog, that is:

| Action Statement | Defined Action                          |
|------------------|-----------------------------------------|
| ISSUECMD         | CMD                                     |
| ISSUEREPLY       | REPLY                                   |
| ACTIVMSG         | AUTO(UP, ACTIVE)                        |
| TERMMSG          | AUTO(ABENDED, BROKEN, TERMINATED, etc.) |
| HALTMSG          | AUTO(HALTED)                            |

This will produce a different AT entry to the standard, specific entry.

Table 10 shows which default AT entry is generated for a particular AUTO action.

Table 10. AT Entries That Are Generated by AUTO Actions

| Status      | Automation Table Action Statement                                   |
|-------------|---------------------------------------------------------------------|
| ACTIVE      | EXEC(CMD('ACTIVMSG UP=NO'))ROUTE(ONE %AOFOPGSSOPER%)                |
| ABENDED     | EXEC(CMD('TERMMSG FINAL=YES,ABEND=YES'))ROUTE(ONE %AOFOPGSSOPER%)   |
| ABENDING    | EXEC(CMD('TERMMSG FINAL=NO,ABEND=YES'))ROUTE(ONE %AOFOPGSSOPER%)    |
| BREAKING    | EXEC(CMD('TERMMSG FINAL=NO,BREAK=YES'))ROUTE(ONE %AOFOPGSSOPER%)    |
| BROKEN      | EXEC(CMD('TERMMSG FINAL=YES,BREAK=YES'))ROUTE(ONE %AOFOPGSSOPER%)   |
| CAPTURE     | EXEC(CMD('AOFCPMSG '))ROUTE(ONE %AOFOPGSSOPER%) DOMACTION(AUTOMATE) |
| HALTED      | EXEC(CMD('HALTMSG '))ROUTE(ONE %AOFOPGSSOPER%)                      |
| TERMINATED  | EXEC(CMD('TERMMSG FINAL=YES'))ROUTE(ONE %AOFOPGSSOPER%)             |
| TERMINATING | EXEC(CMD('TERMMSG FINAL=YES'))ROUTE(ONE %AOFOPGSSOPER%)             |
| UP          | EXEC(CMD('ACTIVMSG UP=YES'))ROUTE(ONE %AOFOPGSSOPER%)               |

The AT entry can also be defined using the OVR action with the following conditions for its generation:

- If OVR is supported for a predefined AT entry, it will be replaced by the override.
- If OVR is defined multiple times for the same message ID but for different APL instances in the PDB, then multiple AT entries are generated.
- If OVR is defined for a message that other actions have also been defined for, only the OVR AT entry will be generated.

- If OVR is defined for a message at APL CLASS level where *no* check is done for the Jobname (&SUBSJOB), only one OVR AT entry will be generated. (The prerequisite is that at least one instance is linked to that class.)
- If OVR is defined for a message at APL CLASS level where a check for the Jobname (&SUBSJOB) *is* done, one OVR AT entry will be generated for each instance linked to that class.

---

## Other Forced AT Entries

The following AT entries are always built:

- BEGIN-END block statements (for performance and design reasons)
- ALWAYS statements
- Capture WTORS

See Figure 46 for examples.

```

INGMSG02
* -----
* Supervisor Messages
IF
MSGID = 'IEA' . & DOMAINID = %AOFDOM%
THEN BEGIN;
*
:
*
* - FORCED AT ENTRY
IF
IFRAUWF1(6) = '1'
THEN
EXEC(CMD('OUTREP ')ROUTE(ONE %AOFOPWTORS%));
*
ALWAYS
%AOFALWAYSACTION%;
*
END;
* -----

```

Figure 46. BEGIN-END Block Statements

---

## Restricted Message IDs

The following restricted message IDs will not create an AT entry:

|            |           |                     |            |
|------------|-----------|---------------------|------------|
| ABCODEPROG | ABCODES   | ABCODESYSTEM        | ABCODETRAN |
| ABENDED    | ABENDING  | ACORESTART          | ACTCODES   |
| ACTIVE     | ALTCODES  | AMRFSHORT           | AMRFFULL   |
| AMRFCLEAR  | AUTODOWN  | AUTOTERM            | BMPABEND   |
| BREAKING   | BRO       | BROKEN              | CAPMSG     |
| CHE        | CICSINFO  | CITIME              | CONN       |
| CQSET      | CTLDOWN   | <del>DATABASE</del> | DOMAINID   |
| DOWN       | ENDED     | ENDING              | EXTSTART   |
| FALLBACK   | FORCE     | FPABEND             | HALFDOWN   |
| HALTED     | HEALTHCHK | HOLDQ               | IMSINFO    |
| INACTIVE   | JESABEND  | LISTSHUT            | LOGREC     |
| LOGGER     | MDSCOUNTA | MDSCOUNTB           | MDSCOUNTE  |

|                     |              |              |                     |
|---------------------|--------------|--------------|---------------------|
| MDSCOUNTF           | MDSCOUNTQ    | MDSCOUNTR    | MDSCOUNTSS          |
| MDSCOUNTSV          | MDSCOUNTU    | MDSCOUNTV    | MDSCOUNTW           |
| MOVED               | MVSDUMP      | MVSDUMPTAKEN | MVSDUMPRESET        |
| NOJSM               | OLDS         | OPCA         | OPCACMD             |
| OPCAPARM            | POSTCHKP     | PPIACTIVE    | PRECHKP             |
| <del>RCVRAUTO</del> | RCVRSOS      | RCVRTRAN     | <del>RCVRVIOL</del> |
| RECONS              | RELEASEQ     | RESTART      | RESTARTABORT        |
| RUNNING             | SHUTFORCEDDF | SHUTTYPES    | SMFDUMP             |
| SNAPQ               | SPOOLFULL    | SPOOLSHORT   | STADC               |
| START               | STARTED      | STARTED2     | STOPBMPREGION       |
| STOPFPREGION        | STOPPED      | STOPPING     | STOPREGION          |
| STUCK               | SYSLOG       | TAPES        | TCO                 |
| TERMINATING         | TERMINATED   | TPABEND      | UNLKAVM             |
| UNLOCK              | UP           | USERSTART    | VTAMTERMS           |
| VTAMUP              | WORKSTATION  | WTORS        | ZOMBIE              |
| VTAMDOWN            |              |              |                     |





---

## Appendix D. TSO User Monitoring

Active TSO users can be monitored in NMC and SDF using the SA z/OS command DFTSOU (EVJETSOU). To enable TSO user monitoring add the following entry to user AT member INGMSGU1 (or to your own user message table):

```
IF (MSGID='IEF125I' | MSGID='IEF126I' | MSGID='IEF450I') & TEXT=MESSAGE
 THEN EXEC(CMD('DFTSOU UPDATE') ROUTE(ALL *))
 DISPLAY(N) NETLOG(N) CONTINUE(Y);
```

Also, put 'DFTSOU SCAN' in the ACORESTART message for the TSO subsystem.

When DFTSOU is called with the UPDATE parameter then:

- For IEF125I, an ADD request is sent to SDF and NMC for the TSO user that produces the message.
- For IEF126I, a DELETE request is sent to SDF and NMC for the TSO user that produces the message.
- For IEF450I, a DELETE request is sent to SDF and NMC for the failing TSO user. When IEF450I is specified, and the trap is coded in INGMSGU1, then CONTINUE(Y) must also be coded.

When DFTSOU is called with the SCAN parameter, an MVS D TS,L command is issued to identify all currently active TSO users. This data is then passed to SDF and NMC.

NMC updates are associated with NMC object TSO. SDF updates are associated with SDF tree entry TSUSERS.



---

## Glossary

This glossary includes terms and definitions from:

- The *IBM Dictionary of Computing* New York: McGraw-Hill, 1994.
- The *American National Standard Dictionary for Information Systems*, ANSI X3.172-1990, copyright 1990 by the American National Standards Institute (ANSI). Copies can be purchased from the American National Standards Institute, 1430 Broadway, New York, New York 10018. Definitions are identified by the symbol (A) after the definition.
- The *Information Technology Vocabulary* developed by Subcommittee 1, Joint Technical Committee 1, of the International Organization for Standardization and the International Electrotechnical Commission (ISO/IEC JTC1/SC1). Definitions of published parts of this vocabulary are identified by the symbol (I) after the definition; definitions taken from draft international standards, committee drafts, and working papers being developed by ISO/IEC JTC1/SC1 are identified by the symbol (T) after the definition, indicating that final agreement has not yet been reached among the participating National Bodies of SC1.

The following cross-references are used in this glossary:

**Contrast with.** This refers to a term that has an opposed or substantively different meaning.

**Deprecated term for.** This indicates that the term should not be used. It refers to a preferred term, which is defined in its proper place in the glossary.

**See.** This refers the reader to multiple-word terms in which this term appears.

**See also.** This refers the reader to terms that have a related, but not synonymous, meaning.

**Synonym for.** This indicates that the term has the same meaning as a preferred term, which is defined in the glossary.

**Synonymous with.** This is a backward reference from a defined term to all other terms that have the same meaning.

## A

**ACF.** Automation control file.

**ACF/NCP.** Advanced Communications Function for the Network Control Program. See *Advanced Communications Function* and *Network Control Program*.

**ACF/VTAM.** Advanced Communications Function for the Virtual Telecommunications Access Method. Synonym for *VTAM*. See *Advanced Communications Function* and *Virtual Telecommunications Access Method*.

**active monitoring.** In SA z/OS, the acquiring of resource status information by soliciting such information at regular, user-defined intervals. See also *passive monitoring*.

**adapter.** Hardware card that enables a device, such as a workstation, to communicate with another device, such as a monitor, a printer, or some other I/O device.

**Address Space Workflow.** In RMF, a measure of how a job uses system resources and the speed at which the job moves through the system. A low workflow indicates that a job has few of the resources it needs and is contending with other jobs for system resources. A high workflow indicates that a job has all the resources it needs to execute.

**adjacent hosts.** Systems connected in a peer relationship using adjacent NetView sessions for purposes of monitoring and control.

**adjacent NetView.** In SA z/OS, the system defined as the communication path between two SA z/OS systems that do not have a direct link. An adjacent NetView is used for message forwarding and as a communication link between two SA z/OS systems. For example, the adjacent NetView is used when sending responses from a focal point to a remote system.

**Advanced Communications Function (ACF).** A group of IBM licensed programs (principally VTAM, TCAM, NCP, and SSP) that use the concepts of Systems Network Architecture (SNA), including distribution of function and resource sharing.

**advanced program-to-program communication (APPC).** A set of inter-program communication services that support cooperative transaction processing in a Systems Network Architecture (SNA) network. APPC is the implementation, on a given system, of SNA's logical unit type 6.2.

**alert.** (1) In SNA, a record sent to a system problem management focal point or to a collection point to communicate the existence of an alert condition. (2) In NetView, a high-priority event that warrants immediate

attention. A database record is generated for certain event types that are defined by user-constructed filters.

**alert condition.** A problem or impending problem for which some or all of the process of problem determination, diagnosis, and resolution is expected to require action at a control point.

**alert focal-point system.** See entry for NPDA focal-point system under *focal—point system*.

**alert threshold.** An application or volume service value that determines the level at which SA z/OS changes the associated icon in the graphical interface to the alert color. SA z/OS may also issue an alert. See *warning threshold*.

**AMC.** (1) Automation Manager Configuration (2) The Auto Msg Classes entry type

**APF.** Authorized program facility.

**API.** Application programming interface.

**APPC.** Advanced program-to-program communications.

**application.** An z/OS subsystem or job monitored by SA z/OS.

**Application entry.** A construct, created with the customization dialogs, used to represent and contain policy for an application.

**application group.** A named set of applications. An application group is part of an SA z/OS enterprise definition and is used for monitoring purposes.

**ApplicationGroup entry.** A construct, created with the customization dialogs, used to represent and contain policy for an application group.

**application program.** (1) A program written for or by a user that applies to the user's work, such as a program that does inventory or payroll. (2) A program used to connect and communicate with stations in a network, enabling users to perform application-oriented activities.

**ARM.** Automatic restart management.

**ASCB.** Address space control block.

**ASCB status.** An application status derived by SA z/OS running a routine (the ASCB checker) that searches the z/OS address space control blocks (ASCBs) for address spaces with a particular job name. The job name used by the ASCB checker is the job name defined in the customization dialog for the application.

**ASCII (American National Standard Code for Information Interchange).** The standard code, using a coded character set consisting of 7-bit coded characters

(8-bit including parity check), for information interchange among data processing systems, data communication systems, and associated equipment. The ASCII set consists of control characters and graphic characters. (A)

**ASF.** Automation status file.

**assist mode facility.** An SA z/OS facility that uses SDF and enables interaction with automation before SA z/OS takes an automation action. SDF prompts the operator with a suggested action, then provides options for using that action, modifying and using the action, or canceling the action. Also called assist mode, it is enabled using the customization dialogs, or dynamically.

**authorized program facility (APF).** A facility that permits identification of programs that are authorized to use restricted functions.

**automated function.** SA z/OS automated functions are automation operators, NetView autotasks that are assigned to perform specific automation functions. However, SA z/OS defines its own synonyms, or *automated function names*, for the NetView autotasks, and these function names are referred to in the sample policy databases provided by SA z/OS. For example, the automation operator AUTBASE corresponds to the SA z/OS automated function BASEOPER.

**automated console operations (ACO).** The concept (versus a product) of using computers to perform a large subset of tasks ordinarily performed by operators, or assisting operators in performing these tasks.

**automatic restart management.** A z/OS recovery function that improves the availability of specified subsystems and applications by automatically restarting them under certain circumstances. Automatic restart management is a function of the Cross-System Coupling Facility (XCF) component of z/OS.

**automatic restart management element name.** In MVS 5.2 or later, z/OS automatic restart management requires the specification of a unique sixteen character name for each address space that registers with it. All automatic restart management policy is defined in terms of the element name, including SA z/OS's interface with it.

**automation.** The automatic initiation of actions in response to detected conditions or events. SA z/OS provides automation for z/OS applications, z/OS components, and remote systems that run z/OS. SA z/OS also provides tools that can be used to develop additional automation.

**automation agent.** In SA z/OS, the automation function is split up between the automation manager and the automation agents. The observing, reacting and doing parts are located within the NetView address

space, and are known as the *automation agents*. The automation agents are responsible for:

- recovery processing
- message processing
- active monitoring: they propagate status changes to the automation manager

**automation configuration file.** The data set that consists of:

- the automation control file (ACF)
- the automation manager configuration file (AMC)
- the NetView automation table (AT)
- the MPFLSTSA member

**automation control file (ACF).** In SA z/OS, a file that contains system-level automation policy information. There is one master automation control file for each NetView system on which SA z/OS is installed. Additional policy information and all resource status information is contained in the policy database (PDB). The SA z/OS customization dialogs must be used to build the automation control files. They must not be edited manually.

**automation flags.** In SA z/OS, the automation policy settings that determine the operator functions that are automated for a resource and the times during which automation is active. When SA z/OS is running, automation is controlled by automation flag policy settings and override settings (if any) entered by the operator. Automation flags are set using the customization dialogs.

**automation manager.** In SA z/OS, the automation function is split up between the automation manager and the automation agents. The coordination, decision making and controlling functions are processed by each sysplex's *automation manager*.

The automation manager contains a model of all of the automated resources within the sysplex. The automation agents feed the automation manager with status information and perform the actions that the automation manager tells them to.

The automation manager provides *sysplex-wide* automation.

**Automation Manager Configuration.** The Automation Manager Configuration file (AMC) contains an image of the automated systems in a sysplex or of a standalone system.

**Automation NetView.** In SA z/OS the NetView that performs routine operator tasks with command procedures or uses other ways of automating system and network management, issuing automatic responses to messages and management services units.

**automation operator.** NetView automation operators are NetView autotasks that are assigned to perform specific automation functions. See also *automated*

*function*. NetView automation operators may receive messages and process automation procedures. There are no logged-on users associated with automation operators. Each automation operator is an operating system task and runs concurrently with other NetView tasks. An automation operator could be set up to handle JES2 messages that schedule automation procedures, and an automation statement could route such messages to the automation operator. Similar to *operator station task*. SA z/OS message monitor tasks and target control tasks are automation operators.

**automation policy.** The policy information governing automation for individual systems. This includes automation for applications, z/OS subsystems, z/OS data sets, and z/OS components.

**automation policy settings.** The automation policy information contained in the automation control file. This information is entered using the customization dialogs. You can display or modify these settings using the customization dialogs.

**automation procedure.** A sequence of commands, packaged as a NetView command list or a command processor written in a high-level language. An automation procedure performs automation functions and runs under NetView.

**automation status file.** In SA z/OS, a file containing status information for each automated subsystem, component or data set. This information is used by SA z/OS automation when taking action or when determining what action to take. In Release 2 and above of AOC/MVS, status information is also maintained in the operational information base.

**automation table (AT).** See *NetView automation table*.

**autotask.** A NetView automation task that receives messages and processes automation procedures. There are no logged-on users associated with autotasks. Each autotask is an operating system task and runs concurrently with other NetView tasks. An autotask could be set up to handle JES2 messages that schedule automation procedures, and an automation statement could route such messages to the autotasks. Similar to *operator station task*. SA z/OS message monitor tasks and target control tasks are autotasks. Also called *automation operator*.

**available.** In VTAM programs, pertaining to a logical unit that is active, connected, enabled, and not at its session limit.

## B

**basic mode.** A central processor mode that does not use logical partitioning. Contrast with *logically partitioned (LPAR) mode*.

**BCP Internal Interface.** Processor function of CMOS-390, zSeries processor families. It allows the communication between basic control programs such as z/OS and the processor support element in order to exchange information or to perform processor control functions. Programs using this function can perform hardware operations such as ACTIVATE or SYSTEM RESET.

**beaconing.** The repeated transmission of a frame or messages (beacon) by a console or workstation upon detection of a line break or outage.

**BookManager.** An IBM product that lets users view softcopy documents on their workstations.

## C

**central processor (CP).** The part of the computer that contains the sequencing and processing facilities for instruction execution, initial program load (IPL), and other machine operations.

**central processor complex (CPC).** A physical collection of hardware that consists of central storage, one or more central processors, timers, and channels.

**central site.** In a distributed data processing network, the central site is usually defined as the focal point for alerts, application design, and remote system management tasks such as problem management.

**CFR/CFS and ISC/ISR.** I/O operations can display and return data about integrated system channels (ISC) connected to a coupling facility and coupling facility receiver (CFR) channels and coupling facility sender (CFS) channels.

**channel.** A path along which signals can be sent; for example, data channel, output channel. See also *link*.

**channel path identifier.** A system-unique value assigned to each channel path.

**CHPID.** In SA z/OS, channel path ID; the address of a channel.

**CHPID port.** A label that describes the system name, logical partitions, and channel paths.

**channel-attached.** (1) Attached directly by I/O channels to a host processor (for example, a channel-attached device). (2) Attached to a controlling unit by cables, rather than by telecommunication lines. Contrast with *link-attached*. Synonymous with *local*.

**CI.** Console integration.

**CICS/VS.** Customer Information Control System for Virtual Storage.

**CLIST.** Command list.

**clone.** A set of definitions for application instances that are derived from a basic application definition by substituting a number of different system-specific values into the basic definition.

**clone ID.** A generic means of handling system-specific values such as the MVS SYSCLONE or the VTAM subarea number. Clone IDs can be substituted into application definitions and commands to customize a basic application definition for the system that it is to be instantiated on.

**CNC.** A channel path that transfers data between a host system image and an ESCON control unit. It can be point-to-point or switchable.

**command.** A request for the performance of an operation or the execution of a particular program.

**command facility.** The component of NetView that is a base for command processors that can monitor, control, automate, and improve the operation of a network. The successor to NCCF.

**command list (CLIST).** (1) A list of commands and statements, written in the NetView command list language or the REXX language, designed to perform a specific function for the user. In its simplest form, a command list is a list of commands. More complex command lists incorporate variable substitution and conditional logic, making the command list more like a conventional program. Command lists are typically interpreted rather than being compiled. (2) In SA z/OS, REXX command lists that can be used for automation procedures.

**command procedure.** In NetView, either a command list or a command processor.

**command processor.** A module designed to perform a specific function. Command processors, which can be written in assembler or a high-level language (HLL), are issued as commands.

**Command Tree/2.** An OS/2-based program that helps you build commands on an OS/2 window, then routes the commands to the destination you specify (such as a 3270 session, a file, a command line, or an application program). It provides the capability for operators to build commands and route them to a specified destination.

**common commands.** The SA z/OS subset of the CPC operations management commands.

**common routine.** One of several SA z/OS programs that perform frequently used automation functions. Common routines can be used to create new automation procedures.

**Common User Access (CUA) architecture.** Guidelines for the dialog between a human and a workstation or terminal.

**communication controller.** A type of communication control unit whose operations are controlled by one or more programs stored and executed in the unit or by a program executed in a processor to which the controller is connected. It manages the details of line control and the routing of data through a network.

**communication line.** Deprecated term for *telecommunication line*.

**connectivity view.** In SA z/OS, a display that uses graphic images for I/O devices and lines to show how they are connected.

**console automation.** The process of having NetView facilities provide the console input usually handled by the operator.

**console connection.** In SA z/OS, the 3270 or ASCII (serial) connection between a PS/2 computer and a target system. Through this connection, the workstation appears (to the target system) to be a console.

**console integration (CI).** A hardware facility that if supported by an operating system, allows operating system messages to be transferred through an internal hardware interface for display on a system console. Conversely, it allows operating system commands entered at a system console to be transferred through an internal hardware interface to the operating system for processing.

**consoles.** Workstations and 3270-type devices that manage your enterprise.

**Control units.** Hardware units that control I/O operations for one or more devices. You can view information about control units through I/O operations, and can start or stop data going to them by blocking and unblocking ports.

**controller.** A unit that controls I/O operations for one or more devices.

**couple data set.** A data set that is created through the XCF couple data set format utility and, depending on its designated type, is shared by some or all of the z/OS systems in a sysplex. See also *sysplex couple data set* and *XCF couple data set*.

**coupling facility.** The hardware element that provides high-speed caching, list processing, and locking functions in a sysplex.

**CP.** Central processor.

**CPC.** Central processor complex.

**CPC operations management commands.** A set of commands and responses for controlling the operation of System/390 CPCs.

**CPC subset.** All or part of a CPC. It contains the minimum *resource* to support a single control program.

**CPCB.** Command processor control block; an I/O operations internal control block that contains information about the command being processed.

**CPU.** Central processing unit. Deprecated term for *processor*.

**cross-system coupling facility (XCF).** XCF is a component of z/OS that provides functions to support cooperation between authorized programs running within a sysplex.

**CTC.** The channel-to-channel (CTC) channel can communicate with a CTC on another host for intersystem communication.

**Customer Information Control System (CICS).** A general-purpose transactional program that controls online communication between terminal users and a database for a large number of end users on a real-time basis.

**customization dialogs.** The customization dialogs are an ISPF application. They are used to customize the enterprise policy, like, for example, the enterprise resources and the relationships between resources, or the automation policy for systems in the enterprise. How to use these dialogs is described in *IBM Tivoli System Automation for z/OS Customizing and Programming*.

**CVC.** A channel operating in converted (CVC) mode transfers data in blocks and a CBY channel path transfers data in bytes. Converted CVC or CBY channel paths can communicate with a parallel control unit. This resembles a point-to-point parallel path and dedicated connection, regardless whether it passes through a switch.

## D

**DASD.** Direct access storage device.

**data services task (DST).** The NetView subtask that gathers, records, and manages data in a VSAM file or a network device that contains network management information.

**data set.** The major unit of data storage and retrieval, consisting of a collection of data in one of several prescribed arrangements and described by control information to which the system has access.

**data set members.** Members of partitioned data sets that are individually named elements of a larger file that can be retrieved by name.

**DBCS.** Double-byte character set.

**DCCF.** Disabled console communication facility.

**DCF.** Document composition facility.

**DELAY Report.** An RMF report that shows the activity of each job in the system and the hardware and software resources that are delaying each job.

**Devices.** You can see information about all devices (such as printers, tape or disk drives, displays, or communications controllers) attached to a particular switch, and control paths and jobs to devices.

**DEVR Report.** An RMF report that presents information about the activity of I/O devices that are delaying jobs.

**dialog.** Interactive 3270 panels.

**direct access storage device (DASD).** A device in which the access time is effectively independent of the location of the data; for example, a disk.

**disabled console communication facility (DCCF).** A z/OS component that provides limited-function console communication during system recovery situations.

**display.** (1) To present information for viewing, usually on the screen of a workstation or on a hardcopy device. (2) Deprecated term for *panel*.

**disk operating system (DOS).** (1) An operating system for computer systems that use disks and diskettes for auxiliary storage of programs and data. (2) Software for a personal computer that controls the processing of programs. For the IBM Personal Computer, the full name is Personal Computer Disk Operating System (PCDOS).

**distribution manager.** The component of the NetView program that enables the host system to use, send, and delete files and programs in a network of computers.

**domain.** (1) An access method and its application programs, communication controllers, connecting lines, modems, and attached workstations. (2) In SNA, a system services control point (SSCP) and the physical units (PUs), logical units (LUs), links, link stations, and associated resources that the SSCP can control by means of activation requests and deactivation requests.

**double-byte character set (DBCS).** A character set, such as Kanji, in which each character is represented by a 2-byte code.

**DP enterprise.** Data processing enterprise.

**DSIPARM.** This file is a collection of members of NetView's customization.

**DST.** Data Services Task.

## E

**EBCDIC.** Extended binary-coded decimal interchange code. A coded character set consisting of 8-bit coded characters.

**ECB.** Event control block. A control block used to represent the status of an event.

**EMCS.** Extended multiple console support.

**enterprise.** An organization, such as a business or a school, that uses data processing.

**enterprise monitoring.** Enterprise monitoring is used by SA z/OS to update the *NetView Management Console (NMC)* resource status information that is stored in the *Resource Object Data Manager (RODM)*. Resource status information is acquired by enterprise monitoring of the *Resource Measurement Facility (RMF) Monitor III* service information at user-defined intervals. SA z/OS stores this information in its operational information base, where it is used to update the information presented to the operator in graphic displays.

**entries.** Resources, such as processors, entered on panels.

**entry type.** Resources, such as processors or applications, used for automation and monitoring.

**environment.** Data processing enterprise.

**error threshold.** An automation policy setting that specifies when SA z/OS should stop trying to restart or recover an application, subsystem or component, or offload a data set.

**ESA.** Enterprise Systems Architecture.

**eServer.** Processor family group designator used by the SA z/OS customization dialogs to define a target hardware as member of the zSeries or 390-CMOS processor families.

**event.** (1) In NetView, a record indicating irregularities of operation in physical elements of a network. (2) An occurrence of significance to a task; for example, the completion of an asynchronous operation, such as an input/output operation. (3) Events are part of a trigger condition, in a way that if all events of a trigger condition have occurred, a *STARTUP* or *SHUTDOWN* of an application is performed.

**exception condition.** An occurrence on a system that is a deviation from normal operation. SA z/OS monitoring highlights exception conditions and allows an SA z/OS enterprise to be managed by exception.

**extended recovery facility (XRF).** A facility that minimizes the effect of failures in z/OS, VTAM, the host processor, or high availability applications during sessions between high availability applications and designated terminals. This facility provides an alternate subsystem to take over sessions from the failing subsystem.



## F

**fallback system.** See *secondary system*.

**field.** A collection of bytes within a record that are logically related and are processed as a unit.

**file manager commands.** A set of SA z/OS commands that read data from or write data to the automation control file or the operational information base. These commands are useful in the development of automation that uses SA z/OS facilities.

**focal point.** In NetView, the focal-point domain is the central host domain. It is the central control point for any management services element containing control of the network management data.

**focus host.** A processor with the role in the context of a unified system image

**focal point system.** (1) A system that can administer, manage, or control one or more target systems. There are a number of different focal point systems associated with IBM automation products. (2) **NMC focal point system.** The NMC focal point system is a NetView system with an attached workstation server and LAN that gathers information about the state of the network. This focal point system uses RODM to store the data it collects in the data model. The information stored in RODM can be accessed from any LAN-connected workstation with NetView Management Console installed. (3) **NPDA focal point system.** This is a NetView system that collects all the NPDA alerts that are generated within your enterprise. It is supported by NetView. If you have SA z/OS installed the NPDA focal point system must be the same as your NMC focal point system. The NPDA focal point system is also known as the *alert focal point system*. (4) **SA z/OS Processor Operations focal point system.** This is a NetView system that has SA z/OS host code installed. The SA z/OS Processor Operations focal point system receives messages from the systems and operator consoles of the machines that it controls. It provides full systems and operations console function for its target systems. It can be used to IPL these systems. Note that some restrictions apply to the Hardware Management Console for an S/390 microprocessor cluster. (5) **SA z/OS SDF focal point system.** The SA z/OS SDF focal point system is an SA z/OS NetView system that collects status information from other SA z/OS NetViews within your enterprise. (6) **Status focal point system.** In NetView, the system to which STATMON, VTAM and NLDM send status information on network resources. If you have a NMC focal point, it must be on the same system as the Status focal point. (7) **Hardware Management Console.** Although not listed as a focal point, the Hardware Management Console acts as a focal point for the console functions of an S/390 microprocessor cluster. Unlike all the other focal points in this definition, the

Hardware Management Console runs on a LAN-connected workstation,

**frame.** For a System/390 microprocessor cluster, a frame contains one or two central processor complexes (CPCs), support elements, and AC power distribution.

**full-screen mode.** In NetView, a form of panel presentation that makes it possible to display the contents of an entire workstation screen at once. Full-screen mode can be used for fill-in-the-blanks prompting. Contrast with *line mode*.

## G

**gateway session.** An NetView-NetView Task session with another system in which the SA z/OS outbound gateway operator logs onto the other NetView session without human operator intervention. Each end of a gateway session has both an inbound and outbound gateway operator.

**generic alert.** Encoded alert information that uses code points (defined by IBM and possibly customized by users or application programs) stored at an alert receiver, such as NetView.

**generic routines.** In SA z/OS, a set of self-contained automation routines that can be called from the NetView automation table, or from user-written automation procedures.

**group.** A collection of target systems defined through configuration dialogs. An installation might set up a group to refer to a physical site or an organizational or application entity.

**group entry.** A construct, created with the customization dialogs, used to represent and contain policy for a group.

**group entry type.** A collection of target systems defined through the customization dialog. An installation might set up a group to refer to a physical site or an organizational entity. Groups can, for example, be of type STANDARD or SYSPLEX.

## H

**Hardware Management Console.** A console used by the operator to monitor and control a System/390 microprocessor cluster.

**Hardware Management Console Application (HWMCA).** A direct-manipulation object-oriented graphical user interface that provides single point of control and single system image for hardware elements. HWMCA provides customer grouping support, aggregated and real-time system status using colors, consolidated hardware messages support, consolidated operating system messages support, consolidated

service support, and hardware commands targeted at a single system, multiple systems, or a customer group of systems.

**heartbeat.** In SA z/OS, a function that monitors the validity of the status forwarding path between remote systems and the NMC focal point, and monitors the availability of remote z/OS systems, to ensure that status information displayed on the SA z/OS workstation is current.

**help panel.** An online panel that tells you how to use a command or another aspect of a product.

**hierarchy.** In the NetView program, the resource types, display types, and data types that make up the organization, or levels, in a network.

**high-level language (HLL).** A programming language that does not reflect the structure of any particular computer or operating system. For the NetView program, the high-level languages are PL/I and C.

**HLL.** High-level language.

**host system.** In a coupled system or distributed system environment, the system on which the facilities for centralized automation run. SA z/OS publications refer to target systems or focal-point systems instead of hosts.

**host (primary processor).** The processor at which you enter a command (also known as the *issuing processor*).

**HWMCA.** Hardware Management Console Application. Application for the graphic hardware management console that monitors and controls a central processor complex. It is attached to a target processor (a system 390 microprocessor cluster) as a dedicated system console. This microprocessor uses OCF to process commands.

## I

**images.** A grouping of processors and I/O devices that you define. You can define a single-image mode that allows a multiprocessor system to function as one central processor image.

**IMS/VS.** Information Management System/Virtual Storage.

**inbound.** In SA z/OS, messages sent to the focal-point system from the PC or target system.

**inbound gateway operator.** The automation operator that receives incoming messages, commands, and responses from the outbound gateway operator at the sending system. The inbound gateway operator handles communications with other systems using a gateway session.

**Information Management System/Virtual Storage (IMS/VS).** A database/data communication (DB/DC) system that can manage complex databases and networks. Synonymous with IMS.

**INGEIO PROC.** The I/O operations default procedure name; part of the SYS1.PROCLIB.

**initial program load (IPL).** (1) The initialization procedure that causes an operating system to commence operation. (2) The process by which a configuration image is loaded into storage at the beginning of a workday or after a system malfunction. (3) The process of loading system programs and preparing a system to run jobs.

**initialize automation.** SA z/OS-provided automation that issues the correct z/OS start command for each subsystem when SA z/OS is initialized. The automation ensures that subsystems are started in the order specified in the automation control file and that prerequisite applications are functional.

**input/output support processor (IOSP).** The hardware unit that provides I/O support functions for the primary support processor and maintenance support functions for the processor controller.

**Interactive System Productivity Facility (ISPF).** An IBM licensed program that serves as a full-screen editor and dialog manager. Used for writing application programs, it provides a means of generating standard screen panels and interactive dialogs between the application programmer and the terminal user.

**interested operator list.** The list of operators who are to receive messages from a specific target system.

**internal token.** A *logical token* (LTOK); name by which the I/O resource or object is known; stored in IODF.

**IOCDs.** I/O configuration data set. The data set that describes the I/O configuration.

**I/O Ops.** I/O operations.

**IOSP.** Input/Output Support Processor.

**I/O operations.** The part of SA z/OS that provides you with a single point of logical control for managing connectivity in your active I/O configurations. I/O operations takes an active role in detecting unusual conditions and lets you view and change paths between a processor and an I/O device, using dynamic switching (the ESCON director). Also known as I/O Ops.

**I/O resource number.** Combination of channel path identifier (CHPID), device number, etc. See internal token.

**IPL.** Initial program load.

**ISA.** Industry Standard Architecture.

**ISPF.** Interactive System Productivity Facility.

**ISPF console.** From this 3270-type console you are logged onto ISPF to use the runtime panels for I/O operations and SA z/OS customization panels.

**issuing host.** See *primary host*; the base program at which you enter a command for processing.

## J

**JCL.** Job control language.

**JES.** Job entry subsystem.

**job.** (1) A set of data that completely defines a unit of work for a computer. A job usually includes all necessary computer programs, linkages, files, and instructions to the operating system. (2) An address space.

**job control language (JCL).** A problem-oriented language designed to express statements in a job that are used to identify the job or describe its requirements to an operating system.

**job entry subsystem (JES).** A facility for spooling, job queuing, and managing I/O. In SA z/OS publications, JES refers to JES2 or JES3, unless distinguished as being either one or the other.

## K

**Kanji.** An ideographic character set used in Japanese. See also *double-byte character set*.

## L

**LAN.** Local area network.

**line mode.** A form of screen presentation in which the information is presented a line at a time in the message area of the terminal screen. Contrast with *full-screen mode*.

**link.** (1) In SNA, the combination of the link connection and the link stations joining network nodes; for example, a System/370 channel and its associated protocols, a serial-by-bit connection under the control of synchronous data link control (SDLC). (2) In SA z/OS, link connection is the physical medium of transmission.

**link-attached.** Describes devices that are physically connected by a telecommunication line. Contrast with *channel-attached*.

**Linux for zSeries and S/390.** UNIX-like open source operating system conceived by Linus Torvalds and developed across the internet.

**local.** Pertaining to a device accessed directly without use of a telecommunication line. Synonymous with *channel-attached*.

**local area network (LAN).** (1) A network in which a set of devices is connected for communication. They can be connected to a larger network. See also *token ring*. (2) A network in which communications are limited to a moderately-sized geographic area such as a single office building, warehouse, or campus, and that do not generally extend across public rights-of-way.

**logical partition (LP).** A subset of the processor hardware that is defined to support an operating system. See also *logically partitioned (LPAR) mode*.

**logical switch number (LSN).** Assigned with the switch parameter of the CHPID macro of the IOCP.

**logical token (LTOK).** Resource number of an object in the IODF.

**logical unit (LU).** In SNA, a port through which an end user accesses the SNA network and the functions provided by system services control points (SSCPs). An LU can support at least two sessions — one with an SSCP and one with another LU — and may be capable of supporting many sessions with other LUs. See also *physical unit (PU)* and *system services control point (SSCP)*.

**logical unit (LU) 6.2.** A type of logical unit that supports general communications between programs in a distributed processing environment. LU 6.2 is characterized by (a) a peer relationship between session partners, (b) efficient use of a session for multiple transactions, (c) comprehensive end-to-end error processing, and (d) a generic application program interface (API) consisting of structured verbs that are mapped into a product implementation. Synonym for advanced program-to-program communications (APPC).

**logically partitioned (LPAR) mode.** A central processor mode that enables an operator to allocate system processor hardware resources among several logical partitions. Contrast with *basic mode*.

**LOGR.** The sysplex logger.

**LP.** Logical partition.

**LPAR.** Logically partitioned (mode).

**LU.** Logical unit.

**LU-LU session.** In SNA, a session between two logical units (LUs) in an SNA network. It provides communication between two end users, or between an end user and an LU services component.

**LU 6.2.** Logical unit 6.2.

**LU 6.2 session.** A session initiated by VTAM on behalf of an LU 6.2 application program, or a session initiated by a remote LU in which the application program specifies that VTAM is to control the session by using the APPCCMD macro.

## M

**MAT.** Deprecated term for NetView Automation Table.

**MCA.** Micro Channel\* architecture.

**MCS.** Multiple console support.

**member.** A specific function (one or more modules/routines) of a multisystem application that is defined to XCF and assigned to a group by the multisystem application. A member resides on one system in the sysplex and can use XCF services to communicate (send and receive data) with other members of the same group.

**message automation table (MAT).** Deprecated term for NetView Automation Table.

**message class.** A number that SA z/OS associates with a message to control routing of the message. During automated operations, the classes associated with each message issued by SA z/OS are compared to the classes assigned to each notification operator. Any operator with a class matching one of the message's classes receives the message.

**message forwarding.** The SA z/OS process of sending messages generated at an SA z/OS target system to the SA z/OS focal-point system.

**message group.** Several messages that are displayed together as a unit.

**message monitor task.** A task that starts and is associated with a number of communications tasks. Message monitor tasks receive inbound messages from a communications task, determine the originating target system, and route the messages to the appropriate target control tasks.

**message processing facility (MPF).** A z/OS table that screens all messages sent to the z/OS console. The MPF compares these messages with a customer-defined list of messages on which to automate, suppress from the z/OS console display, or both, and marks messages to automate or suppress. Messages are then broadcast on the subsystem interface (SSI).

**message suppression.** The ability to restrict the amount of message traffic displayed on the z/OS console.

**Micro Channel architecture.** The rules that define how subsystems and adapters use the Micro Channel bus in a computer. The architecture defines the services that each subsystem can or must provide.

**microprocessor.** A processor implemented on one or a small number of chips.

**migration.** Installation of a new version or release of a program to replace an earlier version or release.

**MP.** Multiprocessor.

**MPF.** Message processing facility.

**MPFLSTSA.** The MPFLST member that is built by SA z/OS.

**Multiple Virtual Storage (MVS).** An IBM licensed program. MVS, which is the predecessor of OS/390, is an operating system that controls the running of programs on a System/390 or System/370 processor. MVS includes an appropriate level of the Data Facility Product (DFP) and Multiple Virtual Storage/Enterprise Systems Architecture System Product Version 5 (MVS/ESA SP5).

**multiprocessor (MP).** A CPC that can be physically partitioned to form two operating processor complexes.

**multisystem application.** An application program that has various functions distributed across z/OS images in a multisystem environment.

**multisystem environment.** An environment in which two or more z/OS images reside in one or more processors, and programs on one image can communicate with programs on the other images.

**MVS.** Multiple Virtual Storage, predecessor of z/OS.

**MVS image.** A single occurrence of the MVS/ESA operating system that has the ability to process work.

**MVS/JES2.** Multiple Virtual Storage/Job Entry System 2. A z/OS subsystem that receives jobs into the system, converts them to internal format, selects them for execution, processes their output, and purges them from the system. In an installation with more than one processor, each JES2 processor independently controls its job input, scheduling, and output processing.

**MVS/ESA.** Multiple Virtual Storage/Enterprise Systems Architecture.

## N

**NAU.** (1) Network accessible unit. (2) Network addressable unit.

**NCCF.** Network Communications Control Facility.

**NCP.** (1) Network Control Program (IBM licensed program). Its full name is Advanced Communications Function for the Network Control Program. Synonymous with *ACF/NCP*. (2) Network control program (general term).

**NetView.** An IBM licensed program used to monitor a network, manage it, and diagnose network problems. NetView consists of a command facility that includes a presentation service, command processors, automation based on command lists, and a transaction processing structure on which the session monitor, hardware monitor, and terminal access facility (TAF) network management applications are built.

**network accessible unit (NAU).** A logical unit (LU), physical unit (PU), control point (CP), or system services control point (SSCP). It is the origin or the destination of information transmitted by the path control network. Synonymous with *network addressable unit*.

**network addressable unit (NAU).** Synonym for *network accessible unit*.

**NetView automation procedures.** A sequence of commands, packaged as a NetView command list or a command processor written in a high-level language. An automation procedure performs automation functions and runs under the NetView program.

**NetView automation table (AT).** A table against which the NetView program compares incoming messages. A match with an entry triggers the specified response. SA z/OS entries in the NetView automation table trigger an SA z/OS response to target system conditions. Formerly known as the message automation table (MAT).

**NetView Command list language.** An interpretive language unique to NetView that is used to write command lists.

**NetView (NCCF) console.** A 3270-type console for NetView commands and runtime panels for system operations and processor operations.

**NetView Graphic Monitor Facility (NGMF).** Deprecated term for NetView Management Console.

**NetView hardware monitor.** The component of NetView that helps identify network problems, such as hardware, software, and microcode, from a central control point using interactive display techniques. Formerly called *network problem determination application*.

**NetView log.** The log in which NetView records events pertaining to NetView and SA z/OS activities.

**NetView message table.** See *NetView automation table*.

**NetView Management Console (NMC).** A function of the NetView program that provides a graphic, topological presentation of a network that is controlled by the NetView program. It provides the operator different views of a network, multiple levels of graphical detail, and dynamic resource status of the network. This function consists of a series of graphic

windows that allows you to manage the network interactively. Formerly known as the NetView Graphic Monitor Facility (NGMF).

**NetView-NetView task (NNT).** The task under which a cross-domain NetView operator session runs. Each NetView program must have a NetView-NetView task to establish one NNT session. See also *operator station task*.

**NetView-NetView Task session.** A session between two NetView programs that runs under a NetView-NetView Task. In SA z/OS, NetView-NetView Task sessions are used for communication between focal point and remote systems.

**NetView paths via logical unit (LU 6.2).** A type of network-accessible port (VTAM connection) that enables end users to gain access to SNA network resources and communicate with each other. LU 6.2 permits communication between processor operations and the workstation.

**network.** (1) An interconnected group of nodes. (2) In data processing, a user application network. See *SNA network*.

**Network Communications Control Facility (NCCF).** The operations control facility for the network. NCCF consists of a presentation service, command processors, automation based on command lists, and a transaction processing structure on which the network management applications NLDM and NPDA are built. NCCF is a precursor to the NetView command facility.

**Network Control Program (NCP).** An IBM licensed program that provides communication controller support for single-domain, multiple-domain, and interconnected network capability. Its full name is Advanced Communications Function for the Network Control Program.

**Networking NetView.** In SA z/OS the NetView that performs network management functions, such as managing the configuration of a network. In SA z/OS it is common to also route alerts to the Networking NetView.

**Network Problem Determination Application (NPDA).** An NCCF application that helps you identify network problems, such as hardware, software, and microcode, from a central control point using interactive display methods. The alert manager for the network. The precursor of the NetView hardware monitor.

**NGMF.** Deprecated term for NetView Management Console.

**NGMF focal-point system.** Deprecated term for NMC focal point system.

**NIP.** Nucleus initialization program.

**NMC focal point system.** See *focal point system*

**NMC workstation.** The NMC workstation is the primary way to dynamically monitor SA z/OS systems. From the windows, you see messages, monitor status, view trends, and react to changes before they cause problems for end users. You can use multiple windows to monitor multiple views of the system.

**NNT.** NetView-NetView task.

**notification message.** An SA z/OS message sent to a human notification operator to provide information about significant automation actions. Notification messages are defined using the customization dialogs.

**notification operator.** A NetView console operator who is authorized to receive SA z/OS notification messages. Authorization is made through the customization dialogs.

**NPDA.** Network Problem Determination Application.

**NPDA focal-point system.** See *focal-point system*.

**NTRI.** NCP/token-ring interconnection.

**nucleus initialization program (NIP).** The program that initializes the resident control program; it allows the operator to request last-minute changes to certain options specified during system generation.

## O

**objective value.** An average Workflow or Using value that SA z/OS can calculate for applications from past service data. SA z/OS uses the objective value to calculate warning and alert thresholds when none are explicitly defined.

**OCA.** In SA z/OS, operator console A, the active operator console for a target system. Contrast with *OCB*.

**OCB.** In SA z/OS, operator console B, the backup operator console for a target system. Contrast with *OCA*.

**OCF.** Operations command facility.

**OCF-based processor.** A central processor complex that uses an operations command facility for interacting with human operators or external programs to perform operations management functions on the CPC.

**OPC/A.** Operations Planning and Control/Advanced.

**OPC/ESA.** Operations Planning and Control/Enterprise Systems Architecture.

**operating system (OS).** Software that controls the execution of programs and that may provide services such as resource allocation, scheduling, input/output

control, and data management. Although operating systems are predominantly software, partial hardware implementations are possible. (T)

**operations.** The real-time control of a hardware device or software function.

**operations command facility (OCF).** A facility of the central processor complex that accepts and processes operations management commands.

**Operations Planning and Control/Advanced (OPC/A).** A set of IBM licensed programs that automate, plan, and control batch workload. OPC/A analyzes system and workload status and submits jobs accordingly.

**Operations Planning and Control/ESA (OPC/ESA).** A set of IBM licensed programs that automate, plan, and control batch workload. OPC/ESA analyzes system and workload status and submits jobs accordingly. The successor to OPC/A.

**operator.** (1) A person who keeps a system running. (2) A person or program responsible for managing activities controlled by a given piece of software such as z/OS, the NetView program, or IMS. (3) A person who operates a device. (4) In a language statement, the lexical entity that indicates the action to be performed on operands.

**operator console.** (1) A functional unit containing devices that are used for communications between a computer operator and a computer. (T) (2) A display console used for communication between the operator and the system, used primarily to specify information concerning application programs and I/O operations and to monitor system operation. (3) In SA z/OS, a console that displays output from and sends input to the operating system (z/OS, LINUX, VM, VSE). Also called *operating system console*. In the SA z/OS operator commands and configuration dialogs, OC is used to designate a target system operator console.

**operator station task (OST).** The NetView task that establishes and maintains the online session with the network operator. There is one operator station task for each network operator who logs on to the NetView program.

**operator view.** A set of group, system, and resource definitions that are associated together for monitoring purposes. An operator view appears as a graphic display in the graphical interface showing the status of the defined groups, systems, and resources.

**OperatorView entry.** A construct, created with the customization dialogs, used to represent and contain policy for an operator view.

**OS.** Operating system.

**z/OS component.** A part of z/OS that performs a specific z/OS function. In SA z/OS, component refers to entities that are managed by SA z/OS automation.

**z/OS subsystem.** Software products that augment the z/OS operating system. JES and TSO/E are examples of z/OS subsystems. SA z/OS includes automation for some z/OS subsystems.

**z/OS system.** A z/OS image together with its associated hardware, which collectively are often referred to simply as a system, or z/OS system.

**OSA.** I/O operations can display the open system adapter (OSA) channel logical definition, physical attachment, and status. You can configure an OSA channel on or off.

**OST.** Operator station task.

**outbound.** In SA z/OS, messages or commands from the focal-point system to the target system.

**outbound gateway operator.** The automation operator that establishes connections to other systems. The outbound gateway operator handles communications with other systems through a gateway session. The automation operator sends messages, commands, and responses to the inbound gateway operator at the receiving system.

## P

**page.** (1) The portion of a panel that is shown on a display surface at one time. (2) To transfer instructions, data, or both between real storage and external page or auxiliary storage.

**panel.** (1) A formatted display of information that appears on a terminal screen. Panels are full-screen 3270-type displays with a monospaced font, limited color and graphics. (2) By using SA z/OS panels you can see status, type commands on a command line using a keyboard, configure your system, and passthru to other consoles. See also *help panel*. (3) In computer graphics, a display image that defines the locations and characteristics of display fields on a display surface. Contrast with *screen*.

**parallel channels.** Parallel channels operate in either byte (BY) or block (BL) mode. You can change connectivity to a parallel channel operating in block mode.

**parameter.** (1) A variable that is given a constant value for a specified application and that may denote the application. (2) An item in a menu for which the user specifies a value or for which the system provides a value when the menu is interpreted. (3) Data passed to a program or procedure by a user or another program, namely as an operand in a language statement, as an item in a menu, or as a shared data structure.

**partition.** (1) A fixed-size division of storage. (2) In VSE, a division of the virtual address area that is available for program processing. (3) On an IBM Personal Computer fixed disk, one of four possible storage areas of variable size; one can be accessed by DOS, and each of the others may be assigned to another operating system.

**partitionable CPC.** A CPC that can be divided into 2 independent CPCs. See also *physical partition*, *single-image mode*, *MP*, *side*.

**partitioned data set (PDS).** A data set in direct access storage that is divided into partitions, called *members*, each of which can contain a program, part of a program, or data.

**passive monitoring.** In SA z/OS, the receiving of unsolicited messages from z/OS systems and their resources. These messages can prompt updates to resource status displays. See also *active monitoring*.

**PCE.** Processor controller. Also known as the “support processor” or “service processor” in some processor families.

**PDB.** Policy Database

**PDS.** Partitioned data set.

**physical partition.** Part of a CPC that operates as a CPC in its own right, with its own copy of the operating system.

**physical unit (PU).** In SNA, the component that manages and monitors the resources (such as attached links and adjacent link stations) of a node, as requested by a system services control point (SSCP) through an SSCP-PU session. An SSCP activates a session with the physical unit to indirectly manage, through the PU, resources of the node such as attached links.

**physically partitioned (PP) configuration.** A mode of operation that allows a multiprocessor (MP) system to function as two or more independent CPCs having separate power, water, and maintenance boundaries. Contrast with *single-image (SI) configuration*.

**POI.** Program operator interface.

**policy.** The automation and monitoring specifications for an SA z/OS enterprise. See *IBM Tivoli System Automation for z/OS Defining Automation Policy*.

**policy database.** The database where the automation policy is recorded. Also known as the PDB.

**POR.** Power-on reset.

**port.** (1) System hardware to which the I/O devices are attached. (2) On an ESCON switch, a port is an addressable connection. The switch routes data through the ports to the channel or control unit. Each port has a name that can be entered into a switch matrix, and you

can use commands to change the switch configuration. (3) An access point (for example, a logical unit) for data entry or exit. (4) A functional unit of a node through which data can enter or leave a data network. (5) In data communication, that part of a data processor that is dedicated to a single data channel for the purpose of receiving data from or transmitting data to one or more external, remote devices. (6) power-on reset (POR) (7) A function that re-initializes all the hardware in a CPC and loads the internal code that enables the CPC to load and run an operating system.

**PP.** Physically partitioned (configuration).

**PPT.** Primary POI task.

**primary host.** The base program at which you enter a command for processing.

**primary POI task (PPT).** The NetView subtask that processes all unsolicited messages received from the VTAM program operator interface (POI) and delivers them to the controlling operator or to the command processor. The PPT also processes the initial command specified to execute when NetView is initialized and timer request commands scheduled to execute under the PPT.

**primary system.** A system is a primary system for an application if the application is normally meant to be running there. SA z/OS starts the application on all the primary systems defined for it.

**problem determination.** The process of determining the source of a problem; for example, a program component, machine failure, telecommunication facilities, user or contractor-installed programs or equipment, environment failure such as a power loss, or user error.

**processor controller.** Hardware that provides support and diagnostic functions for the central processors.

**processor operations.** The part of SA z/OS that monitors and controls processor (hardware) operations. Processor operations provides a connection from a focal-point system to a target system. Through NetView on the focal-point system, processor operations automates operator and system consoles for monitoring and recovering target systems. Also known as ProcOps.

**processor operations control file.** Named by your system programmer, this file contains configuration and customization information. The programmer records the name of this control file in the processor operations file generation panel ISQDPG01.

**Processor Resource/Systems Manager (PR/SM).** The feature that allows the processor to use several operating system images simultaneously and provides logical partitioning capability. See also *LPAR*.

**ProcOps.** Processor operations.

**ProcOps Service Machine (PSM).** The PSM is a CMS user on a VM host system. It runs a CMS multitasking application that serves as "virtual hardware" for ProcOps. ProcOps communicates via the PSM with the VM guest systems that are defined as target systems within ProcOps.

**product automation.** Automation integrated into the base of SA z/OS for the products DB2, CICS, IMS, OPC (formerly called *features*).

**program to program interface (PPI).** A NetView function that allows user programs to send or receive data buffers from other user programs and to send alerts to the NetView hardware monitor from system and application programs.

**protocol.** In SNA, the meanings of, and the sequencing rules for, requests and responses used for managing the network, transferring data, and synchronizing the states of network components.

**proxy resource.** A resource defined like an entry type APL representing a processor operations target system.

**PR/SM.** Processor Resource/Systems Manager.

**PSM.** ProcOps Service Machine.

**PU.** Physical unit.

## R

**remote system.** A system that receives resource status information from an SA z/OS focal-point system. An SA z/OS remote system is defined as part of the same SA z/OS enterprise as the SA z/OS focal-point system to which it is related.

**requester.** A requester is a workstation software, which enables users to log on to a domain, that is, to the server(s) belonging to this domain, and use the resources in this domain. After the log on to a domain, users can access the shared resources and use the processing capability of the server(s). Because the bigger part of shared resources is on the server(s), users can reduce hardware investment.

**resource.** (1) Any facility of the computing system or operating system required by a job or task, and including main storage, input/output devices, the processing unit, data sets, and control or processing programs. (2) In NetView, any hardware or software that provides function to the network. (3) In SA z/OS, any z/OS application, z/OS component, job, device, or target system capable of being monitored or automated through SA z/OS.

**Resource Access Control Facility (RACF).** A program that can provide data security for all your resources. RACF protects data from accidental or deliberate unauthorized disclosure, modification, or destruction.



**resource group.** A physically partitionable portion of a processor. Also known as a *side*.

**Resource Monitoring Facility (RMF) Monitor III.** A program that measures and reports on the availability and activity of system hardware and software resources, such as processors, devices, storage, and address spaces. RMF can issue online reports about system performance problems as they occur.

**Resource Object Data Manager (RODM).** A data cache manager designed to support process control and automation applications. RODM provides an in-memory data cache for maintaining real-time data in an address space that is accessible by multiple applications. RODM also allows an application to query an object and receive a rapid response and act on it.

**resource token.** A unique internal identifier of an ESCON resource or resource number of the object in the IODF.

**restart automation.** SA z/OS-provided automation that monitors subsystems to ensure that they are running. If a subsystem fails, SA z/OS attempts to restart it according to the policy in the automation control file.

**Restructured Extended Executor (REXX).** An interpretive language used to write command lists.

**return code.** A code returned from a program used to influence the issuing of subsequent instructions.

**REXX.** Restructured Extended Executor.

**REXX procedure.** A command list written with the Restructured Extended Executor (REXX), which is an interpretive language.

**RMF.** Resource Measurement Facility.

**RODM.** Resource Object Data Manager.

## S

**SAF.** Security Authorization Facility.

**SA z/OS.** System Automation for z/OS

**SA z/OS customization dialogs.** An ISPF application through which the SA z/OS policy administrator defines policy for individual z/OS systems and builds automation control data and RODM load function files.

**SA z/OS customization focal point system.** See *focal point system*.

**SA z/OS data model.** The set of objects, classes and entity relationships necessary to support the function of SA z/OS and the NetView automation platform.

**SA z/OS enterprise.** The group of systems and resources defined in the customization dialogs under one enterprise name. An SA z/OS enterprise consists of connected z/OS systems running SA z/OS.

**SA z/OS focal point system.** See *focal point system*.

**SA z/OS policy.** The description of the systems and resources that make up an SA z/OS enterprise, together with their monitoring and automation definitions.

**SA z/OS policy administrator.** The member of the operations staff who is responsible for defining SA z/OS policy.

**SA z/OS satellite.** If you are running two NetViews on an z/OS system to split the automation and networking functions of NetView, it is common to route alerts to the Networking NetView. For SA z/OS to process alerts properly on the Networking NetView, you must install a subset of SA z/OS code, called an *SA z/OS satellite* on the Networking NetView.

**SA z/OS SDF focal point system.** See *focal point system*.

**SCA.** In SA z/OS, system console A, the active system console for a target hardware. Contrast with *SCB*.

**SCB.** In SA z/OS, system console B, the backup system console for a target hardware. Contrast with *SCA*.

**screen.** Deprecated term for display panel.

**screen handler.** In SA z/OS, software that interprets all data to and from a full-screen image of a target system. The interpretation depends on the format of the data on the full-screen image. Every processor and operating system has its own format for the full-screen image. A screen handler controls one PS/2 connection to a target system.

**SDF.** Status Display Facility.

**SDLC.** Synchronous data link control.

**SDSF.** System Display and Search Facility.

**secondary system.** A system is a secondary system for an application if it is defined to automation on that system, but the application is not normally meant to be running there. Secondary systems are systems to which an application can be moved in the event that one or more of its primary systems are unavailable. SA z/OS does not start the application on its secondary systems.

**server.** A server is a workstation that shares resources, which include directories, printers, serial devices, and computing powers.

**service language command (SLC).** The line-oriented command language of processor controllers or service processors.

**service processor (SVP).** The name given to a processor controller on smaller System/370 processors.

**service period.** Service periods allow the users to schedule the availability of applications. A service period is a set of time intervals (service windows), during which an application should be active.

**service threshold.** An SA z/OS policy setting that determines when to notify the operator of deteriorating service for a resource. See also *alert threshold* and *warning threshold*.

**session.** In SNA, a logical connection between two network addressable units (NAUs) that can be activated, tailored to provide various protocols, and deactivated, as requested. Each session is uniquely identified in a transmission header by a pair of network addresses identifying the origin and destination NAUs of any transmissions exchanged during the session.

**session monitor.** The component of the NetView program that collects and correlates session-related data and provides online access to this information. The successor to NLDM.

**shutdown automation.** SA z/OS-provided automation that manages the shutdown process for subsystems by issuing shutdown commands and responding to prompts for additional information.

**side.** A part of a partitionable CPC that can run as a physical partition and is typically referred to as the A-side or the B-side.

**Simple Network Management Protocol (SNMP).** An IP based industry standard protocol to monitor and control resources in an IP network.

**single image.** A processor system capable of being physically partitioned that has not been physically partitioned. Single-image systems can be target hardware processors.

**single-image (SI) mode.** A mode of operation for a multiprocessor (MP) system that allows it to function as one CPC. By definition, a uniprocessor (UP) operates in single-image mode. Contrast with *physically partitioned (PP) configuration*.

**SLC.** Service language command.

**SMP/E.** System Modification Program Extended.

**SNA.** Systems Network Architecture.

**SNA network.** In SNA, the part of a user-application network that conforms to the formats and protocols of systems network architecture. It enables reliable

transfer of data among end users and provides protocols for controlling the resources of various network configurations. The SNA network consists of network addressable units (NAUs), boundary function components, and the path control network.

**SNMP.** Simple Network Management Protocol (a TCP/IP protocol). A protocol that allows network management by elements, such as gateways, routers, and hosts. This protocol provides a means of communication between network elements regarding network resources.

**solicited message.** An SA z/OS message that directly responds to a command. Contrast with *unsolicited message*.

**SSCP.** System services control point.

**SSI.** Subsystem interface.

**start automation.** SA z/OS-provided automation that manages and completes the startup process for subsystems. During this process, SA z/OS replies to prompts for additional information, ensures that the startup process completes within specified time limits, notifies the operator of problems, if necessary, and brings subsystems to an UP (or ready) state.

**startup.** The point in time at which a subsystem or application is started.

**status.** The measure of the condition or availability of the resource.

**status focal-point system.** See *focal—point system*.

**status display facility (SDF).** The system operations part of SA z/OS that displays status of resources such as applications, gateways, and write-to-operator messages (WTORs) on dynamic color-coded panels. SDF shows spool usage problems and resource data from multiple systems.

**steady state automation.** The routine monitoring, both for presence and performance, of subsystems, applications, volumes and systems. Steady state automation may respond to messages, performance exceptions and discrepancies between its model of the system and reality.

**structure.** A construct used by z/OS to map and manage storage on a coupling facility. See cache structure, list structure, and lock structure.

**subgroup.** A named set of systems. A subgroup is part of an SA z/OS enterprise definition and is used for monitoring purposes.

**SubGroup entry.** A construct, created with the customization dialogs, used to represent and contain policy for a subgroup.

| **subplex.** Situations where the physical sysplex has  
| been divided into subentities, for example, a test  
| sysplex and a production sysplex. This may be done to  
| isolate the test environment from the production  
| environment.

**subsystem.** (1) A secondary or subordinate system, usually capable of operating independent of, or asynchronously with, a controlling system. (2) In SA z/OS, an z/OS application or subsystem defined to SA z/OS.

**subsystem interface.** The z/OS interface over which all messages sent to the z/OS console are broadcast.

**support element.** A hardware unit that provides communications, monitoring, and diagnostic functions to a central processor complex (CPC).

**support processor.** Another name given to a processor controller on smaller System/370 processors; see *service processor*.

**SVP.** Service processor.

**switches.** ESCON directors are electronic units with ports that dynamically switch to route data to I/O devices. The switches are controlled by I/O operations commands that you enter on a workstation.

**switch identifier.** The switch device number (swchdevn), the logical switch number (LSN) and the switch name

**symbolic destination name (SDN).** Used locally at the workstation to relate to the VTAM application name.

**synchronous data link control (SDLC).** A discipline for managing synchronous, code-transparent, serial-by-bit information transfer over a link connection. Transmission exchanges may be duplex or half-duplex over switched or nonswitched links. The configuration of the link connection may be point-to-point, multipoint, or loop. SDLC conforms to subsets of the Advanced Data Communication Control Procedures (ADCCP) of the American National Standards Institute and High-Level Data Link Control (HDLC) of the International Standards Organization.

**SYSINFO Report.** An RMF report that presents an overview of the system, its workload, and the total number of jobs using resources or delayed for resources.

**SysOps.** System operations.

**sysplex.** A set of z/OS systems communicating and cooperating with each other through certain multisystem hardware components (coupling devices and timers) and software services (couple data sets).

In a sysplex, z/OS provides the coupling services that handle the messages, data, and status for the parts of a multisystem application that has its workload spread

across two or more of the connected processors, sysplex timers, coupling facilities, and couple data sets (which contains policy and states for automation).

A Parallel Sysplex is a sysplex that includes a coupling facility.

**sysplex application group.** A sysplex application group is a grouping of applications that can run on any system in a sysplex.

**sysplex couple data set.** A couple data set that contains sysplex-wide data about systems, groups, and members that use XCF services. All z/OS systems in a sysplex must have connectivity to the sysplex couple data set. See also *couple data set*.

**Sysplex Timer.** An IBM unit that synchronizes the time-of-day (TOD) clocks in multiple processors or processor sides. External Time Reference (ETR) is the z/OS generic name for the IBM Sysplex Timer (9037).

**system.** In SA z/OS, system means a focal point system (z/OS) or a target system (MVS, VM, VSE, LINUX, or CF).

**System Automation for z/OS.** The full name for SA z/OS.

**System Automation for OS/390.** The full name for SA OS/390, the predecessor to System Automation for z/OS.

**system console.** (1) A console, usually having a keyboard and a display screen, that is used by an operator to control and communicate with a system. (2) A logical device used for the operation and control of hardware functions (for example, IPL, alter/display, and reconfiguration). The system console can be assigned to any of the physical displays attached to a processor controller or support processor. (3) In SA z/OS, the hardware system console for processor controllers or service processors of processors connected using SA z/OS. In the SA z/OS operator commands and configuration dialogs, SC is used to designate the system console for a target hardware processor.

**System Display and Search Facility (SDSF).** An IBM licensed program that provides information about jobs, queues, and printers running under JES2 on a series of panels. Under SA z/OS you can select SDSF from a pull-down menu to see the resources' status, view the z/OS system log, see WTOR messages, and see active jobs on the system.

**System entry.** A construct, created with the customization dialogs, used to represent and contain policy for a system.

**System Modification Program/Extended (SMP/E).** An IBM licensed program that facilitates the process of installing and servicing an z/OS system.

**system operations.** The part of SA z/OS that monitors and controls system operations applications and subsystems such as NetView, SDSF, JES, RMF, TSO, RODM, ACF/VTAM, CICS, IMS, and OPC. Also known as SysOps.

**system services control point (SSCP).** In SNA, the focal point within an SNA network for managing the configuration, coordinating network operator and problem determination requests, and providing directory support and other session services for end users of the network. Multiple SSCPs, cooperating as peers, can divide the network into domains of control, with each SSCP having a hierarchical control relationship to the physical units and logical units within its domain.

**Systems Network Architecture (SNA).** The description of the logical structure, formats, protocols, and operational sequences for transmitting information units through, and controlling the configuration and operation of, networks.

**System/390 microprocessor cluster.** A configuration that consists of central processor complexes (CPCs) and may have one or more integrated coupling facilities.

## T

**TAF.** Terminal access facility.

**target.** A processor or system monitored and controlled by a focal-point system.

**target control task.** In SA z/OS, target control tasks process commands and send data to target systems and workstations through communications tasks. A target control task (a NetView autotask) is assigned to a target system when the target system is initialized.

**target hardware.** In SA z/OS, the physical hardware on which a target system runs. It can be a single-image or physically partitioned processor. Contrast with *target system*.

**target system.** (1) In a distributed system environment, a system that is monitored and controlled by the focal-point system. Multiple target systems can be controlled by a single focal-point system. (2) In SA z/OS, a computer system attached to the focal-point system for monitoring and control. The definition of a target system includes how remote sessions are established, what hardware is used, and what operating system is used.

**task.** (1) A basic unit of work to be accomplished by a computer. (2) In the NetView environment, an operator station task (logged-on operator), automation operator (autotask), application task, or user task. A NetView task performs work in the NetView environment. All

SA z/OS tasks are NetView tasks. See also *communications task*, *message monitor task*, and *target control task*.

**telecommunication line.** Any physical medium, such as a wire or microwave beam, that is used to transmit data.

**terminal access facility (TAF).** (1) A NetView function that allows you to log onto multiple applications either on your system or other systems. You can define TAF sessions in the SA z/OS customization panels so you don't have to set them up each time you want to use them. (2) In NetView, a facility that allows a network operator to control a number of subsystems. In a full-screen or operator control session, operators can control any combination of subsystems simultaneously.

**terminal emulation.** The capability of a microcomputer or personal computer to operate as if it were a particular type of terminal linked to a processing unit to access data.

**threshold.** A value that determines the point at which SA z/OS automation performs a predefined action. See *alert threshold*, *warning threshold*, and *error threshold*.

**time of day (TOD).** Typically refers to the time-of-day clock.

**Time Sharing Option (TSO).** An optional configuration of the operating system that provides conversational time sharing from remote stations. It is an interactive service on z/OS, MVS/ESA, and MVS/XA.

**Time-Sharing Option/Extended (TSO/E).** An option of z/OS that provides conversational timesharing from remote terminals. TSO/E allows a wide variety of users to perform many different kinds of tasks. It can handle short-running applications that use fewer sources as well as long-running applications that require large amounts of resources.

**timers.** A NetView command that issues a command or command processor (list of commands) at a specified time or time interval.

**TOD.** Time of day.

**token ring.** A network with a ring topology that passes tokens from one attaching device to another; for example, the IBM Token-Ring Network product.

**TP.** Transaction program.

**transaction program.** In the VTAM program, a program that performs services related to the processing of a transaction. One or more transaction programs may operate within a VTAM application program that is using the VTAM application program interface (API). In that situation, the transaction program would request services from the applications

program using protocols defined by that application program. The application program, in turn, could request services from the VTAM program by issuing the APPCCMD macro instruction.

**transitional automation.** The actions involved in starting and stopping subsystems and applications that have been defined to SA z/OS. This can include issuing commands and responding to messages.

**translating host.** Role played by a host that turns a resource number into a token during a unification process.

**trigger.** Triggers, in combination with events and service periods, are used to control the starting and stopping of applications in a single system or a parallel sysplex.

**TSO.** Time Sharing Option.

**TSO console.** From this 3270-type console you are logged onto TSO or ISPF to use the runtime panels for I/O operations and SA z/OS customization panels.

**TSO/E.** TSO Extensions.

## U

**UCB.** The unit control block; an MVS/ESA data area that represents a device and that is used for allocating devices and controlling I/O operations.

**unsolicited message.** An SA z/OS message that is not a direct response to a command. Contrast with *solicited message*.

**user task.** An application of the NetView program defined in a NetView TASK definition statement.

**Using.** An RMF Monitor III definition. Jobs getting service from hardware resources (processors or devices) are **using** these resources. The use of a resource by an address space can vary from 0% to 100% where 0% indicates no use during a Range period, and 100% indicates that the address space was found using the resource in every sample during that period. See also *Workflow*.

## V

**view.** In the NetView Graphic Monitor Facility, a graphical picture of a network or part of a network. A view consists of nodes connected by links and may also include text and background lines. A view can be displayed, edited, and monitored for status information about network resources.

**Virtual Storage Extended (VSE).** An IBM licensed program whose full name is Virtual Storage Extended/Advanced Function. It is an operating system that controls the execution of programs.

**Virtual Telecommunications Access Method (VTAM).** An IBM licensed program that controls communication and the flow of data in an SNA network. It provides single-domain, multiple-domain, and interconnected network capability. Its full name is Advanced Communications Function for the Virtual Telecommunications Access Method. Synonymous with *ACF/VTAM*.

**VM/ESA.** Virtual Machine/Enterprise Systems Architecture.

**VM Second Level Systems Support.** With this function, Processor Operations is able to control VM second level systems (VM guest systems) in the same way that it controls systems running on real hardware.

**volume.** A direct access storage device (DASD) volume or a tape volume that serves a system in an SA z/OS enterprise.

**volume entry.** A construct, created with the customization dialogs, used to represent and contain policy for a volume.

**volume group.** A named set of volumes. A volume group is part of a system definition and is used for monitoring purposes.

**volume group entry.** An construct, created with the customization dialogs, used to represent and contain policy for a volume group.

**Volume Workflow.** The SA z/OS Volume Workflow variable is derived from the RMF Resource Workflow definition, and is used to measure the performance of volumes. SA z/OS calculates Volume Workflow using:

$$\text{Volume Workflow \%} = \frac{\text{accumulated Using}}{\text{accumulated Using} + \text{accumulated Delay}} * 100$$

The definition of **Using** is the percentage of time when a job has had a request accepted by a channel for the volume, but the request is not yet complete.

The definition of **Delay** is the delay that waiting jobs experience because of contention for the volume. See also *Address Space Workflow*.

**VSE.** Virtual Storage Extended.

**VTAM.** Virtual Telecommunications Access Method.

## W

**warning threshold.** An application or volume service value that determines the level at which SA z/OS changes the associated icon in the graphical interface to the warning color. See *alert threshold*.

**workflow.** See *Address Space Workflow* and *Volume Workflow*.

**workstation.** In SA z/OS workstation means the *graphic workstation* that an operator uses for day-to-day operations.

**write-to-operator (WTO).** A request to send a message to an operator at the z/OS operator console. This request is made by an application and is handled by the WTO processor, which is part of the z/OS supervisor program.

**write-to-operator-with-reply (WTOR).** A request to send a message to an operator at the z/OS operator console that requires a response from the operator. This request is made by an application and is handled by the WTO processor, which is part of the z/OS supervisor program.

**WTO.** Write-to-Operator.

**WTOR.** Write-to-Operator-with-Reply.

**WWV.** The US National Institute of Standards and Technology (NIST) radio station that provides standard time information. A second station, known as WWVB, provides standard time information at a different frequency.

## X

**XCF.** Cross-system coupling facility.

**XCF couple data set.** The name for the sysplex couple data set prior to MVS/ESA System Product Version 5 Release 1. See also *sysplex couple data set*.

**XCF group.** A set of related members that a multisystem application defines to XCF. A member is a specific function, or instance, of the application. A member resides on one system and can communicate with other members of the same group across the sysplex.

**XRF.** Extended recovery facility.

## Numerics

**390-CMOS.** Processor family group designator used in the SA z/OS processor operations documentation and in the online help to identify any of the following S/390 CMOS processor machine types: 9672, 9674, 2003, 3000, or 7060. SA z/OS processor operations uses the OCF facility of these processors to perform operations management functions. See *OCF-based processor*.

---

# Index

## Special characters

"hung" command recovery 94

## A

abend recovery, CICS region 178

accessibility xiii

ACF entries, for DB2 automation 112

active connector 91

adding

    application to automation 1

    processor operations message to  
    automation 69

additional automation operator IDs 108

additional SA z/OS automation

    procedures, programming 5

advanced automation options

    exits 131

    external global variables 203, 204

alternate CDS 89

    turning into primary CDS 89

alternate CDS recovery

    customizing 90

alternate couple data set

    specifying 100

AMRF buffer shortage processing 162

AOCMSG call 14

AOCMSG generic routine 8

AOCQRY common routine

    automation availability 8

    message automation 22

AOCTRACE

    use in testing 17

    use in traces 20

AOCUPDT common routine

    and the AOFEXSTA exit 132

    to update status information 8

AOF\_AAO\_MSG\_EHKVAR 205

AOF\_AAO\_MVSTAPEMON 205

AOF\_ASSIGN\_JOBNAME 205

AOF\_E2E\_EAS\_PPI 205

AOF\_E2E\_EVT\_RETRY 205

AOF\_E2E\_TKOVN\_TIMEOUT 205

AOF\_EMCS\_AUTOTASK\_... 205

AOF\_EMCS\_CN\_ASSIGNMENT 205

AOF\_INIT\_MCSFLAG 208

AOF\_INIT\_ROUTCDE 208

AOF\_INIT\_SYSCONID 208

AOF\_NETWORK\_DOMAIN\_ID 203

AOF\_PRODLVL 203

AOF\_SET\_AVM\_RESTART\_EXIT 210

AOF.0DEBUG 203

AOF.0TRACE 203

AOF3WTIME 212

AOFACFINIT 206

AOFAOCCLONE 203

AOFARMQUERYRETRYS 206

AOFARMQUERYWAIT 206

AOFCNMASK 207

AOFCOMPL 203

AOFCONFIRM global variable 147

AOFCTLOPT 207

AOFDEBUG 203

AOFDEBUG global variable 20

AOFDEFAULT\_TARGET 207

AOFDOM 36, 38

AOFEXC00 exit 142

AOFEXC01 exit 142

AOFEXC03 exit 145

AOFEXC04 exit 145

AOFEXC05 exit 145

AOFEXC06 exit 145

AOFEXC07 exit 146

AOFEXC08 exit 146

AOFEXC09 exit 146

AOFEXC11 exit 146

AOFEXC12 exit 146

AOFEXC13 exit 146

AOFEXC2 exit 144

AOFEXDEF exit 131, 204

AOFEXI01 exit 131

AOFEXI02 exit 131

AOFEXI03 exit 132

AOFEXI04 exit 132

AOFEXINT exit 132, 149, 210

AOFEXPLAIN\_USER 208

AOFEXSTA exit 132

AOFEXX01 exit 133

AOFEXX02 exit 134

AOFEXX03 exit 134

AOFIMSCMDMSG 208

AOFINITIALSTARTTYP 203

AOFINITREPLY 208

AOFJESPREFIX 204

AOFLOCALHOLD 208

AOFMATLISTING 208

AOFMOVOPT 209

AOFMSGST 34

AOFMSGSY 36

AOFOPCCMDMSG 209

AOFPAUSE 209

AOFQUICKWTOR 209

AOFRELOADOPT 209

AOFRESTARTALWAYS 210

AOFRJ3MN monitoring routine 50

AOFRJ3RC monitoring routine 52

AOFRMTCMDWAIT 210

AOFRPCWAIT 210

AOFSENDALERT 210

AOFSERXINT 210

AOFSETSTATEOVERRIDE 213

AOFSETSTATESCOPE 213

AOFSETSTATESTART 213

AOFSHUTCHK 213

AOFSHUTDELAY 210

AOFSHUTOVERRIDE 213

AOFSHUTSCOPE 213

AOFSMARTMAT 211

AOFSPoolFULLCMD 211

AOFSPoolSHORTCMD 211

AOFSSUBSYS 204

AOFSYS 37, 38

AOFSYSNAME 204

AOFSYSTEM 204

AOFTDDF task 18

AOFUPDAM 211

AOFUPDRODM 211

AOFUSSWAIT 212

application

    adding to automation 1

    enable for graphical user interface 3

    health status 45

application messages, entries in MPF

    list 3

application monitor status 45

application monitoring 45

application type IMAGE, defining 104

applications, z/OS UNIX 79

ASCB chaining

    and global variables 206

ASFUSER command 22

assist mode

    for testing automation procedures 18

    monitoring automation interactively

        with 19

    overview 17

AT build

    concept for message automation 30

    determining for message

        automation 30

    message automation 29

AT entries

    always built 31

    preventing the building of 27

    sequence 32

    types 31

    with multiple actions 32

AT load, message automation 33

AT scope, defining for message

    automation 29

AUTO actions, defining for message

    automation 27

automated resources, z/OS UNIX

    Automation 82

automating

    auxiliary storage shortage

        recovery 107

    enqueues, long running 106

    IXC102A message 96

    IXC402D message 96

    Linux console messages 68

    Linux console messages, case

        sensitive 69

    Linux console messages, restrictions

        and limitations 69

    Linux console messages, security

        considerations 69

    long running enqueues 106

    message IXC102A 105

    message IXC402D 105

    USS resources 79

- automating processor operations
  - controlled resources 65
- automation
  - adding an application to 1
  - advanced functions 204
  - extending 5
  - messages 25
  - SYSLOG message 93
  - sysplex, enabling 89
- automation agent
  - enabling message automation for 33
- automation configuration 3
- automation control file 3
  - defining SDF 232
  - reload action exit 147
  - reload permission exit 147
- automation flag exits
  - sample 138
- automation flags 61
  - checking 62
  - example for using 61
  - extended 61
  - for minor resources 61
  - global 62
  - with individual messages 61
  - with status changes 61
- automation manager configuration file 3
- automation manager global automation flag 62
- automation operator IDs
  - additional 108
- automation policy, defining for DB2
  - automation 112
- automation procedures
  - calling 5
  - creating 5
  - debugging 17
  - description 5
  - developing messages 13
  - example 14
  - external code 9
  - global variable names 23
  - initializing 7
  - installing 16
  - making generic 12
  - programming recommendations 22
  - REXX coding example 21
  - structure of 6
  - testing 17
  - use of common routines in 5
  - use of generic routines in 5
  - using AOCTRACE 20
  - writing your own 5
- automation processing
  - performing 8
- automation routines 149
- automation setup, definitions for 80
- automation status file
  - coding your own information 22
  - using commands 9
- automation table
  - See NetView automation table
- auxiliary storage shortage recovery 97
  - automating 107
  - customizing 97
  - defining local page data set 107
  - defining the handling of jobs 107

## B

- BASEOPER 210
- BLDVIEW 3
- building
  - new automation definitions 74

## C

- calling
  - automation procedures 5
- captured messages
  - defining for message automation 27
- cascades 39
- case sensitive, Linux console
  - messages 69
- CDEMATCH common routine 22
- CDS
  - See couple data set
- CF
  - See coupling facility
- CFRM couple data set 91, 101
- CFRM policy 91
- CHKTHRES common routine 9
- CICS link monitoring 181
- CICS region abend recovery 178
- CICS short on storage 184
- CICS shutdown 182
- CICS startup 185
- CICS transaction recovery 187
- CICS unit of work recovery 189
- CICS VSAM RLS status 181
- CICSplex processing 180
- CICSPURG 182
- CICRSY 183
- CICSSHUT 183
- clone ID, Automatic Restart
  - Manager 213
- CMASSHUT 184
- CMD actions, defining for message
  - automation 26
- coding information in automation status file 22
- command flooding recovery 95
- command handler, DB2 automation 115
- command requests
  - DB2 automation 116
  - maintenance start 116
  - start/stop tablespace 120
  - terminate threads 118
- commands
  - processor operations 13
- commands, defining for long running
  - enqueues 107
- commands, writing for monitor
  - resources 47
- common automation items, defining 108
- common global variables 9, 203
- common routines 5
  - use in automation procedures 5
- connecting
  - system to processor 100
- connection monitoring
  - CICS 112
  - IMS 112
- connection monitoring, DB2
  - automation 111, 122

- connector
  - active 91
  - failed persistent 92
- continuous availability, couple data set
  - enabling 100
  - ensuring 89
- controller status, TWS 178
- couple data set 89
  - alternate CDS 89
  - alternate CDS, recovery of 89
  - alternate, specifying 100
  - CFRM 101
  - enabling continuous availability of 100
  - ensuring continuous availability of 89
  - managing 89
  - policy 89
  - primary CDS 89
  - SYSPLEX 101
- coupling facility 91
- coupling facility, managing 91
- creating automation procedures 5
- critical event monitoring 111
- critical event monitoring, DB2
  - automation 125
- critical events, DB2 automation 111
- customization dialog exits 138
  - invocation 141
- customization of z/OS UNIX
  - resources 80
- customize automation
  - for processor operations 10
  - for system operations 8
- customizing
  - alternate CDS recovery 90
  - auxiliary storage shortage 97
  - hung command recovery 96
  - IXC102A message automation 96
  - IXC402D message automation 96
  - LINUX target systems 75
  - MVS target systems 76
  - of system log recovery 93
  - proxy resource automation 66
  - SDF 217
  - SYSIEFSD resource recovery 96
  - system logger recovery 91
  - system to use Parallel Sysplex
    - enhancements 108
  - target systems 75
  - VM target systems 76
  - VSE target systems 77
  - WTO(R) buffer shortage recovery 93

## D

- DB2 automation
  - ACF entries 112
  - command requests 116
  - command requests, maintenance
    - start 116
  - command requests, start/stop
    - tablespace 120
  - command requests, terminate
    - threads 118
  - connection monitoring 111, 122
  - critical event monitoring 125



- DB2 automation (*continued*)
    - critical events 111
    - defining automation policy 112
    - event-driven functions 111, 122
    - installation 112
    - line command functions 115
    - line command functions, command handler 115
    - line mode functions 111
    - line mode invocation 111
    - maintenance start 111
    - overview 111
    - planning requirements 112
    - start/stop tablespace 111
    - terminate threads 111
  - debugging
    - automation procedures 17
    - NetView facilities 21
    - z/OS UNIX Automation 87
  - defining
    - actions for message automation 26
    - application type IMAGE 104
    - AT scope for message automation 29
    - AUTO actions for message automation 27
    - captured messages for message automation 27
    - CMD actions for message automation 26
    - commands for long running enqueues 107
    - common automation items 108
    - handling of jobs for auxiliary storage shortage recovery 107
    - IEADMCxx symbols for long running enqueues 107
    - IMAGE application type 104
    - local page data set for auxiliary storage shortage recovery 107
    - logical partitions 99
    - logical sysplex 100
    - message and status as minor resources 61
    - OVR actions for message automation 28
    - physical sysplex 100
    - processor 99, 104
    - REPLY actions for message automation 26
    - resources for long running enqueues 106
    - SDF in automation control file 232
    - snapshot intervals for long running enqueues 107
    - started task job name 108
    - status messages for message automation 27
    - SYSPLEX policy item 101
    - system 100
    - temporary data set HLQ 108
  - definitions for automation setup 80
  - definitions for z/OS UNIX resources 80
  - deletion of processed WTO(R)s from SDF 161
  - developing messages for automation procedures 13
  - directory extent 91
  - disability xiii
  - DISPASST 18
  - DISPEVT\_WAIT 213
  - DISPEVTS\_WAIT 213
  - DISPTRG\_WAIT 213
  - drain processing prior to JES2 shutdown 170
  - DSICMD member 16
  - DSIPARM data set 16
  - dump processing, JES3 173
- E**
- element names in Automatic Restart Manager 213
  - enabling
    - continuous availability of Couple Data Sets 100
    - message automation for the automation agent 33
    - sysplex automation 89
    - system log failure recovery 101
    - system removal 104
    - WTOR(R) buffer shortage recovery 102
  - ENQs
    - See* enqueues
  - enqueues 93
    - long running, automating 106
    - long running, customizing recovery of 96
    - long running, handling 93
  - environmental setup exits 130
  - error codes 9
  - EVEEARMW 185
  - EVEECMSI 187
  - EVEED004 181
  - EVEEI004 186
  - EVEEI006 186
  - EVEEI009 186
  - EVEEI010 187
  - EVEEI115 185
  - EVEERDMP 185
  - EVEERLSI 181
  - EVEERTRN 187
  - EVEET002 190
  - EVEET003 178
  - EVEETUOW 189
  - EVEEY00S 184
  - event-driven functions
    - connection monitoring 122
    - critical event monitoring 125
    - DB2 automation 122
  - event-driven functions, DB2 automation 111
  - EVERCMRC 180
  - EVERSCMI 180
  - EVERSPPI 182
  - EVIEX002 191
  - EVIEX003 192
  - EVJEAC01 175
  - EVJEAC02 175
  - EVJEAC03 176
  - EVJEAC04 176
  - EVJEBSV 178
  - EVJRAC05 177
  - EJVRSACT 178
  - EJVRSJOB 177
  - example automation procedure 14
  - examples of INGUSS command 83
  - exits 147
    - AOFEXC00 142
    - AOFEXC01 142
    - AOFEXC02 144
    - AOFEXC03 145
    - AOFEXC04 145
    - AOFEXC05 145
    - AOFEXC06 145
    - AOFEXC07 146
    - AOFEXC08 146
    - AOFEXC09 146
    - AOFEXC11 146
    - AOFEXC12 146
    - AOFEXC13 146
    - AOFEXC14 146
    - AOFEXDEF 131
    - AOFEXI01 131
    - AOFEXI02 131
    - AOFEXI03 132
    - AOFEXI04 132
    - AOFEXINT 132, 149
    - AOFEXSTA 132
    - AOFEXX01 133
    - AOFEXX02 134
    - AOFEXX03 134
    - BUILDF processing 138
    - CONVERT processing 140
    - COPY processing 139
    - customization dialog exits 138
    - DELETE processing 140
    - environmental setup exits 130
    - flag exits 134
    - IMPORT functions 141
    - INGEAXIT 134
    - INGEX01 138
    - INGEX02 138
    - INGEX03 139
    - INGEX04 139
    - INGEX05 140
    - INGEX06 140
    - INGEX07 140
    - INGEX08 140
    - INGEX09 141
    - INGEX12 141
    - INGEX14 141
    - INGEX16 141
    - INGEX17 141
    - INGEX18 141
    - MIGRATION functions 141
    - pseudo-exits 146
    - RENAME functions 141
    - sample automation flag exits 138
    - static exits 132
    - status change commands 133
    - subsystem up at initialization commands 147
    - testing 147
  - EXPLAIN 208
  - extended automation flags 61
  - extending automation 5
  - external code, automation procedures 9
  - external common global variables 203
  - EXTSTART status 213

## F

failed persistent connector 92  
failed system, isolation of 96  
file manager commands 9  
file monitoring, z/OS UNIX  
Automation 82  
flag exits 134

## G

generic  
automation 43, 204  
generic automation procedures 12  
generic routines 5  
use in automation procedures 5  
global automation flag 62  
global variable names, for automation  
procedures 23  
graphical user interface, SA z/OS  
enable an application for 3  
guest machines, processor operations  
support 74  
guest target systems  
LINUX 74  
LINUX, user logon 75  
MVS 75  
MVS, NIP console 75  
MVS, NIP messages 75  
MVS, problem determination  
mode 75  
ProcOps Service Machine 74  
VSE 75

## H

health state return codes 47  
how to automate USS resources 79  
hung command recovery,  
customizing 96

## I

IDENT 22  
IEADMCxx symbols, defining  
for long running enqueues 107  
IGNORE WTOR priority 2  
IMAGE application type, defining 104  
important considerations, processor  
operations 108  
IMPORTANT WTOR priority 2  
IMSBMSG 195  
IMSCMD 197  
IMSQRV 198  
IMSRCMD 201  
INCLUDE statement 231  
INGAUTO\_INTERVAL 213  
INGCF command 92  
INGDLG 142  
INGEAXIT exit 134  
INGEVENT\_WAIT 213  
INGEX01 138  
INGEX02 138  
INGEX03 139  
INGEX04 139  
INGEX05 140

INGEX06 140  
INGEX07 140  
INGEX08 140  
INGGROUP\_WAIT 213  
INGHIST\_MAX 213  
INGINFO\_WAIT 213  
INGLIST\_WAIT 213  
INGMSG00 34  
INGMSG01 34  
INGMTRAP monitor command 56  
INGOMX API 55  
INGOPC\_MULTIPLIER 212  
INGRELS\_SHOW 213  
INGRELS\_WAIT 213  
INGREQ\_EXPIRE 213  
INGREQ\_INTERRUPT 213  
INGREQ\_ORIGINATOR 212  
INGREQ\_OVERRIDE 213  
INGREQ\_PRECHECK 213  
INGREQ\_PRI 213  
INGREQ\_PRI.EZEMGR 214  
INGREQ\_REMOVE 214  
INGREQ\_REMOVE.START 214  
INGREQ\_REMOVE.STOP 214  
INGREQ\_RESTART 214  
INGREQ\_SCOPE 214  
INGREQ\_SOURCE 214  
INGREQ\_TIMEOUT 214  
INGREQ\_TYPE 214  
INGREQ\_VERIFY 214  
INGREQ\_WAIT 214  
INGSCHED\_WAIT 214  
INGSET\_VERIFY 214  
INGSET\_WAIT 214  
INGTRIG\_WAIT 214  
INGUSS command 83  
examples 83  
INGVOTE\_EXCLUDE 214  
INGVOTE\_STATUS 214  
INGVOTE\_VERIFY 214  
initialization processing,  
AOFSERXINT 210  
initializing automation procedures 7  
installing  
DB2 automation 112  
installing automation procedures 16  
integration of z/OS UNIX System  
Services 79  
ISQEXEC command 11, 70  
ISQOVRD 71  
ISQOVRD command 12  
ISQXLOC command 11  
ISQXMON command 70  
ISQXUNL command 11  
ISSUECMD 61  
ISSUEREPI 61  
IWTOR 2  
IXC102A message  
automating 105  
automation of 96  
customizing automation of 96  
IXC402D message  
automating 105  
automation of 96  
customizing automation of 96

## J

JES2 shutdown processing 169  
JES2 spool recovery processing 164  
JES3  
dump processing 173  
monitoring 49  
job handling, defining for auxiliary  
storage shortage recovery 107  
job/ASID definitions, making  
for long running enqueues 107

## K

keyboard xiii  
known messages, message  
automation 26

## L

line command functions, for DB2  
automation 115  
line mode functions, DB2  
automation 111  
link monitoring, CICS 181  
Linux console connection to NetView 68  
Linux console messages  
automating 68  
case sensitive 69  
restrictions and limitations 69  
security considerations 69  
LINUX guest target systems, user  
logon 75  
LINUX target systems, customizing 75  
local page data set, defining  
for auxiliary storage shortage  
recovery 107  
log stream 90  
log stream data set 90  
logical partition  
defining 99  
logical sysplex, defining 100  
LOGR couple data set 90, 91  
LOGREC data set processing 150  
long running enqueues  
automating 106  
defining commands 107  
defining IEADMCxx symbols 107  
defining resources 106  
defining snapshot intervals 107  
handling 93  
making job/ASID definitions 107  
LookAt message retrieval tool xvi

## M

maintenance start, DB2 automation 111  
major resources 61, 137  
making generic automation  
procedures 12  
making job/ASID definitions  
for long running enqueues 107  
managing  
couple data set 89  
coupling facilities 91  
system logger 90

- master automation tables 34
  - multiple 35
- message
  - forwarding 70
  - ISQ900I 70
  - ISQ901I 70
  - IXC102A, automation of 96
  - IXC402D, automation of 96
  - testing 70, 73
- message automation 25
  - AT build 29
  - AT build concept 30
  - AT load 33
  - defining actions 26
  - defining AT scope 29
  - defining AUTO actions 27
  - defining captured messages 27
  - defining CMD actions 26
  - defining OVR actions 28
  - defining REPLY actions 26
  - defining status messages 27
  - determining AT build 30
  - enabling for the automation agent 33
  - known messages 26
  - Linux console messages 68
  - Linux console messages, case sensitive 69
  - Linux console messages, restrictions and limitations 69
  - Linux console messages, security considerations 69
  - overview 25
  - predefined 31
  - preparing for processor operations resources 68
  - preventing the building of AT entries 27
  - unknown messages 26
  - use of symbols 26
- message automation for processor operations resources 65
- message presentation 37
- message processing facility list
  - adding application messages 3
- message retrieval tool, LookAt xvi
- message testing 73
- messages
  - automation 25
  - classifications 33
  - defining as minor resources 61
  - developing for automation procedures 13
  - trapping UNIX syslogd 87
- messages, entries in MPF list 3
- minor resources
  - and INGAUTO 61
  - and task globals 137
  - defining message and status as 61
  - resource name 136
- monitor command, INGMTRAP 56
- monitor resource (MTR) 45
- monitor resources 46
  - writing commands 47
- monitor routine 45
  - writing 45
  - writing your own 46

- monitoring
  - automation with interactive assist mode 19
  - JES3 49
  - with OMEGAMON 53
- monitoring applications 45
- monitoring routines
  - AOFRJ3MN 50
  - AOFRJ3RC 52
- monitoring routines for z/OS UNIX
  - resources 81
- MPF list 4
  - adding application messages 3
- MTR
  - See also monitor resource
  - See monitor resources
- MVS Automatic Restart Manager
  - clone ID 213
  - element names 213
  - global variables 213
- MVS guest target systems
  - NIP console 75
  - NIP messages 75
  - problem determination mode 75
- MVS target systems, customizing 76
- MVSESA.RELOAD.ACTION minor resource 147
- MVSESA.RELOAD.CONFIRM flag 147
- MVSESA.RELOAD.CONFIRM minor resource 147

**N**

- NetView
  - generic automation table entries 43
  - Linux console connection to 68
  - testing and debugging facilities 21
- NetView automation table
  - adding processor operations messages to 69
  - adding SDF entries 3
  - AOFMSGSY 36
  - fragments 36
  - generic entries 43
  - integrating 35
  - ISQEXEC 11, 70
  - ISQOVRD 12
  - ISQXLOC 11
  - ISQXMON 70
  - ISQXUNL 11
  - master automation tables 34
  - merging entries 73
  - multiple master automation tables 35
  - production 73
  - reloading tables 4
  - sample entry 71
  - samples 33
  - structure 33
  - user-written statements 35
- new automation definitions
  - building 74
- NMC workstation 3
- NONSNA statement 4
- NORMAL WTOR priority 2
- notifications 8
- NWTOR 2

**O**

- OMEGAMON
  - exception analysis 53
  - monitoring with 53
  - monitoring, overview 53
  - session management, INGMTRAP 56
  - session management, INGOMX 55
  - topologies 54
  - usage scenario 53
- operation and job errors, TWS
  - Automation 175
- operator cascades 39
- outstanding reply processing 1
- overview
  - message automation 25
  - monitoring with OMEGAMON 53
- OVR actions
  - defining for message automation 28

**P**

- panels
  - DISPACF 160, 163, 172, 173
  - INGTHRES 159
  - JES2 168, 169, 172
  - LOGREC 152
  - SMF 154
  - SYSLOG 156, 157
- persistent connection 92
- persistent structure 92
- physical sysplex, defining 100
- planning requirements, DB2
  - automation 112
- policy
  - CFRM 91
  - couple data set 89
- PPI and gateway failures, TWS
  - Automation 175
- predefined message automation 31
- preference list 91
- preventing
  - the building of AT entries 27
- PRI WTOR type 2
- primary CDS 89
- problem determination mode
  - MVS guest target systems 75
- process monitoring, z/OS UNIX
  - Automation 82
- processing, CICSplex 180
- processor
  - defining 99, 104
- PROCESSOR INFO policy item
  - using 99
- processor operations
  - guest machines support 74
  - important considerations 108
- processor operations command
  - messages 71
- processor operations commands 13
- processor operations controlled resources,
  - automating 65
- processor operations resource 65
- processor operations resource message
  - automation 65
- ProcOps Service Machine 74
  - guest target systems 74

- programming
  - additional SA z/OS automation procedures 5
  - recommendations for automation procedures 22
- programming recommendations automation procedures 22
- proxy resource 66
- proxy resources
  - customizing automation for 66
  - shutdown considerations 68
  - startup considerations 68
- pseudo-exits 146
- PSM
  - See ProcOps Service Machine*

**R**

- rebuild 92
  - system-managed 92
  - user-managed 92
- recommendations
  - programming, for automation procedures 22
- recovery
  - "hung" command 94
  - alternate CDS 89
  - alternate CDS, customizing 90
  - auxiliary storage shortage 97
  - auxiliary storage shortage, automating 107
  - command flooding 95
  - handling long-running enqueues 93
  - long running enqueues, customizing 96
  - SYSIEFSD resource 94
  - system log 93
  - system log failure, enabling 101
  - system log, customizing 93
  - system logger, customizing 91
  - system logger, directory shortage 91
  - WTO(R) buffer shortage 93
  - WTO(R) buffer shortage, customizing 93
  - WTOR(R) buffer shortage, enabling 102
- reload action exit 147
- reload permission exit 147
- RELOAD.ACTION flag 147
- RELOAD.CONFIRM flag 147
- reloading NetView automation table 4
- REPLY actions
  - defining for message automation 26
- reply processing
  - outstanding 1
- resolving
  - system log failure 93
  - WTO(R) buffer shortages 93
- resources, defining for long running enqueues 106
- restrictions and limitations, Linux console messages 69
- return codes, health state 47
- REXX coding example 21
- REXX PARSE 22
- REXX trace type 20
- RWTOR 2

**S**

- SA z/OS
  - commands ISQXIPM and ISQCMMT 10
- SA z/OS graphical user interface
  - enable an application for 3
- sample
  - automation tables 33
- scenario
  - OMEGAMON 53
- SDF
  - and specific problems 224
  - components 226
  - customizing 217
  - customizing initialization parameters 231
  - defining hierarchy 228
  - defining in automation control file 232
  - defining in customization dialog 232
  - defining panels 229
  - definition process 227
  - for multiple systems 225
  - how it works 217
  - panels
    - definition 224, 228
    - types 217
  - starting and stopping 226
  - status descriptors 218
  - tree structures 219
- SDF entries 3
- SEC WTOR type 2
- second level systems, VM support 74
- security considerations, Linux console messages 69
- sequence
  - AT entries 32
- serialize command processing 10
- session management
  - OMEGAMON, INGMTRAP 56
  - OMEGAMON, INGOMX 55
- SETASST 18
- setting up z/OS UNIX automation 80
  - example 84
- SFM
  - See Sysplex Failure Management*
- short on storage, CICS 184
- shortcut keys xiii
- shutdown considerations, proxy resource automation 68
- shutdown, CICS 182
- SMF data set processing 153
- snapshot intervals, defining for long running enqueues 107
- start definitions for z/OS UNIX resources 83
- start/stop tablespace, DB2 automation 111
- started task job name
  - defining 108
- startup considerations, proxy resource automation 68
- startup, CICS 185
- status
  - defining as minor resources 61
  - status change commands 133
  - status descriptors 220

- status descriptors (*continued*)
  - chaining to status components 221
  - propagating 223
- status information 8
- status messages
  - defining for message automation 27
- status observer control, TWS 178
- status, CICS VSAM RLS 181
- stop definitions for z/OS UNIX resources 83
- structure 91
  - allocation 91
  - automation procedures, of 6
  - deallocation 92
  - duplexing 92
  - persistent 92
  - preference list 91
  - rebuild 92
    - system-managed rebuild 92
    - user-managed rebuild 92
- SUBSAPPL 22
- SUBSJOB 22
- SUBSTYPE 22
- subsystem
  - adding to automation 1
  - up at initialization commands 147
- SVC dump processing 157
- symbols
  - use with message automation 26
- SYSIEFSD resource recovery 94
  - customizing 96
- SYSLOG message automation 93
- SYSLOG processing 155
- syslogd messages, trapping 87
- sysplex automation
  - enabling 89
- SYSPLEX couple data set 101
- Sysplex Failure Management 96
- sysplex functions 89
  - switching on and off 109
- SYSPLEX policy item
  - defining 101
- system
  - connecting to processor 100
  - defining 100
- system log 93
- system log failure
  - recovery, enabling 101
- system log recovery, customizing 93
- system logger
  - directory extent 91
  - log stream 90
  - log stream data set 90
  - LOGR couple data set 91
  - managing 90
  - recovery, customizing 91
  - recovery, directory shortage 91
- system operations control files 74
  - automation control file 3
  - automation manager configuration file 3
- system removal 96
  - enabling 104
- system-managed rebuild 92

## T

- target systems, customizing 75
- task global variables 9
- TCP port monitoring, z/OS UNIX Automation 82
- TEC Notification 42
- temporary data set HLQ
  - defining 108
- terminate threads, DB2 automation 111
- testing
  - automation procedures 17
  - messages 73
  - more information 22
  - NetView facilities 21
- testing exits 147
- topologies
  - OMEGAMON 54
- Topology Manager 43
- transaction recovery, CICS 187
- trapping UNIX syslogd messages 87
- TWS Automation
  - operation and job errors 175
  - PPI and gateway failures 175
- TWS controller status 178
- TWS status observer control 178

## U

- unit of work recovery, CICS 189
- UNIX Automation
  - automated resources 82
  - debugging 87
  - file monitoring 82
  - hints and tips 87
  - process monitoring 82
  - setting up 80
  - setup example 84
  - TCP port monitoring 82
- UNIX resources
  - customization of 80
  - definitions for 80
  - monitoring routines for 81
  - start and stop definitions 83
- UNIX syslogd messages, trapping 87
- UNIX System Services, integration 79
- unknown messages, message automation 26
- UNUSUAL WTOR priority 2
- user exits 129
  - static exits 132
- user logon, LINUX guest target systems 75
- user-managed rebuild 92
- using
  - PROCESSOR INFO policy item 99
- USS resources, automating 79
- UWTOR 2

## V

- VM second level systems support 74
- VM target systems, customizing 76
- VSAM RLS status, CICS 181
- VSE guest target systems 75
- VSE target systems, customizing 77

- VTAM
  - and assist mode 18

## W

- writing
  - monitor resource commands 47
  - monitor routine 45
- WTO(R)
  - processed, deletion from SDF 161
- WTO(R) buffer 93
- WTO(R) buffer shortage recovery
  - customizing 93
- WTOR
  - priority 1
  - type 1
- WTOR(R) buffer shortage
  - recovery, enabling 102

## Z

- z/OS UNIX applications 79
  - infrastructure overview 79
- z/OS UNIX Automation
  - automated resources 82
  - debugging 87
  - file monitoring 82
  - hints and tips 87
  - process monitoring 82
  - setting up 80
  - setup example 84
  - TCP port monitoring 82
- z/OS UNIX resources
  - customization of 80
  - definitions for 80
  - monitoring routines for 81
  - start and stop definitions 83
- z/OS UNIX System Services, integration of 79



---

# Readers' Comments — We'd Like to Hear from You

IBM Tivoli System Automation for z/OS  
Customizing and Programming  
Version 3 Release 1

Publication No. SC33-8260-01

Overall, how satisfied are you with the information in this book?

|                      | Very Satisfied           | Satisfied                | Neutral                  | Dissatisfied             | Very Dissatisfied        |
|----------------------|--------------------------|--------------------------|--------------------------|--------------------------|--------------------------|
| Overall satisfaction | <input type="checkbox"/> | <input type="checkbox"/> | <input type="checkbox"/> | <input type="checkbox"/> | <input type="checkbox"/> |

How satisfied are you that the information in this book is:

|                          | Very Satisfied           | Satisfied                | Neutral                  | Dissatisfied             | Very Dissatisfied        |
|--------------------------|--------------------------|--------------------------|--------------------------|--------------------------|--------------------------|
| Accurate                 | <input type="checkbox"/> | <input type="checkbox"/> | <input type="checkbox"/> | <input type="checkbox"/> | <input type="checkbox"/> |
| Complete                 | <input type="checkbox"/> | <input type="checkbox"/> | <input type="checkbox"/> | <input type="checkbox"/> | <input type="checkbox"/> |
| Easy to find             | <input type="checkbox"/> | <input type="checkbox"/> | <input type="checkbox"/> | <input type="checkbox"/> | <input type="checkbox"/> |
| Easy to understand       | <input type="checkbox"/> | <input type="checkbox"/> | <input type="checkbox"/> | <input type="checkbox"/> | <input type="checkbox"/> |
| Well organized           | <input type="checkbox"/> | <input type="checkbox"/> | <input type="checkbox"/> | <input type="checkbox"/> | <input type="checkbox"/> |
| Applicable to your tasks | <input type="checkbox"/> | <input type="checkbox"/> | <input type="checkbox"/> | <input type="checkbox"/> | <input type="checkbox"/> |

Please tell us how we can improve this book:

Thank you for your responses. May we contact you?  Yes  No

When you send comments to IBM, you grant IBM a nonexclusive right to use or distribute your comments in any way it believes appropriate without incurring any obligation to you.

\_\_\_\_\_  
Name

\_\_\_\_\_  
Address

\_\_\_\_\_  
Company or Organization

\_\_\_\_\_

\_\_\_\_\_  
Phone No.

\_\_\_\_\_



Fold and Tape

Please do not staple

Fold and Tape



NO POSTAGE  
NECESSARY  
IF MAILED IN THE  
UNITED STATES

# BUSINESS REPLY MAIL

FIRST-CLASS MAIL PERMIT NO. 40 ARMONK, NEW YORK

POSTAGE WILL BE PAID BY ADDRESSEE

IBM Deutschland Entwicklung GmbH  
Department 3248  
Schoenaicher Strasse 220  
D-71032 Boeblingen  
Federal Republic of Germany



Fold and Tape

Please do not staple

Fold and Tape







Program Number: 5698-SA3

Printed in USA

SC33-8260-01



Spine information:



IBM Tivoli System Automation  
for z/OS

Customizing and Programming

Version 3 Release 1

SC33-8260-01